

SENSORS

FA-SEN19Q2

• SENSORI • CAPTEURS • SENSOREN • SENSORES

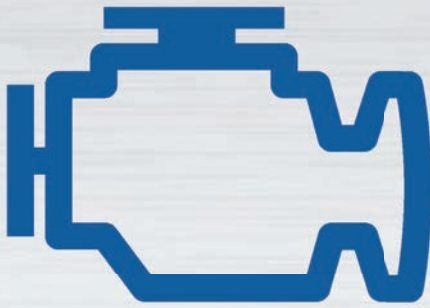
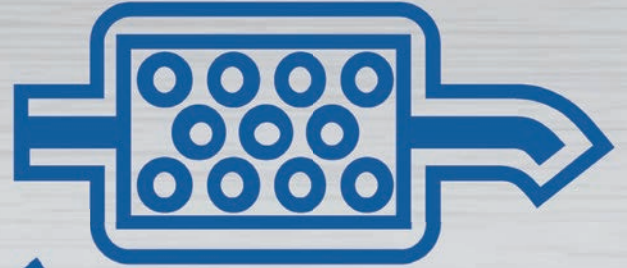

IATF 16949

Manufacturer of automobile spare parts



catalogo.facet.eu





Automotive spare parts manufacturer since 1946

















INDEX

•INDICE •CONTENU •INHALT •CONTENIDO

FA-SEN19Q2

CATALOGUES BY PRODUCT CATEGORY		PAGE
	<ul style="list-style-type: none"> -CATALOGHI PER LINEE DI PRODOTTO -CATALOGUES PAR FAMILLE PRODUIT -KATALOGE NACH PRODUKTENGRUPPEN -CATALOGOS POR FAMILIA PRODUCTO 	4
PRODUCT CATEGORIES BY CATALOGUE		
	<ul style="list-style-type: none"> -LINEE PRODOTTI PER CATALOGO -FAMILLES PRODUIT PAR CATALOGUE -PRODUKTENGRUPPE NACH KATALOG -FAMILIAS PRODUCTO POR CATALOGO 	5
NEW ITEMS AND THEIR AVAILABILITY		
	<ul style="list-style-type: none"> -NUOVI ARTICOLI E LORO DISPONIBILITÀ -NOUVEAUX PRODUITS ET LEURS DISPONIBILITÉ -NEUE TEILE UND IHRE VERFÜGBARKEIT -NOVEDADES Y SU DISPONIBILIDAD 	6

APPLICATION LIST		
EXPLICATION TO APPLICATION LIST		
	<ul style="list-style-type: none"> -SPIEGAZIONE ALLA GUIDA APPLICAZIONI -EXPLICATION À LA LISTE D'APPLICATIONS -ERKLÄRUNG ZUR ANWENDUNGSTABELLE -EXPLICACIÓN A LA LISTA DE APLICACIONES 	12
VEHICLE MANUFACTURERS INDEX		
	<ul style="list-style-type: none"> -INDICE COSTRUTTORI VEICOLI -LISTE DES FABRICANTS VEHICULES -INHALTSVERZEICHNIS DER FAHRZEUGHERSTELLER -LISTA DE FABRICANTES DE VEHICULOS 	13
BODY DESIGN		
	<ul style="list-style-type: none"> -TIPI DI CARROZZERIA -TYPES DE CARROSSERIE -KAROSSERIETYPEN -TIPOS DE CARROCERIA 	14
APPLICATION LIST		
	<ul style="list-style-type: none"> -GUIDA APPLICAZIONI -LISTE D'APPLICATIONS -ANWENDUNGSTABELLE -LISTA DE APLICACIONES 	15
GLOSSARY OF FUNCTIONS ON THE VEHICLE		
	<ul style="list-style-type: none"> -GLOSSARIO PER FUNZIONI SU VETTURA -GLOSSAIRE DES FONCTIONS SUR LE VÉHICULE -GLOSSAR NACH FUNKTION IN AUTO -GLOSSARIO DE LAS FUNCIONES EN LOS VEHICULOS 	2026
PRODUCTS BY VEHICLE MANUFACTURER		
	<ul style="list-style-type: none"> -ELENCO PRODOTTI PER MARCA -PRODUITS PAR FABRICANT VEHICULE -LISTE DER PRODUKTE JE NACH FAHRZEUGMARKE -PRODUCTOS POR FABRICANTE VEHICULO 	2027
APPLICATION LIST GLOSSARY		
	<ul style="list-style-type: none"> -GLOSSARIO GUIDA APPLICAZIONI -GLOSSAIRE LISTE D'APPLICATIONS -GLOSSAR DER VERWENDUNGSLISTE -GLOSSARIO LISTA DE APLICACIONES 	2045

ILLUSTRATED SECTION		
	REVOLUTION AND TIMING (CKP AND CMP) SENSORS -SENSORI GIRI MOTORE E TRASMISSIONE -CAPTEURS DE REGIME ET DE POSITION -DREHZAHL- UND GETRIEBESENSOREN -SENSORES DE REVOLUCIONES Y POSICIÓN DE CIGÜEÑAL Y ÁRBOL DE LEVAS	2063
	KNOCK SENSORS -SENSORI DI DETONAZIONE -CAPTEURS DE CLIQUETIS -KLOPFSENSOREN -SENSORES DE PICADO	2226
	MASS AIR FLOW METERS (MAF) -SENSORI DI PORTATA ARIA (MAF) -CAPTEURS DE MASSE D'AIR -LUFTMASSEMESSER -CAUDALIMETROS	2285
	ABSOLUTE PRESSURE SENSORS (MAP) -SENSORI DI PRESSIONE ARIA ASSOLUTA -CAPTEURS DE PRESSION D'AIR ABSOLU -ABSOLUTLUFTDRUCKSENSOREN -SENSORES DE PRESIÓN ABSOLUTA (MAP)	2329
	DIFFERENTIAL PRESSURE SENSORS -SENSORI DI PRESSIONE ARIA DIFFERENZIALE -CAPTEURS DE PRESSION D'AIR DIFFERENTIEL -DIFFERENZDRUCKSENSOREN -SENSORES DE PRESIÓN DIFERENCIAL (DPS)	2414
	AIR TEMPERATURE SENSORS -SENSORI DI TEMPERATURA DELL'ARIA -CAPTEURS DE TEMPERATURE D'AIR -LUFTTEMPERATUR-SENSOREN -TERMORESISTENCIAS PARA TEMPERATURA DE AIRE	2441
	THROTTLE POSITION SENSORS -SENSORI DI POSIZIONE FARFALLA -SONDES DE POSITION DU PAPILLON -DROSSELKLAPPEN-POSITIONS-SENSOREN -SENSORES DE POSICION DE LA MARIPOSA	2471
	WHEEL SPEED SENSORS -SENSORI DI NUMERO DI GIRI RUOTA -CAPTEURS ABS -RADDREHZAHLSENSOR -SENSORES DE REVOLUCIONES DE RUEDA	2491

CROSS REFERENCE LIST		
	-TABELLA COMPARATIVA -TABLE COMPARAISON -VERGLEICHSTABELLE -TABLA DE EQUIVALENCIAS	2566

VARIATIONS COMPARED TO PREVIOUS CATALOGUE EDITION			
	FA-SEN18Q2 ↓ FA-SEN19Q2	-VARIAZIONI RISPETTO AI PRECEDENTI CATALOGHI -VARIATIONS RAPPORTÉES AUX CATALOGUES PRÉCÉDENTS -ÄNDERUNGEN IM VERGLEICH ZU FRÜHERE KATALOGAUSGABEN -VARIACIONES CON RESPPECTO A CATALOGOS ANTERIORES	2595

GENERAL SALES TERMS		
	-CONDIZIONI GENERALI DI VENDITA -CONDITIONS GÉNÉRALES DE VENTE -ALLGEMEINE VERKAUFSBEDINGUNGEN -CONDICIONES GENERALES DE VENTA	2609

OUR PACKAGING UNITS		
	-LE NOSTRE CONFEZIONI -NOS UNITÉS DE CONDITIONNEMENT -UNSERE ABPACKENTYPEN -NUESTROS ENVASES	2611



CATALOGUES BY PRODUCT CATEGORY

FA-SEN19Q2

-CATALOGHI PER LINEE DI PRODOTTO -CATALOGUES PAR FAMILLE PRODUIT -KATALOGE NACH PRODUKTENGRUPPEN -CATALOGOS POR FAMILIA PRODUCTO





Code	PICTURE	Catalogue	Description
0.0xxx		●	CONDENSERS -CONDENSATORI -CONDENSATEURS -KONDENSATOREN -CONDENSADORES
1.xxxx		●	CONTACT SETS -COPPIE CONTATTI -RUPTEURS -KONTAKTSÄTZE -PLATINOS
2.xxxx		●	DISTRIBUTOR CAPS -CALOTTE -TETES D'ALLUMEUR -VERTEILERKAPPEN -TAPAS DEL DISTRIBUIDOR
3.xxxx		●	ROTORS -DISTRIBUTORI -DISRUPTEURS -VERTEILERLÄUFER -ROTORES DEL DISTRIBUIDOR
4.xxxx		●	IGNITION CABLE SETS -SERIE CAVI ACCENSIONE COMPLETA -JEUX CABLES D'ALLUMAGE -ZÜNDKABELSÄTZE -JUEGOS DE CABLES DE ENCENDIDO
7.0xxx		●	ENGINE OIL PRESSURE WARNING LIGHT SWITCHES -INTERRUTTORI SPIA PRESSIONE OLIO -MANOCONTACTS POUR TEMOIN DE PRESSION D'HUILE -ÖLDRUCKKONTROLLSCHALTER
7.06xx		●	OIL PRESSURE SENSORS -TRASMETTITORI PRESSIONE OLIO -TRANSMETTEURS DE PRESSION D'HUILE -ÖLDRUCK-IMPULSGEBER -TRANSMISORES DE PRESSION DE ACEITE
7.1xxx		●	BRAKE/CLUTCH PEDAL SWITCHES -INTERRUTTORI PEDALI FRENO/FRIZIONE -CONTACTEURS DE FEUX STOP -BREMS-/ KUPPLUNGSPEDALSCHALTE -INTERRUPTORES PEDAL DE FRENO/EMBRAGUE
7.3xxx		●	COOLANT/OIL/FUEL TEMPERATURE SENDERS -SENSORI DI TEMPERATURA REFRIGERANTE/OLIO/CARBURANTE -CAPTEURS DE TEMPERATURE REFRIGERANT/HUILE/CARBURANTS -TEMPERATURESENSOR FÜR KÜHLMITTEL/ÖL/KRAFTSTOFF -SENSORES DE TEMPERATURA REFRIGERANTE/ACEITE/COMBUSTIBLE
7.35xx		●	WATER TEMPERATURE SENDERS WITH WARNING LIGHT SWITCH -TRASMETTITORI CON SPIA TEMPERATURA ACQUA -THERMORESISTANCES AVEC CONTACTEUR POUR TEMOIN TEMPERATURE D'EAU -WASSERTEMPERATUR- IMPULSGEBER MIT KONTROLLLICHTSCHALTER -SENSORES DE TEMPERATURA REFRIGERANTE CON INTERRUPTOR PARA LUZ TESTIGO
7.4xxx		●	WATER TEMPERATURE WARNING LIGHT SWITCHES -INTERRUTTORI COMANDO SPIA TEMPERATURA ACQUA -THERMOCONTACTS POUR TEMOIN TEMPERATURE D'EAU -WASSERTEMPERATUR-KONTROLLLICHTSCHALTER -TERMOCONTACTOS LUZ TESTIGO TEMPERATURA DEL AGUA
7.5xxx		●	THERMO-SWITCHES FOR ELECTRIC FANS -TERMOINTERRUTTORI PER ELETTROVENTILATORI -THERMOCONTACTS D'ELECTROVENTILATEURS -THERMO-SCHALTER FÜR LÜFTERMOTOR -TERMOCONTACTOS PARA ELECTROVENTILADORES
7.56xx		●	THERMO-SWITCHES FOR DOUBLE FAN OR TWO SPEEDS -TERMOINTERRUTTORI PER ELETTROVENTILATORE DOPPIO O A DUE VELOCITÀ -THERMOCONTACTS POUR DOUBLE VENTILATEUR OU A DEUX VITESSES -THERMO-SCHALTER FÜR DOPPELBELÜFTER ODER FÜR ZWEIFANG-LÜFTERMOTOR -TERMOCONTACTOS PARA DOBLE VENTILADOR O DE DOS VELOCIDADES
7.6xxx		●	REVERSING LIGHT SWITCHES -INTERRUTTORI LUCI RETROMARCIA -CONTACTEURS FEUX DE REcul -RÜCKFAHR-SCHEINWERFER-SCHALTER -INTERRUPTORES DE LUZ MARCHA ATRAS
7.8xxx		●	THERMOSTATS -THERMOSTATI -THERMOSTATS -THERMOSTATE -THERMOSTATOS
7.95xx		●	GASKETS FOR THERMOSTATS -GUARNIZIONI PER THERMOSTATI -JOINTS POUR THERMOSTATS -DICHTUNGEN FÜR THERMOSTATEN -JUNTAS POR THERMOSTATOS
8.xxxx		●	PICK-UPS -IMPULSORI -CAPTEURS -IMPULSGEBER -CAPTADORES
9.0xxx		●	REVOLUTION AND TIMING (CKP AND CMP) SENSORS -SENSORI GIRI MOTORE E TRASMISSIONE -CAPTEURS DE REGIME ET DE POSITION -DREHZAHL- UND GETRIEBESESENSOREN -SENSORES DE REVOLUCIONES Y POSICIÓN DE CIGÜEÑAL Y ÁRBOL DE LEVAS
9.3xxx		●	KNOCK SENSORS -SENSORI DI DETONAZIONE -CAPTEURS DE CLIQUETIS -KLOPFSENSOREN -SENSORES DE PICADO
9.4xxx		●	IGNITION MODULES -MODULI DI ACCENSIONE -MODULES D'ALLUMAGE -ZÜNDMODULE -MÓDULOS DE ENCENDIDO
9.6xxx		●	IGNITION COILS -BOBINE DI ACCENSIONE -BOBINES D'ALLUMAGE -ZÜNDSPULEN -BOBINAS DE ENCENDIDO
9.8xxx		●	ELECTRONIC IGNITION KITS -KIT PER ACCENSIONE ELETTRONICA -KIT POUR ALLUMAGE ELECTRONIQUES -ELEKTRONISCHE ZÜNDUNGSSATZ -JUEGOS DE ENCENDIDO ELECTRÓNICO
10.1xxx		●	MASS AIR FLOW METERS (MAF) -SENSORI DI PORTATA ARIA (MAF) -CAPTEURS DE MASSE D'AIR -LUFTMASSENMESSER -CAUDALIMETROS
10.3xxx		● ●	AIR PRESSURE SENSORS -SENSORI DI PRESSIONE ARIA -CAPTEURS DE PRESSION D'AIR -DRUCKSENSOREN -SENSORES DE PRESIÓN DEL AIRE
10.4xxx		●	AIR TEMPERATURE SENSORS -SENSORI DI TEMPERATURA DELL'ARIA -CAPTEURS DE TEMPERATURE D'AIR -LUFTTEMPERATUR-SENSOREN -TERMORESISTENCIAS PARA TEMPERATURA DE AIRE
10.5xxx		●	THROTTLE POSITION SENSORS -SENSORI DI POSIZIONE FARFALLA -SONDES DE POSITION DU PAPILLON -DROSSELKLAPPEN-POSITIONS-SENSOREN -SENSORES DE POSICION DE LA MARIPOSA
10.7xxx 10.8xxx		●	OXYGEN SENSORS -SONDE LAMBDA -SONDES DE RICHESSE -LAMBDASENDEN -SONDAS LAMBDA
21.xxxx		●	WHEEL SPEED SENSORS -SENSORI DI NUMERO DI GIRI RUOTA -CAPTEURS ABS -RADDREHZAHLSENSOR -SENSORES DE REVOLUCIONES DE RUEDA
22.xxxx		●	EXHAUST GAS TEMPERATURE SENSORS (EGT) -SENSORI DI TEMPERATURA GAS DI SCARICO (EGT) -CAPTEURS DE TEMPÉRATURE GAS D'ÉCHAPPEMENT (EGT) -ABGASTEMPÉRATURESENSOREN (EGT) -SENSORES DE TEMPERATURA GASES DE ESCAPE (EGT)
23.xxxx		●	EGR VALVES -VALVOLE EGR -EGR VALVES -ABGASRÜCKFÜHRUNGVENTILE -VALVULAS EGR



PRODUCT CATEGORIES BY CATALOGUE

FA-SEN19Q2

•LINEE PRODOTTI PER CATALOGO •FAMILLES PRODUIT PAR CATALOGUE •PRODUKTENGRUPPE NACH KATALOG •FAMILIAS PRODUCTO POR CATALOGO

CATALOGUE •Catalogo •Catalogue •Katalog •Catalogo			Code
	<p>FA-IGNxx</p> <p>Ignition •Accensione •Allumage •Zündung •Encendido</p>	●	<p>0.0xxx</p> <p>1.xxxx</p> <p>2.xxxx</p> <p>3.xxxx</p> <p>4.xxxx</p> <p>8.xxxx</p> <p>9.4xxx</p> <p>9.6xxx</p> <p>9.8xxx</p>
	<p>FA-SWIxx</p> <p>Switches •Interruttori •Interrupteurs •Schalter •Interruptores</p>	●	<p>7.0xxx</p> <p>7.06xx</p> <p>7.1xxx</p> <p>7.6xxx</p>
	<p>FA-TMxx</p> <p>Thermal management •Gestione termica •Gestion thermique •Thermo-management •Gestió tèrmica</p>	●	<p>7.3xxx</p> <p>7.35xx</p> <p>7.4xxx</p> <p>7.5xxx</p> <p>7.56xx</p> <p>7.8xxx</p> <p>7.9xxx</p>
	<p>FA-SENxx</p> <p>Sensors •Sensori •Capteurs •Sensoren •Sensores</p>	●	<p>9.0xxx</p> <p>9.3xxx</p> <p>10.1xxx</p> <p>10.3xxx</p> <p>10.4xxx</p> <p>10.5xxx</p> <p>21.xxxx</p>
	<p>FA-EMxx</p> <p>Exhaust management •Gestione gas di scarico •Gestion des gaz d'échappement •Abgas-management •Gestió de gas de escape</p>	●	<p>10.3xxx</p> <p>10.7xxx</p> <p>10.8xxx</p> <p>22.0xxx</p> <p>23.0xxx</p>

NEW ITEMS AND THEIR AVAILABILITY

FA-SEN19Q2

-Nuovi articoli e loro disponibilità -Nouveaux produits et leur disponibilité -Neue Teile und vorläufige Verfügbarkeit -Novedades y su disponibilidad

REVOLUTION AND TIMING (CKP AND CMP) SENSORS

SENSORI GIRI MOTORE E TRASMISSIONE
CAPTEURS DE REGIME ET DE POSITION
DREHZAHL- UND GETRIEBESENSOREN
SENSORES DE REVOLUCIONES Y POSICIÓN
DE CIGÜEÑAL Y ÁRBOL DE LEVAS

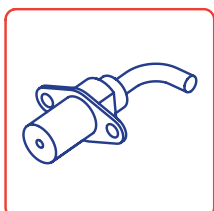

Products listed by code sequence

- Articoli in ordine di **codice**
- Articles en sequence de **réf.**
- Produkte je nach **Artikel-Nr.**
- Articulos en secuencia de **codigo**

CODE	AVAILABILITY
9.0585	20/Q1
9.0728	19/Q3
9.0735	20/Q1
9.0754	20/Q1
9.0760	20/Q2
9.0794	19/Q3

Products listed by date of availability

- Articoli raggruppati per data di **disponibilità**
- Produits groupés par date de **disponibilité**
- Produkte je nach **Verfügbarkeitsdatum** aufgelistet
- Articulos agrupados se gún fecha de **disponibilidad**

AVAILABILITY	CODE
19/Q3	9.0728
19/Q3	9.0794
20/Q1	9.0585
20/Q1	9.0735
20/Q1	9.0754
20/Q2	9.0760

MASS AIR FLOW METERS (MAF)

SENSORI DI PORTATA ARIA (MAF)
CAPTEURS DE MASSE D'AIR
LUFTMASSENMESSER
CAUDALIMETROS

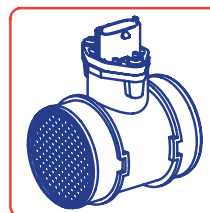

Products listed by code sequence

- Articoli in ordine di **codice**
- Articles en sequence de **réf.**
- Produkte je nach **Artikel-Nr.**
- Articulos en secuencia de **codigo**

CODE	AVAILABILITY
10.1163	19/Q3
10.1298	19/Q3
10.1335	19/Q4
10.1407	19/Q4
10.1527	19/Q4

Products listed by date of availability

- Articoli raggruppati per data di **disponibilità**
- Produits groupés par date de **disponibilité**
- Produkte je nach **Verfügbarkeitsdatum** aufgelistet
- Articulos agrupados se gún fecha de **disponibilidad**

AVAILABILITY	CODE
19/Q3	10.1163
19/Q3	10.1298
19/Q4	10.1335
19/Q4	10.1407
19/Q4	10.1527



AVAILABLE

NEW ITEMS AND THEIR AVAILABILITY

FA-SEN19Q2

-Nuovi articoli e loro disponibilità -Nouveaux produits et leur disponibilité -Neue Teile und vorläufige Verfügbarkeit -Novedades y su disponibilidad

ABSOLUTE PRESSURE SENSORS (MAP)

SENSORI DI PRESSIONE ARIA ASSOLUTA
CAPTEURS DE PRESSION D'AIR ABSOLU
ABSOLUTLUFTDRUCKSENSOREN
SENSORES DE PRESIÓN ABSOLUTA (MAP)

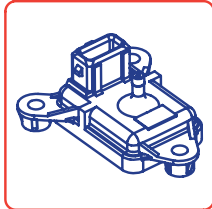

Products listed by code sequence

-Articoli in ordine di **codice**
-Articles en sequence de **réf.**
-Produkte je nach **Artikel-Nr.**
-Articulos en secuencia de **codigo**

CODE	AVAILABILITY
10.3378	😊
10.3382	20/Q1
10.3383	20/Q1
10.3384	20/Q1
10.3385	20/Q1
10.3387	20/Q1
10.3388	20/Q1

Products listed by date of availability

-Articoli raggruppati per data di **disponibilità**
-Produits groupés par date de **disponibilité**
-Produkte je nach **Verfügbarkeitsdatum** aufgelistet
-Articulos agrupados se gún fecha de **disponibilidad**

AVAILABILITY	CODE
😊	10.3378
20/Q1	10.3382
20/Q1	10.3383
20/Q1	10.3384
20/Q1	10.3385
20/Q1	10.3387
20/Q1	10.3388

DIFFERENTIAL PRESSURE SENSORS

SENSORI DI PRESSIONE ARIA
DIFFERENZIALE
CAPTEURS DE PRESSION D'AIR
DIFFERENTIEL
DIFFERENZDRUCKSENSOREN
SENSORES DE PRESIÓN DIFERENCIAL (DPS)

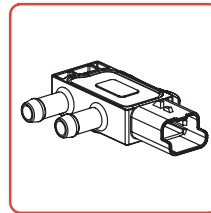

Products listed by code sequence

-Articoli in ordine di **codice**
-Articles en sequence de **réf.**
-Produkte je nach **Artikel-Nr.**
-Articulos en secuencia de **codigo**

CODE	AVAILABILITY
10.3280	😊
10.3316	19/Q3
10.3340	😊
10.3342	😊
10.3386	20/Q1

Products listed by date of availability

-Articoli raggruppati per data di **disponibilità**
-Produits groupés par date de **disponibilité**
-Produkte je nach **Verfügbarkeitsdatum** aufgelistet
-Articulos agrupados se gún fecha de **disponibilidad**

AVAILABILITY	CODE
😊	10.3280
😊	10.3340
😊	10.3342
19/Q3	10.3316
20/Q1	10.3386



AVAILABLE

WHEEL SPEED SENSORS

SENSORI DI NUMERO DI GIRI RUOTA
CAPTEURS ABS
RADDREHZAHLSENSOR
SENSORES DE REVOLUCIONES DE RUEDA

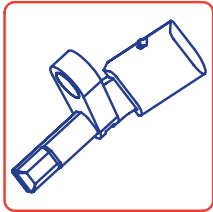

Products listed by code sequence

-Articoli in ordine di **codice**
-Articles en sequence de **réf.**
-Produkte je nach **Artikel-Nr.**
-Artículos en secuencia de **codigo**

CODE	AVAILABILITY
21.0210	☺
21.0211	☺
21.0212	☺
21.0213	☺
21.0214	☺
21.0219	20/Q1
21.0220	20/Q2
21.0221	20/Q2
21.0222	20/Q2
21.2047	19/Q3
21.2078	19/Q2
21.2122	19/Q2
21.2123	19/Q2
21.2124	19/Q2

Products listed by date of availability

-Articoli raggruppati per data di **disponibilità**
-Produits groupés par date de **disponibilité**
-Produkte je nach **Verfügbarkeitsdatum** aufgelistet
-Artículos agrupados se gún fecha de **disponibilidad**

AVAILABILITY	CODE
☺	21.0210
☺	21.0211
☺	21.0212
☺	21.0213
☺	21.0214
19/Q2	21.2078
19/Q2	21.2122
19/Q2	21.2123
19/Q2	21.2124
19/Q3	21.2047
20/Q1	21.0219
20/Q2	21.0220
20/Q2	21.0221
20/Q2	21.0222

Illustration of the components of catalogue SEN and their fitting position in the engine

- Rappresentazione dei componenti del catalogo SEN e loro posizione di montaggio sul motore
- Représentation des composants du catalogue SEN et leur position de montage dans le moteur
- Darstellung von den Bauelementen vom Katalog SEN und ihre Einbaulage im Motor
- Representación de los componentes del catalogo SEN y sus posición de montaje en el motor

10.3XXX

ABSOLUTE PRESSURE SENSORS (MAP)

- Sensori di pressione aria assoluta
- Capteurs de pression d'air absolue
- Absolutluftdrucksensoren
- Sensores de presión absoluta



10.1XXX

MASS AIR FLOW METERS (MAF)

- Sensori di portata aria
- Capteurs de masse d'air
- Luftmassenmesser
- Caudalímetros



10.4XXX

AIR TEMPERATURE SENSOR

- Sensori di temperatura dell'aria
- Capteurs de température d'air
- Lufttemperatursensoren
- Sensores de temperatura del aire



9.0XXX

REVOLUTION AND TIMING (CKP AND CMP) SENSORS

- Sensori di giri motore e trasmissione
- Capteurs du regime et des positions du vilebrequin et de l'arbre à cames
- Drehzahl- und Getriebesensoren
- Sensores de revoluciones y de posición del cigüeñal y árbol de levas



10.5XXX

THROTTLE POSITION SENSORS

- Sensori di posizione farfalla
- Sondes de position du papillon
- Drosselklappenpositionssensoren
- Sensores de posición de la mariposa



9.3XXX

KNOCK SENSORS

- Sensori di detonazione
- Capteurs de cliquetis
- Klopfensensoren
- Sensores de picado

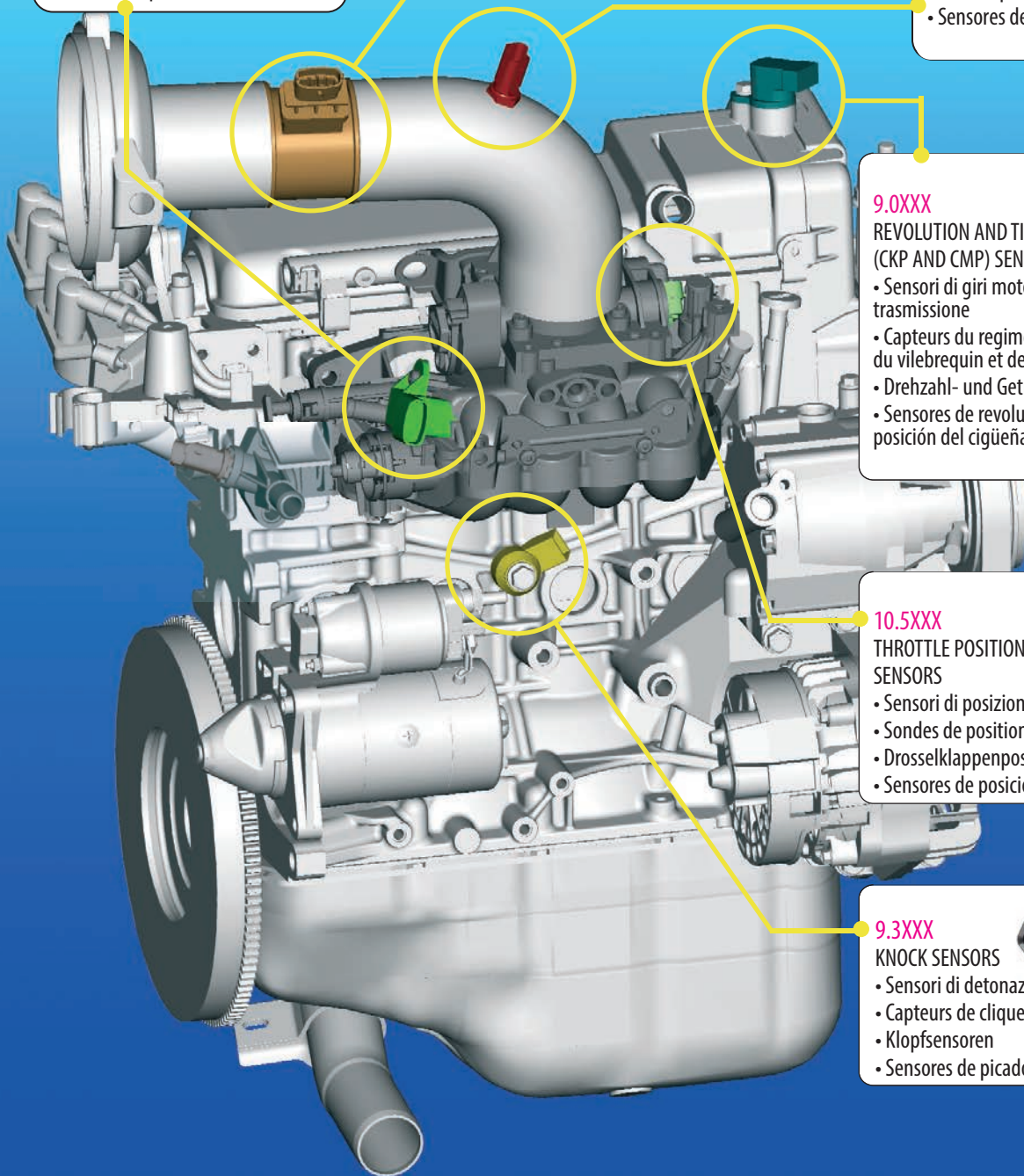

Rendering: by kind concession of FIAT POWERTRAIN TECHNOLOGIES

Illustration of the components of catalogue SEN and their fitting position in the engine

- Rappresentazione dei componenti del catalogo SEN e loro posizione di montaggio sul motore
- Représentation des composants du catalogue SEN et leur position de montage dans le moteur
- Darstellung von den Bauelementen vom Katalog SEN und ihre Einbaulage im Motor
- Representación de los componentes del catalogo SEN y sus posición de montaje en el motor

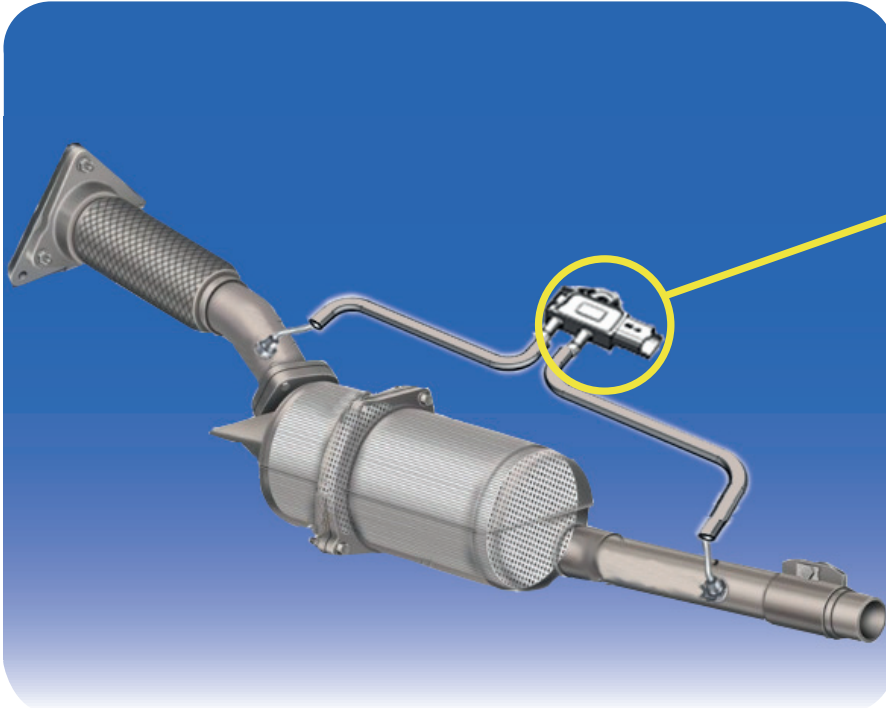

10.3XXX

DIFFERENTIAL PRESSURE SENSORS (DPS)

- Sensori di pressione aria differenziale
- Capteurs de pression d'air différentiel
- Differenzdrucksensoren
- Sensores de presión diferencial

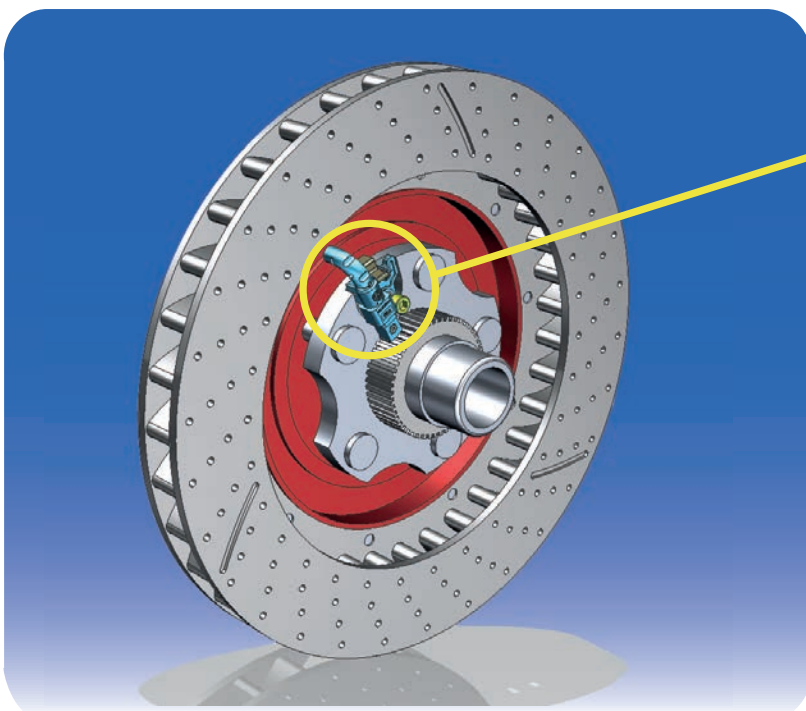

21.XXXX

WHEEL SPEED SENSORS (WSS)

- Sensori di numero di giri ruota
- Capteurs de vitesse de roue
- Raddrehzahlsensor
- Sensores de revoluciones de rueda

ILLUSTRATED SECTION

FA-SEN19Q2

-PARTE FIGURATA -PARTIE ILLUSTRÉE -BILDTEIL -PARTE ILUSTRADA





REVOLUTION AND TIMING (CKP AND CMP) SENSORS

·SENSORI GIRI MOTORE E TRASMISSIONE ·CAPTEURS DE REGIME ET DE POSITION

·DREHZAHL- UND GETRIEBESSENSOREN ·SENSORES DE REVOLUCIONES Y POSICIÓN DE CIGÜEÑAL Y ÁRBOL DE LEVAS

(A) P/NRS. - NOTES

- CODICI - NOTE
- RÉFS. - NOTES
- ARTIKEL-NR. - ANMERKUNGEN
- CODIGOS - NOTAS

(B) PICTURE + TECHNICAL INFO

- FOTO + INFORMAZIONE TECNICA
- ILLUSTRATION + INFORMATION TECHNIQUE
- BILD + TECHNISCHE INFO
- FOTO + INFORMACIÓN TÉCNICA

(C) APPLICATION LIST

- GUIDA APPLICAZIONI
- LISTE D'APPLICATIONS
- ANWENDUNGSTABELLE
- LISTA DE APLICACIONES

9.0754

3

REVOLUTION AND TIMING (CKP AND CMP) SENSORS

Adatt./Suitable:

HYUNDAI
42620-39200
42620-39210

KIA
42620 39200
42620 39210

·NEW - AVAILABLE FROM:

- NUOVO - DISPONIBILE DA:
- NOUVEAU - DISPONIBLE EN:
- NEU - VERFUEGBAR AB:
- NUEVO - DISPONIBLE EN:

19/Q1

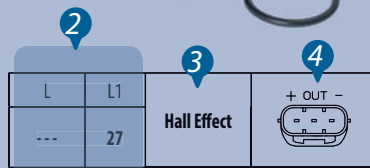

L		L1	3	4
---	---	27	Hall Effect	+ OUT -

HYUNDAI		
ACCENT IV 1.4	G4FA, G4FC	11/10 ⇔
ACCENT IV 1.4 CVT	---	11/10 ⇔
ACCENT IV 1.6	G4FC, G4GC-G	11/10 ⇔

(A)

1 # FACET

2 OEM P/NRS.

- CODICI ORIGINALI
- RÉFS. D'ORIGINE
- ORIGINALTEILE-NR.
- CODIGOS ORIGINALES

3 PACKAGING SIZE

- FORMATO CONFEZIONE
- FORMAT DU CONDITIONNEMENT
- ÄBPACKENSGROESSE
- TAMAÑO DEL ENVASE

4 PRODUCT AVAILABILITY DATE

- DATA DI DISPONIBILITÀ DEL PRODOTTO
- DISPONIBILITÉ DU PRODUIT
- PRODUKTVERFUEGBARKEITSDATUM
- DISPONIBILIDAD ARTÍCULO

5 NOTE

- NOTE
- NOTES
- BERMERKUNGEN
- NOTAS

(B)

1

PICTURE

- FOTO
- PHOTO
- BILD
- FOTO

3

RESISTANCE BETWEEN THE TERMINALS

- RESISTENZA TRA I TERMINALI
- RESISTANCE ENTRE LES CONNEXION
- WIDERSTAND ZWISCHEN DEN ANSCHLÜSSEN
- RESISTENCIA ENTRE LOS ENCHUFES

2

LENGTH OF CABLE & OF SENSORS IN MM MEASURED AS SHOWN:

- LUNGHEZZA IN MM DEL CAVO E DEL SENSORE COSÌ MISURATO:
- LONGUEUR EN MM DU CABLE ET DU CAPTEUR MESURÉ COMME SUIT:
- LÄNGE DES KABELS UND DES SENSORS IN MM GEMESSEN WIE GEZEIGT:
- LARGO EN MM DEL CABLE Y DEL SENSOR MEDIDO DE LA FORMA ILUSTRADA:

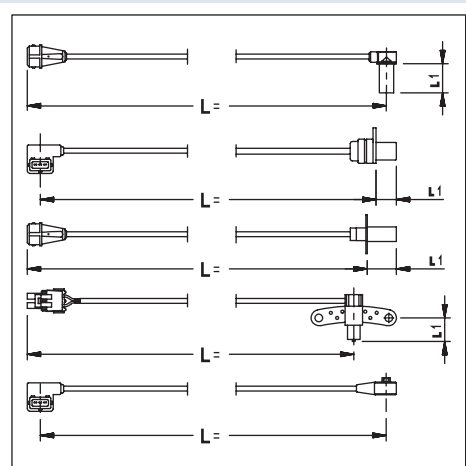

4

TYPE OF CONNECTION

- TIPO DI CONNESSIONE
- TYPE DE CONNEXIONS
- ANSCHLUSSART
- TIPO DE ENCHUFE



9.0XXX

Revolution and timing (CKP and CMP) sensors

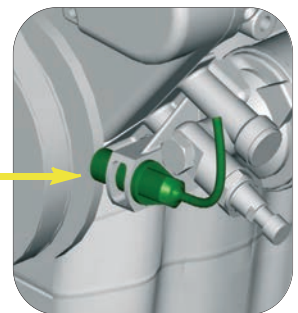
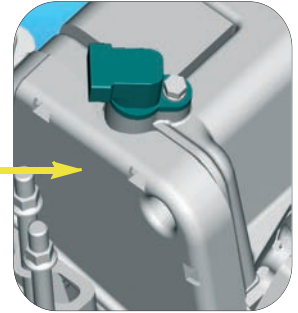
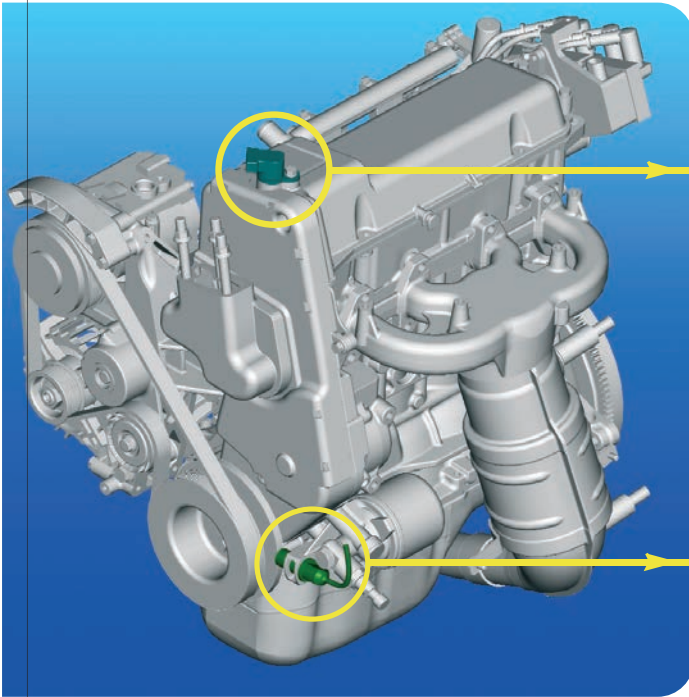

Rendering: by kind concession of FIAT POWERTRAIN TECHNOLOGIES

RPM sensors are normally **installed near a phonic wheel**, also called flywheel (typically, a sprocket wheel or a ferromagnetic cam). **They detect the variations of the magnetic flow** produced by the alternation between the presence and absence of the tooth or cam of the flywheel which generate an electrical signal. This signal is sent to the engine control unit whereby, depending on the phonic wheel where the sensors are installed, the detected signal indicates:

- *The revolving speed of the drive shaft* (Crankshaft Rotational-speed Sensors)
- *The top dead center* by detecting the position of the drive shaft (Crankshaft Position Sensors)
- *The ignition sequence/timing* by detecting the position of the camshaft (Camshaft Position Sensors)

RPM sensors and timing sensors **are installed on any type of engines**. One or more sensors with different functions can be installed on the same car. Structurally equivalent sensors must be installed in the specified position only.

Depending on the specific application, **the connector of the RPM sensor** may be integrated or connected to the body of the sensor with a cable.

Connectors may have 2 terminals (variable reluctance sensors) or 3 terminals (Hall effect sensors) or, if there is an interference suppression, 3 (variable reluctance sensors) or 4 terminals (Hall effect sensors).

The main **reasons for failures** in the product are:

- deformation and dents

- de-magnetisation
- sensor overheating
- lack of signal, broken wire from chafing or excessive vibration, short circuit, internal breakage of the sensor from mechanical or heat stress

- infiltrations of liquids or impurities through poor sealing

The **signs of malfunctions** of the sensor are indicated by illumination of the engine warning lamp, difficulty in starting the vehicle, high fuel consumption, increased exhaust gas emissions.

RPM sensors are designed and assembled to withstand the critical installation conditions inside the engine compartment. In particular, the following **requirements** shall be met:

- *Operating temperature*: $-40^{\circ}\text{C} \div +150^{\circ}\text{C}$

- *Degree of protection*: IP67 (entrance of dust not allowed and protection against water immersion effects for 30 minutes).

The RPM sensors undergo **qualification and endurance tests** on these RPM sensors to determine if the product is suitable for construction and sale:

- Resistance to thermal shocks for a total of 60 hours
- Resistance response to current spikes
- Resistance to impacts

When these tests have been passed and after the approval to manufacture has been given, the product, in the assembly process, is strictly checked through a series of cycles which include **100% testing processes** to verify the resistance and inductance of the sensor, the intensity and polarity of the signal, the resistance response to current spikes and the absence of interruptions or short-circuits.

Structural elements and operation

There are 3 types of RPM sensors:

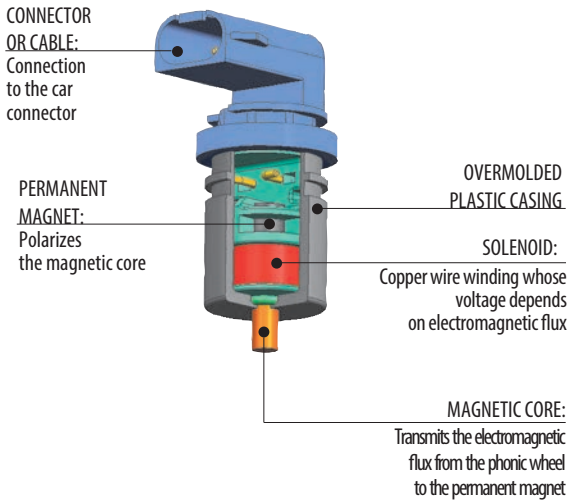

• **Variable Reluctance Sensors:** a solenoid is wound around a *cylindrical magnetic core*, in the shape of a rod tip, polarized by a *permanent magnet*. The sensor detects the electromagnetic flux which goes through the solenoid induced by the variation of the distance between the core and phonic wheel. The sensor generates the U tension according to its own structural parameters and to the speed of the flux variation ($\Delta\Phi/\Delta t$):

$$U = N \frac{\Delta\Phi}{\Delta t} [mV]$$

N : number of turns of the winding
 $\Delta\Phi$: magnetic flux variation
 Δt : duration of the flux variation

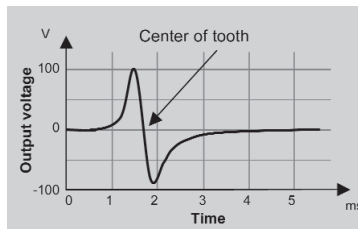

The representation of the wave form inside the oscillogram shows the transition between the positive half wave (+) and the negative half wave (-) of the output signal when the core is located near the center of the tooth.

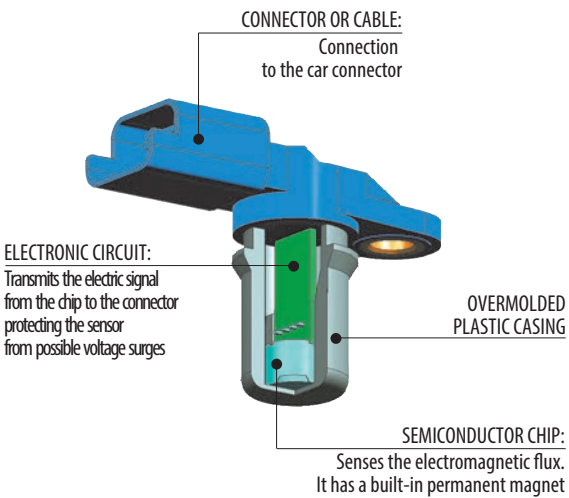

• **Hall Effect Sensors:** the sensitive element is a *semiconductor chip* which has a built-in *permanent magnet*. The chip is installed in an *electronic circuit* which protects the sensor from possible voltage surges. The Hall effect sensors act as normally open switches (NO): they connect to electric ground when the intensity of the magnetic field going through them (with the right polarity) exceeds the chip threshold.

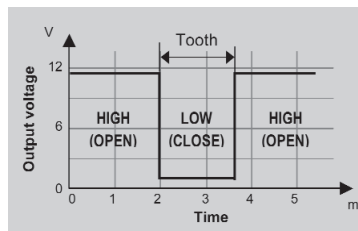

The representation of the wave form inside the oscillogram shows that the signal is high (open-circuit) when there is no tooth, whereas it is low (closed-circuit) when in the presence of the tooth.

Since the output can only accept these values, the Hall effect sensors may also be referred to as "digital".



• **Toroidal sensors:** sensors installed on a high voltage power cable for spark plugs transform the ignition current spike into an electrical signal sent to the electronic unit. This feature is poorly widespread.

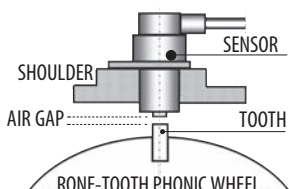

The distance between the sensor rod tip and the tooth of the phonic wheel (*air gap*) must be kept identical to the installation of the original part because, as regards the variable reluctance sensors, the sensitivity of the device depends on that.

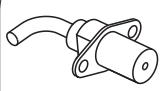

9.0XXX

Sensori Giri Motore e Trasmissione

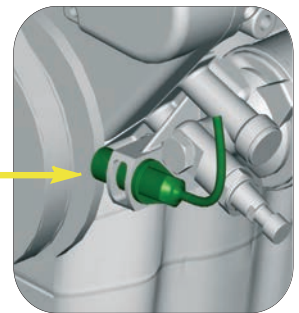
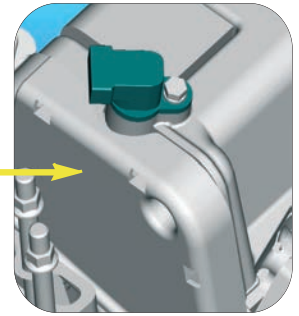
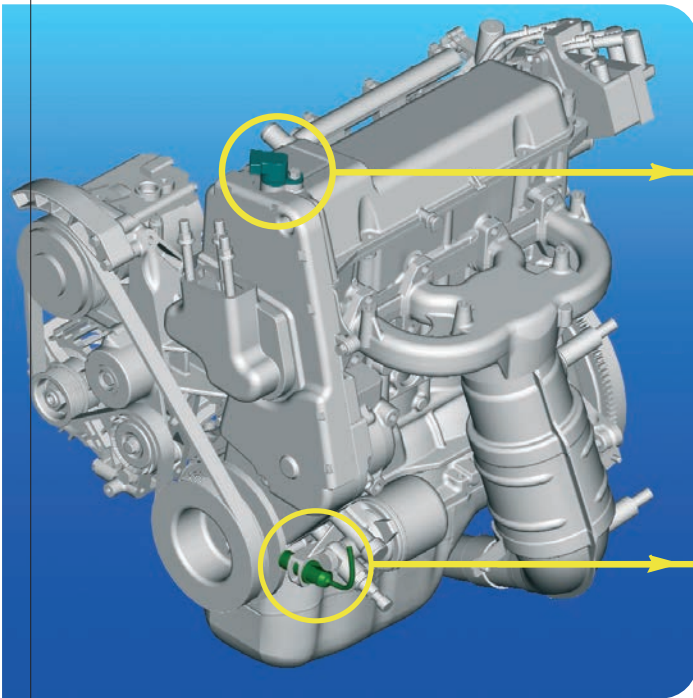

Rendering: per gentile concessione di FIAT POWERTRAIN TECHNOLOGIES

I sensori di numeri di giri sono abitualmente **montati in prossimità di una ruota fonica** detta anche volano (tipicamente una ruota dentata oppure una camma di materiale ferromagnetico). **Rilevano le variazioni del flusso magnetico** prodotte dall'alternanza tra presenza e assenza del dente o della camma del volano e generano un segnale elettrico. Tale segnale è inviato alla centralina controllo motore e, in funzione della ruota fonica su cui i sensori sono montati, il segnale rilevato indica:

- la *velocità di rotazione dell'albero motore* (Crankshaft Rotational speed Sensors)
- la *posizione del punto morto superiore*, tramite il rilevamento della posizione dell'albero motore (Crankshaft Position Sensors)
- la *sequenza o fase di accensione*, tramite il rilevamento della posizione dell'albero a camme (Camshaft Position Sensors)

I sensori di numero di giri e di fase sono **montati su qualsiasi tipo di motore**. Su una stessa vettura possono essere montati uno più sensori con funzione diversa. Sensori costruttivamente analoghi devono essere montati esclusivamente nella posizione specificata. In funzione dell'applicazione specifica il **connettore del sensore di giri** può essere integrato oppure collegato al corpo del sensore tramite un cavo.

I connettori possono avere 2 terminali (sensori a riluttanza variabile) o 3 terminali (sensori ad effetto Hall) oppure, nel caso sia presente la schermatura antidisturbo, 3 (sensori a riluttanza variabile) o 4 terminali (sensori ad effetto Hall).

Le principali **cause di guasto** del prodotto sono:

- deformazioni e ammaccature

- smagnetizzazione
 - surriscaldamento del sensore
 - mancanza di segnale, rottura del cavo per attrito o vibrazione eccessiva, corto circuiti, rottura interna del sensore per stress meccanico o termico
 - infiltrazioni di liquidi o impurità per mancanza di ermeticità
- I **segnali di malfunzionamento** del sensore sono ravvisabili nell'accensione della spia motore, nella difficoltà di accensione del motore, nell'aumento del consumo di carburante e nell'emissione di fumo nero.

I sensori di giri sono progettati e costruiti per sopportare le condizioni critiche di montaggio nel vano motore. In particolare devono soddisfare i seguenti **requisiti**:

- *temperatura di funzionamento*: $-40^{\circ}\text{C} \div +150^{\circ}\text{C}$
- *grado di protezione*: IP67 (ingresso di polveri non consentito e protezione contro gli effetti dell'immersione in acqua per 30 minuti).

I sensori di giri sono sottoposti a rigorose **prove di qualificazione e di durata** per stabilire se il prodotto è idoneo per essere costruito e venduto:

- resistenza agli shock termici per un totale di 60 ore
- resistenza ad un impulso di corrente
- resistenza agli urti

Superate tali prove e concesso il benessere a produrre, durante l'assemblaggio il prodotto viene sottoposto a severi cicli di controllo che prevedono **collaudi al 100%** per verificare la resistenza e l'induttanza del sensore, l'intensità e la polarità del segnale, la resistenza all'impulso di corrente, l'assenza di interruzioni o di corto circuiti.

Elementi costruttivi e principio di funzionamento

Esistono 3 tipologie di sensori di giri:

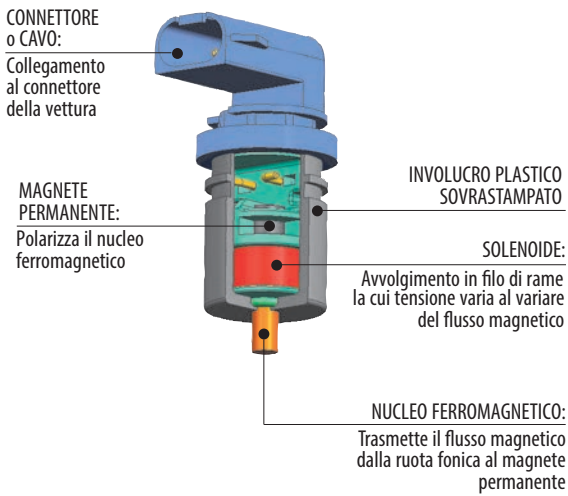

• **A riluttanza variabile:** un solenoide è avvolto su di un *nucleo magnetico cilindrico*, a forma di *puntale*, polarizzato da un magnete permanente. Il sensore rileva il flusso elettromagnetico che attraversa il solenoide indotto dalla variazione della distanza tra il nucleo e la ruota fonica. Il sensore genera la tensione U in funzione dei propri parametri costruttivi e della velocità di variazione del flusso ($\Delta\Phi / \Delta t$):

$$U = N \frac{\Delta\Phi}{\Delta t} \text{ [mV]}$$

N : numero spire dell'avvolgimento
 $\Delta\Phi$: variazione di flusso magnetico
 Δt : durata della variazione del flusso

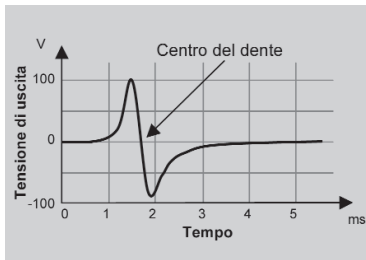

La rappresentazione della forma d'onda nell'oscillogramma mostra la transizione tra la semi onda positiva (+) e la semionda negativa (-) del segnale di uscita quando il nucleo si trova in corrispondenza del centro del dente.

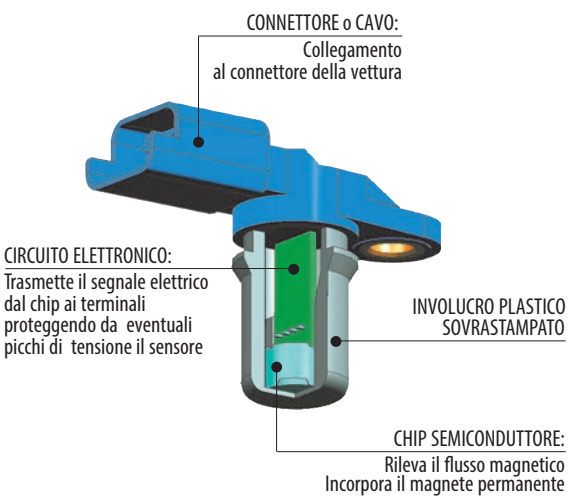

• **Ad effetto hall:** l'elemento sensibile è un *chip semiconduttore* che incorpora un *magnete permanente*. Il chip è montato su un *circuito elettronico* che protegge il sensore da eventuali picchi di tensione. I sensori ad effetto Hall si comportano come interruttori normalmente aperti (NA): si chiudono a massa quando l'intensità del campo magnetico che li attraversa (con la corretta polarità) supera la soglia del chip.

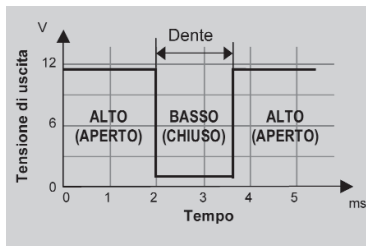

La rappresentazione della forma d'onda nell'oscillogramma mostra che il segnale è alto (circuitto aperto) in assenza del dente mentre è basso (circuitto chiuso) in presenza del dente.

Poiché l'uscita può assumere solo tali valori i sensori a effetto Hall vengono anche chiamati "digitali".



• **Toroidali:** sensori montati su un cavo ad alta tensione di alimentazione delle candele, trasformano l'impulso di corrente relativo all'accensione in un segnale elettrico inviato alla centralina elettronica. È una tipologia scarsamente diffusa.

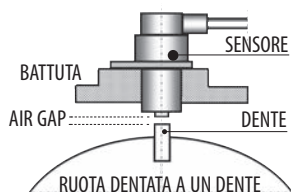

La distanza tra il puntale del sensore e il dente della ruota fonica (air gap) deve essere mantenuta uguale al montaggio del pezzo originale in quanto, per i sensori a riluttanza variabile, da essa dipende la sensibilità del dispositivo.



9.0XXX

Capteurs du régime et des positions du vilebrequin et de l'arbre à cames

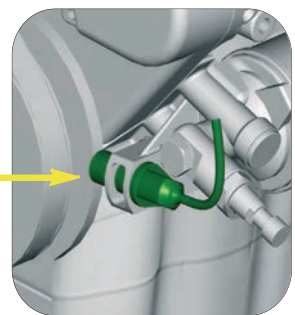
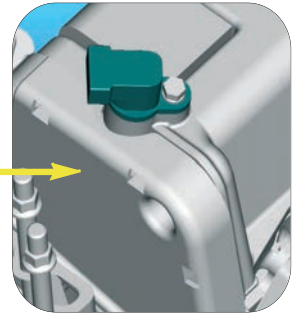
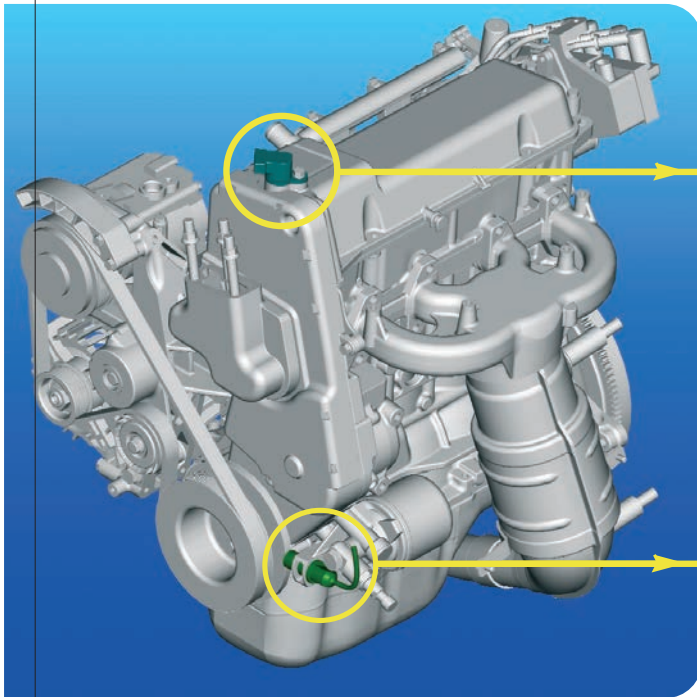

Rendering: par aimable concession de FIAT POWERTRAIN TECHNOLOGIES

Les capteurs de nombre de tours sont habituellement **montés à proximité d'une roue phonique**, désignée aussi volant (typiquement une roue dentée ou une came en matériau ferromagnétique). **Ils se chargent de détecter les variations du flux magnétique** dérivant de l'alternance entre présence et absence de la dent ou de la came du volant et de délivrer un signal électrique. Ce signal est envoyé à l'unité de contrôle du moteur et, en fonction de la roue phonique sur laquelle les capteurs sont montés, le signal détecté peut indiquer:

- la vitesse de rotation du vilebrequin (Crankshaft Rotational-speed Sensors)
- la position du point mort haut, à travers la détection de la position du vilebrequin (Crankshaft Position Sensors)
- la séquence ou phase d'allumage, à travers la détection de la position de l'arbre à cames (Camshaft Position Sensors)

Les capteurs de nombre de tours et de phase peuvent être **montés sur n'importe quel type de moteur**. Une même voiture peut monter un ou plusieurs capteurs ayant des fonctions différentes. Les capteurs analogues du point de vue de leur construction doivent être impérativement montés dans la position indiquée.

Selon l'application spécifique à laquelle il est destiné, **le connecteur du capteur de nombre de tours** peut être intégré ou raccordé sur le corps du capteur à l'aide d'un câble. Les connecteurs peuvent disposer de 2 bornes (capteurs à réductance variable) ou de 3 bornes (capteurs à effet Hall) et, en cas de présence d'un blindage antiparasite, de 3 bornes (capteurs à réductance variable) ou de 4 bornes (capteurs à effet Hall).

Les principales **causes de défaut** sont :

- déformations et bosses

- démagnétisation
- surchauffe du capteur
- absence de signal, rupture du câble par frottement ou vibration excessive, courts circuits, rupture interne du capteur par stress mécanique ou thermique

• infiltrations de liquides ou d'impuretés par manque d'herméticité
Les **signaux de dysfonctionnement** du capteur sont reconnaissables par l'allumage du témoin du moteur, des difficultés de démarrage du véhicule, une consommation élevée de carburant et une augmentation des émissions de gaz d'échappement.

Les capteurs de nombre de tours sont conçus et fabriqués pour supporter les conditions de montage critiques dans le compartiment moteur. En particulier, ils doivent répondre aux **caractéristiques** suivantes:

- température de fonctionnement: $-40^{\circ}\text{C} \div +150^{\circ}\text{C}$
- degré de protection: IP67 (entrée de poussières non admis et protection contre les effets de l'immersion dans l'eau pendant 30 minutes)

Les capteurs de révolutions sont soumis à des **essais de qualification et de durée rigoureux** pour établir si le produit est adéquat à la fabrication et à la vente:

- résistance aux chocs thermiques pendant 60 heures au total
- résistance à une impulsion de courant
- résistance aux coups

À l'issue positive de ces essais et une fois l'autorisation de production accordée, le produit est soumis tout au long de son assemblage à de sévères cycles de contrôle envisageant le **test à 100%** pour vérifier la résistance et l'inductance du capteur, l'intensité et polarité du signal, la résistance à l'impulsion de courant, l'absence de coupures ou de courts-circuits.

Éléments constitutifs et principe de fonctionnement

Il y a 3 typologies de capteurs:

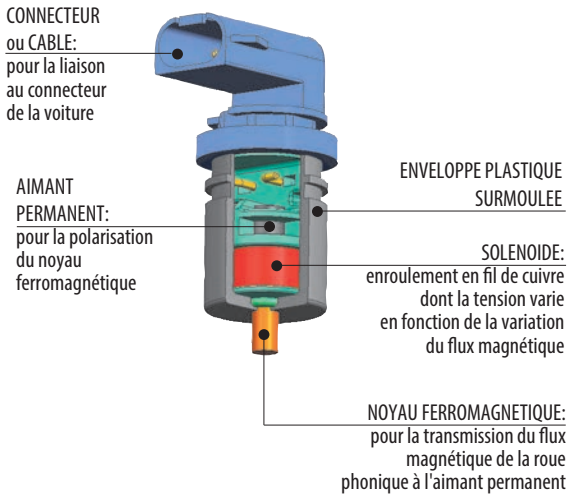

• **A réluctance variable:** un solénoïde est enroulé sur un *noyau magnétique cylindrique*, forme d'embout, polarisé par un *aimant permanent*. Le capteur détecte le flux électromagnétique qui traverse le solénoïde induit par la variation de la distance entre le noyau et la roue phonique. Le capteur génère la tension U en fonction de ses propres paramètres de construction et de la vitesse de variation du flux ($\Delta\Phi / \Delta t$):

$$U = N \frac{\Delta\Phi}{\Delta t} \text{ [mV]}$$

N : nombre spires de l'enroulement

$\Delta\Phi$: variation du flux magnétique

Δt : durée de la variation du flux

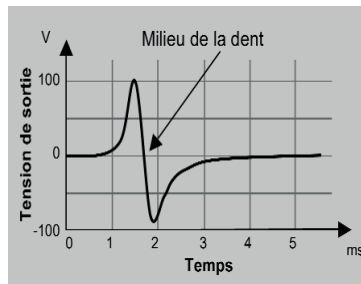

La représentation de la forme d'onde sur l'oscillogramme montre la transition entre la demi-onde positive (+) et la demi-onde négative (-) du signal de sortie lorsque le noyau se situe en correspondance avec le milieu de la dent.

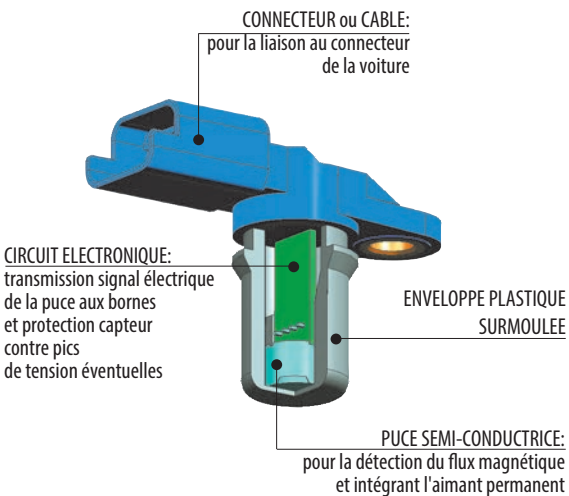

• **A effet Hall:** l'élément sensible est une *puce semi-conductrice* incorporant un *aimant permanent*. La puce est montée dans un circuit électronique qui protège le capteur contre d'éventuelles pics de tension. Les capteurs à effet Hall se comportent comme des interrupteurs normalement ouverts (NO): ils se ferment à la masse lorsque l'intensité du champ magnétique qui les traverse (avec la bonne polarité) dépasse le seuil de la puce.

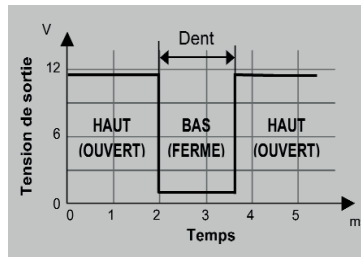

La représentation de la forme d'onde sur l'oscillogramme montre que le signal est à l'état haut (circuit ouvert) en absence de dent, tandis qu'il est à l'état bas (circuit fermé) en présence de la dent.

Etant donné que la sortie ne peut assumer que ces valeurs, les capteurs à effet Hall sont aussi désignés "digitaux".



• **Toroïdaux:** capteurs montés sur un câble haute tension pour l'alimentation des bougies et transformant l'impulsion de courant relative à l'allumage en signal électrique à envoyer à l'unité électronique. Cette typologie n'est que faiblement adoptée.

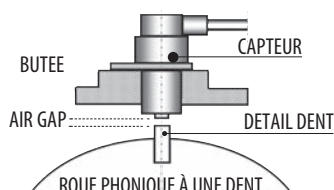

La distance entre l'embout du capteur et la dent de la roue phonique (air gap) doit être maintenue égale à celle du montage de la pièce originale étant donné que, en ce qui concerne les capteurs à réluctance variable, la sensibilité du dispositif dépend de celle-ci.

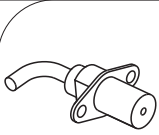

9.0XXX

Drehzahl-und-Kurbel-bzw.Nockenwellen-positionssensoren

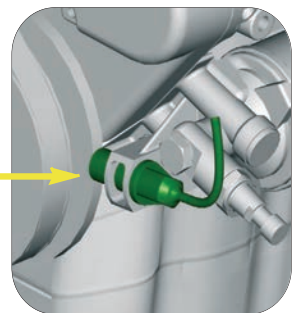
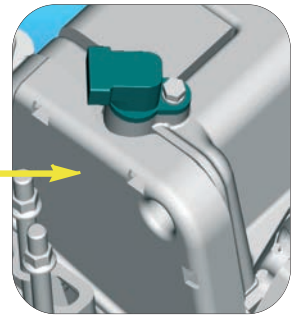
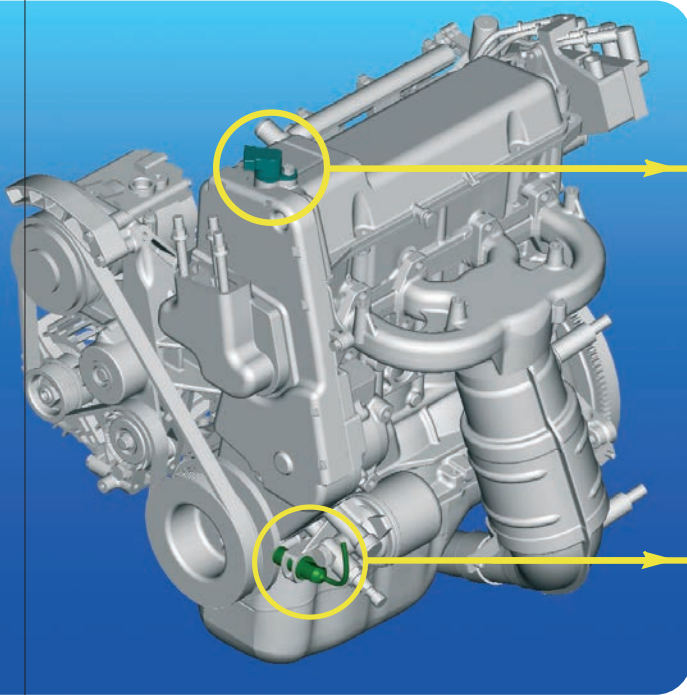

Rendering: bei freundlichem Zugeständnis von FIAT POWERTRAIN TECHNOLOGIES

In der Regel sind die Drehzahlsensoren **in der Nähe eines Impulsrads, auch Schwungrad genannt, montiert** (normalerweise handelt es sich um ein Zahnrad oder um einen Nocken aus ferromagnetischem Material). Diese Sensoren **messen die Änderungen des** durch die Abwechslung zwischen An- und Abwesenheit des Zahns oder des Nockens des Schwungrads erzeugten **Magnetflusses** und generieren ein elektrisches Signal. Dieses Signal wird an die Steuerung des Motors gesendet und je nach Impulsrad, auf dem die Sensoren montiert sind, gibt das empfangene Signal folgendes an:

- **Drehzahl der Kurbelwelle** (Crankshaft Rotational-speed Sensors)
- **Position des oberen Totpunkts** zur Messung der Position der Kurbelwelle (Crankshaft Position Sensors)
- **Einschaltsequenz oder Einschaltphase** durch die Messung der Position der Nockenwelle (Camshaft Position Sensors)

Drehzahl- und Phasensensoren werden **auf alle beliebigen Arten von Motoren montiert**. Auf ein und demselben Fahrzeug können mehrere Sensoren mit unterschiedlicher Funktion montiert sein. In ihrer Bauweise gleiche Sensoren dürfen ausschließlich an der spezifischen Position eingebaut werden.

Je nach spezifischer Anwendung kann das **Anschlussstück des Sensors** integriert oder an den Körper des Sensors mit einem Kabel angeschlossen sein. Die Anschlussstücke können 2 Klemmen (Sensoren mit variabler Reluktanz) oder 3 Klemmen (Hall-Effekt-Sensoren) aufweisen, bei einer Störabschirmung 3 (Sensoren mit variabler Reluktanz) oder 4 Klemmen (Hall-Effekt-Sensoren).

Die **Hauptursachen für Defekte** des Produkts sind:

- Verformungen und Schrammen
- Entmagnetisierung
- Überhitzung des Sensors
- Fehlen des Signals, Kabelbruch durch Reibung oder übermäßige

Erschütterung, Kurzschlüsse, innerer Bruch des Sensors durch mechanische oder thermische Belastung

- Eindringen von Flüssigkeit oder Verunreinigungen wegen mangelnder Dichtheit

Die **Anzeichen für Funktionsstörungen** sind durch Einschalten der Motoranzeige, Schwierigkeiten beim Starten des Fahrzeugs, hohem Kraftstoffverbrauch und Erhöhung der Abgasemissionen zu erkennen.

Die Drehzahlsensoren wurden im Hinblick auf Planung und Bau so ausgelegt, dass sie den kritischen Montagebedingungen im Motorraum standhalten. Insbesondere müssen sie folgende **Anforderungen** erfüllen:

- **Betriebstemperatur:** $-40^{\circ}\text{C} \div +150^{\circ}\text{C}$
- **Schutzart:** IP67 (staubdicht und geschützt gegen die Wirkungen bei 30 Minuten Untertauchen in Wasser).

Die Drehzahlsensoren werden **Qualitäts- und Haltbarkeitstests** unterzogen, ob das Produkt für Bau und Verkauf geeignet ist:

- Beständigkeit gegen starke Temperaturschwankungen für insgesamt 60 Stunden
- Beständigkeit gegen Stromimpuls
- Stoßfestigkeit

Bei positiven Prüfergebnissen und nach Erteilen der Produktionsgenehmigung erfolgen während der Montage strenge Kontrollzyklen auf dem Produkt, mit der **100% - Abnahmeprüfung**, um den Widerstand und die Induktanz des Sensors, die Stärke und die Polarität des Signals sowie die Beständigkeit gegen Stromimpulse zu prüfen sowie sicherzustellen, dass keine Unterbrechungen oder Kurzschlüsse vorliegen.

Bauteile und Funktionsprinzip

Es gibt 3 verschiedene Arten von Drehzahlsensoren:

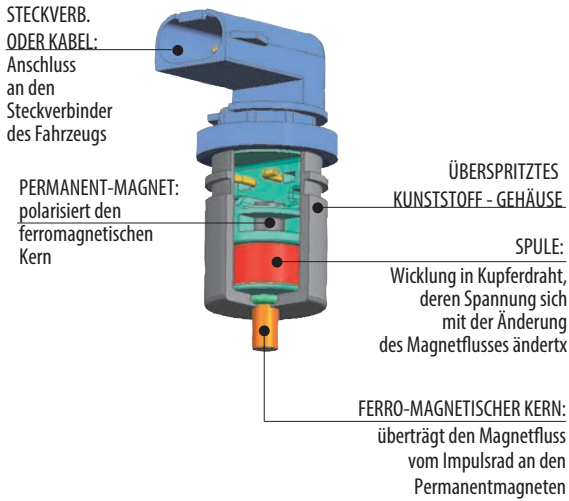

• **Sensoren mit variabler Reluktanz:** Eine Spule ist auf einem zylindrischen Magnetkern in Form eines Stößels aufgewickelt, polarisiert durch einen Permanentmagneten. Der Sensor erfasst den elektromagnetischen Fluss, der die Spule durchfließt, induziert durch die Änderung des Abstands zwischen Kern und Impulsrad.

Der Sensor generiert die Spannung U je nach seinen baulichen Parametern und der Geschwindigkeit der Flussänderung ($\Delta\Phi/\Delta t$):

$$U = N \frac{\Delta\Phi}{\Delta t} \text{ [mV]}$$

N : Anzahl der Windungen der Wicklung
 $\Delta\Phi$: Änderung des Magnetflusses
 Δt : Dauer der Flussänderung

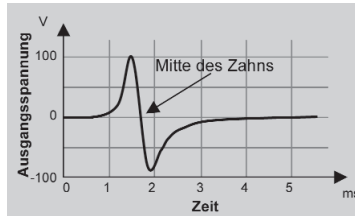

Die Darstellung der Wellenform im Oszillogramm zeigt den Übergang zwischen positiver Halbwelle (+) und negativer Halbwelle (-) des Ausgangssignals, wenn der Kern sich an der Mitte des Zahns befindet.

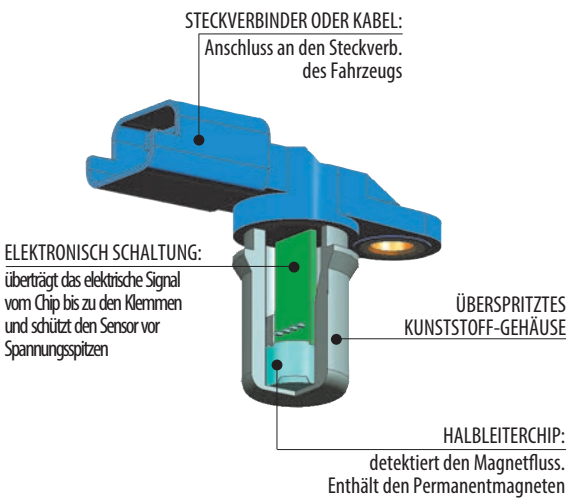

• **Hall-Effekt-Sensoren:** Der Fühler ist ein *Halbleiterchip*, der einen *Permanentmagneten* beinhaltet. Der Chip ist auf einem *elektronischen Schaltkreis* montiert, der den Sensor vor eventuellen Spannungsspitzen schützt. Hall-Effekt-Sensoren verhalten sich wie Schalter mit Arbeitskontakt (NO): Sie schließen sich auf Masse, wenn die Stärke des Magnetfelds, das sie (mit der korrekten Polarität) durchquert, die Schwelle des Chips übersteigt.

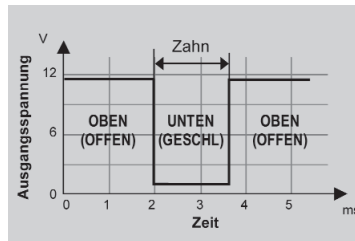

Die Darstellung der Wellenform im Oszillogramm zeigt, dass das Signal bei abwesendem Zahn hoch (Schaltung offen) und bei anwesendem Zahn niedrig ist (Schaltung geschlossen).

Da der Ausgang nur solche Werte annehmen kann, werden die Hall-Effekt-Sensoren auch als "digital" bezeichnet.



• **Ringsensoren:** Diese Sensoren sind auf einem Hochspannungskabel zur Versorgung der Zündkerzen montiert und wandeln den Stromimpuls für die Zündung in ein elektrisches, an die Steuerung gesendetes Signal um. Diese Art von Sensoren ist nicht besonders verbreitet.

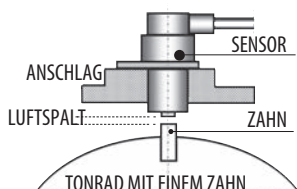

Der Abstand zwischen dem Stößel des Sensors und dem Zahn des Impulsrads (*air gap - Luftspalt*) muss bei der Montage des Original teils entsprechend beibehalten werden, da die Empfindlichkeit der Vorrichtung bei Sensoren mit variabler Reluktanz von diesem Abstand abhängt.

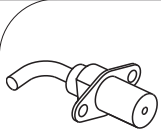

9.0XXX

Sensores de revoluciones y de posición del cigüeñal y árbol de levas

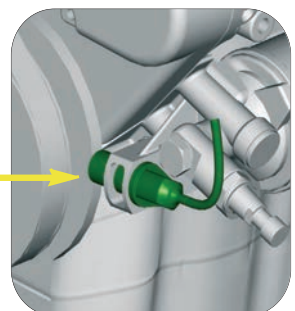
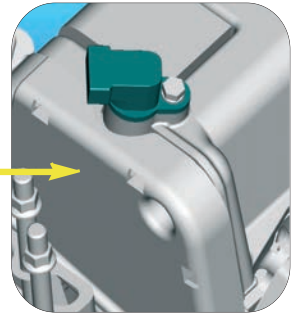
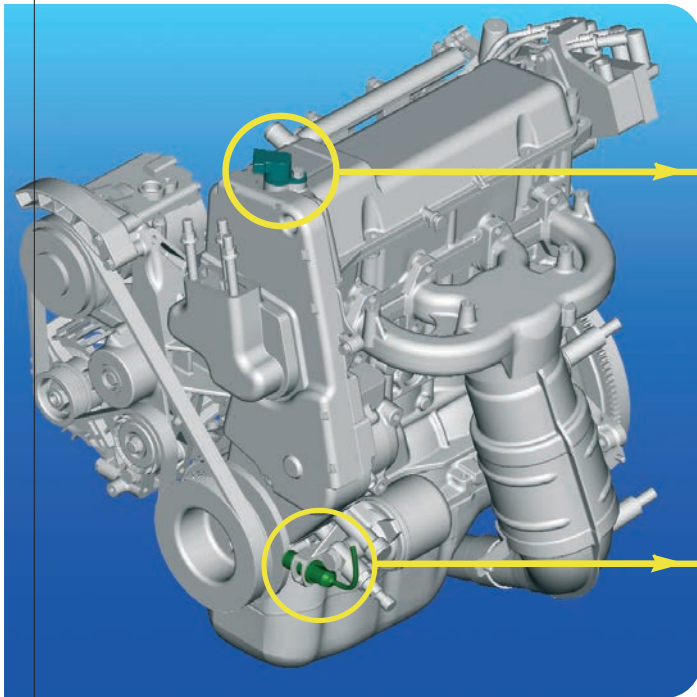

Rendering: por amable concesion de FIAT POWERTRAIN TECHNOLOGIES

Los sensores de revoluciones generalmente están **montados cerca de una rueda fónica** también llamada volante (normalmente una rueda dentada o una leva de material ferromagnético). **Detectan las variaciones del flujo magnético** producidas por la alternancia entre presencia y ausencia del diente o de la leva del volante y generan una señal eléctrica. Dicha señal se envía a la centralita de control del motor y, de acuerdo con la rueda fónica en la que los sensores están montados, la señal detectada indica:

- la *velocidad de revoluciones del árbol motor* (Crankshaft Rotational-speed Sensors)
- la *posición del punto muerto superior*, mediante la detección de la posición del árbol motor (Crankshaft Position Sensors)
- la *secuencia o fase de encendido*, mediante la detección de la posición del árbol de levas (Camshaft Position Sensors)

Los sensores de revoluciones y de fase están **montados en cualquier tipo de motor**. En un mismo vehículo se pueden montar uno o varios sensores con distintas funciones. Los sensores similares, desde un punto de vista de la construcción, se deben montar exclusivamente en la posición especificada.

De acuerdo con la aplicación específica, el **conector del sensor de revoluciones** puede estar incorporado o conectado con el cuerpo del sensor mediante un cable. Los conectores pueden tener 2 terminales (sensores de reluctancia variable) o 3 terminales (sensores de efecto Hall) o, si está presente el blindaje antiparásito, 3 (sensores de reluctancia variable) o 4 terminales (sensores de efecto Hall).

Las principales **causas de avería** del producto son:

- deformaciones y abolladuras
- desmagnetización

- recalentamiento del sensor
- ausencia de señal, rotura del cable por rozamiento o vibración excesiva, cortocircuitos, rotura interior del sensor por tensión mecánica o fatiga calorífica
- filtraciones de líquidos o impurezas por falta de hermeticidad

Las señales de **problemas de funcionamiento** del sensor se pueden observar por el encendido del testigo del motor, la dificultad de arranque del vehículo, un elevado consumo de combustible, el aumento de las emisiones de gases de escape.

Los sensores de revoluciones están diseñados y fabricados para soportar las condiciones críticas de montaje en el espacio motor. En especial, deben cumplir con los siguientes **requisitos**:

- *temperatura de funcionamiento*: $-40^{\circ}\text{C} \div +150^{\circ}\text{C}$
- *grado de protección*: IP67 (entrada de polvo no permitida y protección contra los efectos de la inmersión en agua por 30 minutos)

Los sensores de revoluciones son sometidos a rigurosos **ensayos de calificación y de duración**, para determinar si el producto es apropiado para ser fabricado y vendido:

- resistencia a los choques térmicos por un total de 60 horas
- resistencia a un impulso de corriente
- resistencia a los golpes

Después que ha superado estas pruebas y obtenido la aprobación para la producción, durante el ensamblaje el producto se somete a severos ciclos de control que prevén **ensayos al 100%** para comprobar la resistencia y la inductancia del sensor, la intensidad y la polaridad de la señal, la resistencia al impulso de corriente, la ausencia de interrupciones o de cortocircuitos.

Elementos de construcción y principio de funcionamiento

Existen tres tipos de sensores de revoluciones:

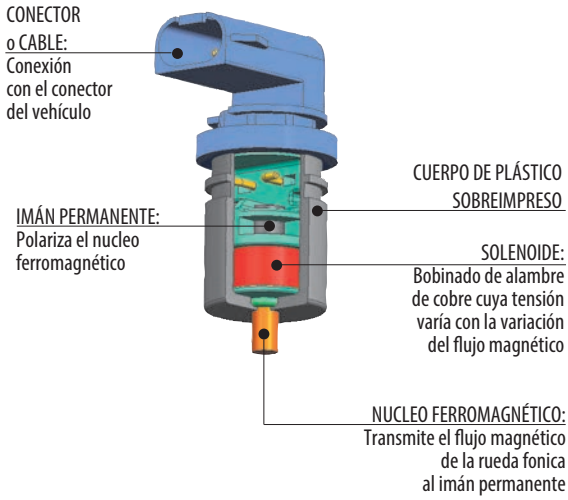

• **De reluctancia variable:** un solenoide está enrollado sobre un núcleo magnético cilíndrico, en forma de asta, polarizado por un imán permanente. El sensor detecta el flujo electromagnético que atraviesa el solenoide inducido por la variación de la distancia entre el núcleo y la rueda fónica. El sensor genera la tensión U de acuerdo con sus parámetros de construcción y la velocidad de variación del flujo ($\Delta\Phi/\Delta t$):

$$U = N \frac{\Delta\Phi}{\Delta t} \text{ [mV]}$$

N : número espiras del bobinado
 $\Delta\Phi$: variación de flujo magnético
 Δt : duración de la variación del flujo

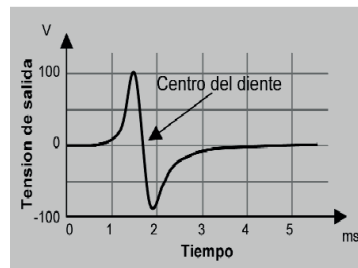

La representación de la forma de onda en el oscilograma muestra la transición entre la semionda positiva (+) y la semionda negativa (-) de la señal de salida cuando el núcleo coincide con el centro del diente.

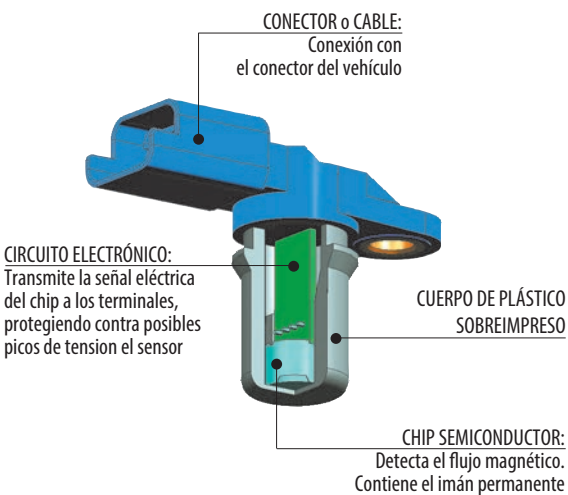

• **De efecto Hall:** el elemento sensible es un chip semiconductor que contiene un imán permanente. El chip está montado sobre un circuito electrónico que protege el sensor contra los posibles picos de tensión. Los sensores de efecto Hall se comportan como interruptores normalmente abiertos (NA): se cierran a masa cuando la intensidad del campo magnético que los atraviesa (con la correcta polaridad) supera el umbral del chip.

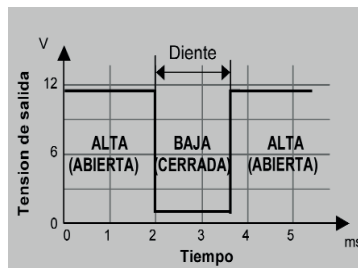

La representación de la forma de onda en el oscilograma muestra que la señal es alta (circuito abierto) en ausencia del diente, mientras que es baja (circuito cerrado) en presencia del diente.

Puesto que la salida puede adoptar sólo dichos valores, los sensores de efecto Hall también se llaman "digitales".



• **Toroidales:** sensores montados sobre un cable de alta tensión de alimentación de las bujías, transforman el impulso de corriente correspondiente al encendido en una señal eléctrica enviada a la centralita electrónica. Es un tipo poco difundido.

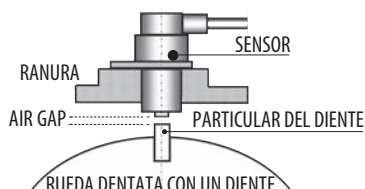

La distancia entre el asta del sensor y el diente de la rueda fónica (air gap) se debe conservar igual a la existente en el montaje de la pieza original, ya que para los sensores de reluctancia variable, de ésta depende la sensibilidad del dispositivo.



REVOLUTION AND TIMING (CKP AND CMP) SENSORS

-SENSORI GIRI MOTORE E TRASMISSIONE -CAPTEURS DE REGIME ET DE POSITION

-DREHZAHL- UND GETRIEBESENSOREN -SENSORES DE REVOLUCIONES Y POSICIÓN DE CIGÜEÑAL Y ÁRBOL DE LEVAS

- **Mounting position and function on the vehicle, of the sensors 9.0xxx***
- **Posizione di montaggio e funzione su vettura dei sensori 9.0xxx** • **Position de montage et fonction sur véhicule des capteurs 9.0xxx**
- **Einbaustellung und Funktion im Auto von den Sensoren 9.0xxx** • **Posición de montaje y función en el vehículo de los sensores 9.0xxx**

H10

ENGINE REVOLUTION SENSOR

Sensore di giri
Capteur de vitesse
Drehzahlsensor
Sensor de revoluciones

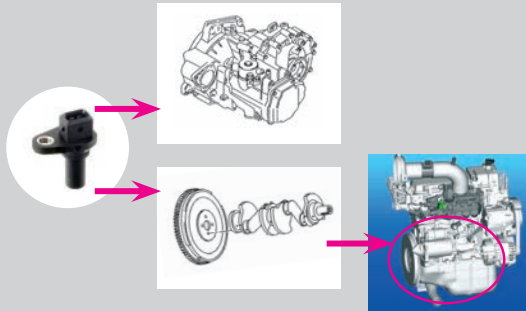

Code	H10
9.0028	

H20

CAMSHAFT POSITION SENSOR

Sensore pos. albero a camme
Capteur position arbre à cames
Nockenwellenpositionssensor
Sensor posición arbol de levas

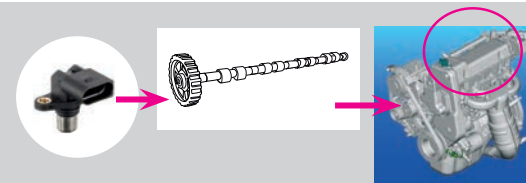

Code	H20
9.0351	

H30

CRANKSHAFT POSITION SENSOR

Sensore pos. albero motore
Capteur position vilebrequin
Kurbelwellenpositionssensor
Sensor de posición cigüeñal





REVOLUTION AND TIMING (CKP AND CMP) SENSORS

-SENSORI GIRI MOTORE E TRASMISSIONE -CAPTEURS DE REGIME ET DE POSITION

-DREHZAHL- UND GETRIEBESENSOREN -SENSORES DE REVOLUCIONES Y POSICIÓN DE CIGÜEÑAL Y ÁRBOL DE LEVAS

•Function on the vehicle, of the sensors 9.0xxx

•Funzione su vettura dei sensori 9.0xxx •Fonction sur véhicule, des capteurs 9.0xxx •Funktion im Auto von den Sensoren 9.0xxx •Función en el vehículo, de los sensores 9.0xxx

#	H10	H20	H30	H40
9.0001	•		•	
9.0002			•	
9.0003			•	
9.0004			•	
9.0005	•		•	
9.0006			•	
9.0008			•	
9.0010			•	
9.0011			•	
9.0012			•	
9.0013			•	
9.0014			•	
9.0015			•	
9.0016		•	•	
9.0017			•	
9.0018			•	
9.0019			•	
9.0020			•	
9.0021			•	
9.0022			•	
9.0023			•	
9.0024			•	
9.0026			•	
9.0028	•			•
9.0030			•	
9.0032			•	
9.0033		•		
9.0034			•	
9.0035			•	
9.0036			•	
9.0037			•	
9.0038			•	
9.0040			•	
9.0042		•		
9.0043		•		
9.0044			•	
9.0046			•	
9.0047			•	

#	H10	H20	H30	H40
9.0048			•	
9.0049			•	
9.0052			•	
9.0053			•	
9.0054		•	•	
9.0056			•	
9.0057			•	
9.0058			•	
9.0060		•		
9.0063			•	
9.0064			•	
9.0065			•	
9.0066			•	
9.0067	•		•	
9.0068		•	•	
9.0069		•		
9.0071		•		
9.0072		•		
9.0073			•	
9.0074			•	
9.0075			•	
9.0076			•	
9.0077			•	
9.0082			•	
9.0084		•		
9.0085		•		
9.0086		•		
9.0087			•	
9.0088		•	•	
9.0089			•	
9.0090			•	
9.0091		•		
9.0092			•	
9.0094			•	
9.0096			•	
9.0097			•	
9.0098	•			
9.0100	•			

LEGEND ·LEGENDA ·LÉGENDE ·ZEICHENERKLÄRUNG ·LEYENDA

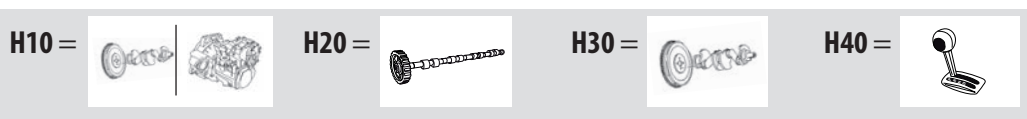



REVOLUTION AND TIMING (CKP AND CMP) SENSORS

-SENSORI GIRI MOTORE E TRASMISSIONE -CAPTEURS DE REGIME ET DE POSITION

-DREHZAHL- UND GETRIEBESENSOREN -SENSORES DE REVOLUCIONES Y POSICIÓN DE CIGÜEÑAL Y ÁRBOL DE LEVAS

•Function on the vehicle, of the sensors 9.0xxx

•Funzione su vettura dei sensori 9.0xxx •Fonction sur véhicule, des capteurs 9.0xxx •Funktion im Auto von den Sensoren 9.0xxx •Función en el vehículo, de los sensores 9.0xxx

#	H10	H20	H30	H40	#	H10	H20	H30	H40
9.0101	•				9.0167			•	
9.0103	•				9.0168			•	
9.0104				•	9.0169			•	
9.0105	•	•			9.0170			•	
9.0106			•		9.0171			•	
9.0107				•	9.0172			•	
9.0108			•		9.0173			•	
9.0111			•		9.0175			•	
9.0112		•			9.0176			•	
9.0127			•		9.0177			•	
9.0128			•		9.0178		•		
9.0129			•		9.0179	•			
9.0130			•		9.0180			•	
9.0131			•		9.0181			•	
9.0132	•	•	•		9.0182			•	
9.0133			•		9.0183			•	
9.0134			•		9.0184	•	•	•	
9.0137			•		9.0185			•	
9.0140			•		9.0187			•	
9.0141			•		9.0188			•	
9.0142			•		9.0189	•	•		
9.0145				•	9.0198			•	
9.0149			•		9.0199K			•	
9.0151			•		9.0202	•	•	•	
9.0152			•		9.0204				•
9.0153	•				9.0205			•	
9.0154			•		9.0206			•	
9.0155			•		9.0208		•		
9.0156			•		9.0209		•		
9.0157			•		9.0210		•		
9.0158			•		9.0211		•		
9.0159			•		9.0212	•		•	
9.0160			•		9.0213		•		
9.0161		•			9.0214			•	
9.0162			•		9.0215			•	
9.0164			•		9.0216			•	
9.0165			•		9.0217			•	
9.0166		•			9.0218		•	•	

LEGEND ·LEGENDA ·LÉGENDE ·ZEICHENERKLÄRUNG ·LEYENDA

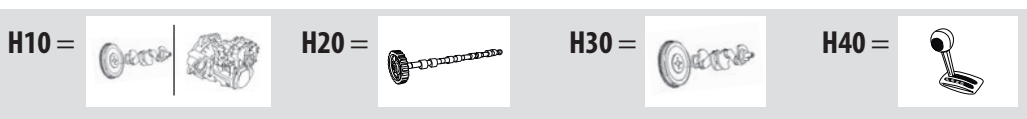



REVOLUTION AND TIMING (CKP AND CMP) SENSORS

-SENSORI GIRI MOTORE E TRASMISSIONE -CAPTEURS DE REGIME ET DE POSITION

-DREHZAHL- UND GETRIEBESENSOREN -SENSORES DE REVOLUCIONES Y POSICIÓN DE CIGÜEÑAL Y ÁRBOL DE LEVAS

•Function on the vehicle, of the sensors 9.0xxx

•Funzione su vettura dei sensori 9.0xxx •Fonction sur véhicule, des capteurs 9.0xxx •Funktion im Auto von den Sensoren 9.0xxx •Función en el vehículo, de los sensores 9.0xxx

#	H10	H20	H30	H40
9.0219			•	
9.0220				•
9.0221				•
9.0222			•	
9.0223			•	
9.0224			•	
9.0225			•	
9.0226		•		
9.0227		•		
9.0228			•	
9.0229			•	
9.0230			•	
9.0231				•
9.0232				•
9.0233				•
9.0234			•	
9.0235			•	
9.0236			•	
9.0237			•	
9.0238			•	
9.0239		•		
9.0240		•		
9.0241			•	
9.0242		•		
9.0243		•		
9.0244		•		
9.0245		•		
9.0246		•		
9.0249	•			
9.0250			•	
9.0251		•		
9.0252			•	
9.0253			•	
9.0254			•	
9.0258			•	
9.0259			•	
9.0260			•	
9.0263			•	

#	H10	H20	H30	H40
9.0264		•		
9.0265			•	
9.0266			•	
9.0267			•	
9.0269	•	•		
9.0270			•	
9.0271			•	
9.0272			•	
9.0273			•	
9.0274			•	
9.0276		•	•	
9.0277		•		
9.0278		•		
9.0279			•	
9.0280			•	
9.0281		•		
9.0282			•	
9.0283			•	
9.0284			•	
9.0285			•	
9.0286		•		
9.0287			•	
9.0288			•	
9.0289			•	
9.0290			•	
9.0291			•	
9.0292			•	
9.0293			•	
9.0294			•	
9.0295			•	
9.0296			•	
9.0297			•	
9.0298			•	
9.0299			•	
9.0301		•	•	
9.0302		•		
9.0303			•	
9.0304			•	

LEGEND ·LEGENDA ·LÉGENDE ·ZEICHENERKLÄRUNG ·LEYENDA

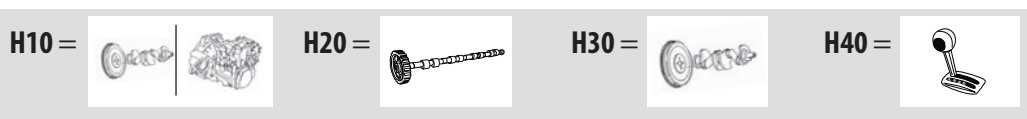



REVOLUTION AND TIMING (CKP AND CMP) SENSORS

-SENSORI GIRI MOTORE E TRASMISSIONE -CAPTEURS DE REGIME ET DE POSITION

-DREHZAHL- UND GETRIEBESENSOREN -SENSORES DE REVOLUCIONES Y POSICIÓN DE CIGÜEÑAL Y ÁRBOL DE LEVAS

•Function on the vehicle, of the sensors 9.0xxx

•Funzione su vettura dei sensori 9.0xxx •Fonction sur véhicule, des capteurs 9.0xxx •Funktion im Auto von den Sensoren 9.0xxx •Función en el vehículo, de los sensores 9.0xxx

#	H10	H20	H30	H40	#	H10	H20	H30	H40
9.0305			•		9.0361	•	•		
9.0307			•		9.0362		•		
9.0308				•	9.0365		•		
9.0309				•	9.0367		•		
9.0310		•			9.0368		•		
9.0311		•			9.0371		•		
9.0313		•			9.0373			•	
9.0314			•		9.0374				•
9.0315		•			9.0375				•
9.0316		•			9.0377			•	
9.0317		•			9.0378			•	
9.0318			•		9.0379			•	
9.0319			•		9.0380		•	•	
9.0320			•		9.0381			•	
9.0321	•			•	9.0382			•	
9.0322				•	9.0383			•	
9.0323			•		9.0384			•	
9.0324			•		9.0387		•		
9.0326		•	•		9.0388		•		
9.0327			•		9.0389			•	
9.0328			•		9.0391			•	
9.0331		•			9.0392				•
9.0332		•			9.0393				•
9.0333			•		9.0397			•	
9.0335		•			9.0398			•	
9.0337			•		9.0400		•		
9.0343		•			9.0401		•		
9.0344	•	•	•		9.0403			•	
9.0346		•			9.0407		•	•	
9.0348		•			9.0417		•	•	
9.0349	•	•	•		9.0422		•		
9.0351		•			9.0423		•		
9.0352			•		9.0437		•	•	
9.0353			•		9.0438	•	•		
9.0354	•			•	9.0440			•	
9.0355		•			9.0441				•
9.0356			•		9.0443			•	
9.0357			•		9.0445			•	

LEGEND ·LEGENDA ·LÉGENDE ·ZEICHENERKLÄRUNG ·LEYENDA

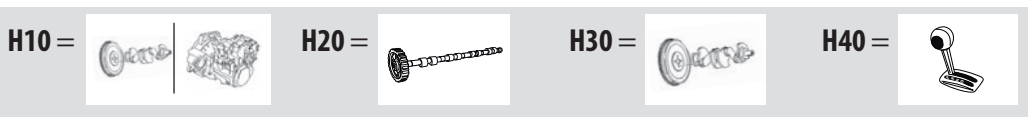



REVOLUTION AND TIMING (CKP AND CMP) SENSORS

-SENSORI GIRI MOTORE E TRASMISSIONE -CAPTEURS DE REGIME ET DE POSITION

-DREHZAHL- UND GETRIEBESENSOREN -SENSORES DE REVOLUCIONES Y POSICIÓN DE CIGÜEÑAL Y ÁRBOL DE LEVAS

•Function on the vehicle, of the sensors 9.0xxx

•Funzione su vettura dei sensori 9.0xxx •Fonction sur véhicule, des capteurs 9.0xxx •Funktion im Auto von den Sensoren 9.0xxx •Función en el vehículo, de los sensores 9.0xxx

#	H10	H20	H30	H40
9.0446			•	
9.0447			•	
9.0448			•	
9.0449		•		
9.0453		•	•	
9.0456		•		
9.0458			•	
9.0459		•		
9.0460		•		
9.0461			•	
9.0462		•		
9.0463		•		
9.0464			•	
9.0465	•			
9.0466		•		
9.0468		•		
9.0469				•
9.0470				•
9.0471		•		
9.0472			•	
9.0473	•		•	
9.0476		•		
9.0477		•		
9.0478			•	
9.0480		•		
9.0481	•			
9.0481K	•			
9.0482			•	
9.0483			•	
9.0485			•	
9.0486		•		
9.0487	•			
9.0488	•			
9.0490		•	•	
9.0493				•
9.0494			•	
9.0495				•
9.0497		•		

#	H10	H20	H30	H40
9.0498	•			
9.0500		•	•	
9.0502			•	
9.0504			•	
9.0505			•	
9.0509		•	•	
9.0514		•	•	
9.0518		•		
9.0522	•			•
9.0523	•	•		
9.0524			•	
9.0535		•		
9.0536			•	
9.0537	•			•
9.0538		•	•	
9.0539	•			
9.0540			•	
9.0540K			•	
9.0543			•	
9.0543K			•	
9.0545			•	
9.0545K			•	
9.0549			•	
9.0551		•		
9.0552			•	
9.0553			•	
9.0555			•	
9.0556		•		
9.0559			•	
9.0560			•	
9.0561			•	
9.0562			•	
9.0563			•	
9.0564			•	
9.0565		•		
9.0568		•		
9.0569			•	
9.0570			•	

LEGEND ·LEGENDA ·LÉGENDE ·ZEICHENERKLÄRUNG ·LEYENDA

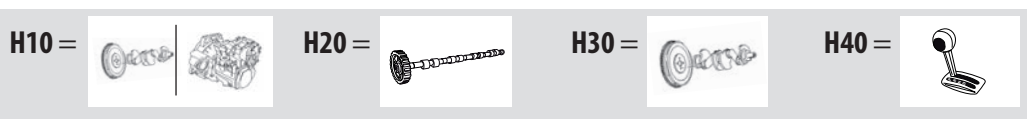



REVOLUTION AND TIMING (CKP AND CMP) SENSORS

-SENSORI GIRI MOTORE E TRASMISSIONE -CAPTEURS DE REGIME ET DE POSITION

-DREHZAHL- UND GETRIEBESENSOREN -SENSORES DE REVOLUCIONES Y POSICIÓN DE CIGÜEÑAL Y ÁRBOL DE LEVAS

•Function on the vehicle, of the sensors 9.0xxx

•Funzione su vettura dei sensori 9.0xxx •Fonction sur véhicule, des capteurs 9.0xxx •Funktion im Auto von den Sensoren 9.0xxx •Función en el vehículo, de los sensores 9.0xxx

#	H10	H20	H30	H40
9.0571			•	
9.0573		•		
9.0578			•	
9.0579			•	
9.0585		•	•	
9.0587			•	
9.0588			•	
9.0593			•	
9.0594			•	
9.0597			•	
9.0597K			•	
9.0598			•	
9.0600			•	
9.0602			•	
9.0605		•		
9.0608			•	
9.0616		•	•	
9.0617				•
9.0618				•
9.0619	•	•		
9.0620			•	
9.0626		•		
9.0631			•	
9.0632		•	•	
9.0633			•	
9.0636	•			•
9.0637		•		
9.0640			•	
9.0641	•			
9.0645			•	
9.0646	•		•	
9.0649				•
9.0651		•		
9.0654			•	
9.0658			•	
9.0659			•	
9.0674		•		
9.0675			•	

#	H10	H20	H30	H40
9.0681			•	
9.0683			•	
9.0697			•	
9.0700		•		
9.0710				•
9.0713		•		
9.0716			•	
9.0719	•			
9.0720			•	
9.0735				•
9.0745	•			
9.0752		•	•	
9.0753			•	
9.0754				•
9.0757		•		
9.0758			•	
9.0759			•	
9.0773	•			
9.0775	•			•
9.0778	•			
9.0793		•		
9.0810			•	

LEGEND ·LEGENDA ·LÉGENDE ·ZEICHENERKLÄRUNG ·LEYENDA

H10 =		H20 =		H30 =		H40 =	
-------	--	-------	--	-------	--	-------	--

9.0001



04,5

REVOLUTION AND TIMING (CKP AND CMP) SENSORS

Adatt./Suitable:

ALFA ROMEO5944390
60512971
60572239**CITROËN**

1920 FA

FIAT5944390
60512971
60572239
7604582**IVECO**

5944390

LANCIA

7604582

MAGNETI MARELLI064820084010
648 200 84
SEN 8E**PEUGEOT**

1920 FA



L	L1	ohm	OUT_GND
460	30	700	

ALFA ROMEO

33 II 1.4 i.e.	AR30753	06/91 ⇒ 09/94
164 2.0 Turbo	AR64102	07/90 ⇒ 10/92
164 2.0 V6 Turbo	AR64101	03/91 ⇒ 09/92
164 2.5 TD	VM84A	06/87 ⇒ 09/92

CITROËN

JUMPER I 2.8 HDi	8140.43S, 154A1.000	09/00 ⇒ 04/02
JUMPER I 2.8 HDi 4x4	8140.43S	09/00 ⇒ 04/02
JUMPER II 2.8 HDi 4x4	8140.43S	04/02 ⇒
JUMPER II 2.8 TD	8140.43	04/02 ⇒

FIAT

CROMA I 1600	154A.048	12/85 ⇒ 12/90
CROMA I 1900 Turbo D i.d.	--	01/87 ⇒ 12/90
CROMA I 2000 CHT	154A1.000, 154C3.000	12/85 ⇒ 09/92
CROMA I 2000 i.e.	154C3.000, 154A2.000	03/86 ⇒ 12/96
CROMA I 2000 i.e. Turbo	154A2.000, 8140.47	12/85 ⇒ 08/96
DUCATO II 2.5 TD	8140.47, 8140.47	06/94 ⇒ 08/98
DUCATO II 2.5 TD 4x4	8140.47, 8140.43	06/94 ⇒ 04/98
DUCATO II 2.5 TDI	8140.47	03/94 ⇒ 04/02
DUCATO II 2.5 TDI 4x4	8140.47	04/97 ⇒ 04/02
DUCATO II 2.5 TDI Panorama/Combinato	8140.47	03/94 ⇒ 04/02
DUCATO II 2.8 iDTD 4x4	8140.43	05/98 ⇒ 09/01
DUCATO II 2.8 JTD	8140.43, 8140.43	11/00 ⇒ 07/06
DUCATO II 2.8 JTD 4x4	8140.43S	11/00 ⇒ 04/02
DUCATO II 2.8 TD	8140.43, 160A6.000	04/02 ⇒ 07/06
DUCATO II 2.8 TD 4x4	8140.43	05/98 ⇒ 09/01
DUCATO II 2.8 TDI	8140.43	10/97 ⇒ 04/02
DUCATO II 2.8 TDI 4x4	8140.43	06/99 ⇒ 04/02
FIORINO II 1.7 D	149B4.046	01/88 ⇒ 12/91
REGATA 85 1.5	149A5.000	05/85 ⇒ 12/87
RITMO II 75 1.5	138A2.000	09/85 ⇒ 12/88
TEMPRA 1.9 D	160A7.000	07/91 ⇒ 08/96
TEMPRA 1.9 TD	160A6.000, 149B4.000	05/90 ⇒ 08/96
TEMPRA 1.9 TDE	160A6.046	07/90 ⇒ 03/93
TIPO I 1.7 D	149B4.000, 160A6.000	01/88 ⇒ 10/95
TIPO I 1.9 D	160A7.000	07/91 ⇒ 08/95
TIPO I 1.9 TD	160A6.000, 146A2.000	09/90 ⇒ 04/95
UNO 1.3 Turbo i.e.	146A2.000, 146A8.000	04/85 ⇒ 03/91
UNO 1.4 Turbo i.e.	146A8.000, 831B6.000	09/89 ⇒ 12/96
UNO 1.7 D	149B4.046	02/88 ⇒ 02/92
UNO 1.9 D	149B5.046	09/89 ⇒ 03/94
UNO 70 TD 1.4	146B3.000	10/86 ⇒ 10/90

FIAT (BR)

UNO 1.4i Turbo	1.4Mpi	01/94 ⇒ 12/96
----------------	--------	---------------

LANCIA

PRISMA 1.6	831B6.000, 834B2.000	08/86 ⇒ 02/92
------------	----------------------	---------------

LANCIA

PRISMA 1.6 i.e.	831B7.000	05/86 ⇒ 12/89
PRISMA 2.0 i.e. Trazione integrale	831B4.000	04/86 ⇒ 12/89
THEMA 2000 16V Turbo	834C1.000	12/88 ⇒ 06/90
THEMA 2000 i.e	834B1.000	09/88 ⇒ 05/92
THEMA 2000 i.e.	834B.146	09/87 ⇒ 05/92
THEMA 2000 i.e. 16V	834B2.000, 834C1.000	05/88 ⇒ 08/92
THEMA 2000 i.e. 16V Turbo	834C1.000, F105L	12/88 ⇒ 03/93
THEMA 2000 i.e. Turbo	834C.146	07/86 ⇒ 05/90
THEMA 2000 Turbo	834C.146	12/88 ⇒ 03/92
THEMA 8.32	F105L, 8140.43S(F28DTCR)	09/87 ⇒ 05/92

PEUGEOT

BOXER I 2.8 HDi	8140.43S(F28DTCR), 8140.43S(F28DTCR)	10/00 ⇒ 04/02
BOXER I 2.8 HDi 4x4	8140.43S(F28DTCR), AR67203	10/00 ⇒ 04/02
BOXER I 2.8 HDi Trazione integrale	8140.43S(F28DTCR)	10/00 ⇒ 11/01

9.0002



04,5

REVOLUTION AND TIMING (CKP AND CMP) SENSORS

Adatt./Suitable:

ALFA ROMEO

7741311

FIAT60806494
7547235**LANCIA**

7547235

MAGNETI MARELLI064820088010
648 200 88
SEN 8I
SEN 8IA

L	L1	ohm	OUT_GND
550	30	700	

ALFA ROMEO

155 2.0 16V Turbo Q4	AR67203, 154C6.000	01/92 ⇒ 12/97
----------------------	--------------------	---------------

FIAT

COUPE 2.0 16V	836A3.000	11/93 ⇒ 08/96
COUPE 2.0 16V [BRA]	836A3.011	11/93 ⇒ 08/96
COUPE 2.0 16V Turbo	175A1.000	11/93 ⇒ 08/96
CROMA I 1900 Turbo D i.d.	154C6.000, 8144.97	08/87 ⇒ 12/96
CROMA I 2500 TD	8144.97, 159A4.000	05/89 ⇒ 08/96
CROMA I 2500 TDE	8144.97S	12/91 ⇒ 08/96
TEMPRA 1.8 4x4	159A4.000	07/92 ⇒ 06/93
TEMPRA 1.8 i.e.	159A4.000, 159A4.000	03/90 ⇒ 08/96
TEMPRA 2.0	159A6.046	04/90 ⇒ 06/93
TEMPRA 2.0 i.e.	159A6.046	10/90 ⇒ 08/96
TEMPRA 2.0 i.e. [BRA]	159A6.011	04/93 ⇒ 12/96
TEMPRA 2.0 i.e. 4x4	159A6.046	03/92 ⇒ 03/95
TIPO I 1.8 i.e.	159A4.000, 159A5.046	10/90 ⇒ 06/93
TIPO I 1.8 i.e. 16V Sport	160A5.000	11/89 ⇒ 06/92
TIPO I 2.0	159A5.046, 159A5.046	10/90 ⇒ 04/95
TIPO I 2.0 i.e.	159A5.046, 835A2.000	03/90 ⇒ 04/95
TIPO I 2.0 i.e. [BRA]	159A6.011	03/93 ⇒ 10/95
TIPO I 2.0 i.e. 16V Sport	836A3.000	03/93 ⇒ 04/95

FIAT (BR)

COUPE 2.0i 16V	2.0Mpi	01/95 ⇒ 12/97
TIPO 2.0i 16V	2.0Mpi	01/94 ⇒ 12/95
TIPO 2.0i 8v	2.0Mpi	01/94 ⇒ 12/95

LANCIA

DEDRA 1.8 i.e.	835A2.000, 835A5.000	09/89 ⇒ 07/99
DEDRA 2.0 16V	836A3.000	07/94 ⇒ 07/99
DEDRA 2.0 HF Integrale	835A7.046	11/90 ⇒ 07/94
DEDRA 2.0 i.e.	835A5.000, 175A4.000	09/89 ⇒ 07/99
DEDRA 2.0 i.e. Turbo	835A8.046	04/91 ⇒ 07/99
DEDRA 2.0 i.e. Turbo Integrale	835A7.000	05/90 ⇒ 07/94
DEDRA 2.0 Integrale	836A3.000	07/94 ⇒ 07/99
DEDRA 2.0 Turbo	835A8.000	11/90 ⇒ 06/94
DELTA II 2.0 16V	836A3.000	06/93 ⇒ 08/99
DELTA II 2.0 16V Turbo	175A4.000, 159A3.000	06/93 ⇒ 08/99

9.0003

9.0003



04,5

REVOLUTION AND TIMING (CKP AND CMP) SENSORS

Adatt./Suitable:

FIAT

7564592

INNOCENTI

7564592

IVECO

7564592

LANCIA

7564592

MAGNETI MARELLI

064820150010

648 201 50

SEN 8M



L	L1	ohm	OUT_GND
470	13,5	780	

FIAT

FIORINO II 1.6	146C6.000	01/94 ⇒ 05/01
FIORINO II 70 i.e. 1.4	146C5.000	05/94 ⇒ 05/01
FIORINO II 75 i.e. 1.6	146C6.000	10/93 ⇒ 05/01
TEMPRA 1.4 i.e.	160A1.046	04/90 ⇒ 08/96
TEMPRA 1.6	159A3.000, 159A3.046	03/90 ⇒ 12/96
TEMPRA 1.6 i.e.	159A3.046, 159A3.048	06/90 ⇒ 08/96
TIPO I 1.4	160A1.048	07/87 ⇒ 12/89
TIPO I 1.4 i.e.	160A1.046	05/89 ⇒ 04/95
TIPO I 1.6	159A3.048, 159A3.046	01/88 ⇒ 10/95
TIPO I 1.6 i.e.	159A3.046, 146C1.000	07/90 ⇒ 04/95
TIPO I 1.6 SX DGT	159A3.000	05/89 ⇒ 10/95
UNO 1.4 Super	146C2.028	09/89 ⇒ 09/92
UNO 70 i.e. 1.4	146C1.000, 835A1.000	09/89 ⇒ 07/96
UNO 70 S 1.4	160A1.048	10/88 ⇒ 06/06
UNO Mondo 1.4 Super	146C2.028	01/96 ⇒

INNOCENTI

ELBA 1.4 i.e.	146C5.000	09/94 ⇒ 12/96
ELBA 1.6 i.e.	146C6.000	09/94 ⇒ 12/96
MILLE 1.4	160A1046	07/95 ⇒ 05/97

LANCIA

DEDRA 1.6	835A1000	07/94 ⇒ 02/97
DEDRA 1.6 i.e.	835A1.000, AR06476	08/89 ⇒ 06/94
DELTA II 1.4 i.e.	160A1.046	10/94 ⇒ 08/99



REVOLUTION AND TIMING (CKP AND CMP) SENSORS

Adatt./Suitable:

ALFA ROMEO4460206
60523246
60800100**FIAT**4460206
7547714**FORD**

1 639 282

INNOCENTI

4460206

IVECO

4460206

LANCIA

4460206

MAGNETI MARELLI064820083010
064820089010
648 200 83
648 200 89
SEN 8D
SEN 8L**RENAULT**

50 00 288 407



L	L1	ohm	OUT GND
460	20,7	700	

ALFA ROMEO

33 I 1.8 TD	VM82A	01/86 ⇒ 06/90
33 II 1.8 TD	VM96A	07/90 ⇒ 09/94
75 2.0 TD	VM80A	05/85 ⇒ 09/92
75 2.4 TD	VM81A	01/89 ⇒ 02/92
164 2.0 Turbo	AR06476, 170A.000	10/87 ⇒ 09/98

FIAT

ARGENTA 2000 i.e.	132C3.000	06/81 ⇒ 07/86
CINQUECENTO 0.7	170A.000, 154A1.000	12/91 ⇒ 02/98
CINQUECENTO 0.7 i	170A.046	07/94 ⇒ 01/98
CROMA I 1600	154A.048	12/85 ⇒ 12/90
CROMA I 2000 CHT	154A1.000, 154C3.000	12/85 ⇒ 09/92
CROMA I 2000 i.e.	154C3.000, 154C4.000	03/86 ⇒ 12/96
CROMA I 2000 i.e. Turbo	154C4.000, 146A2.000	11/86 ⇒ 08/96
ELBA 1.5	149C1.000	01/92 ⇒ 12/96
FIORINO I 1.5	149C1.000	01/88 ⇒ 08/93
FIORINO II 1.5 iE	149C1.000	01/88 ⇒ 10/92
FIORINO II 75 i.e. 1.5	149C1.000	05/88 ⇒ 12/93
REGATA 1.6	--	09/86 ⇒ 06/89
REGATA 100 Super 1.6	149A2.000	10/83 ⇒ 12/90
REGATA 85 1.5	149A5.000	05/85 ⇒ 12/87
RITMO I 1.5	138C2.048	10/85 ⇒ 05/87
RITMO I 1.6	149A4.000	01/83 ⇒ 12/87
RITMO II 75 1.5	138A2.000	09/85 ⇒ 12/88
UNO 1.0	156A2.000	06/89 ⇒ 02/92
UNO 1.0 i.e.	146C7.000	09/89 ⇒ 03/94
UNO 1.3 Turbo i.e.	146A2.000, 138C2.048	04/85 ⇒ 03/91
UNO 1.4 Turbo i.e.	146A8.000	12/89 ⇒ 12/96
UNO 70 1.3i SX	--	01/83 ⇒ 12/89
UNO 75 i.e. 1.5	138C2.048, 831A1.000	10/85 ⇒ 12/93

FIAT (BR)

UNO 1.5i	1.5Spi	01/92 ⇒ 12/96
UNO 1.5i Furgoneta	1.5Spi	01/92 ⇒ 12/96
UNO CS 1.5i	1.5Spi	01/92 ⇒ 12/96
UNO MILLE 1.0	1.0	05/93 ⇒ 12/95
UNO MILLE 1.0i	1.0Spi	01/96 ⇒

FORD

ESCORT V RS Cosworth 4x4	NSF	09/92 ⇒ 01/95
--------------------------	-----	---------------

INNOCENTI

ELBA 1.5 i.e.	149C1.000	08/92 ⇒ 09/94
MILLE 1.0	146C7.000	07/95 ⇒ 05/97
MILLE 1.0i	146C7.000	02/93 ⇒ 02/98

IVECO

DAILY II 35-10	8140.97.2781	01/89 ⇒ 08/98
----------------	--------------	---------------

LANCIA

DELTA I 1.5	831A1.000, 149C2.000	09/79 ⇒ 12/92
DELTA I 1.6 GT i.e.	149C2.000, 831B3.000	08/86 ⇒ 08/92
DELTA I 1.6 HF Turbo	831B3.000, 831E5.000	08/86 ⇒ 03/89
DELTA I 2.0 16V HF Evo Integrale	831E5.000, 831B5.000	06/93 ⇒ 01/94
DELTA I 2.0 16V HF Integrale	831D5.000	03/89 ⇒ 09/91
DELTA I 2.0 HF Integrale	831B5.000, 831B6.000	11/86 ⇒ 12/92
PRISMA 1.5	831B1.000	08/86 ⇒ 02/92
PRISMA 1.6	831B6.000, 146A5.046	08/86 ⇒ 02/92
PRISMA 1.6 i.e.	831B7.000	05/86 ⇒ 12/89
PRISMA 2.0 i.e. Trazione integrale	831B4.000	04/86 ⇒ 12/89
THEMA 2000 i.e	834B1.000	09/88 ⇒ 05/92
THEMA 2000 i.e.	834B.146	09/87 ⇒ 05/92
THEMA 2000 i.e. Turbo	834C.146	07/86 ⇒ 05/90
THEMA 2000 Turbo	834C.146	12/88 ⇒ 03/92
Y10 1.3 i.e.	146A5.046, 14K4C	11/87 ⇒ 12/95

RENAULT

MASTER I 2.5 DT	S9U702	11/89 ⇒ 10/93
MASTER I 28-35 2,5 TD	S9U702	08/89 ⇒ 07/98



REVOLUTION AND TIMING (CKP AND CMP) SENSORS

Adatt./Suitable:

LAND ROVER

ADU7340L

ROVER

ADU7340



L	L1	ohm	OUT GND
250	31	1400	

AUSTIN

MONTEGO 1.6 LS	16HC37	10/84 ⇒ 08/88
MONTEGO 1.6 LS,HL	16HC37	04/84 ⇒ 08/88

LAND ROVER

DISCOVERY I 2.0 16V 4x4	20T4H	06/89 ⇒ 10/98
-------------------------	-------	---------------

ROVER

100 / METRO 111 C/L/S	11K2D	03/90 ⇒ 12/98
100 / METRO 114 GSi	14K4F	10/94 ⇒ 10/95
100 / METRO 114 GTi 16V	14K4C, 14K4C	03/90 ⇒ 12/98
100 / METRO 114 GTi/GT 16V Cat	14K4C, 14K2A	03/90 ⇒ 12/98
100 / METRO 114 S/L/GTA	14K2D	03/90 ⇒ 12/98
100 111	11K2D	04/94 ⇒ 10/97
100 114	14K2D	04/94 ⇒ 10/97
200 II 214	14K2A, 14K4C	09/93 ⇒ 12/95
200 II 214 1.4	14K4C, 14K4C	01/92 ⇒ 11/99
200 II 214 1.4i 16V	14K4F	01/93 ⇒ 11/99
200 II 214 GSi/Si	14K4C, 14K4C	01/90 ⇒ 10/95
200 II 214 Si/Gsi	14K4C, 14K4C	10/89 ⇒ 10/95
200 II 216 GSi	D16A7	10/89 ⇒ 10/95
200 II 216 GTi	D16A9	09/90 ⇒ 10/95
400 I 414	14K4C	01/93 ⇒ 04/95
400 I 414 GSi/Si	14K4C, 12A2A	04/90 ⇒ 04/95
400 I 414 GSi/Si Cat	14K4F	10/92 ⇒ 04/95
400 I 416 GTi/GTE	D16A9	04/90 ⇒ 04/95
MAESTRO 1.6	16H	09/90 ⇒ 01/95
MINI 1.3i Turbo	--	01/85 ⇒
MINI 1300	12A2A, B18E	01/91 ⇒ 04/95



REVOLUTION AND TIMING (CKP AND CMP) SENSORS

Adatt./Suitable:

VOLVO343611-9
34361196

L	L1	ohm	OUT GND
250	24	240	

VOLVO

440 1.6	B16F	09/88 ⇒ 12/96
440 1.7	B18E, B18FT	08/88 ⇒ 12/96
440 1.7 Turbo	B18FT, B18U	08/88 ⇒ 12/96
440 1.8	B18U, B20F	08/91 ⇒ 12/96
440 2.0	B20F, B18EP	08/92 ⇒ 07/96
460 1.6	B16F	07/92 ⇒ 07/96
460 1.7	B18EP, B18FT	08/89 ⇒ 07/95
460 1.7 Turbo	B18FT, B20F	08/89 ⇒ 07/96
460 1.8	B18U	08/91 ⇒ 07/96
460 2.0	B20F, B18E	08/92 ⇒ 07/96
480 1.7	B18E, B18FT	04/86 ⇒ 07/96
480 1.7 Turbo	B18FT, C2J772	08/87 ⇒ 07/96
480 2.0	B20F	08/92 ⇒ 09/95



REVOLUTION AND TIMING (CKP AND CMP) SENSORS

Adatt./Suitable:

BOSCH

0 986 280 403

RENAULT

77 00 720 341

77 00 725 811

77 00 728 639

77 00 732 300

77 00 739 792

SIEMENS

5101750016Z

VOLVO

320982-6

32098261



L	L1	ohm	OUT GND
940	24	240	

RENAULT

19 I 1.2	C1G730	01/88 ⇒ 12/92
19 I 1.4	C2J772, F2N720	01/88 ⇒ 05/93
19 I 1.7	F2N720, F2N720	09/88 ⇒ 12/92
19 II 1.4	E6J706	05/92 ⇒ 12/95
19 II 1.7	F2N720, F2N710	09/90 ⇒ 12/95
21 1.4	C2J770	06/88 ⇒ 12/95
21 1.6	C2L	01/87 ⇒ 12/94
21 1.7	F2N710, F2R702	03/86 ⇒ 12/95
21 2.0	F2R702, J6R706	03/86 ⇒ 10/93
25 2.0	J6R706, J7T706	04/84 ⇒ 12/92
25 2.2	J7T706, E5F710	04/84 ⇒ 12/89
CLIO I 1.2	E5F710, E6J712	05/90 ⇒ 02/98

RENAULT		
CLIO I 1.4	E6J712, C1J	05/90 ⇒ 02/98
CLIO I 1.7	F2N770	01/91 ⇒ 12/93
ESPACE I 2.0	J6R734	01/88 ⇒ 12/90
EXPRESS 1.2	C1G	01/85 ⇒ 10/90
EXPRESS 1.4	C1J, F3R262	01/85 ⇒ 10/90
MEGANE I 2.0	F3R262, C1J768	01/97 ⇒ 02/99
RAPID 1.2	C1G726	09/91 ⇒ 08/93
RAPID 1.4	C1J768, C1G702	07/85 ⇒ 09/97
RAPID 1.4 RN	E6J734	09/91 ⇒ 08/93
SUPER 5 1.2	C1G702, C1J768	01/87 ⇒ 12/96
SUPER 5 1.4	C1J768, C1J782	10/84 ⇒ 08/90
SUPER 5 1.4 Turbo	C1J782, F2N740	04/85 ⇒ 08/90
SUPER 5 1.7	F2N740, J6R234	06/87 ⇒ 03/95
TRAFIC I 1.7	F1N720	08/92 ⇒ 08/94
VOLVO		
340-360 1.7	B172K	08/85 ⇒ 07/91

9.0011

04,5

REVOLUTION AND TIMING (CKP AND CMP) SENSORS

Adatt./Suitable:

RENAULT
60 25 003 234**VOLVO**
320414-1
32041410**00 Eliminated on 26-07-2017. Please verify the availability through our local distributors**

- Eliminato il 26-07-2017. Verificare la disponibilità presso i nostri distributori
- Éliminé le 26-07-2017. Vérifier la disponibilité auprès de nos distributeurs sur place
- Am 26-07-2017 gestrichen. Evtl. Verfügbarkeit bitte bei unseren Händlern prüfen
- Eliminado en fecha 26-07-2017. Verificar la disponibilidad a través de nuestros distribuidores locales



L	L1	ohm	
1410	24	240	

RENAULT

ESPACE I 2.0 J6R234, B13 07/84 ⇒ 12/90

VOLVO

340-360 1.3 B13, B14.3E 08/88 ⇒ 12/90

340-360 1.4 B14.3E, B200E 08/82 ⇒ 07/91

340-360 2.0 B200E, B18K 08/84 ⇒ 07/90

9.0012

04,5

REVOLUTION AND TIMING (CKP AND CMP) SENSORS

Adatt./Suitable:

VOLVO334369-6
33436965
345657-1
34565713**03 Supplied until depletion**

- Fornibile fino ad esaurimento delle scorte
- Fourni jusqu'à épuisement du stock
- Lieferbar solange vorrat reicht
- Suministrado hasta el stock termina

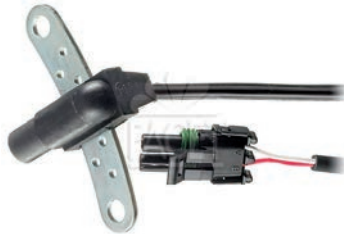

L	L1	ohm	
545	24	240	

VOLVO

440 1.7 B18K, B18K 09/88 ⇒ 12/96

460 1.7 B18K, B18FT 09/88 ⇒ 07/96

9.0013

3,5

REVOLUTION AND TIMING (CKP AND CMP) SENSORS

Adatt./Suitable:

VOLVO334424-7
33442476
343336-3
34333633
343612-0
34361204**03 Supplied until depletion**

- Fornibile fino ad esaurimento delle scorte
- Fourni jusqu'à épuisement du stock
- Lieferbar solange vorrat reicht
- Suministrado hasta el stock termina



L	L1	ohm	
250	24	240	

VOLVO

440 1.7 Turbo B18FT, B18FT 08/88 ⇒ 12/96

460 1.7 Turbo B18FT, B18FT 08/89 ⇒ 07/96

480 1.7 Turbo B18FT, F3N740 08/87 ⇒ 07/96

9.0016

04,5

REVOLUTION AND TIMING (CKP AND CMP) SENSORS

Adatt./Suitable:

BOSCH0 986 280 405
0 986 280 407**RENAULT**77 00 728 637
77 00 728 638
77 00 739 793
77 00 739 794**SIEMENS**

S101750013Z



L	L1	ohm	
540	24	240	

RENAULT

19 I 1.4 C3J710 07/88 ⇒ 04/92

19 I 1.4 Cat C3J710 01/89 ⇒ 04/92

19 I 1.7 F3N740, F7P700 07/88 ⇒ 12/92

19 I 1.8 16V F7P700, C3J710 06/89 ⇒ 09/92

19 II 1.4 C3J710, F3N740 04/92 ⇒ 12/95

19 II 1.7 F3N740, F2N722 04/92 ⇒ 12/95

21 1.7 F2N722, J7R740 03/86 ⇒ 06/94

21 1.7 Cat F3N726 05/88 ⇒ 06/93

21 2.0 J7R740, J7R740 03/86 ⇒ 06/94

21 2.0 4x4 J7R740, J7R752 03/89 ⇒ 02/94

21 2.0 Turbo J7R752, J7R752 04/87 ⇒ 10/92

21 2.0 Turbo 4x4 J7R752, J7R740 08/89 ⇒ 10/93

21 2.0 TXi J7R740, J7T754 07/89 ⇒ 05/93

21 2.2 J7T754, J7T754 04/86 ⇒ 12/95

21 2.2 4x4 J7T754, J7R722 06/86 ⇒ 06/94

25 2.0 J7R722, J7R720 03/87 ⇒ 12/93

25 2.0 12V J7R720, J7T706 06/88 ⇒ 12/93

25 2.2 J7T706, Z7W700 04/84 ⇒ 12/92

25 2.4 V6 Turbo Z7U702 10/84 ⇒ 05/90

25 2.5 V6 Turbo Z7U700 01/90 ⇒ 12/92

25 2.8 V6 Z7W700, Z7W706 06/87 ⇒ 02/90

25 2.8 V6 Injection Z7W706, J7T772 06/87 ⇒ 12/92

ESPACE II 2.0 J7R768 01/91 ⇒ 10/96

ESPACE II 2.2 J7T772, F3R728 01/91 ⇒ 10/96

ESPACE II 2.2 4x4 J7T772 03/91 ⇒ 12/96

ESPACE II 2.8 V6 Z7W712 01/91 ⇒ 10/96

ESPACE III 2.0 F3R728, C3G710 11/96 ⇒ 10/00

ESPACE III 3.0 Z7X775 11/96 ⇒ 10/98

EXPRESS 1.2 C3G710, N7Q700 07/95 ⇒ 10/99

EXPRESS 1.4i C3G/C3J 01/85 ⇒ 10/90

LAGUNA I 2.0 N7Q700, N7Q700 06/95 ⇒ 02/01

LAGUNA I 2.0 16V N7Q700, Z7X760 06/95 ⇒ 03/01

LAGUNA I 3.0 Z7X760, F8Q784 11/93 ⇒ 03/01

MEGANE 1.9 DT/DTi F8Q784, F8Q784 09/96 ⇒ 09/00

MEGANE I 1.9 D F8Q784 04/96 ⇒ 02/01

MEGANE I 1.9 dT F8Q784, F8Q784 01/96 ⇒ 08/03

MEGANE I 1.9 dTi F8Q784, F8Q784 03/97 ⇒ 02/01

MEGANE I 1.9 TDi F8Q784, F3R750 09/96 ⇒ 08/03

MEGANE I 2.0 F3R750, F7R710 04/97 ⇒ 08/03

MEGANE I 2.0 16V F7R710, F3R750 03/96 ⇒ 08/03

MEGANE I 2.0 i F3R750, F3R750 01/96 ⇒ 08/03

MEGANE I 2.0 RT F3R750, F8Q784 10/96 ⇒ 02/99

MEGANE SCÉNIC I 1.9 dT F8Q784, F3R750 01/97 ⇒ 09/99

MEGANE SCÉNIC I 2.0 i F3R750, C3G710 01/97 ⇒ 09/99

MEGANE SCÉNIC I 2.0 RXE 4x4 F3R750 05/97 ⇒ 10/99

RAPID 1.2 C3G710, C3J702 09/91 ⇒ 03/98

RAPID 1.4 Cat C3J702, J7R732 08/88 ⇒ 03/98

SAFRANE I 2.0 J7R732, J7R734 08/92 ⇒ 09/96

SAFRANE I 2.0 12V J7R734, J7T760 04/92 ⇒ 07/96

SAFRANE I 2.2 J7T760, Z7X721 04/92 ⇒ 07/96

SAFRANE I 3.0 Z7X723 02/93 ⇒ 06/96

SAFRANE I 3.0 Biturbo 4x4 Z7X726 02/93 ⇒ 07/96

SAFRANE I 3.0 V6 Z7X721, Z7X721 12/92 ⇒ 07/96

SAFRANE I 3.0 V6 4x4 Z7X721, Z7X755 12/92 ⇒ 07/96

SAFRANE II 3.0 V6 Z7X755, F7R712 07/96 ⇒ 12/00

SCÉNIC I 2.0 F3R798 09/99 ⇒ 08/03

9.0019

RENAULT			
SPORT SPIDER 2.0	F7R710	12/95 ⇒ 08/96	
SPORT SPIDER 2.0 16V	F7R712, C3J702	03/95 ⇒ 10/99	
SUPER 5 1.4	C1J788	04/85 ⇒ 10/87	
SUPER 5 1.4 Cat	C3J702, C1J782	10/85 ⇒ 12/96	
SUPER 5 1.4 Turbo	C1J782, F3N716	04/85 ⇒ 08/90	
SUPER 5 1.7	F3N716, F3N742	10/86 ⇒ 03/95	
SUPER 5 1.7 i	F3N702	10/86 ⇒ 08/91	

9.0019



3,5

REVOLUTION AND TIMING (CKP AND CMP) SENSORS

Adatt./Suitable:

RENAULT
77 00 747 549
77 00 850 589

SIEMENS
S101756003Z



L	L1	ohm	GND OUT
280	24	240	

RENAULT

19 I 1.7	F3N742, F3N742	07/88 ⇒ 04/92	
19 II 1.7	F3N742, F3P682	04/92 ⇒ 12/95	
19 II 1.8	F3P682, F7P704	04/92 ⇒ 06/96	
19 II 1.8 16V	F7P704, F2N722	04/92 ⇒ 06/96	
21 1.7	F2N722, E7J711	03/86 ⇒ 06/94	
CLIO I 1.4	E7J711, F3P754	01/91 ⇒ 09/98	
CLIO I 1.8	F3P754, F3R728	08/90 ⇒ 09/98	
ESPACE III 2.0	F3R728, --	11/96 ⇒ 10/00	
LAGUNA I 2.0	--, J7R751	11/93 ⇒ 03/01	
MEGANE I 1.6 e	K7M703	01/96 ⇒ 08/03	
MEGANE SCÉNIC I 1.6 e	K7M703	10/96 ⇒ 10/99	

9.0020



04,5

REVOLUTION AND TIMING (CKP AND CMP) SENSORS

Adatt./Suitable:

RENAULT
77 00 742 634
77 00 742 635



L	L1	ohm	GND OUT
540	24	240	

RENAULT

21 2.0	J7R751, Z7W713	03/86 ⇒ 06/92	
25 2.8 V6 Injection	Z7W709	06/87 ⇒ 12/92	
ESPACE II 2.2	J7T773	01/91 ⇒ 10/96	
ESPACE II 2.2 4x4	J7T773	03/91 ⇒ 12/96	
ESPACE II 2.8 V6	Z7W713, F3R750	01/91 ⇒ 10/96	
MEGANE I 2.0	F3R750, F3R750	05/98 ⇒ 05/01	

RENAULT

MEGANE I 2.0 i	F3R750, F3R750	01/96 ⇒ 08/03	
MEGANE I 2.0 RT	F3R750, F3R750	10/96 ⇒ 02/99	
MEGANE SCÉNIC I 2.0 i	F3R750, F3R791	01/97 ⇒ 09/99	
SCÉNIC I 2.0	F3R791, KDX(TU3M/Z)	09/99 ⇒ 08/03	

9.0021



04,5

REVOLUTION AND TIMING (CKP AND CMP) SENSORS

Adatt./Suitable:

BOSCH
0 986 280 402

CITROËN
1920 C3
1920 W9
91 541 075
96 037 097
96 068 168

FIAT
9606816880
9622209880

LANCIA
9622209880

PEUGEOT
1920 C3
1920 W9
5918 81
5918 87
5918 90

RENAULT
96 22 209 880

SIEMENS
S102340005Z
S102340006Z

MARKET DIFFUSION: MEDIUM



L	L1	ohm	OUT GND S
330	24	370	

CITROËN

AX 14	KDX(TU3M/Z), 159C	04/87 ⇒ 04/97	
AX 14 4x4	KDY(TU3FM)	08/91 ⇒ 12/96	
BERLINGO I 1.8 i	LFX(XU7JB)	05/97 ⇒ 10/02	
BERLINGO I 1.8 i 4WD	LFX(XU7JB)	04/97 ⇒ 10/01	
BERLINGO I 1.9 D	WJY(DW8B)	07/98 ⇒ 10/05	
BERLINGO I 1.9 D 4WD	WJY(DW8B)	07/98 ⇒ 10/05	
BERLINGO I 1.9 D 70	WJY(DW8B)	04/99 ⇒ 12/11	
BERLINGO I 1.9 D 70 4WD	WJY(DW8B)	07/98 ⇒ 03/06	
BX 1.9	159C, D6D	09/85 ⇒ 12/94	
BX 1.9 GTi	D6D, D6A(XU9J2)	01/87 ⇒ 01/92	
BX 19	D6A(XU9J2), D6A(XU9J2)	07/86 ⇒ 12/94	
BX 19 Cat	DFZ(XU9J1)	07/86 ⇒ 12/94	
BX 19 GTi	D6A(XU9J2), D8B(XUD9TF)	07/86 ⇒ 02/93	
BX 19 GTi 4x4	DKZ(XU9JA)	06/88 ⇒ 02/93	
EVASION 1.8	LFZ(XU7JP)	05/97 ⇒ 07/02	
EVASION 1.9 TD	D8B(XUD9TF), D8B(XUD9TF)	11/94 ⇒ 12/98	
EVASION 2.0	RFU(XU10J2/C)	06/94 ⇒ 07/02	
EVASION 2.0 16V	RFV(XU10J4R)	05/98 ⇒ 04/00	
EVASION 2.0 Turbo C.T.	RGX(XU10J2TE)	06/94 ⇒ 07/02	
EVASION 2.1 TD	P8C(XUD11BTE)	05/96 ⇒ 07/02	
JUMPER I 2.0	RFW(XU10J2U)	02/94 ⇒ 04/02	
JUMPER I 2.0 4x4	RFW(XU10J2U)	08/96 ⇒ 04/02	
JUMPY I 1.9 TD	D8B(XUD9TF), LFX(XU7JB)	10/95 ⇒	
XANTIA I 1.6 i	BFZ(XU5JP)	03/93 ⇒ 03/01	
XANTIA I 1.8 i	LFX(XU7JB), D8B(XUD9TF)	03/93 ⇒ 01/98	
XANTIA I 1.8 i 16V	LFY(XU7JP4)	06/95 ⇒ 04/03	
XANTIA I 1.9 Turbo D	D8B(XUD9TF), RFT(XU10J4/Z)	05/93 ⇒ 04/03	
XANTIA I 2.0	RFXXU10J2C/ZL3	03/93 ⇒ 05/95	
XANTIA I 2.0 HDI 109	RHZ(DW10ATED)	02/99 ⇒ 04/03	
XANTIA I 2.0 HDI 90	RHY(DW10TD)	03/99 ⇒ 04/03	
XANTIA I 2.0 i	RFX(XU10J2C)	03/93 ⇒ 04/03	
XANTIA I 2.0 i 16V	RFT(XU10J4/Z), D8B(XUD9TF)	03/93 ⇒ 04/03	
XANTIA I 2.0 i SX 16V	XU10J4D	04/94 ⇒ 05/95	
XANTIA I 2.0 i VSX 16V	XU10J4D	03/93 ⇒ 05/95	
XANTIA I 2.0 Turbo	RGX(XU10J2TE)	06/95 ⇒ 04/03	
XANTIA I 2.1 Turbo D 12V	P8C(XUD11BTE)	06/95 ⇒ 02/99	

CITROËN

XANTIA I 3.0 i 24V	XFZ(ES9J4)	01/97 ⇒ 04/03	
XANTIA I 3.0 V6	XFZ(ES9J4)	01/98 ⇒ 04/03	
XANTIA II 1.6 i SX	BFZ(XU5JP)	01/98 ⇒ 03/01	
XANTIA II 1.8 i	LFX(XU7JB)	01/98 ⇒ 04/03	
XANTIA II 1.8 i 16V	LFY(XU7JP4)	01/98 ⇒ 04/03	
XANTIA II 1.9 Turbo D	D8B(XUD9TF), RDZ(XU10M2)	01/98 ⇒ 04/03	
XANTIA II 2.0 i	RFX(XU10J2C)	01/98 ⇒ 04/03	
XANTIA II 2.0 i 16V	RFV(XU10J4R)	01/98 ⇒ 04/03	
XANTIA II 2.0 Turbo	RGX(XU10J2TE)	01/98 ⇒ 04/03	
XANTIA II 2.1 Turbo D 12V	P8C(XUD11BTE)	01/98 ⇒ 02/99	
XANTIA II 3.0 V6	XFZ(ES9J4)	01/98 ⇒ 04/03	
XM I 2.0 i	RDZ(XU10M2), SFZ(ZPJ/Z)	05/89 ⇒ 06/94	
XM I 2.0 i Turbo	RGY(XU10J2TE/Z)	09/92 ⇒ 06/94	
XM I 2.0 Turbo	RGY(XU10J2TE/Z)	09/92 ⇒ 04/94	
XM I 3.0	UFZ(ZPJ/Z)	05/89 ⇒ 05/94	
XM I 3.0 V6	SFZ(ZPJ/Z), SKZ(ZPJ4/Z)	05/89 ⇒ 06/94	
XM I 3.0 V6 24V	SKZ(ZPJ4/Z), RGX(XU10J2TE)	07/90 ⇒ 06/94	
XM II 2.0 i	XU10J2	07/94 ⇒ 07/99	
XM II 2.0 i 16V	RFV(XU10J4R)	05/94 ⇒ 10/00	
XM II 2.0 Turbo	RGX(XU10J2TE), SFZ(ZPJ/Z)	05/94 ⇒ 10/00	
XM II 2.1 TD 12V	P8C(XUD11BTE)	05/94 ⇒ 10/00	
XM II 2.5 TD	THY(DKSATE)	05/94 ⇒ 10/00	
XM II 3.0 V6	SFZ(ZPJ/Z), SKZ(ZPJ4/Z)	05/94 ⇒ 10/00	
XM II 3.0 V6 24V	SKZ(ZPJ4/Z), LFX(XU7JB)	05/94 ⇒ 10/00	
XSARA 1.8 i	LFX(XU7JB), DHV(XUD9BSD)	04/97 ⇒ 09/00	
XSARA 1.8 i 16V	LFY(XU7JP4)	04/97 ⇒ 09/00	
XSARA 1.8 i Aut.	LFZ(XU7JP)	04/97 ⇒ 09/00	
XSARA 1.9 D	DHV(XUD9BSD), RFS(XU10J4RS)	01/98 ⇒ 08/05	
XSARA 1.9 SD	DHV(XUD9BSD)	01/98 ⇒ 09/00	
XSARA 2.0 16V	RFS(XU10J4RS), BDY(XU5M)	04/97 ⇒ 09/00	
XSARA 2.0 i 16V	RFS(XU10J4RS)	02/98 ⇒ 03/05	
ZX 1.6	BDY(XU5M), BDY(XU5M)	07/94 ⇒ 10/97	
ZX 1.6 i	BDY(XU5M), LFY(XU7JP4)	03/91 ⇒ 10/97	
ZX 1.8	LFY(XU7JP4), RFS(XU10J4RS)	07/94 ⇒ 10/97	
ZX 1.8 i	LFZ(XU7JP)	07/92 ⇒ 10/97	
ZX 1.8 i 16V	LFY(XU7JP4)	01/96 ⇒ 02/98	
ZX 2.0	RFS(XU10J4RS), RFX(XU10J2C)	07/94 ⇒ 10/97	
ZX 2.0 i	RFX(XU10J2C), RFS(XU10J4RS)	07/92 ⇒ 10/97	
ZX 2.0 i 16V	RFS(XU10J4RS), DHX	07/92 ⇒ 10/97	

FIAT

DUCATO II 1.9 TD	DHX(XUD9TF/L)	04/98 ⇒ 04/02	
DUCATO II 2.0	RFW	03/94 ⇒ 04/02	
DUCATO II 2.0 4x4	RFW	11/94 ⇒ 04/02	
DUCATO II 2.0 Panorama/Combinato	RFW	03/94 ⇒ 04/02	
SCUDO I 1.9 TD	DHX, DHX	02/96 ⇒ 12/06	
SCUDO I 1.9 TD Eco	DHX, RFV	02/96 ⇒ 12/06	
ULYSSE I 1.8	LFW	05/97 ⇒ 08/02	
ULYSSE I 2.0	RFU(XU10J2C)	06/94 ⇒ 08/02	
ULYSSE I 2.0 16V	RFV	05/98 ⇒ 09/00	
ULYSSE I 2.0 Turbo	RGX(XU10J2CTE)	06/94 ⇒ 08/02	
ULYSSE I 2.1 TD	P8C	03/96 ⇒ 10/99	

LANCIA

ZETA 2.0 16V	RFV, RGX	05/98 ⇒ 07/00	
ZETA 2.0 Turbo	RGX, --	05/95 ⇒ 09/02	
ZETA 2.1 TD	P8C	05/96 ⇒ 09/99	

PEUGEOT

205 II 1.6 i	BDZ(XU5M)	01/91 ⇒ 12/94	
206 1.9 D	WJY(DW8B)	09/98 ⇒ 05/07	
306 1.8	--, LFY(XU7JP4)	05/93 ⇒ 04/02	
306 1.8 16V	LFY(XU7JP4), RFV(XU10J4R)	03/97 ⇒ 10/03	
306 1.8 ST	LFZ(XU7JP)	06/94 ⇒ 05/01	
306 2.0	RFV(XU10J4R), RFV(XU10J4R)	03/94 ⇒ 04/02	
306 2.0 16V	RFV(XU10J4R), RFS(XU10J4RS)	03/97 ⇒ 04/02	
306 2.0 S16	RFS(XU10J4RS), BDZ(XU5M)	05/93 ⇒ 05/01	
306 2.0 ST	RFX(XU10J2)	07/94 ⇒ 05/01	
306 2.0 XSi	RFX(XU10J2)	05/93 ⇒ 05/01	
309 II 1.6	BDZ(XU5M)	07/89 ⇒ 12/93	
405 I 1.6	BDZ(XU5M), BDY(XU5M2Z)	07/87 ⇒ 12/92	
405 I 1.6 4x4	BDZ(XU5M)	04/88 ⇒ 07/92	
405 I 1.6 SRI 4x4	BDZ(XU5M)	04/88 ⇒ 07/92	
405 II 1.6	BDY(XU5M2Z), RFX(XU10J2)	08/92 ⇒ 05/97	
405 II 1.8	LFZ(XU7JP)	08/92 ⇒ 10/96	
405 II 2.0	RFX(XU10J2)	08/92 ⇒ 10/96	
405 II 2.0 16V	RFT(XU10J4)	06/94 ⇒ 10/95	
405 II 2.0 4x4	RFX(XU10J2), LFX(XU7JB)	08/92 ⇒ 10/96	
405 II 2.0 T 16 X4	RGZ(XU10J4TE/Z)	08/92 ⇒ 10/95	
405 II 2.0 X4	RFX(XU10J2)	08/92 ⇒ 10/95	

PEUGEOT		
406 1.6	BFZ(XU5JP)	11/95 ⇒ 05/04
406 1.8	LFX(XU7JB), DHX(XUD9TE)	10/96 ⇒ 03/99
406 1.8 16V	LFY(XU7JP4)	11/95 ⇒ 10/00
406 1.9 TD	DHX(XUD9TE), RFV(XU10J4R)	01/96 ⇒ 10/04
406 2.0 16V	RFV(XU10J4R), XFZ(ES9J4)	11/95 ⇒ 12/04
406 2.0 Turbo	RGX(XU10J2TE)	04/96 ⇒ 10/04
406 2.1 TD 12V	P8C(XUD11BTE)	01/96 ⇒ 10/04
406 3.0 24V	XFZ(ES9J4), --	10/96 ⇒ 10/04
406 3.0 V6 24V	XFZ(ES9J4)	03/97 ⇒ 12/04
605 2.0	--, RGX(XU10J2TE)	01/89 ⇒ 09/99
605 2.0 16V	RFV(XU10J4R)	07/94 ⇒ 09/99
605 2.0 Turbo	RGX(XU10J2TE), UFZ(ZPJ)	07/91 ⇒ 09/99
605 2.1 D	P9A(XUD11A)	06/89 ⇒ 07/95
605 2.1 Turbo Diesel	PHZ(XUD11ATE)	06/89 ⇒ 09/99
605 2.5 Turbo Diesel	THY(DKSATE)	07/94 ⇒ 09/99
605 3.0	UFZ(ZPJ), DHX(XUD9TE)	08/89 ⇒ 09/99
605 3.0 SV 24	UKZ(ZPJ4/Z)	08/89 ⇒ 09/99
806 1.8	LFW(XU7JP)	07/95 ⇒ 08/02
806 1.9 TD	DHX(XUD9TE), L6B(XU7JP)	07/95 ⇒ 08/02
806 2.0	RFU(XU10J2)	06/94 ⇒ 08/02
806 2.0 16V	RFV(XU10J4R)	05/98 ⇒ 09/00
806 2.0 Turbo	RGX(XU10J2TE)	06/94 ⇒ 08/02
806 2.1 td 12V	P8C(XUD11BTE)	06/96 ⇒ 08/99
BOXER I 2.0 4x4	--	03/96 ⇒ 09/98
BOXER I 2.0 i	RFW(XU10J2)	03/94 ⇒ 04/02
BOXER I 2.0 i 4x4	RFW(XU10J2)	08/96 ⇒ 04/02
EXPERT I 1.8	L6B(XU7JP), D8B(XUD9TE)	09/96 ⇒
EXPERT I 1.9 TD	D8B(XUD9TE), L7X700	02/96 ⇒ 05/98
PARTNER I 1.8	LFX(XU7JB)	03/97 ⇒ 12/03
PARTNER I 1.9 D	WJY(DW8B)	06/96 ⇒ 12/15
PARTNER I 1.9 D 4x4	WJY(DW8B)	04/04 ⇒ 11/07
RANCH 1.8	LFX(XU7JB)	05/97 ⇒
RANCH 1.9 D	WJY(DW8B)	06/96 ⇒
RANCH 1.9 D 4x4	WJY(DW8B)	04/04 ⇒
RENAULT		
ESPACE III 3.0 V6 24V	L7X727	10/98 ⇒ 10/02
LAGUNA I 3.0 24V	L7X700, E7J706	03/97 ⇒ 03/01
SAFRANE II 2.9 24V	L7X713	03/99 ⇒ 12/00

9.0022



04,5

**REVOLUTION AND TIMING (CKP AND CMP)
SENSORS**

Adatt./Suitable:

BOSCH
F 000 99R 010

FIAT
7735697

MAGNETI MARELLI
064820171010
648 201 71
SEN 8D3

L	L1	ohm	OUT GND S
440	20,7	700	

FIAT		
CINQUECENTO 0.9 i.e.	170A1.046	07/91 ⇒ 09/94
CINQUECENTO 0.9 i.e. S	1170A1.046	07/91 ⇒ 07/99
PANDA I 900	1170A1.046	04/92 ⇒ 12/96
PANDA I 900 i.e.	1170A1.046	01/98 ⇒
SEICENTO / 600 0.9	1170A1.046	11/97 ⇒ 01/10

9.0023



3,5

**REVOLUTION AND TIMING (CKP AND CMP)
SENSORS**

Adatt./Suitable:

RENAULT
77 00 855 719
SIEMENS
S101750021Z

L	L1	ohm	OUT GND
280	24	240	

RENAULT			
19 I 1.2i	E7F	01/89 ⇒ 12/92	
19 I 1.4	E7J700	09/90 ⇒ 04/92	
19 II 1.2	E7F730	05/92 ⇒ 09/94	
19 II 1.4	E7J706, F3P682	01/92 ⇒ 12/95	
19 II 1.8	F3P682, F7P704	04/92 ⇒ 06/96	
19 II 1.8 16V	F7P704, C3G720	04/92 ⇒ 06/96	
CLIO I 1.2	C3G720, E7J601	05/90 ⇒ 09/98	
CLIO I 1.4	E7J601, F3P710	01/90 ⇒ 09/98	
CLIO I 1.8	F3P710, F7P720	08/90 ⇒ 09/98	
CLIO I 1.8 16V	F7P720, F3P712	01/91 ⇒ 03/96	
CLIO I 1.8 Rsi	F3P712, F8Q676	01/93 ⇒ 09/98	
CLIO I 1.9 D	F8Q676, F3R728	01/91 ⇒ 09/98	
CLIO I Williams	F7R700	01/94 ⇒ 09/98	
ESPACE III 2.0	F3R728, C1J	11/96 ⇒ 10/00	
EXPRESS 1.4	C1J, F3P670	01/85 ⇒ 10/90	
LAGUNA I 1.8	F3P670, F3R722	11/93 ⇒ 03/01	
LAGUNA I 2.0	F3R722, E7J626	11/93 ⇒ 03/01	
MEGANE I 1.4	E7J626, E7J626	09/96 ⇒ 08/03	
MEGANE I 1.4 16V	K4J710	05/99 ⇒ 11/02	
MEGANE I 1.4 e	E7J626, K7M702	01/96 ⇒ 08/03	
MEGANE I 1.4 Eco	E7J624	01/96 ⇒ 03/99	
MEGANE I 1.6 e	K7M702, E7J720	01/96 ⇒ 08/03	
MEGANE I 1.6 i	K7M720	01/96 ⇒ 03/99	
MEGANE I 1.6 LPG	K7M702	08/95 ⇒ 03/99	
MEGANE SCÉNIC I 1.4 i	E7J764	01/97 ⇒ 09/99	
MEGANE SCÉNIC I 1.6 e	K7M702	10/96 ⇒ 10/99	
MEGANE SCÉNIC I 1.6 i	K7M720	01/97 ⇒ 09/99	
MEGANE 1.6 BiFuel	K7M702	10/96 ⇒ 10/99	
RAPID 1.4	E7J720, C3G700	09/91 ⇒ 03/98	
TWINGO I 1.2	C3G700, C2J720	03/93 ⇒	

9.0026



04,5

**REVOLUTION AND TIMING (CKP AND CMP)
SENSORS**

Adatt./Suitable:

JEEP
S100470209
RENAULT
77 00 722 143
77 00 739 789
77 01 349 559

⁰⁰ Eliminated on 22-05-2017. Please verify the availability through our local distributors

- Eliminato il 22-05-2017. Verificare la disponibilità presso i nostri distributori
- Éliminé le 22-05-2017. Vérifier la disponibilité auprès de nos distributeurs sur place
- Am 22-05-2017 gestrichen. Evtl. Verfügbarkeit bitte bei unseren Händlern prüfen
- Eliminado en fecha 22-05-2017. Verificar la disponibilidad a través de nuestros distribuidores locales



L	L1	ohm	OUT GND
830	24	240	

RENAULT			
11 1.4	C2J720, 847720	03/83 ⇒ 12/88	
11 1.7	F2N700	10/83 ⇒ 12/87	
18 1.4	847720, A6M725	04/78 ⇒ 07/86	
18 1.6 TS	A6M725, J6R706	05/82 ⇒ 07/86	
18 2.0	J6R716	05/82 ⇒ 07/86	
25 2.0	J6R706, NF	04/84 ⇒ 12/92	
FUEGO 1.6 [USA] R136A	A7L	01/82 ⇒ 12/86	
RAPID 1.4 Cat	C3J700	08/88 ⇒ 03/98	
SUPER 5 1.4	C3J700	09/85 ⇒ 07/86	
SUPER 5 1.4 Cat	C3J700	10/85 ⇒ 12/96	

9.0028



1

REVOLUTION AND TIMING (CKP AND CMP) SENSORS

Adatt./Suitable:

AUDI086 927 321
095 927 321 A
095 927 321 C**FIAT**

9944264

FORD1 006 990
1 094 772
95VW-7F293-AA
95VW-7F293-AB**LANCIA**

9944264

SEAT095 927 321 A
095 927 321 C**SKODA**

095 927 321 C

VW086 927 321
095 927 321
095 927 321 A
095 927 321 C

L	L1	ohm	
---	30,5	800	

AUDI

80 III 2.0 E 16V quattro	6A	03/90 ⇒ 08/91
80 IV 1.9 TD	AZ	09/91 ⇒ 12/94
80 IV 1.9 TDI	1Z	09/91 ⇒ 01/96
80 IV 2.0	ABT	09/91 ⇒ 01/96
80 IV 2.0 E	ABK	09/91 ⇒ 01/96
80 IV 2.0 E quattro	ABK	09/91 ⇒ 12/94
80 IV 2.0 quattro	ADW	11/93 ⇒ 01/96
80 IV 2.3 E	NG	09/91 ⇒ 01/96
80 IV 2.6	ABC	07/92 ⇒ 01/96
80 IV 2.6 E	ACZ	05/93 ⇒ 05/95
80 IV 2.8	AAH	09/91 ⇒ 01/96
80 IV 2.8 quattro	AAH	09/91 ⇒ 12/94
90 II 2.3 E	NG, 7A	04/87 ⇒ 09/91
90 II 2.3 E 20V	7A, AEH	08/88 ⇒ 07/91
90 II 2.3 E quattro	NG	04/87 ⇒ 09/91
100 III 2.3	NF, NF	08/86 ⇒ 11/90
100 III 2.3 E	NF, AAD	10/86 ⇒ 11/90
100 IV 2.0	AAE	12/90 ⇒ 07/94
100 IV 2.0 E	AAD, NG	12/90 ⇒ 07/94
100 IV 2.0 E 16V	ACE	07/92 ⇒ 07/94
100 IV 2.0 E 16V quattro	ACE	07/92 ⇒ 07/94
100 IV 2.0 E quattro	AAD	12/90 ⇒ 07/92
100 IV 2.3 E	AAR	12/90 ⇒ 07/94
100 IV 2.3 E quattro	AAR	12/90 ⇒ 07/94
100 IV 2.6 quattro	ABC	04/92 ⇒ 07/94
100 IV 2.8 E	AAH	12/90 ⇒ 07/94
100 IV 2.8 E quattro	AAH	12/90 ⇒ 07/94
A2 1.2 TDI	ANY	03/01 ⇒ 08/05
A3 1.6	AEH, AGN	08/00 ⇒ 05/03
A3 1.8	AGN, AGU	09/96 ⇒ 05/03
A3 1.8 T	AGU, AGU	12/96 ⇒ 05/03
A3 1.8 T quattro	AGU, AGR	12/96 ⇒ 05/03
A3 1.9 TDI	AGR, ADP	09/96 ⇒ 07/01
A4 1.6	ADP, AFY	11/94 ⇒ 09/01
A4 1.8	AFY, AFY	11/94 ⇒ 09/01
A4 1.8 quattro	AFY, 1Z	01/95 ⇒ 09/01
A4 1.9 DUO	AHU	03/98 ⇒ 09/01
A4 1.9 TDI	1Z, 1Z	01/95 ⇒ 09/01
A4 1.9 TDI quattro	AVG	09/96 ⇒ 09/01
A6 1.8	ADR	12/95 ⇒ 12/97
A6 1.9 TDI	1Z, AFY	06/94 ⇒ 12/97

A6 1.2.0	ABK	06/94 ⇒ 12/97
A6 1.2.3	AAR	06/94 ⇒ 12/95
A6 II 1.8	AFY, AFN	05/97 ⇒ 01/05
A6 II 1.9 TDI	AFN, AKE	04/97 ⇒ 04/01
ALLROAD 2.5 TDI quattro	AKE, ARE	05/00 ⇒ 08/05
ALLROAD 2.7 T quattro	ARE, ABC	05/00 ⇒ 08/05
CABRIOLET 1.8	ADR	01/97 ⇒ 08/00
CABRIOLET 2.3 E	NG	05/91 ⇒ 07/94
CABRIOLET 2.6	ABC, NG	06/93 ⇒ 08/00
CABRIOLET 2.8	AAH	11/92 ⇒ 08/00
COUPE 2.0	ABK	05/89 ⇒ 12/96
COUPE 2.3	NG, 7A	10/88 ⇒ 12/96
COUPE 2.3 20V	7A, BYH	08/89 ⇒ 07/91
COUPE 2.6	ABC	08/92 ⇒ 12/96
COUPE 2.8	AAH	09/91 ⇒ 12/96
R8 4.2 FSI quattro	BYH, BUJ	04/07 ⇒ 07/15
R8 5.2 FSI quattro	BUJ, 159A4.000	04/09 ⇒ 07/15

FIAT

TEMPRA 1.8 4x4	159A4.000	07/92 ⇒ 06/93
TEMPRA 1.8 i.e.	159A4.000, 159A4.000	03/90 ⇒ 08/96
TEMPRA 2.0	159A6.046	04/90 ⇒ 06/93
TEMPRA 2.0 i.e.	159A6.046	10/90 ⇒ 08/96
TEMPRA 2.0 i.e. [BRA]	159A6.011	04/93 ⇒ 12/96
TEMPRA 2.0 i.e. 4x4	159A6.046	03/92 ⇒ 03/95
TIPO I 1.8 i.e	836A5.000	03/93 ⇒ 04/95
TIPO I 1.8 i.e.	159A4.000, 159A5.046	10/90 ⇒ 10/95
TIPO I 2.0	159A5.046, 159A5.046	10/90 ⇒ 04/95
TIPO I 2.0 i.e.	159A5.046, 1Z	03/90 ⇒ 04/95
TIPO I 2.0 i.e. [BRA]	159A6.011	03/93 ⇒ 10/95
TIPO I 2.0 i.e. 16V Sport	836A3.000	03/93 ⇒ 04/95

FORD

GALAXY I 1.9 TDI	1Z, NSE	03/95 ⇒ 05/06
GALAXY I 2.0 i	NSE, E5SA	11/95 ⇒ 05/06
GALAXY I 2.3 16V	E5SA, AAA	09/01 ⇒ 05/06
GALAXY I 2.8 iV6	AAA, AAA	11/95 ⇒ 04/00
GALAXY I 2.8 iV6 4x4	AAA, 835A1.000	04/96 ⇒ 04/00

LANCIA

DEDRA 1.6 i.e.	835A1.000, 835A2.000	08/89 ⇒ 07/99
DEDRA 1.8 i.e.	835A2.000, 835A5.000	09/89 ⇒ 07/99
DEDRA 2.0 i.e.	835A5.000, 1Z	09/89 ⇒ 07/99

SEAT

ALHAMBRA I / II 1.8 T 20V	AJH	10/97 ⇒ 03/10
ALHAMBRA I / II 1.9 TDI	1Z, ADY	11/02 ⇒ 03/10
ALHAMBRA I / II 1.9 Tdi 4x4	ASZ	06/05 ⇒ 11/08
ALHAMBRA I / II 2.0 i	ADY, ABS	04/96 ⇒ 03/10
CORDOBA I 1.6 i	AKL	07/96 ⇒ 10/02
CORDOBA I 1.8 i	ABS, AEH	02/93 ⇒ 09/02
IBIZA II 1.6	AEH, ABS	08/99 ⇒ 02/02
IBIZA II 1.6 i	1F	09/94 ⇒ 06/99
IBIZA II 1.8 i	ABS, AEH	03/93 ⇒ 08/99
LEON I 1.6	AEH, AGN	11/99 ⇒ 06/06
LEON I 1.8 20V	AGN, AHF	11/99 ⇒ 06/06
LEON I 1.9 TDI	AHF, 2E	11/99 ⇒ 06/06
TOLEDO I 2.0 i	2E, AEH	05/91 ⇒ 03/99
TOLEDO II 1.6	AEH, AGN	10/98 ⇒ 07/04
TOLEDO II 1.8 20V	AGN, AHF	10/98 ⇒ 07/04
TOLEDO II 1.9 TDI	AHF, AEH	10/98 ⇒ 07/04

SKODA

OCTAVIA I 1.6	AEH, APK	02/97 ⇒ 12/07
OCTAVIA I 1.8	AGN	09/96 ⇒ 07/00
OCTAVIA I 1.8 20V	AGN	07/98 ⇒ 07/00
OCTAVIA I 1.9 TDI	AHF	08/97 ⇒ 01/06
OCTAVIA I 2.0	APK, AEH	04/99 ⇒ 05/07

VW

BORA 1.6	AEH, AGN	08/00 ⇒ 05/05
BORA 1.8	AGN	10/98 ⇒ 05/05
BORA 1.8 4motion	AGN, AGU	05/99 ⇒ 05/05
BORA 1.8 T	AGU, AGR	05/00 ⇒ 05/05
BORA 1.9 TDI	AGR, AGR	07/01 ⇒
BORA 1.9 TDI 4motion	AGR, APK	07/01 ⇒
BORA 2.0	APK, 2E	10/98 ⇒ 05/05
BORA 2.3 V5	AGZ	10/98 ⇒ 10/00
BORA 2.3 V5 4motion	AGZ	12/98 ⇒ 10/00
CORRADO 1.8 16V	KR	04/89 ⇒ 07/92
CORRADO 1.8 G60	PG	09/88 ⇒ 09/93
CORRADO 2.0 i	2E, AEK	04/93 ⇒ 12/95
CORRADO 2.0 i 16V	9A	08/91 ⇒ 12/95
CORRADO 2.9 VR6	ABV	08/91 ⇒ 12/95
GOLF III 1.6	AEK, AAM	07/94 ⇒ 04/99
GOLF III 1.8	AAM, 1Z	08/91 ⇒ 04/99
GOLF III 1.9 TD	AAZ	07/93 ⇒ 04/99
GOLF III 1.9 TD, GTD	AAZ	11/91 ⇒ 08/97
GOLF III 1.9 TDI	1Z, 2E	09/93 ⇒ 04/99
GOLF III 2.0	2E, AAA	11/91 ⇒ 04/99
GOLF III 2.0 GL	AEP	08/95 ⇒ 09/97
GOLF III 2.8 VR6	AAA, AEH	01/92 ⇒ 09/97
GOLF IV 1.6	AEH, ADZ	06/98 ⇒ 06/06
GOLF IV 1.8	ADZ, AGR	08/97 ⇒ 06/05

VW

GOLF IV 1.8 4motion	AGN	05/98 ⇒ 06/06
GOLF IV 1.8 T	AGU	08/97 ⇒ 06/06
GOLF IV 1.9 TDI	AGR, AGR	06/98 ⇒ 05/06
GOLF IV 1.9 TDI 4motion	AGR, AGG	05/01 ⇒ 05/06
GOLF IV 2.0	AGG, ANY	06/98 ⇒ 06/06
GOLF IV 2.3 V5	AGZ	08/97 ⇒ 06/06
GOLF IV 2.3 V5 4motion	AGZ	12/98 ⇒ 06/06
LUPU 1.2 TDI 3L	ANY, APH	07/99 ⇒ 07/05
NEW BEETLE 1.6	AYD	06/00 ⇒ 09/10
NEW BEETLE 1.8 T	APH, AEG	10/99 ⇒ 09/10
NEW BEETLE 1.9 TDI	ALH	01/98 ⇒ 06/04
NEW BEETLE 2.0	AEG, 1F	01/98 ⇒ 10/10
PASSAT III 1.6	1F, ABS	04/88 ⇒ 08/96
PASSAT III 1.6 TD	RA	08/88 ⇒ 09/93
PASSAT III 1.8	ABS, 1Z	02/88 ⇒ 05/97
PASSAT III 1.8 16V	KR	04/88 ⇒ 12/89
PASSAT III 1.8 GL	KR	08/91 ⇒ 09/93
PASSAT III 1.9 D	1Y	05/89 ⇒ 10/93
PASSAT III 1.9 TD	AAZ	03/91 ⇒ 05/97
PASSAT III 1.9 TDI	1Z, 2E	10/93 ⇒ 05/97
PASSAT III 2.0	2E, 2E	02/90 ⇒ 05/97
PASSAT III 2.0 16V	9A	08/88 ⇒ 09/93
PASSAT III 2.0 Syncro	2E, ADP	10/90 ⇒ 05/97
PASSAT III 2.0i	ACX	08/93 ⇒ 12/96
PASSAT III 2.8 VR6	AAA	06/91 ⇒ 05/97
PASSAT IV 1.6	ADP, ADR	10/96 ⇒ 11/00
PASSAT IV 1.8	ADR, ADR	10/96 ⇒ 03/05
PASSAT IV 1.8 Syncro/4motion	ADR, AFN	10/96 ⇒ 11/00
PASSAT IV 1.9 TDI	AFN, AFN	02/00 ⇒ 05/05
PASSAT IV 1.9 TDI Syncro/4motion	AFN, AEH	10/96 ⇒ 11/00
PASSAT IV 2.0	AZM	11/00 ⇒ 05/05
PASSAT IV 2.0 [CHN]	BNL	01/06 ⇒
PASSAT IV 2.0 4motion	AZM	11/00 ⇒ 05/05
POLO III 1.6	AEH, AEH	05/97 ⇒ 09/01
POLO III 100 1.6	AEH, AFN	12/95 ⇒ 09/01
POLO III 2.0	ADC	08/99 ⇒ 09/01
SHARAN I 1.8 T 20V	AJH	09/97 ⇒ 03/10
SHARAN I 1.9 TDI	AFN, ADY	09/96 ⇒ 04/00
SHARAN I 2.0	ADY, AAA	09/95 ⇒ 03/10
SHARAN I 2.0 LPG	ATM	04/06 ⇒ 03/10
SHARAN I 2.8 VR6	AAA, AAA	09/95 ⇒ 04/00
SHARAN I 2.8 VR6 Syncro	AAA, AAB	11/96 ⇒ 04/00
TRANSPORTER IV 2.0	AAC	07/90 ⇒ 04/03
TRANSPORTER IV 2.4 D	AAB, AAF	07/90 ⇒ 04/98
TRANSPORTER IV 2.4 D Syncro	AAB	10/92 ⇒ 09/98
TRANSPORTER IV 2.5	AAF, AAF	11/90 ⇒ 06/03
TRANSPORTER IV 2.5 Syncro	AAF, ACV	10/92 ⇒ 04/03
TRANSPORTER IV 2.5 TDI	ACV, AES	09/95 ⇒ 04/03
TRANSPORTER IV 2.5 TDI Syncro	ACV	09/95 ⇒ 04/03
TRANSPORTER IV 2.8	AES	05/96 ⇒ 05/00
TRANSPORTER IV 2.8 VR 6	AES	11/95 ⇒ 04/00
TRANSPORTER IV 2.8 VR6 Syncro	AES, ABU	04/00 ⇒ 04/03
TRANSPORTER IV 2.8 VR6 Syncro	AES	01/96 ⇒ 04/96
VENTO 1.4	ABD	11/91 ⇒ 09/98
VENTO 1.6	ABU, AAM	09/92 ⇒ 09/98
VENTO 1.8	AAM, 2E	11/91 ⇒ 09/98
VENTO 1.9 TDI	AHU	09/93 ⇒ 09/98
VENTO 2.0	2E, 834B2.000	11/91 ⇒ 09/98

9.0030



04,5

REVOLUTION AND TIMING (CKP AND CMP) SENSORS

Adatt./Suitable:

FIAT7679221
7694335**LANCIA**

7679221

MAGNETI MARELLI064820162010
648 201 62
SEN 8K**SEAT**

SE 028947.500A



L	L1	ohm	OUT GND
460	20,7	700	

FIAT			
CINQUECENTO 0.9	170A1.000	07/91 ⇨ 12/93	
CINQUECENTO 0.9 i.e. S	1170A1.000	07/91 ⇨ 07/99	
DUCATO II 1.9 TD CAT	230A4.000	08/94 ⇨ 04/02	
DUCATO II 1.9 TD Combinato	230A4.000	08/94 ⇨ 04/02	
UNO 1.4 Turbo i.e.	146A8.046	09/89 ⇨ 09/93	

FIAT (BR)			
UNO 1.4i Turbo	1.4Mpi	01/94 ⇨ 12/96	

LANCIA			
THEMA 2000 16V Turbo	834C1.000	12/88 ⇨ 06/90	
THEMA 2000 i.e. 16V	834B2.000, 834C1.000	05/88 ⇨ 08/92	
THEMA 2000 i.e. 16V Turbo	834C1.000, 835C2.000	12/88 ⇨ 03/93	

SEAT			
MARBELLA 0.9 Cat	08NCB	11/96 ⇨ 10/98	

9.0032



04,5

REVOLUTION AND TIMING (CKP AND CMP) SENSORS

Adatt./Suitable:

ALFA ROMEO60810103
7733001**FIAT**

7733001

LANCIA

7733001

MAGNETI MARELLI064820168010
SEN 8I3

L	L1	ohm	OUT GND S
440	30	700	

ALFA ROMEO			
145 1.4 i.e.	AR33501	07/94 ⇨ 12/96	
146 1.4 i.e.	AR33501	12/94 ⇨ 12/96	

FIAT			
TEMPRA 1.8 i.e.	835C2.000, 835C2.000	09/93 ⇨ 08/96	
TIPO I 1.8 i.e.	836A5.000	03/93 ⇨ 04/95	
TIPO I 1.8 i.e.	835C2.000, 835C2.000	03/93 ⇨ 10/95	

LANCIA			
DEDRA 1.8 i.e.	836A5.000	07/94 ⇨ 07/99	
DELTA II 1.8 i.e.	835C2.000, LUH	06/93 ⇨ 08/99	

9.0035



3

REVOLUTION AND TIMING (CKP AND CMP) SENSORS

Adatt./Suitable:

FORD6 502 252
6 859 701
88WF-6C315-AC
88WF-6C315-AD

L	L1	ohm	GND OUT
---	52	290	

FORD			
FIESTA III 1.6	LUH, LJC	01/89 ⇨ 01/94	
FIESTA III 1.6 Turbo	LHA	03/90 ⇨ 10/92	
FIESTA III 1.6 XR2i	LJC, N9B	03/89 ⇨ 01/94	
SCORPIO I 2.0 i	N9B, J6A	05/89 ⇨ 09/94	
SIERRA II 1.6 i	L6B	10/89 ⇨ 02/93	
SIERRA II 2.0 i	N9B	06/89 ⇨ 02/93	

9.0036



3

REVOLUTION AND TIMING (CKP AND CMP) SENSORS

Adatt./Suitable:

BOSCH

0 986 280 449

FORD6 164 900
6 502 253
6 859 702
89BF-6C315-AA
89BF-6C315-AB
89BF-6C315-AC

L	L1	ohm	GND OUT
---	40	290	

FORD			
ESCORT-NOMADE 1.8	D18NARTH	01/95 ⇨ 04/00	
ESCORT III 1.1	G5G	05/86 ⇨ 07/90	
ESCORT IV 1.1	G5G	12/85 ⇨ 07/90	
ESCORT IV 1.3	J6A, F6F	01/95 ⇨ 08/97	
ESCORT IV 1.4	F6F, RTE	07/90 ⇨ 12/94	
ESCORT IV 1.8 D	RTE, RFK	01/95 ⇨ 08/00	
ESCORT IV 1.8 TD	RFK, J4B	01/95 ⇨ 08/00	
ESCORT V 1.3	J4B, F4B	07/90 ⇨ 01/95	
ESCORT V 1.4	F4B, LUF	07/90 ⇨ 01/95	
ESCORT V 1.4 i	F4B	07/93 ⇨ 01/95	
ESCORT V 1.6	LUF, BL13H-JBE	07/90 ⇨ 12/92	
ESCORT VI 1.3	BL13H-JBE, F4B	01/95 ⇨ 02/99	
ESCORT VI 1.4	F4B, RTE	01/95 ⇨ 02/99	
ESCORT VI 1.8 D	RTE, G6A	01/95 ⇨ 02/99	

FORD			
FIESTA III 1.0	TLB	03/89 ⇨ 12/95	
FIESTA III 1.1	G6A, J6B	03/89 ⇨ 12/95	
FIESTA III 1.3	J6B, LUH	03/89 ⇨ 02/96	
FIESTA III 1.3 Cat	J6B	05/91 ⇨ 01/97	
FIESTA III 1.4	FUG	03/89 ⇨ 12/95	
FIESTA III 1.4 Cat	F4A	03/89 ⇨ 12/95	
FIESTA III 1.6	LUH, LJC	01/89 ⇨ 01/94	
FIESTA III 1.6 Turbo	LHA	03/90 ⇨ 10/92	
FIESTA III 1.6 XR2i	LJC, BL13H-JBE	03/89 ⇨ 01/94	
ORION II 1.3	BL13H-JBE, F6F	07/90 ⇨ 12/94	
ORION II 1.4	F6F, LUJ	07/90 ⇨ 12/93	
ORION II 1.6	LUJ, HL16EFF-LJE	07/90 ⇨ 12/92	
ORION II 1.6 i	HL16EFF-LJE, EDDBA	07/90 ⇨ 09/92	
SIERRA II 1.6 i	L6B	10/89 ⇨ 02/93	

9.0037



3

REVOLUTION AND TIMING (CKP AND CMP) SENSORS

Adatt./Suitable:

FORD6 602 998
6 740 816
6 859 705
928F-6C315-A1F
948F-6C315-AA
F5RZ-6C315-AA**MAZDA**

1E00-18-221

YF09-18-221

MOTORCRAFT

DY-913

MARKET DIFFUSION: MEDIUM



L	L1	ohm	OUT GND
---	37,5	400	

FORD			
COUGAR 2.0 16V	EDBA, L1E	08/98 ⇨ 12/01	
ESCORT-NOMADE 1.6	ZH16L1E, DHA	01/95 ⇨ 04/00	
ESCORT-NOMADE 1.8	ZH18NRDA	01/95 ⇨ 04/00	
ESCORT-NOMADE 1.8 TDi	D18TIRFK	01/95 ⇨ 04/00	
ESCORT IV 1.6 16V	L1E, RFK	10/98 ⇨ 07/00	
ESCORT IV 1.8 TD	RFK, L1E	10/98 ⇨ 07/00	
ESCORT IV 1.8 Turbo D	RVA	12/95 ⇨ 06/01	
ESCORT V 1.6 16V XR3i	L1E	12/92 ⇨ 01/95	
ESCORT V 1.6 i 16V	L1E, RDA	09/92 ⇨ 01/95	
ESCORT V 1.8 16V	RDA	02/92 ⇨ 12/92	
ESCORT V 1.8 16V XR3i	RDA, RDA	02/92 ⇨ 01/95	
ESCORT V 1.8 i 16V	RDA, RDA	09/92 ⇨ 01/95	
ESCORT V 1.8 XR3i 16V 4x4	RDA, BL13H-JBE	08/93 ⇨ 01/95	
ESCORT VI 1.3	BL13H-JBE, L1E	01/95 ⇨ 02/99	
ESCORT VI 1.6 16V	L1E, L1E	01/95 ⇨ 07/00	
ESCORT VI 1.6 16V 4x4	L1E	01/95 ⇨ 10/98	
ESCORT VI 1.6 16V XR3i	L1E, L1E	02/95 ⇨ 09/99	
ESCORT VI 1.6 i 16V	L1E, RDA	01/95 ⇨ 02/99	
ESCORT VI 1.8 16V	RDA, RDA	01/95 ⇨ 02/99	
ESCORT VI 1.8 16V XR3i	RDA, RFK	02/95 ⇨ 08/98	
ESCORT VI 1.8 TD	RFK, ZH16L1E	01/95 ⇨ 07/00	
ESCORT VI 1.8 Turbo D	RVA	12/95 ⇨ 08/99	
FIESTA III 1.1	G6A, J6B	03/89 ⇨ 12/95	
FIESTA III 1.3	J6B, DHA	03/89 ⇨ 02/96	
FIESTA III 1.3 Cat	J6B	05/91 ⇨ 01/97	
FIESTA III 1.4	FUG	03/89 ⇨ 12/95	
FIESTA III 1.6 i 16V	L1G	01/94 ⇨ 12/95	
FIESTA III 1.8 16V	RDB	02/92 ⇨ 12/95	
FIESTA III 1.8 XR2i 16V	RQC	02/92 ⇨ 12/95	
FIESTA IV 1.0 i	ZH10JRB	02/97 ⇨ 09/99	
FIESTA IV 1.25 i 16V	DHA, J4C	08/95 ⇨ 01/02	

FORD			
FIESTA IV 1.3	J4C, J4C	02/96 ⇒ 08/03	
FIESTA IV 1.3 i	J4C, FHA	08/95 ⇒ 01/02	
FIESTA IV 1.4	FHA	08/98 ⇒ 04/02	
FIESTA IV 1.4 i	FHA	04/96 ⇒ 10/99	
FIESTA IV 1.4 i 16V	FHA, L1T	04/96 ⇒ 01/02	
FIESTA IV 1.6 16V Sport	L1T, RTJ	02/00 ⇒ 01/02	
FIESTA IV 1.8 D	RTJ, RTN	08/95 ⇒ 04/02	
FIESTA IV 1.8 Di	RTN, RTJ	04/00 ⇒ 08/03	
FIESTA IV D 1.8	RTJ, RTN	05/98 ⇒ 04/02	
FIESTA IV TD 1.8	RTN, FXDA	03/00 ⇒ 08/03	
FIESTA 1.2	DHA, G6A	01/96 ⇒ 04/02	
FOCUS I 1.4	FXDA, FXDA	04/99 ⇒ 03/05	
FOCUS I 1.4 16V	FXDA, FYDA	10/98 ⇒ 11/04	
FOCUS I 1.6	FYDA, --	04/99 ⇒ 03/05	
FOCUS I 1.6 16V	--, EYDB	02/99 ⇒ 11/04	
FOCUS I 1.6 16V Flexifuel	FYDH	01/02 ⇒ 11/04	
FOCUS I 1.8	EYDB, EYDB	04/99 ⇒ 03/05	
FOCUS I 1.8 16V	EYDB, EYDD	10/98 ⇒ 11/04	
FOCUS I 1.8 16V BiFuel	EYDD, BHDA	09/02 ⇒ 07/04	
FOCUS I 1.8 BiFuel	EYDL	02/03 ⇒ 01/05	
FOCUS I 1.8 Di / TDDi	BHDA, BHDA	08/99 ⇒ 11/04	
FOCUS I 1.8 TDDi	BHDA, BHDA	08/98 ⇒ 03/05	
FOCUS I 1.8 Turbo Di / TDDi	BHDA, EDDB	10/98 ⇒ 03/05	
FOCUS I 2.0 16V	EDDB, A9A	10/98 ⇒ 11/04	
FOCUS IRS	HMDA	10/02 ⇒ 11/04	
FOCUS I ST170	ALDA	03/02 ⇒ 11/04	
IKON 1.3 EFI	--	01/00 ⇒	
IKON 1.3 Rocam	--	10/00 ⇒	
IKON 1.6 EFI Rocam	--	11/99 ⇒	
IKON 1.8 D	--	01/00 ⇒	
KA I 1.3	A9A, JJB	09/02 ⇒ 03/04	
KA I 1.3 i	JJB, L1F	09/96 ⇒ 11/08	
MAVERICK 2.0 16V	YF	02/01 ⇒	
MAVERICK 2.0 16V FWD	YF	02/01 ⇒	
MONDEO I 1.6 i	L1J	08/96 ⇒ 09/00	
MONDEO I 1.6 i 16V	L1F, RKA	02/93 ⇒ 09/00	
MONDEO I 1.8 4x4	RKA	02/93 ⇒ 08/96	
MONDEO I 1.8 i	RKA, RKA	08/96 ⇒ 09/00	
MONDEO I 1.8 i 16V	RKA, NGA	02/93 ⇒ 08/96	
MONDEO I 1.8 i 16V 4x4	RKA	02/93 ⇒ 08/96	
MONDEO I 1.8 TD	RFN	08/96 ⇒ 09/00	
MONDEO I 2.0 i	NGA, NGA	08/96 ⇒ 09/00	
MONDEO I 2.0 i 16V	NGA, NGA	01/93 ⇒ 08/96	
MONDEO I 2.0 i 16V 4x4	NGA, DSBA	02/93 ⇒ 08/96	
MONDEO II 2.0 16V Di / TDDi / TDCi	DSBA, D6BA	10/00 ⇒ 03/07	
MONDEO II 2.0 16V TDDi / TDCi	D6BA, L1E	10/00 ⇒ 03/07	
MONDEO 1.8 TDi	RFN	09/96 ⇒ 09/00	
ORION II 1.3	J6A	07/90 ⇒ 12/93	
ORION II 1.6 i 16V	L1E, RDA	07/92 ⇒ 12/93	
ORION II 1.8 i 16V	RDA, FHD	01/92 ⇒ 12/93	
PUMA 1.4 16V	FHD, MHA	11/97 ⇒ 10/00	
PUMA 1.6 16V	L1W	08/00 ⇒ 06/02	
PUMA 1.7 16V	MHA, EYPA	03/97 ⇒ 06/02	
PUMA Racing ST 160	MHA	06/99 ⇒ 06/02	
TOURNEO 1.8 BiFuel	EYPCNG	08/05 ⇒ 12/06	
TOURNEO 1.8 LPG	EYPC	08/05 ⇒ 12/06	
TOURNEO CONNECT I 1.8 16V	EYPA, BHPA	06/02 ⇒ 12/13	
TOURNEO CONNECT I 1.8 TDCi / TDDi / Di	BHPA, EYPA	06/02 ⇒ 12/13	
TRANSIT III 2.0 Di	ABFA, D2FA	08/00 ⇒ 05/06	
TRANSIT III 2.0 TDCi	FIFA	08/02 ⇒ 05/06	
TRANSIT III 2.4 Di	D2FA, D4FA	01/00 ⇒ 05/06	
TRANSIT III 2.4 Di RWD	D4FA, --	01/00 ⇒ 05/06	
TRANSIT III 2.4 TD	F4FA	08/00 ⇒ 08/03	
TRANSIT III 2.4 TD 4x4	F4FA	08/00 ⇒ 08/03	
TRANSIT III 2.4 TDCi	--, H9FD	03/04 ⇒	
TRANSIT III 2.4 TDCi 4x4	H9FB	11/06 ⇒ 08/14	
TRANSIT III 2.4 TDCi HPCR	--	07/06 ⇒	
TRANSIT III 2.4 TDCi RWD	H9FD, D2FE	04/06 ⇒ 08/14	
TRANSIT III 2.4 TDdi	D2FE, DOFA	08/00 ⇒ 03/06	
TRANSIT III 2.4 TDE	DOFA, 1E03	07/01 ⇒ 05/06	
TRANSIT 1.8 CNG	EYPCNG	05/02 ⇒ 12/13	
TRANSIT 2.0 TDi	F3FA	06/00 ⇒ 03/06	
TRANSIT 2.4 TDDi	D4FA	08/00 ⇒ 08/03	
TRANSIT CONNECT I 1.8 16V	EYPA, EYPA	06/02 ⇒ 12/13	
TRANSIT CONNECT I 1.8 16V LPG	EYPA, BHPA	06/02 ⇒ 12/13	
TRANSIT CONNECT I 1.8 Di	BHPA, ABFA	06/02 ⇒ 12/13	
TRANSIT TOURNEO 2.0	ABFA	06/00 ⇒ 03/05	

FORD (BR)

FIESTA 1.0i	ZL10	07/99 ⇒
FIESTA 1.6i	ZL16	07/99 ⇒

MAZDA

121 1.3	1E03, 1E05	01/96 ⇒ 05/97
121 1.8	1E07	07/96 ⇒ 10/02
121 III 1.25	1E05, 1E03	03/96 ⇒ 04/03

MAZDA

121 III 1.3	1E03, 1E07	03/96 ⇒ 04/03
121 III 1.8 D	1E07, 20M4F	03/96 ⇒ 04/03
121 III 1.8 TD	1E10	02/00 ⇒ 10/02
TRIBUTE 2.0	YF09	03/00 ⇒ 05/08
TRIBUTE 2.0 4WD	YF09	03/00 ⇒ 05/08
TRIBUTE 2.0i [USA]	B	05/00 ⇒
TRIBUTE 2.0i 4x4 [USA]	B	05/00 ⇒

9.0038

04

REVOLUTION AND TIMING (CKP AND CMP) SENSORS

Adatt./Suitable:

ROVER
NSC10003

Eliminated on 26-09-2018. Please verify the availability through our local distributors

• Eliminato il 26-09-2018. Verificare la disponibilità presso i nostri distributori

• Éliminé le 26-09-2018. Vérifier la disponibilité auprès de nos distributeurs sur place

• Am 26-09-2018 gestrichen. Evtl. Verfügbarkeit bitte bei unseren Händlern prüfen

• Eliminado en fecha 26-09-2018. Verificar la disponibilidad a través de nuestros distribuidores locales



L	L1	ohm	OUT GND
250	21	1400	

ROVER

200 II 220 16V	--	01/92 ⇒ 12/95
200 II 220 GSi	20T4H	05/94 ⇒ 06/99
200 II 220 GTi	20M4F, 30NE	09/91 ⇒ 10/95
200 II 220 Turbo	20T4G	10/92 ⇒ 06/99
400 I 420 GSi/SLI/GTi/Vite	20T4H	01/93 ⇒ 04/95
400 I 420 GTi/GSi/Vitesse	20M4F	02/92 ⇒ 04/95
400 I 420 Turbo	20T4G	01/93 ⇒ 04/95
600 620 Ti Vitesse	20T4G	05/94 ⇒ 08/98
800 820 16V Turbo	T16	11/91 ⇒ 02/99
800 820 I/Sl	20T4H	01/91 ⇒ 02/99
800 820 Sport	20T4G	04/94 ⇒ 03/96

9.0040

04,5

REVOLUTION AND TIMING (CKP AND CMP) SENSORS

Adatt./Suitable:

BOSCH
0 261 210 031
GENERAL MOTORS
90 232 732
OPEL
12 38 364



L	L1	ohm	OUT
1360	34,5	550	

OPEL

CORSA A 1.6 GSi Cat	C16SE	02/92 ⇒ 03/93
FRONTERA A 2.4 i	C24NE	03/92 ⇒ 10/98
OMEGA A 2.4 i	C24NE	09/88 ⇒ 03/94
OMEGA A 2.6 i	C26NE	09/90 ⇒ 03/94
OMEGA A 3.0	30NE, C25XE	03/87 ⇒ 03/94
OMEGA A 3.0 Cat	C30NE	03/87 ⇒ 03/94
SENATOR B 3.0	C30LE	09/87 ⇒ 09/93
SENATOR B 3.0 i Cat	C30NE	01/88 ⇒ 09/93

VAUXHALL

FRONTERA A 2.4 i	C24NE	03/92 ⇒ 10/98
------------------	-------	---------------

9.0042

3

REVOLUTION AND TIMING (CKP AND CMP) SENSORS

Adatt./Suitable:

BOSCH
0 232 103 001
GENERAL MOTORS
90 357 480
OPEL
12 38 911
90357480
SAAB
45 04 296
VAUXHALL
90357480

Supplied until depletion

- Fornibile fino ad esaurimento delle scorte
- Fourni jusqu'à épuisement du stock
- Lieferbar solange vorrat reicht
- Suministrado hasta el stock termina



L	L1	Hall Effect	OUT
---	14		

OPEL

CALIBRA A 2.5 i V6	C25XE	04/93 ⇒ 07/97
OMEGA B 2.5 V6	X25XE	03/94 ⇒ 09/00
OMEGA B 3.0 V6	X30XE	04/94 ⇒ 02/01
SINTRA 3.0 i 24V	X30XE	11/96 ⇒ 04/99
VECTRA A 2.5 CD 4x4	C25XE	08/92 ⇒ 08/95

OPEL			
VECTRA A 2.5 V6	C25XE	02/93 ⇒	11/95
SAAB			
900 II 2.5-24 V6	B258I	07/93 ⇒	02/98
VAUXHALL			
CALIBRA 2.5 i V6	C25XE, ED8A	04/93 ⇒	07/97
OMEGA B 2.5 V6	X25XE	03/94 ⇒	09/00
OMEGA B 3.0 V6	X30XE	04/94 ⇒	07/00
SINTRA 3.0 i 24V	X30XE	11/96 ⇒	04/99

9.0043



3

REVOLUTION AND TIMING (CKP AND CMP) SENSORS

Adatt./Suitable:

BOSCH
0 986 280 444

FORD
6 602 999
6 859 706
7 033 372
928F-12K073-A1C
928F-12K073-A1D
928F-12K073-A1E

MAZDA
YF09-18-230

L	L1	ohm	OUT GND S
---	34	550	

FORD			
COUGAR 2.0 16V	ED8A, L1E	08/98 ⇒	12/01
ESCORT-NOMADE 1.6	ZH16L1E, EYDB	01/95 ⇒	04/00
ESCORT-NOMADE 1.8	ZH18NRDA	01/95 ⇒	04/00
ESCORT IV 1.6 16V	L1E, L1E	10/98 ⇒	07/00
ESCORT V 1.6 16V XR3i	L1E	12/92 ⇒	01/95
ESCORT V 1.6 i 16V	L1E, RDA	09/92 ⇒	01/95
ESCORT V 1.8 16V	RDA	02/92 ⇒	12/92
ESCORT V 1.8 16V XR3i	RDA, RDA	02/92 ⇒	01/95
ESCORT V 1.8 i 16V	RDA, RDA	09/92 ⇒	01/95
ESCORT V 1.8 XR3i 16V 4x4	RDA, L1E	08/93 ⇒	01/95
ESCORT VI 1.6 16V	L1E, L1E	01/95 ⇒	07/00
ESCORT VI 1.6 16V 4x4	L1E	01/95 ⇒	10/98
ESCORT VI 1.6 16V XR3i	L1E, L1E	02/95 ⇒	09/99
ESCORT VI 1.6 i 16V	L1E, RDA	01/95 ⇒	02/99
ESCORT VI 1.8 16V	RDA, RDA	01/95 ⇒	02/99
ESCORT VI 1.8 16V XR3i	RDA, ZH16L1E	02/95 ⇒	08/98
FIESTA III 1.6 i 16V	L1G	01/94 ⇒	12/95
FIESTA III 1.8 16V	RDB	02/92 ⇒	12/95
FIESTA III 1.8 XR2i 16V	RQC	02/92 ⇒	12/95
FOCUS I 1.6 16V	--	02/01 ⇒	11/04
FOCUS I 1.8	EYDB, EYDB	04/99 ⇒	03/05
FOCUS I 1.8 16V	EYDB, EYDD	10/98 ⇒	11/04
FOCUS I 1.8 16V BiFuel	EYDD, EDDB	09/02 ⇒	07/04
FOCUS I 1.8 BiFuel	EYDL	02/03 ⇒	01/05
FOCUS I 2.0 16V	EDDB, L1F	10/98 ⇒	11/04
FOCUS I RS	HMDA	10/02 ⇒	11/04
MAVERICK 2.0 16V	YF	02/01 ⇒	
MAVERICK 2.0 16V FWD	YF	02/01 ⇒	
MONDEO I 1.6 i	L1J	08/96 ⇒	09/00
MONDEO I 1.6 i 16V	L1F, RKA	02/93 ⇒	09/00
MONDEO I 1.8 4x4	RKA	02/93 ⇒	08/96
MONDEO I 1.8 i	RKA, RKA	08/96 ⇒	09/00
MONDEO I 1.8 i 16V	RKA, NGA	02/93 ⇒	08/96
MONDEO I 1.8 i 16V 4x4	RKA	02/93 ⇒	08/96
MONDEO I 2.0 i	NGA, NGA	08/96 ⇒	09/00
MONDEO I 2.0 i 16V	NGA, NGA	01/93 ⇒	08/96
MONDEO I 2.0 i 16V 4x4	NGA, L1E	02/93 ⇒	08/96

FORD			
ORION II 1.6 i 16V	L1E, RDA	07/92 ⇒	12/93
ORION II 1.8 i 16V	RDA, EYPA	01/92 ⇒	12/93
SCORPIO II 2.9 i 24V	BOB	10/94 ⇒	08/98
TOURNEO CONNECT I 1.8 16V	EYPA, EYPA	06/02 ⇒	12/13
TRANSIT 1.8 CNG	EYPCNG	05/02 ⇒	12/13
TRANSIT CONNECT I 1.8 16V	EYPA, EYPA	06/02 ⇒	12/13
TRANSIT CONNECT I 1.8 16V LPG	EYPA, BDY(XU5M)	06/02 ⇒	12/13

MAZDA			
TRIBUTE 2.0	YF09	03/00 ⇒	05/08
TRIBUTE 2.0 4WD	YF09	03/00 ⇒	05/08
TRIBUTE 2.0i [USA]	B	05/00 ⇒	
TRIBUTE 2.0i 4x4 [USA]	B	05/00 ⇒	

9.0044



3,5

REVOLUTION AND TIMING (CKP AND CMP) SENSORS

Adatt./Suitable:

CITROËN
1920 E2
96 067 317

PEUGEOT
1920 E2
1920 F5

Eliminated on 05-03-2018. Please verify the availability through our local distributors

- Eliminato il 05-03-2018. Verificare la disponibilità presso i nostri distributori
- Éliminé le 05-03-2018. Vérifier la disponibilité auprès de nos distributeurs sur place
- Am 05-03-2018 gestrichen. Evtl. Verfügbarkeit bitte bei unseren Händlern prüfen
- Eliminado en fecha 05-03-2018. Verificar la disponibilidad a través de nuestros distribuidores locales



L	L1	ohm	OUT GND S
230	24	370	

CITROËN			
BX 16	BDY(XU5M), BDY(XU5M)	05/89 ⇒	12/94
BX 16 É	BDY(XU5M), SKZ(ZPJ4/Z)	05/89 ⇒	02/93
XM I 3.0 V6 24V	SKZ(ZPJ4/Z), SKZ(ZPJ4/Z)	07/90 ⇒	06/94
XM II 3.0 V6 24V	SKZ(ZPJ4/Z), BDZ(XU5M)	05/94 ⇒	10/00
PEUGEOT			
405 I 1.6	BDZ(XU5M), 176A4.000	07/87 ⇒	12/92
405 I 1.6 4x4	BDZ(XU5M)	04/88 ⇒	07/92
405 I 1.6 SRi 4x4	BDZ(XU5M)	04/88 ⇒	07/92
605 3.0	UKZ(ZPJ4/Z)	08/89 ⇒	06/94
605 3.0 SV 24	UKZ(ZPJ4/Z)	08/89 ⇒	09/99

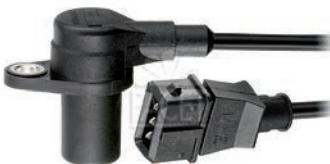

L	L1	ohm	OUT GND S
390	24	900	

FIAT			
PALIO 1.4	178B2.000	04/96 ⇒	10/02
PALIO 1.4 Cat	178B2.016	04/96 ⇒	08/01
PALIO 1.6 16V 100	178C8.098	01/98 ⇒	
PUNTO I 1.4 GT Turbo	176A4.000, 178B2.000	10/93 ⇒	07/99
SIENA 1.4	178B2.000, 178B2.000	04/96 ⇒	12/09
SIENA 1.4 Cat	178B2.000, D4BF	04/96 ⇒	12/09

FIAT (BR)			
PALIO 1.6i	1.6Spi	01/99 ⇒	12/99
SIENA 1.6i	1.6Mpi	01/98 ⇒	12/00
STRADA 1.6i 8v	1.6Mpi	01/99 ⇒	12/00

HYUNDAI			
H-1 I 2.5 D	D4BF	10/97 ⇒	04/04
H-1 I 2.5 TD	D4BF, T8	06/97 ⇒	04/04
H-1 I 2.5 TD 4WD	D4BF	02/98 ⇒	04/04

KIA			
CLARUS 1.8 i 16V	T8, FE	07/96 ⇒	
RETONA 2.0 16V	FE, FE	05/00 ⇒	
RETONA 2.0 TD	RF	06/99 ⇒	
SPORTAGE I 2.0	FE, FE	10/00 ⇒	08/03
SPORTAGE I 2.0 4WD	FE, FE	10/00 ⇒	08/03
SPORTAGE I 2.0 i 16V	FE, FE	10/99 ⇒	08/03
SPORTAGE I 2.0 i 16V 4WD	FE, FERF	04/94 ⇒	08/03
SPORTAGE I 2.0 i 4WD	FE(8V)	04/94 ⇒	08/99
SPORTAGE I 2.0 TD 4WD	FERF, M40B16(164E1)	10/97 ⇒	08/03

9.0047



04,5

REVOLUTION AND TIMING (CKP AND CMP) SENSORS

Adatt./Suitable:

FIAT
7779228

LANCIA
7779228

L	L1	ohm	OUT GND S
600	24	550	

FIAT			
TEMPRA 1.6 i.e.	159B9.000	06/94 ⇒	08/96

LANCIA		
DEDRA 1.6	159B9.000	10/94 ⇒ 07/99
DEDRA 1.6 LE Cat	159B9.000	07/94 ⇒ 07/99

9.0048



04,5

REVOLUTION AND TIMING (CKP AND CMP) SENSORS

Adatt./Suitable:

BMW
13 62 2 242 149
2 242 152



L	L1	ohm	OUT GND S
372	56	900	

BMW		
3 II 324 d	M21D24(246DA)	09/85 ⇒ 08/91
3 II 324 td	M21D24(246TB)	09/87 ⇒ 06/93
5 III 524 td	M21D24(246TB)	03/88 ⇒ 09/95

9.0049



04,5

REVOLUTION AND TIMING (CKP AND CMP) SENSORS

Adatt./Suitable:

BMW
12 14 1 727 554



L	L1	ohm	S GND OUT
615	24	550	

BMW		
3 III 316 i	M40B16(164E1), S38B36(366S1)	09/90 ⇒ 09/93
3 III 318 i	M40B18(184E1)	12/90 ⇒ 10/93
5 III 518 i	M40B18(184E1)	08/89 ⇒ 09/95

9.0052



04,5

REVOLUTION AND TIMING (CKP AND CMP) SENSORS

Adatt./Suitable:

BMW
12 14 1 312 895

Eliminated on 14-11-2016. Please verify the availability through our local distributors

- Eliminato il 14-11-2016. Verificare la disponibilità presso i nostri distributori
- Éliminé le 14-11-2016. Vérifier la disponibilité auprès de nos distributeurs sur place
- Am 14-11-2016 gestrichen. Evtl. Verfügbarkeit bitte bei unseren Händlern prüfen
- Eliminado en fecha 14-11-2016. Verificar la disponibilidad a través de nuestros distribuidores locales



L	L1	ohm	OUT GND S
330	24	550	

BMW		
5 III M5	S38B36(366S1), 8140.43N	10/88 ⇒ 01/97
5 III M5 Cat	S38B36(366S1)	10/88 ⇒ 05/92

9.0053



04,5

REVOLUTION AND TIMING (CKP AND CMP) SENSORS

Adatt./Suitable:

BOSCH
0 261 210 114
0 261 210 124

CITROËN
16 129 074 80

FIAT

46774532
46786042
55187333
55189517
55216915
7763079
7777960
7787256
7798691

LANCIA

46774532
55189517
7763079
7777960
7787256
7798691

MAGNETI MARELLI

111040211103
CWM02/3

PEUGEOT
16 129 074 80

MARKET DIFFUSION: MEDIUM



L	L1	ohm	OUT GND S
615	34,5	1350	

CITROËN		
JUMPER II 2.8 HDi	8140.43N, 182B2.000	04/02 ⇒
JUMPER II 2.8 HDi 4x4	8140.43S	02/02 ⇒ 06/06
JUMPER II 2.8 HDi Trazione integrale	8140.43S	04/02 ⇒

FIAT		
BRAVA 1.2 16V	182B2.000	12/98 ⇒ 12/02
BRAVA 1.2 16V 80	188A5.000	10/00 ⇒ 10/01
BRAVO I 1.2 16V 80	182B2.000, 176A8.000	12/98 ⇒ 10/01
DOBLO I 1.2	223A5.000	03/01 ⇒
MAREA 1.2 16V	182B2.000	10/98 ⇒ 05/02
PALIO 1.2	176A8.000, 176A6.000	04/96 ⇒
PALIO 1.2 75	178B7.045	03/98 ⇒
PALIO 1.2 MPI	178C4.066	01/02 ⇒
PUNTO I 1.1	176B2.000	04/96 ⇒ 02/00
PUNTO I 55 1.1	176A6.000, 176A7.000	09/93 ⇒ 09/99
PUNTO I 60 1.2	176A7.000, 188A4.000	09/93 ⇒ 06/00
PUNTO I 75 1.2	176A8.000	10/93 ⇒ 09/99
PUNTO I 85 16V 1.2	176B9.000	04/97 ⇒ 06/00
PUNTO II 1.2	188A4.000	06/03 ⇒
PUNTO II 1.2 60	188A4.000	09/99 ⇒ 12/10
PUNTO II 1.2 Bifuel	188A4.000	08/07 ⇒ 03/12
PUNTO II 1.2 Bipower	188A4.000	08/01 ⇒ 05/03
PUNTO II 1.2 Natural Power	188A4.000, 178B5.000	01/03 ⇒ 03/12
PUNTO III / GRANDE PUNTO 1.2 [IND]	--	01/08 ⇒
SIENA 1.2	178B5.000, 178B5.000	01/98 ⇒
STRADA 1.2	178B5.000, 188A4.000	04/03 ⇒
UNO Mondo 1.0 i.e.	146D8.000	01/96 ⇒
UNO Mondo 1.2 i.e. [IND]	178D5.066	01/96 ⇒

FIAT (BR)		
PALIO 1.0i	1.0MpiFire	01/01 ⇒
UNO MILLE 1.0i	1.0MpiFire	01/02 ⇒

LANCIA		
Y 1.1	176B2.000	11/95 ⇒ 09/03
Y 1.2	188A4.000, S14B23(234EA)	03/96 ⇒ 09/03
Y 1.2 16V	176B9.000	04/97 ⇒ 09/03
YPSILON I 1.2	188A4.000	10/03 ⇒ 12/11

PEUGEOT		
BOXER I 2.8 HDi	814043S	04/02 ⇒
BOXER I 2.8 HDi 4x4	814043S	04/02 ⇒

9.0054



04,5

REVOLUTION AND TIMING (CKP AND CMP) SENSORS

Adatt./Suitable:

BMW

1 708 610
12 14 1 274 644
12 14 1 708 619

L	L1	ohm	OUT GND S
616	56	900	

BMW

3 II 320 is	S14B20(204EA)	05/88 ⇒ 12/90
3 II M3 2.3	S14B23(234EA), M30B34(346KA)	07/85 ⇒ 06/91
3 II M3 EVO 1.2.3	S14B23(234EA)	10/88 ⇒ 10/90
5 II 524 d	M21D24(246DA)	03/86 ⇒ 12/87
5 II 524 td	M21D24(246TA)	09/83 ⇒ 12/87
5 II 535 i	M30B34(346EC)	01/85 ⇒ 12/87
5 II 535 i, M 535 i	M30B34(346KA), M20B27(276KA)	01/85 ⇒ 12/87
6 I 635 CSi	M30B35(Motronic, 9.3:1)	06/78 ⇒ 04/82

9.0056



04,5

REVOLUTION AND TIMING (CKP AND CMP) SENSORS

Adatt./Suitable:

BMW

12 14 1 729 292
12 14 1 731 887

L	L1	ohm	OUT GND S
465	24	550	

BMW

5 III 530 i V8	M60B30(308S1)	09/92 ⇒ 01/97
5 III 540 i	M60B40(408S1)	09/93 ⇒ 01/97
5 III 540 i V8	M60B40(408S1)	09/92 ⇒ 09/95
7 II 730 i, iL V8	M60B30(308S1)	04/92 ⇒ 09/94
7 II 740 i, iL V8	M60B40(408S1)	04/92 ⇒ 09/94
7 III 730 i, iL	M60B30(308S1)	10/94 ⇒ 11/01
7 III 740 i, iL	M60B40(408S1)	10/94 ⇒ 11/01
8 840 i	M60B40(408S1)	03/93 ⇒ 02/96

9.0057



04,5

REVOLUTION AND TIMING (CKP AND CMP) SENSORS

Adatt./Suitable:

BMW

12 14 1 720 307



L	L1	ohm	OUT GND S
460	24	550	

BMW

7 II 750 i, iL V12	M70B50(5012A)	09/87 ⇒ 09/94
8 850 CSi	S70B56(56121)	11/92 ⇒ 12/96
8 850 i, Gi	M70B50(5012A)	04/90 ⇒ 10/94

9.0058



04,5

REVOLUTION AND TIMING (CKP AND CMP) SENSORS

Adatt./Suitable:

BMW

12 14 1 710 668

BOSCH

0 261 210 028

LAND ROVER
ERR2079

L	L1	ohm	OUT GND S
458	56	900	

BMW

3 II 325 e 2.7	M20B27(276KA), M20B25(256E1)	10/83 ⇒ 12/88
3 II 325 i	M20B25(256E1), M20B25(256E1)	09/83 ⇒ 10/93
3 II 325 i X	M20B25(256E1), M20B27(276EA)	03/86 ⇒ 10/93
5 II 525 e	M20B27(276EA), M50B25(256S1)	09/81 ⇒ 12/87

LAND ROVER

DISCOVERY I 2.5 TDI 4x4	--	08/96 ⇒ 10/98
-------------------------	----	---------------

9.0060



04,5

REVOLUTION AND TIMING (CKP AND CMP) SENSORS

Adatt./Suitable:

BMW

1 740 383
12 14 1 740 959
12 14 1 748 400

BOSCH

0 232 103 003



L	L1	Hall Effect	+ OUT -
410	28		

BMW

3 III 325 i	M50B25(256S1), M50B25(256S1)	09/90 ⇒ 04/99
5 III 525 i	M50B25(256S1), M50B25(256S1)	11/91 ⇒ 01/97
5 III 525 i 24V	M50B25(256S2)	09/89 ⇒ 12/95
5 III 525 ix	M50B25(256S1)	02/92 ⇒ 01/97
5 III 525 ix 24V	M50B25(256S1), M40B16(164E1)	10/91 ⇒ 09/95

9.0063



04,5

REVOLUTION AND TIMING (CKP AND CMP) SENSORS

Adatt./Suitable:

BMW

12 14 1 734 816



L	L1	ohm	S OUT GND
890	24	550	

BMW

3 III 318 is	M42B18(184S1)	03/92 ⇒ 02/98
--------------	---------------	---------------

9.0064



04,5

REVOLUTION AND TIMING (CKP AND CMP) SENSORS

Adatt./Suitable:

BMW
12 14 1 720 854

L	L1	ohm	
725	24	550	

BMW			
3 II 316 i	M40B16(164E1), M40B18(184E1)	09/87 ⇨ 06/94	
3 II 318 i	M40B18(184E1), M88B35(356ED)	09/87 ⇨ 06/94	
5 III 518 i	M40B18(184E1)	08/89 ⇨ 09/95	

9.0065



04,5

REVOLUTION AND TIMING (CKP AND CMP) SENSORS

Adatt./Suitable:

BMW
12 14 1 714 763
12 14 1 720 853**BOSCH**
0 261 210 061

L	L1	ohm	
510	24	550	

BMW			
5 II 530 i	--	01/84 ⇨ 12/88	
5 III 530 i	M30B30(306KA)	01/88 ⇨ 08/91	
5 III 535 i	M30B34(346KB)	01/88 ⇨ 09/95	
6 I 635 CSi	M30B35(Motronic, 9.3:1)	06/78 ⇨ 04/82	
6 I M 635 CSi	M88B35(356ED), M30B30(306EA)	04/84 ⇨ 02/89	
7 II 730 i,jL	M30B30(306EA), M30B34(346KB)	12/86 ⇨ 09/94	
7 II 735 i,jL	M30B34(346KB), AAT	09/86 ⇨ 09/92	

9.0066



04,5

REVOLUTION AND TIMING (CKP AND CMP) SENSORS

Adatt./Suitable:

AUDI
034 905 381 A
035 905 381 B
078 905 375
078 905 381
078 905 381 A**HITACHI**
RS-120
RS-120A**VW**
034 905 381
034 905 381 A
035 905 381 B
078 905 375
078 905 381
078 905 381 A

L	L1	ohm	
750	41	900	

AUDI			
80 IV 2.6	ABC	07/92 ⇨ 01/96	
80 IV 2.6 E	ACZ	05/93 ⇨ 05/95	
80 IV 2.8	AAH	09/91 ⇨ 01/96	
80 IV 2.8 quattro	AAH	09/91 ⇨ 12/94	
80 IV RS2 quattro	ADU	03/94 ⇨ 05/95	
90 II 2.0 20V	NM	08/89 ⇨ 07/91	
90 II 2.3 E 20V	7A, AAT	08/88 ⇨ 07/91	
90 II 2.3 E 20V quattro	7A	06/88 ⇨ 09/91	
100 III 2.2 E Turbo quattro	MC	08/86 ⇨ 11/90	
100 III 2.2 Turbo	MC	08/86 ⇨ 11/90	
100 III 2.5 TDI	1T	01/90 ⇨ 11/90	
100 IV 2.5 TDI	AAT, ABC	12/90 ⇨ 07/94	
100 IV 2.6	ABC, 1B	03/92 ⇨ 07/94	
100 IV 2.6 E quattro	ACZ	08/93 ⇨ 07/94	
100 IV 2.6 quattro	ABC	04/92 ⇨ 07/94	
100 IV 2.8 E	AAH	12/90 ⇨ 07/94	
100 IV 2.8 E quattro	AAH	12/90 ⇨ 07/94	
200 II 2.2 Turbo	1B, 7A	08/85 ⇨ 09/91	
200 II 2.2 Turbo quattro	1B	02/88 ⇨ 11/90	
A4 I 2.4	AFM	07/95 ⇨ 07/97	
A4 I 2.6	ABC	01/95 ⇨ 09/01	
A4 I 2.6 quattro	ABC	01/95 ⇨ 09/01	
A4 I 2.8	AAH	09/95 ⇨ 07/97	
A4 I 2.8 quattro	AAH	01/95 ⇨ 07/97	
A4 2.6 [ExtraEU]	ACZ	01/96 ⇨ 07/97	
A6 I 2.4	AFM	07/95 ⇨ 12/97	
A6 I 2.5 TDI	AAT, ABC	06/94 ⇨ 12/97	
A6 I 2.5 TDI quattro	AEL	07/95 ⇨ 12/97	
A6 I 2.6	ABC, ABC	06/94 ⇨ 12/97	
A6 I 2.6 quattro	ABC, AAH	06/94 ⇨ 12/97	
A6 I 2.8	AAH	06/94 ⇨ 12/97	
A6 I 2.8 quattro	AAH, AAH	06/94 ⇨ 12/97	
A6 I S6 4.2 quattro	AEC	06/94 ⇨ 12/97	
A6 I S6 Turbo quattro	AAN	06/94 ⇨ 12/97	
A8 I 2.8	AAH, AAH	03/94 ⇨ 03/96	
A8 I 2.8 quattro	AAH, 7A	03/94 ⇨ 03/96	
CABRIOLET 2.6	ABC	06/93 ⇨ 08/00	
CABRIOLET 2.8	AAH	11/92 ⇨ 08/00	
COUPE 2.0 20V	NM	08/89 ⇨ 07/91	
COUPE 2.0 20V quattro	NM	08/89 ⇨ 07/91	
COUPE 2.3 20V	7A, 7A	08/89 ⇨ 07/91	
COUPE 2.3 20V quattro	7A, 3B	11/88 ⇨ 12/96	
COUPE 2.6	ABC	08/92 ⇨ 12/96	
COUPE 2.6 quattro	ABC	08/92 ⇨ 12/96	
COUPE 2.8	AAH	09/91 ⇨ 12/96	
COUPE 2.8 quattro	AAH	08/91 ⇨ 12/96	
COUPE S2	3B	09/90 ⇨ 05/95	
COUPE S2 quattro	3B, 1Z	09/90 ⇨ 12/96	

9.0068



04,5

REVOLUTION AND TIMING (CKP AND CMP) SENSORS

Adatt./Suitable:

AUDI
028 907 319 B
FORD
1 051 046
95VW-6C315-CA**SEAT**
028 907 319 B**VW**
028 907 319 B

L	L1	ohm	
525	46	1400	

AUDI			
A4 I 1.9 DUO	AHU	03/98 ⇨ 09/01	
A4 I 1.9 TDI	1Z, AFN	01/95 ⇨ 09/01	
A4 I 1.9 TDI quattro	AFN, 1Z	09/96 ⇨ 09/01	
A6 I 1.9 TDI	1Z, AFN	06/94 ⇨ 12/97	
A6 I 1.9 TDI	AFN, AFN	04/97 ⇨ 04/01	
FORD			
GALAXY I 1.9 TDI	AFN, 1Z	08/97 ⇨ 04/00	
SEAT			
ALHAMBRA I / II 1.9 TDI	1Z, 1Y	04/96 ⇨ 03/10	
AROSA 1.7 SDI	AKU	08/97 ⇨ 06/04	
CORDOBA I 1.9 SDI	AEY	08/96 ⇨ 06/99	
CORDOBA I 1.9 TDI	AHU	08/96 ⇨ 12/02	
IBIZA I 1.9 SDI	AEY	08/96 ⇨ 08/99	
IBIZA II 1.9 TDI	AHU	08/96 ⇨ 02/02	
INCA 1.9 D	1Y, 1Y	11/95 ⇨ 06/03	
INCA 1.9 SDI	1Y, 1Z	11/95 ⇨ 06/03	
TOLEDO I 1.9 TDI	1Z, 1Y	08/95 ⇨ 03/99	
VW			
CADDY II 1.9 D	1Y, 1Y	11/95 ⇨ 01/04	
CADDY II 1.9 SDI	1Y, 1Z	11/95 ⇨ 01/04	
CADDY II 1.9 TDI	1Z, 1Z	09/96 ⇨ 01/04	
GOLF III 1.9 SDI	AEY	07/95 ⇨ 04/99	
GOLF III 1.9 TDI	1Z, 1Z	09/93 ⇨ 04/99	
GOLF III 1.9 TDI Syncro	1Z, AFN	07/95 ⇨ 04/99	
GOLF IV 1.9 TDI	AFN, AFN	06/98 ⇨ 06/02	
LUPO 1.7 SDI	AKU	09/98 ⇨ 07/05	
PASSAT IV 1.9 TDI	AFN, AFN	10/96 ⇨ 11/00	
PASSAT IV 1.9 TDI Syncro/4motion	AFN, AEF	10/96 ⇨ 11/00	
PASSAT III 1.9 TDI	1Z	10/93 ⇨ 05/97	
POLO III 1.7 SDI	AHG	04/97 ⇨ 09/01	
POLO III 1.9 D	AEF, AEF	10/99 ⇨ 09/01	
POLO III 1.9 SDI	AEF, AGR	05/96 ⇨ 09/01	
POLO III 1.9 TDI	AGR, AEF	01/97 ⇨ 09/01	
POLO III 60 1.7 SDI	AKU	08/97 ⇨ 10/99	
POLO III 64 1.9 D	AEF, AEF	10/94 ⇨ 10/99	
POLO III 64 1.9 SDI	AEF, AGR	12/95 ⇨ 10/99	
POLO III 90 1.9 TDI	AGR, 1Z	09/96 ⇨ 09/01	
SHARAN I 1.9 TDI	1Z, 1Z	09/95 ⇨ 03/10	
VENTO 1.9 TDI	1Z, M50B20(20651)	09/93 ⇨ 09/98	

9.0071



04,5

REVOLUTION AND TIMING (CKP AND CMP) SENSORS

Adatt./Suitable:

- BMW**
12 14 1 726 590
- BOSCH**
0 261 210 053



L	L1	ohm	OUT GND S
390	28	1400	

BMW			
3 III 320 i	M50B20(206S1), M50B25(256S1)	09/90 ⇨ 10/99	
3 III 325 i	M50B25(256S1), M50B20(206S1)	09/90 ⇨ 04/99	
5 III 520 i	M50B20(206S1), M50B20(206S1)	11/91 ⇨ 01/97	
5 III 520 i 24V	M50B25(256S1), M50B25(256S1)	09/89 ⇨ 09/95	
5 III 525 i	M50B25(256S1), M50B25(256S1)	11/91 ⇨ 01/97	
5 III 525 i 24V	M50B25(256S2)	09/89 ⇨ 12/95	
5 III 525 ix	M50B25(256S1)	02/92 ⇨ 01/97	
5 III 525 ix 24V	M50B25(256S1), 16LZ2	10/91 ⇨ 09/95	

9.0073



04,5

REVOLUTION AND TIMING (CKP AND CMP) SENSORS

Adatt./Suitable:

- BOSCH**
0 261 210 030
- GENERAL MOTORS**
90 213 515
90 451 441
X0 213 515
- HOLDEN**
90213515
90451441
- OPEL**
12 38 358
62 38 313
90213515
90451441
- SAAB**
42 27 203
- SCANIA**
4227203
55571823
- SIEMENS**
S101918001Z



L	L1	ohm	OUT GND S
990	24	550	

HOLDEN			
CALIBRA_YE 2.0i	C2ONE	09/91 ⇨ 07/95	
CALIBRA_YE 2.0i 16V	C20XE	09/91 ⇨ 07/95	

HOLDEN			
CALIBRA_YE 2.0i 16V Turbo	C20LET	06/94 ⇨ 10/97	
FRONTERA_UT 2.0i	X20SE	10/95 ⇨ 03/99	
OPEL			
ASTRA F 1.6	16LZ2, C2ONE	09/94 ⇨ 09/98	
ASTRA F 1.8 i	C18NZ	09/91 ⇨ 09/98	
ASTRA F 2.0 GSI 16V	C20XE	09/91 ⇨ 01/98	
ASTRA F 2.0 i	C2ONE	09/91 ⇨ 09/98	
ASTRA F 2.0 i 16V	C20XE	03/93 ⇨ 01/98	
CALIBRA A 2.0 i	C2ONE	08/89 ⇨ 12/96	
CALIBRA A 2.0 i 16V	C20XE	06/90 ⇨ 02/94	
CALIBRA A 2.0 i 16V 4x4	C20XE	06/90 ⇨ 02/94	
CALIBRA A 2.0 i 4x4	C2ONE	06/90 ⇨ 07/97	
CALIBRA A 2.0 i Turbo 4x4	C20LET	08/91 ⇨ 07/97	
FRONTERA A 2.0 i	C2ONE, C18NZ	03/92 ⇨ 10/98	
FRONTERA A 2.2 i	X22XE	03/95 ⇨ 10/98	
KADETT E 1.8	18SE	01/86 ⇨ 08/91	
KADETT E 1.8 i	C18NZ, 20NE	06/85 ⇨ 08/91	
KADETT E 1.8 S	E18NV	09/87 ⇨ 08/91	
KADETT E 2.0 GSI	20NE, 18SEH	09/86 ⇨ 08/91	
KADETT E 2.0 GSI 16V	20XE	12/87 ⇨ 08/91	
KADETT E 2.0 GSI 16V Cat	C20XE	03/88 ⇨ 08/91	
KADETT E 2.0 GSI Cat	C2ONE	09/86 ⇨ 08/91	
KADETT E 2.0 i	20NE	10/86 ⇨ 02/93	
KADETT E 2.0 i Cat	C2ONE	10/86 ⇨ 02/93	
OMEGA A 1.8	18SEH, 20SE	09/86 ⇨ 03/94	
OMEGA A 1.8 N	18NV	09/86 ⇨ 08/87	
OMEGA A 1.8 S	18SV	09/86 ⇨ 03/94	
OMEGA A 2.0	20SE, 18SV	09/86 ⇨ 04/94	
OMEGA A 2.0 i	C2ONE	09/86 ⇨ 04/94	
OMEGA B 2.0	20SE	03/94 ⇨ 12/00	
VECTRA A 1.6	C16LZ2	08/92 ⇨ 07/93	
VECTRA A 1.6 i	C16NZ2	09/88 ⇨ 11/95	
VECTRA A 1.6 i Cat	C16NZ2	09/88 ⇨ 11/95	
VECTRA A 1.8 i	18SV	09/88 ⇨ 10/90	
VECTRA A 1.8 i Cat	C18NZ	03/90 ⇨ 11/95	
VECTRA A 1.8 S	18SV, 20NE	09/88 ⇨ 10/90	
VECTRA A 1.8 S 4x4	E18NVR	01/89 ⇨ 07/89	
VECTRA A 2.0 i	20NE, 20NE	09/88 ⇨ 09/92	
VECTRA A 2.0 i 16V	20XEJ	02/89 ⇨ 10/90	
VECTRA A 2.0 i 16V 4x4	C20XE	08/89 ⇨ 08/95	
VECTRA A 2.0 i 16V Cat	C20XE	02/90 ⇨ 11/95	
VECTRA A 2.0 i 4x4	20NE, 16LZ2	01/89 ⇨ 07/92	
VECTRA A 2.0 i Cat	C2ONE	09/88 ⇨ 11/95	
VECTRA A 2.0 i Cat 4x4	C2ONE	01/89 ⇨ 11/95	
VECTRA A 2.0 i GT	20SEH	09/88 ⇨ 11/95	
VECTRA A 2.0 i Turbo 4x4	C20LET	06/94 ⇨ 11/95	
VECTRA A 2000 16V 4x4	20XEJ	01/89 ⇨ 10/90	
VECTRA A 2000/GT 16V	20XEJ	01/89 ⇨ 06/94	
VECTRA A 2000/GT 16V Cat	C20XE	02/90 ⇨ 11/95	
VECTRA A 2000/GT 16V Cat 4x4	C20XE	02/90 ⇨ 11/95	
VECTRA B 1.6 i	16LZ2, B204I	10/95 ⇨ 07/03	

SAAB			
9-3 2.0 i	B204I	02/98 ⇨ 08/03	
9-3 2.0 Turbo	B204E, C2ONE	02/98 ⇨ 08/03	
900 II 2.0 -16 Turbo	B204L	07/93 ⇨ 02/98	
900 II 2.0 i	B204I, B204E	07/93 ⇨ 02/98	
900 II 2.3 -16	B234I	07/93 ⇨ 02/98	
9000 2.0 -16 CD	B204E, B204E	09/93 ⇨ 12/98	
9000 2.0 -16 CS	B204I	09/93 ⇨ 12/98	
9000 2.0 -16 ND Turbo	B204E	09/93 ⇨ 12/98	
9000 2.0 -16 Turbo CD	B204E, B204E	09/92 ⇨ 12/98	
9000 2.3 -16 Aero CS	B234R	02/93 ⇨ 12/98	
9000 2.3 -16 CD	B234I	08/89 ⇨ 12/98	
9000 2.3 -16 CD Turbo	B234L	07/90 ⇨ 12/98	
9000 2.3 -16 CDE	B234I	09/93 ⇨ 12/98	
9000 2.3 -16 CDE Eco-Power	B234E	09/93 ⇨ 12/98	
9000 2.3 -16 CS	B234I	09/89 ⇨ 12/98	
9000 2.3 -16 CSE	B234I	09/93 ⇨ 12/98	
9000 2.3 -16 CSE Eco Power	B234E	09/93 ⇨ 12/98	
9000 2.3 -16 Turbo	B234L	09/90 ⇨ 12/98	
9000 2.3 -16 Turbo CSE	B234L	09/93 ⇨ 12/98	

VAUXHALL			
ASTRA III 1.8 i	C18NZ	09/91 ⇨ 09/98	
ASTRA III 2.0 i	C2ONE	09/91 ⇨ 09/98	
ASTRA III 2.0 i 16V	C20XE	09/91 ⇨ 02/98	
CALIBRA 2.0 i	C2ONE	06/90 ⇨ 07/97	
CALIBRA 2.0 i 16V	C20XE	06/90 ⇨ 02/94	
CALIBRA 2.0 i 16V 4x4	C20XE	06/90 ⇨ 02/94	
CALIBRA 2.0 i 4x4	C2ONE	06/90 ⇨ 07/97	
CALIBRA 2.0 i Turbo 4x4	C20LET	03/92 ⇨ 07/97	
FRONTERA A 2.0	C2ONE, C2ONE	04/95 ⇨ 08/98	
FRONTERA A 2.0 i	C2ONE, 835C1.000	03/92 ⇨ 10/98	
FRONTERA A 2.2 i	X22XE	03/95 ⇨ 10/98	
OMEGA B 2.0	20SE	09/95 ⇨ 09/96	

9.0074



04,5

REVOLUTION AND TIMING (CKP AND CMP) SENSORS

Adatt./Suitable:

- BOSCH**
0 261 210 102
0 261 210 115
- FIAT**
7756925
7799033
- HYUNDAI**
39650-42140
- IVECO**
7799033
82030048
- LANCIA**
7799033



L	L1	ohm	OUT GND S
735	24	900	

FIAT			
TEMPRA 1.4 i.e.	836A4.000	04/90 ⇨ 08/96	
TEMPRA 1.6 i.e.	835C1.000, D4BH	10/90 ⇨ 08/96	
TIPO I 1.4 i.e.	836A4.000	05/89 ⇨ 04/95	
TIPO I 1.6	835C1.000	03/93 ⇨ 10/95	
TIPO I 1.6 i.e.	835C1.000	10/92 ⇨ 04/95	
TIPO I 1.6 i.e. [BRA]	160E2.011	03/93 ⇨ 04/95	
FIAT (BR)			
TIPO 1.6i	1.6Mpi	01/93 ⇨ 12/97	
HYUNDAI			
TERRACAN 2.5 D	D4BH	06/01 ⇨ 10/03	
TERRACAN 2.5 TD	D4BH, 835C1.000	12/01 ⇨ 12/06	
TERRACAN 2.5 TDiC [ExtraEU]	D4BHG	06/01 ⇨ 10/03	
LANCIA			
DEDRA 1.6 i.e.	835C1.000	04/93 ⇨ 07/99	
DELTA II 1.4 i.e.	836A4.000	10/94 ⇨ 08/99	
DELTA II 1.6 i.e.	835C1.000	06/93 ⇨ 08/99	

9.0075



04,5

REVOLUTION AND TIMING (CKP AND CMP) SENSORS

Adatt./Suitable:

- BOSCH**
0 261 210 103
0 261 210 118
- FIAT**
7756924
7799032
- IVECO**
77990320
- LANCIA**
7799032



L	L1	ohm	OUT GND S
640	24	900	

FIAT			
TEMPRA 1.4 i.e.	836A4.000	04/90 ⇨ 08/96	
TEMPRA 1.6	159A3.000	04/93 ⇨ 12/96	
TEMPRA 1.6 i.e.	835C1.000, 160A2.000	10/90 ⇨ 08/96	

FIAT		
TIPO I 1.4 i.e.	836A4.000	05/89 ⇒ 04/95
TIPO I 1.6	160A2.000, 834A4.000	01/88 ⇒ 10/95
TIPO I 1.6 i.e.	835C1.000	10/92 ⇒ 04/95
TIPO I 1.6 i.e. [BRA]	160E2.011	03/93 ⇒ 04/95
TIPO I 1.6 SX DGT	159A3.000	05/89 ⇒ 10/95

FIAT (BR)		
TIPO 1.6i	1.6Mpi	01/93 ⇒ 12/97
UNO 1.6i	1.6Mpi	01/95 ⇒ 12/96

LANCIA		
DEDRA 1.6 i.e.	835C1.000	04/93 ⇒ 07/99
DELTA II 1.4 i.e.	836A4.000	10/94 ⇒ 08/99
DELTA II 1.6 i.e.	835C1.000	06/93 ⇒ 08/99

9.0076



04,5

REVOLUTION AND TIMING (CKP AND CMP) SENSORS

Adatt./Suitable:

BOSCH
0 261 210 093**FIAT**
7739430**IVECO**
7739430**LANCIA**
7739430

L	L1	ohm	OUT GND S
430	24	550	

FIAT		
CROMA I 2000 16V	154E1.000	08/92 ⇒ 08/96
CROMA I 2000 i.e. 16V	154E1.027	03/95 ⇒ 12/96

LANCIA		
KAPPA 2.0 16V Turbo	834A4.000, AAA	02/95 ⇒ 10/01
THEMA 2000 16V	834F1.000	05/92 ⇒ 07/94
THEMA 2000 16V Turbo	834F2.000	10/92 ⇒ 07/94
THEMA 2000 Turbo 16V	834F2.000	11/92 ⇒ 07/94

9.0077



04,5

REVOLUTION AND TIMING (CKP AND CMP) SENSORS

Adatt./Suitable:

BOSCH
0 261 210 080
0 261 210 081
0 261 210 107
0 261 210 108**FORD**
1 021 187
95VW-6C135-BA**VW**
021 906 433 A
021 906 433 C

L	L1	ohm	OUT GND S
370	24	900	

FORD		
GALAXY I 2.8 i V6	AAA, AAA	11/95 ⇒ 04/00
GALAXY I 2.8 i V6 4x4	AAA, AAA	04/96 ⇒ 04/00

VW		
CORRADO 2.9 VR6	ABV	08/91 ⇒ 12/95
GOLF III 2.8 VR6	AAA, AAA	01/92 ⇒ 09/97
GOLF III 2.9 VR6	ABV	10/94 ⇒ 04/99
GOLF III 2.9 VR6 Syncro	ABV	10/94 ⇒ 04/99
PASSAT III 2.8 VR6	AAA	06/91 ⇒ 05/97
PASSAT III 2.9 VR6 Syncro	ABV	01/94 ⇒ 05/97
SHARAN I 2.8 VR6	AAA, AAA	09/95 ⇒ 04/00
SHARAN I 2.8 VR6 Syncro	AAA, AAA	11/96 ⇒ 04/00
TRANSPORTER IV 2.8	AES	05/96 ⇒ 05/00
TRANSPORTER IV 2.8 VR 6	AES	11/95 ⇒ 04/00
TRANSPORTER IV 2.8 VR6	AES	05/96 ⇒ 05/00
TRANSPORTER IV 2.8 VR6 Syncro	AES	01/96 ⇒ 04/96
VENTO 2.8 VR6	AAA, ADY	01/92 ⇒ 09/98

9.0082



04,5

REVOLUTION AND TIMING (CKP AND CMP) SENSORS

Adatt./Suitable:

SEAT
037 906 433 A
037 906 433 B
037 906 433 C
06A 906 433 B**SIEMENS**
S103957001Z**VW**
037 906 433 A
037 906 433 B
037 906 433 C
06A 906 433 B

L	L1	Hall Effect	OUT +
585	24		

SEAT		
ALHAMBRA I / II 2.0 i	ADY, AFT	04/96 ⇒ 03/10

SEAT		
CORDOBA I 1.6 i	AFT	07/96 ⇒ 12/02
CORDOBA I 2.0 i	AGG	02/93 ⇒ 06/99
CORDOBA I 2.0 i 16V	ABF	08/96 ⇒ 06/99
IBIZA II 1.6 i	AFT	04/96 ⇒ 02/02
IBIZA II 2.0 i	AGG	03/93 ⇒ 08/99
IBIZA II 2.0 i 16V	ABF	08/96 ⇒ 08/99
TOLEDO I 1.6 i	AFT	11/96 ⇒ 03/99
TOLEDO I 2.0 i	AGG	05/91 ⇒ 03/99
TOLEDO I 2.0 i 16V	ABF	11/93 ⇒ 03/99

VOLKSWAGEN (BR)		
GOL 2.0i 16V	112	10/95 ⇒
PARATI 2.0i 16V	112	02/96 ⇒

VW		
CORRADO 2.0 i	ADY	04/93 ⇒ 12/95
GOLF III 1.6	AFT, ADY	07/94 ⇒ 04/99
GOLF III 2.0	ADY, AFT	11/91 ⇒ 04/99
GOLF III 2.0 GL	AEP	08/95 ⇒ 09/97
GOLF III 2.0 GTI 16V	ABF	08/92 ⇒ 08/97
GOLF III 2.0 Syncro	AGG	08/95 ⇒ 04/99
GOLF IV 1.6	AFT, AGG	06/98 ⇒ 06/02
GOLF IV 2.0	AGG, ADY	06/98 ⇒ 06/02
PASSAT III 1.6	AFT	07/94 ⇒ 08/96
PASSAT III 2.0	ADY, ADY	02/90 ⇒ 05/97
PASSAT III 2.0 16V	ABF	01/94 ⇒ 05/97
PASSAT III 2.0 Syncro	ADY, AEH	10/90 ⇒ 05/97
POLO III 1.6	AEH, AEH	05/97 ⇒ 09/01
POLO III 100 1.6	AEH, ADY	12/95 ⇒ 09/01
SHARAN I 2.0	ADY, AR67301	09/95 ⇒ 03/10
VENTO 1.6	AKS	04/97 ⇒ 02/99
VENTO 2.0	ADY	11/91 ⇒ 09/98

9.0085



04,5

REVOLUTION AND TIMING (CKP AND CMP) SENSORS

Adatt./Suitable:

BMW
12 14 1 731 886

L	L1	ohm	OUT GND S
560	28	1400	

BMW		
5 III 530 iV8	M60B30(308S1)	09/92 ⇒ 01/97
5 III 540 i	M60B40(408S1)	09/93 ⇒ 01/97
5 III 540 iV8	M60B40(408S1)	09/92 ⇒ 09/95
7 II 730 i,iL V8	M60B30(308S1)	04/92 ⇒ 09/94
7 II 740 i,iL V8	M60B40(408S1)	04/92 ⇒ 09/94
7 III 730 i,iL	M60B30(308S1)	10/94 ⇒ 11/01
7 III 740 i,iL	M60B40(408S1)	10/94 ⇒ 11/01
8 840 i	M60B40(408S1)	03/93 ⇒ 02/96

9.0086



04,5

REVOLUTION AND TIMING (CKP AND CMP) SENSORS

Adatt./Suitable:

BMW
12 14 1 247 219
12 14 1 247 258



L	L1	ohm	OUT GND S
620	28	1400	

BMW

Model	Part No.	Year
3 III 316 i	M43B16(164E2)	07/93 ⇨ 08/00
3 III 318 i	M43B18(184E2)	10/93 ⇨ 10/99
3 III 318 is	M42B18(184S1)	03/92 ⇨ 02/98
3 III 318 ti	M42B18(184S1)	11/94 ⇨ 08/95
5 III 518 g	M43B18(184E2)	11/95 ⇨ 06/96
5 III 518 i	M43B18(184E2)	08/89 ⇨ 01/97

9.0087



04,5

REVOLUTION AND TIMING (CKP AND CMP) SENSORS

Adatt./Suitable:

BMW
12 14 1 247 218
12 14 1 247 259



L	L1	ohm	OUT GND S
960	24	550	

BMW

Model	Part No.	Year
3 III 316 i	M43B16(164E2)	07/93 ⇨ 08/00
3 III 318 i	M43B18(184E2)	10/93 ⇨ 10/99
3 III 318 is	M42B18(184S1)	03/92 ⇨ 02/98
3 III 318 ti	M42B18(184S1)	11/94 ⇨ 08/95
5 III 518 g	M43B18(184E2)	11/95 ⇨ 06/96
5 III 518 i	M43B18(184E2)	08/89 ⇨ 01/97

9.0088



04,5

REVOLUTION AND TIMING (CKP AND CMP) SENSORS

Adatt./Suitable:

ALFA ROMEO
60573739
BOSCH
0 261 210 090
FIAT
60808986
LANCIA
60808986

Eliminated on 29-08-2016. Please verify the availability through our local distributors

- Eliminato il 29-08-2016. Verificare la disponibilità presso i nostri distributori
- Éliminé le 29-08-2016. Vérifier la disponibilité auprès de nos distributeurs sur place
- Am 29-08-2016 gestrichen. Evtl. Verfügbarkeit bitte bei unseren Händlern prüfen
- Eliminado en fecha 29-08-2016. Verificar la disponibilidad a través de nuestros distribuidores locales



L	L1	ohm	S OUT GND
430	24	550	

ALFA ROMEO

Model	Part No.	Year
155 2.5 V6	AR67301, AR66301	03/92 ⇨ 12/97
164 3.0	AR64304	04/93 ⇨ 02/95
164 3.0 24V	AR66301, 159K	09/92 ⇨ 09/98
164 3.0 24V Q4	AR64308	02/94 ⇨ 09/98
164 3.0 24V QV	AR64304	09/92 ⇨ 09/98
164 3.0 24V QV [USA]	AR64308	04/93 ⇨ 02/95
164 3.0i 24V Super [BRA]	64306	09/92 ⇨ 10/98

FIAT

CROMA I 2500 V6 834G.000 06/93 ⇨ 08/96

LANCIA

THEMA 3000 V6 834F.000 08/92 ⇨ 07/94

9.0090



04,5

REVOLUTION AND TIMING (CKP AND CMP) SENSORS

Adatt./Suitable:

BOSCH
0 261 210 043
0 261 210 065
0 261 210 083
0 261 210 154

CITROËN

5918 80

91 541 027

HYUNDAI

39180-22001

KIA

OK04G-18891

OK934-18891

PEUGEOT

5918 80



L	L1	ohm	OUT GND S
330	24	900	

CITROËN

Model	Part No.	Year
BX 1.9 GTi 16V	159K, D6C(XU9J4)	01/87 ⇨ 12/94
BX 1.9 GTi 16V	D6C(XU9J4), D6E(XU9JA)	09/87 ⇨ 02/93

CITROËN

Model	Part No.	Year
ZX 1.9	D6E(XU9JA), DKZ(XU9JA)	03/91 ⇨ 06/97
ZX 1.9 i	DKZ(XU9JA), FE	03/91 ⇨ 06/97

HYUNDAI

Model	Part No.	Year
S COUPE 1.5 i	G4EK	04/92 ⇨ 05/96
S COUPE 1.5 i Turbo	G4EK-TC	04/91 ⇨ 05/96

KIA

Model	Part No.	Year
SPORTAGE I 2.0 i 16V	FE	10/99 ⇨ 08/03
SPORTAGE I 2.0 i 16V 4WD	FE, 141C2.000	04/94 ⇨ 08/03
SPORTAGE I 2.0 i 4WD	FE(8V)	04/94 ⇨ 08/99
SPORTAGE I 2.2 D 4WD	--	08/94 ⇨ 04/99

PEUGEOT

Model	Part No.	Year
405 II 1.9	XU9J2/D6D	01/93 ⇨ 12/96

9.0092



04,5

REVOLUTION AND TIMING (CKP AND CMP) SENSORS

Adatt./Suitable:

BOSCH
0 261 210 098
0 261 210 100
0 261 210 117

FIAT

46406454

46779351

7731633

7731818

7746949

LANCIA

46406454



L	L1	ohm	OUT GND S
465	34,5	1350	

FIAT

Model	Part No.	Year
PANDA I 1.1	156C.046	05/91 ⇨ 03/95
PANDA I 1000 4x4	141C2.000	05/86 ⇨ 12/94
PANDA I 1000 i.e	156A2.246	08/92 ⇨ 02/04
PANDA I 1000 i.e. Cat	141C2.000, 156C.046	10/87 ⇨ 08/98
PANDA I 1100	156C.046, AR33601	05/91 ⇨ 12/99
PANDA I 1100 4x4	176B2.000	02/95 ⇨ 07/04
PANDA I 1100 Trekking 4x4	156C.046	10/91 ⇨ 07/04
TIPO I 1.1 i.e.	156C.046	10/94 ⇨ 10/95

LANCIA

Model	Part No.	Year
Y10 1.1 Fire	176B2.000	01/95 ⇨ 12/95
Y10 1.1 Fire Trazione integrale	176B2.000	01/95 ⇨ 12/95
Y10 1.1 i.e. Fire Trazione integrale	156C.046	09/92 ⇨ 12/95

9.0094



04,5

REVOLUTION AND TIMING (CKP AND CMP) SENSORS

Adatt./Suitable:

ALFA ROMEO
60808895
7656271

FIAT
60808895
7656271

MAGNETI MARELLI
SEN 8U

Eliminated on 08-05-2017. Please verify the availability through our local distributors

- Eliminato il 08-05-2017. Verificare la disponibilità presso i nostri distributori
- Éliminé le 08-05-2017. Vérifier la disponibilité auprès de nos distributeurs sur place
- Am 08-05-2017 gestrichen. Evtl. Verfügbarkeit bitte bei unseren Händlern prüfen
- Eliminado en fecha 08-05-2017. Verificar la disponibilidad a través de nuestros distribuidores locales



L	L1	ohm	OUT GND S
330	30	700	

ALFA ROMEO

Model	Part No.	Year Range
145 1.9TD	AR33601, AR33601	10/94 ⇨ 02/99
146 1.9TD	AR33601, AR33601	12/94 ⇨ 02/99
155 1.9TD	AR33601, 176A3.000	04/93 ⇨ 12/97

FIAT

Model	Part No.	Year Range
FIORINO II 1.7 D	146B2.000	01/88 ⇨ 10/99
FIORINO II 60 1.7 D	146B2.000	05/88 ⇨ 10/96
PALIO 1.7 D	176B3.000	04/96 ⇨
PALIO 1.7 TD	176A3.000, 176A3.000	04/96 ⇨
PALIO 1.7 TD 70	176B7.000	04/99 ⇨
PUNTO I 1.7 D	176B3.000	04/94 ⇨ 02/00
PUNTO I 1.7 TD	176A3.000, 176B7.000	01/94 ⇨ 09/99
SIENA 1.7 D [MAR]	176B3.000	01/98 ⇨
SIENA 1.7 TD	176A3.000	02/06 ⇨ 12/09
SIENA 1.7 TD [IND]	176B7.000, 176A3.000	04/99 ⇨
STRADA 1.7 TD	176A3.000, M20B20	10/06 ⇨ 12/08

9.0097



04,5

REVOLUTION AND TIMING (CKP AND CMP) SENSORS

Adatt./Suitable:

FIAT
7778981



L	L1	ohm	OUT GND S
380	24	550	

FIAT

Model	Part No.	Year Range
PUNTO I 1.6	176A9.000	01/94 ⇨ 04/97
PUNTO I 90 1.6	176A9.000	04/94 ⇨ 04/97

9.0098



04,5

REVOLUTION AND TIMING (CKP AND CMP) SENSORS

Adatt./Suitable:

BMW
12 12 1 722 587

1236 Engine revolution sensor to fit ignition cable sets:

- Sensore contagiri da montare su serie cavi accensione:
- Sonde compte-tours à monter sur fais. de câbles d'allumage:
- Drehzahlgeber zum Einbau auf Zündkabelsätzen:
- Cuenta-revoluciones para montaje en cableados de encendido:

4.8587

4.8597



L	L1	ohm	OUT GND S
710	---	---	

BMW

Model	Part No.	Year Range
3 II 320 i	M20B20, M20B27(276KA)	09/82 ⇨ 10/93
3 II 325 e 2.7	M20B27(276KA), M20B25(256E1)	10/83 ⇨ 12/88
3 II 325 i	M20B25(256E1), M20B25(256E1)	09/83 ⇨ 10/93
3 II 325 i X	M20B25(256E1), M20B20(206KA)	03/86 ⇨ 10/93
5 II 520 i	M20B20(206KA), M20B27(276EA)	08/85 ⇨ 12/87
5 II 525 e	M20B27(276EA), M40B16(164E1)	09/81 ⇨ 12/87
5 III 520 i	M20B20(206KA)	01/88 ⇨ 08/91
5 III 525 i	M20B25(256K1)	01/88 ⇨ 08/91
Z1 2.5	M20B25(256K1)	06/88 ⇨ 06/91

9.0100



04,5

REVOLUTION AND TIMING (CKP AND CMP) SENSORS

Adatt./Suitable:

BMW
12 12 1 734 139

1236 Engine revolution sensor to fit ignition cable sets:

- Sensore contagiri da montare su serie cavi accensione:
- Sonde compte-tours à monter sur fais. de câbles d'allumage:
- Drehzahlgeber zum Einbau auf Zündkabelsätzen:
- Cuenta-revoluciones para montaje en cableados de encendido:

4.8605



L	L1	ohm	OUT GND S
650	---	---	

BMW

Model	Part No.	Year Range
3 III 316 i	M40B16(164E1), M40B16(164E1)	09/90 ⇨ 09/93
3 III 318 i	M40B18(184E1)	12/90 ⇨ 10/93

9.0101



04,5

REVOLUTION AND TIMING (CKP AND CMP) SENSORS

Adatt./Suitable:

BMW
12 12 1 721 775

1236 Engine revolution sensor to fit ignition cable sets:

- Sensore contagiri da montare su serie cavi accensione:
- Sonde compte-tours à monter sur fais. de câbles d'allumage:
- Drehzahlgeber zum Einbau auf Zündkabelsätzen:
- Cuenta-revoluciones para montaje en cableados de encendido:

4.8573



L	L1	ohm	OUT GND S
780	---	---	

BMW

Model	Part No.	Year Range
3 II 316 i	M40B16(164E1), M40B18(184E1)	09/87 ⇨ 06/94
3 II 318 i	M40B18(184E1), ED8A	09/87 ⇨ 06/94
5 III 518 i	M40B18(184E1)	08/89 ⇨ 09/95

9.0103



04,5

REVOLUTION AND TIMING (CKP AND CMP) SENSORS

Adatt./Suitable:

BMW
12 12 1 725 023

00 Eliminated on 02-11-2016. Please verify the availability through our local distributors

- Eliminato il 02-11-2016. Verificare la disponibilità presso i nostri distributori
- Éliminé le 02-11-2016. Vérifier la disponibilité auprès de nos distributeurs sur place
- Am 02-11-2016 gestrichen. Evtl. Verfügbarkeit bitte bei unseren Händlern prüfen
- Eliminado en fecha 02-11-2016. Verificar la disponibilidad a través de nuestros distribuidores locales



L	L1	ohm	
360	---	---	

BMW

7 11 750 i,iL V12	M70B50(5012A)	09/87 ⇒ 09/94
8 850 CSi	S70B56(56121)	11/92 ⇒ 12/96
8 850 i,Ci	M70B50(5012A)	04/90 ⇒ 10/94

9.0104



3

REVOLUTION AND TIMING (CKP AND CMP) SENSORS

Adatt./Suitable:

FORD
3 009 084
6 873 316
F3RP-7H062-AA
F7RP-7M101-AA



L	L1	ohm	
---	29	200	

FORD

COUGAR 2.0 16V	EDBA, L1F	08/98 ⇒ 12/01
MONDEO I 1.6 i	L1J	08/96 ⇒ 09/00
MONDEO I 1.6 i 16V	L1F, RKB	02/93 ⇒ 09/00
MONDEO I 1.8 4x4	RKA	02/93 ⇒ 08/96
MONDEO I 1.8 i	RKB, RKA	08/96 ⇒ 09/00
MONDEO I 1.8 i 16V	RKA, RFM	02/93 ⇒ 08/96
MONDEO I 1.8 i 16V 4x4	RKA	02/93 ⇒ 08/96
MONDEO I 1.8 TD	RFM, NGA	06/93 ⇒ 09/00
MONDEO I 2.0 i	NGA, NGA	08/96 ⇒ 09/00
MONDEO I 2.0 i 16V	NGA, NGA	01/93 ⇒ 08/96
MONDEO I 2.0 i 16V 4x4	NGA, SEA	02/93 ⇒ 08/96

FORD

MONDEO I 2.5 24V	SEA, TU32	08/96 ⇒ 09/00
MONDEO I 2.5 i 24V	SEA	07/94 ⇒ 08/96
MONDEO I 2.5 ST 200	SGA	05/99 ⇒ 09/00

9.0105



3

REVOLUTION AND TIMING (CKP AND CMP) SENSORS

Adatt./Suitable:

BOSCH
0 986 280 452

CITROËN
1920 L1
96 131 733

ELECTRICFIL
14 43 08

PEUGEOT
1920 L1



L	L1	ohm	
---	28	---	

CITROËN

BERLINGO I 1.4 bivalent	TU3JPCNG	11/02 ⇒ 12/11
BERLINGO I 1.4 i	TU3A, KFW(TU3JP)	07/96 ⇒ 12/11
BERLINGO I électrique	SA18	01/00 ⇒ 10/02
BERLINGO 1.4	TU32, TU3A	07/96 ⇒ 12/11
SAXO 1.4 VTS	KFW(TU3JP), RFT(XU10J4/Z)	05/96 ⇒ 06/03
XANTIA I 2.0 i 16V	RFT(XU10J4/Z), KFX(TU3JP)	03/93 ⇒ 01/98
XANTIA I 2.0 i SX 16V	XU10J4D	04/94 ⇒ 05/95
XANTIA I 2.0 i VSX 16V	XU10J4D	03/93 ⇒ 05/95
XSARA 1.4	TU3JP	05/98 ⇒ 03/05
XSARA 1.4 BiFuel [ExtraEU]	TU3JP	05/98 ⇒ 08/00
XSARA 1.4 i	KFX(TU3JP), RFS(XU10J4RS)	04/97 ⇒ 08/05
XSARA 1.4 LPG	TU3JP	05/98 ⇒ 08/00
XSARA 2.0 16V	RFS(XU10J4RS)	04/97 ⇒ 09/00
XSARA 2.0 i 16V	RFS(XU10J4RS), RFS(XU10J4RS)	02/98 ⇒ 03/05
ZX 2.0	RFS(XU10J4RS)	09/96 ⇒ 10/97
ZX 2.0 i 16V	RFS(XU10J4RS), KFW(TU3JP)	07/92 ⇒ 10/97

PEUGEOT

106 I Electric	SA13	04/94 ⇒
106 II 1.4 i	KFW(TU3JP), KFW(TU3JP)	05/96 ⇒ 07/04
206 1.4 i	KFX(TU3JP)	09/98 ⇒
306 1.4	KFW(TU3JP), KFW(TU3JP)	04/93 ⇒ 04/02
306 1.4 SL	KFW(TU3JP), RFS(XU10J4RS)	06/94 ⇒ 05/01
306 2.0 516	RFS(XU10J4RS), KFX(TU3JP)	05/93 ⇒ 05/01
405 II 2.0 16V	RFT(XU10J4)	06/94 ⇒ 10/95
405 II 2.0 4x4	RGZ(XU10J4TE/Z)	08/92 ⇒ 12/95
405 II 2.0 T 16 X4	RGZ(XU10J4TE/Z)	08/92 ⇒ 10/95
PARTNER 1.4	TU3JP	09/99 ⇒ 10/02
PARTNER I 1.4	KFX(TU3JP), K6C(TU3JP)	06/96 ⇒ 12/15
PARTNER I Electric	--	04/96 ⇒ 12/02
RANCH 1.4	K6C(TU3JP), B204I	06/96 ⇒
RANCH Électrique	SA18	01/98 ⇒

9.0107



3,5

REVOLUTION AND TIMING (CKP AND CMP) SENSORS

Adatt./Suitable:

GENERAL MOTORS
90 348 929

HOLDEN
90348929

OPEL
12 38 405

SAAB
44 90 991

03 Supplied until depletion

- Fornibile fino ad esaurimento delle scorte
- Fourni jusqu'à épuisement du stock
- Lieferbar solange vorrat reicht
- Suministrado hasta el stock termina



L	L1	ohm	
210	28	500	

HOLDEN

ASTRA_TR 1.8i 16v Hatchback	C18SEL	09/96 ⇒ 09/98
ASTRA_TR 1.8i 16v Sedan	C18SEL	09/96 ⇒ 09/98
CALIBRA_YE 2.0i	C20NE	09/91 ⇒ 07/95
CALIBRA_YE 2.0i 16V	X20XEV	08/95 ⇒ 10/97
CALIBRA_YE 2.5i 24v	C25XE	08/95 ⇒ 10/97

OPEL

ASTRA F 1.8 i	C18NZ	09/91 ⇒ 09/98
ASTRA F 2.0 i	C20NE	09/91 ⇒ 09/98

SAAB

900 II 2.0 -16 Turbo	B204L	07/93 ⇒ 02/98
900 II 2.0 i	B204I, E32	07/93 ⇒ 02/98
900 II 2.3 -16	B234I	07/93 ⇒ 02/98
900 II 2.5 -24 V6	B258I	07/93 ⇒ 02/98

VAUXHALL

ASTRA III 1.8 i	C18NZ	09/91 ⇒ 09/98
ASTRA III 2.0 i	C20NE	09/91 ⇒ 09/98

9.0108



3

REVOLUTION AND TIMING (CKP AND CMP) SENSORS

Adatt./Suitable:

FORD

6 189 130
6 859 703
91XF-AA6C3-15
91XF-AB6C3-15

03 Supplied until depletion

- Fornibile fino ad esaurimento delle scorte
- Fourni jusqu'à épuisement du stock
- Lieferbar solange vorrat reicht
- Suministrado hasta el stock termina



L	L1	ohm	
---	40	290	

FORD

ESCORT V RS 2000 N7A 05/91 ⇨ 12/92

9.0112



3

REVOLUTION AND TIMING (CKP AND CMP) SENSORS

Adatt./Suitable:

DAEWOO

0021539528

MERCEDES-BENZ

A 002 153 95 28

SSANGYONG

0021539528



L	L1	ohm	
---	24	1200	

DAEWOO

KORANDO 3.2 4x4 E32, M104.992 01/99 ⇨

MUSSO 3.2 4x4 M104.992, M104.992(AMG3.6) 01/99 ⇨

MERCEDES-BENZ

CABRIOLET 300 CE-24 M104.980 04/92 ⇨ 06/93

CLASSE C I C 220 M111.961 03/93 ⇨ 05/00

CLASSE C I C 280 M104.941 05/93 ⇨ 05/00

CLASSE C I C 36 AMG M104.941(AMG3.6) 05/94 ⇨ 05/00

CLASSE E I E 220 M111.960 06/93 ⇨ 03/98

CLASSE E I E 220 T M111.960 06/93 ⇨ 06/96

CLASSE E I E 280 M104.942 06/93 ⇨ 06/95

CLASSE E I E 280 T M104.942 06/93 ⇨ 06/96

CLASSE E I E 320 M104.992 06/93 ⇨ 03/98

CLASSE E I E 320 T M104.992 06/93 ⇨ 06/96

MERCEDES-BENZ

CLASSE E I E 36 AMG M104.992(AMG3.6), M104.995 06/93 ⇨ 03/98

CLASSE E I E 36 T AMG M104.992(AMG3.6) 05/94 ⇨ 06/96

CLASSE E I E 420 M119.975 06/93 ⇨ 06/95

CLASSE E I E 500 M119.974 06/93 ⇨ 06/95

CLASSE E I E 60 AMG M119.974(AMG6.0) 05/94 ⇨ 06/95

CLASSE G II G 320 GE M104.996 09/94 ⇨ 11/97

CLASSE G II G 320 M104.996 09/94 ⇨ 12/97

CLASSE G II G 36 AMG M104.996(AMG3.6) 01/95 ⇨ 07/98

CLASSE S III 300 SE 2.8 M104.944 01/93 ⇨ 10/98

CLASSE S III 300 SE, SEL/S320 M104.990 03/91 ⇨ 10/98

CLASSE S III 400 SE, SEL/S420 M119.971 02/91 ⇨ 10/98

CLASSE S III 500 SE, SEL M119.970 02/91 ⇨ 10/98

CLASSE S III 500 SEC / CL 500 M119.970 10/92 ⇨ 02/99

CLASSE S III S 280 M104.944 02/93 ⇨ 10/98

CLASSE S III S 420 M119.971 01/93 ⇨ 10/98

CLASSE S III S 500 M119.970 01/93 ⇨ 10/98

CLASSE S III SEC/CL 420 M119.971 10/94 ⇨ 02/99

CLASSE SL IV 280 M104.943 08/93 ⇨ 10/01

CLASSE SL IV 300 SL-24 M104.981 03/89 ⇨ 07/93

CLASSE SL IV 320 M104.991 09/93 ⇨ 10/01

CLASSE SL IV 500 M119.972 09/92 ⇨ 10/01

CLASSE SL IV 500 SL M119.960 09/89 ⇨ 08/92

COUPE 220 CE M111.960 10/92 ⇨ 05/93

COUPE 300 CE-24 M104.980 09/89 ⇨ 12/92

COUPE 320 CE M104.992 10/92 ⇨ 05/93

KOMBI II 220 TE M111.960 10/92 ⇨ 05/93

KOMBI II 280 TE M104.942 10/92 ⇨ 06/93

KOMBI II 300 TE-24 M104.980 09/89 ⇨ 08/92

KOMBI II 320 TE M104.992 10/92 ⇨ 06/93

TRE VOLUMI II 220 E M111.960 10/92 ⇨ 06/93

TRE VOLUMI II 280 E M104.942 10/92 ⇨ 06/93

TRE VOLUMI II 300 E-24 M104.980 09/88 ⇨ 08/92

TRE VOLUMI II 320 E M104.992 10/92 ⇨ 06/93

TRE VOLUMI II 400 E 4.2 M119.975 10/92 ⇨ 06/93

TRE VOLUMI II 500 E M119.974 01/91 ⇨ 06/93

TRE VOLUMI II 500 E AMG 6.0 M119.974(AMG6.0) 01/92 ⇨ 06/93

PUCH

G-MODELL G 320 M104.996 02/94 ⇨ 12/97

G-MODELL G 36 AMG M104.952(AMG3, 6) 01/95 ⇨ 04/98

SSANGYONG

KORANDO 3.2 M104.995, KFY(TU3FJ2) 12/96 ⇨ 11/02

9.0127



04,5

REVOLUTION AND TIMING (CKP AND CMP) SENSORS

Adatt./Suitable:

BOSCH

0 986 280 406

CITROËN

1920 4A

1920 J5

1920 Z3

96 085 170

PEUGEOT

1920 4A

1920 J5

1920 Z3

96 085 170



L	L1	ohm	
330	24	370	

CITROËN

AX 1.4 GTi KFY(TU3FJ2), CDY(TU9M) 06/91 ⇨ 12/96

AX 10 CDY(TU9M), K6B(TU3FJ2) 07/86 ⇨ 12/98

AX 11 HDZ(TU1M) 09/86 ⇨ 12/97

AX 14 K6B(TU3FJ2), TU32 04/87 ⇨ 04/97

AX 14 4x4 KDY(TU3FM) 08/91 ⇨ 12/96

BERLINGO I 1.1 i HDZ(TU1M), KFW(TU3JP) 07/96 ⇨ 05/08

BERLINGO I 1.4 i KFW(TU3JP), CDZ(TU9M) 07/96 ⇨ 12/11

BERLINGO I 1.4 i bivalent KFW(TU3JP) 04/03 ⇨ 10/05

BERLINGO 1.1 BiFuel TU1M+ 07/96 ⇨ 10/02

BERLINGO 1.4 TU32, HDZ(TU1M) 07/96 ⇨ 10/02

CITROËN

SAXO 1.0 TU9M 10/97 ⇨ 06/03

SAXO 1.0 X CDZ(TU9M), HDZ(TU1M) 05/96 ⇨ 11/98

SAXO 1.1 X,SX HDZ(TU1M), KFW(TU3JP) 05/96 ⇨ 09/03

SAXO 1.4 VTS KFW(TU3JP), NFT(TU5JP) 05/96 ⇨ 06/03

SAXO 1.6 NFX(TU5JP), NFZ(TU5JP) 02/01 ⇨ 04/04

SAXO 1.6 VTL,VTR NFZ(TU5JP), NFT(TU5JP) 05/96 ⇨ 06/03

SAXO 1.6 VTR NFX(TU5JP4) 05/96 ⇨ 07/99

SAXO 1.6 VTS NFX(TU5JP), KFX(TU3JP) 09/00 ⇨ 09/03

XSARA 1.4 i KFX(TU3JP), NFZ(TU5JP) 04/97 ⇨ 08/05

XSARA 1.4 LPG TU3JP 05/98 ⇨ 08/00

XSARA 1.6 i NFZ(TU5JP), KDX(TU3M/Z) 04/97 ⇨ 09/00

ZX 1.1 HDZ(TU1M) 03/91 ⇨ 06/97

ZX 1.4 KDX(TU3M/Z) 03/91 ⇨ 06/97

ZX 1.4 i KDX(TU3M/Z), CDY(TU9M) 03/91 ⇨ 10/97

PEUGEOT

106 I 1.0 CDY(TU9M), KDX(TU3MC) 09/91 ⇨ 03/01

106 I 1.1 HDZ(TU1M) 09/91 ⇨ 04/96

106 I 1.3 TU2J2 10/93 ⇨ 04/96

106 I 1.4 KDX(TU3MC), TU3FJ 09/91 ⇨ 04/96

106 I 1.4 i TU3FJ, NFY(TU5J2) 01/91 ⇨ 12/96

106 I 1.4 i XSI TU3J 09/91 ⇨ 03/96

106 I 1.6 NFY(TU5J2), TU9M 06/93 ⇨ 04/96

106 II 1.0 i TU9M, HDY(TU1M) 04/96 ⇨ 10/99

106 II 1.1 i HDY(TU1M), KFW(TU3JP) 05/96 ⇨ 07/04

106 II 1.4 i KFW(TU3JP), NFW(TU5J2) 05/96 ⇨ 07/04

106 II 1.6 i NFW(TU5J2), KDX(TU3MC) 05/96 ⇨ 10/99

106 II 1.6 S16 NFX(TU5J4) 05/96 ⇨ 07/04

205 II 1.0 CDZ(TU9M) 08/92 ⇨ 05/97

205 II 1.4 KDX(TU3MC) 07/88 ⇨ 09/98

306 1.1 HDZ(TU1M) 05/93 ⇨ 05/01

306 1.4 KDX(TU3MC), KDX(TU3MC) 04/93 ⇨ 04/02

306 1.4 SL KDX(TU3MC), HDY(TU1M) 06/94 ⇨ 05/01

306 1.6 NFZ(TU5JP) 05/93 ⇨ 10/00

306 1.6 SR NFZ(TU5JP) 06/94 ⇨ 10/00

405 II 1.4 TU3FM 01/93 ⇨ 12/96

PARTNER I 1.1 HDY(TU1M), K6D(TU3A) 06/96 ⇨

PARTNER I 1.4 K6D(TU3A), HDY(TU1M) 06/96 ⇨

RANCH 1.1 HDY(TU1M), 42D 06/96 ⇨

RANCH 1.4 KFX(TU3JP) 06/96 ⇨

9.0129



3,5

REVOLUTION AND TIMING (CKP AND CMP) SENSORS

Adatt./Suitable:

LAND ROVER

ADU7339

ADU7342

ADU7342L

ROVER

ADU7342



L	L1	ohm	
250	17	1400	

AUSTIN

MONTEGO 2.0 20HSC 04/84 ⇨ 08/88

MONTEGO 2.0 Turbo 20HC85 04/84 ⇨ 08/88

LAND ROVER

RANGE ROVER II 3.9 4x4 42D 07/94 ⇨ 03/02

RANGE ROVER II 4.0 4x4 42D, 46D 01/95 ⇨ 03/02

RANGE ROVER II 4.6 4x4 46D, M50820(20651) 07/94 ⇨ 03/02

ROVER

200 II 220 GTi 20M4F 09/91 ⇨ 10/95

400 I 420 16V -- 01/91 ⇨ 12/92

400 I 420 GTI/GSI/Vitesse 20M4F 02/92 ⇨ 04/95

800 820 -- 10/88 ⇨ 10/91

800 820 i/Si 20HD 10/88 ⇨ 12/91

800 820 Si 20HDM16 10/88 ⇨ 12/91

MAESTRO 2.0 -- 01/86 ⇨

MONTEGO 2.0 GTi 20H 10/88 ⇨ 10/91

9.0130



04,5

REVOLUTION AND TIMING (CKP AND CMP) SENSORS

Adatt./Suitable:

BMW12 14 1 726 065
12 14 1 726 066

L	L1	ohm	
725	24	550	

BMW

3 III 320 i	M50B20(206S1), M50B25(256S1)	09/90 ⇨ 10/99
3 III 325 i	M50B25(256S1), M50B20(206S1)	09/90 ⇨ 04/99
5 III 520 i	M50B20(206S1), M50B20(206S1)	11/91 ⇨ 01/97
5 III 520 i 24V	M50B20(206S1), M50B25(256S1)	09/89 ⇨ 09/95
5 III 525 i	M50B25(256S1), M50B25(256S1)	11/91 ⇨ 01/97
5 III 525 i 24V	M50B25(256S2)	09/89 ⇨ 12/95
5 III 525 ix	M50B25(256S1)	02/92 ⇨ 01/97
5 III 525 ix 24V	M50B25(256S1), AR67103	10/91 ⇨ 09/95

9.0132



04,5

REVOLUTION AND TIMING (CKP AND CMP) SENSORS

Adatt./Suitable:

ALFA ROMEO46472687
60513208
60595754
60810692**BOSCH**0 261 210 036
0 261 210 113
0 261 210 163**FIAT**60595754
60810692
99455422**IVECO**0000099455422
5162472
8024223
8024223
99455422**LANCIA**

60595754



L	L1	ohm	
640	24	900	

ALFA ROMEO

33 II 1.5 i.e.	AR30738	09/91 ⇨ 12/95
33 II 1.7 16V	AR30746, AR30746	01/90 ⇨ 09/94
33 II 1.7 16V 4x4	AR30746, AR61102	01/90 ⇨ 09/94
33 II 1.7 i.e.	AR30740	09/91 ⇨ 12/95
75 1.6 Cat	AR61101	05/89 ⇨ 02/92
75 1.8	AR61102, AR06166	09/88 ⇨ 02/92
75 1.8 i.e.	61202	08/89 ⇨ 02/92

ALFA ROMEO

75 2.0 T.S. Cat	AR06224	05/85 ⇨ 02/92
75 2.0 T.S.	AR06166, AR16101	01/87 ⇨ 02/92
75 3.0 V6	AR61503	02/90 ⇨ 02/92
145 1.6 i.e.	AR33201	10/94 ⇨ 12/96
145 1.7 i.e. 16V	AR33401	10/94 ⇨ 12/96
146 1.7 i.e. 16V	AR33401	12/94 ⇨ 12/96
155 1.7 T.S.	AR67103, AR67101	04/93 ⇨ 04/96
155 1.8 T.S.	AR67101	02/92 ⇨ 05/94
155 1.8 T.S. Sport	AR67101, AR67201	03/92 ⇨ 12/96
155 2.0 T.S.	AR67201, AR32401	02/92 ⇨ 05/95
156 2.5 V6 24V	AR32401, AR06416	02/97 ⇨ 05/06
156 2.5 V6 24V [BRA]	AR32402	10/97 ⇨ 12/01
164 2.0 T.S.	AR06416, AR64101	06/87 ⇨ 09/98
164 2.0 Turbo	AR64102	07/90 ⇨ 10/92
164 2.0 Twin Spark	AR06420	06/87 ⇨ 09/92
164 2.0 V6 Turbo	AR64101, AR64307	03/91 ⇨ 09/98
164 3.0	AR06410	11/87 ⇨ 09/91
164 3.0 24V Q4	AR64307, AR06410	09/92 ⇨ 10/98
164 3.0 24V QV Trazione integrale	AR64307	11/92 ⇨ 10/97
164 3.0 i.e. QV	AR64301	09/90 ⇨ 09/92
164 3.0 V6	AR06410, AR30746	06/87 ⇨ 09/98
164 3.0i 24V Super Q4	AR66304	03/95 ⇨ 12/98
166 2.5 V6 24V	AR34201	09/98 ⇨ 12/06
166 3.0 V6 24V	AR34301	09/98 ⇨ 06/07
166 3.0 V6 24V [BRA]	AR34302	08/98 ⇨ 09/00
GTV 2.0 V6 Turbo	AR16202	06/95 ⇨ 09/98
GTV 3.0 V6 24V	AR16102	10/96 ⇨ 10/00
SPIDER 3.0 [ExtraEU]	AR16101, AR01588	04/95 ⇨ 04/05
SPIDER I 2.0i [CAN]	AR01588	09/90 ⇨ 10/93
SPIDER I 2.0i [USA]	AR01588	09/90 ⇨ 10/93
SPIDER I 2.0i Veloce [CAN]	AR01588	09/90 ⇨ 10/93
SPIDER I 2.0i Veloce [USA]	AR01588	09/90 ⇨ 10/93
SPIDER I 2000	AR01588, AR16199	01/77 ⇨ 12/93
SPIDER II 2.0 V6 Turbo	AR16202	05/98 ⇨ 04/05
SPIDER II 3.0 12V [BRA]	AR16199, AR16101	09/95 ⇨ 07/07
SPIDER II 3.0 V6	AR16101, 8140.43B	06/95 ⇨ 04/05

IVECO

DAILY II 2.8 CNG	814903CNG	05/99 ⇨ 07/07
DAILY II 29 L 11	8140.43B, 8140.43B	05/99 ⇨ 04/06
DAILY II 29 L 11 V	8140.43B, 8140.43B	05/99 ⇨ 07/07
DAILY II 29 L 9	8140.63	05/99 ⇨ 04/06
DAILY II 29 L 9 V	8140.63	05/99 ⇨ 07/07
DAILY II 35 S 11 V,35 C 11 V	8140.43B, 8140.43B	05/99 ⇨ 07/07
DAILY II 35 S 11,35 C 11	8140.43B, 8140.43B	05/99 ⇨ 04/06
DAILY II 35 S 9V,35 C 9V	8140.63	05/99 ⇨ 07/07
DAILY II 35 S 9,35 C 9	8140.63	05/99 ⇨ 04/06
DAILY II 50 C 11	8140.43B, T8	05/99 ⇨ 07/07
DAILY II 50 C 11 Natural Power	814903CNG	05/99 ⇨ 04/06
DAILY III 40 C 11, 50 C 11	8140.43C	05/99 ⇨ 05/06
DAILY III 50 C 11 Natural Power	814903CNG	05/02 ⇨ 05/06
DAILY 2.8	8140.43B, 8140.43B	07/99 ⇨ 12/06
DAILY 2.8 CNG	814903CNG	07/99 ⇨ 12/06

LANCIA

KAPPA 3.0 24V	838B.000	08/94 ⇨ 10/01
---------------	----------	---------------

9.0137



04,5

REVOLUTION AND TIMING (CKP AND CMP) SENSORS

Adatt./Suitable:

BOSCH

0 261 210 048

GENERAL MOTORS

90 337 650

HOLDEN

90337650

OPEL

12 38 782

90337650

VAUXHALL

90337650

Supplied until depletion

- Fornibile fino ad esaurimento delle scorte
- Fourni jusqu'à épuisement du stock
- Lieferbar solange vorrat reicht
- Suministrado hasta el stock termina



L	L1	ohm	
835	34,5	550	

HOLDEN

BARINA_SB 1.6i C16XE 04/94 ⇨ 11/95

OPEL

SENATOR B 3.0 24V C30SE 09/89 ⇨ 09/93

9.0140



04,5

REVOLUTION AND TIMING (CKP AND CMP) SENSORS

Adatt./Suitable:

BOSCH

0 261 210 029

FIAT

7616269

KIA

OK2A6-18891

LANCIA

7616269

VOLVO

136764-5

13676457



L	L1	ohm	
185	24	550	

KIA

CARENS I 1.8 i	T8, HJ3	11/00 ⇨ 07/02
CARENS I 1.8 i 16V	T8D	03/00 ⇨ 05/02
CARNIVAL I 2.9 CRDi	J3	10/01 ⇨ 06/06
CARNIVAL I 2.9 TD	HJ3, OK24N	01/99 ⇨ 09/07
CERATO I 1.8	T8	10/01 ⇨ 07/04
RETONA 2.0 TD	RF	06/99 ⇨ 07/01
SEDONA 2.9 CRDi	--	07/01 ⇨ 07/01
SEDONA 2.9 TD	--	06/98 ⇨ 07/01
SEPHIA I 1.8 i 16V	OK24N, T8	01/95 ⇨ 10/97
SEPHIA II 1.8 i 16V	--	09/97 ⇨ 09/97
SHUMA I 1.8 i 16V	T8, T8	10/97 ⇨ 03/01
SHUMA II 1.8	T8, FERF	05/01 ⇨ 08/04
SPECTRA 1.8 i 16V	--	09/97 ⇨ 09/97

KIA			
SPORTAGE I 2.0 TD 4WD	FERE, F105L	10/97 ⇨	08/03
LANCIA			
THEMA 2850 V6 i.e.	B34E.146	06/88 ⇨	05/92
THEMA 8.32	F105L, B280E	09/87 ⇨	05/92
VOLVO			
760 2.8	B280E, B280E	08/81 ⇨	08/91
780 2.9	B280E, B280E	08/86 ⇨	07/90
960 I 2.8 GL	B280E, N7U700	09/90 ⇨	05/92

9.0141



04,5

REVOLUTION AND TIMING (CKP AND CMP) SENSORS

Adatt./Suitable:

OPEL

12 38 904

SAAB

45 04 288



L	L1	ohm	
735	38	550	

SAAB			
900 II 2.5 -24 V6	B258I	07/93 ⇨	02/98
9000 3.0 -24 V6 CD/CDE	B308I	07/94 ⇨	12/98
9000 3.0 -24 V6 CS/CSE	B308I	07/94 ⇨	12/98

9.0142



3,5

REVOLUTION AND TIMING (CKP AND CMP) SENSORS

Adatt./Suitable:

RENAULT

74 33 547 699

SIEMENS

S102460001Z

VOLVO

35079417

354769-9

35476993



L	L1	ohm	
310	32	330	

RENAULT			
SAFRANE II 2.5 20V	N7U700, B5202S	07/96 ⇨	12/00

VOLVO			
850 2.0	B5202S, B5204FT	06/91 ⇨	12/96
850 2.0 10V	B5202FS	08/94 ⇨	12/97
850 2.0 Turbo	B5204FT, B5252	02/93 ⇨	10/97
850 2.3	B5234FS	01/96 ⇨	10/96
850 2.3 T5	B5234FT	02/93 ⇨	12/96
850 2.3 T5-R	B5234T4	08/95 ⇨	12/96
850 2.3 Turbo R	B5234T5	06/95 ⇨	10/97
850 2.4	B5252, B5252FS	06/91 ⇨	12/96
850 2.4 AWD	B5254T	04/96 ⇨	12/96

VOLVO			
850 2.4 GLE	B5254T	09/93 ⇨	10/97
850 2.5 10V	B5252FS, B6304F	06/91 ⇨	12/97
850 2.5 20V	B5254FS	08/91 ⇨	12/97
960 I 2.9	B6304F, B6254FS	08/90 ⇨	07/94
960 II 2.4	B6244FS	01/95 ⇨	08/97
960 II 2.5	B6254S	07/94 ⇨	12/96
960 II 2.5 24V	B6254FS, B6304FS	01/95 ⇨	08/97
960 II 2.9	B6304FS, B5202FS	07/94 ⇨	08/97
C70 I 2.0	B5204T2	03/97 ⇨	10/05
C70 I 2.4 T	B5254T	03/98 ⇨	10/05
S70 2.0	B5202FS, B5204T2	01/97 ⇨	11/00
S70 2.0 Turbo	B5204T2, B5234FS	01/97 ⇨	11/00
S70 2.3	B5234FS, B5234T3	11/96 ⇨	07/99
S70 2.3 AWD	B5234T7	04/99 ⇨	09/00
S70 2.3 T-5	B5234T3	01/97 ⇨	11/00
S70 2.3 T5 AWD	B5234T3, B5234FT+	11/96 ⇨	09/98
S70 2.3 T5-R AWD	B5234T2	11/96 ⇨	09/98
S70 2.3 Turbo	B5234FT+, B5244S	01/97 ⇨	11/00
S70 2.4	B5244S, B5244T	01/97 ⇨	11/00
S70 2.4 AWD	B5252FS	11/96 ⇨	05/99
S70 2.4 Bifuel	GB5252S	10/98 ⇨	11/00
S70 2.4 T5 AWD	B5254T	11/96 ⇨	04/99
S70 2.4 Turbo	B5244T, B6244FS	01/97 ⇨	11/00
S70 2.5 20V	B5254FS	01/97 ⇨	12/98
S70 2.5 Bifuel	GB5252S2	01/99 ⇨	12/99
S90 2.5	B6244FS, B6254FS	11/96 ⇨	10/98
S90 2.5 24V	B6254FS, B6304FS	01/97 ⇨	05/98
S90 2.9	B6304FS, B6304FS	01/97 ⇨	05/98
S90 2.9 24V	B6304FS, B5202FS	01/97 ⇨	05/98
V70 I 2.0	B5202FS, B5204T2	12/95 ⇨	03/00
V70 I 2.0 Turbo	B5204T2, B5234FS	12/95 ⇨	12/00
V70 I 2.0 Turbo AWD	B5204T3	11/96 ⇨	12/00
V70 I 2.3	B5234FS, B5234T3	11/96 ⇨	07/99
V70 I 2.3 AWD	B5234T3, B5234FT+	04/97 ⇨	09/98
V70 I 2.3 T AWD	B5234FT+, B5234T2	04/97 ⇨	12/98
V70 I 2.3 T-5	B5234T2, B5234T2	11/96 ⇨	12/00
V70 I 2.3 T-5 AWD	B5234T2, B5234FT+	01/97 ⇨	12/00
V70 I 2.3 Turbo	B5234FT+, B5244S	12/95 ⇨	12/98
V70 I 2.4	B5244S, B5244T	12/95 ⇨	12/99
V70 I 2.4 Bifuel	GB5252S	05/98 ⇨	12/99
V70 I 2.4 Turbo	B5244T, B5244T	04/96 ⇨	12/00
V70 I 2.4 Turbo AWD	B5244T, B6244FS	04/96 ⇨	12/00
V70 I 2.5	B5252FS	01/97 ⇨	03/00
V70 I 2.5 20V	B5254FS	01/97 ⇨	12/99
V70 I 2.5 Bifuel	GB5252S2	01/99 ⇨	12/99
V70 2.0 T5 [ExtraEU]	B5204T3	10/97 ⇨	03/99
V90 2.5	B6244FS, B6304FS	11/96 ⇨	10/98
V90 2.5 24V	B6254GS	01/97 ⇨	12/97
V90 2.9	B6304FS, B6304FS	01/97 ⇨	12/98
V90 2.9 24V	B6304FS, X16SZ	01/97 ⇨	12/98

9.0149



04,5

REVOLUTION AND TIMING (CKP AND CMP) SENSORS

Adatt./Suitable:

BOSCH

F 000 99R 005

GENERAL MOTORS

90 357 491

90 451 442

HOLDEN

90451442

OPEL

12 38 983

62 38 325

90357491

90451442

SIEMENS

S101938001Z

VAUXHALL

90357491

90451442



L	L1	ohm	
660	34,5	550	

HOLDEN

ASTRA 2.0 GSi X20XEV 08/95 ⇨ 09/98

ASTRA_TR 1.6i Hatchback C16SE 09/96 ⇨ 09/98

ASTRA_TR 1.6i Sedan C16SE 09/96 ⇨ 09/98

OPEL

ASTRA F 1.4 14SE 09/92 ⇨ 09/98

ASTRA F 1.4 Si C14SE 03/92 ⇨ 03/01

ASTRA F 1.6 16NZR 09/95 ⇨ 09/98

ASTRA F 1.6 i X16SZ, C14SE 09/91 ⇨ 01/05

ASTRA F 1.6 Si C16SE 03/92 ⇨ 12/94

COMBO B 1.2 X12SZ 07/94 ⇨ 10/01

COMBO B 1.4 C14SE, 16LZ2 07/94 ⇨ 10/01

CORSA A 1.4 Si C14SE 09/91 ⇨ 03/93

CORSA A 1.6 GSi Cat C16SE 02/92 ⇨ 03/93

CORSA B 1.2 i X12SZ 03/93 ⇨ 09/00

CORSA B 1.4 C14SE 04/93 ⇨ 08/94

CORSA B 1.4 i X14SZ 03/93 ⇨ 09/00

CORSA B 1.4 Si C14SE 03/93 ⇨ 09/00

VECTRA A 1.6 i X16SZ 09/93 ⇨ 11/95

VECTRA B 1.6 i 16LZ2, C16SE 10/95 ⇨ 07/03

VAUXHALL

ASTRA III 1.4 i C14SE 03/91 ⇨ 03/01

ASTRA III 1.6 C16SE 03/94 ⇨ 08/95

ASTRA III 1.6 i C16SE, AR06410 03/92 ⇨ 09/98

ASTRA III 1.6 Si C16SE 03/91 ⇨ 12/94

ASTRAVAN I 1.6 i X16SZ 09/94 ⇨ 08/96

COMBO B 1.2 X12SZ 07/94 ⇨ 10/01

COMBO B 1.4 C14SE 07/94 ⇨ 10/01

CORSA B 1.2 i X12SZ 03/93 ⇨ 09/00

CORSA B 1.4 i X14SZ 03/93 ⇨ 09/00

CORSA B 1.4 i S C14SE 03/93 ⇨ 09/00

VECTRA B 1.6 i X16SZR 08/95 ⇨ 03/02

9.0151



04,5

REVOLUTION AND TIMING (CKP AND CMP) SENSORS

Adatt./Suitable:

ALFA ROMEO
60560715**BOSCH**
0 261 210 047**KIA**
OK2B1-18891
OK2B3-18891**ROLLS-ROYCE**
UE72296

L	L1	ohm	
820	24	550	

ALFA ROMEO

164 3.0	AR06410, AR66301	11/87 ⇒ 02/95
164 3.0 24V	AR66301, BFD	09/92 ⇒ 09/98
164 3.0 24V Q4	AR64308	02/94 ⇒ 09/98
164 3.0 24V QV	AR64304	09/92 ⇒ 09/98
164 3.0 24V QV [USA]	AR64308	04/93 ⇒ 02/95
164 3.0 Lusso [USA] [CAN]	AR06412	10/91 ⇒ 03/93
164 3.0 Sport [CAN] [USA]	AR64301	11/90 ⇒ 03/92
164 3.0 Super	64303	06/87 ⇒ 09/92
164 3.0 V6	AR06410	06/87 ⇒ 09/92
164 3.0i 24V Super [BRA]	64306	09/92 ⇒ 10/98

KIA

SEPHIA I 1.5 i	B5	02/96 ⇒ 10/97
SEPHIA I 1.8 i 16V	--	01/95 ⇒ 10/97
SEPHIA II 1.5 i 16V	--	09/97 ⇒
SHUMA I 1.5	OK280	03/96 ⇒ 12/98
SHUMA I 1.5 i 16V	BFD, M30B30(306EA)	10/97 ⇒ 10/01
SPECTRA 1.5 i	--	09/97 ⇒
SPECTRA 1.5 i 16V	--	09/97 ⇒

9.0153



04,5

REVOLUTION AND TIMING (CKP AND CMP) SENSORS

Adatt./Suitable:

BMW
12 12 1 717 193
12 12 1 722 588**1236 Engine revolution sensor to fit ignition cable sets:**

- Sensore contagiri da montare su serie cavi accensione:
- Sonde compte-tours à monter sur fais. de câbles d'allumage:
- Drehzahlgeber zum Einbau auf Zündkabelsätzen:
- Cuenta-revoluciones para montaje en cableados de encendido:

4.8578

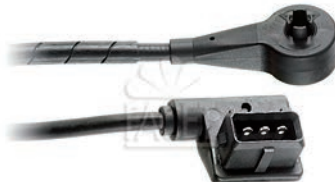

L	L1	ohm	
710	---	---	

BMW

5 III 530 i	M30B30(306KA)	01/88 ⇒ 08/91
5 III 535 i	M30B34(346KB)	01/88 ⇒ 09/95
7 II 730 i,iL	M30B30(306EA), B280E	12/86 ⇒ 09/94

9.0154



04

REVOLUTION AND TIMING (CKP AND CMP) SENSORS

Adatt./Suitable:

VOLVO
136718-8
13671888**00 Eliminated on 04-07-2016. Please verify the availability through our local distributors**

- Eliminato il 04-07-2016. Verificare la disponibilità presso i nostri distributori
- Éliminé le 04-07-2016. Vérifier la disponibilité auprès de nos distributeurs sur place
- Am 04-07-2016 gestrichen. Evtl. Verfügbarkeit bitte bei unseren Händlern prüfen
- Eliminado en fecha 04-07-2016. Verificar la disponibilidad a través de nuestros distribuidores locales



L	L1	ohm	
245	---	---	

VOLVO

760 2.8	B280E, B280E	08/81 ⇒ 08/91
780 2.9	B280E, B280E	08/86 ⇒ 07/90
960 I 2.8 GL	B280E, AR32102	09/90 ⇒ 05/92

9.0155



04,5

REVOLUTION AND TIMING (CKP AND CMP) SENSORS

Adatt./Suitable:

ALFA ROMEO
46411135
60811200**BOSCH**
0 261 210 129

L	L1	ohm	
640	34,5	900	

ALFA ROMEO

145 1.4 i.e. 16V T.S.	AR33503	12/96 ⇒ 01/01
145 1.6 i.e. 16V T.S.	AR32102, AR32102	12/96 ⇒ 01/01
145 1.6 LPG	AR32102	01/98 ⇒ 01/01
145 1.8 i.e. 16V T.S.	AR67106	12/96 ⇒ 12/98
145 1.8 i.e. 16V T.S. [BRA]	AR67199	10/96 ⇒ 02/99
145 2.0 16V T.S.	AR67204	10/95 ⇒ 01/01
145 2.0 16V T.SPARK [BRA]	AR67299	10/96 ⇒ 02/99
145 2.0 16V T.SPARK Q.V. [BRA]	AR67299	10/95 ⇒ 09/96
146 1.4 i.e. 16V T.S.	AR33503	11/96 ⇒ 01/01
146 1.6 i.e. 16V T.S.	AR32102, AR67204	11/96 ⇒ 10/01
146 1.8 i.e. 16V T.S.	AR67106	11/96 ⇒ 01/01
146 2.0 16V T.S.	AR67204	10/95 ⇒ 01/01
155 1.6 16V T.S.	AR67601	05/96 ⇒ 12/97
155 1.7 T.S. 16V	AR67106	05/96 ⇒ 12/97
155 2.0 T.S. 16V	AR67204, AR32102	03/95 ⇒ 12/97
156 1.6 16V T.SPARK	AR32102, AR32102	09/97 ⇒ 09/05
156 1.6 16V T.SPARK.	AR32102, AR16201	05/00 ⇒ 05/06
GTV 2.0 T.SPARK 16V	AR16201, AR16201	06/95 ⇒ 10/05
SPIDER II 2.0 T.SPARK 16V	AR16201, 1580SPI	06/95 ⇒ 04/05

9.0156



04,5

REVOLUTION AND TIMING (CKP AND CMP) SENSORS

Adatt./Suitable:

BOSCH
0 261 210 127**CITROËN**
1920 Y9**FIAT**
46411427**INNOCENTI**
46411427**PEUGEOT**
1920 Y9

L	L1	ohm	
430	24	900	

CITROËN

JUMPY I 1.6	1580SPI, 1580SPI	10/95 ⇒ 08/00
JUMPY I 1.6 i	1580SPI, 178ES.022	10/95 ⇒ 08/00
JUMPY 1.6	220A2.000	04/96 ⇒ 08/00

FIAT			
ELBA 1.4	146D5.000	10/93 → 02/95	
FIORINO II 1.4	146C5.000	11/92 → 05/01	
FIORINO II 1.6	146D6.000	01/94 → 05/01	
FIORINO II 70 i.e. 1.4	146D5.000	05/94 → 05/01	
FIORINO II 75 i.e. 1.6	146D6.000	10/93 → 05/01	
PALIO 1.5	178E5.022	02/02 →	
PALIO 1.5 MPI	178E5.027	08/01 →	
SCUDO I 1.6	220A2.000	02/96 → 12/06	
SIENA 1.5	178E5.022, 220A2000	09/02 →	
SIENA 1.7 [CHN]	--	01/06 →	
INNOCENTI			
ELBA 1.4 i.e.	146D5.000	09/94 → 12/96	
ELBA 1.6 i.e.	146D6.000	09/94 → 12/96	
PEUGEOT			
EXPERT I 1.6	220A2000, 182A4.000	02/96 → 09/00	

9.0157



04,5

REVOLUTION AND TIMING (CKP AND CMP) SENSORS

Adatt./Suitable:

FIAT
46442091
46479975
55189515

LANCIA
46442091
46479975
55189515

MAGNETI MARELLI
111040211101
CWM02/1



L	L1	ohm	OUT GND S
730	34,5	1350	

FIAT			
BRAVA 1.6 16V	182A4.000, 178A8.011	10/95 → 12/02	
BRAVO I 1.6	182B6.000	09/00 → 10/01	
BRAVO I 1.6 16V	178A8.011, 182B6.000	10/95 → 10/01	
DOBLO 1.6 Natural Power	182B6000CNG	02/04 → 07/09	
DOBLO I 1.6	182B6.000	09/02 →	
DOBLO I 1.6 16V	182B6.000	10/01 →	
DOBLO I 1.6 Natural Power	182B6.000, 182B6.000	09/02 →	
MAREA 1.6	182B6.000, 182A4.000	09/00 → 08/02	
MAREA 1.6 100 16V	182A4.000	09/96 → 05/02	
MAREA 1.6 100 16V Bipower	182A4.000, 182B6.000	04/99 → 05/02	
MAREA 1.6 16V	185A3.000	04/97 → 02/99	
MAREA 1.6 SX	182B5.098	09/00 → 08/02	
MULTIPLA 1.6	182B6.000, 182B6.000	09/00 → 06/10	
MULTIPLA 1.6 100 16V	182A4.000	04/99 → 06/10	
MULTIPLA 1.6 16V	182B6.000	04/02 → 06/10	
MULTIPLA 1.6 16V Bipower	182B6.000, 186A3.000	10/01 → 06/10	
MULTIPLA 1.6 16V Blupower	186A3.000, 178C7.098	04/99 → 06/10	
MULTIPLA 1.6 16V GPL	182B6.000	10/01 → 06/10	
MULTIPLA 1.6 Natural Power	182B6000CNG	11/08 → 06/10	
PALIO 1.6	178C7.098, 178B3.000	07/97 →	
PALIO 1.6 16V	178B3.000, --	02/01 →	
PALIO 1.6 16V Sport	178E7.000	10/01 →	
SIENA 1.6	182B6.000	11/00 → 12/09	
SIENA 1.6 16V	178B3.000	09/98 →	
STILO 1.6	--, M43B18(184E2)	04/05 → 08/08	
STILO 1.6 16V	182B6.000	10/01 → 08/08	
STRADA 1.6 MPI	178D2.011	07/05 →	

FIAT (BR)			
BRAVA 1.6i 16v	1.6Mpi	01/00 →	
PALIO 1.6i	1.6Mpi	01/99 → 12/00	
PALIO 1.6i 16v	1.6Mpi16v	01/96 →	
SIENA 1.6i 16v	1.6Mpi	01/98 → 12/99	
STRADA 1.6i 16v	1.6Mpi	01/99 →	

LANCIA			
DEDRA 1.6 16V	182A4.000	01/96 → 07/99	
DELTA II 1.6 i.e.	182A6.000	03/96 → 08/99	
DELTA II 1.6 i.e. 16V	182A4.000	01/96 → 08/99	
LYBRA 1.6	182B6.000	10/00 → 10/05	
LYBRA 1.6 16V	182A4.000	07/99 → 10/05	

9.0158



04,5

REVOLUTION AND TIMING (CKP AND CMP) SENSORS

Adatt./Suitable:

BMW
12 14 1 739 886



L	L1	ohm	OUT GND S
880	24	550	

BMW			
3 III 316 g	M43B16(164E2)	03/94 → 08/00	
3 III 316 i	M43B16(164E2)	07/93 → 08/00	
3 III 318 i	M43B18(184E2)	10/93 → 10/99	
Z3 1.8 i	M43B18(184E2), 135B	10/95 → 10/98	

9.0159



04,5

REVOLUTION AND TIMING (CKP AND CMP) SENSORS

Adatt./Suitable:

BOSCH
0 261 210 064
SKODA
004 165 008

- ⁰³ Supplied until depletion
- Fornibile fino ad esaurimento delle scorte
 - Fourni jusqu'à épuisement du stock
 - Lieferbar solange vorrat reicht
 - Suministrado hasta el stock termina



L	L1	ohm	OUT GND S
430	24	550	

SKODA			
FAVORIT 1.3	135B, X20DTL	09/91 → 06/97	
FAVORIT 1.3 135 X,LX, GLX	781.135E	01/90 → 09/94	

9.0160



04,5

REVOLUTION AND TIMING (CKP AND CMP) SENSORS

Adatt./Suitable:

BOSCH
0 281 002 138
GENERAL MOTORS
90 540 188

OPEL
62 38 395
90540188

SAAB
47 72 232
90 464 741
90 540 188
95 44 560

SCANIA
4772232

VAUXHALL
90540188



L	L1	ohm	OUT GND S
495	34,5	900	

OPEL			
ASTRA F 2.0 Di	X20DTL	03/98 → 08/00	
ASTRA G 2.0 DI	X20DTL, X20DTH	02/98 → 04/05	
ASTRA G 2.0 DTI	Y20DTH	09/00 → 04/05	
ASTRA G 2.0 DTI 16V	X20DTH, X22DTH	08/99 → 01/05	
ASTRA G 2.2 DTI	Y22DTR	09/02 → 10/05	
FRONTERA B 2.2 DTI	X22DTH, X20DTH	09/02 → 07/04	
OMEGA B 2.0 DTI 16V	X20DTH	09/97 → 09/00	
OMEGA B 2.2 DTI 16V	Y22DTH	09/00 → 07/03	
SIGNUM 2.0 DTI	Y20DTH	05/03 → 04/04	
SIGNUM 2.2 DTI	Y22DTR	05/03 → 04/04	
SIGNUM 2.2 DTI 16V	Y22DTR	05/03 → 06/08	
SINTRA 2.2 DTI	X22DTH	07/97 → 04/99	
VECTRA B 2.0 DI 16V	X20DTL	11/96 → 04/02	
VECTRA B 2.0 DTI 16V	X20DTH, Y22DTR	06/97 → 07/03	
VECTRA B 2.2 DTI 16V	Y22DTR, X20DTL	09/00 → 07/03	
VECTRA C 2.2 DTI	Y22DTR	10/03 → 06/08	
VECTRA C 2.2 DTI 16V	Y22DTR	04/02 → 06/08	
ZAFIRA A 2.0 DI	X20DTL, X20DTL	07/99 → 06/00	
ZAFIRA A 2.0 DI 16V	X20DTL, D223L	07/99 → 06/05	
ZAFIRA A 2.0 DTI 16V	Y20DTH	09/00 → 06/05	
ZAFIRA A 2.2 DTI 16V	Y22DTR	01/02 → 06/05	

SAAB			
9-3 2.2 TiD	D223L, X20DTL	11/00 → 02/15	
9-5 2.2 TiD	D223L	03/02 → 12/09	

VAUXHALL			
ASTRA IV 2.0 DI	X20DTL, X20DTL	02/98 → 05/05	
ASTRA IV 2.0 DTI 16V	Y20DTH	02/98 → 05/05	
ASTRA IV 2.2 DTI	Y22DTR	09/02 → 05/05	
ASTRAVAN II 2.0 DI	X20DTL, X22DTH	08/98 → 08/06	
ASTRAVAN II 2.0 DTI	Y20DTH	04/04 → 08/06	
FRONTERA B 2.2 DTI	X22DTH, X20DTH	09/00 → 10/04	
OMEGA B 2.0 DTI 16V	X20DTH	01/98 → 09/00	
OMEGA B 2.2 DTI 16V	Y22DTH	08/00 → 07/03	
SIGNUM 2.0 DTI	Y20DTH	05/03 → 05/08	
SIGNUM 2.2 DTI	Y22DTR	05/03 → 05/08	
SINTRA 2.2 DTI	X22DTH	07/97 → 04/99	
VECTRA B 2.0 DI 16V	X20DTL	08/95 → 10/01	
VECTRA B 2.0 DTI 16V	X20DTH, M43B18(184E2)	08/95 → 10/01	
VECTRA B 2.2 DTI 16V	Y22DTR	08/95 → 10/01	
VECTRA C 2.2 DTI 16V	Y22DTR	08/02 → 07/08	
ZAFIRA A 2.0 DI 16V	X20DTL	10/99 → 08/05	
ZAFIRA A 2.0 DTI 16V	Y20DTH	04/99 → 08/05	
ZAFIRA A 2.2 D	Y22DTR	06/01 → 06/05	

9.0161



04,5

REVOLUTION AND TIMING (CKP AND CMP) SENSORS

Adatt./Suitable:

BMW12 14 1 734 813
12 14 1 739 891

L	L1	ohm	OUT GND S
500	28	1400	

BMW			
3 III 316 g	M43B16(164E2)	03/94 ⇨ 08/00	
3 III 316 i	M43B16(164E2)	07/93 ⇨ 08/00	
3 III 318 i	M43B18(184E2)	10/93 ⇨ 10/99	
3 III 318 is	M42B18(184S1)	03/92 ⇨ 02/98	
Z3 1.8 i	M43B18(184E2), C14SEL	10/95 ⇨ 10/98	

9.0162



04,5

REVOLUTION AND TIMING (CKP AND CMP) SENSORS

Adatt./Suitable:

GENERAL MOTORS

90 483 739

HOLDEN

90483739

OPEL62 38 393
90483739**SIEMENS**

S101938002Z

VAUXHALL

90483739



L	L1	ohm	OUT GND S
885	34,5	550	

HOLDEN			
BARINA 1.6	X16XE	05/97 ⇨ 08/00	
BARINA_SB 1.6i	X16XE	12/95 ⇨ 09/98	
OPEL			
ASTRA F 1.4i 16V	X14XE	01/96 ⇨ 03/01	
ASTRA F 1.6i 16V	X16XEL	08/94 ⇨ 01/05	
COMBO B 1.4 16V	X14XE	08/99 ⇨ 10/01	
CORSA B 1.4i 16V	C14SEL, C16SEL	09/94 ⇨ 12/02	
CORSA B 1.6 GSI 16V	C16XE	03/93 ⇨ 09/00	
CORSA B 1.6i 16V	C16SEL, X14XE	09/94 ⇨ 09/00	
OMEGA A 3.0 24V	C30SE	09/89 ⇨ 03/94	
OMEGA A 3.0 24V Omega 3000	C30SE	09/88 ⇨ 04/94	
TIGRA A 1.4 16V	X14XE, C16SEL	07/94 ⇨ 12/00	
TIGRA A 1.6 16V	C16SEL, X16XEL	07/94 ⇨ 08/98	
VECTRA B 1.6i 16V	X16XEL, X16XEL	10/95 ⇨ 07/02	
VAUXHALL			
ASTRA III 1.4i 16V	X14XE	01/96 ⇨ 03/01	
ASTRA III 1.6i 16V	X16XEL	01/94 ⇨ 09/98	
COMBO B 1.4 16V	X14XE	08/99 ⇨ 10/01	

VAUXHALL			
CORSA B 1.4i 16V	X14XE	09/94 ⇨ 09/00	
CORSA B 1.6 GSI 16V	C16XE	03/93 ⇨ 09/00	
CORSA B 1.6i 16V	X16XE	09/94 ⇨ 09/00	
TIGRA A 1.4 16V	X14XE	07/94 ⇨ 12/00	
TIGRA A 1.6 16V	X16XE	07/94 ⇨ 12/00	
VECTRA B 1.6i 16V	X16XEL, B4164S	08/95 ⇨ 03/02	

9.0164



04,5

REVOLUTION AND TIMING (CKP AND CMP) SENSORS

Adatt./Suitable:

GENERAL MOTORS

90 493 864

OPEL62 38 376
90493864

L	L1	ohm	OUT GND S
1000	24	550	

OPEL			
ASTRA F 1.8 i	C18NZ	09/91 ⇨ 09/98	
ASTRA F 2.0 i	C20NE	09/91 ⇨ 09/98	
OMEGA B 2.0	X20SE	03/94 ⇨ 09/99	
VECTRA A 1.8 i	18SV	09/88 ⇨ 10/90	
VECTRA A 1.8 i Cat	C18NZ	03/90 ⇨ 11/95	
VECTRA A 1.8 S	18SV	09/89 ⇨ 10/90	
VECTRA A 2.0 i	Z0NE	09/88 ⇨ 10/90	
VECTRA A 2.0 i 4x4	Z0NE	01/89 ⇨ 10/90	
VECTRA A 2.0 i Cat	C20NE	09/88 ⇨ 11/95	
VECTRA A 2.0 i Cat 4x4	C20NE	01/89 ⇨ 11/95	
VECTRA B 2.0 i	Z0NEJ	10/95 ⇨ 04/02	

VAUXHALL			
ASTRA III 1.8 i	C18NZ	09/91 ⇨ 09/98	
ASTRA III 2.0 i	C20NE	09/91 ⇨ 09/98	
OMEGA B 2.0	X20SE	03/94 ⇨ 09/99	
VECTRA B 2.0 i	Z0NEJ	10/95 ⇨ 03/02	

9.0165



04,5

REVOLUTION AND TIMING (CKP AND CMP) SENSORS

Adatt./Suitable:

VOLVO30816491
30816491-2

L	L1	ohm	GND OUT
850	21	240	

VOLVO			
S40 1.8 BluFuel	B4184S10	06/01 ⇨ 12/04	
S40 I 1.6	B4164S, B4184S	09/95 ⇨ 08/99	
S40 I 1.8	B4184S, B4204S	06/01 ⇨ 08/99	
S40 I 1.8 16V	B4184S10	08/00 ⇨	

VOLVO			
S40 I 1.8 LPG	B4184S9	03/99 ⇨ 12/04	
S40 I 2.0	B4204S, B4164S	07/95 ⇨ 08/99	
V40 I 1.6	B4164S, B4184S	12/95 ⇨ 08/99	
V40 I 1.8	B4184S, B4204S	07/95 ⇨ 08/99	
V40 I 1.8 16V	B4184S10	08/00 ⇨	
V40 I 1.8 Bi-Fuel	B4184S9	11/99 ⇨ 08/03	
V40 I 1.8 Blu-Fuel	B4184S10	06/01 ⇨ 08/03	
V40 I 2.0	B4204S, JP25LCBD	07/95 ⇨ 08/99	

9.0166



3

REVOLUTION AND TIMING (CKP AND CMP) SENSORS

Adatt./Suitable:

FORD1F1E-6B288-AA
1F1E-6B288-AB
3 724 887
4 094 767
4 469 196
7 103 313
F43E-6B288-AA
XS2E-6B288-AA**MAZDA**GY01-18-230
GY07-18-230
GY07-18-230A

L	L1	ohm	GND OUT
---	37	430	

FORD			
COUGAR 2.5 ST 200	SGA	01/00 ⇨ 12/01	
COUGAR 2.5 ST 200 24V	MABB	08/98 ⇨	
COUGAR 2.5 V6 24V	JP25LCBD, --	06/00 ⇨ 12/01	
MAVERICK 3.0 V6 24V	--, SEA	02/01 ⇨	
MONDEO I 2.5 24V	SEA, MP30MHBA	08/96 ⇨ 09/00	
MONDEO I 2.5 i 24V	SEA	07/94 ⇨ 08/96	
MONDEO I 2.5 ST 200	SGA	05/99 ⇨ 09/00	
MONDEO II 2.5 V6	LCBD	10/00 ⇨ 03/07	
MONDEO II 2.5 V6 24V	LCBD	10/00 ⇨ 03/07	
MONDEO II 3.0 V6 24V	MP30MHBA, AJ	09/04 ⇨ 03/07	
MONDEO II ST220	MEBA	04/02 ⇨ 03/07	

MAZDA			
MPV II 3.0 i V6	AJ	01/02 ⇨ 12/06	
TRIBUTE 3.0 V6 24V 4WD	AJ03	03/00 ⇨ 05/08	
TRIBUTE 3.0 V6 AWD	AJ, 838A1.000	04/04 ⇨ 05/08	
TRIBUTE 3.0i [USA]	1	05/00 ⇨	
TRIBUTE 3.0i 4x4 [USA]	1	05/00 ⇨	

**REVOLUTION AND TIMING (CKP AND CMP) SENSORS**

Adatt./Suitable:

BOSCH
0 261 210 119**FIAT**
7790917**IVECO**
7790917**LANCIA**
7790917

L	L1	ohm	OUT GND S
480	34,5	900	

LANCIA

KAPPA 2.0 20V	838A1.000, 838A2.000	10/94 ⇨ 10/01
KAPPA 2.0 20V Turbo	175A3.000	06/98 ⇨ 10/01
KAPPA 2.4 20V	838A2.000, AR32302	08/94 ⇨ 10/01

**REVOLUTION AND TIMING (CKP AND CMP) SENSORS**

Adatt./Suitable:

ALFA ROMEO
46481639
60814769**BOSCH**
0 281 002 214**FIAT**
46481639
60814769**GENERAL MOTORS**
97 323 554**ISUZU**
8-97240034-1
8-97323554-0
97323554**LANCIA**
60814769**OPEL**
8 51 366

L	L1	ohm	S GND OUT
480	37	900	

ALFA ROMEO

145 1.9 JTD	AR32302	02/99 ⇨ 01/01
146 1.9 JTD	AR32302	02/99 ⇨ 01/01
156 1.9 JTD	AR32302, 839A6.000	05/00 ⇨ 05/01
156 2.4 JTD	839A6.000, 182A7.000	05/00 ⇨ 09/05
166 2.4 JTD	AR34202	09/98 ⇨ 10/00

FIAT

BRAVA 1.9 JTD 105	182B4.000	12/98 ⇨ 10/01
BRAVO I 1.9 JTD 105	182B4.000	12/98 ⇨ 10/01
MAREA 1.9 JTD	182B9.000	01/01 ⇨ 12/07
MAREA 1.9 JTD 105	182B4.000	12/98 ⇨ 12/02
MAREA 1.9 TD 100	182A7.000, 182B4.000	09/96 ⇨ 06/03
MAREA 2.4 JTD 130	185A6.000	04/99 ⇨ 05/02

FIAT

MARENGO 1.9 JTD	182B4.000, 839A5.000	03/99 ⇨ 08/02
MULTIPLA 1.9 JTD 105	182B4.000	04/99 ⇨ 06/10
PUNTO II 1.9 DS 60	188A3.000	09/99 ⇨ 03/12
PUNTO II 1.9 JTD 80	188A2.000	09/99 ⇨ 03/12

ISUZU

D-MAX 2.5 DiTD 4x4	4JA1-TC	05/02 ⇨ 06/12
--------------------	---------	---------------

LANCIA

KAPPA 2.4 JTD	838A8.000	06/98 ⇨ 10/01
LYBRA 1.9 JTD	AR32302	07/99 ⇨ 09/01
LYBRA 2.4 JTD	839A5.000, AR32102	07/99 ⇨ 02/01

OPEL

CAMPO 2.5 TD	4JA1-T	07/94 ⇨ 06/01
CAMPO 2.5 TD 4x4	4JA1-T	07/94 ⇨ 06/01
CAMPO 3.1 TD	4JG2T	12/92 ⇨ 06/01
CAMPO 3.1 TD 4x4	4JG2T	12/92 ⇨ 06/01

**REVOLUTION AND TIMING (CKP AND CMP) SENSORS**

Adatt./Suitable:

ALFA ROMEO
46469866
46470477**BOSCH**
0 261 210 160**FIAT**
46469866
46470477
60814589**LANCIA**
46469866
46470477
60814589

L	L1	ohm	GND OUT
710	34,5	900	

ALFA ROMEO

145 1.4 i.e. 16V.T.S.	AR33503	12/96 ⇨ 01/01
145 1.6 16V.T.S.	AR32102	09/97 ⇨ 12/00
145 1.6 i.e. 16V.T.S.	AR32102, AR32102	12/96 ⇨ 01/01
145 1.6 LPG	AR32102	01/98 ⇨ 01/01
145 1.8 i.e. 16V	AR32201	03/98 ⇨ 01/01
145 2.0 16V	AR32301	03/98 ⇨ 01/01
146 1.4 i.e. 16V.T.S.	AR33503	11/96 ⇨ 01/01
146 1.6 16V.T.S.	AR32102	09/97 ⇨ 12/00
146 1.6 i.e. 16V.T.S.	AR32102, AR32104	11/96 ⇨ 10/01
146 1.8 i.e. 16V.T.S.	AR32201	03/98 ⇨ 01/01
146 2.0 16V	AR32301	03/97 ⇨ 10/01
147 1.6 16V T.SPARK	AR32104	01/01 ⇨ 03/10
147 1.6 16V T.SPARK ECO	AR32203	01/01 ⇨ 03/10
147 1.6 LPG	AR32104, AR32102	03/01 ⇨ 03/10
147 2.0 16V T.SPARK	AR32310	01/01 ⇨ 03/10
156 1.6 16V T.SPARK	AR32102, AR32102	09/97 ⇨ 09/05
156 1.6 16V T.SPARK.	AR32102, AR32201	05/00 ⇨ 05/06
156 1.8 16V T.SPARK	AR32201, AR32301	05/00 ⇨ 05/06
156 2.0 16V T.SPARK	AR32301, AR34103	05/00 ⇨ 06/02
156 2.0 Twin Spark	AR32303	11/97 ⇨ 04/00
166 2.0 T.SPARK	AR34103, AR16201	10/00 ⇨ 06/07
GT 1.8 TS	AR32205	11/03 ⇨ 09/10
GTV 1.8 16V	AR32201	05/98 ⇨ 10/05
GTV 2.0 T.SPARK 16V	AR16201, AR16201	06/95 ⇨ 10/05
SPIDER II 1.8 16V	AR32201	05/98 ⇨ 04/05
SPIDER II 2.0 T.SPARK 16V	AR16201, 838A2.000	06/95 ⇨ 04/05

FIAT

BRAVO I 2.0 HGT 20V	182B7.000	07/98 ⇨ 10/01
COUPE 2.0 20V	182B3.000	04/98 ⇨ 08/00
MAREA 2.0 150 20V	185A8.000	01/01 ⇨ 05/02
MAREA 2.0 155 20V	182B7.000	04/99 ⇨ 02/03
STILO 2.4 20V	192A2.000	10/01 ⇨ 04/07

FIAT (BR)

MAREA 2.4i 20v	2.4Mpi	01/01 ⇨
----------------	--------	---------

LANCIA

KAPPA 2.0 20V	838A6.000	07/96 ⇨ 10/01
KAPPA 2.4 20V	838A2.000, 182B7.000	08/94 ⇨
LYBRA 2.0 20V	182B7.000, AEH	09/00 ⇨ 10/05
LYBRA 2.4 20V	192A2.000	10/01 ⇨ 10/05
THESIS 2.0 Turbo	841E.000	07/02 ⇨ 07/09
THESIS 2.4	841D.000	07/02 ⇨ 07/09

**REVOLUTION AND TIMING (CKP AND CMP) SENSORS**

Adatt./Suitable:

ALFA ROMEO
46413291

L	L1	ohm	OUT GND S
500	24	550	

ALFA ROMEO

145 1.6 i.e.	AR33201	10/94 ⇨ 12/96
146 1.6 i.e.	AR33201	12/94 ⇨ 12/96

**REVOLUTION AND TIMING (CKP AND CMP) SENSORS**

Adatt./Suitable:

AUDI
06A 906 433 C**BOSCH**
0 261 210 147
0 261 210 148**ROLLS-ROYCE**
PF100607PA**SEAT**
06A 906 433 C**SKODA**
06A 906 433 C**VW**
06A 906 433 C

L	L1	ohm	OUT GND S
570	24	900	

AUDI

A3 1.6	AEH, AGN	09/96 ⇨ 05/03
A3 1.8	AGN, AGU	09/96 ⇨ 05/03
A3 1.8 T	AGU, AGU	12/96 ⇨ 05/03
A3 1.8 T quattro	AGU, AMK	12/96 ⇨ 05/03
A3 1.8 quattro	AMK, ADP	03/99 ⇨ 04/02
A4 1.8 quattro	ASN, ASN	11/00 ⇨ 12/05
A4 1.8 quattro	ASN, AGE	11/00 ⇨ 12/05
A4 1.8 quattro	ADP, AGA	11/94 ⇨ 09/01
A4 1.8 quattro	AGA, AGA	03/97 ⇨ 09/01
A4 1.8 quattro	AGA, ACK	03/97 ⇨ 09/01
A4 1.8 quattro	ACK, ACK	10/96 ⇨ 09/01
A4 1.8 quattro	ACK, ASJ	10/96 ⇨ 09/01
A4 1.8 quattro	ASJ, AGB	05/00 ⇨ 09/01
A4 1.8 quattro	AGB, ASN	09/97 ⇨ 09/01

AUDI		
A4 III 3.0	BBJ	11/04 ⇒ 05/06
A4 III 3.0 quattro	BBJ	11/04 ⇒ 07/06
A6 II 1.8	AJP, AGA	07/97 ⇒ 01/05
A6 II 2.4	AGA, AGA	02/97 ⇒ 01/05
A6 II 2.4 quattro	AGA, AJK	08/01 ⇒ 01/05
A6 II 2.7 T	AJK	02/99 ⇒ 01/05
A6 II 2.7 T quattro	AJK, ACK	08/01 ⇒ 01/05
A6 II 2.8	ACK, ACK	02/97 ⇒ 01/05
A6 II 2.8 quattro	ACK, ASN	02/97 ⇒ 01/05
A6 III 3.0 quattro	ASN, ACK	06/01 ⇒ 01/05
A6 2.8	AGE, AJP	04/98 ⇒ 05/01
A8 I 2.8	ACK, ACK	04/96 ⇒ 09/02
A8 I 2.8 quattro	ACK, ARE	04/96 ⇒ 09/02
ALLROAD 2.7 T quattro	ARE, AJQ	05/00 ⇒ 08/05
TT I 1.8 T	AJQ, AJQ	10/98 ⇒ 06/06
TT I 1.8 T quattro	AJQ, AJH	10/98 ⇒ 06/06

SEAT		
ALHAMBRA I / II 1.8 T 20V	AJH, AEH	10/97 ⇒ 03/10
CORDOBA I 1.6 i	AKL	07/96 ⇒ 10/02
CORDOBA I 1.8 T 20V Cupra	AQX	08/00 ⇒ 10/02
IBIZA II 1.6	AEH, AQX	08/99 ⇒ 02/02
IBIZA II 1.8 T 20V Cupra	AQX, AEH	07/00 ⇒ 02/02
LEON I 1.6	AEH, AGN	11/99 ⇒ 06/06
LEON I 1.8 20V	AGN, APP	11/99 ⇒ 06/06
LEON I 1.8 20V T	APP, AJQ	11/99 ⇒ 06/06
LEON I 1.8 20V T 4	AJQ, AEH	11/99 ⇒ 06/06
TOLEDO II 1.6	AEH, AGN	10/98 ⇒ 07/04
TOLEDO II 1.8 20V	AGN, APP	10/98 ⇒ 07/04
TOLEDO II 1.8 20VT	APP, AEH	09/00 ⇒ 07/04
TOLEDO II 1.8 4x4	AJQ	05/01 ⇒ 04/04

SKODA		
FABIA I 2.0	AZL	12/99 ⇒ 03/08
OCTAVIA I 1.6	AEH, AGU	02/97 ⇒ 12/07
OCTAVIA I 1.8	AGN	09/96 ⇒ 07/00
OCTAVIA I 1.8 20V	AGN	07/98 ⇒ 07/00
OCTAVIA I 1.8 T	AGU, AEG	08/97 ⇒ 12/10
OCTAVIA I 1.8 T 4x4	ARX	05/01 ⇒ 05/06
OCTAVIA I 2.0	AEG, AZH	04/99 ⇒ 05/07
OCTAVIA I 2.0 4x4	AZH, AMX	08/00 ⇒ 09/04
SUPERB I 2.0	AZM	12/01 ⇒ 03/08
SUPERB I 2.8 V6	AMX, AEG	12/01 ⇒ 03/08

VOLKSWAGEN (BR)		
GOLF A4 1.6i	AKL	10/99 ⇒
GOLF A4 1.8i Turbo 20v	AGU	10/99 ⇒
GOLF A4 2.0i	AEG, AEH	08/99 ⇒

VW		
BORA 1.6	AEH, APK	10/98 ⇒ 05/05
BORA 1.8 4motion	AGN	02/99 ⇒ 05/05
BORA 2.0	APK, AZH	10/98 ⇒ 05/05
BORA 2.0 4motion	AZH, AEH	04/00 ⇒ 05/05
GOLF IV 1.6	AEH, AGU	05/01 ⇒ 05/04
GOLF IV 1.8	AGN	08/97 ⇒ 06/05
GOLF IV 1.8 4motion	AGN	05/98 ⇒ 06/06
GOLF IV 1.8 T	AGU, APK	08/97 ⇒ 06/06
GOLF IV 2.0	APK, AZH	07/98 ⇒ 06/06
GOLF IV 2.0 4motion	AZH, AGU	10/00 ⇒ 06/06
NEW BEETLE 1.8 T	AGU, AEG	10/99 ⇒ 09/10
NEW BEETLE 2.0	AEG, ADP	01/98 ⇒ 10/10
PASSAT IV 1.6	ADP, AMX	10/96 ⇒ 11/00
PASSAT IV 2.0	AZM	11/00 ⇒ 05/05
PASSAT IV 2.0 4motion	AZM	11/00 ⇒ 05/05
PASSAT IV 2.8	AMX, AMX	10/00 ⇒
PASSAT IV 2.8 4motion	AMX, ACK	10/00 ⇒
PASSAT IV 2.8 Syncro	AGE	05/97 ⇒ 09/99
PASSAT IV 2.8 V6	ACK, ACK	08/96 ⇒ 09/99
PASSAT IV 2.8 V6 Syncro/4motion	ACK, AEH	10/96 ⇒ 11/00
PASSAT 2.8 [ExtraEU]	BBG	10/00 ⇒ 05/05
POLO III 1.6	AEH, AEH	05/97 ⇒ 09/01
POLO III 100 1.6	AEH, AJH	12/95 ⇒ 09/01
POLO 1.6 [ExtraEU]	AKL	10/99 ⇒ 09/01
SHARAN I 1.8 T 20V	AJH, 182A7.000	09/97 ⇒ 03/10

9.0173



04,5

REVOLUTION AND TIMING (CKP AND CMP) SENSORS

Adatt./Suitable:

BOSCH
0 281 002 102

FIAT
7766251

IVECO
7766251

LANCIA
7766251



L	L1	ohm	OUT GND S
420	34,5	900	

FIAT			
BRAVA 1.4	182A5.000	10/95 ⇒	10/01
BRAVA 1.4 12V	182A3.000	10/95 ⇒	08/98
BRAVA 1.9 JTD	182A7.000, 182A7.000	09/00 ⇒	10/01
BRAVA 1.9 TD 100 S	182A7.000, 182A3.000	03/96 ⇒	10/01
BRAVA 1.9 TD 75 S	182A8.000	03/96 ⇒	10/01
BRAVO I 1.4	182A3.000, 182A7.000	10/95 ⇒	10/01
BRAVO I 1.9 JTD	182A7.000, 182A7.000	09/00 ⇒	10/01
BRAVO I 1.9 TD 100 S	182A7.000, 182A7.000	03/96 ⇒	10/01
BRAVO I 1.9 TD 75 S	182A8.000	03/96 ⇒	10/01
BRAVO I 2.0 HGT 20V	182A1.000	10/95 ⇒	07/98
COUPE 2.0 20V	182A1.000	08/96 ⇒	09/98
COUPE 2.0 20V Turbo	175A3.000	08/96 ⇒	08/00
MAREA 1.4 80 12V	182A3.000	09/96 ⇒	05/02
MAREA 1.9 TD	182A7.000, 182A7.000	08/96 ⇒	02/99
MAREA 1.9 TD 100	182A7.000, 182A7.000	05/96 ⇒	06/03
MAREA 1.9 TD 75	182A8.000	09/96 ⇒	05/02
MAREA 2.0 150 20V	182A1.000	09/96 ⇒	04/99
MAREA 2.0i 20v [BRA]	182A1.011	10/96 ⇒	04/99
MAREA 2.4 TD 125	185A2.000	09/96 ⇒	04/99
MARENGO 1.9 TD	182A7.000, 840A2.000	07/96 ⇒	02/99

FIAT (BR)			
MAREA 2.0i 20v	2.0Mpi	01/99 ⇒	12/00
MAREA 2.0i 20v Turbo	2.0MpiTurbo	01/99 ⇒	

LANCIA			
Y 1.4 12V	840A2.000, 176B2.000	03/96 ⇒	09/03

9.0175



04,5

REVOLUTION AND TIMING (CKP AND CMP) SENSORS

Adatt./Suitable:

FIAT
46417650
46764212
55189513

MAGNETI MARELLI
111040211106
511040211106
CWM02/6



L	L1	ohm	OUT GND S
950	34,5	1350	

FIAT			
CINQUECENTO 1.1 Sporting	176B2.000	10/94 ⇒	01/98
SEICENTO / 600 1.1	176B2.000, CDY(TU9M)	01/98 ⇒	01/10

9.0176



05,5

REVOLUTION AND TIMING (CKP AND CMP) SENSORS

Adatt./Suitable:

00 Eliminated on 03-09-2018. Please verify the availability through our local distributors

- Eliminato il 03-09-2018. Verificare la disponibilità presso i nostri distributori
- Eliminé le 03-09-2018. Vérifier la disponibilité auprès de nos distributeurs sur place
- Am 03-09-2018 gestrichen. Evtl. Verfügbarkeit bitte bei unseren Händlern prüfen
- Eliminado en fecha 03-09-2018. Verificar la disponibilidad a través de nuestros distribuidores locales

1006 After depletion of stock this part is replaced by:

- Esaurite le scorte questo pezzo sarà sostituito da:
- Après épuisement du stock, cette pièce est remplacée par:
- Nach Vorraterschöpfung wird ersetzt durch:
- Despues agotamiento stock, sera sustituido por:

9.0299



L	L1	ohm	OUT GND S
---	33	550	

9.0177



05,5

REVOLUTION AND TIMING (CKP AND CMP) SENSORS

Adatt./Suitable:

BOSCH
0 986 280 409
CITROËN
1920 5T
PEUGEOT
1920 5T



L	L1	ohm	OUT GND
---	38,5	550	

CITROËN

AX 10	CDY(TU9M), KDX(TU3M/Z)	07/86 ⇒ 12/98
AX 14	KDX(TU3M/Z), NFX(TU5JP4)	04/87 ⇒ 04/97
AX 14 4x4	KDY(TU3FM)	08/91 ⇒ 12/96
SAXO 1.6	NFX(TU5JP4), NFX(TU5JP4)	02/96 ⇒ 04/04
SAXO 1.6 VTR	NFX(TU5JP4)	05/96 ⇒ 07/99
SAXO 1.6 VTS	NFX(TU5JP4), HDY(TU1M)	06/96 ⇒ 09/03

PEUGEOT

106 I 1.0	CDY(TU9M)	04/96 ⇒ 03/01
106 II 1.1 i	HDY(TU1M), KFW(TU3JP)	05/96 ⇒ 07/04
106 II 1.4 i	KFW(TU3JP), NFW(TU5J2)	05/96 ⇒ 07/04
106 II 1.6 i	NFW(TU5J2), NFX(TU5J4)	05/96 ⇒ 10/99
106 II 1.6 S16	NFX(TU5J4), KFW(TU3JP)	05/96 ⇒ 07/04
306 1.4	KFW(TU3JP), KFW(TU3JP)	04/93 ⇒ 04/02
306 1.4 SL	KFW(TU3JP), RFV	06/94 ⇒ 05/01
306 1.6	NFX(TU5JP)	05/93 ⇒ 10/00
306 1.6 SR	NFX(TU5JP)	06/94 ⇒ 10/00

9.0178



3

REVOLUTION AND TIMING (CKP AND CMP) SENSORS

Adatt./Suitable:

CITROËN
1920 6T
ELECTRICFIL
14 43 21
FIAT
9629684380
LANCIA
9629684380
PEUGEOT
1920 6T

03 Supplied until depletion

- Fornibile fino ad esaurimento delle scorte
- Fourni jusqu'à épuisement du stock
- Lieferbar solange vorrat reicht
- Suministrado hasta el stock termina



L	L1	Hall Effect	OUT
---	29		

CITROËN

EVASION 2.0 16V	RFV(XU10J4R)	05/98 ⇒ 04/00
XANTIA II 1.8 i 16V	LFY(XU7JP4)	01/98 ⇒ 04/03

FIAT

ULYSSE I 2.0 16V	RFV	05/98 ⇒ 09/00
------------------	-----	---------------

LANCIA

ZETA 2.0 16V	RFV, LFY(XU7JP4)	05/98 ⇒ 07/00
--------------	------------------	---------------

PEUGEOT

306 1.8 16V	LFY(XU7JP4), LFY(XU7JP4)	03/97 ⇒ 10/03
406 1.8 16V	LFY(XU7JP4), RFV(XU10J4R)	11/95 ⇒ 10/00
406 1.8 Bifuel	XU7JP4	04/99 ⇒ 05/03
806 2.0 16V	RFV(XU10J4R), 6A	05/98 ⇒ 09/00

9.0179



04,5

REVOLUTION AND TIMING (CKP AND CMP) SENSORS

Adatt./Suitable:

AUDI
053 905 381
BOSCH
0 356 914 222
VW
053 905 381



L	L1	ohm	OUT GND S
305	---	---	

AUDI

80 III 2.0 E 16V	6A	03/90 ⇒ 09/91
80 IV 2.0 E 16V	6A, 6A	09/91 ⇒ 01/96
80 IV 2.0 E 16V quattro	ACE	04/92 ⇒ 07/95
100 IV 2.0 E 16V	ACE	01/92 ⇒ 07/94
A6 I 2.0 16V	ACE	06/94 ⇒ 12/97
A6 I 2.0 16V quattro	ACE	06/94 ⇒ 12/97
CABRIOLET 2.0 16V	ACE	06/95 ⇒ 07/96
COUPE 2.0 16V	6A, 20T2N	01/92 ⇒ 12/96

9.0180



04,5

REVOLUTION AND TIMING (CKP AND CMP) SENSORS

Adatt./Suitable:

BOSCH
0 281 002 121
HONDA
78420-PST-G00
LAND ROVER
NSC100110L
MG
NSC100110
ROVER
NSC100110



L	L1	ohm	OUT S
190	24	900	

HONDA

ACCORD V 2.0 TDi	20T2N	04/96 ⇒ 10/98
ACCORD VI 2.0 TDi	20T2N	12/99 ⇒ 10/00
ACCORD VI 2.0 Turbo DI	20T2N	02/99 ⇒ 12/02
CIVIC VI 2.0 i D	20T2N	04/98 ⇒ 02/01
CIVIC VI 2.0 i TD	20T2R	01/97 ⇒ 02/01

HONDA

CIVIC VI 2.0 TDi	20T2R	05/98 ⇒ 12/00
CIVIC VI 2.0 TDiC	20T2N	11/97 ⇒ 10/00

LAND ROVER

FREELANDER 2.0 DI 4x4	20T2N, 20T2N	02/98 ⇒ 10/06
-----------------------	--------------	---------------

MG

EXPRESS 2.0 TD	20T2N	03/03 ⇒ 05/05
MG ZS 2.0 TD	20T2N	01/04 ⇒ 10/05

ROVER

25 2.0 iDT	20T2N, 20T2N	01/02 ⇒ 05/05
45 2.0 iDT	20T2N, AR64101	02/00 ⇒ 05/05
200 III 220 D/SD	20T2R	11/95 ⇒ 03/00
200 III 220 SDi	20T2N	11/95 ⇒ 03/00
400 II 420 D	20T2R	11/95 ⇒ 03/00
400 II 420 Di	20T2N	05/95 ⇒ 03/00
600 620 Sdi	20T2N	05/94 ⇒ 06/99
CDV 2.0 iDT	20T2N	03/03 ⇒ 04/05
COMMERCE 2.0 iDT	20T2N	01/03 ⇒ 12/05
STREETWISE 2.0 TD	20T2N	08/03 ⇒ 05/05

9.0181



04,5

REVOLUTION AND TIMING (CKP AND CMP) SENSORS

Adatt./Suitable:

GENERAL MOTORS
90 508 494
OPEL
62 38 392
VAUXHALL
90508494

03 Supplied until depletion

- Fornibile fino ad esaurimento delle scorte
- Fourni jusqu'à épuisement du stock
- Lieferbar solange vorrat reicht
- Suministrado hasta el stock termina

1006 After depletion of stock this part is replaced by:

- Esaurite le scorte questo pezzo sarà sostituito da:
- Après épuisement du stock, cette pièce est remplacée par:
- Nach Vorraterschöpfung wird ersetzt durch:
- Despues agotamiento stock, sera sustituido por:

9.0274



L	L1	ohm	OUT GND S
800	38	550	

VAUXHALL

VECTRA B 2.5 i GSi	X25XE	03/98 ⇒ 07/00
VECTRA B 2.5 i V6	X25XE	09/95 ⇒ 08/00

9.0182



04,5

REVOLUTION AND TIMING (CKP AND CMP) SENSORS

Adatt./Suitable:

BOSCH
0 281 002 108
FIAT
7788905
IVECO
7788905



L	L1	ohm	OUT GND S
540	40	860	

FIAT			
DUCATO II 2.5 TDI	8140.47R	03/94 ⇨ 04/02	
DUCATO II 2.5 TDI Combinato	8140.47R	08/94 ⇨ 04/02	
DUCATO II 2.5 TDI Panorama/Combinato	8140.47R	07/94 ⇨ 04/02	

9.0184



3,5

REVOLUTION AND TIMING (CKP AND CMP) SENSORS

Adatt./Suitable:

ALFA ROMEO
60565836
BOSCH
0 356 914 224
SEAT
051 905 381
VW
051 905 381



L	L1	ohm	OUT GND S
190	---	---	

ALFA ROMEO			
164 2.0 Turbo	AR64102	07/90 ⇨ 10/92	
164 2.0 V6 Turbo	AR64101, G4ER	03/91 ⇨ 09/98	
GTV 2.0 V6 Turbo	AR16202	06/95 ⇨ 09/98	
SPIDER II 2.0 V6 Turbo	AR16202	05/98 ⇨ 04/05	
VW			
CORRADO 2.0 i 16V	9A	08/91 ⇨ 12/95	
GOLF III 2.0	2E	11/91 ⇨ 04/99	
PASSAT III 2.0 16V	9A	08/88 ⇨ 09/93	
VENTO 2.0	2E	11/91 ⇨ 09/98	

9.0185



04,5

REVOLUTION AND TIMING (CKP AND CMP) SENSORS

Adatt./Suitable:

JAGUAR
DBC 12508
MAGNETI MARELLI
SEN 8K1

⁰³ Supplied until depletion

- Fornibile fino ad esaurimento delle scorte
- Fourni jusqu'à épuisement du stock
- Lieferbar solange vorrat reicht
- Suministrado hasta el stock termina



L	L1	ohm	GND OUT
770	20,7	700	

JAGUAR			
XJ 5.3	8S(92-93)	05/91 ⇨ 08/93	
XJ 6.0	8D	05/93 ⇨ 03/96	
XJ V12 6.0	8C(92-94)	03/93 ⇨ 11/94	
XJSC 5.3	8S(92-93)	05/91 ⇨ 08/93	
XJSC 6.0	8D	05/93 ⇨ 03/96	

9.0187



04,5

REVOLUTION AND TIMING (CKP AND CMP) SENSORS

Adatt./Suitable:

HYUNDAI
39180-22040
39180-22050
39180-22060
39180-22090
39180-23000



L	L1	ohm	OUT GND S
240	24	900	

HYUNDAI			
ACCENT I 1.3	G4EH	10/94 ⇨ 01/00	
ACCENT I 1.3 i 12V	G4EH	10/94 ⇨ 01/00	
ACCENT I 1.5	G4EK	10/94 ⇨ 07/99	
ACCENT I 1.5 i 12V	G4EK	10/94 ⇨ 01/00	
ACCENT I 1.5 i 16V	G4ER, 4G61	10/95 ⇨ 01/00	
COUPE 2.0	G4DF	04/96 ⇨ 08/99	
COUPE I 1.6 16V	G4GR	03/98 ⇨ 04/02	
COUPE I 1.6 i 16V	4G61, G4DF	12/96 ⇨ 04/02	
COUPE I 2.0	G4DF	08/99 ⇨ 01/02	
COUPE I 2.0 16V	G4DF, G4GL	03/01 ⇨ 04/02	
COUPE I F2 Evolution	G4GF	01/99 ⇨ 12/01	
ELANTRA 1.6	G4GR	08/95 ⇨ 02/98	
ELANTRA II 1.6 i 16V	G4GR	06/95 ⇨ 05/00	
ELANTRA II 1.8 i 16V	G4GM	05/95 ⇨ 05/00	
ELANTRA II 2.0 i 16V	G4DF	06/97 ⇨ 05/00	
EXCEL 1.3 i 12V	G4EH	09/94 ⇨ 08/99	
EXCEL 1.5 i 12V	G4EK	09/94 ⇨ 08/99	

9.0188



3

REVOLUTION AND TIMING (CKP AND CMP) SENSORS

Adatt./Suitable:

FORD
7 009 578
95WF-6C315-AA



L	L1	ohm	OUT GND
---	37,5	400	

FORD			
ESCORT V RS 2000	N7A	05/91 ⇨ 12/92	
ESCORT VI RS 2000	N7A	02/95 ⇨ 02/98	
ESCORT VI RS 2000 4x4	N7A	02/95 ⇨ 10/98	
GALAXY I 2.0 i	NSE, ESSA	11/95 ⇨ 05/06	
GALAXY I 2.3 16V	E5SA, NSF	09/01 ⇨ 05/06	
GALAXY 2.3	DH23E5SB	05/00 ⇨ 10/02	
SCORPIO II 2.0 i	NSD	10/94 ⇨ 08/98	
SCORPIO II 2.0 i 16V	N3A	10/94 ⇨ 08/98	
SCORPIO II 2.3 i 16V	Y5A	06/96 ⇨ 08/98	
TRANSIT II 2.0	NSF, E5FA	06/94 ⇨ 03/00	
TRANSIT II 2.0 CNG	NSH	06/94 ⇨ 03/00	
TRANSIT III 2.3	E5FA, E5FA	08/00 ⇨ 03/06	
TRANSIT III 2.3 16V	E5FA, E5FA	04/01 ⇨ 05/06	
TRANSIT III 2.3 16V RWD	E5FA, NSF	08/00 ⇨ 05/06	
TRANSIT III 2.3 BiFuel	E5FC	03/01 ⇨ 03/06	
TRANSIT 2.3	E5FA	09/00 ⇨ 03/06	
TRANSIT TOURNEO 2.0	NSF, DHA	11/94 ⇨ 12/00	



REVOLUTION AND TIMING (CKP AND CMP) SENSORS

Adatt./Suitable:

BOSCH
0 986 280 439

FORD
1 037 465
1L2E-6B288-AA
4 091 961
5L2E-6B288-AA
5L2Z-6B288-A
7 009 579
95BF-12K073-AA
95BF-12K073-AB
F57Z-12K073-AB

FORD USA
1 037 465
5L2Z-6B288-A

LAND ROVER
4091961
LR000442

MAZDA
1E03-18-194
1E03-18-194A

MOTORCRAFT
DU-76

MARKET DIFFUSION: **MEDIUM**



L	L1	ohm	
---	33,5	530	

FORD		
ENDEAVOUR 4.0 EFI V6	--	11/03 ⇨
EVEREST 4.0 EFI V6	--	11/03 ⇨
FIESTA IV 1.0 i	ZH10JRB	02/97 ⇨ 09/99
FIESTA IV 1.25 i 16V	DHA, J4C	08/95 ⇨ 01/02
FIESTA IV 1.3	J4C, J4C	02/96 ⇨ 08/03
FIESTA IV 1.3 i	J4C, FHA	08/95 ⇨ 01/02
FIESTA IV 1.4 i 16V	FHA, L1T	04/96 ⇨ 01/02
FIESTA IV 1.6 16V Sport	L1T, FXDA	02/00 ⇨ 01/02
FIESTA 1.2	DHA, DHA	01/96 ⇨ 04/02
FOCUS I 1.4	FXDA, FXDA	04/99 ⇨ 03/05
FOCUS I 1.4 16V	FXDA, FYDA	10/98 ⇨ 11/04
FOCUS I 1.6	FYDA, FYDA	04/99 ⇨ 03/05
FOCUS I 1.6 16V	FYDA, NSE	10/98 ⇨ 11/04
FOCUS I 1.6 16V Flexifuel	FYDH	01/02 ⇨ 11/04
GALAXY I 2.0 i	NSE, E5SA	11/95 ⇨ 05/06
GALAXY I 2.3 16V	E5SA, A9A	09/01 ⇨ 05/06
GALAXY 2.3	DH23E5SB	05/00 ⇨ 10/02
IKON 1.3 Rocam	--	10/00 ⇨
IKON 1.6 EFI Rocam	--	11/99 ⇨
KA I 1.3	A9A, JJB	09/02 ⇨ 03/04
KA I 1.3 i	JJB, CDB	09/96 ⇨ 11/08
KA I 1.6 i	CDB, FHD	02/01 ⇨ 11/08
PUMA 1.4 16V	FHD, MHA	11/97 ⇨ 10/00
PUMA 1.6 16V	L1W	08/00 ⇨ 06/02
PUMA 1.7 16V	MHA, ABFA	03/97 ⇨ 06/02
PUMA Racing ST 160	MHA	06/99 ⇨ 06/02
RANGER IV 4.0	--	10/05 ⇨ 06/06
RANGER IV 4.0 4x4	--	10/05 ⇨ 06/06
SCORPIO II 2.0 i	NSD	10/94 ⇨ 08/98
SCORPIO II 2.0 i 16V	N3A	10/94 ⇨ 08/98
SCORPIO II 2.3 i 16V	Y5A	06/96 ⇨ 08/98
TRANSIT III 2.0 DI	ABFA, E5FA	08/00 ⇨ 05/06
TRANSIT III 2.0 TDCi	FIFA	08/02 ⇨ 05/06
TRANSIT III 2.3	E5FA, E5FA	08/00 ⇨ 03/06
TRANSIT III 2.3 16V	E5FA, E5FA	04/01 ⇨ 05/06
TRANSIT III 2.3 16V RWD	E5FA, D2FA	08/00 ⇨ 05/06
TRANSIT III 2.4 DI	D2FA, D4FA	01/00 ⇨ 05/06
TRANSIT III 2.4 DI RWD	D4FA, D2FE	01/00 ⇨ 05/06
TRANSIT III 2.4 TD	F4FA	08/00 ⇨ 08/03
TRANSIT III 2.4 TD 4x4	F4FA	08/00 ⇨ 08/03
TRANSIT III 2.4 TDCi	H9FA	03/04 ⇨ 05/06
TRANSIT III 2.4 TDdi	D2FE, DOFA	08/00 ⇨ 03/06
TRANSIT III 2.4 TDE	DOFA, ABFA	07/01 ⇨ 05/06

FORD		
TRANSIT TOURNEO 2.0	ABFA, --	06/00 ⇨ 03/05
TRANSIT 2.0 TDi	F3FA	06/00 ⇨ 03/06
TRANSIT 2.4 TDdi	D4FA	08/00 ⇨ 08/03
FORD (BR)		
FIESTA 1.0i	ZL10	07/99 ⇨
FIESTA 1.6i	ZL16	07/99 ⇨
FORD USA		
EXPLORER 4.0 V6 4WD	--, --	10/96 ⇨ 12/01
MUSTANG 4.0 V6	--	12/04 ⇨ 12/10
LAND ROVER		
DISCOVERY III 4.0 4x4	--, 1E03	02/05 ⇨ 09/09
DISCOVERY III 4.0 V6 4x4	406PN	10/04 ⇨ 09/09
DISCOVERY IV 4.0 4x4	--	09/09 ⇨
MAZDA		
121 I 1.3	1E03, 1E05	01/96 ⇨ 05/97
121 III 1.25	1E05, 1E03	03/96 ⇨ 04/03
121 III 1.3	1E03, F8Q784	03/96 ⇨ 04/03



REVOLUTION AND TIMING (CKP AND CMP) SENSORS

Adatt./Suitable:

BOSCH
0 281 002 175

RENAULT
77 00 100 650



L	L1	ohm	
430	24	880	

RENAULT		
LAGUNA I 1.9 dTi	F9Q716	10/97 ⇨ 03/01
MEGANE 1.9 DT/DTi	F8Q784, F8Q784	09/96 ⇨ 09/00
MEGANE I 1.9 dTi	F8Q784, F9Q730	03/97 ⇨ 08/03
MEGANE SCÉNIC I 1.9 dTi	F9Q730, K9K790	04/97 ⇨ 09/99



REVOLUTION AND TIMING (CKP AND CMP) SENSORS

Adatt./Suitable:

DACIA
60 01 545 512
82 00 439 315
82 00 688 406
82 01 040 861

NISSAN
23731-BN700
23731-BN70A
23731-BN70B
23750-00Q0A
23750-00Q0G
23750-00Q0M
23750-00QAD
82004-39315

RENAULT
60 01 545 512
77 00 100 566
77 00 109 055
82 00 439 315
82 00 688 406
82 01 040 861

SUZUKI
33957-84A02
33957-84A02-000
35442-84CT1
35442-84CT1-000
35442-84CT2
35442-84CT2-000
35442-86CA0
35442-86CA0-000
35442-86CA1
35442-86CA1-000

MARKET DIFFUSION: **HIGH**



L	L1	ohm	
---	24	840	

DACIA		
LOGAN I 1.5 dCi	K9K790, K9K704	09/05 ⇨
SANDERO I 1.5 dCi	K9K790	06/08 ⇨
SOLENZA 1.9 D	F8Q636	02/03 ⇨
NISSAN		
ALMERA II 1.5 dCi	K9K722	01/03 ⇨ 09/06
KUBISTAR 1.5 dCi	K9K704, K9K276	08/03 ⇨
KUBISTAR 1.5 dCi 70	K9K700	04/06 ⇨ 10/09
KUBISTAR 1.5 dCi 85	K9K276	04/06 ⇨ 10/09
MICRA III 1.5 dCi	K9K276, K9K700	01/03 ⇨ 06/10
RENAULT		
CLIO II 1.5 dCi	K9K700, F8Q632	06/01 ⇨
CLIO II 1.9 D	F8Q632, F9Q780	02/00 ⇨ 05/01
CLIO II 1.9 DTi	F9Q780, K9K750	02/00 ⇨
CLIO III 1.5 dCi	K9K750, F9Q782	05/05 ⇨
ESPACE III 1.9 dTi	F9Q722	02/99 ⇨ 10/02
KANGOO I 1.5 dCi	K9K700, F9Q782	02/01 ⇨
KANGOO I 1.9 D	F8Q632	09/99 ⇨ 06/03
KANGOO I 1.9 dCi	F9Q782	07/03 ⇨
KANGOO I 1.9 dCi 4x4	F9Q782, F9Q780	10/01 ⇨
KANGOO I 1.9 dTi	F9Q780, F8Q630	02/00 ⇨
KANGOO I 1.9 RXED	F8Q632	09/99 ⇨ 06/01
KANGOO I D 65 1.9	F8Q630, F9Q752	08/97 ⇨
KANGOO 1.9 dCi	F9Q782, K9K700	07/03 ⇨ 06/08
LAGUNA I 1.9 dTi	F9Q710	10/97 ⇨ 03/01
LAGUNA II 1.9 dCi	F9Q752, K9K790	06/01 ⇨ 05/05
LOGAN 1.5 dCi	K9K790, F9Q732	09/05 ⇨
MEGANE II 1.5 dCi	K9K722	09/02 ⇨ 12/10
MEGANE 1.9	F8Q622	02/00 ⇨ 09/00

RENAULT			
MEGANE 1.9 dCi	F9Q732, F8Q784	03/99 → 07/03	
MEGANE 1.9 DT/DTi	F8Q784, F8Q284	09/96 → 09/00	
MEGANE 1.9 DTi	F9Q744	04/01 → 07/03	
MEGANE I 1.9	F8Q284, F8Q620	07/97 → 12/99	
MEGANE I 1.9 D	F8Q620, F9Q732	09/96 → 08/03	
MEGANE I 1.9 dCi	F9Q732, F8Q784	05/00 →	
MEGANE I 1.9 dTi	F8Q784, K9K750	03/97 →	
MEGANE SCÉNIC I 1.9 D	F8Q790	03/97 → 09/99	
MEGANE SCÉNIC I 1.9 dTi	F9Q734	04/97 → 09/99	
MODUS / GRAND MODUS 1.5 dCi	K9K750, F8Q788	09/04 →	
MODUS / GRAND MODUS 1.5 dCi 90	K9K750	10/10 →	
SANDERO I 1.5 dCi	K9K790	06/08 →	
SCÉNIC I 1.9 D	F8Q788, F9Q732	09/99 → 03/01	
SCÉNIC I 1.9 dCi	F9Q732, F9Q732	09/99 → 08/03	
SCÉNIC I 1.9 dCi RX4	F9Q732, F9Q731	11/00 → 08/03	
SCÉNIC I 1.9 dTi	F9Q731, K9K722	02/01 → 08/03	
SCÉNIC II 1.5 dCi	K9K722, K9K700	06/03 →	
THALIA I 1.5 dCi	K9K700, G13BA	06/01 →	
THALIA II 1.5 dCi	K9K700	01/09 →	

SUZUKI			
SAMURAI 1.3	G13BA, G13A	11/88 → 03/98	
SAMURAI 1.3 Trazione integrale	G13A, F4R720	01/00 → 12/04	
SAMURAI 1.9 D	--	09/00 → 12/04	
SAMURAI 1.9 D Trazione integrale	--	11/98 → 12/04	
SAMURAI 1.9 TD Trazione integrale	XUD9	11/98 → 12/04	

9.0202

04,5

REVOLUTION AND TIMING (CKP AND CMP) SENSORS

Adatt./Suitable:

GENERAL MOTORS
9 108 457**NISSAN**
23750-00QAC**OPEL**
44 00 457
91 08 457**RENAULT**
77 00 863 523**VAUXHALL**
9108457

L	L1	ohm	GND OUT S
430	32,5	230	

NISSAN			
PRIMASTAR 2.0	F4R720, S8U758	03/01 →	

OPEL			
ARENA 2.5 D	S8U758, S8U770	01/97 → 12/01	
MOVANO A 2.5 D	S8U770, S9W700	07/98 → 09/00	
MOVANO A 2.8 DTI	S9W700, G8T714	07/98 → 10/01	
VIVARO A 2.0 16V	F4R720	08/01 →	

RENAULT			
ESPACE III 2.2 12V TD	G8T714, G8T714	11/96 → 10/00	
ESPACE III 2.2 D	G8T714, S8U770	11/97 → 01/00	
LAGUNA I 2.2 D	G8T792	11/93 → 03/01	
LAGUNA I 2.2 dT	G8T760	03/96 → 03/01	
MASCOTT 2.8	S9W700	01/99 → 12/01	
MASTER II 2.5 D	S8U770, S9W700	10/97 →	
MASTER II 2.8 d	S8W700	05/01 →	
MASTER II 2.8 dTi	S9W700, F4R276	07/98 →	
MASTER 2.8	S8W700	11/97 → 10/03	
MEGANE I 2.0 16V	F4R276, F4R720	05/00 →	
SAFRANE II 2.2 dT	G8T740	07/96 → 12/00	
TRAFIC I 2.5 D	S8U780	05/98 → 03/01	
TRAFIC II 2.0	F4R720, S8U758	03/01 →	

VAUXHALL			
ARENA 2.5 D	S8U758, S8U770	03/98 → 08/01	

VAUXHALL			
MOVANO A 2.5 D	S8U770, S9W700	10/98 → 08/02	
MOVANO A 2.8 DTI	S9W700, AEH	10/98 → 10/01	
MOVANO A 2.8 TDI	S9W702	10/98 → 10/01	
VIVARO 2.0 16V	F4R720	08/01 → 07/14	

9.0204

04,5

REVOLUTION AND TIMING (CKP AND CMP) SENSORS

Adatt./Suitable:

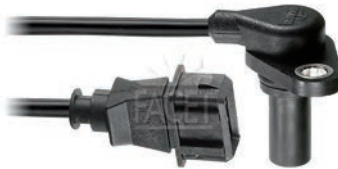
AUDI
01M 927 321**SEAT**
01M 927 321**SKODA**
01M 927 321**VW**
01M 927 321

L	L1	ohm	GND OUT S
390	30,4	840	

AUDI			
A3 I 1.6	AEH, AGN	08/00 → 05/03	
A3 I 1.8	AGN, AGU	09/96 → 05/03	
A3 I 1.8 T	AGU, AGU	12/96 → 05/03	
A3 I 1.8 T quattro	AGU, AGR	12/96 → 05/03	
A3 I 1.9 TDI	AGR, AEH	09/96 → 07/01	

SEAT			
LEON I 1.6	AEH, AGN	11/99 → 06/06	
LEON I 1.8 20V	AGN, AHF	11/99 → 06/06	
LEON I 1.9 TDI	AHF, AEH	11/99 → 06/06	
TOLEDO II 1.6	AEH, AGN	10/98 → 07/04	
TOLEDO II 1.8 20V	AGN, AHF	10/98 → 07/04	
TOLEDO II 1.9 TDI	AHF, AEH	10/98 → 07/04	

SKODA			
OCTAVIA I 1.6	AEH, APK	02/97 → 12/07	
OCTAVIA I 1.8	AGN	09/96 → 07/00	
OCTAVIA I 1.8 20V	AGN	07/98 → 07/00	
OCTAVIA I 1.9 TDI	AHF	08/97 → 01/06	
OCTAVIA I 2.0	APK, AEH	04/99 → 05/07	

VW			
BORA 1.6	AEH, AGN	08/00 → 05/05	
BORA 1.8	AGN	10/98 → 05/05	
BORA 1.8 4motion	AGN, AGU	05/99 → 05/05	
BORA 1.8 T	AGU, AGR	05/00 → 05/05	
BORA 1.9 TDI	AGR, AGR	07/01 →	
BORA 1.9 TDI 4motion	AGR, APK	07/01 →	
BORA 2.0	APK, AEH	10/98 → 05/05	
BORA 2.3 V5	AGZ	10/98 → 10/00	
BORA 2.3 V5 4motion	AGZ	12/98 → 10/00	
GOLF IV 1.6	AEH, AGR	08/00 → 06/06	
GOLF IV 1.8	AGN	08/97 → 06/05	
GOLF IV 1.8 4motion	AGN	05/98 → 06/06	
GOLF IV 1.8 T	AGU	08/97 → 06/06	
GOLF IV 1.9 TDI	AGR, AGR	05/00 → 05/06	
GOLF IV 1.9 TDI 4motion	AGR, APK	05/01 → 05/06	
GOLF IV 2.0	APK, APH	07/98 → 06/06	
GOLF IV 2.3 V5	AGZ	08/97 → 06/06	
GOLF IV 2.3 V5 4motion	AGZ	12/98 → 06/06	
NEW BEETLE 1.6	AYD	06/00 → 09/10	
NEW BEETLE 1.8 T	APH, AEG	10/99 → 09/10	
NEW BEETLE 1.9 TDI	ALH	01/98 → 06/04	
NEW BEETLE 2.0	AEG, AGA	01/98 → 10/10	

9.0205

04,5

REVOLUTION AND TIMING (CKP AND CMP) SENSORS

Adatt./Suitable:

AUDI
078 906 433 B**BOSCH**
0 261 210 178
0 261 210 179**SEAT**
078 906 433 B**SKODA**
078 906 433 B**VW**
078 906 433 B

L	L1	ohm	OUT GND S
450	24	900	

AUDI			
A4 II 2.4	AMM, ASN	09/01 → 12/05	
A4 II 3.0	ASN, ASN	11/00 → 12/05	
A4 II 3.0 quattro	ASN, AGE	11/00 → 12/05	
A4 I 2.4	AGA, AGA	03/97 → 09/01	
A4 I 2.4 quattro	AGA, ACK	03/97 → 09/01	
A4 I 2.8	ACK, ACK	10/96 → 09/01	
A4 I 2.8 quattro	ACK, AMM	10/96 → 09/01	
A4 III 3.0	BBJ	11/04 → 05/06	
A4 III 3.0 quattro	BBJ	11/04 → 07/06	
A6 II 2.4	AGA, AGA	08/01 → 01/05	
A6 II 2.4 quattro	AGA, ACK	08/01 → 01/05	
A6 II 2.8	ACK, ACK	02/97 → 01/05	
A6 II 2.8 quattro	ACK, ASN	02/97 → 01/05	
A6 II 3.0	ASN, ASN	06/01 → 01/05	
A6 II 3.0 quattro	ASN, ASN	06/01 → 01/05	
A6 III 3.0	BBJ	08/04 → 05/06	
A6 III 3.0 quattro	BBJ	05/04 → 05/06	
A6 2.8	AGE, AGA	04/98 → 05/01	
A8 II 3.0	ASN, ASN	07/03 → 05/06	
A8 II 3.0 quattro	ASN, APX	07/03 → 05/05	
A8 II 3.0 TDI quattro	ASB	08/03 → 07/10	
TT I 1.8 T quattro	APX, AMK	10/99 → 06/06	

SEAT			
IBIZA IV 2.0	CEKA	10/08 →	
LEON I 1.8 T Cupra R	AMK, AGU	02/02 → 06/06	
LEON I 1.8 Turbo 4x4	AMK	05/02 → 05/03	

SKODA			
OCTAVIA I 1.8 T	AGU, AEG	08/97 → 12/10	
OCTAVIA I 1.8 T 4x4	ARX	05/01 → 05/06	
OCTAVIA I 2.0	AEG, AMX	04/99 → 05/07	
SUPERB I 2.8 V6	AMX, AEG	12/01 → 03/08	

VW			
GOLF V 2.0	BHY	08/06 → 11/08	
NEW BEETLE 2.0	AEG, AMX	01/98 → 09/10	
PASSAT IV 2.8	AMX, AMX	10/00 →	
PASSAT IV 2.8 4motion	AMX, ACK	10/00 →	
PASSAT IV 2.8 Syncro	AGE	05/97 → 09/99	
PASSAT IV 2.8 V6	ACK, ACK	08/96 → 09/99	
PASSAT IV 2.8 V6 Syncro/4motion	ACK, AQD	10/96 → 11/00	
PASSAT 2.8 [ExtraEU]	BBG	10/00 → 05/05	

9.0206



04,5

REVOLUTION AND TIMING (CKP AND CMP) SENSORS

Adatt./Suitable:

BOSCH
0 261 210 161
0 261 210 219**FIAT**
46474583
46754538

L	L1	ohm	
615	34,5	840	

FIAT			
LINEA 1.4 16V [IND]	--	06/07	⇒
PALIO 1.2	188A5.000	03/00	⇒
PUNTO II 1.2 16V 80	188A5.000	09/99	⇒ 12/06
PUNTO III / GRANDE PUNTO 1.4 16V [IND]	--	01/08	⇒
SIENA 1.2	188A5.000	09/01	⇒ 12/09
SIENA 1.2 16V	178D7.055	01/02	⇒
STILO 1.2 16V	188A5.000	02/02	⇒ 11/06

FIAT (BR)			
PALIO 1.0i 16v	1.0Mpi16vFire	01/01	⇒
PALIO 1.3i 16v	1.3Mpi16vFire	01/00	⇒
SIENA 1.3i 16v	1.3MpiFire	01/00	⇒ 12/00

9.0208



04,5

REVOLUTION AND TIMING (CKP AND CMP) SENSORS

Adatt./Suitable:

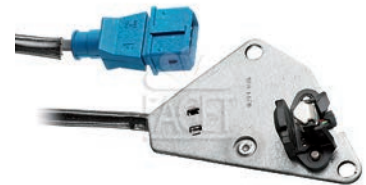
ALFA ROMEO
60811201
7777344**BOSCH**
0 232 101 026**FIAT**
60811201
7777344**IVECO**
77773440**LANCIA**
60811201
7777344

L	L1		
405	---	Hall Effect	

ALFA ROMEO			
145 1.4 i.e. 16V T.S.	AR33503	12/96	⇒ 01/01
145 1.6 i.e. 16V T.S.	AR32102, AR32102	12/96	⇒ 01/01
145 1.6 LPG	AR32102	01/98	⇒ 01/01
145 1.8 i.e. 16V T.S.	AR67106	12/96	⇒ 12/98
145 1.8 i.e. 16V T.S. [BRA]	AR67199	10/96	⇒ 02/99
145 2.0 16V T.S.	AR67204	10/95	⇒ 01/01
145 2.0 16V T.SPARK [BRA]	AR67299	10/96	⇒ 02/99
145 2.0 16V T.SPARK Q.V. [BRA]	AR67299	10/95	⇒ 09/96

ALFA ROMEO			
146 1.4 i.e. 16V T.S.	AR33503	11/96	⇒ 01/01
146 1.6 i.e. 16V T.S.	AR32102, AR67204	11/96	⇒ 10/01
146 1.8 i.e. 16V T.S.	AR67106	11/96	⇒ 01/01
146 2.0 16V T.S.	AR67204	10/95	⇒ 01/01
155 1.6 16V T.S.	AR67601	05/96	⇒ 12/97
155 1.7 T.S. 16V	AR67106	05/96	⇒ 12/97
155 2.0 T.S. 16V	AR67204, AR32102	03/95	⇒ 12/97
156 1.6 16V T.SPARK	AR32102, AR32104	09/97	⇒ 09/05
156 1.6 16V T.SPARK.	AR32104, AR16201	05/00	⇒ 05/06
GTV 2.0 T.SPARK 16V	AR16201, AR16201	06/95	⇒ 10/05
SPIDER II 2.0 T.SPARK 16V	AR16201, 183A1.000	06/95	⇒ 04/05

FIAT			
BARCETTA 1.8 16V	183A1.000, 838A1.000	04/95	⇒ 05/05
BRAVA 1.8 GT 16V	182A2.000	10/95	⇒ 08/01
BRAVO I 1.8 GT	182A2.000	10/95	⇒ 10/01
BRAVO I 2.0 HGT 20V	182A1.000	10/95	⇒ 07/98
COUPE 1.8 16V	183A1.000	03/96	⇒ 08/00
COUPE 2.0 20V	182A1.000	08/96	⇒ 09/98
COUPE 2.0 20V Turbo	175A3.000	08/96	⇒ 08/00
MAREA 1.8 115 16V	182A2.000	09/96	⇒ 05/02
MAREA 2.0 150 20V	182A1.000	09/96	⇒ 04/99
MAREA 2.0i 20v [BRA]	182A1.011	10/96	⇒ 04/99

FIAT (BR)			
MAREA 2.0i 20v	2.0Mpi	01/99	⇒ 12/00
MAREA 2.0i 20v Turbo	2.0MpiTurbo	01/99	⇒

LANCIA			
DEDRA 1.8 16V LE	182A2.000	03/96	⇒ 07/99
DEDRA 1.8 GT 16V	183A1.000	03/96	⇒ 07/99
DELTA II 1.8 i.e. 16V	182A2.000	03/96	⇒ 08/99
DELTA II 1.8 i.e. 16V GT	183A1.000	03/96	⇒ 08/99
KAPPA 2.0 20V	838A1.000, 838A2.000	10/94	⇒ 10/01
KAPPA 2.0 20V Turbo	175A3.000	06/98	⇒ 10/01
KAPPA 2.4 20V	838A2.000, 183A1.000	08/94	⇒ 10/01

9.0209



04,5

REVOLUTION AND TIMING (CKP AND CMP) SENSORS

Adatt./Suitable:

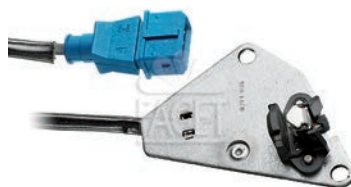
BOSCH
0 232 101 037**FIAT**
46522739**LANCIA**
46522739

L	L1		
345	---	Hall Effect	

FIAT			
BARCETTA 1.8 16V	183A1.000, 183A1.000	04/95	⇒ 05/05
BRAVO I 1.8 GT	182A2.000	10/95	⇒ 10/01
COUPE 1.8 16V	183A1.000	03/96	⇒ 08/00
MAREA 1.8 115 16V	182A2.000	09/96	⇒ 05/02
PUNTO II 1.8 130 HGT	183A1.000, 839A4.000	09/99	⇒ 03/12
PUNTO II 1.8 16V	188A6.000	06/03	⇒
STILO 1.8 16V	192A4.000	10/01	⇒ 08/08

FIAT (BR)			
BRAVA 1.8i 16v	1.8Mpi	01/00	⇒
MAREA 1.8i 16v	1.8Mpi	01/00	⇒ 12/01

LANCIA			
DELTA II 1.8 i.e. 16V GT	183A1.000	03/96	⇒ 08/99
LYBRA 1.8 16V	839A4.000, AR32102	07/99	⇒ 10/05

9.0210



04,5

REVOLUTION AND TIMING (CKP AND CMP) SENSORS

Adatt./Suitable:

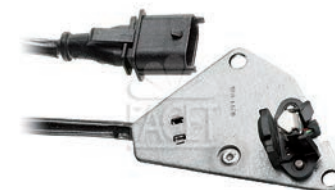
ALFA ROMEO
46469912**BOSCH**
0 232 101 035

L	L1		
725	---	Hall Effect	

ALFA ROMEO			
145 1.4 i.e. 16V T.S.	AR33503	12/96	⇒ 01/01
145 1.6 16V T.S.	AR32102	09/97	⇒ 12/00
145 1.6 i.e. 16V T.S.	AR32102, AR32102	12/96	⇒ 01/01
145 1.6 LPG	AR32102	01/98	⇒ 01/01
145 1.8 i.e. 16V	AR32201	03/98	⇒ 01/01
145 2.0 16V	AR32301	03/98	⇒ 01/01
146 1.4 i.e. 16V T.S.	AR33503	11/96	⇒ 01/01
146 1.6 16V T.S.	AR32102	09/97	⇒ 12/00
146 1.6 i.e. 16V T.S.	AR32102, AR32201	11/96	⇒ 10/01
146 1.8 i.e. 16V T.S.	AR32201, AR32104	11/96	⇒ 01/01
146 2.0 16V	AR32301	03/97	⇒ 10/01
147 1.6 16V T.SPARK	AR32104	01/01	⇒ 03/10
147 1.6 16V T.SPARK ECO	AR37203	01/01	⇒ 03/10
147 1.6 LPG	AR32104, AR32102	03/01	⇒ 03/10
147 2.0 16V T.SPARK	AR32310	01/01	⇒ 03/10
156 1.6 16V T.SPARK	AR32102, AR32102	09/97	⇒ 09/05
156 1.6 16V T.SPARK.	AR32102, AR32201	05/00	⇒ 05/06
156 1.8 16V T.SPARK	AR32201, AR32301	05/00	⇒ 05/06
156 2.0 16V T.SPARK	AR32301, 932A2.000	05/00	⇒ 06/02
156 2.0 JTS	932A2.000, AR34103	01/02	⇒ 05/06
156 2.0 Twin Spark	AR32303	11/97	⇒ 04/00
166 2.0 T.SPARK	AR34103, 932A2.000	10/00	⇒ 06/07
GT 1.8 TS	AR32205	11/03	⇒ 09/10
GT 2.0 JTS	932A2.000, AR16201	11/03	⇒ 09/10
GTV 1.8 16V	AR32201	05/98	⇒ 10/05
GTV 2.0 JTS	937A1.000	04/03	⇒ 10/05
GTV 2.0 T.SPARK 16V	AR16201, AR16201	06/95	⇒ 10/05
SPIDER II 1.8 16V	AR32201	05/98	⇒ 04/05
SPIDER II 2.0 JTS	937A1.000	04/03	⇒ 04/05
SPIDER II 2.0 T.SPARK 16V	AR16201, 838A2.000	06/95	⇒ 04/05

9.0211



04,5

REVOLUTION AND TIMING (CKP AND CMP) SENSORS

Adatt./Suitable:

- BOSCH**
0 232 101 036
- FIAT**
46520138
- LANCIA**
46520138

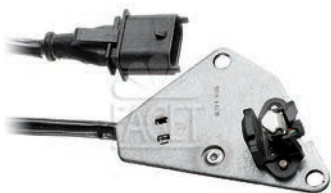

L	L1		
450	---	Hall Effect	

FIAT			
BRAVO 1.2.0 HGT 20V	182B7.000	07/98	⇒ 10/01
COUPE 2.0 20V	182B3.000	04/98	⇒ 08/00
MAREA 2.0 150 20V	185A8.000	01/01	⇒ 05/02
MAREA 2.0 155 20V	182B7.000	04/99	⇒ 02/03
STILO 2.4 20V	192A2.000	10/01	⇒ 04/07
FIAT (BR)			
MAREA 2.4i 20v	2.4Mpi	01/01	⇒
LANCIA			
KAPPA 2.0 20V	838A6.000	07/96	⇒ 10/01
KAPPA 2.4 20V	838A2.000, 182B7.000	08/94	⇒
LYBRA 2.0 20V	182B7.000, SCC	09/00	⇒ 10/05
LYBRA 2.4 20V	192A2.000	10/01	⇒ 10/05
THESIS 2.0 Turbo	841E.000	07/02	⇒ 07/09
THESIS 2.4	841D.000	07/02	⇒ 07/09

9.0212



04,5

REVOLUTION AND TIMING (CKP AND CMP) SENSORS

Adatt./Suitable:

- BOSCH**
0 261 210 003
0 281 002 096
- FORD**
7 072 657
V94DD-6C315-AA
- GENERAL MOTORS**
91 153 898
- OPEL**
62 38 423
- PORSCHE**
944 606 115 00
- VOLVO**
131703-0
13170303



L	L1	ohm	
410	55,7	900	

FORD			
SCORPIO 1.2.5 TD	SCB	08/93	⇒ 09/94

FORD			
SCORPIO II 2.5 TD	SCC, M28.49	10/94	⇒ 08/98
OPEL			
FRONTERA A 2.5 TDS	25TDS(VM41B)	09/96	⇒ 10/98
PORSCHE			
928 5.4 GTS	M28.49, M44.43	08/91	⇒ 11/95
968 3.0	M44.43, B200ET	06/91	⇒ 11/95
VAUXHALL			
FRONTERA A 2.5 TDS	25TDS(VM41B)	11/91	⇒ 10/98
VOLVO			
740 2.0	B200ET, B23ET	01/85	⇒ 08/90
740 2.0 Turbo	B200ET	09/87	⇒ 08/90
740 2.3 Turbo	B230ET	08/85	⇒ 12/88
760 2.3	B230ET	08/84	⇒ 08/87
760 2.3 Turbo	B23ET, 182A4.000	08/82	⇒ 08/90
780 2.0i Turbo	B200ET	01/87	⇒ 12/90

9.0213



04,5

REVOLUTION AND TIMING (CKP AND CMP) SENSORS

Adatt./Suitable:

- FIAT**
46440840
46454057
46462120
46481306
7760493
- LANCIA**
46440840
46454057
46481306
- MAGNETI MARELLI**
111040206502
SFA 200



L	L1		
405	---	Hall Effect	

FIAT			
BRAVA 1.6 16V	182A4.000, 182A4.000	10/95	⇒ 12/02
BRAVO I 1.6	182B6.000	09/00	⇒ 10/01
BRAVO I 1.6 16V	182A4.000, 182B6.000	10/95	⇒ 10/01
DOBLO 1.6 Natural Power	182B6000CNG	02/04	⇒ 07/09
DOBLO I 1.6	182B6.000	09/02	⇒
DOBLO I 1.6 16V	182B6.000	10/01	⇒
DOBLO I 1.6 Natural Power	182B6.000, 182B6.000	09/02	⇒
MAREA 1.6	182B6.000, 182B6.000	09/00	⇒ 08/02
MAREA 1.6 100 16V	182A4.000	09/96	⇒ 05/02
MAREA 1.6 100 16V Bipower	185A3.000	04/99	⇒ 05/02
MAREA 1.6 16V	185A3.000	04/97	⇒ 02/99
MAREA 1.6 SX	182B5.098	09/00	⇒ 08/02
MULTIPLA 1.6	182B6.000, 182B6.000	09/00	⇒ 06/10
MULTIPLA 1.6 16V	182B6.000	04/02	⇒ 06/10
MULTIPLA 1.6 16V Bipower	182B6.000, 186A3.000	10/01	⇒ 06/10
MULTIPLA 1.6 16V Blupower	186A3.000, 178C7.098	04/99	⇒ 06/10
MULTIPLA 1.6 16V GPL	182B6.000	10/01	⇒ 06/10
MULTIPLA 1.6 Natural Power	182B6000CNG	11/08	⇒ 06/10
PALIO 1.6	178C7.098, 178B3.000	07/97	⇒
PALIO 1.6 16V	178B3.000, --	02/01	⇒
PALIO 1.6 16V Sport	178E7.000	10/01	⇒
SIENA 1.6 16V	178B3.000	09/98	⇒ 12/09
STILO 1.6	--, ACK	04/05	⇒ 08/08
STILO 1.6 16V	182B6.000	10/01	⇒ 08/08
FIAT (BR)			
BRAVA 1.6i 16v	1.6Mpi	01/00	⇒ 12/01
PALIO 1.6i	1.6Mpi	01/99	⇒ 12/00
PALIO 1.6i 16v	1.6Mpi16v	01/96	⇒ 12/00
SIENA 1.6i 16v	1.6Mpi	01/98	⇒ 12/99
STRADA 1.6i 16v	1.6Mpi	01/99	⇒

LANCIA			
DELTA II 1.6i.e.	182A6.000	03/96	⇒ 08/99
LYBRA 1.6	182B6.000	10/00	⇒ 10/05

9.0214



04,5

REVOLUTION AND TIMING (CKP AND CMP) SENSORS

Adatt./Suitable:

- AUDI**
078 906 433
- BOSCH**
0 261 210 139
0 261 210 140
- VW**
078 906 433



L	L1	ohm	
740	24	900	

AUDI			
A6 I 2.8	ACK	12/95	⇒ 12/97
A6 I 2.8 quattro	ACK	12/95	⇒ 12/97
A8 I 2.8	ACK, ACK	04/96	⇒ 09/02
A8 I 2.8 quattro	ACK, ACK	04/96	⇒ 09/02
VW			
PASSAT IV 2.3 VR5	AGZ	10/96	⇒ 11/00
PASSAT IV 2.3 VR5 Syncro/4motion	AGZ	10/97	⇒ 11/00

9.0215



04,5

REVOLUTION AND TIMING (CKP AND CMP) SENSORS

Adatt./Suitable:

- AUDI**
050 906 433 B
- BOSCH**
0 261 210 134
0 261 210 135
- VW**
050 906 433 B



L	L1	ohm	
580	24	900	

AUDI			
A4 I 2.8	ACK, ACK	10/96	⇒ 09/01
A4 I 2.8 quattro	ACK, ACK	10/96	⇒ 09/01
A8 I 2.8	ACK, ACK	04/96	⇒ 09/02
A8 I 2.8 quattro	ACK, ACK	04/96	⇒ 09/02
VW			
PASSAT IV 2.8 Syncro	AGE	05/97	⇒ 09/99
PASSAT IV 2.8 V6	ACK, AJM	08/96	⇒ 09/99

9.0218



04,5

REVOLUTION AND TIMING (CKP AND CMP) SENSORS

Adatt./Suitable:

AUDI
038 907 319 E

SKODA
038 907 319 E

VW
038 907 319 E

MARKET DIFFUSION: MEDIUM



L	L1	ohm	S GND OUT
1000	46	490	

AUDI			
A4 II 1.9 TDI	AVB, BPW	11/00 ⇨	12/04
A4 II 1.9 TDI quattro	AVF	11/01 ⇨	12/04
A4 II 2.0 TDI	BPW, BKE	01/06 ⇨	03/09
A4 I 1.9 TDI	AJM, AJM	03/00 ⇨	09/01
A4 I 1.9 TDI quattro	AJM, AVB	03/00 ⇨	09/01
A4 III 1.9 TDI	BKE, AJM	11/04 ⇨	06/08
A4 III 2.0 TDI	BPW	11/04 ⇨	06/08
A4 III 2.0 TDI quattro	BPW	01/06 ⇨	06/08
A6 II 1.9 TDI	AJM, AVB	07/00 ⇨	01/05

SKODA			
SUPERB I 1.9 TDI	AVB, --	12/01 ⇨	03/08
SUPERB I 2.0	--, AJM	02/06 ⇨	
SUPERB I 2.0 TDI	BSS	10/05 ⇨	03/08

VW			
PASSAT IV 1.9 [CHN]	BPZ	04/08 ⇨	
PASSAT IV 1.9 TDI	AJM, AJM	02/00 ⇨	05/05
PASSAT IV 1.9 TDI 4motion	AJM, AGR	08/99 ⇨	05/05
PASSAT IV 1.9 TDI Syncro	AJM	11/97 ⇨	09/00
PASSAT IV 2.0 TDI	BGW	12/03 ⇨	05/05

9.0219



04,5

REVOLUTION AND TIMING (CKP AND CMP) SENSORS

Adatt./Suitable:

AUDI
038 907 319

SEAT
038 907 319

SKODA
038 907 319

VW
038 907 319

L	L1	ohm	OUT GND S
525	46	1400	

AUDI		
A3 I 1.9 TDI	AGR, AGP	09/96 ⇨ 07/01

SEAT		
CORDOBA I 1.9 SDI	AGP, AGP	06/99 ⇨ 12/02
IBIZA II 1.9 SDI	AGP, AGR	08/99 ⇨ 02/02
IBIZA II 1.9 TDI	AGR, AHF	08/99 ⇨ 02/02
TOLEDO II 1.9 TDI	AHF, AGP	10/98 ⇨ 07/04

SKODA		
OCTAVIA I 1.9 SDI	AGP, AGR	06/97 ⇨ 12/03
OCTAVIA I 1.9 TDI	AGR, AGR	09/96 ⇨ 03/10

VW		
BORA 1.9 TDI	AGR, AGP	07/01 ⇨
BORA 1.9 TDI 4motion	AGR	11/98 ⇨ 04/02
GOLF IV 1.9 SDI	AGP, AGR	08/97 ⇨ 06/05
GOLF IV 1.9 TDI	AGR, AGR	05/01 ⇨ 05/06
GOLF IV 1.9 TDI 4motion	AGR, AFN	05/01 ⇨ 05/06
GOLF 1.9 SDi	AQM	11/98 ⇨ 05/04
GOLF 1.9 TDi	AHF	10/97 ⇨ 05/04
POLO III 1.9 TDI	AFN, AGR	05/97 ⇨ 09/01
POLO III 90 1.9 TDI	AGR, AEH	09/96 ⇨ 09/01

9.0220



04,5

REVOLUTION AND TIMING (CKP AND CMP) SENSORS

Adatt./Suitable:

AUDI
01M 927 321 B

SEAT
01M 927 321 B

SKODA
01M 927 321 B

VW
01M 927 321 B

L	L1	ohm	S OUT GND
335	30,5	840	

AUDI		
A3 I 1.6	AEH, AGN	08/00 ⇨ 05/03
A3 I 1.8	AGN, AGU	09/96 ⇨ 05/03

AUDI		
A3 I 1.8 T	AGU, AGU	12/96 ⇨ 05/03
A3 I 1.8 T quattro	AGU, AGR	12/96 ⇨ 05/03
A3 I 1.9 TDI	AGR, AEH	09/96 ⇨ 07/01

SEAT		
LEON I 1.6	AEH, AGN	11/99 ⇨ 06/06
LEON I 1.8 20V	AGN, AHF	11/99 ⇨ 06/06
LEON I 1.9 TDI	AHF, AEH	11/99 ⇨ 06/06
TOLEDO II 1.6	AEH, AGN	10/98 ⇨ 07/04
TOLEDO II 1.8 20V	AGN, AHF	10/98 ⇨ 07/04
TOLEDO II 1.9 TDI	AHF, AEH	10/98 ⇨ 07/04

SKODA		
OCTAVIA I 1.6	AEH, AGU	09/00 ⇨ 12/10
OCTAVIA I 1.8	AGN	09/96 ⇨ 07/00
OCTAVIA I 1.8 20V	AGN	07/98 ⇨ 07/00
OCTAVIA I 1.8 T	AGU, AGR	08/97 ⇨ 12/10
OCTAVIA I 1.8 T 4x4	ARX	05/01 ⇨ 05/06
OCTAVIA I 1.9 TDI	AGR, AEG	09/96 ⇨ 03/10
OCTAVIA I 1.9 TDI 4x4	AGR	11/99 ⇨ 02/06
OCTAVIA I 2.0	AEJ, AGR	04/99 ⇨ 05/07
OCTAVIA I 2.0 4x4	AZJ	08/00 ⇨ 09/04

VOLKSWAGEN (BR)		
GOLF A4 1.6i	AKL	10/99 ⇨
GOLF A4 1.8i Turbo 20v	AGU	10/99 ⇨
GOLF A4 1.9 D	AGR, AEG	01/00 ⇨
GOLF A4 2.0i	AEG, AEH	08/99 ⇨

VW		
BORA 1.6	AEH, AGN	08/00 ⇨ 05/05
BORA 1.8	AGN	10/98 ⇨ 05/05
BORA 1.8 4motion	AGN, AGU	05/99 ⇨ 05/05
BORA 1.8 T	AGU, AGR	05/00 ⇨ 05/05
BORA 1.9 TDI	AGR, AGR	07/01 ⇨
BORA 1.9 TDI 4motion	AGR, APK	07/01 ⇨
BORA 2.0	APK, AEH	10/98 ⇨ 05/05
BORA 2.0 4motion	AZJ	04/00 ⇨ 05/05
BORA 2.3 V5	AGZ	10/98 ⇨ 10/00
BORA 2.3 V5 4motion	AGZ	12/98 ⇨ 10/00
GOLF IV 1.6	AEH, AGU	08/00 ⇨ 06/06
GOLF IV 1.8	AGN	08/97 ⇨ 06/05
GOLF IV 1.8 4motion	AGN	05/98 ⇨ 06/06
GOLF IV 1.8 T	AGU, AGR	08/97 ⇨ 06/06
GOLF IV 1.9 TDI	AGR, AGR	05/00 ⇨ 05/06
GOLF IV 1.9 TDI 4motion	AGR, APK	05/01 ⇨ 05/06
GOLF IV 2.0	APK, AYD	07/98 ⇨ 06/06
GOLF IV 2.0 4motion	AZJ	10/00 ⇨ 06/06
GOLF IV 2.3 V5	AGZ	08/97 ⇨ 06/06
GOLF IV 2.3 V5 4motion	AGZ	12/98 ⇨ 06/06
JETTA V 2.0	BEV	06/01 ⇨ 05/05
NEW BEETLE 1.6	AYD, APH	06/00 ⇨ 09/10
NEW BEETLE 1.8 T	APH, AEG	10/99 ⇨ 09/10
NEW BEETLE 1.9 TDI	ALH	01/98 ⇨ 06/04
NEW BEETLE 2.0	AEG, AEH	01/98 ⇨ 10/10

9.0221



3

REVOLUTION AND TIMING (CKP AND CMP) SENSORS

Adatt./Suitable:

AUDI
095 927 321 B

LANCIA
9606816880

SEAT
095 927 321 B

SKODA
095 927 321 B

VW
095 927 321 B

L	L1	ohm	
---	30,3	840	

AUDI

A3 I 1.6	AEH, AGN	08/00 ⇨ 05/03
A3 I 1.8	AGN, AGU	09/96 ⇨ 05/03
A3 I 1.8 T	AGU, AGU	12/96 ⇨ 05/03
A3 I 1.8 T quattro	AGU, AGR	12/96 ⇨ 05/03
A3 I 1.9 TDI	AGR, AEH	09/96 ⇨ 07/01

SEAT

LEON I 1.6	AEH, AGN	11/99 ⇨ 06/06
LEON I 1.8 20V	AGN, AHF	11/99 ⇨ 06/06
LEON I 1.9 TDI	AHF, AEH	11/99 ⇨ 06/06
TOLEDO II 1.6	AEH, AGN	10/98 ⇨ 07/04
TOLEDO II 1.8 20V	AGN, AHF	10/98 ⇨ 07/04
TOLEDO II 1.9 TDI	AHF, AEH	10/98 ⇨ 07/04

SKODA

OCTAVIA I 1.6	AEH, AGU	09/00 ⇨ 12/10
OCTAVIA I 1.8	AGN	09/96 ⇨ 07/00
OCTAVIA I 1.8 20V	AGN	07/98 ⇨ 07/00
OCTAVIA I 1.8 T	AGU, AGR	08/97 ⇨ 12/10
OCTAVIA I 1.8 T 4x4	ARX	05/01 ⇨ 05/06
OCTAVIA I 1.9 TDI	AGR, AEG	09/96 ⇨ 03/10
OCTAVIA I 1.9 TDI 4x4	AGR	11/99 ⇨ 02/06
OCTAVIA I 2.0	AEG, AGR	04/99 ⇨ 05/07
OCTAVIA I 2.0 4x4	AZJ	08/00 ⇨ 09/04

VOLKSWAGEN (BR)

GOLF A4 1.6i	AKL	10/99 ⇨
GOLF A4 1.8i Turbo 20v	AGU	10/99 ⇨
GOLF A4 1.9 D	AGR, AEG	01/00 ⇨
GOLF A4 2.0i	AEG, AEH	08/99 ⇨

VW

BORA 1.6	AEH, AGN	08/00 ⇨ 05/05
BORA 1.8	AGN	10/98 ⇨ 05/05
BORA 1.8 4motion	AGN, AGU	05/99 ⇨ 05/05
BORA 1.8 T	AGU, AGR	05/00 ⇨ 05/05
BORA 1.9 TDI	AGR, AGR	07/01 ⇨
BORA 1.9 TDI 4motion	AGR, APK	07/01 ⇨
BORA 2.0	APK, AEH	10/98 ⇨ 05/05
BORA 2.0 4motion	AZJ	04/00 ⇨ 05/05
BORA 2.3 V5	AGZ	10/98 ⇨ 10/00
BORA 2.3 V5 4motion	AGZ	12/98 ⇨ 10/00
GOLF IV 1.6	AEH, AGU	08/00 ⇨ 06/06
GOLF IV 1.8	AGN	08/97 ⇨ 06/05
GOLF IV 1.8 4motion	AGN	05/98 ⇨ 06/06
GOLF IV 1.8 T	AGU, AGR	08/97 ⇨ 06/06
GOLF IV 1.9 TDI	AGR, AGR	05/00 ⇨ 05/06
GOLF IV 1.9 TDI 4motion	AGR, APK	05/01 ⇨ 05/06
GOLF IV 2.0	APK, AYD	07/98 ⇨ 06/06
GOLF IV 2.0 4motion	AZJ	10/00 ⇨ 06/06
GOLF IV 2.3 V5	AGZ	08/97 ⇨ 06/06
GOLF IV 2.3 V5 4motion	AGZ	12/98 ⇨ 06/06

VW

JETTA V 2.0	BEV	06/01 ⇨ 05/05
NEW BEETLE 1.6	AYD, APH	06/00 ⇨ 09/10
NEW BEETLE 1.8 T	APH, AEG	10/99 ⇨ 09/10
NEW BEETLE 1.9 TDI	ALH	01/98 ⇨ 06/04
NEW BEETLE 2.0	AEG, CCRA	01/98 ⇨ 10/10
SPACEFOX / SPACE CROSS 1.6 FSI	CCRA, CCRA	03/06 ⇨
SPACEFOX / SPACE CROSS 1.6 Total Flex	CCRA, 183A1.000	03/06 ⇨

9.0222



04,5

REVOLUTION AND TIMING (CKP AND CMP) SENSORS

Adatt./Suitable:

FIAT
46432909
60601207

LANCIA
46432909

L	L1	ohm	
400	34,5	550	

FIAT

BARCETTA 1.8 16V	183A1.000, 1Z	04/95 ⇨ 05/05
BRAVA 1.8 GT 16V	182A2.000	10/95 ⇨ 08/01
BRAVO I 1.8 GT	182A2.000	10/95 ⇨ 10/01
COUPE 1.8 16V	183A1.000	03/96 ⇨ 08/00
MAREA 1.8 115 16V	182A2.000	09/96 ⇨ 05/02

LANCIA

DEDRA 1.8 16V LE	182A2.000	03/96 ⇨ 07/99
DEDRA 1.8 GT 16V	183A1.000	03/96 ⇨ 07/99
DELTA II 1.8 i.e. 16V	182A2.000	03/96 ⇨ 08/99
DELTA II 1.8 i.e. 16V GT	183A1.000	03/96 ⇨ 08/99

9.0224



04,5

REVOLUTION AND TIMING (CKP AND CMP) SENSORS

Adatt./Suitable:

AUDI
028 907 319 C
028 907 319 D

VW
028 907 319 C
028 907 319 D

L	L1	ohm	
700	46	1400	

AUDI

80 IV 1.9 TD	AAZ	09/91 ⇨ 12/94
80 IV 1.9 TDI	1Z	09/91 ⇨ 01/96
CABRIOLET 1.9 TDI	1Z, 183A1.000	06/95 ⇨ 08/00

9.0225



3

REVOLUTION AND TIMING (CKP AND CMP) SENSORS

Adatt./Suitable:

FIAT
46479456

HITACHI
RS-314

LANCIA
46479456

L	L1	ohm	
---	34,7	640	

FIAT

BARCETTA 1.8 16V	183A1.000, 183A1.000	04/95 ⇨ 05/05
BRAVO I 1.8 GT	182A2.000	10/95 ⇨ 10/01
COUPE 1.8 16V	183A1.000	03/96 ⇨ 08/00
MAREA 1.8 115 16V	182A2.000	09/96 ⇨ 05/02
PUNTO II 1.8 130 HGT	183A1.000, 839A4.000	09/99 ⇨ 03/12
PUNTO II 1.8 16V	188A6.000	06/03 ⇨
STILO 1.8 16V	192A4.000	10/01 ⇨ 08/08

FIAT (BR)

BRAVA 1.8i 16v	1.8Mpi	01/00 ⇨
MAREA 1.8i 16v	1.8Mpi	01/00 ⇨ 12/01

LANCIA

DELTA II 1.8 i.e. 16V GT	183A1.000	03/96 ⇨ 08/99
LYBRA 1.8 16V	839A4.000, 550B32(32651)	07/99 ⇨ 10/05

9.0227



04,5

REVOLUTION AND TIMING (CKP AND CMP) SENSORS

Adatt./Suitable:

BMW
12 14 1 404 737

00 Eliminated on 07-11-2017. Please verify the availability through our local distributors

- Eliminato il 07-11-2017. Verificare la disponibilità presso i nostri distributori
- Éliminé le 07-11-2017. Vérifier la disponibilité auprès de nos distributeurs sur place
- Am 07-11-2017 gestrichen. Evtl. Verfügbarkeit bitte bei unseren Händlern prüfen
- Eliminado en fecha 07-11-2017. Verificar la disponibilidad a través de nuestros distribuidores locales



L	L1	ohm	OUT GND S
200	28	1400	

BMW

3 III M3 3.2	S50B32(326S1)	09/95 ⇌ 04/99
Z3 M	S50B32(326S1), S50B32(326S1)	02/98 ⇌ 06/01
Z3 M 3.2	S50B32(326S1), L88	03/97 ⇌ 06/01

9.0228



04,5

REVOLUTION AND TIMING (CKP AND CMP) SENSORS

Adatt./Suitable:

CHEVROLET
10456515
96418382

DAEWOO
10456515
96418382

GENERAL MOTORS
10 456 515
96 418 382

ISUZU
8-10456515-0

OPEL
10456515
48 08 137
62 38 118
96418382

VAUXHALL
10456515
96418382



L	L1	ohm	OUT GND S
1000	24	550	

CHEVROLET

CAPTIVA 2.4	LD9(147CUL4)	06/06 ⇌
CAPTIVA 2.4 4WD	LD9(147CUL4)	06/06 ⇌
EPICA 2.0	L88	01/05 ⇌ 12/06

CHEVROLET

EVANDA 2.0	L88, LDA	03/05 ⇌
LACETTI 2.0	U20SED	03/05 ⇌
LEGANZA 2.0	--	01/98 ⇌
LEGANZA 2.2	--	01/98 ⇌
NUBIRA 1.8	LDA, L88	03/05 ⇌ 12/11
OPTRA 1.8	T18SED	08/03 ⇌ 12/08
OPTRA 1.8 SRV	T18SED	06/06 ⇌
OPTRA 2.0	U20SED	06/99 ⇌
REZZO 2.0	L88, L88	03/05 ⇌
TACUMA 2.0	X20SED	02/05 ⇌
VIVANT 2.0	X20SED	08/00 ⇌
VIVANT 2.0 CX	T20SED	01/05 ⇌

DAEWOO

EVANDA 2.0	L88, T20SED	08/02 ⇌
LACETTI 1.8	T18SED	02/04 ⇌
LEGANZA 2.0	T20SED, T20SED	01/01 ⇌ 12/02
LEGANZA 2.0 16V	T20SED, T20SED	07/00 ⇌ 04/04
LEGANZA 2.2 16V	T22SED	04/99 ⇌ 12/02
MAGNUS 2.0	X20SED	07/99 ⇌ 01/06
NUBIRA 1.2.0	C20SED	06/99 ⇌ 07/03
NUBIRA 1.2.0 16V	T20SED, T20SED	06/99 ⇌
NUBIRA 1.2.0 CDX	T20SED	08/02 ⇌ 07/03
NUBIRA II 1.8	T18SED	07/03 ⇌
REZZO 2.0	T20SED, Z24XE	09/00 ⇌
TACUMA 2.0	X20SED	09/00 ⇌ 01/05

OPEL

ANTARA 2.4	Z24XE, X22SE	07/06 ⇌ 12/11
ANTARA 2.4 4x4	Z24XE	08/06 ⇌ 12/11
ANTARA 2.4 LPG	Z24XE	10/08 ⇌
ANTARA 2.4 LPG 4x4	Z24XE	08/06 ⇌ 12/10
FRONTERA B 2.2 i	X22SE, X22SE	10/98 ⇌ 07/04

VAUXHALL

ANTARA 2.4	Z24XE	08/06 ⇌ 04/15
ANTARA 2.4 4x4	Z24XE	08/06 ⇌ 04/15
ANTARA 2.4 LPG 4x4	Z24XE	08/06 ⇌
FRONTERA B 2.2 i	X22SE, AEX	10/98 ⇌ 10/04

9.0230



04,5

REVOLUTION AND TIMING (CKP AND CMP) SENSORS

Adatt./Suitable:

GENERAL MOTORS
90 492 006

OPEL
62 38 333



L	L1	ohm	OUT GND S
710	38	550	

OPEL

OMEGA B 2.5 V6	X25XE	03/94 ⇌ 09/00
OMEGA B 2.6	--	05/94 ⇌ 05/99
OMEGA B 2.6 V6	Y26SE	09/00 ⇌ 07/03
OMEGA B 3.0 V6	X30XE	04/94 ⇌ 02/01
OMEGA B 3.2 V6	Y32SE	02/01 ⇌ 07/03

VAUXHALL

OMEGA B 2.5 V6	X25XE	03/94 ⇌ 09/00
OMEGA B 2.6 V6	Y26SE	08/00 ⇌ 07/03
OMEGA B 3.0 V6	X30XE	04/94 ⇌ 07/00
OMEGA B 3.2 V6	Y32SE	02/01 ⇌ 07/03

9.0231



04,5

REVOLUTION AND TIMING (CKP AND CMP) SENSORS

Adatt./Suitable:

GENERAL MOTORS
90 348 930

HOLDEN
90348930

OPEL
12 38 406

03 Supplied until depletion

- Fornibile fino ad esaurimento delle scorte
- Fourni jusqu'à épuisement du stock
- Lieferbar solange vorrat reicht
- Suministrado hasta el stock termina



L	L1	ohm	OUT GND
390	28	500	

HOLDEN

ASTRA_TR 1.8i 16v Hatchback	C18SEL	09/96 ⇌ 09/98
ASTRA_TR 1.8i 16v Sedan	C18SEL	09/96 ⇌ 09/98
CALIBRA_YE 2.0i	C20NE	09/91 ⇌ 07/95
CALIBRA_YE 2.0i 16V	X20XEV	08/95 ⇌ 10/97
CALIBRA_YE 2.5i 24v	C25XE	08/95 ⇌ 10/97

OPEL

ASTRA F 1.8 i	C18NZ	09/91 ⇌ 09/98
ASTRA F 2.0 i	C20NE	09/91 ⇌ 09/98

VAUXHALL

ASTRA III 1.8 i	C18NZ	09/91 ⇌ 09/98
ASTRA III 2.0 i	C20NE	09/91 ⇌ 09/98

9.0232



3,5

REVOLUTION AND TIMING (CKP AND CMP) SENSORS

Adatt./Suitable:

HITACHI
RS-123CG

SEAT
001 927 321

SKODA
001 927 321

VW
001 927 321

MARKET DIFFUSION: MEDIUM



L	L1	ohm	OUT GND
260	36,8	570	

SEAT

AROSA 1.4	AEX, BBY	05/97 ⇌ 06/04
CORDOBA II 1.4 16V	BKY	09/02 ⇌ 12/07
IBIZA III 1.4 16V	BBY, AUA	02/02 ⇌ 12/07

SKODA

FABIA I 1.4 16V	AUA, AHW	10/99 ⇌ 03/08
-----------------	----------	---------------

VOLKSWAGEN (BR)

POLO 1.4	BKY	07/06 ⇌
POLO 1.4 16V	BBY	09/02 ⇌

VW

LUPO 1.4 16V	AHW, AEX	09/98 ⇌ 07/05
--------------	----------	---------------

VW		
POLO III 1.4	AEX, AHW	05/98 ⇨ 09/01
POLO III 1.4 16V	AHW, AEX	10/99 ⇨ 09/01
POLO III 55 1.4	AEX	08/95 ⇨ 10/99
POLO III 60 1.4	AEX, AEE	07/95 ⇨ 10/99
POLO III 75 1.6	AEE, BBY	10/94 ⇨ 10/99
POLO IV 1.4	BBY, BBY	11/02 ⇨ 04/12
POLO IV 1.4 16V	BBY, AEX	10/01 ⇨ 05/08

9.0233



3,5

REVOLUTION AND TIMING (CKP AND CMP) SENSORS

Adatt./Suitable:

HITACHI
RS-123B**SEAT**
001 927 321 A**SKODA**
001 927 321 A**VW**
001 927 321 A

MARKET DIFFUSION: MEDIUM

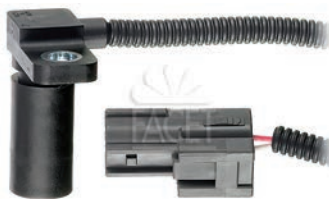

L	L1	ohm	S GND OUT
230	36,8	570	

SEAT		
AROSA 1.4	AEX, BBY	05/97 ⇨ 06/04
CORDOBA II 1.4 16V	BKY	09/02 ⇨ 12/07
IBIZA III 1.4 16V	BBY, AUA	02/02 ⇨ 12/07

SKODA		
FABIA I 1.4 16V	AUA, AHW	10/99 ⇨ 03/08

VOLKSWAGEN (BR)		
POLO 1.4	BKY	07/06 ⇨
POLO 1.4 16V	BBY	09/02 ⇨

VW		
LUPO 1.4 16V	AHW, AEX	09/98 ⇨ 07/05
POLO III 1.4	AEX, AHW	05/98 ⇨ 09/01
POLO III 1.4 16V	AHW, AEX	10/99 ⇨ 09/01
POLO III 55 1.4	AEX	08/95 ⇨ 10/99
POLO III 60 1.4	AEX, AEE	07/95 ⇨ 10/99
POLO III 75 1.6	AEE, BBY	10/94 ⇨ 10/99
POLO IV 1.4	BBY, BBY	11/02 ⇨ 04/12
POLO IV 1.4 16V	BBY, D0836LFL61	10/01 ⇨ 05/08

9.0234



04,5

REVOLUTION AND TIMING (CKP AND CMP) SENSORS

Adatt./Suitable:

GENERAL MOTORS
90 520 855**OPEL**
62 38 080
90520855**VAUXHALL**
90520855

L	L1	ohm	S GND OUT
820	24	550	

OPEL		
ASTRA F 1.8	Z18XEL	02/03 ⇨ 07/04
ASTRA F 2.0 i 16V	X20XER	10/99 ⇨ 08/00
ASTRA G 2.0 16V	X20XEV	02/98 ⇨ 01/05
ASTRA G 2.0 16V OPC	X20XER	11/99 ⇨ 09/02

VAUXHALL		
ASTRA IV 2.0	X20XER	10/99 ⇨ 08/00
ASTRA IV 2.0 16V	X20XEV	02/98 ⇨ 05/05

9.0235



3

REVOLUTION AND TIMING (CKP AND CMP) SENSORS

Adatt./Suitable:

BOSCH
0 261 210 151
0 281 002 662**GENERAL MOTORS**
9 118 368
93 179 850**IVECO**
0005010412449
5010412449**MAN**
51.27120.7038**OPEL**
62 38 050
62 38 109
91 18 368
93179850**RENAULT TRUCKS**
50 10 412 449**SUZUKI**
33220-84E80
33220-84E80-000**VAUXHALL**
9118368
93179850**VOLVO**
20513343

MARKET DIFFUSION: HIGH



L	L1	ohm	GND OUT
---	34,5	970	

MAN		
HOCL	D0836LFL61, D0836LOH40	05/00 ⇨
LC	D0836LOH40, D0826LUH	⇨
LION S CITY	D0826LUH, D2066LOH32	01/02 ⇨
LION S COACH	D2066LOH32, D2066LUH12	10/15 ⇨
NG	D2066LUH12, D2066LUH11	01/06 ⇨ 12/14
NL	D2066LUH11, D0836LOH51	01/06 ⇨
NM	D0836LOH51, D2066LOH12	08/02 ⇨ 06/14
SL II	D2066LOH12, D0836LOH02	01/06 ⇨ 05/14
SÜ	D0836LOH02, D2066LF01	09/03 ⇨
TGA	D2066LF01, D0834LFL40	12/00 ⇨
TGL	D0834LFL40, D0836LFL40	04/05 ⇨
TGM	D0836LFL40, D2066LF01	10/05 ⇨
TGS	D2066LF01, D2066LF25	09/07 ⇨
TGX	D2066LF25, D2866LUH24	09/07 ⇨

NEOPLAN		
TRENDLINER	D2866LUH24, X12XE	09/04 ⇨

OPEL		
AGILA A 1.0	Z10XEP	08/03 ⇨ 12/07
AGILA A 1.0 12V	Z10XE	09/00 ⇨ 12/07
AGILA A 1.2 16V	Z12XE	09/00 ⇨ 12/07
AGILA A 1.2 16V Twinport	Z12XEP	07/04 ⇨ 12/07
ASTRA G 1.2	X12XE	09/98 ⇨ 08/00
ASTRA G 1.2 16V	X12XE, X20DTH	09/00 ⇨ 01/05
ASTRA G 1.4	Z14XEP	10/04 ⇨ 12/09
ASTRA G 2.0 DTI	Y20DTH	09/00 ⇨ 04/05
ASTRA G 2.0 DTI 16V	X20DTH, Z14XEL	08/99 ⇨ 01/05
ASTRA G 2.2 DTI	Y22DTR	09/02 ⇨ 10/05
ASTRA H 1.2	Z12XEP	08/05 ⇨ 10/10
ASTRA H 1.4	Z14XEL, Z10XE	03/04 ⇨ 10/10
ASTRA H 1.4 EcoTec	Z14XEP	12/04 ⇨ 12/12
ASTRA H 1.4 LPG	Z14XEP	08/09 ⇨ 10/10
ASTRA J 1.4	Z14XEP	01/09 ⇨
COMBO C 1.4	Z14XEP	10/04 ⇨ 12/11

OPEL		
COMBO C 1.4 16V	Z14XEP	08/05 →
CORSA B 1.0 i 12V	X10XE	11/96 → 09/00
CORSA B 1.2 i 16V	X12XE	03/98 → 09/00
CORSA C 1.0	Z10XE, Z12XEP	09/00 → 12/09
CORSA C 1.2	Z12XE	09/00 → 12/09
CORSA C 1.2 16V	Z12XE	09/00 → 07/03
CORSA C 1.2 Twinport	Z12XEP	07/04 → 12/09
CORSA C 1.4	Z14XEP	08/03 → 06/12
CORSA C 1.4 Twinport	Z14XEP	06/03 → 12/09
CORSA D 1.0	Z10XEP	07/06 → 08/14
CORSA D 1.2	Z12XEP	07/06 → 08/14
CORSA D 1.2 LPG	Z12XEP, Y22DTR	08/06 → 08/14
CORSA D 1.4	Z14XEP	07/06 → 08/14
CORSA D 1.4 LPG	Z14XEP	08/06 → 12/11
MERIVA A 1.4 16V Twinport	Z14XEP	07/04 → 05/10
MERIVA A 1.4 16V Twinport LPG	Z14XEP	07/04 → 05/10
SIGNUM 2.0 DTI	Y20DTH	05/03 → 04/04
SIGNUM 2.2 DTI	Y22DTR	05/03 → 04/04
SIGNUM 2.2 DTI 16V	Y22DTR	05/03 → 06/08
TIGRA B 1.4	Z14XEP	06/04 → 12/10
VECTRA C 2.0 DTI	Y20DTH	10/03 → 08/05
VECTRA C 2.0 DTI 16V	Y20DTH	04/02 → 08/06
VECTRA C 2.2 DTI	Y22DTR, Y22DTR	10/03 → 06/08
VECTRA C 2.2 DTI 16V	Y22DTR, DTI11-122HH	04/02 → 06/08
ZAFIRA A 2.0 DTI 16V	Y20DTH	09/00 → 06/05
ZAFIRA A 2.2 DTI 16V	Y22DTR	01/02 → 06/05

RENAULT TRUCKS

C-SERIE	DTI11-122HH, DTI11-122HH	01/13 →
D-SERIE	DTI11-122HH, dCi11-270	01/13 →
KERAX	dCi11-270, DTI11-122HH	01/01 →
K-SERIE	DTI11-122HH, DXi13	01/13 →
MAGNUM	DXi13, 8140.43.S.2585	05/06 →
MASCOTT 130	8140.43.S.2585, 8140.43.S.2585	01/99 → 06/04
MASCOTT 130.35	8140.43.S.2585, 8140.43.S.2585	01/99 → 06/04
MASCOTT 130.55	8140.43.S.2585, dCi4B	01/99 → 06/04
MIDLUM	dCi4B, dCi11B/43	10/01 →
PREMIUM	dCi11B/43, DXi11	08/00 →
PREMIUM 2	DXi11, DTI11-122HH	10/05 →
T-SERIE	DTI11-122HH, Z10XE	01/13 →

SUZUKI

WAGON R III 1.2	Z12XEP	06/04 → 08/05
-----------------	--------	---------------

TEMISA

DIAMOND	D2066LOH04	01/06 →
---------	------------	---------

VAUXHALL

AGILA A 1.0 12V	Z10XE, X12XE	02/00 → 11/06
AGILA A 1.2 16V	Z12XE	09/00 → 03/08
AGILA A 1.2 16V Twinport	Z12XEP	07/04 → 11/06
AGILA A 1.3 CDTI	Z13DT	08/03 → 03/08
ASTRA IV 1.2 16V	X12XE, Z14XEL	09/00 → 05/05
ASTRA IV 2.0 DTI 16V	Y20DTH	02/98 → 05/05
ASTRA IV 2.2 DTI	Y22DTR	09/02 → 05/05
ASTRA V 1.2	Z12XEP	08/05 → 10/10
ASTRA V 1.4	Z14XEL, Z10XE	01/04 → 10/10
ASTRA V 1.4 i 16V	Z14XEP	03/05 → 11/10
ASTRAVAN II 2.0 DTI	Y20DTH	04/04 → 08/06
ASTRAVAN III 1.4 i	Z14XEP	03/05 →
COMBO C 1.4	Z14XEP	10/04 → 09/10
COMBO C 1.4 i 16V	Z14XEP	01/04 → 11/11
CORSA B 1.0 i 12V	X10XE	11/96 → 09/00
CORSA B 1.2 i 16V	X12XE	03/98 → 09/00
CORSA C 1.0 12V	Z10XE, Z12XE	09/00 → 10/06
CORSA C 1.2 16V	Z12XE	09/00 → 10/06
CORSA C 1.2 16V Dualfuel	Z12XE	08/01 → 10/06
CORSA C 1.2 Twinport	Z12XEP	07/04 → 10/06
CORSA C 1.4 Twinport	Z14XEP	06/03 → 10/06
CORSA D 1.0	Z10XEP	08/06 → 08/14
CORSA D 1.2	Z12XEP	08/06 → 08/14
CORSA D 1.2 LPG	Z12XEP	09/09 → 08/14
CORSA D 1.4	Z14XEP	08/06 → 08/14
CORSA D 1.4 LPG	Z14XEP	07/06 → 08/14
CORSAVAN II 1.2 16V	Z12XE, Z12XE	09/00 → 11/06
CORSAVAN II 1.2 16V Dualfuel	Z12XE, X16XEL	08/01 → 06/06
CORSAVAN III 1.4	Z14XEP	11/03 → 06/06
CORSAVAN III 1.2	Z12XEP	07/09 →
MERIVA I 1.4 16V Twinport	Z14XEP	01/03 → 06/10
SIGNUM 2.0 DTI	Y20DTH	05/03 → 05/08
SIGNUM 2.2 DTI	Y22DTR	05/03 → 05/08
TIGRA B 1.4	Z14XEP	06/04 → 08/09
VECTRA C 2.0 DTI 16V	Y20DTH	04/02 → 10/08
VECTRA C 2.2 DTI 16V	Y22DTR	04/02 → 10/08
ZAFIRA A 2.0 DTI 16V	Y20DTH	04/99 → 08/05
ZAFIRA A 2.2 D	Y22DTR	06/01 → 06/05

9.0236



04,5

REVOLUTION AND TIMING (CKP AND CMP) SENSORS

Adatt./Suitable:

GENERAL MOTORS
90 520 856

OPEL

62 38 459
90520856

SIEMENS

S103518001Z
S105578001Z

VAUXHALL

90520856



L	L1	ohm	S GND OUT
350	34,5	550	

OPEL

ASTRA F 1.8 i	X18XE1	03/98 → 08/00
ASTRA G 1.8 16V	X18XE1	02/98 → 10/00
VECTRA B 1.6 i 16V	X16XEL, X18XE1	10/95 → 07/02
VECTRA B 1.8 i 16V	X18XE1, X16XEL	10/95 → 09/00
ZAFIRA A 1.8 16V	X18XE1	04/99 → 09/00

VAUXHALL

ASTRA IV 1.8 16V	X18XE1	02/98 → 08/05
VECTRA B 1.6 i 16V	X16XEL, X14XE	08/95 → 03/02
VECTRA B 1.8 i 16V	X18XE1	10/95 → 09/00
ZAFIRA A 1.8 16V	X18XE1	05/99 → 08/00

9.0237



04,5

REVOLUTION AND TIMING (CKP AND CMP) SENSORS

Adatt./Suitable:

BOSCH
0 281 002 285GENERAL MOTORS
09 118 150

OPEL

62 38 101
91 18 150

VAUXHALL

9118150



L	L1	ohm	OUT GND S
300	34,5	900	

OPEL

ASTRA G 1.7 TD	X17DTL	02/98 → 04/05
----------------	--------	---------------

VAUXHALL

ASTRA IV 1.7 TD	X17DTL	02/98 → 08/00
ASTRAVAN II 1.7 TD	X17DTL	08/98 → 08/06

9.0238



04,5

REVOLUTION AND TIMING (CKP AND CMP) SENSORS

Adatt./Suitable:

GENERAL MOTORS
90 520 854

OPEL

62 38 098
90520854

SIEMENS

S101938004Z

VAUXHALL

90520854



L	L1	ohm	OUT GND S
580	34,5	550	

OPEL

ASTRA G 1.4	X14XE, X14XE	09/98 → 04/05
ASTRA G 1.4 16V	X14XE, X14XE	02/98 → 01/05
ASTRA G 1.4 LPG	X14XE, X16XEL	02/98 → 01/05
ASTRA G 1.6	X16SZR	02/98 → 09/00
ASTRA G 1.6 16V	X16XEL, X16XEL	02/98 → 01/05
ASTRA G 1.6 LPG	X16XEL, X16XEL	03/98 → 01/05
ZAFIRA A 1.6 16V	X16XEL, X16XEL	04/99 → 06/05
ZAFIRA A 1.6 LPG	X16XEL, X14XE	04/99 → 06/05

VAUXHALL

ASTRA IV 1.4 16V	X14XE, X14XE	02/98 → 05/05
ASTRA IV 1.4 16V Dualfuel	X14XE, X16XEL	09/99 → 06/03
ASTRA IV 1.6	X16SZR	02/98 → 04/04
ASTRA IV 1.6 16V	X16XEL, X16SZR	02/98 → 05/05
ASTRA IV 1.6 Dualfuel	X16SZR, X16XEL	02/98 → 08/04
ASTRAVAN II 1.6 Dualfuel	X16SZR	02/98 → 12/00
ASTRAVAN II 1.6 i	X16SZR	08/98 → 09/00
ZAFIRA A 1.6 16V	X16XEL, AR32401	04/99 → 08/05
ZAFIRA A 1.6 Dualfuel	X16XEL	11/98 → 08/05

9.0239



04,5

REVOLUTION AND TIMING (CKP AND CMP) SENSORS

Adatt./Suitable:

ALFA ROMEO46811123
60586655
60810695
60816861**BOSCH**0 232 103 009
0 232 103 024**FIAT**46811123
60810695
60816861
8024224**IVECO**000008024224
8024224**LANCIA**46811123
60810695
60816861

L	L1		
425	28	Hall Effect	

ALFA ROMEO

147 3.2 GTA	932A.000	02/03 ⇒ 03/10
156 2.5 V6 24V	AR32401, AR64307	02/97 ⇒ 05/06
156 2.5 V6 24V [BRA]	AR32402	10/97 ⇒ 12/01
156 3.2 GTA	932A.000	03/02 ⇒ 05/06
164 3.0 24V Q4	AR64307, AR34201	09/92 ⇒ 10/98
164 3.0 24V QV Trazione integrale	AR64307	11/92 ⇒ 10/97
164 3.0i 24V Super Q4	AR66304	03/95 ⇒ 12/98
166 2.0 V6	AR34102	09/98 ⇒ 10/00
166 2.5 V6 24V	AR34201, AR34301	10/00 ⇒ 06/07
166 3.0 V6 24V	AR34301, AR16102	10/00 ⇒ 06/07
166 3.0 V6 24V [BRA]	AR34302	08/98 ⇒ 09/00
166 3.2 V6 24V	936A.000	10/03 ⇒ 06/07
GT 3.2 GTA	936A.000	11/03 ⇒ 09/10
GTV 3.0 V6 24V	AR16102, AR16101	10/00 ⇒ 10/05
GTV 3.2 V6 24V	936A6.000	04/03 ⇒ 10/05
SPIDER 3.0 [ExtraEU]	AR16101, AR16199	04/95 ⇒ 04/05
SPIDER II 3.0 12V [BRA]	AR16199, AR16101	09/95 ⇒
SPIDER II 3.0 V6	AR16101, AEH	09/94 ⇒ 04/05
SPIDER II 3.0 V6 24V	AR16102	01/99 ⇒ 10/03
SPIDER II 3.2 V6 24V	936A6.000	04/03 ⇒ 04/05

LANCIA

KAPPA 3.0 24V	838B.000	08/94 ⇒ 10/01
THESIS 3.0 V6	841A.000	07/02 ⇒ 07/09
THESIS 3.2 V6	841L.000	05/03 ⇒ 07/09

9.0240



3,5

REVOLUTION AND TIMING (CKP AND CMP) SENSORS

Adatt./Suitable:

ALFA ROMEO

60605410

BOSCH

0 232 103 010

03 Supplied until depletion

- Fornibile fino ad esaurimento delle scorte
- Fourni jusqu'à épuisement du stock
- Lieferbar solange vorrat reicht
- Suministrado hasta el stock termina



L	L1		
285	28	Hall Effect	

ALFA ROMEO

145 1.7 i.e. 16V	AR33401	10/94 ⇒ 12/96
146 1.7 i.e. 16V	AR33401	12/94 ⇒ 12/96

9.0241



04,5

REVOLUTION AND TIMING (CKP AND CMP) SENSORS

Adatt./Suitable:

AUDI06A 906 433 G
06A 906 433 L**BOSCH**0 261 210 199
0 261 210 200**SEAT**06A 906 433 G
06A 906 433 L**SKODA**06A 906 433 G
06A 906 433 L**VW**06A 906 433 G
06A 906 433 L

MARKET DIFFUSION: MEDIUM



L	L1	ohm	
215	24	900	

AUDI

A1 1.4 TFSI	CTJA	01/11 ⇒ 04/15
A1 2.0 TFSI quattro	CDLH	03/12 ⇒ 11/12
A3 I 1.6	AEH, AGU	08/00 ⇒ 05/03
A3 I 1.8 T	AGU, AGU	12/96 ⇒ 05/03
A3 I 1.8 T quattro	AGU, AMK	12/96 ⇒ 05/03
A3 I S3 quattro	AMK, BGU	10/01 ⇒ 05/03
A3 II 1.6	BGU, CCSA	05/03 ⇒ 08/12
A3 II 1.6 E-Power	CCSA, AXX	01/11 ⇒ 08/12
A3 II 2.0 TFSI	AXX, AXX	09/04 ⇒ 08/12
A3 II 2.0 TFSI quattro	AXX, BHZ	09/04 ⇒ 08/12
A3 II S3 quattro	BHZ, BGU	11/06 ⇒ 08/12
A3 II SPORTBACK 1.6	BGU, CCSA	09/04 ⇒ 03/13
A3 II SPORTBACK 1.6 E-Power	CCSA, AXX	01/11 ⇒ 03/13
A3 II SPORTBACK 2.0 TFSI	AXX, AXX	09/04 ⇒ 03/13
A3 II SPORTBACK 2.0 TFSI quattro	AXX, BHZ	09/04 ⇒ 03/13
A3 II SPORTBACK S3 quattro	BHZ, BWE	06/08 ⇒ 03/13

AUDI

A4 II 2.0 TFSI 16V	BWE, BGB	01/06 ⇒ 03/09
A4 II 2.0 TFSI quattro	BWT	11/05 ⇒ 03/09
A4 III 2.0 TFSI	BGB, BGB	11/04 ⇒ 06/08
A4 III 2.0 TFSI quattro	BGB, BPJ	11/04 ⇒ 06/08
A6 III 2.0 TFSI	BPJ, AJQ	06/05 ⇒ 08/11
TT I 1.8 T	AJQ, AJQ	01/01 ⇒ 06/06
TT I 1.8 T quattro	AJQ, BPY	02/00 ⇒ 06/06
TT II 2.0 TFSI	BPY, CDLA	08/06 ⇒ 06/10
TT II 2.0 TFSI quattro	BWA	06/08 ⇒ 06/10
TT II 2.0 TTS quattro	CDLA, BGU	05/08 ⇒ 06/14

SEAT

ALTEA 1.6	BGU, BGU	03/04 ⇒
ALTEA 1.6 LPG	CHGA	09/09 ⇒
ALTEA 1.6 Multifuel	CMXA	11/10 ⇒ 05/11
ALTEA 2.0 TFSI	BWA	04/06 ⇒ 05/09
ALTEA XL 1.6	BGU, BSE	10/06 ⇒
ALTEA XL 1.6 LPG	CHGA	09/09 ⇒
ALTEA XL 1.6 Multifuel	BSE, AZL	10/06 ⇒
ALTEA XL 2.0 TFSI	BWA	10/06 ⇒ 05/09
ALTEA XL 2.0 TFSI 4x4	BWA	06/07 ⇒ 05/09
CORDOBA II 2.0	AZL, APF	09/02 ⇒ 11/09
EXEO 2.0 TFSI	BWE	03/09 ⇒
IBIZA II 1.6	APF, BBU	08/99 ⇒ 02/02
IBIZA III 1.8 T Cupra R	BBU, BJX	01/04 ⇒ 02/08
IBIZA III 1.8 T FR	BJX, AZL	12/03 ⇒ 05/08
IBIZA III 2.0	AZL, APP	04/02 ⇒ 11/09
IBIZA IV 2.0	CEKA	10/08 ⇒
LEON I 1.6	BFQ	10/05 ⇒ 06/06
LEON I 1.8 20V T	APP, BSE	11/99 ⇒ 06/06
LEON I 1.8 T Cupra R	AMK	02/02 ⇒ 06/06
LEON I 1.8 Turbo 4x4	AMK	05/02 ⇒ 05/03
LEON II 1.6	BSE, BSE	07/05 ⇒ 12/12
LEON II 1.6 LPG	CHGA	12/09 ⇒ 12/12
LEON II 1.6 MultiFuel	BSE, BWA	11/10 ⇒ 12/12
LEON II 2.0 Cupra R	CDLA	09/09 ⇒ 12/12
LEON II 2.0 TFSI	BWA, APP	05/05 ⇒ 05/11
TOLEDO II 1.8 20VT	APP, BGU	09/00 ⇒ 07/04
TOLEDO III 1.6	BGU, AVU	10/04 ⇒ 05/09

SKODA

FABIA I 2.0	AZL	12/99 ⇒ 03/08
OCTAVIA I 1.6	AVU, AGU	09/00 ⇒ 12/10
OCTAVIA I 1.8 T	AGU, AEG	08/97 ⇒ 12/10
OCTAVIA I 2.0	AEG, AZH	04/99 ⇒ 05/07
OCTAVIA I 2.0 4x4	AZH, BGU	08/00 ⇒ 09/04
OCTAVIA I RS 1.8 T	AUQ	05/01 ⇒ 01/06
OCTAVIA II 1.6	BGU, BSE	06/04 ⇒ 06/13
OCTAVIA II 1.6 LPG	BSE, CCSA	08/09 ⇒ 11/12
OCTAVIA II 1.6 MultiFuel	CCSA, BWA	01/08 ⇒ 06/13
OCTAVIA II 2.0 RS	BWA, AEH	10/05 ⇒ 02/13

VOLKSWAGEN (BR)

POLO 2.0	BBX	05/02 ⇒
----------	-----	---------

VW

BORA 1.6	AEH, AGU	08/00 ⇒ 05/05
BORA 1.8 T	AGU, APK	05/00 ⇒ 05/05
BORA 2.0	APK, AZH	10/98 ⇒ 05/05
BORA 2.0 4motion	AZH, BGU	04/00 ⇒ 05/05
CADDY III 1.6	BGU, BSF	04/04 ⇒ 05/15
CADDY III 1.6 BiFuel	BSF, BPY	05/11 ⇒ 05/15
CADDY III 2.0 EcoFuel	BSX	04/06 ⇒ 05/15
EOS 2.0 TFSI	BPY, AEH	03/06 ⇒ 08/15
GOLF 2.0 BiFuel	BEH	05/02 ⇒ 05/03
GOLF 2.0 TSi R 4motion	CDLF	11/09 ⇒ 11/12
GOLF IV 1.6	AEH, AGU	08/00 ⇒ 06/06
GOLF IV 1.8 T	AGU, APK	08/97 ⇒ 06/06
GOLF IV 1.8 T GTI	AUQ	08/01 ⇒ 06/05
GOLF IV 2.0	APK, AZH	07/98 ⇒ 06/06
GOLF IV 2.0 4motion	AZH, BGU	10/00 ⇒ 06/06
GOLF IV 2.0 Bi-Fuel	BEH	02/02 ⇒ 06/06
GOLF V 1.6	BGU, CCSA	01/04 ⇒
GOLF V 1.6 BiFuel	CHGA	05/09 ⇒ 12/13
GOLF V 1.6 MultiFuel	CCSA, BWA	10/07 ⇒ 12/13
GOLF V 2.0	BWA, AXX	06/07 ⇒ 07/09
GOLF V 2.0 GTI	AXX, BSE	10/04 ⇒ 02/09
GOLF VI 1.6	BSE, CCSA	10/08 ⇒
GOLF VI 1.6 BiFuel	BSF	03/09 ⇒
GOLF VI 1.6 MultiFuel	CCSA, CDLA	10/08 ⇒
GOLF VI 2.0	CDLF	05/11 ⇒
GOLF VI 2.0 GTI	CDLG	05/11 ⇒ 11/12
GOLF VI 2.0 R	CDLA	01/13 ⇒ 05/16
GOLF VI 2.0 R 4motion	CDLA, BSE	11/09 ⇒ 11/13
GOLF VI 2.0 TFSI	CRZA	11/11 ⇒
GOLF VI 2.0 TFSI Gti	CDLG	05/11 ⇒
GOLF VI 2.0 TSI	CDLC	01/13 ⇒
JETTA V 1.6	BSE, BPY	10/05 ⇒ 10/10
JETTA V 1.6 MultiFuel	CCSA	01/08 ⇒ 10/10
JETTA V 2.0	BEV	06/01 ⇒ 05/05
JETTA V 2.0 TFSI	BPY, CBPA	10/05 ⇒ 10/10
JETTA VI 2.0	CBPA, AWH	06/10 ⇒ 12/17

VW		
NEW BEETLE 1.6	AWH, AGU	06/00 → 09/10
NEW BEETLE 1.8 T	AGU, AEG	11/01 → 09/10
NEW BEETLE 2.0	AEG, BSE	01/98 → 10/10
PASSAT V 1.6	BSE, AXJ	05/05 → 11/10
PASSAT V 2.0 FSI	AXX, CDLA	07/05 → 11/10
POLO IV 1.8 GTI	BJX	09/05 → 11/09
POLO IV 1.8 GTI Cup Edition	BBU	05/06 → 11/09
POLO IV 2.0	BBX	09/02 →
POLO V 2.0 R WRC	CDLJ	08/13 →
SCIROCCO III 2.0 R	CDLA, BGU	11/09 → 11/17
TOURAN I 1.6	BGU, C25XE	07/03 → 05/10
TOURAN I 1.6 BiFuel	BSF	11/06 → 05/10
TOURAN I 2.0 EcoFuel	BSX	02/06 → 05/09

9.0242 3,5

REVOLUTION AND TIMING (CKP AND CMP) SENSORS

Adatt./Suitable:

- BOSCH**
0 232 103 002
0 232 103 011
- GENERAL MOTORS**
90 449 573
90 510 027
90 510 656
- HOLDEN**
90510656
- OPEL**
12 38 999
62 38 337
62 38 351



L	L1		
165	13,8	Hall Effect	

HOLDEN		
CALIBRA YE 2.0i 16V	C20XE	09/91 → 07/95
OPEL		
ASTRA F 2.0 GSi 16V	C20XE	09/91 → 01/98
ASTRA F 2.0 i 16V	C20XE	03/93 → 01/98
CALIBRA A 2.0 i 16V	C20XE	06/90 → 02/94
CALIBRA A 2.0 i 16V 4x4	C20XE	06/90 → 02/94
VECTRA A 2.0 i 16V	20XEJ	02/89 → 10/90
VECTRA A 2.0 i 16V 4x4	C20XE	08/89 → 08/95
VECTRA A 2.0 i 16V Cat	C20XE	02/90 → 11/95
VECTRA A 2000 16V 4x4	20XEJ	01/89 → 10/90
VECTRA A 2000/GT 16V	20XEJ	01/89 → 06/94
VECTRA A 2000/GT 16V Cat	C20XE	02/90 → 11/95
VECTRA A 2000/GT 16V Cat 4x4	C20XE	02/90 → 11/95
VAUXHALL		
ASTRA III 2.0 i 16V	C20XE	09/91 → 02/98
CALIBRA 2.0 i 16V	C20XE	06/90 → 02/94
CALIBRA 2.0 i 16V 4x4	C20XE	06/90 → 02/94

9.0243



REVOLUTION AND TIMING (CKP AND CMP) SENSORS

Adatt./Suitable:

- BOSCH**
0 232 103 007
- GENERAL MOTORS**
90 505 794
90 510 657
- HOLDEN**
90510657
- OPEL**
62 38 350
90505794
90510657
- SAAB**
46 21 363
- SCANIA**
4621363
- VAUXHALL**
90510657



L	L1		
330	13,8	Hall Effect	

HOLDEN		
CALIBRA YE 2.5i 24v	C25XE	08/95 → 10/97
OPEL		
CALIBRA A 2.5 i V6	C25XE	04/93 → 07/97
VECTRA A 2.5 CD 4x4	C25XE	08/92 → 08/95
VECTRA A 2.5 V6	C25XE	02/93 → 11/95
VECTRA B 2.5	X25XE	10/99 → 06/00
VECTRA B 2.5 i V6	X25XE	10/95 → 09/00
VECTRA B i 500 2.5	X25XE	05/98 → 09/00
SAAB		
900 II 2.5 -24 V6	B258I	07/93 → 02/98
VAUXHALL		
CALIBRA 2.5 i V6	C25XE, EPE	04/93 → 07/97
VECTRA B 2.5 i GSi	X25XE	03/98 → 07/00
VECTRA B 2.5 i V6	X25XE	09/95 → 08/00

9.0245



REVOLUTION AND TIMING (CKP AND CMP) SENSORS

Adatt./Suitable:

- BOSCH**
0 232 103 008
- GENERAL MOTORS**
90 510 667
- OPEL**
62 38 334
62 38 352
90491965
90510667
- SAAB**
46 21 389
47 70 079
- VAUXHALL**
90491965
90510667



L	L1		
250	13,8	Hall Effect	

OPEL		
OMEGA B 2.5 V6	X25XE	03/94 → 09/00
OMEGA B 3.0 V6	X30XE	04/94 → 02/01
SINTRA 3.0 i 24V	X30XE	11/96 → 04/99
SAAB		
900 II 2.5 -24 V6	B258I	07/93 → 02/98
9000 3.0 -24 V6 CD/CDE	B308I	07/94 → 12/98
9000 3.0 -24 V6 CS/CSE	B308I	07/94 → 12/98
VAUXHALL		
OMEGA B 2.5 V6	X25XE	03/94 → 09/00
OMEGA B 3.0 V6	X30XE	04/94 → 07/00
SINTRA 3.0 i 24V	X30XE	11/96 → 04/99

9.0249



REVOLUTION AND TIMING (CKP AND CMP) SENSORS

Adatt./Suitable:

- CHRYSLER**
4713427
56026882
- JEEP**
56026882



L	L1		
450	24,5	Hall Effect	

JEEP		
CHEROKEE II 2.5 i 4x4	EPE, EPE	12/91 → 09/01
COMANCHE 2.5 i	EPE	10/90 → 09/96

9.0252



04,5

REVOLUTION AND TIMING (CKP AND CMP) SENSORS

Adatt./Suitable:
GENERAL MOTORS
 90 508 637
OPEL
 12 38 750
 90508637
VAUXHALL
 90508637



L	L1	ohm	OUT GND S
850	24	550	

OPEL

SINTRA 2.2 i 16V	X22XE	11/96 ⇒ 04/99
------------------	-------	---------------

VAUXHALL

SINTRA 2.2 i 16V	X22XE	11/96 ⇒ 04/99
------------------	-------	---------------

9.0253



04,5

REVOLUTION AND TIMING (CKP AND CMP) SENSORS

Adatt./Suitable:
CHRYSLER
 4638128
 53009954
JEEP
 4638128



L	L1	Hall Effect	OUT
432	24,5		

JEEP

Model	Code	Year Range
CHEROKEE II 2.5	EPE, EPE	10/86 ⇒ 09/96
CHEROKEE II 2.5 4x4	EPE, EPE	10/84 ⇒ 09/90
CHEROKEE II 2.5 i 4x4	EPE, AXW	10/84 ⇒ 09/01
CHEROKEE II 2.5 SE	EPE	10/96 ⇒ 09/99
CHEROKEE II 4.0 i	MX	02/99 ⇒ 09/01
GRAND CHEROKEE 4.0 i 4x4	MX	09/91 ⇒ 04/99
WRANGLER 2.5	--	01/88 ⇒ 12/91

9.0254



04,5

REVOLUTION AND TIMING (CKP AND CMP) SENSORS

Adatt./Suitable:
AUDI
 06A 906 433 K
SEAT
 06A 906 433 K
SKODA
 06A 906 433 K
VW
 06A 906 433 K



L	L1	ohm	OUT GND S
250	24	900	

AUDI

A3 II 2.0 FSI	AXW, AXW	05/03 ⇒ 06/08
---------------	----------	---------------

A3 II SPORTBACK 2.0 FSI	AXW, AJH	09/04 ⇒ 06/08
-------------------------	----------	---------------

SEAT

ALHAMBRA I / II 1.8 T 20V	AJH, ADY	10/97 ⇒ 03/10
---------------------------	----------	---------------

ALHAMBRA I / II 2.0 i	ADY, BLR	04/96 ⇒ 03/10
-----------------------	----------	---------------

ALTEA 2.0 FSI	BLR, BVY	05/04 ⇒ 03/09
---------------	----------	---------------

ALTEA XL 2.0 FSI	BVY, BLR	10/06 ⇒ 03/09
------------------	----------	---------------

LEON II 2.0 FSI	BLR, BLR	07/05 ⇒ 05/10
-----------------	----------	---------------

TOLEDO III 2.0 FSI	BLR, BLR	10/04 ⇒ 05/09
--------------------	----------	---------------

SKODA

OCTAVIA II 2.0 FSI	BLR, BLX	11/04 ⇒ 10/08
--------------------	----------	---------------

OCTAVIA II 2.0 FSI 4x4	BLX, BVY	11/04 ⇒ 10/08
------------------------	----------	---------------

VW

CARAVELLE 2.0 EcoFuel	AXACNG	01/06 ⇒ 03/14
-----------------------	--------	---------------

EOS 2.0 FSI	BVY, AXW	03/06 ⇒ 05/08
-------------	----------	---------------

GOLF V 2.0 FSI	AXW, BLX	01/04 ⇒ 11/08
----------------	----------	---------------

GOLF V 2.0 FSI 4motion	BLX, BLR	08/04 ⇒ 11/08
------------------------	----------	---------------

JETTA V 2.0 FSI	BLR, BLR	08/05 ⇒ 10/10
-----------------	----------	---------------

MULTIVAN 2.0	AXA	11/03 ⇒ 08/15
--------------	-----	---------------

PASSAT V 2.0 FSI	BLR, BLX	03/05 ⇒ 11/10
------------------	----------	---------------

PASSAT V 2.0 FSI 4motion	BLX, AJH	09/05 ⇒ 11/10
--------------------------	----------	---------------

SHARAN I 1.8 T 20V	AJH, ADY	09/97 ⇒ 03/10
--------------------	----------	---------------

SHARAN I 2.0	ADY, BUN	09/95 ⇒ 03/10
--------------	----------	---------------

SHARAN I 2.0 LPG	ATM	04/06 ⇒ 03/10
------------------	-----	---------------

TOUAREG I 3.0 TDI	BUN, BKS	04/06 ⇒ 05/10
-------------------	----------	---------------

TOUAREG I 3.0 V6 TDI	BKS, AXW	11/04 ⇒ 05/10
----------------------	----------	---------------

TOURAN I 2.0 FSI	AXW, AXACNG	10/03 ⇒ 01/07
------------------	-------------	---------------

TRANSPORTER 2.0 EcoFuel	AXACNG, EW10J4	11/03 ⇒ 08/15
-------------------------	----------------	---------------

TRANSPORTER V 2.0	AXA	11/03 ⇒ 08/15
-------------------	-----	---------------

TRANSPORTER V 2.0 BiFuel	AXACNG	05/11 ⇒ 08/15
--------------------------	--------	---------------

9.0257



3,5

REVOLUTION AND TIMING (CKP AND CMP) SENSORS

Adatt./Suitable:
CHRYSLER
 4609055
 4636494

⁰³ Supplied until depletion
 • Fornibile fino ad esaurimento delle scorte
 • Fourni jusqu'à épuisement du stock
 • Lieferbar solange vorrat reicht
 • Suministrado hasta el stock termina



L	L1	Hall Effect	OUT
182	24,5		

9.0258



3

REVOLUTION AND TIMING (CKP AND CMP) SENSORS

Adatt./Suitable:
BOSCH
 0 986 280 414
CITROËN
 1920 9C
 96 357 329 80
FIAT
 9635732980
LANCIA
 9635732980
PEUGEOT
 1920 9C
 96 357 329 80



L	L1	ohm	OUT GND
---	24	400	

CITROËN

C8 2.0	EW10J4, EW10A	07/02 ⇒
--------	---------------	---------

C8 2.0 16V	EW10A, DW10ATED4	09/05 ⇒
------------	------------------	---------

C8 2.0 HDi	DW10ATED4, 3FZ(EW12J4)	07/02 ⇒
------------	------------------------	---------

C8 2.2	3FZ(EW12J4), 4HW(DW12TED4)	07/02 ⇒
--------	----------------------------	---------

C8 2.2 HDi	4HW(DW12TED4), EW10J4	07/02 ⇒
------------	-----------------------	---------

EVASION 2.0 16V	EW10J4, DW10ATED	05/00 ⇒ 07/02
-----------------	------------------	---------------

EVASION 2.0 HDI	DW10ATED, DW10ATED4	08/99 ⇒ 07/02
-----------------	---------------------	---------------

EVASION 2.0 HDI 16V	DW10ATED4, DW8	09/99 ⇒ 07/02
---------------------	----------------	---------------

JUMPY I 1.9 D 70	DW8, DW8	04/98 ⇒ 10/06
------------------	----------	---------------

JUMPY I 1.9 TD	DW8, EW10J4	11/00 ⇒ 10/06
----------------	-------------	---------------

JUMPY I 2.0	EW10J4, DW10ATED	04/00 ⇒ 12/06
-------------	------------------	---------------

CITROËN			
JUMPY 1.2.0 HDi 110	DW10ATED, DW10ATED4	03/00 ⇨	10/06
JUMPY 1.2.0 HDi 110 16V	DW10ATED4, DW10BTE	12/03 ⇨	10/06
JUMPY 1.2.0 HDi 95	DW10BTE, EW10J4	10/99 ⇨	10/06
JUMPY 1.2.0 i 16V	EW10J4, DW8	03/00 ⇨	10/06
FIAT			
SCUDO 2.0	RFN	09/99 ⇨	10/06
SCUDO 1.1.9 D	DW8, RFN	04/98 ⇨	12/06
SCUDO 1.2.0	RFN, RFN	05/00 ⇨	12/06
SCUDO 1.2.0 16V	RFN, RHX	06/00 ⇨	12/06
SCUDO 1.2.0 JTD	RHX, RHK(DW10UTED4)	12/02 ⇨	12/06
SCUDO 1.2.0 JTD 16V	RHK(DW10UTED4), RFN	05/99 ⇨	12/06
ULYSSE 1.2.0 16V	RFN(EW10J4)	09/00 ⇨	08/02
ULYSSE 1.2.0 JTD	RHZ	10/99 ⇨	08/02
ULYSSE 1.2.0 JTD 16V	RHW(DW10ATED4)	05/99 ⇨	08/02
ULYSSE II 2.0	RFN, RHM	08/02 ⇨	06/11
ULYSSE II 2.0 JTD	RHM, RFN	08/02 ⇨	08/06
ULYSSE II 2.2 JTD	4HW(DW12ATED4)	08/02 ⇨	08/06

LANCIA			
PHEDRA 2.0	RFN, RHM	09/02 ⇨	11/10
PHEDRA 2.0 JTD	RHM, 4HW	09/02 ⇨	11/10
PHEDRA 2.2 JTD	4HW, RHZ	09/02 ⇨	11/10
ZETA 2.0 16V	RFN	07/00 ⇨	09/02
ZETA 2.0 JTD	RHZ, RHW	04/00 ⇨	09/02
ZETA 2.0 JTD 16V	RHW, EW10J4	04/01 ⇨	10/03

PEUGEOT			
806 2.0 16V	EW10J4, DW10ATED	09/00 ⇨	08/02
806 2.0 HDi	DW10ATED, DW10ATED4	08/99 ⇨	08/02
806 2.0 HDi 16V	DW10ATED4, EW10J4	08/99 ⇨	08/02
807 2.0	EW10J4, EW10A	06/02 ⇨	
807 2.0 16V	EW10A, DW10ATED4	09/05 ⇨	
807 2.0 HDi	DW10ATED4, 3FZ(EW12J4)	06/02 ⇨	
807 2.2	3FZ(EW12J4), 4HX(DW12TED4/FAP)	06/02 ⇨	
807 2.2 HDi	4HX(DW12TED4/FAP), DW8	06/02 ⇨	
EXPERT 1.1.9 D	DW8, DW8	06/98 ⇨	12/06
EXPERT 1.1.9 D 70	DW8, EW10J4	12/98 ⇨	12/06
EXPERT 1.2.0	EW10J4, DW10ATED	07/00 ⇨	12/06
EXPERT 1.2.0 HDi	DW10ATED, DW10ATED4	07/00 ⇨	12/06
EXPERT 1.2.0 HDi 16V	DW10ATED4, AMF	07/00 ⇨	12/06

9.0259  **04,5**

REVOLUTION AND TIMING (CKP AND CMP) SENSORS

Adatt./Suitable:

- AUDI**
045 957 147 C
- SEAT**
045 957 147
045 957 147 C
- SKODA**
045 957 147 C
- VW**
045 907 319 A
045 957 147
045 957 147 C

MARKET DIFFUSION: MEDIUM

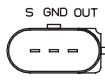

L	L1	ohm	
610	46	490	

AUDI			
A2 1.2 TDI	ANY	03/01 ⇨	08/05
A2 1.4 TDI	AMF, AMF	02/00 ⇨	08/05
SEAT			
AROSA 1.4 TDI	AMF	01/00 ⇨	06/04
CORDOBA II 1.4 TDI	AMF, AMF	10/02 ⇨	11/09
IBIZA III 1.4 TDI	AMF, AMF	05/02 ⇨	11/09
SKODA			
FABIA I 1.4 TDI	AMF, BMS	04/03 ⇨	03/08
FABIA II 1.4 TDI	BMS, BMS	01/07 ⇨	03/10

SKODA			
ROOMSTER 1.4 TDI	BMS, ANY	07/06 ⇨	03/10
VW			
FOX 1.4 TDI	BNM	04/05 ⇨	12/09
Lupo 1.4 TDI	ANY, AMF	07/99 ⇨	07/05
Lupo 1.4 TDI	AMF	01/99 ⇨	07/05
POLO III 1.4 TDI	AMF	10/99 ⇨	09/01
POLO IV 1.4 TDI	AMF, DW10TD	10/01 ⇨	

9.0260  **3**

REVOLUTION AND TIMING (CKP AND CMP) SENSORS

Adatt./Suitable:

- BOSCH**
0 986 280 416
- CITROËN**
1920 7N
96 324 005 80
- FIAT**
9632400580
9634049280
- LANCIA**
9632400580
- PEUGEOT**
1920 7N
96 324 005 80
- SUZUKI**
35466-86CA0-000

MARKET DIFFUSION: HIGH



L	L1	ohm	
---	24	400	

CITROËN			
BERLINGO 1.2.0 HDi 90	DW10TD, 6FZ(EW7J4)	12/99 ⇨	12/11
BERLINGO 1.2.0 HDi 90 4WD	RHY(DW10TD)	11/00 ⇨	10/05
BERLINGO 2.0 HDi	DW10TD	08/99 ⇨	10/05
C5 1.1.8 16V	6FZ(EW7J4), EW10J4	03/01 ⇨	08/04
C5 1.2.0 16V	EW10J4, EW10D	03/01 ⇨	08/04
C5 1.2.0 16V HPI	EW10D, DW10	03/01 ⇨	08/04
C5 1.2.0 HDi	DW10, 4HX(DW12TED4/FAP)	03/01 ⇨	08/04
C5 1.2.2 HDi	4HX(DW12TED4/FAP), EW10J4	03/01 ⇨	08/04
EVASION 2.0 16V	EW10J4, DW10TD	05/00 ⇨	07/02
JUMPER 2.0	XU10J2	02/02 ⇨	06/06
JUMPER 2.0 BiFuel	XU10J2	02/02 ⇨	06/06
JUMPER 1.2.0 HDi	RHV(DW10UTD)	11/01 ⇨	04/02
JUMPER II 2.0	XU10J2	04/02 ⇨	
JUMPER II 2.0 bivalent	XU10J2	02/03 ⇨	
JUMPER II 2.0 HDi	DW10TD, 4HY(DW12UTED)	04/02 ⇨	
JUMPER II 2.2 HDi	4HY(DW12UTED), EW10J4	02/02 ⇨	
JUMPY 1.2.0	EW10J4, EW10J4	04/00 ⇨	12/06
JUMPY 1.2.0 i 16V	EW10J4, EW10J4	03/00 ⇨	10/06
XSARA 2.0 16V	EW10J4, DW10TD	09/00 ⇨	08/05
XSARA 2.0 HDi	DW10TD	09/00 ⇨	03/05
XSARA 2.0 HDi 90	DW10TD, 6FZ(EW7J4)	02/99 ⇨	08/05
XSARA PICASSO 1.8 16V	6FZ(EW7J4), EW10J4	02/00 ⇨	
XSARA PICASSO 2.0 16V	EW10J4, DW10TD	01/03 ⇨	
XSARA PICASSO 2.0 HDi	DW10TD, RFLCNG	12/99 ⇨	

FIAT			
DUCATO II 2.0	RFL	04/02 ⇨	
DUCATO II 2.0 4x4	RFL	05/02 ⇨	07/06
DUCATO II 2.0 Bipower	RFL	11/02 ⇨	
DUCATO II 2.0 JTD	RHV, RFN	07/01 ⇨	
DUCATO 2.0 LPG	RFL	12/01 ⇨	10/04
DUCATO 2.0 Natural Power	RFLCNG, RHV	06/03 ⇨	07/12
SCUDO 2.0	RFN	09/99 ⇨	10/06
SCUDO 1.2.0	RFN, RFN	05/00 ⇨	12/06

FIAT			
SCUDO 1.2.0 16V	RFN, DW10TD	06/00 ⇨	12/06
ULYSSE 1.2.0 16V	RFN(EW10J4)	09/00 ⇨	08/02

LANCIA			
ZETA 2.0 16V	RFN	07/00 ⇨	09/02

PEUGEOT			
206 2.0 16V	RFN(EW10J4)	07/02 ⇨	02/07
206 2.0 HDi	RHY(DW10TD)	07/02 ⇨	
206 2.0 HDi 90	DW10TD, EW10J4	12/99 ⇨	
206 2.0 S16	EW10J4, EW10J4	04/99 ⇨	
307 2.0	RFN(EW10J4)	03/02 ⇨	06/05
307 2.0 16V	EW10J4, DW10TD	08/00 ⇨	04/08
307 2.0 HDi	DW10TD	04/03 ⇨	
307 2.0 HDi 90	DW10TD, 6FZ(EW7J4)	08/00 ⇨	04/08
406 1.8 16V	6FZ(EW7J4), EW10J4	10/00 ⇨	10/04
406 1.8 BiFuel	EW7J4	09/00 ⇨	05/04
406 2.0 16V	EW10J4, EW10D	08/00 ⇨	12/04
406 2.0 16V HPI	EW10D, DW10ATED	05/01 ⇨	10/04
406 2.0 HDi 110	DW10ATED, 3FZ(EW12J4)	08/01 ⇨	10/04
406 2.0 HDi 90	DW10TD	02/99 ⇨	10/04
607 2.2 16V	3FZ(EW12J4), 4HX(DW12TED4/FAP)	02/00 ⇨	08/05
607 2.2 HDi	4HX(DW12TED4/FAP), EW10J4	02/00 ⇨	02/06
806 2.0 16V	EW10J4, RFL(XU10J2U)	09/00 ⇨	08/02
BOXER 2.0 CNG	XU10J2CNG	07/03 ⇨	03/06
BOXER 1.2.0	RFL(XU10J2U), DW10TD	12/01 ⇨	
BOXER 1.2.0 BiFuel	XU10J2	12/01 ⇨	06/06
BOXER 1.2.0 HDi	DW10TD, 4HY(DW12UTED)	08/01 ⇨	
BOXER 1.2.2 HDi	4HY(DW12UTED), EW10J4	04/02 ⇨	
EXPERT 1.2.0	EW10J4, DW10TD	07/00 ⇨	12/06
PARTNER 1.2.0 HDi	DW10TD, HYDB	02/00 ⇨	07/08
RANCH 2.0 HDi	RHY(DW10TD)	02/00 ⇨	
SUZUKI			
VITARA II / III 2.0 HDi	RHP(DW10TD)	12/03 ⇨	12/05
VITARA II / III HDi	RHP(DW10TD)	12/03 ⇨	12/05

9.0263  **3**

REVOLUTION AND TIMING (CKP AND CMP) SENSORS

Adatt./Suitable:

- DENSO**
029600-1211
029600-1212
- FORD**
1 371 654
1 727 897
6M5G-6C315-AA
6M5G-6C315-AB
- VOLVO**
30713485
31331765
862735-5

MARKET DIFFUSION: MEDIUM



L	L1	ohm	
---	30	155	

FORD			
FOCUS II 2.5 RS	JZDA	01/09 ⇨	07/11
FOCUS II 2.5 RS 500	JZDA	05/10 ⇨	07/11
FOCUS II 2.5 ST	HYDA	10/05 ⇨	09/12
GALAXY II 2.5 ST	HUWA	05/06 ⇨	
KUGA 1.2.5	HYDB, HYDB	03/09 ⇨	11/12
KUGA 1.2.5 4x4	HYDB, D5244T13	02/08 ⇨	11/12
MONDEO III 2.5	HUBA	03/07 ⇨	01/15
S-MAX 1.2.5 ST	HUWA	05/06 ⇨	12/14
VOLVO			
C30 2.4 i	B5244S4	10/06 ⇨	12/12
C30 2.5 T5 [ExtraEU]	B525477	03/12 ⇨	12/13

VOLVO		
C30 D3	D5204T5	10/10 ⇒ 12/12
C30 D4	D5204T	10/10 ⇒ 12/12
C30 D5	D5244T13, B5254T3	10/06 ⇒ 12/12
C30 T5	B5254T3, B5234T3	10/06 ⇒ 12/12
C70 I 2.0 T	B5204T4	03/00 ⇒ 10/05
C70 I 2.3 T5	B5234T3, B5244T	07/02 ⇒ 10/05
C70 I 2.3 T-5	B5234T3	03/97 ⇒ 09/02
C70 I 2.4 T	B5244T, D5244T13	03/97 ⇒ 10/05
C70 II 2.4	B5244S5	03/06 ⇒ 10/09
C70 II 2.4 D	D5244T9	03/07 ⇒ 06/13
C70 II 2.4 i	B5244S4	03/06 ⇒ 10/09
C70 II D3	D5204T5	10/10 ⇒ 06/13
C70 II D4	D5204T	10/10 ⇒ 06/13
C70 II D5	D5244T13, B5254T3	03/06 ⇒ 06/13
C70 II T5	B5254T3, B5244S4	03/06 ⇒ 10/09
S40 II 2.4	B5244S4, D5244T13	01/04 ⇒ 12/12
S40 II 2.4 AWD	B5244S4	08/06 ⇒ 12/12
S40 II 2.4 CDI	D5244T9	03/07 ⇒ 12/10
S40 II 2.4 D5	D5244T13, B5254T3	03/06 ⇒ 12/10
S40 II D3	D5204T5	10/10 ⇒ 12/12
S40 II D4	D5204T	10/10 ⇒ 12/12
S40 II T5	B5254T3, B5254T3	01/04 ⇒ 12/12
S40 II T5 AWD	B5254T3, B5244S	04/04 ⇒ 12/10
S60 I 2.0 T	B5204T5	07/00 ⇒ 04/10
S60 I 2.3 T5	B5234T7	07/00 ⇒ 09/02
S60 I 2.4	B5244S, B5244SG	07/00 ⇒ 04/10
S60 I 2.4 AWD	B5244T5	02/04 ⇒ 04/10
S60 I 2.4 Bifuel	B5244SG, D5244T5	07/01 ⇒ 04/10
S60 I 2.4 D	D5244T5, D5204T2	03/05 ⇒ 04/10
S60 I 2.4 D5	D5244T4	03/05 ⇒ 04/10
S60 I 2.4 T	B5244T3	07/00 ⇒ 04/10
S60 I 2.4 T AWD	B5244T3	06/01 ⇒ 04/10
S60 I 2.4 T5	B5244T5	04/04 ⇒ 04/10
S60 I 2.5 AWD	B5254T4	09/03 ⇒ 04/10
S60 I 2.5 T	B5254T2	01/03 ⇒ 04/10
S60 I 2.5 T AWD	B5254T2	07/02 ⇒ 04/10
S60 I R 2.5 T AWD	B5254T4	01/03 ⇒ 04/10
S60 IT5	B5234T3	07/00 ⇒ 04/10
S60 II 2.5 T5	B5254T5	09/11 ⇒
S60 II 2.5 T5 AWD	B5254T5	09/12 ⇒
S60 II D3	D5204T2, D5204T2	04/10 ⇒ 12/14
S60 II D4	D5204T2, B5244S	04/10 ⇒ 12/14
S60 II D5	D5244T10	04/10 ⇒ 12/11
S60 II D5 AWD	D5244T10	04/10 ⇒ 12/11
S80 I 2.0 T	B5204T5	12/99 ⇒ 07/06
S80 I 2.3 R	B5234T7	04/00 ⇒ 08/05
S80 I 2.4	B5244S, B5244SG	01/99 ⇒ 07/06
S80 I 2.4 Bifuel	B5244SG, D5244T14	09/01 ⇒ 07/06
S80 I 2.4 LTP	B5244T4	06/04 ⇒ 07/06
S80 I 2.4 T	B5244T3	06/00 ⇒ 07/06
S80 I 2.4 T5 AWD	B5244T3	04/00 ⇒ 09/03
S80 I 2.5 T	B5254T2	03/03 ⇒ 07/06
S80 I 2.5 T AWD	B5254T2	07/03 ⇒ 07/06
S80 I 3.0	B6294S2	06/01 ⇒ 07/06
S80 I 3.0 T6	B6294T	06/01 ⇒ 07/06
S80 II 2.4 D	D5244T14, B5254T10	03/06 ⇒
S80 II 2.5 T	B5254T10, B5254T11	03/06 ⇒ 12/12
S80 II 2.5 T AWD	B5254T6	10/06 ⇒ 04/09
S80 II 2.5 T FlexFuel	B5254T11, D5204T2	05/08 ⇒ 12/11
S80 II 4.4 V8 AWD	B8444S	03/06 ⇒ 03/12
S80 II D3 / D4	D5204T2, D5244T10	01/10 ⇒
S80 II D5	D5244T10, D5244T10	03/06 ⇒
S80 II D5 AWD	D5244T10, B5244S4	01/07 ⇒
S80L 2.5 T	B5254T6	01/08 ⇒
S80L 2.5 T5	B5254T12	01/12 ⇒
V50 2.4	B5244S4, D5244T13	04/04 ⇒ 12/10
V50 2.4 AWD	B5244S4	08/06 ⇒ 12/09
V50 2.4 D5	D5244T13, B5254T3	03/06 ⇒ 12/10
V50 2.4 Tdi	D5244T9	05/07 ⇒ 12/10
V50 D3	D5204T5	10/10 ⇒ 12/12
V50 D4	D5204T	10/10 ⇒ 12/12
V50 T5	B5254T3, B5254T3	04/04 ⇒ 12/12
V50 T5 AWD	B5254T3, D5204T2	04/04 ⇒ 12/10
V60 I D3 / D4	D5204T2, B5244S	07/10 ⇒ 12/14
V60 I D5	D5244T10	07/10 ⇒ 12/11
V60 I D5 AWD	D5244T10	07/10 ⇒ 12/11
V70 II 2.0 T	B5204T5	11/99 ⇒ 08/07
V70 II 2.3	B5234T7	10/00 ⇒ 09/04
V70 II 2.3 AWD	B5234T7	10/00 ⇒ 09/04
V70 II 2.3 T5	B5234T3	11/99 ⇒ 12/04
V70 II 2.4	B5244S, B5244SG	03/00 ⇒ 08/07
V70 II 2.4 Bifuel	B5244SG, D5244T2	09/01 ⇒ 08/07
V70 II 2.4 CDI	D5244T6	07/05 ⇒ 12/08
V70 II 2.4 D	D5244T2, D5244T	07/01 ⇒ 12/08
V70 II 2.4 D5	D5244T, D5244T4	01/01 ⇒ 12/08
V70 II 2.4 D5 AWD	D5244T4, B5244T3	07/02 ⇒ 08/07
V70 II 2.4 T	B5244T3, D5244T14	01/05 ⇒ 12/05
V70 II 2.4 T AWD	B5244T3	09/01 ⇒ 08/02

VOLVO		
V70 II 2.4 T5	B5244T5	04/04 ⇒ 08/07
V70 II 2.5 AWD	B5254T2	09/02 ⇒ 12/04
V70 II 2.5 R Sport	B5254T4	12/02 ⇒ 08/07
V70 II 2.5 T	B5254T2	07/01 ⇒ 08/07
V70 II 2.5 T AWD	B5254T2	07/02 ⇒ 08/07
V70 II 2.5 TDI	D5252T	11/99 ⇒ 08/07
V70 II R 2.5 T AWD	B5254T4	03/03 ⇒ 08/07
V70 III 2.4 D	D5244T14, B5254T10	04/07 ⇒ 12/10
V70 III 2.5 T	B5254T10, B5254T11	08/07 ⇒ 12/12
V70 III 2.5 T FlexiFuel	B5254T11, D5204T2	05/08 ⇒ 12/11
V70 III D3 / D4	D5204T2, D5244T10	03/10 ⇒ 12/15
V70 III D5	D5244T10, D5244T10	04/07 ⇒ 12/11
V70 III D5 AWD	D5244T10, D5244T16	04/07 ⇒ 12/11
XC60 I 2.4 D	D5244T14	04/09 ⇒ 12/10
XC60 I 2.4 D / D3 / D4 AWD	D5244T16, D5204T2	05/08 ⇒ 02/17
XC60 I 2.4 D AWD	D5244T14	06/09 ⇒ 12/10
XC60 I D3 / D4	D5204T2, D5244T10	03/10 ⇒ 12/14
XC60 I D5 AWD	D5244T10, B5244T	05/08 ⇒ 06/11
XC70 I 2.3 T XC AWD	B5234T7	01/01 ⇒ 07/04
XC70 I 2.4 D5 AWD	D5244T4	12/05 ⇒ 08/07
XC70 I 2.4 T XC AWD	B5244T, D5244T16	03/00 ⇒ 12/06
XC70 I 2.5 T XC AWD	B5254T2	09/02 ⇒ 08/07
XC70 II 2.4 D	D5244T14	06/09 ⇒ 12/10
XC70 II 2.4 D / D4 AWD	D5244T16, D5204T2	08/07 ⇒
XC70 II D3	D5204T2, D5244T10	04/10 ⇒ 12/15
XC70 II D3 AWD	D5204T2	08/11 ⇒
XC70 II D5 AWD	D5244T10, B5254T2	04/07 ⇒ 12/11
XC90 I 2.5 T AWD	B5254T2, D5244T18	10/02 ⇒ 09/14
XC90 I D3 / D5	D5244T5	04/09 ⇒ 12/14
XC90 I D5 AWD	D5244T18, 5S-FE	10/02 ⇒ 12/14
XC90 I T6 AWD	B6294T	10/02 ⇒ 12/06
XC90 I V8 AWD	B8444S	01/05 ⇒ 12/10

9.0264

04

REVOLUTION AND TIMING (CKP AND CMP) SENSORS

Adatt./Suitable:

DENSO

029600-0690

TOYOTA

19300-03010

19300-74010

90080-19010



L	L1	ohm	OUT GND S
---	24	1130	

TOYOTA

AVENSIS I 2.0	3S-FE	09/97 ⇒ 10/00
CAMRY 2.2	5S-FE, 3S-FE	08/96 ⇒
CAMRY SOLARA I 2.2	5S-FE	06/98 ⇒ 11/02
FUNCRUISER 2.0 i 16V 4WD	3SFE	04/94 ⇒
MARK 2.2	5S-FE	01/97 ⇒ 12/02
PICNIC I 2.0	3S-FE	09/96 ⇒ 05/01
RAV 4 I 2.0	3S-FE	06/97 ⇒ 09/99
RAV 4 I 2.0 4WD	3S-FE, 8140.43S	01/94 ⇒ 06/00

9.0265

04,5

REVOLUTION AND TIMING (CKP AND CMP) SENSORS

Adatt./Suitable:

CITROËN

1920 EW

FIAT

46538536

55189519

PEUGEOT

1920 EW



L	L1	ohm	OUT GND S
530	34,5	1350	

CITROËN

JUMPER I 2.8 D	8140.63(F28D)	01/99 ⇒ 02/02
JUMPER I 2.8 HDi	8140.43S, 8140.43	09/00 ⇒ 04/02
JUMPER I 2.8 HDi 4x4	8140.43S	09/00 ⇒ 04/02
JUMPER I 2.8 TD	8140.43	10/99 ⇒ 04/02
JUMPER II 2.8 HDi 4x4	F28DTCR	02/02 ⇒ 06/06

FIAT

DUCATO II 2.8 D	8140.63	02/98 ⇒ 04/02
DUCATO II 2.8 D 4x4	8140.63	08/98 ⇒ 04/02
DUCATO II 2.8 JTD	8140.43, 8140.43S(F28DTCR)	11/00 ⇒ 07/06
DUCATO II 2.8 JTD 4x4	8140.43S	11/00 ⇒ 04/02
DUCATO II 2.8 TD 4x4	8140.63	05/98 ⇒ 11/01

PEUGEOT

BOXER I 2.8 D	8140.63(F28D)	01/99 ⇒ 02/02
BOXER I 2.8 DTiC	8140.43(F28DT)	10/97 ⇒ 09/00
BOXER I 2.8 HDi	8140.43S(F28DTCR), 8140.43S(F28DTCR)	10/00 ⇒
BOXER I 2.8 HDi 4x4	8140.43S(F28DTCR), Y22XE	10/00 ⇒
BOXER I 2.8 HDi Trazione integrale	8140.43S(F28DTCR)	10/00 ⇒ 11/01
BOXER I 2.8 TD	8140.23	10/99 ⇒ 04/02

9.0266

04,5

REVOLUTION AND TIMING (CKP AND CMP) SENSORS

Adatt./Suitable:

GENERAL MOTORS

09 148 306

9 148 306

OPEL

12 38 341



L	L1	ohm	OUT GND S
830	24	550	

OPEL

OMEGA B 2.2 16V | Y22XE, Y22XE | 09/99 ⇒ 07/03

VAUXHALL

OMEGA B 2.2 16V | Y22XE, AEB | 01/94 ⇒ 06/03

9.0267



04,5

REVOLUTION AND TIMING (CKP AND CMP) SENSORS

Adatt./Suitable:

AUDI071 957 147
078 906 433 A**BOSCH**0 261 210 177
0 281 002 222
0 281 002 223**SEAT**071 957 147
078 906 433 A**SKODA**

078 906 433 A

VW071 957 147
078 906 433 A

MARKET DIFFUSION: MEDIUM



L	L1	ohm	S GND OUT
745	24	900	

AUDI

A4 II 1.6	ALZ	11/00 ⇒ 12/04
A4 II 1.8 T	AMB, AMB	11/00 ⇒ 03/09
A4 II 1.8 T quattro	AMB, AYM	11/00 ⇒ 03/09
A4 II 2.0	ALT	11/00 ⇒ 12/05
A4 II 2.5 TDI	AYM, AKE	08/01 ⇒ 12/05
A4 II 2.5 TDI quattro	AKE, AEB	11/00 ⇒ 12/04
A4 I 1.6	ALZ	07/00 ⇒ 09/01
A4 I 1.8 T	AEB, AFB	01/95 ⇒ 09/01
A4 I 1.8 T quattro	AWT	01/95 ⇒ 11/00
A4 I 2.5 TDI	AFB, AFB	09/97 ⇒ 09/01
A4 I 2.5 TDI quattro	AFB, AMB	09/97 ⇒ 09/01
A4 III 1.6	ALZ	11/04 ⇒ 06/08
A4 III 1.8 T	BFB	11/04 ⇒ 06/08
A4 III 1.8 T quattro	BFB	11/04 ⇒ 06/08
A4 III 2.0	ALT	11/04 ⇒ 06/08
A4 III 2.5 TDI	BDG	11/04 ⇒ 05/06
A6 II 1.8 T	AEB, AEB	01/97 ⇒ 01/05
A6 II 1.8 T quattro	AEB, AFB	02/97 ⇒ 01/05
A6 II 2.0	ALT	08/01 ⇒ 01/05
A6 II 2.5 TDI	AFB, AFB	02/00 ⇒ 01/05
A6 II 2.5 TDI quattro	AFB, AJK	02/00 ⇒ 01/05
A6 II 2.7 T	AJK	02/99 ⇒ 01/05
A6 II 2.7 T quattro	AJK, AFB	12/97 ⇒ 01/05
A6 III 2.7 TDI	BPP	11/04 ⇒ 10/08
A8 I 2.5 TDI	AFB, AFB	09/00 ⇒ 09/02
A8 I 2.5 TDI quattro	AFB, ACK	09/00 ⇒ 09/02
A8 I 2.8	ACK, ACK	04/96 ⇒ 09/02
A8 I 2.8 quattro	ACK, AKE	04/96 ⇒ 09/02
ALLROAD 2.5 TDI quattro	AKE, AYM	05/00 ⇒ 08/05

SEAT

EXEO 1.6	ALZ	03/09 ⇒ 09/10
EXEO 1.8 T	CFMA	12/08 ⇒ 05/10
LEON I 2.3 V5	AGZ	10/98 ⇒ 11/00
TOLEDO II 2.3 V5	AGZ	10/98 ⇒ 11/00

SKODA

SUPERB I 1.8 T	AWT	12/01 ⇒ 03/08
SUPERB I 2.5 TDI	AYM, AWL	12/01 ⇒ 03/08

VW

BORA 2.3 V5	AGZ	10/98 ⇒ 10/00
BORA 2.3 V5 4motion	AGZ	12/98 ⇒ 10/00
GOLF IV 2.3 V5	AGZ	08/97 ⇒ 06/06
GOLF IV 2.3 V5 4motion	AGZ	12/98 ⇒ 06/06
PASSAT IV 1.6	ALZ	11/00 ⇒ 05/05
PASSAT IV 1.8 [CHN]	AWL, AWL	06/01 ⇒
PASSAT IV 1.8 T 20V	AWL, AFB	11/00 ⇒ 05/05
PASSAT IV 2.0	ALT	11/01 ⇒ 05/05
PASSAT IV 2.3 V5	AZX	11/00 ⇒ 05/05
PASSAT IV 2.3 V5 4motion	AZX	11/00 ⇒ 05/05
PASSAT IV 2.3 VR5	AZX	11/00 ⇒ 05/05

VW

PASSAT IV 2.3 VR5 4motion	AZX	11/00 ⇒ 05/05
PASSAT IV 2.5 TDI	AFB, AFB	07/98 ⇒ 05/05
PASSAT IV 2.5 TDI 4motion	AFB, AFB	11/00 ⇒ 05/05
PASSAT IV 2.5 TDI Syncro/4motion	AFB, AUA	12/98 ⇒ 11/00
PASSAT IV 2.8 [CHN]	BBG	09/01 ⇒

9.0269



3

REVOLUTION AND TIMING (CKP AND CMP) SENSORS

Adatt./Suitable:

AUDI036 907 601
036 907 601 A
036 907 601 B
036 907 601 C
036 907 601 D
036 907 601 E**BOSCH**

0 986 280 420

SEAT036 907 601
036 907 601 A
036 907 601 B
036 907 601 C
036 907 601 D
036 907 601 E**SKODA**036 907 601
036 907 601 B
036 907 601 C
036 907 601 D
036 907 601 E**VW**036 907 601
036 907 601 A
036 907 601 B
036 907 601 C
036 907 601 D
036 907 601 E

MARKET DIFFUSION: HIGH



L	L1	Hall Effect	- OUT +
---	24		

AUDI

A2 1.4	AUA, BXW	02/00 ⇒ 08/05
--------	----------	---------------

SEAT

ALTEA 1.4 16V	BXW, BXW	05/06 ⇒
ALTEA XL 1.4 16V	BXW, AER	10/06 ⇒
AROSA 1.0	AER, AEX	05/97 ⇒ 06/04
AROSA 1.4	AEX, AFK	05/97 ⇒ 06/04
AROSA 1.4 16V	AFK, APE	01/00 ⇒ 06/04
CORDOBA I 1.4 16V	APE, BBY	06/99 ⇒ 12/02
CORDOBA II 1.4 16V	BBY, APE	09/02 ⇒
IBIZA II 1.4 16V	APE, AUB	08/99 ⇒ 02/02
IBIZA III 1.4 16V	AUB, BXW	02/02 ⇒ 11/09
IBIZA IV 1.4	BXW, AHW	03/08 ⇒
IBIZA IV 1.4 LPG	BXW	03/08 ⇒ 05/11
INCA 1.4 16V	AUA	04/00 ⇒ 06/03
LEON I 1.4 16V	AHW, AUS	11/99 ⇒ 06/06
LEON I 1.6 16V	AUS, BXW	09/00 ⇒ 06/06
LEON II 1.4 16V	BXW, CHYA	06/06 ⇒ 12/12
LEON II 2.0 TFSI	CCZB	06/09 ⇒ 12/12
Mii 1.0	CHYA, AHW	10/11 ⇒
Mii 1.0 EcoFuel	CPGA	11/12 ⇒
TOLEDO II 1.4 16V	AHW, AUS	01/00 ⇒ 05/02
TOLEDO II 1.6 16V	AUS, CHYA	06/00 ⇒ 05/06
TOLEDO III 1.4 16V	BXW	05/06 ⇒ 05/09

SKODA

CITIGO 1.0	CHYA, AUA	10/11 ⇒
CITIGO 1.0 CNG	CPGA	11/12 ⇒
FABIA I 1.4	BKY	05/04 ⇒ 12/07
FABIA I 1.4 16V	AUA, BXW	12/99 ⇒ 03/08
FABIA II 1.4	BXW, BXW	01/07 ⇒ 12/14
FABIA II 1.4 LPG	BXW, AXP	01/07 ⇒ 11/14

SKODA

OCTAVIA I 1.4 16V	AXP, BCA	08/00 ⇒ 12/10
OCTAVIA II 1.4	BCA, AHW	05/04 ⇒ 06/13
ROOMSTER 1.4 LPG	CGGB	03/10 ⇒ 05/15

VOLKSWAGEN (BR)

POLO 1.0	ARA	07/02 ⇒ 01/04
POLO 1.4	BKY	07/06 ⇒

VW

BORA 1.4 16V	AHW, ATN	03/00 ⇒ 05/05
BORA 1.6 16V	ATN, BCA	02/00 ⇒ 05/05
CADDY II 1.4	AUA	08/00 ⇒ 01/04
CADDY III 1.4 16V	AUA	08/00 ⇒ 01/04
CADDY III 1.4	BCA, AXP	03/04 ⇒ 08/10
GOLF IV 1.4	AXP, AHW	05/00 ⇒ 06/06
GOLF IV 1.4 16V	AHW, AUS	08/97 ⇒ 06/06
GOLF IV 1.6	AUS, ATN	05/00 ⇒ 06/06
GOLF IV 1.6 16V	ATN, BCA	02/00 ⇒ 06/06
GOLF V 1.4	BUD	06/07 ⇒ 07/09
GOLF V 1.4 16V	BCA, BUD	10/03 ⇒ 12/13
GOLF VI 1.4	BUD, BUD	07/09 ⇒
GOLF VI 1.4 16V	BUD, AFK	01/09 ⇒ 05/11
LUPU 1.4 16V	AFK, AFH	09/98 ⇒ 07/05
NEW BEETLE 1.4	BCA	11/01 ⇒ 09/10
POLO III 1.4	AUA	06/00 ⇒ 09/01
POLO III 1.4 16V	AFH, AFH	10/99 ⇒ 09/01
POLO III 100 1.4 16V	AFH, APE	04/96 ⇒ 10/99
POLO III 120 1.6 16V GTI	AJV	09/98 ⇒ 10/99
POLO III 75 1.4 16V	APE, BBY	10/99 ⇒ 09/01
POLO IV 1.0	ARA	02/03 ⇒ 10/03
POLO IV 1.4	BBY, AUA	11/02 ⇒
POLO IV 1.4 16V	AUA, CGGB	10/01 ⇒ 11/09
POLO IV 1.4 BiFuel	BUD	05/06 ⇒ 11/09
POLO V 1.4	CGGB, BAC	03/09 ⇒ 05/14
TOUAREG I 2.5 R5 TDI	BAC, --	01/03 ⇒ 05/10
TOUAREG I 3.0 V6 TDI	BKS	11/04 ⇒ 05/10
UP 1.0	--, A16DMS	08/11 ⇒
UP 1.0 EcoFuel	CPGA	11/12 ⇒

9.0270



04,5

REVOLUTION AND TIMING (CKP AND CMP) SENSORS

Adatt./Suitable:

BOSCH

F 000 99R 010

FIAT

46445731



L	L1	ohm	OUT GND S
390	20,7	700	

FIAT

PALIO 1.0	178A1.000	04/96 ⇒ 10/03
-----------	-----------	---------------

FIAT (BR)

PALIO 1.0i	1.0Mpi	01/96 ⇒
PALIO 1.5i	1.5Mpi	01/96 ⇒ 12/00
SIENA 1.0i	1.0Mpi	01/99 ⇒ 12/00
SIENA 1.5i	1.5Mpi	01/99 ⇒ 12/00
STRADA 1.5i	1.5Mpi	01/99 ⇒ 12/01
UNO 1.5i Furgoneta	1.5Mpi	01/97 ⇒
UNO MILLE 1.0i	1.0Mpi	01/99 ⇒

9.0271



04,5

REVOLUTION AND TIMING (CKP AND CMP) SENSORS

Adatt./Suitable:

CHEVROLET25182450
96253542
96434780**DAEWOO**25182450
96253542
96434780**GENERAL MOTORS**25 182 450
96 434 780

L	L1	ohm	OUT GND S
425	38	550	

CHEVROLET

AVEO I 1.4	L14	03/05 ⇨ 12/07
AVEO I 1.4 CNG	L95	01/10 ⇨
AVEO I 1.5	F1553	05/05 ⇨
AVEO I 1.6	A16DMS, F16D3	09/03 ⇨
LACETTI 1.4	F14D3	03/05 ⇨
NUBIRA 1.6	LXT	01/10 ⇨
OPTRA 1.4 16V	F14D3	03/05 ⇨
OPTRA 1.6	F16D3, F14D3	08/03 ⇨ 12/08
OPTRA 1.6 SRV	F16D3	06/06 ⇨
OPTRA 1.8	F18D3	08/05 ⇨
TACUMA 1.6	A16DMS	02/05 ⇨
VIVANT 1.6	A16DMS	08/01 ⇨
VIVANT 1.8	F1852	05/00 ⇨

DAEWOO

KALOS 1.4	F14D3, F14D3	09/02 ⇨
KALOS 1.4 16V	F14D3	04/03 ⇨
KALOS 1.5	F1553	11/02 ⇨ 12/04
KALOS 1.6	F1654	02/03 ⇨
LACETTI 1.4	F14D3, A16DMS	06/02 ⇨
LACETTI 1.6	A16DMS	06/99 ⇨
LACETTI 1.8	T18SED	02/04 ⇨
NUBIRA I 1.6	A16DMS	08/02 ⇨ 07/03
NUBIRA I 1.6 [ExtraEU]	A16DMS	08/02 ⇨ 07/03
NUBIRA I 1.6 16V	A16DMS	06/99 ⇨
NUBIRA II 1.4	F14D3	10/03 ⇨ 12/04
NUBIRA II 1.6	F16D3	07/03 ⇨
REZZO 1.6	A16DMS, A16SMS	09/00 ⇨
REZZO 1.6 SX	A16SMS, --	08/01 ⇨ 12/04
REZZO 1.8	--, A135M	09/00 ⇨
TACUMA 1.6	A16DMS	09/00 ⇨ 01/05
TACUMA 1.8	F1852	09/00 ⇨

9.0272



04,5

REVOLUTION AND TIMING (CKP AND CMP) SENSORS

Adatt./Suitable:

CHEVROLET

96183235

DAEWOO

96183235



L	L1	ohm	OUT GND S
300	24	550	

CHEVROLET

LANOS 1.3	--	01/97 ⇨
LANOS 1.5	A15SMS	11/05 ⇨
LANOS 1.6 16V	A16DMS	11/05 ⇨

DAEWOO

ASSOL 1.3	C14L	04/97 ⇨ 06/99
ASSOL 1.5	Y15L	04/97 ⇨ 06/99
ASSOL 1.6	616L	02/98 ⇨ 06/99
LANOS 1.3	A13SM, A15DMS	05/97 ⇨
LANOS 1.5	A15DMS, 616L	05/97 ⇨
LANOS 1.6	A16DMS	10/97 ⇨ 12/02
LANOS 1.6 16V	616L, 616L	02/97 ⇨
NUBIRA I 1.6	A16DMS	08/02 ⇨ 07/03
NUBIRA I 1.6 16V	616L, YD22DDT	05/97 ⇨
ORION 1.6	616L	04/99 ⇨ 08/00

9.0273



04,5

REVOLUTION AND TIMING (CKP AND CMP) SENSORS

Adatt./Suitable:

VW

021 907 319 B



L	L1	ohm	OUT GND S
570	24	550	

VW

GOLF III 1.6	AEK	07/94 ⇨ 04/99
PASSAT III 1.6	AEK	07/94 ⇨ 08/96

9.0274



04,5

REVOLUTION AND TIMING (CKP AND CMP) SENSORS

Adatt./Suitable:

GENERAL MOTORS90 357 481
90 508 499**HOLDEN**

90357481

OPEL62 38 433
90508499**SIEMENS**

A2C59511640

VAUXHALL

90508499



L	L1	ohm	OUT GND S
795	38	550	

HOLDEN

CALIBRA_YE 2.5i 24v C25XE 08/95 ⇨ 10/97

OPEL

VECTRA B 2.5 X25XE 10/99 ⇨ 06/00

VECTRA B 2.5 i V6 X25XE 10/95 ⇨ 09/00

VECTRA B i 500 2.5 X25XE 05/98 ⇨ 09/00

VAUXHALL

VECTRA B 2.5 i GSi X25XE 03/98 ⇨ 07/00

VECTRA B 2.5 i V6 X25XE 09/95 ⇨ 08/00

9.0276



3

REVOLUTION AND TIMING (CKP AND CMP) SENSORS

Adatt./Suitable:

HITACHI

RS-329

NISSAN23731-AA010
23731-AD200

L	L1	ohm	OUT GND S
---	34	680	

NISSAN

ALMERA II 2.2 dCi YD22DDT, YD22DDT 09/03 ⇨ 09/06

ALMERA II 2.2 Di YD22DDT 03/00 ⇨ 04/03

ALMERA TINO 2.2 dCi YD22DDT, TB48DE 08/00 ⇨

PATROL GR II 4.8 TB48DE, G4GR 03/00 ⇨

9.0277



3,5

REVOLUTION AND TIMING (CKP AND CMP) SENSORS

Adatt./Suitable:

HYUNDAI
39350-23010

L	L1		
140	28	Hall Effect	

HYUNDAI

COUPE 2.0	G4DF	04/96 ⇒ 08/99
COUPE I 1.6 16V	G4GR	03/98 ⇒ 04/02
COUPE I 1.6 i 16V	G4GR, G4DF	08/00 ⇒ 04/02
COUPE I 2.0	G4DF	08/99 ⇒ 01/02
COUPE I 2.0 16V	G4DF, G4EA	03/01 ⇒ 04/02
COUPE I F2 Evolution	G4GF	01/99 ⇒ 12/01
ELANTRA 1.6	G4GR	08/95 ⇒ 02/98
ELANTRA II 1.6 i 16V	G4GR	06/95 ⇒ 05/00
ELANTRA II 1.8 i 16V	G4GM	05/95 ⇒ 05/00
LANTRA II 1.6 16V	G4GR	11/95 ⇒ 10/00
LANTRA II 1.6 i	G4GR	11/95 ⇒ 10/00
LANTRA II 1.8 16V	G4GM	11/95 ⇒ 10/00
TIBURON 2.0 i 16V	G4DF	08/99 ⇒

9.0278



3,5

REVOLUTION AND TIMING (CKP AND CMP) SENSORS

Adatt./Suitable:

HYUNDAI
39350-22040

L	L1		
190	28	Hall Effect	

HYUNDAI

ACCENT I 1.3	G4EH	10/94 ⇒ 01/00
ACCENT I 1.3 i 12V	G4EH	10/94 ⇒ 01/00
ACCENT I 1.5	G4EK	10/94 ⇒ 07/99
ACCENT I 1.5 i 12V	G4EK	10/94 ⇒ 01/00
ACCENT I 1.5 i 16V	G4ER	10/95 ⇒ 01/00
ACCENT II 1.5	G4EC-G	09/99 ⇒ 11/05
EXCEL 1.3 i 12V	G4EH	09/94 ⇒ 08/99
EXCEL 1.5 i 12V	G4EK	09/94 ⇒ 08/99
EXCEL 1.5 i 16V GT	G4ER	10/96 ⇒ 08/99
LANTRA II 1.5 12V	G4EK	12/96 ⇒ 10/00
S COUPE 1.5 i	G4EK	04/92 ⇒ 05/96
S COUPE 1.5 i Turbo	G4EK-TC	04/91 ⇒ 05/96
VERNA I 1.5	G4EC-G	09/99 ⇒

9.0279



04,5

REVOLUTION AND TIMING (CKP AND CMP) SENSORS

Adatt./Suitable:

HYUNDAI
39180-22600
39180-26900

KIA
39180-22600
39180-26900

MARKET DIFFUSION: MEDIUM



L	L1	ohm	
240	24	900	

HYUNDAI

ACCENT II 1.3	G4EA, G4EB	01/00 ⇒ 11/05
ACCENT II 1.5	G4EB, G4ED	01/00 ⇒ 12/06
ACCENT II 1.6	G4ED, 4G61	12/02 ⇒ 11/05
ACCENT III 1.4 GL	G4EE	11/05 ⇒ 11/10
ACCENT III 1.6 GLS	G4ED	11/05 ⇒ 11/10
COUPE I 1.6 16V	G4GR	03/98 ⇒ 04/02
COUPE I 1.6 i 16V	4G61, G4ED	12/96 ⇒ 04/02
COUPE II 1.6 16V	G4ED, G4ED	03/02 ⇒ 08/09
ELANTRA 1.6 [ExtraEU]	G4GA	08/03 ⇒ 05/06
ELANTRA III 1.6	G4ED, G4EA	06/00 ⇒ 07/06
GETZ 1.3	G4EA, G4ED	09/03 ⇒ 06/09
GETZ 1.3 i	G4EA	09/02 ⇒ 03/04
GETZ 1.4 i	G4EE	08/05 ⇒ 12/10
GETZ 1.6	G4ED, G4ED	09/02 ⇒ 12/06
MATRIX 1.6	G4ED, G4EB	06/01 ⇒ 08/10
MATRIX 1.6 [TUR]	G4ED	04/08 ⇒
VERNA I 1.3	G4EA	09/99 ⇒
VERNA I 1.5	G4EB, JP25LCBD	09/99 ⇒
VERNA I 1.6	G4ED-G	12/02 ⇒
VERNA II 1.4 GL	--	11/05 ⇒
VERNA II 1.6 GLS	--	11/05 ⇒

KIA

CERATO I 1.6	G4ED	04/04 ⇒
RIO II 1.4	G4EE	01/10 ⇒ 12/11
RIO II 1.4 16V	G4EE	03/05 ⇒
RIO II 1.6 16V	G4ED	03/05 ⇒
RIO II 1.6 CVT	G4ED	03/05 ⇒

9.0280



3

REVOLUTION AND TIMING (CKP AND CMP) SENSORS

Adatt./Suitable:

FORD
157E-6C315-BA
4 096 750
4 541 091
4 621 599
5L8E-6C315-AB
7 103 314
F43E-6C315-AC

MAZDA
GY01-18-221
GY07-18-221
GY07-18-221A
GY07-18-221B

L	L1	ohm	
---	37,4	430	

FORD

COUGAR 2.5 ST 200	SGA	01/00 ⇒ 12/01
COUGAR 2.5 ST 200 24V	MABB	08/98 ⇒
COUGAR 2.5 V6 24V	JP25LCBD, --	06/00 ⇒ 12/01
MAVERICK 3.0 V6 24V	--, SEA	02/01 ⇒
MAVERICK 3.0 V6 24V FWD	AJ	02/01 ⇒
MONDEO I 2.5 24V	SEA, MP30MHBA	08/96 ⇒ 09/00
MONDEO I 2.5 i 24V	SEA	07/94 ⇒ 08/96
MONDEO I 2.5 ST 200	SGA	05/99 ⇒ 09/00
MONDEO II 2.5 V6	LCBD	10/00 ⇒ 03/07
MONDEO II 2.5 V6 24V	LCBD	10/00 ⇒ 03/07
MONDEO II 3.0 V6 24V	MP30MHBA, AJ	09/04 ⇒ 03/07
MONDEO II ST220	MEBA	04/02 ⇒ 03/07

MAZDA

MPV II 3.0 i V6	AJ	01/02 ⇒ 12/06
TRIBUTE 3.0 V6 24V 4WD	AJ03	03/00 ⇒ 05/08
TRIBUTE 3.0 V6 AWD	AJ, QQDA	04/04 ⇒ 05/08
TRIBUTE 3.0i [USA]	1	05/00 ⇒
TRIBUTE 3.0i 4x4 [USA]	1	05/00 ⇒

9.0281



3,5

REVOLUTION AND TIMING (CKP AND CMP) SENSORS

Adatt./Suitable:

FORD1 119 942
1S7F-12K073-AD**MAZDA**

LF01-18-230

VOLVO

30658182

MARKET DIFFUSION: MEDIUM



L	L1	ohm	GND OUT
---	33,7	550	

FORD

C-MAX I 1.8	QQDA, AODA	02/07 ⇒ 09/10
C-MAX I 1.8 Flexifuel	Q7DA	02/07 ⇒ 09/10
C-MAX I 2.0	AODA, SYDA	02/07 ⇒ 09/10
C-MAX I 2.0 CNG	SYDA, CSDA	04/09 ⇒ 09/10
C-MAX I 2.0 LPG	SYDA	06/08 ⇒ 09/10
FIESTA V ST150	N4JB	03/05 ⇒ 06/08
FOCUS II 1.8	Q7DA, --	03/06 ⇒ 09/12
FOCUS II 1.8 Flexifuel	--, AODA	12/05 ⇒ 09/12
FOCUS II 2.0	AODA, SYDA	07/04 ⇒ 09/12
FOCUS II 2.0 CNG	SYDA, Q7DA	04/09 ⇒ 07/11
FOCUS II 2.0 Flex	SYDA	10/08 ⇒ 03/10
FOCUS II 2.0 LPG	SYDA	06/08 ⇒ 07/11
FOCUS II CASSONE / FURGONATO / PROMISCUO 1.8 Flexifuel	Q7DA, AOWA	06/09 ⇒ 07/11
FOCUS C-MAX 1.8	CSDA, AODA	10/03 ⇒ 03/07
FOCUS C-MAX 1.8 Flexifuel	Q7DA	01/06 ⇒ 03/07
FOCUS C-MAX 2.0	AODA, Q7DA	03/04 ⇒ 03/07
FUSION 2.0	--	11/04 ⇒
GALAXY II 2.0	AOWA, TBWA	05/06 ⇒ 06/15
GALAXY II 2.0 Flexifuel	TBWA, CGBA	05/06 ⇒ 06/15
MAVERICK 2.3	--	05/06 ⇒
MONDEO II 1.8 16V	CGBA, CJBA	10/00 ⇒ 03/07
MONDEO II 2.0 16V	CJBA, Aoba	10/00 ⇒ 03/07
MONDEO III 2.0	Aoba, TBBA	03/07 ⇒ 01/15
MONDEO III 2.0 Flexifuel	TBBA, AODA	03/09 ⇒ 01/15
MONDEO III 2.0 LPG	TBBA	07/09 ⇒ 01/15
MONDEO 2.0	AoBC	03/07 ⇒ 09/14
S-MAX I 2.0	AODA, TBWA	05/06 ⇒ 12/14
S-MAX I 2.0 EcoBoost	TNWA	03/10 ⇒ 12/14
S-MAX I 2.0 Flexifuel	TBWA, GZFCNG	05/06 ⇒ 12/14
TRANSIT III 2.3 16V CNG RWD	GZFCACNG, LF17	04/06 ⇒ 08/14
TRANSIT III 2.3 16V LPG RWD	GZFC	04/06 ⇒ 08/14

MAZDA

3 I 2.0	LF17, LFD7	09/03 ⇒ 12/09
5 I 1.8	L823	02/05 ⇒ 05/10
5 I 2.0	LF07, L823	02/05 ⇒ 05/10
5 I 2.0 CD	RF7J	02/05 ⇒ 05/10
6 I 1.8	L823, L3	08/02 ⇒ 08/07
6 I 2.3 AWD	L3C1	11/02 ⇒ 08/07
MPV II 2.3	L3, 178B5.000	07/02 ⇒ 02/06
TRIBUTE 2.3 AWD	L3-VE	04/04 ⇒ 05/08
TRIBUTE 2.3 GX	L3-VE	12/03 ⇒ 10/04

VOLVO

C30 1.8	B4184511	10/06 ⇒ 12/12
C30 1.8 FlexFuel	B418458	01/07 ⇒ 12/12
C30 2.0	B420453	10/06 ⇒ 12/12
C30 2.0 FlexFuel	B420454	01/10 ⇒ 12/12
S40 II 1.8	B4184511	04/04 ⇒ 12/10
S40 II 1.8 FlexFuel	B418458	01/06 ⇒ 12/10
S40 II 2.0	B420453	10/06 ⇒ 12/12
S40 II 2.0 F	B420454	10/09 ⇒ 12/12

VOLVO

S80 II 2.0	B420453	01/08 ⇒ 09/12
S80 II 2.0 FlexFuel	B420454	01/08 ⇒ 12/11
V50 1.8	B4184511	04/04 ⇒ 12/10
V50 1.8 BiFuel	B418458	01/09 ⇒ 09/10
V50 1.8 FlexFuel	B418458	01/05 ⇒ 12/10
V50 2.0	B420453	10/06 ⇒ 12/12
V50 2.0 FlexFuel	B420454	01/10 ⇒ 12/12
V70 III 2.0	B420453	10/07 ⇒ 12/11
V70 III 2.0 FlexFuel	B420454	01/08 ⇒ 12/11

9.0282



04,5

REVOLUTION AND TIMING (CKP AND CMP) SENSORS

Adatt./Suitable:

BOSCH

0 261 210 132

GENERAL MOTORS

91 153 782

SAAB

43 00 737

91 153 782

SCANIA

4300737

03 Supplied until depletion

- Formibile fino ad esaurimento delle scorte
- Fourni jusqu'à épuisement du stock
- Lieferbar solange vorrat reicht
- Suministrado hasta el stock termina



L	L1	ohm	S GND OUT
710	38	900	

SAAB

900 II 2.5 -24 V6	B258I	07/93 ⇒ 02/98
9000 3.0 -24 V6 CD/CDE	B308I	07/94 ⇒ 12/98
9000 3.0 -24 V6 CS/CSE	B308I	07/94 ⇒ 12/98

9.0283



04,5

REVOLUTION AND TIMING (CKP AND CMP) SENSORS

Adatt./Suitable:

BOSCH

0 261 210 169

GENERAL MOTORS

9 195 885

SAAB

91 85 232

91 95 885



L	L1	ohm	S GND OUT
710	38	900	

SAAB

9-5 3.0 V6t	B308E	01/98 ⇒ 12/09
-------------	-------	---------------

9.0284



04,5

REVOLUTION AND TIMING (CKP AND CMP) SENSORS

Adatt./Suitable:

BOSCH

0 261 210 131

GENERAL MOTORS

90 540 743

OPEL

12 38 740



L	L1	ohm	S GND OUT
700	38	900	

OPEL

OMEGA B 2.6	--	05/94 ⇒ 05/99
OMEGA B 2.6 V6	Y26SE	09/00 ⇒ 07/03
OMEGA B 3.0 V6	X30XE	04/94 ⇒ 02/01
OMEGA B 3.2 V6	Y32SE	02/01 ⇒ 07/03

VAUXHALL

OMEGA B 2.6 V6	Y26SE	08/00 ⇒ 07/03
OMEGA B 3.0 V6	X30XE	04/94 ⇒ 07/00
OMEGA B 3.2 V6	Y32SE	02/01 ⇒ 07/03

9.0285



04,5

REVOLUTION AND TIMING (CKP AND CMP) SENSORS

Adatt./Suitable:

FIAT

46802751

55189518

LANCIA

46802751

MAGNETI MARELLI

11104021108

11140211108

CWM02/8



L	L1	ohm	OUT GND S
625	34,5	1350	

FIAT

DOBLO I 1.2	223A5.000	03/01 ⇒
PALIO 1.2	178B5.000, 178B5.000	04/96 ⇒ 10/04
PALIO 1.2 75	178B7.045	03/98 ⇒
PALIO 1.2 MPI	178C4.066	01/02 ⇒
SIENA 1.2	178B5.000, 188A4.000	01/98 ⇒

LANCIA

Y 1.2	188A4.000, BDB	03/96 ⇒ 09/03
-------	----------------	---------------

9.0286



04

REVOLUTION AND TIMING (CKP AND CMP) SENSORS

Adatt./Suitable:

BOSCH

0 232 103 025

GENERAL MOTORS

9 118 140

OPEL

62 38 111

91 18 140

VAUXHALL

9118140



L	L1		
245	14	Hall Effect	

OPEL

OMEGA B 2.6	--	05/94 ⇒ 05/99
OMEGA B 2.6 V6	Y26SE	09/00 ⇒ 07/03
OMEGA B 3.2 V6	Y32SE	02/01 ⇒ 07/03
SIGNUM 3.2 V6	Z32SE	05/03 ⇒ 07/05
VECTRA B 2.6 i V6	Y26SE	09/00 ⇒ 07/03
VECTRA C 3.2 V6	Z32SE	08/02 ⇒ 07/06

VAUXHALL

OMEGA B 2.6 V6	Y26SE	08/00 ⇒ 07/03
OMEGA B 3.2 V6	Y32SE	02/01 ⇒ 07/03
SIGNUM 3.2 V6	Z32SE	05/03 ⇒ 05/08
VECTRA B 2.6 i V6	Y26SE	09/00 ⇒ 07/03
VECTRA C 3.2 V6	Z32SE	08/02 ⇒ 07/08

9.0287



04,5

REVOLUTION AND TIMING (CKP AND CMP) SENSORS

Adatt./Suitable:

AUDI

022 957 147

FORD

1 120 193

YM21-12A545-AA

SEAT

022 957 147

SKODA

022 957 147

VW

022 957 147



L	L1	ohm	
345	24	900	

AUDI

A3 I [USA] 3.2 24V	CBRA	07/08 ⇒ 05/09
A3 I [USA] 3.2 24V AWD	--	01/06 ⇒ 12/09
A3 II 3.2 V6 quattro	BDB, BDB	07/03 ⇒ 05/09
A3 II SPORTBACK 3.2 V6 quattro	BDB, BHE	09/04 ⇒ 05/09
TT I 3.2 VR6 quattro	BHE, AAA	07/03 ⇒ 06/06
TT II 3.2 V6 quattro	BUB	08/06 ⇒ 06/10

FORD			
GALAXY I 2.8 i V6	AAA, AUE	11/95 ⇒ 04/00	
GALAXY I 2.8 V6	AYL	04/00 ⇒ 05/06	
SEAT			
ALHAMBRA I / II 2.8 V6	AUE, AUE	06/00 ⇒ 03/10	
ALHAMBRA I / II 2.8 V6 4motion	AUE, AUE	06/00 ⇒ 03/10	
LEON I 2.3 VR5	AQN	09/00 ⇒ 11/03	
LEON I 2.8	BDE	05/02 ⇒ 06/04	
LEON I 2.8 Cupra 4	AUE, --	02/01 ⇒ 06/06	
TOLEDO II 2.3 V5 20V	AQN	09/00 ⇒ 11/03	
SKODA			
SUPERB II 3.6 FSI 4x4	--, AQP	11/08 ⇒ 05/15	
SUPERB II 3.6 V6 4x4	CDVA	10/09 ⇒ 05/15	
VW			
BORA 2.3 V5	AQN	10/00 ⇒ 05/05	
BORA 2.3 V5 4motion	AQN	10/00 ⇒ 05/05	
BORA 2.8 V6 4motion	AQP, BUB	03/99 ⇒ 05/05	
BORA 2.8 VR6	AUE	03/00 ⇒ 05/00	
CC 3.6 FSI 4motion	BWS	11/11 ⇒ 12/16	
EOS 3.2 V6	BUB, AQP	06/06 ⇒ 05/09	
EOS 3.6 V6	CDVA	05/09 ⇒ 11/10	
GOLF IV 2.3 V5	AQN	10/00 ⇒ 06/06	
GOLF IV 2.3 V5 4motion	AQN	10/00 ⇒ 06/06	
GOLF IV 2.8 V6 4motion	AQP, AQP	05/99 ⇒ 06/06	
GOLF IV 2.8 VR6 4motion	AQP, BUB	03/99 ⇒ 06/05	
GOLF V 3.2	BUB, BUB	09/05 ⇒ 11/08	
GOLF V 3.2 R32 4motion	BUB, BLV	11/05 ⇒ 11/08	
NEW BEETLE 2.3 V5	AQN	10/00 ⇒ 09/10	
PASSAT V 3.2 FSI 4motion	AXZ	11/05 ⇒ 11/10	
PASSAT V 3.6 FSI	BLV	06/05 ⇒ 11/10	
PASSAT V 3.6 FSI 4motion	BLV	09/05 ⇒ 11/10	
PASSAT V 3.6 R36 4motion	BWS	04/07 ⇒ 11/10	
PASSAT CC 3.6 FSI	BLV, BLV	06/08 ⇒	
PASSAT CC 3.6 FSI 4motion	BLV, X14XE	02/08 ⇒ 01/12	
SHARAN I 2.8 V6 24V	AYL	04/00 ⇒ 03/10	
SHARAN I 2.8 V6 24V 4motion	AYL	04/00 ⇒ 03/10	

9.0288



3

REVOLUTION AND TIMING (CKP AND CMP) SENSORS

Adatt./Suitable:

FIAT

71739726

GENERAL MOTORS

10 456 604

OPEL

10456604

12 38 938

VAUXHALL

10456604

MARKET DIFFUSION: MEDIUM



L	L1	ohm	
---	39,3	2700	

FIAT

STILO 1.6	192B3.000	04/05 ⇒ 08/08
STILO 1.6 16V	192B3.000	03/05 ⇒ 12/07

OPEL

ASTRA G 1.4	X14XE, X14XE	09/98 ⇒ 04/05
ASTRA G 1.4 16V	X14XE, C16SEL	02/98 ⇒ 01/05
ASTRA G 1.6	C16SEL, X16XEL	09/00 ⇒ 12/09
ASTRA G 1.6 16V	X16XEL, X16XEL	02/98 ⇒ 10/05
ASTRA G 1.6 CNG	Z16YNG	03/03 ⇒ 07/04
ASTRA G 1.6 LPG	X16XEL, Z16XE	06/02 ⇒ 06/07
ASTRA H 1.4 16V	Z14XE	05/04 ⇒ 07/09

OPEL			
ASTRA H 1.6	Z16XE, Y16YNG	03/04 ⇒ 10/10	
ASTRA H 1.6 16V	Z16XE	03/04 ⇒ 01/08	
ASTRA H 1.6 EcoTec	Z16XEP	02/04 ⇒ 11/04	
COMBO C 1.6	Z16SE	10/01 ⇒	
COMBO C 1.6 CNG	Y16YNG, Y16YNG	04/05 ⇒ 12/11	
COMBO C 1.6 CNG 16V	Y16YNG, Z16SE	04/05 ⇒	
CORSA C 1.4	Z14XE	07/00 ⇒	
CORSA C 1.6	Z16SE	09/00 ⇒	
CORSA C 1.6 CNG	Y16YNG	05/03 ⇒ 12/09	
CORSA C 1.6 X	Z16YNG	08/05 ⇒	
MERIVA A 1.6	Z16SE, X16XEL	05/03 ⇒ 05/10	
MERIVA A 1.6 16V	Z16XE	05/03 ⇒ 01/06	
VECTRA B 1.6 i 16V	X16XEL, Z16XE	10/95 ⇒ 07/02	
VECTRA C 1.6	Z16XE, X16XEL	08/05 ⇒ 08/08	
VECTRA C 1.6 16V	Z16XE	06/04 ⇒ 09/08	
ZAFIRA A 1.6	Z16XEP	10/03 ⇒ 06/05	
ZAFIRA A 1.6 16V	X16XEL, Z16XE1	09/02 ⇒ 06/05	
ZAFIRA A 1.6 CNG	Z16YNG	09/01 ⇒ 06/05	
ZAFIRA A 1.6 LPG	Z16XEP	10/03 ⇒ 06/05	
ZAFIRA B 1.6	Z16XE1, X14XE	07/05 ⇒ 09/12	
ZAFIRA B 1.6 CNG	Z16YNG	07/05 ⇒ 04/15	

VAUXHALL

ASTRA IV 1.4 16V	X14XE, Z16SE	02/98 ⇒ 05/05
ASTRA IV 1.6	Z16SE, X16XEL	09/00 ⇒ 05/05
ASTRA IV 1.6 16V	X16XEL, X16XEL	02/98 ⇒ 10/05
ASTRA IV 1.6 Dualfuel	X16XEL, Z16XE1	07/00 ⇒ 05/05
ASTRA V 1.6	Z16XE1, Z16SE	01/04 ⇒ 11/10
ASTRAVAN II 1.4 16V	Z14XE	09/00 ⇒ 05/05
ASTRAVAN II 1.6 Dualfuel	Z16SE, Z16XE1	07/00 ⇒ 08/05
ASTRAVAN II 1.6 Dualfuel 16V	Z16XEP	10/04 ⇒ 12/05
ASTRAVAN II 1.6 i	Z16SE	09/00 ⇒ 08/06
ASTRAVAN III 1.6	Z16XE1, Z16SE	03/05 ⇒
COMBO C 1.4 16V	Z14XE	10/01 ⇒ 05/07
COMBO C 1.6	Z16SE, Z16YNG	09/01 ⇒ 11/11
COMBO C 1.6 CNG	Z16YNG, Y16YNG	04/05 ⇒ 02/12
COMBO C 1.6 CNG 16V	Y16YNG, X16XEL	04/05 ⇒ 02/12
CORSA C 1.4 16V	Z14XE	09/00 ⇒ 10/06
MERIVA I 1.6 i	Z16SE	01/03 ⇒ 06/10
MERIVA I 1.6 i 16V	Z16XE	01/03 ⇒ 09/05
MERIVA I 1.6 i 16V Twinport	Z16XEP	05/03 ⇒ 06/10
VECTRA B 1.6 i 16V	X16XEL, Z16XE	08/95 ⇒ 03/02
VECTRA C 1.6 16V	Z16XE, X16XEL	06/04 ⇒ 07/08
ZAFIRA A 1.6 16V	X16XEL, Z16XE1	04/99 ⇒ 08/05
ZAFIRA A 1.6 CNG	Z16YNG	09/01 ⇒ 06/05
ZAFIRA B 1.6	Z16XE1, EER	07/05 ⇒ 11/14
ZAFIRA B 1.6 CNG	Z16YNG	07/05 ⇒ 11/14

9.0289



04,5

REVOLUTION AND TIMING (CKP AND CMP) SENSORS

Adatt./Suitable:

BOSCH

0 261 210 156

0 261 210 157

MERCEDES-BENZ

0001580719

A 000 158 07 19

Eliminated on 16-11-2016. Please verify the availability through our local distributors

- Eliminato il 16-11-2016. Verificare la disponibilità presso i nostri distributori
- Éliminé le 16-11-2016. Vérifier la disponibilité auprès de nos distributeurs sur place
- Am 16-11-2016 gestrichen. Evtl. Verfügbarkeit bitte bei unseren Händlern prüfen
- Eliminado en fecha 16-11-2016. Verificar la disponibilidad a través de nuestros distribuidores locales



L	L1	ohm	
1110	24	900	

MERCEDES-BENZ

CLASSE VV 280	M104.900	08/97 ⇒ 07/03
---------------	----------	---------------

9.0290



3

REVOLUTION AND TIMING (CKP AND CMP) SENSORS

Adatt./Suitable:

CHRYSLER
4609009

- ⁰³ Supplied until depletion
- Fornibile fino ad esaurimento delle scorte
 - Fourni jusqu'à épuisement du stock
 - Lieferbar solange vorrat reicht
 - Suministrado hasta el stock termina



L	L1		
---	27,7	Hall Effect	

CHRYSLER

300M 2.7 V6 24V	EER, F9Q1	08/00 ⇨ 09/04
-----------------	-----------	---------------

9.0291



3

REVOLUTION AND TIMING (CKP AND CMP) SENSORS

Adatt./Suitable:

GENERAL MOTORS

 91 167 211
93 857 630
93 859 837

MITSUBISHI

 M617112
MW-31216432

NISSAN

 23731-00Q0E
23731-AW300
23731-AW30A
23750-00QAB
23750-00QAJ
77001-13552
82006-88405

OPEL

 12 32 268
44 02 729
44 14 098
44 30 629
91167211
93859837

RENAULT

 77 00 113 552
82 00 443 891
82 00 688 405

SUZUKI

 33220-67J00-000
33220-67J01
33220-67J01-000

VAUXHALL

 91167211
93857630
93859837

VOLVO

30617112

MARKET DIFFUSION: MEDIUM



L	L1	ohm	
---	32	840	

MITSUBISHI

CARISMA 1.9 DI-D	F9Q1, F9Q1	09/00 ⇨ 06/06
SPACE STAR 1.9 DI-D	F9Q1, F9Q772	02/01 ⇨ 12/04

NISSAN

INTERSTAR dCi 80	F9Q772, F9Q	04/02 ⇨
PRIMASTAR 1.9 dCi 100	F9Q760	07/02 ⇨
PRIMASTAR 1.9 dCi 80	F9Q762	07/02 ⇨
PRIMASTAR dCi 100	F9Q760	03/01 ⇨
PRIMASTAR dCi 80	F9Q762	03/01 ⇨
PRIMERA III 1.9 dCi	F9Q, F9Q770	08/02 ⇨

OPEL

MOVANO A 1.9 DTI	F9Q770, F9Q762	09/00 ⇨
VIVARO A 1.9 DI	F9Q762, F9Q680	08/01 ⇨
VIVARO A 1.9 DTI	F9Q760	08/01 ⇨

RENAULT

ESPACE IV 1.9 dCi	F9Q680, F9Q803	11/02 ⇨
GRAND SCÉNIC II 1.9 dCi	F9Q803, F9Q650	04/04 ⇨
LAGUNA I 1.9 dCi	F9Q718	09/99 ⇨ 03/01
LAGUNA II 1.9 dCi	F9Q650, F9Q772	03/01 ⇨
MASTER II 1.9 dCi 80	F9Q772, F9Q200	11/01 ⇨
MASTER II 1.9 dTi	F9Q770	09/00 ⇨
MEGANE II 1.9 dCi	F9Q800, F9Q816	11/02 ⇨
MEGANE I 1.9	F9Q200, F9Q718	06/97 ⇨
MEGANE I 1.9 dCi	F9Q718, F9Q800	12/00 ⇨
MEGANE I 1.9 dTi	F9Q770	05/00 ⇨
SCÉNIC II 1.9 D	F9Q812	06/06 ⇨
SCÉNIC II 1.9 dCi	F9Q803, F9Q760	06/03 ⇨
SCÉNIC II 1.9 dCi 130	F9Q804	10/05 ⇨ 12/09
SCENIC 1.9 dCi	F9Q816, F9Q803	06/07 ⇨ 11/08
TRAFIC II 1.9 dCi	F9Q760, F9Q760	03/01 ⇨
TRAFIC II 1.9 dCi 100	F9Q760	03/01 ⇨
TRAFIC II 1.9 dCi 80	F9Q760, F9Q770	03/01 ⇨

VAUXHALL

MOVANO A 1.9 DTI	F9Q770, DW10TD	09/00 ⇨ 05/10
VIVARO 1.9 DI	F9Q762	08/01 ⇨ 07/14
VIVARO 1.9 DTI	F9Q760	08/01 ⇨ 12/06

9.0292



3

REVOLUTION AND TIMING (CKP AND CMP) SENSORS

Adatt./Suitable:

FIAT

71739267

GENERAL MOTORS

 12 567 712
24 576 398

OPEL

 12567712
24576398
62 38 158
62 38 186

VAUXHALL

 12567712
24576398

L	L1	ohm	
---	34,7	700	

FIAT

CROMA II 2.2 16V	194A1.000	06/05 ⇨
------------------	-----------	---------

OPEL

ASTRA G 2.2 16V	Z22SE	06/00 ⇨ 10/05
SIGNUM 2.2 direct	Z22YH	05/03 ⇨ 09/08
SPEEDSTER 2.2	Z22SE	06/00 ⇨ 08/05
VECTRA B 2.2 i 16V	Z22SE	09/00 ⇨ 07/03
VECTRA C 2.2 16V	Z22SE	04/02 ⇨ 12/08
VECTRA C 2.2 DGi	Z22YH	10/03 ⇨ 08/08
VECTRA C 2.2 direct	Z22YH	10/03 ⇨ 08/08
ZAFIRA A 2.2 16V	Z22SE	09/00 ⇨ 06/05
ZAFIRA B 2.2	Z22YH	07/05 ⇨ 12/12

VAUXHALL

ASTRA IV 2.2 16V	Z22SE	03/00 ⇨ 10/05
SIGNUM 2.2 i	Z22YH	05/03 ⇨ 05/08
SPEEDSTER 2.2	Z22SE	03/01 ⇨ 09/06
VECTRA B 2.2 i 16V	Z22SE	08/95 ⇨ 07/03
VECTRA C 2.2 16V	Z22SE	01/02 ⇨ 10/08
VECTRA C 2.2 direct	Z22YH	01/02 ⇨ 10/08
VX220 2.2 i	Z22SE	09/00 ⇨ 07/05
ZAFIRA A 2.2 16V	Z22SE	11/98 ⇨ 08/04
ZAFIRA B 2.2	Z22YH	07/05 ⇨ 11/14



REVOLUTION AND TIMING (CKP AND CMP) SENSORS

Adatt./Suitable:

BOSCH
0 986 280 440

CITROËN
1920 EN
1920 FP
96 406 277 80
96 468 233 80

FIAT
9640627780

LANCIA
9640627780

PEUGEOT
1920 EN
1920 FP
96 468 233 80

SUZUKI
33220-67G00
33220-67G00-000
33220-67G01
33220-67G01-000
33220-67G02-000

MARKET DIFFUSION: HIGH



L	L1	ohm	OUT GND
---	24	400	

CITROËN

BERLINGO I 2.0 HDi 4x4	RHY(DW10TD)	11/02 ⇨ 10/05
BERLINGO I 2.0 HDi 90	DW10TD, 6FY(EW7A)	12/99 ⇨ 12/11
BERLINGO I 2.0 HDi 90 4WD	RHY(DW10TD)	11/00 ⇨ 10/05
BERLINGO 2.0 HDi	DW10TD	08/99 ⇨ 10/05
C4 I 2.0 16V	EW10A, 6FY(EW7A)	11/04 ⇨ 07/11
C4 I 2.0 VTR	EW10A	10/06 ⇨ 12/07
C4 II 2.0 Flex	RFJ(EW10A)	11/09 ⇨
C4 GRAND PICASSO I 1.8 i 16V	6FY(EW7A), EW10A	10/06 ⇨ 12/10
C4 GRAND PICASSO I 1.8 i 16V CNG	EW7ACNG	03/09 ⇨ 12/11
C4 GRAND PICASSO I 1.8 i 16V Flex	EW7A	06/09 ⇨ 01/13
C4 GRAND PICASSO I 2.0 i 16V	EW10A, EW10A	10/06 ⇨ 08/13
C4 PICASSO I 1.8 Bifuel	6FY(EW7A), 6FY(EW7A)	01/09 ⇨ 10/12
C4 PICASSO I 1.8 i 16V	6FY(EW7A), EW10A	02/07 ⇨ 12/11
C4 PICASSO I 2.0 i 16V	EW10A, 6FY(EW7A)	09/07 ⇨ 08/13
C5 I 1.8	EW7J4	09/04 ⇨ 08/05
C5 I 1.8 16V	6FY(EW7A), EW10A	03/01 ⇨
C5 I 2.0	EW10A	11/04 ⇨ 01/08
C5 I 2.0 16V	EW10A, 4HX(DW12TED4/FAP)	03/01 ⇨
C5 I 2.0 16V HPI	EW10D	03/01 ⇨ 08/04
C5 I 2.2 HDi	4HX(DW12TED4/FAP), ES9A	03/01 ⇨
C5 I 3.0 V6	ES9A, 6FY(EW7A)	09/04 ⇨
C5 II 1.8 16V	6FY(EW7A), EW10A	02/08 ⇨
C5 II 2.0 16V	EW10A, EW10A	02/08 ⇨
C5 II 2.0 16V BioFlex	EW10A, ES9A	02/08 ⇨
C5 II 3.0 V6	ES9A, ES9A	02/08 ⇨
C5 3.0 [ExtraEU]	ES9AHP	09/04 ⇨ 01/08
C6 3.0 V6	ES9A, EW10J4	09/05 ⇨ 12/12
C8 2.0	EW10J4, EW10A	07/02 ⇨
C8 2.0 16V	EW10A, ES9J4S	09/05 ⇨
C8 3.0 V6	ES9J4S, EW10A	07/02 ⇨
JUMPY II 2.0 i	EW10A, EW10J4	01/07 ⇨
XSARA 2.0 [ExtraEU]	EW10J4	02/04 ⇨ 10/04
XSARA 2.0 16V	EW10J4, DW10ATED	09/00 ⇨ 08/05
XSARA 2.0 HDi 109	DW10ATED, EW10J4	05/01 ⇨ 08/05
XSARA PICASSO 2.0 16V	EW10J4, DW10TD	01/03 ⇨
XSARA PICASSO 2.0 HDi	DW10TD, RFN	12/99 ⇨

FIAT

ULYSSE II 2.0	RFN, RFN	08/02 ⇨ 06/11
ULYSSE II 3.0	XFW	08/02 ⇨ 06/11

LANCIA

PHEDRA 2.0	RFN, ES9J4S	09/02 ⇨ 11/10
PHEDRA 2.0 D Multijet	RHR	07/06 ⇨ 11/10
PHEDRA 3.0 V6	ES9J4S, EW10J4	09/02 ⇨

PEUGEOT

206 2.0 16V	EW10J4, DW10TD	07/02 ⇨ 02/07
206 2.0 HDi	DW10TD, DW10TD	07/02 ⇨
206 2.0 HDi 90	DW10TD, EW10J4S	12/99 ⇨
206 2.0 RC	EW10J4S, EW10J4	07/03 ⇨
206 2.0 S16	EW10J4, NFP(ECS)	06/99 ⇨
301 1.6 VTI 115	NFP(ECS), EW10J4	11/12 ⇨
307 2.0	EW10J4, EW10A	03/02 ⇨ 06/05
307 2.0 16V	EW10A, DW10ATED	08/00 ⇨ 04/09
307 2.0 HDi	DW10ATED, DW10ATED	01/03 ⇨ 12/09
307 2.0 HDi 110	DW10ATED, DW10TD	08/00 ⇨ 12/09
307 2.0 HDi 90	DW10TD, EW10A	08/00 ⇨ 04/08
308 I 2.0 Bioflex	EW10A, EW10A	01/08 ⇨
308 I 2.0 CVVT	EW10A, EW10J4	07/09 ⇨ 11/14
406 1.8 16V	EW7J4	10/00 ⇨ 10/04
406 1.8 BiFuel	EW7J4	09/00 ⇨ 05/04
406 2.0 16V	EW10J4, 6FZ(EW7J4)	08/00 ⇨ 12/04
406 2.0 16V HPI	EW10D	05/01 ⇨ 10/04
406 2.2	EW12J4	07/00 ⇨ 12/04
406 2.2 HDi	DW12TED4	03/00 ⇨ 12/04
407 1.8	6FZ(EW7J4), 6FY(EW7A)	05/04 ⇨
407 1.8 16V	6FY(EW7A), EW10J4	09/05 ⇨
407 2.0	EW10J4, EW10A	03/04 ⇨
407 2.0 16V	EW10A, EW10A	09/05 ⇨
407 2.0 Bioflex	EW10A, 3FZ(EW12J4)	09/07 ⇨
407 2.0 CVVT [ExtraEU]	EW10A	08/05 ⇨ 12/10
407 2.0 Flex [ExtraEU]	EW10A	10/05 ⇨ 02/11
407 2.2	3FZ(EW12J4), 3FY(EW12J4)	05/04 ⇨
407 2.2 16V	3FY(EW12J4), ES9A	09/05 ⇨
407 3.0	ES9A, ES9A	05/04 ⇨
407 3.0 V6	ES9A, EW10J4	10/05 ⇨
607 2.0	EW10J4, 3FY(EW12J4)	02/00 ⇨ 08/05
607 2.2 16V	3FY(EW12J4), ES9A	02/00 ⇨ 06/10
607 2.2 HDi	4HX(DW12TED4/FAP)	02/00 ⇨ 02/06
607 3.0 V6 24V	ES9A, EW10J4	02/00 ⇨ 07/11
807 2.0	EW10J4, EW10A	06/02 ⇨
807 2.0 16V	EW10A, ES9J4S	09/05 ⇨
807 3.0 V6	ES9J4S, EW10A	06/02 ⇨
EXPERT II 2.0 16V	EW10A, EW10A	01/07 ⇨
EXPERT II TEPEE 2.0 16V	EW10A, DW10TD	01/07 ⇨
PARTNER I 2.0 HDi	DW10TD, AOV	02/00 ⇨ 07/08
PARTNER I 2.0 HDi 4x4	RHY(DW10TD)	04/04 ⇨ 08/05
RANCH 2.0 HDi	RHY(DW10TD)	02/00 ⇨
RANCH 2.0 HDi 4x4	RHY(DW10TD)	04/04 ⇨



REVOLUTION AND TIMING (CKP AND CMP) SENSORS

Adatt./Suitable:

SKODA
047 906 433



L	L1	ohm	OUT GND
---	15,2	400	

SKODA

FABIA I 1.0	AQV, AME	12/99 ⇨ 08/02
FABIA I 1.4	AME, Z20LET	04/00 ⇨ 05/03
OCTAVIA I 1.4	AMD	04/99 ⇨ 03/01



REVOLUTION AND TIMING (CKP AND CMP) SENSORS

Adatt./Suitable:

SEAT
038 957 147
038 957 147 C

SKODA
038 957 147
038 957 147 C

VW
038 957 147
038 957 147 C



L	L1	ohm	OUT GND
545	46	1400	

SEAT

CORDOBA II 1.9 SDI	ASY	09/02 ⇨ 11/09
IBIZA III 1.9 SDI	ASY	02/02 ⇨ 12/05

SKODA

FABIA I 1.9 SDI	ASY	11/99 ⇨ 03/08
-----------------	-----	---------------

VOLKSWAGEN (BR)

POLO 1.9 SDI	ASY	05/02 ⇨
--------------	-----	---------

VW

POLO IV 1.9 SDI	ASY	10/01 ⇨
-----------------	-----	---------



REVOLUTION AND TIMING (CKP AND CMP) SENSORS

Adatt./Suitable:

BOSCH
0 261 210 150

GENERAL MOTORS
93 243 251

OPEL

12 38 241
93243251

VAUXHALL
93243251



L	L1	ohm	OUT GND
830	24	1000	

OPEL

ASTRA G 2.0 16V Turbo	Z20LET, Z20LET	09/00 ⇨ 10/05
ASTRA G 2.0 OPC	Z20LET, Z20LEH	03/02 ⇨ 10/05
ASTRA H 2.0 Turbo	Z20LEH, Z20LET	03/04 ⇨ 10/10
SPEEDSTER 2.0	Z20LET	10/03 ⇨ 08/06
SPEEDSTER 2.0 Turbo	Z20LET	08/02 ⇨ 08/06
ZAFIRA A 2.0 OPC	Z20LET, Z20LEH	09/01 ⇨ 06/05
ZAFIRA B 2.0	Z20LEH, Z20LET	07/05 ⇨ 12/10

VAUXHALL

ASTRA IV 2.0	Z20LET	08/02 ⇨ 10/05
ASTRA IV 2.0 16V Turbo	Z20LET	09/00 ⇨ 08/05
ASTRA IV 2.0 SRI Turbo	Z20LET	11/01 ⇨ 05/05
ASTRA IV 2.0 Turbo	Z20LET, Z20LEH	03/02 ⇨ 10/05
ASTRA V 2.0	Z20LEL	02/06 ⇨ 11/10
ASTRA V 2.0 Turbo	Z20LEH, Z20LEH	01/04 ⇨ 11/10

VAUXHALL			
ASTRA V 2.0 VXR	Z20LEH	02/09 → 11/10	
SPEEDSTER 2.0 Turbo	Z20LET	03/01 → 09/06	
SPEEDSTER VXR20	Z20LET	03/01 → 09/06	
VX220 2.0 i Turbo	Z20LET	03/01 → 07/05	
VX220 2.0 VXR	Z20LET	10/03 → 07/05	
ZAFIRA A 2.0	Z20LET	06/02 → 06/05	
ZAFIRA A 2.0 GSI Turbo	Z20LET	09/01 → 06/05	
ZAFIRA B 2.0	Z20LEH, ADP	07/05 → 11/14	

9.0298



REVOLUTION AND TIMING (CKP AND CMP) SENSORS

Adatt./Suitable:
BOSCH
 0 986 280 408
CITROËN
 1920 AW
 96 399 998 80
ELECTRICFIL
 14 43 35
FIAT
 9637465980
PEUGEOT
 1920 AW

MARKET DIFFUSION: **HIGH**



L	L1	ohm	GND OUT
---	17,2	550	

9.0297



REVOLUTION AND TIMING (CKP AND CMP) SENSORS

Adatt./Suitable:
AUDI
 048 906 433
 050 906 433
VW
 050 906 433



L	L1	ohm	OUT GND S
580	24	480	

AUDI			
80 IV 1.6 E	ADA	06/93 → 01/96	
A4 I 1.6	ADP, ADR	11/94 → 09/01	
A4 I 1.8	ADR, ADR	11/94 → 09/01	
A4 I 1.8 quattro	ADR, AEB	01/95 → 09/01	
A4 I 1.8 T	AEB, AEB	01/95 → 09/01	
A4 I 1.8 T quattro	AEB, AEB	01/95 → 09/01	
A6 II 1.8	AFY	05/97 → 01/05	
A6 II 1.8 T	AEB, AEB	01/97 → 01/05	
A6 II 1.8 T quattro	AEB, ADP	02/97 → 01/05	
CABRIOLET 1.8	ADR	01/97 → 08/00	
VW			
PASSAT IV 1.6	ADP, ADR	10/96 → 11/00	
PASSAT IV 1.8	ADR, ADR	10/96 → 03/05	
PASSAT IV 1.8 Syncro/4motion	ADR, AEB	10/96 → 11/00	
PASSAT IV 1.8 T	AEB, TU32	10/96 → 11/00	
PASSAT IV 1.8 T Syncro	AEB	11/96 → 08/00	

CITROËN			
BERLINGO I 1.1 i	HDZ(TU1M), K6D(TU3A)	07/96 → 05/08	
BERLINGO I 1.4	K6D(TU3A), KFW(TU3JP)	11/02 →	
BERLINGO I 1.4 BiFuel	TU3JP	07/96 → 10/02	
BERLINGO I 1.4 bivalent	KFW(TU3JP), KFW(TU3JP)	11/02 → 12/11	
BERLINGO I 1.4 CNG	KFW(TU3JP)	11/02 → 03/08	
BERLINGO I 1.4 GNC	KFW(TU3JP)	11/02 →	
BERLINGO I 1.4 Hybrid	KFW(TU3JP)	05/05 →	
BERLINGO I 1.4 i	KFW(TU3JP), KFW(TU3JP)	07/96 → 12/11	
BERLINGO I 1.4 i bivalent	KFW(TU3JP), HFX(TU1A)	04/03 → 10/08	
BERLINGO 1.1 BiFuel	TU1M+	07/96 → 10/02	
BERLINGO 1.4	TU32, HDZ(TU1M)	07/96 → 12/11	
BERLINGO 1.4 BiFuel	TU3JP	07/96 → 10/02	
BERLINGO 1.4 Bivalent	TU3JPCNG	04/03 → 10/05	
BERLINGO 1.4 Hybrid	TU3JPHYBRID	05/05 → 05/08	
C2 1.1	HFX(TU1A), KFW(TU3JP)	09/03 →	
C2 1.4	KFW(TU3JP), ET3J4	09/03 →	
C2 1.4 16V	ET3J4, NFU(TU5JP4)	06/06 →	
C2 1.6	NFU(TU5JP4), NFS(TU5JP4S)	09/03 →	
C2 1.6 VTS	NFS(TU5JP4S), HFX(TU1A)	01/05 →	
C3 I 1.1 i	HFX(TU1A), ET3J4	02/02 →	
C3 I 1.1 LPG	TU1A	06/06 → 12/09	
C3 I 1.4 16V	ET3J4, KFW(TU3A)	12/03 →	
C3 I 1.4 BiFuel	TU3JP	09/08 → 12/09	
C3 I 1.4 i	KFW(TU3A), KFW(TU3JP)	02/02 →	
C3 I 1.4 i Bivalent	KFW(TU3JP), N6A(TU5JP4)	02/02 →	
C3 I 1.6 16V	N6A(TU5JP4), KFW(TU3A)	02/02 →	
C3 I PLURIEL 1.4	KFW(TU3A), NFU(TU5JP4)	05/03 →	
C3 I PLURIEL 1.4 Hybrid	KFW(TU3JP)	05/05 →	
C3 I PLURIEL 1.6	NFU(TU5JP4), HFX(TU1JP)	05/03 →	
C3 II 1.1	HFX(TU1JP), HFX(TU1A)	11/09 →	
C3 II 1.1 BiFuel	HFX(TU1A), K6E(TU3A)	11/10 →	
C3 II 1.4	K6E(TU3A), KFT(TU3A)	11/09 →	
C3 II 1.4 LPG	KFT(TU3A), ET3J4	07/10 →	
C3 II 1.6 Flex	NFX(TU5JP4)	11/09 →	
C3 III 1.6 VTI	EC5F	02/17 →	
C4 I 1.4 16V	ET3J4, NFU(TU5JP4)	11/04 → 07/11	
C4 I 1.6 16V	NFU(TU5JP4), N6A(TU5JP4)	11/04 → 07/11	
C4 I 1.6 16V Bio-Flex	N6A(TU5JP4), EC5	09/07 →	
C4 I 1.6 16V Flex Fuel	N6A(TU5JP4)	02/09 →	
C4 I 1.6 Flex	--	02/09 → 07/11	
C-ELYSEE 1.6 VTI 115	EC5, KFT(TU3A)	11/12 →	
NEMO 1.4	KFT(TU3A), TU9M	02/08 →	
SAXO 1.0	TU9M, CDZ(TU9M)	10/97 → 06/03	
SAXO 1.0 X	CDZ(TU9M), HDZ(TU1M)	05/96 → 11/98	
SAXO 1.1 BiFuel	TU1M+	07/00 → 06/03	
SAXO 1.1 X, SX	HDZ(TU1M), KFW(TU3JP)	05/96 → 09/03	
SAXO 1.4 VTS	KFW(TU3JP), NFT(TU5JP)	05/96 → 06/03	
SAXO 1.6	NFT(TU5JP), NFZ(TU5JP)	02/01 → 04/04	
SAXO 1.6 VTL, VTR	NFZ(TU5JP), NFT(TU5JP)	05/96 → 06/03	
SAXO 1.6 VTS	NFT(TU5JP), KFW(TU3JP)	09/00 → 09/03	
XSARA 1.4	TU3JP	05/98 → 03/05	
XSARA 1.4 BiFuel [ExtraEU]	TU3JP	05/98 → 08/00	

CITROËN		
XSARA 1.4 i	KFW(TU3JP), NFU(TU5JP4)	04/97 → 08/05
XSARA 1.4 LPG	TU3JP	05/98 → 08/00
XSARA 1.6 16V	NFU(TU5JP4), NFZ(TU5JP)	09/00 → 08/05
XSARA 1.6 i	NFZ(TU5JP), NFV(TU5JP)	04/97 → 09/00
XSARA 2.0 HDi	DW10TD	09/00 → 03/05
XSARA 2.0 HDi 90	DW10TD	02/99 → 08/05
XSARA PICASSO 1.6	NFV(TU5JP), KFT	06/02 →
XSARA PICASSO 1.6 16V	TU5JP4	09/05 →
XSARA PICASSO 1.6 16V LPG	TU5JP4	09/05 →
XSARA PICASSO 1.6 Chrono	TU5JP	04/01 → 10/04
FIAT		
FIORINO III 1.4	KFT, KFT	11/07 →
QUBO 1.4	KFT, KFW(TU3A)	02/08 →
PEUGEOT		
106 I 1.0	TU9M	04/96 → 03/01
106 II 1.0 i	CDY(TU9M), HFX(TU1JP)	04/96 → 10/99
106 II 1.1 BiFuel	TU1M+	04/96 → 03/01
106 II 1.1 i	HFX(TU1JP), KFW(TU3JP)	05/96 → 07/04
106 II 1.4 i	KFW(TU3JP), HFX(TU1JP)	05/96 → 07/04
106 II 1.6 i	TU5JP	05/96 → 10/99
106 II 1.6 S16	NFX(TU5J4)	05/96 → 07/04
206 1.1	HFX(TU1JP), HFX(TU1JP)	08/98 →
206 1.1 i	HFX(TU1JP), KFW(TU3A)	09/98 →
206 1.4	KFW(TU3A), ET3J4	07/02 →
206 1.4 16V	ET3J4, K6C(TU3JP)	10/03 →
206 1.4 BiFuel [ExtraEU]	TU3JP	07/02 → 02/07
206 1.4 CNG	TU3AF	05/06 → 09/07
206 1.4 i	K6C(TU3JP), N6A(TU5JP4)	04/05 →
206 1.4 LPG	TU3JP	05/06 → 09/07
206 1.6	NFU(TU5JP4)	09/01 → 12/08
206 1.6 16V	N6A(TU5JP4), NFZ(TU5JP)	07/00 →
206 1.6 8V	TU5JP	05/99 → 10/03
206 1.6 BiFuel	TU5JP4	07/00 → 04/09
206 1.6 BiFuel [ExtraEU]	TU5JP4	07/02 → 02/07
206 1.6 i	NFZ(TU5JP), HFX(TU1A)	09/98 → 12/00
206 1.6 LPG	NFU(TU5JP4)	07/02 →
206+ 1.1	HFX(TU1A), K6D(TU3A)	01/09 →
206+ 1.1 LPG	TU1A	04/09 → 06/13
206+ 1.4 i	K6D(TU3A), KFT(TU3A)	01/09 →
206+ 1.6 16V	NFU(TU5JP4)	07/10 →
207 1.4	KFT(TU3A), ET3J4	02/06 →
207 1.4 16V	ET3J4, NFP(EC5)	02/06 →
207 1.4 BiFuel	TU3A	08/07 → 12/13
207 1.4 Flex	KFW(TU3A)	11/08 →
207 1.4 LPG	TU3A	08/07 → 12/12
207 1.6	N6A(TU5JP4)	08/08 →
207 1.6 16V	NFU(TU5JP4)	02/06 →
207 1.6 Bioflex	N6A(TU5JP4)	01/08 →
301 1.6 LPG	EC5	07/14 →
301 1.6 VTI 115	NFP(EC5), KFW(TU3JP)	11/12 →
306 1.4	KFW(TU3JP), KFW(TU3JP)	04/93 → 04/02
306 1.4 SL	KFW(TU3JP), K6D(TU3JP)	06/94 → 05/01
306 1.6	NFT(TU5JP)	10/00 → 04/02
307 1.4	K6D(TU3JP), ET3J4	08/00 →
307 1.4 16V	ET3J4, N6A(TU5JP4)	11/03 → 07/07
307 1.6	TU5JP4	07/06 → 04/12
307 1.6 16V	N6A(TU5JP4), --	08/00 →
307 1.6 BioFlex	--, KFW(TU3A)	07/06 →
308 1.6 VTI [ExtraEU]	EC5	05/15 →
308 II 1.6 VTI	EC5	03/14 →
308 II 1.6 VTI 115	NFP(EC5)	11/12 →
1007 1.4	KFW(TU3A), ET3J4	04/05 →
1007 1.4 16V	ET3J4, NFU(TU5JP4)	10/05 →
1007 1.6 16V	NFU(TU5JP4), CDY(TU9M)	04/05 →
BIPPER 1.4	KFW(TU3A), KFW(TU3A)	02/08 →
BIPPER TEPEE 1.4	KFW(TU3A), TU3JP	04/08 →
PARTNER 1.1 BiFuel	TU1M+	06/96 → 08/00
PARTNER 1.4	TU3JP, HDY(TU1M)	10/05 →
PARTNER 1.4 CNG	TU3JPCNG	11/02 → 10/06
PARTNER 1.1 i	HDY(TU1M), K6D(TU3A)	06/96 →
PARTNER 1.1.4	K6D(TU3A), HDY(TU1M)	06/96 →
PARTNER 1.1.4 BiFuel	TU3JP	04/03 → 10/06
RANCH 1.1	HDY(TU1M), K6C(TU3JP)	06/96 →
RANCH 1.4	K6C(TU3JP), KFW(TU3JP)	04/05 →
RANCH 1.4 BiFuel	KFW(TU3JP)	04/03 →
RANCH 1.4 CNG	TU3JPCNG	01/97 → 12/12

9.0299



05,5

REVOLUTION AND TIMING (CKP AND CMP) SENSORS

Adatt./Suitable:

BOSCH
0 986 280 447**CITROËN**
1920 5V
1920 AV
96 399 999 80**ELECTRICFIL**
14 43 36**PEUGEOT**
1920 5V
1920 AV

L	L1	ohm	GND OUT
---	12	550	

CITROËN

C3 I 1.4 BiFuel	TU3JP	09/08 ⇒ 12/09
C3 I 1.4 i	KFV(TU3JP), TU3JPCNG	02/02 ⇒
C3 I 1.4 i Bivalent	TU3JPCNG, N6A(TU5JP4)	02/02 ⇒
C3 I 1.6 16V	N6A(TU5JP4), NFU(TU5JP4)	02/02 ⇒
C3 II 1.6 Flex	NFX(TU5JP4)	11/09 ⇒
C4 I 1.6 16V	NFU(TU5JP4), N6A(TU5JP4)	11/04 ⇒ 07/11
C4 I 1.6 16V Bio-Flex	N6A(TU5JP4), EC5	09/07 ⇒
C4 I 1.6 16V Flex Fuel	N6A(TU5JP4)	02/09 ⇒
C4 I 1.6 Flex	--	02/09 ⇒ 07/11
C-ELYSEE 1.6 VTi 115	EC5, KFW(TU3JP)	11/12 ⇒
SAXO 1.4 VTS	KFW(TU3JP), NFT(TU5JP)	05/96 ⇒ 06/03
SAXO 1.6	NFT(TU5JP), NFZ(TU5JP)	02/01 ⇒ 04/04
SAXO 1.6 VTL, VTR	NFX(TU5JP), NFU(TU5JP4)	05/96 ⇒ 06/03
SAXO 1.6 VTS	NFT(TU5JP)	09/00 ⇒ 09/03
XSARA 1.6 16V	NFU(TU5JP4), KFW(TU3JP)	09/00 ⇒ 08/05
XSARA 1.6 i	TU5JP	04/97 ⇒ 09/00

PEUGEOT

106 II 1.4 i	KFW(TU3JP), NFZ(TU5JP)	05/96 ⇒ 07/04
106 II 1.6 i	NFX(TU5JP), KFW(TU3JP)	05/96 ⇒ 10/99
206 1.4	KFW(TU3JP), K6C(TU3JP)	07/02 ⇒
206 1.4 i	K6C(TU3JP), N6A(TU5JP4)	09/98 ⇒
206 1.6	NFU(TU5JP4)	09/01 ⇒ 12/08
206 1.6 16V	N6A(TU5JP4), EC5	07/00 ⇒
206 1.6 BiFuel	TU5JP4	07/00 ⇒ 04/09
206 1.6 LPG	NFU(TU5JP4)	07/02 ⇒
301 1.6 VTi 115	EC5, NFT(TU5JP)	11/12 ⇒
306 1.6	NFT(TU5JP), N6A(TU5JP4)	10/00 ⇒ 04/02
306 1.6 SR	NFX(TU5JP)	06/94 ⇒ 10/00
307 1.6 16V	N6A(TU5JP4), --	08/00 ⇒
307 1.6 BioFlex	--, 8140.43S	07/06 ⇒

9.0301



04,5

REVOLUTION AND TIMING (CKP AND CMP) SENSORS

Adatt./Suitable:

BOSCH
0 281 002 332**CITROËN**
1920 CP**FIAT**
500343018**IVECO**
0000500343018
500343018**PEUGEOT**
1920 CP**RENAULT**
50 01 848 541**RENAULT TRUCKS**
50 01 848 541

L	L1	ohm	OUT GND S
640	24	1000	

CITROËN

JUMPER I 2.8 HDi	8140.43S, --	09/00 ⇒ 04/02
JUMPER I 2.8 HDi 4x4	8140.43S	09/00 ⇒ 04/02
JUMPER II 2.8 HDi	--, 8140.43S	04/02 ⇒
JUMPER II 2.8 HDi 4x4	8140.43S, 8140.43	02/02 ⇒ 06/06
JUMPER II 2.8 HDi Trazione integrale	8140.43S	04/02 ⇒

FIAT

DUCATO II 2.8 JTD	8140.43, 8140.43B	11/00 ⇒
DUCATO II 2.8 JTD 4x4	8140.43S	11/00 ⇒
DUCATO II 2.8 JTD Power	8140.43S	05/04 ⇒
DUCATO II 2.8 TD 4x4	8140.43S	11/03 ⇒ 07/06
DUCATO 2.8 JTD	8140.43S	04/04 ⇒ 07/06

IVECO

DAILY II 2.8 CNG	814903CNG	05/99 ⇒ 07/07
DAILY II 29 L 13	8140.43S	05/01 ⇒ 07/07
DAILY II 29 L 9	8140.43R	11/01 ⇒ 04/06
DAILY II 29 L 9 V	8140.43R	11/01 ⇒ 04/06
DAILY II 35 C 15	8140.43N	11/01 ⇒ 04/06
DAILY II 35 C 9, 35 S 9	8140.43R	11/01 ⇒ 04/06
DAILY II 35 S 13 V, 35 C 13 V	8140.43S	05/99 ⇒ 07/07
DAILY II 35 S 13, 35 C 13	8140.43S	05/99 ⇒ 04/06
DAILY II 35 S 15 V, 35 C 15 V	8140.43N	11/02 ⇒ 07/07
DAILY II 35 S 9 V	8140.43R	11/01 ⇒ 04/06
DAILY II 40 C 13	8140.43S	05/99 ⇒ 04/06
DAILY II 40 C 15	8140.43N	11/01 ⇒ 04/06
DAILY II 50 C 13	8140.43S	05/99 ⇒ 07/07
DAILY II 50 C 15	8140.43N	01/01 ⇒ 04/06
DAILY II 65 C 13	8140.43.K	07/99 ⇒ 04/06
DAILY II 65 C 15	8140.43N	11/01 ⇒ 04/06
DAILY III 35 S 13, 40 C 13, 50 C 13	8140.43S	05/99 ⇒ 05/06
DAILY III 40 C 15, 50 C 15	8140.43N	05/99 ⇒ 05/06
DAILY 2.8	8140.43B, 8140.43N	07/99 ⇒ 12/06
DAILY 2.8 CNG	814903CNG	07/99 ⇒ 12/06

PEUGEOT

BOXER I 2.8 HDi	8140.43N, 8140.43S(F28DTCR)	10/00 ⇒
BOXER I 2.8 HDi 4x4	8140.43S(F28DTCR), S9W206	10/00 ⇒
BOXER I 2.8 HDi Trazione integrale	8140.43S(F28DTCR)	10/00 ⇒ 11/01

RENAULT

MASCOTT 110	S9W206	01/99 ⇒ 06/05
MASCOTT 150	S9W212	01/99 ⇒ 06/04
MASTER PRO 2.8 dCi	S9W206, 8140.43.S.2585	06/05 ⇒ 04/10

RENAULT TRUCKS

MASCOTT 130	8140.43.S.2585, 8140.43.S.2585	01/99 ⇒ 06/04
MASCOTT 130.35	8140.43.S.2585, 8140.43.S.2585	01/99 ⇒ 06/04
MASCOTT 130.55	8140.43.S.2585, SPJD	01/99 ⇒ 06/04
MASCOTT 150.35	8140.43N.3585	10/01 ⇒ 06/04
MASCOTT 150.55	8140.43N.3585	10/01 ⇒ 06/04
MASCOTT 150.65	8140.43N.3585	10/01 ⇒ 06/04

9.0302



3

REVOLUTION AND TIMING (CKP AND CMP) SENSORS

Adatt./Suitable:

FORD
1 111 037
YS6A-12K073-AB**MAZDA**
C201-18-230**SIEMENS**
S107542001
S107542002Z**VOLVO**
30711663

MARKET DIFFUSION: HIGH



L	L1	ohm	GND OUT
---	33,5	530	

FORD

B-MAX 1.4	SPJD, RJTC	10/12 ⇒
B-MAX 1.4 LPG	RJTC, HWDA	08/13 ⇒
C-MAX I 1.6	HWDA, DHA	02/07 ⇒ 09/10
FIESTA IV 1.25 i 16V	DHA, FUJA	08/95 ⇒ 01/02
FIESTA V 1.25 16V	FUJA, A9JA	05/02 ⇒ 06/08
FIESTA V 1.3	A9JA, FXJA	11/01 ⇒ 06/08
FIESTA V 1.4 16V	FXJA, FYJA	11/01 ⇒ 06/08
FIESTA V 1.6 16V	FYJA, SNJA	11/01 ⇒ 06/08
FIESTA VI 1.25	SNJA, --	06/08 ⇒
FIESTA VI 1.4	--, RTJA	06/08 ⇒
FIESTA VI 1.4 LPG	RTJA, HWDA	01/09 ⇒
FIESTA 1.2	DHA, DHA	01/96 ⇒ 04/02
FOCUS II 1.4	ASDA, HWDA	07/04 ⇒ 09/12
FOCUS II 1.6	HWDA, HXDA	07/04 ⇒ 09/12
FOCUS II 1.6 LPG	SIDA	10/09 ⇒ 09/12
FOCUS II 1.6 Ti	HXDA, ASDA	07/04 ⇒ 09/12
FOCUS II CASSONE / FURGONATO / PROMISCUO 1.4	ASDA, HXDA	09/05 ⇒ 07/11
FOCUS II CASSONE / FURGONATO / PROMISCUO 1.6 Ti-VCT	HXDA, --	09/05 ⇒ 07/11
FOCUS C-MAX 1.6	HWDA, ASDA	10/03 ⇒ 03/07
FUSION 1.25	--, --	10/02 ⇒
FUSION 1.3	--, --	08/02 ⇒
FUSION 1.4	--, FYJA	08/02 ⇒
FUSION 1.4 LPG	UTJA	01/10 ⇒ 12/12
FUSION 1.6	FYJA, A9A	08/02 ⇒ 11/08
KA I 1.3	A9A, A9A	09/02 ⇒ 03/04
KA I 1.3 i	A9A, CCA	05/02 ⇒ 11/08
KA I 1.6 i	CCA, CDRA	02/01 ⇒ 11/08
STREET KA 1.6	CDRA, FXJA	05/03 ⇒ 07/05

MAZDA

211.2	FUJA	02/03 ⇒ 06/07
211.25	FUJA	04/03 ⇒ 06/07
211.3 L	ZJ-04	04/03 ⇒ 06/07
211.4	FXJA, FYJA	02/03 ⇒ 06/07
211.5	ZY-VE	04/03 ⇒ 06/07
211.6	FYJA, DW8	02/03 ⇒ 06/07

VOLVO

C30 1.6	B416453	10/06 ⇒ 12/12
S40 II 1.6	B416453	01/05 ⇒ 12/12
V50 1.6	B416453	01/05 ⇒ 12/12

9.0303



3

**REVOLUTION AND TIMING (CKP AND CMP)
SENSORS**

Adatt./Suitable:

CITROËN1920 85
96 328 897 80**PEUGEOT**1920 85
96 328 897 80**RENAULT**96 32 889 780
96 34 049 880MARKET DIFFUSION: **MEDIUM**

L	L1	ohm	OUT_GND
---	24	400	

CITROËN

BERLINGO I 1.9 D	DW8, DW8	07/98 ⇨ 10/05
BERLINGO I 1.9 D 4WD	WJY(DW8B)	07/98 ⇨ 10/05
BERLINGO I 1.9 D 70	DW8, DW10TD	04/99 ⇨ 12/11
BERLINGO I 1.9 D 70 4WD	WJY(DW8B)	07/98 ⇨ 03/06
BERLINGO I 2.0 HDI 90	DW10TD, DW10ATED	12/99 ⇨ 12/11
BERLINGO I 2.0 HDI 90 4WD	RHY(DW10TD)	11/00 ⇨ 10/05
BERLINGO 1.9	DW8, DW8	07/98 ⇨ 12/11
BERLINGO 2.0 HDi	DW10TD	08/99 ⇨ 10/05
C5 I 2.0 HDi	DW10ATED, 4HX(DW12TED4/FAP)	03/01 ⇨ 08/04
C5 I 2.2 HDi	4HX(DW12TED4/FAP), E59J45HP	03/01 ⇨ 08/04
C5 I 3.0 Carlsson	E59J45HP, E59J45	09/03 ⇨ 08/04
C5 I 3.0 V6	E59J45, DW10ATED	03/01 ⇨ 08/04
XSARA 2.0 HDi 109	DW10ATED, DW10TD	05/01 ⇨ 08/05
XSARA 2.0 HDi 90	DW10TD, DW10ATED	02/99 ⇨ 08/05

PEUGEOT

306 1.9 D	WJY(DW8B)	09/98 ⇨ 08/02
306 2.0 HDI 90	RHY(DW10TD)	06/99 ⇨ 12/02
406 2.0 HDI 110	DW10ATED, 4HX(DW12TED4/FAP)	08/01 ⇨ 10/04
406 2.0 HDI 90	RHY(DW10TD)	02/99 ⇨ 10/04
406 2.2 HDi	4HX(DW12TED4/FAP), E59J45	03/00 ⇨ 12/04
406 3.0 V6	E59J45, DW10ATED	03/00 ⇨ 12/04
607 2.0 HDi	DW10ATED, 4HX(DW12TED4/FAP)	05/00 ⇨ 09/05
607 2.0 HDi 110 FAP	RHS(DW10ATED)	12/04 ⇨
607 2.2 HDi	4HX(DW12TED4/FAP), E59J45	02/00 ⇨ 02/06
607 3.0 V6 24V	E59J45, DW8	02/00 ⇨ 07/11
PARTNER I 1.9 D	DW8, DW10TD	06/96 ⇨ 12/15
PARTNER I 2.0 HDi	DW10TD, L7X731	02/00 ⇨ 07/08
RANCH 1.9 D	WJY(DW8B)	06/96 ⇨
RANCH 2.0 HDi	RHY(DW10TD)	02/00 ⇨

RENAULT

LAGUNA II 2.9 V6 24V	L7X731, L7X731	03/01 ⇨ 12/07
LAGUNA II 3.0 V6 24V	L7X731, SPJD	03/01 ⇨

9.0304



3

**REVOLUTION AND TIMING (CKP AND CMP)
SENSORS**

Adatt./Suitable:

FORD1 110 834
1 473 035
6M5G-6D298-BA
YS6A-6C315-AB**MAZDA**

C201-18-221

SIEMENSS107543001
S107543002Z**VOLVO**

30711660

MARKET DIFFUSION: **HIGH**

L	L1	ohm	OUT_GND
---	37,5	400	

FORD

B-MAX 1.4	SPJD, RJTC	10/12 ⇨
B-MAX 1.4 LPG	RJTC, IQJA	08/13 ⇨
B-MAX 1.6 Ti	IQJA, HWDA	10/12 ⇨
C-MAX I 1.6	HWDA, --	02/07 ⇨ 09/10
C-MAX I 1.6 Ti-VCT	--, MUDA	03/07 ⇨
C-MAX II 1.6	--	12/10 ⇨
C-MAX II 1.6 CNG	MUDACNG	01/13 ⇨
C-MAX II 1.6 Flexifuel	MUDA, MUDA	02/11 ⇨
C-MAX II 1.6 LPG	MUDA, IQDA	02/12 ⇨
C-MAX II 1.6 Ti	IQDA, TXDB	12/10 ⇨
C-MAX II 2.0 TDCi	TXDB, UEJB	04/10 ⇨
ECOSPORT 1.5 Ti	UEJB, UEJB	10/13 ⇨
ECOSPORT 1.5 Ti-VCT [ExtraEU]	UEJB, HXUD	10/13 ⇨
ECOSPORT 1.6 Ti-VCT	HXJD, DHA	08/12 ⇨
FIESTA 1.2	DHA, HXJB	01/96 ⇨ 04/02
FIESTA 1.6 Ti-VCT [ExtraEU]	HXJB, DHA	03/15 ⇨
FIESTA IV 1.25 i 16V	DHA, FUJA	08/95 ⇨ 01/02
FIESTA V 1.25 16V	FUJA, A9JA	05/02 ⇨ 06/08
FIESTA V 1.3	A9JA, FXJA	11/01 ⇨ 08/08
FIESTA V 1.4	FXJA	05/02 ⇨ 09/05
FIESTA V 1.4 16V	FXJA, FYJA	11/01 ⇨ 06/08
FIESTA V 1.6 16V	FYJA, SNJA	11/01 ⇨ 06/08
FIESTA VI 1.25	SNJA, --	06/08 ⇨
FIESTA VI 1.4	--, RTJA	06/08 ⇨
FIESTA VI 1.4 LPG	RTJA, --	01/09 ⇨
FIESTA VI 1.6	XTJA	03/15 ⇨
FIESTA VI 1.6 Ti	--, HXJA	06/08 ⇨
FIESTA VI 1.6 Ti-VCT	HXJA, HWDA	10/08 ⇨ 12/12
FOCUS II 1.4	ASDA, HWDA	07/04 ⇨ 09/12
FOCUS II 1.6	HWDA, G8DC	07/04 ⇨ 09/12
FOCUS II 1.6 LPG	SIDA	10/09 ⇨ 09/12
FOCUS II 1.6 TDCi	G8DC, HXDA	07/04 ⇨ 09/12
FOCUS II 1.6 Ti	HXDA, ASDA	07/04 ⇨ 09/12
FOCUS II 1.6 Ti-VCT	--	12/07 ⇨
FOCUS II 2.0 LPG	SYDA	06/08 ⇨ 07/11
FOCUS II CASSONE / FURGONATO / PROMISCUO 1.4	ASDA, HXDA	09/05 ⇨ 07/11
FOCUS II CASSONE / FURGONATO / PROMISCUO 1.6	HWDA	09/05 ⇨ 07/11
FOCUS II CASSONE / FURGONATO / PROMISCUO 1.6 Ti-VCT	HXDA, MUDA	09/05 ⇨ 07/11
FOCUS III 1.6 Flexifuel	MUDA, MUDA	07/10 ⇨
FOCUS III 1.6 LPG	MUDA, IQDA	02/12 ⇨
FOCUS III 1.6 Ti	IQDA, --	07/10 ⇨
FOCUS III 1.6 Ti-VCT	--	07/10 ⇨

FORD

FOCUS C-MAX 1.6	HWDA, HXDA	10/03 ⇨ 03/07
FOCUS C-MAX 1.6 Ti	HXDA, ASDA	08/04 ⇨ 03/07
FUSION 1.25	--, --	10/02 ⇨
FUSION 1.3	--, --	08/02 ⇨
FUSION 1.4	--, FYJA	08/02 ⇨
FUSION 1.4 LPG	UTJA	01/10 ⇨ 12/12
FUSION 1.6	FYJA, IQDA	08/02 ⇨ 11/08
GRAND C-MAX 1.6 Ti	IQDA, TXDB	12/10 ⇨
GRAND C-MAX 2.0 TDCi	TXDB, A9A	12/10 ⇨
KA+ 1.2	B2KA, YSKD	06/16 ⇨
KA+ 1.2 Ti-VCT	YSKD, KGBA	06/16 ⇨
KA I 1.3 i	A9A, CCA	05/02 ⇨ 11/08
KA I 1.6 i	CCA, B2KA	02/01 ⇨ 11/08
MONDEO III 1.6 Ti	KGBA, CDRA	03/07 ⇨ 01/15
STREET KA 1.6	CDRA, FXJA	05/03 ⇨ 07/05

MAZDA

2 I 1.2	FUJA	02/03 ⇨ 06/07
2 I 1.25	FUJA	04/03 ⇨ 06/07
2 I 1.3 L	ZJ-04	04/03 ⇨ 06/07
2 I 1.4	FXJA, FYJA	02/03 ⇨ 06/07
2 I 1.5	ZY-VE	04/03 ⇨ 06/07
2 I 1.6	FYJA, NFU(TU5JP4)	02/03 ⇨ 06/07

VOLVO

C30 1.6	B4164S3	10/06 ⇨ 12/12
S40 II 1.6	B4164S3	01/05 ⇨ 12/12
V50 1.6	B4164S3	01/05 ⇨ 12/12

9.0305



3

**REVOLUTION AND TIMING (CKP AND CMP)
SENSORS**

Adatt./Suitable:

BOSCH

0 986 280 417

CITROËN1920 7P
96 334 757 80**PEUGEOT**1920 7P
96 334 757 80MARKET DIFFUSION: **MEDIUM**

L	L1	ohm	OUT_GND
---	24	400	

CITROËN

BERLINGO I 1.6 16V	NFU(TU5JP4), N6A(TU5JP4)	10/00 ⇨ 12/11
BERLINGO II 1.6	N6A(TU5JP4), NFU(TU5JP4)	04/08 ⇨
C4 I 1.6 16V	NFU(TU5JP4), N6A(TU5JP4)	11/04 ⇨ 07/11
C4 I 1.6 16V Bio-Flex	N6A(TU5JP4), NFV(TU5JP)	09/07 ⇨
C4 I 1.6 16V Flex Fuel	N6A(TU5JP4)	02/09 ⇨
C4 I 1.6 Flex	--	02/09 ⇨ 07/11
C4 II 1.6 Flex	NFX(TU5JP4)	11/09 ⇨
XSARA 2.0 HDi 90	RHY(DW10TD)	02/99 ⇨ 08/05
XSARA PICASSO 1.6	NFV(TU5JP), N6A(TU5JP4)	06/02 ⇨
XSARA PICASSO 1.6 16V	N6A(TU5JP4), N6A(TU5JP4)	03/05 ⇨
XSARA PICASSO 1.6 16V LPG	TU5JP4	09/05 ⇨
XSARA PICASSO 1.6 Chrono	TU5JP	04/01 ⇨ 10/04

PEUGEOT

307 1.6	TU5JP4	07/06 ⇨ 04/12
307 1.6 16V	N6A(TU5JP4), --	08/00 ⇨
307 1.6 BioFlex	--, N6A(TU5JP4)	07/06 ⇨
308 I 1.6 16V	N6A(TU5JP4)	07/08 ⇨

PEUGEOT		
308 I 1.6 Bioflex	N6A(TU5JP4), 3FZ(EW12J4)	04/08 →
406 2.2	3FZ(EW12J4), EW10J4	07/00 → 12/04
607 2.0	EW10J4, 3FZ(EW12J4)	02/00 → 08/05
607 2.2 16V	3FZ(EW12J4), TU5JP4	02/00 → 08/05
PARTNER 1.6	TU5JP4, N6A(TU5JP4)	09/11 →
PARTNER 1.6 Bioflex	TU5JP4	09/00 → 10/02
PARTNER I 1.6	N6A(TU5JP4), N6A(TU5JP4)	09/00 →
PARTNER I 1.6 [ExtraEU]	TU5JP4	09/00 → 05/08
PARTNER I 1.6 16V	NFU(TU5JP4), NFU(TU5JP4)	07/01 → 03/08
PARTNER I 1.6 Bioflex	TU5JP4	09/00 → 10/02
PARTNER I 1.6 Flexfuel	NFU(TU5JP4), NFR(TU5JP4B)	09/00 → 10/02
PARTNER II 1.6	NFR(TU5JP4B), NFR(TU5JP4B)	04/08 →
PARTNER II TEPEE 1.6 VTi	NFR(TU5JP4B), N6A(TU5JP4)	04/08 →
RANCH 1.6 16V	N6A(TU5JP4), 4HV(P22DTE)	07/01 →

9.0307  **3**

REVOLUTION AND TIMING (CKP AND CMP) SENSORS

Adatt./Suitable:

- CITROËN**
1920 LV
- FIAT**
9662221580
- FORD**
1 143 723
257Q-6C315-AC
- JAGUAR**
JD6 1138
- LAND ROVER**
LR004396
- PEUGEOT**
1920 LV

MARKET DIFFUSION: **MEDIUM**



L	L1	ohm	
---	40,5	400	

CITROËN		
JUMPER III 2.2 HDi 100	4HV(P22DTE), 4HU(P22DTE)	04/06 →
JUMPER III 2.2 HDi 120	4HU(P22DTE), 4HH(P22DTE)	04/06 →
JUMPER III 2.2 HDi 130	4HH(P22DTE), D5BA	04/06 →
FIAT		
DUCCATO III 100 Multijet 2,2 D	4HV	07/06 →
FORD		
MONDEO II 2.0 16V DI / TDDi / TDCi	D5BA, D6BA	10/00 → 03/07
MONDEO II 2.0 16V TDDi / TDCi	D6BA, --	10/00 → 03/07
MONDEO II 2.0 DI	PD20FMCR	10/00 → 03/07
MONDEO II 2.0 TDCi	--, QJBA	10/01 → 03/07
MONDEO II 2.2 TDCi	QJBA, P8FA	09/04 → 03/07
TRANSIT III 2.0 TDCi	FIFA	08/02 → 05/06
TRANSIT III 2.2 TDCi	P8FA, DRRR	04/06 → 08/14
TRANSIT III 2.2 TDCi RWD	DRRA, --	10/11 → 08/14
TRANSIT III 2.4 TDCi	--, H9FD	04/06 →
TRANSIT III 2.4 TDCi 4x4	H9FB	11/06 → 08/14
TRANSIT III 2.4 TDCi HPCR	--	07/06 →
TRANSIT III 2.4 TDCi RWD	H9FD, SAFA	04/06 → 08/14
TRANSIT III 3.2 TDCi	SAFA, SAFA	02/08 → 08/14
TRANSIT III 3.2 TDCi RWD	SAFA, PGFA	09/07 → 08/14
TRANSIT TOURNEO 2.0	FIFA	03/02 → 03/06
TRANSIT TOURNEO 2.2 TDCi	PGFA, LJ46B	07/06 → 08/14
TRANSIT 2.2 TDCi	P8FA	04/06 → 08/14

JAGUAR		
X-TYPE 2.0 D	LJ46B, LJ46G	07/03 → 12/09
X-TYPE 2.2 D	LJ46G, DT244	10/05 → 12/09
LAND ROVER		
DEFENDER 2.4 TD4 [ExtraEU]	DT244	05/07 →
DEFENDER 2.4 Td4 4x4	DT244, 4HV(P22DTE)	05/07 → 02/16
PEUGEOT		
BOXER II 2.2 HDi 100	4HV(P22DTE), 4HU(P22DTE)	04/06 →
BOXER II 2.2 HDi 120	4HU(P22DTE), HWDA	04/06 →
BOXER II 2.2 HDi 130	4HH(P22DTE)	03/11 →

9.0308  **3**

REVOLUTION AND TIMING (CKP AND CMP) SENSORS

Adatt./Suitable:

- FORD**
3 043 996
4 617 388
4 900 624
554P-7M101-AA
854P-7M101-AA
XS4P-7M101-AB
- GENERAL MOTORS**
10 456 578



L	L1	ohm	
---	27	400	

FORD		
C-MAX I 1.6	HWDA, G8DA	02/07 → 09/10
C-MAX I 1.6 TDCi	G8DA, --	02/07 → 09/10
C-MAX I 1.6 Ti-VCT	--, QQDA	03/07 →
C-MAX I 1.8	QQDA, AODA	02/07 → 09/10
C-MAX I 1.8 Flexifuel	Q7DA	02/07 → 09/10
C-MAX I 1.8 TDCi	KKDA	02/07 → 09/10
C-MAX I 2.0	AODA, G6DA	02/07 → 09/10
C-MAX I 2.0 CNG	SYDA	04/09 → 09/10
C-MAX I 2.0 LPG	SYDA	06/08 → 09/10
C-MAX I 2.0 TDCi	G6DA, SNJA	02/07 → 09/10
FIESTA VI 1.25	SNJA, --	06/08 →
FIESTA VI 1.4	--, RTJA	06/08 →
FIESTA VI 1.4 LPG	RTJA, F6JB	01/09 →
FIESTA VI 1.4 TDCi	F6JB, HHJC	01/09 →
FIESTA VI 1.6 TDCi	HHJC, HXJA	06/08 →
FIESTA VI 1.6 TDCi SOHC	--	02/10 →
FIESTA VI 1.6 Ti	HXJA, HWDA	06/08 →
FOCUS I 1.4 16V	FXDA, --	10/98 → 11/04
FOCUS I 1.6 16V	--, EYDB	02/99 → 11/04
FOCUS I 1.6 16V Flexifuel	FYDH	01/02 → 11/04
FOCUS I 1.8 16V	EYDB, BHDA	10/98 → 11/04
FOCUS I 1.8 BiFuel	EYDL	02/03 → 01/05
FOCUS I 1.8 DI / TDDi	BHDA, F9DA	08/99 → 11/04
FOCUS I 1.8 TDCi	F9DA, BHDA	03/01 → 11/04
FOCUS I 1.8 Turbo DI / TDDi	BHDA, EDDB	10/98 → 03/05
FOCUS I 2.0 16V	EDDB, ASDA	10/98 → 11/04
FOCUS I RS	HMDA	10/02 → 11/04
FOCUS I ST170	ALDA	03/02 → 11/04
FOCUS II 1.4	ASDA, HWDA	07/04 → 09/12
FOCUS II 1.6	HWDA, G8DA	07/04 → 09/12
FOCUS II 1.6 TDCi	G8DA, HXDA	07/04 → 09/12
FOCUS II 1.6 Ti	HXDA, Q7DA	07/04 → 09/12
FOCUS II 1.6 Ti-VCT	--	12/07 →
FOCUS II 1.8	Q7DA, --	03/06 → 09/12
FOCUS II 1.8 Flexifuel	--, KKDA	12/05 → 09/12
FOCUS II 1.8 TDCi	KKDA, AODA	07/04 → 09/12
FOCUS II 2.0	AODA, G6DA	07/04 → 09/12
FOCUS II 2.0 CNG	SYDA	04/09 → 07/11
FOCUS II 2.0 LPG	SYDA	06/08 → 07/11
FOCUS II 2.0 TDCi	G6DA, EDDB	07/04 → 09/12

FORD		
FOCUS II 2.5 RS	JZDA	01/09 → 07/11
FOCUS II 2.5 ST	HYDA	10/05 → 09/12
FOCUS C-MAX 1.6	HWDA, G8DA	10/03 → 03/07
FOCUS C-MAX 1.6 TDCi	G8DA, HXDA	10/03 → 03/07
FOCUS C-MAX 1.6 Ti	HXDA, CSDA	08/04 → 03/07
FOCUS C-MAX 1.8	CSDA, AODA	10/03 → 03/07
FOCUS C-MAX 1.8 Flexifuel	Q7DA	01/06 → 03/07
FOCUS C-MAX 1.8 TDCi	KKDA	01/05 → 03/07
FOCUS C-MAX 2.0	AODA, G6DA	03/04 → 03/07
FOCUS C-MAX 2.0 TDCi	G6DA, FXDA	10/03 → 03/07

9.0309  **3,5**

REVOLUTION AND TIMING (CKP AND CMP) SENSORS

Adatt./Suitable:

- FORD**
157Z-7M101-KA
4 040 494
4 047 431
4 383 679
4 429 622
XS4Z-7M101-KA
XS7P-7M101-AA
XS7Z-7M101-KA



L	L1	ohm	
---	29	850	

FORD		
COUGAR 2.0 16V	EDBA, LCBA	08/98 → 12/01
COUGAR 2.5 ST 200	SGA	01/00 → 12/01
COUGAR 2.5 ST 200 24V	MABB	08/98 →
COUGAR 2.5 V6 24V	LCBA, AJ	06/00 → 12/01
MAVERICK 2.0 16V	YF	02/01 →
MAVERICK 2.3 16V	GZ	03/04 →
MAVERICK 3.0 V6 24V	AJ, L1L	02/01 →
MONDEO I 1.6 i	L1J	08/96 → 09/00
MONDEO I 1.6 i 16V	L1L, RKB	05/98 → 09/00
MONDEO I 1.8 i	RKB, NGA	08/96 → 09/00
MONDEO I 1.8 TD	RFN	08/96 → 09/00
MONDEO I 2.0 i	NGA, SEA	08/96 → 09/00
MONDEO I 2.5 24V	SEA, CGBA	08/96 → 09/00
MONDEO I 2.5 ST 200	SGA	05/99 → 09/00
MONDEO II 1.8 16V	CGBA, CJBA	10/00 → 03/07
MONDEO II 1.8 SCi	CFBA	06/03 → 03/07
MONDEO II 2.0 16V	CJBA, D5BA	10/00 → 03/07
MONDEO II 2.0 16V DI / TDDi / TDCi	D5BA, D6BA	10/00 → 03/07
MONDEO II 2.0 16V TDDi / TDCi	D6BA, --	10/00 → 03/07
MONDEO II 2.0 TDCi	--, QJBA	10/01 → 03/07
MONDEO II 2.2 TDCi	QJBA, Y22XE	09/04 → 03/07
MONDEO II 2.5 V6 24V	LCBD	10/00 → 03/07
MONDEO II 3.0 V6 24V	REBA	09/04 → 03/07
MONDEO II ST220	MEBA	04/02 → 03/07

9.0310



04

REVOLUTION AND TIMING (CKP AND CMP) SENSORS

Adatt./Suitable:

GENERAL MOTORS
90 520 850**OPEL**
62 38 079
90520850**SIEMENS**
5WK9 6052
S105570001Z**VAUXHALL**
90520850

L	L1	Hall Effect	
---	---		

OPEL			
ASTRA F 1.8	Z18XE	02/03	⇒ 07/04
ASTRA F 2.0 i 16V	X20XER	10/99	⇒ 08/00
ASTRA G 2.0 16V	X20XE	02/98	⇒ 01/05
ASTRA G 2.0 16V OPC	X20XER	11/99	⇒ 09/02
OMEGA B 2.2 16V	Y22XE, Y22XE	09/99	⇒ 07/03
VAUXHALL			
ASTRA IV 2.0	X20XER	10/99	⇒ 08/00
ASTRA IV 2.0 16V	X20XE	02/98	⇒ 05/05
OMEGA B 2.2 16V	Y22XE, Z20LET	01/94	⇒ 06/03

9.0311



04

REVOLUTION AND TIMING (CKP AND CMP) SENSORS

Adatt./Suitable:

BOSCH
0 232 103 015**GENERAL MOTORS**
90 506 101
93 176 039**OPEL**
12 38 749
62 38 939
90506101
93176039**VAUXHALL**
90506101
93176039

L	L1	Hall Effect	
---	---		

OPEL			
ASTRA G 2.0 16V Turbo	Z20LET, Z20LET	09/00	⇒ 10/05
ASTRA G 2.0 OPC	Z20LET, Z20LEH	03/02	⇒ 10/05
ASTRA H 2.0 Turbo	Z20LEH, Z20LET	03/04	⇒ 10/10
SINTRA 2.2 i 16V	X22XE	11/96	⇒ 04/99
SPEEDSTER 2.0	Z20LET	10/03	⇒ 08/06
SPEEDSTER 2.0 Turbo	Z20LET	08/02	⇒ 08/06
ZAFIRA A 2.0 OPC	Z20LET, Z20LEH	09/01	⇒ 06/05
ZAFIRA B 2.0	Z20LEH, Z20LET	07/05	⇒ 12/10
VAUXHALL			
ASTRA IV 2.0	Z20LET	08/02	⇒ 10/05
ASTRA IV 2.0 16V Turbo	Z20LET	09/00	⇒ 08/05
ASTRA IV 2.0 SRI Turbo	Z20LET	11/01	⇒ 05/05
ASTRA IV 2.0 Turbo	Z20LET, Z20LEH	03/02	⇒ 10/05
ASTRA V 2.0	Z20LEH	02/06	⇒ 11/10
ASTRA V 2.0 Turbo	Z20LEH, Z20LEH	01/04	⇒ 11/10

VAUXHALL			
ASTRA V 2.0 VXR	Z20LEH	02/09	⇒ 11/10
SINTRA 2.2 i 16V	X22XE	11/96	⇒ 04/99
SPEEDSTER 2.0 Turbo	Z20LET	03/01	⇒ 09/06
SPEEDSTER VXR20	Z20LET	03/01	⇒ 09/06
VX220 2.0 i Turbo	Z20LET	03/01	⇒ 07/05
VX220 2.0 VXR	Z20LET	10/03	⇒ 07/05
ZAFIRA A 2.0	Z20LET	06/02	⇒ 06/05
ZAFIRA A 2.0 GSI Turbo	Z20LET	09/01	⇒ 06/05
ZAFIRA B 2.0	Z20LEH, X22SE	07/05	⇒ 11/14

9.0313



3

REVOLUTION AND TIMING (CKP AND CMP) SENSORS

Adatt./Suitable:

CHEVROLET
10456506**DAEWOO**
10456506**GENERAL MOTORS**
10 456 506**OPEL**
10456506
62 38 117**VAUXHALL**
10456506

L	L1	Hall Effect	
---	---		

DAEWOO			
NUBIRA 1.2.0 16V	X20SED	05/97	⇒
OPEL			
FRONTERA B 2.2 i	X22SE, X22SE	10/98	⇒ 07/04
VAUXHALL			
FRONTERA B 2.2 i	X22SE, C18SEL	10/98	⇒ 10/04

9.0314



04,5

REVOLUTION AND TIMING (CKP AND CMP) SENSORS

Adatt./Suitable:

GENERAL MOTORS
9 174 621
90 506 103**HOLDEN**
90506103**OPEL**
12 38 228
62 38 377
90506103
91 74 621**SIEMENS**
S103857002Z**VAUXHALL**
90506103
9174621

L	L1	Hall Effect	
840	24		

HOLDEN			
ASTRA_TR 1.8i 16V Hatchback	C18SEL	09/96	⇒ 09/98

HOLDEN			
ASTRA_TR 1.8i 16v Sedan	C18SEL	09/96	⇒ 09/98
OPEL			
ASTRA F 1.8 i 16V	C18SEL, C20SEL	07/94	⇒ 03/01
ASTRA F 2.0 i 16V	X20XE	02/95	⇒ 08/00
CALIBRA A 2.0 i 16V	X20XE	02/94	⇒ 07/97
CALIBRA A 2.0 i 16V 4x4	X20XE	02/94	⇒ 07/97
OMEGA B 2.0 16V	X20XE	03/94	⇒ 09/99
VECTRA 2.0	C20SEL	10/95	⇒ 04/02
VECTRA B 1.8 FlexFuel	X18XE	01/99	⇒ 09/00
VECTRA B 1.8 i 16V	X18XE	10/95	⇒ 09/00
VECTRA B 2.0 i 16V	C20SEL, X18XE	10/95	⇒ 07/03
VECTRA B 2.2 i 16V	C22SEL	07/00	⇒ 07/02

VAUXHALL			
ASTRA III 1.8 16V	X18XE	11/94	⇒ 03/01
ASTRA III 1.8 i 16V	X18XE	09/94	⇒ 02/98
ASTRA III 2.0 i 16V	X20XE	01/94	⇒ 09/98
CALIBRA 2.0 i 16V	X20XE	06/90	⇒ 07/97
CALIBRA 2.0 i 16V 4x4	X20XE	02/94	⇒ 07/97
OMEGA B 2.0 16V	X20XE	03/94	⇒ 07/01
VECTRA B 1.8 i 16V	X18XE, C16XE	09/95	⇒ 09/00
VECTRA B 2.0 Dualfuel	X20XE	05/98	⇒ 01/01
VECTRA B 2.0 i 16V	X20XE	10/95	⇒ 01/01

9.0315



04,5

REVOLUTION AND TIMING (CKP AND CMP) SENSORS

Adatt./Suitable:

GENERAL MOTORS
90 412 795**HOLDEN**
90412795**OPEL**
62 38 000
90412795**VAUXHALL**
90412795

L	L1	Hall Effect	
525	14,7		

HOLDEN			
BARINA 1.6	X16XE	05/97	⇒ 08/00
BARINA_SB 1.6i	C16XE, X14XE	04/94	⇒ 09/98

OPEL			
ASTRA F 1.4 i 16V	X14XE	01/96	⇒ 03/01
ASTRA F 1.6 i 16V	X16XEL	08/94	⇒ 01/05
ASTRA G 1.4	X14XE, X14XE	09/98	⇒ 04/05
ASTRA G 1.4 16V	X14XE, X14XE	02/98	⇒ 01/05
ASTRA G 1.4 LPG	X14XE, X16XEL	02/98	⇒ 01/05
ASTRA G 1.6 16V	X16XEL, X16XEL	02/98	⇒ 01/05
ASTRA G 1.6 LPG	X16XEL, C14SEL	03/98	⇒ 01/05
COMBO B 1.4 16V	X14XE	08/99	⇒ 10/01
CORSA B 1.4 i 16V	C14SEL, C16SEL	09/94	⇒ 12/02
CORSA B 1.6 GSI 16V	C16XE	03/93	⇒ 09/00
CORSA B 1.6 i 16V	C16SEL, X14XE	09/94	⇒ 09/00
TIGRA A 1.4 16V	X14XE, C16SEL	07/94	⇒ 12/00
TIGRA A 1.6 16V	C16SEL, X16XEL	07/94	⇒ 08/98
VECTRA B 1.6 i 16V	X16XEL, X16XEL	10/95	⇒ 07/02
ZAFIRA A 1.6 16V	X16XEL, X16XEL	04/99	⇒ 06/05
ZAFIRA A 1.6 LPG	X16XEL, X14XE	04/99	⇒ 06/05

VAUXHALL			
ASTRA III 1.4 i 16V	X14XE	01/96	⇒ 03/01
ASTRA III 1.6 i 16V	X16XEL	01/94	⇒ 09/98
ASTRA IV 1.4 16V	X14XE, X14XE	02/98	⇒ 05/05
ASTRA IV 1.4 16V Dualfuel	X14XE, X16XEL	09/99	⇒ 06/03
ASTRA IV 1.6 16V	X16XEL, X16XEL	02/98	⇒ 05/05
ASTRA IV 1.6 Dualfuel	X16XEL, X16XEL	09/99	⇒ 08/04
COMBO B 1.4 16V	X14XE	08/99	⇒ 10/01
CORSA B 1.4 i 16V	X14XE	09/94	⇒ 09/00
CORSA B 1.6 GSI 16V	C16XE	03/93	⇒ 09/00

VAUXHALL			
CORSA B 1.6 i 16V	X16XE	09/94 ⇒	09/00
TIGRA A 1.4 16V	X14XE	07/94 ⇒	12/00
TIGRA A 1.6 16V	X16XE	07/94 ⇒	12/00
VECTRA B 1.6 i 16V	X16XEL, X16XEL	08/95 ⇒	03/02
ZAFIRA A 1.6 16V	X16XEL, X14XE	04/99 ⇒	08/05
ZAFIRA A 1.6 Dualfuel	X16XEL	11/98 ⇒	08/05

9.0316



04,5

REVOLUTION AND TIMING (CKP AND CMP) SENSORS

Adatt./Suitable:
GENERAL MOTORS
10 456 585

OPEL
10456585
12 38 937

VAUXHALL
10456585



L	L1		
385	---	Hall Effect	

OPEL			
ASTRA G 1.4	X14XE, X14XE	09/98 ⇒	04/05
ASTRA G 1.4 16V	X14XE, C16SEL	02/98 ⇒	01/05
ASTRA G 1.6	C16SEL, X16XEL	09/98 ⇒	01/04
ASTRA G 1.6 16V	X16XEL, X16XEL	02/98 ⇒	10/05
ASTRA G 1.6 CNG	Z16YNG	03/03 ⇒	07/04
ASTRA G 1.6 LPG	X16XEL, Y16YNG	03/98 ⇒	01/05
ASTRA H 1.4 16V	Z14XE	05/04 ⇒	07/09
ASTRA H 1.6	Z16XE	06/04 ⇒	02/06
ASTRA H 1.6 16V	Z16XE	03/04 ⇒	01/08
COMBO C 1.6 CNG	Y16YNG, Y16YNG	04/05 ⇒	12/11
COMBO C 1.6 CNG 16V	Y16YNG, X16XEL	04/05 ⇒	
CORSA C 1.4	Z14XE	07/00 ⇒	
CORSA C 1.6 CNG	Y16YNG	05/03 ⇒	12/09
CORSA C 1.6 X	Z16YNG	08/05 ⇒	
MERIVA A 1.6 16V	Z16XE	05/03 ⇒	01/06
VECTRA B 1.6 i 16V	X16XEL, X16XEL	10/95 ⇒	07/02
VECTRA C 1.6	Z16XE	08/05 ⇒	08/08
VECTRA C 1.6 16V	Z16XE	06/04 ⇒	09/08
ZAFIRA A 1.6 16V	X16XEL, X14XE	09/02 ⇒	06/05
ZAFIRA A 1.6 CNG	Z16YNG	09/01 ⇒	06/05
ZAFIRA B 1.6 CNG	Z16YNG	07/05 ⇒	04/15

VAUXHALL			
ASTRA IV 1.4 16V	X14XE, X16XEL	02/98 ⇒	05/05
ASTRA IV 1.6 16V	X16XEL, X16XEL	02/98 ⇒	10/05
ASTRA IV 1.6 Dualfuel	X16XEL, Z16YNG	03/98 ⇒	05/05
ASTRAVAN II 1.4 16V	Z14XE	09/00 ⇒	05/05
ASTRAVAN II 1.6 Dualfuel	Z16XE	07/00 ⇒	08/05
COMBO C 1.4 16V	Z14XE	10/01 ⇒	05/07
COMBO C 1.6 CNG	Z16YNG, Y16YNG	04/05 ⇒	02/12
COMBO C 1.6 CNG 16V	Y16YNG, X16XEL	04/05 ⇒	02/12
CORSA C 1.4 16V	Z14XE	09/00 ⇒	10/06
MERIVA 1.6 i 16V	Z16XE	01/03 ⇒	09/05
VECTRA B 1.6 i 16V	X16XEL, X16XEL	08/95 ⇒	03/02
VECTRA C 1.6 16V	Z16XE	06/04 ⇒	07/08
ZAFIRA A 1.6 16V	X16XEL, X18XE1	04/99 ⇒	08/05
ZAFIRA A 1.6 CNG	Z16YNG	09/01 ⇒	06/05
ZAFIRA B 1.6 CNG	Z16YNG	07/05 ⇒	11/14

9.0317



04,5

REVOLUTION AND TIMING (CKP AND CMP) SENSORS

Adatt./Suitable:
GENERAL MOTORS
90 536 064

OPEL
12 38 425
90536064

SAAB
90 536 064

SIEMENS
5WK 96060

VAUXHALL
90536064

MARKET DIFFUSION: MEDIUM



L	L1		
355	---	Hall Effect	

OPEL			
ASTRA F 1.8 i	X18XE1	03/98 ⇒	08/00
ASTRA G 1.8	Z18XEL	02/03 ⇒	07/04
ASTRA G 1.8 16V	X18XE1, X18XE1	03/00 ⇒	10/05
ASTRA H 1.8	Z18XE	01/04 ⇒	10/10
CORSA C 1.8	Z18XE	09/00 ⇒	12/09
MERIVA A 1.8	Z18XE	05/03 ⇒	05/10
SIGNUM 1.8	Z18XE	05/03 ⇒	07/05
TIGRA B 1.8	Z18XE	06/04 ⇒	12/10
VECTRA B 1.8 i 16V	X18XE1, Z18XE	09/00 ⇒	07/03
VECTRA C 1.8	Z18XE	04/02 ⇒	07/08
VECTRA C 1.8 16V	Z18XE, X18XE1	04/02 ⇒	09/08
ZAFIRA A 1.8	Z18XEL	02/03 ⇒	06/05
ZAFIRA A 1.8 16V	X18XE1, X18XE1	09/00 ⇒	06/05
SAAB			
9-3 1.8 i	Z18XE	01/04 ⇒	02/15
VAUXHALL			
ASTRA IV 1.8 16V	X18XE1, Z18XE	02/98 ⇒	10/05
ASTRA IV 1.8 16V Dualfuel	Z18XE, X18XE1	07/02 ⇒	08/05
ASTRA V 1.8	Z18XE	01/04 ⇒	11/10
CORSA C 1.8 16V	Z18XE	08/00 ⇒	09/06
MERIVA I 1.8 i 16V	Z18XE	05/03 ⇒	06/10
SIGNUM 1.8	Z18XE	06/03 ⇒	07/05
TIGRA B 1.8	Z18XE	06/04 ⇒	08/09
VECTRA B 1.8 Dualfuel	Z18XE	09/00 ⇒	07/03
VECTRA B 1.8 i 16V	X18XE1, X18XE1	09/00 ⇒	07/03
VECTRA C 1.8	Z18XEL	04/02 ⇒	07/08
VECTRA C 1.8 16V	Z18XE	04/02 ⇒	07/08
VECTRA C 1.8 16V Dualfuel	Z18XE	04/02 ⇒	07/08
ZAFIRA A 1.8 16V	X18XE1, L7X720	09/00 ⇒	08/05
ZAFIRA A 1.8 Dualfuel	Z18XE	09/00 ⇒	08/05

9.0318



04,5

REVOLUTION AND TIMING (CKP AND CMP) SENSORS

Adatt./Suitable:

BOSCH
0 261 210 128

GENERAL MOTORS
92 062 490

OPEL
62 38 414



L	L1	ohm	
1000	24	1000	

OPEL			
FRONTERA A 2.2 i	X22XE	03/95 ⇒	10/98
VAUXHALL			
FRONTERA A 2.2 i	X22XE	03/95 ⇒	10/98

9.0319



3

REVOLUTION AND TIMING (CKP AND CMP) SENSORS

Adatt./Suitable:

RENAULT
60 25 403 357

- ⁰³ Supplied until depletion
- Fornibile fino ad esaurimento delle scorte
 - Fourni jusqu'à épuisement du stock
 - Lieferbar solange vorrat reicht
 - Suministrado hasta el stock termina



L	L1	ohm	
---	24	400	

RENAULT			
AVANTIME 3.0 V6	L7X720, L7X760	09/01 ⇒	05/03
AVANTIME 3.0i 24V	L7X722	05/01 ⇒	
CLIO II 3.0 RS V6	L7X760, L7X760	01/03 ⇒	
CLIO II 3.0 V6 Sport	L7X760, L7X760	11/00 ⇒	
CLIO IV 3.0 RS V6	L7X760, M02.2Y	03/13 ⇒	

9.0320



04,5

REVOLUTION AND TIMING (CKP AND CMP) SENSORS

Adatt./Suitable:

AUDI021 906 433 E
022 957 147 A**PORSCHE**955 606 147 00
955 606 433 00**VW**021 906 433 E
021 957 147
022 957 147 A

L	L1	ohm	OUT GND S
420	24	900	

AUDI

Q7 1.3.6 FSI quattro BHK 08/06 ⇒ 05/10

PORSCHE

CAYENNE I 3.2 M02.2Y, BFH 08/03 ⇒ 09/07

CAYENNE I 3.6 M55.01 02/07 ⇒ 09/10

VW

CARAVELLE 3.2 BDL 11/03 ⇒ 11/09

GOLF IV 3.2 R32 4motion BFH, BDL 09/02 ⇒ 06/05

MULTIVAN 3.2 V6 BDL, BKK 02/04 ⇒ 11/09

MULTIVAN 3.2 V6 4motion BKK, AYT 07/04 ⇒ 11/09

PHAETON 3.2 V6 AYT, BKL 04/02 ⇒ 05/05

PHAETON 3.2 V6 4motion BKL, CHNA 02/04 ⇒ 11/08

PHAETON 3.6 V6 4motion CHNA, AZZ 11/08 ⇒ 03/16

TOUAREG I 3.2 V6 AZZ, BDL 10/02 ⇒ 11/06

TOUAREG I 3.6 V6 FSI BHK 10/05 ⇒ 05/10

TRANSPORTER 3.2 BDL 03/04 ⇒ 06/05

TRANSPORTER IV 2.8 VR6 AMV 04/00 ⇒ 04/03

TRANSPORTER V 3.2 4motion BDL, BDL 11/03 ⇒ 11/09

TRANSPORTER V 3.2 V6 BDL, BKK 04/03 ⇒ 11/09

TRANSPORTER V 3.2 V6 4motion BKK, EDDB 11/03 ⇒ 11/09

9.0321



3,5

REVOLUTION AND TIMING (CKP AND CMP) SENSORS

Adatt./Suitable:

FORD3 023 785
4 628 032
6L8P-7H103-AA
6L8Z-7H103-AA
F8RP-7H103-AA**GENERAL MOTORS**

10 456 574



L	L1	ohm	GND OUT
---	37	680	

FORD

COUGAR 2.0 16V EDDB, LCBA 08/98 ⇒ 12/01

COUGAR 2.5 ST 200 SGA 01/00 ⇒ 12/01

COUGAR 2.5 V6 24V MABB 08/98 ⇒

COUGAR 2.5 V6 24V LCBA, AJ 06/00 ⇒ 12/01

MAVERICK 2.0 16V YF 02/01 ⇒

MAVERICK 2.3 16V GZ 03/04 ⇒

MAVERICK 3.0 V6 24V AJ, L1L 02/01 ⇒

MONDEO I 1.6 i L1J 08/96 ⇒ 09/00

MONDEO I 1.6 i 16V L1L, RKB 05/98 ⇒ 09/00

MONDEO I 1.8 i RKB, NGA 08/96 ⇒ 09/00

MONDEO I 1.8 TD RFN 08/96 ⇒ 09/00

MONDEO I 2.0 i NGA, SEA 08/96 ⇒ 09/00

MONDEO I 2.5 24V SEA, CGBA 08/96 ⇒ 09/00

MONDEO I 2.5 ST 200 SGA 05/99 ⇒ 09/00

MONDEO II 1.8 16V CGBA, CJBA 10/00 ⇒ 03/07

MONDEO II 1.8 SCi CFBA 06/03 ⇒ 03/07

MONDEO II 2.0 16V CJBA, D5BA 10/00 ⇒ 03/07

MONDEO II 2.0 16V DI / TDDi D5BA, D6BA 10/00 ⇒ 03/07

MONDEO II 2.0 16V TDDi / TDCi D6BA, -- 10/00 ⇒ 03/07

MONDEO II 2.0 TDCi --, QJBA 10/01 ⇒ 03/07

MONDEO II 2.2 TDCi QJBA, HWDA 09/04 ⇒ 03/07

MONDEO II 2.5 V6 24V LCBD 10/00 ⇒ 03/07

MONDEO II 3.0 V6 24V REBA 09/04 ⇒ 03/07

MONDEO II ST220 MEBA 04/02 ⇒ 03/07

9.0322



3,5

REVOLUTION AND TIMING (CKP AND CMP) SENSORS

Adatt./Suitable:

FORD3 043 998
4 617 387
4 882 780
5S4P-7H103-AA
8S4P-7H103-AA
XS4P-7H103-AB**GENERAL MOTORS**

10 456 576



L	L1	ohm	OUT GND
---	30	850	

FORD

C-MAX I 1.6 HWDA, G8DA 02/07 ⇒ 09/10

C-MAX I 1.6 TDCi G8DA, -- 02/07 ⇒ 09/10

C-MAX I 1.6 Ti-VCT --, QQDA 03/07 ⇒

C-MAX I 1.8 QQDA, AODA 02/07 ⇒ 09/10

C-MAX I 1.8 Flexifuel Q7DA 02/07 ⇒ 09/10

C-MAX I 1.8 TDCi KKDA 02/07 ⇒ 09/10

C-MAX I 2.0 AODA, G6DA 02/07 ⇒ 09/10

C-MAX I 2.0 CNG SYDA 04/09 ⇒ 09/10

C-MAX I 2.0 LPG SYDA 06/08 ⇒ 09/10

C-MAX I 2.0 TDCi G6DA, SNJA 02/07 ⇒ 09/10

FIESTA VI 1.25 SNJA, -- 06/08 ⇒

FIESTA VI 1.4 --, RTJA 06/08 ⇒

FIESTA VI 1.4 LPG RTJA, F6JB 01/09 ⇒

FIESTA VI 1.4 TDCi F6JB, HHJC 01/09 ⇒

FIESTA VI 1.6 TDCi HHJC, HXJA 06/08 ⇒

FIESTA VI 1.6 TDCi SOHC -- 02/10 ⇒

FIESTA VI 1.6 Ti HXJA, HWDA 06/08 ⇒

FOCUS I 1.4 16V FXDA, -- 10/98 ⇒ 11/04

FOCUS I 1.6 16V --, EYDB 02/99 ⇒ 11/04

FOCUS I 1.6 16V Flexifuel FYDH 01/02 ⇒ 11/04

FOCUS I 1.8 16V EYDB, BHDA 10/98 ⇒ 11/04

FOCUS I 1.8 BiFuel EYDL 02/03 ⇒ 01/05

FOCUS I 1.8 DI / TDDi BHDA, F9DA 08/99 ⇒ 11/04

FOCUS I 1.8 TDCi F9DA, BHDA 03/01 ⇒ 11/04

FOCUS I 1.8 Turbo DI / TDDi BHDA, EDDb 10/98 ⇒ 03/05

FOCUS I 2.0 16V EDDb, ASDA 10/98 ⇒ 11/04

FOCUS I RS HMDA 10/02 ⇒ 11/04

FOCUS I ST170 ALDA 03/02 ⇒ 11/04

FOCUS II 1.4 ASDA, HWDA 07/04 ⇒ 09/12

FOCUS II 1.6 HWDA, G8DA 07/04 ⇒ 09/12

FOCUS II 1.6 TDCi G8DA, HXDA 07/04 ⇒ 09/12

FOCUS II 1.6 Ti HXDA, Q7DA 07/04 ⇒ 09/12

FOCUS II 1.6 Ti-VCT -- 12/07 ⇒

FOCUS II 1.8 Q7DA, -- 03/06 ⇒ 09/12

FOCUS II 1.8 Flexifuel --, KKDA 12/05 ⇒ 09/12

FOCUS II 1.8 TDCi KKDA, AODA 07/04 ⇒ 09/12

FOCUS II 2.0 AODA, G6DA 07/04 ⇒ 09/12

FOCUS II 2.0 CNG SYDA 04/09 ⇒ 07/11

FOCUS II 2.0 LPG SYDA 06/08 ⇒ 07/11

FOCUS II 2.0 TDCi G6DA, KKDA 07/04 ⇒ 09/12

FOCUS II 2.5 RS JZDA 01/09 ⇒ 07/11

FOCUS II 2.5 ST HYDA 10/05 ⇒ 09/12

FOCUS C-MAX 1.6 HWDA, G8DA 10/03 ⇒ 03/07

FOCUS C-MAX 1.6 TDCi G8DA, HXDA 10/03 ⇒ 03/07

FOCUS C-MAX 1.6 Ti HXDA, CSDA 08/04 ⇒ 03/07

FOCUS C-MAX 1.8 CSDA, AODA 10/03 ⇒ 03/07

FOCUS C-MAX 1.8 Flexifuel Q7DA 01/06 ⇒ 03/07

FOCUS C-MAX 1.8 TDCi KKDA 01/05 ⇒ 03/07

FOCUS C-MAX 2.0 AODA, G6DA 03/04 ⇒ 03/07

FOCUS C-MAX 2.0 TDCi G6DA, FXDA 10/03 ⇒ 03/07

9.0323



REVOLUTION AND TIMING (CKP AND CMP) SENSORS

Adatt./Suitable:

- FORD**
- 1 131 913
- 1 135 856
- 1 323 872
- 1 385 381
- 1 385 382
- 1MSA-6C315-AB
- 1MSA-6C315-AC
- 1MSA-6C315-AD
- 1MSA-6C315-AE
- 1MSA-6C315-BA

MARKET DIFFUSION: MEDIUM



L	L1	ohm	OUT GND
---	34,5	530	

FORD		
C-MAX I 1.8 TDCi	KKDA, KKDA	02/07 ⇒ 09/10
FOCUS I 1.8 TDCi	F9DA, KKDA	03/01 ⇒ 03/05
FOCUS II 1.8 TDCi	KKDA, FFWA	07/04 ⇒ 09/12
FOCUS C-MAX 1.8 TDCi	KKDA, F9DA	01/05 ⇒ 03/07
GALAXY II 1.8 TDCi	FFWA, FFBA	05/06 ⇒ 06/15
MONDEO III 1.8 TDCi	FFBA, FFWA	03/07 ⇒ 01/15
S-MAX I 1.8 TDCi	FFWA, HCPA	05/06 ⇒ 12/14
TOURNEO CONNECT I 1.8 TDCi	HCPA, BHPA	06/02 ⇒ 12/13
TOURNEO CONNECT I 1.8 TDCi /TDDi /DI	BHPA, BHPA	06/02 ⇒ 12/13
TRANSIT CONNECT I 1.8 Di	BHPA, HCPA	06/02 ⇒ 12/13
TRANSIT CONNECT I 1.8 TDCi	HCPA, F9Q732	06/02 ⇒ 12/13

9.0324



REVOLUTION AND TIMING (CKP AND CMP) SENSORS

Adatt./Suitable:

- RENAULT**
- 77 00 300 992



L	L1	ohm	GND OUT
---	24	840	

RENAULT		
LAGUNA I 1.9 dTi	F9Q717	10/97 ⇒ 03/01
MEGANE I 1.9 dCi	F9Q732, F8Q784	02/01 ⇒ 08/03
MEGANE I 1.9 dTi	F8Q784, F9Q732	03/97 ⇒ 03/01
MEGANE 1.9 dCi	F9Q732, F9Q732	04/01 ⇒ 07/03
SCÉNIC I 1.9 dCi	F9Q732, F9Q731	09/99 ⇒ 08/03
SCÉNIC I 1.9 dTi	F9Q731, Z17DTH	09/99 ⇒ 08/03

9.0326



REVOLUTION AND TIMING (CKP AND CMP) SENSORS

Adatt./Suitable:

- BOSCH**
- 0 281 002 486
- 0 281 002 717
- GENERAL MOTORS**
- 97 226 992
- HONDA**
- 37841-PLZ-D00
- ISUZU**
- 8-97226992-0
- 8-97226992-1
- 8-97376977-1
- 8-97378846-0
- OPEL**
- 62 35 607
- 97226992
- VAUXHALL**
- 97226992

MARKET DIFFUSION: MEDIUM



L	L1	ohm	S GND OUT
235	37	900	

HONDA		
CIVIC VII 1.7 CTDi	4EE-2	01/02 ⇒ 09/05
OPEL		
ASTRA G 1.7 CDTi	Z17DTL	04/03 ⇒ 12/09
ASTRA H 1.7 CDTi	Z17DTH, Z17DTH	03/04 ⇒ 10/10
VAUXHALL		
ASTRA IV 1.7 CDTi 16V	Z17DTL	04/03 ⇒ 05/05
ASTRA V 1.7 CDTi	Z17DTH, Z17DTH	01/04 ⇒ 11/10
ASTRAVAN II 1.7 CDTi	Z17DTL	04/04 ⇒ 08/06
ASTRAVAN III 1.7 CDTi	Z17DTH, X18XE1	03/05 ⇒ 11/11

9.0327



REVOLUTION AND TIMING (CKP AND CMP) SENSORS

Adatt./Suitable:

- GENERAL MOTORS**
- 9 115 115
- OPEL**
- 12 38 223
- 91 15 115
- SAAB**
- 91 15 115
- SIEMENS**
- 5WK 91711
- S107541001Z
- VAUXHALL**
- 9115115

MARKET DIFFUSION: MEDIUM



L	L1	ohm	GND OUT
---	39	1400	

OPEL		
ASTRA G 1.8	Z18XEL	02/03 ⇒ 07/04
ASTRA G 1.8 16V	Z18XE	06/00 ⇒ 10/05
ASTRA H 1.8	Z18XE	01/04 ⇒ 10/10
CORSA C 1.8	Z18XE	09/00 ⇒ 12/09
MERIVA A 1.8	Z18XE	05/03 ⇒ 05/10
SIGNUM 1.8	Z18XE	05/03 ⇒ 07/05
TIGRA B 1.8	Z18XE	06/04 ⇒ 12/10
VECTRA B 1.8 i 16V	X18XE1, Z18XE	09/00 ⇒ 07/03
VECTRA C 1.8	Z18XE	04/02 ⇒ 07/08
VECTRA C 1.8 16V	Z18XE, Z18XE	04/02 ⇒ 09/08
ZAFIRA A 1.8	Z18XEL	02/03 ⇒ 06/05
ZAFIRA A 1.8 16V	Z18XE	09/00 ⇒ 06/05
SAAB		
9-3 1.8 i	Z18XE	01/04 ⇒ 02/15
VAUXHALL		
ASTRA IV 1.8 16V	Z18XE	02/98 ⇒ 10/05
ASTRA IV 1.8 16V Dualfuel	Z18XE, Z18XE	07/02 ⇒ 08/05
ASTRA V 1.8	Z18XE	01/04 ⇒ 11/10
CORSA C 1.8 16V	Z18XE	08/00 ⇒ 09/06
MERIVA I 1.8 i 16V	Z18XE	05/03 ⇒ 06/10
SIGNUM 1.8	Z18XE	06/03 ⇒ 07/05
TIGRA B 1.8	Z18XE	06/04 ⇒ 08/09
VECTRA B 1.8 Dualfuel	Z18XE	09/00 ⇒ 07/03
VECTRA B 1.8 i 16V	Z18XE, F4R760	09/00 ⇒ 07/03
VECTRA C 1.8	Z18XEL	04/02 ⇒ 07/08
VECTRA C 1.8 16V	Z18XE	04/02 ⇒ 07/08
VECTRA C 1.8 16V Dualfuel	Z18XE	04/02 ⇒ 07/08
ZAFIRA A 1.8 16V	Z18XE	09/00 ⇒ 08/05
ZAFIRA A 1.8 Dualfuel	Z18XE	09/00 ⇒ 08/05

9.0328



04,5

REVOLUTION AND TIMING (CKP AND CMP) SENSORS

Adatt./Suitable:

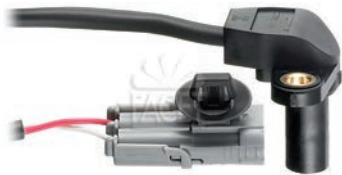
RENAULT
82 00 128 449

L	L1	ohm	GND OUT
340	32,5	230	

RENAULT

Model	Part No.	Year Range
AVANTIME 2.0 16V Turbo	F4R760, F4R786	11/01 ⇨ 05/03
LAGUNA II 2.0 16V	F4R713	09/02 ⇨ 05/05
LAGUNA II 2.0 16V Turbo	F4R786, F4R760	01/03 ⇨ 08/05
MEGANE I 1.8 16V	F4P775	01/99 ⇨ 11/02
MEGANE I 2.0 16V	F4R760, F4R770	11/00 ⇨
MEGANE II 2.0	F4R770, F4R770	09/03 ⇨
SCÉNIC II 2.0	F4R770, F4R762	06/03 ⇨ 07/10
VEL SATIS 2.0 16V Turbo	F4R762, DW10TD	06/02 ⇨

9.0331



3,5

REVOLUTION AND TIMING (CKP AND CMP) SENSORS

Adatt./Suitable:

BOSCH
0 232 103 017
GENERAL MOTORS
90 540 744
OPEL
12 38 742
90540744
VAUXHALL
90540744

L	L1	Hall Effect	+ OUT -
230	13,8		

OPEL

Model	Part No.	Year Range
OMEGA B 2.5 V6	X25XE	03/94 ⇨ 09/00
OMEGA B 3.0 V6	X30XE	04/94 ⇨ 02/01
SINTRA 3.0 i 24V	X30XE	11/96 ⇨ 04/99

VAUXHALL

Model	Part No.	Year Range
OMEGA B 2.5 V6	X25XE	03/94 ⇨ 09/00
OMEGA B 3.0 V6	X30XE	04/94 ⇨ 07/00
SINTRA 3.0 i 24V	X30XE	11/96 ⇨ 04/99

9.0332



3

REVOLUTION AND TIMING (CKP AND CMP) SENSORS

Adatt./Suitable:

CITROËN
1920 ES
96 435 790 80
FIAT
9643579080
PEUGEOT
1920 ES

L	L1	Hall Effect	+ OUT -
---	23,2		

CITROËN

Model	Part No.	Year Range
JUMPER I 2.0 HDI	RHV(DW10UTD)	11/01 ⇨ 04/02
JUMPER II 2.0 HDi	DW10TD, 4HY(DW12UTED)	04/02 ⇨
JUMPER II 2.2 HDi	4HY(DW12UTED), DW10BTED	02/02 ⇨
JUMPY I 2.0 HDi 110	RHZ(DW10BTED+)	03/00 ⇨ 10/06
JUMPY I 2.0 HDi 95	DW10BTED, DW10TD	10/99 ⇨ 10/06

FIAT

Model	Part No.	Year Range
DUCATO II 2.0 JTD	RHV(DW10)	07/01 ⇨
SCUDO I 2.0 JTD	RHZ	12/99 ⇨ 12/06

PEUGEOT

Model	Part No.	Year Range
BOXER I 2.0 HDi	DW10TD, 4HY(DW12UTED)	08/01 ⇨
BOXER I 2.2 HDi	4HY(DW12UTED), QQDA	04/02 ⇨
EXPERT I 2.0 HDI	RHZ(DW10BTED+)	07/00 ⇨ 12/06

9.0333



3,5

REVOLUTION AND TIMING (CKP AND CMP) SENSORS

Adatt./Suitable:

BOSCH
0 986 280 443
FORD
1 119 150
1 129 988
157F-6C315-AD
157F-6D315-AA
157F-GC315-AD
MAZDA
LF01-18-221
VOLVO
30658179
31422276

MARKET DIFFUSION: MEDIUM



L	L1	ohm	GND OUT
---	6	400	

FORD

Model	Part No.	Year Range
C-MAX I 1.8	QQDA, AODA	02/07 ⇨ 09/10
C-MAX I 1.8 Flexifuel	Q7DA	02/07 ⇨ 09/10
C-MAX I 2.0	AODA, SYDA	02/07 ⇨ 09/10
C-MAX I 2.0 CNG	SYDA, CSDA	04/09 ⇨ 09/10
C-MAX I 2.0 LPG	SYDA	06/08 ⇨ 09/10
ECOSPORT 2.0 4x4	C20HDEA	08/12 ⇨
FIESTA V ST150	NAJB	03/05 ⇨ 06/08
FOCUS II 1.8	Q7DA, --	03/06 ⇨ 09/12
FOCUS II 1.8 Flexifuel	--, AODA	12/05 ⇨ 09/12
FOCUS II 2.0	AODA, SYDA	07/04 ⇨ 09/12
FOCUS II 2.0 CNG	SYDA, Q7DA	04/09 ⇨ 07/11
FOCUS II 2.0 Flex	SYDA	10/08 ⇨ 03/10
FOCUS II 2.0 LPG	SYDA	06/08 ⇨ 07/11
FOCUS II CASSONE / FURGONATO / PROMISCOU 1.8 Flexifuel	Q7DA, AOWA	06/09 ⇨ 07/11
FOCUS C-MAX 1.8	CSDA, AODA	10/03 ⇨ 03/07
FOCUS C-MAX 1.8 Flexifuel	Q7DA	01/06 ⇨ 03/07
FOCUS C-MAX 2.0	AODA, Q7DA	03/04 ⇨ 03/07
FUSION 2.0	--	11/04 ⇨
GALAXY II 2.0	AOWA, TBWA	05/06 ⇨ 06/15
GALAXY II 2.0 Flexifuel	TBWA, GZ	05/06 ⇨ 06/15
MAVERICK 2.3	--	05/06 ⇨
MAVERICK 2.3 16V	GZ, CGBA	03/04 ⇨
MONDEO II 1.8 16V	CGBA, CJBA	10/00 ⇨ 03/07
MONDEO II 2.0 16V	CJBA, AOBA	10/00 ⇨ 03/07
MONDEO III 2.0	AOBA, TBBA	03/07 ⇨ 01/15
MONDEO III 2.0 Flexifuel	TBBA, AODA	03/09 ⇨ 01/15
MONDEO III 2.0 LPG	TBBA	07/09 ⇨ 01/15
MONDEO 2.0	AOBC	03/07 ⇨ 09/14
S-MAX I 2.0	AODA, TBWA	05/06 ⇨ 12/14
S-MAX I 2.0 EcoBoost	TNWA	03/10 ⇨ 12/14
S-MAX I 2.0 Flexifuel	TBWA, LF17	05/06 ⇨ 12/14

MAZDA

Model	Part No.	Year Range
3 I 2.0	LF17, LFD7	09/03 ⇨ 12/09
5 I 1.8	L823	02/05 ⇨ 05/10
5 I 2.0	LFD7, G4AC	02/05 ⇨ 05/10
5 I 2.0 CD	RF7J	02/05 ⇨ 05/10

VOLVO

Model	Part No.	Year Range
C30 1.8	B4184S11	10/06 ⇨ 12/12
C30 1.8 FlexFuel	B4184S8	01/07 ⇨ 12/12
C30 2.0	B4204S3	10/06 ⇨ 12/12
C30 2.0 FlexFuel	B4204S4	01/10 ⇨ 12/12
S40 II 1.8	B4184S11	04/04 ⇨ 12/10
S40 II 1.8 FlexFuel	B4184S8	01/06 ⇨ 12/10
S40 II 2.0	B4204S3	10/06 ⇨ 12/12
S40 II 2.0 F	B4204S4	10/09 ⇨ 12/12
S80 II 2.0	B4204S3	01/08 ⇨ 09/12
S80 II 2.0 FlexFuel	B4204S4	01/08 ⇨ 12/11

VOLVO			
V50 1.8	B4184511	04/04 ⇒	12/10
V50 1.8 BiFuel	B418458	01/09 ⇒	09/10
V50 1.8 FlexFuel	B418458	01/05 ⇒	12/10
V50 2.0	B420453	10/06 ⇒	12/12
V50 2.0 FlexFuel	B420454	01/10 ⇒	12/12
V70 III 2.0	B420453	10/07 ⇒	12/11
V70 III 2.0 FlexiFuel	B420454	01/08 ⇒	12/11

9.0335



3

REVOLUTION AND TIMING (CKP AND CMP) SENSORS

Adatt./Suitable:

HYUNDAI
39310-38050

KIA
39310-38050

MITSUBISHI
J5T23071
J5T23071A
MD327107

VOLVO
30874179

MARKET DIFFUSION: MEDIUM



L	L1		
---	27	Hall Effect	

HYUNDAI

ATOS 1.0 i	G4AC, G4HD	03/01 ⇒	07/03
ATOS 1.1	G4HD, G4HD	06/03 ⇒	12/10
ATOS PRIME 1.0 i	G4HC-E	03/01 ⇒	07/03
ATOS PRIME 1.1	G4HD, G4HD	08/03 ⇒	12/08
GETZ 1.1	G4HD, G4CS	09/02 ⇒	06/09
H-1 I 2.4	G4CS, G4CS	03/00 ⇒	04/04
H-1 I 2.4 4WD	G4CS, G4JS	06/01 ⇒	04/04
H1 2.4 [ExtraEU]	G4JS	11/01 ⇒	08/07
H200 2.4	G4CS	09/00 ⇒	10/06
HIGHWAY VAN 2.0 16V	G4CPDOHC	03/00 ⇒	03/04
HIGHWAY VAN 2.0 CVT	G4GC	11/03 ⇒	03/04
SANTA FE I 2.0	G4JP	08/01 ⇒	03/06
SANTA FE I 2.4 16V	G4JS, G4JS	02/01 ⇒	03/06
SANTA FE I 2.4 16V 4x4	G4JS, G4JP	02/01 ⇒	03/06
SANTRO 1.1	G4HD	01/03 ⇒	
SONATA IV 2.0 16V	G4JP, G4CPDOHC	10/01 ⇒	11/04
SONATA IV 2.4 16V	G4BS	03/98 ⇒	10/01
SONATA V 2.0 [RUS]	--	01/05 ⇒	04/06
TRAJET 2.0	G4CPDOHC, 4G13(16V)	03/00 ⇒	07/08

KIA

MAGENTIS I 2.0	G4JP	05/01 ⇒	09/05
MAGENTIS I 2.4 [USA]	--	01/01 ⇒	12/04
MAGENTIS I 2.5 V6	G6BV	05/01 ⇒	
PICANTO I 1.0	G4HE	04/04 ⇒	
PICANTO I 1.1	G4HG	04/04 ⇒	
SORENTO I 2.4	G4JS	08/02 ⇒	

MITSUBISHI

CARISMA 1.3	4G13S	09/00 ⇒	10/04
CARISMA 1.3 16V	4G13(16V), 4G92	09/00 ⇒	10/04
CARISMA 1.6	4G92, 4G93	09/00 ⇒	06/06
CARISMA 1.8	4G93, 4G93(GDI)	07/95 ⇒	09/97
CARISMA 1.8 16V GDI	4G93(GDI), 4G93(GDI)	09/97 ⇒	06/06
CARISMA 1.8 GDI	4G93(GDI), 4G93(DOHC16V)	10/00 ⇒	06/06
CARISMA 1.8 MSX - 16V	4G93(DOHC16V), 4G13(16V)	07/95 ⇒	07/97
COLT V 1.3	4G19	08/02 ⇒	09/03
COLT V 1300	4G13(16V), 4G13(12V)	06/00 ⇒	09/03

MITSUBISHI

COLT V 1300 GL, GLX	4G13(12V), 4G92	05/96 ⇒	06/00
COLT V 1600	4G92, 4G92	09/00 ⇒	09/03
COLT V 1600 GLX	4G92, 4G63(SOHC16V)	05/96 ⇒	09/00
ECLIPSE II 2.0 Turbo	4G63-T(DOHC16V)	04/94 ⇒	04/99
ECLIPSE II 2000 GS 16V	4G63DOHC	12/95 ⇒	04/99
ECLIPSE II 2000 GT 16V	4G63DOHC	12/95 ⇒	04/99
GALANT VIII 2.0	4G63(SOHC16V), 4G64(GDI)	09/00 ⇒	10/04
GALANT VIII 2.4 GDI	4G64(GDI), 4G64(GDI)	09/00 ⇒	10/04
GRANDIS 2.0	4G63(SOHC8V)	04/04 ⇒	
GRANDIS 2.4 GDI GLX	4G64(GDI), 4G64(GDI)	08/00 ⇒	05/03
GRANDIS 2.4 GDI GLX 4WD	4G64(GDI), 4G64(16V)	08/00 ⇒	05/03
L200 III 2.4 4WD	4G64(16V), 4G63Turbo	06/96 ⇒	12/07
L200 IV 2.4 i	4G64(16V)	11/05 ⇒	12/15
LANCER VII 1.6 16V	4G92(SOHC16V)	12/95 ⇒	08/03
LANCER VII 2.0 16V EVO IV	4G63Turbo	08/96 ⇒	06/97
LANCER VII EVO V	4G63Turbo, 4G13(16V)	01/98 ⇒	12/98
LANCER VII EVO VI	4G63Turbo	01/99 ⇒	02/01
LANCER VIII 1.3	4G13(16V), 4G63DOHC	09/03 ⇒	12/13
LANCER VIII 1.6	4G18	09/03 ⇒	12/13
LANCER VIII 2.0	4G63DOHC	09/03 ⇒	12/13
LANCER VIII EVO IX	4G63DOHC, 4G63(DOHC16V)	01/05 ⇒	10/08
LANCER VIII EVO IX - FQ-300	4G63DOHC	06/05 ⇒	12/06
LANCER VIII EVO IX - FQ-340	4G63DOHC	06/05 ⇒	12/07
LANCER VIII EVO IX - FQ-360	4G63DOHC	07/06 ⇒	12/07
LANCER VIII EVO VIII	4G63DOHC	04/03 ⇒	03/05
LANCER VIII EVO VIII - 260	4G63DOHC	03/04 ⇒	07/05
LANCER VIII EVO VIII - FQ-300	4G63DOHC	04/03 ⇒	04/04
LANCER VIII EVO VIII - FQ-320	4G63DOHC	04/04 ⇒	08/06
LANCER VIII EVO VIII - FQ-330	4G63DOHC	10/03 ⇒	08/06
LANCER VIII EVO VIII - FQ-340	4G63DOHC	04/04 ⇒	03/05
LANCER VIII EVO VIII - FQ-400	4G63DOHC	10/04 ⇒	08/06
LANCER 2.0	4G63DOHC	04/04 ⇒	08/06
OUTLANDER I 2.0	4G63(DOHC16V), 4G63(DOHC16V)	05/03 ⇒	10/06
OUTLANDER I 2.0 4WD	4G63(DOHC16V), 4G63DOHC	05/03 ⇒	10/06
OUTLANDER I 2.0 Turbo 4WD	4G63DOHC, 4G63Turbo	04/04 ⇒	10/06
OUTLANDER I 2.0 Turbo-R 4WD	4G63Turbo, --	01/02 ⇒	10/06
SPACE RUNNER 2.0	--, 4G64(GDI)	01/92 ⇒	08/02
SPACE RUNNER 2.4	--	01/92 ⇒	12/01
SPACE RUNNER 2.4 GDI	4G64(GDI), 4G13(16V)	08/99 ⇒	01/03
SPACE STAR 1.3 16V	4G13(16V), 4G93(GDI)	09/00 ⇒	12/04
SPACE STAR 1.6 16V	4G18	01/01 ⇒	12/04
SPACE STAR 1.8 GDI	4G93(GDI), 4G93	06/98 ⇒	12/04
SPACE STAR 1.8 MPI	4G93, 4G63S	10/02 ⇒	12/04
SPACE WAGON 2.0	4G63S, 4G64(GDI)	10/98 ⇒	12/04
SPACE WAGON 2.4 GDI	4G64(GDI), 4G64(GDI)	09/00 ⇒	12/04
SPACE WAGON 2.4 GDI 4WD	4G64(GDI), B4184SJ	09/00 ⇒	12/04

VOLVO

S40 I 1.8 i	B4184SJ, B4184SJ	06/01 ⇒	12/03
V40 I 1.8 i	B4184SJ, Z16SE	06/01 ⇒	06/04

9.0337



3

REVOLUTION AND TIMING (CKP AND CMP) SENSORS

Adatt./Suitable:

GENERAL MOTORS
97 180 388

MITSUBISHI
J5T23381

OPEL
62 38 153
97180388

VAUXHALL
97180388

L	L1		
---	26,6	Hall Effect	

OPEL

ASTRA G 1.7 DTI 16V	Y17DT	02/00 ⇒	04/05
COMBO C 1.7 DI 16V	Y17DTL	10/01 ⇒	
COMBO C 1.7 DTI 16V	Y17DT	10/01 ⇒	
CORSA C 1.7 DI	Y17DTL	09/00 ⇒	12/09
CORSA C 1.7 DI 16V	Y17DTL	09/00 ⇒	07/03
CORSA C 1.7 DTI	Y17DT	09/00 ⇒	
CORSA C 1.7 DTI 16V	Y17DT	09/00 ⇒	07/03
MERIVA A 1.7 DTI	Y17DT	09/03 ⇒	05/10

VAUXHALL

ASTRA IV 1.7 DTI 16V	Y17DT	02/00 ⇒	05/05
ASTRAVAN II 1.7 DTI 16V	Y17DT	04/01 ⇒	08/06
COMBO C 1.7 DI 16V	Y17DTL	09/01 ⇒	11/11
COMBO C 1.7 DTI 16V	Y17DT	10/01 ⇒	02/12
CORSA C 1.7 DI 16V	Y17DTL	08/00 ⇒	09/06
CORSA C 1.7 DTI 16V	Y17DT	08/00 ⇒	09/06
CORSAVAN II 1.7 DI 16V	Y17DTL	09/00 ⇒	06/06
CORSAVAN II 1.7 DTI 16V	Y17DT	09/00 ⇒	06/06
MERIVA I 1.7 DTI	Y17DT	06/03 ⇒	06/10

9.0343



3

REVOLUTION AND TIMING (CKP AND CMP) SENSORS

Adatt./Suitable:

GENERAL MOTORS

10 456 592

OPEL10456592
12 36 308**VAUXHALL**

10456592



L	L1		
---	24	Hall Effect	

OPEL

ASTRA G 1.6	Z16SE	09/00 ⇨ 04/05
COMBO C 1.6	Z16SE	10/01 ⇨
CORSA C 1.6	Z16SE	09/00 ⇨
MERIVA A 1.6	Z16SE	05/03 ⇨ 05/10

VAUXHALL

ASTRA IV 1.6	Z16SE	03/98 ⇨ 05/05
ASTRA IV 1.6 Dualfuel	Z16SE, Z16SE	07/00 ⇨ 05/05
ASTRAVAN II 1.6 Dualfuel	Z16SE	09/00 ⇨ 10/04
ASTRAVAN II 1.6 i	Z16SE	09/00 ⇨ 08/06
COMBO C 1.6	Z16SE, 176B2.000	09/01 ⇨ 11/11
MERIVA I 1.6 i	Z16SE	01/03 ⇨ 06/10

9.0344



3

REVOLUTION AND TIMING (CKP AND CMP) SENSORS

Adatt./Suitable:

BOSCH0 232 103 033
0 232 103 034
0 232 103 039
0 232 103 040
0 232 103 041
0 232 103 045
0 281 002 406
0 281 002 407**FIAT**

46786049

FORD1 222 677
2S7G-12K073-AA**GENERAL MOTORS**

97 306 560

HONDA37501-PLZ-D00
37841-RBD-E01**ISUZU**

8-97306560-1

MINI

13 62 7 791 127

NISSAN

23731-1F710

OPEL62 35 604
97306560**PORSCHE**

996 606 106 03

TOYOTA90080-19026
90919-05055**VAUXHALL**

97306560

VOLVO

863153-3

MARKET DIFFUSION: HIGH



L	L1		
---	24	Hall Effect	

FIAT

DOBLO I 1.2	223A5.000	03/01 ⇨
DOBLO I 1.6	182B6.000	09/02 ⇨
DOBLO I 1.6 Natural Power	182B6.000	09/02 ⇨
PANDA I 1100	187A1.000	02/95 ⇨ 09/03
PANDA I 1100 i.e. 4x4	187A1.000	12/00 ⇨
PUNTO II 1.2	188A4.000	06/03 ⇨
PUNTO II 1.2 60	188A4.000	09/99 ⇨ 12/10
PUNTO II 1.2 Bifuel	188A4.000	08/07 ⇨ 03/12
PUNTO II 1.2 Bipower	188A4.000	08/01 ⇨ 05/03
PUNTO II 1.2 Natural Power	188A4.000	09/03 ⇨ 03/12
SEICENTO / 600 1.1	176B2.000, 178B5.000	01/98 ⇨ 01/10
STRADA 1.2	178B5.000, 1ND	04/03 ⇨
STRADA 1.9 D	223A6.000	12/00 ⇨

FORD

MONDEO II 1.8 SCi	CFBA	06/03 ⇨ 03/07
-------------------	------	---------------

HONDA

ACCORD VII 2.2 i-CTDi	N22A1	01/04 ⇨ 05/08
CIVIC VII 1.7 CTDi	4EE-2	01/02 ⇨ 09/05
CR-V II 2.2 CTDi	N22A2	02/05 ⇨ 09/06
FR-V 2.2 i CTDi	N22A1	07/05 ⇨

MINI

MINI I One D	1ND, CG10DE	06/03 ⇨ 09/06
--------------	-------------	---------------

NISSAN

MICRA II 1.0 i 16V	CG10DE, M96.21	09/00 ⇨ 02/03
MICRA II 1.4 i 16V	CGA3DE	09/00 ⇨ 02/03

OPEL

ASTRA G 1.7 CDTi	Z17DTL	04/03 ⇨ 12/09
ASTRA H 1.7 CDTi	Z17DTL	03/04 ⇨ 10/10

PORSCHE

911 IV 3.6	M96.03	12/01 ⇨ 08/05
------------	--------	---------------

PORSCHE

911 IV 3.6 Carrera	M96.03	10/01 ⇨ 08/05
911 IV 3.6 Carrera 4	M96.03	10/01 ⇨ 08/05
911 IV 3.6 Carrera 4S	M96.03	06/02 ⇨ 08/05
911 IV 3.6 Carrera S	M96.03	06/02 ⇨ 08/05
911 IV 3.6 GT3	M96.79	03/03 ⇨ 08/05
BOXSTER I 2.7	M96.23	07/02 ⇨ 12/04
BOXSTER I S 3.2	M96.24	07/02 ⇨ 12/04
BOXSTER I S 3.2	M96.21, 1ND-TV	01/04 ⇨ 12/04
CARRERA GT 5.7	M80.01	07/03 ⇨ 12/06

TOYOTA

AURIS I 1.4 D-4D	1ND-TV	03/07 ⇨ 04/13
COROLLA IX 1.4 D	1ND-TV	07/04 ⇨ 02/07
COROLLA IX 1.4 D-4D	1ND-TV	06/04 ⇨ 10/06
COROLLA IX 1.4 D4-D	1ND-TV	06/04 ⇨ 10/07
COROLLA X 1.4 D-4D	1ND-TV	10/06 ⇨ 07/14
FUNCARGO 1.4 D4d	1ND-TV	09/00 ⇨ 09/05
YARIS I 1.4 D-4D	1ND-TV, D5244T2	10/01 ⇨ 10/05
YARIS II 1.4 D-4D	1ND-TV	08/05 ⇨ 12/12
YARIS VERSO 1.4 D-4D	1ND-TV	10/01 ⇨ 09/05
YARIS 1.4 D4d	1ND-TV	10/01 ⇨ 09/05

VAUXHALL

ASTRA IV 1.7 CDTi 16V	Z17DTL	04/03 ⇨ 05/05
ASTRA V 1.7 CDTi	Z17DTH	01/04 ⇨ 11/10
ASTRAVAN II 1.7 CDTi	Z17DTL	04/04 ⇨ 08/06
ASTRAVAN III 1.7 CDTi	Z17DTL	03/05 ⇨ 07/06

VOLVO

S60 I 2.4 CDI	D5244T3	10/03 ⇨ 12/05
S60 I 2.4 D	D5244T2	05/01 ⇨ 04/10
S60 I 2.4 D5	D5244T	01/01 ⇨ 04/10
S80 I 2.4 D	D5244T2	10/01 ⇨ 07/06
S80 I 2.4 D5	D5244T	08/01 ⇨ 07/06
V70 II 2.4 D	D5244T2, D5244T	07/01 ⇨ 08/07
V70 II 2.4 D5	D5244T	01/01 ⇨ 12/08
V70 II 2.4 D5 AWD	D5244T, X12XE	07/02 ⇨ 08/07
XC70 I 2.4 D5 XC AWD	D5244T	09/02 ⇨ 08/07
XC90 I D5 AWD	D5244T	10/02 ⇨ 12/06

9.0346



3

REVOLUTION AND TIMING (CKP AND CMP) SENSORS

Adatt./Suitable:

BOSCH

0 232 103 021

GENERAL MOTORS9 118 374
90 560 111**OPEL**62 38 110
90560111
91 18 374**VAUXHALL**

9118374

MARKET DIFFUSION: MEDIUM



L	L1		
---	20,3	Hall Effect	

OPEL

AGILA A 1.0 12V	Z10XE	09/00 ⇨ 12/07
AGILA A 1.2 16V	Z12XE	09/00 ⇨ 12/07
ASTRA G 1.2	X12XE	09/98 ⇨ 08/00
ASTRA G 1.2 16V	X12XE, Z14XEL	09/00 ⇨ 01/05
ASTRA H 1.4	Z14XEL, Z10XE	03/04 ⇨ 10/10
ASTRA H 1.4 EcoTec	Z14XEP	12/04 ⇨ 12/12
ASTRA H 1.4 LPG	Z14XEP	08/09 ⇨ 10/10
COMBO C 1.4	Z14XEP	10/04 ⇨ 12/11
COMBO C 1.4 16V	Z14XEP	08/05 ⇨
CORSA B 1.0 i 12V	X10XE	11/96 ⇨ 09/00
CORSA B 1.2 i 16V	X12XE	03/98 ⇨ 09/00

OPEL			
CORSA C 1.0	Z10XE, X12XE	09/00 ⇒ 12/09	
CORSA C 1.2	Z12XE	09/00 ⇒ 12/09	
CORSA C 1.2 16V	Z12XE	09/00 ⇒ 07/03	
CORSA C 1.4 Twinport	Z12XEP	07/04 ⇒ 12/09	
CORSA C 1.4	Z14XEP	08/03 ⇒ 06/12	
CORSA C 1.4 Twinport	Z14XEP	06/03 ⇒ 12/09	
MERIVA A 1.4 16V Twinport LPG	Z14XEP	07/04 ⇒ 05/10	
TIGRA B 1.4	Z14XEP	06/04 ⇒ 12/10	
VAUXHALL			
AGILA A 1.0 12V	Z10XE	09/00 ⇒ 08/05	
AGILA A 1.2 16V	Z12XE	09/00 ⇒ 03/08	
AGILA A 1.3 CDTI	Z13DT	08/03 ⇒ 03/08	
ASTRA IV 1.2 16V	X12XE, Z14XEL	09/00 ⇒ 05/05	
ASTRA V 1.4	Z14XEL, Z10XE	01/04 ⇒ 10/10	
ASTRA V 1.4i 16V	Z14XEP	03/05 ⇒ 11/10	
ASTRAVAN III 1.4 i	Z14XEP	03/05 ⇒	
COMBO C 1.4	Z14XEP	10/04 ⇒ 09/10	
COMBO C 1.4 i 16V	Z14XEP	01/04 ⇒ 11/11	
CORSA B 1.0 i 12V	X10XE	11/96 ⇒ 09/00	
CORSA B 1.2 i 16V	X12XE	03/98 ⇒ 09/00	
CORSA C 1.0 12V	Z10XE, Z12XE	09/00 ⇒ 10/06	
CORSA C 1.2 16V	Z12XE	09/00 ⇒ 10/06	
CORSA C 1.2 16V Dualfuel	Z12XE	08/01 ⇒ 10/06	
CORSA C 1.2 Twinport	Z12XEP	07/04 ⇒ 10/06	
CORSA C 1.4 Twinport	Z14XEP	06/03 ⇒ 10/06	
CORSAVAN II 1.2 16V	Z12XE, Z12XE	09/00 ⇒ 11/06	
CORSAVAN II 1.2 16V Dualfuel	Z12XE, K9K790	08/01 ⇒ 06/06	
CORSAVAN II 1.4	Z14XEP	11/03 ⇒ 06/06	
MERIVA I 1.4 16V Twinport	Z14XEP	01/03 ⇒ 06/10	
TIGRA B 1.4	Z14XEP	06/04 ⇒ 08/09	

9.0348



3

REVOLUTION AND TIMING (CKP AND CMP) SENSORS

Adatt./Suitable:

- BOSCH**
0 986 280 433
- DACIA**
82 00 285 798
- GENERAL MOTORS**
93 167 895
93 179 803
95 507 625
- NISSAN**
22630-00QAG
23731-BN701
23731-DB000
23731-DB00A
23760-00QAB
23760-00QAD
- OPEL**
44 15 077
44 20 249
44 21 645
- RENAULT**
23 73 195 76R
23 73 1DB 00A
77 01 058 077
82 00 033 686
82 00 285 798
- RENAULT TRUCKS**
74 85 129 995
- SAGEM**
21591287-4
- SUZUKI**
33220-84A00
33220-84A00-000
33220-84A10-000

MARKET DIFFUSION: HIGH



L	L1		
---	28	Hall Effect	

DACIA			
DUSTER 1.5 dCi 4x4	K9K892	04/11 ⇒	

DACIA			
LOGAN I 1.5 dCi	K9K790, K9K790	09/05 ⇒	
SANDERO I 1.5 dCi	K9K790, K9K704	06/08 ⇒	
NISSAN			
ALMERA II 1.5 dCi	K9K722	01/03 ⇒ 09/06	
CABSTAR 3.0 TDi	ZD30DDTi	09/06 ⇒ 12/13	
CABSTAR III 35.14 DCI 3.0	ZD30DDTi	09/06 ⇒ 12/13	
CABSTAR III 35.15 DCI, 45.15 DCI 3.0	ZD30DDTi	09/06 ⇒ 12/13	
INTERSTAR dCi 140	ZD30	11/03 ⇒	
KUBISTAR 1.5 dCi	K9K704, K9K276	08/03 ⇒	
KUBISTAR 1.5 dCi 70	K9K700	04/06 ⇒ 10/09	
KUBISTAR 1.5 dCi 85	K9K276	04/06 ⇒ 10/09	
MICRA III 1.5 dCi	K9K276, K9K276	01/03 ⇒ 06/10	
NOTE I 1.5 dCi	K9K276, K9K	03/06 ⇒ 06/12	
NV200 / EVALIA 1.5 dCi	K9K	07/10 ⇒	
NV200 1.5 dCi	K9K	02/10 ⇒	
QASHQAI 1.5 dCi	K9K, K9K	08/08 ⇒ 11/13	
QASHQAI 1.5 dCi	K9K, K9K	02/07 ⇒ 12/13	
THIDA I 1.5 dCi	K9K, ZD3200	01/07 ⇒ 12/12	

OPEL			
MOVANO A 3.0 DTi	ZD3200, K9K700	10/03 ⇒	

RENAULT			
CLIO II 1.5 dCi	K9K700, D4F764	06/01 ⇒	
CLIO III 1.2	D4F764	10/05 ⇒	
CLIO III 1.2 16V	D4F764, K9K750	06/05 ⇒	
CLIO III 1.5 dCi	K9K750, K4M800	05/05 ⇒	
CLIO III 1.6 16V	K4M800, --	06/05 ⇒	
CLIO III 1.6 16V GT	K4M862	06/09 ⇒	
CLIO III 2.0 16V Sport	--, K9K728	02/06 ⇒	
GRAND SCÉNIC II 1.5 dCi	K9K728, K4M761	04/04 ⇒	
GRAND SCÉNIC II 1.6	K4M761, K9K700	04/04 ⇒	
GRAND SCÉNIC II 1.6 Flex	K4M766	06/06 ⇒ 11/08	
KANGOO I 1.5 dCi	K9K700, K9K800	02/01 ⇒	
KANGOO II 1.5 dCi	K9K800, K9K804	02/08 ⇒	
KANGOO II 1.5 dCi 110	K9K804, K9K800	09/10 ⇒	
KANGOO II 1.5 dCi 85	K9K800, K9K780	02/08 ⇒	
LAGUNA II 1.6 16V	K4M716	02/05 ⇒ 08/07	
LAGUNA III 1.5 dCi	K9K780, K9K790	10/07 ⇒ 12/15	
LAGUNA III 1.6 16V	K4M824	10/07 ⇒ 12/15	
LOGAN 1.5 dCi	K9K790, ZD3200	09/05 ⇒	
LOGAN EXPRESS 1.5 dCi	K9K792	04/07 ⇒	
MASTER II 3.0 dCi 120	ZD3600	06/05 ⇒	
MASTER II 3.0 dCi 140	ZD3200, ZD3606	10/03 ⇒	
MASTER II 3.0 dCi 160	ZD3604	06/05 ⇒	
MEGANE II 1.5 dCi	K9K722, K4M760	09/02 ⇒ 12/10	
MEGANE II 1.6	K4M760, K4M760	08/03 ⇒	
MEGANE II 1.6 16V	K4M760, K4M848	11/02 ⇒	
MEGANE II 1.6 LPG 16V	K4M760	01/06 ⇒ 08/09	
MASTER PRO 3.0 dCi	ZD3606, K9K722	06/05 ⇒ 04/10	
MEGANE I 1.6 16V	K4M761	11/00 ⇒	
MEGANE III 1.6 16V	K4M848, K9K750	11/08 ⇒	
MODUS / GRAND MODUS 1.2	D4F764	12/04 ⇒	
MODUS / GRAND MODUS 1.5 dCi	K9K750, K4M790	09/04 ⇒	
MODUS / GRAND MODUS 1.5 dCi 90	K9K750	10/10 ⇒	
MODUS / GRAND MODUS 1.6	K4M790, K9K728	12/04 ⇒	
SANDERO I 1.5 dCi	K9K790	04/07 ⇒	
SCÉNIC II 1.5 dCi	K9K722, K4M761	06/03 ⇒	
SCÉNIC II 1.6	K4M761, K4M766	06/03 ⇒	
SCÉNIC II 1.6 16V	K4M766, K9K700	10/05 ⇒	
SCÉNIC II 1.6 BiFuel	K4M764	08/03 ⇒ 05/06	
SCÉNIC II 1.6 Hi-Flex	K4M766	03/05 ⇒ 07/10	
SCENIC 1.5 dCi	K9K728, K4M812	06/07 ⇒ 11/08	
SCENIC 1.6	K4M812, K9K722	07/07 ⇒ 05/09	
THALIA I 1.5 dCi	K9K700, K9K700	01/01 ⇒	
THALIA II 1.5 dCi	K9K700, DXI	09/08 ⇒	
TWINGO II 1.5 dCi	K9K740	03/07 ⇒	
TWINGO II 1.6 RS	K4M854	05/08 ⇒	

RENAULT TRUCKS			
MASCOTT 120.35	DXI, DXI	05/04 ⇒ 12/10	
MASCOTT 120.55	DXI, DXI	05/04 ⇒ 12/10	
MASCOTT 120.65	DXI, DXI	05/04 ⇒ 12/10	
MASCOTT 150.35	DXI	05/04 ⇒ 12/13	
MASCOTT 160.35	DXI, DXI	05/04 ⇒ 12/10	
MASCOTT 160.55	DXI, DXI	05/04 ⇒ 12/10	
MASCOTT 160.65	DXI, ZD3200	05/04 ⇒ 12/10	
MASCOTT 3.0	DXI	05/04 ⇒ 12/13	

SUZUKI			
JIMNY III 1.5 DDIS 4WD	K9K700	12/03 ⇒	
JIMNY III 1.5 DDIS 4x4	K9K266	08/05 ⇒	
VAUXHALL			
MOVANO A 3.0 DTi	ZD3200, F9Q	10/03 ⇒ 05/10	

9.0349



3

REVOLUTION AND TIMING (CKP AND CMP) SENSORS

Adatt./Suitable:

- BOSCH**
0 986 280 412
- ELECTRICFIL**
14 44 08
14 44 47
- GENERAL MOTORS**
9 201 843
93 161 272
- MITSUBISHI**
M883794
MW-30652288
MW-31216651
MW-31251169
- NISSAN**
23760-00Q0C
23760-00QAA
23760-00QAC
23796-AW300
25565-00Q0B
- OPEL**
44 13 789
44 35 050
45 06 177
92 01 843
93161272
- RENAULT**
77 00 103 486
82 00 038 472
82 00 370 572
82 00 709 844
82 00 789 528
- SUZUKI**
33220-67J10-000
33220-67J11
33220-67J11-000
33220-67J12
33220-67J12-000
- VAUXHALL**
9201843
93161272
- VOLVO**
30652288
30883794
31216651
31251169

MARKET DIFFUSION: HIGH



L	L1		
---	28	Hall Effect	

MITSUBISHI			
CARISMA 1.9 DI-D	F9Q, F9Q	09/00 ⇒ 06/06	
SPACE STAR 1.9 DI-D	F9Q, G9U650	02/01 ⇒ 12/04	

NISSAN			
INTERSTAR dCi 100	G9U650, G9U650	11/03 ⇒	
INTERSTAR dCi 120	G9U650, F9Q772	04/02 ⇒	
INTERSTAR dCi 150	G9U632	08/06 ⇒	
INTERSTAR dCi 80	F9Q772, G9T722	04/02 ⇒	
INTERSTAR dCi 90	G9T722, G9U630	07/02 ⇒	
PRIMASTAR 1.9 dCi 100	F9Q760	07/02 ⇒	
PRIMASTAR 1.9 dCi 80	F9Q762	09/02 ⇒	
PRIMASTAR 2.5 dCi 115	G9U630, G9U630	09/08 ⇒	
PRIMASTAR 2.5 dCi 140	G9U730	07/03 ⇒	
PRIMASTAR 2.5 dCi 150	G9U632	09/06 ⇒	
PRIMASTAR dCi 100	F9Q760	03/01 ⇒	
PRIMASTAR dCi 115	G9U630, F9Q	09/08 ⇒	
PRIMASTAR dCi 140	G9U730	07/03 ⇒	
PRIMASTAR dCi 150	G9U632	09/06 ⇒	
PRIMASTAR dCi 80	F9Q762	03/01 ⇒	
PRIMERA III 1.9 dCi	F9Q, G9U632	08/02 ⇒	

OPEL			
MOVANO A 1.9 DTi	F9Q770	09/00 ⇒ 10/01	
MOVANO A 2.2 DTi	G9T750	09/00 ⇒	
MOVANO A 2.5 CDTi	G9U632, S8U770	10/03 ⇒	
MOVANO A 2.5 D	S8U770, S9W700	07/98 ⇒ 09/00	
MOVANO A 2.8 DTi	S9W700, G9T642	07/98 ⇒ 10/01	

OPEL		
VIVARO A 1.9 DI	F9Q774	08/01 →
VIVARO A 2.5 CDTI	G9MB6	08/06 →
RENAULT		
AVANTIME 2.2 dCi	G9T712	05/02 → 05/03
ESPACE III 2.2 dCi	G9T642, F9Q680	07/00 → 10/02
ESPACE I 1.9 dCi	F9Q680, G9T645	11/02 →
ESPACE IV 2.2 dCi	G9T645, F9Q803	11/02 →
GRAND SCÉNIC II 1.9 dCi	F9Q803, F9Q782	04/04 →
KANGOO I 1.9 dCi 4x4	F9Q782, F9Q780	10/01 →
KANGOO I 1.9 dTi	F9Q780, F9Q650	02/00 →
KANGOO 1.9 dCi	F9Q782, F9Q782	07/03 → 06/08
LAGUNA II 1.9 dCi	F9Q650, G9T600	03/01 →
LAGUNA II 2.2 dCi	G9T600, F9Q772	03/01 →
MASTER II 1.9 dCi 80	F9Q772, G9T720	11/01 →
MASTER II 2.5 dCi 90	G9T720, G9U632	09/00 →
MASTER II 2.5 dCi	G9U632, G9U650	01/04 →
MASTER II 2.5 dCi 100	G9U650, G9U720	10/03 →
MASTER II 2.5 dCi 120	G9U720, F9Q732	10/01 →
MEGANE II 1.9 dCi	F9Q800, F9Q816	11/02 →
MASTER 2.5 dCi	G9U724	11/02 → 05/10
MEGANE 1.9 dCi	F9Q732, F9Q732	03/99 → 07/03
MEGANE I 1.9 dCi	F9Q732, F9Q730	10/00 → 08/03
MEGANE I 1.9 dTi	F9Q730, F9Q800	02/01 → 08/03
SCÉNIC I 1.9 dCi	F9Q732, F9Q732	09/99 → 08/03
SCÉNIC I 1.9 dCi RX4	F9Q732, F9Q738	11/00 → 08/03
SCÉNIC I 1.9 dTi	F9Q738, F9Q803	02/01 → 08/03
SCÉNIC II 1.9 D	F9Q812	06/06 →
SCÉNIC II 1.9 dCi	F9Q803, F9Q760	06/03 →
SCÉNIC II 1.9 dCi 130	F9Q804	10/05 → 12/09
SCÉNIC 1.9 dCi	F9Q816, F9Q732	06/07 → 11/08
TRAFIC II 1.9 dCi	F9Q760, F9Q760	03/01 →
TRAFIC II 1.9 dCi 100	F9Q760	03/01 →
TRAFIC II 1.9 dCi 80	F9Q760, G9T600	03/01 →
TRAFIC II 2.5 dCi	G9U630	08/07 →
TRAFIC II 2.5 dCi 115	G9U630	02/08 →
TRAFIC II 2.5 dCi 135	G9U730	03/01 →
TRAFIC II 2.5 dCi 145	G9U630	08/06 →
TRAFIC II 2.5 DTi	G9U730	03/03 → 07/03
VEL SATIS 2.2 dCi	G9T600, F9QB	06/02 →

SUZUKI

GRAND VITARA II 1.9 DDiS	F9QB	03/06 → 08/08
GRAND VITARA II 1.9 DDiS Trazione integrale	F9QB, G9U632	10/05 → 02/15

VAUXHALL

MOVANO A 1.9 DTI	F9Q770	09/00 → 10/01
MOVANO A 2.5 CDTI	G9U632, G9U630	10/01 → 12/10
MOVANO A 2.5 D	S8U770	10/98 → 08/02
MOVANO A 2.8 DTI	S9W702	10/98 → 10/01
MOVANO A 2.8 TDI	S9W702	10/98 → 10/01
VIVARO 2.5 CDTI	G9U630, D4192T3	04/03 → 07/14
VIVARO 2.5 DTI	G9U630	07/03 → 07/14

VOLVO

S40 I 1.9 DI	D4192T3, D4192T3	07/00 → 12/03
V40 I 1.9 DI	D4192T3, BHT	07/00 → 06/04

9.0351



3

REVOLUTION AND TIMING (CKP AND CMP) SENSORS

Adatt./Suitable:

AUDI

06A 905 161 A

BENTLEY

06A 905 161 A

BOSCH

0 232 103 019

0 232 103 020

FORD

1 072 303

95VW-9P986-BA

MERCEDES-BENZ

A 004 153 37 28

PORSCHE

955 606 106 00

SEAT

06A 905 161 A

VW

06A 905 161 A



L	L1		
---	23	Hall Effect	

AUDI

A8 I 6.0 W12 quattro	AZC	01/01 → 09/02
A8 II 6.0 W12 quattro	BHT, BHE	12/03 → 07/10
TT I 3.2 VR6 quattro	BHE, BEB	07/03 → 06/06

BENTLEY

CONTINENTAL 6.0	BEB, BEB	06/03 → 12/11
CONTINENTAL FLYING SPUR 6.0	BWR	03/05 →
CONTINENTAL FLYING SPUR 6.0 FLEX	BEB, AAA	03/05 → 12/13

FORD

GALAXY I 2.8 iV6	AAA, AAA	11/95 → 04/00
GALAXY I 2.8 iV6 4x4	AAA, AUE	04/96 → 04/00
GALAXY I 2.8 V6	AYL	04/00 → 05/06

MERCEDES-BENZ

CLASSE V V 280	M104.900	08/97 → 07/03
----------------	----------	---------------

PORSCHE

CAYENNE I 3.2	M02.2Y	10/03 → 09/07
---------------	--------	---------------

SEAT

ALHAMBRA I / II 2.8 V6	AUE, AUE	06/00 → 03/10
ALHAMBRA I / II 2.8 V6 4motion	AUE, AGZ	06/00 → 03/10
LEON I 2.3 V5	AGZ	10/98 → 11/00
LEON I 2.3 VR5	AQN	09/00 → 11/03
LEON I 2.8	BDE	05/02 → 06/04
LEON I 2.8 Cupra 4	AUE	02/01 → 06/06
TOLEDO II 2.3 V5	AGZ	10/98 → 11/00
TOLEDO II 2.3 V5 20V	AQN	09/00 → 11/03

VW

BORA 2.3 V5	AGZ, AGZ	10/00 → 05/05
BORA 2.3 V5 4motion	AGZ, AQP	10/00 → 05/05
BORA 2.8 V6 4motion	AQP, BUB	03/99 → 05/05
BORA 2.8 VR6	AUE	03/00 → 05/00
CARAVELLE 3.2	BDL	11/03 → 11/09
EOS 3.2 V6	BUB, AGZ	06/06 → 05/09
GOLF III 2.9 VR6	ABV	10/94 → 04/99
GOLF III 2.9 VR6 Syncro	ABV	10/94 → 04/99
GOLF IV 2.3 V5	AGZ, AGZ	10/00 → 06/06
GOLF IV 2.3 V5 4motion	AGZ, AQP	10/00 → 06/06
GOLF IV 2.8 V6 4motion	AQP, AQP	05/99 → 06/06
GOLF IV 2.8 VR6 4motion	AQP, BFH	03/99 → 06/05
GOLF IV 3.2 R32 4motion	BFH, BDL	09/02 → 06/05
MULTIVAN 3.2 V6	BDL, BKK	02/04 → 11/09
MULTIVAN 3.2 V6 4motion	BKK, BDN	07/04 → 11/09
NEW BEETLE 2.3 V5	AQN	10/00 → 09/10
NEW BEETLE RSI 3.2 4motion	AXJ	04/00 → 05/01
PASSAT IV 2.3 V5	AZX	11/00 → 05/05

PASSAT IV 2.3 V5 4motion	AZX	11/00 → 05/05
PASSAT IV 2.3 VR5	AGZ	10/96 → 05/05
PASSAT IV 2.3 VR5 4motion	AZX	11/00 → 05/05
PASSAT IV 2.3 VR5 Syncro/4motion	AGZ	10/97 → 11/00
PASSAT IV 4.0 W8 4motion	BDN, AYT	09/01 → 09/04
PHAETON 3.2 V6	AYT, BKL	04/02 → 05/05
PHAETON 3.2 V6 4motion	BKL, AAA	02/04 → 11/08
PHAETON 6.0 W12 4motion	BAN	04/02 → 12/05
SHARAN I 2.8 V6 24V	AYL	04/00 → 03/10
SHARAN I 2.8 V6 24V 4motion	AYL	04/00 → 03/10
SHARAN I 2.8 VR6	AAA, AAA	09/95 → 04/00
SHARAN I 2.8 VR6 Syncro	AAA, AZZ	11/96 → 04/00
TOUAREG I 3.2 V6	AZZ, BJN	10/02 → 11/06
TOUAREG I 6.0 W12	BJN, AES	08/04 → 05/10
TRANSPORTER 3.2	BDL	03/04 → 06/05
TRANSPORTER IV 2.8	AES	05/96 → 05/00
TRANSPORTER IV 2.8 VR 6	AES	11/95 → 04/00
TRANSPORTER IV 2.8 VR6	AES, BDL	04/00 → 04/03
TRANSPORTER IV 2.8 VR6 Syncro	AES	01/96 → 04/96
TRANSPORTER V 3.2 4motion	BDL, BDL	11/03 → 11/09
TRANSPORTER V 3.2 V6	BDL, BKK	04/03 → 11/09
TRANSPORTER V 3.2 V6 4motion	BKK, 4A90	11/03 → 11/09

9.0352



3,5

REVOLUTION AND TIMING (CKP AND CMP) SENSORS

Adatt./Suitable:

VOLVO

30872381

Eliminated on 25-07-2016. Please verify the availability through our local distributors

• Eliminato il 25-07-2016. Verificare la disponibilità presso i nostri distributori

• Éliminé le 25-07-2016. Vérifier la disponibilité auprès de nos distributeurs sur place

• Am 25-07-2016 gestrichen. Evtl. Verfügbarkeit bitte bei unseren Händlern prüfen

• Eliminado en fecha 25-07-2016. Verificar la disponibilidad a través de nuestros distribuidores locales



L	L1	ohm	
180	24	240	

VOLVO

S40 I 1.9 TD	D4192T	07/95 → 08/99
V40 I 1.9 TD	D4192T	07/95 → 08/99

REVOLUTION AND TIMING (CKP AND CMP) SENSORS

Adatt./Suitable:

ELECTRICFIL900.9.0085.02
900.9.0288.02**MITSUBISHI**

MN902313

SMARTA 004 542 03 18
Q 0003228V002000000
Q 0015145V001000000

L	L1	ohm	
---	34	850	

MITSUBISHI

COLT VI 1.3	4A90, 4A91	06/04 ⇨
COLT VI 1.3 4WD	4A90	08/04 ⇨
COLT VI 1.5	4A91, M160E6ALB03	06/04 ⇨
COLT VI 1.5 4WD	4A91	08/04 ⇨
COLT VI 1.5 DI-D	OM639.939	08/04 ⇨ 06/12

SMART

CABRIO 0.6	M160E6ALB03, OM660DE8LA	03/00 ⇨ 01/04
CABRIO 0.7	M160.910	01/03 ⇨ 01/04
CABRIO 0.8 CDI	OM660DE8LA, M160E6ALB03	03/01 ⇨ 01/04
CITY-COUPE 0.6	M160E6ALB03, M160.910	01/01 ⇨ 01/04
CITY-COUPE 0.7	M160.910, OM660DE8LA	01/03 ⇨ 01/04
CITY-COUPE 0.8 CDI	OM660DE8LA, OM660DE8LA	11/99 ⇨ 01/04
CROSSBLADE 0.6	M160.920	06/02 ⇨ 12/03
FORFOUR 1.1	M134.910	01/04 ⇨ 06/06
FORFOUR 1.3	M135.930	01/04 ⇨ 06/06
FORFOUR 1.5	M135.950	01/04 ⇨ 06/06
FORTWO I 0.7	M160.910	01/04 ⇨ 01/07
FORTWO I 0.8 CDI	OM660DE8LA, 182B9.000	01/04 ⇨ 01/07
ROADSTER 0.7	M160.921	04/03 ⇨ 11/05

REVOLUTION AND TIMING (CKP AND CMP) SENSORS

Adatt./Suitable:

ALFA ROMEO46481640
60814770**BOSCH**

0 281 002 213

FIAT46432103
46481640
60814770**GENERAL MOTORS**

93 179 513

LANCIA46481640
60814770**OPEL**62 35 667
93179513**SAAB**

93 179 513

SUZUKI33220-79JU0
33220-79JU0-000**VAUXHALL**

93179513

MARKET DIFFUSION: MEDIUM

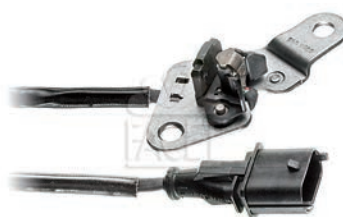

L	L1	Hall Effect	
720	---		

ALFA ROMEO

145 1.9 JTD	AR32302	02/99 ⇨ 01/01
146 1.9 JTD	AR32302	02/99 ⇨ 01/01
147 1.9 JTD	182B9.000, 937A2.000	10/00 ⇨ 03/10
147 1.9 JTDM	937A2.000, 937A2.000	10/04 ⇨ 03/10
147 1.9 JTDM 8V	937A3.000	07/05 ⇨ 03/10
156 1.9 JTD	937A2.000, 839A6.000	05/00 ⇨ 05/06
156 2.4 JTD	839A6.000, 937A7.000	05/00 ⇨ 05/06
159 1.9 JTDM 8V	937A7.000, 839A6.000	09/05 ⇨ 11/11
159 MY2011 1.9 8V JTD	--	01/10 ⇨
166 2.4 JTD	839A6.000, 192A1.000	10/00 ⇨ 06/07

FIAT

BRAVA 1.9 JTD	182B9.000	09/00 ⇨ 10/01
BRAVA 1.9 JTD 105	182B4.000	12/98 ⇨ 10/01
BRAVO I 1.9 JTD	182B9.000	09/00 ⇨ 10/01
BRAVO I 1.9 JTD 105	182B4.000	12/98 ⇨ 10/01
BRAVO II 1.9 D Multijet	192A1.000, 939A1.000	11/06 ⇨ 12/14
BRAVO II 1.9 D Multijet 8V	--	01/10 ⇨
CROMA II 1.9 D Multijet	939A1.000, 182B9.000	06/05 ⇨
CROMA II 1.9 MJTD	939A1.000	04/06 ⇨ 12/11
DOBLO I 1.9 D Multijet	186A9.000	10/05 ⇨
DOBLO I 1.9 JTD	182B9.000, 182A7.000	10/01 ⇨
DOBLO I 1.9 JTD 8V	--	10/05 ⇨
DOBLO I 1.9 JTD Multijet	186A9.000	12/06 ⇨
IDEA 1.9 D	--	01/08 ⇨
IDEA 1.9 JTD	188B2.000	01/04 ⇨
MAREA 1.9 JTD	182B9.000	01/01 ⇨ 12/07
MAREA 1.9 JTD 105	182B4.000	12/98 ⇨ 12/02
MAREA 1.9 JTD 110	186A6.000	09/00 ⇨ 08/02
MAREA 1.9 TD 100	182A7.000, 182B4.000	09/96 ⇨ 06/03
MAREA 2.4 JTD 130	185A6.000	04/99 ⇨ 05/02
MARENGO 1.9 JTD	182B4.000, 188A7.000	03/99 ⇨ 08/02
MULTIPLA 1.9 JTD	186A9.000	04/02 ⇨ 06/10
MULTIPLA 1.9 JTD 105	182B4.000	04/99 ⇨ 06/10
MULTIPLA 1.9 JTD 110	186A6.000	03/01 ⇨ 07/02
MULTIPLA 1.9 JTD 115	186A8.000	07/02 ⇨ 06/10
PALIO 1.9 JTD	188A2.000	09/01 ⇨
PUNTO II 1.9 JTD	188A7.000, 199A5.000	02/00 ⇨ 03/12
PUNTO II 1.9 JTD 80	188A2.000	09/99 ⇨ 03/12
PUNTO III / GRANDE PUNTO 1.9 D Multijet	199A5.000, 192A8.000	10/05 ⇨
SEDICI 1.9 D Multijet	D19AA	06/06 ⇨ 10/11
SEDICI 1.9 D Multijet 4x4	D19AA	06/06 ⇨ 10/11

FIAT

STILO 1.9 D	192B5.000	09/04 ⇨ 08/08
STILO 1.9 D Multijet	192A8.000, 192A1.000	09/05 ⇨ 08/08
STILO 1.9 JTD	192A1.000, 937A2.000	10/01 ⇨ 08/08
STRADA 1.9 JTD	188A2.000	04/03 ⇨

LANCIA

KAPPA 2.4 JTD	838A8.000	06/98 ⇨ 10/01
LYBRA 1.9 JTD	937A2.000, 839A5.000	09/00 ⇨ 10/05
LYBRA 2.4 JTD	839A5.000, Z19DT	09/00 ⇨ 10/05
MUSA 1.9 D Multijet	188B2.000	10/04 ⇨ 09/12
THESIS 2.4 JTD	841C.000	07/02 ⇨ 07/09

OPEL

ASTRA H 1.9 CDTi	Z19DT, Z19DT	06/04 ⇨ 12/12
SIGNUM 1.9 CDTi	Z19DT, Z19DT	04/04 ⇨
VECTRA C 1.9 CDTi	Z19DT, Z19DT	04/04 ⇨ 01/09
ZAFIRA B 1.9 CDTi	Z19DT, Z19DT	07/05 ⇨ 04/15

SAAB

9-3 1.9 TiD	Z19DT	09/04 ⇨ 02/15
-------------	-------	---------------

SUZUKI

SX4 I 1.9 DDiS	D19AA	06/06 ⇨
SX4 I 1.9 DDiS 4x4	D19AA	06/06 ⇨

VAUXHALL

ASTRA V 1.9 CDTi	Z19DT, Z19DT	01/04 ⇨ 11/10
ASTRAVAN III 1.9 CDTi	Z19DT	03/05 ⇨ 11/11
SIGNUM 1.9 CDTi	Z19DT	04/04 ⇨ 03/08
SIGNUM 1.9 Turbo	Z19DTL	01/05 ⇨ 05/08
VECTRA C 1.9 CDTi	Z19DT, Z19DT	04/02 ⇨ 09/08
ZAFIRA B 1.9 CDTi	Z19DT, 176B9.000	07/05 ⇨ 11/14

REVOLUTION AND TIMING (CKP AND CMP) SENSORS

Adatt./Suitable:

BOSCH0 261 210 220
0 261 210 266**FIAT**46779352
55187332**LANCIA**

46779352



L	L1	ohm	
690	34,6	840	

FIAT

BRAVA 1.2 16V 80	182B2.000	12/98 ⇨ 12/02
BRAVO I 1.2 16V 80	188A5.000	10/00 ⇨ 10/01
PALIO 1.0 i	--	06/05 ⇨
PALIO 1.0 MPI	178F1.011	11/03 ⇨ 07/05
PALIO 1.2 16V	178D7.055	06/05 ⇨
SIENA 1.2 16V	178D7.055	01/02 ⇨

LANCIA

Y 1.2 16V	176B9.000, ENS	10/00 ⇨ 09/03
-----------	----------------	---------------

9.0361



3

REVOLUTION AND TIMING (CKP AND CMP) SENSORS

Adatt./Suitable:

ALFA ROMEO
55187973

BOSCH
0 232 103 046
0 232 103 052
0 232 103 053
0 232 103 067
0 232 103 127
0 232 103 128
0 232 103 158
0 232 103 162
0 281 002 667
0 281 002 904

CHEVROLET
93310500

CHRYSLER
5066856AA
5066856AB
5140332AA
K05066856AA
K05066856AB
K05140332AA

CITROËN
1920 JH

DODGE
5140332AA
K05140332AA

FIAT
46798367
504048261
55187973

FORD
1 319 158
1 826 557
1 851 681
1 905 522
4M5G-12K073-AA
4M5G-12K073-AB
4M5G-12K073-AC
4M5G-12K073-AD

FUSO (MITSUBISHI)
MK667126

GENERAL MOTORS
55 187 973
93 183 528
93 186 840
93 310 500

HYUNDAI
39300-27400

IVECO
0000504048261
504048261
80891268

JEEP
5066856AA
5140332AA
K05066856AA
K05066856AB
K05140332AA

KIA
39300-27400

LANCIA
K05066856AB
K05140332AA

LAND ROVER
LR000634
LR052493
LR058405

MASERATI
46328202
673001045

MERCEDES-BENZ
6519050600
A 651 905 06 00

MOPAR PARTS
05140332AA

OPEL
12 47 810
55187973
62 35 685
62 35 715
93183528
93186840

PEUGEOT
1920 JH

SAAB
93 183 528

SUZUKI
33220-84EA0
33220-84EA0-000

VAUXHALL
55187973
93183528
93186840

MARKET DIFFUSION: HIGH

L	L1		
---	24,2	Hall Effect	

ALFA ROMEO

159 1.9 JTS	939A6.000	09/05 ⇨ 11/11
159 2.2 JTS	939A5.000	09/05 ⇨ 11/11
159 MY2011 2.2 JTS	--	01/10 ⇨
BRERA 2.2 JTS	939A5.000	01/06 ⇨ 05/11
SPIDER III 2.2 JTS	939A5.000	03/06 ⇨ 03/11

CHEVROLET

TRAILBLAZER 2.8 CRDi [ExtraEU]	LWH	08/12 ⇨
--------------------------------	-----	---------

CHRYSLER

300C II 3.0 CRD	EXF	09/11 ⇨
GRAND VOYAGER V 2.8 CRD	ENS, ENJ	10/07 ⇨
VOYAGER III 2.5 CRD	ENJ, --	02/00 ⇨ 12/08
VOYAGER III 2.8 CRD	ENR	06/04 ⇨ 12/08

CITROËN

JUMPER II 2.8 HDi	--, 8140.435	04/02 ⇨
JUMPER II 2.8 HDi 4x4	8140.435, F300FAP	02/02 ⇨
JUMPER II 2.8 HDi Trazione integrale	8140.435	04/02 ⇨
JUMPER III 3.0 HDi 145	F300FAP, F30DTFAP	07/10 ⇨
JUMPER III 3.0 HDi 155	F30DTFAP, F30DTFAP	07/10 ⇨
JUMPER III 3.0 HDi 160	F30DTFAP, ENR	09/06 ⇨
JUMPER III 3.0 HDi 180	F30DT	07/11 ⇨

DODGE

NITRO 2.8 CRD	ENR, ENR	10/06 ⇨ 12/12
NITRO 2.8 CRD 4WD	ENR, 8140.43	06/07 ⇨ 12/12

FIAT

DUCATO II 2.8 JTD	8140.43, F1CE0441A	04/02 ⇨
DUCATO II 2.8 JTD 4x4	8140.435	11/00 ⇨
DUCATO II 2.8 JTD Power	8140.435	05/04 ⇨
DUCATO II 2.8 TD	8140.43	04/02 ⇨ 07/06
DUCATO II 2.8 TD 4x4	8140.435	11/03 ⇨ 07/06
DUCATO III 140 Natural Power	F1CE0441A, F1CE0481D	04/09 ⇨
DUCATO III 150 Multijet 3,0 D	F1CE3481N	04/10 ⇨
DUCATO III 160 Multijet 3,0 D	F1CE0481D, IQJA	07/06 ⇨
DUCATO III 180 Multijet 3,0 D	F1CE3481E	06/11 ⇨
DUCATO III 3.0	--	01/14 ⇨
DUCATO 2.8 JTD	8140.435	04/04 ⇨ 07/06
PANDA I 1.1	187A1.000	09/00 ⇨ 02/04
PANDA I 1.1 AWD	187A1.000	09/00 ⇨ 02/04
PANDA II 1.1	187A1.000	09/03 ⇨
PANDA II 1.2	188A4.000	09/03 ⇨
PANDA II 1.2 4x4	188A4.000	09/04 ⇨
PANDA II 1.2 Bipower	188A4.000	09/04 ⇨ 12/11
PANDA II 1.2 Euro 4	--	04/09 ⇨
PANDA II 1.2 LPG	188A4.000	04/09 ⇨
PANDA II 1.2 Natural Power	188A4000CNG	01/07 ⇨ 12/11
PUNTO II 1.2	188A4.000	06/03 ⇨
SIENA 1.7 [CHN]	--	01/06 ⇨

FORD

B-MAX 1.6 Ti	IQJA, HXDA	10/12 ⇨
C-MAX I 1.6	HXDA, --	04/07 ⇨ 09/10
C-MAX I 1.6 Ti-VCT	--, MUDA	03/07 ⇨
C-MAX II 1.6	--	12/10 ⇨
C-MAX II 1.6 CNG	MUDACNG	01/13 ⇨
C-MAX II 1.6 Flexifuel	MUDA, MUDA	02/11 ⇨
C-MAX II 1.6 LPG	MUDA, IQDA	02/12 ⇨
C-MAX II 1.6 Ti	IQDA, UEJB	12/10 ⇨
ECOSPORT 1.5 Ti	UEJB, UEJB	10/13 ⇨
ECOSPORT 1.5 Ti-VCT [ExtraEU]	UEJB, HXJD	10/13 ⇨
ECOSPORT 1.6 Ti-VCT	HXJD, HXJB	08/12 ⇨
FIESTA 1.6 Ti-VCT [ExtraEU]	HXJB, --	03/15 ⇨
FIESTA VI 1.6	XTJA	03/15 ⇨
FIESTA VI 1.6 Ti	--, HXJA	06/08 ⇨
FIESTA VI 1.6 Ti-VCT	HXJA, HXDA	10/08 ⇨ 12/12
FOCUS II 1.6 Ti-VCT	--	12/07 ⇨
FOCUS III 1.6 Flexifuel	MUDA, MUDA	07/10 ⇨
FOCUS III 1.6 LPG	MUDA, IQDA	02/12 ⇨
FOCUS III 1.6 Ti	IQDA, IQDA	07/10 ⇨
FOCUS III 1.6 Ti-VCT	--	07/10 ⇨
FOCUS C-MAX 1.6	HWDA, HXDA	10/03 ⇨ 03/07
FOCUS C-MAX 1.6 Ti	HXDA, MUDA	08/04 ⇨ 03/07
GRAND C-MAX 1.6 Ti	IQDA, B2KA	12/10 ⇨
KA+ 1.2	B2KA, YSKD	06/16 ⇨
KA+ 1.2 Ti-VCT	YSKD, KGBA	06/16 ⇨
MONDEO III 1.6 Ti	KGBA, 4P10T2	03/07 ⇨ 01/15

FUSO (MITSUBISHI)

CANTER 3.0 DiTD	4P10T2, D4EB	04/06 ⇨
-----------------	--------------	---------

HYUNDAI

GRANDEUR 2.2 CRDi	D4EB, D4EA	06/06 ⇨ 12/11
-------------------	------------	---------------

HYUNDAI

I30 I 2.0 CRDi	D4EA, D4EB	10/07 ⇨ 06/12
SANTA FE I 2.2 CRDi	D4EB	10/05 ⇨ 03/06
SANTA FE II 2.2 CRDi	D4EB, D4EB	03/06 ⇨ 12/12
SANTA FE II 2.2 CRDi 4x4	D4EB, D4EA	10/05 ⇨ 12/12
SANTA FE II 2.2 CRDi GLS	D4EB	03/06 ⇨ 12/09
SANTA FE II 2.2 CRDi GLS 4x4	D4EB	03/06 ⇨ 12/09
SONATA V 2.0 CRDi	D4EA, D4EA	02/06 ⇨ 12/10
TRAJET 2.0 CRDi	D4EA, D4EA	04/01 ⇨ 07/08
TUCSON 2.0 CRDi	D4EA, D4EA	08/04 ⇨ 03/10
TUCSON 2.0 CRDi Trazione integrale	D4EA, F1CE0441A	08/04 ⇨ 03/10

IVECO

DAILY II 29 L 13	8140.435	05/01 ⇨ 07/07
DAILY II 29 L 9	8140.43R	11/01 ⇨ 04/06
DAILY II 29 L 9 V	8140.43R	11/01 ⇨ 04/06
DAILY II 35 C 14	F1CE0481A, F1CE0481A	09/04 ⇨ 04/06
DAILY II 35 C 15	8140.43N	11/01 ⇨ 04/06
DAILY II 35 C 17, 35 S 17	F1CE0481B	01/05 ⇨ 04/06
DAILY II 35 C 9, 35 S 9	8140.43R	11/01 ⇨ 04/06
DAILY II 35 S 13 V, 35 C 13 V	8140.43S	05/99 ⇨ 07/07
DAILY II 35 S 13, 35 C 13	8140.43S	05/99 ⇨ 04/06
DAILY II 35 S 15 V, 35 C 15 V	8140.43N	11/02 ⇨ 07/07
DAILY II 35 S 9 V	8140.43R	11/01 ⇨ 04/06
DAILY II 40 C 13	8140.43S	05/99 ⇨ 04/06
DAILY II 40 C 14	F1CE0481A	09/04 ⇨ 04/06
DAILY II 40 C 15	8140.43N	11/01 ⇨ 04/06
DAILY II 40 C 17, 40 S 17	F1CE0481B	01/05 ⇨ 04/06
DAILY II 45 C 14	F1CE0481A	07/99 ⇨ 04/06
DAILY II 50 C 13	8140.43S	05/99 ⇨ 07/07
DAILY II 50 C 14	F1CE0481A, F1CE0481A	09/04 ⇨ 04/06
DAILY II 50 C 15	8140.43N	01/01 ⇨ 04/06
DAILY II 50 C 17	F1CE0481B	09/04 ⇨ 04/06
DAILY II 65 C 14	F1CE0481A, F1CE0481A	09/04 ⇨ 04/06
DAILY II 65 C 15	8140.43N	11/01 ⇨ 04/06
DAILY II 65 C 17	F1CE0481B	09/04 ⇨ 04/06
DAILY III 35 S 13, 40 C 13, 50 C 13	8140.43S	05/99 ⇨ 05/06
DAILY III 35 S 14, 50 C 14	F1CE0481A, F1CE3481B	01/04 ⇨ 05/06
DAILY III 40 C 17, 50 C 17	F1CE0481B	01/04 ⇨ 05/06
DAILY IV 35C14 G, 35C14 G/P, 35S14 G, 35S14 G/P, 35C14 GD,...	F1CE0441CNG	07/07 ⇨ 08/11
DAILY IV 35C14 GV, 35C14 GV/P, 35S14 GV, 35S14 GV/P	F1CE0441CNG	07/07 ⇨ 08/11
DAILY IV 35C14 K, 35C14 DK, 35S14 K, 35S14 DK	F1CE3481L	07/07 ⇨ 08/11
DAILY IV 35C14 V, 35C14 V/P, 35S14 V, 35S14 V/P	F1CE3481L	07/07 ⇨ 08/11
DAILY IV 35C14, 35C14 /P, 35S14, 35S14 /P, 35S14 D, 35S14 D/P	F1CE3481L	07/07 ⇨ 08/11
DAILY IV 35C15	F1CE0481F	05/06 ⇨ 08/11
DAILY IV 35C15 V, 35C15 V/P	F1CE0481F	05/06 ⇨ 08/11
DAILY IV 35C15 V, 40C15 V, 50C15 V, 60C15 V	F1CE3481B, F1CE3481B	09/11 ⇨ 02/14
DAILY IV 35C15, 35C15D, 35S15, 40C15, 45C15, 50C15, 60C15, 70C15	F1CE3481B	09/11 ⇨ 02/14
DAILY IV 35C15K, 35S15DKP, 50C15K, 60C15K, 65C15DK, 70C15K	F1CE3481B	09/11 ⇨ 02/14
DAILY IV 35C17 K, 35C17 DK, 35S17 K, 35S17 DK	F1CE3481C	07/07 ⇨ 08/11
DAILY IV 35C17 V, 35C17 V/P, 35S17 V, 35S17 V/P	F1CE3481C	07/07 ⇨ 08/11
DAILY IV 35C17 V, 35S17 V, 40C17 V, 45C17 V, 50C17 V, 60C17 V	F1CE3481C	09/11 ⇨ 02/14
DAILY IV 35C17, 35C17 /P, 35S17, 35S17 /P, 35S17 D	F1CE3481C	07/07 ⇨ 08/11
DAILY IV 35C17, 35C17D, 35S17, 40C17, 45C17, 50C17, 60C17, 70C17	F1CE3481C	09/11 ⇨ 02/14
DAILY IV 35C17K, 35S17DKP, 50C17K, 65C17DK 70C17K	F1CE3481C, F1CE0481H	09/11 ⇨ 02/14
DAILY IV 35C18	F1CE0481H	05/06 ⇨ 08/11
DAILY IV 35C18 V, 35C18 V/P, 35S18 V, 35S18 V/P	F1CE0481H, F1CE0481H	05/06 ⇨ 08/11
DAILY IV 35C18, 35S18	F1CE0481H, F1CE0481H	05/06 ⇨ 08/11
DAILY IV 35C21 V, 35S21 V, 40C21 V, 45C21 V, 50C21 V	F1CE3481D	09/11 ⇨ 02/14
DAILY IV 35C21, 35S21, 40C21, 45C21, 50C21, 60C21, 70C21	F1CE3481D	09/11 ⇨ 02/14
DAILY IV 35S17 W, 35S17 WD	F1CE3481C	07/07 ⇨ 08/11
DAILY IV 40C14 G, 40C14 G/P	F1CE0441CNG	07/07 ⇨ 08/11
DAILY IV 40C14 GV, 40C14 GV/P	F1CE0441CNG	07/07 ⇨ 08/11
DAILY IV 40C14 K, 40C14 DK	F1CE3481L	07/07 ⇨ 08/11
DAILY IV 40C14 V, 40C14 V/P	F1CE3481L	07/07 ⇨ 08/11
DAILY IV 40C14, 40C14 /P	F1CE3481L	07/07 ⇨ 08/11

IVECO			
DAILY IV 40C15	F1CE0481F	05/06 → 08/11	
DAILY IV 40C15 V, 40C15 V/P	F1CE0481F	05/06 → 08/11	
DAILY IV 40C17 K, 40C17 DK	F1CE3481C	07/07 → 08/11	
DAILY IV 40C17 V, 40C17 V/P	F1CE3481C	07/07 → 08/11	
DAILY IV 40C17, 40C17 /P	F1CE3481C	07/07 → 08/11	
DAILY IV 40C18	F1CE0481H	05/06 → 08/11	
DAILY IV 40C18 V, 40C18 V/P	F1CE0481H	05/06 → 08/11	
DAILY IV 45C14, 45C14 /P	F1CE3481L	07/07 → 08/11	
DAILY IV 45C15	F1CE0481F	05/06 → 08/11	
DAILY IV 45C15 V	F1CE0481F	05/06 → 08/11	
DAILY IV 45C17 V, 45C17 V/P	F1CE3481C	07/07 → 08/11	
DAILY IV 45C17, 45C17 /P	F1CE3481C	07/07 → 08/11	
DAILY IV 45C18	F1CE0481H	05/06 → 08/11	
DAILY IV 45C18, 45C18 /P, 45C18 D, 45C18 D/P	F1CE0481H	05/06 → 08/11	
DAILY IV 50C14 G, 50C14 G/P, 50C14 GD, 50C14 GD/P	F1CE0441CNG	07/07 → 08/11	
DAILY IV 50C14 GV, 50C14 GV/P	F1CE0441CNG	07/07 → 08/11	
DAILY IV 50C14 K, 50C14 DK	F1CE3481L	07/07 → 08/11	
DAILY IV 50C14 V, 50C14 V/P	F1CE3481L	07/07 → 08/11	
DAILY IV 50C14, 50C14 /P	F1CE3481L	07/07 → 08/11	
DAILY IV 50C15	F1CE0481F	05/06 → 08/11	
DAILY IV 50C15 V, 50C15 V/P	F1CE0481F	05/06 → 08/11	
DAILY IV 50C17 K, 50C17 DK	F1CE3481C	07/07 → 08/11	
DAILY IV 50C17 V, 50C17 V/P	F1CE3481C	07/07 → 08/11	
DAILY IV 50C17, 50C17 /P	F1CE3481C	07/07 → 08/11	
DAILY IV 50C18	F1CE0481H	05/06 → 08/11	
DAILY IV 50C18 V, 50C18 V/P	F1CE0481H, F1CE0481H	05/06 → 08/11	
DAILY IV 55C17	F1CE3481C	08/07 → 03/12	
DAILY IV 55S17 W, 55S17 WD	F1CE3481C	07/07 → 08/11	
DAILY IV 55S18 W	F1CE0481H	06/06 → 08/11	
DAILY IV 60C14 K, 60C14 DK	F1CE3481L	07/07 → 08/11	
DAILY IV 60C14, 60C14 /P	F1CE3481L	07/07 → 08/11	
DAILY IV 60C15	F1CE0481F	05/06 → 08/11	
DAILY IV 60C15 V	F1CE0481F	05/06 → 08/11	
DAILY IV 60C15, 60C15 /P, 60C15 D, 60C15 D/P	F1CE0481F	05/06 → 08/11	
DAILY IV 60C17 K, 60C17 DK	F1CE3481C	07/07 → 08/11	
DAILY IV 60C17 V, 60C17 V/P	F1CE3481C	07/07 → 08/11	
DAILY IV 60C17, 60C17 /P	F1CE3481C	07/07 → 08/11	
DAILY IV 60C18	F1CE0481H	05/06 → 08/11	
DAILY IV 65C14 G, 65C14 G/P, 65C14 GD, 65C14 GD/P	F1CE0441CNG	07/07 → 08/11	
DAILY IV 65C14 K, 65C14 DK	F1CE3481L	07/07 → 08/11	
DAILY IV 65C14 V, 65C14 V/P	F1CE3481L	07/07 → 08/11	
DAILY IV 65C14, 65C14 /P	F1CE3481L	07/07 → 08/11	
DAILY IV 65C15	F1CE0481F	05/06 → 08/11	
DAILY IV 65C15, 65C15 /P, 65C15 D, 65C15 D/P	F1CE0481F	05/06 → 08/11	
DAILY IV 65C17 K, 65C17 DK, 65C17KK	F1CE3481C	07/07 → 08/11	
DAILY IV 65C17 V, 65C17 V/P	F1CE3481C	07/07 → 08/11	
DAILY IV 65C17, 65C17 /P	F1CE3481C	07/07 → 08/11	
DAILY IV 65C18	F1CE0481H, F1CE3481J	05/06 → 08/11	
DAILY IV 70C14 K, 70C14 DK, 70C14 KK	F1CE3481L	07/07 → 08/11	
DAILY IV 70C14 V, 70C14 V/P	F1CE3481L	07/07 → 08/11	
DAILY IV 70C14, 70C14 /P	F1CE3481L	07/07 → 08/11	
DAILY IV 70C15	F1CE0481L	07/08 → 08/11	
DAILY IV 70C17 K, 70C17 DK, 70C17 KK	F1CE3481C	07/07 → 08/11	
DAILY IV 70C17, 70C17 /P	F1CE3481C	07/07 → 08/11	
DAILY IV 70C17 V, 70C17 V/P	F1CE3481C	07/07 → 08/11	
DAILY IV Natural Power 35S14, 35C14, 40C14, 50C14, 65C14, 70C14	F1CE0441CNG	09/11 → 02/14	
DAILY IV NaturalPower 35S14, 35C14, 40C14, 50C14, 65C14, 70C14, ..	F1CE0441CNG	09/11 → 02/14	
DAILY V 35S14, 35S15, 35C15, 40S14, 40C15, 50C15, 65C15, 70C15	F1CE3481J	03/14 → 04/16	
DAILY V 35S15, 35C15, 40C15, 50C15, 65C15, 70C15, 72C15	F1CGL411A	04/16 →	
DAILY V 35S17, 35C17, 40C17, 45S17, 45C17, 50C17, 55C17, 65C17, ..	F1CFL411F	03/14 → 04/16	
DAILY V 35S17, 35C17, 40C17, 50C17, 55C17, 65C17, 70C17	F1CFL411F, F1CFL411W	03/14 → 04/16	
DAILY V 35S17, 55S17 4x4	F1CFL411F	08/15 → 04/16	
DAILY V 35S18, 35C18, 40C18, 50C18, 65C18, 70C18	F1CGL411B	04/16 →	
DAILY V 35S18, 35C18, 40C18, 50C18, 65C18, 70C18, 72C18	F1CFL411W, F1CFL411W	04/16 →	
DAILY V 35S18, 55S18 4x4	F1CFL411W, F1CFL411G	09/16 →	
DAILY V 35S21, 35C21, 40C21, 50C21, 65C21, 70C21	F1CFL411G, F1CE3481J	03/14 →	
DAILY V 40C15, 50C15, 60C15	F1CE3481J, F1CE3481J	06/14 → 10/16	
DAILY V 40C15, 50C15, 65C15	F1CE3481J, F1CFL411F	03/14 → 04/16	
DAILY V 40C17, 50C17, 60C17	F1CFL411F	06/14 → 10/16	
DAILY V 50C15	F1CE3481J, ENR	06/14 → 10/16	
DAILY V 50C17	F1CFL411F	06/14 → 10/16	
DAILY V 50C17, 65C17	F1CFL411F	06/14 → 10/16	
DAILY V Natural Power 35S14, 35C14, 40C14, 50C14, 65C14, 70C14, ..	F1CFA401A	04/16 →	
DAILY V Natural Power 35S14, 35C14, 40C14, 50C14, 65C14, 70C14	F1CFA401A	03/14 →	
DAILY V NaturalPower 35S14, 35C14, 40C14, 50C14, 65C14, 70C14, ..	F1CFA401A	03/14 →	
DAILY 2.8	8140.43R	07/99 → 12/06	
DAILY 3.0	F1CE0441A, F1CE0441CNG	06/06 →	
DAILY 3.0 CNG	F1CE0441CNG, F1CE0481A	06/06 → 02/14	
MASSIF 3.0 HPI	F1CE0481F	10/08 → 02/11	
MASSIF 3.0 HPT	F1CE0481H	10/08 → 02/11	

IVECO			
DAILY V 35S18, 35C18, 40C18, 50C18, 65C18, 70C18	F1CGL411B	04/16 →	
DAILY V 35S18, 35C18, 40C18, 50C18, 65C18, 70C18, 72C18	F1CFL411W, F1CFL411W	04/16 →	
DAILY V 35S18, 55S18 4x4	F1CFL411W, F1CFL411G	09/16 →	
DAILY V 35S21, 35C21, 40C21, 50C21, 65C21, 70C21	F1CFL411G, F1CE3481J	03/14 →	
DAILY V 40C15, 50C15, 60C15	F1CE3481J, F1CE3481J	06/14 → 10/16	
DAILY V 40C15, 50C15, 65C15	F1CE3481J, F1CFL411F	03/14 → 04/16	
DAILY V 40C17, 50C17, 60C17	F1CFL411F	06/14 → 10/16	
DAILY V 50C15	F1CE3481J, ENR	06/14 → 10/16	
DAILY V 50C17	F1CFL411F	06/14 → 10/16	
DAILY V 50C17, 65C17	F1CFL411F	06/14 → 10/16	
DAILY V Natural Power 35S14, 35C14, 40C14, 50C14, 65C14, 70C14, ..	F1CFA401A	04/16 →	
DAILY V Natural Power 35S14, 35C14, 40C14, 50C14, 65C14, 70C14	F1CFA401A	03/14 →	
DAILY V NaturalPower 35S14, 35C14, 40C14, 50C14, 65C14, 70C14, ..	F1CFA401A	03/14 →	
DAILY 2.8	8140.43R	07/99 → 12/06	
DAILY 3.0	F1CE0441A, F1CE0441CNG	06/06 →	
DAILY 3.0 CNG	F1CE0441CNG, F1CE0481A	06/06 → 02/14	
MASSIF 3.0 HPI	F1CE0481F	10/08 → 02/11	
MASSIF 3.0 HPT	F1CE0481H	10/08 → 02/11	

JEEP			
CHEROKEE III 2.5 CRD 4x4	ENJ	09/01 → 01/08	
CHEROKEE III 2.8 CRD 4x4	ENR, ENS	11/02 → 01/08	
CHEROKEE IV 2.8 CRD 4x4	ENS, EXF	05/08 →	
GRAND CHEROKEE 3.0 CRD	EXF	09/13 →	
GRAND CHEROKEE 3.0 CRD V6 4x4	EXF, ENS	01/11 →	
WRANGLER 2.8 CRD	ENS, D4EA	04/07 →	
WRANGLER 2.8 CRD RWD	ENS	04/07 → 02/10	

KIA			
CARENS II 2.0 CRDi	D4EA, D4EA	07/02 →	
CARENS III 2.0 CRDi 115	D4EA	05/07 →	
CARENS III 2.0 CRDi 135	D4EA	08/09 →	
CARENS III 2.0 CRDi 140	D4EA	09/06 →	
CEED I 2.0 CRDi	D4EA	06/07 → 12/12	
CEED I 2.0 CRDi 140	D4EA, D4EA	07/07 → 12/12	
MAGENTIS II 2.0 CRDi	D4EA, D4EA	11/05 →	
OPTIMA II 2.0 CRDi	D4EA	09/06 →	
PRO CEE'D I 2.0 CRDi 140	D4EA, D4EA	02/08 → 09/12	
SPORTAGE II 2.0 CRDi	D4EA, D4EA	02/05 →	
SPORTAGE II 2.0 CRDi 4WD	D4EA, ENS	09/04 →	

LANCIA			
THEMA 2011 3.0 D	EXF	09/11 → 10/14	
VOYAGER 2.8 CRD	ENS, 368DT	09/11 → 12/14	

LAND ROVER			
RANGE ROVER 4.4 TD [ExtraEU]	448DT	08/13 →	
RANGE ROVER III 3.6 D 4x4	368DT, 448DT	04/06 → 08/12	
RANGE ROVER III 4.4 D 4x4	448DT, 368DT	07/10 → 08/12	
RANGE ROVER IV 4.4 D V8 4x4	448DT	08/12 →	
RANGE ROVER SPORT I 3.6 D 4x4	368DT, Z14XEL	04/06 → 03/13	
RANGE ROVER SPORT I 3.6 TDV8	306DT	09/09 →	
RANGE ROVER SPORT II 4.4 D 4x4	44DDOR	10/13 →	

MASERATI			
GHIBLI 3.0 D	M15746D	08/13 →	
LEVANTE 3.0 D Trazione integrale	B630WM	06/16 →	
QUATTROPORTE 3.0 D	M15746D	09/13 →	

OPEL			
AGILA A 1.0	Z10XEP	08/03 → 12/07	
AGILA A 1.2 16V Twinport	Z12XEP	07/04 → 12/07	
ASTRA G 1.4	Z14XEP	10/04 → 12/09	
ASTRA H 1.2	Z12XEP	08/05 → 10/10	
ASTRA H 1.4	Z14XEL, A16LET	03/04 → 10/10	
ASTRA H 1.4 EcoTec	Z14XEP	12/04 → 12/12	
ASTRA H 1.4 LPG	Z14XEP	08/09 → 10/10	
ASTRA H 1.6 Turbo	A16LET, Z10XE	02/07 → 10/10	
ASTRA J 1.4	Z14XEP	01/09 →	
COMBO C 1.4	Z14XEP	10/04 → 12/11	
COMBO C 1.4 16V	Z14XEP	08/05 →	
CORSA C 1.0	Z10XE, Z12XEP	09/00 → 12/09	
CORSA C 1.2	Z12XE	09/00 → 12/09	
CORSA C 1.2 16V	Z12XE	09/00 → 07/03	
CORSA C 1.2 Twinport	Z12XEP	07/04 → 12/09	

OPEL			
CORSA C 1.4	Z14XEP	08/03 → 06/12	
CORSA C 1.4 Twinport	Z14XEP	06/03 → 12/09	
CORSA D 1.0	Z10XEP	07/06 → 08/14	
CORSA D 1.2	Z12XEP	07/06 → 08/14	
CORSA D 1.2 LPG	Z12XEP, A16LEL	08/06 → 08/14	
CORSA D 1.4	Z14XEP	07/06 → 08/14	
CORSA D 1.4 LPG	Z14XEP	08/06 → 12/11	
CORSA D 1.6	Z16LER	07/12 → 08/14	
CORSA D 1.6 Turbo	A16LEL, A16XNT	11/06 → 08/14	
INSIGNIA 1.6 Turbo	A16LET	07/08 → 03/17	
MERIVA A 1.4 16V Twinport	Z14XEP	07/04 → 05/10	
MERIVA A 1.4 16V Twinport LPG	Z14XEP	07/04 → 05/10	
MERIVA A 1.6 Turbo	Z16LET	09/05 → 05/10	
TIGRA B 1.4	Z14XEP	06/04 → 12/10	
ZAFIRA B 1.6 CNG Turbo	A16XNT, A16XNT	02/09 → 04/15	
ZAFIRA C 1.6 CNG	A16XNT, 8140.43N	10/11 →	

PEUGEOT			
BOXER I 2.8 HDi	8140.43N, 8140.43S(F28DTCR)	04/02 →	
BOXER I 2.8 HDi 4x4	8140.43S(F28DTCR), F1CE0481D(F30DT)	04/02 →	
BOXER II 3.0 D	F30DT	09/08 → 12/09	
BOXER II 3.0 HDi	F1CE0481D(F30DT), F1CE3481N(F30DTE)	07/06 →	
BOXER II 3.0 HDi 145	F1CE3481N(F30DTE), F1CE0481D(F30DT)	04/10 →	
BOXER II 3.0 HDi 160	F1CE0481D(F30DT), F1CE0481D(F30DT)	04/06 →	
BOXER II 3.0 HDi 175	F1CE0481D(F30DT), Z14XEL	03/11 →	

SAAB			
9-5 1.6 Turbo	A16LET	05/10 → 01/12	

SUZUKI			
WAGON R III 1.0	G10A	07/03 → 08/05	
WAGON R III 1.2	Z12XEP	06/04 → 08/05	

VAUXHALL			
AGILA A 1.0 12V	Z10XEP	02/00 → 11/06	
AGILA A 1.2 16V Twinport	Z12XEP	07/04 → 11/06	
ASTRA V 1.2	Z12XEP	08/05 → 10/10	
ASTRA V 1.4	Z14XEL, A16LET	01/04 → 10/10	
ASTRA V 1.4 i 16V	Z14XEP	03/05 → 11/10	
ASTRA V 1.6	A16LET, A16LET	08/04 → 11/10	
ASTRA V 1.6 Turbo	A16LET, Z10XE	09/06 → 09/09	
ASTRAVAN III 1.4 i	Z14XEP	03/05 →	
COMBO C 1.4	Z14XEP	10/04 → 09/10	
COMBO C 1.4 i 16V	Z14XEP	01/04 → 11/11	
CORSA C 1.0 12V	Z10XE, A16LEL	09/00 → 10/06	
CORSA C 1.2 16V	Z12XE	09/00 → 10/06	
CORSA C 1.2 16V Dualfuel	Z12XE	08/01 → 10/06	
CORSA C 1.2 Twinport	Z12XEP	07/04 → 10/06	
CORSA C 1.4 Twinport	Z14XEP	06/03 → 10/06	
CORSA D 1.0	Z10XEP	08/06 → 08/14	
CORSA D 1.2	Z12XEP	08/06 → 08/14	
CORSA D 1.2 LPG	Z12XEP	09/09 → 08/14	
CORSA D 1.4	Z14XEP	08/06 → 08/14	
CORSA D 1.4 LPG	Z14XEP	07/06 → 08/14	
CORSA D 1.6 SRI	A16LEL, A16LER	05/07 → 08/14	
CORSA D 1.6 VXR	A16LER, Z12XE	11/06 → 08/14	
CORSAVAN II 1.2 16V	Z12XE, Z12XE	09/00 → 11/06	
CORSAVAN II 1.2 16V Dualfuel	Z12XE, A16XNT	08/01 → 06/06	
CORSAVAN II 1.4	Z14XEP	11/03 → 06/06	
CORSAVAN III 1.2	Z12XEP	07/09 →	
INSIGNIA 1.6 Turbo	A16LET	01/09 → 05/17	
MERIVA I 1.4 16V Twinport	Z14XEP	01/03 → 06/10	
MERIVA I 1.6 Turbo	Z16LET	05/06 → 06/10	
TIGRA B 1.4	Z14XEP	06/04 → 08/09	
ZAFIRA B 1.6 CNG Turbo	A16XNT, B205E	02/09 → 11/14	
ZAFIRA C 1.6 CNG	A16XNT	10/11 → 08/18	

9.0362



3

REVOLUTION AND TIMING (CKP AND CMP) SENSORS

Adatt./Suitable:

DENSO
029600-1100
GENERAL MOTORS
97 160 535

ISUZU
8-97160535-0

OPEL
62 36 600
97160535

RENAULT
77 01 052 657

SAAB
59 54 375

VAUXHALL
97160535

L	L1	ohm	
---	26	2100	

OPEL

SIGNUM 3.0 V6 CDTi	Y30DT	05/03 ⇨ 07/05
VECTRA C 3.0 CDTi	Y30DT	02/03 ⇨ 07/05
VECTRA C 3.0 V6 CDTi	Y30DT	10/03 ⇨ 07/05

RENAULT

ESPACE IV 3.0 dCi	P9X701	11/02 ⇨
VEL SATIS 3.0 dCi	P9X701	06/02 ⇨

SAAB

9-5 2.0 t	B205E, AGN	09/97 ⇨ 12/09
9-5 2.0 Turbo SE	B205E	10/98 ⇨ 07/00
9-5 3.0 TiD	D308L	07/01 ⇨ 12/09

VAUXHALL

SIGNUM 3.0 CDTi	Y30DT	05/03 ⇨ 05/08
VECTRA C 3.0 V6 CDTi	Y30DT	06/03 ⇨ 08/05

9.0365



04

REVOLUTION AND TIMING (CKP AND CMP) SENSORS

Adatt./Suitable:

AUDI
058 905 161 B

BOSCH
0 232 101 024
0 232 101 025

SEAT
058 905 161 B

SKODA
058 905 161 B

VW
058 905 161 B

MARKET DIFFUSION: MEDIUM

L	L1	Hall Effect	
---	---		

AUDI

A3 I 1.8	AGN, AGU	09/96 ⇨ 05/03
A3 I 1.8 T	AGU, AGU	12/96 ⇨ 05/03
A3 I 1.8 T quattro	AGU, AMK	12/96 ⇨ 05/03
A3 I S3 quattro	AMK, ADR	10/01 ⇨ 05/03
A4 II 1.8 T	AMB, AMB	11/00 ⇨ 03/09
A4 II 1.8 T quattro	AMB, AMM	11/00 ⇨ 03/09
A4 II 2.0	ALT	11/00 ⇨ 12/05
A4 II 2.4	AMM, AGE	09/01 ⇨ 12/05
A4 I 1.8	ADR, ADR	11/94 ⇨ 09/01
A4 I 1.8 quattro	ADR, AEB	01/95 ⇨ 09/01
A4 I 1.8 T	AEB, AEB	01/95 ⇨ 09/01
A4 I 1.8 T quattro	AEB, AGA	01/95 ⇨ 09/01
A4 I 2.4	AGA, AGA	03/97 ⇨ 09/01
A4 I 2.4 quattro	AGA, ACK	03/97 ⇨ 09/01
A4 I 2.8	ACK, ACK	10/96 ⇨ 09/01
A4 I 2.8 quattro	ACK, ASJ	10/96 ⇨ 09/01
A4 I RS4 quattro	ASJ, AGB	05/00 ⇨ 09/01
A4 I S4 quattro	AGB, AMB	09/97 ⇨ 09/01
A4 III 1.8 T	BFB	11/04 ⇨ 06/08
A4 III 1.8 T quattro	BFB	11/04 ⇨ 06/08
A4 III 2.0	ALT	11/04 ⇨ 06/08
A6 I 1.8	ADR	12/95 ⇨ 12/97
A6 I 1.8 quattro	ADR	12/95 ⇨ 12/97
A6 I 2.8	ACK	12/95 ⇨ 12/97
A6 I 2.8 quattro	ACK	12/95 ⇨ 12/97
A6 I S6 Plus quattro	AHK	04/96 ⇨ 12/97
A6 II 1.8	AFY, AEB	05/97 ⇨ 01/05
A6 II 1.8 T	AEB, AEB	01/97 ⇨ 01/05
A6 II 1.8 T quattro	AEB, AGA	02/97 ⇨ 01/05
A6 II 2.0	ALT	08/01 ⇨ 01/05
A6 II 2.4	AGA, AGA	08/01 ⇨ 01/05
A6 II 2.4 quattro	AGA, AJK	08/01 ⇨ 01/05
A6 II 2.7 T	AJK	02/99 ⇨ 01/05
A6 II 2.7 T quattro	AJK, ACK	08/01 ⇨ 01/05
A6 II 2.8	ACK, ACK	02/97 ⇨ 01/05
A6 II 2.8 quattro	ACK, ARS	02/97 ⇨ 01/05
A6 II 4.2 quattro	ARS, ANK	11/98 ⇨ 01/05
A6 II RS6 plus quattro	BRV	04/04 ⇨ 01/05
A6 II RS6 quattro	BCY	07/02 ⇨ 01/05
A6 II S6 quattro	ANK, ACK	09/99 ⇨ 01/05
A6 2.8	AGE, AFY	04/98 ⇨ 05/01
A8 I 2.8	ACK, ACK	04/96 ⇨ 09/02
A8 I 2.8 quattro	ACK, AEW	04/96 ⇨ 09/02
A8 I 3.7	AEW, AEW	07/95 ⇨ 12/98
A8 I 3.7 quattro	AEW, ABZ	07/95 ⇨ 11/98
A8 I 4.2 quattro	ABZ, AQH	03/94 ⇨ 12/99
A8 I S 8 quattro	AQH, AHC	06/99 ⇨ 09/02
A8 I S 8 quattro	AHC, ARE	09/00 ⇨ 06/99
A8 II 3.7 quattro	BFL	10/02 ⇨ 05/06
A8 II 4.2 quattro	BFM	10/02 ⇨ 07/10
ALLROAD 2.7 T quattro	ARE, AJQ	05/00 ⇨ 08/05
CABRIOLET 1.8	ADR	01/97 ⇨ 08/00

AUDI

TT I 1.8 T	AJQ, AJQ	01/01 ⇨ 06/06
TT I 1.8 T quattro	AJQ, AJH	02/00 ⇨ 06/06

SEAT

ALHAMBRA I / II 1.8 T 20V	AJH, BBU	10/97 ⇨ 03/10
IBIZA III 1.8 T Cupra R	BBU, BJX	01/04 ⇨ 02/08
IBIZA III 1.8 T FR	BJX, AGN	12/03 ⇨ 05/08
LEON I 1.8 20V	AGN, APP	11/99 ⇨ 06/06
LEON I 1.8 20V T	APP, AMK	11/99 ⇨ 06/06
LEON I 1.8 20V T 4	ARY	11/99 ⇨ 06/06
LEON I 1.8 T Cupra R	AMK, AGN	02/02 ⇨ 06/06
LEON I 1.8 Turbo 4x4	AMK	05/02 ⇨ 05/03
TOLEDO II 1.8 20V	AGN, AGU	10/98 ⇨ 07/04
TOLEDO II 1.8 20VT	AUQ	09/00 ⇨ 07/04

SKODA

OCTAVIA I 1.8	AGN	09/96 ⇨ 07/00
OCTAVIA I 1.8 20V	AGN	07/98 ⇨ 07/00
OCTAVIA I 1.8 T	AGU, AMX	08/97 ⇨ 12/10
OCTAVIA I 1.8 T 4x4	ARX	05/01 ⇨ 05/06
OCTAVIA I RS 1.8 T	AUQ	05/01 ⇨ 01/06
SUPERB I 1.8 T	AWT	12/01 ⇨ 03/08
SUPERB I 2.8 V6	AMX, AGU	12/01 ⇨ 03/08

VW

BORA 1.8 4motion	AGN	02/99 ⇨ 05/05
BORA 1.8 T	AGU, AGU	05/00 ⇨ 05/05
GOLF IV 1.8	AGN	08/97 ⇨ 06/05
GOLF IV 1.8 4motion	AGN	05/98 ⇨ 06/06
GOLF IV 1.8 T	AGU, APH	08/97 ⇨ 06/06
GOLF IV 1.8 T GTI	AUQ	08/01 ⇨ 06/05
NEW BEETLE 1.8 T	APH, ADR	11/01 ⇨ 09/10
PASSAT IV 1.8	ADR, ADR	10/96 ⇨ 03/05
PASSAT IV 1.8 Syncro/4motion	ADR, AEB	10/96 ⇨ 11/00
PASSAT IV 1.8 T	AEB, AMX	10/96 ⇨ 11/00
PASSAT IV 1.8 T 20V	AWT	11/00 ⇨ 05/05
PASSAT IV 1.8 T Syncro	AEB	11/96 ⇨ 08/00
PASSAT IV 2.0	ALT	11/01 ⇨ 05/05
PASSAT IV 2.8	AMX, AMX	10/00 ⇨
PASSAT IV 2.8 4motion	AMX, AGE	10/00 ⇨
PASSAT IV 2.8 V6	AGE, ACK	08/96 ⇨ 09/99
PASSAT IV 2.8 V6 Syncro/4motion	ACK, BGH	10/96 ⇨ 11/00
PASSAT 2.8 [ExtraEU]	BBG	10/00 ⇨ 05/05
PHAETON 4.2 V8 4motion	BGH, AJH	05/03 ⇨ 03/16
SHARAN I 1.8 T 20V	AJH, AEH	09/97 ⇨ 03/10
TOUAREG I 4.2 V8	AXQ	12/02 ⇨ 11/06

9.0367



04,5

REVOLUTION AND TIMING (CKP AND CMP) SENSORS

Adatt./Suitable:

AUDI
06A 905 161 B
06A 905 161 C

BOSCH
0 232 101 031
0 232 101 032
0 232 101 038
0 232 101 039

SEAT
06A 905 161 B

SKODA
06A 905 161 B
06A 905 161 C

VW
06A 905 161 B
06A 905 161 C

MARKET DIFFUSION: MEDIUM

L	L1	Hall Effect	
---	---		

AUDI

A3 I 1.6	AEH, ADP	08/00 ⇨ 05/03
A4 I 1.6	ADP, ADY	07/00 ⇨ 09/01

SEAT

ALHAMBRA I / II 2.0 i	ADY, AZL	04/96 ⇨ 03/10
CORDOBA II 2.0	AZL, AZL	09/02 ⇨ 11/09
IBIZA III 2.0	AZL, AEH	04/02 ⇨ 11/09

SEAT		
IBIZA IV 2.0	CEKA	10/08 →
LEON I 1.6	AEH, AEH	11/99 → 06/06
TOLEDO II 1.6	AEH, AEH	10/98 → 07/04
SKODA		
FABIA I 2.0	AZL	12/99 → 03/08
OCTAVIA I 1.6	AEH, AEG	09/00 → 12/10
OCTAVIA I 2.0	AEG, AZH	04/99 → 05/07
OCTAVIA I 2.0 4x4	AZH, AEH	08/00 → 09/04
SUPERB I 2.0	AZM	12/01 → 03/08
VOLKSWAGEN (BR)		
POLO 2.0	BBX	05/02 →
VW		
BORA 1.6	AEH, APK	08/00 → 05/05
BORA 2.0	APK, AZH	10/98 → 05/05
BORA 2.0 4motion	AZH, AEH	04/00 → 05/05
CADDY III 2.0 EcoFuel	BSX	04/06 → 05/15
CARAVELLE 2.0 EcoFuel	AXACNG	01/06 → 03/14
GOLF 2.0 BiFuel	BEH	05/02 → 05/03
GOLF IV 1.6	AEH, APK	08/00 → 06/06
GOLF IV 2.0	APK, AZH	07/98 → 06/06
GOLF IV 2.0 4motion	AZH, CBPA	10/00 → 06/06
GOLF IV 2.0 Bi-Fuel	BEH	02/02 → 06/06
GOLF V 2.0	BHY	08/06 → 11/08
JETTA VI 2.0	CBPA, AWH	06/10 → 12/17
MULTIVAN 2.0	AXA	11/03 → 08/15
NEW BEETLE 1.6	AWH, AEG	06/00 → 09/10
NEW BEETLE 2.0	AEG, ADP	01/98 → 10/10
PASSAT I 1.6	ADP, AZM	10/96 → 05/05
PASSAT IV 2.0	AZM, BFF	11/00 → 05/05
PASSAT IV 2.0 [CHN]	BFF, AEH	06/03 →
PASSAT IV 2.0 4motion	AZM	11/00 → 05/05
POLO III 1.6	AEH, AEH	05/97 → 09/01
POLO III 100 1.6	AEH, ADY	12/95 → 09/01
POLO IV 1.8 GTI	BJX	09/05 → 11/09
POLO IV 1.8 GTI Cup Edition	BBU	05/06 → 11/09
POLO IV 2.0	BBX	09/02 →
POLO 1.6 [ExtraEU]	AKL	10/99 → 09/01
SHARAN I 2.0	ADY, AXACNG	09/95 → 03/10
SHARAN I 2.0 LPG	ATM	04/06 → 03/10
TOURAN I 2.0 EcoFuel	BSX	02/06 → 05/09
TRANSPORTER 2.0 EcoFuel	AXACNG, CAVG	11/03 → 08/15
TRANSPORTER V 2.0	AXA	11/03 → 08/15
TRANSPORTER V 2.0 BiFuel	AXACNG	05/11 → 08/15

9.0368



REVOLUTION AND TIMING (CKP AND CMP) SENSORS

Adatt./Suitable:

AUDI

030 907 601 E

BENTLEY

030 907 601 E

BOSCH

0 986 280 432

PORSCHE

955 606 106 10

SEAT

030 907 601

030 907 601 D

030 907 601 E

030 907 901 D

03D 907 601

SKODA

030 907 601 E

03D 907 601

VW

030 907 601

030 907 601 C

030 907 601 D

030 907 601 E

03D 907 601

MARKET DIFFUSION: HIGH



L	L1	Hall Effect	
---	24,4		

AUDI		
A1 1.2 TFSI	CBZA	05/10 → 04/15
A1 1.4 TFSI	CAVG, CAXC	05/10 → 04/15
A2 1.6 FSI	BAD	05/02 → 08/05
A3 I [USA] 3.2 24V	CBRA	07/08 → 05/09
A3 I [USA] 3.2 24V AWD	--	01/06 → 12/09
A3 II 1.2 TFSI	CBZB	03/10 → 05/13
A3 II 1.2 TFSI	CBZB	04/10 → 08/12
A3 II 1.4 TFSI	CAXC, BAG	09/07 → 05/13
A3 II 1.6 FSI	BAG, BDB	08/03 → 09/07
A3 II 3.2 V6 quattro	BDB, CAXC	07/03 → 05/09
A3 II SPORTBACK 1.2 TFSI	CBZB	04/10 → 03/13
A3 II SPORTBACK 1.4 TFSI	CAXC, BLF	09/07 → 03/13
A3 II SPORTBACK 1.6 FSI	BLF, BDB	09/04 → 09/07
A3 II SPORTBACK 3.2 V6 quattro	BDB, CEJA	09/04 → 05/09
A8 III 6.3 W12 quattro	CEJA, BEB	01/11 → 01/18
Q7 1.6 FSI quattro	BHK	08/06 → 05/10
TT II 3.2 V6 quattro	BUB	08/06 → 06/10

BENTLEY		
CONTINENTAL 6.0	BEB, BEB	06/03 →
CONTINENTAL 6.0 AWD	BEB, CKHB	06/06 →
CONTINENTAL 6.0 FLEX	CKHB, CKHA	11/10 →
CONTINENTAL 6.0 FLEX AWD	CKHA, BWRB	03/10 →
CONTINENTAL 6.0 FlexFuel	CKHC	01/10 → 07/10
CONTINENTAL 6.0 Flexfuel [ExtraEU]	BWRB, BWRA	02/08 →
CONTINENTAL 6.0 ISR/ISR Flexfuel	CKHE	03/11 → 06/14
CONTINENTAL 6.0 Speed [ExtraEU]	DBDD	11/17 → 07/18
CONTINENTAL 6.0 Super-sports AWD	DJLA	09/17 → 05/18
CONTINENTAL 6.0 Trazione integrale	BWRA, BWR	08/07 → 04/11
CONTINENTAL FLYING SPUR 6.0	BWR, BEB	03/05 →
CONTINENTAL FLYING SPUR 6.0 FLEX	BEB, CVAA	03/05 →
FLYING SPUR 6.0	CVAA, M55.02	03/13 →
FLYING SPUR W12 S 6.0	DBDE	11/16 →

PORSCHE		
CAYENNE I 3.6	M55.01	02/07 → 09/10
CAYENNE II 3.6	M55.02, CAVA	06/10 →

SEAT		
ALHAMBRA III 1.4 TSI	CAVA, AZQ	06/10 →
ALTEA 1.2 TSI	CBZB	04/10 →
ALTEA 1.4 TFSI	CAXC	05/10 → 04/11
ALTEA 1.4 TSI	CAXC	11/07 →
ALTEA XL 1.2 TSI	CBZB	04/10 →
ALTEA XL 1.4 TSI	CAXC	11/07 →
CORDOBA II 1.2	AZQ, BBY	10/02 → 06/06
CORDOBA II 1.2 12V	BXV	05/06 → 11/09
CORDOBA II 1.4 16V	BBY, ALD	09/02 → 11/09
CORDOBA II 1.6	BAH	04/03 → 11/09
CORDOBA II 1.6 16V	BTS	11/06 → 11/09
IBIZA II 1.0	ALD, AKK	08/99 → 02/02
IBIZA II 1.4	AKK, AZQ	08/99 → 02/02
IBIZA III 1.2	AZQ, BZG	02/02 → 05/08
IBIZA III 1.2 12V	BXV	05/06 → 11/09
IBIZA III 1.6	BAH	02/03 → 11/09
IBIZA III 1.6 16V	BTS	11/06 → 11/09
IBIZA IV 1.2	BZG, CBZA	03/08 →
IBIZA IV 1.2 LPG	BZG	03/08 →
IBIZA IV 1.2 TSI	CBZA, CAVF	09/10 →
IBIZA IV 1.4 TSI	CAVE, CAVE	06/09 →
IBIZA IV 1.4 TSI Cupra	CAVE, AEX	06/09 →
IBIZA IV 1.6	BTS	05/08 →
IBIZA IV 1.6 LPG	CNKA	05/11 →
IBIZA 1.2	CGPA	04/08 →
INCA 1.4 i	AEX, AHW	11/95 → 06/03
LEON I 1.4 16V	AHW, AHW	11/99 → 06/06
LEON II 1.2 TSI	CBZB	02/10 → 12/12
LEON II 1.4 TSI	CAXC	11/07 → 12/12
TOLEDO II 1.4 16V	AHW, CBZA	01/00 → 05/02
TOLEDO III 1.4 TSI	CAXC	11/07 → 05/09
TOLEDO IV 1.2	CGPC	07/12 →
TOLEDO IV 1.2 TSI	CBZA, AZQ	07/12 →
TOLEDO IV 1.4 TSI	CAXA	07/12 →

SKODA		
FABIA I 1.2	AZQ, BBM	01/03 → 03/08
FABIA II 1.2	BBM, CGPA	12/06 → 12/14
FABIA II 1.2 [IND]	CJLA	09/10 →
FABIA II 1.2 12V	CGPB	11/11 → 12/14
FABIA II 1.2 LPG	CGPA, CBZA	07/07 → 11/14
FABIA II 1.2 TSI	CBZA, CAVE	03/10 → 12/14
FABIA II 1.4 TSI RS	CAVE, BTS	05/10 → 12/14
FABIA II 1.6	BTS, CBZA	04/07 → 12/14
OCTAVIA II 1.2 TSI	CBZB	02/10 → 06/13
OCTAVIA II 1.4 TSI	CAXA	11/08 → 06/13
OCTAVIA II 1.6 [CHN]	CDFA	09/07 →
OCTAVIA II 1.6 FSI	BLF	02/04 → 10/08
RAPID 1.2	CGPC	07/12 →
RAPID 1.2 LPG	CBZA, CBZA	07/12 →
RAPID 1.2 TSI	CBZA, BME	07/12 →
RAPID 1.4 TSI	CAXA	07/12 →
ROOMSTER 1.2	BME, CBZA	05/06 → 05/15
ROOMSTER 1.2 LPG	CGPA	03/09 → 05/15
ROOMSTER 1.2 TSI	CBZA, BXW	03/10 → 05/15
ROOMSTER 1.4	BXW, BXW	09/06 → 05/15
ROOMSTER 1.4 LPG	BXW, BTS	03/10 → 05/15
ROOMSTER 1.6	BTS, --	09/06 → 05/15
ROOMSTER 1.6 LPG	BTS	06/06 → 07/10
SUPERB II 1.4 TSI	CAXC	07/08 → 05/15
SUPERB II 3.6 FSI 4x4	--, BAH	11/08 → 05/15
SUPERB II 3.6 V6 4x4	CDVA	10/09 → 05/15
YETI 1.2 TSI	CBZB	09/09 → 05/15
YETI 1.4 TSI	CAXA	06/10 → 05/15

VOLKSWAGEN (BR)		
POLO 1.6	BAH, CAVD	02/02 →

VW		
ATLAS 3.6 FSI 4motion	CDVC	12/16 →
BEETLE 1.2 TSI	CBZB	07/11 →
BEETLE 1.4 TSI	CAVD, AEX	10/11 →
BORA 1.6 FSI	BAD	01/02 → 05/05
CADDY II 1.4	AEX, AEX	11/95 → 01/04
CADDY II 60 1.4	AEX, CBZA	11/95 → 01/04
CADDY III 1.2 TSI	CBZA, CKMA	09/10 → 05/15
CC 1.4 TSI	CKMA, CAVD	11/11 → 12/16
CC 1.4 TSI MultiFuel	CKMA	11/11 → 12/16
CC 3.6 FSI	CNNA	11/11 →
CC 3.6 FSI 4motion	BWS	11/11 → 12/16
EOS 1.4 TSI	CAVD, BUB	11/07 → 08/15
EOS 1.6 FSI	BLF	06/06 → 05/08
EOS 3.2 V6	BUB, --	06/06 → 05/09
EOS 3.6 V6	CDVA	05/09 → 11/10
FOX 1.0	--, BJE	10/03 →
FOX 1.0 Alcohol	BJE, BMD	10/03 →
FOX 1.0 Total Flex	CCNA	03/08 →
FOX 1.2	BMD, BAH	04/05 → 12/11
FOX 1.4	BKR	04/05 → 12/09
FOX 1.6	BAH, BJA	10/03 → 08/14
FOX 1.6 Alcohol	--	10/03 →

VW		
FOX 1.6 Total Flex	BJA, CAVD	10/03 → 08/14
FOX 1.9 D	ASY	12/07 →
GOLF IV 1.6 FSI	BAD, BUD	01/02 → 06/06
GOLFF V 1.2 TSi	CBZA	05/10 → 12/13
GOLFF V 1.4 16V	BUD, BKG	05/06 → 12/13
GOLFF V 1.4 FSI	BKG, BLG	10/03 → 11/06
GOLFF V 1.4 TSi	BLG, BAG	11/05 → 12/13
GOLFF V 1.6 FSI	BAG, BUB	10/03 → 07/08
GOLFF V 3.2	BUB, BUB	09/05 → 11/08
GOLFF V 3.2 R32 4motion	BUB, CAVD	11/05 → 11/08
GOLFF VI 1.2 TSi	CBZA, CAVD	11/08 →
GOLFF VI 1.4	CGGA	10/08 → 11/12
GOLFF VI 1.4 TSi	CAVD, BLG	10/08 →
GOLFF 1.2 TSi	CBZA	11/09 → 08/14
GOLFF 1.2 TSi BlueMotion	CBZB	05/09 → 11/12
GOLFF 1.4 TSi	CAVD, BAD	10/08 → 08/14
GOLFF TSi	CAXA	10/08 → 11/12
GOLFF VAN 1.2 TSi	CBZB	09/09 → 05/14
GOLFF VAN 1.4 TSi	CAVD, CBZA	07/09 → 05/14
JETTA V 1.4 TSi	BLG, CAVA	07/06 → 10/10
JETTA V 1.6 FSI	BLF	09/05 → 10/10
JETTA VI 1.2 TSi	CBZB	10/10 →
JETTA VI 1.4 TSi	CAVA, CFNA	04/11 →
JETTA VI 1.6	CFNA, AER	12/11 →
LUPO 1.0	AER, BLV	09/98 → 07/05
LUPO 1.4	AUD	10/00 → 07/05
LUPO 1.4 FSI	ARR	02/01 → 07/05
LUPO 1.6 GTI	AVY	09/00 → 07/05
PASSAT V 1.4 TSi	CAXA, CHNA	05/07 → 12/14
PASSAT V 1.4 TSi EcoFuel	CDGA	01/09 → 12/14
PASSAT V 1.6 FSI	BLF	03/05 → 06/08
PASSAT V 3.2 FSI 4motion	AXZ	11/05 → 11/10
PASSAT V 3.6 FSI	BLV	06/05 →
PASSAT V 3.6 FSI 4motion	BLV	09/05 → 12/14
PASSAT V 3.6 R36 4motion	BWS	04/07 → 11/10
PASSAT CC 1.4 TSi MultiFuel	CKMA	01/11 → 01/12
PASSAT CC 3.6 FSI	BLV, BLV	06/08 →
PASSAT CC 3.6 FSI 4motion	BLV, CAXA	02/08 → 01/12
PASSAT 1.4 TSi BlueMotion	CAXA	08/10 → 12/14
PASSAT 3.6 FSI 4motion	BWS	01/11 → 12/14
PHAETON 3.0 V6 FSI 4motion	CPFA	11/11 →
PHAETON 3.6 V6 4motion	CHNA, BRN	11/08 → 03/16
PHAETON 6.0 W12 4motion	BRN, AER	05/05 → 03/16
POLO 1.0 [ExtraEU]	AER, AER	07/95 → 09/01
POLO 1.6 [ExtraEU]	BAH	11/02 → 07/06
POLO III 1.0	AER, AEX	10/99 → 09/01
POLO III 1.4	AEX, ARC	05/97 → 09/01
POLO III 1.6 16V GTI	ARC, AGR	10/99 → 09/01
POLO III 1.9 TDI	AGR, AER	05/97 → 09/01
POLO III 50 1.0	AER, AEX	09/96 → 10/99
POLO III 55 1.4	AEX, AEX	08/95 → 10/99
POLO III 60 1.4	AEX, AGR	07/95 → 09/01
POLO III 90 1.9 TDI	AGR, AWY	09/96 → 09/01
POLO IV 1.2	AWY, AZQ	01/02 → 11/09
POLO IV 1.2 12V	AZQ, BBY	10/01 → 11/09
POLO IV 1.4	BBY, AUA	08/02 →
POLO IV 1.4 16V	AUA, BAH	10/01 → 05/08
POLO IV 1.4 FSI	AXU	02/02 → 07/06
POLO IV 1.6	BAH, CGPA	08/02 →
POLO IV 1.6 [ExtraEU]	BAH	09/02 →
POLO IV 1.6 16V	BTS	05/06 → 11/09
POLO V 1.2	CGPA, CBZB	03/09 →
POLO V 1.2 [IND]	CJLA	08/11 →
POLO V 1.2 BlueMotion	CGPA	03/09 → 05/14
POLO V 1.2 TSi	CBZB, CGGB	11/09 →
POLO V 1.2 TSi BlueMotion	CBZB	11/09 → 05/14
POLO V 1.4	CGGB, CAVE	03/09 → 05/14
POLO V 1.4 BiFuel	CMAA	03/10 → 01/11
POLO V 1.4 GTI	CAVE, CFNA	05/10 →
POLO V 1.6	CFNA, CAVD	01/10 →
POLO V 1.6 BiFuel	CNKA	01/11 →
SCIROCCO III 1.4 TSi	CAVD, CAVA	05/08 → 11/17
SCIROCCO 1.4 TSi	CAVD, CAVD	06/08 → 05/14
SHARAN II 1.4 TSi	CAVA, BAH	05/10 →
SPACEFOX / SPACE CROSS 1.6	BAH, BPA	03/06 →
SPACEFOX / SPACE CROSS 1.6 FSI	BPA, BPA	03/06 →
SPACEFOX / SPACE CROSS 1.6 Total Flex	BPA, BWK	03/06 →
SPACEFOX / SPACE CROSS 1.9 SDI	ASY	09/07 →
TERAMONT 3.6 FSi	CDVD	01/19 →
TIGUAN I 1.4 TSi	BWK, BWK	05/08 →
TIGUAN I 1.4 TSi 4motion	BWK, CGRA	09/07 →
TOUAREG I 3.6 V6 FSI	BHK	10/05 → 05/10
TOUAREG II 3.6 V6 FSI	CGRA, BLG	04/10 → 03/18
TOURAN I 1.2 TSi	CBZB	05/10 → 05/15
TOURAN I 1.4 FSI	BLG, BMY	11/06 → 05/10

VW		
TOURAN I 1.4 TSi	BMY, BAG	02/06 → 05/15
TOURAN I 1.4 TSi EcoFuel	CDGA	05/09 → 05/15
TOURAN I 1.6 FSI	BAG, N7Q700	02/03 → 01/07
TRANSPORTER V 1.4 Brasile	BTJ	12/05 →

9.0371



04

REVOLUTION AND TIMING (CKP AND CMP) SENSORS

Adatt./Suitable:

BOSCH
0 232 101 030

RENAULT
74 39 146 108

VOLVO
138396-6
914610-8



L	L1		- QUT +
160	---	Hall Effect	

RENAULT

LAGUNA I 2.0	N7Q700, N7Q700	06/95 → 02/01
LAGUNA I 2.0 16V	N7Q700, N7Q710	06/95 → 03/01
SAFRANE II 2.0 16V	N7Q710, N7U700	07/96 → 12/00
SAFRANE II 2.5 20V	N7U700, B5202S	07/96 → 12/00

VOLVO

850 2.0	B5202S, B5204FT	06/91 → 12/96
850 2.0 10V	B5202FS	08/94 → 12/97
850 2.0 Turbo	B5204FT, B5252	02/93 → 10/97
850 2.3	B5234FS	01/96 → 10/96
850 2.3 T5	B5234FT	02/93 → 12/96
850 2.3 T5-R	B5234T4	08/95 → 12/96
850 2.3 Turbo R	B5234T5	06/95 → 10/97
850 2.4	B5252, B5252FS	06/91 → 12/96
850 2.4 AWD	B5254T	04/96 → 12/96
850 2.4 GLE	B5254T	09/93 → 10/97
850 2.5 10V	B5252FS, B6304F	06/91 → 12/97
850 2.5 20V	B5254FS	08/91 → 12/97
960 I 2.9	B6304F, B6254FS	08/90 → 07/94
960 II 2.4	B6244FS	01/95 → 08/97
960 II 2.5	B6254S	07/94 → 12/96
960 II 2.5 24V	B6254FS, B6304FS	01/95 → 08/97
960 II 2.9	B6304FS, B5202FS	07/94 → 08/97
C70 I 2.0	B5204T2	03/97 → 10/05
C70 I 2.4 T	B5254T	03/98 → 10/05
S70 2.0	B5202FS, B5204T2	01/97 → 11/00
S70 2.0 Turbo	B5204T2, B5234FS	01/97 → 11/00
S70 2.3	B5234FS, B5234T3	11/96 → 07/99
S70 2.3 AWD	B5234T7	04/99 → 09/00
S70 2.3 T-5	B5234T3	01/97 → 11/00
S70 2.3 T5 AWD	B5234T3, B5234FT+	11/96 → 09/98
S70 2.3 T5-R AWD	B5234T2	11/96 → 09/98
S70 2.3 Turbo	B5234FT+, B5244S	01/97 → 11/00
S70 2.4	B5244S, B5244T	01/97 → 11/00
S70 2.4 AWD	B5252FS	11/96 → 05/99
S70 2.4 Bifuel	GB5252S	10/98 → 11/00
S70 2.4 T5 AWD	B5254T	11/96 → 04/99
S70 2.4 Turbo	B5244T, B6244FS	01/97 → 11/00
S70 2.5 20V	B5254FS	01/97 → 12/98
S70 2.5 Bifuel	GB5252S2	01/99 → 12/99
S90 2.5	B6244FS, B6254FS	11/96 → 10/98
S90 2.5 24V	B6254FS, B6304FS	01/97 → 05/98
S90 2.9	B6304FS, B6304FS	01/97 → 05/98
S90 2.9 24V	B6304FS, B5202FS	01/97 → 05/98
V70 I 2.0	B5202FS, B5234FS	12/95 → 03/00
V70 I 2.0 Turbo	B5204T3	11/96 → 12/00
V70 I 2.0 Turbo AWD	B5204T3	11/96 → 12/00
V70 I 2.3	B5234FS, B5234T3	11/96 → 07/99
V70 I 2.3 AWD	B5234T3, B5234FT+	04/97 → 09/98
V70 I 2.3 T AWD	B5234FT+, B5234T2	04/97 → 12/98
V70 I 2.3 T-5	B5234T2, B5234T2	11/96 → 12/00

VOLVO		
V70 I 2.3 T-5 AWD	B5234T2, B5234FT+	01/97 → 12/00
V70 I 2.3 Turbo	B5234FT+, B5244S	12/95 → 12/98
V70 I 2.4	B5244S, B5244T	12/95 → 12/99
V70 I 2.4 Bifuel	GB5252S	05/98 → 12/99
V70 I 2.4 Turbo	B5244T, B5244T	04/96 → 12/00
V70 I 2.4 Turbo AWD	B5244T, B6244FS	04/96 → 12/00
V70 I 2.5	B5252FS	01/97 → 03/00
V70 I 2.5 20V	B5254FS	01/97 → 12/99
V70 I 2.5 Bifuel	GB5252S2	01/99 → 12/99
V70 2.0 T5 [ExtraEU]	B5204T3	10/97 → 03/99
V90 2.5	B6244FS, B6304FS	11/96 → 10/98
V90 2.5 24V	B6254GS	01/97 → 12/97
V90 2.9	B6304FS, B6304FS	01/97 → 12/98
V90 2.9 24V	B6304FS, B4184S2	01/97 → 12/98

9.0373

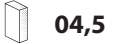

04,5

REVOLUTION AND TIMING (CKP AND CMP) SENSORS

Adatt./Suitable:

VOLVO
127060-3



L	L1	ohm	GND OUT
970	32,6	330	

VOLVO

S40 I 1.6	B4164S2	03/99 → 12/03
S40 I 1.8	B4184S2, B4194T	06/01 → 12/03
S40 I 1.9 T4	B4194T, B4204S	05/97 → 07/00
S40 I 2.0	B4204S, B4204T	07/95 → 12/03
S40 I 2.0 T	B4204T, B4184S2	07/00 → 12/03
S40 I 2.0 T4	B4204T5	07/00 → 12/03
V40 I 1.6	B4164S2	03/99 → 06/04
V40 I 1.8	B4184S2, B4194T	03/99 → 06/04
V40 I 1.9 T4	B4194T, B4204S	05/97 → 07/00
V40 I 2.0	B4204S, B4204T	07/95 → 06/04
V40 I 2.0 T	B4204T, B4184S	06/01 → 06/04
V40 I 2.0 T4	B4204T5	07/00 → 06/04

9.0374



04,5

REVOLUTION AND TIMING (CKP AND CMP) SENSORS

Adatt./Suitable:

VOLVO
30613400

03 Supplied until depletion

- Fornibile fino ad esaurimento delle scorte
- Fourni jusqu'à épuisement du stock
- Lieferbar solange vorrat reicht
- Suministrado hasta el stock termina



L	L1	ohm	
275	28	500	

VOLVO			
S40 I 1.8	B4184S, B4194T	06/01 ⇌ 08/99	
S40 I 1.9T4	B4194T, B4204S	05/97 ⇌ 07/00	
S40 I 2.0	B4204S, B4204T	07/95 ⇌ 08/99	
S40 I 2.0T	B4204T, B4184S	10/97 ⇌ 12/03	
V40 I 1.8	B4184S, B4194T	07/95 ⇌ 08/99	
V40 I 1.9T4	B4194T, B4204S	05/97 ⇌ 07/00	
V40 I 2.0	B4204S, B4204T	07/95 ⇌ 08/99	
V40 I 2.0T	B4204T, AR32103	10/97 ⇌ 06/04	

9.0375



3,5

REVOLUTION AND TIMING (CKP AND CMP) SENSORS

Adatt./Suitable:

ALFA ROMEO
9949501

03 Supplied until depletion

- Fornibile fino ad esaurimento delle scorte
- Fourni jusqu'à épuisement du stock
- Lieferbar solange vorrat reicht
- Suministrado hasta el stock termina

FIAT
9949501

LANCIA
9949501

VOLVO
30865935

L	L1	ohm	
240	28	500	

ALFA ROMEO			
156 1.6 16V T.SPARK.	AR32103, 192B1.000	05/00 ⇌ 05/06	
156 1.9 JTD	192B1.000, AR32310	05/01 ⇌	
156 1.9 JTD 16V	192A5.000	11/02 ⇌ 05/06	
156 1.9 JTD 16V Q4	937A5.000	07/04 ⇌ 05/06	
156 2.0 16V T.SPARK	AR32310, 932A2.000	05/00 ⇌ 06/02	
156 2.0 JTS	932A2.000, 841C000	01/02 ⇌ 05/06	
156 2.4 JTD	841C000, 839A4.000	03/02 ⇌ 05/06	
156 2.5 V6 24V	AR32405	02/97 ⇌ 05/06	
156 3.2 GTA	932A.000	03/02 ⇌ 05/06	
LANCIA			
LYBRA 1.8 16V	839A4.000, B4184S	07/99 ⇌ 10/05	
LYBRA 2.0 20V	185A8.000	09/00 ⇌ 10/05	
LYBRA 2.4 20V	192A2.000	10/01 ⇌ 10/05	
VOLVO			
S40 I 1.8	B4184S, B4194T	06/01 ⇌ 08/99	

VOLVO			
S40 I 1.9T4	B4194T, B4204S	05/97 ⇌ 07/00	
S40 I 2.0	B4204S, B4204T	07/95 ⇌ 08/99	
S40 I 2.0T	B4204T, B4184S	10/97 ⇌ 12/03	
V40 I 1.8	B4184S, B4194T	07/95 ⇌ 08/99	
V40 I 1.9T4	B4194T, B4204S	05/97 ⇌ 07/00	
V40 I 2.0	B4204S, B4204T	07/95 ⇌ 08/99	
V40 I 2.0T	B4204T, 312A1.000	10/97 ⇌ 06/04	

9.0377



3

REVOLUTION AND TIMING (CKP AND CMP) SENSORS

Adatt./Suitable:

ABARTH
46815160

ALFA ROMEO
46815160

BOSCH
0 261 210 238

CHRYSLER
46815160

FIAT
46815160

GENERAL MOTORS
95 512 935

LANCIA
46815160

OPEL
12 47 491
95512935

MARKET DIFFUSION: MEDIUM



L	L1	ohm	
---	34,5	900	

ABARTH			
500 1.4	312A1.000, 312A1.000	08/08 ⇌	
500 MY12 1.4	--	01/12 ⇌	
500C / 595C 1.4	312A1.000, 199A8.000	05/08 ⇌	
GRANDE PUNTO 1.4	199A8.000, 940A2.000	12/07 ⇌ 12/12	
PUNTO EVO 1.4	955A8.000	07/08 ⇌ 02/12	
ALFA ROMEO			
GIULIETTA II 1.4 TB	940A2.000, 199A6.000	09/14 ⇌	
MITO 1.4	199A6.000, 198A4.000	08/08 ⇌ 08/13	
MITO 1.4 Bifuel	198A4.000, 198A1.000	01/09 ⇌	
MITO 1.4 TJet	198A1.000, 169A3.000	08/08 ⇌	
CHRYSLER			
DELTA 1.4	198A4.000	08/11 ⇌	
FIAT			
500 1.4	169A3.000	10/07 ⇌	
500 C 1.4	169A3.000, 843A1.000	09/09 ⇌	
500 MY12 1.4	--	01/12 ⇌	
500 MY15 1.4	--	01/15 ⇌	
500L 1.4	843A1.000, --	09/12 ⇌	
500L 1.4 LPG	940B7.000	02/14 ⇌	
500X 1.4 LPG	55277701	03/17 ⇌	
BRAVO II 1.4	192B2.000	04/07 ⇌ 12/14	
BRAVO II 1.4 16V	--	04/07 ⇌	
BRAVO II 1.4 LPG	--	12/08 ⇌	
BRAVO II 1.4 T-Jet	--, 198A4.000	09/07 ⇌	
DOBLO II 1.4	198A4.000, 198A4.000	02/10 ⇌	
DOBLO II 1.4 Natural Power	198A4.000, --	02/10 ⇌	
IDEA 1.2	--	01/08 ⇌	
IDEA 1.2 16V	188A5.000	01/04 ⇌	
IDEA 1.4	192B2.000	12/03 ⇌	
IDEA 1.4 16V	--, 199A6.000	01/04 ⇌	
LINEA 1.4 16V TURBO [IND]	--	09/07 ⇌	
LINEA 1.4 T-Jet	198A4.000	09/07 ⇌	

FIAT			
PANDA II 1.4	--	10/06 ⇌	
PUNTO II 1.2 16V	188A5.000	06/03 ⇌	
PUNTO II 1.2 16V 80	188A5.000	09/99 ⇌ 12/06	
PUNTO II 1.4	199A6.000, 192B2.000	09/03 ⇌	
PUNTO III / GRANDE PUNTO 1.4 16V	199A6.000	10/05 ⇌	
PUNTO III / GRANDE PUNTO 1.4 T-Jet	198A4.000	09/07 ⇌	
STILO 1.4	843A1.000	01/04 ⇌ 08/08	
STILO 1.4 16V	192B2.000, 198A1.000	01/04 ⇌ 08/08	
TIPO II 1.4	843A1.000	10/15 ⇌	

LANCIA			
DELTA III 1.4	198A1.000, 192B2.000	09/08 ⇌ 08/14	
DELTA III 1.4 Bifuel	198A4.000	07/11 ⇌ 08/14	
MUSA 1.4	192B2.000, 350A1.000	10/04 ⇌ 09/12	
MUSA 1.4 16V	--	01/11 ⇌ 12/12	
YPSILON I 1.2	188A5.000	10/03 ⇌ 12/11	
YPSILON I 1.4 16V	843A1.000	10/03 ⇌ 12/11	
OPEL			
COMBO D 1.4	A14FC	02/12 ⇌	
COMBO D 1.4 CNG	A14FC	02/12 ⇌	
VAUXHALL			
COMBO D 1.4 CNG	A14FC	11/11 ⇌	

9.0378



3

REVOLUTION AND TIMING (CKP AND CMP) SENSORS

Adatt./Suitable:

ALFA ROMEO
55229700
55267144

CHRYSLER
55267144

FIAT
55187380
55229700
55267144

FORD
1 535 716
1 564 811
1 699 523
9551-9E731-BA
A551-9E731-AA

LANCIA
55187380
55229700
55267144

MARKET DIFFUSION: HIGH



L	L1	ohm	
---	34,5	1100	

ALFA ROMEO			
MITO 1.4	350A1.000, 350A1.000	03/11 ⇌	
CHRYSLER			
YPSILON 1.2	169A4.000	05/11 ⇌	
FIAT			
500 1.2	169A4.000	10/07 ⇌	
500 1.2 LPG	169A4.000	12/10 ⇌	
500 C 1.2	169A4.000	09/09 ⇌	
500 MY12 1.2	--	01/12 ⇌	
500 MY15 1.2	--	01/15 ⇌	
500 MY15 1.2 LPG	--	01/15 ⇌	
DOBLO I 1.4	350A1.000	10/05 ⇌	
FIORINO III 1.4	350A1.000	10/09 ⇌	
FIORINO III 1.4 Natural Power	350A1.000, 350A1.000	06/08 ⇌	
GRANDE PUNTO 1.4	350A1.000	02/06 ⇌ 06/13	
GRANDE PUNTO 1.4 LPG	350A1.000	03/09 ⇌ 12/12	

FIAT		
GRANDE PUNTO 1.4 Natural Power	350A1000CNG	03/09 → 12/12
IDEA 1.4	350A1.000	10/05 →
IDEA 1.4 LPG	350A1.000	03/09 →
LINEA 1.4	350A1.000	06/07 →
PALIO 1.0 GLX	--	07/98 → 10/03
PALIO 1.1	187A1.000	06/06 →
PALIO 1.2	178C4.066	07/97 → 08/02
PALIO 1.2 75	178B7.045	03/98 →
PALIO 1.2 MPI	178C4.066	01/02 →
PALIO 1.4	350A1.000, 169A4.000	10/02 →
PANDA II 1.1	187A1.000	09/00 → 02/04
PANDA I 1.1 AWD	187A1.000	09/00 → 02/04
PANDA II 1.1	--	09/03 →
PANDA II 1.2	169A4.000, 169A4.000	09/03 →
PANDA II 1.2 4x4	169A4.000, 169A4.000	09/04 →
PANDA II 1.2 Bipower	188A4.000	09/04 → 12/11
PANDA II 1.2 Bi-Power / Natural Power	--	04/09 →
PANDA II 1.2 Euro 4	--	04/09 →
PANDA II 1.2 Euro 5	--	04/09 →
PANDA II 1.2 LPG	169A4.000, 188A4.000	04/09 →
PANDA II 1.2 Natural Power	188A4.000, 350A1.000	01/07 → 12/11
PANDA II 1.4 16V	--	01/10 →
PANDA II 1.4 Natural Power	350A1.000, 188A4.000	10/09 →
PANDA III 1.2	169A4.000	02/12 →
PANDA III 1.2 LPG	169A4.000	06/12 →
PUNTO II 1.2	188A4.000	06/03 →
PUNTO II 1.2 60	188A4.000	09/99 → 12/10
PUNTO II 1.2 Bifuel	188A4.000	08/07 → 03/12
PUNTO II 1.2 Bipower	188A4.000	08/01 → 05/03
PUNTO II 1.2 Natural Power	188A4.000, 169A4.000	01/03 → 03/12
PUNTO III / GRANDE PUNTO 1.2	169A4.000, 199A7.000	10/05 →
PUNTO III / GRANDE PUNTO 1.2 Actual	--	09/09 →
PUNTO III / GRANDE PUNTO 1.2 LPG	199A4.000	07/08 →
PUNTO III / GRANDE PUNTO 1.4	199A7.000, 350A1.000	06/05 → 12/15
PUNTO III / GRANDE PUNTO 1.4 Actual	--	09/09 →
PUNTO III / GRANDE PUNTO 1.4 LPG	350A1.000	12/08 →
PUNTO III / GRANDE PUNTO 1.4 Natural Power	350A1.000, 169A4.000	07/08 →
PUNTO III EVO 1.2	169A4.000, 199A7.000	10/09 → 02/12
PUNTO III EVO 1.4	199A7.000, 350A1.000	03/09 →
PUNTO III EVO 1.4 LPG	350A1.000	06/09 → 02/12
PUNTO III EVO 1.4 Natural Power	350A1.000, 350A1.000	10/09 → 02/12
PUNTO III 1.2	169A4.000, 199A7.000	03/12 →
PUNTO III 1.4	199A7.000, 350A1.000	04/08 →
PUNTO III 1.4 Bifuel	350A1.000	03/12 →
PUNTO III 1.4 LPG	350A1.000	03/09 →
PUNTO III 1.4 Multi Air	955A6.000	03/12 →
PUNTO III 1.4 Natural Power	350A1.000, 169A4.000	03/09 →
PUNTO 1.4	350A1.000	03/12 →
PUNTO 1.4 LPG	350A1.000	03/09 → 02/12
PUNTO 1.4 Natural Power	350A1000CNG	03/09 → 02/12
QUBO 1.4	350A1.000	10/09 →
QUBO 1.4 Natural Power	350A1.000, --	10/09 →
SIENA 1.2	178B7.045	01/98 →
SIENA 1.4	--	01/02 →
STRADA 1.2	178B7.045	01/05 →
STRADA 1.2 Trekking	--, FP4	11/05 →

FORD		
KA II 1.2	FP4, 169A4.000	10/08 →

LANCIA		
MUSA 1.4	350A1.000	09/05 → 09/12
MUSA 1.4 8V	--	01/11 → 12/12
MUSA 1.4 LPG	350A1.000	11/10 → 09/12
YPSILON I 1.2	169A4.000, 182B9.000	10/03 → 12/11
YPSILON I 1.4	350A1.000	02/06 → 12/11
YPSILON I 1.4 LPG	350A1.000	11/10 → 12/11
YPSILON II 1.2 Bi-fuel	169A4.000	05/11 →

9.0379



REVOLUTION AND TIMING (CKP AND CMP) SENSORS

Adatt./Suitable:

ALFA ROMEO
46798352BOSCH
0 281 002 603CHRYSLER
46798352FIAT
46798352GENERAL MOTORS
93 179 433LANCIA
46798352OPEL
62 35 664
93179433SAAB
93 179 433SUZUKI
33220-79JRO
33220-79JRO-000VAUXHALL
93179433

MARKET DIFFUSION: MEDIUM



L	L1	ohm	OUT GND
---	36,5	900	

ALFA ROMEO		
147 1.9 JTD	182B9.000, 937A2.000	10/00 → 03/10
147 1.9 JTDM	937A2.000, 937A7.000	10/04 → 03/10
147 1.9 JTDM 8V	937A3.000	07/05 → 03/10
156 1.9 JTD	937A2.000	05/01 → 05/06
159 1.8 Tbi	939B1.000	05/09 → 12/12
159 1.9 JTDM 8V	937A7.000, 940A1.000	09/05 → 11/11
159 MY2011 1.9 8V JTD	--	01/10 →
166 2.4 JTD	841C000	04/02 → 06/07
BRERA 1.8 Tbi	939B1.000	05/09 → 06/10
GIULIETTA II 1.8	940A1.000	04/11 → 02/16
GIULIETTA II 1.8 Tbi	940A1.000, 192A1.000	04/10 →
SPIDER III 1.8 Tbi	939B1.000	05/09 → 03/11
FIAT		
BRAVO II 1.9 D Multijet	192A1.000, 939A1.000	11/06 → 12/14
BRAVO II 1.9 D Multijet 8V	--	01/10 →
CROMA II 1.9 D Multijet	939A1.000, 182B9.000	06/05 →
CROMA II 1.9 MJTD	939A1.000	04/06 → 12/11
DOBLO I 1.9 D Multijet	186A9.000	10/05 →
DOBLO I 1.9 JTD	182B9.000, 188A7.000	10/01 →
DOBLO I 1.9 JTD 8V	--	10/05 →
DOBLO I 1.9 JTD Multijet	186A9.000	12/06 →
IDEA 1.9 D	--	01/08 →
IDEA 1.9 JTD	188B2.000	01/04 →
MULTIPLA 1.9 JTD	186A9.000	04/02 → 06/10
MULTIPLA 1.9 JTD 115	186A8.000	07/02 → 06/10
PALIO 1.9 JTD	188A2.000	09/01 →
PUNTO II 1.9 JTD	188A7.000, 199A5.000	02/00 → 03/12
PUNTO III / GRANDE PUNTO 1.9 D Multijet	199A5.000, 192A8.000	10/05 →
SEDICI 1.9 D Multijet	D19AA	06/06 → 10/11
SEDICI 1.9 D Multijet 4x4	D19AA	06/06 → 10/11
STILO 1.9 D	192B5.000	09/04 → 08/08
STILO 1.9 D Multijet	192A8.000, 192A1.000	09/05 → 08/08
STILO 1.9 JTD	192A1.000, Z19DT	10/01 → 08/08
STRADA 1.9 JTD	188A2.000	04/03 →
LANCIA		
DELTA III 1.8	939B1.000	01/09 → 08/14
LYBRA 1.9 JTD	937A2.000	05/01 → 10/05
LYBRA 2.4 JTD	841C.000	05/02 → 10/05
MUSA 1.9 D Multijet	188B2.000	10/04 → 09/12

LANCIA		
THEISIS 2.4 JTD	841C.000	07/02 → 07/09
OPEL		
ASTRA H 1.9 CDTI	Z19DT, Z19DT	06/04 → 12/12
SIGNUM 1.9 CDTI	Z19DT, Z19DT	04/04 →
VECTRA C 1.9 CDTI	Z19DT, Z19DT	04/04 → 01/09
ZAFIRA B 1.9 CDTI	Z19DT, Z19DT	07/05 → 04/15
SAAB		
9-3 1.9 TiD	Z19DT	09/04 → 02/15
SUZUKI		
SX4 I 1.9 DDiS	D19AA	06/06 →
SX4 I 1.9 DDiS 4x4	D19AA	06/06 →
VAUXHALL		
ASTRA V 1.9 CDTI	Z19DT, Z19DT	01/04 → 11/10
ASTRAVAN III 1.9 CDTi	Z19DT	03/05 → 11/11
SIGNUM 1.9 CDTI	Z19DT	04/04 → 03/08
SIGNUM 1.9 Turbo	Z19DTL	01/05 → 05/08
VECTRA C 1.9 CDTI	Z19DT, Z19DT	04/02 → 09/08
ZAFIRA B 1.9 CDTI	Z19DT, 940A1.000	07/05 → 11/14

9.0380



REVOLUTION AND TIMING (CKP AND CMP) SENSORS

Adatt./Suitable:

ALFA ROMEO

55201874
55216241

CHEVROLET

55216241

CHRYSLER

55216241

CITROËN

1920 SR
1920 TS

FIAT

46798365
55201874
55216241

FORD

1 547 994
1 581 176
1 710 917

9551-12K073-BA
A551-12K073-AA

GENERAL MOTORS

55 201 874
55 216 241
93 178 046
93 190 703
93 193 371
95 508 510

LANCIA

46798365
55201874
55216241

OPEL

12 35 269
12 47 432
47 00 042
47 08 542
55216241
62 38 646
93178046
93190703
93193371
95508510

PEUGEOT

1920 SR
1920 TS

SUBARU

33220-85E00

SUZUKI

33220-63P10-000
33220-85E00
33220-85E00-000
33220-85E01-000
33220-86J10
33220-86J10-000
33220-86J20
33220-86J20-000
33220M86J20
33220M86J20-000
33220N86J10
33220N86J10-000
33220N86J20
33220N86J20-000

VAUXHALL

55216241
93178046
93190703
93193371
95508510

MARKET DIFFUSION: HIGH



L	L1	Hall Effect	
---	28		

ALFA ROMEO

159 1.8 Tbi 939B1.000 05/09 ⇨ 12/12

4C 1.8 960A1.000 03/13 ⇨

GIULIETTA II 1.8 Tbi 940A1.000, 199A3.000 04/10 ⇨

MITO 1.3 Multijet 199A3.000, LDV 08/08 ⇨

SPIDER III 1.8 Tbi 939B1.000 05/09 ⇨ 03/11

CHEVROLET

AVEO II 1.3 D LDV, F13DTE6 07/11 ⇨

CHRYSLER

YPSILON 1.3 Multijet 199B1.000 05/11 ⇨

CITROËN

NEMO 1.3 BlueHdi 80 F13DTE6, F13DTE5 02/16 ⇨

CITROËN

NEMO 1.3 HDi 75 F13DTE5, F13DTE6 10/10 ⇨

NEMO 1.3 HDi 80 F13DTE6, 169A1.000 10/15 ⇨

FIAT

500 1.3 D Multijet 169A1.000, 169A1.000 10/07 ⇨

500 C 1.3 D Multijet 169A1.000, 199B4.000 09/09 ⇨

500 MY12 1.3 JTD -- 01/12 ⇨

500 MY15 1.3 JTD -- 01/15 ⇨

500L 1.3 D Multijet 199B4.000, 188A8.000 09/12 ⇨

500L 1.6 D Multijet 199B5.000 09/12 ⇨

500X 1.3 D Multijet 55266963 11/14 ⇨

BRAVO II 1.9 D Multijet 16V -- 01/10 ⇨

DOBLO I 1.3 D Multijet 199A2.000 10/05 ⇨

DOBLO I 1.3 JTD 199A2.000 05/05 ⇨

DOBLO I 1.3 JTD 16V 188A8.000, 199A3.000 05/04 ⇨ 12/06

DOBLO I 1.3 JTD 16V Multijet 223A9.000 08/06 ⇨

DOBLO II 1.3 D Multijet 199A3.000, 198A3.000 02/10 ⇨

DOBLO II 1.6 D Multijet 198A3.000, 199A2.000 02/10 ⇨

FIORINO III 1.3 D Multijet 199A2.000, 199A2.000 11/07 ⇨

GRANDE PUNTO 1.3 JTD Multijet 199A2.000, 188A9.000 02/06 ⇨ 06/13

IDEA 1.2 D -- 01/08 ⇨

IDEA 1.3 D Multijet 188A9.000, -- 01/04 ⇨

LINEA 1.3 D Multijet --, -- 06/07 ⇨

LINEA 1.3 JTD Multijet 199A3.000 10/06 ⇨

PALIO 1.3 -- 06/03 ⇨

PALIO 1.3 JTD Multijet 188A9.000 06/03 ⇨

PALIO 1.3 Multijet INDIA 199A2.000 06/05 ⇨

PANDA II 1.2 169A4.000 03/10 ⇨ 08/13

PANDA II 1.2 4x4 169A4.000 11/09 ⇨

PANDA II 1.2 LPG 169A4.000 11/10 ⇨ 08/13

PANDA II 1.3 D Multijet --, 169A1.000 09/03 ⇨

PANDA II 1.3 D Multijet 4x4 169A1.000, 169A1.000 10/04 ⇨

PANDA II 1.3 JTD Multijet 4x4 169A1.000, 199A1.000 09/10 ⇨ 08/13

PANDA III 1.3 D Multijet 199A1.000, 199A1.000 02/12 ⇨

PANDA III 1.3 D Multijet 4x4 199A1.000, 199A2.000 06/12 ⇨

PUNTO II 1.3 D Multijet 188A9.000 02/05 ⇨ 10/09

PUNTO II 1.3 JTD 188A9.000 06/03 ⇨ 10/05

PUNTO II 1.3 JTD 16V 188A9.000 06/03 ⇨ 03/12

PUNTO III / GRANDE PUNTO 1.3 D Multijet 199A2.000, 199A2.000 10/05 ⇨

PUNTO III / GRANDE PUNTO 1.3 JTD -- 01/08 ⇨ 09/09

PUNTO III / GRANDE PUNTO 1.3 JTD Actual -- 09/09 ⇨

PUNTO III / GRANDE PUNTO 1.3 Multijet (IND) -- 01/08 ⇨

PUNTO III EVO 1.3 D Multijet 199A2.000, 199A2.000 07/08 ⇨

PUNTO III 1.3 D Multijet 199A2.000, 199A2.000 04/08 ⇨

PUNTO III 1.3 JTD Multijet 955B2.000 05/18 ⇨

QUBO 1.3 D Multijet 199A2.000, 199B1.000 02/08 ⇨

SIENA 1.3 JTD 188A9.000 09/03 ⇨ 12/09

STRADA 1.3 D -- 01/11 ⇨

STRADA 1.3 D Multijet 199B1.000 05/06 ⇨

TIPO II 1.3 D 199B1.000, 55260384 10/15 ⇨

TIPO II 1.6 D 55260384, BAAA 09/16 ⇨

FORD

KA II 1.3 TDCi BAAA, -- 10/08 ⇨

LANCIA

DELTA III 1.8 939B1.000 01/09 ⇨ 08/14

MUSA 1.3 D Multijet --, 199A2.000 10/04 ⇨ 12/12

YPSILON I 1.3 D Multijet 199A2.000, 199B1.000 09/06 ⇨ 12/11

YPSILON I 1.3 JTD 188A9.000 10/03 ⇨ 12/11

YPSILON II 1.3 D Multijet 199B1.000, D13A 05/11 ⇨

OPEL

AGILA A 1.3 CDTi Z13DT 08/03 ⇨ 12/07

AGILA B 1.3 CDTi D13A, Y13DT 04/08 ⇨ 04/10

ASTRA H 1.3 CDTi Z13DTH 04/05 ⇨ 10/10

ASTRA J 1.3 CDTi A13DTE 01/09 ⇨

COMBO C 1.3 CDTi 16V Y13DT, A13FD 06/04 ⇨

COMBO D 1.3 CDTi A13FD, Y13DT 02/12 ⇨

CORSA C 1.3 CDTi Y13DT, A13DTC 06/03 ⇨

CORSA C 1.3 CDTi 16V Z13DT 07/05 ⇨ 06/06

CORSA C 1.3 DTi Y13DT 09/03 ⇨

CORSA D 1.3 CDTi A13DTC, Y13DT 07/06 ⇨ 08/14

MERIVA A 1.3 CDTi Y13DT, A13DTC 09/03 ⇨ 05/10

MERIVA B 1.3 CDTi A13DTC, 199A9.000 06/10 ⇨ 11/14

TIGRA B 1.3 CDTi Z13DT 06/04 ⇨ 12/10

PEUGEOT

BIPPER 1.3 BlueHdi 80 F13DTE6 12/15 ⇨

BIPPER 1.3 HDi 75 199A9.000, 199A9.000 10/10 ⇨

BIPPER TEPEE 1.3 HDi 75 199A9.000, F13DTE6 10/10 ⇨

BIPPER TEPEE 1.3 HDi 80 F13DTE6, D13A 12/15 ⇨

SUZUKI

SPLASH 1.3 CDTi D13A, D13A 01/08 ⇨

SWIFT IV 1.3 DDiS Z13DT 08/05 ⇨

SWIFT V 1.3 DDiS D13A, D13A 10/10 ⇨

VAUXHALL

AGILA A 1.3 CDTi Z13DT 08/03 ⇨ 03/08

VAUXHALL

AGILA B 1.3 CDTi D13A, Y13DT 01/08 ⇨ 11/14

ASTRA V 1.3 CDTi Z13DTH 01/04 ⇨ 11/10

ASTRA VI 1.3 CDTi A13DTE 12/09 ⇨

ASTRAVAN III 1.3 CDTi Z13DTH 08/05 ⇨

COMBO C 1.3 CDTi 16V Y13DT, A13FD 09/04 ⇨ 02/12

COMBO D 1.3 CDTi A13FD, Y13DT 11/11 ⇨

CORSA C 1.3 CDTi 16V Y13DT, A13DTC 08/00 ⇨ 09/06

CORSA D 1.3 CDTi A13DTC, A13DTC 08/06 ⇨ 08/14

CORSAVAN II 1.3 CDTi 16V Z13DT 04/04 ⇨ 06/06

CORSAVAN III 1.3 CDTi A13DTC, Y13DT 07/06 ⇨

MERIVA I 1.3 CDTi Y13DT, A13DTC 01/03 ⇨ 06/10

MERIVA II 1.3 CDTi A13DTC, 176B2.000 06/10 ⇨

TIGRA B 1.3 CDTi Z13DT 06/04 ⇨ 08/09

9.0381



04,5

REVOLUTION AND TIMING (CKP AND CMP) SENSORS

Adatt./Suitable:

FIAT

46778331
55189514

MAGNETI MARELLI

111040211105
CWM02/5

MARKET DIFFUSION: MEDIUM



L	L1	ohm	OUT GND S
845	34,5	1350	

FIAT

PANDA I 1100 187A1.000 02/95 ⇨ 09/03

PANDA I 1100 i.e. 4x4 187A1.000 12/00 ⇨

SEICENTO / 600 1.1 176B2.000, F1CE0441A 01/98 ⇨ 01/10

9.0382



04,5

REVOLUTION AND TIMING (CKP AND CMP) SENSORS

Adatt./Suitable:

BOSCH

0 281 002 513

FIAT

500374763

IVECO

0000500374763
500374763



L	L1	ohm	S GND OUT
175	38	900	

FIAT

DUCATO II 2.3 JTD F1AE0481C 04/02 ⇨

IVECO

DAILY II 29 L 10 F1AE0481A 09/02 ⇨ 04/06

DAILY II 29 L 10 V F1AE0481A 09/02 ⇨ 07/07

DAILY II 29 L 12 F1AE0481B 09/02 ⇨ 04/06

DAILY II 29 L 12 V F1AE0481B 09/02 ⇨ 07/07

IVECO		
DAILY II 29 L 14	F1AE0481M	01/05 ⇒ 04/06
DAILY II 35 C 10 V, 35 S 10 V	F1AE0481A	09/02 ⇒ 04/06
DAILY II 35 C 12, 35 S 12	F1AE0481B	09/02 ⇒ 04/06
DAILY II 35 C 12 V, 35 S 12 V	F1AE0481B	09/02 ⇒ 07/07
DAILY II 35 C 14	F1CE0481A, F1CE0481A	09/04 ⇒ 04/06
DAILY II 35 C 14, 35 S 14	F1AE0481M	01/05 ⇒ 04/06
DAILY II 35 C 17, 35 S 17	F1CE0481B	01/05 ⇒ 04/06
DAILY II 35 S 10	F1AE0481A	09/02 ⇒ 07/07
DAILY II 40 C 10	F1AE0481A	09/02 ⇒ 04/06
DAILY II 40 C 14	F1CE0481A	09/04 ⇒ 04/06
DAILY II 40 C 17, 40 S 17	F1CE0481B	01/05 ⇒ 04/06
DAILY II 45 C 14	F1CE0481A	07/99 ⇒ 04/06
DAILY II 50 C 14	F1CE0481A, F1CE0481A	09/04 ⇒ 04/06
DAILY II 50 C 17	F1CE0481B	09/04 ⇒ 04/06
DAILY II 65 C 14	F1CE0481A, F1CE0481A	09/04 ⇒ 04/06
DAILY II 65 C 17	F1CE0481B	09/04 ⇒ 04/06
DAILY III 35 S 12, 35 C 12, 40 C 12	F1AE0481B	01/03 ⇒ 05/06
DAILY III 35 S 14, 50 C 14	F1CE0481A, F1CE0481H	01/04 ⇒ 05/06
DAILY III 40 C 17, 50 C 17	F1CE0481B	01/04 ⇒ 05/06
DAILY IV 26L11, 26L11D, 35C11D, 35S11, 40C11	F1AE3481A	09/11 ⇒ 02/14
DAILY IV 29L10	F1AE0481F	05/06 ⇒ 08/11
DAILY IV 29L10 V	F1AE0481F	05/06 ⇒ 08/11
DAILY IV 29L11 V, 35C11 V, 35S11 V, 40C11 V	F1AE3481A	09/11 ⇒ 02/14
DAILY IV 29L12	F1AE0481G	05/06 ⇒ 08/11
DAILY IV 29L12 V, 29L12 V/P	F1AE0481G	05/06 ⇒ 08/11
DAILY IV 29L13 V, 35C13 V, 35S13 V, 40C13 V, 40S13 V	F1AE3481B	09/11 ⇒ 02/14
DAILY IV 29L13, 29L13D, 35C13D, 40C13	F1AE3481B	09/11 ⇒ 02/14
DAILY IV 29L14	F1AE0481H	05/06 ⇒ 08/11
DAILY IV 29L14 C, 29L14 C/P, 29L14 V, 29L14 V/P	F1AE0481H	05/06 ⇒ 08/11
DAILY IV 29L15 V, 35C15L V, 40C15L V, 50C15L V	F1AE3481C	09/11 ⇒ 02/14
DAILY IV 29L15 V, 35S15 V, 35C15L V, 40C15L V, 50C15L V	F1AE3481C	09/11 ⇒ 02/14
DAILY IV 35C10 K	F1AE0481F	05/06 ⇒ 08/11
DAILY IV 35C10, 35S10	F1AE0481F	05/06 ⇒ 08/11
DAILY IV 35C11 K, 35C11 DK, 35S11 K, 35S11 DK	F1AE0481F	07/07 ⇒ 08/11
DAILY IV 35C11 V, 35S11 V	F1AE0481F	07/07 ⇒ 08/11
DAILY IV 35C11, 35S11, 35S11 D, 35S11 /P	F1AE0481F	07/07 ⇒ 08/11
DAILY IV 35C11K, 35S11DKP	F1AE3481A	09/11 ⇒ 02/14
DAILY IV 35C12	F1AE0481G	05/06 ⇒ 08/11
DAILY IV 35C12 V, 35C12 V/P, 35S12 V, 35S12 V/P	F1AE0481G	05/06 ⇒ 08/11
DAILY IV 35C12, 35S12	F1AE0481G	05/06 ⇒ 08/11
DAILY IV 35C13 K, 35C13 DK, 35S13 K, 35S13 DK	F1AE0481V	07/07 ⇒ 08/11
DAILY IV 35C13 V, 35C13 V/P, 35S13 V, 35S13 V/P	F1AE0481V	07/07 ⇒ 08/11
DAILY IV 35C13, 35C13 /P, 35S13 D, 35S13, 35S13 /P	F1AE0481V	07/07 ⇒ 08/11
DAILY IV 35C13K, 35C13DKP	F1AE3481B	09/11 ⇒ 02/14
DAILY IV 35C14 G, 35C14 G/P, 35S14 G, 35S14 G/P, 35C14 GD,...	F1CE0441CNG	07/07 ⇒ 08/11
DAILY IV 35C14 GV, 35C14 GV/P, 35S14 GV, 35S14 GV/P	F1CE0441CNG	07/07 ⇒ 08/11
DAILY IV 35C14, 35S14, 35S14 /P	F1AE0481H	05/06 ⇒ 08/11
DAILY IV 35C15	F1CE0481F	05/06 ⇒ 08/11
DAILY IV 35C15 V, 35C15 V/P	F1CE0481F	05/06 ⇒ 08/11
DAILY IV 35C17 V, 35S17 V, 40C17 V, 45C17 V, 50C17 V, 60C17 V	F1CE3481C	09/11 ⇒ 02/14
DAILY IV 35C18	F1CE0481H	05/06 ⇒ 08/11
DAILY IV 35C18 V, 35C18 V/P, 35S18 V, 35S18 V/P	F1CE0481H, F1CE0481H	05/06 ⇒ 08/11
DAILY IV 35C18, 35S18	F1CE0481H, F1CE0481H	05/06 ⇒ 08/11
DAILY IV 35S14 C, 35S14 C/P, 35S14 V, 35S14 V/P, 35C14 V,...	F1AE0481H	05/06 ⇒ 08/11
DAILY IV 35S14 K, 35S14 DK	F1AE0481H	07/07 ⇒ 08/11
DAILY IV 35S14, 35S14 /P	F1AE0481H	05/06 ⇒ 08/11
DAILY IV 40C10	F1AE0481F	05/06 ⇒ 08/11
DAILY IV 40C10 V	F1AE0481F	05/06 ⇒ 08/11
DAILY IV 40C11 V	F1AE0481F	07/07 ⇒ 08/11
DAILY IV 40C11, 40C11 D	F1AE0481F	07/07 ⇒ 08/11
DAILY IV 40C12	F1AE0481G	05/06 ⇒ 08/11
DAILY IV 40C12 V, 40C14 V/P	F1AE0481G	05/06 ⇒ 08/11
DAILY IV 40C13 V, 40C13 V/P	F1AE0481V	07/07 ⇒ 08/11
DAILY IV 40C13, 40C13 /P	F1AE0481V	07/07 ⇒ 08/11
DAILY IV 40C14 G, 40C14 G/P	F1CE0441CNG	07/07 ⇒ 08/11
DAILY IV 40C14 GV, 40C14 GV/P	F1CE0441CNG	07/07 ⇒ 08/11

IVECO		
DAILY IV 40C15	F1CE0481F	05/06 ⇒ 08/11
DAILY IV 40C15 V, 40C15 V/P	F1CE0481F	05/06 ⇒ 08/11
DAILY IV 40C18	F1CE0481H	05/06 ⇒ 08/11
DAILY IV 40C18 V, 40C18 V/P	F1CE0481H	05/06 ⇒ 08/11
DAILY IV 45C15	F1CE0481F	05/06 ⇒ 08/11
DAILY IV 45C15 V	F1CE0481F	05/06 ⇒ 08/11
DAILY IV 45C18	F1CE0481H	05/06 ⇒ 08/11
DAILY IV 45C18, 45C18 /P, 45C18 D, 45C18 D/P	F1CE0481H	05/06 ⇒ 08/11
DAILY IV 50C14 G, 50C14 G/P, 50C14 GD, 50C14 GD/P	F1CE0441CNG	07/07 ⇒ 08/11
DAILY IV 50C14 GV, 50C14 GV/P	F1CE0441CNG	07/07 ⇒ 08/11
DAILY IV 50C15	F1CE0481F	05/06 ⇒ 08/11
DAILY IV 50C15 V, 50C15 V/P	F1CE0481F	05/06 ⇒ 08/11
DAILY IV 50C18	F1CE0481H	05/06 ⇒ 08/11
DAILY IV 50C18 V, 50C18 V/P	F1CE0481H, F1CE0481H	05/06 ⇒ 08/11
DAILY IV 55S18W	F1CE0481H	06/06 ⇒ 08/11
DAILY IV 60C15	F1CE0481F	05/06 ⇒ 08/11
DAILY IV 60C15 V	F1CE0481F	05/06 ⇒ 08/11
DAILY IV 60C15, 60C15 /P, 60C15 D, 60C15 D/P	F1CE0481F	05/06 ⇒ 08/11
DAILY IV 60C18	F1CE0481H	05/06 ⇒ 08/11
DAILY IV 65C14 G, 65C14 G/P, 65C14 GD, 65C14 GD/P	F1CE0441CNG	07/07 ⇒ 08/11
DAILY IV 65C15	F1CE0481F	05/06 ⇒ 08/11
DAILY IV 65C15, 65C15 /P, 65C15 D, 65C15 D/P	F1CE0481F	05/06 ⇒ 08/11
DAILY IV 65C18	F1CE0481H, AR32401	05/06 ⇒ 08/11
DAILY IV 70C15	F1CE0481L	07/08 ⇒ 08/11
DAILY IV Natural Power 35S14, 35C14, 40C14, 50C14, 65C14, 70C14	F1CE0441CNG	09/11 ⇒ 02/14
DAILY IV NaturalPower 35S14, 35C14, 40C14, 50C14, 65C14, 70C14,...	F1CE0441CNG	09/11 ⇒ 02/14
DAILY V 33S11, 35S11, 35C11	F1AFL411A	03/14 ⇒ 04/16
DAILY V 33S12, 35S12	F1AGL411H	04/16 ⇒
DAILY V 33S12, 35S12, 35C12	F1AGL411H	04/16 ⇒
DAILY V 33S13, 35S13, 35C13	F1AFL411B	03/14 ⇒ 04/16
DAILY V 33S14, 35S14	F1AGL411J	04/16 ⇒
DAILY V 33S14, 35S14, 35C14	F1AGL411J	04/16 ⇒
DAILY V 33S15, 35S15, 35C15	F1AFL411C	03/14 ⇒ 04/16
DAILY V 33S16, 35S16	F1AGL411G	04/16 ⇒
DAILY V 33S16, 35S16, 35C16	F1AGL411G	04/16 ⇒
DAILY V Natural Power 35S14, 35C14, 40C14, 50C14	F1CFA401A	04/16 ⇒
DAILY V Natural Power 35S14, 35C14, 40C14, 50C14, 65C14, 70C14	F1CFA401A	03/14 ⇒
DAILY V NaturalPower 35S14, 35C14, 40C14, 50C14, 65C14, 70C14,...	F1CFA401A	03/14 ⇒
DAILY 2.3	F1AE0481A	07/99 ⇒ 02/14
DAILY 3.0	F1CE0441A, F1CE0441CNG	07/99 ⇒ 08/11
DAILY 3.0 CNG	F1CE0441CNG, F1CE0481A	06/06 ⇒ 02/14
MASSIF 3.0 HPI	F1CE0481F	10/08 ⇒ 02/11
MASSIF 3.0 HPT	F1CE0481H	10/08 ⇒ 02/11

9.0383



REVOLUTION AND TIMING (CKP AND CMP) SENSORS

Adatt./Suitable:

- AUDI 077 905 381 G
- BOSCH 0 261 210 192 0 261 210 193
- VW 077 905 381 G



L	L1	ohm	OUT GND S
450	34,5	900	

9.0384



REVOLUTION AND TIMING (CKP AND CMP) SENSORS

Adatt./Suitable:

- ALFA ROMEO 46808734 60816746
- BOSCH 0 261 210 203
- FIAT 46808734 60816746
- LANCIA 46808734 60816746



L	L1	ohm	GND OUT
810	24	900	

ALFA ROMEO		
147 3.2 GTA	932A.000	02/03 ⇒ 03/10
156 2.5 V6 24V	AR32401, 266960NGT	02/97 ⇒ 05/06
156 3.2 GTA	932A.000	03/02 ⇒ 05/06
166 2.5 V6 24V	AR36201	10/00 ⇒ 06/07
166 3.0 V6 24V	AR36101	10/00 ⇒ 06/07
166 3.2 V6 24V	936A.000	10/03 ⇒ 06/07
GT 3.2 GTA	936A.000	11/03 ⇒ 09/10
GTV 3.0 V6 24V	AR16105	10/00 ⇒ 10/05
GTV 3.2 V6 24V	936A6.000	04/03 ⇒ 10/05
SPIDER II 3.0 V6	AR16105	09/94 ⇒ 04/05
SPIDER II 3.0 V6 24V	AR16102	01/99 ⇒ 10/03
SPIDER II 3.2 V6 24V	936A6.000	04/03 ⇒ 04/05
LANCIA		
THESIS 3.0 V6	841A.000	07/02 ⇒ 07/09
THESIS 3.2 V6	841L.000	05/03 ⇒ 07/09

9.0387



1

REVOLUTION AND TIMING (CKP AND CMP) SENSORS

Adatt./Suitable:

- BOSCH**
- 0 232 103 050
- 0 232 103 051
- 0 232 103 057
- 0 232 103 092
- 0 232 103 093
- 0 232 103 114
- 0 232 103 115
- 0 232 103 120
- MERCEDES-BENZ**
- 0009050443
- 0041536028
- 0041539628
- 2729050043
- 2729050143
- A 000 905 04 43
- A 004 153 60 28
- A 004 153 96 28
- A 272 905 00 43
- A 272 905 01 43
- PORSCHE**
- 997 606 106 01
- 997 606 106 03

MARKET DIFFUSION: HIGH



L	L1	Hall Effect	
---	24,2		

MAYBACH

57 5.5	285950	09/02 → 12/12
57 6.0	285980	01/11 → 12/12
57 5 6.0	285980	09/05 → 12/12
62 5.5	285950	09/02 → 12/12
62 6.0	285980	01/11 → 12/12
62 5 6.0	285980	09/05 → 12/12

MERCEDES-BENZ

B-SERIES B150 BlueEFFICIENCY	M266.920	01/09 → 11/11
CLASSE A II A 150	M266.920	09/04 → 06/12
CLASSE A II A 160	M266.920	04/09 → 06/12
CLASSE A II A 170	M266.940	09/04 → 06/12
CLASSE A II A 180	M266.940	04/09 → 06/12
CLASSE A II A 200	M266.960	09/04 → 06/12
CLASSE A II A 200 TURBO	M266.980	09/05 → 06/12
CLASSE B I B 150	M266.920	03/05 → 11/11
CLASSE B I B 160	M266.920	04/09 → 11/11
CLASSE B I B 170	M266.940	03/05 → 11/11
CLASSE B I B 170 NGT	266960NGT, 266960NGT	04/08 → 11/11
CLASSE B I B 180	M266.940	04/09 → 11/11
CLASSE B I B 180 NGT	266960NGT, M112.910	04/08 → 11/11
CLASSE B I B 200	M266.960	03/05 → 11/11
CLASSE B I B 200 TURBO	M266.980	03/05 → 11/11
CLASSE C I C 240	M112.910	06/97 → 05/00
CLASSE C I C 240 T	M112.910, M271.820	09/00 → 03/01
CLASSE C II C 160 Kompressor	M271.921	05/02 → 05/08
CLASSE C II C 180 Kompressor	M271.946	05/02 → 05/08
CLASSE C II C 200 CGI Kompressor	M271.942	03/03 → 05/08
CLASSE C II C 200 Kompressor	M271.940	05/02 → 05/08
CLASSE C II C 220	M271.948	05/02 → 05/08
CLASSE C II C 230	M272.920	01/05 → 05/08
CLASSE C II C 230 Kompressor	M271.948	05/02 → 05/08
CLASSE C II C 240	M112.912	05/00 → 08/07
CLASSE C II C 240 4-matic	M112.916	07/02 → 08/07
CLASSE C II C 280	M272.940	01/05 → 08/07
CLASSE C II C 280 4-matic	M272.941	01/05 → 08/07
CLASSE C II C 32 AMG Kompressor	M112.961	02/01 → 08/07
CLASSE C II C 320	M112.946	05/00 → 05/08
CLASSE C II C 320 4-matic	M112.953	07/02 → 08/07
CLASSE C II C 350	M272.960	01/05 → 05/08

MERCEDES-BENZ

CLASSE C II C 350 4-matic	M272.970	01/05 → 08/07
CLASSE C II C 55 AMG	M113.988	02/04 → 08/07
CLASSE C III C 180	M271.820	06/11 →
CLASSE C III C 180 CGI	M271.820, M271.820	01/07 → 08/14
CLASSE C III C 180 Kompressor	M271.820, M271.820	01/07 → 08/14
CLASSE C III C 200	M271.820	05/11 → 01/14
CLASSE C III C 200 CGI	M271.820, M271.820	01/07 →
CLASSE C III C 200 Kompressor	M271.820, M271.911	01/07 → 08/14
CLASSE C III C 230	M272.921	01/07 → 08/14
CLASSE C III C 230 4-matic	M272.911	07/07 → 01/14
CLASSE C III C 250	M271.860	01/07 →
CLASSE C III C 250 4-matic	M272.911	07/07 →
CLASSE C III C 250 CGI	M271.860	07/09 → 08/14
CLASSE C III C 280	M272.940	01/07 → 08/14
CLASSE C III C 280 4-matic	M272.948	07/07 → 01/14
CLASSE C III C 300	M272.947	08/07 → 08/14
CLASSE C III C 300 4-matic	M272.948	07/07 → 01/14
CLASSE C III C 350	M272.961	01/07 → 08/14
CLASSE C III C 350 4-matic	M272.971	07/07 → 01/14
CLASSE C III C 350 CGI	M272.982	09/08 → 01/14
CLASSE CLC CLC 160	M271.911, M271.940	02/09 → 06/11
CLASSE CLC CLC 180 Kompressor	M271.940, M271.940	05/08 → 06/11
CLASSE CLC CLC 200 Kompressor	M271.957	05/08 → 06/11
CLASSE CLC CLC 230	M272.920	05/08 → 06/11
CLASSE CLC CLC 350	M272.960	05/08 → 06/11
CLASSE CLC CLC250 [ExtraEU]	M272.920	06/09 → 06/11
CLASSE CLK I 320	M112.940	06/97 → 06/02
CLASSE CLK I 430	M113.943	07/98 → 06/02
CLASSE CLK I 55 AMG	M113.984	08/99 → 06/02
CLASSE CLK II 200 CGI	M271.942	07/03 → 05/09
CLASSE CLK II 200 Kompressor	M271.940, M113.968	09/02 → 05/09
CLASSE CLK II 240	M112.912	06/02 → 05/09
CLASSE CLK II 280	M272.940	01/05 → 05/09
CLASSE CLK II 320	M112.955	06/02 → 05/09
CLASSE CLK II 350	M272.960	01/05 → 05/09
CLASSE CLK II 500	M113.968, M271.940	06/02 →
CLASSE CLK II 55 AMG	M113.987	09/02 → 05/09
CLASSE CLK II 550	M273.967	06/06 →
CLASSE CLK II CLK 200 CGI	M271.942	07/03 → 03/10
CLASSE CLK II CLK 200 Kompressor	M271.940, M113.968	02/03 → 03/10
CLASSE CLK II CLK 240	M112.912	02/03 → 03/10
CLASSE CLK II CLK 280	M272.940	01/05 → 03/10
CLASSE CLK II CLK 320	M112.955	02/03 → 03/10
CLASSE CLK II CLK 350	M272.960	01/05 → 03/10
CLASSE CLK II CLK 500	M113.968, M272.964	02/03 → 03/10
CLASSE CLK II CLK 55 AMG	M113.987	02/03 → 03/10
CLASSE CLK II CLK AMG DTM	M113.987	06/04 → 03/10
CLASSE CLK II DTM AMG	M113.987	06/04 → 05/09
CLASSE CLS I CLS 280	M272.943	07/08 → 12/10
CLASSE CLS I CLS 300	M272.943	04/09 → 12/10
CLASSE CLS I CLS 350	M272.964, M113.967	10/04 → 12/10
CLASSE CLS I CLS 500	M113.967, M112.911	10/04 → 12/10
CLASSE CLS I CLS 55 AMG	M113.990	01/05 → 12/10
CLASSE CLS I CLS 550	M273.960	04/06 → 02/11
CLASSE E II E 240	M112.911, M112.911	08/00 → 03/02
CLASSE E II E 240 T	M112.911, M271.941	08/00 → 03/03
CLASSE E II E 280	M112.921	12/96 → 03/02
CLASSE E II E 280 4-matic	M112.921	12/96 → 03/02
CLASSE E II E 280 T	M112.921	12/96 → 03/03
CLASSE E II E 280 T 4-matic	M112.921	12/96 → 03/03
CLASSE E II E 320	M112.941	06/97 → 03/02
CLASSE E II E 320 4-matic	M112.941	06/97 → 03/02
CLASSE E II E 320 T	M112.941	12/96 → 03/03
CLASSE E II E 320 T 4-matic	M112.941	12/96 → 03/03
CLASSE E II E 420	M119.985	01/96 → 06/97
CLASSE E II E 420 T	M119.985	06/96 → 06/97
CLASSE E II E 430	M113.940	06/97 → 03/02
CLASSE E II E 430 4-matic	M113.940	05/99 → 03/02
CLASSE E II E 430 T	M113.940	06/97 → 03/03
CLASSE E II E 430 T 4-matic	M113.940	05/99 → 03/03
CLASSE E II E 50 AMG	M119.980	02/96 → 08/97
CLASSE E II E 55 AMG	M113.980	08/97 → 03/02
CLASSE E II E 55 T AMG	M113.980	08/97 → 03/03
CLASSE E III E 350 CGI	M272.985	05/06 → 07/09
CLASSE E III E 200 Kompressor	M271.941, 271941NGT	11/02 → 07/09
CLASSE E III E 200 NGT	271941NGT, M272.944	03/04 → 12/08
CLASSE E III E 200 T Kompressor	M271.941	03/03 → 07/09
CLASSE E III E 230	M272.922	09/07 → 12/08
CLASSE E III E 230 T	M272.922	05/07 → 07/09
CLASSE E III E 240	M112.913	03/02 → 12/08

MERCEDES-BENZ

CLASSE E III E 240 4-matic	M112.917	03/03 → 12/08
CLASSE E III E 240 T	M112.913	03/03 → 07/09
CLASSE E III E 240 T 4-matic	M112.917	07/03 → 07/09
CLASSE E III E 250	M272.922	09/07 → 12/08
CLASSE E III E 280	M272.943	03/05 → 12/08
CLASSE E III E 280 4-matic	M272.944, M272.972	03/05 → 12/08
CLASSE E III E 280 T	M272.943	03/05 → 07/09
CLASSE E III E 280 T 4-matic	M272.944	03/05 → 07/09
CLASSE E III E 300	M272.943	03/05 → 12/08
CLASSE E III E 300 T 4-matic	M272.944	03/05 → 07/09
CLASSE E III E 320	M112.949	03/02 → 12/08
CLASSE E III E 320 4-matic	M112.954	03/03 → 12/08
CLASSE E III E 320 T	M112.949	03/03 → 07/09
CLASSE E III E 320 T 4-matic	M112.954	07/03 → 07/09
CLASSE E III E 350	M272.964	03/05 → 12/08
CLASSE E III E 350 4-matic	M272.972, M113.967	08/04 → 12/08
CLASSE E III E 350 CGI	M272.985	09/07 → 12/08
CLASSE E III E 350 T	M272.964	03/05 → 07/09
CLASSE E III E 350 T 4-matic	M272.972	03/05 → 07/09
CLASSE E III E 420 CDI	OM629.910	01/06 → 12/08
CLASSE E III E 500	M113.967, M113.969	03/02 → 12/08
CLASSE E III E 500 4-matic	M113.969, M113.967	10/03 → 12/08
CLASSE E III E 500 T	M113.967, M113.969	10/03 → 07/09
CLASSE E III E 500 T 4-matic	M113.969, M271.820	10/03 → 07/09
CLASSE E III E 55 AMG Kompressor	M113.990	10/02 → 12/08
CLASSE E III E 55 T AMG Kompressor	M113.990	07/03 → 07/09
CLASSE E III E 550 4-matic	M273.962	04/06 → 12/08
CLASSE E III E 550 T 4-matic	M273.962	04/06 → 07/09
CLASSE E IV E 200 CGI	M271.820, 271958NGT	08/09 →
CLASSE E IV E 200 NGT	271958NGT, M272.952	03/11 →
CLASSE E IV E 250	M272.923	01/10 →
CLASSE E IV E 250 CGI	M271.860	01/09 →
CLASSE E IV E 300	M272.952, M272.961	01/09 →
CLASSE E IV E 350	M272.961, M272.982	01/09 →
CLASSE E IV E 350 4-matic	M272.977	01/09 →
CLASSE E IV E 350 CGI	M272.982, M272.961	01/09 →
CLASSE E IV E 500	M273.966	01/09 →
CLASSE E IV E 500 4-matic	M273.970	01/09 →
CLASSE E IV E 550 [USA]	M273.966	01/09 →
CLASSE E IV E 550 [USA] [CAN] [JPN]	M273.971	01/09 →
CLASSE E IV E 550 4-matic [USA] [CAN]	M273.970	01/09 →
CLASSE E IV E350 [ExtraEU]	M272.961, M273.963	05/11 →
CLASSE E E 280	M112.921	07/99 → 11/02
CLASSE G II G 500	M273.963, M273.963	01/07 →
CLASSE G II G 500 GUARD	M273.963	06/10 →
CLASSE G II G 550	M273.963, M112.970	06/10 →
CLASSE G II G 65 AMG	M279.982	05/12 →
CLASSE GL I GL 420 CDI 4-matic	OM629.912	09/06 → 05/09
CLASSE GL I GL 450 4-matic	M273.923	09/06 →
CLASSE GL I GL 450 CDI 4-matic	OM629.912	05/09 →
CLASSE GL I GL 500 4-matic	M273.963	09/06 →
CLASSE GL I GL 550 4-matic	M273.963	09/06 →
CLASSE GLK 280 4-matic	M272.948	06/08 → 06/09
CLASSE GLK 300 4-matic	M272.948	07/09 → 04/11
CLASSE GLK 350	M272.991	04/09 → 06/15
CLASSE GLK 350 4-matic	M272.971	06/08 → 04/11
CLASSE M I ML 320	M112.942	02/98 → 08/02
CLASSE M I ML 350	M112.970, M113.964	08/02 → 06/05
CLASSE M I ML 430	M113.942	02/98 → 06/05
CLASSE M I ML 500	M113.965	09/01 → 06/05
CLASSE M I ML 55 AMG	M113.981	02/00 → 06/05
CLASSE M II ML 300	M272.945	07/09 →
CLASSE M II ML 300 4-matic	M272.945	03/10 → 12/11
CLASSE M II ML 350	M272.967	07/05 →
CLASSE M II ML 350 4-matic	M272.967	02/05 → 12/11
CLASSE M II ML 420 CDI 4-matic	OM629.912	02/06 → 09/09
CLASSE M II ML 450 4-matic Hybrid	M272.973	07/05 →
CLASSE M II ML 450 CDI 4-matic	OM629.912	09/09 → 12/11
CLASSE M II ML 500 4-matic	M113.964, M113.971	07/05 → 12/11
CLASSE M II ML 550 4-matic	M273.963	12/07 →
CLASSE R R 280	M272.945	01/07 →
CLASSE R R 280 4-matic	M272.945	05/07 →
CLASSE R R 300	M272.945	07/09 →
CLASSE R R 300 4-matic	M272.945	07/09 →
CLASSE R R 350	M272.967	01/07 →
CLASSE R R 350 4-matic	M272.967	01/06 →
CLASSE R R 500 4-matic	M113.971, M113.960	01/06 →
CLASSE R R 550 4-matic	M273.963	01/07 →
CLASSE S IV CL 500	M113.960	03/99 → 03/06
CLASSE S IV CL 55 AMG	M113.986	10/99 → 03/06

MERCEDES-BENZ		
CLASSE S IV CL 55 AMG Kompressor	M113.991	06/02 → 03/06
CLASSE S IV CL 600	M275.950	09/02 → 03/06
CLASSE S IV CL 65 AMG	M113.980	09/03 → 03/06
CLASSE S IV S 280	M112.922	10/98 → 08/05
CLASSE S IV S 320	M112.944	10/98 → 08/05
CLASSE S IV S 350	M112.972	09/02 → 08/05
CLASSE S IV S 350 4-matic	M112.975	06/03 → 08/05
CLASSE S IV S 430	M113.941	10/98 → 08/05
CLASSE S IV S 430 4-matic	M113.948	09/02 → 08/05
CLASSE S IV S 500	M113.960, M275.982	10/98 → 08/05
CLASSE S IV S 500 4-matic	M113.966	09/02 → 08/05
CLASSE S IV S 55 AMG	M113.986	04/99 → 08/05
CLASSE S IV S 55 AMG Kompressor	M113.991	06/02 → 08/05
CLASSE S IV S 600	M275.950	09/02 → 08/05
CLASSE S IV S 65 AMG	M275.980	03/04 → 08/05
CLASSE S V CL 500	M273.961	06/06 → 12/13
CLASSE S V CL 500 4-matic	M273.968	02/08 → 12/13
CLASSE S V CL 550 [JPN]	M273.961	06/06 →
CLASSE S V CL 550 [USA]	M273.961	06/06 →
CLASSE S V CL 550 4-matic [JPN]	M273.968	02/08 →
CLASSE S V CL 550 4-matic [USA]	M273.968	02/08 →
CLASSE S V CL 600	M275.953	05/06 → 12/13
CLASSE S V CL 65 AMG	M275.982	02/11 → 12/13
CLASSE S V S 280	M272.946	08/06 → 12/13
CLASSE S V S 300	M272.946	08/06 → 12/13
CLASSE S V S 350	M272.965	10/05 → 12/13
CLASSE S V S 350 4-matic	M272.975	02/08 → 12/13
CLASSE S V S 400 Hybrid	M272.974	01/09 → 12/13
CLASSE S V S 420 CDI	OM629.911	10/06 → 12/09
CLASSE S V S 450	M273.922	12/05 → 12/13
CLASSE S V S 450 4-matic	M273.924	12/05 → 12/13
CLASSE S V S 450 CDI	OM629.911	01/09 → 12/13
CLASSE S V S 500	M273.961	10/05 → 12/13
CLASSE S V S 500 4-matic	M273.968	10/05 → 12/13
CLASSE S V S 550 [JPN]	M273.961	10/05 →
CLASSE S V S 550 [USA]	M273.961	10/05 →
CLASSE S V S 550 4-matic [JPN]	M273.968	10/05 →
CLASSE S V S 550 4-matic [USA]	M273.968	10/05 →
CLASSE S V S 600	M275.953	12/05 → 12/13
CLASSE S V S 65 AMG	M275.982, M112.973	12/05 → 12/13
CLASSE S VI AMG S 65	M279.980	04/16 →
CLASSE S VI S 600	M277.980	02/14 →
CLASSE S VI S 600 Maybach	M277.980	12/14 →
CLASSE S VI S 65 AMG	M279.980	02/14 →
CLASSE S VI S 650 Maybach	M279.980	07/17 →
CLASSE SL V 280	M272.949	03/08 → 01/12
CLASSE SL V 300	M272.949	04/09 → 01/12
CLASSE SL V 350	M112.973, M113.963	03/03 → 01/12
CLASSE SL V 500	M113.963, M113.992	10/01 → 01/12
CLASSE SL V 55 AMG	M113.992, M275.951	10/01 → 01/12
CLASSE SL V 55 AMG Kompressor	M113.992	06/02 → 01/12
CLASSE SL V 550	M273.965	03/06 → 01/12
CLASSE SL V 600	M275.951, M271.944	04/03 → 01/12
CLASSE SL V 65 AMG	M275.981	03/04 → 01/12
CLASSE SL V 65 AMG Black Series	M275.983	07/08 → 01/12
CLASSE SL VI 65 AMG	M279.981	05/12 →
CLASSE SLK I 32 AMG Kompressor	M112.960	03/01 → 04/04
CLASSE SLK I 320	M112.947	03/00 → 04/04
CLASSE SLK II 200 Kompressor	M271.944, M272.963	03/04 → 02/11
CLASSE SLK II 280	M272.942	01/05 → 02/11
CLASSE SLK II 300	M272.942	04/09 → 02/11
CLASSE SLK II 350	M272.963, M113.989	06/04 → 02/11
CLASSE SLK II 55 AMG	M113.989, M155.980	06/04 → 02/11
CLASSE SLK III 200	M271.861	02/11 →
CLASSE SLK III 250	M271.861	02/11 →
C-SERIES C160 Kompressor	M271.921	06/02 → 07/06
E-SERIES E250	M272.922	05/07 → 12/08
R-SERIES R300	M272.945	07/09 → 12/11
SLR McLAREN S.4	M155.980, 271951NGT	04/04 →
SLR McLAREN S.4 722 Edition	M155.980	10/06 →
SLR-SERIES SLR McLaren Kompressor Stirling Moss	M155.980	06/09 → 12/11
SPRINTER II 216	M271.951	09/08 →
SPRINTER II 224	M272.979	06/06 →
SPRINTER II 316	M271.951	09/08 →
SPRINTER II 316 LGT	M271.951	09/08 →
SPRINTER II 316 NGT	271951NGT, 271951NGT	09/08 →
SPRINTER II 324	M272.979	06/06 → 12/13

MERCEDES-BENZ		
SPRINTER II 424	M272.979	06/06 → 12/13
SPRINTER II 516	M271.951	09/08 →
SPRINTER II 516 NGT	271951NGT, M112.976	09/08 →
SPRINTER II 524	M272.979	06/06 → 12/13
SPRINTER SERIES Sprinter 516 NGT Supercharged	271951NGT	03/09 →
SPRINTER SERIES Sprinter 516 Supercharged	M271.951	03/09 →
VIANO 3,0	M112.951	09/03 →
VIANO 3.2	M112.951	09/03 →
VIANO 3.5	M272.978	09/07 →
VIANO 3.7	M112.976, M112.976	06/04 →
VITO II 119	M112.951	09/03 →
VITO II 122	M112.951	09/03 →
VITO II 123	M112.976, M96.05	06/04 →
VITO II 126	M272.978	09/07 →

PORSCHE		
911 V 3.6 Carrera	M96.05, M96.05	07/04 → 12/11
911 V 3.6 Carrera 4	M96.05, M97.01	07/04 → 12/12
911 V 3.6 GT 2	M97.705	09/07 → 12/12
911 V 3.6 GT2 RS	M97.70	05/10 → 12/12
911 V 3.6 GT3	M97.76	03/06 → 12/09
911 V 3.6 Turbo	M97.70	03/06 → 12/09
911 V 3.8 Carrera 4 GTS	MA1.01	06/09 → 12/12
911 V 3.8 Carrera 4S	M97.01, M97.01	07/04 → 12/12
911 V 3.8 Carrera GTS	MA1.01	06/09 → 12/11
911 V 3.8 Carrera S	M97.01, MA1.04	07/04 → 12/11
911 V 3.8 GT3	M97.77	05/09 → 12/11
911 V 3.8 GT3 RS	M97.77R	08/09 → 12/11
911 V 3.8 Turbo	MA1.70	09/09 → 12/12
911 V 3.8 Turbo S	MA1.70	02/10 → 12/12
911 V 4.0 GT3 RS	M97.74	07/11 → 12/12
911 VI 3.4 Carrera	MA1.04, MA1.03	12/11 →
911 VI 3.4 Carrera 4	MA1.04	11/12 →
911 VI 3.8 Carrera 4S	MA1.03	11/12 →
911 VI 3.8 Carrera 4S / 4 GTS	MA1.03	11/12 →
911 VI 3.8 Carrera S	MA1.03, MA1.71	12/11 →
911 VI 3.8 Carrera S / GTS	MA1.03	07/12 →
911 VI 3.8 GT2 RS	MDH.NA	07/17 →
911 VI 3.8 GT3	MA1.75	08/13 →
911 VI 3.8 Turbo	MA1.71, MA1.71	09/13 →
911 VI 3.8 Turbo S	MA1.71, MA1.76	09/13 →
911 VI 4.0 GT3	MA1.76, MA1.76	05/17 →
911 VI 4.0 GT3 RS / R	MA1.76, M96.25	04/15 →
BOXSTER II 2.7	M96.25, MA1.20	11/04 → 12/09
BOXSTER II 2.9	MA1.20, MA1.21	02/09 → 03/12
BOXSTER II 3.4	MA1.21, M97.21	09/09 → 12/11
BOXSTER II 3.4 RS 60	M97.22	09/07 → 12/08
BOXSTER II S 3.2	M96.26	11/04 → 12/06
BOXSTER II S 3.4	M97.21, --	07/06 → 12/11
BOXSTER III 2.7	MA1.22	04/12 →
BOXSTER III 3.8	MDB.XA	07/15 →
BOXSTER III GTS 3.4	--, MA1.20	02/14 →
BOXSTER III S 3.4	MA1.23	04/12 →
CAYENNE I Turbo S 4.8	M48.51	08/08 → 09/10
CAYMAN I 2.9	MA1.20, --	02/09 → 06/13
CAYMAN I R 3.4	MA1.21	11/10 → 12/12
CAYMAN I S 3.4	MA1.21	02/09 → 06/13
CAYMAN II 2.7	MA1.22	03/13 →
CAYMAN II 3.8 GT4	MDB.XA	01/15 →
CAYMAN II GTS 3.4	--, 192A5.000	02/14 →
CAYMAN II S 3.4	MA1.23	03/13 →

9.0388

3

REVOLUTION AND TIMING (CKP AND CMP) SENSORS

Adatt./Suitable:

ALFA ROMEO46798364
55201876
55216243**CHEVROLET**

55216243

FIAT46798364
55201876
55216243**GENERAL MOTORS**55 216 243
93 179 392
93 190 702**LANCIA**

55201876

OPEL12 35 268
12 47 060
55216243
62 35 665
93179392
93190702**SAAB**55 216 243
93 179 392
93 190 702**VAUXHALL**55216243
93179392
93190702

MARKET DIFFUSION: MEDIUM



L	L1		+ OUT -
---	28	Hall Effect	

ALFA ROMEO

147 1.9 JTD 16V	192A5.000, 937A5.000	11/02 → 03/10
147 1.9 JTDM 16V	937A5.000, 192B1.000	09/04 → 03/10
156 1.9 JTD	192B1.000, 841G.000	11/02 →
156 1.9 JTD 16V	192A5.000	11/02 → 05/06
156 1.9 JTD 16V Q4	937A5.000	07/04 → 05/06
156 2.4 JTD	841G.000, 937A8.000	06/03 → 05/06
159 1.9 JTDM 16V	937A8.000, 939A3.000	09/05 → 11/11
159 2.4 JTDM	939A3.000, 841G.000	09/05 → 12/12
159 2.4 JTDM Q4	939A9.000	05/07 → 11/11
159 MY2011 2.4 JTD	--	01/10 →
166 2.4 JTD	841G.000, 939A3.000	10/03 → 06/07
BRERA 2.4 JTDM 20V	939A3.000, 937A5.000	01/06 → 06/10
GT 1.9 JTD	937A5.000, 939A3.000	11/03 → 09/10
SPIDER III 2.4 JTDM	939A3.000, 219DTR	04/07 → 06/10

CADILLAC

BLS 1.9 D	Z19DTR, 939A2.000	04/06 →
-----------	-------------------	---------

CHEVROLET

MALIBU 2.0 D	LBS	04/12 →
--------------	-----	---------

FIAT

BRAVO II 1.9 D Multijet	937A5.000	04/07 → 12/14
BRAVO II 1.9 D Multijet 16V	--	01/10 →
CROMA II 1.9 D Multijet	939A2.000, 192A5.000	06/05 →
CROMA II 2.4 D Multijet	939A3.000	06/05 →
STILO 1.9 D Multijet	937A5.000	09/05 → 08/08
STILO 1.9 JTD	192A5.000, 841G.000	09/03 → 08/08

LANCIA

THESIS 2.4 D Multijet	841P000	04/06 → 07/09
THESIS 2.4 JTD	841G.000, A20DTH	05/03 →

OPEL

ASTRA H 1.9 CDTi	Z19DTH	09/04 → 10/10
ASTRA H 1.9 CDTi 16V	Z19DTH	04/04 → 10/10
ASTRA J 2.0 BiTurbo CDTi	A20DTR	09/12 → 10/15
ASTRA J 2.0 CDTi	A20DTH, A20DTH	09/09 →
CASCADA 2.0 CDTi	A20DTH, A20DTR	04/13 →
INSIGNIA 2.0 Biturbo CDTi	A20DTR, A20DTR	07/08 → 03/17

OPEL		
INSIGNIA 2.0 Biturbo CDTI 4x4	A20DTR, A20DT	07/08 ⇨ 03/17
INSIGNIA 2.0 CDTI	A20DT, A20DTH	07/08 ⇨ 03/17
INSIGNIA 2.0 CDTI 4x4	A20DTH, A20DT	06/10 ⇨ 03/17
SIGNUM 1.9 CDTI	Z19DTH	04/04 ⇨ 02/08
VECTRA C 1.9 CDTI	Z19DTH	04/04 ⇨ 08/08
ZAFIRA B 1.9 CDTI	Z19DTH	07/05 ⇨ 04/15
ZAFIRA C 2.0 BiTurbo CDTI	A20DTR	01/13 ⇨
ZAFIRA C 2.0 CDTI	A20DT, A19DTR	10/11 ⇨

SAAB		
9-3 1.9 TiD	Z19DTH	09/04 ⇨ 02/15
9-3 1.9 TTiD	A19DTR, Z19DTH	12/07 ⇨ 02/15
9-5 1.9 TiD	Z19DTH, A20DTH	01/06 ⇨ 12/09
9-5 2.0 TiD	A20DTH	05/10 ⇨ 01/12
9-5 2.0 TTiD	A20DTR	05/10 ⇨ 01/12
9-5 2.0 TTiD XWD	A20DTR	05/10 ⇨ 01/12
9-3X 1.9 TTiD AWD	Z19DTR	02/09 ⇨ 12/12

VAUXHALL		
ASTRA V 1.9 CDTI	Z19DTH	01/04 ⇨ 11/10
ASTRA V 1.9 CDTI 16V	Z19DTJ	01/04 ⇨ 05/09
ASTRA VI 2.0 BiTurbo CDTI	A20DTR	12/12 ⇨
ASTRA VI 2.0 CDTI	A20DTH, A20DTH	12/09 ⇨
ASTRAVAN III 1.9 CDTI	Z19DTH	03/05 ⇨ 11/11
CASCADA 2.0 CDTI	A20DTH, A20DT	02/13 ⇨
INSIGNIA 2.0 Biturbo CDTI	A20DTR	03/12 ⇨ 05/17
INSIGNIA 2.0 Biturbo CDTI 4x4	A20DTR	03/12 ⇨ 05/17
INSIGNIA 2.0 CDTI	A20DT, A20DTH	07/08 ⇨ 05/17
INSIGNIA 2.0 CDTI 4x4	A20DTH, A20DT	07/08 ⇨ 05/17
SIGNUM 1.9 CDTI 16V	Z19DTH	04/04 ⇨ 03/08
VECTRA C 1.9 CDTI 16V	Z19DTH	04/04 ⇨ 05/09
ZAFIRA B 1.9 CDTI	Z19DTH	07/05 ⇨ 11/14
ZAFIRA C 2.0 BiTurbo CDTI	A20DTR	11/12 ⇨ 08/18
ZAFIRA C 2.0 CDTI	A20DT, AR32104	10/11 ⇨

9.0389



3

REVOLUTION AND TIMING (CKP AND CMP) SENSORS

Adatt./Suitable:

ALFA ROMEO
46798363

BOSCH
0 261 210 227

L	L1	ohm	OUT GND
---	34,5	900	

ALFA ROMEO

147 1.6 16V T.SPARK	AR32104	01/01 ⇨ 03/10
147 1.6 16V T.SPARK ECO	AR37203	01/01 ⇨ 03/10
147 1.6 LPG	AR32104, AR32102	03/01 ⇨ 03/10
147 2.0 16V T.SPARK	AR32310	01/01 ⇨ 03/10
156 1.6 16V T.SPARK	AR32102, AR32102	09/97 ⇨ 09/05
156 1.6 16V T.SPARK.	AR32102, AR32310	05/00 ⇨ 05/06
156 1.8 16V T.SPARK	AR32205	02/97 ⇨ 05/06
156 2.0 16V T.SPARK	AR32310, 932A2.000	05/00 ⇨ 06/02
156 2.0 JTS	932A2.000, AR34103	01/02 ⇨ 05/06
166 2.0 T.SPARK	AR34103, 932A2.000	10/00 ⇨ 06/07
GT 1.8 TS	AR32205	11/03 ⇨ 09/10
GT 2.0 JTS	932A2.000, AR16201	11/03 ⇨ 09/10
GTV 2.0 JTS	937A1.000	04/03 ⇨ 10/05
GTV 2.0 T.SPARK 16V	AR16201, AR16201	06/95 ⇨ 10/05
SPIDER II 2.0 JTS	937A1.000	04/03 ⇨ 04/05
SPIDER II 2.0 T.SPARK 16V	AR16201, AGR	06/95 ⇨ 04/05

9.0391



04,5

REVOLUTION AND TIMING (CKP AND CMP) SENSORS

Adatt./Suitable:

AUDI
038 907 319 A
038 907 319 F

SEAT
038 907 319 A
038 907 319 F

SKODA
038 907 319 A
038 907 319 F

VW
038 907 319 A
038 907 319 F

MARKET DIFFUSION: MEDIUM



L	L1	ohm	S GND OUT
535	46	1200	

AUDI

A3 I 1.9 TDI	AGR, AGP	09/96 ⇨ 07/01
--------------	----------	---------------

SEAT

CORDOBA I 1.9 SDI	AGP, AGP	06/99 ⇨ 12/02
IBIZA II 1.9 SDI	AGP, AGR	08/99 ⇨ 02/02
IBIZA II 1.9 TDI	AGR, 1Y	08/99 ⇨ 02/02
INCA 1.9 D	1Y, 1Y	11/95 ⇨ 06/03
INCA 1.9 SDI	1Y, AGR	11/95 ⇨ 06/03
LEON I 1.9 SDI	AQM	11/99 ⇨ 06/06
LEON I 1.9 TDI	AGR, AGR	11/99 ⇨ 06/06
TOLEDO II 1.9 TDI	AGR, AGP	10/98 ⇨ 07/04

SKODA

FABIA I 1.9 SDI	ASY	11/99 ⇨ 03/08
OCTAVIA I 1.9 D	AQM	08/00 ⇨ 12/03
OCTAVIA I 1.9 SDI	AGP, AGR	06/97 ⇨ 12/03
OCTAVIA I 1.9 TDI	AGR, AGR	09/96 ⇨ 03/10
OCTAVIA I 1.9 TDI 4x4	AGR	11/99 ⇨ 02/06

VOLKSWAGEN (BR)

GOLF A4 1.9 D	AGR, AGP	01/00 ⇨
POLO 1.9 SDI	ASY	05/02 ⇨

VW

BORA 1.9 SDI	AGP, AGR	10/98 ⇨ 05/05
BORA 1.9 TDI	AGR, AGR	07/01 ⇨
BORA 1.9 TDI 4motion	AGR, 1Y	07/01 ⇨
CADDY II 1.9 D	1Y, 1Y	11/95 ⇨ 01/04
CADDY II 1.9 SDI	1Y, 1Z	11/95 ⇨ 01/04
CADDY II 1.9 TDI	1Z, AGP	09/96 ⇨ 01/04
FOX 1.9 D	ASY	12/07 ⇨
GOLF IV 1.9 SDI	AGP, AGR	08/97 ⇨ 06/06
GOLF IV 1.9 TDI	AGR, AGR	05/99 ⇨ 05/06
GOLF IV 1.9 TDI 4motion	AGR, AGP	05/01 ⇨ 05/06
GOLF 1.9 SDI	AQM	11/98 ⇨ 05/04
GOLF 1.9 TDI	AHF	10/97 ⇨ 05/04
JETTA V 1.9 SDI [CHN]	AQM	02/02 ⇨
NEW BEETLE 1.9 TDI	ALH	01/98 ⇨ 06/04
POLO III 1.9 SDI	AGP, AFN	08/99 ⇨ 09/01
POLO III 1.9 TDI	AFN, AFN	05/97 ⇨ 09/01
POLO III 110 1.9 TDI	AFN, AGP	06/98 ⇨ 01/02
POLO III 68 1.9 SDI	AGP, AGR	08/99 ⇨ 01/02
POLO III 90 1.9 TDI	AGR, B5202S	09/96 ⇨ 09/01

9.0392



3,5

REVOLUTION AND TIMING (CKP AND CMP) SENSORS

Adatt./Suitable:

VOLVO
916803-9

L	L1	ohm	GND OUT
170	28	500	

VOLVO

850 2.0	B5202S, B5204FT	06/91 ⇨ 12/96
850 2.0 10V	B5202FS	08/94 ⇨ 12/97
850 2.0 Turbo	B5204FT, B5252	02/93 ⇨ 10/97
850 2.3	B5234FS	01/96 ⇨ 10/96
850 2.3 T5	B5234FT	02/93 ⇨ 12/96
850 2.3 T5 R	B5234T2	04/96 ⇨ 10/96
850 2.3 T5-R	B5234T4	08/95 ⇨ 12/96
850 2.3 Turbo R	B5234T5	06/95 ⇨ 10/97
850 2.4	B5252, B5252FS	06/91 ⇨ 12/96
850 2.4 AWD	B5254T	04/96 ⇨ 12/96
850 2.4 GLE	B5254T	09/93 ⇨ 10/97
850 2.5 10V	B5252FS, B5202FS	06/91 ⇨ 12/97
850 2.5 20V	B5254FS	08/91 ⇨ 12/97
850 2.5 TDI	D5252T	08/95 ⇨ 12/96
C70 1.2.0	B5204T2	03/97 ⇨ 10/05
C70 1.2.0 T	B5204T3	03/97 ⇨ 10/05
C70 1.2.3 T5	B5234T3	03/98 ⇨ 10/05
C70 1.2.3 T5-5	B5234T3	03/97 ⇨ 09/02
C70 1.2.4 T	B5254T	03/97 ⇨ 10/05
S70 2.0	B5202FS, B5234FS	01/97 ⇨ 11/00
S70 2.0 Turbo	B5204T3	01/97 ⇨ 11/00
S70 2.3	B5234FS, B5202FS	01/97 ⇨ 07/99
S70 2.3 AWD	B5234T7	04/99 ⇨ 09/00
S70 2.3 T-5	B5234T3	01/97 ⇨ 11/00
S70 2.3 T5-R AWD	B5234T2	11/96 ⇨ 09/98
S70 2.4	B5254S	06/98 ⇨ 11/00
S70 2.4 AWD	B5252FS	11/96 ⇨ 05/99
S70 2.4 Bifuel	GB5252S	10/98 ⇨ 11/00
S70 2.4 T5 AWD	B5254T	11/96 ⇨ 04/99
S70 2.4 Turbo	B5254T	01/97 ⇨ 11/00
S70 2.5 20V	B5254FS	01/97 ⇨ 12/98
S70 2.5 TDI	D5252T	01/97 ⇨ 11/00
S70 2.5 TDI AWD	D5252T	10/99 ⇨ 09/00
V70 1.2.0	B5202FS, B5234T3	12/95 ⇨ 12/00
V70 1.2.0 Turbo	B5204T3	11/96 ⇨ 12/00
V70 1.2.0 Turbo AWD	B5204T3	11/96 ⇨ 12/00
V70 1.2.3	B5234FS	01/97 ⇨ 07/99
V70 1.2.3 AWD	B5234T3, B5202S	04/97 ⇨ 09/98
V70 1.2.3 T-5	B5234T3	11/96 ⇨ 12/00
V70 1.2.3 T-5 AWD	B5234T3	01/97 ⇨ 12/00
V70 1.2.3 Turbo	B5234T2	01/97 ⇨ 12/98
V70 1.2.4	B5254S	06/98 ⇨ 12/99
V70 1.2.4 Bifuel	GB5252S	05/98 ⇨ 12/99
V70 1.2.4 Turbo AWD	B5254T	04/96 ⇨ 12/00
V70 1.2.5	B5252FS	01/97 ⇨ 03/00
V70 1.2.5 20V	B5254FS	01/97 ⇨ 12/99
V70 1.2.5 TDI	D5252T	12/95 ⇨ 12/00
V70 1.2.5 TDI AWD	D5252T	11/96 ⇨ 02/00

9.0393



04,5

REVOLUTION AND TIMING (CKP AND CMP) SENSORS

Adatt./Suitable:

VOLVO
351526-6

Eliminated on 09-10-2017. Please verify the availability through our local distributors

- Eliminato il 09-10-2017. Verificare la disponibilità presso i nostri distributori
- Éliminé le 09-10-2017. Vérifier la disponibilité auprès de nos distributeurs sur place
- Am 09-10-2017 gestrichen. Evtl. Verfügbarkeit bitte bei unseren Händlern prüfen
- Eliminado en fecha 09-10-2017. Verificar la disponibilidad a través de nuestros distribuidores locales

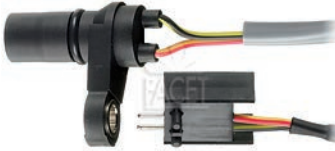

L	L1	ohm	OUT GND S
435	28	500	

VOLVO

850 2.0	B5202S, B5204FT	06/91 → 12/96
850 2.0 10V	B5202FS	08/94 → 12/97
850 2.0 Turbo	B5204FT, B5252	02/93 → 10/97
850 2.3	B5234FS	01/96 → 10/96
850 2.3 T5	B5234FT	02/93 → 12/96
850 2.3 T5 R	B5234T2	04/96 → 10/96
850 2.3 T5-R	B5234T4	08/95 → 12/96
850 2.3 Turbo R	B5234T5	06/95 → 10/97
850 2.4	B5252, B5252FS	06/91 → 12/96
850 2.4 AWD	B5254T	04/96 → 12/96
850 2.4 GLE	B5254T	09/93 → 10/97
850 2.5 10V	B5252FS, B5202FS	06/91 → 12/97
850 2.5 20V	B5254FS	08/91 → 12/97
850 2.5 TDI	D5252T	08/95 → 12/96
C70 1.2.0	B5204T2	03/97 → 10/05
C70 1.2.0 T	B5204T3	03/97 → 10/05
C70 1.2.3 T5	B5234T3	03/98 → 10/05
C70 1.2.3 T-5	B5234T3	03/97 → 09/02
C70 1.2.4 T	B5254T	03/97 → 10/05
S70 2.0	B5202FS, B5234FS	01/97 → 11/00
S70 2.0 Turbo	B5204T3	01/97 → 11/00
S70 2.3	B5234FS, B5202FS	01/97 → 07/99
S70 2.3 AWD	B5234T7	04/99 → 09/00
S70 2.3 T-5	B5234T3	01/97 → 11/00
S70 2.3 T5-R AWD	B5234T2	11/96 → 09/98
S70 2.4	B5254S	06/98 → 11/00
S70 2.4 AWD	B5252FS	11/96 → 05/99
S70 2.4 Bifuel	GB5252S	10/98 → 11/00
S70 2.4 T5 AWD	B5254T	11/96 → 04/99
S70 2.4 Turbo	B5254T	01/97 → 11/00
S70 2.5 20V	B5254FS	01/97 → 12/98
S70 2.5 TDI	D5252T	01/97 → 11/00
S70 2.5 TDi AWD	D5252T	10/99 → 09/00
V70 1.2.0	B5202FS, B5234T3	12/95 → 12/00
V70 1.2.0 Turbo	B5204T3	11/96 → 12/00
V70 1.2.0 Turbo AWD	B5204T3	11/96 → 12/00
V70 1.2.3	B5234FS	01/97 → 07/99
V70 1.2.3 AWD	B5234T3, B230FD	04/97 → 09/98
V70 1.2.3 T-5	B5234T3	11/96 → 12/00
V70 1.2.3 T-5 AWD	B5234T3	01/97 → 12/00
V70 1.2.3 Turbo	B5234T2	01/97 → 12/98
V70 1.2.4	B5254S	06/98 → 12/99
V70 1.2.4 Bifuel	GB5252S	05/98 → 12/99
V70 1.2.4 Turbo AWD	B5254T	04/96 → 12/00
V70 1.2.5	B5252FS	01/97 → 03/00
V70 1.2.5 20V	B5254FS	01/97 → 12/99
V70 1.2.5 TDI	D5252T	12/95 → 12/00
V70 1.2.5 TDi AWD	D5252T	11/96 → 02/00

9.0397



04,5

REVOLUTION AND TIMING (CKP AND CMP) SENSORS

Adatt./Suitable:

BOSCH
0 986 280 401

VOLVO
138939-9
13893995
271949
354784-7
35478478

L	L1	ohm	OUT GND S
520	24	170	

VOLVO

240 2.0	B200F	09/88 → 12/93
240 2.3	B230FD, B204FT	08/86 → 08/93
240 2.3 Cat	B230F	08/91 → 07/92
240 2.3 i Cat	B230F	08/86 → 07/93
740 2.0 16V	B204E	09/87 → 08/90
740 2.0 16V Turbo	B204FT, B230F	08/89 → 07/90
740 2.0 GLE	B204E	09/87 → 08/90
740 2.0 Turbo	B200FT	09/90 → 08/91
740 2.3	B230F, B230FT	08/84 → 12/92
740 2.3 Turbo	B230FT, B230FT	08/86 → 08/91
760 2.3	B230FT	01/88 → 07/92
760 2.3 Turbo	B230FT, B200F	09/87 → 08/90
780 2.0i	B204GT	01/87 → 12/90
940 1.2.0	B200F, B230F	09/90 → 07/94
940 1.2.0 GL	B204E	09/90 → 04/92
940 1.2.0 Turbo	B200FT	08/90 → 07/95
940 1.2.3	B230F, B230FD	08/90 → 07/95
940 1.2.3 16V	B234G	08/90 → 07/92
940 1.2.3 Turbo	B230FT	08/90 → 07/94
940 1.2.0 GLT	B200GT	10/94 → 05/97
940 1.2.0 Turbo	B200FT	04/96 → 10/98
940 1.2.3	B230FD, B230FT	08/94 → 05/97
940 1.2.3 ti	B230FK	01/95 → 10/98
940 1.2.3 Turbo	B230FT, ASB	08/94 → 12/98
960 1.2.0	B204FT	08/90 → 09/93
960 1.2.3	B230GT	08/90 → 07/94
960 1.2.3 Turbo	B230FT	09/90 → 08/93

9.0398



04,5

REVOLUTION AND TIMING (CKP AND CMP) SENSORS

Adatt./Suitable:

AUDI
06A 906 433 E

BOSCH
0 261 210 145
0 261 210 146

VW
06A 906 433 E

L	L1	ohm	OUT GND S
335	24	900	

AUDI

A4 II 2.0 FSI	AWA	07/02 → 12/04
A4 II 2.7 TDI	BPP	06/06 → 03/09
A4 II 3.0 TDI quattro	ASB, BPP	01/06 → 03/09
A4 III 2.7 TDI	BPP, ASB	11/05 → 06/08
A4 III 3.0 TDI quattro	ASB, BPP	11/04 → 06/08
A6 III 2.7 TDI	BPP, BPP	11/04 → 08/11
A6 III 2.7 TDI quattro	BPP, ASB	11/04 → 08/11
A6 III 3.0 TDI	ASB	06/06 → 08/11
A6 III 3.0 TDI quattro	ASB, ASB	05/04 → 08/11
A8 II 3.0 TDI quattro	ASB, BMK	08/03 → 07/10

VW

JETTA V 1.6 [CHN]	BJG	01/05 →
PHAETON 3.0 V6 TDI 4motion	BMK, EW10D	09/04 → 03/16

9.0400



1

REVOLUTION AND TIMING (CKP AND CMP) SENSORS

Adatt./Suitable:

CITROËN
1920 AE
96 346 059 80

FIAT
9634605580

LANCIA
9634605580

PEUGEOT
1920 AE

RENAULT
96 34 605 580

L	L1	Hall Effect	- OUT +
---	19,6		

CITROËN

C5 1.2.0 16V HPI	EW10D, ES9J4SHP	03/01 → 08/04
C5 1.3.0 Carlsson	ES9J4SHP, ES9A	09/03 → 08/04
C5 1.3.0 V6	ES9A, ES9A	03/01 →
C5 II 3.0 V6	ES9A, ES9A	02/08 →
C5 3.0 [ExtraEU]	ES9AHP	09/04 → 01/08
C6 3.0 V6	ES9A, ES9J4S	09/05 → 12/12

9.0401

CITROËN		
C8 3.0 V6	ES9J4S, ES9J4S	07/02 →
FIAT		
ULYSSE II 3.0	XFW	08/02 → 06/11
LANCIA		
PHEDRA 3.0 V6	ES9J4S, EW10D	09/02 →
PEUGEOT		
406 2.0 16V HPI	EW10D, ES9J4S	05/01 → 10/04
406 3.0 V6	ES9J4S, ES9A	03/00 → 12/04
407 3.0	ES9A, ES9A	05/04 →
407 3.0 V6	ES9A, ES9A	10/05 →
607 3.0 V6 24V	ES9A, ES9J4S	02/00 → 07/11
807 3.0 V6	ES9J4S, L7X720	06/02 →
RENAULT		
AVANTIME 3.0 V6	L7X720, L7X760	09/01 → 05/03
AVANTIME 3.0i 24V	L7X722	05/01 →
CLIO II 3.0 RS V6	L7X760, L7X760	01/03 →
CLIO II 3.0 V6 Sport	L7X760, L7X760	11/00 →
CLIO IV 3.0 RS V6	L7X760, L7X731	03/13 →
LAGUNA II 2.9 V6 24V	L7X731, L7X731	03/01 → 12/07
LAGUNA II 3.0 V6 24V	L7X731, ABC	03/01 →

9.0401



04

REVOLUTION AND TIMING (CKP AND CMP) SENSORS

Adatt./Suitable:

AUDI078 905 161 A
078 905 161 C**BOSCH**0 232 101 010
0 232 101 011
0 232 101 027
0 232 101 028**VW**078 905 161 A
078 905 161 C

L	L1		
---	---	Hall Effect	

AUDI		
80 IV 2.6	ABC	07/92 → 01/96
80 IV 2.8	AAH	09/91 → 01/96
80 IV 2.8 quattro	AAH	09/91 → 12/94
100 IV 2.6	ABC, ABC	03/92 → 07/94
100 IV 2.6 E quattro	ACZ	08/93 → 07/94
100 IV 2.6 quattro	ABC	04/92 → 07/94
100 IV 2.8 E	AAH	12/90 → 07/94
100 IV 2.8 E quattro	AAH	12/90 → 07/94
A4 I 2.6	ABC	01/95 → 09/01
A4 I 2.6 quattro	ABC	01/95 → 09/01
A4 I 2.8	AAH	09/95 → 07/97
A4 I 2.8 quattro	AAH	01/95 → 07/97
A6 I 2.6	ABC, ABC	06/94 → 12/97
A6 I 2.6 quattro	ABC, AAH	06/94 → 12/97
A6 I 2.8	AAH	06/94 → 12/97
A6 I 2.8 quattro	AAH, AAH	06/94 → 12/97
A8 I 2.8	AAH, AAH	03/94 → 03/96
A8 I 2.8 quattro	AAH, ABC	03/94 → 03/96
CABRIOLET 2.6	ABC, ACZ	06/93 → 08/00
CABRIOLET 2.8	AAH	11/92 → 08/00
COUPE 2.6	ABC	08/92 → 12/96
COUPE 2.6 quattro	ABC	08/92 → 12/96
COUPE 2.8	AAH	09/91 → 12/96
COUPE 2.8 quattro	AAH	08/91 → 12/96

9.0403



3,5

REVOLUTION AND TIMING (CKP AND CMP) SENSORS

Adatt./Suitable:

KIA

OK2N1-18891



L	L1	ohm	
230	24	900	

KIA

CARENS II 1.6	GA6D	07/02 →
CERATO I 1.6	B4ZE	04/04 → 12/09
SEPHIA II 1.6 i 16V	--	07/00 →
SHUMA I 1.6	GA6D	01/01 → 12/01
SHUMA II 1.6	GA6D	05/01 → 08/04
SHUMA II 1.8	T8D	04/03 → 08/04
SPECTRA 1.6 i 16V	--	07/00 →

9.0407



3

REVOLUTION AND TIMING (CKP AND CMP) SENSORS

Adatt./Suitable:

ALFA ROMEO
73502752

BOSCH
0 986 280 424

CHEVROLET
12855457

CHRYSLER
73502752

CITROËN
1920 SQ

FIAT
73502752

FORD
1 547 993
1 564 860
9551-9E731-AA

GENERAL MOTORS
12 855 457
93 178 045
93 193 372

LANCIA
73502752

OPEL
12 47 679
12855457
47 08 543
62 35 645
93178045
93193372

PEUGEOT
1920 SQ

SUBARU
33220-85E10
33220-85E11

SUZUKI
33220-63P00
33220-63P00-000
33220-85E10
33220-85E10-000
33220-85E11
33220-85E11-000
33220-86J00
33220-86J00-000
33220M86J00
33220M86J00-000
33220N86J00
33220N86J00-000

VAUXHALL
12855457
93178045
93193372

MARKET DIFFUSION: HIGH



L	L1	ohm	OUT GND
---	36,5	850	

ALFA ROMEO

MITO 1.3 Multijet 199A3.000, LDV 08/08 ⇨

CHEVROLET

AVEO II 1.3 D LDV, F13DTE6 07/11 ⇨

CHRYSLER

YPSILON 1.3 Multijet 199B1.000 05/11 ⇨

CITROËN

NEMO 1.3 BlueHdi 80 F13DTE6, F13DTE5 02/16 ⇨

NEMO 1.3 Hdi 75 F13DTE5, F13DTE6 10/10 ⇨

NEMO 1.3 Hdi 80 F13DTE6, 169A1.000 10/15 ⇨

FIAT

500 1.3 D Multijet 169A1.000, 169A1.000 10/07 ⇨

500 C 1.3 D Multijet 169A1.000, 199B4.000 09/09 ⇨

500 MY12 1.3 JTD -- 01/12 ⇨

500 MY15 1.3 JTD -- 01/15 ⇨

500L 1.3 D Multijet 199B4.000, 188A8.000 09/12 ⇨

500L 1.6 D Multijet 199B5.000 09/12 ⇨

500X 1.3 D Multijet 55266963 11/14 ⇨

DOBLO I 1.3 D Multijet 199A2.000 10/05 ⇨

DOBLO I 1.3 JTD 199A2.000 05/05 ⇨

FIAT

DOBLO I 1.3 JTD 16V 188A8.000, 199A3.000 05/04 ⇨ 12/06

DOBLO I 1.3 JTD 16V Multijet 223A9.000 08/06 ⇨

DOBLO II 1.3 D Multijet 199A3.000, 198A3.000 02/10 ⇨

DOBLO II 1.6 D Multijet 198A3.000, 199A2.000 02/10 ⇨

FIORINO III 1.3 D Multijet 199A2.000, 199A2.000 11/07 ⇨

GRANDE PUNTO 1.3 JTD Multijet 199A2.000, 188A9.000 02/06 ⇨ 06/13

IDEA 1.2 D -- 01/08 ⇨

IDEA 1.3 D Multijet 188A9.000, -- 01/04 ⇨

LINEA 1.3 D Multijet --, -- 06/07 ⇨

LINEA 1.3 JTD Multijet 199A3.000 10/06 ⇨

PALIO 1.3 -- 06/03 ⇨

PALIO 1.3 JTD Multijet 188A9.000 06/03 ⇨

PALIO 1.3 Multijet INDIA 199A2.000 06/05 ⇨

PANDA II 1.2 169A4.000 03/10 ⇨ 08/13

PANDA II 1.2 4x4 169A4.000 11/09 ⇨

PANDA II 1.2 LPG 169A4.000 11/10 ⇨ 08/13

PANDA II 1.3 D Multijet --, 169A1.000 09/03 ⇨

PANDA II 1.3 D Multijet 4x4 169A1.000, 169A1.000 10/04 ⇨

PANDA II 1.3 JTD Multijet 4x4 169A1.000, 199A1.000 09/10 ⇨ 08/13

PANDA III 1.3 D Multijet 199A1.000, 199A1.000 02/12 ⇨

PANDA III 1.3 D Multijet 4x4 199A1.000, 199A2.000 06/12 ⇨

PUNTO II 1.3 D Multijet 188A9.000 02/05 ⇨ 10/09

PUNTO II 1.3 JTD 188A9.000 06/03 ⇨ 10/05

PUNTO II 1.3 JTD 16V 188A9.000 06/03 ⇨ 03/12

PUNTO III / GRANDE PUNTO 1.3 D Multijet 199A2.000, 199A2.000 10/05 ⇨

PUNTO III / GRANDE PUNTO 1.3 JTD -- 01/08 ⇨ 09/09

PUNTO III / GRANDE PUNTO 1.3 JTD Actual -- 09/09 ⇨

PUNTO III / GRANDE PUNTO 1.3 Multijet (IND) -- 01/08 ⇨

PUNTO III EVO 1.3 D Multijet 199A2.000, 199A2.000 07/08 ⇨

PUNTO III 1.3 D Multijet 199A2.000, 199A2.000 04/08 ⇨

PUNTO III 1.3 JTD Multijet 955B2.000 05/18 ⇨

QUBO 1.3 D Multijet 199A2.000, 199B1.000 02/08 ⇨

SIENA 1.2 MJTD -- 01/02 ⇨

SIENA 1.3 JTD 188A9.000 09/03 ⇨ 12/09

STRADA 1.3 D -- 01/11 ⇨

STRADA 1.3 D Multijet 199B1.000 05/06 ⇨

TIPO II 1.3 D 199B1.000, 55260384 10/15 ⇨

TIPO II 1.6 D 55260384, BAAA 09/16 ⇨

FORD

KA II 1.3 TDCi BAAA, -- 10/08 ⇨

LANCIA

MUSA 1.3 D Multijet --, 199A2.000 10/04 ⇨ 12/12

YPSILON I 1.3 D Multijet 199A2.000, 199B1.000 09/06 ⇨ 12/11

YPSILON I 1.3 JTD 188A9.000 10/03 ⇨ 12/11

YPSILON II 1.3 D Multijet 199B1.000, D13A 05/11 ⇨

OPEL

AGILA A 1.3 CDTi Z13DT 08/03 ⇨ 12/07

AGILA B 1.3 CDTi D13A, Y13DT 04/08 ⇨ 04/10

ASTRA H 1.3 CDTi Z13DTH 04/05 ⇨ 10/10

ASTRA J 1.3 CDTi A13DTE 01/09 ⇨

COMBO C 1.3 CDTi 16V Y13DT, A13FD 06/04 ⇨

COMBO D 1.3 CDTi A13FD, Y13DT 02/12 ⇨

CORSA C 1.3 CDTi Y13DT, A13DTC 06/03 ⇨

CORSA C 1.3 CDTi 16V Z13DT 07/05 ⇨ 06/06

CORSA C 1.3 DTi Y13DT 09/03 ⇨

CORSA D 1.3 CDTi A13DTC, Y13DT 07/06 ⇨ 08/14

MERIVA A 1.3 CDTi Y13DT, A13DTC 09/03 ⇨ 05/10

MERIVA B 1.3 CDTi A13DTC, 199A9.000 06/10 ⇨ 11/14

TIGRA B 1.3 CDTi Z13DT 06/04 ⇨ 12/10

PEUGEOT

BIPPER 1.3 BlueHdi 80 F13DTE6 12/15 ⇨

BIPPER 1.3 Hdi 75 199A9.000, 199A9.000 10/10 ⇨

BIPPER TEPEE 1.3 Hdi 75 199A9.000, F13DTE6 10/10 ⇨

BIPPER TEPEE 1.3 Hdi 80 F13DTE6, D13A 12/15 ⇨

SUBARU

JUSTY III 1.3 CDTi Z13DT 12/03 ⇨ 08/07

SUZUKI

IGNIS II 1.3 DDiS Z13DT 09/03 ⇨

SPLASH 1.3 CDTi D13A, D13A 01/08 ⇨

SWIFT IV 1.3 DDiS D13A, D13A 08/05 ⇨

SWIFT V 1.3 DDiS D13A, D13A 10/10 ⇨

WAGON R+ II 1.3 DDiS Z13DT 09/03 ⇨

VAUXHALL

AGILA A 1.3 CDTi Z13DT 08/03 ⇨ 03/08

AGILA B 1.3 CDTi D13A, Y13DT 01/08 ⇨ 11/14

ASTRA V 1.3 CDTi Z13DTH 01/04 ⇨ 11/10

ASTRA VI 1.3 CDTi A13DTE 12/09 ⇨

ASTRAVAN III 1.3 CDTi Z13DTH 08/05 ⇨

COMBO C 1.3 CDTi 16V Y13DT, A13FD 09/04 ⇨ 02/12

COMBO D 1.3 CDTi A13FD, Y13DT 11/11 ⇨

CORSA C 1.3 CDTi 16V Y13DT, A13DTC 08/00 ⇨ 09/06

CORSA D 1.3 CDTi A13DTC, A13DTC 08/06 ⇨ 08/14

CORSAVAN II 1.3 CDTi 16V Z13DT 04/04 ⇨ 06/06

VAUXHALL

CORSAVAN III 1.3 CDTi A13DTC, Y13DT 07/06 ⇨

MERIVA I 1.3 CDTi Y13DT, A13DTC 01/03 ⇨ 06/10

MERIVA II 1.3 CDTi A13DTC, 4M420A 06/10 ⇨

TIGRA B 1.3 CDTi Z13DT 06/04 ⇨ 08/09

9.0417



3

REVOLUTION AND TIMING (CKP AND CMP) SENSORS

Adatt./Suitable:

DENSO
029600-0580
029600-1180
029600-1190
029600-1361
029600-1391

FUSO (MITSUBISHI)

ME212060

GENERAL MOTORS

97 174 899

MINI

13 62 7 799 452

NISSAN

23731-8H800

OPEL
62 35 614
97174899
RENAULT

77 01 052 664

SAAB

59 51 819

TOYOTA
19311-78060
89411-E0040
90919-05053
90919-05063
VAUXHALL

97174899

MARKET DIFFUSION: MEDIUM



L	L1	ohm	OUT GND
---	36,5	2065	

FUSO (MITSUBISHI)

CANTER 3.0 DiTD 4M420A, N04C-TQ 08/05 ⇨

MINI

MINI I One D 1ND-TV 06/03 ⇨ 09/06

NISSAN

PRIMERA III 2.2 Di YD22DDT 03/02 ⇨ 05/07

X-TRAIL 2.2 dCi [ExtraEU] YD22ETI 06/01 ⇨ 02/07

X-TRAIL I 2.2 Dci YD22DDTi 10/04 ⇨ 01/13

X-TRAIL I 2.2 Dci FWD YD22ETI 06/01 ⇨ 09/03

X-TRAIL I 2.2 Di 4x4 YD22ETI 07/01 ⇨ 10/05

OPEL

SIGNUM 3.0 V6 CDTi Y30DT 05/03 ⇨ 07/05

VECTRA C 3.0 CDTi Y30DT 02/03 ⇨ 07/05

VECTRA C 3.0 V6 CDTi Y30DT 10/03 ⇨ 07/05

RENAULT

ESPACE IV 3.0 dCi P9X701 11/02 ⇨

VEL SATIS 3.0 dCi P9X701 06/02 ⇨

SAAB

9-5 3.0 TiD D308L 07/01 ⇨ 12/09

TOYOTA

AURIS I 1.4 D-4D 1ND-TV 03/07 ⇨ 04/13

COROLLA IX 1.4 D 1ND-TV 07/04 ⇨ 02/07

COROLLA IX 1.4 D-4D 1ND-TV 06/04 ⇨ 10/06

COROLLA IX 1.4 D4-D 1ND-TV 06/04 ⇨ 10/07

COROLLA X 1.4 D-4D 1ND-TV 10/06 ⇨ 07/14

DYNA 4.0 D4d N04C-TQ, N04C-UL 08/01 ⇨

DYNA 4.0 D4d 4WD N04C-UL, ASZ 10/06 ⇨

DYNA 4.0 Hybrid N04C-UL 05/11 ⇨

PREVIA II 2.0 D-4D 1CD-FTV 03/01 ⇨ 01/06

TARAGO MPV / SPACE 2.0 TDi 1CD-FTV 10/03 ⇨ 12/05

TOYOTA		
YARIS II 1.4 D-4D	1ND-TV	08/05 → 12/12
YARIS III 1.4 D	1ND-TV	09/11 →
YARIS 1.4 D4d	1ND-TV	07/14 →
VAUXHALL		
SIGNUM 3.0 CDTi	Y30DT	05/03 → 05/08
VECTRA C 3.0 V6 CDTI	Y30DT	06/03 → 08/05

9.0422



04,5

REVOLUTION AND TIMING (CKP AND CMP) SENSORS

Adatt./Suitable:

SEAT
038 957 147 A
038 957 147 G

SKODA
038 957 147 A
038 957 147 G

VW
038 957 147 A
038 957 147 G

MARKET DIFFUSION: MEDIUM



L	L1		
445	---	Hall Effect	

SEAT		
CORDOBA II 1.9 TDI	ASZ, ASZ	09/02 → 11/09
IBIZA III 1.9 TDI	ASZ, ATD	02/02 → 11/09
SKODA		
FABIA I 1.9 TDI	ATD, ASZ	01/00 → 03/08
FABIA I 1.9 TDI RS	ASZ, BLS	06/03 → 03/08
FABIA II 1.9 TDI	BLS, AXR	04/07 → 03/10
ROOMSTER 1.9 TDI	AXR, ASZ	03/06 → 03/10
VW		
POLO 1.9 Tdi [ExtraEU]	ATD	07/03 → 06/05
POLO IV 1.9 SDI	ASY	10/01 →
POLO IV 1.9 TDI	ASZ, AMF	10/01 → 11/09

9.0423



04,5

REVOLUTION AND TIMING (CKP AND CMP) SENSORS

Adatt./Suitable:

AUDI
045 957 147 B

FORD
1 100 748
1 253 755
3M21-6B288-AA
XM21-6B288-AA

SEAT
045 957 147 A
045 957 147 B

SKODA
045 957 147 A
045 957 147 B

VW
045 957 147 A
045 957 147 B

MARKET DIFFUSION: MEDIUM



L	L1		
340	---	Hall Effect	

AUDI		
A2 1.2 TDI	ANY	03/01 → 08/05
A2 1.4 TDI	AMF, ASZ	02/00 → 08/05
A3 I 1.9 TDI	ASZ, 1Z	08/00 → 05/03
A3 I 1.9 TDI quattro	ASZ	08/00 → 05/03
FORD		
GALAXY I 1.9 TDI	1Z, 1Z	04/00 → 05/06
SEAT		
ALHAMBRA I / II 1.9 TDI	1Z, AUY	06/00 → 03/10
ALHAMBRA I / II 1.9 TDI 4motion	AUY, AMF	06/00 → 03/10
ALHAMBRA I / II 1.9 Tdi 4x4	ASZ	06/05 → 11/08
AROSA 1.4 TDI	AMF	01/00 → 06/04
CORDOBA II 1.4 TDI	AMF, AMF	10/02 → 11/09
IBIZA III 1.4 TDI	AMF, BPX	05/02 → 11/09
IBIZA III 1.9 TDI Cupra R	BPX, ARL	03/04 → 02/08
LEON I 1.9 TDI	ARL, ARL	09/00 → 06/06
LEON I 1.9 TDI Syncro	ARL	05/02 → 06/06
TOLEDO II 1.9 TDI	ARL, AMF	10/00 → 05/06
TOLEDO II 1.9 TDI 4Drive	ARL	10/00 → 10/05
SKODA		
FABIA I 1.4 TDI	AMF, BMS	04/03 → 03/08
FABIA II 1.4 TDI	BMS, AHF	01/07 → 03/10
OCTAVIA I 1.9 TDI	AHF, BMS	08/00 → 12/10
OCTAVIA I 1.9 TDI 4x4	ATD	09/00 → 01/06
ROOMSTER 1.4 TDI	BMS, AJM	07/06 → 03/10
VW		
BORA 1.9 TDI	AJM, AJM	05/00 → 05/05
BORA 1.9 TDI 4motion	AJM, AXB	05/00 → 05/05
CAMPMOBILE 1.9 TDi	AXB, AJM	03/04 → 11/09
FOX 1.4 TDI	BNM	04/05 → 12/09
GOLF IV 1.9 TDI	AJM, AJM	02/00 → 06/06
GOLF IV 1.9 TDI 4motion	AJM, ANY	02/00 → 06/06
GOLF IV 1.9 TDI GTi	ARL	06/01 → 06/06
GOLF 1.9 TDi	AUY	01/00 → 04/01
LUPO 1.2 TDI 3L	ANY, AXB	07/99 → 07/05
LUPO 1.4 TDI	AMF	01/99 → 07/05
MULTIVAN 1.9 TDI	AXB, ATD	04/03 → 11/09
NEW BEETLE 1.9 TDI	ATD, AMF	02/01 → 09/10
POLO III 1.4 TDI	AMF	10/99 → 09/01
POLO IV 1.4 TDI	AMF, 1Z	10/01 →
SHARAN I 1.9 TDI	1Z, AUY	04/00 → 03/10
SHARAN I 1.9 TDI 4motion	AUY, AXB	04/00 → 03/10
TRANSPORTER V 1.9 TDI	AXB, AGG	04/03 → 11/09

9.0437



04,5

REVOLUTION AND TIMING (CKP AND CMP) SENSORS

Adatt./Suitable:

BOSCH
0 261 210 094

VW
021 907 319 C



L	L1	ohm	
660	24	550	

VW		
GOLF IV 2.0	AGG, OM611.962	06/98 → 06/02

9.0438



3

REVOLUTION AND TIMING (CKP AND CMP) SENSORS

Adatt./Suitable:

BOSCH

0 232 103 012
0 232 103 013
0 232 103 022
0 232 103 023
0 232 103 037
0 232 103 038

CHRYSLER
5101122AA

MERCEDES-BENZ
0031538328
0041530728
0041536928
A 003 153 83 28
A 004 153 07 28
A 004 153 69 28

PORSCHE
996 606 106 01
996 606 106 02

VW
0B8 927 321

MARKET DIFFUSION: HIGH



L	L1		
---	24	Hall Effect	

CHRYSLER		
CROSSFIRE 3.2	EGX	07/03 → 12/08
MERCEDES-BENZ		
CLASSE C I C 280	M112.920	06/97 → 05/00
CLASSE C I C 280 T	M112.920	06/97 → 03/01
CLASSE C I C 43 AMG	M113.944	08/97 → 03/01
CLASSE C II C 160 Kompressor	M271.921	05/02 → 05/08
CLASSE C II C 180	M111.951	10/00 → 05/02
CLASSE C II C 180 Kompressor	M271.946	05/02 → 05/08
CLASSE C II C 200 CDI	OM611.962, M111.955	09/00 →

MERCEDES-BENZ		
CLASSE C II C 200 CGI Kompressor	M271.942	03/03 ⇒ 05/08
CLASSE C II C 200 Kompressor	M111.955, OM611.962	05/00 ⇒ 05/08
CLASSE C II C 220 CDI	OM611.962, M111.981	05/00 ⇒ 05/08
CLASSE C II C 230	M272.920	01/05 ⇒ 05/08
CLASSE C II C 230 Kompressor	M111.981, M271.820	03/01 ⇒ 05/08
CLASSE C II C 240	M112.912	05/00 ⇒ 08/07
CLASSE C II C 270 CDI	OM612.962	12/00 ⇒ 08/07
CLASSE C II C 280	M272.940	01/05 ⇒ 08/07
CLASSE C II C 320	M112.946	05/00 ⇒ 05/08
CLASSE C II C 320 CDI	OM642.910	01/05 ⇒ 08/07
CLASSE C II C 350	M272.960	01/05 ⇒ 05/08
CLASSE C III C 180	M271.820	06/11 ⇒
CLASSE C III C 180 CDI	OM651.913	01/11 ⇒ 08/14
CLASSE C III C 180 CGI	M271.820, M271.910	01/07 ⇒ 08/14
CLASSE C III C 180 Kompressor	M271.910, OM646.811	01/07 ⇒ 08/14
CLASSE C III C 200	M271.820	05/11 ⇒ 01/14
CLASSE C III C 200 CDI	OM646.811, M271.820	01/07 ⇒ 08/14
CLASSE C III C 200 CGI	M271.820, OM646.811	01/07 ⇒ 08/14
CLASSE C III C 200 Kompressor	M271.950	01/07 ⇒ 08/14
CLASSE C III C 220 CDI	OM646.811, M271.911	01/07 ⇒
CLASSE C III C 230	M272.921	01/07 ⇒ 08/14
CLASSE C III C 250	M272.921	01/07 ⇒
CLASSE C III C 280	M272.947	01/07 ⇒ 01/14
CLASSE C III C 300	M272.947	07/09 ⇒ 01/14
CLASSE CLC CLC 160	M271.911, M271.940	02/09 ⇒ 06/11
CLASSE CLC CLC 180 Kompressor	M271.940, OM646.962	05/08 ⇒ 06/11
CLASSE CLC CLC 200 CDI	OM646.962, M271.940	05/08 ⇒ 06/11
CLASSE CLC CLC 200 Kompressor	M271.957	05/08 ⇒ 06/11
CLASSE CLC CLC 220 CDI	OM646.963	05/08 ⇒ 06/11
CLASSE CLC CLC 230	M272.920	05/08 ⇒ 06/11
CLASSE CLC CLC 350	M272.960	05/08 ⇒ 06/11
CLASSE CLK I 200 Kompressor	M111.956	06/00 ⇒ 06/02
CLASSE CLK I 230 Kompressor	M111.982	06/00 ⇒ 06/02
CLASSE CLK II 200 CGI	M271.942	07/03 ⇒ 05/09
CLASSE CLK II 200 Kompressor	M271.940, OM612.962	09/02 ⇒ 05/09
CLASSE CLK II 220 CDI	OM646.966	01/05 ⇒ 05/09
CLASSE CLK II 240	M112.912	06/02 ⇒ 05/09
CLASSE CLK II 270 CDI	OM612.962, M271.940	10/02 ⇒ 05/09
CLASSE CLK II 280	M272.940	01/05 ⇒ 05/09
CLASSE CLK II 320 CDI	OM642.910	01/05 ⇒ 05/09
CLASSE CLK II 350	M272.960	01/05 ⇒ 05/09
CLASSE CLK II CLK 200 CGI	M271.942	07/03 ⇒ 03/10
CLASSE CLK II CLK 200 Kompressor	M271.940, OM611.961	02/03 ⇒ 03/10
CLASSE CLK II CLK 240	M112.912	02/03 ⇒ 03/10
CLASSE CLK II CLK 280	M272.940	01/05 ⇒ 03/10
CLASSE CLK II CLK 320 CDI	OM642.910	03/05 ⇒ 03/10
CLASSE CLK II CLK 350	M272.960	01/05 ⇒ 03/10
CLASSE E II E 200	M111.942	06/95 ⇒ 08/00
CLASSE E II E 200 CDI	OM611.961, M111.947	06/98 ⇒ 03/02
CLASSE E II E 200 Kompressor	M111.947, M111.947	08/00 ⇒ 03/02
CLASSE E II E 200 T	M111.942	06/96 ⇒ 08/00
CLASSE E II E 200 T Kompressor	M111.947, OM611.961	08/00 ⇒ 03/03
CLASSE E II E 220 CDI	OM611.961, OM611.961	06/98 ⇒ 07/99
CLASSE E II E 220 T CDI	OM611.961, M112.911	06/98 ⇒ 07/99
CLASSE E II E 240	M112.911, M112.911	08/00 ⇒ 03/02
CLASSE E II E 240 T	M112.911, OM612.961	08/00 ⇒ 03/03
CLASSE E II E 270 CDI	OM612.961	07/99 ⇒ 03/02
CLASSE E II E 270 T CDI	OM612.961, M119.980	02/00 ⇒ 03/03
CLASSE E II E 280	M112.921	12/96 ⇒ 03/02
CLASSE E II E 280 4-matic	M112.921	12/96 ⇒ 03/02
CLASSE E II E 280 T	M112.921	12/96 ⇒ 03/03
CLASSE E II E 280 T 4-matic	M112.921	12/96 ⇒ 03/03
CLASSE E II E 420	M119.980	01/96 ⇒ 06/97
CLASSE E II E 50 AMG	M119.980, OM646.820	02/96 ⇒ 08/97
CLASSE E III E 200 CDI	OM646.820, M271.941	07/02 ⇒ 07/09
CLASSE E III E 200 Kompressor	M271.941, OM646.821	11/02 ⇒ 07/09
CLASSE E III E 200 NGT	M271.941	03/04 ⇒ 12/08
CLASSE E III E 200 T Kompressor	M271.941	03/03 ⇒ 07/09
CLASSE E III E 220 CDI	OM646.821, OM646.821	03/02 ⇒ 07/09
CLASSE E III E 220 T CDI	OM646.821, M271.820	03/03 ⇒ 07/09
CLASSE E III E 230	M272.922	09/07 ⇒ 12/08
CLASSE E III E 230 T	M272.922	05/07 ⇒ 07/09
CLASSE E III E 240	M112.913	03/02 ⇒ 12/08
CLASSE E III E 240 T	M112.913	03/03 ⇒ 07/09
CLASSE E III E 250	M272.922	09/07 ⇒ 12/08
CLASSE E III E 270 CDI	OM647.961	03/02 ⇒ 12/08
CLASSE E III E 270 T CDI	OM647.961	03/03 ⇒ 07/09
CLASSE E III E 280	M272.943	03/05 ⇒ 12/08
CLASSE E III E 280 CDI	OM642.920	03/05 ⇒ 12/08

MERCEDES-BENZ		
CLASSE E III E 280 T	M272.943	03/05 ⇒ 07/09
CLASSE E III E 280 T CDI	OM642.920	03/05 ⇒ 07/09
CLASSE E III E 300	M272.943	03/05 ⇒ 12/08
CLASSE E III E 350	M272.964	03/05 ⇒ 12/08
CLASSE E III E 350 T	M272.964	03/05 ⇒ 07/09
CLASSE E IV E 200 CDI / BlueTEC	OM651.925	01/09 ⇒
CLASSE E IV E 200 CGI	M271.820, M112.945	08/09 ⇒
CLASSE E IV E 220 BlueTEC	OM651.924	05/14 ⇒
CLASSE E IV E 220 CDI	OM651.911	01/09 ⇒
CLASSE E IV E 220 CDI / BlueTEC	OM651.924	01/09 ⇒
CLASSE E IV E 220 CDI / BlueTEC / d	OM651.911	01/10 ⇒
CLASSE E IV E 220 CDI / d	OM651.911	01/10 ⇒
CLASSE E IV E 250	M272.923	01/10 ⇒
CLASSE E IV E 250 CDI / BlueTEC	OM651.924	01/09 ⇒
CLASSE E IV E 250 CGI	M271.860	01/09 ⇒
CLASSE E IV E 300	M272.952	01/09 ⇒
CLASSE G II G 320	M112.945, M113.962	06/97 ⇒
CLASSE G II G 500	M113.962	04/98 ⇒
CLASSE G II G 55 AMG	M113.962, OM651.913	04/98 ⇒
CLASSE GLK 200 CDI	OM651.913, M113.961	07/10 ⇒ 06/15
CLASSE GLK 220 CDI	OM651.916	12/08 ⇒ 06/15
CLASSE M I ML 270 CDI	OM612.963	12/99 ⇒ 06/05
CLASSE S III 400 SE, SEL/S420	M119.981	01/93 ⇒ 09/98
CLASSE S III 600 SE, SEL	M120.982	04/91 ⇒ 12/92
CLASSE S III S 500	M119.980	01/93 ⇒ 10/98
CLASSE S III S 600	M120.982	01/93 ⇒ 09/99
CLASSE S III SEC/CL 420	M119.981	10/94 ⇒ 02/99
CLASSE S III SEC/CL 600	M120.982	09/92 ⇒ 02/99
CLASSE SL IV 280	M112.923	05/98 ⇒ 10/01
CLASSE SL IV 320	M112.943	05/98 ⇒ 10/01
CLASSE SL IV 500	M113.961, M271.944	09/92 ⇒ 10/01
CLASSE SL IV 600	M120.983	07/92 ⇒ 10/01
CLASSE SL IV 600 SL	M120.983	02/92 ⇒ 08/94
CLASSE SL V 350	M112.973	03/03 ⇒ 01/12
CLASSE SLK I 200 Kompressor	M111.958	03/00 ⇒ 04/04
CLASSE SLK I 230 Kompressor	M111.983	03/00 ⇒ 04/04
CLASSE SLK I 320	M112.947	03/00 ⇒ 04/04
CLASSE SLK II 200 Kompressor	M271.944, M272.963	03/04 ⇒ 02/11
CLASSE SLK II 280	M272.942	01/05 ⇒ 02/11
CLASSE SLK II 300	M272.942	04/09 ⇒ 02/11
CLASSE SLK II 350	M272.963, OM646.981	06/04 ⇒ 02/11
SPRINTER I 208 CDI	OM611.987	04/00 ⇒ 05/06
SPRINTER I 211 CDI	OM611.981	04/00 ⇒ 05/06
SPRINTER I 213 CDI	OM611.981	04/00 ⇒ 05/06
SPRINTER I 214	M111.984	02/95 ⇒ 05/06
SPRINTER I 214 NGT	M111.984	02/95 ⇒ 05/06
SPRINTER I 216 CDI	OM612.981	04/00 ⇒ 05/06
SPRINTER I 308 CDI	OM611.987	04/00 ⇒ 05/06
SPRINTER I 311 CDI	OM611.981	04/00 ⇒ 05/06
SPRINTER I 311 CDI 4x4	OM611.981	08/02 ⇒ 05/06
SPRINTER I 313 CDI	OM611.981	04/00 ⇒ 05/06
SPRINTER I 313 CDI 4x4	OM611.981	08/02 ⇒ 05/06
SPRINTER I 314	M111.984	02/95 ⇒ 05/06
SPRINTER I 314 4x4	M111.984	08/02 ⇒ 05/06
SPRINTER I 314 NGT	M111.984	02/95 ⇒ 05/06
SPRINTER I 316 CDI	OM612.981	04/00 ⇒ 05/06
SPRINTER I 316 CDI 4x4	OM612.981	08/02 ⇒ 05/06
SPRINTER I 408 CDI	OM611.987	04/00 ⇒ 05/06
SPRINTER I 411 CDI	OM611.981	04/00 ⇒ 05/06
SPRINTER I 411 CDI 4x4	OM611.981	04/00 ⇒ 05/06
SPRINTER I 413 CDI	OM611.981	04/00 ⇒ 05/06
SPRINTER I 413 CDI 4x4	OM611.981	04/00 ⇒ 05/06
SPRINTER I 416 CDI	OM612.981	04/00 ⇒ 05/06
SPRINTER I 416 CDI 4x4	OM612.981	04/00 ⇒ 05/06
VIANO 3.0	M112.951	09/03 ⇒
VIANO 3.2	M112.951	09/03 ⇒
VIANO 3.5	M272.978	09/07 ⇒
VIANO 3.7	M112.976	06/04 ⇒
VIANO CDI 2.0	OM646.981, OM646.982	09/03 ⇒
VIANO CDI 2.0 4-matic	OM646.982, OM646.982	07/05 ⇒
VIANO CDI 2.2	OM646.982, OM646.982	09/03 ⇒
VIANO CDI 2.2 4-matic	OM646.982, OM642.890	07/05 ⇒
VIANO CDI 3.0	OM642.890, OM646.980	03/06 ⇒
VITO II 109 CDI	OM646.980, OM646.980	09/03 ⇒
VITO II 109 CDI 4x4	OM646.981	09/07 ⇒
VITO II 110 CDI	OM651.940	09/10 ⇒
VITO II 111 CDI	OM646.980, M96.01	09/03 ⇒
VITO II 111 CDI 4x4	OM646.982	09/07 ⇒
VITO II 113 CDI	OM651.940	09/10 ⇒
VITO II 113 CDI 4x4	OM651.940	09/10 ⇒
VITO II 115 CDI	OM646.982	09/03 ⇒
VITO II 115 CDI 4x4	OM646.982	07/06 ⇒
VITO II 116 CDI	OM651.940	09/10 ⇒

MERCEDES-BENZ		
VITO II 116 CDI 4x4	OM651.940	09/10 ⇒
VITO II 119	M112.951	09/03 ⇒
VITO II 120 CDI	OM642.990	07/06 ⇒
VITO II 122	M112.951	09/03 ⇒
VITO II 122 CDI	OM642.890	09/10 ⇒
VITO II 123	M112.976	06/04 ⇒
VITO II 126	M272.978	09/07 ⇒

PORSCHE

911 IV 3.4 Carrera	M96.01, M96.01	09/97 ⇒ 09/01
911 IV 3.4 Carrera 4	M96.01, M96.22	09/97 ⇒ 09/01
911 IV 3.6	M96.03	12/01 ⇒ 08/05
911 IV 3.6 Carrera	M96.03	10/01 ⇒ 08/05
911 IV 3.6 Carrera 4	M96.03	10/01 ⇒ 08/05
911 IV 3.6 Carrera 4S	M96.03	06/02 ⇒ 08/05
911 IV 3.6 Carrera S	M96.03	06/02 ⇒ 08/05
911 IV 3.6 GT3	M96.76	03/99 ⇒ 08/05
BOXSTER I 2.5	M96.20	09/96 ⇒ 08/99
BOXSTER I 2.7	M96.22, CKTB	07/02 ⇒ 12/04
BOXSTER I S 3,2	M96.24	07/02 ⇒ 12/04
BOXSTER I S 3.2	M96.21	08/99 ⇒ 07/02
CAYENNE I S 4.5	M48.00	09/02 ⇒ 09/07
CAYENNE I Turbo 4.5	M48.50	09/02 ⇒ 09/07
CAYENNE I Turbo S 4.5	M48.50S	01/04 ⇒ 09/07

PUCH

G-MODELL G 500	M113.962	12/97 ⇒ 11/00
G-MODELL G 55 AMG	M113.982	04/99 ⇒ 03/01

VW

CRAFTER 2.0 TDI	CKTB, CKUB	05/11 ⇒
CRAFTER 2.0 TDI 4motion	CKUB, BJJ	11/11 ⇒ 12/16
CRAFTER 2.5 TDI	BJJ, 192A5.000	04/06 ⇒

9.0439

3

REVOLUTION AND TIMING (CKP AND CMP) SENSORS

Adatt./Suitable:

00 Eliminated on 23-06-2016. Please verify the availability through our local distributors

- Eliminato il 23-06-2016. Verificare la disponibilità presso i nostri distributori
- Éliminé le 23-06-2016. Vérifier la disponibilité auprès de nos distributeurs sur place
- Am 23-06-2016 gestrichen. Evtl. Verfügbarkeit bitte bei unseren Händlern prüfen
- Eliminado en fecha 23-06-2016. Verificar la disponibilidad a través de nuestros distribuidores locales

R8 Replaced by

- Sostituito da
- Remplacé par
- Ersetzt durch
- Reemplazado por

9.0235



L	L1	ohm	
---	34,5	970	

9.0440



3

REVOLUTION AND TIMING (CKP AND CMP) SENSORS

Adatt./Suitable:

ALFA ROMEO46798345
K68093401AA**BOSCH**

0 986 280 446

CHEVROLET

12855170

CHRYSLER

46798345

FIAT46798345
K68093401AA**GENERAL MOTORS**12 855 170
93 179 391**JEEP**46798345
68093401AA
K68093401AA**LANCIA**

46798345

OPEL12 35 129
12855170
62 35 666
93179391**SAAB**

93 179 391

SUZUKI33220-55L00
33220-55L00-000**VAUXHALL**12855170
93179391

MARKET DIFFUSION: MEDIUM



L	L1	ohm	OUT_GND
---	36,5	900	

ALFA ROMEO

147 1.9 JTD 16V	192A5.000, 937A5.000	11/02 → 03/10
147 1.9 JTDM 16V	937A5.000, 192B1.000	09/04 → 03/10
156 1.9 JTD	192B1.000, 841G.000	11/02 →
156 1.9 JTD 16V	192A5.000	11/02 → 05/06
156 1.9 JTD 16V Q4	937A5.000	07/04 → 05/06
156 2.4 JTD	841G.000, 937A8.000	06/03 → 05/06
159 1.9 JTDM 16V	937A8.000, 844A2.000	09/05 → 11/11
159 2.0 JTDM	844A2.000, 939A3.000	05/09 → 11/11
159 2.4 JTDM	939A3.000, 841G.000	09/05 → 12/12
159 2.4 JTDM Q4	939A9.000	05/07 → 11/11
159 MY2011 2.0 JTD	--	01/10 →
159 MY2011 2.4 JTD	--	01/10 →
166 2.4 JTD	841G.000, 939A3.000	10/03 → 06/07
BRERA 2.4 JTDM 20V	939A3.000, 940A3.000	01/06 → 06/10
GIULIETTA II 1.6 JTDM	940A3.000, 940A4.000	04/10 →
GIULIETTA II 2.0 JTDM	940A4.000, 937A5.000	04/10 →
GT 1.9 JTD	937A5.000, 198A2.000	11/03 → 09/10
MITO 1.6 JTDM	198A2.000, 844A2.000	08/08 →
SPIDER III 2.0 JTDM	844A2.000, 939A3.000	04/09 → 06/10
SPIDER III 2.4 JTDM	939A3.000, 199B.5000	04/07 → 06/10

CADILLAC

BLS 1.9 D Z19DTH 04/06 →

CHEVROLET

MALIBU 2.0 D LBS 04/12 →

CHRYSLER

DELTA 1.6 D Multijet 844A3000 08/11 →

DELTA 2.0 D Multijet 198A5.000 08/11 →

FIAT

500L 1.6 D Multijet 199B.5000, 55263087 09/12 →

500X 1.6 D Multijet 55260384 09/14 →

500X 2.0 4x4 -- 09/15 →

FIAT

500X 2.0 D Multijet 4x4	55263087, --	09/14 →
BRAVO II 1.6 D Multijet	--, --	09/07 →
BRAVO II 1.6 JTD	198A3.000	03/08 → 12/14
BRAVO II 1.9 D Multijet	937A5.000	04/07 → 12/14
BRAVO II 2.0 D Multijet	--, 939A2.000	09/08 →
CROMA II 1.9 D Multijet	939A2.000, 198A3.000	06/05 →
CROMA II 2.4 D Multijet	939A3.000	06/05 →
DOBLO II 1.6 D Multijet	198A3.000, 250A1.000	02/10 →
DOBLO II 2.0 D Multijet	263A1.000	01/10 →
DUCATO III 115 Multijet 2,0 D	250A1.000, 939B5.000	06/11 →
DUCATO III 2.0	--	01/14 →
FREEMONT 2.0 JTD	939B5.000, 939B5.000	08/11 →
FREEMONT 2.0 JTD 4x4	939B5.000, 192A5.000	08/11 →
IDEA 1.6 D Multijet	350A2.000	05/08 →
LINEA 1.6 D Multijet	198A3.000	06/09 →
PUNTO III / GRANDE PUNTO 1.6 D Multijet	955A3.000	07/08 →
PUNTO III EVO 1.6 D Multijet	955A3.000	10/09 → 02/12
SEDICI 2.0 D Multijet	D20AA	06/06 → 10/14
SEDICI 2.0 D Multijet 4x4	D20AA	06/06 → 10/14
SEDICI MY12 2.0 D	--	01/12 →
STILO 1.9 D Multijet	937A5.000	09/05 → 08/08
STILO 1.9 JTD	192A5.000, EBS	09/03 → 08/08
TIPO II 1.6 D	55260384	03/16 →

JEEP

CHEROKEE V 2.0 CRD	EBS, EBS	04/14 →
CHEROKEE V 2.0 CRD [ExtraEU]	EBS, EBS	04/14 →
CHEROKEE V 2.0 CRD 4x4	EBS, EBS(55263087)	04/14 →
CHEROKEE V 2.2 CRD 4x4	LAU61	08/15 →
COMPASS 1.6 CRD	EJJ(55260384)	03/17 →
COMPASS 2.0 CRD 4x4	EBS(55263087), EJJ(55263084)	12/16 →
RENEGADE 1.6 CRD	EJJ(55260384), 55263088	07/14 →
RENEGADE 2.0 CRD 4x4	55263088, 198A2.000	07/14 →

LANCIA

DELTA III 1.6 D Multijet	198A2.000, 198A5.000	08/08 → 08/14
DELTA III 1.9 D Multijet	844A1.000	01/09 → 08/14
DELTA III 2.0 D Multijet	198A5.000, --	09/08 → 08/14
MUSA 1.6 D Multijet	--, 841G.000	07/08 → 12/12
THESIS 2.4 D Multijet	841P.000	04/06 → 07/09
THESIS 2.4 JTD	841G.000, A20DTH	05/03 →

OPEL

ASTRA H 1.9 CDTi	Z19DTH	09/04 → 10/10
ASTRA H 1.9 CDTi 16V	Z19DTJ	04/04 → 10/10
ASTRA J 2.0 CDTi	A20DTH, A16FDH	09/09 →
CASCADA 2.0 CDTi	A20DTH	04/13 →
COMBO D 1.6 CDTi	A16FDH, A20DTR	02/12 →
COMBO D 2.0 CDTi	A20FD	02/12 →
INSIGNIA 2.0 Biturbo CDTi	A20DTR, A20DTR	07/08 → 03/17
INSIGNIA 2.0 Biturbo CDTi 4x4	A20DTR, A20DT	07/08 → 03/17
INSIGNIA 2.0 CDTi	A20DT, A20DTH	07/08 → 03/17
INSIGNIA 2.0 CDTi 4x4	A20DTH, A20DT	06/10 → 03/17
SIGNUM 1.9 CDTi	Z19DTH	04/04 → 02/08
VECTRA C 1.9 CDTi	Z19DTH	04/04 → 08/08
ZAFIRA B 1.9 CDTi	Z19DTH	07/05 → 04/15
ZAFIRA C 2.0 Biturbo CDTi	A20DTR	01/13 →
ZAFIRA C 2.0 CDTi	A20DT, A19DTR	10/11 →

SAAB

9-3 1.9 TiD	Z19DTH	09/04 → 02/15
9-3 1.9 TTiD	A19DTR, Z19DTH	12/07 → 02/15
9-5 1.9 TiD	Z19DTH, A20DTH	01/06 → 12/09
9-5 2.0 TiD	A20DTH	05/10 → 01/12
9-5 2.0 TTiD	A20DTR	05/10 → 01/12
9-5 2.0 TTiD XWD	A20DTR	05/10 → 01/12
9-3X 1.9 TTiD AWD	Z19DTR	02/09 → 12/12

SUZUKI

SX4 I 2.0 DDiS	D20AA	07/09 →
SX4 I 2.0 DDiS 4x4	D20AA	07/09 →
SX4 II 1.6 DDiS	D16AA	08/13 →
SX4 II 1.6 DDiS AllGrip	D16AA	08/13 →
SX4 2.0 DDiS	D20AA	09/13 → 12/15
VITARA IV 1.6 DDiS	D16AA	02/15 →
VITARA IV 1.6 DDiS AllGrip	D16AA	02/15 →

VAUXHALL

ASTRA V 1.9 CDTi	Z19DTH	01/04 → 11/10
ASTRA V 1.9 CDTi 16V	Z19DTJ	01/04 → 05/09
ASTRA VI 2.0 CDTi	A20DTH, A16FDH	12/09 →
ASTRAVAN III 1.9 CDTi	Z19DTH	03/05 → 11/11
CASCADA 2.0 CDTi	A20DTH	02/13 →
COMBO D 1.6 CDTi	A16FDH, A20DT	11/11 →
COMBO D 2.0 CDTi	A20FD	11/11 →
INSIGNIA 2.0 Biturbo CDTi	A20DTR	03/12 → 05/17
INSIGNIA 2.0 Biturbo CDTi 4x4	A20DTR	03/12 → 05/17
INSIGNIA 2.0 CDTi	A20DT, A20DTH	07/08 → 05/17
INSIGNIA 2.0 CDTi 4x4	A20DTH, A20DT	07/08 → 05/17
SIGNUM 1.9 CDTi 16V	Z19DTH	04/04 → 03/08

VAUXHALL

VECTRA C 1.9 CDTi 16V	Z19DTH	04/04 → 05/09
ZAFIRA B 1.9 CDTi	Z19DTH	07/05 → 11/14
ZAFIRA C 2.0 CDTi	A20DT, C16NZ	10/11 →

9.0441



1

REVOLUTION AND TIMING (CKP AND CMP) SENSORS

Adatt./Suitable:

GENERAL MOTORS

90 512 494

HOLDEN

90512494

KIA

0K9A1-21412

OPEL12 38 113
90512494**SUZUKI**26143-60G10
26143-60G10-000**VAUXHALL**

90512494



L	L1	ohm	OUT_GND
---	28	500	

HOLDEN

ASTRA 2.0 GSi	X20XEV	08/95 → 09/98
ASTRA_TR 1.6i Hatchback	C16SE	09/96 → 09/98
ASTRA_TR 1.6i Sedan	C16SE	09/96 → 09/98
BARINA 1.4i	C14NZ	04/94 → 07/97
COMBO 1.4i	C14NZ	03/96 → 07/97
COMBO_SB 1.4i	C14NZ	04/94 → 07/97

KIA

CARNIVAL I 2.5 V6	K5	08/99 → 06/06
CARNIVAL I 2.9 CRDi	J3	10/01 → 06/06
CARNIVAL I 2.9 TD	J3	01/99 → 09/07
CLARUS 1.8i 16V	T8	07/96 →
CLARUS 2.0i 16V	FE(16V)	07/96 →
CREDOS 2.0 [AUS]	--	06/95 → 10/00

OPEL

ASTRA F 1.4	14SE	09/92 → 09/98
ASTRA F 1.4 Si	C14SE	03/92 → 03/01
ASTRA F 1.6	16NZR	09/95 → 09/98
ASTRA F 1.6 i	C16NZ, X20XER	09/91 → 01/05
ASTRA F 1.6i 16V	X16XEL	08/94 → 01/05
ASTRA F 1.6 Si	C16SE	03/92 → 12/94
ASTRA F 1.8	Z18XEL	02/03 → 07/04
ASTRA F 1.8 i	X18XE1	03/98 → 08/00
ASTRA F 2.0 Di	X20DTL	03/98 → 08/00
ASTRA F 2.0 i 16V	X20XER, X12XE	02/95 → 08/00
ASTRA G 1.2 16V	X12XE, X14XE	09/00 → 01/05
ASTRA G 1.4	X14XE, X14XE	09/98 → 12/09
ASTRA G 1.4 16V	X14XE, X14XE	02/98 → 01/05
ASTRA G 1.4 LPG	X14XE, C16SEL	02/98 → 01/05
ASTRA G 1.6	C16SEL, X16XEL	09/00 → 12/09
ASTRA G 1.6 16V	X16XEL, X16XEL	02/98 → 10/05
ASTRA G 1.6 CNG	Z16VNG	03/03 → 07/04
ASTRA G 1.6 LPG	X16XEL, X18XE1	03/98 → 01/05
ASTRA G 1.7 CDTi	Z17DTL	04/03 → 12/09
ASTRA G 1.7 DTi 16V	Y17DT	02/00 → 01/05
ASTRA G 1.7 TD	X17DTL	02/98 → 04/05
ASTRA G 1.8	Z18XEL	02/03 → 07/04
ASTRA G 1.8 16V	X18XE1, Z20LET	03/00 → 10/05
ASTRA G 2.0 16V	X20XEV	02/98 → 01/05
ASTRA G 2.0 16V OPC	X20XER	11/99 → 09/02
ASTRA G 2.0 16V Turbo	Z20LET, X20DTL	09/00 → 10/05
ASTRA G 2.0 DI	X20DTL, X20DTH	02/98 → 04/05

OPEL			
ASTRA G 2.0 DTI 16V	X20DTH, Z20LET	08/99 → 01/05	
ASTRA G 2.0 OPC	Z20LET, Z14XEL	03/02 → 10/05	
ASTRA G 2.2 16V	Z22SE	06/00 → 10/05	
ASTRA G 2.2 DTI	Y22DTR	09/02 → 10/05	
ASTRA H 1.2	Z12XEP	08/05 → 10/10	
ASTRA H 1.3 CDTi	Z13DTH	04/05 → 10/10	
ASTRA H 1.4	Z14XEL, Z16XE	03/04 → 10/10	
ASTRA H 1.4 LPG	Z14XEP	08/09 → 10/10	
ASTRA H 1.6	Z16XE, A17DTJ	03/04 → 05/14	
ASTRA H 1.6 16V	Z16XE	03/04 → 01/08	
ASTRA H 1.6 EcoTec	Z16XEP	02/04 → 11/04	
ASTRA H 1.6 LPG	Z16XER	08/09 → 10/10	
ASTRA H 1.6 Turbo	Z16LET	02/07 → 10/10	
ASTRA H 1.7 CDTi	A17DTJ, A18XER	03/04 → 05/14	
ASTRA H 1.8	A18XER, Z19DT	01/04 → 05/14	
ASTRA H 1.9 CDTi	Z19DT, Z20LEH	06/04 → 10/10	
ASTRA H 1.9 CDTi 16V	Z19DTJ	04/04 → 10/10	
ASTRA H 2.0 Turbo	Z20LEH, C14NZ	03/04 → 10/10	
ASTRA H 2.2	Z22YH	03/04 →	
ASTRA J 1.8	Z18XER	02/07 →	
COMBO B 1.4	C14NZ, C14NZ	07/94 → 10/01	
COMBO B 1.4 16V	X14XE	08/99 → 10/01	
CORSA B 1.2 i 16V	X12XE	03/98 → 09/00	
CORSA B 1.4	C14SE	04/93 → 08/94	
CORSA B 1.4 i	C14NZ, C14SEL	03/93 → 09/00	
CORSA B 1.4 i 16V	C14SEL, C16SEL	09/94 → 12/02	
CORSA B 1.4 Si	C14SE	03/93 → 09/00	
CORSA B 1.6 GSI 16V	C16XE	03/93 → 09/00	
CORSA B 1.6 i 16V	C16SEL, A14XER	09/94 → 09/00	
CORSA C 1.4	Z14XE	09/00 → 12/09	
CORSA D 1.4	A14XER, X14XE	07/06 → 08/14	
CORSA D 1.4 LPG	Z14XEP	08/06 → 12/11	
TIGRA A 1.4 16V	X14XE, C16SEL	07/94 → 12/00	
TIGRA A 1.6 16V	C16SEL, X16XEL	07/94 → 08/98	
VECTRA B 1.6 i 16V	X16XEL, X18XE	10/95 → 07/02	
VECTRA B 1.8 i 16V	X18XE, X16XEL	09/00 → 07/03	
ZAFIRA A 1.6 16V	X16XEL, X18XE1	09/02 → 06/05	
ZAFIRA A 1.6 CNG	Z16YNG	09/01 → 06/05	
ZAFIRA A 1.8	Z18XEL	02/03 → 06/05	
ZAFIRA A 1.8 16V	X18XE1, Z20LET	09/00 → 06/05	
ZAFIRA A 2.0 DI	X20DTL	07/99 → 06/00	
ZAFIRA A 2.0 DI 16V	X20DTL	07/99 → 06/05	
ZAFIRA A 2.0 DTI 16V	Y20DTH	09/00 → 06/05	
ZAFIRA A 2.0 OPC	Z20LET, C16NZ	09/01 → 06/05	
ZAFIRA A 2.2 16V	Z22SE	09/00 → 06/05	
ZAFIRA A 2.2 DTI 16V	Y22DTR	01/02 → 06/05	
ZAFIRA B 2.2	Z22YH	07/05 → 12/12	

SUZUKI

LIANA 1.6	M16A	07/01 → 12/07	
LIANA 1.6 4WD	M16A	07/01 → 12/07	
LIANA 1.8 i	M18A	10/01 →	
SX4 I 2.0	J20A	06/06 →	
SX4 I 2.0 4x4	J20A	06/06 →	

VAUXHALL

ASTRA III 1.4 i	C14SE	03/91 → 03/01	
ASTRA III 1.6	C16SE	03/94 → 08/95	
ASTRA III 1.6 i	C16NZ, X12XE	09/91 → 12/98	
ASTRA III 1.6 i 16V	X16XEL	01/94 → 09/98	
ASTRA III 1.6 Si	C16SE	03/91 → 12/94	
ASTRA III 2.0 i 16V	X20XEV	01/94 → 09/98	
ASTRA IV 1.2 16V	X12XE, X14XE	09/00 → 05/05	
ASTRA IV 1.4 16V	X14XE, X16SZR	02/98 → 05/05	
ASTRA IV 1.6	X16SZR, X16XEL	09/00 → 05/05	
ASTRA IV 1.6 16V	X16XEL, X16SZR	02/98 → 10/05	
ASTRA IV 1.6 Dualfuel	X16SZR, X18XE1	02/98 → 05/05	
ASTRA IV 1.7 CDTi 16V	Z17DTL	04/03 → 05/05	
ASTRA IV 1.7 DTI 16V	Y17DT	02/00 → 05/05	
ASTRA IV 1.7 TD	X17DTL	02/98 → 08/00	
ASTRA IV 1.8 16V	X18XE1, X20XER	02/98 → 10/05	
ASTRA IV 1.8 16V Dualfuel	Z18XE	02/98 → 05/05	
ASTRA IV 2.0	X20XER, X20DTL	08/02 → 10/05	
ASTRA IV 2.0 16V	X20XEV	02/98 → 05/05	
ASTRA IV 2.0 16V Turbo	Z20LET	09/00 → 08/05	
ASTRA IV 2.0 DI	X20DTL, X20DTH	02/98 → 05/05	
ASTRA IV 2.0 DTI 16V	X20DTH, Z20LET	02/98 → 05/05	
ASTRA IV 2.0 SRI Turbo	Z20LET	11/01 → 05/05	
ASTRA IV 2.0 Turbo	Z20LET, Z14XEL	03/02 → 10/05	
ASTRA IV 2.2 16V	Z22SE	03/00 → 10/05	
ASTRA IV 2.2 DTI	Y22DTR	09/02 → 05/05	
ASTRA V 1.2	Z12XEP	08/05 → 10/10	
ASTRA V 1.3 CDTi	Z13DTH	01/04 → 11/10	
ASTRA V 1.4	Z14XEL, Z16LET	01/04 → 10/10	
ASTRA V 1.4 i 16V	Z14XEP	03/05 → 11/10	
ASTRA V 1.6	Z16LET, A17DTJ	01/04 → 11/10	
ASTRA V 1.6 i 16V	Z16XER	10/06 → 08/11	
ASTRA V 1.6 Turbo	Z16LET	09/06 → 09/09	
ASTRA V 1.7 CDTi	A17DTJ, A18XER	01/04 → 10/12	
ASTRA V 1.8	A18XER, Z19DT	01/04 → 11/10	

VAUXHALL

ASTRA V 1.8 i 16V	Z18XER	03/07 → 11/10	
ASTRA V 1.9 CDTi	Z19DT, Z20LEH	01/04 → 11/10	
ASTRA V 1.9 CDTi 16V	Z19DTJ	01/04 → 05/09	
ASTRA V 2.0	Z20LEL	02/06 → 11/10	
ASTRA V 2.0 Turbo	Z20LEH, C16NZ	01/04 → 11/10	
ASTRAVAN I 1.6 i	C16NZ, X16SZR	10/91 → 08/98	
ASTRAVAN II 1.6 Dualfuel	X16SZR, X16SZR	07/00 → 08/05	
ASTRAVAN II 1.6 i	X16SZR, Z16XE1	09/00 → 08/06	
ASTRAVAN III 1.7 CDTi	Z17DTL	04/04 → 08/06	
ASTRAVAN III 1.7 DTI 16V	Y17DT	04/01 → 08/06	
ASTRAVAN III 1.7 TD	X17DTL	08/98 → 08/06	
ASTRAVAN III 2.0 DI	X20DTL	08/98 → 08/06	
ASTRAVAN III 1.3 CDTi	Z13DTH	08/05 →	
ASTRAVAN III 1.4 i	Z14XEP	03/05 →	
ASTRAVAN III 1.6	Z16XE1, Z17DTH	03/05 →	
ASTRAVAN III 1.7 CDTi	Z17DTH, Z19DT	03/05 → 11/11	
ASTRAVAN III 1.9 CDTi	Z19DT, C14NZ	03/05 → 11/11	
COMBO B 1.4	C14NZ, C14NZ	07/94 → 10/01	
COMBO B 1.4 16V	X14XE	08/99 → 10/01	
CORSA B 1.2 i 16V	X12XE	03/98 → 09/00	
CORSA B 1.4 i	C14NZ, A14XER	03/93 → 09/00	
CORSA B 1.4 i 16V	X14XE	09/94 → 09/00	
CORSA B 1.4 i S	C14SE	03/93 → 09/00	
CORSA B 1.6 GSI 16V	C16XE	03/93 → 09/00	
CORSA B 1.6 i 16V	X16XE	09/94 → 09/00	
CORSA D 1.4	A14XER, X16XEL	08/06 → 08/14	
CORSA D 1.4 LPG	Z14XEP	07/06 → 08/14	
CORSAVAN I 1.4 i	C14NZ	01/94 → 09/00	
TIGRA A 1.4 16V	X14XE	07/94 → 12/00	
TIGRA A 1.6 16V	X16XE	07/94 → 12/00	
VECTRA B 1.6 i 16V	X16XEL, X18XE	08/95 → 10/01	
VECTRA B 1.8 Dualfuel	Z18XE	09/00 → 07/03	
VECTRA B 1.8 i 16V	X18XE, X16XEL	09/00 → 07/03	
ZAFIRA A 1.6 16V	X16XEL, X18XE1	04/99 → 08/05	
ZAFIRA A 1.6 CNG	Z16YNG	09/01 → 06/05	
ZAFIRA A 1.8 16V	X18XE1, AUA	09/00 → 08/05	
ZAFIRA A 1.8 Dualfuel	Z18XE	09/00 → 08/05	
ZAFIRA A 2.0	Z20LET	06/02 → 06/05	
ZAFIRA A 2.0 DI 16V	X20DTL	10/99 → 08/05	
ZAFIRA A 2.0 DTI 16V	Y20DTH	04/99 → 08/05	
ZAFIRA A 2.0 GSI Turbo	Z20LET	09/01 → 06/05	
ZAFIRA A 2.2 16V	Z22SE	11/98 → 08/04	
ZAFIRA A 2.2 D	Y22DTR	06/01 → 06/05	
ZAFIRA B 2.2	Z22YH	07/05 → 11/14	

9.0443

04,5

REVOLUTION AND TIMING (CKP AND CMP) SENSORS

Adatt./Suitable:

AUDI

030 906 433 G
030 957 147 AA
030 957 147 AB
030 957 147 J
030 957 147 N
036 906 433 C

SEAT

030 957 147 AA
030 957 147 AB
030 957 147 E
030 957 147 J
030 957 147 M
030 957 147 N
036 906 433 C

SKODA

030 957 147 AA
030 957 147 AB
030 957 147 M
030 957 147 N
036 906 433 C

VW

030 906 433 G
030 957 147 A
030 957 147 AA
030 957 147 AB
030 957 147 E
030 957 147 J
030 957 147 M
030 957 147 N
036 906 433 C

MARKET DIFFUSION: MEDIUM

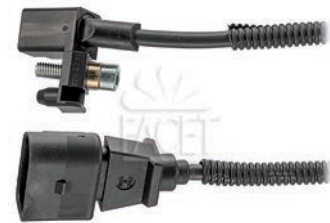

L	L1		
520	---	Hall Effect	

AUDI

A2 1.4	AUA, BBY	02/00 → 08/05
A2 1.6 FSI	BAD	05/02 → 08/05

SEAT

CORDOBA II 1.4 16V	BBY, AUB	09/02 → 11/09
IBIZA III 1.4 16V	AUB, AHW	02/02 → 11/09
LEON I 1.4 16V	AHW, AUS	11/99 → 06/06
LEON I 1.6 16V	AUS, AHW	09/00 → 06/06
TOLEDO II 1.4 16V	AHW, AUS	01/00 → 05/02
TOLEDO II 1.6 16V	AUS, AUA	06/00 → 05/06

SKODA

FABIA I 1.4 16V	AUA, AXP	10/99 → 03/08
OCTAVIA I 1.4 16V	AXP, AHW	08/00 → 12/10

VW

BORA 1.4 16V	AHW, ATN	03/00 → 05/05
BORA 1.6 16V	ATN, AXP	02/00 → 05/05
BORA 1.6 FSI	BAD	01/02 → 05/05
GOLF IV 1.4	AXP, AHW	05/00 → 06/06
GOLF IV 1.4 16V	AHW, AUS	08/97 → 06/06
GOLF IV 1.6	AUS, ATN	05/00 → 06/06
GOLF IV 1.6 16V	ATN, BBY	02/00 → 06/06
GOLF IV 1.6 FSI	BAD	01/02 → 06/06
NEW BEETLE 1.4	BCA	11/01 → 09/10
POLO IV 1.4	BBY, AUA	11/02 →
POLO IV 1.4 16V	AUA, AUA	10/01 → 05/08

**REVOLUTION AND TIMING (CKP AND CMP)
SENSORS**

Adatt./Suitable:

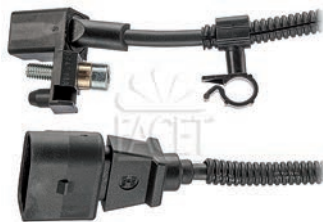
AUDI030 906 433 B
030 957 147 B**SEAT**030 906 433 B
030 957 147 B
030 957 147 H
030 957 147 T**SKODA**030 906 433 B
030 957 147 B
030 957 147 H
030 957 147 T**VW**030 906 433 B
030 957 147 B
030 957 147 H
030 957 147 T

L	L1		
520	---	Hall Effect	

AUDI

A2 1.4 AUA, AER 02/00 ⇒ 08/05

SEAT

AROSA 1.0	AER, AEX	05/97 ⇒ 06/04
AROSA 1.4	AEX, AFK	05/97 ⇒ 06/04
AROSA 1.4 16V	AFK, APE	01/00 ⇒ 06/04
CORDOBA I 1.4 16V	APE, BBY	06/99 ⇒ 12/02
CORDOBA II 1.4 16V	BBY, ALD	09/02 ⇒ 12/07
IBIZA II 1.0	ALD, AKK	08/99 ⇒ 02/02
IBIZA II 1.4	AKK, APE	08/99 ⇒ 02/02
IBIZA II 1.4 16V	APE, BBY	08/99 ⇒ 02/02
IBIZA III 1.4 16V	BBY, AUA	02/02 ⇒ 12/07
INCA 1.4 16V	AUA	04/00 ⇒ 06/03

SKODAFABIA I 1.4 BKY 05/04 ⇒ 12/07
FABIA I 1.4 16V AUA, AER 10/99 ⇒ 03/08**VOLKSWAGEN (BR)**

GOL 1.0i 16v Turbo	512	06/00 ⇒
PARATI 1.0i 16v Turbo	512	06/00 ⇒
POLO 1.4	BKY	07/06 ⇒
POLO 1.4 16V	BBY	09/02 ⇒

VW

CADDY II 1.4	AUA	08/00 ⇒ 01/04
CADDY II 1.4 16V	AUA	08/00 ⇒ 01/04
LUPO 1.0	AER, AFK	09/98 ⇒ 07/05
LUPO 1.4 16V	AFK, AER	09/98 ⇒ 07/05
POLO 1.0 [ExtraEU]	AER, AER	07/95 ⇒ 09/01
POLO III 1.0	AER, AEX	10/99 ⇒ 09/01
POLO III 1.4	AEX, AFH	05/97 ⇒ 09/01
POLO III 1.4 16V	AFH, AFH	10/99 ⇒ 09/01
POLO III 100 1.4 16V	AFH, AER	04/96 ⇒ 10/99
POLO III 120 1.6 16V GTI	AJV	09/98 ⇒ 10/99
POLO III 50 1.0	AER, AEX	09/96 ⇒ 10/99
POLO III 55 1.4	AEX, AEX	08/95 ⇒ 10/99
POLO III 60 1.4	AEX, APE	07/95 ⇒ 09/01
POLO III 75 1.4 16V	APE, BBY	10/99 ⇒ 09/01
POLO IV 1.4	BBY, AUA	11/02 ⇒ 04/12
POLO IV 1.4 16V	AUA, AER	10/01 ⇒ 05/08

**REVOLUTION AND TIMING (CKP AND CMP)
SENSORS**

Adatt./Suitable:

BOSCH0 261 210 188
0 261 210 189
0 261 210 194
0 261 210 195
0 261 210 213
0 261 210 214
0 261 210 215**SEAT**030 906 433 H
030 957 147 D
030 957 147 F
030 957 147 G
030 957 147 L**SKODA**030 906 433 H
030 957 147 K
030 957 147 L**VW**030 906 433 H
030 957 147 D
030 957 147 F
030 957 147 G
030 957 147 K
030 957 147 L

L	L1		
510	---	Hall Effect	

SEAT

AROSA 1.0	AER, AEX	05/97 ⇒ 06/04
AROSA 1.4	AEX, ALD	05/97 ⇒ 06/04
IBIZA II 1.0	ALD, AKK	08/99 ⇒ 02/02
IBIZA II 1.4	AKK, AEX	08/99 ⇒ 02/02
INCA 1.4 16V	AUA	04/00 ⇒ 06/03
INCA 1.4 i	AEX, AHW	11/95 ⇒ 06/03
LEON I 1.4 16V	AHW, AUS	11/99 ⇒ 06/06
LEON I 1.6 16V	AUS, AHW	09/00 ⇒ 06/06
TOLEDO II 1.4 16V	AHW, AUS	01/00 ⇒ 05/02
TOLEDO II 1.6 16V	AUS, AUA	06/00 ⇒ 05/06

SKODAFABIA I 1.4 16V AUA, AXP 10/99 ⇒ 03/08
OCTAVIA I 1.4 16V AXP, AHW 08/00 ⇒ 12/10**VOLKSWAGEN (BR)**

POLO 1.6 BAH 02/02 ⇒

VW

BORA 1.4 16V	AHW, ATN	03/00 ⇒ 05/05
BORA 1.6 16V	ATN, AEX	02/00 ⇒ 05/05
CADDY II 1.4	AEX, AEX	11/95 ⇒ 01/04
CADDY II 60 1.4	AEX, AXP	11/95 ⇒ 01/04
GOLF IV 1.4	AXP, AHW	05/00 ⇒ 06/06
GOLF IV 1.4 16V	AHW, AUS	08/97 ⇒ 06/06
GOLF IV 1.6	AUS, ATN	05/00 ⇒ 06/06
GOLF IV 1.6 16V	ATN, AER	02/00 ⇒ 06/06
LUPO 1.0	AER, AER	09/98 ⇒ 07/05
LUPO 1.4	AUD	10/00 ⇒ 07/05
LUPO 1.4 FSI	ARR	02/01 ⇒ 07/05
LUPO 1.6 GTI	AVY	09/00 ⇒ 07/05
POLO 1.0 [ExtraEU]	AER, AER	07/95 ⇒ 09/01
POLO III 1.0	AER, AEX	10/99 ⇒ 09/01
POLO III 1.4	AEX, ARC	05/97 ⇒ 09/01
POLO III 1.6 16V GTI	ARC, AER	10/99 ⇒ 09/01
POLO III 120 1.6 16V GTI	AJV	09/98 ⇒ 10/99
POLO III 50 1.0	AER, AEX	09/96 ⇒ 10/99
POLO III 55 1.4	AEX, AEX	08/95 ⇒ 10/99
POLO III 60 1.4	AEX, BBY	07/95 ⇒ 09/01

**REVOLUTION AND TIMING (CKP AND CMP)
SENSORS**

Adatt./Suitable:

BOSCH0 261 210 257
0 261 210 258**SEAT**

030 957 147 S

SKODA

030 957 147 S

VW

030 957 147 S



L	L1		
400	---	Hall Effect	

SEAT

CORDOBA II 1.4 16V	BBY, BBY	09/02 ⇒ 12/07
IBIZA III 1.4 16V	BBY, BTS	02/02 ⇒ 12/07
IBIZA III 1.6 16V	BTS	11/06 ⇒ 11/09

SKODA

FABIA II 1.6	BTS, BTS	04/07 ⇒ 12/14
ROOMSTER 1.6	BTS, BBY	09/06 ⇒ 05/15
ROOMSTER 1.6 LPG	BTS	06/06 ⇒ 07/10

VW

POLO IV 1.4	BBY, AUA	11/02 ⇒ 04/12
POLO IV 1.4 16V	AUA, BAG	10/01 ⇒ 05/08
POLO IV 1.6	BMH	03/06 ⇒ 09/07
POLO IV 1.6 16V	BTS	05/06 ⇒ 11/09

9.0448



04,5

REVOLUTION AND TIMING (CKP AND CMP) SENSORS

Adatt./Suitable:

AUDI
03C 957 147**BOSCH**
0 261 210 250
0 261 210 251**SKODA**
03C 957 147**VW**
03C 957 147

L	L1		
275	---	Hall Effect	

AUDI			
A3 II 1.6 FSI	BAG, BAG	08/03	⇒ 09/07
SKODA			
OCTAVIA II 1.6 FSI	BLF	02/04	⇒ 10/08
VW			
GOLF IV 1.6 FSI	BAG	10/03	⇒ 07/04
GOLF V 1.6 FSI	BAG, BMY	10/03	⇒ 07/08
PASSAT V 1.6 FSI	BLF	03/05	⇒ 06/08
TOURAN I 1.4 TSI	BMY, BAG	02/06	⇒ 05/10
TOURAN I 1.6 FSI	BAG, Z16XE1	02/03	⇒ 01/07

9.0449



3

REVOLUTION AND TIMING (CKP AND CMP) SENSORS

Adatt./Suitable:

FIAT
71739799**GENERAL MOTORS**
24 435 096
25 337 265**OPEL**
24435096
62 38 282**VAUXHALL**
24435096

MARKET DIFFUSION: MEDIUM



L	L1		
---	8,3	Hall Effect	

FIAT			
STILO 1.6	192B3.000	04/05	⇒ 08/08

FIAT			
STILO 1.6 16V	192B3.000	03/05	⇒ 12/07
OPEL			
ASTRA G 1.6	Z16XEP	12/02	⇒ 12/09
ASTRA G 1.6 16V	Z16XEP	03/00	⇒ 05/05
ASTRA G 1.6 LPG	Z16XEP	06/02	⇒ 06/07
ASTRA H 1.6	Z16XE1, Z16XE1	03/04	⇒ 10/10
ASTRA H 1.6 EcoTec	Z16XEP	02/04	⇒ 11/04
MERIVA A 1.6	Z16XEP	01/06	⇒ 05/10
VECTRA C 1.6	Z16XEP	08/05	⇒ 08/08
ZAFIRA A 1.6	Z16XEP	10/03	⇒ 06/05
ZAFIRA A 1.6 16V	Z16XEP	10/03	⇒ 06/05
ZAFIRA A 1.6 LPG	Z16XEP	10/03	⇒ 06/05
ZAFIRA B 1.6	Z16XE1, Z16XE1	07/05	⇒ 09/12

VAUXHALL			
ASTRA IV 1.6	Z16XEP	12/02	⇒ 05/05
ASTRA IV 1.6 16V	Z16XEP	09/98	⇒ 10/05
ASTRA V 1.6	Z16XE1, Z16XE1	01/04	⇒ 11/10
ASTRAVAN II 1.6 Dualfuel	Z16XEP	07/00	⇒ 08/05
ASTRAVAN II 1.6 Dualfuel 16V	Z16XEP	10/04	⇒ 12/05
ASTRAVAN III 1.6	Z16XE1, Z16XE1	03/05	⇒
MERIVA I 1.6 i 16V Twinport	Z16XEP	05/03	⇒ 06/10
VECTRA C 1.6 16V	Z16XEP	01/06	⇒ 07/08
ZAFIRA B 1.6	Z16XE1, QG15DE	07/05	⇒ 11/14

9.0453



3

REVOLUTION AND TIMING (CKP AND CMP) SENSORS

Adatt./Suitable:

INFINITI
23731-4M50B**NISSAN**
23731-4M500
23731-4M505
23731-4M506
23731-4M50B
23731-4M560
23731-5M000
23731-5M005
23731-95F0D

MARKET DIFFUSION: MEDIUM



L	L1		
---	37,9	Hall Effect	

INFINITI			
FX 45	VK45DE	02/03	⇒ 12/08
FX 45 AWD	VK45DE	10/08	⇒
FX 45 Trazione integrale	VK45DE	01/03	⇒ 12/08
M45 4.5	VK45DE	01/05	⇒
M SERIES 4.5 [ExtraEU]	VK45DE	01/05	⇒ 05/10
QX56 5.6 [ExtraEU]	VK56DE	09/03	⇒ 12/09
QX56 5.6 V8	VK56DE	04/08	⇒

NISSAN			
ALMERA I 1.8	QG18DE	07/95	⇒ 05/00
ALMERA II 1.5	QG15DE, QG18DE	03/00	⇒
ALMERA II 1.5 XL	QG15DE	03/01	⇒
ALMERA II 1.8	QG18DE, QG16	01/00	⇒
ALMERA III 1.6	QG16	01/06	⇒
ALMERA III 1.6 16V	QG16, QG18DE	03/06	⇒
ALMERA TINO 1.8	QG18DE, CR12DE	08/00	⇒ 02/06
MICRA III 1.0 16V	CG10DE	01/03	⇒ 06/10
MICRA III 1.2	CR12DE, CG12DE	10/03	⇒ 06/10
MICRA III 1.2 16V	CG12DE, CG12DELPG	01/03	⇒ 06/10
MICRA III 1.2 LPG	CG12DELPG, GA16DE	10/02	⇒ 06/10
MICRA III 1.3	CGA3DE	08/04	⇒
MICRA III 1.4 16V	CR14DE	01/03	⇒ 06/10
MICRA C+C 1.4 16V	CR14DE	08/05	⇒
NOTE I 1.4	CR14DE	03/06	⇒ 06/12
NOTE I 1.4 LPG	CR14DE	01/06	⇒ 08/13

NISSAN			
PRIMERA 1.6 LPG	GA16DE, QG18DE	09/96	⇒ 07/02
PRIMERA 1.8 LPG	QG18DE, GA16DE	08/99	⇒ 07/02
PRIMERA II 1.6 16V	GA16DE, SR20DE	06/96	⇒ 07/02
PRIMERA II 1.6 16V LPG	QG16DE	09/00	⇒ 07/02
PRIMERA II 1.8 16V	QG18DE	08/99	⇒ 07/02
PRIMERA II 2.0 16V	SR20DE, QG16DE	06/96	⇒ 07/02
PRIMERA II 2.0 TD	CD20T	09/96	⇒ 07/02
PRIMERA III 1.6	QG16DE, AZV	01/02	⇒ 08/08
PRIMERA III 1.6 Visia	QG16DE	01/02	⇒ 04/06
PRIMERA III 1.8	QG18DE	03/02	⇒ 10/08
PRIMERA III 1.8 LPG	QG18DE	03/02	⇒

9.0456



04

REVOLUTION AND TIMING (CKP AND CMP) SENSORS

Adatt./Suitable:

AUDI
03G 957 147 A
03G 957 147 C**CHRYSLER**
68001591AA
K68001591AA**DODGE**
68001591AA
K68001591AA**JEEP**
68001591AA
K68001591AA**MITSUBISHI**
MN980233**MOPAR PARTS**
68001591AA**SEAT**
03G 957 147 A
03G 957 147 C**SKODA**
03G 957 147 C**VW**
03G 957 147 A
03G 957 147 C

MARKET DIFFUSION: MEDIUM



L	L1		
310	---	Hall Effect	

AUDI			
A3 II 2.0 TDI	AZV, BKD	05/03	⇒ 08/12
A3 II 2.0 TDI 16V	BKD, BKD	05/03	⇒ 08/12
A3 II 2.0 TDI 16V quattro	BKD, AZV	08/04	⇒ 08/12
A3 II 2.0 TDI quattro	AZV, AZV	05/03	⇒ 08/12
A3 II SPORTBACK 2.0 TDI	AZV, BKD	09/04	⇒ 03/13
A3 II SPORTBACK 2.0 TDI 16V	BKD, BKD	09/04	⇒ 03/13
A3 II SPORTBACK 2.0 TDI 16V quattro	BKD, BMM	11/05	⇒ 03/13
A3 II SPORTBACK 2.0 TDI quattro	BMM, BNA	01/06	⇒ 03/13
A4 III 2.0 TDI	BNA, BLB	11/04	⇒ 06/08
A4 III 2.0 TDI 16V	BLB, BRD	11/04	⇒ 06/08
A4 III 2.0 TDI quattro	BRD, BLB	06/06	⇒ 06/08
A6 III 2.0 TDI	BLB, ECD	07/04	⇒ 08/11

CHRYSLER			
SEBRING III 2.0 CRD	ECD	07/07	⇒ 12/10

DODGE			
CALIBER 2.0 CRD	ECD, ECE	02/06	⇒
JOURNEY 2.0 CRD	ECE, ECD	06/08	⇒

JEEP			
COMPASS 2.0 CRD	ECD, ECD	08/06	⇒
COMPASS 2.0 CRD 4x4	ECD, ECD	09/06	⇒
PATRIOT 2.0 CRD	ECD, ECD	02/07	⇒
PATRIOT 2.0 CRD 4x4	ECD, BSY	02/07	⇒

MITSUBISHI			
GRANDIS 2.0 DI-D	BSY, BKD	09/05	⇒ 03/10
LANCER IX 2.0 DI-D	BKD, AZV	01/08	⇒
OUTLANDER II 2.0 DI-D	BSY	12/06	⇒ 11/12

SEAT			
ALTEA 2.0 TDI	AZV, BKD	03/04	⇒

SEAT			
ALTEA 2.0 TDI 16V	BKD, AZV	03/04	⇒
ALTEA XL 2.0 TDI	AZV, BKD	11/06	⇒
ALTEA XL 2.0 TDI 16V	BKD, BMN	10/06	⇒
ALTEA XL 2.0 TDI 4x4	BMN, AZV	06/07	⇒
LEON II 2.0 TDI	AZV, BKD	07/05	⇒ 12/12
LEON II 2.0 TDI 16V	BKD, AZV	07/05	⇒ 12/12
TOLEDO III 2.0 TDI	AZV, AZV	09/04	⇒ 05/09
TOLEDO III 2.0 TDI 16V	BKD	04/04	⇒ 05/09

SKODA			
OCTAVIA II 2.0 TDI	AZV	02/04	⇒ 05/10
OCTAVIA II 2.0 TDI 16V	AZV, BMN	02/04	⇒ 05/13
OCTAVIA II 2.0 TDI RS	BMN, BKD	04/06	⇒ 02/13
SUPERB II 2.0 TDI 16V	BKD, AZV	01/09	⇒ 05/15

VW			
GOLF V 2.0 TDI	AZV, BKD	10/03	⇒ 12/13
GOLF V 2.0 TDI 16V	BKD, AZV	10/03	⇒ 12/13
GOLF V 2.0 TDI 16V 4motion	BKD	08/04	⇒ 11/08
GOLF V 2.0 TDI 4motion	AZV	06/07	⇒ 07/09
JETTA V 2.0 TDI	AZV, BKD	09/05	⇒ 10/10
JETTA V 2.0 TDI 16V	BKD, BMA	08/05	⇒ 10/10
PASSAT V 2.0 TDI	BMA, BKP	03/05	⇒ 11/10
PASSAT V 2.0 TDI 16V	BKP, BKP	03/05	⇒ 11/10
PASSAT V 2.0 TDI 16V 4motion	BKP, AZV	03/05	⇒ 11/10
TOURAN I 2.0 TDI	AZV, DV6B	02/03	⇒ 05/10
TOURAN I 2.0 TDI 16V	BKD	08/03	⇒ 05/10

9.0458



3,5

REVOLUTION AND TIMING (CKP AND CMP) SENSORS

Adatt./Suitable:

BOSCH
0 986 280 419

CITROËN
1920 EH
96 372 208 80
96 374 669 80

FIAT
9637220880

FORD
1 148 073
256Q-9E731-AA

LANCIA
9637220880

LAND ROVER
LR000681

MAZDA
Y401-18-221

MINI
13 62 7 805 004

MITSUBISHI
MN982270

PEUGEOT
1920 EH
96 374 669 80

TOYOTA
SU001-00640

VOLVO
30711104

MARKET DIFFUSION: HIGH



L	L1		
---	---	Hall Effect	

CITROËN			
BERLINGO I 1.6 HDI 75	DV6B, 9HX(DV6ATED4)	07/05	⇒ 12/11
BERLINGO I 1.6 HDI 90	9HX(DV6ATED4), 8HT(DV4TD)	07/05	⇒ 12/11
C1 I 1.4 HDi	8HT(DV4TD), 8HX(DV4TD)	06/05	⇒ 09/14
C2 1.4 HDi	8HX(DV4TD), 9HZ(DV6TED4)	09/03	⇒
C2 1.6 HDi	9HZ(DV6TED4), 8HY(DV4TED4)	09/05	⇒
C3 I 1.4 16V HDi	8HY(DV4TED4), 8HX(DV4TD)	02/02	⇒

CITROËN			
C3 I 1.4 HDi	8HX(DV4TD), 9HX(DV6ATED4)	02/02	⇒
C3 I 1.6 16V HDi	9HX(DV6ATED4), 8HX(DV4TD)	09/05	⇒
C3 I PLURIEL 1.4 HDi	8HX(DV4TD), 9HY(DV6TED4)	04/04	⇒
C4 I 1.6 HDi	9HY(DV6TED4), 9HY(DV6TED4)	11/04	⇒
C4 GRAND PICASSO I 1.6 HDi	9HY(DV6TED4), 9HY(DV6TED4)	10/06	⇒ 06/11
C4 PICASSO I 1.6 HDi	9HY(DV6TED4), 9HY(DV6TED4)	02/07	⇒ 08/13
C5 I 1.6 HDi	9HY(DV6TED4), 4HP(DW12BTE4)	09/04	⇒
C5 I 2.2 HDi	4HP(DW12BTE4), 4HP(DW12BTE4)	04/06	⇒
C5 II 1.6 HDi 110	9HZ(DV6TED4)	02/08	⇒
C6 2.2 HDi	4HP(DW12BTE4), 4HP(DW12BTE4)	06/06	⇒ 12/12
C8 2.2 HDi	4HP(DW12BTE4), 4HN(DW12MTE4)	06/06	⇒
C-CROSSER 2.2 HDi	4HN(DW12MTE4), 9HU(DV6GUTED4)	02/07	⇒
C-CROSSER ENTERPRISE 2.2 HDi	4HN(DW12MTE4)	01/09	⇒
DISPATCH 1.6 HDi	DV6GUTED4	06/07	⇒ 03/16
JUMPY 1.6 HDi	DV6GUTED4	06/07	⇒ 03/16
JUMPY II 1.6 HDi 90 16V	9HU(DV6GUTED4), 8HX(DV4TD)	01/07	⇒
XSARA 1.4 HDi	8HX(DV4TD), 9HX(DV6ATED4)	01/03	⇒
XSARA PICASSO 1.6 HDi	9HX(DV6ATED4), 9H07(DV6UC)	05/04	⇒

FIAT			
SCUDO II 1.6 D Multijet	9H07(DV6UC), 4H01	01/07	⇒
ULYSSE II 2.2 D Multijet	4H01, G8DA	10/07	⇒
ULYSSE II 2.2 JTD	4HW	08/02	⇒ 08/06

FORD			
C-MAX I 1.6 TDCi	G8DA, F6JA	02/07	⇒ 09/10
FIESTA V 1.4 TDCi	F6JA, HHJA	11/01	⇒ 12/10
FIESTA V 1.6 TDCi	HHJA, G8DA	11/04	⇒ 09/09
FOCUS II 1.6 TDCi	G8DA, G8DA	07/04	⇒ 09/12
FOCUS II CASSONE / FURGONATO / PROMISCUO 1.6 TDCi	G8DA, F6JA	07/04	⇒ 07/11
FOCUS C-MAX 1.6 TDCi	G8DA, G8DA	10/03	⇒ 03/07
FUSION 1.4 TDCi	F6JA, HHJA	08/02	⇒ 12/12
FUSION 1.6 TDCi	HHJA, KNWA	11/04	⇒ 12/12
GALAXY II 2.0 TDCi	TXWA	03/10	⇒ 06/15
GALAXY II 2.2 TDCi	KNWA, KNWA	03/08	⇒ 06/15
MONDEO III 2.2 TDCi	Q4BA	03/08	⇒ 10/10
S-MAX I 2.2 TDCi	KNWA, 224DT	03/08	⇒ 12/14

LANCIA			
PHEDRA 2.2 D Multijet	4HS	03/08	⇒ 11/10
PHEDRA 2.2 JTD	4H01	03/08	⇒

LAND ROVER			
FREELANDER 2 2.2 eD4	224DT, 224DT	08/10	⇒ 10/14
FREELANDER 2 2.2 SD4 4x4	224DT	08/10	⇒ 10/14
FREELANDER 2 2.2 TD4 4x4	224DT, F6JA	10/06	⇒ 10/14

MAZDA			
2 II 1.4 MZR-CD	Y404	01/08	⇒ 06/15
2 II 1.6 MZ-CD	Y406, Y601	10/08	⇒ 06/15
3 I 1.6 DI Turbo	Y601, Y601	06/04	⇒ 06/09
3 I 1.6 MZ-CD	Y406	06/06	⇒ 12/09
3 II 1.6 MZR CD	Y601, 9HZ	12/08	⇒ 05/13
2 I 1.4 CD	F6JA, Y406	04/03	⇒ 06/07

MINI			
MINI II Cooper D	9HZ, 4HK	11/06	⇒ 09/10

MITSUBISHI			
OUTLANDER II 2.2 DI-D 4WD	4HK, 8HX(DV4TD)	08/07	⇒ 11/12

PEUGEOT			
107 1.4 HDi	8HT(DV4TD), 8HX(DV4TD)	06/05	⇒ 05/14
206 1.4 HDi	8HX(DV4TD), 8HX(DV4TD)	09/01	⇒
206 1.4 HDi eco 70	8HX(DV4TD), 9HY(DV6TED4)	09/01	⇒
206 1.6 HDi 110	9HY(DV6TED4), 8HZ(DV4TD)	05/04	⇒
207 1.4 HDi	8HZ(DV4TD), 9HV(DV6TED4)	02/06	⇒
207 1.6 HDi	9HV(DV6TED4), 9HZ(DV6TED4)	02/06	⇒
207 CC 1.6 HDi	9HZ(DV6TED4), 8HX(DV4TD)	02/07	⇒
307 1.4 HDi	8HX(DV4TD), 9HV(DV6ATED4)	10/01	⇒ 06/05
307 1.4 HDi 70	8HZ(DV4TD)	03/02	⇒ 06/05
307 1.6 HDi	9HV(DV6ATED4), 9HY(DV6TED4)	04/05	⇒ 03/09
307 1.6 HDi 110	9HY(DV6ATED4), 9HV(DV6ATED4)	02/04	⇒ 03/09
307 1.6 HDi 90	9HV(DV6ATED4), 9HV(DV6ATED4)	12/06	⇒ 04/08
308 I 1.6 HDi	9HV(DV6ATED4), 4HK(DW12MTE4)	09/07	⇒
407 1.6 HDi	DV6GTE4	08/04	⇒ 12/10
407 1.6 HDi 110	9HZ(DV6ATED4), 4HR(DW12BTE4)	05/04	⇒

PEUGEOT			
407 2.0 HDi 135	DW10BTE4	05/04	⇒
407 2.2 HDi	DW12BTE4	03/06	⇒
407 2.2 HDi 170	4HR(DW12BTE4), 4HP(DW12BTE4)	05/06	⇒
607 2.2 HDi	4HP(DW12BTE4), 4HT(DW12BTE4)	05/06	⇒
807 2.2 HDi	4HT(DW12BTE4), 9HU(DV6GUTED4)	06/06	⇒
1007 1.4 HDi	8HX(DV4TD), 9HZ(DV6TED4)	04/05	⇒
1007 1.6 HDi	9HZ(DV6TED4), 8HT(DV4TD)	06/07	⇒
4007 2.2 HDi	4HK(DW12MTE4), 9HZ(DV6TED4)	02/07	⇒
EXPERT II 1.6 HDi 90 16V	9HU(DV6GUTED4), 9HU(DV6GUTED4)	01/07	⇒
EXPERT II TEPEE 1.6 HDi 90 16V	9HU(DV6GUTED4), 9HW(DV6BTE4)	01/07	⇒
PARTNER 1.6 HDi	DV6BTE4	08/05	⇒ 07/08
PARTNER I 1.6 HDi 75	9HW(DV6BTE4), 9HX(DV6ATED4)	02/06	⇒
PARTNER I 1.6 HDi 90	9HX(DV6ATED4), D4164T	10/05	⇒ 12/15
RANCH 1.6 HDi 75	DV6B	02/06	⇒
RANCH 1.6 HDi 90	9HX(DV6ATED4)	02/06	⇒

TOYOTA			
AYGO I 1.4 HDi	2WZ-TV	07/05	⇒ 08/10

VOLVO			
C30 1.6 D	D4164T	10/06	⇒ 12/12
S40 II 1.6 D	D4164T	01/05	⇒ 12/12
S80 II 1.6 D DRIVE	D4164T	01/10	⇒ 12/11
V50 1.6 D	D4164T, M166.940	01/05	⇒ 12/12
V70 III 1.6 D	D4164T	07/09	⇒ 12/11

9.0459



3

REVOLUTION AND TIMING (CKP AND CMP) SENSORS

Adatt./Suitable:

CHRYSLER
5080346AA
K05080346AA

JEEP
5080346AA

MERCEDES-BENZ
A 003 153 97 28
A 005 153 13 28

MOPAR PARTS
05080346AA

MARKET DIFFUSION: HIGH



L	L1		
---	24,3	Hall Effect	

MERCEDES-BENZ			
CLASSE A I A 140	M166.940, OM668.940	01/01	⇒ 08/04
CLASSE A I A 160	M166.960	07/97	⇒ 08/04
CLASSE A I A 160 CDI	OM668.940, OM668.940	02/01	⇒ 08/04
CLASSE A I A 170 CDI	OM668.940, OM611.962	02/01	⇒ 08/04
CLASSE A I A 190	M166.990	03/99	⇒ 08/04
CLASSE A I A 210	M166.995	12/01	⇒ 08/04
CLASSE A II A 160 CDI	OM640.942	09/04	⇒ 06/12
CLASSE A II A 180 CDI	OM640.940	09/04	⇒ 06/12
CLASSE A II A 200 CDI	OM640.941	09/04	⇒ 06/12
CLASSE B I B 180 CDI	OM640.940	03/05	⇒ 11/11
CLASSE B I B 200 CDI	OM640.941	03/05	⇒ 11/11
CLASSE C I C 200 CDI	OM611.960	03/98	⇒ 05/00
CLASSE C I C 200 T CDI	OM611.960	03/98	⇒ 03/01
CLASSE C I C 220 CDI	OM611.960	09/97	⇒ 05/00
CLASSE C I C 220 T CDI	OM611.960	09/97	⇒ 03/01
CLASSE C II C 200 CDI	OM611.962, OM611.962	09/00	⇒
CLASSE C II C 220 CDI	OM611.962, OM646.811	05/00	⇒ 05/08
CLASSE C II C 270 CDI	OM612.962	12/00	⇒ 08/07
CLASSE C II C 30 CDI AMG	OM612.990	09/02	⇒ 05/08
CLASSE C II C 320 CDI	OM642.910	01/05	⇒ 08/07

MERCEDES-BENZ			MERCEDES-BENZ			MERCEDES-BENZ		
CLASSE C III C 200 CDI	OM646.811, OM642.830	01/07 → 12/11	CLASSE GL I GL 350 CDI 4-matic	OM642.822, OM642.824	05/09 →	SPRINTER II 319 CDI / BlueTEC 4x4	OM642.896, OM646.986	03/09 →
CLASSE C III C 220 CDI	OM646.811	01/07 → 11/08	CLASSE GL II GL 350 CDI / BlueTEC 4-matic	OM642.826	07/12 → 10/15	SPRINTER II 411 CDI	OM646.701	06/09 →
CLASSE C III C 300 CDI 4-matic	OM642.832	01/11 → 01/14	CLASSE GLC 350 d 4-matic	OM642.873	10/16 →	SPRINTER II 413 CDI	OM646.986	06/06 → 05/16
CLASSE C III C 320 CDI	OM642.960	01/07 → 08/14	CLASSE GLE 350 d 4-matic	OM642.824, OM642.832	03/15 →	SPRINTER II 415 CDI	OM646.986, OM642.896	06/06 → 12/09
CLASSE C III C 320 CDI 4-matic	OM642.961	07/07 → 01/14	CLASSE GLK 320 CDI 4-matic	OM642.961	06/08 → 06/15	SPRINTER II 418 CDI	OM642.896, OM642.896	06/06 → 05/16
CLASSE C III C 350 CDI	OM642.830, OM642.832	08/07 → 08/14	CLASSE GLK 350 CDI 4-matic	OM642.832, OM642.826	07/09 →	SPRINTER II 419 CDI	OM642.896, OM646.986	03/09 →
CLASSE C III C 350 CDI 4-matic	OM642.832, OM646.962	08/07 → 08/14	CLASSE GLS 350 d 4-matic	OM642.826, OM642.820	11/15 →	SPRINTER II 509 CDI	OM646.984	06/06 → 12/09
CLASSE V V 200 CDI	OM611.980	03/99 → 07/03	CLASSE M I ML 270 CDI	OM612.963	12/99 → 06/05	SPRINTER II 511 CDI	OM646.985	06/06 → 12/09
CLASSE V V 220 CDI	OM611.980	03/99 → 07/03	CLASSE M I ML 400 CDI	OM628.963	09/01 → 06/05	SPRINTER II 511 CDI 4x4	OM646.985	06/06 → 12/09
CLASSE CLC CLC 200 CDI	OM646.962, OM612.962	05/08 → 06/11	CLASSE M II ML 280 CDI 4-matic	OM642.940	07/05 → 07/09	SPRINTER II 513 CDI	OM646.986	06/06 →
CLASSE CLC CLC 220 CDI	OM646.963	05/08 → 06/11	CLASSE M II ML 300 CDI 4-matic	OM642.820, OM642.820	07/09 → 12/11	SPRINTER II 515 CDI	OM646.986, OM646.986	06/06 → 12/09
CLASSE CLK II 220 CDI	OM646.966	01/05 → 05/09	CLASSE M II ML 320 CDI 4-matic	OM642.820, OM642.820	07/05 →	SPRINTER II 515 CDI 4x4	OM646.986, OM642.896	06/06 → 12/09
CLASSE CLK II 270 CDI	OM612.962, OM642.852	10/02 → 05/09	CLASSE M II ML 350 CDI 4-matic	OM642.820, OM642.870	07/09 → 12/11	SPRINTER II 518 CDI	OM642.896, OM642.896	06/06 → 12/09
CLASSE CLK II 320 CDI	OM642.910	01/05 → 05/09	CLASSE M III ML 350 BlueTEC 4-matic	OM642.826	06/11 → 02/15	SPRINTER II 518 CDI 4x4	OM642.896, OM642.896	06/06 → 12/09
CLASSE CLK II CLK 320 CDI	OM642.910	03/05 → 03/10	CLASSE M III ML 350 CDI BlueEfficiency 4-matic	OM642.826	02/12 →	SPRINTER II 519 CDI / BlueTEC	OM642.896, OM642.896	03/09 →
CLASSE CLS I CLS 320 CDI	OM642.920	01/05 → 12/10	CLASSE R R 280 CDI	OM642.870, OM642.870	05/06 →	SPRINTER 319 CDI	OM642.899	02/18 →
CLASSE CLS I CLS 350 CDI	OM642.920	04/09 → 12/10	CLASSE R R 280 CDI 4-matic	OM642.950	05/06 →	SPRINTER 419 CDI	OM642.899	02/18 →
CLASSE CLS II CLS 350 BlueTEC	OM642.852	05/14 →	CLASSE R R 300 CDI	OM642.870, OM642.870	07/09 →	SPRINTER 519 CDI	OM642.899	02/18 →
CLASSE CLS II CLS 350 BlueTEC / d	OM642.852, OM642.854	11/12 →	CLASSE R R 300 CDI 4-matic	OM642.950	07/09 →	SPRINTER SERIES Sprinter 213D Cdi	OM646.986	04/12 →
CLASSE CLS II CLS 350 BlueTEC / d 4-matic	OM642.854, OM642.854	11/12 →	CLASSE R R 320 CDI 4-matic	OM642.870, OM642.870	01/06 →	SPRINTER SERIES Sprinter 318D Cdi	OM642.896, OM646.981	03/09 →
CLASSE CLS II CLS 350 BlueTEC 4-matic	OM642.854	01/13 →	CLASSE R R 320 CDI 4-matic	OM642.870, OM642.870	01/06 →	VANEO 1.6	M166.961	02/02 → 07/05
CLASSE CLS II CLS 350 CDI / d	OM642.853	01/11 →	CLASSE R R 350 CDI 4-matic	OM642.870, OM613.960	01/06 →	VANEO 1.7 CDI	OM668.914	02/02 → 07/05
CLASSE CLS II CLS 350 CDI / d 4-matic	OM642.854	09/11 →	CLASSE S IV S 320 CDI	OM613.960, OM628.960	09/02 → 08/05	VANEO 1.9	M166.991	02/02 → 07/05
CLASSE CLS II CLS 350 d 4-matic	OM642.854, OM611.961	04/15 →	CLASSE S IV S 400 CDI	OM628.960, OM642.930	06/00 → 08/05	VIANO CDI 2.0	OM646.981, OM646.982	09/03 →
CLASSE E II E 200 CDI	OM611.961, OM611.961	06/98 → 03/02	CLASSE S IV S 320 CDI	OM642.930, OM642.932	10/05 → 12/13	VIANO CDI 2.0 4-matic	OM646.982, OM646.980	07/05 →
CLASSE E II E 220 CDI	OM611.961, OM611.961	06/98 → 07/99	CLASSE S IV S 400 CDI	OM642.932, OM642.932	10/05 → 12/13	VIANO CDI 2.2	OM646.980, OM642.890	09/03 →
CLASSE E II E 220 T CDI	OM612.961	07/99 → 03/02	CLASSE S V S 320 CDI 4-matic	OM642.862	04/11 → 12/13	VIANO CDI 2.2 4-matic	OM646.982	07/05 →
CLASSE E II E 270 CDI	OM612.961, OM646.820	02/00 → 03/03	CLASSE S V S 350 BlueTEC 4-matic	OM642.868	04/11 → 12/13	VIANO CDI 3.0	OM642.890, OM611.980	03/06 →
CLASSE E II E 320 CDI	OM613.961	07/99 → 03/02	CLASSE S V S 350 BlueTEC 4-matic	OM642.868	04/11 → 12/13	VITO I 108 CDI 2.2	OM611.980, OM611.980	03/99 → 07/03
CLASSE E II E 320 T CDI	OM613.961	07/99 → 03/03	CLASSE SV S 350 CDI	OM642.930	06/09 → 12/13	VITO I 110 CDI 2.2	OM611.980, OM646.980	03/99 → 07/03
CLASSE E III E 200 CDI	OM646.820, OM646.821	07/02 → 07/09	CLASSE SV S 350 CDI 4-matic	OM642.932, OM642.824	01/09 → 07/13	VITO I 112 CDI 2.2	OM611.980	03/99 → 07/03
CLASSE E III E 220 CDI	OM646.821, OM646.821	03/02 → 07/09	CLASSE SV S 530 Cdi [ExtraEU]	OM642.930	06/09 → 12/13	VITO II 109 CDI	OM646.980, OM646.980	09/03 →
CLASSE E III E 220 T CDI	OM646.821, OM642.920	03/03 → 07/09	CLASSE SVI S 350 BlueTEC / d	OM642.861	05/13 →	VITO II 109 CDI 4x4	OM646.981	09/07 →
CLASSE E III E 270 CDI	OM647.961	03/02 → 12/08	CLASSE SVI S 350 BlueTEC / d 4-matic	OM642.867	02/14 →	VITO II 111 CDI	OM646.980, OM646.980	09/03 →
CLASSE E III E 270 T CDI	OM647.961	03/03 → 07/09	CLASSE SVI S 350 BlueTEC 4-matic	OM642.867	02/14 →	VITO II 111 CDI 4x4	OM646.982	09/07 →
CLASSE E III E 280 CDI	OM642.920, OM642.920	05/04 → 12/08	CLASSE X X 350 d 4-matic	OM642.889	07/18 →	VITO II 115 CDI	OM646.980, DV6B	09/03 →
CLASSE E III E 280 CDI 4-matic	OM642.921	03/05 → 12/08	CLC-SERIES CLC220 Cdi	OM646.963	05/08 → 06/11	VITO II 115 CDI 4x4	OM646.982	07/06 →
CLASSE E III E 280 T CDI	OM642.920, OM642.920	05/04 → 07/09	CLS-SERIES CLS350 BlueTEC	OM642.852	05/14 → 12/17	VITO II 120 CDI	OM642.990	07/06 →
CLASSE E III E 280 T CDI 4-matic	OM642.921	03/05 → 07/09	C-SERIES C300 Cdi/Cdi BlueEFFICIENCY	OM642.832	01/11 → 01/14	VITO II 122 CDI	OM642.890	09/10 →
CLASSE E III E 300 BlueTEC	OM642.920	09/07 → 12/08	GLE-SERIES GLE350	OM642.824, OM646.986	04/15 →			
CLASSE E III E 320 CDI	OM642.920, OM642.920	11/02 → 12/08	ML-SERIES ML350 -/BlueTEC [ExtraEU]	OM642.826	06/11 → 02/15			
CLASSE E III E 320 CDI 4-matic	OM642.921	03/05 → 12/08	SPRINTER I 208 CDI	OM611.987	04/00 → 05/06			
CLASSE E III E 320 T CDI	OM642.920, OM642.850	03/03 → 07/09	SPRINTER I 211 CDI	OM611.981	04/00 → 05/06			
CLASSE E III E 320 T CDI 4-matic	OM642.921	03/05 → 07/09	SPRINTER I 213 CDI	OM611.981	04/00 → 05/06			
CLASSE E III E 400 CDI	OM628.961	02/03 → 12/08	SPRINTER I 216 CDI	OM612.981	04/00 → 05/06			
CLASSE E IV E 300 BlueTEC	OM642.852	03/11 →	SPRINTER I 308 CDI	OM611.987	04/00 → 05/06			
CLASSE E IV E 300 CDI	OM642.850, OM642.850	12/09 →	SPRINTER I 311 CDI	OM611.981	04/00 → 05/06			
CLASSE E IV E 300 CDI / BlueTEC	OM642.850, OM642.838	11/09 →	SPRINTER I 311 CDI 4x4	OM611.981	08/02 → 05/06			
CLASSE E IV E 350 BlueTEC	OM642.838, OM642.852	01/09 →	SPRINTER I 313 CDI	OM611.981	04/00 → 05/06			
CLASSE E IV E 350 BlueTEC / d	OM642.838	05/14 →	SPRINTER I 313 CDI 4x4	OM611.981	08/02 → 05/06			
CLASSE E IV E 350 BlueTEC 4-matic	OM642.852, OM642.836	11/12 →	SPRINTER I 316 CDI	OM612.981	04/00 → 05/06			
CLASSE E IV E 350 BlueTEC / d	OM642.838	05/14 →	SPRINTER I 316 CDI 4x4	OM612.981	08/02 → 05/06			
CLASSE E IV E 350 CDI	OM642.836, OM642.856	01/09 →	SPRINTER I 408 CDI	OM611.987	04/00 → 05/06			
CLASSE E IV E 350 CDI 4-matic	OM642.856, OM612.963	09/09 →	SPRINTER I 411 CDI	OM611.981	04/00 → 05/06			
CLASSE EV E 350 d	OM642.855	01/16 →	SPRINTER I 411 CDI 4x4	OM611.981	04/00 → 05/06			
CLASSE EV E 350 d 4-matic	OM642.873	06/17 →	SPRINTER I 413 CDI	OM611.981	04/00 → 05/06			
CLASSE E E 220 Cdi	OM611.961, OM612.961	07/99 → 07/09	SPRINTER I 413 CDI 4x4	OM611.981	04/00 → 05/06			
CLASSE E E 270 CDI	OM612.961, OM611.961	07/99 → 07/09	SPRINTER I 416 CDI	OM612.981	04/00 → 05/06			
CLASSE E E 280 CDI	OM642.920	08/05 → 07/09	SPRINTER I 416 CDI 4x4	OM612.981	04/00 → 05/06			
CLASSE G II G 270 CDI	OM612.963, OM642.822	01/01 →	SPRINTER I 616 CDI	OM612.981	04/01 →			
CLASSE G II G 280 CDI	OM642.975	04/09 →	SPRINTER II 209 CDI	OM646.984	06/06 → 12/09			
CLASSE G II G 300 CDI	OM642.884	01/10 →	SPRINTER II 211 CDI	OM646.985	06/06 → 12/09			
CLASSE G II G 320 CDI	OM642.970	09/06 →	SPRINTER II 213 CDI	OM646.986	06/06 → 12/09			
CLASSE G II G 350 BlueTEC	OM642.970	07/09 →	SPRINTER II 215 CDI	OM646.986, OM642.896	06/06 → 12/09			
CLASSE G II G 350 CDI	OM642.886	07/11 →	SPRINTER II 218 CDI	OM642.896, OM642.896	06/06 → 12/09			
CLASSE G II G 400 CDI	OM628.962	12/00 →	SPRINTER II 219 CDI / BlueTEC	OM642.896, OM646.986	03/09 →			
CLASSE GL I GL 320 CDI / 350 BlueTEC 4-matic	OM642.820	12/09 →	SPRINTER II 309 CDI	OM646.984	06/06 → 12/09			
CLASSE GL I GL 320 CDI 4-matic	OM642.940	09/06 → 05/09	SPRINTER II 311 CDI	OM646.701	06/06 →			
CLASSE GL I GL 320 CDI BlueTEC 4-matic	OM642.820	12/09 →	SPRINTER II 311 CDI 4x4	OM646.985	02/08 → 12/09			
			SPRINTER II 313 CDI	OM646.986	06/06 →			
			SPRINTER II 315 CDI	OM646.986, OM646.986	06/06 → 12/09			
			SPRINTER II 315 CDI 4x4	OM646.986, OM642.896	02/08 → 12/09			
			SPRINTER II 318 CDI	OM642.896, OM642.896	06/06 → 12/09			
			SPRINTER II 318 CDI 4x4	OM642.896, OM642.896	02/08 → 12/09			
			SPRINTER II 319 CDI / BlueTEC	OM642.896, OM642.896	03/09 →			

9.0460



1

REVOLUTION AND TIMING (CKP AND CMP) SENSORS

Adatt./Suitable:

BOSCH
0 986 280 413

CITROËN
1920 7V
1920 FY
1920 QN
96 285 598 80
96 285 599 80
96 458 440 80
96 654 434 80

DS
1920 7V
1920 FY
1920 QN
96 285 599 80
9628559880

FIAT
9628559880
9628559980
9663752580
9665443680

LANCIA
9628559880
9665443680

PEUGEOT
1920 7V
1920 FY
1920 QN
96 285 598 80
96 285 599 80

MARKET DIFFUSION: HIGH



L	L1	Hall Effect	
---	22		

CITROËN			
BERLINGO I 1.6 HDi 75	DV6B, 9HX(DV6ATED4)	07/05 ⇨ 12/11	
BERLINGO I 1.6 HDi 90	9HX(DV6ATED4), DW10TD	07/05 ⇨ 12/11	
BERLINGO I 2.0 HDi 4x4	RHY(DW10TD)	11/02 ⇨ 10/05	
BERLINGO I 2.0 HDi 90	DW10TD, 9HZ(DV6ATED4)	12/99 ⇨ 12/11	
BERLINGO I 2.0 HDi 90 4WD	RHY(DW10TD)	11/00 ⇨ 10/05	
BERLINGO II 1.6 HDi 110	9HZ(DV6ATED4), 9HT(DV6ATED4)	04/08 ⇨	
BERLINGO II 1.6 HDi 75	9HT(DV6ATED4), 9HT(DV6ATED4)	04/08 ⇨	
BERLINGO II 1.6 HDi 75 16V	9HT(DV6ATED4), 9HX(DV6ATED4)	04/08 ⇨	
BERLINGO II 1.6 HDi 90	9HX(DV6ATED4), 9HS(DV6ATED4BU)	04/08 ⇨	
BERLINGO II 1.6 HDi 90 16V	9HS(DV6ATED4BU), 9HZ(DV6ATED4)	04/08 ⇨	
BERLINGO 1.6 HDi	DV6ATED4	06/08 ⇨ 12/11	
BERLINGO 2.0 HDi	DW10TD	08/99 ⇨ 10/05	
C2 1.6 HDi	9HZ(DV6ATED4), 8HY(DV4ATED4)	09/05 ⇨	
C3 I 1.4 16V HDi	8HY(DV4ATED4), 9HX(DV6ATED4)	02/02 ⇨	
C3 I 1.6 16V HDi	9HX(DV6ATED4), DV4C	09/05 ⇨	
C3 II 1.4 HDi 70	DV4C, DV6ATED	11/09 ⇨	
C3 II 1.6 HDi	DV6ATED, 9HX(DV6ATED4)	11/09 ⇨	
C3 II 1.6 HDi 90	9HX(DV6ATED4), HNV(EB2DTM)	11/09 ⇨	
C3 III 1.2 THP 110	HNV(EB2DTM), 9HX(DV6ATED4)	07/16 ⇨	
C3 III 1.2 VTI 82	HMZ(EB2F)	07/16 ⇨	
C3 PICASSO 1.6 HDi	9HX(DV6ATED4), 9HY(DV6ATED4)	02/09 ⇨	
C4 I 1.6 HDi	9HV(DV6ATED4), DW10ATED	11/04 ⇨	
C4 I 2.0 HDi	DW10ATED, DW10CFAPDTR	11/04 ⇨ 07/11	
C4 II 2.0 HDi	DW10CFAPDTR, DW10CTED4	10/10 ⇨	

CITROËN			
C4 II 2.0 HDi / BlueHdi 150	DW10CTED4, 9HY(DV6ATED4)	11/09 ⇨	
C4 GRAND PICASSO I 1.6 HDi	9HY(DV6ATED4), DW10ATED4	10/06 ⇨ 06/11	
C4 GRAND PICASSO I 2.0 HDi 138	DW10ATED4, DW10CTED4	10/06 ⇨ 12/13	
C4 GRAND PICASSO I 2.0 HDi 150	DW10CTED4, DW10CTED4	07/09 ⇨ 08/13	
C4 GRAND PICASSO I 2.0 HDi 165	DW10CTED4, 9HV(DV6ATED4)	09/10 ⇨ 08/13	
C4 PICASSO I 1.6 HDi	9HY(DV6ATED4), DW10ATED4	02/07 ⇨ 08/13	
C4 PICASSO I 2.0 HDi 138	DW10ATED4, DW10CTED4	10/06 ⇨ 08/13	
C4 PICASSO I 2.0 HDi 150	DW10CTED4, DW10CTED4	07/09 ⇨ 08/13	
C4 PICASSO I 2.0 HDi 165	DW10CTED4, 9HY(DV6ATED4)	09/10 ⇨	
C5 I 1.6 HDi	9HY(DV6ATED4), DW10	09/04 ⇨	
C5 I 2.0 HDi	DW10, 4HP(DW12BATED4)	03/01 ⇨	
C5 I 2.2 HDi	4HP(DW12BATED4), 9HZ(DV6ATED4)	03/01 ⇨	
C5 II 1.6 HDi 110	9HZ(DV6ATED4), DW10ATED4	02/08 ⇨	
C5 II 2.0 HDi	DW10ATED4, DW10ATED4	02/08 ⇨	
C5 II 2.0 HDi 140	DW10ATED4, DW10ATED4	04/09 ⇨	
C5 II 2.0 HDi 150 / BlueHdi 150	DW10ATED4, DW10ATED4	04/09 ⇨	
C5 II 2.0 HDi 165	DW10ATED4, 4HT(DW12BATED4)	04/09 ⇨	
C5 II 2.2 HDi	4HT(DW12BATED4), 4HP(DW12BATED4)	02/08 ⇨	
C5 II 2.2 HDi 165	4HP(DW12BATED4), 4HL(DW12C)	02/08 ⇨	
C5 II 2.2 HDi 200	4HL(DW12C), 4HP(DW12BATED4)	07/10 ⇨	
C6 2.2 HDi	4HP(DW12BATED4), DW10ATED4	06/06 ⇨ 12/12	
C8 2.0 HDi	DW10ATED4, DW10ATED4	07/02 ⇨	
C8 2.0 HDi 135	DW10ATED4, DW10ATED4	03/06 ⇨	
C8 2.0 HDi 165	DW10ATED4, 4HP(DW12BATED4)	03/06 ⇨	
C8 2.2 HDi	4HP(DW12BATED4), 4HN(DW12MATED4)	07/02 ⇨	
C-CROSSER 2.2 HDi	4HN(DW12MATED4), DW10ATED4	02/07 ⇨	
C-CROSSER ENTERPRISE 2.2 HDi	4HN(DW12MATED4), DW10ATED4	01/09 ⇨	
DISPATCH 1.6 HDi	DV6ATED4	06/07 ⇨ 03/16	
DISPATCH 2.0 HDi	DW10ATED4	06/07 ⇨ 03/16	
DS4 2.0 HDi / BlueHdi 135	DW10ATED4, DW10ATED4	09/11 ⇨ 07/15	
DS4 2.0 HDi 165	DW10ATED4, DW10ATED4	04/11 ⇨ 07/15	
DS5 2.0 HDi 135	DW10ATED4, DW10ATED4	11/11 ⇨ 07/15	
DS5 2.0 HDi 165	DW10ATED4, DW10ATED4	11/11 ⇨ 07/15	
DS5 2.0 HDi 165 Hybrid4 4x4	DW10ATED4, DW10ATED4	12/11 ⇨ 07/15	
DS5 2.0 HDi 200 Hybrid4 Trazione integrale	DW10ATED4	12/11 ⇨ 07/15	
EVASION 2.0 HDi	DW10ATED4, DW10ATED4	08/99 ⇨ 07/02	
EVASION 2.0 HDi 16V	DW10ATED4, DW10ATED4	09/99 ⇨ 07/02	
JUMPY I 2.0 HDi 110	DW10ATED4, DW10ATED4	03/00 ⇨ 10/06	
JUMPY I 2.0 HDi 110 16V	DW10ATED4, DW10ATED4	12/03 ⇨ 10/06	
JUMPY I 2.0 HDi 95	DW10ATED4, 9HU(DV6ATED4)	10/99 ⇨ 10/06	
JUMPY 1.6 HDi	DV6ATED4	06/07 ⇨ 03/16	
JUMPY 2.0 HDi	DW10ATED4	06/07 ⇨ 03/16	
JUMPY II 1.6 HDi 90 16V	9HU(DV6ATED4), DW10ATED4	01/07 ⇨	
JUMPY II 2.0 HDi 120	DW10ATED4, AHZ(DW10CD)	01/07 ⇨	
JUMPY II 2.0 HDi 120 4x4	RHK(DW10ATED4)	01/10 ⇨	
JUMPY II 2.0 HDi 125	AHZ(DW10CD), DW10ATED4	07/11 ⇨	
JUMPY II 2.0 HDi 125 4x4	AHZ(DW10CD)	07/11 ⇨	
JUMPY II 2.0 HDi 140	DW10ATED4, DW10ATED4	01/07 ⇨	
JUMPY II 2.0 HDi 165	DW10ATED4, AHY(DW10CE)	07/10 ⇨	
JUMPY II 2.0 HDi 95	AHY(DW10CE), DW10ATED4	07/11 ⇨	
XANTIA I 2.0 HDi 109	RHZ(DW10ATED)	02/99 ⇨ 04/03	
XANTIA I 2.0 HDi 90	RHY(DW10TD)	03/99 ⇨ 04/03	
XSARA 2.0 HDi	DW10TD	09/00 ⇨ 03/05	
XSARA 2.0 HDi 109	DW10ATED, DW10TD	05/01 ⇨ 08/05	
XSARA 2.0 HDi 90	DW10TD, 9HX(DV6ATED4)	02/99 ⇨ 08/05	
XSARA PICASSO 1.6 HDi	9HX(DV6ATED4), DW10TD	05/04 ⇨	
XSARA PICASSO 2.0 HDi	DW10TD, DW10ATED4	12/99 ⇨	

DS

DS5 2.0 HDi 165 Hybrid4 4x4	DW10ATED4, RHX	04/15 ⇨	
-----------------------------	----------------	---------	--

FIAT			
ULYSSE II 2.2 JTD	4HW(DW12ATED4)	08/02 ⇨ 08/06	

LANCIA			
PHEDRA 2.0 D Multijet	RHR(DW10ATED4)	07/06 ⇨ 11/10	
PHEDRA 2.0 JTD	RHK(DW10ATED4), 4HS	09/02 ⇨ 11/10	
PHEDRA 2.2 D Multijet	4HS, 4H01	03/08 ⇨ 11/10	
PHEDRA 2.2 JTD	4H01, 9HZ(DV6ATED4)	09/02 ⇨	
ZETA 2.0 JTD	RHZ(DW10ATED)	04/00 ⇨ 09/02	
ZETA 2.0 JTD 16V	RHW(DW10ATED4)	09/99 ⇨ 09/02	

PEUGEOT			
206 1.6 HDi 110	9HY(DV6ATED4), DW10TD	05/04 ⇨	
206 2.0 HDi	DW10TD, DW10TD	07/02 ⇨	
206 2.0 HDi 90	DW10TD, 9HV(DV6ATED4)	12/99 ⇨	
207 1.6 HDi	9HV(DV6ATED4), 9HZ(DV6ATED4)	02/06 ⇨	
207 CC 1.6 HDi	9HZ(DV6ATED4), 9HZ(DV6ATED4)	02/07 ⇨	
306 2.0 HDi 90	RHY(DW10TD)	06/99 ⇨ 12/02	
307 1.6 HDi	9HV(DV6ATED4), 9HY(DV6ATED4)	04/05 ⇨ 03/09	
307 1.6 HDi 110	9HY(DV6ATED4), 9HV(DV6ATED4)	02/04 ⇨ 03/09	
307 1.6 HDi 90	9HV(DV6ATED4), DW10ATED	12/06 ⇨ 04/08	
307 2.0 HDi	DW10ATED, DW10ATED	01/03 ⇨	
307 2.0 HDi 110	DW10ATED, DW10ATED4	08/00 ⇨ 12/09	
307 2.0 HDi 135	DW10ATED4, DW10TD	10/03 ⇨ 04/09	
307 2.0 HDi 90	DW10TD, 9HV(DV6ATED4)	08/00 ⇨ 04/08	
308 1.6 HDi	9HV(DV6ATED4), DW10ATED4	09/07 ⇨	
308 1.2 HDi	DW10ATED4, 4HK(DW12ATED4)	09/07 ⇨	
406 2.0 HDi 110	DW10ATED, DW10TD	08/01 ⇨ 10/04	
406 2.0 HDi 90	DW10TD, 4HX(DW12ATED4/FAP)	02/99 ⇨ 10/04	
406 2.2 HDi	4HX(DW12ATED4/FAP), 9HZ(DV6ATED4)	03/00 ⇨ 12/04	
407 1.6 HDi	DV6ATED4	08/04 ⇨ 12/10	
407 1.6 HDi 110	9HZ(DV6ATED4), DW10ATED4	05/04 ⇨	
407 2.0 HDi	DW10ATED4, DW10ATED4	11/04 ⇨	
407 2.0 HDi [ExtraEU]	DW10ATED4	11/04 ⇨ 10/07	
407 2.0 HDi 135	DW10ATED4, 4HP(DW12BATED4)	05/04 ⇨	
407 2.2 HDi	4HP(DW12BATED4), 4HR(DW12BATED4)	03/06 ⇨	
407 2.2 HDi 170	4HR(DW12BATED4), 9HZ(DV6ATED4)	05/06 ⇨	
508 1.2 HDi	DW10ATED4, DW10ATED4	11/10 ⇨	
508 1.2 HDi Hybrid4 AWC	DW10ATED4, DW10ATED4	11/10 ⇨	
508 1.2 HDi RXH Hybrid4	DW10ATED4, 4HL(DW12C)	11/10 ⇨	
508 1.2 HDi	4HL(DW12C), DW10ATED	11/10 ⇨	
607 2.0 HDi	DW10ATED, 4HP(DW12BATED4)	05/00 ⇨ 07/11	
607 2.0 HDi 110 FAP	RHS(DW10ATED)	12/04 ⇨	
607 2.0 HDi 135	RHL(DW10ATED4)	09/05 ⇨	
607 2.2 HDi	4HP(DW12BATED4), DW10ATED	02/00 ⇨	
806 2.0 HDi	DW10ATED, DW10ATED4	08/99 ⇨ 08/02	
806 2.0 HDi 16V	DW10ATED4, DW10ATED4	08/99 ⇨ 08/02	
807 2.0 HDi	DW10ATED4, 4HT(DW12BATED4)	06/02 ⇨	
807 2.2 HDi	4HT(DW12BATED4), DW10ATED	06/02 ⇨	
1007 1.6 HDi	9HZ(DV6ATED4), 9HY(DV6ATED4)	06/07 ⇨	
3008 1.6 HDi	9HZ(DV6ATED4), DW10CB	06/09 ⇨ 08/16	
3008 2.0 HDi	DW10CB, DW10ATED4	06/09 ⇨	
3008 2.0 HDi 150 / BlueHdi 150	DW10ATED4, DW10ATED4	06/09 ⇨ 08/16	
3008 2.0 HDi Hybrid4	DW10ATED4, 9HV(DV6ATED4)	02/11 ⇨ 08/16	
4007 2.2 HDi	4HK(DW12ATED4), DW10ATED	02/07 ⇨	
5008 1.6 HDi	9HZ(DV6ATED4), DW10CBFAPDTR	09/09 ⇨	
5008 2.0 HDi	DW10CBFAPDTR, DW10CB	09/09 ⇨	
5008 2.0 HDi 136 / BlueHdi 136	DW10CB, DW10ATED4	02/12 ⇨	
5008 2.0 HDi 150 / BlueHdi 150	DW10ATED4, DW10ATED4	06/09 ⇨	
EXPERT I 2.0 HDi	DW10ATED, DW10ATED4	07/00 ⇨ 12/06	
EXPERT I 2.0 HDi 16V	DW10ATED4, 9HU(DV6ATED4)	07/00 ⇨ 12/06	
EXPERT II 1.6 HDi 90 16V	9HU(DV6ATED4), DW10ATED4	01/07 ⇨	
EXPERT II 2.0 HDi 120	DW10ATED4, AHZ(DW10CD)	01/07 ⇨	
EXPERT II 2.0 HDi 120 4x4	RHK(DW10ATED4)	01/10 ⇨	
EXPERT II 2.0 HDi 130	AHZ(DW10CD), DW10ATED4	03/11 ⇨	
EXPERT II 2.0 HDi 130 4x4	AHZ(DW10CD)	01/12 ⇨	
EXPERT II 2.0 HDi 140	DW10ATED4, DW10ATED4	01/07 ⇨	
EXPERT II 2.0 HDi 165	DW10ATED4, 9HU(DV6ATED4)	09/09 ⇨	
EXPERT II TEPEE 1.6 HDi 90 16V	9HU(DV6ATED4), AHY(DW10CE)	01/07 ⇨	

PEUGEOT		
EXPERT II TEPEE 2.0 HDi 100	AHY(DW10CE), DW10UTED4	03/11 →
EXPERT II TEPEE 2.0 HDi 120	DW10UTED4, AHZ(DW10CD)	01/07 →
EXPERT II TEPEE 2.0 HDi 120 4x4	RHK(DW10UTED4)	01/07 →
EXPERT II TEPEE 2.0 HDi 130	AHZ(DW10CD), DW10BTED4	03/11 →
EXPERT II TEPEE 2.0 HDi 130 4x4	AHZ(DW10CD)	03/11 →
EXPERT II TEPEE 2.0 HDi 140	DW10BTED4, DW10CTED4	01/07 →
EXPERT II TEPEE 2.0 HDi 165	DW10CTED4, DV6AUTED4	09/09 →
PARTNER 1.6 HDi	DV6AUTED4, 9HW(DV6BTED4)	08/05 →
PARTNER I 1.6 HDi 75	9HW(DV6BTED4), 9HX(DV6ATED4)	02/06 →
PARTNER I 1.6 HDi 90	9HX(DV6ATED4), DW10TD	10/05 → 12/15
PARTNER I 2.0 HDi	DW10TD, 9HT(DV6BTED4)	02/00 → 07/08
PARTNER I 2.0 HDi 4x4	RHY(DW10TD)	04/04 → 08/05
PARTNER II 1.6 HDi	9HT(DV6BTED4), 9HS(DV6TED4BU)	04/08 →
PARTNER II 1.6 HDi 16V	9HS(DV6TED4BU), 9HS(DV6TED4BU)	04/08 →
PARTNER II 1.6 HDi 16V 4x4	9HS(DV6TED4BU), 9HT(DV6BTED4)	04/12 →
PARTNER II TEPEE 1.6 HDi	9HT(DV6BTED4), 9HV(DV6TED4)	04/08 →
PARTNER II TEPEE 1.6 HDi 16V	9HV(DV6TED4), DW10CTED4	04/08 →
RANCH 1.6 HDi 75	DV6B	02/06 →
RANCH 1.6 HDi 90	9HX(DV6ATED4)	02/06 →
RANCH 2.0 HDi	RHY(DW10TD)	02/00 →
RANCH 2.0 HDi 4x4	RHY(DW10TD)	04/04 →
RCZ 2.0 HDi	DW10CTED4, 1KR	03/10 → 12/15

9.0461



3

REVOLUTION AND TIMING (CKP AND CMP) SENSORS

Adatt./Suitable:

CITROËN

1920 HW

DAIHATSU

90919-0506

90919-05062

90919-05062-000

PEUGEOT

1920 HW

SUBARU

90919-05062

TOYOTA

90919-05062

90919-W5002

MARKET DIFFUSION: HIGH



L	L1	ohm	
---	62	2250	

CITROËN

C1 I 1.0	1KR, 1KR	06/05 →
C1 II 1.0VTi 68	1KR	04/14 →
C1 II 1.0VTi 72	1KR	06/18 →

DAIHATSU

CUORE VII 1.0	1KR-FE	04/07 →
CUORE VII 1.0 LPG	1KR-FE	09/11 → 12/12

PEUGEOT

107 1.0	1KR, 1KR	06/05 →
108 1.0VTi	1KR, 1KR-FE	05/14 →
108 1.0VTi 72	1KR	05/18 →

SUBARU

JUSTY IV 1.0	1KR-FE	01/07 →
JUSTY IV 1.0 BiFuel	1KR-FE	09/07 → 03/12

TOYOTA

AYGO I 1.0	1KR-FE	07/05 → 05/14
AYGO I 1.0 GPL	1KR-FE	07/05 → 05/14
AYGO I 1.0 VVTi	1KR-FE	07/05 → 05/14
AYGO II 1.0	1KR-FE	05/14 →
AYGO II 1.0 VVTi [ExtraEU]	1KR-FE	03/18 →
IQ 1.0	1KR-FE	01/09 → 12/15
VIOS / YARIS 1.0	1KR-FE	09/05 → 10/13

TOYOTA

VITZ 1.0 VVTi [ExtraEU]	1KR-FE	11/05 → 11/10
YARIS II 1.0 GPL	1KR-FE	01/06 → 12/11
YARIS II 1.0 VVT-i	1KR-FE	01/05 → 12/11
YARIS III 1.0	1KR-FE, 6FY(EW7A)	12/10 →
YARIS 1.0 VVTi	1KR-FE	07/14 →

9.0462



3

REVOLUTION AND TIMING (CKP AND CMP) SENSORS

Adatt./Suitable:

CITROËN

1920 8W

96 305 956 80

FIAT

9629139880

LANCIA

9629139880

PEUGEOT

1920 8W

96 305 956 80

MARKET DIFFUSION: MEDIUM



L	L1		
---	20,3	Hall Effect	

CITROËN

C4 I 2.0 16V	EW10A, 6FY(EW7A)	11/04 → 07/11
C4 I 2.0 VTR	EW10A	10/06 → 12/07
C4 II 2.0 Flex	RFL(EW10A)	11/09 →
C4 GRAND PICASSO I 1.8 i 16V	6FY(EW7A), EW10A	10/06 → 12/10
C4 GRAND PICASSO I 1.8 i 16V CNG	EW7ACNG	03/09 → 12/11
C4 GRAND PICASSO I 1.8 i 16V Flex	EW7A	06/09 → 01/13
C4 GRAND PICASSO I 2.0 i 16V	EW10A, EW10A	10/06 → 08/13
C4 PICASSO I 1.8 Bifuel	6FY(EW7A), 6FY(EW7A)	01/09 → 10/12
C4 PICASSO I 1.8 i 16V	6FY(EW7A), EW10A	02/07 → 12/11
C4 PICASSO I 2.0 i 16V	EW10A, 6FY(EW7A)	09/07 → 08/13
C5 I 1.8	EW7J4	09/04 → 08/05
C5 I 1.8 16V	6FY(EW7A), EW10A	03/01 →
C5 I 2.0	EW10A	11/04 → 01/08
C5 I 2.0 16V	EW10A, 6FY(EW7A)	03/01 →
C5 II 1.8 16V	6FY(EW7A), EW10A	02/08 →
C5 II 2.0 16V	EW10A, EW10A	02/08 →
C5 II 2.0 16V BioFlex	EW10A, EW10J4	02/08 →
C8 2.0	EW10J4, EW10A	07/02 →
C8 2.0 16V	EW10A, 3FZ(EW12J4)	09/05 →
C8 2.2	3FZ(EW12J4), EW10J4	07/02 →
EVASION 2.0 16V	EW10J4, EW10J4	05/00 → 07/02
JUMPER 2.0	XU10J2	02/02 → 06/06
JUMPER 2.0 BiFuel	XU10J2	02/02 → 06/06
JUMPER II 2.0	XU10J2	04/02 →
JUMPER II 2.0 bivalent	XU10J2	02/03 →
JUMPY I 2.0	EW10J4, EW10J4	04/00 → 12/06
JUMPY I 2.0 i 16V	EW10J4, EW10A	03/00 → 10/06
JUMPY II 2.0 i	EW10A, EW10J4	01/07 →
XSARA 2.0 [ExtraEU]	EW10J4	02/04 → 10/04
XSARA 2.0 16V	EW10J4, 6FZ(EW7J4)	09/00 → 08/05
XSARA PICASSO 1.8 16V	6FZ(EW7J4), EW10J4	02/00 →
XSARA PICASSO 2.0 16V	EW10J4, RFLCNG	01/03 →

FIAT

DUCATO II 2.0	RFL	04/02 →
DUCATO II 2.0 4x4	RFL	05/02 → 07/06
DUCATO II 2.0 Bipower	RFL	11/02 →
DUCATO 2.0 LPG	RFL	12/01 → 10/04
DUCATO 2.0 Natural Power	RFLCNG, RFN	06/03 → 07/12
SCUDO 2.0	RFN	09/99 → 10/06

FIAT

SCUDO I 2.0	RFN, RFN	05/00 → 12/06
SCUDO I 2.0 16V	RFN, RFN	06/00 → 12/06
ULYSSE I 2.0 16V	RFN(EW10J4)	09/00 → 08/02
ULYSSE II 2.0	RFN, EW10J4	08/02 → 06/11

LANCIA

PHEDRA 2.0	RFN(EW10J4)	09/02 → 11/10
ZETA 2.0 16V	RFN	07/00 → 09/02

PEUGEOT

206 2.0 16V	EW10J4, EW10J4S	07/02 → 02/07
206 2.0 RC	EW10J4S, EW10J4	07/03 →
206 2.0 S16	EW10J4, EW10J4	04/99 →
307 2.0	EW10J4, EW10A	03/02 → 06/05
307 2.0 16V	EW10A, EW10A	08/00 → 04/09
308 1.2.0 Bioflex	EW10A, EW10A	01/08 →
308 1.2.0 CVVT	EW10A, 6FZ(EW7J4)	07/09 → 11/14
406 1.8 16V	6FZ(EW7J4), EW10J4	10/00 → 10/04
406 1.8 BiFuel	EW7J4	09/00 → 05/04
406 2.0 16V	EW10J4, 3FZ(EW12J4)	08/00 → 12/04
406 2.2	3FZ(EW12J4), 6FZ(EW7J4)	07/00 → 12/04
407 1.8	6FZ(EW7J4), 6FY(EW7A)	05/04 →
407 1.8 16V	6FY(EW7A), EW10A	09/05 →
407 2.0	EW10J4, EW10A	03/04 →
407 2.0 16V	EW10A, EW10A	09/05 →
407 2.0 Bioflex	EW10A, 3FZ(EW12J4)	09/07 →
407 2.0 CVVT [ExtraEU]	EW10A	08/05 → 12/10
407 2.0 Flex [ExtraEU]	EW10A	10/05 → 02/11
407 2.2	3FZ(EW12J4), 3FY(EW12J4)	05/04 →
407 2.2 16V	3FY(EW12J4), EW10J4	09/05 →
607 2.0	EW10J4, 3FY(EW12J4)	02/00 → 08/05
607 2.2 16V	3FY(EW12J4), EW10J4	02/00 → 06/10
806 2.0 16V	RFN(EW10J4)	09/00 → 08/02
807 2.0	EW10J4, EW10A	06/02 →
807 2.0 16V	EW10A, 3FZ(EW12J4)	09/05 →
807 2.2	3FZ(EW12J4), RFL(XU10J2U)	06/02 →
BOXER 2.0 CNG	XU10J2CNG	07/03 → 03/06
BOXER I 2.0	RFL(XU10J2U), EW10J4	12/01 →
BOXER I 2.0 BiFuel	XU10J2	12/01 → 06/06
EXPERT I 2.0	EW10J4, EW10A	07/00 → 12/06
EXPERT II 2.0 16V	EW10A, EW10A	01/07 →
EXPERT II TEPEE 2.0 16V	EW10A, 8HT(DV4TD)	01/07 →

9.0463



3

REVOLUTION AND TIMING (CKP AND CMP) SENSORS

Adatt./Suitable:

BOSCH
0 986 280 427

CITROËN
1920 EJ
96 374 991 80
96 605 820 80

FORD
1 148 056
256Q-12K073-AA

MAZDA
Y401-18-230

PEUGEOT
1920 EJ
96 374 991 80

TOYOTA
SU001-00641

MARKET DIFFUSION: HIGH

L	L1		
---	63,1	Hall Effect	

CITROËN

C1 1.4 HDi	8HT(DV4TD), 8HX(DV4TD)	06/05 → 09/14
C2 1.4 HDi	8HX(DV4TD), 8HX(DV4TD)	09/03 →
C3 1.4 HDi	8HX(DV4TD), 8HX(DV4TD)	02/02 →
C3 I PLURIEL 1.4 HDi	8HX(DV4TD), 8HZ(DV4TD)	04/04 →
C3 II 1.4 HDi 70	8HZ(DV4TD), 8HS(DV4TED)	11/09 →
NEMO 1.4 HDi	8HS(DV4TED), 8HX(DV4TD)	02/08 →
XSARA 1.4 HDi	8HX(DV4TD), F6JA	01/03 →

FORD

FIESTA V 1.4 TDCi	F6JA, HHJA	11/01 → 12/10
FIESTA V 1.6 TDCi	HHJA, F6JB	11/04 → 06/08
FIESTA VI 1.4 TDCi	F6JB, F6JA	01/09 →
FUSION 1.4 TDCi	F6JA, F6JA	08/02 → 12/12

MAZDA

2 II 1.4 MZR-CD	Y404	01/08 → 06/15
2 I 1.4 CD	F6JA, 8HX(DV4TD)	04/03 → 06/07

PEUGEOT

107 1.4 HDi	8HT(DV4TD), 8HX(DV4TD)	06/05 → 05/14
206 1.4 HDi	8HX(DV4TD), 8HX(DV4TD)	09/01 →
206 1.4 HDi eco 70	8HX(DV4TD), 8HX(DV4TD)	09/01 →
206+ 1.4 HDi eco 70	8HX(DV4TD), 8HZ(DV4TD)	01/09 →
207 1.4 HDi	8HZ(DV4TD), 8HX(DV4TD)	02/06 →
307 1.4 HDi	8HX(DV4TD), 8HS(DV4TED)	10/01 → 06/05
307 1.4 HDi 70	8HZ(DV4TD)	03/02 → 06/05
1007 1.4 HDi	8HX(DV4TD), 8HT(DV4TD)	04/05 →
BIPPER 1.4 HDi	8HS(DV4TED), 8HS(DV4TED)	02/08 →
BIPPER TEEPE 1.4 HDi	8HS(DV4TED), BAG	04/08 →

TOYOTA

AYGO 1.4 HDi	2WZ-TV	07/05 → 08/10
--------------	--------	---------------

9.0464



3

REVOLUTION AND TIMING (CKP AND CMP) SENSORS

Adatt./Suitable:

AUDI
036 906 433
036 906 433 A
036 906 433 E
045 906 433 A

CHRYSLER
68025592AA
68040931AB
K68025592AA
K68040931AA
K68040931AB

DODGE
68025592AA
68040931AA
68040931AB
K68025592AA
K68040931AA
K68040931AB

JEEP
68025592AA
68040931AB
K68025592AA
K68040931AA
K68040931AB

MITSUBISHI
MN980249
MN980339
MN980415

MOPAR PARTS
68040931AB

SEAT
036 906 433
036 906 433 A
036 906 433 E
045 906 433 A

SKODA
036 906 433
036 906 433 A
036 906 433 E
045 906 433 A

VW
036 906 433
036 906 433 A
036 906 433 E
045 906 433 A

MARKET DIFFUSION: HIGH

L	L1		
---	23,9	Hall Effect	

AUDI

A3 II 1.6 FSI	BAG, BKC	08/03 → 09/07
A3 II 1.9 TDI	BKC, AZV	05/03 → 05/10
A3 II 2.0 TDI	AZV, BKD	05/03 → 08/12
A3 II 2.0 TDI 16V	BKD, BKD	05/03 → 08/12
A3 II 2.0 TDI 16V quattro	BKD, AZV	08/04 → 08/12
A3 II 2.0 TDI quattro	AZV, BLF	05/03 → 08/12
A3 II SPORTBACK 1.6 FSI	BLF, BKC	09/04 → 09/07
A3 II SPORTBACK 1.9 TDI	BKC, AZV	09/04 → 05/10
A3 II SPORTBACK 2.0 TDI	AZV, BKD	09/04 → 03/13
A3 II SPORTBACK 2.0 TDI 16V	BKD, BKD	09/04 → 03/13
A3 II SPORTBACK 2.0 TDI 16V quattro	BKD, BMM	11/05 → 03/13
A3 II SPORTBACK 2.0 TDI quattro	BMM, BNA	01/06 → 03/13
A4 III 2.0 TDI	BNA, BLB	11/04 → 06/08
A4 III 2.0 TDI 16V	BLB, BRD	11/04 → 06/08
A4 III 2.0 TDI quattro	BRD, BLB	06/06 → 06/08
A6 III 2.0 TDI	BLB, ECD	07/04 → 08/11

CHRYSLER

SEBRING III 2.0 CRD	ECD	07/07 → 12/10
---------------------	-----	---------------

DODGE

CALIBER 2.0 CRD	ECD, ECE	02/06 →
JOURNEY 2.0 CRD	ECE, ECD	06/08 →

JEEP

COMPASS 2.0 CRD	ECD, ECD	08/06 →
COMPASS 2.0 CRD 4x4	ECD, ECD	09/06 →
PATRIOT 2.0 CRD	ECD, ECD	02/07 →
PATRIOT 2.0 CRD 4x4	ECD, BSY	02/07 →

MITSUBISHI

GRANDIS 2.0 DI-D	BSY, BKD	09/05 → 03/10
LANCER IX 2.0 DI-D	BKD, BXW	01/08 →

MITSUBISHI

OUTLANDER II 2.0 DI-D	BSY	12/06 → 11/12
-----------------------	-----	---------------

SEAT

ALHAMBRA I / II 2.0 TDI	BRT	11/05 → 03/10
ALTEA 1.4 16V	BXW, BJB	05/06 →
ALTEA 1.9 TDI	BJB, AZV	04/04 →
ALTEA 2.0 TDI	AZV, BKD	03/04 →
ALTEA 2.0 TDI 16V	BKD, BXW	03/04 →
ALTEA XL 1.4 16V	BXW, BKC	10/06 →
ALTEA XL 1.9 TDI	BKC, AZV	10/06 →
ALTEA XL 1.9 TDI 4x4	BLS	06/09 → 12/10
ALTEA XL 2.0 TDI	AZV, BKD	10/06 →
ALTEA XL 2.0 TDI 16V	BKD, BMM	10/06 →
ALTEA XL 2.0 TDI 4x4	BMM, BBY	06/07 →
CORDOBA II 1.4 16V	BBY, BMS	09/02 →
CORDOBA II 1.4 TDI	BMS, ATD	06/05 → 11/09
CORDOBA II 1.6	BAH	04/03 → 11/09
CORDOBA II 1.9 TDI	ATD, BBY	09/02 → 11/09
IBIZA III 1.4 16V	BBY, BMS	02/02 → 11/09
IBIZA III 1.4 TDI	BMS, ATD	06/05 → 11/09
IBIZA III 1.6	BAH	02/03 → 11/09
IBIZA III 1.9 TDI	ATD, BLS	02/02 → 11/09
IBIZA IV 1.4 TDI	BMS	07/08 → 06/10
IBIZA IV 1.9 TDI	BLS, BXW	03/08 → 06/10
LEON II 1.4 16V	BXW, BKC	06/06 → 12/12
LEON II 1.9 TDI	BKC, AZV	07/05 → 12/10
LEON II 2.0 TDI	AZV, BKD	07/05 → 12/12
LEON II 2.0 TDI 16V	BKD, BJB	07/05 → 12/12
TOLEDO III 1.4 16V	BXW	05/06 → 05/09
TOLEDO III 1.9 TDI	BJB, AZV	10/04 → 05/09
TOLEDO III 2.0 TDI	AZV, AUA	09/04 → 05/09
TOLEDO III 2.0 TDI 16V	BKD	04/04 → 05/09

SKODA

FABIA I 1.4	BKY	05/04 → 12/07
FABIA I 1.4 16V	AUA, BMS	12/99 → 03/08
FABIA II 1.4 TDI	BMS, BLS	01/07 → 03/10
FABIA II 1.9 TDI	BLS, BJB	04/07 → 03/10
OCTAVIA II 1.4	BCA	05/04 → 05/06
OCTAVIA II 1.6 FSI	BLF	02/04 → 10/08
OCTAVIA II 1.9 TDI	BJB, BKC	06/04 → 12/10
OCTAVIA II 1.9 TDI 4x4	BKC, AZV	11/04 → 12/10
OCTAVIA II 2.0 TDI	AZV, AZV	02/04 → 05/10
OCTAVIA II 2.0 TDI 16V	AZV, BKD	02/04 → 05/13
OCTAVIA II 2.0 TDI 16V 4x4	BKD, BMN	05/10 → 02/13
OCTAVIA II 2.0 TDI 4x4	BMM	07/06 → 05/10
OCTAVIA II 2.0 TDI RS	BMN, BXW	04/06 → 02/13
ROOMSTER 1.4	BXW, BXW	09/06 → 05/15
ROOMSTER 1.4 LPG	BXW, BMS	03/10 → 05/15
ROOMSTER 1.4 TDI	BMS, BTS	09/06 → 03/10
ROOMSTER 1.6	BTS, BLS	09/06 → 05/15
ROOMSTER 1.6 LPG	BTS	06/06 → 07/10
ROOMSTER 1.9 TDI	BLS, BLS	09/06 → 03/10
SUPERB II 1.9 TDI	BLS, BKD	03/08 → 11/10
SUPERB II 2.0 TDI	BMP	03/08 → 05/10
SUPERB II 2.0 TDI 16V	BKD, BJB	01/09 → 05/15

VOLKSWAGEN (BR)

POLO 1.0	ARA	07/02 → 01/04
POLO 1.6	BAH	02/02 →

VW

CADDY III 1.4	BCA	03/04 → 05/06
CADDY III 1.9 TDI	BJB, BDJ	04/04 → 08/10
CADDY III 1.9 TDI 4motion	BLS	05/08 → 08/10
CADDY III 2.0 SDI	BDJ, BRR	03/04 → 08/10
CADDY III 2.0 TDI	BMM	09/07 → 08/10
CAMPMOBILE 1.9 TDI	BRR, BJJ	03/04 → 11/09
CRAFTER 2.5 TDI	BJJ, --	04/06 →
EOS 1.6 FSI	BLF	06/06 → 05/08
EOS 2.0 TDI	BMM	06/06 → 05/08
FOX 1.0	--, BJE	10/03 →
FOX 1.0 Alcohol	BJE, BAH	10/03 →
FOX 1.0 Total Flex	CCNA	03/08 →
FOX 1.4	BKR	04/05 → 12/09
FOX 1.6	BAH, BJA	10/03 → 08/14
FOX 1.6 Alcohol	--	10/03 →
FOX 1.6 Total Flex	BJA, BCA	10/03 → 08/14
GOLF IV 1.6 FSI	BAG	10/03 → 07/04
GOLF V 1.4 16V	BCA, BKG	10/03 → 12/13
GOLF V 1.4 FSI	BKG, BLG	10/03 → 11/06
GOLF V 1.4 TSI	BLG, BAG	11/05 → 12/13
GOLF V 1.6 FSI	BAG, BKC	10/03 → 07/08
GOLF V 1.9 TDI	BKC, BKC	10/03 → 07/09
GOLF V 1.9 TDI 4motion	BKC, AZV	08/04 → 07/09
GOLF V 2.0 SDI	BKD	01/04 → 11/08
GOLF V 2.0 TDI	AZV, BKD	10/03 → 12/13
GOLF V 2.0 TDI 16V	BKD, BLG	10/03 → 12/13
GOLF V 2.0 TDI 16V 4motion	BKD	08/04 → 11/08
GOLF V 2.0 TDI 4motion	AZV	08/04 → 07/09
GOLF VI 2.0 TDI	BMM	07/09 → 07/13
JETTA V 1.4 TSI	BLG, BKC	07/06 → 10/10

VW			
JETTA V 1.6 FSI	BLF	09/05 → 10/10	
JETTA V 1.9 TDI	BKC, AZV	01/05 →	
JETTA V 2.0 TDI	AZV, BKD	09/05 → 10/10	
JETTA V 2.0 TDI 16V	BKD, BRR	08/05 → 10/10	
MULTIVAN 1.9 TDI	BRR, BKC	01/06 → 11/09	
PASSAT V 1.4 TSI	CAXA	05/07 → 11/10	
PASSAT V 1.6 FSI	BLF	03/05 → 06/08	
PASSAT V 1.9 TDI	BKC, BMA	03/05 → 11/10	
PASSAT V 2.0 TDI	BMA, BKP	03/05 → 11/10	
PASSAT V 2.0 TDI 16V	BKP, BKP	03/05 → 11/10	
PASSAT V 2.0 TDI 16V 4motion	BKP, BBY	03/05 → 11/10	
PASSAT V 2.0 TDI 4motion	BMP	03/05 → 05/09	
POLO 1.6 [ExtraEU]	BAH	11/02 → 07/06	
POLO IV 1.0	ARA	02/03 → 10/03	
POLO IV 1.4	BBY, AUA	08/02 → 04/12	
POLO IV 1.4 16V	AUA, BMS	10/01 → 11/09	
POLO IV 1.4 BiFuel	BUD	05/06 → 11/09	
POLO IV 1.4 FSI	AXU	02/02 → 07/06	
POLO IV 1.4 TDI	BMS, ATD	04/05 → 11/09	
POLO IV 1.6	BAH	08/02 →	
POLO IV 1.6 [ExtraEU]	BAH	09/02 →	
POLO IV 1.6 16V	BTS	05/06 → 11/09	
POLO IV 1.9 TDI	ATD, BRT	10/01 → 11/09	
SHARAN I 2.0 TDI	BRT, BAH	11/05 → 03/10	
SPACEFOX / SPACE CROSS 1.6 FSI	BAH, BLG	03/06 →	
SPACEFOX / SPACE CROSS 1.6 Total Flex	BPA	03/06 →	
SPACEFOX / SPACE CROSS 1.9 SDI	ASY	09/07 →	
TOURAN I 1.4 FSI	BLG, BMY	11/06 → 05/10	
TOURAN I 1.4 TSI	BMY, BAG	02/06 → 05/10	
TOURAN I 1.6 FSI	BAG, AVQ	02/03 → 01/07	
TOURAN I 1.9 TDI	AVQ, BLX	02/03 → 05/10	
TOURAN I 2.0 FSI	BLX, AZV	10/03 → 01/07	
TOURAN I 2.0 TDI	AZV, BRR	02/03 → 05/10	
TOURAN I 2.0 TDI 16V	BKD	08/03 → 05/10	
TRANSPORTER V 1.4 Brasile	BTJ	12/05 →	
TRANSPORTER V 1.9 TDI	BRR, 1KR-FE	01/06 → 11/09	

TOYOTA			
AYGO I 1.0	1KR-FE	07/05 → 05/14	
AYGO I 1.0 GPL	1KR-FE	07/05 → 05/14	
AYGO II 1.0	1KR-FE	05/14 →	
AYGO II 1.0 VVTi [ExtraEU]	1KR-FE	03/18 →	
VIOS / YARIS 1.0	1KR-FE	09/05 → 10/13	
VIOS / YARIS 1.3	2SZ-FE	09/05 → 10/13	
YARIS II 1.0 GPL	1KR-FE	01/06 → 12/11	
YARIS II 1.0 VVT-i	1KR-FE	01/05 → 12/11	
YARIS II 1.3 VVT-i	2SZ-FE, 1KR	08/05 → 12/12	

9.0468

3

REVOLUTION AND TIMING (CKP AND CMP) SENSORS

Adatt./Suitable:

- CITROËN**
1920 GQ
96 445 492 80
- PEUGEOT**
1920 GQ



L	L1		+ OUT -
---	19,4	Hall Effect	

CITROËN			
C2 1.4 16V	ET3J4, ET3J4	06/06 →	
C3 1.4 16V	ET3J4, ET3J4	12/03 →	
C4 1.4 16V	ET3J4, ET3J4	11/04 → 07/11	
PEUGEOT			
206 1.4 16V	ET3J4, ET3J4	10/03 →	
207 1.4 16V	ET3J4, ET3J4	02/06 →	
307 1.4 16V	ET3J4, N6A(TU5JP4)	11/03 → 07/07	
1007 1.4 16V	ET3J4, ET3J4	10/05 →	

9.0465



3,5

REVOLUTION AND TIMING (CKP AND CMP) SENSORS

Adatt./Suitable:

- CITROËN**
2529 S8
- PEUGEOT**
2529 S8
- TOYOTA**
89413-70010
89413-70020

MARKET DIFFUSION: MEDIUM



L	L1	ohm	GND OUT
260	30,3	640	

CITROËN			
C1 I 1.0	1KR-FE, CFA(384F)	06/05 →	
PEUGEOT			
107 1.0	CFA(384F), 2SZ-FE	06/05 →	
107 1.4 HDi	8HT(DV4TD)	06/05 → 05/14	

9.0466



3

REVOLUTION AND TIMING (CKP AND CMP) SENSORS

Adatt./Suitable:

- BOSCH**
0 232 103 069
- CITROËN**
1920 HV
1920 NP
- PEUGEOT**
1920 HV
1920 NP
- TOYOTA**
90919-W5001
90919-W5003

MARKET DIFFUSION: HIGH



L	L1		+ OUT -
---	30	Hall Effect	

CITROËN			
C1 I 1.0	1KR, 1KR	06/05 →	
C1 II 1.0 VTi 68	1KR	04/14 →	
C1 II 1.0 VTi 72	1KR	06/18 →	
PEUGEOT			
107 1.0	1KR, 1KR	06/05 →	
108 1.0 VTi	1KR, 1KR-FE	05/14 →	
108 1.0 VTi 72	1KR	05/18 →	
TOYOTA			
AYGO I 1.0	1KR-FE	07/05 → 05/14	
AYGO I 1.0 GPL	1KR-FE	07/05 → 05/14	
AYGO I 1.0 VVTi	1KR-FE	07/05 → 05/14	
AYGO II 1.0	1KR-FE	05/14 →	
AYGO II 1.0 VVTi [ExtraEU]	1KR-FE	03/18 →	
VIOS / YARIS 1.0	1KR-FE	09/05 → 10/13	
VITZ 1.0 VVTi [ExtraEU]	1KR-FE	11/05 → 11/10	
YARIS II 1.0 GPL	1KR-FE	01/06 → 12/11	
YARIS II 1.0 VVT-i	1KR-FE	01/05 → 12/11	
YARIS III 1.0	1KR-FE, ET3J4	12/10 →	
YARIS 1.0 VVTi	1KR-FE	07/14 →	

9.0469



04,5

REVOLUTION AND TIMING (CKP AND CMP) SENSORS

Adatt./Suitable:

- CITROËN**
2529 29
- DACIA**
77 00 100 008
- FIAT**
7700100008
- LANCIA**
7700100008
- NISSAN**
31935-00QAA
- PEUGEOT**
2529 29
- RENAULT**
77 00 100 008

MARKET DIFFUSION: MEDIUM



L	L1	ohm	GND OUT
565	30	300	

CITROËN			
C3 I 1.4i	KFV(TU3JP)	02/02 →	
C3 I 1.6 16V	N6A(TU5JP4), K6E(TU3A)	02/02 →	
C3 II 1.1	HFX(TU1JP)	11/09 →	
C3 II 1.1 BiFuel	HFX(TU1A)	11/10 →	
C3 II 1.4	K6E(TU3A), HNV(EB2DTM)	11/09 →	
C3 II 1.4 HDi 70	8HZ(DV4TD)	11/09 →	
C3 II 1.4 LPG	KFT(TU3A)	07/10 →	
C3 II 1.6 Flex	NFX(TU5JP4)	11/09 →	

CITROËN		
C3 II 1.6 HDi 90	9HX(DV6ATED4)	11/09 →
C3 II 1.6 Vti 120	5FS(EP6C)	11/09 →
C3 III 1.2 THP 110	HMV(EB2DTM), RFJ(EW10A)	07/16 →
C3 III 1.2 Vti 82	HMZ(EB2F)	07/16 →
C3 PICASSO 1.6 HDi	9HX(DV6ATED4)	02/09 →
C4 I 1.6 16V	NFU(TU5JP4)	11/04 → 07/11
C4 I 1.6 16V Bio-Flex	N6A(TU5JP4), RHS(DW10ATED)	09/07 →
C4 I 1.6 16V Flex Fuel	N6A(TU5JP4)	02/09 →
C4 I 1.6 Flex	--	02/09 → 07/11
C4 I 1.6 THP 140	5FT(EP6DT)	07/08 → 07/11
C4 I 1.6 Vti 120	5FW(EP6)	07/08 → 07/11
C4 I 2.0 16V	RFJ(EW10A)	11/04 → 07/11
C4 GRAND PICASSO I 1.6 16V	5FT(EP6DT)	07/08 → 12/10
C4 GRAND PICASSO I 2.0 16V	RFJ(EW10A), N6A(TU5JP4)	10/06 → 08/13
C4 PICASSO I 1.6 THP 140	5FT(EP6DT)	07/08 → 08/13
C4 PICASSO I 2.0 i 16V	RFJ(EW10A)	09/07 → 08/13
C5 I 1.8 16V	6FZ(EW7J4)	03/01 → 08/04
C5 I 2.0 16V	RFJ(EW10A)	03/01 →
C5 I 2.0 HDi	RHS(DW10ATED), 9HU(DV6DTEDM)	03/01 → 08/04
C5 II 2.0 16V	RFJ(EW10A)	02/08 →
C5 II 2.0 16V BioFlex	RFJ(EW10A)	02/08 →
C8 2.0	RFN(EW10J4)	07/02 →
C8 2.0 16V	RFJ(EW10A)	09/05 →
C-ELYSEE 1.2 Vti 72	HMV(EB2M)	11/12 →
C-ELYSEE 1.2 Vti 82	EB2F	12/14 →
C-ELYSEE 1.6 BlueHdi 100	BHY(DV6FD)	11/14 →
C-ELYSEE 1.6 HDi 92	9HU(DV6DTEDM), F4R410	11/12 →
C-ELYSEE 1.6 Vti 115	NFP(ECS)	11/12 →
DS3 1.6 THP 150	5FN(EP6CDT)	01/10 → 07/15
DS3 1.6 THP 155	5FV(EP6CDT)	04/10 → 07/15
DS3 1.6 Vti 120	5FS(EP6C)	04/10 → 07/15
JUMPY I 2.0	RFN(EW10J4)	04/00 → 12/06
JUMPY I 2.0 i 16V	RFN(EW10J4)	03/00 → 10/06
XSARA 1.6 16V	NFU(TU5JP4)	09/00 → 08/05
XSARA 2.0 16V	RFN(EW10J4)	09/00 → 08/05
XSARA 2.0 HDi 109	RHZ(DW10ATED)	05/01 → 08/05
XSARA PICASSO 2.0 16V	RFN(EW10J4)	01/03 →

DACIA		
DUSTER 2.0	F4R410, K4M842	04/10 →
SANDERO II 1.6 16V	K4M842, K6C(TU3JP)	01/13 →

FIAT		
ULYSSE II 2.0	RFN(EW10J4)	08/02 → 06/11
ULYSSE II 2.0 JTD	RHM(DW10ATED4)	05/03 → 08/06

LANCIA		
PHEDRA 2.0	RFN(EW10J4)	09/02 → 11/10
PHEDRA 2.0 JTD	RHM(DW10ATED4)	07/03 → 11/10

NISSAN		
ALMERA III 1.6	K4M	11/12 →

PEUGEOT		
206 1.4	KFW(TU3JP)	07/02 → 02/07
206 1.4 i	K6C(TU3JP), N6A(TU5JP4)	04/05 →
206 1.6	NFU(TU5JP4)	09/01 → 12/08
206 1.6 16V	N6A(TU5JP4), KFT(TU3A)	07/00 →
206 1.6 LPG	NFU(TU5JP4)	07/02 →
206+ 1.6 16V	NFU(TU5JP4)	07/10 →
207 1.4	KFT(TU3A), 8FR(EP3)	02/06 →
207 1.4 16V	8FR(EP3), 8HR(DV4C)	02/06 →
207 1.4 Flex	KFW(TU3A)	11/08 →
207 1.4 HDi	8HR(DV4C), 5FS(EP6C)	02/06 →
207 1.6	N6A(TU5JP4)	08/08 →
207 1.6 16V	5FS(EP6C), 5FR(EP6DT)	02/06 →
207 1.6 16V RC	5FY(EP6DTS)	02/07 →
207 1.6 16V Turbo	5FR(EP6DT), 5FS(EP6C)	02/06 →
207 1.6 16V Vti	5FS(EP6C), 9HP(DV6DTE)	02/07 →
207 1.6 Bioflex	N6A(TU5JP4)	01/08 →
207 1.6 HDi	9HP(DV6DTE), 5FS(EP6C)	02/06 →
207 1.6 HDi 110	9HR(DV6C)	08/09 →
207 CC 1.6 16V	5FS(EP6C), 5FR(EP6DT)	02/07 →
207 CC 1.6 16V Turbo	5FR(EP6DT), 9HR(DV6C)	02/07 →
207 CC 1.6 HDi	9HR(DV6C), 9HF(DV6DTE)	02/07 →
301 1.2	HMZ(EB2F)	11/12 →
301 1.2 Vti 72	HMV(EB2M)	11/12 →
301 1.6 HDi 100	BHY(DV6FD)	11/12 →
301 1.6 HDi 90	9HF(DV6DTE), NFP(ECS)	11/12 →
301 1.6 Vti 115	NFP(ECS), N6A(TU5JP4)	11/12 →
307 1.6 16V	N6A(TU5JP4), --	08/00 →
307 1.6 BioFlex	--, RFJ(EW10A)	07/06 →
307 2.0	RFN(EW10J4)	03/02 → 06/05
307 2.0 16V	RFJ(EW10A), 5FT(EP6DT)	08/00 → 04/09
308 I 1.6 16V	5FT(EP6DT), RHM(DW10ATED)	09/07 →
308 I 2.0 Bioflex	RFJ(EW10A)	01/08 →
308 I 2.0 CVT	RFJ(EW10A)	07/09 → 11/14

PEUGEOT		
406 2.0 HDi 110	RHS(DW10ATED), RHM(DW10ATED4)	08/01 → 10/04
407 2.0	RFN(EW10J4)	03/04 →
407 2.0 16V	RFJ(EW10A)	09/05 →
407 2.0 Bioflex	RFJ(EW10A)	09/07 →
806 2.0 16V	RFN(EW10J4)	09/00 → 08/02
807 2.0	RFN(EW10J4)	06/02 →
807 2.0 16V	RFJ(EW10A)	09/05 →
807 2.0 HDi	RHM(DW10ATED4), K4J711	06/02 →
EXPERT I 2.0	RFN(EW10J4)	07/00 → 12/06

RENAULT		
CLIO II 1.4	E7J635	03/99 →
CLIO II 1.4 16V	K4J711, K4M838	02/00 → 07/08
CLIO II 1.6	K7M745	09/98 → 05/05
CLIO II 1.6 16V	K4M745	09/98 →
FLUENCE 1.6 16V	K4M838, E7J634	02/10 →
GRAND SCÉNIC II 1.6	K4M761	04/04 →
KANGOO I 1.4	E7J634, F4P771	08/97 →
KANGOO I 1.6 16V	K4M753	06/01 →
KANGOO I 1.6 16V 4x4	K4M753	10/01 →
LAGUNA I 1.9 dTi	F9Q717	10/97 → 03/01
LAGUNA I 2.0	F3R611	03/99 → 03/01
LAGUNA II 1.6 16V	K4M711	03/01 →
LAGUNA II 1.8 16V	F4P771, F9Q751	03/01 → 12/07
LAGUNA II 1.9 dCi	F9Q751, F4R713	03/01 →
LAGUNA II 2.0 16V	F4R713, K4J710	08/02 → 12/07
LAGUNA II 2.0 16V IDE	F5R701	04/01 → 09/07
LOGAN 1.6	K4M697	04/07 →
MEGANE I 1.4 16V	K4J710, E7J626	03/99 → 08/03
MEGANE I 1.4 e	E7J626, K4M700	01/96 → 08/03
MEGANE I 1.4 Eco	E7J624	01/96 → 03/99
MEGANE I 1.6	K7M704	02/00 → 09/00
MEGANE I 1.6 16V	K4M700, K7M702	05/00 →
MEGANE I 1.6 e	K7M702, F4P260	01/96 → 03/99
MEGANE I 1.6 i	K7M720	01/96 → 03/99
MEGANE I 1.6 LPG	K4M704	10/00 → 08/02
MEGANE I 1.8 16V	F4P260, F8Q284	07/00 → 08/03
MEGANE I 1.9	F8Q284, F8Q620	01/96 →
MEGANE I 1.9 D	F8Q620, F8Q620	04/96 → 08/03
MEGANE I 1.9 D Eco	F8Q620, F9Q718	01/96 → 08/03
MEGANE I 1.9 dCi	F9Q718, F8Q784	05/00 →
MEGANE I 1.9 dT	F8Q784, F9Q710	01/96 → 08/03
MEGANE I 1.9 DTi	F9Q710, F3R262	03/97 →
MEGANE I 1.9 TDI	F8Q784	09/96 → 08/03
MEGANE I 2.0	F3R262, F4R276	01/97 → 05/01
MEGANE I 2.0 16V	F4R276, F3R750	05/00 →
MEGANE I 2.0 i	F3R750, K4M760	01/96 → 08/03
MEGANE I 2.0 RT	F4R747	03/01 → 08/03
MEGANE II 1.6	K4M760, K4M760	08/03 →
MEGANE II 1.6 16V	K4M760, F9Q803	11/02 →
MEGANE II 1.9 dCi	F9Q803, K4M700	09/03 →
MEGANE SCÉNIC I 1.6 16V	K4M700, F9Q730	04/98 → 10/99
MEGANE SCÉNIC I 1.9 D	F8Q790	03/97 → 09/99
MEGANE SCÉNIC I 1.9 dTi	F9Q730, F3R750	04/97 → 09/99
MEGANE SCÉNIC I 2.0 i	F3R750, K4J714	01/97 → 09/99
SCÉNIC I 1.4 16V	K4J714, K4M708	09/99 → 08/03
SCÉNIC I 1.6	K4M708, F9Q732	03/01 → 09/03
SCÉNIC I 1.9 dCi	F9Q732, F9Q731	09/99 → 08/03
SCÉNIC I 1.9 dCi RX4	F9Q732	12/02 → 08/03
SCÉNIC I 1.9 dTi	F9Q731, F4R740	02/01 → 08/03
SCÉNIC I 2.0	F3R791	09/99 → 08/03
SCÉNIC I 2.0 16V	F4R740, AR32103	07/00 → 08/03
SCÉNIC II 1.6	K4M761	06/03 →
SCÉNIC II 1.6 16V	K4M813	10/05 →
SCÉNIC II 1.9 dCi	F9Q803	04/04 → 10/08
THALIA I 1.4 16V	K4J713	08/00 →
THALIA I 1.6	K4M745	01/01 →

REVOLUTION AND TIMING (CKP AND CMP) SENSORS

Adatt./Suitable:

ALFA ROMEO

9947855

CHEVROLET

8941160A030
93741836

DAEWOO

8941160A030

FIAT

9947855

GENERAL MOTORS

93 741 836

HYUNDAI

45584-H1070

LANCIA

9947855

Eliminated on 25-09-2017. Please verify the availability through our local distributors

• Eliminato il 25-09-2017. Verificare la disponibilità presso i nostri distributori

• Éliminé le 25-09-2017. Vérifier la disponibilité auprès de nos distributeurs sur place

• Am 25-09-2017 gestrichen. Evtl. Verfügbarkeit bitte bei unseren Händlern prüfen

• Eliminado en fecha 25-09-2017. Verificar la disponibilidad a través de nuestros distribuidores locales



L	L1	ohm	
---	28	500	

ALFA ROMEO

156 1.6 16V T.SPARK.	AR32103, 192B1.000	05/00 → 05/06
156 1.9 JTD	192B1.000, AR32310	05/01 →
156 1.9 JTD 16V	192A5.000	11/02 → 05/06
156 1.9 JTD 16V Q4	937A5.000	07/04 → 05/06
156 2.0 16V T.SPARK	AR32310, 932A2.000	05/00 → 06/02
156 2.0 JTS	932A2.000, 841C000	01/02 → 05/06
156 2.4 JTD	841C000, J3	03/02 → 05/06
156 2.5 V6 24V	AR32405	02/97 → 05/06
156 3.2 GTA	932A.000	03/02 → 05/06

CHEVROLET

LEGANZA 2.2	--	01/98 →
-------------	----	---------

DAEWOO

LEGANZA 2.2 16V	T22SED	04/99 → 12/02
-----------------	--------	---------------

FIAT

BRAVA 1.6 16V	182A4.000	02/96 → 10/01
BRAVO I 1.6 16V	182A4.000	03/96 → 10/01
MAREA 1.6 100 16V	182A4.000	09/96 → 05/02

HYUNDAI

TERRACAN 2.5 D	D4BH	06/01 → 10/03
TERRACAN 2.5 TD	D4BH	12/01 → 12/06
TERRACAN 2.9 CRDi	J3	11/01 → 07/03
TERRACAN 2.9 CRDi 4WD	J3, 839A4.000	12/01 → 12/06
TERRACAN 3.5 V6 4WD	G6CU	12/01 → 12/06

LANCIA

LYBRA 1.6 16V	182A4.000	07/99 → 10/05
LYBRA 1.8 16V	839A4.000, N43B16A	07/99 → 10/05
LYBRA 2.0 20V	185A8.000	09/00 → 10/05
LYBRA 2.4 20V	192A2.000	10/01 → 10/05

9.0471



3

REVOLUTION AND TIMING (CKP AND CMP) SENSORS

Adatt./Suitable:

BMW

1 438 082 F
12 14 1 435 351
12 14 1 438 082
12 14 7 506 273
12 14 7 518 628
7 506 273 C
7 518 628

SWF

602.137/2
602.336/2

¹⁴¹ Only for vehicles manufactured as from 01.06.1998

• Solo per vetture prodotte dal 01/06/1998

• Uniquement pour les véhicules fabriqués à partir du 01.06.98

• Nur für Fahrzeuge von 01.06.1998 hergestellt

• Sólo para vehículos fabricados a partir de 01.06.1998

MARKET DIFFUSION: MEDIUM



L	L1	Hall Effect	
---	28,2		

BMW			
1 1116 i	N43B16A, N43B20A	11/03 ⇒ 12/11	
1 1118 i	N43B20A, N46B20B	07/04 ⇒ 12/11	
1 1120 i	N46B20B, M43B16(164E3)	11/03 ⇒ 06/11	
3 III 316 i	M43B19(194E1)	12/98 ⇒ 08/00	
3 IV 316 Ci	M43B16(164E3), M43B16(164E3)	04/00 ⇒	
3 IV 316 i	M43B16(164E3), N40B16A	04/00 ⇒ 02/05	
3 IV 316 ti	N40B16A, M43B19(194E1)	06/01 ⇒ 02/05	
3 IV 318 Ci	M43B19(194E1), M43B19(194E1)	12/00 ⇒ 12/07	
3 IV 318 i	M43B19(194E1), N42B20A	09/01 ⇒ 02/05	
3 IV 318 ti	N42B20A, M52B20(20654)	03/01 ⇒ 12/04	
3 IV 320 Ci	M52B20(20654), M52B20(20654)	01/00 ⇒ 12/07	
3 IV 320 i	M52B20(20654), M52B25(25654)	09/00 ⇒ 02/05	
3 IV 323 Ci	M52B25(25654), -(24653)	04/99 ⇒ 09/00	
3 IV 323 i	-(24653), M54B25(25655)	03/98 ⇒ 12/03	
3 IV 325 Ci	M54B25(25655), -(24654)	09/00 ⇒	
3 IV 325 i	-(24654), M54B25(25655)	09/00 ⇒	
3 IV 325 ti	M54B25(25655), M54B25(25655)	06/01 ⇒ 02/05	
3 IV 325 xi	M54B25(25655), M52B28(28652)	09/00 ⇒ 02/05	
3 IV 328 Ci	M52B28(28652), M54B30(30653)	04/99 ⇒ 06/00	
3 IV 328 i	M52B28(28652)	02/98 ⇒ 06/00	
3 IV 330 Ci	M54B30(30653), M54B30(30653)	06/00 ⇒ 12/07	
3 IV 330 i	M54B30(30653), M54B30(30653)	06/00 ⇒ 04/05	
3 IV 330 xi	M54B30(30653), N45B16A	06/00 ⇒ 07/06	
3 V 316 i	N45B16A, N46B20B	09/05 ⇒ 10/11	
3 V 318 i	N46B20B, N46B20A	03/05 ⇒ 03/12	
3 V 320 i	N46B20A, M52B20(20653)	03/05 ⇒ 06/12	
3 V 320 si	N45B20A	09/05 ⇒ 08/06	
3 SERIES 316i Coupe	M43164E3	04/99 ⇒ 02/02	
5 IV 520 i	M52B20(20653), M52B25(25653)	09/00 ⇒ 05/04	
5 IV 523 i	M52B25(25653), M54B25(25655)	11/95 ⇒ 09/00	
5 IV 525 i	M54B25(25655), M52B28(28651)	09/00 ⇒ 05/04	
5 IV 528 i	M52B28(28651), M54B30(30653)	11/95 ⇒ 09/00	

BMW			
5 IV 530 i	M54B30(30653), M5422651	09/00 ⇒ 05/04	
5 IV M5	S62B50(50851)	10/98 ⇒ 06/03	
5 V 520 i	M5422651, M54B25(25655)	07/03 ⇒	
5 V 525 i	M54B25(25655), M5430653	09/03 ⇒ 12/10	
5 V 530 i	M5430653, M52B28(28651)	12/01 ⇒	
5 V 545 i	N62B44A	09/03 ⇒ 12/10	
6 II 645 Ci	N62B44A	01/04 ⇒ 08/05	
7 III 728 i, iL	M52B28(28651), M54B30(30653)	08/95 ⇒ 11/01	
7 III 728i X	M52B28(28651)	11/95 ⇒ 09/01	
7 IV 730 i, Li	M54B30(30653), M54B25(25655)	03/03 ⇒ 07/08	
7 IV 735 i, Li	N62B36A	11/01 ⇒ 02/05	
7 IV 745 i, Li	N62B44A	11/01 ⇒ 07/08	
7 IV B7 Alpina	H1	01/06 ⇒	
X3 I 2.0 i	N46B20B	07/05 ⇒ 08/08	
X3 I 2.5 i	M54B25(25655), M54B30(30653)	01/04 ⇒ 08/06	
X3 I 3.0 i xDrive	M54B30(30653), M54B30(30653)	01/04 ⇒ 08/06	
X3 I xDrive 20 i	N46B20B	09/08 ⇒ 08/11	
X5 I 3.0 i	M54B30(30653), N62B44A	05/00 ⇒ 12/06	
X5 I 4.4 i	N62B44A, M43B19(194E1)	12/03 ⇒ 09/06	
X5 I 4.8 is	N62B48A	04/04 ⇒ 09/06	
Z3 1.9 i	M43B19(194E1), M52B20(20654)	07/98 ⇒ 01/03	
Z3 2.0 i	M52B20(20654), M54B22(22651)	04/99 ⇒ 01/03	
Z3 2.2 i	M54B22(22651), M52B28(28651)	08/00 ⇒ 01/03	
Z3 2.8 i	M52B28(28651), M54B30(30653)	01/96 ⇒ 07/00	
Z3 3.0 i	M54B30(30653), N46B20A	06/00 ⇒ 06/03	
Z4 I 2.0 i	N46B20A, M54B22(22651)	03/05 ⇒ 02/09	
Z4 I 2.2 i	M54B22(22651), M54B25(25655)	10/03 ⇒ 10/05	
Z4 I 2.5 i	M54B25(25655), M54B30(30653)	02/03 ⇒ 12/05	
Z4 I 3.0 i	M54B30(30653), M50B20(20651)	02/03 ⇒ 10/05	
Z8 4.9	S62B50(50851)	06/00 ⇒ 06/03	

9.0472



3

REVOLUTION AND TIMING (CKP AND CMP) SENSORS

Adatt./Suitable:

BMW

1 709 616
12 14 1 709 616
12 14 1 744 492

LAND ROVER

NSC106100L

MG

NSC106100

ROVER

NSC106100

SIEMENS

S107230001Z

MARKET DIFFUSION: MEDIUM



L	L1	Hall Effect	
---	33		

BMW			
3 III 316 i	M43B19(194E1)	12/98 ⇒ 08/00	
3 III 320 i	M50B20(20651), M52B25(25653)	09/90 ⇒ 10/99	
3 III 323 i	M52B25(25653)	03/95 ⇒ 10/99	
3 III 323 i 2.5	M52B25(25653)	03/95 ⇒ 02/98	
3 III 323 ti	M52B25(25653), M43B16(164E3)	06/97 ⇒ 09/00	

BMW			
3 III 328 i	M52B28(28651)	08/94 ⇒ 12/99	
3 IV 316 Ci	M43B16(164E3), M43B16(164E3)	04/00 ⇒ 07/06	
3 IV 316 i	M43B16(164E3), M43B19(194E1)	04/00 ⇒ 02/05	
3 IV 318 Ci	M43B19(194E1), M43B19(194E1)	11/99 ⇒ 09/01	
3 IV 318 i	M43B19(194E1), M52B20(20654)	02/98 ⇒ 09/01	
3 IV 320 Ci	M52B20(20654), M52B20(20654)	01/00 ⇒ 12/07	
3 IV 320 i	M52B20(20654), M52B25(25654)	09/00 ⇒ 02/05	
3 IV 323 Ci	M52B25(25654), -(24653)	04/99 ⇒ 09/00	
3 IV 323 i	-(24653), M54B25(25655)	03/98 ⇒ 12/03	
3 IV 325 Ci	M54B25(25655), -(24654)	09/00 ⇒	
3 IV 325 i	-(24654), M54B25(25655)	09/00 ⇒	
3 IV 325 ti	M54B25(25655), M54B25(25655)	06/01 ⇒ 02/05	
3 IV 325 xi	M54B25(25655), M52B28(28652)	09/00 ⇒ 02/05	
3 IV 328 Ci	M52B28(28652), M52B28(28652)	04/99 ⇒ 06/00	
3 IV 328 i	M52B28(28652), M54B30(30653)	02/98 ⇒ 06/00	
3 IV 330 Ci	M54B30(30653), M54B30(30653)	06/00 ⇒ 12/07	
3 IV 330 i	M54B30(30653), M54B30(30653)	06/00 ⇒ 04/05	
3 IV 330 xi	M54B30(30653), M52B20(20653)	06/00 ⇒ 07/06	
3 SERIES 316i Coupe	M43164E3	04/99 ⇒ 02/02	
5 IV 520 i	M52B20(20653), M52B25(25653)	09/00 ⇒ 05/04	
5 IV 523 i	M52B25(25653), M54B25(25655)	11/95 ⇒ 09/00	
5 IV 525 i	M54B25(25655), M52B28(28651)	09/00 ⇒ 05/04	
5 IV 528 i	M52B28(28651), M54B30(30653)	11/95 ⇒ 09/00	
5 IV 530 i	M54B30(30653), M5422651	09/00 ⇒ 05/04	
5 V 520 i	M5422651, M54B25(25655)	07/03 ⇒	
5 V 525 i	M54B25(25655), M5430653	09/03 ⇒ 12/10	
5 V 530 i	M5430653, M52B28(28651)	12/01 ⇒	
7 III 728 i, iL	M52B28(28651), M54B30(30653)	08/95 ⇒ 11/01	
7 III 728i X	M52B28(28651)	11/95 ⇒ 09/01	
7 IV 730 i, Li	M54B30(30653), M54B25(25655)	03/03 ⇒ 07/08	
X3 I 2.5 i	M54B25(25655), M54B30(30653)	01/04 ⇒ 08/06	
X3 I 3.0 i xDrive	M54B30(30653), M43B19(194E1)	01/04 ⇒ 08/06	
X5 I 3.0 i	M54B30(30653)	05/00 ⇒ 12/06	
Z3 1.9 i	M43B19(194E1), M54B22(22651)	07/98 ⇒ 01/03	
Z3 2.0 i	M52B20(20654)	04/99 ⇒ 01/03	
Z3 2.2 i	M54B22(22651), M52B28(28651)	08/00 ⇒ 01/03	
Z3 2.8 i	M52B28(28651), M54B30(30653)	01/96 ⇒ 07/00	
Z3 3.0 i	M54B30(30653), M54B22(22651)	06/00 ⇒ 06/03	
Z4 I 2.2 i	M54B22(22651), M54B25(25655)	10/03 ⇒ 10/05	
Z4 I 2.5 i	M54B25(25655), M54B30(30653)	02/03 ⇒ 12/05	
Z4 I 3.0 i	M54B30(30653), N46B20B	02/03 ⇒ 10/05	

LAND ROVER

FREELANDER 2.5 V6 4x4 25KV6 11/00 ⇒ 10/06

ROVER

75 1.8 K1.8 02/99 ⇒ 05/05

75 1.8 Turbo -- 05/03 ⇒ 05/05

75 2.5 V6 KV6 02/99 ⇒ 05/05

9.0473



3

REVOLUTION AND TIMING (CKP AND CMP) SENSORS

Adatt./Suitable:

BMW
13 62 7 548 994
7 548 994



L	L1	Hall Effect	
---	28		

BMW			
11116 i	N45B16A	11/03 ⇨ 12/11	
11118 i	N46B20B, N46B20B	07/04 ⇨ 12/13	
11120 i	N46B20A, N40B16A	11/03 ⇨ 12/13	
1 SERIES 118i [ExtraEU]	N46B20B	09/04 ⇨ 02/08	
3 IV 316 Ci	N40B16A, N40B16A	10/01 ⇨	
3 IV 316 i	N40B16A, N40B16A	02/02 ⇨ 02/05	
3 IV 316 ti	N40B16A, N42B20A	06/01 ⇨ 02/05	
3 IV 318 Ci	N42B20A, N42B20A	12/00 ⇨ 12/07	
3 IV 318 i	N42B20A, N42B20A	09/01 ⇨ 02/05	
3 IV 318 ti	N42B20A, N45B16A	03/01 ⇨ 12/04	
3 V 316 i	N45B16A, N46B20B	09/05 ⇨ 10/11	
3 V 318 i	N46B20B, N46B20A	03/05 ⇨ 03/12	
3 V 320 i	N46B20A, N43B20A	03/05 ⇨ 12/13	
3 V 320 si	N45B20A	09/05 ⇨ 08/06	
5 V 520 i	N43B20A, N46B20B	04/06 ⇨ 03/10	
5 V 520Li	N46B20B, N46B20B	09/07 ⇨	
X1 sDrive 18 i	N46B20B, N52B25A	03/09 ⇨ 06/15	
X3 12.0 i	N46B20B	07/05 ⇨ 08/08	
X3 1 xDrive 20 i	N46B20B	09/08 ⇨ 08/11	
X3 1 xDrive 25 i	N52B25A, N46B20A	09/08 ⇨ 08/10	
Z4 12.0 i	N46B20A, K3-VE	03/05 ⇨ 02/09	

9.0476



04,5

REVOLUTION AND TIMING (CKP AND CMP) SENSORS

Adatt./Suitable:

BOSCH
0 281 002 512
FIAT
500371540
IVECO
0000500371540
500371540



L	L1	ohm	
260	24	900	

IVECO		
DAILY II 29 L 10	F1AE0481A	09/02 ⇨ 04/06

IVECO		
DAILY II 29 L 10 V	F1AE0481A	09/02 ⇨ 07/07
DAILY II 29 L 12	F1AE0481B	09/02 ⇨ 04/06
DAILY II 29 L 12 V	F1AE0481B	09/02 ⇨ 07/07
DAILY II 29 L 14	F1AE0481M	01/05 ⇨ 04/06
DAILY II 35 C 10 V, 35 S 10 V	F1AE0481A	09/02 ⇨ 04/06
DAILY II 35 C 12, 35 S 12	F1AE0481B	09/02 ⇨ 04/06
DAILY II 35 C 12 V, 35 S 12 V	F1AE0481B	09/02 ⇨ 07/07
DAILY II 35 C 14, 35 S 14	F1AE0481M	01/05 ⇨ 04/06
DAILY II 35 S 10	F1AE0481A	09/02 ⇨ 07/07
DAILY II 40 C 10	F1AE0481A	09/02 ⇨ 04/06
DAILY III 35 S 12, 35 C 12, 40 C 12	F1AE0481B	01/03 ⇨ 05/06
DAILY IV 26L11, 26L11D, 35C11D, 35S11, 40C11	F1AE3481A	09/11 ⇨ 02/14
DAILY IV 29L10	F1AE0481F	05/06 ⇨ 08/11
DAILY IV 29L10 V	F1AE0481F	05/06 ⇨ 08/11
DAILY IV 29L11 V, 35C11 V, 35S11 V, 40C11 V	F1AE3481A	09/11 ⇨ 02/14
DAILY IV 29L12	F1AE0481G	05/06 ⇨ 08/11
DAILY IV 29L12 V, 29L12 V/P	F1AE0481G	05/06 ⇨ 08/11
DAILY IV 29L13 V, 35C13 V, 35S13 V, 40C13 V, 40S13 V	F1AE3481B	09/11 ⇨ 02/14
DAILY IV 29L13, 29L13D, 35C13D, 40C13	F1AE3481B	09/11 ⇨ 02/14
DAILY IV 29L14	F1AE0481H	05/06 ⇨ 08/11
DAILY IV 29L14 C, 29L14 C/P, 29L14 V, 29L14 V/P	F1AE0481H	05/06 ⇨ 08/11
DAILY IV 29L15 V, 35C15L V, 40C15L V, 50C15L V	F1AE3481C	09/11 ⇨ 02/14
DAILY IV 29L15 V, 35S15 V, 35C15L V, 40C15L V, 50C15L V	F1AE3481C	09/11 ⇨ 02/14
DAILY IV 35C10 K	F1AE0481F	05/06 ⇨ 08/11
DAILY IV 35C10, 35S10	F1AE0481F	05/06 ⇨ 08/11
DAILY IV 35C11 K, 35C11 DK, 35S11 K, 35S11 DK	F1AE0481F	07/07 ⇨ 08/11
DAILY IV 35C11 V, 35S11 V	F1AE0481F	07/07 ⇨ 08/11
DAILY IV 35C11, 35S11, 35S11 D, 35S11 /P	F1AE0481F	07/07 ⇨ 08/11
DAILY IV 35C11K, 35S11DKP	F1AE3481A	09/11 ⇨ 02/14
DAILY IV 35C12	F1AE0481G	05/06 ⇨ 08/11
DAILY IV 35C12 V, 35C12 V/P, 35S12 V, 35S12 V/P	F1AE0481G	05/06 ⇨ 08/11
DAILY IV 35C12, 35S12	F1AE0481G	05/06 ⇨ 08/11
DAILY IV 35C13 K, 35C13 DK, 35S13 K, 35S13 DK	F1AE0481V	07/07 ⇨ 08/11
DAILY IV 35C13 V, 35C13 V/P, 35S13 V, 35S13 V/P	F1AE0481V	07/07 ⇨ 08/11
DAILY IV 35C13, 35C13 /P, 35S13 D, 35S13, 35S13 /P	F1AE0481V	07/07 ⇨ 08/11
DAILY IV 35C13K, 35C13DKP	F1AE3481B	09/11 ⇨ 02/14
DAILY IV 35C14, 35S14, 35S14 /P	F1AE0481H	05/06 ⇨ 08/11
DAILY IV 35C17 V, 35S17 V, 40C17 V, 45C17 V, 50C17 V, 60C17 V	F1CE3481C	09/11 ⇨ 02/14
DAILY IV 35S14 C, 35S14 C/P, 35S14 V, 35S14 V/P, 35C14 V,...	F1AE0481H	05/06 ⇨ 08/11
DAILY IV 35S14 K, 35S14 DK	F1AE0481H	07/07 ⇨ 08/11
DAILY IV 35S14, 35S14 /P	F1AE0481H	05/06 ⇨ 08/11
DAILY IV 40C10	F1AE0481F	05/06 ⇨ 08/11
DAILY IV 40C10 V	F1AE0481F	05/06 ⇨ 08/11
DAILY IV 40C11 V	F1AE0481F	07/07 ⇨ 08/11
DAILY IV 40C11, 40C11 D	F1AE0481F	07/07 ⇨ 08/11
DAILY IV 40C12	F1AE0481G	05/06 ⇨ 08/11
DAILY IV 40C12 V, 40C14 V/P	F1AE0481G	05/06 ⇨ 08/11
DAILY IV 40C13 V, 40C13 V/P	F1AE0481V	07/07 ⇨ 08/11
DAILY IV 40C13, 40C13 /P	F1AE0481V	07/07 ⇨ 08/11
DAILY V 33S11, 35S11, 35C11	F1AFL411A	03/14 ⇨ 04/16
DAILY V 33S12, 35S12	F1AGL411H	04/16 ⇨
DAILY V 33S12, 35S12, 35C12	F1AGL411H	04/16 ⇨
DAILY V 33S13, 35S13, 35C13	F1AFL411B	03/14 ⇨ 04/16
DAILY V 33S14, 35S14	F1AGL411J	04/16 ⇨
DAILY V 33S14, 35S14, 35C14	F1AGL411J	04/16 ⇨
DAILY V 33S15, 35S15, 35C15	F1AFL411C	03/14 ⇨ 04/16
DAILY V 33S16, 35S16	F1AGL411G	04/16 ⇨
DAILY V 33S16, 35S16, 35C16	F1AGL411G	04/16 ⇨
DAILY 2.3	F1AE0481A	07/99 ⇨ 02/14

9.0477



3

REVOLUTION AND TIMING (CKP AND CMP) SENSORS

Adatt./Suitable:

DAIHATSU
90919-0502
90919-05024
90919-05024-000
DENSO
029600-0590
SUBARU
90919-05024
TOYOTA
90919-05024

MARKET DIFFUSION: MEDIUM



L	L1	ohm	
---	30	2250	

DAIHATSU		
COPEN 1.3	K3-VE	03/06 ⇨ 09/12
CUORE VII 1.0	1KR-FE	04/07 ⇨
CUORE VII 1.0 LPG	1KR-FE	09/11 ⇨ 12/12
MATERIA 1.3	K3-VE	10/06 ⇨
MATERIA 1.5	3SZ-VE	10/06 ⇨
MATERIA 1.5 ECO 4WD	3SZ-VE	10/06 ⇨
MATERIA 1.5 LPG	3SZ-VE	01/10 ⇨ 12/11
SIRION 1.0	1KR-FE	01/05 ⇨ 06/13
SIRION 1.0 LPG	1KR-FE	01/05 ⇨ 06/13
SIRION 1.3	K3-VE, K3-VE	01/05 ⇨
SIRION 1.3 4WD	K3-VE, K3-VE	04/05 ⇨
SIRION 1.3 Rally	K3-VE	06/02 ⇨ 03/05
SIRION 1.3 Rally 4WD	K3-VE	06/02 ⇨ 03/05
SIRION 1.3 Sport	K3-VE, 3SZ-VE	08/00 ⇨ 01/05
SIRION 1.3 Sport 4WD	K3-VE2	08/00 ⇨ 03/05
SIRION 1.5	3SZ-VE	03/08 ⇨
TERIOS 1.3	K3-VE	09/01 ⇨ 10/05
TERIOS 1.3 4WD	K3-VE	10/00 ⇨ 10/05
TERIOS 1.3 VVT-i Turbo 4WD	K3-VE	10/02 ⇨ 10/05
TERIOS II 1.3 VVT-i 4x4	K3-VE	11/05 ⇨
TERIOS II 1.3 VVT-i LPG 4x4	K3-VE	01/09 ⇨ 12/09
TERIOS II 1.5 4x4	3SZ-VE	05/06 ⇨
TERIOS II 1.5 LPG 4x4	3SZ-VE	06/09 ⇨
TERIOS II 1.5 VVT-i 4x4	3SZ-VE	09/10 ⇨
TERIOS II 1.5 VVT-i RWD	3SZ-VE, 4A-FE	11/05 ⇨
YRV 1.3	K3-VE	02/01 ⇨
YRV 1.3 4WD	K3-VE	02/01 ⇨
YRV 1.3 GTi	K3VT	07/02 ⇨
SUBARU		
JUSTY IV 1.0	1KR-FE	01/07 ⇨
JUSTY IV 1.0 BiFuel	1KR-FE	09/07 ⇨ 03/12
TOYOTA		
AQUA 1.5 Hybrid	1NZ-FXE	12/11 ⇨
AVENSIS I 1.6	4A-FE, 2NZ-FE	09/97 ⇨ 10/00
AVENSIS I 1.8	7A-FE	09/97 ⇨ 10/00
COROLLA X 1.3 VVT-i	2NZ-FE	03/08 ⇨
COROLLA X 1.5	1NZ-FE	09/06 ⇨
COROLLA X 1.5 4WD	1NZ-FE	09/06 ⇨
COROLLA XI 1.5	1NZ-FE	05/12 ⇨
COROLLA XI 1.5 4WD	1NZ-FE	05/12 ⇨
COROLLA XI 1.5 Hybrid	1NZ-FXE	10/14 ⇨
ECHO 1.5 i 16V [USA]	1NZFE	08/99 ⇨
IQ 1.0	1KR-FE	01/09 ⇨ 12/15
PRIUS I 1.5 Hybrid	1NZ-FXE	05/00 ⇨ 01/04
PRIUS II 1.5	1NZ-FXE	09/03 ⇨ 12/09
PRIUS C 1.5 Hybrid	1NZ-FXE	12/11 ⇨
RACTIS 1.5 VVTi [ExtraEU]	1NZ-FE	07/11 ⇨
VIOS / YARIS 1.3	2NZ-FE, 1NZ-FE	09/05 ⇨ 10/13
VIOS / YARIS 1.3 4WD	2NZ-FE	09/05 ⇨ 04/13

TOYOTA			
VIOS / YARIS 1.5	1NZ-FE, 2NZ-FE	08/07	⇒
YARIS I 1.0	1SZ-FE, 1NZ-FE	03/03	⇒ 09/05
YARIS I 1.3	2NZ-FE	11/99	⇒ 10/05
YARIS I 1.5	1NZ-FE, 1NZ-FE	03/00	⇒ 11/05
YARIS II 1.3 4WD	2NZ-FE	08/07	⇒ 11/10
YARIS II 1.3 VVT-i	2NZ-FE	11/05	⇒ 12/12
YARIS II 1.5	1NZ-FE, 1NZ-FXE	11/05	⇒
YARIS III 1.3	2NZ-FE	12/11	⇒
YARIS III 1.5	1NZ-FE	12/10	⇒
YARIS III 1.5 Hybrid	1NZ-FXE, 2NZ-FE	03/12	⇒
YARIS VERSO 1.3	2NZ-FE, 1NZ-FE	11/02	⇒ 09/05
YARIS VERSO 1.5	1NZ-FE, 2NZ-FE	01/00	⇒ 09/05
YARIS 1.3 VVTi	2NZ-FE, 1SZ-FE	03/00	⇒ 09/05
YARIS 1.5 VVTi	1NZ-FE	03/00	⇒ 03/03

9.0478



3

REVOLUTION AND TIMING (CKP AND CMP) SENSORS

Adatt./Suitable:

TOYOTA
90919-05045
90919-05081
90919-05087

MARKET DIFFUSION: MEDIUM



L	L1	ohm	GND	OUT
---	62	1160	+	-

TOYOTA

AQUA 1.5 Hybrid	1NZ-FXE	12/11	⇒
COROLLA X 1.3 VVT-i	2NZ-FE	03/08	⇒
COROLLA X 1.5	1NZ-FE	09/06	⇒
COROLLA X 1.5 4WD	1NZ-FE	09/06	⇒
COROLLA XI 1.5	1NZ-FE	05/12	⇒
COROLLA XI 1.5 4WD	1NZ-FE	05/12	⇒
COROLLA XI 1.5 Hybrid	1NZ-FXE	10/14	⇒
ECHO 1.5 i 16V [USA]	1NZFE	08/99	⇒
PRIUS I 1.5 Hybrid	1NZ-FXE	05/00	⇒ 01/04
PRIUS II 1.5	1NZ-FXE	09/03	⇒ 12/09
PRIUS C 1.5 Hybrid	1NZ-FXE	12/11	⇒
RACTIS 1.5 VVTi [ExtraEU]	1NZ-FE	07/11	⇒
VIOS / YARIS 1.3	2NZ-FE, 1NZ-FE	09/05	⇒ 10/13
VIOS / YARIS 1.3 4WD	2NZ-FE	09/05	⇒ 04/13
VIOS / YARIS 1.5	1NZ-FE, 2NZ-FE	08/07	⇒
YARIS I 1.3	2NZ-FE	11/99	⇒ 10/05
YARIS I 1.5	1NZ-FE, 1NZ-FE	03/00	⇒ 11/05
YARIS II 1.3 4WD	2NZ-FE	08/07	⇒ 11/10
YARIS II 1.3 VVT-i	2NZ-FE	11/05	⇒ 12/12
YARIS II 1.5	1NZ-FE, 2NZ-FE	11/05	⇒
YARIS III 1.3	2NZ-FE	12/11	⇒
YARIS III 1.5	1NZ-FE	12/10	⇒
YARIS III 1.5 Hybrid	1NZ-FXE	03/12	⇒
YARIS VERSO 1.3	2NZ-FE, 1NZ-FE	11/02	⇒ 09/05
YARIS VERSO 1.5	1NZ-FE, A16XER	01/00	⇒ 09/05
YARIS 1.3 VVTi	2NZ-FE, 1NZ-FE	03/00	⇒ 09/05
YARIS 1.5 VVTi	1NZ-FE	03/00	⇒ 03/03

9.0480



3

REVOLUTION AND TIMING (CKP AND CMP) SENSORS

Adatt./Suitable:

ALFA ROMEO
55352609
FIAT
55352609
GENERAL MOTORS
24 405 977
25 192 205
55 352 609
OPEL
12 47 862
24405977
25192205
55352609
62 35 697
62 38 241
VAUXHALL
24405977
25192205
55352609

MARKET DIFFUSION: MEDIUM



L	L1	Hall Effect	+ - OUT
---	24	Hall Effect	+

ALFA ROMEO

159 1.8 MPI	939A4.000	06/05	⇒ 11/11
-------------	-----------	-------	---------

FIAT

CROMA II 1.8 16V	939A4.000	12/05	⇒
------------------	-----------	-------	---

OPEL

ASTRA H 1.6	A16XER, A18XER	12/06	⇒ 05/14
ASTRA H 1.6 EcoTec	Z16XER	10/06	⇒ 12/10
ASTRA H 1.6 LPG	Z16XER	08/09	⇒ 10/10
ASTRA H 1.8	A18XER, A16XER	08/05	⇒ 05/14
ASTRA J 1.6	Z16XER	12/06	⇒
ASTRA J 1.8	Z18XER	02/07	⇒
SIGNUM 1.8	Z18XER	09/05	⇒ 12/08
SIGNUM 2.2 direct	Z22YH	05/03	⇒ 09/08
VECTRA C 1.8	Z18XER	08/05	⇒ 08/08
VECTRA C 2.2 DGi	Z22YH	10/03	⇒ 08/08
VECTRA C 2.2 direct	Z22YH	10/03	⇒ 08/08
ZAFIRA B 1.6	A16XER, A18XER	01/08	⇒ 04/15
ZAFIRA B 1.6 FlexFuel	Z16XER	08/08	⇒ 12/12
ZAFIRA B 1.8	A18XER, A16XER	07/05	⇒ 04/15
ZAFIRA B 1.8 LPG	Z18XER	07/09	⇒ 04/15
ZAFIRA B 2.2	Z22YH	07/05	⇒ 12/12
ZAFIRA 1.8 ECOTEC	A18XER	01/11	⇒

VAUXHALL

ASTRA V 1.6	A16XER, A16XER	01/04	⇒ 05/09
ASTRA V 1.6 i 16V	A16XER, A18XER	10/06	⇒ 08/11
ASTRA V 1.8	A18XER, A16XER	01/04	⇒ 11/10
ASTRA V 1.8 i 16V	Z18XER	03/07	⇒ 11/10
SIGNUM 1.8	Z18XER	08/05	⇒ 05/08
SIGNUM 2.2 i	Z22YH	05/03	⇒ 05/08
VECTRA C 1.8	Z18XER	01/06	⇒ 07/08
VECTRA C 2.2 direct	Z22YH	01/02	⇒ 10/08
ZAFIRA B 1.6	A16XER, A18XER	12/07	⇒ 11/14
ZAFIRA B 1.8	A18XER, FUJA	04/05	⇒ 11/14
ZAFIRA B 2.2	Z22YH	07/05	⇒ 11/14

9.0481



3

REVOLUTION AND TIMING (CKP AND CMP) SENSORS

Adatt./Suitable:

FORD
1 062 545
1 066 383
1 079 388
1 085 854
1 087 548
98AB-9E731-AG
MAZDA
C202-21-551
SWF
602.149

- ¹¹⁶With clip
- Con clip
 - Avec agrafe
 - Mit Klammer
 - Con grapa

9.0481K

MARKET DIFFUSION: HIGH



L	L1	Hall Effect	+ - OUT
---	---	Hall Effect	+

FORD

FIESTA V 1.25 16V	FUJA, A9JA	05/02	⇒ 06/08
FIESTA V 1.3	A9JA, FXJA	11/01	⇒ 06/08
FIESTA V 1.4 16V	FXJA, F6JA	11/01	⇒ 06/08
FIESTA V 1.4 TDCi	F6JA, FYJA	11/01	⇒ 12/10
FIESTA V 1.6 16V	FYJA, HHJA	11/01	⇒ 06/08
FIESTA V 1.6 TDCi	HHJA, SNJA	11/04	⇒ 09/09
FIESTA V ST150	N4JB	03/05	⇒ 06/08
FIESTA VI 1.25	SNUA, --	06/08	⇒
FIESTA VI 1.4	--, RTJA	06/08	⇒
FIESTA VI 1.4 LPG	RTJA, F6JB	01/09	⇒
FIESTA VI 1.4 TDCi	F6JB, HHJC	01/09	⇒
FIESTA VI 1.6 TDCi	HHJC, HWDA	06/08	⇒
FIESTA VI 1.6 TDCi SOHC	--	02/10	⇒
FIESTA VI 1.6 Ti	USJA	12/10	⇒
FOCUS I 1.4 16V	FXDA, --	10/98	⇒ 11/04
FOCUS I 1.6 16V	--, EYDB	02/99	⇒ 11/04
FOCUS I 1.6 16V Flexifuel	FYDH	01/02	⇒ 11/04
FOCUS I 1.8 16V	EYDB, BHDA	10/98	⇒ 11/04
FOCUS I 1.8 BiFuel	EYDL	02/03	⇒ 01/05
FOCUS I 1.8 DI / TDDi	BHDA, F9DA	08/99	⇒ 11/04
FOCUS I 1.8 TDCi	F9DA, BHDA	03/01	⇒ 11/04
FOCUS I 1.8 Turbo DI / TDDi	BHDA, EDDB	10/98	⇒ 03/05
FOCUS I 2.0 16V	EDDB, ASDA	10/98	⇒ 11/04
FOCUS I RS	HMDA	10/02	⇒ 11/04
FOCUS I ST170	ALDA	03/02	⇒ 11/04
FOCUS II 1.4	ASDA, HWDA	07/04	⇒ 09/12
FOCUS II 1.6	HWDA, G8DA	07/04	⇒ 09/12
FOCUS II 1.6 TDCi	G8DA, HXDA	07/04	⇒ 09/12
FOCUS II 1.6 Ti	HXDA, Q7DA	07/04	⇒ 09/12
FOCUS II 1.6 Ti-VCT	--	12/07	⇒
FOCUS II 1.8	Q7DA, --	03/06	⇒ 09/12
FOCUS II 1.8 Flexifuel	--, KKDA	12/05	⇒ 09/12
FOCUS II 1.8 TDCi	KKDA, AODA	07/04	⇒ 09/12
FOCUS II 2.0	AODA, G6DA	07/04	⇒ 09/12
FOCUS II 2.0 CNG	SYDA	04/09	⇒ 07/11
FOCUS II 2.0 LPG	SYDA	06/08	⇒ 07/11
FOCUS II 2.0 TDCi	G6DA, --	07/04	⇒ 09/12
FOCUS II 2.5 RS	JZDA	01/09	⇒ 07/11
FOCUS II 2.5 ST	HYDA	10/05	⇒ 09/12
FOCUS C-MAX 1.6	HWDA, G8DA	10/03	⇒ 03/07
FOCUS C-MAX 1.6 TDCi	G8DA, HXDA	10/03	⇒ 03/07
FOCUS C-MAX 1.6 Ti	HXDA, CSDA	08/04	⇒ 03/07
FOCUS C-MAX 1.8	CSDA, AODA	10/03	⇒ 03/07
FOCUS C-MAX 1.8 Flexifuel	Q7DA	01/06	⇒ 03/07
FOCUS C-MAX 1.8 TDCi	KKDA	01/05	⇒ 03/07
FOCUS C-MAX 2.0	AODA, G6DA	03/04	⇒ 03/07
FOCUS C-MAX 2.0 TDCi	G6DA, FXDA	10/03	⇒ 03/07
FUSION 1.25	--, --	10/02	⇒
FUSION 1.3	--, --	08/02	⇒
FUSION 1.4	--, F6JA	08/02	⇒
FUSION 1.4 LPG	UTJA	01/10	⇒ 12/12
FUSION 1.4 TDCi	F6JA, FYJA	08/02	⇒ 12/12

FORD			
FUSION 1.6	FYJA, HHJA	08/02 → 11/08	
FUSION 1.6 TDCi	HHJA, FXJA	11/04 → 12/12	
FUSION 2.0	--	11/04 →	
MAZDA			
2 II 1.4 MZR-CD	Y404	01/08 → 06/15	
2 II 1.6 MZ-CD	Y406, FUJA	10/08 → 06/15	
2 I 1.2	FUJA	02/03 → 06/07	
2 I 1.25	FUJA	04/03 → 06/07	
2 I 1.3 L	ZJ-04	04/03 → 06/07	
2 I 1.4	FXJA, F6JA	02/03 → 06/07	
2 I 1.4 CD	F6JA, FYJA	04/03 → 06/07	
2 I 1.5	ZY-VE	04/03 → 06/07	
2 I 1.6	FYJA, Y406	02/03 → 06/07	

9.0481K



3

REVOLUTION AND TIMING (CKP AND CMP) SENSORS

Adatt./Suitable:

- ¹¹⁸ Without clip
- Senza clip
- Sans agrafe
- Ohne Klammer
- Sin grapa

9.0481

MARKET DIFFUSION: HIGH



L	L1		
---	---	Hall Effect	

FORD			
FIESTA V 1.25 16V	FUJA, A9JA	05/02 → 06/08	
FIESTA V 1.3	A9JA, FXJA	11/01 → 06/08	
FIESTA V 1.4 16V	FXJA, F6JA	11/01 → 06/08	
FIESTA V 1.4 TDCi	F6JA, FYJA	11/01 → 12/10	
FIESTA V 1.6 16V	FYJA, HHJA	11/01 → 06/08	
FIESTA V 1.6 TDCi	HHJA, SNJA	11/04 → 09/09	
FIESTA V ST150	N4JB	03/05 → 06/08	
FIESTA VI 1.25	SNJA, --	06/08 →	
FIESTA VI 1.4	--, RTJA	06/08 →	
FIESTA VI 1.4 LPG	RTJA, F6JB	01/09 →	
FIESTA VI 1.4 TDCi	F6JB, HHJC	01/09 →	
FIESTA VI 1.6 TDCi	HHJC, HWDA	06/08 →	
FIESTA VI 1.6 TDCi SOHC	--	02/10 →	
FIESTA VI 1.6 Ti	USJA	12/10 →	
FOCUS I 1.4 16V	FXDA, --	10/98 → 11/04	
FOCUS I 1.6 16V	--, EYDB	02/99 → 11/04	
FOCUS I 1.6 16V Flexifuel	FYDH	01/02 → 11/04	
FOCUS I 1.8 16V	EYDB, BHDA	10/98 → 11/04	
FOCUS I 1.8 BiFuel	EYDL	02/03 → 01/05	
FOCUS I 1.8 DI / TDDi	BHDA, F9DA	08/99 → 11/04	
FOCUS I 1.8 TDCi	F9DA, BHDA	03/01 → 11/04	
FOCUS I 1.8 Turbo DI / TDDi	BHDA, EDDB	10/98 → 03/05	
FOCUS I 2.0 16V	EDDB, ASDA	10/98 → 11/04	
FOCUS IRS	HMDA	10/02 → 11/04	
FOCUS I ST170	ALDA	03/02 → 11/04	
FOCUS II 1.4	ASDA, HWDA	07/04 → 09/12	
FOCUS II 1.6	HWDA, G8DA	07/04 → 09/12	
FOCUS II 1.6 TDCi	G8DA, HXDA	07/04 → 09/12	
FOCUS II 1.6 Ti	HXDA, Q7DA	07/04 → 09/12	
FOCUS II 1.6 Ti-VCT	--	12/07 →	
FOCUS II 1.8	Q7DA, --	03/06 → 09/12	
FOCUS II 1.8 Flexifuel	--, KKDA	12/05 → 09/12	
FOCUS II 1.8 TDCi	KKDA, AODA	01/05 → 09/12	
FOCUS II 2.0	AODA, G6DA	07/04 → 09/12	
FOCUS II 2.0 CNG	SYDA	04/09 → 07/11	
FOCUS II 2.0 LPG	SYDA	06/08 → 07/11	
FOCUS II 2.0 TDCi	G6DA, --	07/04 → 09/12	
FOCUS II 2.5 RS	JZDA	01/09 → 07/11	

FORD			
FOCUS II 2.5 ST	HYDA	10/05 → 09/12	
FOCUS C-MAX 1.6	HWDA, G8DA	10/03 → 03/07	
FOCUS C-MAX 1.6 TDCi	G8DA, HXDA	10/03 → 03/07	
FOCUS C-MAX 1.6 Ti	HXDA, CSDA	08/04 → 03/07	
FOCUS C-MAX 1.8	CSDA, AODA	10/03 → 03/07	
FOCUS C-MAX 1.8 Flexifuel	Q7DA	01/06 → 03/07	
FOCUS C-MAX 1.8 TDCi	KKDA	01/05 → 03/07	
FOCUS C-MAX 2.0	AODA, G6DA	03/04 → 03/07	
FOCUS C-MAX 2.0 TDCi	G6DA, FXDA	10/03 → 03/07	
FUSION 1.25	--, --	10/02 →	
FUSION 1.3	--, --	08/02 →	
FUSION 1.4	--, F6JA	08/02 →	
FUSION 1.4 LPG	UTJA	01/10 → 12/12	
FUSION 1.4 TDCi	F6JA, FYJA	08/02 → 12/12	
FUSION 1.6	FYJA, HHJA	08/02 → 11/08	
FUSION 1.6 TDCi	HHJA, FXJA	11/04 → 12/12	
FUSION 2.0	--	11/04 →	

MAZDA			
2 II 1.4 MZR-CD	Y404	01/08 → 06/15	
2 II 1.6 MZ-CD	Y406, E23	10/08 → 06/15	
2 I 1.2	FUJA	02/03 → 06/07	
2 I 1.25	FUJA	04/03 → 06/07	
2 I 1.3 L	ZJ-04	04/03 → 06/07	
2 I 1.4	FXJA, F6JA	02/03 → 06/07	
2 I 1.4 CD	F6JA, FYJA	04/03 → 06/07	
2 I 1.5	ZY-VE	04/03 → 06/07	
2 I 1.6	FYJA, Y406	02/03 → 06/07	

9.0482



3

REVOLUTION AND TIMING (CKP AND CMP) SENSORS

Adatt./Suitable:

- BOSCH**
- 0 281 002 123
- 0 281 002 124

- DAEWOO**
- 0031537228
- 0031537428

- MERCEDES-BENZ**
- 0031537228
- 0031537428
- A 003 153 72 28
- A 003 153 74 28

- SSANGYONG**
- 0031537228
- 0031537428
- 0031537428



L	L1	ohm	
---	40	1100	

DAEWOO			
KORANDO 2.0	E20	12/98 → 02/01	
KORANDO 2.0 16V	E20	02/99 →	
KORANDO 2.3	E23, M111.921	01/99 →	
MUSSO 2.3	M111.970	01/99 →	
MERCEDES-BENZ			
100 LI 2.3	M161.971	11/96 →	
CLASSE A I A 140	M166.940	07/97 → 08/04	
CLASSE A I A 160	M166.960	07/97 → 08/04	
CLASSE C I C 180	M111.921, M111.944	03/93 → 05/00	
CLASSE C I C 180 T	M111.921	06/96 → 09/00	
CLASSE C I C 200	M111.945	01/94 → 05/00	
CLASSE C I C 200 CDI	OM611.960	03/98 → 05/00	
CLASSE C I C 200 D	OM604.915	10/96 → 05/00	
CLASSE C I C 200 Kompressor	M111.944, OM604.910	10/95 → 05/00	
CLASSE C I C 200 T	M111.945	06/96 → 03/01	
CLASSE C I C 200 T CDI	OM611.960	03/98 → 03/01	
CLASSE C I C 200 T D	OM604.915	10/96 → 03/01	
CLASSE C I C 200 T Kompressor	M111.944	11/96 → 03/01	
CLASSE C I C 220 CDI	OM611.960	09/97 → 05/00	
CLASSE C I C 220 D	OM604.910, OM604.910	08/93 → 05/00	
CLASSE C I C 220 T CDI	OM611.960	09/97 → 03/01	
CLASSE C I C 220 T D	OM604.910, OM611.961	06/96 → 09/98	

MERCEDES-BENZ			
CLASSE C I C 230	M111.974	06/96 → 06/97	
CLASSE C I C 230 Kompressor	M111.975	10/95 → 05/00	
CLASSE C I C 230 T	M111.974	06/96 → 06/98	
CLASSE C I C 230 T Kompressor	M111.975	06/97 → 09/00	
CLASSE C I C 250 T Turbo-D	OM605.960	06/96 → 03/01	
CLASSE C I C 250 Turbo-D	OM605.960	10/95 → 05/00	
CLASSE CLK I 200	M111.945	06/97 → 06/02	
CLASSE CLK I 200 Kompressor	M111.944	06/97 → 06/00	
CLASSE CLK I 230 Kompressor	M111.975	06/97 → 06/00	
CLASSE E II E 200	M111.942	06/95 → 08/00	
CLASSE E II E 200 CDI	OM611.961, OM604.912	06/98 → 03/02	
CLASSE E II E 200 D	OM604.917	01/96 → 03/02	
CLASSE E II E 200 Kompressor	M111.947	06/97 → 03/02	
CLASSE E II E 200 T	M111.942	06/96 → 08/00	
CLASSE E II E 200 T Kompressor	M111.947	06/97 → 03/03	
CLASSE E II E 220 CDI	OM611.961	06/98 → 07/99	
CLASSE E II E 220 D	OM604.912, OM611.961	06/95 → 07/99	
CLASSE E II E 220 T CDI	OM611.961, M119.980	06/98 → 07/99	
CLASSE E II E 230	M111.970	06/95 → 06/97	
CLASSE E II E 230 T	M111.970	06/96 → 06/97	
CLASSE E II E 250 D	OM605.912	06/95 → 07/99	
CLASSE E II E 250 T D	OM605.912	06/96 → 07/99	
CLASSE E II E 250 T Turbo-D	OM605.962	06/97 → 07/99	
CLASSE E II E 250 Turbo-D	OM605.962	06/97 → 07/99	
CLASSE E II E 280	M104.945	01/96 → 06/97	
CLASSE E II E 290 T Turbo-D	OM602.982	06/96 → 07/99	
CLASSE E II E 290 Turbo-D	OM602.982	03/96 → 07/99	
CLASSE E II E 300 D	OM606.912	06/95 → 06/97	
CLASSE E II E 300 T Turbo-D	OM606.962	12/96 → 07/99	
CLASSE E II E 300 Turbo-D	OM606.962	12/96 → 07/99	
CLASSE E II E 320	M104.995	06/95 → 06/97	
CLASSE E II E 36 AMG	M104995AMG	04/96 → 01/98	
CLASSE E II E 420	M119.980, M119.980	01/96 → 06/97	
CLASSE E II E 420 T	M119.985	06/96 → 06/97	
CLASSE E II E 50 AMG	M119.980, OM602.980	02/96 → 08/97	
CLASSE E E 220 CDI	OM611.961	07/99 → 12/02	
CLASSE E E 220 d	OM605.912	06/96 → 06/98	
CLASSE E E 290 TD	OM602.982	07/96 → 07/99	
CLASSE G II G 320 GE	M104.996	09/94 → 11/97	
CLASSE G II G 290 TD	OM602.983	07/97 →	
CLASSE G II G 300 TD	OM606.964	08/96 → 07/00	
CLASSE G II G 320	M104.996	09/94 → 12/97	
CLASSE G II G 36 AMG	M104.996(AMG3.6)	01/95 → 07/98	
CLASSE S III 300 SE 2.8	M104.944	01/93 → 10/98	
CLASSE S III 300 SE, SEL/S320	M104.994	03/91 → 10/98	
CLASSE S III 400 SE, SEL/S420	M119.981	01/93 → 09/98	
CLASSE S III 600 SE, SEL	M120.982	04/91 → 12/92	
CLASSE S III S 280	M104.944	02/93 → 10/98	
CLASSE S III S 300 Turbo-D	OM606.961	05/96 → 10/98	
CLASSE S III S 500	M119.980	01/93 → 10/98	
CLASSE S III S 600	M120.982	01/93 → 09/99	
CLASSE S III SEC/CL 420	M119.981	10/94 → 02/99	
CLASSE S III SEC/CL 600	M120.982	09/92 → 02/99	
CLASSE SL IV 280	M104.943	08/93 → 10/01	
CLASSE SL IV 320	M104.991	09/93 → 10/01	
CLASSE SL IV 500	M119.982	09/92 → 10/01	
CLASSE SL IV 600	M120.983	07/92 → 10/01	
CLASSE SL IV 600 SL	M120.983	02/92 → 08/94	
CLASSE SLK I 200	M111.946	09/96 → 03/00	
CLASSE SLK I 200 Kompressor	M111.943	10/96 → 03/00	
CLASSE SLK I 230 Kompressor	M111.973	09/96 → 03/00	
SPRINTER I 210 D	OM602.980	01/97 → 04/00	
SPRINTER I 212 D	OM602.980	02/95 → 04/00	
SPRINTER I 310 D	OM602.980	01/97 → 12/99	
SPRINTER I 310 D 2.9	OM602.980	02/95 → 04/00	
SPRINTER I 310 D 2.9 4x4	OM602.980	06/97 → 04/00	
SPRINTER I 310 D 4x4	OM602.980	05/97 → 08/02	
SPRINTER I 312 D 2.9	OM602.980, OM602.981	02/95 → 09/01	
SPRINTER I 312 D 2.9 4x4	OM602.980	05/97 → 08/02	
SPRINTER I 410 D	OM602.980	02/96 → 05/06	
SPRINTER I 410 D 4x4	OM602.980	05/97 → 05/06	
SPRINTER I 412 D	OM602.980	02/96 → 05/06	
SPRINTER I 412 D 4x4	OM602.980	05/97 → 05/06	
SPRINTER I 414 D 4x4	OM602.980	05/97 → 05/06	
SPRINTER SERIES Sprinter 414	OM602.980	05/97 → 07/00	
UNIMOG	OM602.981, OM602.984	09/96 →	
VARIO 512 D	OM602.984	09/96 → 12/10	
VARIO 612 D	OM602.984, OM602.984	09/96 → 12/10	
VARIO 812 D	OM602.984, OM602.984	09/96 → 12/10	
VARIO O 812	OM602.984, E32	09/96 → 12/10	
PUCH			
G-MODELL 290 GD Turbo-diesel	OM602.983	04/97 → 12/01	
G-MODELL G 300 Turbodiesel	OM606.964	01/96 → 11/00	
G-MODELL G 320	M104.996	02/94 → 12/97	

PUCH		
G-MODELL G 36 AMG	M104.952(AMG3, 6)	01/95 ⇒ 04/98

9.0483



REVOLUTION AND TIMING (CKP AND CMP) SENSORS

Adatt./Suitable:

BOSCH
0 261 210 122
0 261 210 123

DAEWOO
0031537328
0031537528

MERCEDES-BENZ
0031537528
A 003 153 73 28
A 003 153 75 28

SSANGYONG
0031537328
0031537528



L	L1	ohm	GND OUT
---	40	1100	

DAEWOO		
KORANDO 3.2 4x4	E32, M104.992	01/99 ⇒
MUSSO 3.2 4x4	M104.992, M104.992(AMG3.6)	01/99 ⇒

MERCEDES-BENZ		
CLASSE C I C 220	M111.961	03/93 ⇒ 05/00
CLASSE C I C 280	M104.941	05/93 ⇒ 05/00
CLASSE C I C 36 AMG	M104.941(AMG3.6)	05/94 ⇒ 05/00
CLASSE E I E 220	M111.960	06/93 ⇒ 03/98
CLASSE E I E 220 T	M111.960	06/93 ⇒ 06/96
CLASSE E I E 280	M104.942	06/93 ⇒ 06/95
CLASSE E I E 280 T	M104.942	06/93 ⇒ 06/96
CLASSE E I E 320	M104.992	06/93 ⇒ 03/98
CLASSE E I E 320 T	M104.992	06/93 ⇒ 06/96
CLASSE E I E 36 AMG	M104.992(AMG3.6), E20M160	06/93 ⇒ 03/98
CLASSE E I E 36 T AMG	M104.992(AMG3.6)	05/94 ⇒ 06/96
CLASSE G II 320 GE	M104.996	09/94 ⇒ 11/97
CLASSE G II G 320	M104.996	09/94 ⇒ 12/97
CLASSE G II G 36 AMG	M104.996(AMG3.6)	01/95 ⇒ 07/98
CLASSE S III 300 SE 2.8	M104.944	01/93 ⇒ 10/98
CLASSE S III 300 SE, SEL/S320	M104.994	03/91 ⇒ 10/98
CLASSE S III S 280	M104.944	02/93 ⇒ 10/98
CLASSE SL IV 280	M104.943	08/93 ⇒ 10/01
CLASSE SL IV 320	M104.991	09/93 ⇒ 10/01
COUPE 220 CE	M111.960	10/92 ⇒ 05/93
COUPE 320 CE	M104.992	10/92 ⇒ 05/93
KOMBI II 220 TE	M111.960	10/92 ⇒ 05/93
KOMBI II 280 TE	M104.942	10/92 ⇒ 06/93
KOMBI II 320 TE	M104.992	10/92 ⇒ 06/93
TRE VOLUMI II 220 E	M111.960	10/92 ⇒ 06/93
TRE VOLUMI II 280 E	M104.942	10/92 ⇒ 06/93
TRE VOLUMI II 320 E	M104.992	10/92 ⇒ 06/93

PUCH		
G-MODELL G 320	M104.996	02/94 ⇒ 12/97
G-MODELL G 36 AMG	M104.952(AMG3, 6)	01/95 ⇒ 04/98

SSANGYONG		
KORANDO 2.0	E20M160, E23	05/97 ⇒ 10/02
KORANDO 2.3	E23, OM662	01/02 ⇒ 11/06
KORANDO 2.3 D	OM661	12/96 ⇒ 06/98
KORANDO 2.3 TDiC	OM661LA	07/98 ⇒ 11/06
KORANDO 2.3 TDiC 4x4	OM661LA	07/98 ⇒ 11/06
KORANDO 2.9 D	OM662, E32	12/96 ⇒ 10/00
KORANDO 2.9 TD	OM662LA	04/98 ⇒ 11/06
KORANDO 3.2	E32, M20B20	12/96 ⇒ 11/06

9.0485



REVOLUTION AND TIMING (CKP AND CMP) SENSORS

Adatt./Suitable:

BMW
12 14 1 713 007
12 14 1 720 852

BOSCH
0 261 210 060



L	L1	ohm	OUT GND S
670	24	550	

BMW			
3 II 320 i	M20B20, M20B27(276KA)	09/82 ⇒ 10/93	
3 II 325 e 2.7	M20B27(276KA), M20B25(256E1)	10/83 ⇒ 12/88	
3 II 325 i	M20B25(256E1), M20B25(256E1)	09/83 ⇒ 10/93	
3 II 325 i X	M20B25(256E1), M20B20(206KA)	03/86 ⇒ 10/93	
5 II 520 i	M20B20(206KA), M20B27(276EA)	08/85 ⇒ 12/87	
5 II 525 e	M20B27(276EA), 1S2-FE	09/81 ⇒ 12/87	
5 III 520 i	M20B20(206KA)	01/88 ⇒ 08/91	
5 III 525 i	M20B25(256K1)	01/88 ⇒ 08/91	
Z1 2.5	M20B25(256K1)	06/88 ⇒ 06/91	

9.0486



REVOLUTION AND TIMING (CKP AND CMP) SENSORS

Adatt./Suitable:

DENSO
029600-1280

TOYOTA
90080-19020



L	L1	ohm	GND OUT
---	32,7	2250	

TOYOTA		
VIOS / YARIS 1.3	2S2-FE	09/05 ⇒ 10/13
YARIS 1.1.0	1S2-FE, 2S2-FE	03/03 ⇒ 09/05
YARIS 1.1.3	2S2-FE	04/02 ⇒ 09/05
YARIS 1.1.3 VVT-i	2S2-FE, --	08/05 ⇒ 12/12

9.0487



REVOLUTION AND TIMING (CKP AND CMP) SENSORS

Adatt./Suitable:

CITROËN
2529 V1
96 491 911 80

DS
2529 V1

PEUGEOT
2529 V1

MARKET DIFFUSION: HIGH



L	L1	ohm	OUT GND
---	21,8	885	

CITROËN			
BERLINGO II 1.2 PureTech 110	--, N6A(TU5JP4)	02/16 ⇒	
BERLINGO II 1.6	N6A(TU5JP4), BHY(DV6FD)	04/08 ⇒	
BERLINGO II 1.6 BlueHdi 100	BHY(DV6FD), BHZ(DV6FC)	12/14 ⇒	
BERLINGO II 1.6 BlueHdi 100 4x4	BHY(DV6FD)	12/14 ⇒	
BERLINGO II 1.6 BlueHdi 120	BHZ(DV6FC), 9HN(DV6ETED)	12/14 ⇒	
BERLINGO II 1.6 HdI / BlueHdi 75	9HN(DV6ETED), 9HL(DV6C)	07/10 ⇒	
BERLINGO II 1.6 HdI 110	9HL(DV6C), 9HL(DV6C)	04/08 ⇒	
BERLINGO II 1.6 HdI 115	9HL(DV6C), 9HT(DV68TED4)	07/10 ⇒	
BERLINGO II 1.6 HdI 115 4x4	--	02/12 ⇒	
BERLINGO II 1.6 HdI 75	9HT(DV68TED4), 9HN(DV6ETED)	04/08 ⇒	
BERLINGO II 1.6 HdI 75 / BlueHdi 75	9HN(DV6ETED), 9HF(DV6DTEd)	04/08 ⇒	
BERLINGO II 1.6 HdI 75 16V	9HT(DV68TED4)	04/08 ⇒	
BERLINGO II 1.6 HdI 75 4x4	9HN(DV6ETED)	02/12 ⇒	
BERLINGO II 1.6 HdI 90	9HF(DV6DTEd), 9HS(DV6TED4BU)	04/08 ⇒	
BERLINGO II 1.6 HdI 90 16V	9HS(DV6TED4BU), K6E(TU3A)	04/08 ⇒	
BERLINGO II 1.6 HdI 90 4x4	9HF(DV6DTEd)	02/12 ⇒	
BERLINGO II 1.6 HdI 92	9HJ(DV6DTEdM)	07/10 ⇒	
BERLINGO II 1.6 Vti 120	5F5(EP6C)	11/09 ⇒	
BERLINGO II 1.6 Vti 95	5F5(EP6C)	07/10 ⇒	
C3 II 1.0 Vti 68	ZMZ(E80)	08/12 ⇒	
C3 II 1.1	HFX(TU1JP)	11/09 ⇒	
C3 II 1.1 BiFuel	HFX(TU1A)	11/10 ⇒	
C3 II 1.2 THP 110	HNZ(E82DT)	10/14 ⇒	
C3 II 1.2 Vti 82	HMZ(E82F)	06/12 ⇒	
C3 II 1.4	K6E(TU3A), 8HR(DV4C)	11/09 ⇒	
C3 II 1.4 16V	EP3C	11/09 ⇒	
C3 II 1.4 HdI 70	8HR(DV4C), 8FN(EP3)	11/09 ⇒	
C3 II 1.4 LPG	8FN(EP3), 9HJ(DV6DTEdM)	07/10 ⇒	
C3 II 1.4 Vti	8FR(EP3)	11/09 ⇒	
C3 II 1.4 Vti 95	8FP(EP3)	11/09 ⇒	
C3 II 1.6 BlueHdi 100	BHY(DV6FD)	07/14 ⇒	
C3 II 1.6 BlueHdi 75	BHW(DV6FE)	04/15 ⇒	
C3 II 1.6 Flex	NFX(TU5JP4)	11/09 ⇒	
C3 II 1.6 HdI	9HJ(DV6DTEdM), HNV(E82DTM)	11/09 ⇒	
C3 II 1.6 HdI 110	9HR(DV6C)	11/09 ⇒	
C3 II 1.6 HdI 115	9HD(DV6C)	09/12 ⇒	
C3 II 1.6 HdI 90	9HX(DV6ATED4)	11/09 ⇒	
C3 II 1.6 Vti 120	5F5(EP6C)	11/09 ⇒	
C3 III 1.2 THP 110	HNV(E82DTM), 8FN(EP3)	07/16 ⇒	
C3 III 1.2 Vti 82	HMZ(E82F)	07/16 ⇒	
C3 PICASSO 1.2 THP 110	HNZ(E82DT)	01/15 ⇒	
C3 PICASSO 1.4	EP3C	02/09 ⇒	
C3 PICASSO 1.4 Vti 95	8FN(EP3), 9HP(DV6DTEd)	02/09 ⇒	

CITROËN		
C3 PICASSO 1.4VTi 95 LPG	8FN(EP3)	01/12 →
C3 PICASSO 1.6 BlueHdi 100	BHY(DV6FD)	01/15 →
C3 PICASSO 1.6 Hdi	9HX(DV6ATED4)	02/09 →
C3 PICASSO 1.6 Hdi 110	9HR(DV6C)	05/10 →
C3 PICASSO 1.6 Hdi 115	9HD(DV6C)	01/13 →
C3 PICASSO 1.6 Hdi 90	9HP(DV6DTE), 5FS(EP6C)	07/10 →
C3 PICASSO 1.6 Vti 120	5FS(EP6C), BHY(DV6FD)	02/09 →
C4 I 1.6 Hdi	9HV(DV6TED4), DV6C	11/04 →
C4 I 1.6 BlueHdi 115	DV6C, 9HR(DV6C)	08/14 →
C4 II 1.6 Hdi	DV6C	11/09 →
C4 II 1.6 Hdi 110	9HR(DV6C), 9HD(DV6C)	11/09 →
C4 II 1.6 Hdi 115	9HD(DV6C), 5FV(EP6CDT)	07/12 →
C4 II 1.6 THP 155	5FV(EP6CDT), 9HY(DV6TED4)	11/09 →
C4 CACTUS 1.2 THP 110	HNZ(EB2DT)	09/14 →
C4 CACTUS 1.2 Vti 75	HMU(EB2D)	09/14 →
C4 CACTUS 1.2 Vti 82	HMZ(EB2F)	09/14 →
C4 CACTUS 1.5 BlueHdi 120	DV5RC	09/18 →
C4 CACTUS 1.6 BlueHdi 100	BHY(DV6FD), 5FX(EP6DT)	09/14 →
C4 CACTUS 1.6 Hdi 90	9HP(DV6DTE)	09/14 →
C4 GRAND PICASSO I 1.6 16V	5FX(EP6DT), 9HY(DV6TED4)	10/08 → 08/13
C4 GRAND PICASSO I 1.6 Hdi	9HY(DV6TED4), 9HL(DV6C)	10/06 → 06/11
C4 GRAND PICASSO I 1.6 Hdi 110	9HL(DV6C), RHJ(DW10BTED4)	09/10 →
C4 GRAND PICASSO I 1.6 THP 155	5FV(EP6CDT)	09/10 → 08/13
C4 GRAND PICASSO I 2.0 Hdi 138	RHJ(DW10BTED4), RFJ(EW10A)	10/06 → 12/13
C4 GRAND PICASSO I 2.0 Hdi 150	DW10CTED4	07/09 → 08/13
C4 GRAND PICASSO I 2.0 Hdi 165	DW10CTED4	09/10 → 08/13
C4 GRAND PICASSO I 2.0 i 16V	RFJ(EW10A), 9HC(DV6C)	10/06 → 08/13
C4 GRAND PICASSO II 1.2 THP 130	HNY(EB2DTS)	04/14 →
C4 GRAND PICASSO II 1.6 BlueHdi 100	BHY(DV6FD)	01/15 →
C4 GRAND PICASSO II 1.6 BlueHdi 120	BHZ(DV6FC)	07/14 →
C4 GRAND PICASSO II 1.6 Hdi / BlueHdi 115	9HC(DV6C), 9HP(DV6DTE)	09/13 →
C4 GRAND PICASSO II 1.6 Hdi 90	9HP(DV6DTE), AHX(DW10FD)	09/13 →
C4 GRAND PICASSO II 1.6 THP 155	5FV(EP6CDT)	09/13 →
C4 GRAND PICASSO II 1.6 THP 165	5GZ(EP6FDT)	07/14 →
C4 GRAND PICASSO II 1.6 Vti 120	5FS(EP6C)	09/13 →
C4 GRAND PICASSO II 2.0 BlueHdi 135	DW10FD	09/13 →
C4 GRAND PICASSO II 2.0 BlueHdi 135 Hybrid	AHS(DW10FD)	09/13 →
C4 GRAND PICASSO II 2.0 BlueHdi 150	AHX(DW10FD), 9HV(DV6TED4)	09/13 →
C4 PICASSO I 1.6 16V	5FX(EP6DT)	07/08 → 08/13
C4 PICASSO I 1.6 Hdi	9HY(DV6TED4), 9HL(DV6C)	02/07 → 08/13
C4 PICASSO I 1.6 Hdi 110	9HL(DV6C), 5FV(EP6CDT)	09/10 →
C4 PICASSO I 1.6 THP 155	5FV(EP6CDT), DW10BTED4	09/10 → 08/13
C4 PICASSO I 2.0 Hdi 138	DW10BTED4, EW10A	10/06 → 08/13
C4 PICASSO I 2.0 Hdi 150	DW10CTED4	07/09 → 08/13
C4 PICASSO I 2.0 Hdi 165	DW10CTED4	09/10 → 08/13
C4 PICASSO I 2.0 i 16V	EW10A, BHX(DV6FC)	09/07 → 08/13
C4 PICASSO II 1.2 THP 130	HNY(EB2DTS)	04/14 →
C4 PICASSO II 1.6 BlueHdi 100	BHY(DV6FD)	12/14 →
C4 PICASSO II 1.6 BlueHdi 120	BHZ(DV6FC)	07/14 →
C4 PICASSO II 1.6 Hdi / BlueHdi 115	BHX(DV6FC), 9HP(DV6DTE)	02/13 →
C4 PICASSO II 1.6 Hdi 90	9HP(DV6DTE), 9HL(DV6C)	02/13 →
C4 PICASSO II 1.6 THP 155	5FV(EP6CDT)	02/13 →
C4 PICASSO II 1.6 THP 165	5GZ(EP6FDT)	07/14 →
C4 PICASSO II 1.6 Vti 120	5FS(EP6C)	02/13 →
C4 PICASSO II 2.0 BlueHdi 135 Hybrid	AHS(DW10FD)	09/13 →
C4 PICASSO II 2.0 BlueHdi 150	DW10FD	09/13 →
C4 SPACETOURER 2.0 BlueHdi 150	DW10FD	04/18 →
C5 II 1.6 Hdi 110	9HL(DV6C), 9HL(DV6C)	07/10 →
C5 II 1.6 Hdi 115	9HL(DV6C), 5FS(EP6C)	01/12 →
C5 II 1.6 THP 150	5FN(EP6CDT)	04/09 →
C5 II 1.6 THP 155	5FV(EP6CDT)	04/09 →
C5 II 1.6 Vti 120	5FS(EP6C), 5FM(EP6DT)	07/10 →
DS3 1.4 Vti 95	8FP(EP3)	04/10 → 07/15

CITROËN		
DS3 1.4 Vti 95 LPG	8FN(EP3)	08/12 → 07/15
DS3 1.4 Vti 98	8FR(EP3)	11/09 → 07/15
DS3 1.6	5FM(EP6DT), 9HD(DV6C)	02/11 → 07/15
DS3 1.6 BlueHdi 100	BHY(DV6FD)	07/14 → 07/15
DS3 1.6 BlueHdi 115	BHX(DV6FC)	10/13 → 07/15
DS3 1.6 BlueHdi 120	BHZ(DV6FC)	10/13 → 07/15
DS3 1.6 Hdi 110	9HR(DV6C)	11/09 → 07/15
DS3 1.6 Hdi 115	9HD(DV6C), 9HP(DV6DTE)	08/12 → 07/15
DS3 1.6 Hdi 90	9HP(DV6DTE), 9HR(DV6C)	11/09 → 07/15
DS3 1.6 Racing	5FD(EP6DTS)	02/11 → 07/15
DS3 1.6 THP 150	5FX(EP6DT)	01/10 → 07/15
DS3 1.6 THP 155	5FR(EP6DT)	04/10 → 07/15
DS3 1.6 THP 165	5GZ(EP6FDT)	10/14 → 07/15
DS4 1.6 Hdi 110	9HR(DV6C), 9HD(DV6C)	04/11 → 07/15
DS4 1.6 Hdi 115	9HD(DV6C), 5FV(EP6CDT)	08/12 → 07/15
DS4 1.6 THP 155	5FV(EP6CDT), 9HR(DV6C)	04/11 → 07/15
DS5 1.6 Hdi 110	9HR(DV6C), DV6C	11/11 → 07/15
DS5 1.6 Hdi 115	DV6C, 5FM(EP6DT)	06/12 → 07/15
DS5 1.6 THP 155	5FV(EP6CDT)	11/11 → 07/15
DS5 1.6 THP 165	5FM(EP6DT), DW10CTED4	01/12 → 07/15
DS5 1.6 THP 165 Hybrid	5GZ(EP6FDT)	06/12 → 07/15
DS5 1.6 THP 200	5FU(EP6DTX)	11/11 → 07/15
DS5 1.6 THP 210	5GM(EP6DFTX)	11/14 → 07/15
DS5 2.0 BlueHdi 135 Hybrid	AHS(DW10FD)	11/11 → 07/15
DS5 2.0 BlueHdi 180	AHW(DW10FC)	08/13 → 07/15
DS5 2.0 Hdi 135	RHD(DW10CB)	11/11 → 07/15
DS5 2.0 Hdi 150 Hybrid	AHX(DW10FD)	11/11 → 07/15
DS5 2.0 Hdi 165	DW10CTED4, DW10CTED4	11/11 → 07/15
DS5 2.0 Hdi 165 Hybrid4 4x4	DW10CTED4, DV6C	12/11 → 07/15
DS5 2.0 Hdi 200 Hybrid4 Trazione integrale	DW10CTED4	12/11 → 07/15
GRAND C4 SPACETOURER 2.0 BlueHdi 150	DW10FD	04/18 →
DS		
DS 5 1.6 BlueHdi 115	DV6C, DW10CTED4	06/15 →
DS 5 1.6 BlueHdi 120	BHZ(DV6FC)	06/15 →
DS 5 1.6 THP 165	5GZ(EP6FDT)	07/15 →
DS 5 1.6 THP 210	5GM(EP6DFTX)	04/15 →
DS 5 2.0 BlueHdi 150	AHR(DW10FD)	04/15 →
DS 5 2.0 BlueHdi 180	AHW(DW10FC)	04/15 →
DS 5 2.0 Hdi 165 Hybrid4 4x4	DW10CTED4, HMZ(EB2)	04/15 →
DS3 1.6 BlueHdi 100	BHY(DV6FD)	04/15 →
DS3 1.6 BlueHdi 120	BHZ(DV6FC)	07/15 →
DS3 1.6 THP 165	5GZ(EP6FDT)	07/15 →
DS3 1.6 THP 208	5GR(EP6DFTX)	09/15 →
DS4 / DS4 CROSSBACK 1.6 BlueHdi 115	DV6FC	07/15 →
DS4 / DS4 CROSSBACK 1.6 BlueHdi 120	DV6FC	07/15 →
PEUGEOT		
208 1.0	ZMZ(EBO)	03/12 →
208 1.2	HMZ(EB2F)	03/12 →
208 1.2 GPL	HMZ(EB2F)	06/15 →
208 1.2 THP	HNZ(EB2DT)	01/13 →
208 1.2 Vti	HMZ(EB2)	09/13 →
208 1.4 GPL	EP3C	10/13 →
208 1.4 Hdi	8HP(DV4C), 8FS(EP3)	03/12 →
208 1.4 Vti	8FS(EP3), 5FS(EP6C)	03/12 →
208 1.6	5FS(EP6C), 9HP(DV6DTE)	02/12 →
208 1.6 BlueHdi 100	BHY(DV6FD)	01/15 →
208 1.6 BlueHdi 120	BHZ(DV6FC)	11/13 →
208 1.6 BlueHdi 75	BHW(DV6FE)	04/15 →
208 1.6 GTi	5FU(EP6CDTX)	08/12 →
208 1.6 Hdi	9HP(DV6DTE), 9HK(DV6ETEDM)	03/12 →
208 1.6 Hdi / BlueHdi 75	9HK(DV6ETEDM), 9HR(DV6C)	01/13 →
208 1.6 Hdi 90	9HV(DV6DTEDM)	03/12 →
208 1.6 THP 210	5GM(EP6DFTX)	04/15 →
308 I 1.6 Hdi	9HR(DV6C), 9HD(DV6CTED)	09/07 →
508 I 1.6 Hdi	9HD(DV6CTED), 5FH(EP6C)	11/10 →
508 I 1.6 Vti	5FH(EP6C), RHC(DW10CTED4)	11/10 →
508 I 2.0 Hdi	RHH(DW10CTED4)	11/10 →
508 I 2.0 Hdi Hybrid4 AWC	RHC(DW10CTED4), 5FK(EP6CB)	11/10 →
508 I 2.0 Hdi RXH Hybrid4	RHC(DW10CTED4)	11/10 →
2008 1.2 THP 110	HNZ(EB2DT)	01/15 →
2008 1.2 THP 130	HNY(EB2DTS)	01/15 →
2008 1.2 Vti	HMZ(EB2), 8HR(DV4C)	03/13 →
2008 1.4 Hdi	8HR(DV4C), 9HP(DV6DTE)	06/13 →
2008 1.6 BlueHdi	BHX(DV6FC)	07/14 →
2008 1.6 BlueHdi 100	BHY(DV6FD)	01/15 →
2008 1.6 BlueHdi 120	BHZ(DV6FC)	07/14 →
2008 1.6 BlueHdi 75	BHW(DV6FE)	01/15 →

PEUGEOT		
2008 1.6 Hdi	9HP(DV6DTE), 8HP(DV4C)	03/13 →
2008 1.6 Vti	5FS(EP6C)	03/13 →
3008 1.6 Hdi	9HR(DV6C), DV6C	06/09 → 08/16
3008 1.6 Hdi 115 / BlueHdi 115	DV6C, DW10CTED4(RHE)	02/13 → 08/16
3008 2.0 Hdi	RHH(DW10CTED4)	06/09 → 08/16
3008 2.0 Hdi 150 / BlueHdi 150	DW10CTED4(RHE), 9HR(DV6C)	06/09 → 08/16
3008 2.0 Hdi Hybrid4	RHC(DW10CTED4)	02/11 → 08/16
5008 1.6 Hdi	9HD(DV6CTED), 9HD(DV6CTED)	09/09 →
PARTNER II 1.6	5FK(EP6CB), 9HF(DV6DTE)	04/08 →
PARTNER II 1.6 BlueHdi 100	BHY(DV6FD)	04/15 →
PARTNER II 1.6 BlueHdi 120	BHZ(DV6FC)	04/15 →
PARTNER II 1.6 Hdi	9HF(DV6DTE), 9HN(DV6ETED)	04/08 →
PARTNER II 1.6 Hdi / BlueHdi 75	9HN(DV6ETED), 9HS(DV6TED4BU)	07/11 →
PARTNER II 1.6 Hdi 16V	9HS(DV6TED4BU), 9HS(DV6TED4BU)	04/08 →
PARTNER II 1.6 Hdi 16V 4x4	9HS(DV6TED4BU), HNV(EB2DTM)	04/12 →
PARTNER II 1.6 Hdi 90	9HP(DV6DTE)	04/10 →
PARTNER II TEPEE 1.2 THP	HNV(EB2DTM), 9HF(DV6DTE)	02/16 →
PARTNER II TEPEE 1.6 BlueHdi 100	BHY(DV6FD)	12/14 →
PARTNER II TEPEE 1.6 BlueHdi 120	BHZ(DV6FC)	12/14 →
PARTNER II TEPEE 1.6 Hdi	9HF(DV6DTE), 9HV(DV6TED4)	04/08 →
PARTNER II TEPEE 1.6 Hdi / BlueHdi 75	BHW(DV6FE)	01/15 →
PARTNER II TEPEE 1.6 Hdi 16V	9HV(DV6TED4), 9HJ(DV6DTEDM)	04/08 →
PARTNER II TEPEE 1.6 Hdi 90	9HJ(DV6DTEDM), 5FK(EP6CB)	04/10 →
PARTNER II TEPEE 1.6 Vti	5FK(EP6CB), M13A	04/08 →

9.0488

04,5

REVOLUTION AND TIMING (CKP AND CMP) SENSORS

Adatt./Suitable:

SUZUKI
24770-62JE0
24770-62JE0-000

TOYOTA
89413-52030



L	L1	ohm	
600	30,3	640	

SUZUKI		
SWIFT IV 1.3	M13A, D13A	02/05 →
SWIFT IV 1.3 DDiS	D13A, 1M2-FE	08/05 →
SWIFT IV 1.5	M15A	02/05 →
SWIFT IV 1.6	M16A	05/06 →
TOYOTA		
YARIS I 1.0	15Z-FE	03/03 → 09/05

9.0490



1

REVOLUTION AND TIMING (CKP AND CMP) SENSORS

Adatt./Suitable:

DENSO
029600-0251
029600-0680

LEXUS
90080-19009
90919-05012

TOYOTA
90080-19009
90919-05012



L	L1	ohm	GND OUT
---	28	2065	

LEXUS

RX I 300	1MZ-FE, 1MZ-FE	01/98 ⇨ 02/03
RX I 300 AWD	1MZ-FE, 1CD-FTV	10/00 ⇨ 05/03
RX II 300	1MZ-FE	05/03 ⇨ 12/08
RX II 400h	3MZ-FE	09/05 ⇨ 12/08
RX II 400h AWD	3MZ-FE	09/04 ⇨ 12/08

TOYOTA

AVALON 3.0 i [USA]	1MZ-FE	09/94 ⇨
AVENSIS I 2.0 D	1CD-FTV	09/02 ⇨ 02/03
AVENSIS I 2.0 D-4D	1CD-FTV, 1MZ-FE	10/99 ⇨ 02/03
AVENSIS II 2.0 D	1CD-FTV	08/01 ⇨ 08/05
AVENSIS II 2.0 D-4D	1CD-FTV	04/03 ⇨ 11/08
CAMRY 3.0	1MZ-FE, 1CD-FTV	08/96 ⇨ 11/06
CAMRY 3.0 24V	1MZ-FE	08/96 ⇨ 11/01
CAMRY 3.0 V6	1MZ-FE	08/96 ⇨ 11/01
CAMRY SOLARA I 3.0	1MZ-FE	06/98 ⇨ 11/02
CAMRY SOLARA II 3.0	1MZ-FE	07/03 ⇨ 11/08
COROLLA VIII 1.4	4E-FE	04/97 ⇨ 02/00
COROLLA VIII 2.0 D-4D	1CD-FTV, C16NZ	08/00 ⇨ 01/02
COROLLA IX 2.0 D4d	1CD-FTV	09/00 ⇨ 10/01
COROLLA IX 2.0 D-4D	1CD-FTV, 1CD-FTV	01/02 ⇨ 07/07
COROLLA 1.3 Efi	4E-FE	05/97 ⇨ 09/99
COROLLA VERSO I 2.0 D-4D	1CD-FTV, 1CD-FTV	09/01 ⇨ 07/04
COROLLA VERSO II 2.0 D-4D	1CD-FTV	04/04 ⇨ 03/09
PREVIA II 2.0 D-4D	1CD-FTV	03/01 ⇨ 01/06
RAV 4 II 2.0 D 4WD	1CD-FTV	05/01 ⇨ 11/05
SIENNA 3.0	1MZ-FE	08/97 ⇨ 12/02
TARAGO MPV / SPACE 2.0 TDi	1CD-FTV	10/03 ⇨ 12/05

9.0493



3,5

REVOLUTION AND TIMING (CKP AND CMP) SENSORS

Adatt./Suitable:

GENERAL MOTORS
90 486 211

HOLDEN
90486211

OPEL
12 38 111

⁰³ Supplied until depletion

- Fornibile fino ad esaurimento delle scorte
- Fourni jusqu'à épuisement du stock
- Lieferbar solange vorrat reicht
- Suministrado hasta el stock termina



L	L1	ohm	OUT GND
255	28	700	

HOLDEN

BARINA 1.4 i	C14NZ	04/94 ⇨ 07/97
COMBO 1.4 i	C14NZ	03/96 ⇨ 07/97
COMBO_SB 1.4i	C14NZ	04/94 ⇨ 07/97

OPEL

ASTRA F 1.4	14SE	09/92 ⇨ 09/98
ASTRA F 1.4 Si	C14SE	03/92 ⇨ 03/01
ASTRA F 1.6	16NZR	09/95 ⇨ 09/98
ASTRA F 1.6 i	C16NZ, C14NZ	09/91 ⇨ 01/05
COMBO B 1.4	C14NZ, C14NZ	07/94 ⇨ 10/01
COMBO B 1.4 16V	X14XE	08/99 ⇨ 10/01
CORSA B 1.4 i	C14NZ, C14SEL	03/93 ⇨ 09/00
CORSA B 1.4 i 16V	C14SEL, X14XE	09/94 ⇨ 12/02
TIGRA A 1.4 16V	X14XE, C16NZ	07/94 ⇨ 12/00

VAUXHALL

ASTRA III 1.4 i	C14SE	03/91 ⇨ 03/01
ASTRA III 1.6 i	C16NZ, C16NZ	09/91 ⇨ 12/98
ASTRAVAN I 1.6 i	C16NZ, C14NZ	10/91 ⇨ 08/98
COMBO B 1.4	C14NZ	07/94 ⇨ 10/01
COMBO B 1.4 16V	X14XE	08/99 ⇨ 10/01
CORSA B 1.4 i	C14NZ, D4CB	03/93 ⇨ 09/00
CORSA B 1.4 i 16V	X14XE	09/94 ⇨ 09/00
CORSAVAN I 1.4 i	C14NZ	01/94 ⇨ 09/00
TIGRA A 1.4 16V	X14XE	07/94 ⇨ 12/00

9.0494



04,5

REVOLUTION AND TIMING (CKP AND CMP) SENSORS

Adatt./Suitable:

HYUNDAI
39180-4A051
39180-4A111

KIA
39180-4A111



L	L1	ohm	S GND OUT
260	24	900	

HYUNDAI

H-1 I 2.5 CRDi	D4CB, C16NZ	07/01 ⇨
H-1 I 2.5 CRDi 4WD	D4CB	12/02 ⇨ 04/04
H-1 I 2.5 CRDi 4x4	D4CB	12/02 ⇨
H1 2.5 CRDi	D4CB	09/06 ⇨ 08/07

KIA

SORENTO I 2.5 CRDi	D4CB	08/02 ⇨
--------------------	------	---------

9.0495



3,5

REVOLUTION AND TIMING (CKP AND CMP) SENSORS

Adatt./Suitable:

GENERAL MOTORS
90 486 210

HOLDEN
90486210

OPEL
12 38 110

⁰³ Supplied until depletion

- Fornibile fino ad esaurimento delle scorte
- Fourni jusqu'à épuisement du stock
- Lieferbar solange vorrat reicht
- Suministrado hasta el stock termina



L	L1	ohm	GND OUT
440	28	480	

HOLDEN

BARINA 1.4 i	C14NZ	04/94 ⇨ 07/97
COMBO 1.4 i	C14NZ	03/96 ⇨ 07/97
COMBO_SB 1.4i	C14NZ	04/94 ⇨ 07/97

OPEL

ASTRA F 1.4	14SE	09/92 ⇨ 09/98
ASTRA F 1.4 Si	C14SE	03/92 ⇨ 03/01
ASTRA F 1.6	16NZR	09/95 ⇨ 09/98
ASTRA F 1.6 i	C16NZ, C14NZ	09/91 ⇨ 01/05
COMBO B 1.4	C14NZ, C14NZ	07/94 ⇨ 10/01
COMBO B 1.4 16V	X14XE	08/99 ⇨ 10/01
CORSA B 1.4 i	C14NZ, C14SEL	03/93 ⇨ 09/00
CORSA B 1.4 i 16V	C14SEL, X14XE	09/94 ⇨ 12/02
TIGRA A 1.4 16V	X14XE, C16NZ	07/94 ⇨ 12/00

VAUXHALL

ASTRA III 1.4 i	C14SE	03/91 ⇨ 03/01
ASTRA III 1.6 i	C16NZ, C16NZ	09/91 ⇨ 12/98
ASTRAVAN I 1.6 i	C16NZ, C14NZ	10/91 ⇨ 08/98
COMBO B 1.4	C14NZ	07/94 ⇨ 10/01
COMBO B 1.4 16V	X14XE	08/99 ⇨ 10/01
CORSA B 1.4 i	C14NZ, 1AD-FTV	03/93 ⇨ 09/00
CORSA B 1.4 i 16V	X14XE	09/94 ⇨ 09/00
CORSAVAN I 1.4 i	C14NZ	01/94 ⇨ 09/00
TIGRA A 1.4 16V	X14XE	07/94 ⇨ 12/00

9.0497



3

**REVOLUTION AND TIMING (CKP AND CMP)
SENSORS**

Adatt./Suitable:

DENSO
029600-0740
LEXUS
90919-05029
SUBARU
90919-05029
TOYOTA
90919-05029

MARKET DIFFUSION: **MEDIUM**

L	L1	ohm	
---	30	1200	

LEXUS

IS II 200d	2AD-FTV	07/10 ⇨ 07/12
IS II 220d	2AD-FHV	08/05 ⇨ 07/12
LX 450d	1VD-FTV	09/15 ⇨

SUBARU

TREZIA 1.4 D	1ND-TV	03/11 ⇨
--------------	--------	---------

TOYOTA

AURIS I 1.4 D-4D	1ND-TV	03/07 ⇨ 04/13
AURIS I 2.0 D-4D	1AD-FTV	03/07 ⇨ 09/12
AURIS I 2.2 D	2AD-FHV	11/06 ⇨ 09/12
AURIS II 1.4 D-4D	1ND-TV	10/12 ⇨
AVENSIS II 2.0 D-4D	1AD-FTV	03/06 ⇨ 11/08
AVENSIS II 2.2 D-4D	2AD-FTV	10/05 ⇨ 11/08
AVENSIS II 2.2 D-CAT	2AD-FHV	07/05 ⇨ 11/08
AVENSIS III 2.0 D-4D	1AD-FTV, 2AD-FHV	11/08 ⇨
AVENSIS III 2.2 D-4D	2AD-FHV, 2AD-FHV	11/08 ⇨
COROLLA X 1.4 D-4D	1ND-TV	10/06 ⇨ 07/14
COROLLA X 2.0 D-4D	1AD-FTV	11/06 ⇨ 07/14
COROLLA XI 1.4 D-4D	1ND-TV	06/13 ⇨
COROLLA VERSO II 2.2 D-4D	2AD-FHV, 1VD-FTV	10/05 ⇨ 03/09
IQ 1.4 D-4D	1ND-TV	01/09 ⇨ 12/15
LAND CRUISER 200 4.5 D V8	1VD-FTV	01/08 ⇨
LAND CRUISER 200 4.5 D-4D	1VD-FTV	01/08 ⇨
LAND CRUISER 200 4.5 D4-D	1VD-FTV, 2AD-FHV	08/07 ⇨
RAV 4 IV 2.2 D 4WD	2AD-FHV, FXDA	12/12 ⇨
RAV 4 III 2.2 D	2AD-FHV, 2AD-FHV	12/08 ⇨ 06/13
RAV 4 III 2.2 D 4WD	2AD-FHV, 2AD-FHV	11/05 ⇨ 06/13
URBAN CRUISER 1.4 D-4D	1ND-TV	01/09 ⇨ 04/14
URBAN CRUISER 1.4 D-4D 4WD	1ND-TV	01/09 ⇨ 04/14
VERSO 2.0 D-4D	1AD-FTV	04/09 ⇨
VERSO 2.2 D-4D	2AD-FHV	04/09 ⇨
VERSO 2.2 D-CAT	2AD-FHV	04/09 ⇨
VERSO S 1.4 D4-D	1ND-TV	11/10 ⇨ 10/16
YARIS II 1.4 D-4D	1ND-TV	08/05 ⇨ 12/12
YARIS III 1.4 D	1ND-TV	09/11 ⇨
YARIS 1.4 D4d	1ND-TV	07/14 ⇨

9.0498



3

**REVOLUTION AND TIMING (CKP AND CMP)
SENSORS**

Adatt./Suitable:

FORD
1 048 905
1 057 051
1 066 382
1 136 248
97BB-9E731-AE
JAGUAR
C25 2688
SWF
602.520

MARKET DIFFUSION: **HIGH**

L	L1		
---	37,3	Hall Effect	

FORD

FOCUS I 1.4 16V	FXDA, --	10/98 ⇨ 11/04
FOCUS I 1.6 16V	--, EYDB	02/99 ⇨ 11/04
FOCUS I 1.6 16V Flexifuel	FYDH	01/02 ⇨ 11/04
FOCUS I 1.8 16V	EYDB, BHDA	10/98 ⇨ 11/04
FOCUS I 1.8 BiFuel	EYDL	02/03 ⇨ 01/05
FOCUS I 1.8 DI / TDDi	BHDA, F9DA	08/99 ⇨ 11/04
FOCUS I 1.8 TDCi	F9DA, BHDA	03/01 ⇨ 11/04
FOCUS I 1.8 Turbo DI / TDDi	BHDA, EDDB	10/98 ⇨ 03/05
FOCUS I 2.0 16V	EDDB, ASDA	10/98 ⇨ 11/04
FOCUS I RS	HMDA	10/02 ⇨ 11/04
FOCUS I ST170	ALDA	03/02 ⇨ 11/04
FOCUS II 1.4	ASDA, HWDA	07/04 ⇨ 09/12
FOCUS II 1.6	HWDA, G8DA	07/04 ⇨ 09/12
FOCUS II 1.6 TDCi	G8DA, HXDA	07/04 ⇨ 09/12
FOCUS II 1.6 Ti	HXDA, Q7DA	07/04 ⇨ 09/12
FOCUS II 1.6 Ti-VCT	--	12/07 ⇨
FOCUS II 1.8	Q7DA, --	03/06 ⇨ 09/12
FOCUS II 1.8 Flexifuel	--, KKDA	12/05 ⇨ 09/12
FOCUS II 1.8 TDCi	KKDA, AODA	07/04 ⇨ 09/12
FOCUS II 2.0	AODA, G6DA	07/04 ⇨ 09/12
FOCUS II 2.0 CNG	SYDA	04/09 ⇨ 07/11
FOCUS II 2.0 LPG	SYDA	06/08 ⇨ 07/11
FOCUS II 2.0 TDCi	G6DA, CGBA	07/04 ⇨ 09/12
FOCUS II 2.5 RS	JZDA	01/09 ⇨ 07/11
FOCUS II 2.5 ST	HYDA	10/05 ⇨ 09/12
MONDEO II 1.8 16V	CGBA, CJBA	10/00 ⇨ 03/07
MONDEO II 1.8 SCi	CFBA	06/03 ⇨ 03/07
MONDEO II 2.0 16V	CJBA, D5BA	10/00 ⇨ 03/07
MONDEO II 2.0 16V DI / TDDi / TDCi	D5BA, D6BA	10/00 ⇨ 03/07
MONDEO II 2.0 16V TDDi / TDCi	D6BA, --	10/00 ⇨ 03/07
MONDEO II 2.0 TDCi	--, QJBA	10/01 ⇨ 03/07
MONDEO II 2.2 TDCi	QJBA, EYPA	09/04 ⇨ 03/07
MONDEO II 2.5 V6 24V	LCBD	10/00 ⇨ 03/07
MONDEO II 3.0 V6 24V	REBA	09/04 ⇨ 03/07
MONDEO II ST220	MEBA	04/02 ⇨ 03/07
TOURNEO CONNECT I 1.8 16V	EYPA, EYPA	06/02 ⇨ 12/13
TRANSIT CONNECT I 1.8 16V	EYPA, 1AZ-FE	06/02 ⇨ 12/13
TRANSIT CONNECT I 1.8 16V LPG	EYPC	06/02 ⇨ 12/13

JAGUAR

X-TYPE 2.1 V6	YB(AJ-V6)	03/02 ⇨ 11/09
X-TYPE 2.5	XB(AJ-V6)	02/04 ⇨ 12/09
X-TYPE 2.5 V6 Trazione integrale	XB(AJ-V6)	06/01 ⇨ 11/09
X-TYPE 3.0	AJ-V6	02/04 ⇨ 12/09
X-TYPE 3.0 Trazione integrale	AJ-V6	09/02 ⇨ 12/08

JAGUAR

X-TYPE 3.0 V6 Trazione integrale	AJ-V6	06/01 ⇨ 12/08
----------------------------------	-------	---------------

9.0500



3

**REVOLUTION AND TIMING (CKP AND CMP)
SENSORS**

Adatt./Suitable:

DENSO
029600-0660
029600-0890
LEXUS
90919-05026
TOYOTA
90080-19014
90919-05026

MARKET DIFFUSION: **MEDIUM**

L	L1	ohm	
---	30	1200	

LEXUS

HS 2.4 VVTi Hybrid [ExtraEU]	2AZ-FXE	06/09 ⇨
IS I 200	1G-FE	04/99 ⇨ 10/05
IS I 300	2JZ-GE	09/01 ⇨ 10/05
RX I 300	1MZ-FE	01/98 ⇨ 02/03
RX II 400h	3MZ-FE	09/05 ⇨ 12/08
RX II 400h AWD	3MZ-FE	09/04 ⇨ 12/08

TOYOTA

4 RUNNER 2.7 4WD	3RZ-FE	11/95 ⇨ 08/02
4 RUNNER 2.7 i	3RZ-FE	11/95 ⇨ 03/96
AVALON 3.0 i [USA]	1MZ-FE	08/99 ⇨
AVENSIS I 1.6	3ZZ-FE	07/00 ⇨ 02/03
AVENSIS I 1.6 VVT-i	3ZZ-FE	10/00 ⇨ 02/03
AVENSIS I 1.8	1ZZ-FE	10/00 ⇨ 02/03
AVENSIS I 1.8 VVT-i	1ZZ-FE	10/00 ⇨ 02/03
AVENSIS I 2.0	1AZ-FSE	10/00 ⇨ 02/03
AVENSIS I 2.0 VVT-i	1AZ-FSE	10/00 ⇨ 02/03
AVENSIS II 1.6 VVT-i	3ZZ-FE	04/03 ⇨ 11/08
AVENSIS II 1.8	1ZZ-FE	03/03 ⇨ 11/08
AVENSIS II 2.0	1AZ-FE	08/01 ⇨ 11/09
AVENSIS II 2.0 VVTi	1AZ-FE, 2AZ-FE	04/03 ⇨ 11/08
AVENSIS II 2.4	2AZ-FE, 2AZ-FE	08/01 ⇨ 11/08
AVENSIS II 2.4 4WD	2AZ-FE	11/03 ⇨ 08/06
AVENSIS III 2.0	1AZ-FE	11/08 ⇨ 04/11
CAMRY 2.0	1AZ-FE	08/01 ⇨
CAMRY 2.0 VVTi [ExtraEU]	1AZ-FE	09/11 ⇨
CAMRY 2.4	2AZ-FE, 2AZ-FXE	09/01 ⇨ 09/11
CAMRY 2.4 [CHN]	3AZ-FXE	03/10 ⇨
CAMRY 2.4 Hybrid	2AZ-FXE, 3ZZ-FE	01/06 ⇨ 09/11
CAMRY 2.4 VVTi LE	2AZ-FE	01/06 ⇨ 11/06
CAMRY SOLARA II 2.4	2AZ-FE	07/03 ⇨ 11/08
CELICA VII 1.8 16V VT-i	1ZZ-FE	08/99 ⇨ 07/05
COROLLA VIII 1.6	3ZZ-FE	10/99 ⇨ 01/02
COROLLA VIII 1.6 16V	3ZZ-FE	10/99 ⇨ 10/01
COROLLA IX 1.6 VVT-i	3ZZ-FE	10/01 ⇨ 03/08
COROLLA X 1.6 VVTi	3ZZ-FE, 3RZ-FE	08/07 ⇨ 06/13
COROLLA X 1.8 16V	1ZZ-FE	08/07 ⇨
COROLLA X 1.8 CNG	1ZZ-FE	06/09 ⇨
COROLLA X 1.8 FlexFuel [BRA]	1ZZ-FBE	03/08 ⇨
COROLLA X 2.4	2AZ-FE	01/08 ⇨
COROLLA VERSO I 1.6 VVT-i	3ZZ-FE	08/01 ⇨ 05/04
COROLLA VERSO I 1.8 VVT-i	1ZZ-FE	12/01 ⇨ 05/04
COROLLA VERSO I 1.8 VVTi 4WD	1ZZ-FE	07/01 ⇨ 02/04
COROLLA VERSO II 1.6	3ZZ-FE	04/04 ⇨ 03/09
COROLLA VERSO II 1.8	1ZZ-FE	04/04 ⇨ 03/09

TOYOTA			
HIACE IV 2.7	3RZ-FE, 3RZ-FE	04/98 → 12/06	
HIACE IV 2.7 4WD	3RZ-FE, 1GR-FE	04/98 →	
HILUX VI 2.4 i 4WD	2RZ-FE	08/97 → 10/05	
LAND CRUISER 120 4.0	1GR-FE, 2AZ-FE	09/02 → 12/10	
LAND CRUISER 120 4.0 V6 VVT-i	1GR-FE	01/03 → 07/09	
LAND CRUISER PRADO 120 2.7	3RZ-FE	09/02 → 08/04	
LAND CRUISER PRADO 120 4.0	1GR-FE	01/03 → 08/09	
MATRIX 2.4	2AZ-FE	01/08 → 05/14	
MATRIX 2.4 4WD	2AZ-FE	01/09 → 12/10	
MR 2 III 1.8 16V VT-i	1ZZ-FE	10/99 → 06/07	
PICNIC II 2.0 VVTi	1AZ-FE	05/01 → 08/06	
PICNIC II 2.4 VVTi	2AZ-FE	11/03 → 08/06	
PREVIA II 2.4	2AZ-FE, 1AD-FTV	02/00 → 02/06	
PREVIA II 2.4 4WD	2AZ-FE	02/00 → 01/06	
PREVIA III 2.4	2AZ-FE	10/05 →	
RAV 4 II 1.8	1ZZ-FE	08/00 → 11/05	
RAV 4 II 2.0	1AZ-FE	09/00 → 12/03	
RAV 4 II 2.0 4WD	1AZ-FE	05/00 → 11/05	
RAV 4 II 2.4	2AZ-FE	08/00 → 11/05	
RAV 4 II 2.4 4WD	2AZ-FE	08/03 → 11/05	
RAV 4 II 2.4 VVTi [ExtraEU]	2AZ-FE	08/03 → 11/05	
RAV 4 III 2.0 4WD	1AZ-FE	02/06 → 06/13	
RAV 4 III 2.0 VVT-i [CHN]	1AZ-FE	03/09 →	
RAV 4 III 2.4	2AZ-FE	11/05 → 06/13	
RAV 4 III 2.4 4WD	2AZ-FE	11/05 → 06/13	
RAV 4 III 2.4 VVTi [CHN]	2AR-FE	03/09 →	
T100 2.7 i [USA]	3RZFE	10/93 → 07/98	
TACOMA 2.4 i [USA]	2RZFE	01/95 →	
TACOMA 2.7 i [USA]	3RZFE	02/98 →	
TARAGO MPV / SPACE 2.4 VVTi	2AZ-FE	02/00 → 12/05	

TOYOTA		
RAV 4 IV 2.2 D 4WD	2AD-FHV, 1AD-FTV	12/12 →
RAV 4 III 2.2 D	2AD-FHV, 2AD-FHV	12/08 → 06/13
RAV 4 III 2.2 D 4WD	2AD-FHV, 2AD-FHV	11/05 → 06/13
VERSO 2.0 D-4D	1AD-FTV, ASZ	04/09 →
VERSO 2.2 D-4D	2AD-FHV	04/09 →
VERSO 2.2 D-CAT	2AD-FHV	04/09 →

9.0504

04,5

REVOLUTION AND TIMING (CKP AND CMP) SENSORS

Adatt./Suitable:

AUDI
038 907 319 D
038 957 147 F

FORD
1 100 749
1 358 961
1 424 270
1 431 016
1 431 017
6M21-6C315-AA
6M21-6C315-BA
6M21-6C315-CA
XM21-6C315-AA
XM21-6C315-AB

SEAT
038 907 319 D
038 957 147 D
038 957 147 F

SKODA
038 957 147 D
038 957 147 F

VW
038 907 319 D
038 957 147 D
038 957 147 F

MARKET DIFFUSION: MEDIUM



L	L1	ohm	S GND OUT
530	46	490	

AUDI		
A3 I 1.9 TDI	ASZ, 1Z	08/00 → 05/03
A3 I 1.9 TDI quattro	ASZ	08/00 → 05/03

FORD		
GALAXY I 1.9 TDI	1Z, 1Z	04/00 → 05/06

SEAT		
ALHAMBRA I / II 1.9 TDI	1Z, AUY	06/00 → 03/10
ALHAMBRA I / II 1.9 TDI 4motion	AUY, BPX	06/00 → 03/10
ALHAMBRA I / II 1.9 Tdi 4x4	ASZ	06/05 → 11/08
IBIZA III 1.9 TDI Cupra R	BPX, AHF	03/04 → 02/08
LEON I 1.9 TDI	AHF, AHF	09/00 → 06/06
LEON I 1.9 TDI Syncro	ARL	05/02 → 06/06
TOLEDO II 1.9 TDI	AHF, ATD	10/00 → 05/06
TOLEDO II 1.9 TDI 4Drive	ARL	10/00 → 10/05

SKODA		
FABIA I 1.9 TDI	ATD, ASZ	01/00 → 03/08
FABIA I 1.9 TDI RS	ASZ, ASZ	06/03 → 03/08
OCTAVIA I 1.9 TDI	ASZ, AJM	08/00 → 12/10
OCTAVIA I 1.9 TDI 4x4	ATD	09/00 → 01/06

VW		
BORA 1.9 TDI	AJM, AJM	05/00 → 05/05
BORA 1.9 TDI 4motion	AJM, AXB	05/00 → 05/05
CAMPMOBILE 1.9 TDi	AXB, AJM	03/04 → 11/09
GOLF IV 1.9 TDI	AJM, AJM	02/00 → 06/06
GOLF IV 1.9 TDI 4motion	AJM, AXB	02/00 → 06/06
GOLF IV 1.9 TDI GTi	ARL	06/01 → 06/06
GOLF 1.9 TDi	AUY	01/00 → 04/01
MULTIVAN 1.9 TDI	AXB, ATD	04/03 → 11/09
NEW BEETLE 1.9 TDI	ATD, 1Z	02/01 → 09/10
SHARAN I 1.9 TDI	1Z, AUY	04/00 → 03/10
SHARAN I 1.9 TDI 4motion	AUY, AXB	04/00 → 03/10
TRANSPORTER V 1.9 TDI	AXB, ASZ	04/03 → 11/09

9.0502

04,5

REVOLUTION AND TIMING (CKP AND CMP) SENSORS

Adatt./Suitable:

DENSO
029600-1471

LEXUS
90919-05069

TOYOTA
90919-05064
90919-05069

MARKET DIFFUSION: MEDIUM

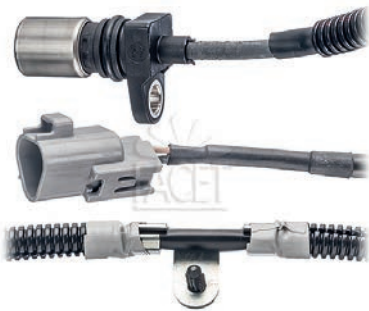

L	L1	ohm	GND OUT
315	36,5	1100	

LEXUS		
IS II 200d	2AD-FTV	07/10 → 07/12
IS II 220d	2AD-FHV	08/05 → 07/12

TOYOTA		
AURIS I 2.0 D-4D	1AD-FTV	03/07 → 09/12
AURIS I 2.2 D	2AD-FHV	11/06 → 09/12
AURIS II 2.0 D-4D	1AD-FTV	10/12 →
AVENSIS II 2.0 D-4D	1AD-FTV	03/06 → 11/08
AVENSIS II 2.2 D-4D	2AD-FTV	10/05 → 11/08
AVENSIS II 2.2 D-CAT	2AD-FHV	07/05 → 11/08
AVENSIS III 2.0 D-4D	1AD-FTV, 2AD-FHV	11/08 →
AVENSIS III 2.2 D-4D	2AD-FHV, 2AD-FHV	11/08 →
COROLLA X 2.0 D-4D	1AD-FTV	11/06 → 07/14
COROLLA VERSO II 2.2 D-4D	2AD-FHV, 2AD-FHV	10/05 → 03/09
RAV 4 IV 2.0 D	1AD-FTV	12/12 →
RAV 4 IV 2.0 D 4WD	1AD-FTV	01/13 →

9.0505

04,5

REVOLUTION AND TIMING (CKP AND CMP) SENSORS

Adatt./Suitable:

SEAT
038 957 147 B
038 957 147 E

SKODA
038 957 147 B
038 957 147 E

VW
038 957 147 B
038 957 147 E



L	L1	ohm	S GND OUT
555	46	490	

SEAT		
ALHAMBRA I / II 1.9 TDI	ASZ	11/02 → 11/08
CORDOBA II 1.9 TDI	ASZ, ASZ	09/02 → 11/09
IBIZA III 1.9 TDI	ASZ, ATD	02/02 → 11/09

SKODA		
FABIA I 1.9 TDI	ATD, ASZ	01/00 → 03/08
FABIA I 1.9 TDI RS	ASZ, BLS	06/03 → 03/08
FABIA II 1.9 TDI	BLS, AXR	04/07 → 03/10
ROOMSTER 1.9 TDI	AXR, ASZ	03/06 → 03/10

VW		
POLO 1.9 TDI [ExtraEU]	ATD	07/03 → 06/05
POLO IV 1.9 TDI	ASZ, ASZ	10/01 → 11/09
SHARAN I 1.9 TDI	ASZ, RF1F	11/02 → 03/10

9.0509



3

REVOLUTION AND TIMING (CKP AND CMP) SENSORS

Adatt./Suitable:

- DENSO**
029600-0381
029600-1160
029600-1300
- MAZDA**
RF5C-18-230
- TOYOTA**
90919-05020
90919-05052



L	L1	ohm	
---	31,8	2400	

MAZDA			
6 I 2.0 CiTD 4x4	RF5C	10/02 ⇨	02/05
MPV II 2.0 DI	RF1F, 1KD-FTV	07/02 ⇨	02/06
TOYOTA			
4 RUNNER 3.4 4WD	5VZ-FE	11/95 ⇨	11/02
4 RUNNER 3.4 i	5VZ-FE	11/95 ⇨	03/96
DYNA 100 3.0 D4d	1KD-FTV, 2KD-FTV	10/09 ⇨	
DYNA 2.5 D4d	2KD-FTV, 1KD-FTV	07/01 ⇨	
DYNA 3.0 D4d	1KD-FTV, 2KD-FTV	08/01 ⇨	
DYNA 3.0 D4d 4WD	1KD-FTV	09/06 ⇨	
HIACE 3.0 [ExtraEU]	1KD-FTV	11/08 ⇨	
HIACE IV 2.5 D-4D	2KD-FTV, 2KD-FTV	11/01 ⇨	
HIACE IV 2.5 D-4D 4WD	2KD-FTV, 1KD-FTV	08/01 ⇨	
HIACE IV 3.0 [ExtraEU]	1KD-FTV	05/10 ⇨	
HIACE IV 3.0 D	1KD-FTV, 1KD-FTV	08/04 ⇨	
HILUX 2.5 D4d	2KD-FTV	11/01 ⇨	07/05
HILUX VI 2.5 D-4D 4WD	2KD-FTV	11/01 ⇨	07/05
LAND CRUISER 90 3.0 D-4D 4WD	1KD-FTV	08/00 ⇨	08/02
LAND CRUISER 90 3.4 i 24V	5VZ-FE	03/96 ⇨	12/02
LAND CRUISER 120 3.0 D-4D	1KD-FTV, 1KD-FTV	09/02 ⇨	12/10
LAND CRUISER 150 3.0 D-4D	1KD-FTV, BYT	08/09 ⇨	
LAND CRUISER PRADO 120 3.0 D-4D	1KD-FTV	08/06 ⇨	08/09
LAND CRUISER PRADO 150 3.0 D-4D	1KD-FTV	08/09 ⇨	
LAND CRUISER VAN 3.0 D4d 4WD	1KD-FTV	01/11 ⇨	
T100 3.4 i [USA]	5VZFE	08/94 ⇨	07/98
TUNDRA 3.4 i 24V [USA]	5VZFE	02/99 ⇨	

9.0514



1

REVOLUTION AND TIMING (CKP AND CMP) SENSORS

Adatt./Suitable:

- AUDI**
07L 905 163
07L 905 163 A
07L 905 163 B
07L 905 163 C
- PORSCHE**
955 606 106 20
958 606 106 00
958 606 106 01
- SEAT**
07L 905 163
07L 905 163 A
07L 905 163 B
07L 905 163 C
- SKODA**
07L 905 163
07L 905 163 A
07L 905 163 B
07L 905 163 C
- VW**
07L 905 163
07L 905 163 A
07L 905 163 B
07L 905 163 C

MARKET DIFFUSION: MEDIUM



L	L1		
---	24	Hall Effect	

AUDI			
A3 II 1.8 TFSI	BYT, AXX	11/06 ⇨	05/13
A3 II 1.8 TFSI quattro	CDAA	07/08 ⇨	08/12
A3 II 2.0 TFSI	AXX, AXX	09/04 ⇨	05/13
A3 II 2.0 TFSI quattro	AXX, BYT	09/04 ⇨	08/12
A3 II SPORTBACK 1.8 TFSI	BYT, AXX	11/06 ⇨	03/13
A3 II SPORTBACK 1.8 TFSI quattro	CDAA	07/08 ⇨	03/13
A3 II SPORTBACK 2.0 TFSI	AXX, AXX	09/04 ⇨	03/13
A3 II SPORTBACK 2.0 TFSI quattro	AXX, AUK	09/04 ⇨	03/13
A3 II SPORTBACK RS3 quattro	CEPA	01/11 ⇨	12/12
A4 II 3.2 FSI	AUK	01/06 ⇨	03/09
A4 II 3.2 FSI quattro	AUK	01/06 ⇨	03/09
A4 II RS4 quattro	BNS	06/06 ⇨	03/09
A3 III RS3 quattro	CZGB	03/15 ⇨	
A4 III 3.2 FSI	AUK	01/05 ⇨	06/08
A4 III 3.2 FSI quattro	AUK, CABA	01/05 ⇨	06/08
A4 III RS4 quattro	BNS	09/05 ⇨	06/08
A4 IV 1.8 TFSI	CABA, CAEA	11/07 ⇨	12/15
A4 IV 1.8 TFSI quattro	CDHB	09/08 ⇨	03/12
A4 IV 2.0 TFSI	CAEA, CAEB	06/08 ⇨	12/15
A4 IV 2.0 TFSI flexible fuel	CFKA	11/09 ⇨	12/15
A4 IV 2.0 TFSI flexible fuel quattro	CFKA	11/09 ⇨	12/15
A4 IV 2.0 TFSI quattro	CAEB, CAMA	06/08 ⇨	12/15
A4 IV 2.7 TDI	CAMA, CAPA	11/07 ⇨	03/12
A4 IV 3.0 TDI	CLAB	11/11 ⇨	12/15
A4 IV 3.0 TDI quattro	CAPA, CMUA	11/07 ⇨	12/15
A4 IV 3.0 TFSI quattro	CMUA, CDNC	02/12 ⇨	12/15
A4 IV 3.2 FSI	CALA	09/08 ⇨	03/12
A4 IV 3.2 FSI quattro	CALA	11/07 ⇨	03/12
A4 IV RS4 quattro	CFSA	05/12 ⇨	08/15
A4 IV S4 quattro	CAKA, CABD	11/08 ⇨	12/15
A4 IV ALLROAD 2.0 TFSI quattro	CDNC, CCWA	04/09 ⇨	05/16
A4 IV ALLROAD 3.0 TDI quattro	CCWA, CAKA	04/09 ⇨	05/16
A4 2.0 TFSI [ExtraEU]	CFKA	11/09 ⇨	03/13
A5 I 1.8 TFSI	CABD, CAHA	10/07 ⇨	01/17
A5 I 2.0 TDI	CAHA, CAEA	05/09 ⇨	06/14
A5 I 2.0 TFSI	CAEA, CAEB	06/08 ⇨	12/14
A5 I 2.0 TFSI quattro	CAEB, CAMA	06/08 ⇨	

AUDI			
A5 I 2.7 TDI	CAMA, CAPA	06/07 ⇨	01/17
A5 I 3.0 TDI	CLAB	10/11 ⇨	01/17
A5 I 3.0 TDI quattro	CAPA, CHMB	06/07 ⇨	01/17
A5 I 3.0 TFSI quattro	CHMB, CAKA	08/11 ⇨	
A5 I 3.2 FSI	CALA	06/07 ⇨	03/12
A5 I 3.2 FSI quattro	CALA	06/07 ⇨	03/12
A5 I RS5 quattro	CFSA	03/10 ⇨	08/15
A5 I S5 quattro	CAKA, BSG	06/07 ⇨	01/17
A6 III 2.4	BDW	05/04 ⇨	10/08
A6 III 2.4 quattro	BDW	01/05 ⇨	10/08
A6 III 2.7 TDI	BSG, BSG	11/04 ⇨	08/11
A6 III 2.7 TDI quattro	BSG, BDX	06/05 ⇨	08/11
A6 III 2.8 FSI	BDX, BDX	11/06 ⇨	08/11
A6 III 2.8 FSI quattro	BDX, BNG	06/07 ⇨	08/11
A6 III 3.0 TDI quattro	BNG, CAJA	05/04 ⇨	08/11
A6 III 3.0 TFSI quattro	CAJA, AUK	10/08 ⇨	08/11
A6 III 3.2 FSI	AUK, AUK	05/04 ⇨	05/09
A6 III 3.2 FSI quattro	AUK, CAEB	05/04 ⇨	10/08
A6 III 4.2 FSI quattro	BVJ	05/06 ⇨	08/11
A6 III RS6 quattro	BUH	04/08 ⇨	08/10
A6 III S6 quattro	BXA	03/06 ⇨	08/11
A6 IV 2.0 TFSI	CAEB, CHVA	03/11 ⇨	
A6 IV 2.0 TFSI hybrid	CHJA	11/11 ⇨	09/18
A6 IV 2.0 TFSI quattro	CAEB	05/12 ⇨	05/13
A6 IV 2.8 FSI	CHVA	11/10 ⇨	04/15
A6 IV 2.8 FSI quattro	CHVA, CLAB	11/10 ⇨	09/18
A6 IV 3.0 TDI	CLAB, CDUC	11/10 ⇨	09/18
A6 IV 3.0 TDI quattro	CDUC, CGWB	03/11 ⇨	
A6 IV 3.0 TFSI quattro	CGWB, CHVA	11/10 ⇨	09/18
A7 SPORTBACK 2.5 FSI	CLXB	05/12 ⇨	
A7 SPORTBACK 2.8 FSI	CHVA	02/11 ⇨	03/15
A7 SPORTBACK 2.8 FSI quattro	CHVA, CLAB	10/10 ⇨	05/18
A7 SPORTBACK 2.8 TFSI	CVPA	09/14 ⇨	
A7 SPORTBACK 3.0 TDI	CLAB, CDUC	11/10 ⇨	05/18
A7 SPORTBACK 3.0 TDI quattro	CDUC, CGWB	10/10 ⇨	05/18
A7 SPORTBACK 3.0 TFSI	CREH	05/14 ⇨	
A7 SPORTBACK 3.0 TFSI quattro	CGWB, BDX	10/10 ⇨	05/18
A7 SPORTBACK S7 quattro	CTGE	07/14 ⇨	05/18
A8 II 2.8 FSI	BDX, BSM	08/07 ⇨	07/10
A8 II 3.2 FSI	BPK	06/05 ⇨	07/10
A8 II 3.2 FSI quattro	BPK	06/05 ⇨	07/10
A8 II 4.2 FSI quattro	BVJ	06/06 ⇨	07/10
A8 II S8 quattro	BSM, CCAA	06/06 ⇨	07/10
A8 III 2.0 TFSI hybrid	CHJA	02/12 ⇨	11/15
A8 III 2.5 TFSI	CPAA, CDTA	07/12 ⇨	06/16
A8 III 3.0 TDI	CLAB	09/11 ⇨	09/13
A8 III 3.0 TDI quattro	CDTA, CGWA	07/10 ⇨	
A8 III 3.0 TFSI quattro	CGWA, CDSB	06/10 ⇨	01/18
A8 III 4.2 FSI quattro	CDRA	11/09 ⇨	12/12
A8 III 4.2 TDI quattro	CDSB, CCZC	11/09 ⇨	01/18
Q3 2.0 TFSI	CTCA	10/13 ⇨	
Q3 2.0 TFSI quattro	CCZC, CTSA	06/11 ⇨	10/18
Q3 RS 2.5 quattro	CTSA, CAEB	05/13 ⇨	10/18
Q3 RS performance 2.5 quattro	CZGB	01/15 ⇨	10/18
Q5 I 2.0 TFSI hybrid quattro	CHJA	06/11 ⇨	
Q5 I 2.0 TFSI quattro	CAEB, CCWA	11/08 ⇨	
Q5 I 3.0 TDI	CTBC	06/12 ⇨	
Q5 I 3.0 TDI quattro	CCWA, CTUC	11/08 ⇨	
Q5 I 3.0 TFSI quattro	CTUC, CGQB	06/12 ⇨	
Q5 I 3.2 FSI quattro	CALB	11/08 ⇨	
Q5 I SQ5 TDI quattro	CGQB, CTUD	12/12 ⇨	
Q5 I SQ5 TFSI quattro	CTUD, BUN	05/13 ⇨	
Q7 I 3.0 TDI quattro	BUN, CJTB	03/06 ⇨	08/15
Q7 I 3.0 TFSI quattro	CJTB, CCFA	05/10 ⇨	08/15
Q7 I 4.2 FSI quattro	BAR	03/06 ⇨	05/10
Q7 I 4.2 TDI quattro	CCFA, BYH	05/09 ⇨	08/15
Q7 I 6.0 TDI quattro	CCGA	09/08 ⇨	05/14
R8 4.2 FSI quattro	BYH, BUJ	04/07 ⇨	07/15
R8 5.2 FSI quattro	BUJ, CCTA	04/09 ⇨	07/15
TT II 1.8 TFSI	CDAA	06/08 ⇨	06/14
TT II 2.0 TFSI	CCTA, CCZA	08/06 ⇨	06/14
TT II 2.0 TFSI quattro	CCZA, CEPA	06/08 ⇨	06/14
TT II 2.5 RS quattro	CEPA, M05.9E	07/09 ⇨	06/14
PORSCHE			
CAYENNE I 3.0 TDI	M05.9D	02/09 ⇨	09/10
CAYENNE II 3.0 Diesel	M05.9E, M06.EC	06/10 ⇨	
CAYENNE II 3.0 S E-Hybrid	M06.EC, MCU.DB	06/10 ⇨	
CAYENNE II 4.2 S Diesel	MCU.DB, MCD.UD	10/12 ⇨	
MACAN 3.0 S [ExtraEU]	MCD.UD	02/14 ⇨	
MACAN 3.0 S Diesel	MCD.UD, MCR.C	02/14 ⇨	
PANAMERA 3.0 D	MCR.C, MCG.EA	08/11 ⇨	10/16
PANAMERA 3.0 S E-Hybrid	MCG.EA, BYT	03/11 ⇨	10/16
SEAT			
ALHAMBRA III 1.8 TSI	CDAA	11/12 ⇨	

SEAT		
ALHAMBRA III 2.0 TSI	CCZA	11/10 →
ALTEA 1.8 TFSI	BYT, BYT	01/07 →
ALTEA 2.0 TFSI [ExtraEU]	CCZB	05/09 →
ALTEA XL 1.8 TFSI	BYT, BZB	01/07 →
ALTEA XL 2.0 TFSI 4x4	CCZB	05/09 →
EXEO 2.0 TFSI	CDND	05/10 →
LEON II 1.8 TFSI	BZB, BYT	06/07 → 12/12
TOLEDO III 1.8 TFSI	BYT, BZB	01/07 → 05/09

SKODA		
OCTAVIA II 1.8 TSI	BZB, CDAA	06/07 → 06/13
OCTAVIA II 1.8 TSI 4x4	CDAA, BWA	11/08 → 02/13
OCTAVIA II 2.0 4x4	CCZA	11/08 →
OCTAVIA II 2.0 RS	BWA, BZB	10/05 → 02/13
SUPERB II 1.8 TSI	BZB, CDAA	03/08 → 05/15
SUPERB II 1.8 TSI 4x4	CDAA, CDAA	11/08 → 05/15
SUPERB II 2.0 TSI	CCZA	05/10 → 05/15
YETI 1.8	CDAB	02/11 →
YETI 1.8 TSI 4x4	CDAA, CBFA	05/09 → 12/17

VW		
AMAROK 2.0 TSI	CFPA	12/10 →
BEETLE 2.0 TSI	CBFA, CJKA	04/11 → 07/16
CAMPMOBILE 2.0 TSi BlueMotion	CJKA, CDAA	04/15 →
CC 1.8 TSI	CDAA, CBFA	11/11 → 12/16
CC 2.0 TSI	CBFA, BPY	11/11 →
EOS 2.0 TFSI	BPY, BWA	03/06 → 08/15
EOS 2.0 TSI	CCZB	11/09 → 08/15
GOLF V 2.0	BWA, CBFA	06/07 → 07/09
GOLF VI 1.8 TSI	CDAA	06/09 → 01/11
GOLF VI 2.0 GTi	CBFA, CBFA	04/09 → 05/16
GOLF VI 2.0 TFSi Gti	CBFA, BWA	05/11 →
GOLF VI 2.0 TSI	CCZA	07/09 → 07/13
GOLF 2.0 GTi	CCZB	02/09 → 11/12
JETTA V 2.0 TFSI	BWA, CBFA	10/05 → 10/10
JETTA VI 2.0 TSI	CBFA, CJKA	12/10 →
MULTIVAN 2.0 TSI	CJKA, BZB	05/11 →
MULTIVAN 2.0 TSI 4motion	CJKA	07/11 →
PASSAT V 1.8 TSI	BZB, AXX	05/07 → 12/14
PASSAT V 2.0 FSI	AXX, CARA	07/05 → 11/10
PASSAT V 2.0 TSI	CCZB	11/10 → 12/15
PASSAT V 2.0 TSI 4motion	CCZB	01/12 → 12/14
PASSAT CC 1.8 TSI	BZB, CAWB	06/08 → 01/12
PASSAT CC 2.0 TSI	CAWB, BZB	06/08 → 01/12
PASSAT 1.8 TFSI	CDAA	08/10 → 12/14
PASSAT 2.0 TFSI	CCZB	11/10 → 12/14
PHAETON 3.0 V6 TDI 4motion	CARA, CAWB	06/07 → 03/16
SCIROCCO III 2.0 TSI	CAWB, CAWA	05/08 → 11/17
SCIROCCO 2.0 TFSI	CCZB	11/09 → 05/14
SHARAN II 1.8 TSI	CDAA	11/11 →
SHARAN II 2.0 TSI	CCZA	12/10 →
TIGUAN I 2.0 TFSI	CCTB	05/08 →
TIGUAN I 2.0 TFSI 4motion	CAWA, CCZB	09/07 →
TIGUAN I 2.0 TSI 4motion	CCZB, BUN	05/11 →
TOUAREG I 3.0 TDI	BUN, CASA	04/06 → 05/10
TOUAREG I 3.0 V6 TDI	CASA, CASA	11/07 → 05/10
TOUAREG I 4.2 V8 FSI	BAR	06/06 → 05/10
TOUAREG II 3.0 TFSI	CYJA	01/15 →
TOUAREG II 3.0 V6 TDI	CASA, CGEA	01/10 → 03/18
TOUAREG II 3.0 V6 TSI	CJTA	08/10 → 03/18
TOUAREG II 3.0 V6 TSI Hybrid	CGEA, CJKA	04/10 → 03/18
TOUAREG II 4.2 V8 FSI	CGNA	01/11 → 03/18
TOUAREG II 4.2 V8 TDI	CKDA	01/10 → 03/18
TRANSPORTER V 2.0 TSI	CJKA, CJKA	05/11 → 08/15
TRANSPORTER V 2.0 TSI 4motion	CJKA	07/11 → 08/15
TRANSPORTER VI 2.0 TSI	CJKA, M47D20(204D4)	04/15 →
TRANSPORTER VI 2.0 TSI 4motion	CJKA	06/15 →

9.0518



REVOLUTION AND TIMING (CKP AND CMP) SENSORS

Adatt./Suitable:

BMW
13 62 7 792 256
13 62 7 837 904
7 792 256
8 837 904

MARKET DIFFUSION: MEDIUM



L	L1		+ OUT -
---	23,8	Hall Effect	

BMW		
11 118 d	M47D20(204D4), M47D20(204D4)	11/03 → 02/07
11 120 d	M47D20(204D4), M47D20(204D4)	03/03 → 12/11
3V 318 d	M47D20(204D4), M47D20(204D4)	03/05 → 08/07
3V 320 d	M47D20(204D4), M57D30(306D3)	12/04 → 06/12
3V 325 d	M57D30(306D3), M57D30(306D3)	09/06 → 06/12
3V 330 d	M57D30(306D3), M57D30(306D3)	12/04 → 12/13
3V 330 xd	M57D30(306D3), M57D30(306D5)	09/05 → 06/12
3V 335 d	M57D30(306D5), M47D20(204D4)	03/06 → 03/13
3V M	S65B40A	03/07 → 06/13
3V M3	S65B40A	03/07 → 10/13
5V 520 d	M47D20(204D4), M57D25(256D2)	02/05 → 02/08
5V 525 d	M57D25(256D2), M57D30(306D3)	03/04 →
5V 525 d xDrive	M57D30(306D3), M57D30(306D3)	09/07 → 05/10
5V 525 xd	M57D30(306D3), M57D30(306D3)	11/06 → 09/08
5V 530 d	M57D30(306D3), M57D30(306D3)	09/02 → 05/10
5V 530 d xDrive	M57D30(306D3), M57D30(306D3)	09/07 → 05/10
5V 530 xd	M57D30(306D3), M57D30(306D4)	02/05 → 08/07
5V 535 d	M57D30(306D4), M57D30(306D5)	09/04 → 12/10
611 635 d	M57D30(306D5), M57D30(306D3)	07/07 → 07/10
71V 730 d	M57D30(306D3), M57D30(306D3)	10/02 → 07/08
71V 730 Ld	M57D30(306D3), M67D44(448D1)	07/05 → 08/08
71V 745 d	M67D44(448D1), M47D20(204D4)	03/05 → 07/08
X3 I 2.0 d	M47D20(204D4), M57D30(306D3)	11/03 → 08/07
X3 I 3.0 d	M57D30(306D3), M57D30(306D5)	09/05 → 08/08
X3 I 3.0 sd	M57D30(306D5), M57D30(306D3)	09/06 → 08/08
X3 I xDrive 30 d	M57D30(306D3), M57D30(306D3)	09/08 → 08/10
X3 I xDrive 35 d	M57D306D5	09/08 → 08/11
X5 II 3.0 d	M57D30(306D3), M57D30(306D5)	02/07 → 09/08
X5 II 3.0 sd	M57D30(306D5), M57D30(306D5)	10/07 → 09/08
X5 II xDrive 30 d	M57D306D3	10/08 → 03/10
X5 II xDrive 35 d	M57D30(306D5), M57D30(306D5)	10/08 → 06/13
X6 I 30 d	M57D30(306D3)	05/08 → 08/08
X6 I 35 d	M57D30(306D5)	05/08 → 08/08
X6 I xDrive 30 d	M57D306D3	04/08 → 03/10
X6 I xDrive 35 d	M57D30(306D5), FUJA	01/08 → 03/10

9.0522



REVOLUTION AND TIMING (CKP AND CMP) SENSORS

Adatt./Suitable:

FORD
1 256 781
3N21-7M101-AA
GENERAL MOTORS
93 196 224
LEXUS
89413-32010
MAZDA
SJ01-21-5H2
MITSUBISHI
2560A080
NISSAN
25010-4A00A
OPEL
47 10 773
SUZUKI
26143-79C10
26143-79C10-000
TOYOTA
89413-0C010
89413-32010
SU003-03838

MARKET DIFFUSION: HIGH



L	L1	ohm	GND OUT
---	30,5	670	

FORD		
FIESTA V 1.25 16V	FUJA, A9JA	05/02 → 06/08
FIESTA V 1.3	A9JA, FXJA	11/01 → 06/08
FIESTA V 1.4 16V	FXJA, F6JA	11/01 → 06/08
FIESTA V 1.4 TDCi	F6JA, FYJA	11/01 → 12/10
FIESTA V 1.6 16V	FYJA, HHJA	11/01 → 06/08
FIESTA V 1.6 TDCi	HHJA, --	11/04 → 09/09
FIESTA V ST150	N4JB	03/05 → 06/08
FUSION 1.25	--, --	10/02 →
FUSION 1.3	--, --	08/02 →
FUSION 1.4	--, F6JA	08/02 →
FUSION 1.4 LPG	UTJA	01/10 → 12/12
FUSION 1.4 TDCi	F6JA, FYJA	08/02 → 12/12
FUSION 1.6	FYJA, HHJA	08/02 → 11/08
FUSION 1.6 TDCi	HHJA, 4GR-FSE	11/04 → 12/12
FUSION 2.0	--	11/04 →
LEXUS		
IS II 250	4GR-FSE, 2GR-FSE	08/05 →
IS II 250 AWD	4GR-FSE	11/10 → 03/13
IS II 350	2GR-FSE, --	01/08 →
LS III 430	3UZ-FE	10/00 → 08/06
MAZDA		
MX-5 III 2.0	--, 4M41	03/05 →
MX-5 IV 2.0	PEX6	12/16 →
MITSUBISHI		
PAJERO IV 3.2 DI-D	4M41	11/06 →
PAJERO IV 3.2 DI-D 4WD	4M41, K10B	02/07 →
PAJERO IV 3.2 DI-D GLS	4M41	02/07 →
PAJERO IV 3.2 TD 4WD	4M41	01/10 →
SHOGUN IV 3.2 TD 4x4	4M41	01/09 →
NISSAN		
PIXO 1.0	K10B	06/09 →
PIXO 1.0 LPG	K10B	06/09 →
OPEL		
AGILA B 1.0	K10B, K12B	04/08 → 07/14
AGILA B 1.0 LPG	K10B	01/10 → 06/11
AGILA B 1.2	K12B, D13A	04/08 → 10/14
AGILA B 1.2 LPG	K12B	04/08 → 10/10
AGILA B 1.3 CDTi	D13A, H27A	04/08 → 04/10
SUZUKI		
ALTO VII 1.0	K10B	01/09 →

SUZUKI			
GRAND VITARA I 2.0 HDI 110 16V 4x4	RHW	07/01 → 09/05	
GRAND VITARA I 2.0 HDI 110 4x4	RHZ	07/01 → 09/05	
GRAND VITARA I 2.7	H27A, H27A	06/01 → 08/06	
GRAND VITARA I 2.7 4x4	H27A, M16A	09/01 → 07/03	
GRAND VITARA II 3.2 Trazione integrale	N32A	01/09 → 02/15	
IGNIS II 1.3	M13A	09/03 →	
IGNIS II 1.3 4x4	M13A	09/03 →	
IGNIS II 1.5	M15A	09/03 →	
IGNIS II 1.5 4x4	M15A	09/03 →	
IGNIS II 1.5 Sport	M15A	12/03 →	
LIANA 1.6	M16A, M16A	03/02 →	
LIANA 1.6 4WD	M16A, K12B	03/02 →	
LIANA 1.6 i	M16A	04/02 →	
SPLASH 1.2	K12B	01/08 →	
SPLASH 1.2 VVT	K12B, D13A	09/10 →	
SPLASH 1.3 CDTI	D13A, M13A	01/08 →	
SWIFT IV 1.3	M13A, M13A	02/05 →	
SWIFT IV 1.3 4x4	M13A, D13A	02/05 →	
SWIFT IV 1.3 DDIS	D13A, K12B	08/05 →	
SWIFT IV 1.5	M15A	02/05 →	
SWIFT IV 1.5 4x4	M15A	02/05 →	
SWIFT IV 1.6	M16A	05/06 →	
SWIFT IV 1.6 4x4	M16A	02/05 →	
SWIFT V 1.2	K12B, M16A	10/10 →	
SWIFT V 1.2 4WD	K12B	08/12 →	
SWIFT V 1.2 4x4	K12B	10/10 →	
SWIFT V 1.3 DDIS	D13A	10/10 →	
SWIFT V 1.4	K14B	02/11 →	
SWIFT V 1.6	M16A	01/12 →	
SX4 I 1.5	M15A	06/06 → 07/10	
SX4 I 1.5 VVT	M15A	07/10 →	
SX4 I 1.5 VVT 4x4	M15A	07/10 →	
SX4 I 1.6	M16A	06/06 →	
SX4 I 1.6 AWD	M16A, M16A	10/07 →	
SX4 I 1.6 DDIS	9HX	04/07 →	
SX4 I 1.6 VVT	M16A, M16A	06/06 →	
SX4 I 1.6 VVT 4x4	M16A, 1ZR-FAE	06/06 →	
SX4 I 1.9 DDIS	D19AA	06/06 →	
SX4 I 1.9 DDIS 4x4	D19AA	06/06 →	
SX4 I 2.0 DDIS	D20AA	07/09 →	
SX4 I 2.0 DDIS 4x4	D20AA	07/09 →	
WAGON R+ II 1.3	M13A	09/03 →	
WAGON R+ II 1.3 4WD	M13A	09/03 →	
WAGON R+ II 1.3 DDIS	Z13DT	09/03 →	
WAGON R III 1.0	Z10XEP	06/04 → 08/05	

TOYOTA			
AURIS I 1.6	1ZR-FAE, 1ZR-FE	03/07 → 09/12	
AVENSIS II 1.8	1ZZ-FE	03/03 → 11/08	
CELICA VII 1.8 16V VT-i	1ZZ-FE	08/99 → 07/05	
COROLLA IX 1.6	1ZR-FE	11/06 → 07/07	
COROLLA X 1.5	1NZ-FE	09/06 →	
COROLLA X 1.5 4WD	1NZ-FE	09/06 →	
COROLLA X 1.6	1ZR-FAE	11/06 → 11/13	
COROLLA X 1.6 Dual VVTi	1ZR-FE	01/07 → 07/14	
COROLLA X 1.6 VVTi	1ZR-FE, 2ZR-FE	08/07 → 05/14	
COROLLA X 1.8	2ZR-FE, 2ZR-FBE	10/06 →	
COROLLA X 1.8 16V	1ZZ-FE	08/07 →	
COROLLA X 1.8 CNG	1ZZ-FE	06/09 →	
COROLLA X 1.8 FlexFuel [BRA]	1ZZ-FBE	03/08 →	
COROLLA X 1.8 VVTi	2ZR-FBE, 1GR-FE	01/08 →	
COROLLA X 2.0	3ZR-FE	04/10 →	
COROLLA X 2.0 VVTi	3ZR-FE	08/10 →	
COROLLA XI 1.8 VVTi	2ZR-FE	06/13 →	
COROLLA XI 1.8 VVT-i	2ZR-FE	12/13 →	
COROLLA VERSO I 1.8 VVT-i	1ZZ-FE	12/01 → 05/04	
COROLLA VERSO I 1.8 VVTi 4WD	1ZZ-FE	07/01 → 02/04	
FJ CRUISER 4.0	1GR-FE, 1GR-FE	06/05 → 06/14	
FJ CRUISER 4.0 4WD	1GR-FE, 2KD-FTV	06/05 →	
GT 86 2.0	FA20D	03/12 →	
HILUX VII 2.5 D 4WD	2KD-FTV	08/05 → 05/15	
HILUX VII 2.5 D-4D	2KD-FTV, 2KD-FTV	08/05 →	
HILUX VII 2.5 D-4D 4WD	2KD-FTV, 1KD-FTV	12/07 →	
HILUX VII 3.0 D	1KD-FTV	02/05 →	
HILUX VII 3.0 D 4WD	1KD-FTV	02/05 →	
HILUX VII 3.0 D-4D 4WD	1KD-FTV, 1KD-FTV	08/05 → 05/15	
HILUX VII 4.0	1GR-FE	02/05 →	
HILUX VII 4.0 4WD	1GR-FE	02/05 →	
LAND CRUISER 120 3.0 D-4D	1KD-FTV, 1KD-FTV	09/02 → 12/10	
LAND CRUISER 120 4.0	1GR-FE	12/02 → 12/10	
LAND CRUISER 200 4.0	1GR-FE	01/10 →	
LAND CRUISER 200 4.7 V8	2UZ-FE, 3S-FE	08/07 →	
LAND CRUISER 150 3.0 D-4D	1KD-FTV, 1GR-FE	08/09 →	
LAND CRUISER 150 4.0 V6 Dual VVTi	1GR-FE	08/09 →	

TOYOTA			
LAND CRUISER 150 4.0 V6 VVTi	1GR-FE, 2UZ-FE	08/09 →	
LAND CRUISER 150 4.0 V6 VVT-i	1GR-FE	08/09 →	
LAND CRUISER PRADO 120 3.0 D-4D	1KD-FTV	08/06 → 08/09	
LAND CRUISER PRADO 120 4.0	1GR-FE	01/03 → 08/09	
LAND CRUISER PRADO 150 3.0 D-4D	1KD-FTV	08/09 →	
LAND CRUISER PRADO 150 4.0 V6 VVTi	1GR-FE	08/09 →	
RAV 4 I 2.0	3S-FE	06/97 → 09/99	
RAV 4 I 2.0 4WD	3S-FE, 1NZ-FE	01/94 → 09/99	
VIOS / YARIS 1.3	2NZ-FE	09/05 → 10/13	
VIOS / YARIS 1.3 4WD	2NZ-FE	09/05 → 04/13	
VIOS / YARIS 1.5	1NZ-FE, 2NZ-FE	08/07 →	
YARIS I 1.3	2NZ-FE, 1NZ-FE	04/02 → 10/05	
YARIS II 1.3 4WD	2NZ-FE	08/07 → 11/10	
YARIS II 1.3 VVT-i	2NZ-FE	11/05 → 12/12	
YARIS II 1.5	1NZ-FE, 2NZ-FE	11/05 →	
YARIS II 1.6 [CHN]	1ZR-FE	05/08 →	
YARIS III 1.3	2NZ-FE	12/11 →	
YARIS III 1.5	1NZ-FE	12/10 →	
YARIS VERSO 1.3	2NZ-FE, D13A	11/02 → 09/05	

VAUXHALL			
AGILA B 1.0 12V	K10B	01/08 → 11/14	
AGILA B 1.0 i	K10B	08/11 → 11/14	
AGILA B 1.2 i 16V	K12B	01/08 → 11/14	
AGILA B 1.3 CDTI	D13A, N43B16A	01/08 → 11/14	

9.0523



REVOLUTION AND TIMING (CKP AND CMP) SENSORS

Adatt./Suitable:

BMW

- 12 72 8 523 317
- 13 62 7 525 014
- 13 62 7 546 660
- 13 62 7 558 518
- 13 62 7 594 040
- 13 62 7 729 480
- 7 525 014
- 7 558 518
- 8 523 317

MINI

- 13 62 7 525 014
- 13 62 7 546 660
- 13 62 7 558 518
- 13 62 7 594 040

MARKET DIFFUSION: HIGH



L	L1	Hall Effect	
---	27,9		

ALPINA

B6 4.4 Biturbo 4x4 [USA]	N63M20A	03/14 →	
B7 4.4 Biturbo [USA]	N63M20A	01/11 →	
B7 4.4 Biturbo 4x4 [USA]	N63M20A	01/12 →	
B7 BITURBO	N63M10A	03/09 → 06/12	
B7 BITURBO Trazione integrale	N63M10A	09/10 → 06/12	

BMW

1 I 116 i	N43B16A, N43B20A	11/03 → 12/11	
1 I 118 i	N43B20A, N43B20A	09/06 → 12/13	
1 I 120 i	N43B20A, N52B30A	11/03 → 12/13	
1 I 125 i	N52B30A, N51B30A	10/07 →	
1 I 128 i	N51B30A, N52B30A	03/08 →	
1 I 130 i	N52B30A, N54B30A	03/05 → 09/12	
1 I 135 i	N54B30A, N20B20A	10/07 → 12/13	
1 I M	N54B30A	04/11 → 06/12	
1 I 125 i	N20B20A, N55B30A	08/11 →	

BMW			
1 I 125i Flex [ExtraEU]	N20B20A	03/15 →	
1 I M 135 i	N55B30A, N55B30A	11/11 →	
1 I M 135 i xDrive	N55B30A, N20B20A	02/12 →	
1 SERIES 118i [ExtraEU]	N46B20B	09/04 → 02/08	
1 SERIES 125i Flex [ExtraEU]	N20B20A	08/14 →	
2 220 i	N20B20A, N52B25A	10/13 →	
2 228 i	N20B20A	07/14 →	
2 M 235 i	N55B30A	10/13 →	
2 M 235 i xDrive	N55B30A	07/14 →	
2 M2	N55B30A	11/15 → 06/18	
2 M2 Competition	S55B30A	06/18 →	
3 V 316 i	N43B16A, N43B20A	09/05 → 12/13	
3 V 318 i	N43B20A, N43B20A	02/07 → 12/13	
3 V 320 i	N43B20A, N52B25A	03/05 → 12/13	
3 V 323 i	N52B25A, N52B25A	09/05 →	
3 V 325 i	N52B25A, N52B25A	12/04 →	
3 V 325i xDrive	N52B25A, N52B25A	09/08 → 12/13	
3 V 325 xi	N52B25A, N51B30A	01/05 →	
3 V 328 i	N51B30A, N51B30A	07/05 →	
3 V 328 xi	N51B30A, N52B30A	09/06 →	
3 V 330 i	N52B30A, N52B30A	12/04 → 12/13	
3 V 330 i xDrive	N53B30A	09/07 → 06/13	
3 V 330 xi	N52B30A, N54B30A	09/05 → 12/13	
3 V 335 i	N54B30A, N54B30A	11/05 → 10/13	
3 V 335 i xDrive	N54B30A, N54B30A	05/08 → 12/13	
3 V 335 xi	N54B30A, N20B20A	09/06 → 02/10	
3 V 320 i	N20B20A, N20B20A	04/11 → 06/16	
3 V 320 i xDrive	N20B20A, N20B20A	05/11 → 06/16	
3 V 320 Li [CHN]	--	02/12 →	
3 V 320i [ExtraEU]	N20B20A, N20B20A	04/11 →	
3 V 328 i	N20B20A, N20B20A	04/11 → 10/18	
3 V 328 i xDrive	N20B20A, N55B30A	05/11 → 07/16	
3 V 328 i xDrive [USA]	--	10/11 →	
3 V 328 Li [CHN]	N20B20A	10/11 →	
3 V 328 Li xDrive [CHN]	--	10/11 →	
3 V 335 i	N55B30A, N55B30A	04/11 →	
3 V 335 i xDrive	N55B30A, N20B20A	04/11 →	
3 V 335 Li [CHN]	N55B30A	10/11 →	
3 V ActiveHybrid	N55B30A	11/11 → 05/15	
3 V M3	S55B30A	03/14 → 10/18	
3 V M3 Competition	S55B30A	03/16 → 10/18	
3 V M3 CS	S55B30A	01/18 → 10/18	
3 SERIES 320i Touring [ExtraEU]	N43B20A	06/07 → 10/12	
3 SERIES 325i Coupe [ExtraEU]	N52B25A, N43B16A	03/10 → 06/13	
3 SERIES 330i Coupe Xi [ExtraEU]	N52B30A	09/06 → 09/08	
4 420 i	N20B20A, N20B20A	11/13 →	
4 420 i xDrive	N20B20A, N20B20A	11/13 →	
4 428 i	N20B20A, N20B20A	07/13 →	
4 428 i xDrive	N20B20A, N43B20A	07/13 →	
4 435 i	N55B30A	07/13 →	
4 435 i xDrive	N55B30A	07/13 →	
4 M4	S55B30A	01/14 →	
4 M4 Competition	S55B30A	03/16 →	
4 M4 CS	S55B30A	09/16 →	
4 M4 GTS	S55B30A	03/16 → 02/17	
5 V 520 i	N20B16A, N52B25A	10/10 → 02/17	
5 V 520Li [CHN]	N20B20D	01/09 →	
5 V 523 i	N52B25A, N20B20A	01/09 → 08/11	
5 V 523Li [CHN]	N52B25AF	01/09 →	
5 V 525 d	N47D20D(N47S1)	09/11 → 10/16	
5 V 525Li [CHN]	N20B20A	09/11 →	
5 V 528 i	N20B20A, N52B30A	11/09 →	
5 V 528 i xDrive	N20B20A	09/11 → 02/17	
5 V 528Li [CHN]	N20B20C	09/10 →	
5 V 530 Hybrid [CHN]	--	01/13 →	
5 V 530 i	N52B30A, N55B30A	06/09 → 06/13	
5 V 530Li [CHN]	N52B30AF	09/10 →	
5 V 535 i	N55B30A, N55B30A	01/10 → 02/17	
5 V 535 i xDrive	N55B30A, N63B44A	03/11 → 02/17	
5 V 535Li [CHN]	N55B30A	01/09 →	
5 V 550 i	N63B44A, N63B44A	01/09 → 02/17	
5 V 550 i xDrive	N63B44A, N63B44A	08/10 → 10/16	
5 V ActiveHybrid	N55B30A	12/11 → 10/16	
5 V M5	S63B44B	09/11 → 10/16	
5 V M5 Competition	S63B44B	02/13 → 10/16	
5 V M5 Edition 30	S63B44B	07/14 → 10/16	
5 V GT 528 i	N20B20A	07/13 → 02/17	
5 V GT 535 i	N55B30A	01/09 → 02/17	
5 V GT 535 i xDrive	N55B30A	01/10 → 02/17	
5 V GT 550 i</			

BMW		
5 V 525 i	N52B25A, N52B25A	10/04 →
5 V 525 i xDrive	N53B30A	09/08 → 12/10
5 V 525 xi	N52B25A, N52B25A	07/05 →
5 V 525Li	N52B25A, N52B30A	07/05 →
5 V 528 i	N52B30A	09/08 → 12/09
5 V 528 xi	N52B30A	03/07 →
5 V 530 i	N52B30A, N52B30A	09/04 → 12/10
5 V 530 i xDrive	N53B30A	09/08 → 05/10
5 V 530 xi	N52B30A, N52B30A	09/04 → 05/10
5 V 530Li	N52B30A, N62B40A	07/05 →
5 V 535 i	N54B30A	04/06 → 12/09
5 V 535xi	N54B30A	03/07 →
5 V 540 i	N62B40A, N62B48A	07/05 → 02/10
5 V 550 i	N62B48A, N20B16A	07/05 → 12/10
6 II 630 i	N52B30A, N63B44A	02/04 → 07/10
6 II 650 i	N62B48B	07/05 → 07/10
6 III 640 i	N55B30A	11/10 →
6 III 640 i xDrive	N55B30A	01/13 →
6 III 650 i	N63B44A, N63B40A	11/10 →
6 III 650 i xDrive	N63B40A, S63B44B	06/11 →
6 III 650 i xDrive 4.0	N63B40A	06/11 →
6 III M6	S63B44B, N52B30A	01/12 →
7 IV 730 i, Li	N52B30A, N52B30A	03/05 → 07/08
7 IV 730 i, Li	N52B30B	03/05 →
7 IV 740 i, Li	N62B40A	07/05 → 07/08
7 IV 750 i, Li	N62B48B	03/05 → 08/08
7 V 730 i, Li	N52B30A, N54B30A	06/08 → 12/15
7 V 740 i, Li	N54B30A, N63B44A	10/08 → 12/15
7 V 740 i, Li xDrive	N55B30A	07/12 → 12/15
7 V 750 i	N63B44A, N63B44A	10/08 → 12/15
7 V 750 i xDrive	N63B44A, N55B30A	09/09 → 12/15
7 V 750Li xDrive	N63B40A	01/11 →
7 V 760 i	N74B60A	09/09 → 12/15
7 V ActiveHybrid	N55B30A, IB1P25B	09/09 → 05/15
I3 Range Extender	IB1P25B, N46B20B	08/13 →
I3 s Range Extender	W20K06A	11/17 →
X1 sDrive 16 i	N20B16A	03/13 → 06/15
X1 sDrive 18 i	N46B20B, N20B20A	03/09 → 06/15
X1 sDrive 18 i [CHN]	N20B20C	01/13 →
X1 sDrive 20 i	N20B20A	09/11 → 06/15
X1 sDrive 28 i [USA]	N20B20A	01/09 →
X1 xDrive 20 i	N20B20A	09/11 → 06/15
X1 xDrive 25 i	N52B30A	01/10 → 06/15
X1 xDrive 28 i	N20B20A, N52B25A	10/09 → 06/15
X1 xDrive 28 i Flex	N20B20A	04/11 → 06/15
X1 xDrive 35i	N55B30A	01/11 →
X3 I 2.5 si	N52B25A, N52B25A	08/06 → 08/08
X3 I 2.5 si xDrive	N52B25A, N52B30A	08/06 → 08/08
X3 I 3.0 si	N52B30A, N52B25A	09/06 → 08/08
X3 I xDrive 2.5si	N52B25BF	09/06 →
X3 I xDrive 25 i	N52B25A, N52B30A	09/08 → 08/10
X3 I xDrive 3.0si	N52B30B	09/06 →
X3 I xDrive 30 i	N52B30A, N20B16A	09/08 → 12/11
X3 II sDrive 20 i	N20B16A, N20B20A	04/14 → 08/17
X3 II sDrive 28 i [USA]	N20B20A	01/13 →
X3 II xDrive 20 i	N20B20A	10/11 → 08/17
X3 II xDrive 28 i	N20B20A, N52B30A	01/11 → 08/17
X3 II xDrive 35 i	N55B30A	09/10 → 08/17
X4 M 40 i	N55B30A	12/15 → 03/18
X4 xDrive 20 i	N20B20A	04/14 → 03/18
X4 xDrive 28 i	N20B20A	04/14 → 03/18
X4 xDrive 35 i	N55B30A	04/14 → 03/18
X5 III M	S63B44B	12/14 → 07/18
X5 III sDrive 35 i [USA]	N55B30A	01/13 →
X5 III xDrive 35 i	N55B30A	12/13 → 07/18
X5 III xDrive 40e	N20B20A	08/15 → 07/18
X5 III xDrive 50 i	N63B44B	08/13 → 07/18
X5 III xDrive 50i	N63B40A	07/13 →
X5 II 3.0 si	N52B30A, N52B30A	02/06 → 09/08
X5 II 4.8 i xDrive	N62B48B	02/07 → 09/08
X5 II M	S63B44A	09/09 → 06/13
X5 II xDrive 30 i	N52B30A, N55B30A	09/08 → 12/10
X5 II xDrive 35 i	N55B30A, N54B30A	09/10 → 06/13
X5 II xDrive 40 i	N55B30A	01/12 → 06/13
X5 II xDrive 48 i	N62B48B	09/08 → 06/13
X5 II xDrive 50 i	N63B44A	07/09 → 06/13
X5 SERIES X5 xDrive 28i [ExtraEU]	N20B20A	06/15 → 07/18
X6 I 35 i	N54B30A	05/08 → 08/08
X6 I 50 i	N63B44A	05/08 → 06/14
X6 I ActiveHybrid	N63B44A	01/09 → 10/11
X6 I ActiveHybrid xDrive	N63B44A	01/09 → 10/11
X6 I M	S63B44A	07/08 → 06/14
X6 I xDrive 35 i	N54B30A, N55B30A	06/07 → 06/14
X6 I xDrive 40 i	N55B30A	01/12 →
X6 I xDrive 50 i	N63B44A	10/07 → 06/14
X6 II 35 i [USA]	N55B30A	08/14 →
X6 II M	S63B44B	12/14 →

BMW		
X6 II xDrive 35 i	N55B30A, N63B40A	12/14 →
X6 II xDrive 50 i	N63B40A, N52B25A	08/14 →
X6 II xDrive 50 i [USA]	N63B44B	08/14 →
Z4 I 2.5 i	N52B25A, N52B25A	09/05 →
Z4 I 2.5 si	N52B25A, N52B30A	09/05 →
Z4 I 3.0 i	N52B30A	01/06 →
Z4 I 3.0 si	N52B30A, N52B25A	01/06 →
Z4 II sDrive 18 i	N20B20A	04/13 → 08/16
Z4 II sDrive 20 i	N20B20A	09/11 → 08/16
Z4 II sDrive 23 i	N52B25A, N52B30A	03/09 → 08/11
Z4 II sDrive 28 i	N20B20A	09/11 → 08/16
Z4 II sDrive 30 i	N52B30A, N52B30B	02/09 → 08/11
Z4 II sDrive 35 i	N54B30A	02/09 → 08/16
Z4 II sDrive 35 is	N54B30A	03/10 → 08/16
Z4 II sDrive30i	N52B30B, DW10BTEd4	05/09 →
Z SERIES Z4 sDrive 35i Cabrio [ExtraEU]	N54B30A	02/09 → 08/16

MINI		
MINI III Cooper	B38A15A	09/13 →
MINI III John Cooper Works	B48A20B	03/15 →
MINI III One	B38A15A	07/17 →

9.0524 

REVOLUTION AND TIMING (CKP AND CMP) SENSORS

- Adatt./Suitable:
- BOSCH**
0 986 280 445
 - CITROËN**
1920 GJ
96 436 957 80
96 648 938 80
 - FIAT**
9643695780
 - FORD**
1 231 925
3M5Q-9E731-AA
 - LANCIA**
9643695780
 - PEUGEOT**
1920 GJ
 - VOLVO**
865370-3

MARKET DIFFUSION: **MEDIUM**



L	L1	Hall Effect	
---	---		

CITROËN		
C4 I 2.0 HDi	DW10BTEd4, DW10BTEd4	11/04 → 07/11
C4 GRAND PICASSO I 2.0 HDi 138	DW10BTEd4, DW10BTEd4	10/06 → 12/13
C4 PICASSO I 2.0 HDi 138	DW10BTEd4, DW10BTEd4	10/06 → 08/13
C5 I 2.0 HDi	DW10BTEd4, DW10BTEd4	09/04 →
C5 II 2.0 HDi	DW10BTEd4, DW10BTEd4	02/08 →
C5 II 2.0 HDi 140	DW10BTEd4, DW10U-TED4	04/09 →
C8 2.0 HDi	DW10UTED4, DW10BTEd4	07/02 →
C8 2.0 HDi 135	DW10BTEd4, DW10U-TED4	03/06 →
DISPATCH 2.0 HDi	DW10UTED4	06/07 → 03/16
JUMPY 2.0 HDi	DW10UTED4	06/07 → 03/16
JUMPY II 2.0 HDi 120	DW10UTED4, DW10BTEd4	01/07 →
JUMPY II 2.0 HDi 120 4x4	RHK(DW10UTED4)	01/10 →
JUMPY II 2.0 HDi 140	DW10BTEd4, DW10BTEd4	01/07 →
FIAT		
SCUDO II 2.0 D Multijet	DW10BTEd4, RHK	01/07 →
SCUDO II 2.0 D Multijet 4x4	RHK	01/07 →
ULYSSE II 2.0 D Multijet	RHK, G6DA	05/06 → 06/11
FORD		
C-MAX I 2.0 TDCi	G6DA, G6DA	02/07 → 09/10
FOCUS II 2.0 TDCi	G6DA, G6DB	07/04 → 09/12

FORD		
FOCUS II CASSONE / FURGONATO / PROMISCUO 2.0 TDCi	G6DB, AZWA	09/05 → 07/11
FOCUS C-MAX 2.0 TDCi	G6DA, G6DA	10/03 → 03/07
GALAXY II 2.0 TDCi	AZWA, G6DG	05/06 → 06/15
KUGA I 2.0 TDCi	G6DG, G6DG	03/08 → 11/12
KUGA I 2.0 TDCi 4x4	G6DG, AZBA	03/08 → 11/12
MONDEO III 2.0 TDCi	AZBA, AZWA	03/07 → 01/15
MONDEO 2.0 TDCi	KLBA	11/07 → 09/14
S-MAX I 2.0 TDCi	AZWA, DW10BTEd4	05/06 → 12/14

LANCIA		
PHEDRA 2.0 D Multijet	RHR(DW10BTEd4)	07/06 → 11/10
PHEDRA 2.0 JTD	RHK(DW10UTED4)	06/06 → 11/10

PEUGEOT		
307 2.0 HDi	DW10BTEd4	04/04 → 11/07
307 2.0 HDi 135	DW10BTEd4, DW10BTEd4	10/03 → 04/09
308 I 2.0 HDi	DW10BTEd4, DW10BTEd4	09/07 →
407 2.0 HDi	DW10BTEd4, RHL(DW10BTEd4)	11/04 →
407 2.0 HDi [ExtraEU]	DW10BTEd4	11/04 → 10/07
407 2.0 HDi 135	RHL(DW10BTEd4), DW10BTEd4	05/04 →
508 I 2.0 HDi	DW10BTEd4, DW10BTEd4	11/10 →
607 2.0 HDi	DW10BTEd4, DW10U-TED4	09/05 → 07/11
607 2.0 HDi 135	RHL(DW10BTEd4)	09/05 →
807 2.0 HDi	DW10UTED4, DW10U-TED4	02/06 →
EXPERT II 2.0 HDi 120	DW10UTED4, DW10BTEd4	01/07 →
EXPERT II 2.0 HDi 120 4x4	RHK(DW10UTED4)	01/10 →
EXPERT II 2.0 HDi 140	DW10BTEd4, DW10U-TED4	01/07 →
EXPERT II TEPEE 2.0 HDi 120	DW10UTED4, DW10BTEd4	01/07 →
EXPERT II TEPEE 2.0 HDi 120 4x4	RHK(DW10UTED4)	01/07 →
EXPERT II TEPEE 2.0 HDi 140	DW10BTEd4, BKC	01/07 →

VOLVO		
C30 2.0 D	D4204T	10/06 → 12/12
C70 II 2.0 D	D4204T	01/08 → 10/09
S40 II 2.0 CDI	D4204T2	07/05 → 12/06
S40 II 2.0 D	D4204T	01/04 → 12/10
S40 II 2.0 D4	D4204T2	07/05 → 12/12
S80 II 2.0 TDi	D4204T	02/08 → 03/11
V50 2.0 CDI	D4204T2	12/03 → 12/06
V50 2.0 D	D4204T	04/04 → 12/10
V50 2.0 D4	D4204T2	07/05 → 12/06
V70 III 2.0 D	D4204T	10/07 → 12/15



REVOLUTION AND TIMING (CKP AND CMP) SENSORS

Adatt./Suitable:

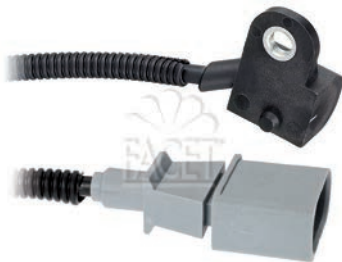
AUDI03G 957 147
03G 957 147 B**SEAT**03G 957 147
03G 957 147 B
045 957 147 D**SKODA**03G 957 147 B
045 957 147 D**VW**03G 957 147
03G 957 147 B
045 957 147 D
076 906 433MARKET DIFFUSION: **HIGH**

L	L1		
320	---	Hall Effect	

AUDI

A3 II 1.9 TDI	BKC, BKC	05/03 ⇒ 05/10
A3 II 2.0 TDI	BMM	06/05 ⇒ 06/08
A3 II SPORTBACK 1.9 TDI	BKC, BJB	09/04 ⇒ 05/10
A3 II SPORTBACK 2.0 TDI	BMM	06/05 ⇒ 06/08

SEAT

ALHAMBRA I / II 2.0 TDI	BRT	11/05 ⇒ 03/10
ALTEA 1.9 TDI	BJB, BKC	04/04 ⇒
ALTEA 2.0 TDI	BMM	11/05 ⇒
ALTEA XL 1.9 TDI	BKC, BMS	10/06 ⇒
ALTEA XL 1.9 TDI 4x4	BLS	06/09 ⇒ 12/10
ALTEA XL 2.0 TDI	BMM	10/06 ⇒
ALTEA XL 2.0 TDI 4x4	BMM	06/07 ⇒
CORDOBA II 1.4 TDI	BMS, ATD	06/05 ⇒ 11/09
CORDOBA II 1.9 TDI	ATD, BMS	09/02 ⇒ 11/09
IBIZA III 1.4 TDI	BMS, ATD	06/05 ⇒ 11/09
IBIZA III 1.9 TDI	ATD, BLS	02/02 ⇒ 11/09
IBIZA IV 1.4 TDI	BMS	07/08 ⇒ 06/10
IBIZA IV 1.9 TDI	BLS, BKC	03/08 ⇒ 06/10
LEON II 1.9 TDI	BKC, BJB	07/05 ⇒ 12/10
LEON II 2.0 TDI	BMM	10/05 ⇒ 10/10
TOLEDO III 1.9 TDI	BJB, BMS	10/04 ⇒ 05/09
TOLEDO III 2.0 TDI	BMM	11/05 ⇒ 05/09

SKODA

FABIA II 1.4 TDI	BMS, BLS	01/07 ⇒ 03/10
FABIA II 1.9 TDI	BLS, BJB	04/07 ⇒ 03/10
OCTAVIA II 1.9 TDI	BJB, BKC	06/04 ⇒ 12/10
OCTAVIA II 1.9 TDI 4x4	BKC, BMS	11/04 ⇒ 12/10
OCTAVIA II 2.0 TDI	BMM	11/05 ⇒ 05/10
OCTAVIA II 2.0 TDI 16V 4x4	CFHC	05/10 ⇒ 02/13
OCTAVIA II 2.0 TDI 4x4	BMM	07/06 ⇒ 05/10
ROOMSTER 1.4 TDI	BMS, BLS	09/06 ⇒ 03/10
ROOMSTER 1.9 TDI	BLS, BLS	09/06 ⇒ 03/10
SUPERB II 1.9 TDI	BLS, BJB	03/08 ⇒ 11/10
SUPERB II 2.0 TDI	BMP	03/08 ⇒ 05/10

VW

CADDY III 1.9 TDI	BJB, BDJ	04/04 ⇒ 08/10
CADDY III 1.9 TDI 4motion	BLS	05/08 ⇒ 08/10
CADDY III 2.0 SDI	BDJ, BRR	03/04 ⇒ 08/10
CADDY III 2.0 TDI	BMM	09/07 ⇒ 08/10
CAMPMOBILE 1.9 TDi	BRR, BJJ	03/04 ⇒ 11/09
CRAFTER 2.5 TDI	BJJ, BKC	04/06 ⇒
EOS 2.0 TDI	BMM	06/06 ⇒ 05/08
GOLF V 1.9 TDI	BKC, BKC	10/03 ⇒ 07/09
GOLF V 1.9 TDI 4motion	BKC, BKC	08/04 ⇒ 07/09
GOLF V 2.0 SDI	BDK	01/04 ⇒ 11/08
GOLF V 2.0 TDI	BMM	12/04 ⇒ 05/11
GOLF V 2.0 TDI 4motion	BMM	08/04 ⇒ 11/08

VW

GOLF VI 2.0 TDI	BMM	07/09 ⇒ 07/13
JETTA V 1.9 TDI	BKC, BRR	01/05 ⇒
JETTA V 2.0 TDI	BMM	10/05 ⇒ 10/10
MULTIVAN 1.9 TDI	BRR, BKC	01/06 ⇒ 11/09
PASSAT V 1.9 TDI	BKC, BMS	03/05 ⇒ 11/10
PASSAT V 2.0 TDI	BMP	03/05 ⇒ 05/09
PASSAT V 2.0 TDI 4motion	BMP	03/05 ⇒ 05/09
POLO IV 1.4 TDI	BMS, ATD	04/05 ⇒ 11/09
POLO IV 1.9 TDI	ATD, BRT	10/01 ⇒ 11/09
SHARAN I 2.0 TDI	BRT, AVQ	11/05 ⇒ 03/10
TOURAN I 1.9 TDI	AVQ, BRR	02/03 ⇒ 05/10
TOURAN I 2.0 TDI	BMM	12/05 ⇒ 05/10
TRANSPORTER V 1.9 TDI	BRR, K4M490	01/06 ⇒ 11/09



REVOLUTION AND TIMING (CKP AND CMP) SENSORS

Adatt./Suitable:

DACIA

82 00 647 559

RENAULT82 00 244 869
82 00 412 638
82 00 428 137
82 00 647 559**SIEMENS**

S119296001



L	L1	ohm	
---	47	245	

DACIA

DUSTER 1.6 16V 4x4 K4M490, K4M800 06/10 ⇒

RENAULT

CLIO III 1.4 16V	K4J780	06/05 ⇒
CLIO III 1.6 16V	K4M800, K4M858	06/05 ⇒
GRAND SCÉNIC II 1.6 Flex	K4M766	06/06 ⇒ 11/08
GRAND SCÉNIC III 1.6 16V	K4M858	02/09 ⇒
GRAND SCÉNIC III 1.6 E85	K4M866	02/09 ⇒
LAGUNA III 1.6 16V	K4M824	10/07 ⇒ 12/15
MEGANE III 1.6 16V	K4M858, K4J770	11/08 ⇒
MEGANE III 1.6 16V Bifuel	K4M866	11/08 ⇒
MEGANE III 1.6 BiFuel	K4M866	11/08 ⇒
MODUS 1.4	K4J770, --	04/06 ⇒ 12/13
MODUS / GRAND MODUS 1.4	K4J770, K4M790	12/04 ⇒
MODUS / GRAND MODUS 1.6	K4M790, K4J770	12/04 ⇒
SCÉNIC II 1.6 16V	K4M766	10/05 ⇒
SCÉNIC II 1.6 Hi-Flex	K4M766	03/05 ⇒ 07/10
SCÉNIC III 1.6 16V	K4M858	02/09 ⇒



REVOLUTION AND TIMING (CKP AND CMP) SENSORS

Adatt./Suitable:

ALFA ROMEO

55185789

FIAT

55185789

GENERAL MOTORS

55 185 789

LANCIA

55185789

OPEL

7 84 527

MARKET DIFFUSION: **MEDIUM**

L	L1	ohm	
---	68,8	885	

ALFA ROMEO

159 2.2 JTS	939A5.000	09/05 ⇒ 11/11
159 MY2011 2.2 JTS	--	01/10 ⇒
BRERA 2.2 JTS	939A5.000	01/06 ⇒ 05/11
SPIDER III 2.2 JTS	939A5.000	03/06 ⇒ 03/11

FIAT

BRAVO II 1.4 T-Jet	--, --	09/07 ⇒
BRAVO II 1.6 D Multijet	--, 199B1.000	09/07 ⇒
FIORINO III 1.3 D Multijet	199B1.000, --	11/07 ⇒
LINEA 1.3 D Multijet	--, 199A2.000	06/07 ⇒
PUNTO III / GRANDE PUNTO 1.3 D Multijet	199A2.000, 199A2.000	10/05 ⇒
PUNTO III / GRANDE PUNTO 1.3 JTD	--	01/08 ⇒ 09/09
PUNTO III EVO 1.3 D Multijet	199A2.000, 199A2.000	07/08 ⇒
PUNTO III 1.3 D Multijet	199A2.000, 199A2.000	04/08 ⇒
PUNTO III 1.3 JTD Multijet	955B2.000	05/18 ⇒
QUBO 1.3 D Multijet	199A2.000, 198A2.000	02/08 ⇒

LANCIA

DELTA III 1.6 D Multijet 198A2.000, Z14XEL 08/08 ⇒ 08/14

OPEL

ASTRA H 1.2	Z12XEP	08/05 ⇒ 10/10
ASTRA H 1.3 CDTi	Z13DTH	04/05 ⇒ 10/10
ASTRA H 1.4	Z14XEL, Z16XE1	03/04 ⇒ 10/10
ASTRA H 1.4 LPG	Z14XEP	08/09 ⇒ 10/10
ASTRA H 1.6	Z16XE1, A17DTJ	03/04 ⇒ 05/14
ASTRA H 1.6 EcoTec	Z16XEP	02/04 ⇒ 11/04
ASTRA H 1.6 LPG	Z16XER	08/09 ⇒ 10/10
ASTRA H 1.6 Turbo	Z16LET	02/07 ⇒ 10/10
ASTRA H 1.7 CDTi	A17DTJ, Z18XE	03/04 ⇒ 05/14
ASTRA H 1.8	Z18XE, Z19DT	01/04 ⇒ 05/14
ASTRA H 1.9 CDTi	Z19DT, Z20LEH	06/04 ⇒ 10/10
ASTRA H 1.9 CDTi 16V	Z19DTJ	04/04 ⇒ 10/10
ASTRA H 2.0 Turbo	Z20LEH, Z14XEL	03/04 ⇒ 10/10
ASTRA H 2.2	Z22YH	03/04 ⇒
CORSA D 1.3 CDTi	Z13DTH	07/06 ⇒ 06/11

VAUXHALL

ASTRA V 1.2	Z12XEP	08/05 ⇒ 10/10
ASTRA V 1.3 CDTi	Z13DTH	01/04 ⇒ 11/10
ASTRA V 1.4	Z14XEL, Z16LET	01/04 ⇒ 10/10
ASTRA V 1.4 i 16V	Z14XEP	03/05 ⇒ 11/10
ASTRA V 1.6	Z16LET, A17DTJ	01/04 ⇒ 11/10
ASTRA V 1.6 i 16V	Z16XER	10/06 ⇒ 08/11
ASTRA V 1.6 Turbo	Z16LET	09/06 ⇒ 09/09
ASTRA V 1.7 CDTi	A17DTJ, Z18XE	01/04 ⇒ 10/12
ASTRA V 1.8	Z18XE, Z19DT	01/04 ⇒ 11/10
ASTRA V 1.8 i 16V	Z18XER	03/07 ⇒ 11/10
ASTRA V 1.9 CDTi	Z19DT, Z20LEH	01/04 ⇒ 11/10
ASTRA V 1.9 CDTi 16V	Z19DTJ	01/04 ⇒ 05/09
ASTRA V 2.0	Z20LEL	02/06 ⇒ 11/10
ASTRA V 2.0 Turbo	Z20LEH, Z16XE1	01/04 ⇒ 11/10
ASTRAVAN III 1.3 CDTi	Z13DTH	08/05 ⇒
ASTRAVAN III 1.4 i	Z14XEP	03/05 ⇒
ASTRAVAN III 1.6	Z16XE1, Z17DTH	03/05 ⇒

VAUXHALL			
ASTRAN III 1.7 CDTi	Z17DTH, Z19DT	03/05 → 11/11	
ASTRAN III 1.9 CDTi	Z19DT, K9K792	03/05 → 11/11	
CORSA D 1.3 CDTi	Z13DTH	08/06 → 08/14	
CORSAVAN III 1.3 CDTi	Z13DTH	07/06 →	

9.0539



3

REVOLUTION AND TIMING (CKP AND CMP) SENSORS

Adatt./Suitable:

DACIA

31 93 591 25R

82 00 012 097

GENERAL MOTORS

93 184 435

MAGNETI MARELLI

CVS02

NISSAN

32005-00Q0C

32005-00QAC

OPEL

44 15 997

RENAULT

31 93 591 25R

82 00 012 097

9.0538



3,5

REVOLUTION AND TIMING (CKP AND CMP) SENSORS

Adatt./Suitable:

DACIA

82 00 434 068

NISSAN

23731-BC41A

23750-00Q0B

23750-00QAK

RENAULT

82 00 187 804

82 00 373 588

82 00 434 068

82 00 691 795

SIEMENS

S119455001

MARKET DIFFUSION: HIGH



MARKET DIFFUSION: HIGH



L	L1	ohm	OUT GND
---	47,3	770	

L	L1	ohm	OUT GND
---	40,5	590	

DACIA

LOGAN I 1.5 dCi	K9K792, K9K704	01/06 →
SANDERO I 1.5 dCi	K9K796	11/08 →

NISSAN

KUBISTAR 1.5 dCi	K9K704, K9K276	08/03 →
KUBISTAR 1.5 dCi 70	K9K700	04/06 → 10/09
KUBISTAR 1.5 dCi 85	K9K276	04/06 → 10/09
MICRA III 1.5 dCi	K9K276, K9K276	06/05 → 06/10
NOTE I 1.5 dCi	K9K276, K9K	03/06 → 06/12
QASHQAI I 1.5 dCi	K9K, K9K	02/07 → 12/13
TIIDA I 1.5 dCi	K9K, K9K712	01/07 → 06/13

RENAULT

CLIO II 1.5 dCi	K9K712, K9K764	01/04 →
CLIO III 1.5 dCi	K9K764, K9K728	06/05 →
GRAND SCÉNIC II 1.5 dCi	K9K728, K9K714	04/04 →
KANGOO I 1.5 dCi	K9K714, K9K608	06/05 →
KANGOO II 1.5 dCi	K9K608, K9K804	02/08 →
KANGOO II 1.5 dCi 110	K9K804, K9K800	09/10 →
KANGOO II 1.5 dCi 85	K9K800, K9K780	02/08 →
LAGUNA III 1.5 dCi	K9K780, K9K636	10/07 → 12/15
LOGAN 1.5 dCi	K9K792	04/07 →
LOGAN EXPRESS 1.5 dCi	K9K792	04/07 →
MEGANE II 1.5 dCi	K9K724, K9K636	08/03 → 12/10
MEGANE III 1.5 dCi	K9K636, K9K836	02/09 →
MEGANE 1.5 dCi	K9K636, K9K724	01/09 → 08/15
MEGANE III HATCHBACK VAN 1.5 dCi	K9K836, K9K752	02/09 → 08/15
MODUS / GRAND MODUS 1.5 dCi	K9K752, K9K728	12/04 →
SANDERO I 1.5 dCi	K9K792	04/07 →
SCÉNIC II 1.5 dCi	K9K722, K9K636	11/03 →
SCÉNIC III 1.5 dCi	K9K636, K9K714	02/09 →
SCÉNIC 1.5 dCi	K9K728, K9K722	06/07 → 11/08
THALIA I 1.5 dCi	K9K714, K9K718	01/01 →
THALIA II 1.5 dCi	K9K718, K9K718	09/08 →
TWINGO II 1.5 dCi	K9K718, K7M764	03/07 →

DACIA

DUSTER 1.5 dCi	K9K856	04/13 →
DUSTER 1.5 dCi 4x4	K9K858	04/13 →
LOGAN II 1.6 16V	K7M764, H4B408	10/12 →
LOGAN II Tce 90	H4B408, H4M734	10/12 →
SANDERO II 1.5 dCi	K9K626	10/12 →
SANDERO II 1.6	H4M734, G9U650	10/12 →
SANDERO II 1.6 I	K7M764	10/12 →
SANDERO II Tce 90	--	10/12 →

NISSAN

INTERSTAR dCi 100	G9U650, G9U650	11/03 →
INTERSTAR dCi 120	G9U650, F9Q772	04/02 →
INTERSTAR dCi 140	ZD30	11/03 →
INTERSTAR dCi 150	G9U632	08/06 →
INTERSTAR dCi 80	F9Q772, G9T722	04/02 →
INTERSTAR dCi 90	G9T722, M9T694	07/02 →
NV400 2.3 dCi 145 RWD	M9T694, M9T670	11/11 → 02/14
NV400 2.3 dCi 150	M9T880	02/14 → 09/16
NV400 2.3 dCi 165	M9T	06/14 → 09/16
NV400 dCi 100	M9T670, M9T670	11/11 → 06/14
NV400 dCi 110	--	06/14 →
NV400 dCi 125	M9T670, M9T686	11/11 → 09/16
NV400 dCi 125 RWD	M9T686, --	11/11 → 09/16
NV400 dCi 125 RWD	--, M9T696	06/14 → 09/16
NV400 dCi 140 RWD	M9T696, M9T678	06/14 → 09/16
NV400 dCi 145	M9T678, M9T694	11/11 → 06/16
NV400 dCi 145 RWD	M9T694, F4R720	11/11 → 06/16
NV400 dCi 150	M9T880	02/14 → 09/16
NV400 dCi 150 RWD	M9T880	02/14 → 09/16
NV400 dCi 160	M9T	06/14 → 09/16
NV400 dCi 165	M9T	06/14 → 06/16
NV400 dCi 165 RWD	M9T	06/14 →
NV400 dCi 170	M9T	07/15 →
PRIMASTAR 1.9 dCi 100	F9Q760	07/02 →
PRIMASTAR 1.9 dCi 80	F9Q762	09/02 →
PRIMASTAR 2.0	F4R720, G9U630	03/01 →
PRIMASTAR 2.0 dCi 115	M9R780	09/06 →
PRIMASTAR 2.0 dCi 90	M9R782	09/06 →
PRIMASTAR 2.5 dCi 115	G9U630, G9U630	09/08 →
PRIMASTAR 2.5 dCi 140	G9U730	07/03 →
PRIMASTAR 2.5 dCi 150	G9U632	09/06 →
PRIMASTAR dCi 100	F9Q760	03/01 →
PRIMASTAR dCi 115	G9U630, F9Q770	09/08 →
PRIMASTAR dCi 120	M9R780	09/06 →
PRIMASTAR dCi 140	G9U730	07/03 →
PRIMASTAR dCi 150	G9U632	09/06 →

NISSAN

PRIMASTAR dCi 80	F9Q762	03/01 →
PRIMASTAR dCi 90	M9R782	09/06 →

OPEL

MOVANO A 1.9 DTi	F9Q770, G9T720	09/00 →
MOVANO A 2.2 DTi	G9T720, G9U632	09/00 →
MOVANO A 2.5 CDTi	G9U632, S8U770	10/03 →
MOVANO A 2.5 D	S8U770, G9U720	07/98 → 09/00
MOVANO A 2.5 DTi	G9U720, S9W700	10/01 →
MOVANO A 2.8 DTi	S9W700, ZD3200	07/98 → 10/01
MOVANO A 3.0 DTi	ZD3200, M9T670	10/03 →
MOVANO B 2.3 CDTi FWD	M9T670, M9T686	05/10 →
MOVANO B 2.3 CDTi RWD	M9T686, F9Q762	05/10 →
VIVARO A 1.9 DI	F9Q762, M9R630	08/01 →
VIVARO A 1.9 DTi	F9Q760	08/01 →
VIVARO A 2.0 16V	F4R720	08/01 →
VIVARO A 2.0 CDTi	M9R630, G9MB6	01/06 →
VIVARO A 2.0 ECOTEC	F4R820	08/06 →
VIVARO A 2.5 CDTi	G9MB6, D4F740	08/06 →
VIVARO A 2.5 DTi	G9U730	05/03 →

RENAULT

CLIO III 1.2	D4F764	10/05 →
CLIO III 1.2 16V	D4F740, K9K750	06/05 →
CLIO III 1.2 16V Hi-Flex	D4F740	07/08 →
CLIO III 1.5 dCi	K9K750, K4M800	05/05 →
CLIO III 1.6 16V	K4M800, --	06/05 →
CLIO III 2.0 16V Sport	--, G9U650	02/06 →
MASTER II 2.5 dCi	G9U650, M9T670	01/04 →
MASTER II 2.5 dCi 120	G9U750	10/01 →
MASTER III 2.3 dCi 100 FWD	M9T670, M9T690	02/10 →
MASTER III 2.3 dCi 100 RWD	M9T690, M9T870	02/10 →
MASTER III 2.3 dCi 110 FWD	M9T870, M9T670	09/14 →
MASTER III 2.3 dCi 125 FWD	M9T670, M9T686	02/10 →
MASTER III 2.3 dCi 125 RWD	M9T686, M9T700	02/10 →
MASTER III 2.3 dCi 135 FWD	M9T700, M9T700	07/14 →
MASTER III 2.3 dCi 135 RWD	M9T700, M9T678	07/14 →
MASTER III 2.3 dCi 145 FWD	M9T678, M9T694	02/10 →
MASTER III 2.3 dCi 145 RWD	M9T694, M9T880	02/10 →
MASTER III 2.3 dCi 150 FWD	M9T880, M9T880	10/12 →
MASTER III 2.3 dCi 150 RWD	M9T880, M9T700	03/13 →
MASTER III 2.3 dCi 165 FWD	M9T700, M9T700	07/14 →
MASTER III 2.3 dCi 165 RWD	M9T700, D4F740	07/14 →
MODUS / GRAND MODUS 1.2	D4F740, K9K750	12/04 →
MODUS / GRAND MODUS 1.2 16V Hi-Flex	D4F740	10/08 →
MODUS / GRAND MODUS 1.5 dCi	K9K750, M9R780	09/04 →
MODUS / GRAND MODUS 1.5 dCi 90	K9K750	10/10 →
TRAFIC II 2.0 dCi 115	M9R780, M9R780	08/06 →
TRAFIC II 2.0 dCi 90	M9R780, K9K718	08/06 →
TRAFIC II 2.5 dCi	G9U630	08/07 →
TRAFIC II 2.5 dCi 115	G9U630	02/08 →
TRAFIC II 2.5 dCi 135	G9U730	03/01 →
TRAFIC II 2.5 dCi 145	G9U630	08/06 →
TRAFIC II 2.5 DTi	G9U730	03/03 → 07/03
TWINGO II 1.2	D7F800	03/07 →
TWINGO II 1.5 dCi	K9K718, F9Q770	03/07 →

VAUXHALL

MOVANO A 1.9 DTi	F9Q770, G9T720	09/00 → 05/10
MOVANO A 2.2 DTi	G9T720, G9U632	09/00 → 05/10
MOVANO A 2.5 CDTi	G9U632, G9U720	10/01 → 12/10
MOVANO A 2.5 D	S8U770	10/98 → 08/02
MOVANO A 2.5 DTi	G9U720, ZD3200	01/01 → 05/10
MOVANO A 2.8 DTi	S9W702	10/98 → 10/01
MOVANO A 2.8 TDI	S9W702	10/98 → 10/01
MOVANO A 3.0 DTi	ZD3200, M9T686	10/03 → 05/10
MOVANO B 2.3 CDTi [RWD]	M9T686, M9T670	07/10 →
MOVANO B 2.3 CDTi FWD	M9T670, M9T670	05/10 →
MOVANO B 2.3 CDTi RWD	M9T670, M9R630	05/10 →
VIVARO 1.9 DI	F9Q762	08/01 → 07/14
VIVARO 1.9 DTi	F9Q760	08/01 → 12/06
VIVARO 2.0 16V	F4R720	08/01 → 07/14
VIVARO 2.0 CDTi	M9R630, G9U630	01/06 → 07/14
VIVARO 2.0 ECOTEC	F4R820	08/06 → 07/14
VIVARO 2.5 CDTi	G9U630, G9U630	04/03 → 07/14
VIVARO 2.5 DTi	G9U630, K7J710	07/03 → 07/14



REVOLUTION AND TIMING (CKP AND CMP) SENSORS

Adatt./Suitable:

BOSCH

0 986 280 411

DACIA

82 00 643 171

NISSAN

23798-00Q0B

RENAULT

60 01 543 612

82 00 643 171

SIEMENS

A2C5318384001

A2C5318384002

*9 with cable

- con cavo
- avec câble
- mit Kabel
- con cable

9.0540K

MARKET DIFFUSION: HIGH



L	L1	ohm	
---	24	290	

DACIA

LOGAN 1.6 Hi-Flex	K7M714	01/11 → 10/12
LOGAN I 1.0	D4D760	12/05 →
LOGAN I 1.0 Hi-Flex	D4D760	01/11 → 10/12
LOGAN I 1.2 16V	D4F732	02/06 →
LOGAN I 1.2 16V LPG	D4F734	02/06 →
LOGAN I 1.4	K7J710	09/04 →
LOGAN I 1.4 MPI LPG	K7J710, K7M710	02/06 →
LOGAN I 1.6	K7M710, K7M710	09/04 →
LOGAN I 1.6 Bifuel	K7M710, D4F732	11/08 →
LOGAN I 1.6 LPG	K7M718	08/04 → 03/11
LOGAN II 1.2	D4F732, D4F732	10/12 →
LOGAN II 1.2 LPG	D4F732, D4F732	10/12 →
LOGAN II MCV 1.2	D4F732, D4F732	02/13 →
LOGAN II MCV 1.2 LPG	D4F732, D4F732	02/13 →
SANDERO I 1.0 Hi-Flex	D4D760	01/11 → 12/12
SANDERO I 1.2 16V	D4F732	11/08 →
SANDERO I 1.2 16V LPG	D4F732, K7M710	11/08 →
SANDERO I 1.4	K7J710	06/08 →
SANDERO I 1.4 MPI LPG	K7J714	01/09 →
SANDERO I 1.6	K7M710, D4F732	06/08 →
SANDERO I 1.6 LPG	K7M718	06/08 → 12/12
SANDERO II 1.2	D4F732, D4F732	10/12 →
SANDERO II 1.2 LPG	D4F732, D7F726	10/12 →

NISSAN

KUBISTAR 1.2	D7F726, K7J700	08/03 →
KUBISTAR 1.2 16V	D4F730	04/06 →
KUBISTAR 1.4	K7J700, D4F728	08/03 → 10/09

RENAULT

CLIO 1.2	D4F728, D7F720	08/98 →
CLIO 1.2 BiFuel	D7F722	03/98 → 10/01
CLIO 1.2 Hi-Flex	D4F742	11/07 → 12/09
CLIO II 1.2	D7F720, D4F706	09/98 →
CLIO II 1.2 16V	D4F706, D7F722	06/01 →
CLIO II 1.2 LPG	D7F722, E7J634	09/98 → 06/09
CLIO II 1.4	E7J634, K7M744	09/98 → 05/05
CLIO II 1.6	K7M744, D4F740	09/98 → 05/05
CLIO III 1.2	D4F740, D4F706	10/05 →
CLIO III 1.2 16V	D4F706, D4F740	06/05 →
CLIO III 1.2 16V Hi-Flex	D4F740, D4F740	07/08 →
CLIO III 1.2 Ethanol	D4F742	07/08 →
CLIO IV 1.2 16V	D4F740, D7D700	11/12 →
CLIO IV 1.2 16V LPG	D4F744	01/14 →
CLIO IV 1.2 LPG	D4F744	01/14 →
CLIO IV 1.2 LPG 16V	D4F744	11/12 → 06/15
KANGOO 1.0	D7D700, D4D700	07/01 → 06/03
KANGOO 1.0 [ExtraEU]	D4D700, D4F712	01/02 → 01/07
KANGOO 1.2	D4F712, D7F710	07/01 → 10/03
KANGOO 1.2 BiFuel	D7F710, D4D700	06/97 → 06/03
KANGOO I 1.0	D4D700, D7F710	01/02 → 01/07
KANGOO I 1.2	D7F710, D4F712	08/97 →

RENAULT

KANGOO I 1.2 16V	D4F712, D7F710	06/01 →
KANGOO I 1.2 BiFuel	D7F710, E7J634	07/98 → 07/01
KANGOO I 1.4	E7J634, D4F732	08/97 →
KANGOO I 1.6	K7M746	09/99 → 06/01
KANGOO II 1.6	K7M750	02/08 →
LOGAN 1.0	D4D760	12/05 →
LOGAN 1.2 16V	D4F732, D4F732	02/06 →
LOGAN 1.2 16V LPG	D4F732, D4F732	12/13 →
LOGAN 1.4	K7J710	09/04 →
LOGAN 1.4 LPG	K7J714	02/08 → 10/13
LOGAN 1.6	K7M710	09/04 →
LOGAN EXPRESS 1.6	K7M710	04/07 →
LOGAN/STEPWAY 1.2	D4F732, D4F732	11/13 →
LOGAN/STEPWAY 1.2 16V LPG	D4F732, D4F740	11/13 →
MEGANE I 1.6 LPG	K7M702	08/95 → 03/99
MEGANE 1.6 BiFuel	K7M702	10/96 → 10/99
MODUS / GRAND MODUS 1.2	D4F740, D4F740	12/04 →
MODUS / GRAND MODUS 1.2 16V	D4F784	05/07 →
MODUS / GRAND MODUS 1.2 16V Hi-Flex	D4F740, K7M710	10/08 →
MODUS / GRAND MODUS 1.2 GPL	D4F744	05/08 → 12/12
SANDERO I 1.2 16V	D4F732	11/08 →
SANDERO I 1.4	K7J710	02/09 →
SANDERO I 1.4 LPG	K7J714	02/09 →
SANDERO I 1.6	K7M710, D4F732	12/07 →
SANDERO II 1.2 16V	D4F732, K7J700	12/13 →
SANDERO II 1.2 16V LPG	D4F734	12/13 →
SYMBOL 1.2 LPG [ExtraEU]	D4F734	12/13 →
THALIA I 1.2 16V	D4F728	04/02 →
THALIA I 1.4	K7J700, K7M730	05/00 →
THALIA I 1.6	K7M730, D4F728	01/01 →
THALIA II 1.2 16V	D4F728, C3G700	09/08 →
THALIA II 1.2 LPG	D4F728	01/10 → 12/13
THALIA II 1.4	K7J700	09/08 → 06/14
THALIA III 1.2 16V	D4F732	12/13 →
TWINGO 1.2	D4F770	09/10 → 09/14
TWINGO I 1.2	C3G700, D4F702	03/93 →
TWINGO I 1.2 16V	D4F702, D4F764	01/01 → 06/07
TWINGO II 1.2	D7F800	03/07 →
TWINGO II 1.2 16V	D4F764, D4F780	03/07 →
TWINGO II 1.2 TCe 100	D4F782	02/11 →
TWINGO II 1.2 Turbo	D4F780, D7F726	03/07 →



REVOLUTION AND TIMING (CKP AND CMP) SENSORS

Adatt./Suitable:

BOSCH

0 986 280 411

DACIA

77 00 101 969

82 00 396 919

82 00 436 025

NISSAN

23798-00Q0A

23798-00QAC

23798-00QAD

RENAULT

60 01 548 175

77 00 101 969

82 00 396 919

82 00 436 025

SIEMENS

S105548001E

S105548001F

S119915001C

S119915001Z

*0 without cable

- senza cavo
- sans câble
- ohne Kabel
- sin cable

9.0540

MARKET DIFFUSION: MEDIUM



L	L1	ohm	
---	24	290	

DACIA

SANDERO I 1.2 16V LPG	D4F732	11/08 →
-----------------------	--------	---------

NISSAN

KUBISTAR 1.2	D7F726, D4F712	08/03 →
KUBISTAR 1.2 16V	D4F712, K7J700	04/06 →
KUBISTAR 1.4	K7J700, D7F730	08/03 → 10/09

RENAULT

CLIO I 1.2	D7F730, E7J601	05/90 → 09/98
CLIO I 1.4	E7J601, D7F710	01/91 → 09/98
CLIO II 1.0	D7D760	02/00 → 05/01
CLIO II 1.0 16V	D4D700	01/01 →
CLIO II 1.2	D7F710, D4F706	03/98 →
CLIO II 1.6	K7M746	10/99 →
CLIO III 1.2 16V	D4F706, D7D700	06/05 →
CLIO IV 1.2 16V Hi-Flex	D4F740	07/08 →
CLIO IV 1.2 16V	D4F744	11/12 →
KANGOO I 1.0	D7D700, D4D700	09/98 →
KANGOO I 1.0 16V	D4D700, D7F710	03/98 →
KANGOO I 1.2	D7F710, E7J626	08/97 →
KANGOO I 1.6	K7M746	09/99 →
LOGAN 1.2 16V	D4F732	02/06 →
MEGANE I 1.4	E7J626, E7J626	09/96 → 08/03
MEGANE I 1.4 16V	K4J710	05/99 → 11/02
MEGANE I 1.4 e	E7J626, C3G700	01/96 → 08/03
MEGANE I 1.6 e	K7M702	01/96 → 08/03
MEGANE I 1.6 i	K7M720	01/96 → 03/99
MEGANE SCÉNIC I 1.4 i	E7J764	01/97 → 09/99
MEGANE SCÉNIC I 1.6 e	K7M702	10/96 → 10/99
MEGANE SCÉNIC I 1.6 i	K7M720	01/97 → 09/99
MODUS / GRAND MODUS 1.2	D4F742	01/08 →
SANDERO I 1.2 16V	D4F732	11/08 →
THALIA I 1.2 16V	D4F728	04/04 →
TWINGO I 1.0	D7D740	01/00 →
TWINGO I 1.0 16V	D4D712	01/01 →
TWINGO I 1.2	C3G700, D4F702	03/93 →
TWINGO I 1.2 16V	D4F702, D4F764	01/01 → 06/07
TWINGO II 1.2 16V	D4F764, K4M694	03/07 →
TWINGO II 1.2 TCe 100	D4F782	02/11 →

9.0543



3,5

9.0543K



3,5

REVOLUTION AND TIMING (CKP AND CMP) SENSORS

Adatt./Suitable:

BOSCH
0 986 280 410
DAZIA
82 00 647 554
NISSAN
23750-00Q0H
RENAULT
82 00 647 554
SIEMENS
A2C5318384901
A2C5318384902

- ⁹with cable
- con cavo
 - avec câble
 - mit Kabel
 - con cable

9.0543K



L	L1	ohm	
---	24	290	

DAZIA

DUSTER 1.6	K4M694, K4M750	04/10 ⇨
DUSTER 1.6 16V	K4M616	06/10 ⇨
DUSTER 1.6 16V LPG	K4M696	04/11 ⇨
LOGAN I 1.6 16V	K4M694	12/05 ⇨
LOGAN I 1.6 16V Hi-Flex	K4M690	11/09 ⇨
SANDERO I 1.6 16V Bifuel	K4M690	01/11 ⇨

NISSAN

KUBISTAR 1.6 16V	K4M750, K4M720	08/03 ⇨
------------------	----------------	---------

RENAULT

CLIO II 1.6i	K4M736	11/04 ⇨
CLIO II 2.0 16V	F4R732	06/01 ⇨
LAGUNA I 1.6 16V	K4M720, F4P770	11/97 ⇨ 03/01
LAGUNA I 2.0	F4R780	09/99 ⇨ 02/01
LAGUNA I 2.0 16V	F4R780	09/99 ⇨ 03/01
LAGUNA II 1.6 16V	K4M714	03/01 ⇨ 12/07
LAGUNA II 1.6 LPG	K4M714	03/01 ⇨ 05/05
LAGUNA II 1.8 16V	F4P770, K4M760	03/01 ⇨
LOGAN 1.6 16V	K4M694	12/05 ⇨
MEGANE II 1.6	K4M760, K4M812	09/03 ⇨
MEGANE II 1.6 16V	K4M812, K4M670	11/02 ⇨
THALIA I 1.6	K4M670, K4M750	01/01 ⇨
THALIA II 1.6 16V	K4M744	09/08 ⇨

REVOLUTION AND TIMING (CKP AND CMP) SENSORS

Adatt./Suitable:

BOSCH
0 986 280 410
GENERAL MOTORS
09 110 560
NISSAN
01436-00QAB
23750-00QAH
OPEL
44 02 560
91 10 560
RENAULT
77 00 101 970
77 00 103 069A
82 00 468 645
SIEMENS
S105757001E
S105757001Z
S119975001B
VAUXHALL
9110560

- ⁰without cable
- senza cavo
 - sans câble
 - ohne Kabel
 - sin cable

9.0543



L	L1	ohm	
---	24	290	

NISSAN

KUBISTAR 1.6 16V	K4M750, K4M708	08/03 ⇨
------------------	----------------	---------

OPEL

ARENA 1.9 D	F8Q600	03/98 ⇨ 08/01
-------------	--------	---------------

RENAULT

CLIO II 1.4 16V	K4J700	08/00 ⇨
CLIO II 1.6 16V	K4M734	10/99 ⇨
CLIO II 1.6i	K4M736	11/04 ⇨
CLIO II 1.9 D	F8Q630	02/00 ⇨ 05/01
CLIO II 2.0 16V	F4R732	06/01 ⇨
KANGOO I 1.6	K4M730	09/01 ⇨
KANGOO I 1.6 16V 4x4	K4M708, K4M720	02/01 ⇨
LAGUNA I 1.6 16V	K4M720, F4P770	11/97 ⇨ 03/01
LAGUNA I 1.8 16V	F4P760	04/98 ⇨ 03/01
LAGUNA I 2.0	F4R780	09/99 ⇨ 02/01
LAGUNA I 2.0 16V	F4R780	09/99 ⇨ 03/01
LAGUNA II 1.6 16V	K4M714	03/01 ⇨ 12/07
LAGUNA II 1.6 LPG	K4M714	03/01 ⇨ 05/05
LAGUNA II 1.8 16V	F4P770, E7J626	03/01 ⇨
MEGANE I 1.4	E7J626, K4J710	09/96 ⇨ 08/03
MEGANE I 1.4 16V	K4J710, E7J626	11/00 ⇨ 08/03
MEGANE I 1.4 e	E7J626, K4M700	01/96 ⇨ 08/03
MEGANE I 1.6	K7M704	02/00 ⇨ 09/00
MEGANE I 1.6 16V	K4M700, F4P760	03/99 ⇨
MEGANE I 1.6 e	K7M702	01/96 ⇨ 08/03
MEGANE I 1.6 i	K7M720	01/96 ⇨ 03/99
MEGANE I 1.8 16V	F4P760, F4R700	07/00 ⇨ 11/02
MEGANE I 1.9	F8Q788	01/96 ⇨ 02/99
MEGANE I 2.0 16V	F4R700, K4M760	05/00 ⇨
MEGANE II 1.6	K4M760, K4M812	09/03 ⇨
MEGANE II 1.6 16V	K4M812, K4M700	11/02 ⇨
MEGANE SCÉNIC I 1.4 i	E7J764	01/97 ⇨ 09/99
MEGANE SCÉNIC I 1.6 16V	K4M700, F4R744	04/98 ⇨ 10/99
MEGANE SCÉNIC I 1.6 e	K7M702	10/96 ⇨ 10/99
MEGANE SCÉNIC I 1.6 i	K7M720	01/97 ⇨ 09/99
SCÉNIC I 1.6	K4M708	06/01 ⇨ 09/03
SCÉNIC I 1.6 16V	K4M712	05/00 ⇨ 08/03
SCÉNIC I 1.9 D	F8Q788	05/97 ⇨ 06/99
SCÉNIC I 2.0 16V	F4R744, F8Q600	07/00 ⇨ 08/03
SCÉNIC I 2.0 16V RX4	F4R746	06/00 ⇨ 08/03

RENAULT

TRAFIC I 1.9 D	F8Q600, K4M690	06/97 ⇨ 05/01
----------------	----------------	---------------

VAUXHALL

ARENA 1.9 D	F8Q600	03/98 ⇨ 08/01
-------------	--------	---------------

9.0545



3,5

REVOLUTION AND TIMING (CKP AND CMP) SENSORS

Adatt./Suitable:

DAZIA
82 00 647 556
NISSAN
23750-00Q0E
RENAULT
82 00 468 647
82 00 647 556
SIEMENS
A2C5318385101
A2C5318385102

- ⁹with cable
- con cavo
 - avec câble
 - mit Kabel
 - con cable

9.0545K



L	L1	ohm	
---	24	290	

DAZIA

LOGAN I 1.6 16V	K4M690, F4R700	02/06 ⇨
-----------------	----------------	---------

NISSAN

KUBISTAR 1.6 16V	K4M753	08/03 ⇨
------------------	--------	---------

RENAULT

ESPACE III 2.0	F4R700, F4R700	09/01 ⇨ 10/02
ESPACE III 2.0 16V	F4R700, K4M708	10/98 ⇨ 10/02
FLUENCE 1.6 LPG 16V	K4M839	01/12 ⇨
KANGOO 1.6 [ExtraEU]	K4M708, K4M708	06/01 ⇨ 03/09
KANGOO I 1.6 16V	K4M708, K4M750	06/01 ⇨
KANGOO I 1.6 16V 4x4	K4M750, K4M830	10/01 ⇨
KANGOO II 1.6	K4M830, K4M830	02/09 ⇨
KANGOO II 1.6 16V	K4M830, F3R750	02/08 ⇨
MEGANE I 2.0	F3R750, F3R750	04/97 ⇨ 08/03
MEGANE I 2.0 i	F3R750, F3R750	01/96 ⇨ 08/03
MEGANE I 2.0 RT	F3R750, K4M761	10/96 ⇨ 02/99
MEGANE II 1.6	K4M761	09/03 ⇨ 11/08
MEGANE II 1.6 16V	K4M761, F3R750	10/03 ⇨
MEGANE SCÉNIC I 2.0 i	F3R750, K4M697	01/97 ⇨ 09/99
SANDERO I 1.6	K4M697, K4M812	12/07 ⇨
SCÉNIC I 1.6	K4M700, K4J712	03/01 ⇨ 09/03
SCÉNIC 1.6	K4M812, K4M700	07/07 ⇨ 05/09
THALIA I 1.4 16V	K4J713	08/00 ⇨
THALIA I 1.6	K4M745	01/01 ⇨
THALIA II 1.4	K4J712, K4J711	01/09 ⇨ 12/11

9.0545K



3,5

REVOLUTION AND TIMING (CKP AND CMP) SENSORS

Adatt./Suitable:

- NISSAN**
01436-00QAC
23750-00QAG
- RENAULT**
77 00 108 073
- SIEMENS**
S107306001A
S119976001Z

*without cable

- senza cavo
- sans câble
- ohne Kabel
- sin cable

9.0545



L	L1	ohm	
---	24	290	

NISSAN		
KUBISTAR 1.6 16V	K4M753	08/03 →
RENAULT		
KANGOO I 1.6 16V 4x4	K4M753	10/01 →
MEGANE I 1.4 16V	K4J711, K4M701	05/99 → 12/00
MEGANE I 1.6 16V	K4M701, K4M761	05/00 →
MEGANE I 1.6 e	K7M703	01/96 → 08/03
MEGANE I 1.8 16V	F4P771	01/99 → 11/02
MEGANE I 2.0 16V	F4R701	05/00 →
MEGANE I 2.0 RT	F4R747	03/01 → 08/03
MEGANE II 1.6	K4M761	09/03 → 11/08
MEGANE II 1.6 16V	K4M761, F4R760	10/03 →
MEGANE SCÉNIC I 1.6 16V	K4M701	04/98 → 10/99
MEGANE SCÉNIC I 1.6 e	K7M703	10/96 → 10/99
SCÉNIC I 2.0	F3R791	09/99 → 08/03

9.0549



04,5

REVOLUTION AND TIMING (CKP AND CMP) SENSORS

Adatt./Suitable:

- RENAULT**
82 00 275 614
82 00 766 056



L	L1	ohm	
340	32,5	230	

RENAULT		
AVANTIME 2.0 16V Turbo	F4R760, F4R790	11/01 → 05/03
ESPACE IV 2.0	F4R790, F4R794	11/02 →
ESPACE IV 2.0 Turbo	F4R794, F4R713	11/02 →
LAGUNA II 2.0 16V	F4R713, F4R764	09/02 → 09/07

RENAULT		
LAGUNA II 2.0 16V Turbo	F4R764, F4R770	01/03 → 08/05
MEGANE I 2.0 16V	F4R770	01/02 → 08/03
MEGANE II 2.0	F4R770, F4R770	08/03 →
MEGANE II 2.0 16V	F4R770, F4R774	11/02 → 02/08
MEGANE II 2.0 16V Turbo	F4R776	05/04 → 03/09
MEGANE II 2.0 Renault Sport	F4R774, F4R770	05/04 → 10/09
SCÉNIC II 2.0	F4R770, F4R762	06/03 → 07/10
VEL SATIS 2.0 16V Turbo	F4R762, F4R767	06/02 →
VEL SATIS 2.0 Turbo	F4R767, M9T694	04/05 →

9.0551



3

REVOLUTION AND TIMING (CKP AND CMP) SENSORS

Adatt./Suitable:

- BOSCH**
0 986 280 433
- ELECTRICFIL**
14 44 10
- GENERAL MOTORS**
93 198 004
- INFINITI**
23731-00Q0C
- NISSAN**
23731-00Q0A
23731-00Q0C
- OPEL**
44 31 517
44 32 892
93161772
93198004
- RENAULT**
82 00 454 170
82 00 567 414
- SUZUKI**
33220-80KA0
33220-80KA0-000
- Vauxhall**
93161772
93198004

MARKET DIFFUSION: MEDIUM



L	L1		
---	28,6	Hall Effect	

INFINITI		
EX 30d	V9X	04/10 →
FX 30d AWD	V9X	04/10 →
M 30d	V9X	03/10 →
Q70 3.0	V9X	03/13 →
QX50 30d AWD	V9X	08/13 →
QX70 30d AWD	V9X	08/13 →

NISSAN		
FRONTIER 2.3 dCi	M9T	11/14 →
NAVARA II 3.0 dCi	V9X	03/10 →
NAVARA II 3.0 dCi 4WD	V9X	02/10 →
NAVARA III 2.3 dCi	M9T	10/14 →
NP300 2.3 dCi	M9T	06/14 →
NV400 2.3 dCi 145 RWD	M9T694, M9T670	11/11 → 02/14
NV400 2.3 dCi 150	M9T880	02/14 → 09/16
NV400 2.3 dCi 165	M9T	06/14 → 09/16
NV400 dCi 100	M9T670, --	11/11 → 06/14
NV400 dCi 110	--, M9T670	06/14 →
NV400 dCi 125	M9T670, M9T686	11/11 → 09/16
NV400 dCi 125 RWD	M9T686, --	11/11 → 09/16
NV400 dCi 140	--, M9T696	06/14 → 09/16
NV400 dCi 140 RWD	M9T696, M9T678	06/14 → 09/16
NV400 dCi 145	M9T678, M9T694	11/11 → 06/16
NV400 dCi 145 RWD	M9T694, M9R630	11/11 → 06/16
NV400 dCi 150	M9T880	02/14 → 09/16
NV400 dCi 150 RWD	M9T880	02/14 → 09/16
NV400 dCi 160	M9T	06/14 → 09/16
NV400 dCi 165	M9T	06/14 → 06/16
NV400 dCi 165 RWD	M9T	06/14 →

NISSAN		
NV400 dCi 170	M9T	07/15 →
PATHFINDER III 3.0 dCi	V9X	05/10 →
PRIMASTAR 2.0 dCi 115	M9R630, M9R630	09/06 →
PRIMASTAR 2.0 dCi 90	M9R630, M9R630	09/06 →
PRIMASTAR dCi 120	M9R630, M9R630	09/06 →
PRIMASTAR dCi 90	M9R630, M1D	09/06 →
QASHQAI 2.0 dCi	M9R	08/08 → 11/13
QASHQAI I 2.0 dCi	M1D, M1D	02/07 → 12/13
QASHQAI I 2.0 dCi Trazione integrale	M1D, M9R	02/07 → 12/13
X-TRAIL 2.0 dCi [ExtraEU]	M9R760	10/09 → 02/14
X-TRAIL II 2.0 dCi	M9R760	06/07 → 11/13
X-TRAIL II 2.0 dCi 4x4	M9R, M9T670	06/07 → 11/13
X-TRAIL III 2.0 dCi	M9R	10/16 →
X-TRAIL III 2.0 dCi ALL MODE 4x4-i	M9R	10/16 →

OPEL		
MOVANO B 2.3 CDTI FWD	M9T670, M9T686	05/10 →
MOVANO B 2.3 CDTI RWD	M9T686, M9R630	05/10 →
VIVARO A 2.0 CDTI	M9R630, M9R740	01/06 →

RENAULT		
ESPACE IV 2.0 dCi	M9R740, M9R700	01/06 →
GRAND SCÉNIC II 2.0 dCi	M9R700, F9Q870	09/05 →
GRAND SCÉNIC III 1.9 dCi	F9Q870, M9R610	02/09 →
GRAND SCÉNIC III 2.0 dCi	M9R610, M9R830	02/09 →
KOLEOS 2.0 dCi	M9R830, M9R830	09/08 →
KOLEOS 2.0 dCi [ExtraEU]	M9R830, M9R830	07/13 →
KOLEOS 2.0 dCi 175	M9R868	08/16 →
KOLEOS 2.0 dCi 175 4WD	M9R868	08/16 →
KOLEOS 2.0 dCi 4x4	M9R830, M9R740	09/08 →
LAGUNA II 2.0 dCi	M9R740, M9R742	08/05 → 12/07
LAGUNA III 2.0 dCi	M9R742, M9R816	10/07 →
LAGUNA III 2.0 dCi GT	M9R816, V9X791	03/08 → 12/15
LAGUNA III 3.0 dCi	V9X791, M9R824	09/08 → 12/15
LATITUDE 2.0 dCi 130	M9R756	12/13 →
LATITUDE 2.0 dCi 150	M9R824, M9R804	02/11 →
LATITUDE 2.0 dCi 175	M9R804, M9T676	05/11 →
LATITUDE 3.0 dCi 240	V9X891	02/11 →
MASTER III 2.3 dCi 100 FWD	M9T670, M9T690	02/10 →
MASTER III 2.3 dCi 100 RWD	M9T690, M9T870	02/10 →
MASTER III 2.3 dCi 110 FWD	M9T870, M9T670	09/14 →
MASTER III 2.3 dCi 125 FWD	M9T670, M9T686	02/10 →
MASTER III 2.3 dCi 125 RWD	M9T686, M9T672	02/10 →
MASTER III 2.3 dCi 145 FWD	M9T672, M9T694	02/10 →
MASTER III 2.3 dCi 145 RWD	M9T694, M9T880	02/10 →
MASTER III 2.3 dCi 150 FWD	M9T880, M9T694	10/12 →
MASTER III 2.3 dCi 150 RWD	M9T694, F9Q870	03/13 →
MASTER 2.3 dCi	M9T676, M9T670	02/10 →
MEGANE II 2.0 dCi	M9R700, F9Q870	09/05 →
MEGANE III 1.9 dCi	F9Q870, M9R610	11/08 →
MEGANE III 2.0 dCi	M9R610, M9R700	04/09 →
MEGANE CC 1.9 dCi	F9Q870, M9R700	06/10 →
MEGANE CC 2.0 dCi	M9R610	06/10 →
SCÉNIC II 2.0 dCi	M9R700, F9Q870	09/05 →
SCÉNIC III 1.9 dCi	F9Q870, M9R610	02/09 →
SCÉNIC III 2.0 dCi	M9R610, M9R630	02/09 →
TRAFIC 2.0 dCi	M9R630, M9R630	08/06 →
TRAFIC II 2.0 dCi 115	M9R630, M9R630	08/06 →
TRAFIC II 2.0 dCi 90	M9R630, M9R760	08/06 →
VEL SATIS 2.0 dCi	M9R760, M9T686	08/05 →

SUZUKI		
GRAND VITARA II 1.9 DDiS	F9QB	03/06 → 08/08

VAUXHALL		
MOVANO 2.3 CDTi	M9T880	05/10 →
MOVANO B 2.3 CDTi [RWD]	M9T686, M9T670	07/10 →
MOVANO B 2.3 CDTi FWD	M9T670, M9T670	05/10 →
MOVANO B 2.3 CDTi RWD	M9T670, M9R630	05/10 →
VIVARO 2.0 CDTi	M9R630, BKC	01/06 → 07/14

9.0552



3

REVOLUTION AND TIMING (CKP AND CMP) SENSORS

Adatt./Suitable:

AUDI
036 906 433 B

BOSCH
0 261 210 233
0 261 210 234

SEAT
036 906 433 B

SKODA
036 906 433 B

VW
036 906 433 B

MARKET DIFFUSION: **HIGH**

L	L1		
---	24	Hall Effect	

AUDI			
A3 II 1.9 TDI	BKC, AZV	05/03	⇒ 05/10
A3 II 2.0 TDI	AZV, BKD	05/03	⇒ 08/12
A3 II 2.0 TDI 16V	BKD, BKD	05/03	⇒ 08/12
A3 II 2.0 TDI 16V quattro	BKD, AZV	08/04	⇒ 08/12
A3 II 2.0 TDI quattro	AZV, BKC	05/03	⇒ 08/12
A3 II SPORTBACK 1.9 TDI	BKC, AZV	09/04	⇒ 05/10
A3 II SPORTBACK 2.0 TDI	AZV, BKD	09/04	⇒ 03/13
A3 II SPORTBACK 2.0 TDI 16V	BKD, BKD	09/04	⇒ 03/13
A3 II SPORTBACK 2.0 TDI 16V quattro	BKD, BMM	11/05	⇒ 03/13
A3 II SPORTBACK 2.0 TDI quattro	BMM, BJB	01/06	⇒ 03/13
SEAT			
ALTEA 1.9 TDI	BJB, BKC	04/04	⇒
ALTEA XL 1.9 TDI	BKC, BKC	10/06	⇒
ALTEA XL 1.9 TDI 4x4	BLS	06/09	⇒ 12/10
LEON II 1.9 TDI	BKC, BKD	07/05	⇒ 12/10
LEON II 2.0 TDI 16V	BKD, BJB	07/05	⇒ 12/12
TOLEDO III 1.9 TDI	BJB, BJB	10/04	⇒ 05/09

SKODA			
OCTAVIA II 1.9 TDI	BJB, BKC	06/04	⇒ 12/10
OCTAVIA II 1.9 TDI 4x4	BKC, BLS	11/04	⇒ 12/10
SUPERB II 1.9 TDI	BLS, BUD	03/08	⇒ 11/10

VW			
GOLF V 1.4 16V	BUD, BKG	05/06	⇒ 12/13
GOLF V 1.4 FSI	BKG, BLG	10/03	⇒ 11/06
GOLF V 1.4 TSI	BLG, BAG	05/06	⇒ 12/13
GOLF V 1.6 FSI	BAG, BKC	10/03	⇒ 07/08
GOLF V 1.9 TDI	BKC, BKC	10/03	⇒ 01/09
GOLF V 1.9 TDI 4motion	BKC, AZV	08/04	⇒ 11/08
GOLF V 2.0 TDI	AZV, BAG	10/03	⇒ 05/11
GOLF V 2.0 TDI 16V	BKD	10/03	⇒ 11/08
GOLF V 2.0 TDI 16V 4motion	BKD	08/04	⇒ 11/08
GOLF V 2.0 TDI 4motion	AZV	06/07	⇒ 07/09
GOLF VI 2.0 TDI	BMM	07/09	⇒ 07/13
POLO IV 1.4	BMG	03/06	⇒ 09/07
POLO IV 1.6	BMH	03/06	⇒ 09/07
TOURAN I 1.6 FSI	BAG, BKC	02/03	⇒ 01/07
TOURAN I 1.9 TDI	BKC, BLX	08/03	⇒ 05/10
TOURAN I 2.0 FSI	BLX, AZV	10/03	⇒ 01/07
TOURAN I 2.0 TDI	AZV, F9Q803	02/03	⇒ 05/10
TOURAN I 2.0 TDI 16V	BKD	08/03	⇒ 05/10

9.0553



3,5

REVOLUTION AND TIMING (CKP AND CMP) SENSORS

Adatt./Suitable:

GENERAL MOTORS
93 859 838

NISSAN
23731-00Q0F

OPEL
44 18 589
93859838

RENAULT
82 00 676 078

SUZUKI
33220-67J02
33220-67J02-000

VAUXHALL
93859838

MARKET DIFFUSION: **MEDIUM**

L	L1	ohm	
---	32	780	

OPEL			
VIVARO A 1.9 DTI	F9Q760	08/01	⇒
RENAULT			
GRAND SCÉNIC II 1.9 dCi	F9Q803, F9Q800	04/04	⇒
MEGANE II 1.9 dCi	F9Q800, F9Q816	11/02	⇒
SCÉNIC II 1.9 D	F9Q812	06/06	⇒
SCÉNIC II 1.9 dCi	F9Q803, F9Q760	06/03	⇒
SCÉNIC II 1.9 dCi 130	F9Q804	10/05	⇒ 12/09
SCENIC 1.9 dCi	F9Q816, F9Q803	06/07	⇒ 11/08
TRAFIC II 1.9 dCi	F9Q760, F9Q760	03/01	⇒
TRAFIC II 1.9 dCi 100	F9Q760	03/01	⇒
TRAFIC II 1.9 dCi 80	F9Q760, F9QB	03/01	⇒

SUZUKI			
GRAND VITARA II 1.9 DDiS	F9QB	03/06	⇒ 08/08
GRAND VITARA II 1.9 DDiS Trazione integrale	F9QB, M9T870	10/05	⇒ 02/15

VAUXHALL			
VIVARO 1.9 DTI	F9Q760	08/01	⇒ 12/06

9.0555



3

REVOLUTION AND TIMING (CKP AND CMP) SENSORS

Adatt./Suitable:

GENERAL MOTORS
93 198 161

NISSAN
23731-00Q0D

OPEL
44 33 781
93198161

RENAULT
82 00 639 913
82 00 662 598
82 00 668 500

VAUXHALL
93198161

MARKET DIFFUSION: **MEDIUM**

L	L1	ohm	
---	43,2	890	

NISSAN			
NV400 2.3 dCi 165	M9T	06/14	⇒ 09/16
NV400 dCi 110	--	06/14	⇒ 06/16
NV400 dCi 125 RWD	M9T870, --	11/11	⇒ 09/16
NV400 dCi 140	--, M9T696	06/14	⇒ 09/16
NV400 dCi 140 RWD	M9T696, M9T670	06/14	⇒ 09/16
NV400 dCi 160	M9T	06/14	⇒ 09/16
NV400 dCi 165	M9T	06/14	⇒ 06/16
NV400 dCi 165 RWD	M9T	06/14	⇒
NV400 dCi 170	M9T	07/15	⇒
QASHQAI 1.2.0 dCi	M1D	02/07	⇒ 12/13
QASHQAI 1.2.0 dCi Trazione integrale	M1D	02/07	⇒ 12/13

OPEL			
MOVANO B 2.3 CDTI FWD	M9T670, M9T686	05/10	⇒
MOVANO B 2.3 CDTI RWD	M9T686, M9R630	05/10	⇒
VIVARO A 2.0 CDTI	M9R630, M9R740	01/06	⇒

RENAULT			
ESPACE IV 2.0 dCi	M9R740, M9R830	01/06	⇒
KOLEOS 2.0 dCi	M9R830, M9R740	09/08	⇒
LAGUNA II 2.0 dCi	M9R740, M9T692	08/05	⇒ 12/07
LAGUNA III 2.0 dCi	M9R742	10/07	⇒
LATITUDE 2.0 dCi 175	M9R839	05/11	⇒
MASTER III 2.3 dCi 100 FWD	M9T890	02/10	⇒
MASTER III 2.3 dCi 100 RWD	M9T692, M9T696	02/10	⇒
MASTER III 2.3 dCi 110 FWD	M9T890	09/14	⇒
MASTER III 2.3 dCi 125 FWD	M9T696, M9T694	02/10	⇒
MASTER III 2.3 dCi 125 RWD	M9T870	02/10	⇒
MASTER III 2.3 dCi 145 FWD	M9T694, M9T686	02/10	⇒
MASTER III 2.3 dCi 150 FWD	M9T898	03/13	⇒
MASTER III 2.3 dCi 150 RWD	M9T880	03/13	⇒
MEGANE II 2.0 dCi	M9R722	09/05	⇒
TRAFIC II 2.0 dCi 115	M9R630	08/06	⇒
VEL SATIS 2.0 dCi	M9R760	01/06	⇒

VAUXHALL			
MOVANO 2.3 CDTi	M9T880	05/10	⇒
MOVANO B 2.3 CDTI [RWD]	M9T686, M9T670	07/10	⇒
MOVANO B 2.3 CDTI FWD	M9T670, M9T670	05/10	⇒
MOVANO B 2.3 CDTI RWD	M9T670, M9R630	05/10	⇒
VIVARO 2.0 CDTI	M9R630, D4FB	01/06	⇒ 07/14

9.0556



3

REVOLUTION AND TIMING (CKP AND CMP) SENSORS

Adatt./Suitable:

HYUNDAI
39300-2A000

KIA
39300-2A000

MARKET DIFFUSION: MEDIUM



L	L1		
---	24,2	Hall Effect	

HYUNDAI

Model	Code	Date
ACCENT III 1.5 CRDi GLS	D4FA	11/05 ⇨ 11/10
ACCENT IV 1.6 CRDi	D4FB, D4FB	11/10 ⇨
ELANTRA IV 1.6 CRDi	D4FB	02/06 ⇨
ELANTRA V 1.6 CRDi	D4FB, D4FA	02/11 ⇨
GETZ 1.5 CRDi	D4FA	08/05 ⇨ 06/09
GETZ 1.5 CRDi GLS	D4FA, D4FC	07/04 ⇨ 06/09
I10 I 1.1 CRDi	D3FA	01/08 ⇨ 12/11
I20 1.1 CRDi	D3FA	05/15 ⇨
I20 1.4 CRDi	D4FC	05/15 ⇨
I20 I 1.1 CRDi	D3FA	03/12 ⇨ 12/15
I20 I 1.4 CRDi	D4FC, D4FB	08/08 ⇨ 12/15
I20 I 1.6 CRDi	D4FB, D4FB	09/08 ⇨ 12/12
I20 II 1.1 CRDi	D3FA	11/14 ⇨
I20 II 1.4 CRDi	D4FC	11/14 ⇨
I30 1.6 CRDi	D4FB	05/15 ⇨
I30 1.6 CRDi VGT	D4FB	10/07 ⇨ 11/11
I30 I 1.6 CRDi	D4FB, D4FB	10/07 ⇨ 06/12
I30 II 1.4 CRDi	D4FC	12/11 ⇨
I30 II 1.6 CRDi	D4FB, D4FD	11/11 ⇨
I30 III 1.6 CRDi	D4FB	11/16 ⇨
I40 1.7 CRDi	D4FD, D4FC	07/11 ⇨
IX20 1.4 CRDi	D4FC, D4FD	11/10 ⇨
IX20 1.6 CRDi	D4FB	06/11 ⇨
IX35 1.7 CRDi	D4FD	11/10 ⇨
LAVITA 1.5 CRDi	--	01/07 ⇨
MATRIX 1.5 CRDi	D3EA	10/01 ⇨ 08/10
MATRIX 1.5 CRDi VGT	D4FA	08/05 ⇨ 08/10
MATRIX 1.5 CRDi VGT [TUR]	D4FA	04/08 ⇨
SB 11 1.6 CRDi	--	01/11 ⇨
TUCSON 1.7 CRDi	D4FD	06/15 ⇨
VERNA II 1.5 CRDi GLS	--	11/05 ⇨

KIA

Model	Code	Date
CARENS III 1.6 CRDi 110	D4FB	10/10 ⇨
CARENS III 1.6 CRDi 128	D4FB	10/10 ⇨
CARENS IV 1.7 CRDi	D4FD, D4FB	03/13 ⇨
CEED I 1.6 CRDi 115	D4FB	12/06 ⇨ 12/12
CEED I 1.6 CRDi 128	D4FB	10/10 ⇨ 12/12
CEED I 1.6 CRDi 90	D4FB, D4FA	12/06 ⇨ 12/12
CEED II 1.4 CRDi	D4FC	04/15 ⇨
CEED II 1.4 CRDi 90	D4FC	05/12 ⇨
CEED II 1.6 CRDi	D4FB	07/12 ⇨
CEED II 1.6 CRDi 110	D4FB	05/12 ⇨
CEED II 1.6 CRDi 115	D4FB	05/12 ⇨
CEED II 1.6 CRDi 128	D4FB	05/12 ⇨
CEED II 1.6 CRDi 136	D4FB	07/15 ⇨
CEED II 1.6 CRDi 90	D4FB-L	05/12 ⇨
CERATO I 1.5 CRDi	D4FA, D4FB	07/05 ⇨
CERATO I 1.6 CRDi	D4FB	06/05 ⇨
OPTIMA III 1.7 CRDi	D4FD-L	03/12 ⇨
OPTIMA IV 1.7 CRDi	D4FD	11/15 ⇨
PICANTO I 1.0 D	--	09/05 ⇨
PICANTO I 1.1 CRDi	D3FA	11/05 ⇨
PRO CEE'D I 1.6 CRDi 115	D4FB	02/08 ⇨ 09/12
PRO CEE'D I 1.6 CRDi 128	D4FB	10/10 ⇨ 09/12
PRO CEE'D I 1.6 CRDi 90	D4FB, D4FA	02/08 ⇨ 09/12
PRO CEE'D II 1.4 CRDi 90	D4FC	03/13 ⇨

KIA

Model	Code	Date
PRO CEE'D II 1.6 CRDi 110	D4FB	03/13 ⇨
PRO CEE'D II 1.6 CRDi 128	D4FB	03/13 ⇨
PRO CEE'D II 1.6 CRDi 136	D4FB	07/15 ⇨
PRO CEE'D 1.4 CRDi	D4FC	05/15 ⇨
PRO CEE'D 1.6 CRDi	D4FB	10/12 ⇨
RIO II 1.5 CRDi	D4FA, D4FD	03/05 ⇨
RIO III 1.1 CRDi	D3FA	09/11 ⇨
RIO III 1.4 CRDi	D4FC	09/11 ⇨
RIO 1.1 CRDi	D3FA	09/11 ⇨
RIO 1.4 CRDi	D4FC	04/15 ⇨
RIO IV 1.4 CRDi 77	D4FC	01/17 ⇨
RIO IV 1.4 CRDi 90	D4FC	01/17 ⇨
SOUL I 1.6 CRDi 115	D4FB	02/09 ⇨
SOUL I 1.6 CRDi 128	D4FB	02/09 ⇨
SOUL II 1.6 CRDi 128	D4FB	02/14 ⇨
SOUL II 1.6 CRDi 136	D4FB	04/15 ⇨
SPORTAGE III 1.7 CRDi	D4FD, D4FD	12/10 ⇨
SPORTAGE IV 1.7 CRDi	D4FD, HJ3	09/15 ⇨
STONIC 1.6 CRDi	D4FB	07/17 ⇨
VENGA 1.4 CRDi 75	D4FC	02/10 ⇨
VENGA 1.4 CRDi 90	D4FC	02/10 ⇨
VENGA 1.6 CRDi 115	D4FB	02/10 ⇨
VENGA 1.6 CRDi 128	D4FB	02/10 ⇨
VENGA CRDi	D4FC	04/15 ⇨

9.0559



04

REVOLUTION AND TIMING (CKP AND CMP) SENSORS

Adatt./Suitable:

KIA
39600-4X300



L	L1	ohm	
360	24	900	

KIA

Model	Code	Date
CARNIVAL II 2.9 CRDi	HJ3, D4CB	06/06 ⇨

9.0560



04

REVOLUTION AND TIMING (CKP AND CMP) SENSORS

Adatt./Suitable:

KIA
39180-4A410



L	L1	ohm	
240	24	900	

KIA

Model	Code	Date
SORENTO 2.5 CRDi [ExtraEU]	D4CB	09/06 ⇨ 12/11

KIA

Model	Code	Date
SORENTO I 2.5 CRDi	D4CB, D4CB	05/06 ⇨

9.0561



04

REVOLUTION AND TIMING (CKP AND CMP) SENSORS

Adatt./Suitable:

KIA
39180-4A400



L	L1	ohm	
160	24	900	

KIA

Model	Code	Date
SORENTO 2.5 CRDi [ExtraEU]	D4CB	09/06 ⇨ 12/11
SORENTO I 2.5 CRDi	D4CB, D3DA	05/06 ⇨

9.0562



04

REVOLUTION AND TIMING (CKP AND CMP) SENSORS

Adatt./Suitable:

KIA
39600-4X310



L	L1	ohm	
210	24	900	

KIA

Model	Code	Date
CARNIVAL II 2.9 CRDi	J3	06/06 ⇨
CARNIVAL II 2.9 CRDi LX	J3	09/06 ⇨

9.0563



04,5

REVOLUTION AND TIMING (CKP AND CMP) SENSORS

Adatt./Suitable:

HYUNDAI
39180-27000
39180-27400**KIA**
39180-27000
39180-27400

MARKET DIFFUSION: MEDIUM



L	L1	ohm	S GND OUT
495	36,8	970	

HYUNDAI

ACCENT II 1.5 CRDi	D3DA, D4EB	01/02 ⇒ 11/05
ELANTRA III 2.0 CRDi	D4EA	04/01 ⇒ 07/06
GETZ 1.5 CRDi	D3EA	03/03 ⇒ 09/05
GRANDEUR 2.2 CRDi	D4EB, D4EA	06/06 ⇒ 12/11
HIGHWAY VAN 2.0 CRDi	D4EA	03/01 ⇒ 03/04
I30 I 2.0 CRDi	D4EA, D4EA	10/07 ⇒ 06/12
LANTRA II 2.0 CRDi	D4EA	04/01 ⇒
MATRIX 1.5 CRDi	D4FA	12/04 ⇒ 08/10
NF 2.0 CVVT	G4BPPE	05/05 ⇒ 12/10
SANTA FE I 2.0 CRDi	D4EA	08/01 ⇒ 03/06
SANTA FE I 2.0 CRDi 4x4	D4EA, D4EA	04/01 ⇒ 03/06
SANTA FE I 2.0 CRDi Trazione integrale	D4EA	11/03 ⇒ 02/06
SONATA V 2.0 CRDi	D4EA, G4KA	02/06 ⇒ 12/10
SONATA V 2.0 VVTi GLS	G4KA, G4KC	05/05 ⇒ 12/10
SONATA V 2.4	G4KC, D4EA	01/05 ⇒ 12/10
TRAJET 2.0 CRDi	D4EA, D4EA	04/01 ⇒ 07/08
TUCSON 2.0 CRDi	D4EA, D4EA	08/04 ⇒ 03/10
TUCSON 2.0 CRDi Trazione integrale	D4EA, D4EA	08/04 ⇒ 03/10
VERNA I 1.5 CRDi	D3EA	01/02 ⇒

KIA

CARENS II 2.0 CRDi	D4EA, D4EA	07/02 ⇒
CARENS III 2.0 CRDi 115	D4EA	05/07 ⇒
CARENS III 2.0 CRDi 135	D4EA	08/09 ⇒
CARENS III 2.0 CRDi 140	D4EA	09/06 ⇒
CEED I 2.0 CRDi	D4EA	06/07 ⇒ 12/12
CEED I 2.0 CRDi 140	D4EA, D4EA	07/07 ⇒ 12/12
CERATO I 2.0 CRDi	D4EA	04/04 ⇒
MAGENTIS II 2.0 CRDi	D4EA, D4EA	11/05 ⇒
OPTIMA II 2.0 CRDi	D4EA	09/06 ⇒
PRO CEE'D I 2.0 CRDi 140	D4EA, D4EA	02/08 ⇒ 09/12
SPORTAGE II 2.0 CRDi	D4EA, D4EA	02/05 ⇒
SPORTAGE II 2.0 CRDi 4WD	D4EA, D4FC	09/04 ⇒

9.0564



04

REVOLUTION AND TIMING (CKP AND CMP) SENSORS

Adatt./Suitable:

HYUNDAI
39180-2A100
39180-2A200**KIA**
39180-2A000
39180-2A100
39180-2A200

MARKET DIFFUSION: MEDIUM



L	L1	ohm	S GND OUT
360	24	900	

HYUNDAI

ACCENT III 1.5 CRDi GLS	D4FA	11/05 ⇒ 11/10
ACCENT IV 1.6 CRDi	D4FB	11/10 ⇒ 12/15
ELANTRA IV 1.6 CRDi	D4FB	02/06 ⇒
ELANTRA V 1.6 CRDi	D4FB	02/11 ⇒ 12/15
GETZ 1.5 CRDi GLS	D4FA	07/04 ⇒ 08/05
I20 I 1.4 CRDi	D4FC, D4FB	08/08 ⇒ 12/15
I20 I 1.6 CRDi	D4FB, D4FB	09/08 ⇒ 12/12
I20 II 1.4 CRDi	D4FC	11/14 ⇒
I30 1.6 CRDi VGT	D4FB	10/07 ⇒ 11/11
I30 I 1.6 CRDi	D4FB, D4FB	10/07 ⇒ 06/12
I30 II 1.4 CRDi	D4FC	12/11 ⇒
I30 III 1.6 CRDi	D4FB, D4FC	11/11 ⇒
IX20 1.4 CRDi	D4FC, D4FB	11/10 ⇒
IX20 1.6 CRDi	D4FB	06/11 ⇒
IX35 1.7 CRDi	D4FD	11/10 ⇒
LAVITA 1.5 CRDi	--	01/07 ⇒
MATRIX 1.5 CRDi	D3EA	10/01 ⇒ 08/10
MATRIX 1.5 CRDi VGT	D4FA	08/05 ⇒ 08/10
MATRIX 1.5 CRDi VGT [TUR]	D4FA	04/08 ⇒
SB 11 1.6 CRDi	--	01/11 ⇒
VERNA II 1.5 CRDi GLS	--	11/05 ⇒

KIA

CARENS III 1.6 CRDi 110	D4FB	10/10 ⇒
CARENS III 1.6 CRDi 128	D4FB	10/10 ⇒
CEED I 1.6 CRDi 115	D4FB	12/06 ⇒ 12/12
CEED I 1.6 CRDi 128	D4FB	10/10 ⇒ 12/12
CEED I 1.6 CRDi 90	D4FB, D4FA	12/06 ⇒ 12/12
CEED II 1.4 CRDi 90	D4FC	05/12 ⇒
CEED II 1.6 CRDi	D4FB	07/12 ⇒
CEED II 1.6 CRDi 110	D4FB	05/12 ⇒
CEED II 1.6 CRDi 115	D4FB	05/12 ⇒
CEED II 1.6 CRDi 128	D4FB	05/12 ⇒
CEED II 1.6 CRDi 90	D4FB-L	05/12 ⇒
CERATO I 1.5 CRDi	D4FA, D4FB	07/05 ⇒
CERATO I 1.6 CRDi	D4FB	06/05 ⇒
PRO CEE'D I 1.6 CRDi 115	D4FB	02/08 ⇒ 09/12
PRO CEE'D I 1.6 CRDi 128	D4FB	10/10 ⇒ 09/12
PRO CEE'D I 1.6 CRDi 90	D4FB, D4FA	02/08 ⇒ 09/12
PRO CEE'D II 1.4 CRDi 90	D4FC	03/13 ⇒
PRO CEE'D II 1.6 CRDi 110	D4FB	03/13 ⇒
PRO CEE'D II 1.6 CRDi 128	D4FB	03/13 ⇒
PRO CEE'D 1.6 CRDi	D4FB	10/12 ⇒
RIO II 1.5 CRDi	D4FA, D4FD	03/05 ⇒
RIO III 1.4 CRDi	D4FC	09/11 ⇒
SOUL I 1.6 CRDi 115	D4FB	02/09 ⇒
SOUL I 1.6 CRDi 128	D4FB	02/09 ⇒
SOUL II 1.6 CRDi 128	D4FB	02/14 ⇒
SOUL II 1.6 CRDi 136	D4FB	04/15 ⇒
SPORTAGE III 1.7 CRDi	D4FD, AJM	12/10 ⇒
VENGA 1.4 CRDi 75	D4FC	02/10 ⇒
VENGA 1.4 CRDi 90	D4FC	02/10 ⇒
VENGA 1.6 CRDi 115	D4FB	02/10 ⇒
VENGA 1.6 CRDi 128	D4FB	02/10 ⇒
VENGA CRDi	D4FC	04/15 ⇒

9.0565



04,5

REVOLUTION AND TIMING (CKP AND CMP) SENSORS

Adatt./Suitable:

AUDI
038 906 433 A**SKODA**
038 906 433 A**VW**
038 906 433 A

MARKET DIFFUSION: MEDIUM



L	L1		S GND OUT
1010	---	Hall Effect	

AUDI

A4 II 1.9 TDI	AVB, BPW	11/00 ⇒ 12/04
A4 II 1.9 TDI quattro	AVF	11/01 ⇒ 12/04
A4 II 2.0 TDI	BPW, BKE	01/06 ⇒ 03/09
A4 I 1.9 TDI	AJM, AJM	03/00 ⇒ 09/01
A4 I 1.9 TDI quattro	AJM, AVB	03/00 ⇒ 09/01
A4 III 1.9 TDI	BKE, AJM	11/04 ⇒ 06/08
A4 III 2.0 TDI	BPW	11/04 ⇒ 06/08
A4 III 2.0 TDI quattro	BPW	01/06 ⇒ 06/08
A6 II 1.9 TDI	AJM, AVB	07/00 ⇒ 01/05

SKODA

SUPERB I 1.9 TDI	AVB, --	12/01 ⇒ 03/08
SUPERB I 2.0	--, AJM	02/06 ⇒
SUPERB I 2.0 TDI	BSS	10/05 ⇒ 03/08

VW

PASSAT IV 1.9 [CHN]	BPZ	04/08 ⇒
PASSAT IV 1.9 TDI	AJM, AJM	02/00 ⇒ 05/05
PASSAT IV 1.9 TDI 4motion	AJM, G4HD	08/99 ⇒ 05/05
PASSAT IV 1.9 TDI Syncro	AJM	11/97 ⇒ 09/00
PASSAT IV 2.0 TDI	BGW	12/03 ⇒ 05/05

9.0568



3

REVOLUTION AND TIMING (CKP AND CMP) SENSORS

Adatt./Suitable:

HYUNDAI
39350-02710
39350-02800
KIA
39350-02710
39350-02800

MARKET DIFFUSION: MEDIUM



L	L1		
---	27	Hall Effect	

HYUNDAI

Model	Code	Period
ATOS 1.1	G4HD, G4HD	06/03 ⇨ 12/10
ATOS PRIME 1.1	G4HG	01/97 ⇨ 12/08
GETZ 1.1	G4HD, G4HG	09/05 ⇨ 06/09
I10 1.1 LPG	G4HG	01/10 ⇨ 12/13
I10 I 1.1	G4HG, --	12/07 ⇨ 12/13
I10 I 1.1 LPG	G4HG	04/11 ⇨ 12/13

KIA

Model	Code	Period
PICANTO I 1.0	--, --	04/04 ⇨
PICANTO I 1.0 LPG	G4HE	01/09 ⇨ 04/11
PICANTO I 1.1	--, D4EB	04/04 ⇨
PICANTO I 1.1 LPG	G4HG	01/09 ⇨ 04/11

9.0569



04,5

REVOLUTION AND TIMING (CKP AND CMP) SENSORS

Adatt./Suitable:

HYUNDAI
39180-27800



L	L1	ohm	
615	36,8	970	

HYUNDAI

Model	Code	Period
SANTA FE 1.2.2 CRDi	D4EB	10/05 ⇨ 03/06
SANTA FE II 2.2 CRDi	D4EB, D4EB	03/06 ⇨ 12/12
SANTA FE II 2.2 CRDi 4x4	D4EB, G4FC	10/05 ⇨ 12/12
SANTA FE II 2.2 CRDi GLS	D4EB	03/06 ⇨ 12/09
SANTA FE II 2.2 CRDi GLS 4x4	D4EB	03/06 ⇨ 12/09

9.0570



04

REVOLUTION AND TIMING (CKP AND CMP) SENSORS

Adatt./Suitable:

HYUNDAI
39180-2A400
39180-2A500
KIA
39180-2A500



L	L1	ohm	
310	24	900	

HYUNDAI

Model	Code	Period
GETZ 1.5 CRDi	D4FA	08/05 ⇨ 06/09
GETZ 1.5 CRDi GLS	D4FA	08/05 ⇨ 06/09
I10 I 1.1 CRDi	D3FA	01/08 ⇨ 12/11
I20 I 1.1 CRDi	D3FA	03/12 ⇨ 12/15

KIA

Model	Code	Period
RIO III 1.1 CRDi	D3FA	09/11 ⇨
RIO 1.1 CRDi	D3FA	09/11 ⇨

9.0571



04,5

REVOLUTION AND TIMING (CKP AND CMP) SENSORS

Adatt./Suitable:

HYUNDAI
39180-2B000
39180-2B100
KIA
39180-2B000
39180-2B100

MARKET DIFFUSION: MEDIUM



L	L1	ohm	
350	46,2	1035	

HYUNDAI

Model	Code	Period
ACCENT IV 1.4	G4FA	11/10 ⇨
ACCENT IV 1.6	G4FC, G4FG	11/10 ⇨
CRETA 1.6	G4FG	01/16 ⇨
CRETA 1.6 4WD	G4FG	08/16 ⇨
CRETA 2.0	G4NA	01/16 ⇨
CRETA 2.0 4WD	G4NA	01/16 ⇨
ELANTRA 1.8 CVT [ExtraEU]	G4NB	01/11 ⇨ 12/16
ELANTRA IV 1.6 CVT	G4FC	06/06 ⇨ 06/11
ELANTRA V 1.6	G4FG, G4NA	06/11 ⇨
ELANTRA V 1.8	G4NB-B	09/10 ⇨
ELANTRA V 2.0	G4NA	10/15 ⇨
ELANTRA V 2.0 MPI [ExtraEU]	G4NA, G4FA	02/16 ⇨
I20 1.4 CVT LPG	G4FA	12/08 ⇨ 12/12
I20 I 1.4	G4FA	09/08 ⇨ 12/15
I20 I 1.6	G4FC	09/08 ⇨ 12/12

Model	Code	Period
I30 1.4 CVT LPG	G4FA, G4FD	01/09 ⇨ 06/12
I30 1.4 LPG	G4FA	01/13 ⇨
I30 1.6 CVT	G4FC	06/14 ⇨
I30 1.6 GDi	G4FD, G4FA	07/14 ⇨
I30 I 1.4	G4FA, G4FC	10/07 ⇨ 06/12
I30 I 1.6	G4FC, G4FA	10/07 ⇨ 06/12
I30 II 1.4	G4FA, G4FC	12/11 ⇨
I30 II 1.6	G4FC, G4NA	12/11 ⇨
I30 II 1.6 CVT [ExtraEU]	G4FC	03/16 ⇨
I30 II 1.6 GDI	G4FD	12/11 ⇨
I30 II 1.6 MPI	G4FC	11/16 ⇨
I40 1.6 GDI	G4FD	07/11 ⇨
I40 2.0	G4NC	03/12 ⇨
I40 2.0 CVT	G4NA	10/12 ⇨
I40 2.0 GDI	G4NA, G4FC	07/11 ⇨
IX20 1.4	G4FA	11/10 ⇨
IX20 1.4 CVT [ExtraEU]	G4FA	11/10 ⇨
IX20 1.4 LPG	G4FA	11/10 ⇨
IX20 1.6	G4FC	11/10 ⇨
IX20 1.6 LPG ECONEXT	G4FC	03/15 ⇨
IX35 1.6	G4FD	11/10 ⇨
IX35 2.0	G4NA	08/13 ⇨ 12/15
IX35 2.0 4WD	G4NA	09/14 ⇨
IX35 2.0 AWD	G4NA	11/13 ⇨
IX35 2.0 CVT	G4NA	08/13 ⇨ 12/15
IX35 2.0 CVT [ExtraEU]	G4NA	11/13 ⇨
IX35 2.0 CVT 4WD	G4NA	08/13 ⇨ 12/15
IX35 2.0 CVT AWD	G4NA	08/09 ⇨
IX35 2.0 GDi	G4NC	08/13 ⇨
IX35 2.0 GDi 4WD	G4NC	08/13 ⇨
SB 11 1.4	--	01/11 ⇨
SB 11 1.6	--	01/11 ⇨
SOLARIS 1.4 16V	--	01/11 ⇨
SOLARIS 1.6	G4FC, G4FC	01/17 ⇨
SOLARIS 1.6 16V	--	01/11 ⇨
SONATA VI 2.0	G4NA	09/10 ⇨ 12/15
SONATA VI 2.0 i	G4KD	09/12 ⇨ 06/14
TUCSON 1.6 GDi	G4FD	06/15 ⇨
TUCSON 2.0	G4NA	06/15 ⇨
VELOSTER 1.6	G4FG	06/11 ⇨
VELOSTER 1.6 GDI	G4FD	03/11 ⇨
VELOSTER 1.6 GDi [ExtraEU]	G4FD	01/11 ⇨
VELOSTER 1.6 MPI	G4FC	04/11 ⇨

KIA

Model	Code	Period
CARENS III 1.6 CVT	G4FC, G4FA	08/09 ⇨
CARENS IV 1.6 GDi	G4FD	03/13 ⇨
CARENS IV 2.0 GDi	G4NC	03/13 ⇨
CEED I 1.4	G4FA, G4FA	12/06 ⇨ 12/12
CEED I 1.4 CVT	G4FA, G4FA	07/09 ⇨ 12/12
CEED I 1.4 LPG	G4FA, G4FC	01/09 ⇨ 04/12
CEED I 1.6	G4FC, G4FC	12/06 ⇨ 12/12
CEED I 1.6 CVT	G4FC	06/09 ⇨ 12/12
CEED I 1.6 LPG	G4FC, G4FA	06/07 ⇨ 09/12
CEED II 1.4 CVT	G4FA, G4FC	05/12 ⇨
CEED II 1.4 LPG	G4FA	05/12 ⇨
CEED II 1.6 CVT	G4FC, G4FC	05/12 ⇨
CEED II 1.6 GDi	G4FD	05/12 ⇨
CEED III 1.6	G4FG	03/18 ⇨
CERATO 1.6 CVT [ExtraEU]	G4FC	06/13 ⇨
CERATO I 1.6	G4FC, G4FC	04/04 ⇨
CERATO II 1.6	G4FC	01/10 ⇨
CERATO II 1.6 CVT	G4FC, --	02/09 ⇨
CERATO III 1.6	--	07/12 ⇨
CERATO III 1.6 CVT	G4FC	07/16 ⇨
CERATO III 1.8	--	07/12 ⇨
CERATO III 2.0	--	07/12 ⇨
CERATO III 2.0 MPI	G4KD	06/13 ⇨
FORTE III 1.6	--	07/12 ⇨
FORTE III 1.8	--	07/12 ⇨
FORTE III 2.0	--	07/12 ⇨
OPTIMA III 2.0 CVT	G4NA	03/13 ⇨ 12/15
OPTIMA III 2.0 CVT Hybrid	--, G4NA	12/12 ⇨
OPTIMA IV 2.0	G4ND	09/15 ⇨
OPTIMA IV 2.0 CVVL	G4NA, G4FA	09/15 ⇨
PRO CEE'D I 1.4	G4FA	02/08 ⇨ 09/12
PRO CEE'D I 1.4 CVT	G4FA, G4FC	06/10 ⇨ 09/12
PRO CEE'D I 1.6	G4FC	02/08 ⇨ 09/12
PRO CEE'D I 1.6 CVT	G4FC, G4FA	02/08 ⇨ 02/13
PRO CEE'D II 1.4 CVT	G4FA, G4FA	03/13 ⇨
PRO CEE'D II 1.4 MPI	G4LC	07/13 ⇨
PRO CEE'D II 1.6 CVT	G4FC	03/13 ⇨
PRO CEE'D II 1.6 GDI	G4FD	03/13 ⇨
PRO CEE'D 1.4 CVT	G4FA	05/12 ⇨
PRO CEE'D 1.6 GDI	G4FD	04/15 ⇨
RIO III 1.4 CVT	G4FA, G4FC	06/11 ⇨
RIO III 1.6 CVT	G4FC	06/12 ⇨
RIO 1.4 CVT	G4FA	04/15 ⇨
RIO IV 1.6	G4FG	07/17 ⇨

KIA		
SOUL 1.6 LPG	G4FG	12/14 →
SOUL I 1.6	G4FC	09/09 → 12/14
SOUL I 1.6 CVVT	G4FC, G4FC	02/09 →
SOUL I 1.6 Flex	--	01/11 →
SOUL I 1.6 GDI	G4FD	06/11 →
SOUL I 1.6 LPG	G4FC, G4FC	02/09 → 12/14
SOUL I 2.0	G4KD	02/09 →
SOUL II 1.6 CVVT	G4FC, G4FC	02/14 →
SOUL II 1.6 GDI	G4FD	02/14 →
SOUL II 1.6 MPI [ExtraEU]	G4FC, G4NA	07/16 →
SOUL II 2.0 CVVT	G4NA, G4NA	02/14 →
SOUL II 2.0 MPI	--	02/14 →
SPORTAGE III 1.6 GDI	G4FD	02/11 →
SPORTAGE III 1.6 LPG	G4FD	01/14 → 12/15
SPORTAGE III 2.0 CVVT	G4NA, G4NA	01/14 → 12/15
SPORTAGE III 2.0 flex	--	07/10 →
SPORTAGE III 2.0 GDI	G4NC	02/14 →
SPORTAGE III 2.0 GDI AWD	G4NC	02/14 →
SPORTAGE IV 1.6 GDI	G4FD	09/15 →
SPORTAGE IV 2.0	G4NA	12/15 →
SPORTAGE IV 2.0 AWD	G4NA	12/15 →
VENGA 1.4 CVVT	G4FA, G4FA	02/10 →
VENGA 1.4 LPG	G4FA	02/10 →
VENGA 1.6 CVVT	G4FC	02/10 →
VENGA CVVT	G4FA, G4FC	02/15 →

9.0578



REVOLUTION AND TIMING (CKP AND CMP) SENSORS

Adatt./Suitable:

- BOSCH**
0 261 210 170
0 261 210 171
- CHRYSLER**
5080350AA
5080352AA
K05080350AA
K05080352AA
- JEEP**
5080350AA
5080352AA
K05080350AA
K05080352AA
- MERCEDES-BENZ**
0031532728
0031532828
31532728
6519050000
A 003 153 27 28
A 003 153 28 28
A 651 905 00 00
A31532728
- MITSUBISHI**
MN960274
MN960372
- MOPAR PARTS**
05080352AA
- SMART**
A 003 153 27 28
A 003 153 28 28

9.0573



REVOLUTION AND TIMING (CKP AND CMP) SENSORS

Adatt./Suitable:

- BOSCH**
0 232 103 074
- HYUNDAI**
39350-2B000
39350-2B010
- KIA**
39350-2B000
39350-2B010

MARKET DIFFUSION: HIGH



L	L1	ohm	OUT GND
---	40	800	



L	L1	Hall Effect	
---	28,2	Hall Effect	

CHRYSLER			
300C I 3.0 CRD	EXL	09/05 →	11/12
300C I 3.0 V6 CRD	EXL	11/10 →	11/12
300C II 3.0 CRD	EXL	09/05 →	12/10
CROSSFIRE 3.2	EGX	07/03 →	12/08
CROSSFIRE SRT-6	EGZ	09/04 →	12/07
PT CRUISER 2.2 CRD	EDJ, EXL	03/02 →	12/10
JEEP			
COMMANDER 3.0 CRD 4x4	EXL, ENE	09/05 →	12/10
COMPASS 2.2 CRD	ENE	05/11 →	
COMPASS 2.2 CRD 4x4	ENE, M166.940	12/10 →	
GRAND CHEROKEE 2.7 CRD 4x4	ENF	10/01 →	09/05
GRAND CHEROKEE 3.0 CRD 4x4	EXL	05/06 →	12/10
PATRIOT 2.2 CRD	ENE	01/11 →	
PATRIOT 2.2 CRD 4x4	ENE	01/11 →	
MAYBACH			
57 5.5	285950	09/02 →	12/12
57 6.0	285980	01/11 →	12/12
57 S 6.0	285980	09/05 →	12/12
62 5.5	285950	09/02 →	12/12
62 6.0	285980	01/11 →	12/12
62 S 6.0	285980	09/05 →	12/12
MERCEDES-BENZ			
B-SERIES B150 BlueEFFICIENCY	M266.920	01/09 →	11/11
CLASSE A I A 140	M166.940, OM668.940	01/01 →	08/04
CLASSE A I A 160	M166.960	07/97 →	08/04
CLASSE A I A 160 CDI	OM668.940, OM668.940	02/01 →	08/04
CLASSE A I A 170 CDI	OM668.940, 266960NGT	02/01 →	08/04
CLASSE A I A 190	M166.990	03/99 →	08/04
CLASSE A I A 210	M166.995	12/01 →	08/04
CLASSE A II A 150	M266.920	09/04 →	06/12
CLASSE A II A 160	M266.920	04/09 →	06/12
CLASSE A II A 160 CDI	OM640.942	09/04 →	06/12
CLASSE A II A 170	M266.940	09/04 →	06/12
CLASSE A II A 180	M266.940	04/09 →	06/12
CLASSE A II A 180 CDI	OM640.940	09/04 →	06/12
CLASSE A II A 200	M266.960	09/04 →	06/12
CLASSE A II A 200 CDI	OM640.941	09/04 →	06/12
CLASSE A II A 200 TURBO	M266.980	09/05 →	06/12
CLASSE B I B 150	M266.920	03/05 →	11/11

MERCEDES-BENZ			
CLASSE B I B 160	M266.920	04/09 →	11/11
CLASSE B I B 170	M266.940	03/05 →	11/11
CLASSE B I B 170 NGT	266960NGT, 266960NGT	04/08 →	11/11
CLASSE B I B 180	M266.940	04/09 →	11/11
CLASSE B I B 180 CDI	OM640.940	03/05 →	11/11
CLASSE B I B 180 NGT	266960NGT, M111.921	04/08 →	11/11
CLASSE B I B 200	M266.960	03/05 →	11/11
CLASSE B I B 200 CDI	OM640.941	03/05 →	11/11
CLASSE B I B 200 TURBO	M266.980	03/05 →	11/11
CLASSE C I C 180	M111.921, M111.921	03/93 →	05/00
CLASSE C I C 180 T	M111.921, M111.944	09/00 →	03/01
CLASSE C I C 200	M111.945	01/94 →	05/00
CLASSE C I C 200 Kompressor	M111.944, M111.944	10/95 →	05/00
CLASSE C I C 200 T	M111.945	06/96 →	03/01
CLASSE C I C 200 T Kompressor	M111.944, M112.910	09/00 →	03/01
CLASSE C I C 230 Kompressor	M111.975	10/95 →	05/00
CLASSE C I C 230 T Kompressor	M111.975	06/97 →	09/00
CLASSE C I C 240	M112.910	06/97 →	05/00
CLASSE C I C 240 T	M112.910, OM611.962	09/00 →	03/01
CLASSE C I C 280	M112.920	06/97 →	05/00
CLASSE C I C 280 T	M112.920	06/97 →	03/01
CLASSE C I C 43 AMG	M113.944	08/97 →	03/01
CLASSE C II C 160 Kompressor	M271.921	05/02 →	05/08
CLASSE C II C 180	M111.951	10/00 →	05/02
CLASSE C II C 180 Kompressor	M271.946	05/02 →	05/08
CLASSE C II C 200 CDI	OM611.962, M111.955	09/00 →	
CLASSE C II C 200 CGI Kompressor	M271.942	03/03 →	05/08
CLASSE C II C 200 Kompressor	M111.955, OM611.962	05/00 →	05/08
CLASSE C II C 220	M271.948	05/02 →	05/08
CLASSE C II C 220 CDI	OM611.962, M111.981	05/00 →	05/08
CLASSE C II C 230 Kompressor	M111.981, M271.820	03/01 →	05/08
CLASSE C II C 240	M112.912	05/00 →	08/07
CLASSE C II C 240 4-matic	M112.916	07/02 →	08/07
CLASSE C II C 270 CDI	OM612.962	12/00 →	08/07
CLASSE C II C 30 CDI AMG	OM612.990	09/02 →	05/08
CLASSE C II C 32 AMG Kompressor	M112.961	02/01 →	08/07
CLASSE C II C 320	M112.946	05/00 →	08/07
CLASSE C II C 320 4-matic	M112.953	07/02 →	08/07
CLASSE C II C 55 AMG	M113.988	02/04 →	08/07
CLASSE C III C 180 CDI	OM651.913	01/11 →	08/14
CLASSE C III C 180 CGI	M271.820, M271.820	01/07 →	08/14
CLASSE C III C 180 Kompressor	M271.820, OM646.811	01/07 →	08/14
CLASSE C III C 200 CDI	OM646.811, M271.820	01/07 →	08/14
CLASSE C III C 200 CGI	M271.820, M271.820	01/07 →	08/14
CLASSE C III C 200 Kompressor	M271.820, OM646.811	01/07 →	08/14
CLASSE C III C 220 CDI	OM646.811, M271.911	01/07 →	
CLASSE C III C 220 CDI 4-matic	OM651.912	02/13 →	08/14
CLASSE C III C 250 CDI	OM651.911	08/08 →	
CLASSE C III C 250 CDI 4-matic	OM651.912	04/10 →	08/14
CLASSE C IV C 220 d	OM651.921	06/16 →	
CLASSE V V 200 CDI	OM611.980	03/99 →	07/03
CLASSE V V 220 CDI	OM611.980	03/99 →	07/03
CLASSE V V 230	M111.978, M155.980	10/96 →	07/03
CLASSE CLC CLC 160	M271.911, M271.940	02/09 →	06/11
CLASSE CLC CLC 180 Kompressor	M271.940, OM646.962	05/08 →	06/11
CLASSE CLC CLC 200 CDI	OM646.962, M111.944	05/08 →	06/11
CLASSE CLC CLC 200 Kompressor	M271.957	05/08 →	06/11
CLASSE CLC CLC 220 CDI	OM646.963	05/08 →	06/11
CLASSE CLK I 200	M111.945	06/97 →	06/02
CLASSE CLK I 200 Kompressor	M111.944, M111.975	06/00 →	06/02
CLASSE CLK I 230 Kompressor	M111.975, M271.940	06/00 →	06/02
CLASSE CLK I 320	M112.940	06/97 →	06/02
CLASSE CLK I 430	M113.943	07/98 →	06/02
CLASSE CLK I 55 AMG	M113.984	08/99 →	06/02
CLASSE CLK II 200 CGI	M271.942	07/03 →	05/09
CLASSE CLK II 200 Kompressor	M271.940, OM612.962	09/02 →	05/09
CLASSE CLK II 220 CDI	OM646.966	01/05 →	05/09
CLASSE CLK II 240	M112.912	06/02 →	05/09
CLASSE CLK II 270 CDI	OM612.962, M113.968	10/02 →	05/09
CLASSE CLK II 320	M112.955	06/02 →	05/09
CLASSE CLK II 500	M113.968, M271.940	06/02 →	05/09
CLASSE CLK II 55 AMG	M113.987	09/02 →	05/09
CLASSE CLK II CLK 200 CGI	M271.942	07/03 →	03/10
CLASSE CLK II CLK 200 Kompressor	M271.940, M113.968	02/03 →	03/10
CLASSE CLK II CLK 240	M112.912	02/03 →	03/10
CLASSE CLK II CLK 320	M112.955	02/03 →	03/10
CLASSE CLK II CLK 500	M113.968, OM611.961	02/03 →	03/10

MERCEDES-BENZ			MERCEDES-BENZ			MERCEDES-BENZ		
CLASSE CLK II CLK 55 AMG	M113.987	02/03 → 03/10	CLASSE E E 270 CDI	OM612.961, OM611.961	07/99 → 07/09	SPRINTER I 308 CDI	OM611.987	04/00 → 05/06
CLASSE CLK II CLK AMG DTM	M113.987	06/04 → 03/10	CLASSE E E 280	M112.921	07/99 → 11/02	SPRINTER I 311 CDI	OM611.981	04/00 → 05/06
CLASSE CLK I DTM AMG	M113.987	06/04 → 05/09	CLASSE G II G 270 CDI	OM612.963, M112.945	01/01 →	SPRINTER I 311 CDI 4x4	OM611.981	08/02 → 05/06
CLASSE CLS I CLS 500	M113.967	10/04 → 12/10	CLASSE G II G 320	M112.945, M113.962	06/97 →	SPRINTER I 313 CDI	OM611.981	04/00 → 05/06
CLASSE CLS I CLS 55 AMG	M113.990	01/05 → 12/10	CLASSE G II G 400 CDI	OM628.962	12/00 →	SPRINTER I 313 CDI 4x4	OM611.981	08/02 → 05/06
CLASSE CLS II CLS 220 BlueTEC / d	OM651.924	05/14 →	CLASSE G II G 500	M113.962	04/98 →	SPRINTER I 314	M111.979, 111979NGT	02/95 → 05/06
CLASSE CLS II CLS 250 BlueTEC / d 4-matic	OM651.924	05/14 →	CLASSE G II G 55 AMG	M113.962, OM651.913	04/98 →	SPRINTER I 314 4x4	M111.984	08/02 → 05/06
CLASSE CLS II CLS 250 CDI / BlueTEC / d	OM651.924	04/11 →	CLASSE GLC 220 d 4-matic	OM651.921	06/16 →	SPRINTER I 314 NGT	111979NGT, 111979NGT	02/95 → 05/06
CLASSE E II E 200	M111.942	06/95 → 08/00	CLASSE GLC 250 d 4-matic	OM651.921	06/16 →	SPRINTER I 316 CDI	OM612.981	04/00 → 05/06
CLASSE E II E 200 CDI	OM611.961, M111.947	06/98 → 03/02	CLASSE GLE 250 d	OM651.960	04/15 →	SPRINTER I 316 CDI 4x4	OM612.981	08/02 → 05/06
CLASSE E II E 200 Kompressor	M111.947, M111.947	08/00 → 03/02	CLASSE GLE 250 d 4-matic	OM651.960	04/15 →	SPRINTER I 408 CDI	OM611.987	04/00 → 05/06
CLASSE E II E 200 T	M111.942	06/96 → 08/00	CLASSE GLK 200 CDI	OM651.913, M112.970	07/10 → 06/15	SPRINTER I 411 CDI	OM611.981	04/00 → 05/06
CLASSE E II E 200 T Kompressor	M111.947, M112.911	08/00 → 03/03	CLASSE GLK 220 CDI	OM651.916	12/08 → 06/15	SPRINTER I 411 CDI 4x4	OM611.981	04/00 → 05/06
CLASSE E II E 220 CDI	OM611.961	07/99 → 03/02	CLASSE GLK 220 CDI 4-matic	OM651.912	12/08 → 06/15	SPRINTER I 413 CDI	OM611.981	04/00 → 05/06
CLASSE E II E 220 T CDI	OM611.961	05/99 → 03/03	CLASSE GLK 250 CDI 4-matic	OM651.912	09/09 → 06/15	SPRINTER I 413 CDI 4x4	OM611.981	04/00 → 05/06
CLASSE E II E 240	M112.911, M112.911	08/00 → 03/02	CLASSE M I ML 230	M111.977	02/98 → 06/05	SPRINTER I 414 NGT	111979NGT, OM646.985	02/95 → 05/06
CLASSE E II E 240 T	M112.911, OM612.961	08/00 → 03/03	CLASSE M I ML 270 CDI	OM612.963	12/99 → 06/05	SPRINTER I 416 CDI	OM612.981	04/00 → 05/06
CLASSE E II E 270 CDI	OM612.961	07/99 → 03/02	CLASSE M I ML 320	M112.942	02/98 → 08/02	SPRINTER I 416 CDI 4x4	OM612.981	04/00 → 05/06
CLASSE E II E 270 T CDI	OM612.961, OM646.820	02/00 → 03/03	CLASSE M I ML 350	M112.970, M137.970	08/02 → 06/05	SPRINTER I 616 CDI	OM612.981	04/01 →
CLASSE E II E 280	M112.921	12/96 → 03/02	CLASSE M I ML 400 CDI	OM628.963	09/01 → 06/05	SPRINTER II 209 CDI	OM646.984	06/06 → 12/09
CLASSE E II E 280 4-matic	M112.921	12/96 → 03/02	CLASSE M I ML 430	M113.942	02/98 → 06/05	SPRINTER II 210 CDI	OM651.955	03/09 →
CLASSE E II E 280 T	M112.921	12/96 → 03/03	CLASSE M I ML 500	M113.965	09/01 → 06/05	SPRINTER II 211 CDI	OM646.985, OM646.986	06/06 →
CLASSE E II E 280 T 4-matic	M112.921	12/96 → 03/03	CLASSE M I ML 55 AMG	M113.981	02/00 → 06/05	SPRINTER II 213 CDI	OM646.986, OM646.986	06/06 →
CLASSE E II E 320	M112.941	06/97 → 03/02	CLASSE M II ML 500 4-matic	M113.964	07/05 → 12/11	SPRINTER II 214 CDI	OM651.955	04/16 →
CLASSE E II E 320 4-matic	M112.941	06/97 → 03/02	CLASSE M III ML 250 CDI / BlueTEC 4-matic	OM651.960	06/11 → 12/15	SPRINTER II 215 CDI	OM646.986, OM651.955	06/06 → 12/09
CLASSE E II E 320 CDI	OM613.961	07/99 → 03/02	CLASSE R R 500 4-matic	M113.971	01/06 →	SPRINTER II 216	M271.951	09/08 →
CLASSE E II E 320 T	M112.941	12/96 → 03/03	CLASSE S IV CL 500	M113.960	03/99 → 03/06	SPRINTER II 216 CDI	OM651.955, OM642.896	06/06 →
CLASSE E II E 320 T 4-matic	M112.941	12/96 → 03/03	CLASSE S IV CL 55 AMG	M113.986	10/99 → 03/06	SPRINTER II 219 CDI / BlueTEC	OM642.896, OM651.955	03/09 →
CLASSE E II E 320 T CDI	OM613.961	07/99 → 03/02	CLASSE S IV CL 55 AMG Kompressor	M113.991	06/02 → 03/06	SPRINTER II 309 CDI	OM646.984	06/06 → 12/09
CLASSE E II E 320 T 4-matic	M112.941	12/96 → 03/03	CLASSE S IV CL 600	M137.970, OM613.960	09/02 → 03/06	SPRINTER II 310 CDI	OM651.955, OM646.701	03/09 →
CLASSE E II E 320 T CDI	OM613.961	07/99 → 03/03	CLASSE S IV CL 65 AMG	M275.980	09/03 → 03/06	SPRINTER II 311 CDI	OM646.701, OM646.986	06/06 →
CLASSE E II E 430	M113.940	06/97 → 03/02	CLASSE S IV S 280	M112.922	10/98 → 08/05	SPRINTER II 311 CDI 4x4	OM646.985	02/08 → 12/09
CLASSE E II E 430 4-matic	M113.940	05/99 → 03/02	CLASSE S IV S 320	M112.944	10/98 → 08/05	SPRINTER II 313 CDI	OM646.986, OM651.955	06/06 →
CLASSE E II E 430 T	M113.940	06/97 → 03/03	CLASSE S IV S 320 CDI	OM613.960, OM628.960	09/02 → 08/05	SPRINTER II 313 CDI 4x4	OM651.955, OM646.986	06/06 →
CLASSE E II E 430 T 4-matic	M113.940	05/99 → 03/03	CLASSE S IV S 350	M112.972	09/02 → 08/05	SPRINTER II 314 CDI	OM651.955	05/16 →
CLASSE E II E 55 AMG	M113.980	08/97 → 03/02	CLASSE S IV S 350 4-matic	M112.975	06/03 → 08/05	SPRINTER II 314 CDI 4x4	OM651.955	05/16 →
CLASSE E II E 55 T AMG	M113.980	08/97 → 03/03	CLASSE S IV S 400 CDI	OM628.960, M113.960	06/00 → 08/05	SPRINTER II 315 CDI	OM646.986, OM646.986	06/06 → 12/09
CLASSE E III E 200 CDI	OM646.820, M271.941	07/02 → 07/09	CLASSE S IV S 430	M113.941	10/98 → 08/05	SPRINTER II 315 CDI 4x4	OM646.986, OM651.955	02/08 → 12/09
CLASSE E III E 200 Kompressor	M271.941, 271941NGT	11/02 → 07/09	CLASSE S IV S 430 4-matic	M113.948	09/02 → 08/05	SPRINTER II 316	M271.951	09/08 →
CLASSE E III E 200 NGT	271941NGT, OM646.821	03/04 → 12/08	CLASSE S IV S 500	M113.960, M137.970	10/98 → 08/05	SPRINTER II 316 CDI	OM651.955, OM651.955	03/09 →
CLASSE E III E 200 T Kompressor	M271.941	03/03 → 07/09	CLASSE S IV S 500 4-matic	M113.966	09/02 → 08/05	SPRINTER II 316 CDI 4x4	OM651.955, 271951NGT	03/09 →
CLASSE E III E 220 CDI	OM646.821, OM646.821	03/02 → 07/09	CLASSE S IV S 55 AMG	M113.986	04/99 → 08/05	SPRINTER II 316 LGT	M271.951	09/08 →
CLASSE E III E 220 T CDI	OM646.821, 271958NGT	03/03 → 07/09	CLASSE S IV S 55 AMG Kompressor	M113.991	06/02 → 08/05	SPRINTER II 316 NGT	271951NGT, OM646.986	09/08 →
CLASSE E III E 240	M112.913	03/02 → 12/08	CLASSE S IV S 600	M137.970, M275.982	01/00 → 08/05	SPRINTER II 411 CDI	OM646.701	06/09 →
CLASSE E III E 240 4-matic	M112.917	03/03 → 12/08	CLASSE S IV S 65 AMG	M275.980	03/04 → 08/05	SPRINTER II 413 CDI	OM646.986, OM646.986	06/06 →
CLASSE E III E 240 T	M112.913	03/03 → 07/09	CLASSE S V CL 600	M275.953	05/06 → 12/13	SPRINTER II 414 CDI	OM651.955	05/16 →
CLASSE E III E 240 T 4-matic	M112.917	07/03 → 07/09	CLASSE S V CL 65 AMG	M275.982, M275.982	10/06 → 12/13	SPRINTER II 415 CDI	OM646.986, OM646.985	06/06 → 12/09
CLASSE E III E 270 CDI	OM647.961	03/02 → 12/08	CLASSE S V S 250 CDI	OM651.961	01/11 → 12/13	SPRINTER II 416 CDI	OM651.957	03/09 →
CLASSE E III E 270 T CDI	OM647.961	03/03 → 07/09	CLASSE S V S 600	M275.953	12/05 → 12/13	SPRINTER II 509 CDI	OM646.984	06/06 → 12/09
CLASSE E III E 280 CDI	OM648.961	05/04 → 12/08	CLASSE S V S 65 AMG	M275.982, M113.992	12/05 → 12/13	SPRINTER II 510 CDI	OM651.955	03/09 →
CLASSE E III E 280 T CDI	OM648.961	05/04 → 07/09	CLASSE SL IV 280	M112.923	05/98 → 10/01	SPRINTER II 511 CDI	OM646.985, OM646.986	06/06 →
CLASSE E III E 320	M112.949	03/02 → 12/08	CLASSE SL IV 320	M112.943	05/98 → 10/01	SPRINTER II 511 CDI 4x4	OM646.985	06/06 → 12/09
CLASSE E III E 320 4-matic	M112.954	03/03 → 12/08	CLASSE SL IV 500	M113.961	05/98 → 10/01	SPRINTER II 513 CDI	OM646.986, OM651.955	06/06 →
CLASSE E III E 320 CDI	OM648.961	11/02 → 12/08	CLASSE SL V 350	M112.973	03/03 → 01/12	SPRINTER II 513 CDI 4x4	OM651.955, OM646.986	06/06 →
CLASSE E III E 320 T	M112.949	03/03 → 07/09	CLASSE SL V 500	M113.963	10/01 → 01/12	SPRINTER II 514 CDI	OM651.955	05/16 →
CLASSE E III E 320 T 4-matic	M112.954	07/03 → 07/09	CLASSE SL V 55 AMG	M113.992, M275.951	10/01 → 01/12	SPRINTER II 514 CDI 4x4	OM651.955	05/16 →
CLASSE E III E 320 T CDI	OM648.961	03/03 → 07/09	CLASSE SL V 55 AMG Kompressor	M113.992	06/02 → 01/12	SPRINTER II 515 CDI	OM646.986, OM646.986	06/06 → 12/09
CLASSE E III E 400 CDI	OM628.961	02/03 → 12/08	CLASSE SL V 600	M275.951, M111.943	04/03 → 01/12	SPRINTER II 515 CDI 4x4	OM646.986, OM651.955	06/06 → 12/09
CLASSE E III E 500	M113.967	03/02 → 12/08	CLASSE SL V 65 AMG	M275.981	03/04 → 01/12	SPRINTER II 516	M271.951	09/08 →
CLASSE E III E 500 4-matic	M113.969	10/03 → 12/08	CLASSE SL V 65 AMG Black Series	M275.983	07/08 → 01/12	SPRINTER II 516 CDI	OM651.957	03/09 →
CLASSE E III E 500 T	M113.967	10/03 → 07/09	CLASSE SLC 250 d	OM651.980	01/16 → 10/17	SPRINTER II 516 CDI 4x4	OM651.955, 271951NGT	06/06 →
CLASSE E III E 500 T 4-matic	M113.969	10/03 → 07/09	CLASSE SLK I 200	M111.946	09/96 → 03/00	SPRINTER II 516 NGT	271951NGT, OM646.981	09/08 →
CLASSE E III E 55 AMG Kompressor	M113.990	07/03 → 07/09	CLASSE SLK I 200 Kompressor	M111.943, M111.973	03/00 → 04/04	SPRINTER SERIES Sprinter 213D CDI	OM646.986	04/12 →
CLASSE E IV E 200 CDI / BlueTEC	OM651.925	01/09 →	CLASSE SLK I 230 Kompressor	M111.973, M271.944	03/00 → 04/04	SPRINTER SERIES Sprinter 411D CDI/CDI BlueEFFICIENCY	OM651.955	04/16 →
CLASSE E IV E 200 NGT	271958NGT, OM612.963	03/11 →	CLASSE SLK I 320 AMG Kompressor	M112.960	03/01 → 04/04	SPRINTER SERIES Sprinter 414D CDI	OM651.955	04/16 →
CLASSE E IV E 220 BlueTEC	OM651.924	05/14 →	CLASSE SLK II 200 Kompressor	M112.947	03/00 → 04/04	SPRINTER SERIES Sprinter 416D CDI	OM651.957	11/13 →
CLASSE E IV E 220 BlueTEC 4-matic	OM651.924	12/14 →	CLASSE SLK II 200 Kompressor	M271.944, M113.989	03/04 → 02/11	SPRINTER SERIES Sprinter 516 NGT Supercharged	271951NGT	03/09 →
CLASSE E IV E 220 CDI	OM651.911	01/09 →	CLASSE SLK II 55 AMG	M113.989, M111.978	06/04 → 02/11	SPRINTER SERIES Sprinter 516 Supercharged	M271.951	03/09 →
CLASSE E IV E 220 CDI / BlueTEC	OM651.924	01/09 →	CLASSE SLK III 250 CDI / d	OM651.980	01/12 →	SPRINTER SERIES Sprinter 519D CDI	OM651.957	03/09 →
CLASSE E IV E 220 CDI / BlueTEC / d	OM651.911	01/10 →	CLC-SERIES CLC220 Cdi	OM646.963	05/08 → 06/11	VANEO 1.6	M166.961	02/02 → 07/05
CLASSE E IV E 220 CDI / d	OM651.911	01/10 →	C-SERIES C160 Kompressor	M271.921	06/02 → 07/06	VANEO 1.7 CDI	OM668.914	02/02 → 07/05
CLASSE E IV E 250 BlueTEC	OM651.924	01/09 →	C-SERIES C200 Cdi	OM651.913	01/10 → 01/14	VANEO 1.9	M166.991	02/02 → 07/05
CLASSE E IV E 250 CDI / BlueTEC	OM651.911	01/10 →	SLR McLAREN 5.4	M155.980, 111979NGT	04/04 →	VIANO 3,0	M112.951	09/03 →
CLASSE E IV E 250 CDI / BlueTEC / d	OM651.911	01/10 →	SLR McLAREN 5.4 722 Edition	M155.980	10/06 →	VIANO 3.2	M112.951	09/03 →
CLASSE E IV E 250 CDI / BlueTEC / d 4-matic	OM651.924	01/09 →	SLR-SERIES SLR McLaren Kompressor Stirling Moss	M155.980	06/09 → 12/11	VIANO 3.7	M112.976	06/04 →
CLASSE E IV E 250 CDI / BlueTEC / d	OM651.911	01/09 →	SPRINTER I 208 CDI	OM611.987	04/00 → 05/06	VIANO CDI 2.0	OM646.981, OM646.982	09/03 →
CLASSE E IV E 250 CDI / BlueTEC 4-matic	OM651.924	01/09 →	SPRINTER I 211 CDI	OM611.981	04/00 → 05/06	VIANO CDI 2.0 4-matic	OM646.982, OM646.980	07/05 →
CLASSE E E 220 Cdi	OM611.961, OM612.961	07/99 → 07/09	SPRINTER I 213 CDI	OM611.981	04/00 → 05/06	VIANO CDI 2.2	OM646.980, OM646.982	09/03 →
			SPRINTER I 214 NGT	111979NGT, M111.979	02/95 → 05/06	VIANO CDI 2.2 4-matic	OM646.982, OM611.980	07/05 →
			SPRINTER I 216 CDI	OM612.981	04/00 → 05/06	VITO I 108 CDI 2.2	OM611.980, OM611.980	03/99 → 07/03

MERCEDES-BENZ			
VITO I 110 CDI 2.2	OM611.980, OM646.980	03/99 → 07/03	
VITO I 112 CDI 2.2	OM611.980	03/99 → 07/03	
VITO II 109 CDI	OM646.980, OM646.980	09/03 →	
VITO II 109 CDI 4x4	OM646.981	09/07 →	
VITO II 111 CDI	OM646.980, OM646.980	09/03 →	
VITO II 111 CDI 4x4	OM646.982	09/07 →	
VITO II 115 CDI	OM646.980, 605960	09/03 →	
VITO II 115 CDI 4x4	OM646.982	07/06 →	
VITO II 119	M112.951	09/03 →	
VITO II 122	M112.951	09/03 →	
VITO II 123	M112.976	06/04 →	

MITSUBISHI			
COLT VI 1.5 DiD	605910	08/04 → 06/12	
COLT VI 1.5 Di-D	605960, F4R720	08/04 → 06/12	

PUCH			
G-MODELL G 500	M113.962	12/97 → 11/00	
G-MODELL G 55 AMG	M113.982	04/99 → 03/01	

SMART			
FORFOUR 1.5 CDI	OM639.939	09/04 → 06/06	

9.0579



3

REVOLUTION AND TIMING (CKP AND CMP) SENSORS

Adatt./Suitable:

GENERAL MOTORS
93 852 584
93 857 943

NISSAN
23750-00Q0D
23750-00QAF

OPEL
44 13 261
44 17 782
93852584
93857943

RENAULT
82 00 260 327
82 00 513 668

SIEMENS
S1 19297001

VAUXHALL
93852584
93857943



L	L1	ohm	OUT GND
---	32	280	

NISSAN			
PRIMASTAR 2.0	F4R720, --	03/01 →	

OPEL			
VIVARO A 2.0 16V	F4R720	08/01 →	
VIVARO A 2.0 ECOTEC	F4R820	08/06 →	

RENAULT			
CLIO III 2.0 16V Sport	--, F4R790	02/06 →	
ESPACE IV 2.0	F4R790, F4R794	11/02 →	
ESPACE IV 2.0 Turbo	F4R794, F4R770	11/02 →	
GRAND SCÉNIC II 2.0	F4R770, F4R712	04/04 →	
LAGUNA II 2.0 16V	F4R712, F4R764	08/02 → 12/07	
LAGUNA II 2.0 16V Turbo	F4R764, F4R811	01/03 → 08/05	
LAGUNA III 2.0	F4R813	02/08 →	
LAGUNA III 2.0 16V Turbo	F4R811, F4R800	10/07 → 12/15	
LAGUNA III 2.0 GT	F4R800, F4R770	03/08 → 12/15	
MEGANE I 2.0 16V	F4R720	05/00 →	
MEGANE II 2.0	F4R770, F4R770	08/03 →	
MEGANE II 2.0 16V	F4R770, F4R774	11/02 → 02/08	
MEGANE II 2.0 16V Turbo	F4R776	05/04 → 03/09	
MEGANE II 2.0 Renault Sport	F4R774, F4R874	05/04 → 10/09	
MEGANE III 2.0 R.S.	F4R874, F4R870	11/08 →	
MEGANE III 2.0 TCe	F4R870, F4R770	11/08 →	
MEGANE III 2.0 TCe 220	F4R874	11/13 →	
MEGANE CC 2.0 TCe	F4R870	06/10 →	

RENAULT			
MEGANE CC 2.0 Turbo	F4R874	10/11 →	
SCÉNIC II 2.0	F4R770, F4R720	06/03 →	
SCÉNIC II 2.0 16V Turbo	F4R776	05/04 →	
TRAFIC II 2.0	F4R720, F4R766	03/01 →	
TRAFIC II 2.0 16V	F4R820	08/06 →	
VEL SATIS 2.0 16V Turbo	F4R766, F4R762	04/04 →	
VEL SATIS 2.0 16V Turbo	F4R762, 4G15DOHC	06/02 →	

VAUXHALL			
VIVARO 1.5	F4R720	08/01 → 07/14	
VIVARO 2.0 ECOTEC	F4R820	08/06 → 07/14	

9.0585



3

REVOLUTION AND TIMING (CKP AND CMP) SENSORS

Adatt./Suitable:

CITROËN
16 075 785 80

FIAT
71742419
71768500

MITSUBISHI
J5T23191
J5T30771
J5T30773
J5T30776
MR578768

PEUGEOT
16 075 785 80

SMART
A 122 153 02 28

SUBARU
33220-50G02

SUZUKI
33220-50G00
33220-50G00-000
33220-50G01
33220-50G01-000
33220-50G02
33220-50G02-000
33220-50M30
33220-50M30-000
33220-63J10
33220-63J10-000

- AVAILABLE FROM:**
- DISPONIBILE DA:
 - DISPONIBILE EN:
 - VERFUEGBAR AB:
 - DISPONIBLE EN:
- 20/Q1**

MARKET DIFFUSION: MEDIUM



L	L1	Hall Effect	+ OUT -
---	27		

CITROËN			
C4 AIRCROSS 1.8 HDi 150	4N13	04/12 →	
C4 AIRCROSS 1.8 HDi 150 AWC	4N13	04/12 →	

FIAT			
SEDICI 1.6 16V	M16A	06/06 → 10/14	
SEDICI 1.6 16V 4x4	M16A	06/06 → 10/14	

MITSUBISHI			
ASX 1.8 DI-D	4N13	06/10 →	
ASX 1.8 DI-D 4WD	4N13	06/10 →	
ASX 2.2 Di-D 4WD	4N14	04/13 →	
COLT VI 1.5 CZT	4G15DOHC, 4G15DOHC	03/05 → 06/12	
COLT VI 1.5 Ralliart R	4G15DOHC, 4G15DOHC	02/10 → 06/12	
COLT VI 1.5 Turbo	4G15DOHC, 4G69	05/06 → 06/12	
GALANT IX 2.4	4G69, 4N13	10/03 →	
GALANT IX 2.4 GDi Sport 4WD	4G69	10/03 →	
GRANDIS 2.4 MIVEC	4G69	04/04 → 12/11	
LANCER IX 1.8 DI-D	4N13, 4G64(16V)	05/10 →	
OUTLANDER I 2.4 4WD	4G64(16V), 4N14	05/03 → 10/06	
OUTLANDER I 2.4 HDD Mivec	4G69	03/01 → 12/06	
OUTLANDER II 2.2 DI-D	4N14	11/06 → 11/12	
OUTLANDER II 2.2 DI-D 4WD	4N14, 4N13	11/06 → 11/12	

MITSUBISHI			
OUTLANDER III 2.2 Di-D	4N14	08/12 →	
OUTLANDER III 2.2 DiD 4WD	4N14	05/15 →	
OUTLANDER III 2.2 Di-D 4WD	4N14	08/12 →	
PAJERO 3.5	6G74SOHC	09/08 →	
PAJERO SPORT II 3.5	6G74(SOHC24V)	01/10 →	
PAJERO SPORT II 3.5 V6 24V	6G74(SOHC24V)	09/08 →	

PEUGEOT			
4008 1.8 HDi	4N13	05/12 →	
4008 1.8 HDi AWC	4N13, G16B	05/12 →	

SMART			
FORFOUR 1.5 BRABUS	M122.950	05/05 → 06/06	

SUBARU			
JUSTY II 1.3 4x4	G13BB	04/01 → 11/03	
JUSTY II 1.3 GX 4x4	G13BA	10/95 → 11/03	
JUSTY III 1.3 AWD	M13A	09/03 →	
JUSTY III 1.5 AWD	M15A	09/03 →	

SUZUKI			
BALENO 1.3	G13BA	09/96 → 05/02	
BALENO 1.3 16V	G13BB	03/97 → 05/02	
BALENO 1.3 i 16V	G13BB	07/95 → 05/02	
BALENO 1.6	G16B	07/96 → 01/99	
BALENO 1.6 i 16V	G16B	07/95 → 05/02	
BALENO 1.6 i 16V 4x4	G16B	07/95 → 05/02	
ESTEEM 1.6i [USA]	G16B	09/98 →	
GRAND VITARA 1.6 VVT [ExtraEU]	M16A	09/05 → 02/15	
GRAND VITARA I 1.6 4x4	G16B, M16A	03/98 → 09/05	
GRAND VITARA II 1.6	M16A, M16A	10/05 →	
GRAND VITARA II 1.6 4x4	M16A, M16A	09/05 → 02/15	
GRAND VITARA II 1.6 Trazione integrale	M16A	04/05 →	
IGNIS II 1.3	M13A	09/03 →	
IGNIS II 1.3 4x4	M13A	09/03 →	
IGNIS II 1.5	M15A	09/03 →	
IGNIS II 1.5 4x4	M15A	09/03 →	
IGNIS II 1.5 Sport	M15A	12/03 →	
JIMNY III 1.3 16V	G13BB	09/98 →	
JIMNY III 1.3 16V 4WD	G13BB	09/98 →	
JIMNY III 1.3 4WD	M13A	03/13 →	
JIMNY III 1.3 4x4	G13BB	09/98 → 08/00	
LIANA 1.3	M13A	07/01 →	
LIANA 1.6	M16A	07/01 →	
LIANA 1.6 4WD	M16A, M16A	07/01 →	
LIANA 1.6 i	M16A	04/02 →	
LIANA 1.8 i	M18A	10/01 →	
SWIFT III 1.3 [USA]	--	06/95 → 05/01	
SWIFT IV 1.5	M15A	02/05 →	
SWIFT IV 1.5 4x4	M15A	02/05 →	
SWIFT IV 1.6	M16A	05/06 →	
SWIFT IV 1.6 4x4	M16A	02/05 →	
SWIFT V 1.6	M16A	01/12 →	
SX4 I 1.6	M16A	06/06 →	
SX4 I 1.6 AWD	M16A, M16A	10/07 →	
SX4 I 1.6 LPG	M16A	06/06 → 12/12	
SX4 I 1.6 VVT	M16A, M16A	06/06 →	
SX4 I 1.6 VVT 4x4	M16A, M16A	06/06 →	
SX4 II 1.6	M16A, M16A	08/13 →	
SX4 II 1.6 AllGrip	M16A, M16A	08/13 →	
SX4 1.6 VVT	M16A	09/13 → 12/15	
VITARA I 1.6 16V	G16B	10/99 → 10/02	
VITARA II 1.6i [USA]	--	08/99 → 12/06	
VITARA IV 1.6	M16A, M16A	02/15 →	
VITARA IV 1.6 AllGrip	M16A, G13BB	02/15 →	
WAGON R+ II 1.3	G13BB, G13BB	05/00 →	
WAGON R+ II 1.3 4WD	G13BB, J3	10/01 →	
WAGON R III 1.3	M13A	09/03 → 12/10	
WAGON R 1.3 [ExtraEU]	G13BB	04/99 → 08/03	

9.0587



04

REVOLUTION AND TIMING (CKP AND CMP) SENSORS

Adatt./Suitable:
HYUNDAI
39600-4X100



L	L1	ohm	OUT GND S
540	24	900	

HYUNDAI

TERRACAN 2.9 CRDi	J3	11/01 ⇨ 07/03
TERRACAN 2.9 CRDi 4WD	J3, D4BH	12/01 ⇨ 12/06

9.0588



04

REVOLUTION AND TIMING (CKP AND CMP) SENSORS

Adatt./Suitable:
KIA
39180-4A101



L	L1	ohm	S GND OUT
160	24	900	

KIA

SORENTO I 2.5 CRDi	D4CB	08/02 ⇨
--------------------	------	---------

9.0593



04,5

REVOLUTION AND TIMING (CKP AND CMP) SENSORS

Adatt./Suitable:
HYUNDAI
39650-42150



L	L1	ohm	OUT GND S
210	24	900	

HYUNDAI

TERRACAN 2.5 D	D4BH	06/01 ⇨ 10/03
TERRACAN 2.5 TD	D4BH, 32PDR	12/01 ⇨ 12/06
TERRACAN 2.5 TDiC [ExtraEU]	D4BHG	06/01 ⇨ 10/03

9.0594



3

REVOLUTION AND TIMING (CKP AND CMP) SENSORS

Adatt./Suitable:
DENSO
029600-1500
029600-1501

FORD
6G9N-6C315-AB
6G9N-6C315-AC

LAND ROVER
LR004255
LR030200

VOLVO
30756106
31331753



L	L1	ohm	GND OUT
---	30	155	

LAND ROVER

FREELANDER 2 3.2 4x4	32PDR, B6304T3	10/06 ⇨ 10/14
----------------------	----------------	---------------

VOLVO

S60 II 3.0 T AWD	B6304T5	04/14 ⇨
S60 II T6 AWD	B6304T3, B6324S	04/10 ⇨ 12/15
S80 II 3.2	B6324S, B6324S	03/06 ⇨
S80 II 3.2 AWD	B6324S, B6304T2	01/07 ⇨ 12/12
S80 II 3.2 Flexifuel AWD	B6324S	01/09 ⇨ 03/10
S80 II T6 AWD	B6304T2, B6304T2	01/07 ⇨ 12/16
S80L T6 AWD	B6304T2, B6304T3	01/08 ⇨
V60 I 3.0 T AWD	B6304T5	04/14 ⇨
V60 I T6 AWD	B6304T3, B6324S	07/10 ⇨ 12/15
V70 III 3.0 T6 AWD	B6304T4	11/13 ⇨
V70 III 3.2	B6324S, B6324S	08/07 ⇨ 12/14
V70 III 3.2 AWD	B6324S, B6304T2	04/07 ⇨ 12/15
V70 III T6 AWD	B6304T2, B6324S	08/07 ⇨ 12/15
XC60 I 3.2 AWD	B6324S, B6304T2	07/09 ⇨ 12/15

9.0597



3,5

REVOLUTION AND TIMING (CKP AND CMP) SENSORS

Adatt./Suitable:

NISSAN
23750-00Q0K

RENAULT
82 00 647 388

SIEMENS
A2C5318384501

- ⁹⁹with cable
- con cavo
 - avec câble
 - mit Kabel
 - con cable

9.0597K



L	L1	ohm	GND OUT
---	24	290	

RENAULT

CLIO II 1.4	E7J634, K7M744	09/98 ⇨ 05/05
CLIO II 1.6	K7M744, E7J634	09/98 ⇨ 05/05
KANGOO I 1.4	E7J634, K7M702	08/97 ⇨
MEGANE I 1.6 e	K7M702, K7M702	01/96 ⇨ 03/99
MEGANE SCÉNIC I 1.6 e	K7M702, CAVG	10/96 ⇨ 10/99

9.0597K

3,5

REVOLUTION AND TIMING (CKP AND CMP) SENSORS

Adatt./Suitable:

NISSAN23750-00Q0C
23750-00QAE**RENAULT**77 00 101 971
77 00 273 419 A
82 00 468 646**SIEMENS**S105758001E
S119974001Z

*without cable

- senza cavo
- sans câble
- ohne Kabel
- sin cable

9.0597



L	L1	ohm	
---	24	290	

RENAULT

Model	Part No.	Year Range
CLIO II 1.4	E7J635	03/99 →
MEGANE I 1.6 e	K7M703	01/96 → 08/03
MEGANE SCÉNIC I 1.6 e	K7M703	10/96 → 10/99

9.0598

3

REVOLUTION AND TIMING (CKP AND CMP) SENSORS

Adatt./Suitable:

AUDI032 906 433
03C 906 433 A
03C 906 433 E**BOSCH**

0 986 280 435

SEAT032 906 433
036 906 433 D
03C 906 433 A
03C 906 433 E**SKODA**032 906 433
03C 906 433 A
03C 906 433 B
03C 906 433 E**VW**032 906 433
032 906 433 A
03C 906 433 A
03C 906 433 B
03C 906 433 E

MARKET DIFFUSION: HIGH



L	L1	Hall Effect	
---	20		

AUDI

Model	Part No.	Year Range
A1 1.2 TFSI	CBZA	05/10 → 04/15

AUDI

Model	Part No.	Year Range
A1 1.4 TFSI	CAVG, CAYB	05/10 → 04/15
A1 1.6 TDI	CAYB, CFHB	05/10 → 04/15
A1 2.0 TDI	CFHB, CAXC	09/11 → 04/15
A3 I [USA] 2.0	CBEA	08/09 →
A3 I [USA] 2.0 16V	--	01/06 → 12/10
A3 II 1.2 TFSI	CBZB	03/10 → 05/13
A3 II 1.2 TSI	CBZB	04/10 → 08/12
A3 II 1.4 TFSI	CAXC, CAYB	09/07 → 08/12
A3 II 1.6 TDI	CAYB, AZV	05/09 → 05/13
A3 II 2.0 TDI	AZV, BKD	05/03 → 05/13
A3 II 2.0 TDI 16V	BKD, BKD	05/03 → 08/12
A3 II 2.0 TDI 16V quattro	BKD, BMN	08/04 → 08/12
A3 II 2.0 TDI quattro	BMN, CAXC	03/06 → 08/12
A3 II SPORTBACK 1.2 TSI	CBZB	04/10 → 03/13
A3 II SPORTBACK 1.4 TFSI	CAXC, CAYB	09/07 → 03/13
A3 II SPORTBACK 1.6 TDI	CAYB, AZV	05/09 → 03/13
A3 II SPORTBACK 2.0 TDI	AZV, BKD	09/04 → 03/13
A3 II SPORTBACK 2.0 TDI 16V	BKD, BKD	09/04 → 03/13
A3 II SPORTBACK 2.0 TDI 16V quattro	BKD, BMN	11/05 → 03/13
A3 II SPORTBACK 2.0 TDI quattro	BMN, CAGA	03/06 → 03/13
A4 IV 2.0 TDI	CAGA, CAGA	11/07 → 12/15
A4 IV 2.0 TDI quattro	CAGA, CAMA	01/08 → 12/15
A4 IV 2.7 TDI	CAMA, CAPA	11/07 → 03/12
A4 IV 3.0 TDI quattro	CAPA, CAGA	11/07 → 03/12
A4 IV ALLROAD 2.0 TDI quattro	CAGA, CAGA	04/09 → 05/16
A5 I 2.0 TDI	CAGA, CAHA	08/08 → 01/17
A5 I 2.0 TDI quattro	CAHA, BNA	08/08 → 01/17
A6 III 2.0 TDI	BNA, CGLC	07/04 → 08/11
A6 IV 2.0 TDI	CGLC, CFFA	03/11 → 09/18
Q3 2.0 TDI	CFFA, CFFB	06/11 → 10/18
Q3 2.0 TDI quattro	CFFB, CJCA	06/11 → 10/18
Q5 I 2.0 TDI	CJCA, CAGA	11/10 →
Q5 I 2.0 TDI quattro	CAGA, CBBB	11/08 →
TT II 2.0 TDI quattro	CBBB, CFFA	06/08 → 06/14

SEAT

Model	Part No.	Year Range
ALHAMBRA III 2.0 TDI	CFFA, BXW	06/10 →
ALHAMBRA III 2.0 TDI 4Drive	CFFB	05/11 →
ALTEA 1.2 TSI	CBZB	04/10 →
ALTEA 1.4 16V	BXW, CAYB	05/06 →
ALTEA 1.4 TFSI	CAXC	05/10 → 04/11
ALTEA 1.4 TSI	CAXC	11/07 →
ALTEA 1.6 TDI	CAYB, BMN	10/09 →
ALTEA 1.9 TDI	BXF	08/09 →
ALTEA 2.0 TDI	BMN, BKD	03/06 →
ALTEA 2.0 TDI 16V	BKD, BXW	03/04 →
ALTEA 2.0 TDI 16V 4WD	CFHC	10/10 →
ALTEA XL 1.2 TSI	CBZB	04/10 →
ALTEA XL 1.4 16V	BXW, CAYB	10/06 →
ALTEA XL 1.4 TSI	CAXC	11/07 →
ALTEA XL 1.6 TDI	CAYB, BMN	10/09 →
ALTEA XL 2.0 TDI	BMN, BKD	06/07 →
ALTEA XL 2.0 TDI 16V	BKD, BMN	10/06 →
ALTEA XL 2.0 TDI 16V 4x4	CFHC	10/10 →
ALTEA XL 2.0 TDI 4x4	BMN, CAGA	06/07 →
CORDOBA II 1.4 16V	BXW	05/06 → 11/09
CORDOBA II 1.6	BAH	04/03 → 11/09
CORDOBA II 1.6 16V	BTS	11/06 → 11/09
EXEO 2.0 TDI	CAGA, CBZA	12/08 →
IBIZA III 1.4 16V	BXW	05/06 → 11/09
IBIZA III 1.6	BAH	02/03 → 11/09
IBIZA III 1.6 16V	BTS	11/06 → 11/09
IBIZA IV 1.2 TDI	CFWA	04/10 →
IBIZA IV 1.2 TSI	CBZA, BXW	09/10 →
IBIZA IV 1.4	BXW, CAVF	03/08 →
IBIZA IV 1.4 LPG	BXW	03/08 → 05/11
IBIZA IV 1.4 TSI	CAVF, CAVE	06/09 →
IBIZA IV 1.4 TSI Cupra	CAVE, CAYB	06/09 →
IBIZA IV 1.6	BTS	05/08 →
IBIZA IV 1.6 LPG	CNKA	05/11 →
IBIZA IV 1.6 TDI	CAYB, BXW	05/09 →
IBIZA IV 2.0 TDI	CFHD	01/10 →
IBIZA 1.2 TDI	CFWA	05/10 →
IBIZA 1.6 TDI	CAYB	05/09 →
LEON II 1.2 TSI	CBZB	02/10 → 12/12
LEON II 1.4 16V	BXW, CAYB	06/06 → 12/12
LEON II 1.4 TSI	CAXC	11/07 → 12/12
LEON II 1.6 TDI	CAYB, BMN	02/10 → 12/12
LEON II 2.0 TDI	BMN, BKD	05/06 → 12/12
LEON II 2.0 TDI 16V	BKD, BMN	07/05 → 12/12
LEON II 2.0 TFSI	CCZB	06/09 → 12/12
TOLEDO III 1.4 16V	BXW	05/06 → 05/09
TOLEDO III 1.4 TSI	CAXC	11/07 → 05/09
TOLEDO III 2.0 TDI	BMN, CBZA	01/06 → 05/09
TOLEDO III 2.0 TFSI	BWA	11/05 → 05/09
TOLEDO IV 1.2 TSI	CBZA, CAYB	07/12 →

SEAT

Model	Part No.	Year Range
TOLEDO IV 1.4 TSI	CAXA	07/12 →
TOLEDO IV 1.6	CFNA	07/13 →
TOLEDO IV 1.6 TDI	CAYB, AUA	07/12 →

Model	Part No.	Year Range
FABIA I 1.4	BKY	05/04 → 12/07
FABIA I 1.4 16V	AUA, CBZA	12/99 → 03/08
FABIA II 1.2 TDI	CFWA	05/10 → 12/14
FABIA II 1.2 TSI	CBZA, BXW	03/10 → 12/14
FABIA II 1.4	BXW, BXW	01/07 → 12/14
FABIA II 1.4 [CHN]	CDDA	12/08 →
FABIA II 1.4 LPG	BXW, CAVE	01/07 → 11/14
FABIA II 1.4 TSI RS	CAVE, BTS	05/10 → 12/14
FABIA II 1.6	BTS, CDEA	04/07 → 12/14
FABIA II 1.6 [CHN]	CDEA, CAYA	12/08 →
FABIA II 1.6 TDI	CAYA, BUD	03/10 → 12/14
OCTAVIA II 1.2 TSI	CBZB	02/10 → 06/13
OCTAVIA II 1.4	BUD, CDFB	06/04 → 06/13
OCTAVIA II 1.4 [CHN]	CFBA	03/10 →
OCTAVIA II 1.6 [CHN]	CDFB, CFHF	09/07 →
OCTAVIA II 1.6 TDI	CAYC	06/09 → 04/13
OCTAVIA II 1.6 TDI 4x4	CAYC	06/09 → 02/13
OCTAVIA II 2.0 TDI	CFHF, BKD	03/10 → 06/13
OCTAVIA II 2.0 TDI 16V	BKD, BKD	02/04 → 05/13
OCTAVIA II 2.0 TDI 16V 4x4	BKD, BMN	05/10 → 02/13
OCTAVIA II 2.0 TDI 4x4	CFHF	05/11 → 02/13
OCTAVIA II 2.0 TDI RS	BMN, CBZA	04/06 → 02/13
RAPID 1.2 LPG	CBZA	07/12 →
RAPID 1.2 TSI	CBZA, CAYB	07/12 →
RAPID 1.4 TSI	CAXA	07/12 →
RAPID 1.6	CFNA	07/12 →
RAPID 1.6 TDI	CAYB, CBZA	07/12 →
ROOMSTER 1.2 TDI	CFWA	03/10 → 05/15
ROOMSTER 1.2 TSI	CBZA, BXW	03/10 → 05/15
ROOMSTER 1.4	BXW, BXW	09/06 → 05/15
ROOMSTER 1.4 LPG	BXW, BTS	03/10 → 05/15
ROOMSTER 1.6	BTS, CAYA	09/06 → 05/15
ROOMSTER 1.6 LPG	BTS	06/06 → 07/10
ROOMSTER 1.6 TDI	CAYA, CBBB	03/10 → 05/15
SUPERB II 1.4 [CHN]	CFBA	03/10 →
SUPERB II 1.4 TSI	CAXC	07/08 → 05/15
SUPERB II 1.6 TDI	CAYC	09/10 → 05/15
SUPERB II 2.0 TDI	CBBB, BKD	07/08 → 05/15
SUPERB II 2.0 TDI 16V	BKD, CBBB	01/09 → 05/15
SUPERB II 2.0 TDI 16V 4x4	CFFB	11/10 → 05/15
SUPERB II 2.0 TDI 4x4	CBBB, CFHA	09/08 → 05/15
YETI 1.2 TSI	CBZB	09/09 → 05/15
YETI 1.4 TSI	CAXA	06/10 → 05/15
YETI 1.6 TDI	CAYC	11/10 → 05/15
YETI 2.0 TDI	CFHA, CBDB	11/09 → 12/17
YETI 2.0 TDI 4x4	CBDB, BAH	05/09 → 12/17

Model	Part No.	Year Range
POLO 1.6	BAH, CDCA	02/02 →

Model	Part No.	Year Range
AMAROK 2.0 BitDI	CDCA, CDCA	09/10 →
AMAROK 2.0 BitDI 4motion	CDCA, CDCA	09/10 →
AMAROK 2.0 TDI	CDCA, CDCA	09/10 →
AMAROK 2.0 TDI 4motion	CDCA, CDCA	09/10 →
AMAROK 2.0 TDI/TDi BlueMotion	CDCA, CDCA	05/12 → 10/13
AMAROK 2.0 TDI/TDi BlueMotion [ExtraEU]	CDCA, CAVD	09/11 →
BEETLE 1.2 TSI	CBZB	07/11 →
BEETLE 1.4 TSI	CAVD, CFFB	10/11 →
BEETLE 1.6 TDI	CAYC	10/11 → 07/16
BEETLE 2.0 TDI	CFFB, CBZA	04/11 → 07/16
CADDY III 1.2 TSI	CBZA, CAYD	09/10 → 05/15
CADDY III 1.4	BUD	05/06 → 08/10
CADDY III 1.6 TDI	CAYD, CFHC	08/10 →
CADDY III 2.0 TDI	CFHC, CFHC	08/10 →
CADDY III 2.0 TDI 16V	CFHC, CFHC	11/10 → 05/15
CADDY III 2.0 TDI 16V 4motion	CFHC	11/10 → 05/15
CADDY III 2.0 TDI 4motion	CFHC, CAAB	08/10 →
CAMPMOBILE 2.0 TDI	CHBH	05/10 → 08/15
CAMPMOBILE 2.0 TDI BlueMotion	CAAB, CKMA	04/15 →
CC 1.4 TSI	CKMA, CFFA	11/11 → 12/16
CC 1.4 TSI MultiFuel	CKMA	11/11 → 12/16
CC 2.0 TDI	CFFA, CFFB	11/11 → 12/16
CC 2.0 TDI 4motion	CFFB, CKTB	11/11 → 12/16
CRAFTER 2.0 TDI	CKTB, CKUB	05/11 →
CRAFTER 2.0 TDI 4motion	CKUB, BJJ	11/11 → 12/16
CRAFTER 2.5 TDI	BJJ, CAVD	04/06 →
EOS 1.4 TSI	CAVD, CBAB	11/07 → 08/15
EOS 2.0 TDI	CFFA	11/10 → 08/15
EOS 2.0 TDI 16V	CBAB, --	05/08 → 08/15
FOX 1.0	--, BJE	10/03 →
FOX 1.0 Alcohol	BJE, BAH	10/03 →

FOX 1.0 Total Flex	CCNA	03/08 →
FOX 1.4	BKR	04/05 → 12/09
FOX 1.6	BAH, BJA	10/03 → 08/14
FOX 1.6 Alcohol	--	10/03 →
FOX 1.6 Total Flex	BJA, CAVD	10/03 → 08/14
GOLF V 1.2 TSi	CBZA, BUD	11/09 → 12/13
GOLF V 1.4	BUD	06/07 → 07/09
GOLF V 1.4 16V	BUD, BLG	05/06 → 12/13
GOLF V 1.4 TSi	BLG, CAYB	11/05 → 12/13
GOLF V 1.6 TDi	CAYB, BRU	02/09 → 12/13
GOLF V 1.9 TDi	BRU, AZV	05/05 → 12/08
GOLF V 2.0 TDi	AZV, BKD	05/05 →
GOLF V 2.0 TDi 16V	BKD, CAVD	01/05 → 12/13
GOLF VI 1.2 TSi	CBZA, BUD	11/08 →
GOLF VI 1.4	BUD, BUD	10/08 →
GOLF VI 1.4 16V	BUD, CAVD	01/09 → 05/11
GOLF VI 1.4 TSi	CAVD, CAYB	10/08 →
GOLF VI 1.6 TDi	CAYB, CBAA	02/09 →
GOLF VI 1.6 TDi 4motion	CAYC	07/09 → 07/13
GOLF VI 2.0 TDi	CBAA, CBAB	10/08 →
GOLF VI 2.0 TDi 4motion	CBAB, BLG	05/09 →
GOLF VI 2.0 TDi Gtd	CFGB	05/11 →
GOLF 1.2 TSi	CBZA	11/09 → 08/14
GOLF 1.2 TSi BlueMotion	CBZB	05/09 → 11/12
GOLF 1.4 TSi	CAVD, CAYB	10/08 → 08/14
GOLF 1.6 TDi	CAYB, CFFB	02/09 → 08/14
GOLF 1.6 TDi BlueMotion	CAYC	05/09 → 11/12
GOLF 2.0 TDi	CFFB, CBZA	09/09 → 08/14
GOLF TSi	CAXA	10/08 → 11/12
GOLF VAN 1.2 TSi	CBZB	09/09 → 05/14
GOLF VAN 1.4 TSi	CAVD, CBDB	07/09 → 05/14
GOLF VAN 1.6 TDi	CAYB	12/09 → 10/12
GOLF VAN 1.6 TDi BlueMotion	CAYC	07/09 → 05/14
GOLF VAN 2.0 TDi	CBDB, CBZA	07/09 → 05/19
JETTA V 1.4 TSi	BLG, CAYB	07/06 → 10/10
JETTA V 1.6 FSi	BLF	09/05 → 10/10
JETTA V 1.6 TDi	CAYB, AZV	06/09 → 10/10
JETTA V 2.0 TDi	AZV, BKD	09/05 → 10/10
JETTA V 2.0 TDi 16V	BKD, CAVA	08/05 → 10/10
JETTA VI 1.2 TSi	CBZB	10/10 →
JETTA VI 1.4 TSi	CAVA, CFNA	04/11 →
JETTA VI 1.6	CFNA, CFFB	12/11 →
JETTA VI 1.6 TDi	CAYC	04/10 → 07/14
JETTA VI 2.0 TDi	CFFB, CAAA	10/10 →
MULTIVAN 2.0 BiTDI	CFCA	09/09 → 08/15
MULTIVAN 2.0 BiTDI 4motion	CFCA	09/09 → 08/15
MULTIVAN 2.0 TDi	CAAA, CAAC	09/09 →
MULTIVAN 2.0 TDi 4motion	CAAC, CFFB	09/09 →
PASSAT 1.4 TSi BlueMotion	CAXA	08/10 → 12/14
PASSAT 1.6 TDi BlueMotion	CAYC	08/10 → 12/14
PASSAT 2.0 Blue TDi/TDi/TDi BlueMotion [ExtraEU]	CFFB	08/10 → 12/14
PASSAT 2.0 TDi BlueMotion	CFFB, CBAA	08/10 → 12/14
PASSAT V 1.4 TSi	CAXA, CDAB	05/07 → 12/14
PASSAT V 1.4 TSi EcoFuel	CDGA	11/09 → 12/14
PASSAT V 1.4 TSi MultiFuel	CKMA	11/10 → 12/14
PASSAT V 1.6 TDi	CAYC	08/09 → 12/14
PASSAT V 1.8 TSi	CDAB, BMA	11/09 → 11/10
PASSAT V 2.0 BlueTDI	CBAC	01/09 → 11/10
PASSAT V 2.0 TDi	BMA, BKP	03/05 →
PASSAT V 2.0 TDi 16V	BKP, BKP	03/05 → 11/10
PASSAT V 2.0 TDi 16V 4motion	BKP, CBAB	03/05 → 11/10
PASSAT V 2.0 TDi 4motion	CBAB, BAH	05/09 → 12/14
PASSAT CC 1.4 TSi MultiFuel	CKMA	01/11 → 01/12
PASSAT CC 2.0 BlueTDI	CBAC	05/09 → 11/10
PASSAT CC 2.0 TDi	CBAA, CBAB	06/08 → 01/12
PASSAT CC 2.0 TDi 4motion	CBAB, CAXA	08/09 → 01/12
POLO 1.6 [ExtraEU]	BAH	11/02 → 07/06
POLO IV 1.4	BLM	08/02 →
POLO IV 1.4 16V	BUD	05/06 → 11/09
POLO IV 1.4 BiFuel	BUD	05/06 → 11/09
POLO IV 1.6	BAH, CBZB	08/02 →
POLO IV 1.6 [ExtraEU]	BAH	09/02 →
POLO IV 1.6 16V	BTS	05/06 → 11/09
POLO V 1.2 TDi	CFWA	10/09 →
POLO V 1.2 TDi BlueMotion	CFWA	10/09 → 05/14
POLO V 1.2 TSi	CBZB, CGGB	11/09 →
POLO V 1.2 TSi BlueMotion	CBZB	11/09 → 05/14
POLO V 1.4	CGGB, CAVE	03/09 → 05/14
POLO V 1.4 BiFuel	CMAA	03/10 → 01/11
POLO V 1.4 GTI	CAVE, CWXA	05/10 →
POLO V 1.5 TDi [IND]	CWXA, CFNA	05/14 →
POLO V 1.6	CFNA, CAYA	01/10 →
POLO V 1.6 BiFuel	CNKA	01/11 →
POLO V 1.6 TDi	CAYA, CAVD	06/09 →
POLO V 1.6 TDi BlueMotion	CAYB	06/09 → 05/14
SCIROCCO III 1.4 TSi	CAVD, CBAB	05/08 → 11/17

SCIROCCO III 2.0 TDi	CBAB, CFFA	08/08 → 11/17
SCIROCCO 1.4 TSi	CAVD, CBAB	06/08 → 05/14
SCIROCCO 2.0 TDi	CBAB, CAVD	08/08 → 05/14
SHARAN II 2.0 TDi	CFFA, CFFA	05/10 →
SHARAN II 2.0 TDi 4motion	CFFA, BAH	05/11 →
SPACEFOX / SPACE CROSS 1.6	BAH, BPA	03/06 →
SPACEFOX / SPACE CROSS 1.6 FSi	BPA, BPA	03/06 →
SPACEFOX / SPACE CROSS 1.6 Total Flex	BPA, BWK	03/06 →
SPACEFOX / SPACE CROSS 1.9 SDI	ASY	09/07 →
TIGUAN I 1.4 TSi	BWK, BWK	05/08 →
TIGUAN I 1.4 TSi 4motion	BWK, CBAB	09/07 →
TIGUAN I 2.0 TDi	CBAB, CBAA	03/08 →
TIGUAN I 2.0 TDi 4motion	CBAA, BLG	09/07 →
TOURAN I 1.2 TSi	CBZB	05/10 → 05/15
TOURAN I 1.4 FSi	BLG, BMY	11/06 → 05/10
TOURAN I 1.4 TSi	BMY, CAYB	02/06 → 05/15
TOURAN I 1.4 TSi EcoFuel	CDGA	05/09 → 05/15
TOURAN I 1.6 TDi	CAYB, BMN	05/10 → 05/15
TOURAN I 2.0 TDi	BMN, CAAA	12/05 → 05/15
TRANSPORTER V 1.4 Brasile	BTJ	12/05 →
TRANSPORTER V 2.0 BiTDI	CFCA	09/09 → 08/15
TRANSPORTER V 2.0 BiTDI 4motion	CFCA	09/09 → 08/15
TRANSPORTER V 2.0 TDi	CAAA, CAAC	09/09 → 08/15
TRANSPORTER V 2.0 TDi 4motion	CAAC, CAAA	09/09 → 08/15
TRANSPORTER VI 2.0 TDi	CAAA, CAAC	04/15 →
TRANSPORTER VI 2.0 TDi 4motion	CAAC, K9K790	06/15 →

9.0600  **3,5**

REVOLUTION AND TIMING (CKP AND CMP) SENSORS

Adatt./Suitable:

- DACIA**
82 00 647 366
- NISSAN**
23750-00Q0J
- RENAULT**
82 00 647 366

MARKET DIFFUSION: MEDIUM



L	L1	ohm	
---	24	840	

DACIA		
LOGAN I 1.5 dCi	K9K790, K9K704	09/05 →
SANDERO I 1.5 dCi	K9K790	06/08 →
NISSAN		
KUBISTAR 1.5 dCi	K9K704, K9K700	08/03 →
KUBISTAR 1.5 dCi 70	K9K700	04/06 → 10/09
KUBISTAR 1.5 dCi 85	K9K276	04/06 → 10/09
MICRA III 1.5 dCi	K9K722	09/03 → 06/10
RENAULT		
CLIO II 1.5 dCi	K9K700, F9Q780	06/01 →
CLIO II 1.9 D	F8Q632	02/00 → 05/01
CLIO II 1.9 DTi	F9Q780, K9K750	12/99 → 05/05
CLIO III 1.5 dCi	K9K750, F9Q782	05/05 →
KANGOO I 1.5 dCi	K9K700, F9Q782	12/01 →
KANGOO I 1.9 D	F8Q632	09/99 → 06/03
KANGOO I 1.9 dCi	F9Q782	07/03 →
KANGOO I 1.9 dCi 4x4	F9Q782, F9Q780	10/01 →
KANGOO I 1.9 dTi	F9Q780, F8Q630	02/00 →
KANGOO I 1.9 RXED	F8Q632	09/99 → 06/01
KANGOO I D 65 1.9	F8Q630, K9K790	08/97 →
KANGOO 1.9 dCi	F9Q782, K9K700	07/03 → 06/08
LAGUNA II 1.9 dCi	F9Q752	06/01 → 05/05
LOGAN 1.5 dCi	K9K790, F8Q784	09/05 →

9.0602



3,5

REVOLUTION AND TIMING (CKP AND CMP) SENSORS

Adatt./Suitable:

BOSCH

0 986 280 438

CITROËN

1920 PW

96 643 873 80

DS

1920 PW

FIAT

9664387280

FORD

1 517 990

856Q-9E731-AA

LANCIA

9664387280

MAZDA

Y603-18-221

MINI

13 62 7 808 449

MITSUBISHI

MN982334

PEUGEOT

1920 PW

SUZUKI

33220-73J20

33220-73J20-000

TOYOTA

SU001-00873

VOLVO

31216677

MARKET DIFFUSION: HIGH

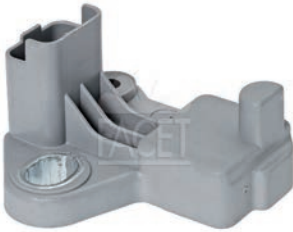

L	L1		
---	---	Hall Effect	

CITROËN

BERLINGO I 1.6 HDi 75	DV6B, 9HX(DV6ATED4)	07/05 → 12/11
BERLINGO I 1.6 HDi 90	9HX(DV6ATED4), 9HN(DV6ETED)	07/05 → 12/11
BERLINGO II 1.6 HDi / BlueHdi 75	9HN(DV6ETED), 9HL(DV6C)	07/10 →
BERLINGO II 1.6 HDi 110	9HL(DV6C), 9HL(DV6C)	04/08 →
BERLINGO II 1.6 HDi 115	9HL(DV6C), 9HT(DV6BTED4)	07/10 →
BERLINGO II 1.6 HDi 115 4x4	--	02/12 →
BERLINGO II 1.6 HDi 75	9HT(DV6BTED4), 9HN(DV6ETED)	04/08 →
BERLINGO II 1.6 HDi 75 / BlueHdi 75	9HN(DV6ETED), 9HT(DV6BTED4)	04/08 →
BERLINGO II 1.6 HDi 75 16V	9HT(DV6BTED4), 9HF(DV6GTED)	04/08 →
BERLINGO II 1.6 HDi 75 4x4	9HN(DV6ETED)	02/12 →
BERLINGO II 1.6 HDi 90	9HF(DV6GTED), 9HS(DV6TED4BU)	04/08 →
BERLINGO II 1.6 HDi 90 16V	9HS(DV6TED4BU), 9HL(DV6GTEDM)	04/08 →
BERLINGO II 1.6 HDi 90 4x4	9HF(DV6GTED)	02/12 →
BERLINGO II 1.6 HDi 92	9HL(DV6GTEDM), 8HT(DV4TD)	07/10 →
BERLINGO 1.6 HDi	DV6BTED4	06/08 → 12/11
C1 1.4 HDi	8HT(DV4TD), 8HX(DV4TD)	06/05 → 09/14
C2 1.4 HDi	8HX(DV4TD), 9HZ(DV6TED4)	09/03 →
C2 1.6 HDi	9HZ(DV6TED4), 9HX(DV6ATED4)	09/05 →
C3 I 1.4 HDi	8HZ(DV4TD)	07/03 →
C3 I 1.6 16V HDi	9HX(DV6ATED4), 8HX(DV4TD)	09/05 →
C3 I PLURIEL 1.4 HDi	8HX(DV4TD), 8HR(DV4C)	04/04 →
C3 II 1.4 HDi	DV4C	06/10 → 09/16
C3 II 1.4 HDi 70	8HR(DV4C), DV6GTEDM	11/09 →
C3 II 1.6 BlueHdi 75	DV6GTEDM, 9HJ(DV6GTEDM)	04/15 →
C3 II 1.6 HDi	9HJ(DV6GTEDM), 9HR(DV6C)	11/09 →
C3 II 1.6 HDi 110	9HR(DV6C), 9HD(DV6C)	11/09 →
C3 II 1.6 HDi 115	9HD(DV6C), 9HX(DV6ATED4)	09/12 →

CITROËN

C3 II 1.6 HDi 90	9HX(DV6ATED4), HNV(EB2DTM)	11/09 →
C3 III 1.2 THP 110	HNV(EB2DTM), 9HX(DV6ATED4)	07/16 →
C3 III 1.2 Vti 82	HMZ(EB2F)	07/16 →
C3 AIRCROSS 1.6 HDi 92	DV6D	10/17 →
C3 PICASSO 1.6 HDi	9HX(DV6ATED4), 9HR(DV6C)	02/09 →
C3 PICASSO 1.6 HDi 110	9HR(DV6C), 9HD(DV6C)	05/10 →
C3 PICASSO 1.6 HDi 115	9HD(DV6C), 9HP(DV6GTED)	01/13 →
C3 PICASSO 1.6 HDi 90	9HP(DV6GTED), 9HL(DV6C)	07/10 →
C4 I 1.6 HDi	9HV(DV6ATED4), DV6C	11/04 →
C4 II 1.6 BlueHdi 115	DV6C, DV6C	08/14 →
C4 II 1.6 HDi	DV6C, 9HR(DV6C)	11/09 →
C4 II 1.6 HDi 110	9HR(DV6C), 9HD(DV6C)	11/09 →
C4 II 1.6 HDi 115	9HD(DV6C), 9HJ(DV6GTEDM)	07/12 →
C4 II 1.6 HDi 90	9HJ(DV6GTEDM), 9HY(DV6TED4)	11/09 →
C4 II 1.6 HDi 92	9HJ(DV6GTEDM)	07/10 →
C4 AIRCROSS 1.6 HDi 115	9HL(DV6C), 9HL(DV6C)	04/12 →
C4 AIRCROSS 1.6 HDi 115 AWC	9HL(DV6C), 9HP(DV6GTED)	05/12 →
C4 CACTUS 1.6 HDi 90	9HP(DV6GTED), 9HY(DV6ATED4)	09/14 →
C4 GRAND PICASSO I 1.6 HDi	9HY(DV6ATED4), 9HL(DV6C)	10/06 → 06/11
C4 GRAND PICASSO I 1.6 HDi 110	9HL(DV6C), 9HC(DV6C)	09/10 →
C4 GRAND PICASSO II 1.6 HDi / BlueHdi 115	9HC(DV6C), 9HP(DV6GTED)	09/13 →
C4 GRAND PICASSO II 1.6 HDi 90	9HP(DV6GTED), 9HV(DV6ATED4)	09/13 →
C4 PICASSO I 1.6 HDi	9HY(DV6ATED4), 9HL(DV6C)	02/07 → 08/13
C4 PICASSO I 1.6 HDi 110	9HL(DV6C), DV6C	09/10 →
C4 PICASSO II 1.6 HDi / BlueHdi 115	DV6C, 9HP(DV6GTED)	02/13 →
C4 PICASSO II 1.6 HDi 90	9HP(DV6GTED), 9HY(DV6ATED4)	02/13 →
C5 I 1.6 HDi	9HY(DV6ATED4), 9HL(DV6C)	09/04 →
C5 II 1.6 HDi 110	9HL(DV6C), 9HL(DV6C)	02/08 →
C5 II 1.6 HDi 115	9HL(DV6C), 4HT(DW12BTED4)	01/12 →
C5 II 2.2 HDi	4HT(DW12BTED4), 4HP(DW12BTED4)	02/08 →
C5 II 2.2 HDi 165	4HP(DW12BTED4), 4HL(DW12C)	02/08 →
C5 II 2.2 HDi 200	4HL(DW12C), 4HP(DW12BTED4)	07/10 →
C6 2.2 HDi	4HP(DW12BTED4), 4HP(DW12BTED4)	06/06 → 12/12
C8 2.2 HDi	4HP(DW12BTED4), 4HN(DW12MTED4)	06/06 →
C-CROSSER 2.2 HDi	4HN(DW12MTED4), 4HN(DW12MTED4)	02/07 →
C-CROSSER ENTERPRISE 2.2 HDi	4HN(DW12MTED4), 9HJ(DV6GTEDM)	01/09 →
C-ELYSEE 1.6 HDi 92	9HJ(DV6GTEDM), 8HR(DV4C)	11/12 →
DISPATCH 1.6 HDi	DV6GTED4	06/07 → 03/16
DS3 1.4 HDi 70	8HR(DV4C), 9HR(DV6C)	04/10 → 07/15
DS3 1.6 HDi 110	9HR(DV6C), 9HD(DV6C)	11/09 → 07/15
DS3 1.6 HDi 115	9HD(DV6C), 9HP(DV6GTED)	08/12 → 07/15
DS3 1.6 HDi 90	9HP(DV6GTED), 9HR(DV6C)	11/09 → 07/15
DS4 1.6 HDi 110	9HR(DV6C), 9HD(DV6C)	04/11 → 07/15
DS4 1.6 HDi 115	9HD(DV6C), 9HP(DV6GTED)	08/12 → 07/15
DS4 1.6 HDi 90	9HP(DV6GTED), 9HR(DV6C)	05/11 → 07/15
DS5 1.6 HDi 110	9HR(DV6C), DV6C	11/11 → 07/15
DS5 1.6 HDi 115	DV6C, DV6DUM	06/12 → 07/15
JUMPY 1.6 HDi	DV6DUM, 9HU(DV6GTED4)	06/07 → 03/16
JUMPY II 1.6 HDi 90	DV6DU	01/07 →
JUMPY II 1.6 HDi 90 16V	9HU(DV6GTED4), 9HH(DV6DUM)	01/07 →
JUMPY II 1.6 HDi 90 8V	9HH(DV6DUM), 8HS(DV4TED)	01/07 →
JUMPY III 1.6 HDi 90	DV6DU	04/16 →
NEMO 1.4 HDi	8HS(DV4TED), 9HX(DV6ATED4)	02/08 →
XSARA PICASSO 1.6 HDi	9HX(DV6ATED4), DV6C	05/04 →

DS**FIAT****SCUDO II 1.6 D Multijet****ULYSSE II 2.2 D Multijet****ULYSSE II 2.2 JTD****FORD****C-MAX I 1.6 TDCi****C-MAX II 1.6 TDCi****FIESTA V 1.4 TDCi****FIESTA V 1.6 TDCi****FORD**

FIESTA VI 1.4 TDCi	F6JB, HHJC	01/09 →
FIESTA VI 1.6 TDCi	HHJC, G8DA	06/08 →
FIESTA VI 1.6 TDCi SOHC	--	02/10 →
FOCUS II 1.6 TDCi	G8DA, G8DA	07/04 → 09/12
FOCUS I CASSONE / FURGONATO / PROMISCOU 1.6 TDCi	G8DA, T1DA	07/04 → 07/11
FOCUS III 1.6 TDCi	T1DA, F6JA	07/10 →
FUSION 1.4 TDCi	F6JA, HHJA	08/02 → 12/12
FUSION 1.6 TDCi	HHJA, T1DA	11/04 → 12/12
GALAXY II 2.2 TDCi	Q4BA	03/08 → 12/12
GRAND C-MAX 1.6 TDCi	T1DA, T1BA	12/10 →
MONDEO III 1.6 TDCi	T1BA, 4HS	12/10 → 01/15
MONDEO III 2.2 TDCi	KNBA	07/10 → 01/15
MONDEO 2.2 TDCi	KNBA	03/13 → 09/14

LANCIA**PHEDRA 2.2 D Multijet****PHEDRA 2.2 JTD****MAZDA****3 II 1.6 MZR CD****5 II 1.6 CD****MINI****MINI II Cooper D****MINI II One D****MITSUBISHI****ASX 1.6 DI-D****ASX 1.6 DI-D 4WD****OUTLANDER II 2.2 DI-D 4WD****PEUGEOT****107 1.4 HDi****206 1.4 HDi****206 1.4 HDi eco 70****206+ 1.4 HDi****206+ 1.4 HDi eco 70****207 1.4 HDi****207 1.6 HDi****207 1.6 HDi 110****207 CC 1.6 HDi****208 1.4 HDi****208 1.6 HDi****208 1.6 HDi / BlueHdi 75****208 1.6 HDi 90****301 1.6 HDi 90****307 1.6 HDi****307 1.6 HDi 110****307 1.6 HDi 90****308 1.6 HDi****308 II 1.6 e-Hdi 115****308 II 1.6 HDi****308 II 1.6 HDi / BlueHdi 115****308 II 1.6 HDi 92****407 1.6 HDi****407 1.6 HDi 110****407 2.0 HDi****407 2.0 HDi 135****407 2.2 HDi****407 2.2 HDi 170****508 1.6 HDi****508 1.2 HDi****607 2.2 HDi****807 2.2 HDi****1007 1.4 HDi****1007 1.6 HDi****2008 1.4 HDi****2008 1.6 HDi****3008 1.6 HDi****3008 1.6 HDi 115 / BlueHdi 115****4007 2.2 HDi****4008 1.6 HDi****4008 1.6 HDi AWC**

PEUGEOT		
5008 1.6 HDi	9HD(DV6CTED), 9HD(DV6CTED)	09/09 →
BIPPER 1.4 HDi	8HS(DV4TED), 8HS(DV4TED)	02/08 →
BIPPER TEPEE 1.4 HDi	8HS(DV4TED), 9HU(DV6UTED4)	04/08 →
EXPERT II 1.6 HDi 90 16V	9HU(DV6UTED4), 9HH(DV6DUM)	01/07 →
EXPERT II 1.6 HDi 90 8V	9HH(DV6DUM), 9HU(DV6UTED4)	01/07 →
EXPERT II TEPEE 1.6 HDi 90 16V	9HU(DV6UTED4), 9HH(DV6DUM)	01/07 →
EXPERT II TEPEE 1.6 HDi 90 8V	9HH(DV6DUM), DV6AUTED4	01/07 →
PARTNER 1.6 HDi	DV6AUTED4, 9HW(DV6BTED4)	08/05 →
PARTNER I 1.6 HDi 75	9HW(DV6BTED4), 9HX(DV6ATED4)	08/05 →
PARTNER I 1.6 HDi 90	9HX(DV6ATED4), 9HF(DV6DTED)	10/05 → 12/15
PARTNER II 1.6 HDi	9HF(DV6DTED), 9HN(DV6ETED)	04/08 →
PARTNER II 1.6 HDi / BlueHDi 75	9HN(DV6ETED), 9HS(DV6TED4BU)	07/11 →
PARTNER II 1.6 HDi 16V	9HS(DV6TED4BU), 9HS(DV6TED4BU)	04/08 →
PARTNER II 1.6 HDi 16V 4x4	9HS(DV6TED4BU), 9HP(DV6DTED)	04/12 →
PARTNER II 1.6 HDi 90	9HP(DV6DTED), 9HF(DV6DTED)	04/10 →
PARTNER II TEPEE 1.6 HDi	9HF(DV6DTED), DV6ETEDM	04/08 →
PARTNER II TEPEE 1.6 HDi / BlueHDi 75	DV6ETEDM, 9HV(DV6TED4)	01/15 →
PARTNER II TEPEE 1.6 HDi 16V	9HV(DV6TED4), 9HJ(DV6TDEM)	04/08 →
PARTNER II TEPEE 1.6 HDi 90	9HJ(DV6TDEM), D4164T	04/10 →
RANCH 1.6 HDi 75	DV6B	02/06 →
RANCH 1.6 HDi 90	9HX(DV6ATED4)	02/06 →

SUZUKI

SX4 I 1.6 DDIS	9HX	04/07 →
----------------	-----	---------

TOYOTA

AYGO I 1.4 HDi	2WZ-TV	07/05 → 08/10
PROACE 1.6 D	3WZ-TV	06/13 → 03/16

VOLVO

C30 1.6 D	D4164T	10/06 → 12/12
C30 1.6 D2	D4162T	10/10 → 12/12
S40 II 1.6 D	D4164T	01/05 → 12/12
S40 II 1.6 D2	D4162T	10/10 → 12/12
S80 II 1.6 D DRIVE	D4164T	01/10 → 12/11
V50 1.6 D	D4164T, CAYB	01/05 → 12/12
V50 1.6 D2	D4162T	01/10 → 12/12
V70 III 1.6 D	D4164T	07/09 → 12/11

9.0605



REVOLUTION AND TIMING (CKP AND CMP) SENSORS

Adatt./Suitable:

AUDI
03L 907 601
03L 957 147
03L 957 147 A

SEAT
03L 907 601
03L 957 147
03L 957 147 A

SKODA
03L 907 601
03L 957 147
03L 957 147 A

VW
03L 907 601
03L 957 147
03L 957 147 A

MARKET DIFFUSION: HIGH

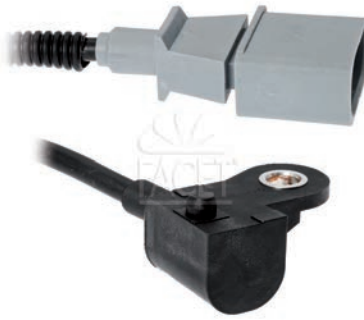

L	L1	Hall Effect	- OUT +
320	---		

AUDI

A1 1.6 TDI	CAYB, CFHB	05/10 → 04/15
A1 2.0 TDI	CFHB, CAYB	09/11 → 04/15
A3 I [USA] 2.0	CBEA	08/09 →
A3 I [USA] 2.0 16V	--	01/06 → 12/10
A3 II 1.6 TDI	CAYB, CBAA	05/09 → 05/13
A3 II 2.0 TDI	CBAA, BKD	04/08 → 05/13
A3 II 2.0 TDI 16V	BKD, BKD	05/03 → 08/12
A3 II 2.0 TDI 16V quattro	BKD, CAYB	08/04 → 08/12
A3 II SPORTBACK 1.6 TDI	CAYB, BKD	05/09 → 03/13
A3 II SPORTBACK 2.0 TDI 16V	BKD, BKD	09/04 → 03/13
A3 II SPORTBACK 2.0 TDI 16V quattro	BKD, CAGA	11/05 → 03/13
A4 IV 2.0 TDI	CAGA, CAGA	11/07 → 12/15
A4 IV 2.0 TDI quattro	CAGA, CAGA	01/08 → 12/15
A4 IV ALLROAD 2.0 TDI quattro	CAGA, CAGA	04/09 → 05/16
A5 I 2.0 TDI	CAGA, CAHA	08/08 → 01/17
A5 I 2.0 TDI quattro	CAHA, BNA	08/08 → 01/17
A6 III 2.0 TDI	BNA, CGLC	07/04 → 08/11
A6 IV 2.0 TDI	CGLC, CFFA	03/11 → 09/18
Q3 2.0 TDI	CFFA, CFFB	06/11 → 10/18
Q3 2.0 TDI quattro	CFFB, CJCA	06/11 → 10/18
Q5 I 2.0 TDI	CJCA, CAGA	11/10 →
Q5 I 2.0 TDI quattro	CAGA, CBBB	11/08 →
TT II 2.0 TDI quattro	CBBB, CFFA	06/08 → 06/14

SEAT

ALHAMBRA III 2.0 TDI	CFFA, CAYB	06/10 →
ALHAMBRA III 2.0 TDI 4Drive	CFFB	05/11 →
ALTEA 1.6 TDI	CAYB, BMN	10/09 →
ALTEA 2.0 TDI	BMN, BKD	03/06 →
ALTEA 2.0 TDI 16V	BKD, CAYB	03/04 →
ALTEA 2.0 TDI 16V 4WD	CFHC	10/10 →
ALTEA XL 1.6 TDI	CAYB, BMN	10/09 →
ALTEA XL 2.0 TDI	BMN, BKD	06/07 →
ALTEA XL 2.0 TDI 16V	BKD, BMN	10/06 →
ALTEA XL 2.0 TDI 16V 4x4	CFHC	10/10 →
ALTEA XL 2.0 TDI 4x4	BMN, CAGA	06/07 →
EXEO 2.0 TDI	CAGA, CAYB	12/08 →
IBIZA IV 1.2 TDI	CFWA	04/10 →
IBIZA IV 1.6 TDI	CAYB, CAYB	05/09 →
IBIZA IV 2.0 TDI	CFHD	01/10 →
IBIZA 1.2 TDi	CFWA	05/10 →
IBIZA 1.6 TDi	CAYB	05/09 →
LEON II 1.6 TDI	CAYB, BMN	02/10 → 12/12
LEON II 2.0 TDI	BMN, BKD	05/06 → 12/12

SEAT

LEON II 2.0 TDI 16V	BKD, BMN	07/05 → 12/12
TOLEDO III 2.0 TDI	BMN, CAYB	01/06 → 05/09
TOLEDO IV 1.6 TDI	CAYB, CAYA	07/12 →

SKODA

FABIA II 1.2 TDI	CFWA	05/10 → 12/14
FABIA II 1.6 TDI	CAYA, CFHF	03/10 → 12/14
OCTAVIA II 1.6 TDI	CAYC	06/09 → 04/13
OCTAVIA II 1.6 TDI 4x4	CAYC	06/09 → 02/13
OCTAVIA II 2.0 TDI	CFHF, BKD	03/10 → 06/13
OCTAVIA II 2.0 TDI 16V	BKD, BKD	02/04 → 05/13
OCTAVIA II 2.0 TDI 16V 4x4	BKD, BMN	05/10 → 02/13
OCTAVIA II 2.0 TDI 4x4	CFHF	05/11 → 02/13
OCTAVIA II 2.0 TDI RS	BMN, CAYB	04/06 → 02/13
RAPID 1.6 TDI	CAYB, CAYA	07/12 →
ROOMSTER 1.2 TDI	CFWA	03/10 → 05/15
ROOMSTER 1.6 TDI	CAYA, CBBB	03/10 → 05/15
SUPERB II 1.6 TDI	CAYC	09/10 → 05/15
SUPERB II 2.0 TDI	CBBB, BKD	07/08 → 05/15
SUPERB II 2.0 TDI 16V	BKD, CBBB	01/09 → 05/15
SUPERB II 2.0 TDI 16V 4x4	CFFB	11/10 → 05/15
SUPERB II 2.0 TDI 4x4	CBBB, CFHA	09/08 → 05/15
YETI 1.6 TDI	CAYC	11/10 → 05/15
YETI 2.0 TDI	CFHA, CBDB	11/09 → 12/17
YETI 2.0 TDI 4x4	CBDB, CDCA	05/09 → 12/17

VW

AMAROK 2.0 BiTDI	CDCA, CDCA	09/10 →
AMAROK 2.0 BiTDI 4motion	CDCA, CDBA	09/10 →
AMAROK 2.0 TDI	CDBA, CDBA	09/10 →
AMAROK 2.0 TDI 4motion	CDBA, CDBA	09/10 →
AMAROK 2.0 TDi/TDi BlueMotion	CDBA, CDBA	05/12 → 10/13
AMAROK 2.0 TDi/TDi BlueMotion [ExtraEU]	CDBA, CFFB	05/12 → 10/13
BETLE 1.6 TDI	CAYC	10/11 → 07/16
BETLE 2.0 TDI	CFFB, CAYD	04/11 → 07/16
CADDY III 1.6 TDI	CAYD, CFHC	08/10 →
CADDY III 2.0 TDI	CFHC, CFHC	08/10 →
CADDY III 2.0 TDI 16V	CFHC, CFHC	11/10 → 05/15
CADDY III 2.0 TDI 16V 4motion	CFHC	11/10 → 05/15
CADDY III 2.0 TDI 4motion	CFHC, CAAC	08/10 →
CAMPMOBILE 2.0 TDi	CCHB	05/10 → 08/15
CAMPMOBILE 2.0 TDi BlueMotion	CAAC, CFFA	04/15 →
CC 2.0 TDI	CFFA, CFFB	11/11 → 12/16
CC 2.0 TDI 4motion	CFFB, CBAB	11/11 → 12/16
EOS 2.0 TDI	CFFA	11/10 → 08/15
EOS 2.0 TDI 16V	CBAB, CAYB	05/08 → 08/15
GOLF V 1.6 TDI	CAYB, AZV	02/09 → 12/13
GOLF V 2.0 TDI	AZV, BKD	05/05 →
GOLF V 2.0 TDI 16V	BKD, CBDB	01/05 → 12/13
GOLF VI 1.6 TDI	CAYB, CBAA	02/09 →
GOLF VI 1.6 TDI 4motion	CAYC	07/09 → 07/13
GOLF VI 2.0 TDI	CBAA, CBAB	10/08 →
GOLF VI 2.0 TDI 4motion	CBAB, CAYB	05/09 →
GOLF VI 2.0 TDI Gtd	CFGB	05/11 →
GOLF 1.6 TDi	CAYB, CFFB	02/09 → 08/14
GOLF 1.6 TDi BlueMotion	CAYC	05/09 → 11/12
GOLF 2.0 TDi	CFFB, CAYB	09/09 → 08/14
GOLF VAN 1.6 TDi BlueMotion	CAYC	07/09 → 05/14
GOLF VAN 2.0 TDi	CBBB, CAYB	07/09 → 05/19
JETTA V 1.6 TDI	CAYB, AZV	06/09 → 10/10
JETTA V 2.0 TDI	AZV, BKD	09/05 → 10/10
JETTA V 2.0 TDI 16V	BKD, CFFB	08/05 → 10/10
JETTA VI 1.6 TDI	CAYC	04/10 → 07/14
JETTA VI 2.0 TDI	CFFB, CAAA	10/10 →
MULTIVAN 2.0 BiTDI	CFCA	09/09 → 08/15
MULTIVAN 2.0 BiTDI 4motion	CFCA	09/09 → 08/15
MULTIVAN 2.0 TDI	CAAA, CAAC	09/09 →
MULTIVAN 2.0 TDI 4motion	CAAC, CFFB	09/09 →
PASSAT 1.6 TDi BlueMotion	CAYC	08/10 → 12/14
PASSAT 2.0 Blue TDi/TDi/TDi BlueMotion [ExtraEU]	CFFB	08/10 → 12/14
PASSAT 2.0 TDi BlueMotion	CFFB, CBAA	08/10 → 12/14
PASSAT V 1.6 TDI	CAYC	08/09 → 12/14
PASSAT V 2.0 BlueTDI	CBAC	01/09 → 11/10
PASSAT V 2.0 TDI	BMA, BKP	03/05 →
PASSAT V 2.0 TDI 16V	BKP, BKP	03/05 → 07/10
PASSAT V 2.0 TDI 16V 4motion	BKP, CBBB	08/05 → 11/10
PASSAT V 2.0 TDI 4motion	CBBB, CWXA	05/09 → 12/14
PASSAT CC 2.0 BlueTDI	CBAC	05/09 → 11/10
PASSAT CC 2.0 TDI	CBAA, CBAB	06/08 → 01/12
PASSAT CC 2.0 TDI 4motion	CBAB, BMA	08/09 → 01/12
POLO V 1.2 TDI	CFWA	10/09 →
POLO V 1.2 TDi BlueMotion	CFWA	10/09 → 05/14
POLO V 1.5 TDI [IND]	CWXA, CAYA	05/14 →
POLO V 1.6 TDI	CAYA, CBBB	06/09 →
POLO V 1.6 TDi BlueMotion	CAYB	06/09 → 05/14

VW			
SCIROCCO III 2.0 TDI	CBBB, CFFA	08/08 →	11/17
SCIROCCO 2.0 TDi	CBBB, CBBB	08/08 →	05/14
SHARAN II 2.0 TDI	CFFA, CFFA	05/10 →	
SHARAN II 2.0 TDI 4motion	CFFA, CBAB	05/11 →	
TIGUAN I 2.0 TDI	CBAB, CBAA	03/08 →	
TIGUAN I 2.0 TDI 4motion	CBAA, CAYB	09/07 →	
TOURAN I 1.6 TDI	CAYB, BMN	05/10 →	05/15
TOURAN I 2.0 TDI	BMN, CAAA	12/05 →	05/15
TRANSPORTER V 2.0 BitDI	CFCA	09/09 →	08/15
TRANSPORTER V 2.0 BitDI 4motion	CFCA	09/09 →	08/15
TRANSPORTER V 2.0 TDI	CAAA, CAAC	09/09 →	08/15
TRANSPORTER V 2.0 TDI 4motion	CAAC, CAAA	09/09 →	08/15
TRANSPORTER VI 2.0 TDI	CAAA, CAAC	04/15 →	
TRANSPORTER VI 2.0 TDI 4motion	CAAC, M104.941	06/15 →	

SMART			
FORTWO 0.6 [ExtraEU]	M160.910	01/04 →	12/06
ROADSTER 0.7	M160.921, H5F402	04/03 →	11/05
ROADSTER 0.7 Brabus	M160.923	12/03 →	11/05

9.0616



REVOLUTION AND TIMING (CKP AND CMP) SENSORS

Adatt./Suitable:

- DACIA**
23 73 107 76R
23 73 128 32R
23 73 156 48R
23 73 181 26R
23 73 199 02R
82 00 681 385
82 00 963 886

- FIAT**
6000616715
- GENERAL MOTORS**
95 518 299
95 519 129
- INFINITI**
23760-00Q0E
- MERCEDES-BENZ**
A 607 905 07 00
A 626 905 08 00
A 626 905 11 00

- NISSAN**
23731-00Q0M
23731-00Q1B
23731-00Q1C
23731-00Q1E
23760-00Q0D
23760-00Q0E

- OPEL**
44 23 328
44 23 729
95518299
95519129

- RENAULT**
23 73 107 76R
23 73 128 32R
23 73 156 48R
23 73 176 26R
23 73 181 26R
23 73 199 02R
82 00 681 385
82 00 963 886

- SMART**
A 626 905 08 00
A 626 905 11 00

- VAUXHALL**
95518299
95519129

9.0608



REVOLUTION AND TIMING (CKP AND CMP) SENSORS

Adatt./Suitable:

- BOSCH**
0 261 210 141
0 261 210 142
- MERCEDES-BENZ**
0031539528
A 003 153 95 28
A 003 153 96 28
- SMART**
A 003 153 95 28
A 003 153 96 28
Q 0003117V002000000



L	L1	ohm	
---	40	800	

MERCEDES-BENZ

CLASSE C I C 240	M112.910	06/97 →	05/00
CLASSE C I C 240 T	M112.910	06/97 →	09/00
CLASSE C I C 280	M104.941, M160E6ALB03	05/93 →	05/00
CLASSE C I C 280 T	M112.920	06/97 →	03/01
CLASSE C I C 36 AMG	M104.941(AMG3.6)	05/94 →	05/00
CLASSE C I C 43 AMG	M113.944	08/97 →	03/01
CLASSE CLK I 320	M112.940	06/97 →	06/02
CLASSE E II E 240	M112.911	06/97 →	08/00
CLASSE E II E 240 T	M112.911	06/97 →	03/03
CLASSE E II E 280	M112.921	12/96 →	03/02
CLASSE E II E 280 4-matic	M112.921	12/96 →	03/02
CLASSE E II E 280 T	M112.921	12/96 →	03/03
CLASSE E II E 280 T 4-matic	M112.921	12/96 →	03/03
CLASSE E II E 320	M112.941	06/97 →	03/02
CLASSE E II E 320 4-matic	M112.941	06/97 →	03/02
CLASSE E II E 320 T	M112.941	12/96 →	03/03
CLASSE E II E 320 T 4-matic	M112.941	12/96 →	03/03
CLASSE E II E 430	M113.940	06/97 →	03/02
CLASSE E II E 430 4-matic	M113.940	05/99 →	03/02
CLASSE E II E 430 T	M113.940	06/97 →	03/03
CLASSE E II E 430 T 4-matic	M113.940	05/99 →	03/03
CLASSE E II E 55 AMG	M113.980	08/97 →	03/02
CLASSE E II E 55 T AMG	M113.980	08/97 →	03/03
CLASSE E E 280	M112.921	07/99 →	11/02

SMART

CABRIO 0.6	M160E6ALB03, M160.910	03/00 →	01/04
CABRIO 0.7	M160.910, OM660DE8LA	01/03 →	01/04
CABRIO 0.8 CDI	OM660DE8LA, M160E-6ALB03	03/01 →	01/04
CITY-COUPE 0.6	M160E6ALB03, M160.910	01/01 →	01/04
CITY-COUPE 0.7	M160.910, OM660DE8LA	01/03 →	01/04
CITY-COUPE 0.8 CDI	OM660DE8LA, M160.910	11/99 →	01/04
CITY COUPE 0.6	M160.910	12/99 →	04/03
CROSSBLADE 0.6	M160.910, M160.910	06/02 →	12/03
FORTWO I 0.6	M160.910	01/04 →	02/07
FORTWO I 0.7	M160.910, OM660DE8LA	01/04 →	01/07
FORTWO I 0.8 CDI	OM660DE8LA, OM660.950	01/04 →	01/07
FORTWO II 0.8 Cdi	OM660.950, M160.921	01/07 →	

L	L1		
---	28,2	Hall Effect	

MARKET DIFFUSION: HIGH



DACIA

DOKKER 1.2 Tce	H5F402, --	11/12 →	
DOKKER 1.2 Tce 115	--, K9K612	12/12 →	
DOKKER 1.5 dCi	K9K612, H5F404	11/12 →	
DOKKER 1.5 dCi [ExtraEU]	K9K830	11/12 →	
DUSTER 1.2 Tce 125	H5F404, K9K612	01/12 →	
DUSTER 1.2 Tce 125 4x4	H5F404	10/13 →	
DUSTER 1.5 dCi	K9K612, K9K656	04/10 →	
DUSTER 1.5 dCi 110	K9K656, K9K658	10/17 →	
DUSTER 1.5 dCi 4x4	K9K658, F4R400	06/10 →	
DUSTER 1.5 dCi 90	K9K656	10/17 →	
DUSTER 1.6	K4M884	04/10 →	
DUSTER 2.0	F4R400, H5F402	04/10 →	
LOGGY 1.2 Tce	H5F402, --	03/12 →	
LOGGY 1.5 dCi	--, K9K790	03/12 →	
LOGGY 1.5 dCi [ExtraEU]	K9K830	11/12 →	
LOGAN I 1.5 dCi	K9K790, K9K612	09/05 →	
LOGAN II 1.0	D4D754	10/12 →	
LOGAN II 1.5 dCi	K9K612, F4R412	10/12 →	
LOGAN II 1.6 16V	K7M764	01/13 →	
LOGAN II 2.0	F4R412, K9K612	10/12 →	

DACIA

LOGAN II Tce 90	H4B400, K9K790	10/12 →	
LOGAN II Tce 90 LPG	H4B410	09/15 →	
LOGAN II MCV 1.5 dCi	K9K612, H4B400	02/13 →	
LOGAN II MCV Tce 90	H4B400, H4B405	02/13 →	
LOGAN II MCV Tce 90 LPG	H4B405, H4B400	09/15 →	
SANDERO I 1.5 dCi	K9K790, K9K612	06/08 →	
SANDERO II 1.0	D4D754	10/12 →	
SANDERO II 1.5 dCi	K9K612, --	10/12 →	
SANDERO II 1.6 16V	K4M842	01/13 →	
SANDERO II 1.6 I	K7M764	10/12 →	
SANDERO II 2.0	F4R416	10/12 →	
SANDERO II 2.0 LPG	F4R412	10/12 →	
SANDERO II Tce 90	--, K9K	10/12 →	
SANDERO II Tce 90 LPG	H4B410	09/15 →	

FIAT

TALENTO 1.6 D	R9M408	06/16 →	
---------------	--------	---------	--

INFINITI

Q30 1.5 D	K9K480	11/15 →	
-----------	--------	---------	--

MERCEDES-BENZ

CITAN 108 CDI	OM607.951	11/12 →	
CITAN 109 CDI	OM607.951	11/12 →	
CITAN 111 CDI	OM607.951	06/13 →	
CITAN 112	M200.711	06/13 →	
CLASSE A III A 160 CDI / d	OM607.951	06/13 →	
CLASSE A III A 180 CDI / d	OM607.951	06/12 →	
CLASSE B II B 160 CDI / d	OM607.951	05/13 →	
CLASSE B II B 180 CDI / d	OM607.951	02/13 →	
CLASSE C IV C 180 BlueTEC / d	OM626.951	05/14 →	
CLASSE C IV C 200 BlueTEC / d	OM626.951	05/14 →	
CLASSE CLA CLA 180 CDI / d	OM607.951	10/13 →	
CLASSE CLA CLA 180 d	OM607.951	07/15 →	
CLASSE GLA GLA 180 CDI / d	OM607.951	07/14 →	
VITO III 109 CDI	OM622.951	10/14 →	
VITO III 109 CDI / 109 BlueTEC	OM622.951	10/14 →	
VITO III 111 CDI	OM622.951	10/14 →	
VITO III 111 CDI / 111 BlueTEC	OM622.951	10/14 →	

NISSAN

ALMERA III 1.5 dCi	K9K	08/12 →	
CUBE 1.5 dCi	K9K, HR12DDT	03/10 →	
JUKE 1.2 DIG-T	HR12DDT, K9K410	05/14 →	
JUKE 1.5 dCi	K9K410, YS23DDT	06/10 →	
MICRA III 1.5 dCi	K9K276	06/05 →	06/10
MICRA IV 1.5 dCi	K9K	05/10 →	
MICRA V 0.9 IG-T	HR09DET	12/16 →	
MICRA V 1.5 DCI	K9K	12/16 →	
NAVARA III 2.3 dCi	YS23DDT	01/15 →	
NAVARA III 2.3 dCi 4x4	YS23DDT, K9K276	01/15 →	
NOTE I 1.5 dCi	K9K276, K9K608	03/06 →	06/12
NOTE II 1.5 dCi	K9K608, K9K	06/13 →	
NV200 / EVALIA 1.5 dci	K9K, K9K	07/10 →	
NV200 1.5 dci	K9K, M9T	02/10 →	
NV300 1.6 dci 120	R9M413	09/16 →	
NV300 1.6 dci 125	R9M452	09/16 →	
NV300 1.6 dci 145	R9M452	09/16 →	
NV300 1.6 dci 95	R9M413	09/16 →	
NV400 2.3 dCi 165	M9T, M9T870	06/14 →	09/16
NV400 dCi 110	--	06/14 →	06/16
NV400 dCi 125 RWD	M9T870, --	11/11 →	09/16
NV400 dCi 130	M9T704	06/16 →	
NV400 dCi 130 RWD	M9T710	06/16 →	
NV400 dCi 140	--, M9T696	06/14 →	09/16
NV400 dCi 140 RWD	M9T696, M9T	06/14 →	09/16
NV400 dCi 160	M9T, M9T	06/14 →	09/16
NV400 dCi 165	M9T, K9K732	06/14 →	06/16
NV400 dCi 165 RWD	M9T	06/14 →	
NV400 dCi 170	M9T	07/15 →	
PULSAR 1.2 DIG-T	HRA2DDT	10/14 →	
PULSAR 1.5 dCi	K9K	10/14 →	
QASHQAI 1.5 dCi	K9K	08/08 →	10/11
QASHQAI 1.6 dCi	R9M	07/11 →	11/13
QASHQAI I 1.5 dCi	K9K732, K9K636	02/07 →	12/13
QASHQAI I 1.6 dCi	R9M	10/11 →	12/13
QASHQAI I 1.6 dCi Trazione integrale	R9M	10/11 →	12/13
QASHQAI II 1.5 dCi	K9K636, F4R	11/13 →	
QASHQAI II 1.6 dCi	R9M	11/13 →	
QASHQAI II 1.6 dCi ALL MODE 4x4-i	R9M	11/13 →	
TERRANO III 2.0	F4R	09/13 →	
TERRANO III 2.0 4x4	F4R, K9K	03/14 →	
TIIDA I 1.5 dCi	K9K, M9T678	01/07 →	12/12
X-TRAIL III 1.6 dCi	R9M	04/14 →	
X-TRAIL III 1.6 dCi ALL MODE 4x4-i	R9M	04/14 →	

OPEL

MOVANO 2.3 CDTI	M9T704	04/16 →	
MOVANO B 2.3 CDTI FWD	M9T678, M9T694	05/10 →	
MOVANO B 2.3 CDTI RWD	M9T694, R9M408	05/10 →	

OPEL			
VIVARO B 1.6 CDTI	R9M408, H4B400	06/14 →	
RENAULT			
ALASKAN 2.3 dCi 163 4x4	M9T260	09/17 →	
ALASKAN 2.3 dCi 190 4x4	M9T260	09/17 →	
CAPTUR 0.9 TCe 90	H4B400, H5F403	06/13 →	
CAPTUR 1.2 T	H5F403	06/13 →	
CAPTUR 1.2 TCe 120	H5F403, K9K628	06/13 →	
CAPTUR 1.5 dCi	K9K628, K9K608	06/13 →	
CAPTUR 1.5 dCi 110	K9K646	01/15 →	
CAPTUR 1.5 dCi 90	K9K608, K9K612	06/13 →	
CLIO 1.5 dCi	K9K612, D4F764	11/12 →	
CLIO III 1.2 16V	D4F764, K9K764	06/05 →	
CLIO III 1.5 dCi	K9K764, K4M800	06/05 →	
CLIO III 1.6 16V	K4M800, H4B400	06/05 →	
CLIO III 1.6 16V GT	K4M862	06/09 →	
CLIO III 2.0 16V Sport	F4R832	09/08 →	
CLIO IV 0.9 TCe 75	H4B408	10/18 →	
CLIO IV 0.9 TCe 90	H4B400, H5F403	11/12 →	
CLIO IV 0.9 TCe 90 LPG	H4B410	08/15 →	
CLIO IV 1.2 TCe 120	H5F403, K9K628	03/13 →	
CLIO IV 1.5 dCi	K9K628, K9K612	11/12 →	
CLIO IV 1.5 dCi 110	K9K646	06/16 →	
CLIO IV 1.5 dCi 75	K9K612, K9K608	11/12 →	
CLIO IV 1.5 dCi 90	K9K608, K9K612	11/12 →	
DOKKER 1.5 dCi	K9K612, F4R403	12/13 →	
DUSTER 1.5 dCi [ExtraEU]	K9K796	06/11 →	
DUSTER 1.5 dCi 4x4	K9K884	06/11 →	
DUSTER 2.0	F4R403, F4R410	02/12 →	
DUSTER 2.0 [ExtraEU]	F4R410, F4R400	10/11 →	
DUSTER 2.0 4x4	F4R400, K9K656	02/12 →	
ESPACE V 1.6 dCi 130	R9M409	06/15 →	
ESPACE V 1.6 dCi 160	R9M452	06/15 →	
FLUENCE 1.5 dCi	K9K656, K4M838	02/10 →	
FLUENCE 1.6 16V	K4M838, H5F400	02/10 →	
FLUENCE 1.6 dCi	R9M402	07/14 →	
FLUENCE 1.6 LPG 16V	K4M839	01/12 →	
GRAND SCÉNIC III 1.2 TCe	H5F400, K9K636	04/12 →	
GRAND SCÉNIC III 1.5 dCi	K9K636, K4M866	02/09 →	
GRAND SCÉNIC III 1.6 16V	K4M858	02/09 →	
GRAND SCÉNIC III 1.6 16V Bifuel	K4M866, R9M402	02/09 →	
GRAND SCÉNIC III 1.6 dCi	R9M402, K9K646	04/11 →	
GRAND SCÉNIC III 1.6 E85	K4M866	02/09 →	
GRAND SCÉNIC IV 1.2 TCe 115	H5F408	09/16 →	
GRAND SCÉNIC IV 1.2 TCe 130	H5F408	09/16 →	
GRAND SCÉNIC IV 1.5 dCi 110	K9K646, K9K646	09/16 →	
GRAND SCÉNIC IV 1.5 dCi 110 Hybrid Assist	K9K646, K9K646	04/17 →	
GRAND SCÉNIC IV 1.6 dCi 130	R9M409	09/16 →	
GRAND SCÉNIC IV 1.6 dCi 160	R9M452	09/16 →	
KADJAR 1.2 TCe 130	H5F408	06/15 →	
KADJAR 1.5 dCi 110	K9K646, R9M410	06/15 →	
KADJAR 1.6 dCi 130	R9M410, R9M414	06/15 →	
KADJAR 1.6 dCi 130 4x4	R9M414, K9K708	06/15 →	
KANGOO 1.5 dCi	K9K708, H5F400	02/01 →	
KANGOO II 1.2 TCe 115	H5F400, K9K608	07/13 →	
KANGOO II 1.5 dCi	K9K608, K9K636	02/08 →	
KANGOO II 1.5 dCi 110	K9K636, K9K608	09/10 →	
KANGOO II 1.5 dCi 75	K9K608, K9K800	09/10 →	
KANGOO II 1.5 dCi 85	K9K800, K9K608	02/08 →	
KANGOO II 1.5 dCi 90	K9K608, K9K780	06/09 →	
KANGOO 1.2 LPG	H5F400	07/13 →	
KAPTUR 2.0 4WD	F4R410	03/16 →	
KOLEOS 1.6 dCi 130	R9M409	08/16 →	
LAGUNA III 1.5 dCi	K9K780, K9K782	10/07 →	
LAGUNA III 1.6 16V	K4M824	10/07 →	12/15
LATITUDE 1.5 dCi	K9K782, K9K830	07/10 →	
LODGY 1.5 dCi [ExtraEU]	K9K830, K9K612	11/14 →	
LOGAN 1.5 dCi	K9K612, K9K612	09/05 →	
LOGAN EXPRESS 1.5 dCi	K9K792	04/07 →	
LOGAN/STEPWAY 1.5 dCi	K9K612, M9T706	12/13 →	
MASTER III 2.3 dCi 130 RWD	M9T710	03/12 →	
MASTER III 2.3 dCi 135 FWD	M9T700, M9T700	07/14 →	
MASTER III 2.3 dCi 135 RWD	M9T700, M9T700	07/14 →	
MASTER III 2.3 dCi 165 FWD	M9T700, M9T700	07/14 →	
MASTER III 2.3 dCi 165 RWD	M9T700, K9K636	07/14 →	
MASTER III 2.3 dCi 170 FWD	M9T706	07/15 →	
MEGANE II 1.5 dCi	K9K724, H5F400	08/03 →	07/09
MASTER 2.3 dCi	M9T706, M9T700	07/15 →	
MEGANE 1.5 dCi	K9K636, H5F400	01/09 →	08/15
MEGANE 1.6 Bifuel	K4M858	05/09 →	08/15
MEGANE 1.6 VVT	K4M858	01/13 →	08/15
MEGANE III 1.2 TCe	H5F400, K9K636	03/12 →	
MEGANE III 1.5 dCi	K9K636, K4M858	11/08 →	
MEGANE III 1.6 16V	K4M858, R9M402	11/08 →	
MEGANE III 1.6 16V Bifuel	K4M866	11/08 →	
MEGANE III 1.6 Bifuel	K4M866	11/08 →	
MEGANE III 1.6 dCi	R9M402, F4R874	04/11 →	

RENAULT			
MEGANE III 2.0 R.S.	F4R874, F4R870	11/08 →	
MEGANE III 2.0 TCe	F4R870, K9K834	11/08 →	
MEGANE III 2.0 TCe 220	F4R874	11/13 →	
MEGANE IV 1.2 TCe 100	H5F408	11/15 →	
MEGANE IV 1.2 TCe 130	H5F408	11/15 →	
MEGANE IV 1.5 dCi 110	K9K646, K9K656	11/15 →	
MEGANE IV 1.5 dCi 90	K9K656, R9M409	11/15 →	
MEGANE IV 1.6 dCi 130	R9M409, K9K760	11/15 →	
MEGANE IV 1.6 dCi 165	R9M452	11/15 →	
MEGANE III HATCHBACK VAN 1.5 dCi	K9K834, K9K646	11/08 →	08/15
MEGANE CC 1.2 TCe	H5F400, K9K636	09/12 →	
MEGANE CC 1.5 dCi	K9K636, F4R870	06/10 →	
MEGANE CC 1.6 16V	K4M858	06/10 →	
MEGANE CC 1.6 16V Hi-Flex	K4M866	06/10 →	
MEGANE CC 1.6 dCi	R9M402	04/11 →	
MEGANE CC 2.0 TCe	F4R870, K9K724	06/10 →	
MEGANE CC 2.0 Turbo	F4R874	10/11 →	
MODUS / GRAND MODUS 1.5 dCi	K9K760, K9K750	12/04 →	
MODUS / GRAND MODUS 1.5 dCi 75	K9K770	10/10 →	
MODUS / GRAND MODUS 1.5 dCi 90	K9K750, K4M790	10/10 →	
MODUS / GRAND MODUS 1.6	K4M790, K9K612	12/04 →	
SANDERO I 1.5 dCi	K9K790	04/07 →	
SANDERO II 1.5 dCi	K9K612, K4M812	12/13 →	
SCÉNIC II 1.6 Hi-Flex	K4M766	03/05 →	07/10
SCÉNIC III 1.2 TCe	H5F400, K9K636	04/12 →	
SCÉNIC III 1.5 dCi	K9K636, K4M866	02/09 →	
SCÉNIC III 1.6 16V	K4M858	02/09 →	
SCÉNIC III 1.6 16V Bifuel	K4M866, R9M402	02/09 →	
SCÉNIC III 1.6 dCi	R9M402, K9K646	04/11 →	
SCÉNIC III 1.6 E85	K4M866	02/09 →	
SCÉNIC IV 1.2 TCe 115	H5F408	09/16 →	
SCÉNIC IV 1.2 TCe 130	H5F408	09/16 →	
SCÉNIC IV 1.5 dCi 110	K9K646, K9K646	09/16 →	
SCÉNIC IV 1.5 dCi 110 Hybrid Assist	K9K646, K9K646	04/17 →	
SCÉNIC IV 1.5 dCi 95	K9K646, K9K646	09/16 →	
SCÉNIC IV 1.6 dCi 130	R9M409	09/16 →	
SCÉNIC IV 1.6 dCi 160	R9M452	09/16 →	
SCENIC 1.6	K4M812, H5F400	07/07 →	05/09
TALISMAN 1.5 dCi 110	K9K646, R9M452	11/15 →	
TALISMAN 1.6 dCi 130	R9M409	11/15 →	
TALISMAN 1.6 dCi 160	R9M452, K9K700	06/15 →	
THALIA I 1.5 dCi	K9K700, K9K612	01/01 →	
THALIA II 0.9 TCe	H4B400	11/12 →	06/14
THALIA II 1.5 dCi	K9K612, D4F764	09/08 →	
THALIA III 1.5 dCi	K9K612	12/13 →	
TRAFIC III 1.6 dCi 115	R9M408	05/14 →	
TRAFIC III 1.6 dCi 125	R9M452	07/15 →	
TRAFIC III 1.6 dCi 145	R9M452	07/15 →	
TRAFIC III 1.6 dCi 90	R9M408	05/14 →	
TRAFIC III 1.6 dCi 95	R9M413	07/15 →	
TWINGO 1.2	D4F770	09/10 →	09/14
TWINGO 1.5 dCi	K9K820	10/10 →	09/14
TWINGO II 1.2 16V	D4F764, K9K718	03/07 →	
TWINGO II 1.5 dCi	K9K718, H4D400	03/07 →	
TWINGO II 1.5 dCi 75	K9K820	10/10 →	
TWINGO II 1.5 dCi 90	K9K820	10/10 →	
TWINGO III 1.6 RS	K4M854	05/08 →	
TWINGO III 0.9 TCe 110	H4B401	11/16 →	
TWINGO III 0.9 TCe 90	H4B401	09/14 →	
TWINGO III 1.0 SCe 70	H4D400, M281.920	09/14 →	
WIND 1.6	K4M854	07/10 →	
SMART			
FORFOUR III 0.9	M281.910	11/14 →	
FORFOUR III 0.9 Brabus	M281.910	07/16 →	
FORFOUR III 1.0	M281.920, M281.920	07/14 →	
FORTWO III 0.9	M281.910	09/14 →	
FORTWO III 0.9 Brabus	M281.910	07/16 →	
FORTWO III 1.0	M281.920, M9T702	07/14 →	
VAUXHALL			
MOVANO 2.3 CDTi	M9T702, M9T678	04/16 →	
MOVANO B 2.3 CDTi FWD	M9T678, M9T694	05/10 →	
MOVANO B 2.3 CDTi RWD	M9T694, R9M408	05/10 →	
VIVARO 1.6 CDTi	R9M408, R9M408, R9M408	05/14 →	



REVOLUTION AND TIMING (CKP AND CMP) SENSORS

Adatt./Suitable:

CITROËN

2529 28

FIAT

7700103119

PEUGEOT

2529 28

RENAULT

77 00 103 119



L	L1	ohm	GND OUT
230	77,3	1200	

CITROËN

CS I 1.8 16V	6FZ(EW7J4)	03/01 →	08/04
CS I 2.0 16V	RFJ(EW10A)	03/01 →	
CS I 2.0 HDi	RHS(DW10ATED), K6C(TU3JP)	03/01 →	08/04
CS II 2.0 16V	RFJ(EW10A)	02/08 →	
CS II 2.0 16V BioFlex	RFJ(EW10A)	02/08 →	
JUMPY I 2.0	RFN(EW10J4)	04/00 →	12/06
JUMPY I 2.0 i 16V	RFN(EW10J4)	03/00 →	10/06

PEUGEOT

206 1.4	KFW(TU3JP)	07/02 →	02/07
206 1.4 i	K6C(TU3JP), N6A(TU5JP4)	09/98 →	
206 1.6	NFU(TU5JP4)	09/01 →	12/08
206 1.6 16V	N6A(TU5JP4), 5FT(EF6DT)	07/00 →	
206 1.6 LPG	NFU(TU5JP4)	07/02 →	
308 I 1.6 16V	5FT(EF6DT), RHS(DW10ATED)	09/07 →	
308 I 2.0 Bioflex	RFJ(EW10A)	01/08 →	
308 I 2.0 CVT	RFJ(EW10A)	07/09 →	11/14
406 2.0 HDi 110	RHS(DW10ATED), K4J711	08/01 →	10/04
407 2.0	RFN(EW10J4)	03/04 →	
407 2.0 16V	RFJ(EW10A)	09/05 →	
407 2.0 Bioflex	RFJ(EW10A)	09/07 →	
806 2.0 16V	RFN(EW10J4)	09/00 →	08/02
EXPERT I 2.0	RFN(EW10J4)	07/00 →	12/06

RENAULT

CLIO II 1.4	E7J635	03/99 →	
CLIO II 1.4 16V	K4J711, K4M838	02/00 →	07/08
CLIO II 1.6	K7M745	09/98 →	05/05
CLIO II 1.6 16V	K4M745	09/98 →	
CLIO III 1.6 16V	K4M801	06/05 →	
FLUENCE 1.6 16V	K4M838, E7J634	02/10 →	
GRAND SCÉNIC II 1.6	K4M761	04/04 →	
KANGOO I 1.4	E7J634, F4P771	08/97 →	
KANGOO I 1.6 16V	K4M753	06/01 →	
KANGOO I 1.6 16V 4x4	K4M753	10/01 →	
LAGUNA I 1.9 dTi	F9Q717	10/97 →	03/01
LAGUNA I 2.0	F3R611	03/99 →	03/01
LAGUNA II 1.6 16V	K4M711	03/01 →	
LAGUNA II 1.8 16V	F4P771, F9Q751	03/01 →	12/07
LAGUNA II 1.9 dCi	F9Q751, F4R713	03/01 →	
LAGUNA II 2.0 16V	F4R713, K4J710	08/02 →	12/07
LAGUNA II 2.0 16V IDE	F5R701	04/01 →	09/07
MEGANE I 1.4 16V	K4J710, E7J626		

RENAULT			
MEGANE I 1.9 D Eco	F8Q620, F9Q718	01/96 → 08/03	
MEGANE I 1.9 dCi	F9Q718, F8Q784	05/00 →	
MEGANE I 1.9 dT	F8Q784, F9Q710	01/96 → 08/03	
MEGANE I 1.9 DTi	F9Q710, F3R262	03/97 →	
MEGANE I 1.9 TDI	F8Q784	09/96 → 08/03	
MEGANE I 2.0	F3R262, F4R276	01/97 → 05/01	
MEGANE I 2.0 16V	F4R276, F3R750	05/00 →	
MEGANE I 2.0 i	F3R750, K4M760	01/96 → 08/03	
MEGANE I 2.0 RT	F4R747	03/01 → 08/03	
MEGANE II 1.6	K4M760, K4M760	08/03 →	
MEGANE II 1.6 16V	K4M760, F9Q803	11/02 →	
MEGANE II 1.9 dCi	F9Q803, K4M700	09/03 →	
MEGANE SCÉNIC I 1.6 16V	K4M700, F9Q730	04/98 → 10/99	
MEGANE SCÉNIC I 1.9 D	F8Q790	03/97 → 09/99	
MEGANE SCÉNIC I 1.9 dTi	F9Q730, F3R750	04/97 → 09/99	
MEGANE SCÉNIC I 2.0 i	F3R750, K4J714	01/97 → 09/99	
SCÉNIC I 1.4 16V	K4J714, K4M708	09/99 → 08/03	
SCÉNIC I 1.6	K4M708, F9Q732	03/01 → 09/03	
SCÉNIC I 1.9 dCi	F9Q732, F9Q731	09/99 → 08/03	
SCÉNIC I 1.9 dCi RX4	F9Q732	12/02 → 08/03	
SCÉNIC I 1.9 dTi	F9Q731, F4R740	02/01 → 08/03	
SCÉNIC I 2.0	F3R791	09/99 → 08/03	
SCÉNIC I 2.0 16V	F4R740, RHS(DW10ATED)	07/00 → 08/03	
SCÉNIC II 1.6	K4M761	06/03 →	
SCÉNIC II 1.6 16V	K4M813	10/05 →	
SCÉNIC II 1.9 dCi	F9Q803	04/04 → 10/08	
THALIA I 1.4 16V	K4J713	08/00 →	
THALIA I 1.6	K4M745	01/01 →	

9.0618



04,5

REVOLUTION AND TIMING (CKP AND CMP) SENSORS

Adatt./Suitable:

CITROËN

2529 80

DACIA

77 00 116 378

FIAT

7700116377

LANCIA

7700116377

PEUGEOT

2529 80

RENAULT

77 00 116 378



L	L1	ohm	
380	77,3	1200	

CITROËN

C5 I 1.8 16V	6FZ(EW7J4)	03/01 → 08/04	
C5 I 2.0 16V	RFJ(EW10A)	03/01 →	
C5 I 2.0 HDi	RHS(DW10ATED), F4R410	03/01 → 08/04	
C5 II 2.0 16V	RFJ(EW10A)	02/08 →	
C5 II 2.0 16V BioFlex	RFJ(EW10A)	02/08 →	
C8 2.0	RFN(EW10J4)	07/02 →	
C8 2.0 16V	RFJ(EW10A)	09/05 →	
JUMPY I 2.0	RFN(EW10J4)	04/00 → 12/06	
JUMPY I 2.0 i 16V	RFN(EW10J4)	03/00 → 10/06	
XSARA 1.6 16V	NFU(TU5JP4)	09/00 → 08/05	
XSARA 2.0 16V	RFN(EW10J4)	09/00 → 08/05	
XSARA 2.0 HDi 109	RHZ(DW10ATED)	05/01 → 08/05	
XSARA PICASSO 2.0 16V	RFN(EW10J4)	01/03 →	

DACIA

DUSTER 2.0	F4R410, K4M842	04/10 →	
SANDERO II 1.6 16V	K4M842, K6C(TU3JP)	01/13 →	

FIAT

ULYSSE II 2.0 JTD	RHM(DW10ATED4)	05/03 → 08/06	
-------------------	----------------	---------------	--

LANCIA			
PHEDRA 2.0	RFN(EW10J4)	09/02 → 11/10	
PHEDRA 2.0 JTD	RHM(DW10ATED4)	07/03 → 11/10	
PEUGEOT			
206 1.4	KFW(TU3JP)	07/02 → 02/07	
206 1.4 i	K6C(TU3JP), N6A(TU5JP4)	09/98 →	
206 1.6	NFU(TU5JP4)	09/01 → 12/08	
206 1.6 16V	N6A(TU5JP4), N6A(TU5JP4)	07/00 →	
206 1.6 8V	TU5JP	05/99 → 10/03	
206 1.6 LPG	NFU(TU5JP4)	07/02 →	
206+ 1.6 16V	NFU(TU5JP4)	07/10 →	
307 1.6 16V	N6A(TU5JP4), RFJ(EW10A)	08/00 →	
307 2.0	RFN(EW10J4)	03/02 → 06/05	
307 2.0 16V	RFJ(EW10A), 5FT(EP6DT)	08/00 → 04/09	
308 I 1.6 16V	5FT(EP6DT), RHS(DW10ATED)	09/07 →	
308 I 2.0 Bioflex	RFJ(EW10A)	01/08 →	
308 I 2.0 CVVT	RFJ(EW10A)	07/09 → 11/14	
406 2.0 HDi 110	RHS(DW10ATED), RHM(DW10ATED4)	08/01 → 10/04	
407 2.0	RFN(EW10J4)	03/04 →	
407 2.0 16V	RFJ(EW10A)	09/05 →	
407 2.0 Bioflex	RFJ(EW10A)	09/07 →	
807 2.0	RFN(EW10J4)	06/02 →	
807 2.0 16V	RFJ(EW10A)	09/05 →	
807 2.0 HDi	RHM(DW10ATED4), K4J711	06/02 →	
EXPERT I 2.0	RFN(EW10J4)	07/00 → 12/06	
RENAULT			
CLIO II 1.4	E7J635	03/99 →	
CLIO II 1.4 16V	K4J711, E7J634	02/00 → 07/08	
CLIO II 1.6	K7M745	09/98 → 05/05	
CLIO II 1.6 16V	K4M745	09/98 →	
KANGOO I 1.4	E7J634, F4P771	08/97 →	
KANGOO I 1.6 16V	K4M753	06/01 →	
KANGOO I 1.6 16V 4x4	K4M753	10/01 →	
LAGUNA I 2.0	F3R611	03/99 → 03/01	
LAGUNA II 1.6 16V	K4M711	03/01 →	
LAGUNA II 1.8 16V	F4P771, F9Q751	03/01 → 12/07	
LAGUNA II 1.9 dCi	F9Q751, F4R713	03/01 →	
LAGUNA II 2.0 16V	F4R713, K4J710	08/02 → 12/07	
LOGAN 1.6	K4M697	04/07 →	
MEGANE I 1.4 16V	K4J710, E7J626	03/99 → 08/03	
MEGANE I 1.4 e	E7J626, K4M700	01/96 → 08/03	
MEGANE I 1.4 Eco	E7J624	01/96 → 03/99	
MEGANE I 1.6	K7M704	02/00 → 09/00	
MEGANE I 1.6 16V	K4M700, K7M702	05/00 →	
MEGANE I 1.6 e	K7M702, F4P260	01/96 → 03/99	
MEGANE I 1.6 i	K7M720	01/96 → 03/99	
MEGANE I 1.6 LPG	K4M704	10/00 → 08/02	
MEGANE I 1.8 16V	F4P260, F8Q284	07/00 → 08/03	
MEGANE I 1.9	F8Q284, F8Q620	01/96 →	
MEGANE I 1.9 D	F8Q620, F8Q620	04/96 → 08/03	
MEGANE I 1.9 D Eco	F8Q620, F9Q718	01/96 → 08/03	
MEGANE I 1.9 dCi	F9Q718, F8Q784	05/00 →	
MEGANE I 1.9 dT	F8Q784, F9Q710	01/96 → 08/03	
MEGANE I 1.9 DTi	F9Q710, F3R262	03/97 →	
MEGANE I 1.9 TDI	F8Q784	09/96 → 08/03	
MEGANE I 2.0	F3R262, F4R276	01/97 → 05/01	
MEGANE I 2.0 16V	F4R276, F3R750	05/00 →	
MEGANE I 2.0 i	F3R750, K4M760	01/96 → 08/03	
MEGANE I 2.0 RT	F4R747	03/01 → 08/03	
MEGANE II 1.6	K4M760, K4M760	08/03 →	
MEGANE II 1.6 16V	K4M760, K4M700	11/02 →	
MEGANE SCÉNIC I 1.6 16V	K4M700, F9Q730	04/98 → 10/99	
MEGANE SCÉNIC I 1.9 D	F8Q790	03/97 → 09/99	
MEGANE SCÉNIC I 1.9 dTi	F9Q730, F3R750	04/97 → 09/99	
MEGANE SCÉNIC I 2.0 i	F3R750, K4J714	01/97 → 09/99	
SCÉNIC I 1.4 16V	K4J714, K4M708	09/99 → 08/03	
SCÉNIC I 1.6	K4M708, F9Q732	03/01 → 09/03	
SCÉNIC I 1.9 dCi	F9Q732, F9Q731	09/99 → 08/03	
SCÉNIC I 1.9 dCi RX4	F9Q732	12/02 → 08/03	
SCÉNIC I 1.9 dTi	F9Q731, F4R740	02/01 → 08/03	
SCÉNIC I 2.0	F3R791	09/99 → 08/03	
SCÉNIC I 2.0 16V	F4R740, 312A1.000	07/00 → 08/03	
THALIA I 1.4 16V	K4J713	08/00 →	
THALIA I 1.6	K4M745	01/01 →	

9.0619



3

REVOLUTION AND TIMING (CKP AND CMP) SENSORS

Adatt./Suitable:

ABARTH

46798368
46811121
55181460
55228528
55242637
6000100156

ALFA ROMEO

46798368
46811121
55181460
55228528
55242637
6000100156

BENTLEY

07V 907 271 A

BOSCH

0 232 103 043
0 232 103 048
0 232 103 097

CHRYSLER

55242637

FIAT

46798368
46811121
55181460
55228528
55242637
6000100156
K68070491AB

FORD

1 535 717
1 564 814
9551-12K073-CA

GENERAL MOTORS

55 242 637
95 510 649

HYUNDAI

39350-3F000

JEEP

55228528
55242637
6000100156
K68070491AA
K68070491AB

KIA

39350-3F000

LANCIA

46798368
46811121
55181460
55228528
55242637

MOPAR PARTS

68070491AA

OPEL

55242637
7 84 059
7 84 083
95510649

VAUXHALL

55242637
95510649

MARKET DIFFUSION: HIGH



L	L1		
---	28,2	Hall Effect	

ABARTH

124 1.4	55253268	03/16 →	
500 1.4	312A1.000, 312A1.000	08/08 →	
500 MY12 1.4	--	01/12 →	
500C / 595C 1.4	312A1.000, 199A8.000	05/08 →	
GRANDE PUNTO 1.4	199A8.000, 199A8.000	12/07 → 12/12	
PUNTO 1.4	199A8.000, 955A8.000	03/12 →	
PUNTO EVO 1.4	955A8.000, 198A4.000	07/08 → 02/12	

ALFA ROMEO

GIULIETTA II 1.4	198A4.000, 198A4.000	04/11 →	
GIULIETTA II 1.4 BiFuel	198A4.000	12/11 →	
GIULIETTA II 1.4 TB	198A4.000, 199B6.000	04/10 →	
MITO 0.9	199B6.000	12/13 →	
MITO 0.9 TwinAir	199B6.000, 199A6.000	07/11 →	

ALFA ROMEO			
MITO 1.4	199A6.000, 198A4.000	08/08	⇒
MITO 1.4 Bifuel	198A4.000, 940A2.000	01/09	⇒
MITO 1.4 MultiAir	940A2.000, 198A1.000	09/09	⇒
MITO 1.4 TB	955B1.000	12/13	⇒
MITO 1.4 TJet	198A1.000, 955A2.000	08/08	⇒
MITO 1.4 Turbo MultiAir	955A2.000, CKBB	10/09	⇒
BENTLEY			
MULSANNE 6.8	CKBB, 199B6.000	09/09	⇒
CHRYSLER			
DELTA 1.4	198A4.000	08/11	⇒
DELTA 1.4 16V	198A7.000	08/11	⇒
YPSILON 0.9 Twinair	312A2.000	05/11	⇒
YPSILON 1.2	169A4.000	05/11	⇒
FIAT			
124 1.4	55253268	03/16	⇒
500 0.9	199B6.000, 199B6.000	07/10	⇒
500 1.2	169A4.000	10/07	⇒
500 1.2 LPG	169A4.000	12/10	⇒
500 1.4	169A3.000	10/07	⇒
500 1.4 [CHN]	--	01/10	⇒
500 1.4 [USA]	--	01/10	⇒
500 C 0.9	199B6.000, 169A3.000	09/09	⇒
500 C 1.2	169A4.000	09/09	⇒
500 C 1.4	169A3.000, 199B6000CNG	09/09	⇒
500 MY12 0.9	--	01/12	⇒
500 MY12 1.2	--	01/12	⇒
500 MY15 0.9	--	01/15	⇒
500 MY15 1.2	--	01/15	⇒
500 MY15 1.2 LPG	--	01/15	⇒
500L 0.9	199B6.000	09/12	⇒
500L 0.9 Natural Power	199B6000CNG, 843A1.000	03/13	⇒
500L 1.4	843A1.000, --	09/12	⇒
500L 1.4 [CAN]	--	01/13	⇒
500L 1.4 LPG	940B7.000	02/14	⇒
500X 1.4	55263624	09/14	⇒
500X 1.4 4x4	55263623	02/15	⇒
500X 1.4 LPG	55277701	03/17	⇒
BRAVO I 1.4	192B2.000	04/07	⇒ 12/14
BRAVO II 1.4 16V	--	04/07	⇒
BRAVO II 1.4 T-Jet	--, 198A4.000	09/07	⇒
DOBLO I 1.4	350A1.000	10/05	⇒
DOBLO II 1.4	198A4.000, 198A4.000	02/10	⇒
DOBLO II 1.4 Natural Power	198A4.000, 350A1.000	02/10	⇒
FIORINO III 1.4	350A1.000, 350A1.000	11/07	⇒
FIORINO III 1.4 Natural Power	350A1.000, 192B2.000	06/08	⇒
GRANDE PUNTO 1.4	350A1.000	02/06	⇒ 06/13
GRANDE PUNTO 1.4 LPG	350A1.000	03/09	⇒ 12/12
GRANDE PUNTO 1.4 Natural Power	350A1000CNG	03/09	⇒ 12/12
IDEA 1.2	--	01/08	⇒
IDEA 1.2 16V	188A5.000	01/04	⇒
IDEA 1.4	192B2.000, --	12/03	⇒
IDEA 1.4 16V	--, 350A1.000	01/04	⇒
IDEA 1.4 LPG	350A1.000	03/09	⇒
LINEA 1.4	350A1.000	06/07	⇒
LINEA 1.4 16V [IND]	--	06/07	⇒
LINEA 1.4 16V TURBO [IND]	--	09/07	⇒
LINEA 1.4 T-Jet	198A4.000	09/07	⇒
PALIO 1.0	178A1.000	04/96	⇒ 10/03
PALIO 1.0 GLX	--	07/98	⇒ 10/03
PALIO 1.1	187A1.000	06/06	⇒
PALIO 1.2	178C4.066	07/97	⇒
PALIO 1.2 MPI	178C4.066	01/02	⇒
PALIO 1.4	350A1.000, 169A4.000	10/02	⇒
PANDA I 1.1	187A1.000	09/00	⇒ 02/04
PANDA I 1.1 AWD	187A1.000	09/00	⇒ 02/04
PANDA II 1.1	--	09/03	⇒
PANDA II 1.2	169A4.000, 169A4.000	09/03	⇒
PANDA II 1.2 4x4	169A4.000, 169A4.000	09/04	⇒
PANDA II 1.2 Bipower	188A4.000	09/04	⇒ 12/11
PANDA II 1.2 Bi-Power / Natural Power	--	04/09	⇒
PANDA II 1.2 Euro 5	--	04/09	⇒
PANDA II 1.2 LPG	169A4.000, 188A4.000	04/09	⇒
PANDA II 1.2 Natural Power	188A4.000, 350A1.000	01/07	⇒ 12/11
PANDA II 1.4	--	10/06	⇒
PANDA II 1.4 16V	--	01/10	⇒
PANDA II 1.4 Natural Power	350A1.000, 312A2.000	10/09	⇒
PANDA III 0.9	312A2.000, 312A2.000	02/12	⇒
PANDA III 0.9 4x4	312A2.000, 312A2.000	09/12	⇒
PANDA III 0.9 Natural Power	312A2.000, 199A6.000	07/12	⇒
PANDA III 1.2	169A4.000	02/12	⇒
PANDA III 1.2 LPG	169A4.000	06/12	⇒
PUNTO II 1.2	188A4.000	06/03	⇒
PUNTO II 1.2 16V	188A5.000	06/03	⇒
PUNTO II 1.2 60	188A4.000	09/99	⇒ 12/10
PUNTO II 1.2 Bifuel	188A4.000	08/07	⇒ 03/12

FIAT			
PUNTO II 1.2 Bipower	188A4.000	08/01	⇒ 05/03
PUNTO II 1.2 Natural Power	188A4.000	09/03	⇒ 03/12
PUNTO II 1.4	199A6.000, 169A4.000	09/03	⇒
PUNTO III / GRANDE PUNTO 1.2	169A4.000, 199A7.000	10/05	⇒
PUNTO III / GRANDE PUNTO 1.2 [IND]	--	01/08	⇒
PUNTO III / GRANDE PUNTO 1.2 Actual	--	09/09	⇒
PUNTO III / GRANDE PUNTO 1.2 LPG	199A4.000	07/08	⇒
PUNTO III / GRANDE PUNTO 1.4	199A7.000, 350A1.000	06/05	⇒ 12/15
PUNTO III / GRANDE PUNTO 1.4 16V	199A6.000	10/05	⇒
PUNTO III / GRANDE PUNTO 1.4 16V [IND]	--	01/08	⇒
PUNTO III / GRANDE PUNTO 1.4 Actual	--	09/09	⇒
PUNTO III / GRANDE PUNTO 1.4 LPG	350A1.000	12/08	⇒
PUNTO III / GRANDE PUNTO 1.4 Natural Power	350A1.000, 199B6.000	07/08	⇒
PUNTO III / GRANDE PUNTO 1.4 T-Jet	198A4.000	09/07	⇒
PUNTO III EVO 1.2	169A4.000, 199A7.000	10/09	⇒ 02/12
PUNTO III EVO 1.4	199A7.000, 955A2.000	03/09	⇒
PUNTO III EVO 1.4 16V	955A2.000, 350A1.000	10/09	⇒ 02/12
PUNTO III EVO 1.4 LPG	350A1.000	06/09	⇒ 02/12
PUNTO III EVO 1.4 Natural Power	350A1.000, 350A1.000	10/09	⇒ 02/12
PUNTO III 0.9	199B6.000, 169A4.000	07/13	⇒
PUNTO III 0.9 Bifuel	312A2.000	03/12	⇒
PUNTO III 0.9 Twinair Turbo	312A2.000	03/12	⇒
PUNTO III 1.2	169A4.000, 199A7.000	03/12	⇒
PUNTO III 1.4	199A7.000, 350A1.000	04/08	⇒
PUNTO III 1.4 Bifuel	350A1.000	03/12	⇒
PUNTO III 1.4 LPG	350A1.000	03/09	⇒
PUNTO III 1.4 Multi Air	955A6.000	03/12	⇒
PUNTO III 1.4 Natural Power	350A1.000, 169A4.000	03/09	⇒
PUNTO III 1.4 Turbo Multi Air	955A2.000	03/12	⇒
PUNTO 1.4	350A1.000	03/12	⇒
PUNTO 1.4 LPG	350A1.000	03/09	⇒ 02/12
PUNTO 1.4 Natural Power	350A1000CNG	03/09	⇒ 02/12
QUBO 1.4	350A1.000, 350A1.000	02/08	⇒
QUBO 1.4 Natural Power	350A1.000, 176B2.000	10/09	⇒
SEICENTO / 600 1.1	176B2.000, 192B2.000	01/98	⇒ 01/10
SIENA 1.4	--	01/02	⇒
STILO 1.4 16V	192B2.000, --	01/04	⇒ 08/08
STRADA 1.2	178B7.045	01/05	⇒
STRADA 1.2 Trekking	--, 843A1.000	11/05	⇒
TIPO II 1.4	843A1.000, FP4	10/15	⇒
TIPO II 1.4 LPG	940B7.000	05/16	⇒
FORD			
KA II 1.2	FP4, G6AA	10/08	⇒
HYUNDAI			
ACCENT IV 1.4	G4LC	11/10	⇒
ACCENT IV 1.4 CVT	--	11/10	⇒
AZERA [USA] 3.0	--	09/10	⇒
AZERA 3.0 MPI [ExtraEU]	G6DE	03/11	⇒
EQUUS 5.0 GDi [ExtraEU]	G8BE	08/14	⇒
EQUUS / CENTENNIAL II 4.6 V8	G6AA, G6DE	03/09	⇒
EQUUS / CENTENNIAL II 5.0 GDi	G8BE	03/09	⇒
GRANDEUR 3.0	G6DE, G4LA	07/11	⇒
I10 II 1.2	G4LA	12/13	⇒
I20 1.2 CVVT	G4LA	05/15	⇒
I20 1.4 CVVT	G4LC	05/15	⇒
I20 I 1.2	G4LA	03/12	⇒ 12/15
I20 II 1.2	G4LA, G4LC	11/14	⇒
I20 II 1.2 LPGi	G4LA	11/14	⇒
I20 II 1.4	G4LC	05/15	⇒
I30 I 1.4	G4LC	12/14	⇒
I30 III 1.4 MPI	G4LC, 55263624	11/16	⇒
I30 III 1.4 T-GDi	G4LD	11/16	⇒
JEEP			
COMPASS 1.4 MultiAir	EAQ(55263624)	03/17	⇒
COMPASS 1.4 MultiAir Trazione integrale	EAQ(55263623)	03/17	⇒
RENEGADE 1.4	55263624, EAM	07/14	⇒
RENEGADE 1.4 4x4	EAM, 198A1.000	07/14	⇒
RENEGADE 1.6	EJH(55263842)	07/14	⇒
KIA			
BORREGO 4.6	G8BA	09/08	⇒ 12/11
CEED II 1.4 CVVT	G4FA	04/15	⇒
CEED II 1.4 MPI	G4LC	04/15	⇒
CEED III 1.4	G4LC	04/18	⇒
CEED III 1.4 LPG	G4LC	12/18	⇒
CEED III 1.4 MPI [ExtraEU]	G4LC	03/18	⇒

KIA			
CEED III 1.4 T-GDi	G4LD	04/18	⇒
CEED III 1.4 T-GDi [ExtraEU]	G4LD	03/18	⇒
MOHAVE 4.6	--	09/08	⇒
PICANTO II 1.2	G4LA	09/11	⇒
PICANTO III 1.0	G3LA	03/17	⇒
PICANTO III 1.0 CVVT [ExtraEU]	G3LA	03/17	⇒
PICANTO III 1.0 LPG	G3LA	11/18	⇒
PICANTO III 1.0 T-GDi	G3LC	03/17	⇒
PROCEED 1.4 T-GDi	G4LD	10/18	⇒
PROCEED II 1.4 MPI	G4LC	04/15	⇒
PROCEED II 1.4 CVVT	G4FA	05/12	⇒
QUORIS 5.0 GDi	G8BE	05/15	⇒
RIO III 1.2	G4LA	09/11	⇒
RIO III 1.2 CVVT	G4LA	11/14	⇒
RIO III 1.25 CVVT	G4LA	09/11	⇒
RIO III 1.25 LPG	G4LA	09/11	⇒
RIO 1.2 CVVT	G4LA	04/15	⇒
RIO IV 1.4	G4LC	01/17	⇒
STONIC 1.4 CVVT	G4LC	07/17	⇒
STONIC 1.4 LPG	G4LC	11/18	⇒
LANCIA			
DELTA III 1.4	198A1.000, 192B2.000	09/08	⇒ 08/14
DELTA III 1.4 16V	198A7.000	07/10	⇒ 08/14
DELTA III 1.4 Bifuel	198A4.000	07/11	⇒ 08/14
MUSA 1.4	192B2.000, 169A4.000	10/04	⇒ 09/12
MUSA 1.4 8V	--	01/11	⇒ 12/12
MUSA 1.4 LPG	350A1.000	11/10	⇒ 09/12
YPSILON I 1.2	169A4.000, 312A2.000	10/03	⇒ 12/11
YPSILON I 1.4	350A1.000	02/06	⇒ 12/11
YPSILON I 1.4 16V	843A1.000	10/03	⇒ 12/11
YPSILON I 1.4 LPG	350A1.000	11/10	⇒ 12/11
YPSILON II 0.9 CNG	312A2.000, 312A2.000	05/11	⇒
YPSILON II 0.9 TwinAir	312A2.000, A14FC	05/11	⇒
YPSILON II 1.2	169A4.000	05/11	⇒
YPSILON II 1.2 Bi-fuel	169A4.000	05/11	⇒
OPEL			
COMBO D 1.4	A14FC, A14FC	02/12	⇒
COMBO D 1.4 CNG	A14FC, A16FDH	02/12	⇒
COMBO D 1.6 CDTi	A16FDH, A16FDH	02/12	⇒
COMBO D 2.0 CDTi	A20FD	02/12	⇒
VAUXHALL			
COMBO D 1.4	A14FP	11/11	⇒
COMBO D 1.4 CNG	A14FC	11/11	⇒
COMBO D 1.6 CDTi	A16FDH, B204E	11/11	⇒
COMBO D 2.0 CDTi	A20FD	11/11	⇒

9.0620

04,5

REVOLUTION AND TIMING (CKP AND CMP) SENSORS

Adatt./Suitable:

BOSCH

0 261 210 133
0 261 210 269

GENERAL MOTORS

55 557 326

SAAB

30 561 772

55 557 326

91 77 221

SCANIA

30561772

55557326



L	L1	ohm	S GND OUT
580	24	1000	

SAAB

9-3 2.0 SE Turbo	B204R	02/98	⇒ 08/03
9-3 2.0 Turbo	B204E, B205E	02/98	⇒ 08/03
9-3 2.3	B235R	09/99	⇒ 01/02
9-3 2.3 i	B234I	02/98	⇒ 08/03
9-3 2.3 Turbo	B235R	10/98	⇒ 08/03
9-5 2.0 t	B205E, B205E	07/00	⇒ 12/09
9-5 2.0 t BioPower	B205E, B235E	01/05	⇒ 12/09

SAAB			
9-5 2.0 Turbo SE	B205E	10/98 ⇨	07/00
9-5 2.3 t	B235E, --	01/01 ⇨	12/09
9-5 2.3 t BioPower	--, B235E	11/06 ⇨	12/09
9-5 2.3 Turbo	B235E, 844A2.000	09/01 ⇨	12/09
900 II 2.0 i	B204I	12/93 ⇨	02/98
900 II 2.3 -16	B234I	07/93 ⇨	02/98

9.0626



3

REVOLUTION AND TIMING (CKP AND CMP) SENSORS

Adatt./Suitable:

ALFA ROMEO

55208561
55216242
K68093400AA

CHRYSLER

55216242

FIAT

55208561
55216242
K68093400AA

GENERAL MOTORS

55 216 242

JEEP

55208561
55216242
68093400AA
K68093400AA

LANCIA

55208561
55216242

OPEL

12 60 496
55216242

SUZUKI

33220-55L10
33220-55L10-000
33220-55L20
33220-55L20-000

MARKET DIFFUSION: MEDIUM



L	L1		
---	28	Hall Effect	

ALFA ROMEO

159 2.0 JTDM	844A2.000, 55266388	05/09 ⇨	11/11
159 MY2011 2.0 JTD	--	01/10 ⇨	
GIULIA 2.2 D	55266388, 940A3.000	10/15 ⇨	
GIULIA 2.2 D Q4	55268818	04/17 ⇨	
GIULIETTA II 1.6 JTDM	940A3.000, 940A4.000	04/10 ⇨	
GIULIETTA II 2.0 JTDM	940A4.000, 198A2.000	04/10 ⇨	
MITO 1.6 JTDM	198A2.000, 844A2.000	08/08 ⇨	
SPIDER III 2.0 JTDM	844A2.000, 199B.5000	04/09 ⇨	06/10
STELVIO 2.2 D	55275156	12/16 ⇨	
STELVIO 2.2 D Q4	55271838	12/16 ⇨	

CHRYSLER

DELTA 1.6 D Multijet	844A3000	08/11 ⇨	
DELTA 2.0 D Multijet	198A5.000	08/11 ⇨	

FIAT

500L 1.6 D Multijet	199B.5000, 55263087	09/12 ⇨	
500X 1.6 D Multijet	55260384	09/14 ⇨	
500X 2.0 4x4	--	09/15 ⇨	
500X 2.0 D Multijet 4x4	55263087, --	09/14 ⇨	
BRAVO II 1.6 D Multijet	--, --	09/07 ⇨	
BRAVO II 1.6 JTD	198A3.000	03/08 ⇨	12/14
BRAVO II 2.0 D Multijet	--, 198A3.000	09/08 ⇨	
DOBLO II 1.6 D Multijet	198A3.000, 250A1.000	02/10 ⇨	
DOBLO II 1.6 D Multijet	263A1.000	01/10 ⇨	
DUCATO III 115 Multijet 2,0 D	250A1.000, 939B5.000	06/11 ⇨	
DUCATO III 2.0	--	01/14 ⇨	
FREEMONT 2.0 JTD	939B5.000, 939B5.000	08/11 ⇨	
FREEMONT 2.0 JTD 4x4	939B5.000, EBS	08/11 ⇨	
IDEA 1.6 D Multijet	350A2.000	05/08 ⇨	
LINEA 1.6 D Multijet	198A3.000	06/09 ⇨	

FIAT			
PUNTO III / GRANDE PUNTO 1.6 D Multijet	955A3.000	07/08 ⇨	
PUNTO III EVO 1.6 D Multijet	955A3.000	10/09 ⇨	02/12
SEDCICI 2.0 D Multijet	D20AA	06/06 ⇨	10/14
SEDCICI 2.0 D Multijet 4x4	D20AA	06/06 ⇨	10/14
SEDCICI MY12 2.0 D	--	01/12 ⇨	
TIPO II 1.6 D	55260384	03/16 ⇨	

JEEP

CHEROKEE V 2.0 CRD	EBS, EBS	04/14 ⇨	
CHEROKEE V 2.0 CRD [ExtraEU]	EBS, EBS	04/14 ⇨	
CHEROKEE V 2.0 CRD 4x4	EBS, EBS(55263087)	04/14 ⇨	
CHEROKEE V 2.2 CRD 4x4	LAU61	08/15 ⇨	
COMPASS 2.0 CRD 4x4	EBS(55263087), EJJ(55260384)	12/16 ⇨	
RENEGADE 1.6 CRD	EJJ(55260384), 55263088	07/14 ⇨	
RENEGADE 2.0 CRD 4x4	55263088, 198A2.000	07/14 ⇨	
WRANGLER 2.2 Multijet II	EBH	11/17 ⇨	

LANCIA

DELTA III 1.6 D Multijet	198A2.000, 198A5.000	08/08 ⇨	08/14
DELTA III 1.9 D Multijet	844A1.000	01/09 ⇨	08/14
DELTA III 2.0 D Multijet	198A5.000, --	09/08 ⇨	08/14
MUSA 1.6 D Multijet	--, A16FDH	07/08 ⇨	12/12

OPEL

COMBO D 1.6 CDTi	A16FDH, A16FDH	02/12 ⇨	
COMBO D 2.0 CDTi	A20FD	02/12 ⇨	

SUZUKI

SX4 I 2.0 DDiS	D20AA	07/09 ⇨	
SX4 I 2.0 DDiS 4x4	D20AA	07/09 ⇨	
SX4 II 1.6 DDiS	D16AA	08/13 ⇨	
SX4 II 1.6 DDiS AllGrip	D16AA	08/13 ⇨	
SX4 2.0 DDiS	D20AA	09/13 ⇨	12/15
VITARA IV 1.6 DDiS	D16AA	02/15 ⇨	
VITARA IV 1.6 DDiS AllGrip	D16AA	02/15 ⇨	

VAUXHALL

COMBO D 1.6 CDTi	A16FDH, 182B9.000	11/11 ⇨	
COMBO D 2.0 CDTi	A20FD	11/11 ⇨	

9.0631



04,5

REVOLUTION AND TIMING (CKP AND CMP) SENSORS

Adatt./Suitable:

ALFA ROMEO

46806128
60816553

BOSCH

0 281 002 474

FIAT

46806128
60816553

LANCIA

46806128

MARKET DIFFUSION: MEDIUM



L	L1	ohm	
480	37	900	

ALFA ROMEO

145 1.9 JTD	AR32302	02/99 ⇨	01/01
146 1.9 JTD	AR32302	02/99 ⇨	01/01
147 1.9 JTD	182B9.000, 937A2.000	04/01 ⇨	03/10
147 1.9 JTDM	937A2.000, 937A2.000	10/04 ⇨	03/10
156 1.9 JTD	937A2.000, 839A6.000	05/00 ⇨	05/06
156 2.4 JTD	839A6.000, 839A6.000	05/00 ⇨	05/06
166 2.4 JTD	839A6.000, 182B9.000	10/00 ⇨	06/07

FIAT

DOBLO I 1.9 D	223A6.000	03/01 ⇨	
DOBLO I 1.9 JTD	182B9.000, 182A7.000	10/01 ⇨	
MAREA 1.9 JTD	182B9.000	01/01 ⇨	12/07
MAREA 1.9 JTD 110	186A6.000	09/00 ⇨	08/02
MAREA 1.9 TD 100	182A7.000, 182B4.000	09/96 ⇨	06/03
MARENGO 1.9 JTD	182B4.000, 192A1.000	03/99 ⇨	08/02
MULTIPLA 1.9 JTD 110	186A6.000	03/01 ⇨	07/02

9.0632



1

REVOLUTION AND TIMING (CKP AND CMP) SENSORS

Adatt./Suitable:

- BOSCH**
0 986 280 413
- CITROËN**
96 611 359 80
96 654 435 80
- FORD**
1 229 954
1 255 020
1 314 032
1 427 776
1 451 478
1 490 841
1 580 907
1 595 453
1 695 278
1 837 835
3MSQ-12K073-AB
3MSQ-12K073-AC
3MSQ-12K073-CA
6G9Q-12K073-AC
9MSQ-12K073-AA
9MSQ-12K073-AB
- JAGUAR**
C2S 46526
- LAND ROVER**
LR004249
LR016847
- MAZDA**
Y601-18-230A
Y601-18-230B
Y602-18-230
- MINI**
13 62 7 805 005
- MITSUBISHI**
MN982271
MN982363
- SANTANA**
33220-86CT0
35466-86SA4
- SUZUKI**
33220-67G10
33220-67G10-000
33220-69K10
33220-69K10-000
33220-69K20-000
33220-73J00
33220-73J00-000
33220-73J10
33220-73J10-000
33220-86CT0
33220-86CT0-000
33220-86CT1
33220-86CT1-000
35466-86SA4
35466-86SA4-000
- TOYOTA**
5U001-A0690
- VOLVO**
30711105
30725738
30725885
31216443
31342337

FORD		
FOCUS III 2.0 TDCi	TXDB, HHJA	07/10 ⇨
FOCUS C-MAX 1.6 TDCi	G8DA, G6DA	10/03 ⇨ 03/07
FOCUS C-MAX 2.0 TDCi	G6DA, G8DA	10/03 ⇨ 03/07
FUSION 1.6 TDCi	HHJA, --	11/04 ⇨ 12/12
GALAXY II 2.0 TDCi	--, KNWA	05/06 ⇨
GALAXY II 2.0 TDCi CRT C	--	03/10 ⇨
GALAXY II 2.0 TDCi DSL	--	03/10 ⇨
GALAXY II 2.2 TDCi	KNWA, --	03/08 ⇨ 06/15
GRAND C-MAX 2.0 TDCi	TYDA	02/11 ⇨
KUGA I 2.0 TDCi	--, G6DG	03/08 ⇨
KUGA I 2.0 TDCi 4x4	G6DG, TYMA	03/08 ⇨ 11/12
KUGA I 2.0 TDCi CRT C	--	03/10 ⇨
KUGA II 2.0 TDCi	TYMA, TXDA	03/13 ⇨
KUGA II 2.0 TDCi 4x4	TXDA, KLBA	03/13 ⇨
MONDEO III 2.0 TDCi	AZBA, KNBA	03/07 ⇨ 01/15
MONDEO III 2.2 TDCi	KNBA, AZWA	03/08 ⇨ 01/15
MONDEO 2.0 TDCi	KLBA, AZBA	03/07 ⇨ 09/14
MONDEO 2.2 TDCi	KNBA	03/13 ⇨ 09/14
S-MAX I 2.0 TDCi	AZWA, KNWA	05/06 ⇨ 12/14
S-MAX I 2.0 TDCi CRT C	--	03/10 ⇨
S-MAX I 2.0 TDCi DSL	--	03/10 ⇨
S-MAX I 2.2 TDCi	KNWA, 224DT	03/08 ⇨ 12/14

JAGUAR		
XF 2.2 D	224DT, 224DT	04/11 ⇨ 04/15

LAND ROVER		
DISCOVERY IV 2.2 D 4x4	224DT	09/14 ⇨
FREELANDER 2 2.2 eD4	224DT, 224DT	08/10 ⇨ 10/14
FREELANDER 2 2.2 SD4 4x4	224DT	08/10 ⇨ 10/14
FREELANDER 2 2.2 TD4 4x4	224DT, Y406	10/06 ⇨ 10/14
RANGE ROVER EVOQUE 2.2 D	224DT	06/11 ⇨
RANGE ROVER EVOQUE 2.2 D 4x4	224DT	06/11 ⇨

MAZDA		
2 II 1.6 MZ-CD	Y406, Y601	10/08 ⇨ 06/15
3 I 1.6 Di Turbo	Y601, Y601	06/04 ⇨ 06/09
3 I 1.6 MZ-CD	Y406	06/06 ⇨ 12/09
3 II 1.6 MZR CD	Y601, 9HZ	12/08 ⇨ 05/13

MINI		
MINI II Cooper D	9HZ, 9HZ	11/06 ⇨ 09/10
MINI II One D	9HZ, 4HK	06/09 ⇨ 07/10

MITSUBISHI		
OUTLANDER II 2.2 DI-D 4WD	4HK, 4WZ-FHV	08/07 ⇨ 11/12

SUZUKI		
GRAND VITARA I 2.0 TD 4x4	RF	03/98 ⇨ 07/03
LIANA 1.4 DDIS	8HY	04/04 ⇨
SX4 I 1.6 DDIS	9HX	04/07 ⇨
VITARA II / III 2.0 HDI	RHP(DW10TD)	12/03 ⇨ 12/05
VITARA II / III HDI	RHP(DW10TD)	12/03 ⇨ 12/05

TOYOTA		
PROACE 2.0 D	4WZ-FHV, 1ZR-FAE	06/13 ⇨ 03/16
PROACE 2.0 D 4WD	4WZ-FTV	06/13 ⇨ 03/16

VOLVO		
S40 II 2.0 D4	D4204T2	07/05 ⇨ 12/12
S80 II 2.0 TDi	D4204T	02/08 ⇨ 03/11

MARKET DIFFUSION: HIGH



L	L1		
---	23,3	Hall Effect	

FORD		
C-MAX I 1.6 TDCi	G8DA, G6DA	02/07 ⇨ 09/10
C-MAX I 2.0 TDCi	G6DA, HHJA	02/07 ⇨ 09/10
FIESTA V 1.6 TDCi	HHJA, HHJC	04/07 ⇨ 09/09
FIESTA VI 1.6 TDCi	HHJC, G8DA	06/08 ⇨
FOCUS II 1.6 TDCi	G8DA, G6DA	07/04 ⇨ 09/12
FOCUS II 2.0 TDCi	G6DA, G8DA	07/04 ⇨ 09/12
FOCUS II CASSONE / FURGONATO / PROMISCOU 1.6 TDCi	G8DA, G6DB	07/04 ⇨ 07/11
FOCUS II CASSONE / FURGONATO / PROMISCOU 2.0 TDCi	G6DB, TXDB	09/05 ⇨ 07/11

9.0633



3

REVOLUTION AND TIMING (CKP AND CMP) SENSORS

Adatt./Suitable:

- DENSO**
029600-1480
- LEXUS**
90919-05070
- TOYOTA**
90919-05070
90919-A5004

MARKET DIFFUSION: MEDIUM



L	L1	ohm	
---	61,8	2100	

LEXUS		
CT 200h	2ZR-FXE	12/10 ⇨

LEXUS		
ES 250	2AR-FE	06/12 ⇨
ES 300h	2AR-FXE	06/12 ⇨
GS 300h	2AR-FSE	10/13 ⇨
IS III 300h	2AR-FSE	04/13 ⇨
RC 300h	2AR-FSE	09/14 ⇨
RX III 270	1AR-FE	12/08 ⇨ 10/15

TOYOTA		
AURIS I 1.6	1ZR-FAE, 2ZR-FAE	03/07 ⇨ 09/12
AURIS I 1.8	2ZR-FAE, 3ZR-FAE	10/06 ⇨ 09/12
AURIS I 1.8 4WD	2ZR-FAE	02/09 ⇨ 09/12
AURIS I 1.8 Hybrid	2ZR-FXE	09/10 ⇨ 09/12
AURIS II 1.6	1ZR-FAE	10/12 ⇨
AURIS II 1.8 Hybrid	2ZR-FXE	10/12 ⇨
AVENSIS III 1.6	1ZR-FAE	11/08 ⇨
AVENSIS III 1.8	2ZR-FAE	11/08 ⇨
AVENSIS III 2.0	3ZR-FAE, 2AR-FE	11/08 ⇨
CAMRY 2.5	2AR-FE, 1ZR-FAE	01/10 ⇨
CAMRY 2.5 [CHN]	5AR-FE	12/11 ⇨
CAMRY 2.5 Hybrid	2AR-FXE	09/11 ⇨
CAMRY 2.5 Hybrid [CHN]	4AR-FXE	05/12 ⇨
C-HR 2.0	3ZR-FAE	11/16 ⇨
COROLLA 1.8 Hybrid	2ZR-FXE	10/18 ⇨
COROLLA IX 1.6	1ZR-FE	11/06 ⇨ 07/07
COROLLA X 1.6	1ZR-FAE, 1ZR-FE	11/06 ⇨ 11/13
COROLLA X 1.6 Dual VVTi	1ZR-FE	01/07 ⇨ 07/14
COROLLA X 1.6 VVTi	1ZR-FE, 2ZR-FAE	03/07 ⇨ 05/14
COROLLA X 1.8	2ZR-FAE, 2ZR-FBE	09/06 ⇨
COROLLA X 1.8 4WD	2ZR-FAE	09/06 ⇨
COROLLA X 1.8 VVTi	2ZR-FBE, 1ZR-FAE	01/08 ⇨
COROLLA X 2.0	3ZR-FE	04/10 ⇨
COROLLA X 2.0 FlexFuel	3ZR-FBE	04/10 ⇨
COROLLA X 2.0 VVTi	3ZR-FE	08/10 ⇨
COROLLA XI 1.6	1ZR-FAE, 2ZR-FXE	06/13 ⇨
COROLLA XI 1.6 BiFuel	1ZR-FE	06/13 ⇨
COROLLA XI 1.8	2ZR-FAE	05/12 ⇨
COROLLA XI 1.8 [USA] [CAN]	2ZR-FAE	08/13 ⇨
COROLLA XI 1.8 VVTi	2ZR-FE	06/13 ⇨
COROLLA XI 1.8 VVT-i	2ZR-FE	12/13 ⇨
PRIUS 1.8 Hybrid	2ZR-FXE	03/12 ⇨
HIGHLANDER / KLUGER 2.7 VVTi [ExtraEU]	1AR-FE	09/16 ⇨
MATRIX 1.8	2ZR-FE	01/08 ⇨ 05/14
PRIUS III 1.8 Hybrid	2ZR-FXE, 3ZR-FAE	06/08 ⇨
PRIUS III 1.8 Hybrid [ExtraEU]	2ZR-FXE	06/08 ⇨
PRIUS III 1.8 Plug-in Hybrid	2ZR-FXE	01/12 ⇨
PRIUS IV 1.8 Hybrid	2ZR-FXE	09/15 ⇨
PRIUS IV 1.8 Plug-in Hybrid	2ZR-FXE	01/16 ⇨
RAV 4 IV 2.0	3ZR-FE	12/12 ⇨
RAV 4 IV 2.0 4WD	3ZR-FAE, 2AR-FXE	12/12 ⇨
RAV 4 IV 2.0 VVTi [ExtraEU]	3ZR-FE	12/12 ⇨
RAV 4 IV 2.5	2AR-FE	12/12 ⇨
RAV 4 IV 2.5 4WD	2AR-FE	12/12 ⇨
RAV 4 IV 2.5 Hybrid	2AR-FXE, G4JS	10/15 ⇨
RAV 4 IV 2.5 Hybrid 4WD	2AR-FXE	10/15 ⇨
RAV 4 III 2.0	3ZR-FAE, 3ZR-FAE	12/08 ⇨ 06/13
RAV 4 III 2.0 4WD	3ZR-FAE, 3ZR-FAE	12/08 ⇨ 06/13
RAV 4 III 2.5	2AR-FE	12/08 ⇨
SIENNA 2.7 VVTi [ExtraEU]	1AR-FE	09/10 ⇨ 07/13
VENZA 2.7	1AR-FE	11/08 ⇨ 11/16
VENZA 2.7 4WD	1AR-FE	11/08 ⇨ 11/16
VENZA 2.7 VVTi [ExtraEU]	1AR-FE	11/08 ⇨ 04/12
VERSO 1.6	1ZR-FAE	04/09 ⇨
VERSO 1.8	2ZR-FAE	04/09 ⇨
YARIS II 1.6 [CHN]	1ZR-FE	05/08 ⇨
YARIS II 1.8 VVTi	2ZR-FE	01/07 ⇨ 12/11
YARIS III 1.8 GRMN	2ZR-FE	09/17 ⇨

9.0636



3,5

REVOLUTION AND TIMING (CKP AND CMP) SENSORS

Adatt./Suitable:

HYUNDAI
45589-H1150
LEXUS
89413-22010
TOYOTA
89413-22010



L	L1	ohm	GND_OUT
---	42,1	670	

HYUNDAI

Model	Part No.	Year Range
H-112.4	G4JS, 1ZR-FAE	11/01 ⇨ 04/04
TERRACAN 2.5 D	D4BH	06/01 ⇨ 10/03
TERRACAN 2.5 TD	D4BH	12/01 ⇨ 12/06

LEXUS

Model	Part No.	Year Range
IS I 200	1G-FE	04/99 ⇨ 10/05

TOYOTA

Model	Part No.	Year Range
AURIS I 1.4 D-4D	1ND-TV	03/07 ⇨ 04/13
AURIS I 1.6	1ZR-FAE, 1NR-FE	03/07 ⇨ 09/12
AURIS II 1.4 D-4D	1ND-TV	10/12 ⇨
COROLLA 1.2	8NR-FTS	01/19 ⇨
COROLLA IX 1.6	1ZR-FE	11/06 ⇨ 07/07
COROLLA X 1.4 D-4D	1ND-TV	10/06 ⇨ 07/14
COROLLA X 1.6	1ZR-FAE	11/06 ⇨ 11/13
COROLLA X 1.6 Dual VVTi	1ZR-FE	01/07 ⇨ 07/14
COROLLA XI 1.4 D-4D	1ND-TV	06/13 ⇨
VERSO S 1.4 D4-D	1ND-TV	11/10 ⇨ 10/16
YARIS II 1.33 VVT-i	1NR-FE, 2KD-FTV	11/08 ⇨ 12/11
YARIS II 1.4 D-4D	1ND-TV	08/05 ⇨ 12/12
YARIS III 1.4 D	1ND-TV	09/11 ⇨

9.0637



3

REVOLUTION AND TIMING (CKP AND CMP) SENSORS

Adatt./Suitable:

DAIHATSU
19300-97202
19300-97202-000
DENSO
029600-0630
029600-0960
TOYOTA
90919-05025



L	L1	ohm	GND_OUT
---	32	1200	

DAIHATSU

Model	Part No.	Year Range
CUORE V 1.0 DVVT	EJ-VE	10/00 ⇨ 02/03
CUORE VI 1.0	EJ-VE	05/03 ⇨
MOVE 1.0 i	EJ-DE	10/98 ⇨ 09/02
TREVIS 1.0	EJ-VE	06/06 ⇨
YRV 1.0	EJ-VE	02/01 ⇨

TOYOTA

Model	Part No.	Year Range
HIACE IV 2.5 D-4D	2KD-FTV, 2KD-FTV	11/01 ⇨
HIACE IV 2.5 D-4D 4WD	2KD-FTV	08/04 ⇨
HIACE IV 3.0 D	1KD-FTV	05/10 ⇨
HILUX VII 2.5 D-4D	2KD-FTV	08/05 ⇨ 05/15
HILUX VII 2.5 D-4D 4WD	2KD-FTV, 2KD-FTV	08/05 ⇨
HILUX VII 2.5 D-4D 4WD	2KD-FTV, 1KD-FTV	11/04 ⇨
HILUX VII 3.0 D	1KD-FTV, 1KD-FTV	11/04 ⇨
HILUX VII 3.0 D 4WD	1KD-FTV, 1KD-FTV	02/05 ⇨
HILUX VII 3.0 D-4D 4WD	1KD-FTV, BYT	08/05 ⇨ 05/15
PICNIC I 2.0	3S-FE	01/01 ⇨ 12/01
PICNIC I 2.0 16V	3S-FE	08/96 ⇨ 09/00

9.0640



3

REVOLUTION AND TIMING (CKP AND CMP) SENSORS

Adatt./Suitable:

AUDI
06H 906 433
SEAT
06H 906 433
SKODA
06H 906 433
VW
06H 906 433

MARKET DIFFUSION: MEDIUM



L	L1	ohm	GND_OUT
---	33,3	770	

AUDI

Model	Part No.	Year Range
A3 II 1.8 TFSI	BYT, AXX	11/06 ⇨ 05/13
A3 II 1.8 TFSI quattro	CDAA	07/08 ⇨ 08/12
A3 II 2.0 TFSI	AXX, AXX	09/04 ⇨ 05/13
A3 II 2.0 TFSI quattro	AXX, BYT	09/04 ⇨ 08/12
A3 II SPORTBACK 1.8 TFSI	BYT, AXX	11/06 ⇨ 03/13
A3 II SPORTBACK 1.8 TFSI quattro	CDAA	07/08 ⇨ 03/13
A3 II SPORTBACK 2.0 TFSI	AXX, AXX	09/04 ⇨ 03/13
A3 II SPORTBACK 2.0 TFSI quattro	AXX, CABA	09/04 ⇨ 03/13
A4 IV 1.8 TFSI	CABA, CAEA	11/07 ⇨ 12/15
A4 IV 1.8 TFSI quattro	CDHB	09/08 ⇨ 03/12
A4 IV 2.0 TFSI	CAEA, CAEB	06/08 ⇨ 12/15
A4 IV 2.0 TFSI quattro	CAEB, CDNC	06/08 ⇨ 12/15
A4 IV ALLROAD 2.0 TFSI quattro	CDNC, CABD	04/09 ⇨ 05/16
A5 I 1.8 TFSI	CABD, CAHB	10/07 ⇨ 01/17
A5 I 2.0 TDI	CAHB, CAEA	08/08 ⇨ 01/17
A5 I 2.0 TFSI	CAEA, CAEB	06/08 ⇨ 06/14
A5 I 2.0 TFSI quattro	CAEB, CAEB	06/08 ⇨ 01/17
Q3 2.0 TFSI	CCTA	10/13 ⇨
Q3 2.0 TFSI [ExtraEU]	CCTA	09/14 ⇨ 10/18
Q5 I 2.0 TFSI quattro	CAEB, BYT	11/08 ⇨
Q5 I 2.0 TFSI quattro [CHN]	CADA	09/09 ⇨
TT II 1.8 TFSI	CDAA	06/08 ⇨ 06/14
TT II 2.0 TFSI	CCTA	08/06 ⇨ 06/10
TT II 2.0 TFSI quattro	CCZA	06/08 ⇨ 06/10

SEAT

Model	Part No.	Year Range
ALHAMBRA III 1.8 TSI	CDAA	11/12 ⇨
ALHAMBRA III 2.0 TSI	CCZA	11/10 ⇨
ALTEA 1.8 TFSI	BYT, BYT	01/07 ⇨
ALTEA 2.0 TFSI [ExtraEU]	CCZB	05/09 ⇨
ALTEA XL 1.8 TFSI	BYT, CDHA	01/07 ⇨
ALTEA XL 2.0 TFSI 4x4	CCZB	05/09 ⇨
EXEO 1.8 TSI	CDHA, BZB	05/10 ⇨
LEON II 1.8 TSI	BZB, BYT	06/07 ⇨ 12/12
TOLEDO III 1.8 TFSI	BYT, BYJ	01/07 ⇨ 05/09

SKODA

Model	Part No.	Year Range
OCTAVIA II 1.4 TSI	CAXA	11/08 ⇨ 06/13
OCTAVIA II 1.8 [CHN]	BYJ, BZB	04/07 ⇨
OCTAVIA II 1.8 TSI	BZB, CDAA	06/07 ⇨ 06/13
OCTAVIA II 1.8 TSI 4x4	CDAA, BWA	11/08 ⇨ 02/13
OCTAVIA II 2.0 [CHN]	CGMA	07/10 ⇨
OCTAVIA II 2.0 4x4	CCZA	11/08 ⇨
OCTAVIA II 2.0 RS	BWA, BZB	10/05 ⇨ 02/13
SUPERB II 1.8 [CHN]	CEAA	04/09 ⇨
SUPERB II 1.8 TSI	BZB, CDAA	03/08 ⇨ 05/15
SUPERB II 1.8 TSI 4x4	CDAA, CDAA	11/08 ⇨ 05/15
SUPERB II 2.0 [CHN]	CGMA	04/09 ⇨
SUPERB II 2.0 TSI	CCZA	05/10 ⇨ 05/15

SKODA			
YETI 1.8	CDAB	02/11 →	
YETI 1.8 TSI 4x4	CDA, CBFA	05/09 →	12/17
VW			
AMAROK 2.0 TSI	CFPA	12/10 →	
BEETLE 2.0 TSI	CBFA, CDA	04/11 →	07/16
CC 1.8 TSI	CDA, CBFA	11/11 →	12/16
CC 2.0 TSI	CBFA, BPA	11/11 →	
EOS 2.0 TFSI	BPA, BWA	03/06 →	08/15
EOS 2.0 TSI	CCZB	11/09 →	08/15
GOLF V 2.0	BWA, CBFA	06/07 →	07/09
GOLF VI 1.8 TSI	CDA	06/09 →	01/11
GOLF VI 2.0 GTI	CBFA, CBFA	04/09 →	05/16
GOLF VI 2.0 TFSI GTi	CBFA, BWA	05/11 →	
GOLF VI 2.0 TSI	CCZA	07/09 →	07/13
GOLF 2.0 GTI	CCZB	02/09 →	11/12
JETTA V 2.0 TFSI	BWA, CBFA	10/05 →	10/10
JETTA VI 2.0 TSI	CBFA, BZB	12/10 →	
PASSAT V 1.8 TSI	BZB, AXX	05/07 →	12/14
PASSAT V 2.0 FSI	AXX, CAWB	07/05 →	11/10
PASSAT V 2.0 TSI	CCZB	11/10 →	12/15
PASSAT V 2.0 TSI 4motion	CCZB	01/12 →	12/14
PASSAT CC 1.8 TSI	BZB, CAWB	06/08 →	01/12
PASSAT CC 2.0 TSI	CAWB, BZB	06/08 →	01/12
PASSAT 1.8 TFSI	CDA	08/10 →	12/14
PASSAT 2.0 TFSI	CCZB	11/10 →	12/14
SCIROCCO III 2.0 TSI	CAWB, CAWA	05/08 →	11/17
SCIROCCO 2.0 TFSI	CCZB	11/09 →	05/14
SHARAN II 1.8 TSI	CDA	11/11 →	
SHARAN II 2.0 TSI	CCZA	12/10 →	
TIGUAN I 1.8 [CHN]	CEAA	12/09 →	
TIGUAN I 2.0 [CHN]	CGMA	12/09 →	
TIGUAN I 2.0 TFSI	CCTB	05/08 →	
TIGUAN I 2.0 TFSI 4motion	CAWA, CCZB	09/07 →	
TIGUAN I 2.0 TSI 4motion	CCZB, OM660.950	05/11 →	

9.0645



REVOLUTION AND TIMING (CKP AND CMP) SENSORS

Adatt./Suitable:

BOSCH
0 986 280 441

DACIA
82 00 885 209

FIAT
6000616717

GENERAL MOTORS
95 517 836

INFINITI
23750-00Q0L

MERCEDES-BENZ
A 607 905 03 00

NISSAN
23731-5X20A
23731-BC42B
23750-00Q0L

OPEL
44 07 993
95517836

RENAULT
82 00 885 209

SUZUKI
33220-80K00
33220-80K00-000

VAUXHALL
95517836

MARKET DIFFUSION: HIGH



L	L1	ohm	GND_OUT
---	47,2	850	

DACIA			
DOKKER 1.5 dCi	K9K612, K9K612	11/12 →	
DOKKER 1.5 dCi [ExtraEU]	K9K830	11/12 →	
DUSTER 1.5 dCi	K9K612, K9K656	04/10 →	
DUSTER 1.5 dCi 110	K9K656, K9K658	10/17 →	
DUSTER 1.5 dCi 110 4x4	K9K658	10/17 →	
DUSTER 1.5 dCi 4x4	K9K658, --	06/10 →	
DUSTER 1.5 dCi 90	K9K656	10/17 →	
LODGY 1.5 dCi	--, K9K792	03/12 →	
LODGY 1.5 dCi [ExtraEU]	K9K830	11/12 →	
LOGAN I 1.5 dCi	K9K792, K9K612	01/06 →	
LOGAN II 1.5 dCi	K9K612, K9K612	10/12 →	
LOGAN II MCV 1.5 dCi	K9K612, K9K792	02/13 →	
SANDERO I 1.5 dCi	K9K792, K9K612	11/08 →	
SANDERO II 1.5 dCi	K9K612, K9K	10/12 →	

FIAT			
TALENTO 1.6 D	R9M408	06/16 →	

INFINITI			
Q30 1.5 D	K9K480	11/15 →	

MERCEDES-BENZ			
CITAN 108 CDI	OM607.951	11/12 →	
CITAN 109 CDI	OM607.951	11/12 →	
CITAN 111 CDI	OM607.951	06/13 →	
CITAN 112	M200.711	06/13 →	
CLASSE A III A 160 CDI / d	OM607.951	06/13 →	
CLASSE A III A 180 CDI / d	OM607.951	06/12 →	
CLASSE B II B 160 CDI / d	OM607.951	05/13 →	
CLASSE B II B 180 CDI / d	OM607.951	02/13 →	
CLASSE CLA CLA 180 CDI / d	OM607.951	10/13 →	
CLASSE CLA CLA 180 d	OM607.951	07/15 →	
CLASSE GLA GLA 180 CDI / d	OM607.951	07/14 →	
VITO III 109 CDI	OM622.951	10/14 →	
VITO III 109 CDI / 109 BlueTEC	OM622.951	10/14 →	
VITO III 111 CDI	OM622.951	10/14 →	
VITO III 111 CDI / 111 BlueTEC	OM622.951	10/14 →	

NISSAN			
ALMERA III 1.5 dCi	K9K	08/12 →	
CUBE 1.5 dCi	K9K, K9K410	03/10 →	
JUKE 1.5 dCi	K9K410, K9K276	06/10 →	
MICRA III 1.5 dCi	K9K276	06/05 →	06/10

NISSAN			
MICRA IV 1.5 dCi	K9K	05/10 →	
MICRA V 1.5 DCI	K9K	12/16 →	
NAVARA II 3.0 dCi	V9X	03/10 →	
NAVARA II 3.0 dCi 4WD	V9X	02/10 →	
NOTE I 1.5 dCi	K9K276, K9K608	03/06 →	06/12
NOTE II 1.5 dCi	K9K608, K9K	06/13 →	
NV200 / EVALIA 1.5 dci	K9K, K9K	07/10 →	
NV200 1.5 dci	K9K, K9K732	02/10 →	
NV300 1.6 dci 120	R9M413	09/16 →	
NV300 1.6 dci 125	R9M452	09/16 →	
NV300 1.6 dci 145	R9M452	09/16 →	
NV300 1.6 dci 95	R9M413	09/16 →	
PATHFINDER III 3.0 dCi	V9X	05/10 →	
QASHQAI 1.5 dCi	K9K	08/08 →	10/11
QASHQAI I 1.5 dCi	K9K732, K9K636	02/07 →	12/13
QASHQAI II 1.5 dCi	K9K636, K9K	11/13 →	
QASHQAI II 1.6 dCi	R9M	11/13 →	
QASHQAI II 1.6 dCi ALL MODE 4x4-i	R9M	11/13 →	
TIIDA I 1.5 dCi	K9K, R9M408	01/07 →	12/12
X-TRAIL III 1.6 dCi	R9M	04/14 →	
X-TRAIL III 1.6 dCi ALL MODE 4x4-i	R9M	04/14 →	

OPEL			
VIVARO B 1.6 CDTI	R9M408, K9K628	06/14 →	

RENAULT			
CAPTUR 1.5 dCi	K9K628, K9K608	06/13 →	
CAPTUR 1.5 dCi 110	K9K646	01/15 →	
CAPTUR 1.5 dCi 90	K9K608, K9K612	06/13 →	
CLIO 1.5 dCi	K9K612, K9K764	11/12 →	
CLIO III 1.5 dCi	K9K764, K9K628	06/05 →	
CLIO IV 1.5 dCi	K9K628, K9K612	11/12 →	
CLIO IV 1.5 dCi 110	K9K646	06/16 →	
CLIO IV 1.5 dCi 75	K9K612, K9K608	11/12 →	
CLIO IV 1.5 dCi 90	K9K608, K9K612	11/12 →	
DOKKER 1.5 dCi	K9K612, K9K656	12/13 →	
DUSTER 1.5 dCi [ExtraEU]	K9K796	06/11 →	
DUSTER 1.5 dCi 4x4	K9K884	06/11 →	
ESPACE V 1.6 dCi 130	R9M409	06/15 →	
ESPACE V 1.6 dCi 160	R9M452	06/15 →	
FLUENCE 1.5 dCi	K9K656, K9K636	02/10 →	
FLUENCE 1.6 dCi	R9M402	07/14 →	
GRAND SCÉNIC III 1.5 dCi	K9K636, R9M402	02/09 →	
GRAND SCÉNIC III 1.6 dCi	R9M402, F9Q870	04/11 →	
GRAND SCÉNIC III 1.9 dCi	F9Q870, K9K646	02/09 →	
GRAND SCÉNIC IV 1.5 dCi 110	K9K646, K9K646	09/16 →	
GRAND SCÉNIC IV 1.5 dCi 110 Hybrid Assist	K9K646, K9K646	04/17 →	
GRAND SCÉNIC IV 1.6 dCi 130	R9M409	09/16 →	
GRAND SCÉNIC IV 1.6 dCi 160	R9M452	09/16 →	
KADJAR 1.5 dCi 110	K9K646, R9M410	06/15 →	
KADJAR 1.6 dCi 130	R9M410, R9M414	06/15 →	
KADJAR 1.6 dCi 130 4x4	R9M414, K9K608	06/15 →	
KANGOO II 1.5 dCi	K9K608, K9K636	02/08 →	
KANGOO II 1.5 dCi 110	K9K636, K9K608	09/10 →	
KANGOO II 1.5 dCi 75	K9K608, K9K800	09/10 →	
KANGOO II 1.5 dCi 85	K9K800, K9K608	02/08 →	
KANGOO II 1.5 dCi 90	K9K608, K9K780	06/09 →	
KOLEOS 1.6 dCi 130	R9M409	08/16 →	
LAGUNA III 1.5 dCi	K9K780, V9X791	10/07 →	
LAGUNA III 3.0 dCi	V9X791, K9K782	09/08 →	12/15
LATITUDE 1.5 dCi	K9K782, K9K830	07/10 →	
LATITUDE 3.0 dCi 240	V9X891	02/11 →	
LODGY 1.5 dCi [ExtraEU]	K9K830, K9K612	11/14 →	
LOGAN 1.5 dCi	K9K612, K9K612	04/07 →	
LOGAN EXPRESS 1.5 dCi	K9K792	04/07 →	
LOGAN/STEPWAY 1.5 dCi	K9K612, K9K636	12/13 →	
MEGANE II 1.5 dCi	K9K724, K9K636	08/03 →	07/09
MEGANE III 1.5 dCi	K9K636, R9M402	11/08 →	
MEGANE III 1.6 dCi	R9M402, F9Q870	04/11 →	
MEGANE III 1.9 dCi	F9Q870, K9K834	11/08 →	
MEGANE 1.5 dCi	K9K636, K9K636	01/09 →	08/15
MEGANE IV 1.5 dCi 110	K9K646, K9K656	11/15 →	
MEGANE IV 1.5 dCi 90	K9K656, R9M409	11/15 →	
MEGANE IV 1.6 dCi 130	R9M409, K9K760	11/15 →	
MEGANE IV 1.6 dCi 165	R9M452	11/15 →	
MEGANE III HATCHBACK VAN 1.5 dCi	K9K834, K9K646	11/08 →	08/15
MEGANE CC 1.5 dCi	K9K636, F9Q870	06/10 →	
MEGANE CC 1.6 dCi	R9M402	04/11 →	
MEGANE CC 1.9 dCi	F9Q870, K9K724	06/10 →	
MODUS / GRAND MODUS 1.5 dCi	K9K760, K9K612	12/04 →	
MODUS / GRAND MODUS 1.5 dCi 75	K9K770	10/10 →	
MODUS / GRAND MODUS 1.5 dCi 90	K9K770	10/10 →	
SANDERO I 1.5 dCi	K9K792	04/07 →	
SANDERO II 1.5 dCi	K9K612, K9K636	12/13 →	

9.0641



REVOLUTION AND TIMING (CKP AND CMP) SENSORS

Adatt./Suitable:

ELECTRICFIL
900.9.0526.02

SMART
A 451 542 06 18
Q 0015150V01000000



L	L1	ohm	GND_OUT
---	34,8	790	

SMART			
FORTWO II 0.8 Cdi	OM660.950, K9K612	01/07 →	
FORTWO II 1.0	M132.910	01/07 →	
FORTWO II 1.0 Brabus	M132.930	01/08 →	
FORTWO II 1.0 Turbo	M132.930	01/07 →	
FORTWO II 1.0 Turbo Brabus	M132.930	07/10 →	
ROADSTER 0.7	M160.921	04/03 →	11/05
ROADSTER 0.7 Brabus	M160.923	12/03 →	11/05

RENAULT			
SCÉNIC III 1.5 dCi	K9K636, R9M402	02/09 →	
SCÉNIC III 1.6 dCi	R9M402, F9Q870	04/11 →	
SCÉNIC III 1.9 dCi	F9Q870, K9K646	02/09 →	
SCÉNIC IV 1.5 dCi 110	K9K646, K9K646	09/16 →	
SCÉNIC IV 1.5 dCi 110 Hybrid Assist	K9K646, K9K646	04/17 →	
SCÉNIC IV 1.5 dCi 95	K9K646, K9K646	09/16 →	
SCÉNIC IV 1.6 dCi 130	R9M409	09/16 →	
SCÉNIC IV 1.6 dCi 160	R9M452	09/16 →	
TALISMAN 1.5 dCi 110	K9K646, R9M452	11/15 →	
TALISMAN 1.6 dCi 130	R9M409	11/15 →	
TALISMAN 1.6 dCi 160	R9M452, K9K612	06/15 →	
THALIA I 1.5 dCi	K9K718	01/01 →	
THALIA II 1.5 dCi	K9K612, R9M413	09/08 →	
THALIA III 1.5 dCi	K9K612	12/13 →	
TRAFIC III 1.6 dCi 115	R9M408	05/14 →	
TRAFIC III 1.6 dCi 120	R9M413, K9K718	05/14 →	
TRAFIC III 1.6 dCi 125	R9M452	07/15 →	
TRAFIC III 1.6 dCi 140	R9M450	05/14 →	
TRAFIC III 1.6 dCi 145	R9M452	07/15 →	
TRAFIC III 1.6 dCi 90	R9M408	05/14 →	
TRAFIC III 1.6 dCi 95	R9M413	07/15 →	
TWINGO 1.5 dCi	K9K820	10/10 →	09/14
TWINGO II 1.5 dCi	K9K718, R9M408	03/07 →	
TWINGO II 1.5 dCi 75	K9K820	10/10 →	
TWINGO II 1.5 dCi 90	K9K820	10/10 →	

VAUXHALL			
VIVARO 1.6 CDti	R9M408, K4M642	05/14 →	

9.0646



3

REVOLUTION AND TIMING (CKP AND CMP) SENSORS

Adatt./Suitable:

DACIA
24 01 164 82R
82 00 746 592

RENAULT
24 01 164 82R
82 00 746 592



L	L1	ohm	
---	47,2	300	

DACIA			
DUSTER 1.6	K4M642, K4M490	04/10 →	
DUSTER 1.6 16V	K4M490, K4M616	04/10 →	
DUSTER 1.6 16V LPG	K4M616, H4B400	04/11 →	
LOGAN II 1.6 16V	K4M842	01/13 →	
LOGAN II TCe 90	H4B400, H4B400	10/12 →	
LOGAN II MCV TCe 90	H4B400, H4B400	02/13 →	
SANDERO II 1.6 16V	K4M842	01/13 →	
SANDERO II TCe 90	H4B400, K4M866	10/12 →	

RENAULT			
CLIO III 1.6 16V	K4M862	11/08 →	
CLIO III 1.6 16V GT	K4M862	06/09 →	
GRAND SCÉNIC III 1.4 16V	H4J700	02/09 →	
GRAND SCÉNIC III 1.6 16V	K4M858	02/09 →	
GRAND SCÉNIC III 1.6 16V Bifuel	K4M866, K4M858	02/09 →	
GRAND SCÉNIC III 1.6 E85	K4M866	02/09 →	
MEGANE 1.6 Bifuel	K4M858	05/09 →	08/15
MEGANE 1.6 VVT	K4M858	01/13 →	08/15
MEGANE III 1.4 TCe	H4J700	04/09 →	
MEGANE III 1.6 16V	K4M858, K4M842	11/08 →	
MEGANE III 1.6 16V Bifuel	K4M866	11/08 →	
MEGANE III 1.6 Bifuel	K4M866	11/08 →	
MEGANE CC 1.4 TCe	H4J700	06/10 →	

RENAULT			
MEGANE CC 1.6 16V	K4M858	06/10 →	
MEGANE CC 1.6 16V Hi-Flex	K4M866	06/10 →	
SANDERO II 1.6 16V	K4M842, K4M866	04/14 →	
SCÉNIC III 1.4 16V	H4J700	02/09 →	
SCÉNIC III 1.6 16V	K4M858	02/09 →	
SCÉNIC III 1.6 16V Bifuel	K4M866, 4HN(DW12MTED4)	02/09 →	
SCÉNIC III 1.6 E85	K4M866	02/09 →	
THALIA II 0.9 TCe	H4B400	11/12 →	06/14
TWINGO II 1.6 RS	K4M854	05/08 →	
WIND 1.6	K4M854	07/10 →	

9.0649



3

REVOLUTION AND TIMING (CKP AND CMP) SENSORS

Adatt./Suitable:

CITROËN
2529 TN

MITSUBISHI
8651A067
8651A239

NISSAN
31935-1XF00
31935-8E003
31935-8E005
31935-8E007
31935-X420A

PEUGEOT
2529 TN

RENAULT
31 93 51X F00

MARKET DIFFUSION: MEDIUM



L	L1		
---	36,5	Hall Effect	

CITROËN			
C4 AIRCROSS 1.6 HDi 115	9HL(DV6C)	04/12 →	
C4 AIRCROSS 1.6 HDi 115 AWC	9HL(DV6C)	05/12 →	
C4 AIRCROSS 1.8 HDi 150	4N13	04/12 →	
C4 AIRCROSS 1.8 HDi 150 AWC	4N13	04/12 →	
C4 AIRCROSS 2.0	4B11	04/12 →	
C4 AIRCROSS 2.0 AWC	4B11	04/12 →	
C-CROSSER 2.0	4B11	11/10 →	
C-CROSSER 2.0 Trazione integrale	4B11	11/10 →	
C-CROSSER 2.2 HDi	4HN(DW12MTED4), 9HD(DV6C)	02/07 →	
C-CROSSER 2.4 16V	SFZ(4B12-MMC)	08/08 →	
C-CROSSER ENTERPRISE 2.2 HDi	4HN(DW12MTED4)	01/09 →	
C-CROSSER ENTERPRISE 2.4 16V	4B12	01/09 →	
DS4 1.6 HDi 110	9HR(DV6C)	04/11 →	07/15
DS4 1.6 HDi 115	9HD(DV6C), 4B11	08/12 →	07/15

MITSUBISHI			
ASX 1.8	4B10	02/10 →	
ASX 1.8 4WD	4B10	02/10 →	
ASX 2.0 i	4B11	06/10 →	
ASX 2.0 i 4WD	4B11, 4B10	01/10 →	
LANCER IX 1.8	4B10, 4B11	02/08 →	
LANCER IX 1.8 Bifuel	4B10	01/10 →	
LANCER IX 1.8 Flex	4B10	03/09 →	
LANCER IX 1.8 Flexfuel	4B10	03/09 →	
LANCER IX 1.8 i	--	10/07 →	
LANCER IX 1.8 MIVEC	4B10	03/09 →	
LANCER IX 2.0	4B11, 4B11	04/08 →	
LANCER IX 2.0 i	4B11, 3A92	01/09 →	
MIRAGE VI 1.0	--	05/12 →	

MITSUBISHI			
MIRAGE VI 1.2	3A92, 4B11	01/12 →	
OUTLANDER II 2.0	4B11, 4B11	11/06 →	11/12
OUTLANDER II 2.0 4WD	4B11	11/06 →	11/12
OUTLANDER II 2.4	4B12	11/06 →	11/12
OUTLANDER II 2.4 4WD	4B12	09/07 →	11/12
OUTLANDER II 2.4 Flex 4WD	4B12	09/07 →	11/12
OUTLANDER III 2.0	4B11, 4B11	08/12 →	
OUTLANDER III 2.0 4WD	4B11, HR15DE	08/12 →	
OUTLANDER III 2.4	4B12	08/12 →	
OUTLANDER III 2.4 4WD	4B12	10/12 →	
SPACE STAR 1.2	3A92	05/12 →	

NISSAN			
ALMERA III 1.2 i	HR12DE	09/11 →	
ALMERA III 1.5 i	HR15DE, HR16DE	01/12 →	
CUBE 1.6 16V	HR16DE	03/10 →	
JUKE 1.5	HR15DE	10/13 →	
JUKE 1.6	HR16DE, HR12DR	06/10 →	
JUKE 1.6 DIG-T	MR16DDT	06/10 →	
JUKE 1.6 DIG-T 4x4	MR16DDT	06/10 →	
JUKE 1.6 DIG-T NISMO	MR16DDT	03/13 →	07/14
JUKE 1.6 DIG-T NISMO 4x4	MR16DDT	02/13 →	07/14
JUKE 1.6 DIG-T NISMO RS	MR16DDT	08/14 →	
JUKE 1.6 DIG-T NISMO RS 4x4	MR16DDT	08/14 →	
MICRA IV 1.2	HR12DR, VQ35DE	05/10 →	
MICRA IV 1.2 4WD	HR12DE	05/10 →	
MICRA IV 1.2 DIG-S	HR12DDR	04/11 →	
MICRA C+C 1.6 160 SR	HR16DE	08/05 →	
MURANO III 3.5	VQ35DE, VQ35DE	11/07 →	09/14
MURANO III 3.5 4x4	VQ35DE, VQ35DE	11/07 →	09/14
MURANO III 3.5 V6 ALL MODE 4x4-i	VQ35DE, HR16DE	10/14 →	
NOTE I 1.6	HR16DE	03/06 →	06/12
NOTE II 1.2	HR12DR	06/13 →	
NOTE II 1.2 DIG-S	HR12DDR	06/13 →	
NOTE II 1.6 NISMO S	HR16DE	06/13 →	
NV200 / EVALIA 1.5	HR15DE	01/12 →	
NV200 / EVALIA 2.0	MR20DE	07/10 →	
PATHFINDER IV 2.5 Hybrid	QR25DER	10/13 →	
PATHFINDER IV 2.5 Hybrid 4WD	QR25DER	10/13 →	
PATHFINDER IV 3.5 4WD	VQ35DE	09/12 →	
QASHQAI I 1.6	HR16DE, HR16DE	02/07 →	12/13
QASHQAI I 2.0	MR20DE	02/07 →	12/13
QASHQAI I 2.0 Trazione integrale	MR20DE	02/07 →	12/13
QASHQAI II 1.2 DIG-T	HR12DDT	11/13 →	
QASHQAI II 1.6 dCi	R9M	11/13 →	
QASHQAI II 1.6 dCi ALL MODE 4x4-i	R9M	11/13 →	
QASHQAI II 2.0	MR20DD	06/14 →	
SENTRA VII 1.6	HR16DE	08/14 →	
SENTRA VII 1.6 DIG-T	MR16DDT	07/12 →	
SENTRA VII 1.6 i	HR16DE	07/12 →	
SENTRA VII 1.8	MRA8DE	08/12 →	
SENTRA VII 1.8 [TWN]	MRA8DE	08/13 →	
SENTRA VII 1.8 i	MRA8DE	07/12 →	
SENTRA VII 2.0	MR20DE	09/12 →	
SUNNY IV 1.5	HR15DE	01/11 →	
SYLPHY III 1.6	HR16DE	08/12 →	
SYLPHY III 1.6 DIG-T	MR16DDT	07/12 →	
SYLPHY III 1.8	MRA8DE	08/12 →	
TEANA I 3.5	VQ35DE	10/03 →	06/08
TEANA II 2.5	VQ25DE	07/08 →	09/13
TEANA II 3.5	VQ35DE	07/08 →	09/13
TEANA III 2.0	MR20DE	09/13 →	
TEANA III 2.5	QR25DE	09/13 →	
TEANA III 3.5	VQ35DE	01/14 →	
TIIDA I 1.6	HR16DE	09/07 →	12/12
TIIDA II 1.6	HR16DE, MR20DE	08/11 →	
TIIDA II 1.6 [RUS]	HR16DE	01/15 →	
TIIDA II 1.6 DIG-T	MR16DDT	08/11 →	
TIIDA II 1.8	MRA8DE	08/12 →	
X-TRAIL II 2.0	MR20DE, MR20DE	06/07 →	02/14
X-TRAIL II 2.0 dCi FWD	M9R	06/07 →	11/13
X-TRAIL II 2.0 FWD	MR20DE, QR25DE	03/07 →	11/13
X-TRAIL II 2.5	QR25DE, SFY(4B12-MMC)	09/07 →	07/14
X-TRAIL II 2.5 4x4	QR25DE	06/07 →	11/13
X-TRAIL III 1.6 dCi	R9M	04/14 →	
X-TRAIL III 1.6 dCi ALL MODE 4x4-i	R9M	04/14 →	
X-TRAIL III 2.0	MR20DD	09/14 →	
X-TRAIL III 2.5	QR25DE	12/13 →	
X-TRAIL III 2.5 ALL MODE 4x4-i	QR25DE	12/13 →	

PEUGEOT			
4007 2.4 16V	SFY(4B12-MMC), --	01/08 →	
4008 1.6	--, M4R711	05/12 →	
4008 1.6 HDi AWC	9HD(DV6C)	05/12 →	
4008 1.8 HDi AWC	6RZ(4N13)	05/12 →	

PEUGEOT			
4008 2.0	4B11	05/13 →	
4008 2.0 AWC	4B11	05/12 →	
RENAULT			
FLUENCE 1.6	H4M729	01/13 →	
GRAND SCÉNIC III 2.0 16V	M4R711	02/09 →	
KOLEOS 2.5	2TR701	09/08 →	
KOLEOS 2.5 4x4	2TR701	09/08 →	
MEGANE III 2.0 CVT	M4R711, D5244T13	02/09 →	
MEGANE CC 2.0 CVT	M4R711, M4R711	06/10 →	
SCÉNIC III 2.0 16V	M4R711	01/09 →	

VOLVO			
V60 I D4 AWD	D5244T12, D5244T10	05/12 →	
V60 I D5	D5244T10, D5244T10	07/10 → 12/15	
V60 I D5 AWD	D5244T10, D5244T4	07/10 → 12/15	
V60 I D6 Hybrid AWD	D97PHEV	03/15 →	
V70 2.0 D4/D4 DRIVE	D5204T3	09/13 →	
V70 II 2.4 CDI	D5244T6	07/05 → 12/08	
V70 II 2.4 D	D5244T7	04/05 → 12/08	
V70 II 2.4 D5	D5244T4, D5244T4	04/05 → 12/08	
V70 II 2.4 D5 AWD	D5244T4, D5244T14	07/02 → 08/07	
V70 III 2.0 D3 DRIVE	D5204T7	09/13 →	
V70 III 2.4 D	D5244T14, D5244T11	04/07 → 12/10	
V70 III 2.4 D4 AWD	D5244T17	09/13 →	
V70 III 2.4 D5	D5244T11, D5204T2	09/13 →	
V70 III D3	D5204T7	10/07 → 12/15	
V70 III D3 / D4	D5204T2, D5244T12	03/10 → 12/15	
V70 III D4 AWD	D5244T12, D5244T10	10/07 →	
V70 III D5	D5244T10, D5244T10	04/07 →	
V70 III D5 AWD	D5244T10, D5244T16	04/07 →	
XC60 I 2.4 D	D5244T14	04/09 → 12/10	
XC60 I 2.4 D / D3 / D4 AWD	D5244T16, D5204T2	05/08 → 02/17	
XC60 I 2.4 D AWD	D5244T14	06/09 → 12/10	
XC60 I D3	D5204T7	04/12 → 12/15	
XC60 I D3 / D4	D5204T2, D5244T12	03/10 → 12/14	
XC60 I D4 AWD	D5244T12, D5244T10	10/13 → 02/17	
XC60 I D5	D5244T11	06/11 → 02/17	
XC60 I D5 AWD	D5244T10, D5244T16	05/08 → 02/17	
XC70 I 2.4 D5 AWD	D5244T4	12/05 → 08/07	
XC70 II 2.4 D	D5244T14	06/09 → 12/10	
XC70 II 2.4 D / D4 AWD	D5244T16, D5204T2	08/07 →	
XC70 II D3	D5204T2, D5244T10	04/10 → 12/15	
XC70 II D3 AWD	D5204T2	08/11 →	
XC70 II D4 AWD	D5244T12	10/13 →	
XC70 II D5 AWD	D5244T10, D5244T18	04/07 →	
XC90 I D3 / D5	D5244T5	04/09 → 12/14	
XC90 I D5 AWD	D5244T18, EXL	10/02 → 12/14	

CHRYSLER			
300C I 3.0 V6 CRD	EXL	11/10 → 11/12	
300C II 3.0 CRD	EXL	09/05 → 12/10	
JEEP			
COMMANDER 3.0 CRD 4x4	EXL, EXL	09/05 → 12/10	
GRAND CHEROKEE 3.0 CRD	EXL	06/05 → 12/10	
GRAND CHEROKEE 3.0 CRD 4x4	EXL, M271.820	06/05 → 12/10	

MERCEDES-BENZ			
CLASSE C II C 230	M272.920	01/05 → 05/08	
CLASSE C II C 280	M272.940	01/05 → 08/07	
CLASSE C II C 280 4-matic	M272.941	01/05 → 08/07	
CLASSE C II C 320	M112.946	09/02 → 05/08	
CLASSE C II C 320 CDI	OM642.910	01/05 → 08/07	
CLASSE C II C 350	M272.960	01/05 → 05/08	
CLASSE C II C 350 4-matic	M272.970	01/05 → 08/07	
CLASSE C III C 180 CGI	M271.820, M271.820	11/09 → 08/14	
CLASSE C III C 180 Kompressor	M271.820, M271.820	08/07 → 08/14	
CLASSE C III C 200	M271.820	05/11 → 01/14	
CLASSE C III C 200 CGI	M271.820, M271.820	01/07 →	
CLASSE C III C 200 Kompressor	M271.820, OM642.830	01/07 → 08/14	
CLASSE C III C 230	M272.921	01/07 → 08/14	
CLASSE C III C 230 4-matic	M272.911	07/07 → 01/14	
CLASSE C III C 250	M272.921	01/07 →	
CLASSE C III C 250 4-matic	M272.911	07/07 →	
CLASSE C III C 250 CGI	M271.860	07/09 → 08/14	
CLASSE C III C 280	M272.947	01/07 → 08/14	
CLASSE C III C 280 4-matic	M272.948	07/07 → 01/14	
CLASSE C III C 300	M272.947	08/07 → 08/14	
CLASSE C III C 300 4-matic	M272.948	07/07 → 01/14	
CLASSE C III C 320 CDI	OM642.960	01/07 → 08/14	
CLASSE C III C 320 CDI 4-matic	OM642.961	07/07 → 01/14	
CLASSE C III C 350	M272.961	01/07 → 08/14	
CLASSE C III C 350 4-matic	M272.971	07/07 → 01/14	
CLASSE C III C 350 CDI	OM642.830, OM642.832	08/07 → 08/14	
CLASSE C III C 350 CDI 4-matic	OM642.832, --	08/07 → 08/14	
CLASSE C III C 350 CGI	M272.982	09/08 → 01/14	
CLASSE C III C 63 AMG	--, --	02/08 →	
CLASSE C III C 63 AMG DR 520	--, M156.982	07/10 → 01/14	
CLASSE C IV C 180 BlueTEC / d	OM626.951	05/14 →	
CLASSE C IV C 200 BlueTEC / d	OM626.951	05/14 →	
CLASSE CLC CLC 230	M272.920	05/08 → 06/11	
CLASSE CLC CLC 350	M272.960	05/08 → 06/11	
CLASSE CLC CLC250 [ExtraEU]	M272.920	06/09 → 06/11	
CLASSE CLK II 280	M272.940	01/05 → 05/09	
CLASSE CLK II 320 CDI	OM642.910	01/05 → 05/09	
CLASSE CLK II 350	M272.960	01/05 → 05/09	
CLASSE CLK II 500	M273.967	06/06 →	
CLASSE CLK II 550	M273.967	06/06 →	
CLASSE CLK II 63 AMG	M156.982, M272.964	04/06 → 05/09	
CLASSE CLK II CLK 280	M272.940	01/05 → 03/10	
CLASSE CLK II CLK 320 CDI	OM642.910	03/05 → 03/10	
CLASSE CLK II CLK 350	M272.960	01/05 → 03/10	
CLASSE CLK II CLK 63 AMG	M156.982	04/06 → 03/10	
CLASSE CLS I CLS 280	M272.943	07/08 → 12/10	
CLASSE CLS I CLS 300	M272.943	04/09 → 12/10	
CLASSE CLS I CLS 320 CDI	OM642.920	01/05 → 12/10	
CLASSE CLS I CLS 350	M272.964, M272.944	10/04 → 12/10	
CLASSE CLS I CLS 350 CDI	OM642.920	04/09 → 12/10	
CLASSE CLS I CLS 500	M273.960	04/06 → 12/10	
CLASSE CLS I CLS 550	M273.960	04/06 → 02/11	
CLASSE CLS I CLS 63 AMG	M156.983	04/06 → 12/10	
CLASSE E III 350 CGI	M272.985	05/06 → 07/09	
CLASSE E III E 230	M272.922	09/07 → 12/08	
CLASSE E III E 230 T	M272.922	05/07 → 07/09	
CLASSE E III E 250	M272.922	09/07 → 12/08	
CLASSE E III E 280	M272.943	03/05 → 12/08	
CLASSE E III E 280 4-matic	M272.944, OM642.920	03/05 → 12/08	
CLASSE E III E 280 CDI	OM642.920	03/05 → 12/08	
CLASSE E III E 280 CDI 4-matic	OM642.921	03/05 → 12/08	
CLASSE E III E 280 T	M272.943	03/05 → 07/09	
CLASSE E III E 280 T 4-matic	M272.944	03/05 → 07/09	
CLASSE E III E 280 T CDI	OM642.920	03/05 → 07/09	
CLASSE E III E 280 T CDI 4-matic	OM642.921	03/05 → 07/09	
CLASSE E III E 300	M272.943	03/05 → 12/08	
CLASSE E III E 300 BlueTEC	OM642.920	09/07 → 12/08	
CLASSE E III E 300 T 4-matic	M272.944	03/05 → 07/09	
CLASSE E III E 320 CDI	OM642.920	03/05 → 12/08	
CLASSE E III E 320 CDI 4-matic	OM642.921	03/05 → 12/08	
CLASSE E III E 320 T CDI	OM642.920, M272.972	03/05 → 07/09	
CLASSE E III E 320 T CDI 4-matic	OM642.921	03/05 → 07/09	

9.0651



3

REVOLUTION AND TIMING (CKP AND CMP) SENSORS

Adatt./Suitable:

BOSCH

0 232 103 063

VOLVO

21123875

865872-6

MARKET DIFFUSION: MEDIUM



L	L1		
---	24,2	Hall Effect	

VOLVO			
C30 D3	D5204T5	10/10 → 12/12	
C30 D4	D5204T	10/10 → 12/12	
C30 D5	D5244T13, D5244T13	10/06 → 12/12	
C70 II 2.4 D	D5244T9	03/07 → 06/13	
C70 II D3	D5204T5	10/10 → 06/13	
C70 II D4	D5204T	10/10 → 06/13	
C70 II D5	D5244T13, D5244T13	03/06 → 06/13	
S40 II 2.4 CDI	D5244T9	03/07 → 12/10	
S40 II 2.4 D5	D5244T13, D5244T5	03/06 → 12/10	
S40 II D3	D5204T5	10/10 → 12/12	
S40 II D4	D5204T	10/10 → 12/12	
S60 I 2.4 D	D5244T5, D5204T2	03/05 → 04/10	
S60 I 2.4 D5	D5244T4	03/05 → 04/10	
S60 II 2.4 D4 AWD	D5244T21	03/15 →	
S60 II D3	D5204T2, D5204T2	04/10 → 12/15	
S60 II D4	D5204T2, D5244T10	04/10 → 12/14	
S60 II D5	D5244T10, D5244T10	04/10 → 12/15	
S60 II D5 AWD	D5244T10, D5244T14	04/10 → 12/15	
S80 II 2.4 D	D5244T14, D5204T2	03/06 →	
S80 II D3	D5204T7	05/12 →	
S80 II D3 / D4	D5204T2, D5244T10	01/10 →	
S80 II D5	D5244T10, D5244T10	03/06 →	
S80 II D5 AWD	D5244T10, D5244T13	01/07 →	
V40 II 2.0 D3	D5204T6	09/13 → 12/15	
V40 II 2.0 D4	D5204T4	09/13 → 12/14	
V40 II D3	D5204T6	03/12 → 03/15	
V40 II D4	D5204T4	03/12 →	
V40 2.0 D3	D5204T6	09/13 → 12/15	
V40 2.0 D4	D5204T4	09/13 → 12/14	
V50 2.4 D5	D5244T13, D5244T11	03/06 → 12/10	
V50 2.4 Tdi	D5244T9	05/07 → 12/10	
V50 D3	D5204T5	10/10 → 12/12	
V50 D4	D5204T	10/10 → 12/12	
V60 I 2.0 D3	D5204T7	09/13 → 12/15	
V60 I 2.0 D4	D5204T3	09/13 → 12/15	
V60 I 2.4 D4 AWD	D5244T12	09/13 → 12/15	
V60 I 2.4 D5	D5244T11, D5244T11	04/11 → 12/15	
V60 I 2.4 D5 AWD	D5244T11, D5244T15	04/11 → 12/15	
V60 I 2.4 D5 Hybrid AWD	D87PHEV	03/15 →	
V60 I 2.4 Hybrid D6 AWD	D5244T15, D5204T2	06/12 → 12/15	
V60 I D3	D5204T7	05/12 → 12/15	
V60 I D3 / D4	D5204T2, D5244T12	07/10 → 12/14	

9.0654



3

REVOLUTION AND TIMING (CKP AND CMP) SENSORS

Adatt./Suitable:

CHRYSLER

5175763AA

68039478AC

K05175763AA

K05175763AB

K68039478AA

K68039478AC

JEEP

5175763AA

68039478AC

K05175763AA

K05175763AB

K68039478AA

K68039478AC

MERCEDES-BENZ

A 004 153 87 28

A 272 905 00 00

A 642 153 07 28

A 642 905 00 00

MOPAR PARTS

68039478AC

MARKET DIFFUSION: MEDIUM



L	L1		
---	39,9	Hall Effect	

CHRYSLER			
300C I 3.0 CRD	EXL	09/05 → 11/12	

MERCEDES-BENZ			
CLASSE E III E 350	M272.964	03/05 → 12/08	
CLASSE E III E 350 4-matic	M272.972, M271.820	08/04 → 12/08	
CLASSE E III E 350 CGI	M272.985	09/07 → 12/08	
CLASSE E III E 350 T	M272.964	03/05 → 07/09	
CLASSE E III E 350 T 4-matic	M272.972	03/05 → 07/09	
CLASSE E III E 420 CDI	OM629.910	01/06 → 12/08	
CLASSE E III E 500	M273.960	04/06 → 12/08	
CLASSE E III E 500 4-matic	M273.962	04/06 → 12/08	
CLASSE E III E 500 T	M273.960	04/06 → 07/09	
CLASSE E III E 500 T 4-matic	M273.962	04/06 → 07/09	
CLASSE E III E 550 4-matic	M273.962	04/06 → 12/08	
CLASSE E III E 550 T 4-matic	M273.962	04/06 → 07/09	
CLASSE E III E 63 AMG	M156.983	03/06 → 07/09	
CLASSE E IV E 200 CGI	M271.820, M272.952	08/09 →	
CLASSE E IV E 250	M272.923	01/10 →	
CLASSE E IV E 250 CGI	M271.860	01/09 →	
CLASSE E IV E 300	M272.952, OM642.850	01/09 →	
CLASSE E IV E 300 BlueTEC	OM642.852	03/11 →	
CLASSE E IV E 300 CDI	OM642.850, OM642.850	12/09 →	
CLASSE E IV E 300 CDI / BlueTEC	OM642.850, M272.961	11/09 →	
CLASSE E IV E 350	M272.961, OM642.836	01/09 →	
CLASSE E IV E 350 4-matic	M272.977	01/09 →	
CLASSE E IV E 350 BlueTEC	OM642.850	01/09 →	
CLASSE E IV E 350 BlueTEC 4-matic	OM642.852	11/12 →	
CLASSE E IV E 350 CGI	OM642.836, M272.982	01/09 →	
CLASSE E IV E 350 CDI	OM642.856	09/09 →	
CLASSE E IV E 350 CGI	M272.982, M272.961	01/09 →	
CLASSE E IV E 500	M273.966	01/09 →	
CLASSE E IV E 500 4-matic	M273.970	01/09 →	
CLASSE E IV E 550 [USA]	M273.966	01/09 →	
CLASSE E IV E 550 [USA] [CAN] [JPN]	M273.971	01/09 →	
CLASSE E IV E 550 4-matic [USA] [CAN]	M273.970	01/09 →	
CLASSE E IV E 63 AMG	M156.985	08/09 →	
CLASSE E IV E350 [ExtraEU]	M272.961, M273.963	05/11 →	
CLASSE E E 280 CDI	OM642.920	08/05 → 07/09	
CLASSE G II G 280 CDI	OM642.975	04/09 →	
CLASSE G II G 300 CDI	OM642.884	01/10 →	
CLASSE G II G 320 CDI	OM642.970	09/06 →	
CLASSE G II G 350 BlueTEC	OM642.970	07/09 →	
CLASSE G II G 350 CDI	OM642.886	07/11 →	
CLASSE G II G 500	M273.963, M273.963	01/07 →	
CLASSE G II G 500 GUARD	M273.963	06/10 →	
CLASSE G II G 550	M273.963, OM642.822	06/10 →	
CLASSE GL I GL 320 CDI / 350 BlueTEC 4-matic	OM642.820	12/09 →	
CLASSE GL I GL 320 CDI 4-matic	OM642.940	09/06 → 05/09	
CLASSE GL I GL 320 CDI BlueTEC 4-matic	OM642.820	12/09 →	
CLASSE GL I GL 350 CDI 4-matic	OM642.822, OM642.832	05/09 →	
CLASSE GL I GL 420 CDI 4-matic	OM629.912	09/06 → 05/09	
CLASSE GL I GL 450 4-matic	M273.923	09/06 →	
CLASSE GL I GL 450 CDI 4-matic	OM629.912	05/09 →	
CLASSE GL I GL 500 4-matic	M273.963	09/06 →	
CLASSE GL I GL 550 4-matic	M273.963	09/06 →	
CLASSE GLK 280 4-matic	M272.948	06/08 → 06/09	
CLASSE GLK 300 4-matic	M272.948	07/09 → 04/11	
CLASSE GLK 320 CDI 4-matic	OM642.961	06/08 → 06/15	
CLASSE GLK 350	M272.991	04/09 → 06/15	
CLASSE GLK 350 4-matic	M272.971	06/08 → 04/11	
CLASSE GLK 350 CDI 4-matic	OM642.832, OM642.820	07/09 →	
CLASSE M II ML 280 CDI 4-matic	OM642.940	07/05 → 07/09	
CLASSE M II ML 300	M272.945	07/09 →	
CLASSE M II ML 300 4-matic	M272.945	03/10 → 12/11	
CLASSE M II ML 300 CDI 4-matic	OM642.820, OM642.820	07/09 → 12/11	
CLASSE M II ML 320 CDI 4-matic	OM642.820, OM642.820	07/05 →	
CLASSE M II ML 350	M272.967	07/05 →	
CLASSE M II ML 350 4-matic	M272.967	02/05 → 12/11	
CLASSE M II ML 350 CDI 4-matic	OM642.820, OM642.870	07/09 → 12/11	
CLASSE M II ML 420 CDI 4-matic	OM629.912	02/06 → 09/09	
CLASSE M II ML 450 4-matic Hybrid	M272.973	07/05 →	
CLASSE M II ML 450 CDI 4-matic	OM629.912	09/09 → 12/11	
CLASSE M II ML 500 4-matic	M273.963	12/07 → 12/11	
CLASSE M II ML 550 4-matic	M273.963	12/07 →	

MERCEDES-BENZ			
CLASSE M II ML 63 AMG 4-matic	M156.980	01/06 → 12/11	
CLASSE R R 280	M272.945	01/07 →	
CLASSE R R 280 4-matic	M272.945	05/07 →	
CLASSE R R 280 CDI	OM642.870, OM642.870	05/06 →	
CLASSE R R 280 CDI 4-matic	OM642.950	05/06 →	
CLASSE R R 300	M272.945	07/09 →	
CLASSE R R 300 4-matic	M272.945	07/09 →	
CLASSE R R 300 CDI	OM642.870, OM642.870	07/09 →	
CLASSE R R 300 CDI 4-matic	OM642.950	07/09 →	
CLASSE R R 320 CDI 4-matic	OM642.870, OM642.870	01/06 →	
CLASSE R R 350	M272.967	01/07 →	
CLASSE R R 350 4-matic	M272.967	01/06 →	
CLASSE R R 350 CDI 4-matic	OM642.870, OM642.930	01/06 →	
CLASSE R R 500 4-matic	M273.963	01/07 →	
CLASSE R R 550 4-matic	M273.963	01/07 →	
CLASSE R R 63 AMG 4-matic	M156.980	02/06 →	
CLASSE SV CL 500	M273.961	06/06 → 12/13	
CLASSE SV CL 500 4-matic	M273.968	02/08 → 12/13	
CLASSE SV CL 550 [JPN]	M273.961	06/06 →	
CLASSE SV CL 550 [USA]	M273.961	06/06 →	
CLASSE SV CL 550 4-matic [JPN]	M273.968	02/08 →	
CLASSE SV CL 550 4-matic [USA]	M273.968	02/08 →	
CLASSE SV CL 63 AMG	M156.984	10/06 → 12/13	
CLASSE SV S 280	M272.946	08/06 → 12/13	
CLASSE SV S 300	M272.946	08/06 → 12/13	
CLASSE SV S 320 CDI	OM642.930, OM642.932	10/05 → 12/13	
CLASSE SV S 320 CDI 4-matic	OM642.932, OM642.932	10/05 → 12/13	
CLASSE SV S 350	M272.965	10/05 → 12/13	
CLASSE SV S 350 4-matic	M272.975	02/08 → 12/13	
CLASSE SV S 350 CDI	OM642.930	06/09 → 12/13	
CLASSE SV S 350 CDI 4-matic	OM642.932, M272.966	01/09 → 07/13	
CLASSE SV S 400 Hybrid	M272.974	01/09 → 12/13	
CLASSE SV S 420 CDI	OM629.911	10/06 → 12/09	
CLASSE SV S 450	M273.922	12/05 → 12/13	
CLASSE SV S 450 4-matic	M273.924	12/05 → 12/13	
CLASSE SV S 450 CDI	OM629.911	01/09 → 12/13	
CLASSE SV S 500	M273.961	10/05 → 12/13	
CLASSE SV S 500 4-matic	M273.968	10/05 → 12/13	
CLASSE SV S 550 [JPN]	M273.961	10/05 →	
CLASSE SV S 550 [USA]	M273.961	10/05 →	
CLASSE SV S 550 4-matic [JPN]	M273.968	10/05 →	
CLASSE SV S 550 4-matic [USA]	M273.968	10/05 →	
CLASSE SV S 63 AMG	M156.984	10/06 → 12/13	
CLASSE SV S350 CDI [ExtraEU]	OM642.930	06/09 → 12/13	
CLASSE SL V 280	M272.949	03/08 → 01/12	
CLASSE SL V 300	M272.949	04/09 → 01/12	
CLASSE SL V 350	M272.966, M272.963	03/06 → 01/12	
CLASSE SL V 500	M273.965	03/06 → 01/12	
CLASSE SL V 550	M273.965	03/06 → 01/12	
CLASSE SL V 63 AMG	M156.981	03/08 → 01/12	
CLASSE SLK II 280	M272.942	01/05 → 02/11	
CLASSE SLK II 300	M272.942	04/09 → 02/11	
CLASSE SLK II 350	M272.963, M159.980	06/04 → 02/11	
CLASSE SLK III 200	M271.861	02/11 →	
CLASSE SLK III 250	M271.861	02/11 →	
CLK-SERIES CLK63 AMG Black Series	M156.982	05/07 → 05/09	
E-SERIES E250	M272.922	05/07 → 12/08	
R-SERIES R300	M272.945	07/09 → 12/11	
SLS AMG 6.2	M159.980, OM642.896	03/10 →	
SLS AMG 6.2 GT	M159.980	06/13 →	
SPRINTER II 218 CDI	OM642.896, OM642.896	06/06 → 12/09	
SPRINTER II 224	M272.979	06/06 →	
SPRINTER II 318 CDI	OM642.896, OM642.896	06/06 → 12/09	
SPRINTER II 318 CDI 4x4	OM642.896, OM642.896	02/08 → 12/09	
SPRINTER II 319 CDI / BlueTEC	OM642.896, OM642.896	03/09 →	
SPRINTER II 319 CDI / BlueTEC 4x4	OM642.896, OM651.955	03/09 →	
SPRINTER II 324	M272.979	06/06 → 12/13	
SPRINTER II 413 CDI	OM651.955, OM642.896	06/06 → 05/16	
SPRINTER II 418 CDI	OM642.896, OM642.896	06/06 → 05/16	
SPRINTER II 419 CDI	OM642.896, OM642.896	03/09 →	
SPRINTER II 424	M272.979	06/06 → 12/13	
SPRINTER II 518 CDI	OM642.896, OM642.896	06/06 → 12/09	
SPRINTER II 518 CDI 4x4	OM642.896, OM642.896	06/06 → 12/09	
SPRINTER II 519 CDI / BlueTEC	OM642.896, OM642.896	03/09 →	
SPRINTER II 519 CDI / BlueTEC 4x4	OM642.896, OM642.896	03/09 →	
SPRINTER II 524	M272.979	06/06 → 12/13	
SPRINTER SERIES Sprinter 318D CDI	OM642.896, OM642.890	03/09 →	

MERCEDES-BENZ			
VIANO 3.5	M272.978	09/07 →	
VIANO 3.7	M112.976	06/04 → 07/07	
VIANO CDI 3.0	OM642.890, K4M642	03/06 →	
VITO II 120 CDI	OM642.990	07/06 →	
VITO II 122 CDI	OM642.890	09/10 →	
VITO II 123	M112.976	06/04 → 07/08	
VITO II 126	M272.978	09/07 →	

9.0658

3,5

REVOLUTION AND TIMING (CKP AND CMP) SENSORS

Adatt./Suitable:

CONTINENTAL A2C53255629

DACIA 82 00 746 497

LADA 82007-46497

NISSAN 23731-4AA0A

23750-00Q1D

82007-46497

RENAULT 82 00 746 497

MARKET DIFFUSION: MEDIUM



L	L1	ohm	
---	18	200	

DACIA			
DUSTER 1.6	K4M642, K4M490	04/10 →	
DUSTER 1.6 16V	K4M490, K4M490	04/10 →	
DUSTER 1.6 16V 4x4	K4M490, K4M616	06/10 →	
DUSTER 1.6 16V Hi-Flex	K4M696	08/10 →	
DUSTER 1.6 16V LPG	K4M616, K4M690	04/11 →	
LOGAN I 1.6 16V	K4M690, K4M690	12/05 →	
LOGAN I 1.6 16V Flexifuel	K4M696	07/10 →	
LOGAN I 1.6 16V Hi-Flex	K4M690, K4M690	11/09 →	
LOGAN II 1.6 16V	K4M842	01/13 →	
SANDERO I 1.6 16V	K4M690, K4M690	07/11 →	
SANDERO I 1.6 16V BiFuel	K4M690, 21129	01/11 →	
SANDERO II 1.6 16V	K4M842	01/13 →	
LADA			
LARGUS 1.6	21129, K4M490	03/12 →	
NISSAN			
ALMERA III 1.6	K4M	11/12 →	
BLUEBIRD SYLPHY 1.6	K4M490, K4M	12/12 →	
TERRANO III 1.6	K4M, K4M606	09/13 →	
TERRANO III 1.6 4x4	K4M606, K4M734	03/14 →	
RENAULT			
CLIO 1.4	K7J700	08/00 → 02/09	
CLIO 1.6	K4M734, K4J710	07/00 → 02/10	
CLIO 1.6 [ExtraEU]	K4M708	03/99 → 12/08	
CLIO II 1.4 16V	K4J710, K4M708	02/00 → 07/08	
CLIO II 1.6	K4M746	11/03 →	
CLIO II 1.6 16V	K4M708, F8Q630	09/98 →	
CLIO II 1.6 Hi-Flex	K4M748	01/05 → 02/10	
CLIO II 1.9 D	F8Q630, F4R730	09/98 →	
CLIO II 2.0 16V Sport	F4R730, F4R700	02/00 →	
DUSTER 1.6 16V	K4M616	02/12 →	
DUSTER 1.6 16V 4x4	K4M616	06/11 → 05/15	
ESPACE III 2.0	F4R700, F4R700	09/01 → 10/02	
ESPACE III 2.0 16V	F4R700, K4M838	10/98 → 10/02	
FLUENCE 1.6 16V	K4M838, K4M761	02/10 →	
GRAND SCÉNIC II 1.6	K4M761, K4M708	04/04 →	
KANGOO 1.6	K4M836	02/12 →	
KANGOO 1.6 [ExtraEU]	K4M708, K4M830CNG	06/01 → 03/09	
KANGOO 1.6 BiFuel	K4M750	06/05 → 06/08	
KANGOO 1.6 CNG	K4M830CNG, K4M834	10/07 →	
KANGOO 1.6 Hi-Flex	K4M834	02/12 →	
KANGOO 1.6 Hi-Flex [ExtraEU]	K4M850	03/07 →	
KANGOO 1.6 LPG	K4M834, K4M708	02/12 →	

RENAULT		
KANGOO I 1.6 16V	K4M708, K4M750	06/01 →
KANGOO I 1.6 16V 4x4	K4M750, F8Q630	10/01 →
KANGOO I 1.6 16V bivalent	K4M850CNG	06/05 →
KANGOO I D 55 1.9	F8Q662	08/97 →
KANGOO I D 65 1.9	F8Q630, K4M830	08/97 →
KANGOO II 1.6	K4M830, K4M830	02/09 →
KANGOO II 1.6 16V	K4M830, K4M834	02/08 →
KANGOO II 1.6 16V Flex	K4M834	02/08 →
KANGOO II 1.6 16V Hi-Flex	K4M834	02/08 →
KANGOO II 1.6 16V LPG	K4M834, K4M710	12/08 →
LAGUNA II 1.6	K4M710	03/01 → 10/05
LAGUNA II 1.6 16V	K4M710, F4P770	03/01 → 12/07
LAGUNA II 1.6 Bifuel	K4M714	06/05 → 12/07
LAGUNA II 1.6 LPG	K4M714	03/01 → 05/05
LAGUNA II 1.8 16V	F4P770, F4R712	03/01 → 12/07
LAGUNA II 2.0 16V	F4R712, F5R700	08/02 → 12/07
LAGUNA II 2.0 16V IDE	F5R700, K4M690	04/01 → 09/07
LOGAN 1.6	K4M690, K4M842	04/07 →
LOGAN 1.6 16V	K4M694	12/05 →
LOGAN/STEPWAY 1.6	K4M842, K4J714	04/14 →
MEGANE II 1.4	K4J730, K4J730	08/03 →
MEGANE II 1.4 16V	K4J730, K4M760	11/02 → 02/08
MEGANE II 1.6	K4M760, K4M760	08/03 →
MEGANE II 1.6 16V	K4M760, K4M848	11/02 →
MEGANE II 1.6 16V Hi-Flex	K4M856	02/08 → 07/09
MEGANE II 1.6 Bifuel	K4M788	06/05 → 02/08
MEGANE II 1.6 Flex-Fuel	K4M856	01/07 → 02/08
MEGANE II 1.6 LPG 16V	K4M760	01/06 → 08/09
MEGANE 1.4	K4J714, K4M704	04/01 → 07/03
MEGANE 1.6 Bifuel	K4M704, F4R740	10/96 → 07/03
MEGANE 1.8	F4P722	04/01 → 07/03
MEGANE 2.0	F4R740, K4J700	08/95 → 02/99
MEGANE I 1.4 16V	K4J700, K4M704	03/99 → 08/03
MEGANE I 1.6	K7M704	02/00 → 09/00
MEGANE I 1.6 Bifuel	K4M712	03/99 → 09/00
MEGANE I 1.6 LPG	K4M704, F4P720	10/00 → 03/99
MEGANE I 1.8 16V	F4P720, F3R750	01/01 → 08/03
MEGANE I 2.0	F3R750, F4R746	05/98 → 05/01
MEGANE I 2.0 16V	F4R746	01/02 → 08/03
MEGANE I 2.0 16V IDE	F4R746, F3R750	11/99 → 08/03
MEGANE I 2.0 i	F3R750, F3R750	01/96 → 08/03
MEGANE I 2.0 RT	F3R750, K4J730	03/01 → 02/99
MEGANE III 1.6 16V	K4M848, F3R750	11/08 →
MEGANE SCÉNIC I 2.0 i	F3R750, K4M842	01/97 → 09/99
SANDERO II 1.6 16V	K4M842, K4M812	04/14 →
SCÉNIC I 1.4 16V	K4J714, K4M700	09/99 → 08/03
SCÉNIC I 1.6	K4M700, K4M704	03/01 → 09/03
SCÉNIC I 1.6 Bifuel	K4M704, F4P720	03/01 → 08/03
SCÉNIC I 1.8 16V	F4P720, F8Q788	01/01 → 08/03
SCÉNIC I 1.8 4x4	F4P722	07/00 → 04/01
SCÉNIC I 1.9 D	F8Q788, F4R740	09/99 → 03/01
SCÉNIC I 2.0 16V	F4R740, K4J730	07/00 → 08/03
SCÉNIC I 2.0 16V RX4	F4R744	06/00 → 08/03
SCÉNIC II 1.4	K4J730, K4M761	06/03 →
SCÉNIC II 1.6	K4M761, K4M812	06/03 →
SCÉNIC II 1.6 16V	K4M812, K4M744	10/05 →
SCÉNIC II 1.6 Bifuel	K4M764	08/03 → 05/06
SCÉNIC 1.6	K4M812, K4J714	07/07 → 05/09
SYMBOL 1.6 [ExtraEU]	K4M744, K4J712	01/09 → 06/14
THALIA I 1.4	K7J700	08/00 →
THALIA I 1.4 16V	K4J712, K4M670	08/00 →
THALIA I 1.6	K4M670, K4M742	01/01 →
THALIA I 1.6 16V	K7M734	04/02 →
THALIA I 1.6 Authentique Hi-Flex	K4M742, K4J712	11/04 → 02/09
THALIA I 1.9 D	F8Q630	02/98 → 05/01
THALIA II 1.4	K4J712, K4M670	01/09 → 12/11
THALIA II 1.6 16V	K4M670, K7M812	09/08 →

9.0659



3,5

REVOLUTION AND TIMING (CKP AND CMP) SENSORS

Adatt./Suitable:

CONTINENTAL
A2C53255627

DACIA
82 00 772 182

LADA
82 00 772 182

RENAULT
82 00 772 182

MARKET DIFFUSION: MEDIUM



L	L1	ohm	GND OUT
---	18	200	

DACIA

DOKKER 1.6	K7M812, K7M812	11/12 →
DOKKER 1.6 LPG	K7M812, K7M812	11/13 →
LODGY 1.6	K7M812, K7M812	03/12 →
LODGY 1.6 LPG	K7M812, K7J710	11/13 →
LOGAN 1.6	K7M812	06/13 → 08/16
LOGAN 1.6 Hi-Flex	K7M714	01/11 → 10/12
LOGAN I 1.4	K7J710	09/04 →
LOGAN I 1.4 MPI LPG	K7J710, K7M710	02/06 →
LOGAN I 1.6	K7M710, K7M710	09/04 →
LOGAN I 1.6 Bifuel	K7M710, D4F732	11/08 →
LOGAN I 1.6 LPG	K7M718	08/04 → 12/12
LOGAN I 1.6 MPI 85	K7M800	05/10 →
LOGAN II 1.0	D4D754	10/12 →
LOGAN II 1.2	D4F732, K7M764	10/12 →
LOGAN II 1.6 16V	K7M764, K7M710	10/12 →
LOGAN II MCV 1.2	D4F732	05/15 →
LOGAN II MCV 1.6	K7M812	06/13 →
SANDERO I 1.4 MPI LPG	K7J714	01/09 →
SANDERO I 1.6	K7M710, K7M718	06/08 →
SANDERO I 1.6 LPG	K7M718, 11189	06/08 → 12/12
SANDERO I 1.6 MPI 85	K7M800	05/10 →
SANDERO II 1.0	D4D754	10/12 →
SANDERO II 1.2	D4F732	05/15 →
SANDERO II 1.6	K7M812	11/12 →
SANDERO II 1.6 I	K7M764	10/12 →

LADA

LARGUS 1.6	11189, K7M812	03/12 →
------------	---------------	---------

RENAULT

CLIO 1.2	D4F740	11/12 →
CLIO IV 1.2 16V	D4F740	11/12 →
CLIO IV 1.2 LPG 16V	D4F744	11/12 → 06/15
DOKKER 1.6	K7M812	12/13 →
LODGY 1.6	K7M812, K7M812	07/13 →
LOGAN 1.4	K7J710	09/04 →
LOGAN 1.4 LPG	K7J714	02/08 → 10/13
LOGAN 1.6	K7M710	09/04 →
LOGAN 1.6 MPI 85	K7M800	05/10 →
LOGAN EXPRESS 1.6	K7M710	04/07 →
LOGAN/STEPWAY 1.6	K7M812, K7M710	11/13 →
SANDERO I 1.4 LPG	K7J714	02/09 →
SANDERO I 1.6	K7M710, D4F728	12/07 →
SANDERO I 1.6 MPI 85	K7M800	05/10 →
SANDERO II 1.2 16V	D4F732	04/15 →
SANDERO II 1.6	K7M812	11/13 →
SYMBOL 1.2 LPG [ExtraEU]	D4F734	12/13 →
THALIA I 1.2i 16V	D4F728	04/04 →
THALIA II 1.2 16V	D4F728, D4F764	09/08 →
THALIA II 1.2 LPG	D4F728	01/10 → 12/13
TWINGO 1.2	D4F770	09/10 → 09/14
TWINGO II 1.2	D7F800	03/07 →
TWINGO II 1.2 16V	D4F764, D4F780	03/07 →
TWINGO II 1.2 TCe 100	D4F780, D4F780	02/11 →
TWINGO II 1.2 Turbo	D4F780, D4F780	03/07 →
WIND 1.2	D4F780, CR12DE	07/10 →

RENAULT		
WIND 1.2 TCe 100	D4F780	02/11 →

9.0674



3

REVOLUTION AND TIMING (CKP AND CMP) SENSORS

Adatt./Suitable:

NISSAN
23731-4M50C
23731-4M56C



L	L1	Hall Effect	
---	37,7	Hall Effect	

NISSAN

MICRA III 1.2	CR12DE, CG12DE	10/03 → 06/10
MICRA III 1.2 16V	CG12DE, CG12DELPG	01/03 → 06/10
MICRA III 1.2 LPG	CG12DELPG, CR12DE	10/02 → 06/10
MICRA III 1.4 16V	CR14DE	01/03 → 06/10
MICRA C+C 1.4 16V	CR14DE	08/05 →
NOTE I 1.4	CR14DE	03/06 → 06/12
NOTE I 1.4 LPG	CR14DE	01/06 → 08/13

9.0675



3

REVOLUTION AND TIMING (CKP AND CMP) SENSORS

Adatt./Suitable:

NISSAN
23731-6J90A
23731-6J90C
23731-6J966
23731-6J96B

MARKET DIFFUSION: MEDIUM



L	L1	Hall Effect	
---	37,7	Hall Effect	

NISSAN

MICRA III 1.0 16V	CG10DE	01/03 → 06/10
MICRA III 1.2	CR12DE, CG12DE	10/03 → 06/10
MICRA III 1.2 16V	CG12DE, CG12DELPG	01/03 → 06/10
MICRA III 1.2 LPG	CG12DELPG, 8140.43N	10/02 → 06/10
MICRA III 1.3	CGA3DE	08/04 →
MICRA III 1.4 16V	CR14DE	01/03 → 06/10
MICRA C+C 1.4 16V	CR14DE	08/05 →

NISSAN		
NOTE I 1.4	CR14DE	03/06 ⇒ 06/12
NOTE I 1.4 LPG	CR14DE	01/06 ⇒ 08/13

9.0681



3

REVOLUTION AND TIMING (CKP AND CMP) SENSORS

Adatt./Suitable:

BOSCH
0 281 002 778

CITROËN
1131 J7

FIAT
504129943

FUSO (MITSUBISHI)
MK666963

IVECO
0000504129943
504129943

PEUGEOT
1131 J7

ITEM NOW AVAILABLE FROM PRODUCTION

- ARTICOLO ORA DISPONIBILE PER LA VENDITA
- ARTICLE DISPONIBLE EN PRODUCTION COURANTE
- JETZT ZUM VERKAUF VERFÜGBARER ARTIKEL
- ARTICULO AHORA DISPONIBLE EN PRODUCCION

MARKET DIFFUSION: MEDIUM



L	L1	ohm	
---	38,3	1100	

CITROËN

JUMPER II 2.8 HDi	8140.43N, 8140.43S	04/02 ⇒
JUMPER II 2.8 HDi 4x4	8140.43S, F300FAP	02/02 ⇒ 06/06
JUMPER II 2.8 HDi Trazione integrale	8140.43S	04/02 ⇒
JUMPER III 3.0 HDi 145	F300FAP, F30DTFAP	07/10 ⇒
JUMPER III 3.0 HDi 155	F30DTFAP, F30DTFAP	07/10 ⇒
JUMPER III 3.0 HDi 160	F30DTFAP, F1AE0481D	09/06 ⇒
JUMPER III 3.0 HDi 180	F30DT	07/11 ⇒

FIAT

DUCATO II 2.3 JTD	F1AE0481C	04/02 ⇒
DUCATO III 110 Multijet 2,3 D	F1AE0481D, F1AE0481D	08/06 ⇒
DUCATO III 120 Multijet 2,3 D	F1AE0481D, F1AE0481N	07/06 ⇒
DUCATO III 120 Multijet 2,3 D 4x4	F1AE0481D	03/10 ⇒
DUCATO III 130 Multijet 2,3 D	F1AE0481N, F1CE0441A	07/06 ⇒
DUCATO III 140 Natural Power	F1CE0441A, F1AE3481E	04/09 ⇒
DUCATO III 150 Multijet 2,3 D	F1AE3481E, F1CE0481D	06/11 ⇒
DUCATO III 150 Multijet 3,0 D	F1CE3481N	04/10 ⇒
DUCATO III 160 Multijet 3,0 D	F1CE0481D, 4P10T2	07/06 ⇒
DUCATO III 180 Multijet 2,3 D	F1AGL411B	12/15 ⇒
DUCATO III 180 Multijet 3,0 D	F1CE3481E	06/11 ⇒
DUCATO III 2.3	--	01/14 ⇒
DUCATO III 3.0	--	01/14 ⇒
DUCATO 2.3 Multijet	F1AE0481N	01/07 ⇒ 07/14

FUSO (MITSUBISHI)

CANTER 3.0 DiTD	4P10T2, F1CE0481A	04/06 ⇒
-----------------	-------------------	---------

IVECO

DAILY II 29 L 10	F1AE0481A	09/02 ⇒ 04/06
DAILY II 29 L 10 V	F1AE0481A	09/02 ⇒ 07/07
DAILY II 29 L 12	F1AE0481B	09/02 ⇒ 04/06
DAILY II 29 L 12 V	F1AE0481B	09/02 ⇒ 07/07
DAILY II 29 L 14	F1AE0481M	01/05 ⇒ 04/06
DAILY II 35 C 10 V, 35 S 10 V	F1AE0481A	09/02 ⇒ 04/06
DAILY II 35 C 12, 35 S 12	F1AE0481B	09/02 ⇒ 04/06
DAILY II 35 C 12 V, 35 S 12 V	F1AE0481B	09/02 ⇒ 07/07
DAILY II 35 C 14	F1CE0481A, F1CE0481A	09/04 ⇒ 04/06
DAILY II 35 C 14, 35 S 14	F1AE0481M	01/05 ⇒ 04/06
DAILY II 35 C 17, 35 S 17	F1CE0481B	01/05 ⇒ 04/06
DAILY II 35 S 10	F1AE0481A	09/02 ⇒ 07/07
DAILY II 40 C 10	F1AE0481A	09/02 ⇒ 04/06
DAILY II 40 C 14	F1CE0481A	09/04 ⇒ 04/06
DAILY II 40 C 17	F1CE0481B	01/05 ⇒ 04/06
DAILY II 45 C 14	F1CE0481A	07/99 ⇒ 04/06

IVECO

DAILY II 50 C 14	F1CE0481A, F1CE0481A	09/04 ⇒ 04/06
DAILY II 50 C 17	F1CE0481B	09/04 ⇒ 04/06
DAILY II 65 C 14	F1CE0481A, F1CE0481A	09/04 ⇒ 04/06
DAILY II 65 C 17	F1CE0481B	09/04 ⇒ 04/06
DAILY III 35 S 12, 35 C 12, 40 C 12	F1AE0481B	01/03 ⇒ 05/06
DAILY III 35 S 14, 50 C 14	F1CE0481A, F1CE3481B	01/04 ⇒ 05/06
DAILY III 40 C 17, 50 C 17	F1CE0481B	01/04 ⇒ 05/06
DAILY IV 26L11, 26L11D, 35C11D, 35S11, 40C11	F1AE3481A	09/11 ⇒ 02/14
DAILY IV 29L10	F1AE0481F	05/06 ⇒ 08/11
DAILY IV 29L10 V	F1AE0481F	05/06 ⇒ 08/11
DAILY IV 29L11 V, 35C11 V, 35S11 V, 40C11 V	F1AE3481A	09/11 ⇒ 02/14
DAILY IV 29L12	F1AE0481G	05/06 ⇒ 08/11
DAILY IV 29L12 V, 29L12 V/P	F1AE0481G	05/06 ⇒ 08/11
DAILY IV 29L13 V, 35C13 V, 35S13 V, 40C13 V, 40S13 V	F1AE3481B	09/11 ⇒ 02/14
DAILY IV 29L13D, 29L13D, 35C13D, 40C13	F1AE3481B	09/11 ⇒ 02/14
DAILY IV 29L14	F1AE0481H	05/06 ⇒ 08/11
DAILY IV 29L14 C, 29L14 C/P, 29L14 V, 29L14 V/P	F1AE0481H	05/06 ⇒ 08/11
DAILY IV 29L15 V, 35C15L V, 40C15L V, 50C15L V	F1AE3481C	09/11 ⇒ 02/14
DAILY IV 29L15 V, 35S15 V, 35C15L V, 40C15L V, 50C15L V	F1AE3481C	09/11 ⇒ 02/14
DAILY IV 35C10 K	F1AE0481F	05/06 ⇒ 08/11
DAILY IV 35C10, 35S10	F1AE0481F	05/06 ⇒ 08/11
DAILY IV 35C11 K, 35C11 DK, 35S11 K, 35S11 DK	F1AE0481F	07/07 ⇒ 08/11
DAILY IV 35C11 V, 35S11 V	F1AE0481F	07/07 ⇒ 08/11
DAILY IV 35C11, 35S11, 35S11 D, 35S11 /P	F1AE0481F	07/07 ⇒ 08/11
DAILY IV 35C11K, 35S11DKP	F1AE3481A	09/11 ⇒ 02/14
DAILY IV 35C12	F1AE0481G	05/06 ⇒ 08/11
DAILY IV 35C12 V, 35C12 V/P, 35S12 V, 35S12 V/P	F1AE0481G	05/06 ⇒ 08/11
DAILY IV 35C12, 35S12	F1AE0481G	05/06 ⇒ 08/11
DAILY IV 35C13 K, 35C13 DK, 35S13 K, 35S13 DK	F1AE0481V	07/07 ⇒ 08/11
DAILY IV 35C13 V, 35C13 V/P, 35S13 V, 35S13 V/P	F1AE0481V	07/07 ⇒ 08/11
DAILY IV 35C13, 35C13 /P, 35S13 D, 35S13, 35S13 /P	F1AE0481V	07/07 ⇒ 08/11
DAILY IV 35C13K, 35C13DKP	F1AE3481B	09/11 ⇒ 02/14
DAILY IV 35C14 G, 35C14 G/P, 35S14 G, 35S14 G/P, 35C14 GD,...	F1CE0441CNG	07/07 ⇒ 08/11
DAILY IV 35C14 GV, 35C14 GV/P, 35S14 GV, 35S14 GV/P	F1CE0441CNG	07/07 ⇒ 08/11
DAILY IV 35C14 K, 35C14 DK, 35S14 K, 35S14 DK	F1CE3481L	07/07 ⇒ 08/11
DAILY IV 35C14 V, 35C14 V/P, 35S14 V, 35S14 V/P	F1CE3481L	07/07 ⇒ 08/11
DAILY IV 35C14, 35C14 /P, 35S14, 35S14 /P, 35S14 D, 35S14 D/P	F1CE3481L	07/07 ⇒ 08/11
DAILY IV 35C14, 35S14, 35S14 /P	F1AE0481H	05/06 ⇒ 08/11
DAILY IV 35C15 V, 40C15 V, 50C15 V, 60C15 V	F1CE3481B, F1CE3481B	09/11 ⇒ 02/14
DAILY IV 35C15, 35C15D, 35S15, 40C15, 45C15, 50C15, 60C15, 70C15	F1CE3481B	09/11 ⇒ 02/14
DAILY IV 35C15K, 35S15DKP, 50C15K, 60C15K, 65C15DK, 70C15K	F1CE3481B	09/11 ⇒ 02/14
DAILY IV 35C17 K, 35C17 DK, 35S17 K, 35S17 DK	F1CE3481C	07/07 ⇒ 08/11
DAILY IV 35C17 V, 35C17 V/P, 35S17 V, 35S17 V/P	F1CE3481C	07/07 ⇒ 08/11
DAILY IV 35C17 V, 35S17 V, 40C17 V, 45C17 V, 50C17 V, 60C17 V	F1CE3481C	09/11 ⇒ 02/14
DAILY IV 35C17, 35C17 /P, 35S17, 35S17 /P, 35S17 D	F1CE3481C	07/07 ⇒ 08/11
DAILY IV 35C17, 35C17D, 35S17, 40C17, 45C17, 50C17, 60C17, 70C17	F1CE3481C	09/11 ⇒ 02/14
DAILY IV 35C17K, 35S17DKP, 50C17K, 65C17DK 70C17K	F1CE3481C, F1CE0481H	09/11 ⇒ 02/14
DAILY IV 35C18	F1CE0481H	05/06 ⇒ 08/11
DAILY IV 35C18 V, 35C18 V/P, 35S18 V, 35S18 V/P	F1CE0481H, F1CE0481H	05/06 ⇒ 08/11
DAILY IV 35C18, 35S18	F1CE0481H, F1CE0481H	05/06 ⇒ 08/11
DAILY IV 35C21 V, 35S21 V, 40C21 V, 45C21 V, 50C21 V	F1CE3481D	09/11 ⇒ 02/14
DAILY IV 35C21, 35S21, 40C21, 45C21, 50C21, 60C21, 70C21	F1CE3481D	09/11 ⇒ 02/14

IVECO

DAILY IV 35S14 C, 35S14 C/P, 35S14 V, 35S14 V/P, 35C14 V,...	F1AE0481H	05/06 ⇒ 08/11
DAILY IV 35S14 K, 35S14 DK	F1AE0481H	07/07 ⇒ 08/11
DAILY IV 35S14, 35S14 /P	F1AE0481H	05/06 ⇒ 08/11
DAILY IV 35S17 W, 35S17 WD	F1CE3481C	07/07 ⇒ 08/11
DAILY IV 40C10	F1AE0481F	05/06 ⇒ 08/11
DAILY IV 40C10 V	F1AE0481F	05/06 ⇒ 08/11
DAILY IV 40C11 V	F1AE0481F	07/07 ⇒ 08/11
DAILY IV 40C11, 40C11 D	F1AE0481F	07/07 ⇒ 08/11
DAILY IV 40C12	F1AE0481G	05/06 ⇒ 08/11
DAILY IV 40C12 V, 40C14 V/P	F1AE0481G	05/06 ⇒ 08/11
DAILY IV 40C13 V, 40C13 V/P	F1AE0481V	07/07 ⇒ 08/11
DAILY IV 40C13, 40C13 /P	F1AE0481V	07/07 ⇒ 08/11
DAILY IV 40C14 G, 40C14 G/P	F1CE0441CNG	07/07 ⇒ 08/11
DAILY IV 40C14 GV, 40C14 GV/P	F1CE0441CNG	07/07 ⇒ 08/11
DAILY IV 40C14 K, 40C14 DK	F1CE3481L	07/07 ⇒ 08/11
DAILY IV 40C14 V, 40C14 V/P	F1CE3481L	07/07 ⇒ 08/11
DAILY IV 40C14, 40C14 /P	F1CE3481L	07/07 ⇒ 08/11
DAILY IV 40C17 K, 40C17 DK	F1CE3481C	07/07 ⇒ 08/11
DAILY IV 40C17 V, 40C17 V/P	F1CE3481C	07/07 ⇒ 08/11
DAILY IV 40C17, 40C17 /P	F1CE3481C	07/07 ⇒ 08/11
DAILY IV 40C18	F1CE0481H	05/06 ⇒ 08/11
DAILY IV 40C18 V, 40C18 V/P	F1CE0481H	05/06 ⇒ 08/11
DAILY IV 45C14, 45C14 /P	F1CE3481L	07/07 ⇒ 08/11
DAILY IV 45C15	F1CE0481F	05/06 ⇒ 08/11
DAILY IV 45C17 V, 45C17 V/P	F1CE3481C	07/07 ⇒ 08/11
DAILY IV 45C17, 45C17 /P	F1CE3481C	07/07 ⇒ 08/11
DAILY IV 45C18	F1CE0481H	05/06 ⇒ 08/11
DAILY IV 45C18, 45C18 /P, 45C18 D, 45C18 D/P	F1CE0481H	05/06 ⇒ 08/11
DAILY IV 50C14 G, 50C14 G/P, 50C14 GD, 50C14 GD/P	F1CE0441CNG	07/07 ⇒ 08/11
DAILY IV 50C14 GV, 50C14 GV/P	F1CE0441CNG	07/07 ⇒ 08/11
DAILY IV 50C14 K, 50C14 DK	F1CE3481L	07/07 ⇒ 08/11
DAILY IV 50C14 V, 50C14 V/P	F1CE3481L	07/07 ⇒ 08/11
DAILY IV 50C14, 50C14 /P	F1CE3481L	07/07 ⇒ 08/11
DAILY IV 50C15	F1CE0481F	05/06 ⇒ 08/11
DAILY IV 50C17 K, 50C17 DK	F1CE3481C	07/07 ⇒ 08/11
DAILY IV 50C17 V, 50C17 V/P	F1CE3481C	07/07 ⇒ 08/11
DAILY IV 50C17, 50C17 /P	F1CE3481C	07/07 ⇒ 08/11
DAILY IV 50C18	F1CE0481H	05/06 ⇒ 08/11
DAILY IV 50C18 V, 50C18 V/P	F1CE0481H, F1CE0481H	05/06 ⇒ 08/11
DAILY IV 55C17	F1CE3481C	08/07 ⇒ 03/12
DAILY IV 55S17 W, 55S17 WD	F1CE3481C	07/07 ⇒ 08/11
DAILY IV 55S18W	F1CE0481H	06/06 ⇒ 08/11
DAILY IV 60C14 K, 60C14 DK	F1CE3481L	07/07 ⇒ 08/11
DAILY IV 60C14, 60C14 /P	F1CE3481L	07/07 ⇒ 08/11
DAILY IV 60C17 K, 60C17 DK	F1CE3481C	07/07 ⇒ 08/11
DAILY IV 60C17 V, 60C17 V/P	F1CE3481C	07/07 ⇒ 08/11
DAILY IV 60C17, 60C17 /P	F1CE3481C	07/07 ⇒ 08/11
DAILY IV 60C18	F1CE0481H	05/06 ⇒ 08/11
DAILY IV 65C14 G, 65C14 G/P, 65C14 GD, 65C14 GD/P	F1CE0441CNG	07/07 ⇒ 08/11
DAILY IV 65C14 K, 65C14 DK	F1CE3481L	07/07 ⇒ 08/11
DAILY IV 65C14 V, 65C14 V/P	F1CE3481L	07/07 ⇒ 08/11
DAILY IV 65C14, 65C14 /P	F1CE3481L	07/07 ⇒ 08/11
DAILY IV 65C17 K, 65C17 DK, 65C17KK	F1CE3481C	07/07 ⇒ 08/11
DAILY IV 65C17 V, 65C17 V/P	F1CE3481C	07/07 ⇒ 08/11
DAILY IV 65C17, 65C17 /P	F1CE3481C	07/07 ⇒ 08/11
DAILY IV 65C18	F1CE0481H, F1CE3481J	05/06 ⇒ 08/11
DAILY IV 70C14 K, 70C14 DK, 70C14 KK	F1CE3481L	07/07 ⇒ 08/11
DAILY IV 70C14 V, 70C14 V/P	F1CE3481L	07/07 ⇒ 08/11
DAILY IV 70C14, 70C14 /P	F1CE3481L	07/07 ⇒ 08/11
DAILY IV 70C15	F1CE0481L	07/08 ⇒ 08/11
DAILY IV 70C17 K, 70C17 DK, 70C17 KK	F1CE3481C	07/07 ⇒ 08/11
DAILY IV 70C17, 70C17 /P	F1CE3481C	07/07 ⇒ 08/11
DAILY IV 70C17V, 70C17 V/P	F1CE3481C	07/07 ⇒ 08/11
DAILY IV Natural Power 35S14, 35C14, 40C14, 50C14, 65C14, 70C14	F1CE0441CNG	09/11 ⇒ 02/14
DAILY IV NaturalPower 35S14, 35C14, 40C14, 50C14, 65C14, 70C14,...	F1CE0441CNG	09/11 ⇒ 02/14
DAILY V 33S11, 35S11, 35C11	F1AFL411A	03/14 ⇒ 04/16
DAILY V 33S12, 35S12	F1AGL411H	04/16 ⇒
DAILY V 33S12, 35S12, 35C12	F1AGL411H	04/16 ⇒
DAILY V 33S13, 35S13, 35C13	F1AFL411B	03/14 ⇒ 04/16
DAILY V 33S14, 35S14	F1AGL411J	04/16 ⇒
DAILY V 33S14, 35S14, 35C14	F1AGL411J	04/16 ⇒
DAILY V 33S15, 35S15, 35C15	F1AGL411C	03/14 ⇒ 04/16
DAILY V 33S16, 35S16	F1AGL411G	04/16 ⇒
DAILY V 33S16, 35S16, 35C16	F1AGL411G	04/16 ⇒

IVECO		
DAILY V 35S14, 35S15, 35C15, 40S14, 40C15, 50C15, 65C15, 70C15	F1CE3481J	03/14 → 04/16
DAILY V 35S15, 35C15, 40C15, 50C15	F1CGL411A	04/16 →
DAILY V 35S15, 35C15, 40C15, 50C15, 65C15, 70C15	F1CE3481J, F1CFL411F	03/14 →
DAILY V 35S15, 35C15, 40C15, 50C15, 65C15, 70C15, 72C15	F1CGL411A	04/16 →
DAILY V 35S17, 35C17, 40C17, 45S17, 45C17, 50C17, 55C17, 65C17,...	F1CFL411F	03/14 → 04/16
DAILY V 35S17, 35C17, 40C17, 50C17, 55C17, 65C17, 70C17	F1CFL411F, F1CFL411W	03/14 → 04/16
DAILY V 35S17, 55S17 4x4	F1CFL411F	08/15 → 04/16
DAILY V 35S18, 35C18, 40C18, 50C18	F1CGL411B	04/16 →
DAILY V 35S18, 35C18, 40C18, 50C18, 65C18, 70C18	F1CGL411B	04/16 →
DAILY V 35S18, 35C18, 40C18, 50C18, 65C18, 70C18, 72C18	F1CFL411W, F1CFL411W	04/16 →
DAILY V 35S18, 55S18 4x4	F1CFL411W, F1CFL411G	09/16 →
DAILY V 35S21, 35C21, 40C21, 50C21, 65C21, 70C21	F1CFL411G, F1CE3481J	03/14 →
DAILY V 40C15, 50C15, 60C15	F1CE3481J, F1CE3481J	06/14 → 10/16
DAILY V 40C15, 50C15, 65C15	F1CE3481J, F1CFL411F	03/14 → 04/16
DAILY V 40C17, 50C17, 60C17	F1CFL411F	06/14 → 10/16
DAILY V 40C17, 50C17, 65C17	F1CFL411F, F1CE3481J	03/14 → 04/16
DAILY V 50C15	F1CE3481J, F1CE0481D(F30DT)	06/14 → 10/16
DAILY V 50C17	F1CFL411F	06/14 → 10/16
DAILY V 50C17, 65C17	F1CFL411F	06/14 → 10/16
DAILY V Natural Power 35S14, 35C14, 40C14, 50C14	F1CFA401A	04/16 →
DAILY V Natural Power 35S14, 35C14, 40C14, 50C14, 65C14, 70C14	F1CFA401A	03/14 →
DAILY V Natural Power 35S14, 35C14, 40C14, 50C14, 65C14, 70C14,...	F1CFA401A	03/14 →
DAILY 2.3	F1AE0481A	07/99 → 02/14
DAILY 3.0	F1CE0481A, F1CE0441CNG	07/99 →
DAILY 3.0 CNG	F1CE0441CNG, F1CE0481A	06/06 → 02/14
MASSIF 3.0 HPI	F1CE0481F	10/08 → 02/11
MASSIF 3.0 HPT	F1CE0481H	10/08 → 02/11
PEUGEOT		
BOXER II 3.0 D	F30DT	09/08 → 12/09
BOXER II 3.0 HdI	F1CE0481D(F30DT), F1CE3481N(F30DTE)	07/06 →
BOXER II 3.0 HdI 145	F1CE3481N(F30DTE), F1CE0481D(F30DT)	04/10 →
BOXER II 3.0 HdI 160	F1CE0481D(F30DT), F1CE0481D(F30DT)	04/06 →
BOXER II 3.0 HdI 175	F1CE0481D(F30DT), AZQ	03/11 →

9.0683



3,5

REVOLUTION AND TIMING (CKP AND CMP) SENSORS

Adatt./Suitable:

BOSCH
0 986 280 422**SEAT**
03D 906 433
03D 906 433 A**SKODA**
03D 906 433
03D 906 433 A**VW**
03D 906 433
03D 906 433 AMARKET DIFFUSION: **HIGH**

L	L1		
---	20,2	Hall Effect	

SEAT

CORDOBA II 1.2	AZQ, AZQ	10/02 → 06/06
CORDOBA II 1.2 12V	BXV	05/06 → 11/09
IBIZA III 1.2	AZQ, BZG	02/02 → 05/08
IBIZA III 1.2 12V	BXV	05/06 → 11/09
IBIZA IV 1.2	BZG, AWY	03/08 →
IBIZA IV 1.2 LPG	BZG	03/08 →
IBIZA 1.2	CGPA	04/08 →
TOLEDO IV 1.2	CGPC	07/12 →

SKODA

FABIA I 1.2	AWY, BBM	07/01 → 03/08
FABIA II 1.2	BBM, CGPA	12/06 →
FABIA II 1.2 [IND]	CJLA	09/10 →
FABIA II 1.2 12V	CGPB	11/11 → 12/14
FABIA II 1.2 LPG	CGPA, BME	07/07 → 11/14
RAPID 1.2	CGPC	07/12 →
RAPID 1.2 LPG	CGPC	07/12 →
ROOMSTER 1.2	BME, BMD	05/06 → 05/15
ROOMSTER 1.2 LPG	CGPA	03/09 → 05/15

VW

FOX 1.2	BMD, AWY	04/05 → 12/11
POLO IV 1.2	AWY, AZQ	01/02 → 11/09
POLO IV 1.2 12V	AZQ, CGPA	10/01 → 11/09
POLO V 1.2	CGPA, G4LA	03/09 →
POLO V 1.2 [IND]	CJLA	08/11 →
POLO V 1.2 BlueMotion	CGPA	03/09 → 05/14

9.0697



3

REVOLUTION AND TIMING (CKP AND CMP) SENSORS

Adatt./Suitable:

HYUNDAI
39180-03000**KIA**
39180-03000MARKET DIFFUSION: **MEDIUM**

L	L1	ohm	
---	28	1030	

HYUNDAI

ACCENT IV 1.4	G4LC	11/10 →
ACCENT IV 1.4 CVT	--	11/10 →
110 1.2 LPG	G4LA	01/10 → 12/13
110 I 1.2	G4LA, G4LA	11/08 → 12/13
110 II 1.2	G4LA	12/13 →
120 1.2	G4AG	12/08 → 08/14
120 1.2 CVVT	G4LA	05/15 →
120 1.2 LPG	G4LA	01/09 → 08/14
120 I 1.2	G4LA, G4LA	09/08 → 12/15
120 II 1.2	G4LA, G4FA	11/14 →

KIA

PICANTO II 1.2	G4LA	09/11 →
RIO III 1.2	G4LA	09/11 →
RIO III 1.2 CVVT	G4LA	11/14 →
RIO III 1.25 CVVT	G4LA	09/11 →
RIO III 1.25 LPG	G4LA	09/11 →
RIO 1.2 CVVT	G4LA	04/15 →
RIO IV 1.25	G4LA	01/17 →
STONIC 1.2 CVVT	G4LA	07/17 →

9.0700



3

REVOLUTION AND TIMING (CKP AND CMP) SENSORS

Adatt./Suitable:

HYUNDAI
39350-2B030**KIA**
39350-2B030MARKET DIFFUSION: **HIGH**

L	L1		
---	28,2	Hall Effect	

HYUNDAI

ACCENT IV 1.4	G4FA, G4FC	11/10 →
ACCENT IV 1.4 CVT	--	11/10 →
ACCENT IV 1.6	G4FC, G4FG	11/10 →
CRETA 1.6	G4FG	01/16 →

HYUNDAI		
CRETA 1.6 4WD	G4FG	08/16 →
ELANTRA V 1.6	G4FG, G4LA	06/11 →
ELANTRA V 1.6 T-GDi [ExtraEU]	G4FJ	02/16 →
I10 II 1.2	G4LA	12/13 →
I20 1.2 CVVT	G4LA	05/15 →
I20 1.4 CVVT	G4LC	05/15 →
I20 1.4 CVVT LPG	G4FA	12/08 → 12/12
I20 II 1.2	G4LA	03/12 → 12/15
I20 II 1.2	G4LA, G4FA	11/14 →
I20 II 1.2 LPGI	G4LA	11/14 →
I20 II 1.4	G4LC	05/15 →
I30 1.4 CVVT	G4LC	05/15 →
I30 1.4 CVVT LPG	G4FA, G4FD	01/09 → 06/12
I30 1.4 LPG	G4FA	01/13 →
I30 1.6 CVVT	G4FC	06/14 →
I30 1.6 GDi	G4FD, G4FA	07/14 →
I30 I 1.4	G4FA, G4FA	10/07 → 06/12
I30 II 1.4	G4FA, G4FC	12/11 →
I30 II 1.6	G4FC, G4LC	12/11 →
I30 II 1.6 CVVT [ExtraEU]	G4FC	03/16 →
I30 II 1.6 GDi	G4FD	12/11 →
I30 II 1.6 MPI	G4FC	11/16 →
I30 II 1.6 T-GDi	G4FJ	01/15 →
I30 III 1.4 MPI	G4LC, G4FC	11/16 →
I30 III 1.4 T-GDi	G4LD	11/16 →
I40 1.6 GDi	G4FD	07/11 →
IONIQ 1.6 GDi Hybrid	G4LE	03/16 →
IX20 1.4	G4FA	11/10 →
IX20 1.4 CVVT [ExtraEU]	G4FA	11/10 →
IX20 1.4 LPG	G4FA	11/10 →
IX20 1.6	G4FC	11/10 →
IX20 1.6 LPG ECONEXT	G4FC	03/15 →
IX35 1.6	G4FD	11/10 →
KONA 1.6 T-GDi	G4FJ	07/17 →
KONA 1.6 T-GDi 4WD	G4FJ	06/17 →
SB 11 1.4	--	01/11 →
SB 11 1.6	--	01/11 →
SOLARIS 1.4 16V	--	01/11 →
SOLARIS 1.6	G4FC, G4FC	01/17 →
SOLARIS 1.6 16V	--	01/11 →
TUCSON 1.6 T-GDi	G4FJ	06/15 →
TUCSON 1.6 T-GDi Trazione integrale	G4FJ	06/15 →
VELOSTER 1.6	G4FG	06/11 →
VELOSTER 1.6 GDi	G4FD	03/11 →
VELOSTER 1.6 GDi [ExtraEU]	G4FD	01/11 →
VELOSTER 1.6 MPI	G4FC	04/11 →
VELOSTER 1.6 T-GDi	G4FJ	10/12 →

KIA		
CARENS III 1.6 CVVT	G4FC, G4FA	08/09 →
CARENS IV 1.6 GDi	G4FD	03/13 →
CEED II 1.4 CVVT	G4FA, G4FC	05/12 →
CEED II 1.4 LPG	G4FA	05/12 →
CEED II 1.4 MPI	G4LC	04/15 →
CEED II 1.6 CVVT	G4FC, G4FC	05/12 →
CEED II 1.6 GDi	G4FD	05/12 →
CEED II 1.6 GT	G4FJ	06/13 →
CEED III 1.6	G4FG	03/18 →
CEED III 1.6 T-GDi GT	G4FJ	10/18 →
CERATO 1.6 CVVT [ExtraEU]	G4FC	06/13 →
CERATO 1.6 T-GDi [ExtraEU]	G4FJ	09/14 →
CERATO II 1.6	G4FC	01/10 →
CERATO II 1.6 CVVT	G4FC, G4FA	02/09 →
CERATO III 1.6	--	07/12 →
CERATO III 1.6 CVVT	G4FC	07/16 →
FORTE III 1.6	--	07/12 →
NIRO 1.6 GDi Hybrid	G4LE	09/16 →
OPTIMA IV 1.6 T-GDi	G4FJ	01/18 →
PICANTO II 1.2	G4LA	09/11 →
PROCEED 1.6 T-GDi	G4FJ	10/18 →
PRO CEE'D II 1.4 CVVT	G4FA, G4LC	03/13 →
PRO CEE'D II 1.4 MPI	G4LC, G4FA	07/13 →
PRO CEE'D II 1.6 CVVT	G4FC	03/13 →
PRO CEE'D II 1.6 GDi	G4FD	03/13 →
PRO CEE'D II 1.6 GT	G4FJ	06/13 →
PRO CEE'D 1.6 GDi	G4FD	04/15 →
RIO III 1.2	G4LA	09/11 →
RIO III 1.2 CVVT	G4LA	11/14 →
RIO III 1.25 CVVT	G4LA	09/11 →
RIO III 1.25 LPG	G4LA	09/11 →
RIO III 1.4 CVVT	G4FA, G4FC	06/11 →
RIO III 1.6 CVVT	G4FC	06/12 →
RIO 1.2 CVVT	G4LA	04/15 →
RIO 1.4 CVVT	G4FA	04/15 →
RIO IV 1.6	G4FG	07/17 →
SOUL 1.6 LPG	G4FG	12/14 →
SOUL I 1.6	G4FC	09/09 → 12/14

KIA		
SOUL I 1.6 CVVT	G4FC	03/12 →
SOUL I 1.6 Flex	--	01/11 →
SOUL I 1.6 GDi	G4FD	06/11 →
SOUL I 1.6 LPG	G4FC	06/11 → 12/14
SOUL II 1.6 CVVT	G4FC, G4FC	02/14 →
SOUL II 1.6 GDi	G4FD	02/14 →
SOUL II 1.6 MPI [ExtraEU]	G4FC, G4FD	07/16 →
SOUL II 1.6 TGD I	G4FJ	11/16 →
SPORTAGE III 1.6 GDi	G4FD	02/11 →
SPORTAGE III 1.6 LPG	G4FD	01/14 → 12/15
SPORTAGE IV 1.6 GDi	G4FD, G4FA	09/15 →
SPORTAGE IV 1.6 GDi AWD	G4FJ	09/15 →
VENGA 1.4 CVVT	G4FA-L	02/10 →
VENGA 1.4 LPG	G4FA	02/10 →
VENGA 1.6 CVVT	G4FC	02/10 →
VENGA CVVT	G4FA, 6B31	02/15 →

9.0710  **3**

REVOLUTION AND TIMING (CKP AND CMP) SENSORS

Adatt./Suitable:

- FIAT**
9948812
- MITSUBISHI**
2702A036
G4T07371
G4T07381
- NISSAN**
31935-1XK0C
31935-AN600
- RENAULT**
77 01 065 844
77 01 067 658

MARKET DIFFUSION: **MEDIUM**



L	L1		
---	36,6	Hall Effect	

FIAT		
PALIO 1.2	188A5.000	09/01 →
PUNTO II 1.2 16V	188A5.000	06/03 →
PUNTO II 1.2 16V 80	188A5.000	09/99 → 12/06
PUNTO II 1.2 60	188A4.000	09/99 → 12/10
PUNTO II 1.8 130 HGT	183A1.000	09/99 → 03/12
SIENA 1.2	188A5.000	09/01 → 12/09

MITSUBISHI		
OUTLANDER II 3.0 4WD	6B31, CG10DE	11/06 → 11/12
OUTLANDER II 3.0 FWD	6B31	11/06 → 11/12
OUTLANDER III 2.2 Di-D	4N14	08/12 →
OUTLANDER III 2.2 Di-D 4WD	4N14	08/12 →
OUTLANDER III 3.0	6B31	08/12 →

NISSAN		
MICRA II 1.0 i 16V	CG10DE, M1D	09/00 → 02/03
MICRA II 1.4 i 16V	CGA3DE	09/00 → 02/03
MURANO II 2.5 dCi 4x4	YD25DDTi	01/10 → 09/14
QASHQAI I 2.0 dCi	M1D, M1D	02/07 → 12/13
QASHQAI I 2.0 dCi Trazione integrale	M1D, M9R761	02/07 → 12/13
X-TRAIL II 2.0 dCi	M9R760	06/07 → 11/13
X-TRAIL II 2.0 dCi 4x4	M9R	06/07 → 11/13

RENAULT		
ESPACE IV 2.0 dCi	M9R761, M9R805	01/06 →
GRAND SCÉNIC II 2.0 dCi	M9R721	09/05 →
GRAND SCÉNIC III 2.0 dCi	M9R615	02/09 →
KOLEOS 2.0 dCi	M9R833	09/08 →
LAGUNA III 2.0	F4R813	02/08 →
LAGUNA III 2.0 16V Turbo	F4R811	10/07 → 12/15
LAGUNA III 2.0 dCi	M9R805, V9X891	10/07 → 12/15

RENAULT		
LAGUNA III 3.0 dCi	V9X891, M9R817	09/08 → 12/15
LAGUNA III 3.5 V6	V4Y713	04/08 → 12/15
LATITUDE 2.0 dCi 175	M9R817, 2GR-FSE	05/11 →
LATITUDE 2.5 V6	2ZV604	05/11 →
LATITUDE 3.0 dCi 240	V9X891	02/11 →
LATITUDE 3.5	5ZV604	05/11 →
MEGANE III 2.0 dCi	M9R615	04/09 →
SCÉNIC II 2.0 dCi	M9R721	09/05 →
SCÉNIC III 2.0 dCi	M9R615	02/09 →

9.0713  **1**

REVOLUTION AND TIMING (CKP AND CMP) SENSORS

Adatt./Suitable:

- ASTON MARTIN**
90919-05060
- DAIHATSU**
90919-05060
- DENSO**
07H18 1290
- LEXUS**
90919-05060
90919-C5001
- SUBARU**
90919-05060
- TOYOTA**
90919-05060
90919-C5001

MARKET DIFFUSION: **HIGH**



L	L1		
---	30	Hall Effect	

ASTON MARTIN		
CYGNET 1.3	1NR-FE	04/11 → 10/13

DAIHATSU		
CHARADE VI 1.33 16V	1NR-FE	05/11 →

LEXUS		
CT 200h	2ZR-FXE	12/10 →
ES 200	6AR-FSE	08/15 →
ES 250	2AR-FE	06/12 →
ES 3.5	2GR-FE	05/06 → 06/12
ES 300h	2AR-FXE	06/12 →
ES 350	2GR-FE	06/12 →
GS 250	4GR-FSE	01/12 →
GS 3.5 VVTi	2GR-FSE	04/05 → 12/12
GS 3.5 VVTi [ExtraEU]	2GR-FSE, 3GR-FE	09/06 → 11/11
GS 300	3GR-FE, 2GR-FSE	04/05 → 11/11
GS 300h	2AR-FSE	10/13 →
GS 350	2GR-FSE, 2GR-FSE	01/12 →
GS 350 AWD	2GR-FSE	09/06 →
GS 450h	2GR-FSE, 4GR-FSE	02/06 →
GS 460	1UR-FSE	09/07 → 11/11
GS F	2UR-GSE	09/15 →
GX 460 4WD	1UR-FE	01/10 →
IS II 250	4GR-FSE, 4GR-FSE	08/05 →
IS II 250 AWD	4GR-FSE, 2GR-FSE	10/05 → 03/13
IS II 350	2GR-FSE, 2UR-GSE	01/08 →
IS II S F	2UR-GSE	11/07 → 03/13
IS III 250	4GR-FSE	04/13 →
IS III 300h	2AR-FSE	04/13 →
LC 500	2UR-GSE, 1LR-GUE	11/16 →
LC 500h	8GR-FXS	11/16 →
LFA 4.8	1LR-GUE, 1UR-FE	12/10 → 11/12
LS IV 460	1UR-FE, 1UR-FSE	04/06 →
LS IV 460 4WD	1UR-FSE	08/06 →
LS IV 460 AWD	1UR-FSE, 2UR-FSE	12/08 →

LEXUS			
LS IV 600h AWD	2UR-FSE, 3UR-FE	04/07	⇒
LS V 350	8GR-FKS	10/18	⇒
LS V 500h	8GR-FXS	10/17	⇒
LS V 500h AWD	8GR-FXS	10/17	⇒
LS 4.6 VVTi [ExtraEU]	1UR-FSE	10/09	⇒
LS 5.0 VVTi Hybrid [ExtraEU]	2UR-FSE	04/07	⇒
LX 570	3UR-FE, 2UR-GSE	08/07	⇒
NX 2.5 VVTi Hybrid [ExtraEU]	2AR-FXE	07/14	⇒
NX 200	3ZR-FAE	11/14	⇒
NX 200 AWD	3ZR-FAE	11/14	⇒
NX 300h	2AR-FXE	07/14	⇒
NX 300h AWD	2AR-FXE	07/14	⇒
RC 3.5 [ExtraEU]	2GR-FSE	08/14	⇒
RC 300h	2AR-FSE	09/14	⇒
RC F	2UR-GSE, 2GR-FE	08/14	⇒
RX II 300	1MZ-FE	05/03	⇒ 12/08
RX II 330	3MZ-FE	04/03	⇒ 01/06
RX II 330 AWD	3MZ-FE	04/03	⇒ 12/08
RX II 350	2GR-FE	01/06	⇒ 12/08
RX II 350 AWD	2GR-FE	02/06	⇒ 12/08
RX III 270	1AR-FE	12/08	⇒ 10/15
RX III 350	2GR-FE	01/09	⇒ 09/15
RX III 350 AWD	2GR-FE, 1NR-FE	12/08	⇒ 08/15
RX III 450h	2GR-FXE	12/08	⇒ 10/15
RX III 450h AWD	2GR-FXE	12/08	⇒ 10/15
RX IV 3.5 VVTi Hybrid [ExtraEU]	2GR-FXS	10/15	⇒
RX IV 350 AWD	2GR-FKS	10/15	⇒
RX IV 450h AWD	2GR-FXS	11/15	⇒

SUBARU

TREZIA 1.3	1NR-FE	03/11	⇒
------------	--------	-------	---

TOYOTA

AURION 3.5	2GR-FE	03/06	⇒ 09/11
AURION 3.5 VVTi [ExtraEU]	2GR-FE	09/11	⇒
AURIS I 1.33 Dual-VVTi	1NR-FE, 1ZR-FAE	05/09	⇒ 09/12
AURIS I 1.6	1ZR-FAE, 2ZR-FAE	03/07	⇒ 09/12
AURIS I 1.8	2ZR-FAE, 3ZR-FAE	10/06	⇒ 09/12
AURIS I 1.8 4WD	2ZR-FAE	02/09	⇒ 09/12
AURIS I 1.8 Hybrid	2ZR-FXE	09/10	⇒ 09/12
AURIS II 1.2	8NR-FTS	03/15	⇒
AURIS II 1.3	1NR-FE	10/12	⇒
AURIS II 1.6	1ZR-FAE	10/12	⇒
AURIS II 1.8 Hybrid	2ZR-FXE	10/12	⇒
AVENSIS III 1.6	1ZR-FAE	11/08	⇒
AVENSIS III 1.8	2ZR-FAE	11/08	⇒
AVENSIS III 2.0	3ZR-FAE, 6ARFSE	11/08	⇒
CAMRY 2.0	6ARFSE, 2AR-FE	12/14	⇒
CAMRY 2.5	2AR-FE, 2GR-FE	01/10	⇒
CAMRY 2.5 [CHN]	5AR-FE	12/11	⇒
CAMRY 2.5 Hybrid	2AR-FXE	09/11	⇒
CAMRY 2.5 Hybrid [CHN]	4AR-FXE	05/12	⇒
CAMRY 3.5	2GR-FE, 2ZR-FXE	01/06	⇒
CAMRY 3.5 VVTi [ExtraEU]	2GR-FE	01/06	⇒ 12/11
C-HR 1.2	8NR-FTS	10/16	⇒
C-HR 1.2 4WD	8NR-FTS	10/16	⇒
C-HR 1.8 Hybrid	2ZR-FXE, 1ZR-FAE	10/16	⇒
C-HR 2.0	3ZR-FAE	11/16	⇒
COROLLA 1.2	8NR-FTS	01/19	⇒
COROLLA 1.8 Hybrid	2ZR-FXE	10/18	⇒
COROLLA IX 1.6	1ZR-FE	11/06	⇒ 07/07
COROLLA X 1.33	1NR-FE	12/08	⇒ 07/14
COROLLA X 1.6	1ZR-FAE, 1ZR-FE	11/06	⇒ 11/13
COROLLA X 1.6 Dual VVTi	1ZR-FE	01/07	⇒ 07/14
COROLLA X 1.6 VVTi	1ZR-FE, 2ZR-FAE	03/07	⇒ 05/14
COROLLA X 1.8	2ZR-FAE, 2ZR-FBE	09/06	⇒
COROLLA X 1.8 4WD	2ZR-FAE	09/06	⇒
COROLLA X 1.8 VVTi	2ZR-FBE, 1ZR-FAE	01/08	⇒
COROLLA X 2.0	3ZR-FE	04/10	⇒
COROLLA X 2.0 FlexFuel	3ZR-FBE	04/10	⇒
COROLLA X 2.0 VVTi	3ZR-FE	08/10	⇒
COROLLA XI 1.3	1NR-FE	05/12	⇒
COROLLA XI 1.5	1NZ-FE	05/12	⇒
COROLLA XI 1.6	1ZR-FAE, 1GR-FE	06/13	⇒
COROLLA XI 1.6 BiFuel	1ZR-FE	06/13	⇒
COROLLA XI 1.8	2ZR-FAE	05/12	⇒
COROLLA XI 1.8 [USA] [CAN]	2ZR-FAE	08/13	⇒
COROLLA XI 1.8 VVTi	2ZR-FE	06/13	⇒
COROLLA XI 1.8 VVT-i	2ZR-FE	12/13	⇒
FJ CRUISER 4.0	1GR-FE, 1GR-FE	06/05	⇒ 06/14
FJ CRUISER 4.0 4WD	1GR-FE, 2GR-FE	06/05	⇒
FORTUNER 2.8 [ExtraEU]	1GD-FTV	05/15	⇒
FORTUNER 2.8 4x4	1GD-FTV	05/15	⇒
PRIUS 1.8 Hybrid	2ZR-FXE	03/12	⇒
HIGHLANDER / KLUGER 2.7 VVTi [ExtraEU]	1AR-FE	09/16	⇒
HIGHLANDER / KLUGER 3.5 AWD	2GR-FE, 2GD-FTV	09/14	⇒
HILUX VII 4.0	1GR-FE	02/05	⇒

TOYOTA

HILUX VII 4.0 4WD	1GR-FE	02/05	⇒
HILUX VIII 2.4 D	2GD-FTV	05/15	⇒
HILUX VIII 2.4 D 4WD	2GD-FTV, 1NR-FE	05/15	⇒
HILUX VIII 2.8 D	1GD-FTV	05/15	⇒
HILUX VIII 2.8 D 4WD	1GD-FTV	05/15	⇒
IQ 1.33	1NR-FE, 1GR-FE	01/09	⇒
LAND CRUISER 2.8 D4d	1GD-FTV	10/18	⇒
LAND CRUISER 120 4.0	1GR-FE, 1GD-FTV	09/02	⇒ 12/10
LAND CRUISER 120 4.0 V6 VVT-i	1GR-FE	01/03	⇒ 07/09
LAND CRUISER 200 4.0	1GR-FE	01/10	⇒
LAND CRUISER 200 4.6 V8	1UR-FE, 3UR-FE	09/10	⇒
LAND CRUISER 200 5.7 V8	3UR-FE, 2ZR-FXE	08/07	⇒
LAND CRUISER 150 2.8 D-4D	1GD-FTV, 1GR-FE	06/15	⇒
LAND CRUISER 150 3.5	7GR-FKS	09/15	⇒
LAND CRUISER 150 4.0 V6 Dual VVTi	1GR-FE	08/09	⇒
LAND CRUISER 150 4.0 V6 VVTi	1GR-FE, 1UR-FE	08/09	⇒
LAND CRUISER 150 4.0 V6 VVT-i	1GR-FE	08/09	⇒
LAND CRUISER PRADO 120 4.0	1GR-FE	01/03	⇒ 08/09
LAND CRUISER PRADO 150 4.0 V6 VVTi	1GR-FE	08/09	⇒
MATRIX 1.8	2ZR-FE	01/08	⇒ 05/14
PREVIA III 3.5	2GR-FE	01/06	⇒
PREVIA III 3.5 4WD	2GR-FE	01/06	⇒
PRIUS III 1.8 Hybrid	2ZR-FXE, 3ZR-FAE	06/08	⇒
PRIUS III 1.8 Hybrid [ExtraEU]	2ZR-FXE	06/08	⇒
PRIUS III 1.8 Plug-in Hybrid	2ZR-FXE	01/12	⇒
PRIUS IV 1.8 Hybrid	2ZR-FXE	09/15	⇒
PRIUS IV 1.8 Plug-in Hybrid	2ZR-FXE	01/16	⇒
RACTIS 1.3 VVTi [ExtraEU]	1NR-FE	07/10	⇒ 04/14
RACTIS 1.5 VVTi [ExtraEU]	1NZ-FE	07/11	⇒
RAV 4 IV 2.0	3ZR-FE	12/12	⇒
RAV 4 IV 2.0 4WD	3ZR-FAE, 2AR-FXE	12/12	⇒
RAV 4 IV 2.0 VVTi [ExtraEU]	3ZR-FE	12/12	⇒
RAV 4 IV 2.5	2AR-FE	12/12	⇒
RAV 4 IV 2.5 4WD	2AR-FE	12/12	⇒
RAV 4 IV 2.5 Hybrid	2AR-FXE, 2AR-FXE	10/15	⇒
RAV 4 IV 2.5 Hybrid 4WD	2AR-FXE, 1NR-FE	10/15	⇒
RAV 4 III 2.0	3ZR-FAE, 3ZR-FAE	12/08	⇒ 06/13
RAV 4 III 2.0 4WD	3ZR-FAE, 2GR-FE	12/08	⇒ 06/13
RAV 4 III 2.5	2AR-FE	12/08	⇒
RAV 4 III 3.5 4WD	2GR-FE, 3ZR-FAE	11/05	⇒
SIENNA 2.7 VVTi [ExtraEU]	1AR-FE	09/10	⇒ 07/13
SIENNA 3.5	2GR-FE	01/10	⇒
SIENNA 3.5 4WD	2GR-FE	01/10	⇒
SIENNA 3.5 VVTi [ExtraEU]	2GR-FE	01/10	⇒
URBAN CRUISER 1.33	1NR-FE, 1NR-FE	01/09	⇒ 03/16
VELLFIRE 3.5	2GR-FE	04/08	⇒ 12/14
VENZA 2.7	1AR-FE	11/08	⇒ 11/16
VENZA 2.7 4WD	1AR-FE	11/08	⇒ 11/16
VENZA 2.7 VVTi [ExtraEU]	1AR-FE	11/08	⇒ 04/12
VENZA 3.5	2GR-FE	11/08	⇒ 11/16
VENZA 3.5 4WD	2GR-FE	11/08	⇒ 11/16
VERSO 1.6	1ZR-FAE	04/09	⇒
VERSO 1.8	2ZR-FAE	04/09	⇒
VERSO S 1.33	1NR-FE	11/10	⇒ 10/16
YARIS II 1.33 VVT-i	1NR-FE, K3-VE	11/08	⇒ 12/11
YARIS II 1.6 [CHN]	1ZR-FE	05/08	⇒
YARIS II 1.8 VVTi	2ZR-FE	01/07	⇒ 12/11
YARIS III 1.3	1NR-FE	09/11	⇒
YARIS III 1.3 4WD	1NR-FE	12/10	⇒
YARIS III 1.5	2NR-FKE	03/17	⇒
YARIS III 1.8 GRMN	2ZR-FE	09/17	⇒
YARIS 1.3 VVTi	1NR-FE	10/12	⇒

REVOLUTION AND TIMING (CKP AND CMP) SENSORS

Adatt./Suitable:

DAIHATSU

19311-9740
19311-97401
19311-97401-000

DENSO

029600-1000

TOYOTA

90919-05043

MARKET DIFFUSION: MEDIUM



L	L1	ohm	
---	30,3	2100	

DAIHATSU

MATERIA 1.3	K3-VE	10/06	⇒
MATERIA 1.5	3S2-VE	10/06	⇒
MATERIA 1.5 ECO 4WD	3S2-VE	10/06	⇒
MATERIA 1.5 LPG	3S2-VE	01/10	⇒ 12/11
SIRION 1.0 i	EJ-DE	04/98	⇒ 09/00
SIRION 1.0 i 4WD	EJ-DE	04/99	⇒ 09/00
SIRION 1.3 Rally	K3-VE	06/02	⇒ 03/05
SIRION 1.3 Rally 4WD	K3-VE	06/02	⇒ 03/05
SIRION 1.3 Sport	K3-VE, 3S2-VE	08/00	⇒ 01/05
SIRION 1.3 Sport 4WD	K3-VE2	08/00	⇒ 03/05
TERIOS 1.3	K3-VE	09/01	⇒ 10/05
TERIOS 1.3 4WD	K3-VE	10/00	⇒ 10/05
TERIOS 1.3 VVT-i Turbo 4WD	K3-VE	10/02	⇒ 10/05
TERIOS II 1.3 VVT-i 4x4	K3-VE	11/05	⇒
TERIOS II 1.3 VVT-i LPG 4x4	K3-VE	01/09	⇒ 12/09
TERIOS II 1.5 4x4	3S2-VE	05/06	⇒
TERIOS II 1.5 LPG 4x4	3S2-VE	06/09	⇒
TERIOS II 1.5 VVT-i 4x4	3S2-VE	09/10	⇒
TERIOS II 1.5 VVT-i RWD	3S2-VE, 1S2-VE	11/05	⇒
YRV 1.0	EJ-VE	02/01	⇒
YRV 1.3	K3-VE	02/01	⇒
YRV 1.3 4WD	K3-VE	02/01	⇒
YRV 1.3 GTi	K3VT	07/02	⇒

TOYOTA

VIOS / YARIS 1.3	2S2-FE	09/05	⇒ 10/13
YARIS I 1.0	1S2-FE, 2S2-FE	03/03	⇒ 09/05
YARIS I 1.3	2S2-FE	04/02	⇒ 09/05
YARIS II 1.3 VVT-i	2S2-FE, 2ZZ-GE	08/05	⇒ 12/12

9.0719



04,5

REVOLUTION AND TIMING (CKP AND CMP) SENSORS

Adatt./Suitable:

TOYOTA
89413-52010

L	L1	ohm	
300	30,3	640	

TOYOTA

YARIS I 1.0	1SZ-FE	04/99 ⇨ 09/05
-------------	--------	---------------

9.0720



04,5

REVOLUTION AND TIMING (CKP AND CMP) SENSORS

Adatt./Suitable:

DENSO
029600-0754
029600-0755

TOYOTA
90919-05030

MARKET DIFFUSION: MEDIUM



L	L1	ohm	
460	30	2090	

TOYOTA

AURIS I 1.4	4ZZ-FE	03/07 ⇨ 09/12
AVENSIS I 1.6	3ZZ-FE	07/00 ⇨ 02/03
AVENSIS I 1.6 VVT-i	3ZZ-FE	10/00 ⇨ 02/03
AVENSIS I 1.8	1ZZ-FE	10/00 ⇨ 02/03
AVENSIS I 1.8 VVT-i	1ZZ-FE	10/00 ⇨ 02/03
AVENSIS II 1.6 VVT-i	3ZZ-FE	04/03 ⇨ 11/08
AVENSIS II 1.8	1ZZ-FE	03/03 ⇨ 11/08
CELICA VII 1.8 16V VT-i	1ZZ-FE	08/99 ⇨ 07/05
COROLLA VIII 1.4	4ZZ-FE	10/99 ⇨ 01/02

TOYOTA

COROLLA VIII 1.4 16V	4ZZ-FE	02/00 ⇨ 11/01
COROLLA VIII 1.6	3ZZ-FE	10/99 ⇨ 01/02
COROLLA VIII 1.6 16V	3ZZ-FE	10/99 ⇨ 10/01
COROLLA IX 1.4 VVT-i	4ZZ-FE	10/01 ⇨ 02/07
COROLLA IX 1.6 VVT-i	3ZZ-FE	10/01 ⇨ 03/08
COROLLA IX 1.8 VVT-i TS	2ZZ-GE, 3ZZ-FE	01/02 ⇨ 02/07
COROLLA X 1.4 VVT-i	4ZZ-FE	11/06 ⇨ 11/13
COROLLA X 1.6 VVTi	3ZZ-FE, G4FA	08/07 ⇨ 06/13
COROLLA X 1.8 16V	1ZZ-FE	08/07 ⇨
COROLLA X 1.8 CNG	1ZZ-FE	06/09 ⇨
COROLLA X 1.8 FlexFuel [BRA]	1ZZ-FBE	03/08 ⇨
COROLLA VERSO I 1.6 VVT-i	3ZZ-FE	08/01 ⇨ 05/04
COROLLA VERSO I 1.8 VVT-i	1ZZ-FE	12/01 ⇨ 05/04
COROLLA VERSO I 1.8 VVTi 4WD	1ZZ-FE	07/01 ⇨ 02/04
COROLLA VERSO II 1.6	3ZZ-FE	04/04 ⇨ 03/09
COROLLA VERSO II 1.8	1ZZ-FE	04/04 ⇨ 03/09
MR 2 III 1.8 16V VT-i	1ZZ-FE	10/99 ⇨ 06/07
RAV 4 II 1.8	1ZZ-FE	08/00 ⇨ 11/05

9.0728



04,5

REVOLUTION AND TIMING (CKP AND CMP) SENSORS

Adatt./Suitable:

DENSO
029600-1551

SUBARU
90919-05074 *1a

TOYOTA
90919-05074 *1a

- NEW - AVAILABLE FROM:

- NUOVO - DISPONIBILE DA:
- NOUVEAU - DISPONIBLE EN:
- NEU - VERFUEGBAR AB:
- NUEVO - DISPONIBLE EN:

19/Q3

*1a without synthetic carrier

- senza supporto in plastica
- sans support plastique
- ohne Kunststoffträger
- sin soporte plástico



L	L1	ohm	
480	36,5	2150	

SUBARU

TREZIA 1.4 D	1ND-TV	03/11 ⇨
--------------	--------	---------

TOYOTA

AURIS I 1.4 D-4D	1ND-TV	03/07 ⇨ 04/13
AURIS II 1.4 D-4D	1ND-TV	10/12 ⇨
COROLLA XI 1.4 D-4D	1ND-TV	06/13 ⇨
URBAN CRUISER 1.4 D-4D	1ND-TV	01/09 ⇨ 04/14
URBAN CRUISER 1.4 D-4D 4WD	1ND-TV	01/09 ⇨ 04/14
VERSO S 1.4 D4-D	1ND-TV	11/10 ⇨ 10/16
YARIS II 1.4 D-4D	1ND-TV	08/05 ⇨ 12/12
YARIS III 1.4 D	1ND-TV	09/11 ⇨
YARIS I 1.4 D4d	1ND-TV	07/14 ⇨

9.0735



3

REVOLUTION AND TIMING (CKP AND CMP) SENSORS

Adatt./Suitable:

HYUNDAI
42620-39050
42620-39051
42620-39100

KIA
42620-39051
42620-39100

- AVAILABLE FROM:

- DISPONIBILE DA:
- DISPONIBLE EN:
- VERFUEGBAR AB:
- DISPONIBLE EN:

20/Q1



L	L1	Hall Effect	
---	27	Hall Effect	

HYUNDAI

ACCENT IV 1.4	G4FA, G4FC	11/10 ⇨
ACCENT IV 1.4 CVT	--	11/10 ⇨
ACCENT IV 1.6	G4FC, G4GC-G	11/10 ⇨
ACCENT IV 1.6 CRDi	D4FB	11/10 ⇨ 12/15
COUPE II 2.0	G4GC-G, G4BB	08/01 ⇨ 08/09
COUPE II 2.0 GLS	G4GC-G	02/03 ⇨ 08/09
COUPE II 2.7 V6	G6BA-G	03/02 ⇨ 08/09
ELANTRA III 1.8	G4BB, G4GC	06/00 ⇨ 07/06
ELANTRA III 2.0	G4GC, G4GC	06/00 ⇨ 07/06
ELANTRA IV 1.6 CVVT	G4FC	06/06 ⇨ 06/11
ELANTRA IV 2.0 CVVT	G4GC, D4EB	06/06 ⇨ 06/11
EQUUS / CENTENNIAL I 3.5	G6CU	10/99 ⇨ 03/09
EQUUS / CENTENNIAL I 4.5	8A80	10/99 ⇨ 09/03
GRANDEUR 2.2 CRDi	D4EB, G4HG	06/06 ⇨ 12/11
GRANDEUR 2.7	G6BA	05/06 ⇨ 10/10
GRANDEUR 3.3	G6DB	04/05 ⇨ 12/10
I10 I 1.1	G4HG, G4LA	12/07 ⇨ 12/13
I10 I 1.2	G4LA, D4EA	11/08 ⇨ 12/13
I10 II 1.0	G3LA	08/13 ⇨
I10 II 1.2	G4LA	12/13 ⇨
I20 I 1.4	G4FA	09/08 ⇨ 12/15
IX20 1.6	G4FC	11/10 ⇨
LANTRA II 1.8	G4GB	06/00 ⇨
LANTRA II 2.0	G4GC-G	06/00 ⇨
SANTA FE I 2.0	G4BP	08/01 ⇨ 03/06
SANTA FE I 2.0 CRDi	D4EA	08/01 ⇨ 03/06
SANTA FE I 2.0 CRDi 4x4	D4EA, G6BA	04/01 ⇨ 03/06
SANTA FE I 2.0 CRDi Trazione integrale	D4EA	11/03 ⇨ 02/06
SANTA FE I 2.2 CRDi	D4EB	10/05 ⇨ 03/06
SANTA FE I 2.4 16V	G4JS-G	02/01 ⇨ 03/06
SANTA FE I 2.4 16V 4x4	G4JS-G	02/01 ⇨ 03/06
SANTA FE I 2.7	G6EA	10/05 ⇨ 03/06
SANTA FE I 2.7 4x4	G6BA, G6BA	09/02 ⇨ 03/06
SANTA FE I 2.7 V6 4x4	G6BA, D4EB	02/01 ⇨ 03/06
SANTA FE I 3.5	G6CU	09/03 ⇨ 02/06
SANTA FE I 3.5 4x4	G6CU	09/03 ⇨ 02/06
SANTA FE II 2.2 CRDi	D4EB, D4EB	03/06 ⇨ 12/12
SANTA FE II 2.2 CRDi 4x4	D4EB, G4JP-EG	10/05 ⇨ 12/12
SANTA FE II 2.2 CRDi GLS	D4EB	03/06 ⇨ 12/09
SANTA FE II 2.2 CRDi GLS 4x4	D4EB	03/06 ⇨ 12/09
SOLARIS 1.4 16V	--	01/11 ⇨
SOLARIS 1.6 16V	--	01/11 ⇨
SONATA IV 2.0 16V	G4JP-EG, G6BA	10/01 ⇨ 11/04
SONATA IV 2.4 16V	G4BS	03/98 ⇨ 10/01
SONATA IV 2.5 V6 24V	G6BV-G	06/98 ⇨ 10/01
SONATA IV 2.7 V6	G6BA, G6DB	10/01 ⇨ 11/04
SONATA V 2.0 [RUS]	--	01/05 ⇨ 04/06
SONATA V 2.0 CRDi	D4EA	02/06 ⇨ 12/10
SONATA V 2.0 i [RUS]	--	04/06 ⇨ 12/10
SONATA V 2.0 VVTi GLS	G4KA	05/05 ⇨ 12/10

HYUNDAI			
SONATA V 2.4	G4KC	01/05 →	12/10
SONATA V 2.7 V6 [RUS]	--	01/05 →	12/10
SONATA V 3.3	G6DB, G4GC	01/05 →	12/10
TRAJET 2.0	G4GC, D4EA	03/00 →	07/08
TRAJET 2.0 CRDi	D4EA, D4EA	04/01 →	07/08
TRAJET 2.7 V6	G6BA-G	09/00 →	07/08
TUCSON 2.0	G4GC	08/04 →	
TUCSON 2.0 CRDi	D4EA, D4EA	08/04 →	03/10
TUCSON 2.0 CRDi Trazione integrale	D4EA, G4GC	08/04 →	03/10
TUCSON 2.0 Trazione integrale	G4GC, D4EA	08/04 →	11/10
TUCSON 2.7 Trazione integrale	G6BA-G	08/04 →	
XG 250	G6AV	12/98 →	12/05
XG 30	G6CT-G	12/98 →	12/05
XG 350	G6CU	10/02 →	12/05

KIA			
AMANTI 3.5 [CAN] [USA]	--	09/03 →	
CARENS II 2.0 CRDi	D4EA, G4FC	07/02 →	
CARENS II 2.0 CVVT	G4GC	08/04 →	
CARENS III 2.0 CRDi 140	D4EA	09/06 →	
CARENS III 2.0 CVVT	G4KA	09/06 →	
CARNIVAL I 2.5 V6	K5	08/99 →	06/06
CARNIVAL I 3.5	G6CU	07/02 →	04/06
CARNIVAL II 2.7 V6	G6EA	06/06 →	
CARNIVAL II 2.9 CRDi	J3	06/06 →	
CARNIVAL II 2.9 CRDi LX	J3	09/06 →	
CEED I 1.6	G4FC, G4FC	12/06 →	12/12
CEED I 1.6 CRDi 128	D4FB	10/10 →	12/12
CEED I 1.6 CVVT	G4FC	06/09 →	12/12
CEED I 2.0	G4GC	12/06 →	12/12
CERATO I 1.6	G4FC	05/06 →	
CERATO I 1.6 CRDi	D4FB	06/05 →	
CERATO I 2.0	G4GC	04/04 →	
CERATO II 1.6	G4FC	01/10 →	
CERATO II 1.6 CVVT	G4FC, G4KD	02/09 →	
CERATO II 2.0	G4KD, G4JP	01/09 →	
CERATO II 2.0 CVVT	--	01/09 →	
MAGENTIS I 2.0	G4JP	05/01 →	09/05
MAGENTIS I 2.4 [USA]	--	01/01 →	12/04
MAGENTIS I 2.5 V6	G6BV	05/01 →	
MAGENTIS I 2.7 V6	G6BA	04/04 →	
MAGENTIS II 2.0	G4JP, D4EA	11/05 →	
MAGENTIS II 2.0 CRDi	D4EA, G6BA	11/05 →	
MAGENTIS II 2.7	G6BA, D4FA	11/05 →	
MAGENTIS II 2.7 V6	G6EA	07/09 →	
OPIRUS 3.0	--	05/04 →	08/06
OPIRUS 3.5	G6CU	09/03 →	
OPIRUS 3.8 V6	G6DA	10/06 →	
OPTIMA II 2.0	G4KA	05/08 →	
OPTIMA II 2.0 CRDi	D4EA	09/06 →	
OPTIMA II 2.7	G6EA	09/07 →	
PICANTO I 1.1	--	08/07 →	
PICANTO II 1.0	G3LA	05/11 →	
PICANTO II 1.0 Bi-Fuel	B3LA	05/11 →	
PICANTO II 1.2	G4LA	09/11 →	
PICANTO III 1.0 CVVT [ExtraEU]	G3LA	03/17 →	
PRO CEE'D I 1.6	G4FC	02/08 →	09/12
PRO CEE'D I 1.6 CRDi 128	D4FB	10/10 →	09/12
PRO CEE'D I 1.6 CVVT	G4FC	10/10 →	02/13
PRO CEE'D I 2.0	G4GC	02/08 →	09/12
RIO II 1.5 CRDi	D4FA, G4FA	03/05 →	
RIO III 1.4 CVVT	G4FA, D4EA	06/11 →	
SEDONA 3.5 [CAN] [USA]	--	04/01 →	
SOUL I 1.6 CRDi 115	D4FB	02/09 →	
SOUL I 1.6 CRDi 128	D4FB	02/09 →	
SPORTAGE II 2.0 16V 4WD	G4GC	09/04 →	
SPORTAGE II 2.0 CRDi	D4EA, D4EA	02/05 →	
SPORTAGE II 2.0 CRDi 4WD	D4EA, ABFA	09/04 →	
SPORTAGE II 2.0 i 16V	G4GC	09/04 →	
SPORTAGE II 2.7 V6 4WD	G6BA	09/04 →	
VENGA 1.6 CVVT	G4FC	02/10 →	

9.0745



3

REVOLUTION AND TIMING (CKP AND CMP) SENSORS

Adatt./Suitable:

FORD

256T-9E731-AA

256T-9E731-AB

4 533 778

4 583 104

SWF

605 008

MARKET DIFFUSION: MEDIUM



L	L1		
---	33,9	Hall Effect	

FORD

TRANSIT III 2.0 DI	ABFA, CYFA	08/00 →	05/06
TRANSIT III 2.0 TDCi	FIFA	08/02 →	05/06
TRANSIT III 2.2 TDCi	CYFA, CYRB	04/06 →	08/14
TRANSIT III 2.2 TDCi 4x4	CYRB, CVRA	10/11 →	08/14
TRANSIT III 2.2 TDCi RWD	CVRA, E5FA	09/11 →	
TRANSIT III 2.3	E5FA, E5FA	03/01 →	03/06
TRANSIT III 2.3 16V	E5FA, E5FA	04/01 →	05/06
TRANSIT III 2.3 16V CNG RWD	GZFC	04/06 →	08/14
TRANSIT III 2.3 16V LPG RWD	GZFC	04/06 →	08/14
TRANSIT III 2.3 16V RWD	E5FA, D2FA	08/00 →	08/14
TRANSIT III 2.4 DI	D2FA, D4FA	01/00 →	05/06
TRANSIT III 2.4 DI RWD	D4FA, --	01/00 →	05/06
TRANSIT III 2.4 TD	F4FA	08/00 →	08/03
TRANSIT III 2.4 TD 4x4	F4FA	08/00 →	08/03
TRANSIT III 2.4 TDCi	--, H9FD	03/04 →	
TRANSIT III 2.4 TDCi 4x4	H9FB	11/06 →	08/14
TRANSIT III 2.4 TDCi HPCR	--	07/06 →	
TRANSIT III 2.4 TDCi RWD	H9FD, D2FE	04/06 →	08/14
TRANSIT III 2.4 TDCi	D2FE, DOFA	08/00 →	03/06
TRANSIT III 2.4 TDE	DOFA, SAFA	07/01 →	05/06
TRANSIT III 3.2 TDCi	SAFA, SAFA	02/08 →	08/14
TRANSIT III 3.2 TDCi RWD	SAFA, PGFA	09/07 →	08/14
TRANSIT TOURNEO 2.2 TDCi	PGFA, QG16	07/06 →	08/14

9.0752



3

REVOLUTION AND TIMING (CKP AND CMP) SENSORS

Adatt./Suitable:

INFINTI

23731-AL61A

NISSAN

23731-95F0B

23731-AL615

23731-AL616

23731-AL61A

RENAULT

23 73 1AL 615

23 73 1AL 61A

77 01 060 598



L	L1		
---	37,9	Hall Effect	

NISSAN

ALMERA III 1.6 QG16 01/06 →

ALMERA III 1.6 16V QG16, V4Y711 03/06 →

RENAULT

ESPACE IV 3.5 V6 V4Y711, V4Y701 11/02 →

VEL SATIS 3.5 V4Y715 10/04 →

VEL SATIS 3.5 V6 V4Y701, D4FD 06/02 →

9.0753



04

REVOLUTION AND TIMING (CKP AND CMP) SENSORS

Adatt./Suitable:

HYUNDAI

39180-2A900

KIA

39180-2A900



L	L1	ohm	
340	24,2	900	

HYUNDAI

I40 1.7 CRDi D4FD, D4FD 07/11 →

IX35 1.7 CRDi D4FD 11/10 →

KIA

CARENS IV 1.7 CRDi D4FD, D4FD 03/13 →

OPTIMA III 1.7 CRDi D4FD, D4FD 03/12 →

SPORTAGE III 1.7 CRDi D4FD, G4FA 12/10 →

9.0754



3

REVOLUTION AND TIMING (CKP AND CMP) SENSORS

Adatt./Suitable:

HYUNDAI
42620-39200
42620-39210

KIA
42620-39200
42620-39210

AVAILABLE FROM:

- DISPONIBILE DA:
- DISPONIBILE EN:
- VERFUEGBAR AB:
- DISPONIBILE EN:

20/Q1



L	L1		
---	27	Hall Effect	

HYUNDAI

ACCENT IV 1.4	G4FA, G4FC	11/10 →
ACCENT IV 1.4 CVT	--	11/10 →
ACCENT IV 1.6	G4FC, G4GC-G	11/10 →
ACCENT IV 1.6 CRDi	D4FB	11/10 → 12/15
COUPE II 2.0	G4GC-G, G4BB	08/01 → 08/09
COUPE II 2.0 GLS	G4GC-G	02/03 → 08/09
COUPE II 2.7 V6	G6BA-G	03/02 → 08/09
ELANTRA III 1.8	G4BB, G4GC	06/00 → 07/06
ELANTRA III 2.0	G4GC, G4GC	06/00 → 07/06
ELANTRA IV 1.6 CVVT	G4FC	06/06 → 06/11
ELANTRA IV 2.0 CVVT	G4GC, D4EB	06/06 → 06/11
EQUUS / CENTENNIAL I 4.5	8A80	10/99 → 09/03
GRANDEUR 2.2 CRDi	D4EB, G4FC	06/06 → 12/11
GRANDEUR 2.7	G6BA	05/06 → 10/10
GRANDEUR 3.3	G6DB	04/05 → 12/10
I20 I 1.4	G4FA	09/08 → 12/15
I20 I 1.6	G4FC	09/08 → 12/12
I20 II 1.4	G4LC	11/14 →
I30 I 1.6	G4FC, D4FB	10/07 → 06/12
I30 I 1.6 CRDi	D4FB, G4GC	10/07 → 06/12
I30 I 2.0	G4GC, D4EB	10/07 → 06/12
IX20 1.6	G4FC	11/10 →
LANTRA II 1.8	G4GB	06/00 →
LANTRA II 2.0	G4GC-G	06/00 →
SANTA FE 12.2 CRDi	D4EB	10/05 → 03/06
SANTA FE 12.7	G6EA	10/05 → 03/06
SANTA FE 12.7 4x4	G6EA	10/05 → 03/06
SANTA FE II 2.2 CRDi	D4EB, D4EB	03/06 → 12/12
SANTA FE II 2.2 CRDi 4x4	D4EB, G6BA	10/05 → 12/12
SANTA FE II 2.2 CRDi GLS	D4EB	03/06 → 12/09
SANTA FE II 2.2 CRDi GLS 4x4	D4EB	03/06 → 12/09
SANTA FE II 2.7	G6BA	03/06 → 12/12
SANTA FE II 2.7 4x4	G6BA, D4EA	03/06 → 12/12
SANTA FE II 2.7 V6 GLS	G6EA	03/06 → 12/09
SANTA FE II 2.7 V6 GLS 4x4	G6EA	03/06 → 12/09
SANTA FE II 3.3	G6DB	07/07 → 11/08
SANTA FE II 3.3 Dynamic 4x4	G6DB	03/06 → 12/12
SB 11 1.4	--	01/11 →
SB 11 1.6	--	01/11 →
SB 11 1.6 CRDi	--	01/11 →
SOLARIS 1.4 16V	--	01/11 →
SOLARIS 1.6	G4FC	01/17 →
SOLARIS 1.6 16V	--	01/11 →
SONATA V 2.0 CRDi	D4EA, G4KA	02/06 → 12/10
SONATA V 2.0 VVTi GLS	G4KA, G4KC	05/05 → 12/10
SONATA V 2.4	G4KC, G6DB	01/05 → 12/10
SONATA V 3.3	G6DB, G4GC	01/05 → 12/10
TRAJET 2.0	G4GC, D4EA	03/00 → 07/08
TRAJET 2.0 CRDi	D4EA, G4GC	04/01 → 07/08
TRAJET 2.7 V6	G6BA-G	09/00 → 07/08

HYUNDAI

TUCSON 2.0	G4GC, D4EA	08/04 →
TUCSON 2.0 CRDi	D4EA, D4EA	08/04 → 03/10
TUCSON 2.0 CRDi Trazione integrale	D4EA, G4GC	08/04 → 03/10
TUCSON 2.0 Trazione integrale	G4GC, G4JP	08/04 → 11/10
TUCSON 2.7 Trazione integrale	G6BA-G	08/04 →

KIA

CARENS III 2.0 CRDi 140	D4EA	09/06 →
CARENS III 2.0 CVVT	G4KA	09/06 →
CARNIVAL II 2.7 V6	G6EA	06/06 →
CARNIVAL II 2.9 CRDi LX	J3	09/06 →
MAGENTIS II 2.0	G4JP, D4EA	09/06 →
MAGENTIS II 2.0 CRDi	D4EA, G6BA	11/05 →
MAGENTIS II 2.7	G6BA, D4EA	11/05 →
MAGENTIS II 2.7 V6	G6EA	07/09 →
OPTIMA II 2.0 CRDi	D4EA	09/06 →
OPTIMA II 2.7	G6EA	09/07 →
SPORTAGE II 2.0 16V 4WD	G4GC	09/04 →
SPORTAGE II 2.0 CRDi	D4EA, D4EA	02/05 →
SPORTAGE II 2.0 CRDi 4WD	D4EA, N47D20A	09/04 →
SPORTAGE II 2.0 i 16V	G4GC	09/04 →
SPORTAGE II 2.7 V6 4WD	G6BA	09/04 →

9.0757



3

REVOLUTION AND TIMING (CKP AND CMP) SENSORS

Adatt./Suitable:

BMW
13 62 7 803 093
7 803 093

MINI
13 62 7 803 093

TOYOTA
19300-WA010

MARKET DIFFUSION: HIGH



L	L1		
---	28,4	Hall Effect	

BMW

1 I 116 d	N47D20A, N47D20A	11/08 → 09/12
1 I 118 d	N47D20A, N47D20A	09/06 → 12/13
1 I 120 d	N47D20A, N47D20B	03/03 → 12/13
1 I 123 d	N47D20B, N47D16A	03/07 → 12/13
1 I 114 d	N47D16A	07/12 →
1 I 116 d	N47D16A, B47D20A	12/10 →
1 I 118 d	B47D20A, B47D20A	12/10 →
1 I 118 d xDrive	N47D20C	05/13 →
1 I 120 d	B47D20A, N47D20C	12/10 →
1 I 120 d xDrive	N47D20C, B47D20B	01/11 →
1 I 125 d	B47D20B, B47D20A	08/11 →
2218 d	B47D20A, B47D20A	01/14 →
2220 d	B47D20A, N47D20A	10/12 →
2225 d	N47D20D	01/14 →
3 V 316 d	N47D20C	07/09 → 06/12
3 V 318 d	N47D20A, M47D204D4	02/07 → 06/12
3 V 320 d	M47D204D4, N47D20C	12/04 → 12/13
3 V 320 d xDrive	N47D20C, --	02/08 → 06/13
3 V 320 xd	--, M57D306D3	03/07 →
3 V 325 d	N57D30A	09/09 → 12/13
3 V 330 d	M57D306D3, B47D20A	06/05 → 12/13
3 V 330 d xDrive	N57D30A	09/08 → 06/13

BMW

3 V 330 xd	N57D30A	03/08 → 02/10
3 VI 316 d	B47D20A, B47D20A	05/11 →
3 VI 318 d	B47D20A, B47D20A	05/11 →
3 VI 318 d xDrive	N47D20C	11/12 → 05/15
3 VI 320 d	B47D20A, B47D20A	03/11 →
3 VI 320 d xDrive	B47D20A, N47D20D	05/11 →
3 VI 325 d	N47D20D, B47D20A	07/12 →
3 VI 328 d [USA]	--	10/11 →
3 VI 328 d xDrive [USA]	--	10/11 →
3 VI 330 d	N57D30A	01/12 →
3 VI 330 d xDrive	N57D30A	06/12 →
3 VI 335 d xDrive	N57D30B	04/13 →
4 418 d	B47D20A, B47D20A	03/14 →
4 420 d	B47D20A, B47D20A	07/13 →
4 420 d xDrive	B47D20A, N57D30A	11/13 →
4 425 d	N47D20D	01/14 →
4 430 d	N57D30A, N57D30A	10/13 →
4 430 d xDrive	N57D30A, N47D20A	11/13 →
4 435 d xDrive	N57D30B	11/13 →
5 VI GT 520 d	N47D20C, N57D30A	04/11 → 02/17
5 VI GT 530 d	N57D30A, N57D30A	08/09 → 02/17
5 VI GT 530 d xDrive	N57D30A, N57D30B	06/10 → 02/17
5 VI GT 535 d	N57D30B, N57D30B	03/10 → 02/17
5 VI GT 535 d xDrive	N57D30B, N57D30A	03/10 → 02/17
5 V 520 d	N47D20A, N47D20C	02/05 → 05/10
5 VI 518 d	N47D20C, B47D20A	07/13 → 02/17
5 VI 520 d	B47D20A, N47D20C	06/10 → 02/17
5 VI 520 d xDrive	N47D20D, N47D20D	01/13 → 02/17
5 VI 525 d	N47D20D, N57D30A	03/10 → 02/17
5 VI 525 d xDrive	N47D20D	09/11 → 02/17
5 VI 530 d	N57D30A, N57D30B	01/10 → 02/17
5 VI 530 d xDrive	N57D30A	03/11 → 02/17
5 VI 535 d	N57D30B, N47D20C	09/10 → 02/17
5 VI 535 d xDrive	N57D30B	09/11 → 02/17
5 VI M 550 d xDrive	N57D30C	03/12 → 02/17
6 III 640 d	N57D30B	11/10 →
6 III 640 d xDrive	N57D30B	09/11 →
7 V 730 d	N57D30A, N57D30B	02/08 → 05/15
7 V 730 d LCI	N57D30A	01/11 →
7 V 730 d xDrive	N57D30A	11/11 → 05/15
7 V 730Ld	N57D30A	06/08 →
7 V 740 d	N57D30B, N57D30B	09/09 → 12/15
7 V 740 d LCI [USA]	N57D30B	01/11 →
7 V 740 d LCI xDrive [USA]	N57D30B	01/11 →
7 V 740 d xDrive	N57D30B, N47D20C	09/09 → 12/15
7 V 740Ld xDrive [USA]	N57D30A	01/13 →
7 V 750 d xDrive	N57D30C	07/12 → 12/15
X1 sDrive 16 d	N47D20C	04/12 → 06/15
X1 sDrive 18 d	N47D20C, N47D20C	03/09 → 06/15
X1 sDrive 20 d	N47D20C, N47D20C	10/09 → 06/15
X1 xDrive 18 d	N47D20C, N47D20C	03/09 → 06/15
X1 xDrive 20 d	N47D20C, N47D20C	10/09 → 06/15
X1 xDrive 23 d	N47D20C, N47D20A	10/09 → 06/15
X1 xDrive 25 d	N47D20D	10/09 → 06/15
X3 I 2.0 d	N47D20A, N47D20C	03/07 → 03/09
X3 I xDrive 18 d	N47D20C, N57D30A	09/08 → 12/11
X3 I xDrive 20 d	N47D20C	09/07 → 08/10
X3 II sDrive 18 d	N47D20C	10/12 → 03/14
X3 II xDrive 20 d	N47D20C	09/10 → 03/14
X3 II xDrive 28 d	N47D20C	09/14 →
X3 II xDrive 30 d	N57D30A, N57D30A	04/11 → 08/17
X3 II xDrive 35 d	N57D30B	10/11 → 08/17
X4 xDrive 30 d	N57D30A, N57D30A	04/14 → 03/18
X4 xDrive 35 d	N57D30B	04/14 → 03/18
X5 III M 50 d	N57D30C	12/13 → 07/18
X5 III sDrive 25 d	N47D20D	12/13 → 07/15
X5 III xDrive 25 d	N47D20D, N57D30A	12/13 → 07/18
X5 III xDrive 30 d	N57D30A, N57D30B	08/13 → 07/18
X5 III xDrive 35 d [USA]	N57D30A	01/13 →
X5 III xDrive 40 d	N57D30B, M57D30(306D3)	12/13 → 07/18
X5 II M 50 d	N57D30C	08/11 → 06/13
X5 II xDrive 30 d	N57D30A, N47D20D	10/08 → 07/13
X5 II xDrive 40 d	N57D30B	09/10 → 06/13
X6 I M 50 d	N57D30C	08/11 → 06/14
X6 I xDrive 30 d	M57D30(306D3), N57D30A	04/08 → 07/14
X6 I xDrive 40 d	N57D30B	07/09 → 06/14
X6 II M 50 d	N57D30C	08/14 →
X6 II xDrive 30 d	N57D30A, N47C16A	08/14 →
X6 II xDrive 40 d	N57D30B	12/14 →

MINI

MINI II Cooper D	N47C16A, N47C16A	05/09 → 10/16
MINI II Cooper D ALL4	N47C16A, N47C20A	01/10 → 10/16
MINI II Cooper SD	N47C20A, N47D20A	06/09 → 10/16
MINI II Cooper SD ALL4	N47C20A	01/10 → 09/16
MINI II One D	N47C16A	01/10 → 10/16

TOYOTA			
AURIS II 1.6 D4-D	1WW	04/15 →	
AVENSIS III 1.6 D4-D	1WW	04/15 →	
AVENSIS III 2.0 D-4D	2WW	04/15 →	
RAV 4 IV 2.0 D	2WW	10/15 →	
VERSO 1.6 D4-D	1WW	11/13 →	

9.0758



04

REVOLUTION AND TIMING (CKP AND CMP) SENSORS

Adatt./Suitable:

BMW
13 62 7 805 188
7 805 188

MINI
13 62 7 805 188

TOYOTA
19301-WA010

MARKET DIFFUSION: HIGH



L	L1		
---	85,2	Hall Effect	

BMW			
1 I 116 d	N47D20A, N47D20A	11/08 →	09/12
1 I 118 d	N47D20A, N47D20A	09/06 →	12/13
1 I 120 d	N47D20A, N47D20B	03/03 →	12/13
1 I 123 d	N47D20B, N47D16A	03/07 →	12/13
1 II 114 d	N47D16A	07/12 →	
1 II 116 d	N47D16A, B47D20A	12/10 →	
1 II 118 d	B47D20A, B47D20A	12/10 →	
1 II 118 d xDrive	N47D20C	05/13 →	
1 II 120 d	B47D20A, N47D20C	12/10 →	
1 II 120 d xDrive	N47D20C, B47D20B	01/11 →	
1 II 125 d	B47D20B, B47D20A	08/11 →	
2 218 d	B47D20A, B47D20A	01/14 →	
2 220 d	B47D20A, N47D20A	10/12 →	
2 225 d	N47D20D	01/14 →	
3 V 316 d	N47D20C	07/09 →	06/12
3 V 318 d	N47D20A, M47D204D4	02/07 →	06/12
3 V 320 d	M47D204D4, N47D20C	12/04 →	12/13
3 V 320 d xDrive	N47D20C, --	02/08 →	06/13
3 V 320 xd	--, B47D20A	03/07 →	
3 VI 316 d	B47D20A, B47D20A	05/11 →	
3 VI 318 d	B47D20A, B47D20A	05/11 →	
3 VI 318 d xDrive	N47D20C	11/12 →	05/15
3 VI 320 d	B47D20A, B47D20A	03/11 →	
3 VI 320 d xDrive	B47D20A, N47D20D	05/11 →	
3 VI 325 d	N47D20D, B47D20A	07/12 →	
3 VI 328 d [USA]	--	10/11 →	
3 VI 328 d xDrive [USA]	--	10/11 →	
4 418 d	B47D20A, B47D20A	03/14 →	
4 420 d	B47D20A, B47D20A	07/13 →	
4 420 d xDrive	B47D20A, N57D30A	11/13 →	
4 425 d	N47D20D	01/14 →	
4 430 d xDrive	N57D30A, N47D20A	11/13 →	
5 VI GT 520 d	N47D20C, N47D20C	04/11 →	02/17
5 V 520 d	N47D20A, N47D20C	02/05 →	05/10
5 VI 518 d	N47D20C, B47D20A	07/13 →	02/17
5 VI 520 d	B47D20A, N47D20C	06/10 →	02/17
5 VI 520 d xDrive	N47D20C, N47D20D	01/13 →	02/17
5 VI 525 d	N47D20D, N47D20C	09/11 →	02/17
5 VI 525 d xDrive	N47D20D	09/11 →	02/17
X1 sDrive 16 d	N47D20C	04/12 →	06/15
X1 sDrive 18 d	N47D20C, N47D20C	03/09 →	06/15
X1 sDrive 20 d	N47D20C, N47D20C	10/09 →	06/15
X1 xDrive 18 d	N47D20C, N47D20C	03/09 →	06/15
X1 xDrive 20 d	N47D20C, N47D20C	10/09 →	06/15
X1 xDrive 23 d	N47D20C, N47D20A	10/09 →	06/15
X1 xDrive 25 d	N47D20D	10/09 →	06/15
X3 I 2.0 d	N47D20A, N47D20C	03/07 →	03/09
X3 I xDrive 18 d	N47D20C, N47C16A	09/08 →	12/11
X3 I xDrive 20 d	N47D20C	09/07 →	08/10
X3 II sDrive 18 d	N47D20C	10/12 →	03/14
X3 II xDrive 20 d	N47D20C	09/10 →	03/14

BMW			
X3 II xDrive 28 d	N47D20C	09/14 →	
X5 III sDrive 25 d	N47D20D	12/13 →	07/15
X5 III xDrive 25 d	N47D20D	12/13 →	07/15

MINI			
MINI II Cooper D	N47C16A, N47C16A	05/09 →	10/16
MINI II Cooper D ALL4	N47C16A, N47C20A	01/10 →	10/16
MINI II Cooper SD	N47C20A, M47D20(204D4)	06/09 →	10/16
MINI II Cooper SD ALL4	N47C20A	01/10 →	09/16
MINI II One D	N47C16A	01/10 →	10/16

TOYOTA			
AURIS II 1.6 D4-D	1WW	04/15 →	
AVENSIS III 1.6 D4-D	1WW	04/15 →	
AVENSIS III 2.0 D-4D	2WW	04/15 →	
RAV 4 IV 2.0 D	2WW	10/15 →	
VERSO 1.6 D4-D	1WW	11/13 →	

9.0759



3,5

REVOLUTION AND TIMING (CKP AND CMP) SENSORS

Adatt./Suitable:

BMW
13 62 7 787 192
13 62 7 809 334

BOSCH
0 281 002 477

MARKET DIFFUSION: MEDIUM

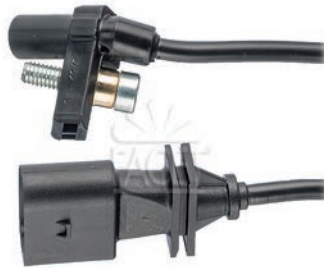

L	L1		
226	---	Hall Effect	

BMW			
1 I 118 d	M47D20(204D4), M47D20(204D4)	11/03 →	02/07
1 I 120 d	M47D20(204D4), M47D20(204D4)	03/03 →	12/11
3 IV 318 d	M47D20(204D4), M47D20(204D4)	03/03 →	02/05
3 IV 318 td	M47D20(204D4), M47D20(204D4)	03/03 →	02/05
3 IV 320 Cd	M47D20(204D4), M47D20(204D4)	11/03 →	12/07
3 IV 320 d	M47D20(204D4), M47D20(204D4)	09/01 →	02/05
3 IV 320 td	M47D20(204D4), M57D30(306D2)	09/01 →	02/05
3 IV 330 Cd	M57D30(306D2), M57D30(306D2)	03/03 →	12/07
3 IV 330 d	M57D30(306D2), M57D30(306D2)	03/03 →	02/05
3 IV 330 xd	M57D30(306D2), M47D20(204D4)	08/02 →	05/05
3 V 318 d	M47D20(204D4), M47D20(204D4)	03/05 →	08/07
3 V 320 d	M47D20(204D4), M57D30(306D3)	12/04 →	06/12
3 V 325 d	M57D30(306D3), M57D30(306D3)	09/06 →	06/12
3 V 330 d	M57D30(306D3), M57D30(306D3)	12/04 →	12/13
3 V 330 xd	M57D30(306D3), M57D30(306D5)	09/05 →	06/12
3 V 335 d	M57D30(306D5), M47D20(204D4)	03/06 →	03/13
5 V 520 d	M47D20(204D4), M57D25(256D2)	02/05 →	02/08
5 V 525 d	M57D25(256D2), M57D30(306D3)	03/04 →	
5 V 525 d xDrive	M57D30(306D3), M57D30(306D3)	09/07 →	05/10
5 V 525 xd	M57D30(306D3), M57D30(306D2)	11/06 →	09/08
5 V 530 d	M57D30(306D2), M57D30(306D3)	09/02 →	05/10

9.0760



3

REVOLUTION AND TIMING (CKP AND CMP) SENSORS

Adatt./Suitable:

BMW
13 62 7 525 015
23 21 7 636 260
7 525 015

NEW - AVAILABLE FROM:
 • NUOVO - DISPONIBILE DA:
 • NOUVEAU - DISPONIBLE EN:
 • NEU - VERFUEGBAR AB:
 • NUEVO - DISPONIBLE EN:

20/Q2



L	L1		
---	28	Hall Effect	

BMW			
1 I 125 i	N52B30A, N51B30A	10/07 →	
1 I 128 i	N51B30A, N52B30A	03/08 →	
1 I 130 i	N52B30A, N54B30A	03/05 →	09/12
1 I 135 i	N54B30A, N52B25A	10/07 →	12/13
1 I M	N54B30A	04/11 →	06/12
3 V 323 i	N52B25A, N52B25A	09/05 →	
3 V 325 i	N52B25A, N52B25A	12/04 →	
3 V 325 i xDrive	N52B25A, N52B25A	09/08 →	12/13
3 V 325 xi	N52B25A, N51B30A	01/05 →	
3 V 328 i	N51B30A, N51B30A	07/05 →	
3 V 328 xi	N51B30A, N52B30A	09/06 →	
3 V 330 i	N52B30A, N52B30A	12/04 →	12/13
3 V 330 i xDrive	N53B30A	09/07 →	06/13
3 V 330 xi	N52B30A, N54B30A	09/05 →	12/13
3 V 335 i	N54B30A, N54B30A	11/05 →	10/13
3 V 335 i xDrive	N54B30A, N54B30A	05/08 →	12/13
3 V 335 xi	N54B30A, N52B25A	09/06 →	02/10
3 V M	S65B40A	03/07 →	06/13
3 V M3	S65B40A	03/07 →	10/13

BMW		
3 SERIES 325i Coupe [ExtraEU]	N52B25A, N52B25A	03/10 → 06/13
3 SERIES 330i Coupe Xi [ExtraEU]	N52B30A	09/06 → 09/08
5 VI 520Li [CHN]	N52B25AF	01/09 →
5 VI 523 i	N52B25A, N52B30BF	01/09 → 08/11
5 VI 523Li [CHN]	N52B25AF	01/09 →
5 VI 528 i	N52B30BF, N57D30A	11/09 →
5 VI 528Li [CHN]	N52B30AF	09/10 →
5 VI 530 d	N57D30A, N52B30A	01/10 → 02/17
5 VI 530 i	N52B30A, N52B30A	06/09 → 06/13
5 VI 530Li [CHN]	N52B30AF	09/10 →
5 VI 550 i	N63B44A	01/09 → 06/13
5 VI M5	S63B44B	09/11 → 10/16
5 VI M5 Competition	S63B44B	02/13 → 10/16
5 VI M5 Edition 30	S63B44B	07/14 → 10/16
5 V 523 i	N52B25A, N52B25A	10/04 →
5 V 523Li	N52B25A, N52B25A	07/05 →
5 V 525 i	N52B25A, N52B25A	10/04 →
5 V 525 i xDrive	N53B30A	09/08 → 12/10
5 V 525 xi	N52B25A, N52B25A	07/05 →
5 V 525Li	N52B25A, N52B30A	07/05 →
5 V 528 i	N52B30A	09/08 → 12/09
5 V 528 xi	N52B30A	03/07 →
5 V 530 i	N52B30A, N52B30A	09/04 → 12/10
5 V 530 i xDrive	N53B30A	09/08 → 05/10
5 V 530 xi	N52B30A, N52B30A	09/04 → 05/10
5 V 530Li	N52B30A, N52B25A	07/05 →
5 V 535 i	N54B30A	04/06 → 12/09
5 V 535xi	N54B30A	03/07 →
5 V M5	S85B50A	09/04 → 12/10
6 II 630 i	N52B30A, N63B44A	02/04 → 07/10
6 II M	S85B50A	09/05 → 07/10
6 III 650 i	N63B44A, S63B44B	11/10 →
6 III M6	S63B44B, N52B30A	02/14 →
7 IV 730 i, Li	N52B30A, N52B30A	03/05 → 07/08
7 IV 730 i, Li	N52B30B	03/05 →
7 V 730 i, Li	N52B30A, IB1P25B	06/08 → 12/15
7 V 740 i, Li	N54B30A	10/08 → 12/15
I3 Range Extender	IB1P25B, N52B25A	08/13 →
X1 xDrive 25 i	N52B30A	01/10 → 06/15
X1 xDrive 28 i	N52B30A	10/09 → 06/15
X3 I 2.5 si	N52B25A, N52B25A	08/06 → 08/08
X3 I 2.5 si xDrive	N52B25A, N52B30A	08/06 → 08/08
X3 I 3.0 si	N52B30A, N52B25A	09/06 → 08/08
X3 I xDrive 2.5si	N52B25BF	09/06 →
X3 I xDrive 25 i	N52B25A, N52B30A	09/08 → 08/10
X3 I xDrive 3.0si	N52B30B	09/06 →
X3 I xDrive 30 i	N52B30A, N52B30A	09/08 → 12/11
X3 II xDrive 28 i	N52B30A, N52B30A	01/11 → 10/12
X5 II 3.0 si	N52B30A, N52B30A	02/06 → 09/08
X5 II xDrive 30 i	N52B30A, N54B30A	09/08 → 12/10
X6 I 35 i	N54B30A	05/08 → 08/08
X6 I xDrive 35 i	N54B30A, N52B25A	06/07 → 06/14
Z4 I 2.5 i	N52B25A, N52B25A	09/05 →
Z4 I 2.5 si	N52B25A, N52B30A	09/05 →
Z4 I 3.0 i	N52B30A	01/06 →
Z4 I 3.0 si	N52B30A, N52B25A	01/06 →
Z4 II sDrive 23 i	N52B25A, N52B30A	03/09 → 08/11
Z4 II sDrive 30 i	N52B30A, N52B30B	02/09 → 08/11
Z4 II sDrive 35 i	N54B30A	02/09 → 08/16
Z4 II sDrive 35 is	N54B30A	03/10 → 08/16
Z4 II sDrive30i	N52B30B, CHZB	05/09 →
Z SERIES Z4 sDrive 35i Cabrio [ExtraEU]	N54B30A	02/09 → 08/16

9.0773



REVOLUTION AND TIMING (CKP AND CMP) SENSORS

Adatt./Suitable:

AUDI

02T 906 207 A
02T 906 207 D

SEAT

02T 906 207 A
02T 906 207 D

SKODA

02T 906 207 A
02T 906 207 D

VW

02T 906 207 A
02T 906 207 D

MARKET DIFFUSION: HIGH



L	L1	Hall Effect	
---	24		

AUDI			
A1 1.0 TFSI	CHZB, CAVG	03/15 →	10/18
A1 1.2 TFSI	CBZA	05/10 →	04/15
A1 1.4 TDI	CUSB	11/14 →	10/18
A1 1.4 TFSI	CAVG, CAYB	05/10 →	10/18
A1 1.4 TSI	CZEA	11/14 →	10/18
A1 1.6 TDI	CAYB, CFHB	05/10 →	10/18
A1 1.8 TFSI	DAJB	02/15 →	10/18
A1 2.0 TDI	CFHB, BZB	09/11 →	04/15
A1 2.0 TFSI quattro	CDLH	03/12 →	11/12
A1 S1 quattro	CWZA	03/14 →	10/18
A3 II 1.2 TFSI	CBZB	03/10 →	05/13
A3 II 1.2 TSI	CBZB	04/10 →	08/12
A3 II 1.4 TFSI	CAXC	09/07 →	05/13
A3 II 1.8 TFSI	BZB, CBAA	04/08 →	05/13
A3 II 2.0 TDI	CBAA, CBAB	05/03 →	05/13
A3 II 2.0 TDI 16V quattro	CBAB, CBBB	08/04 →	08/12
A3 II 2.0 TDI quattro	CBBB, CAWB	03/06 →	08/12
A3 II 2.0 TFSI	CAWB, CBAA	04/08 →	05/13
A3 II SPORTBACK 1.2 TSI	CBZB	04/10 →	03/13
A3 II SPORTBACK 1.4 TFSI	CAXC	09/07 →	03/13
A3 II SPORTBACK 2.0 TDI	CBAA, CBAB	09/04 →	03/13
A3 II SPORTBACK 2.0 TDI 16V quattro	CBAB, CBBB	11/05 →	03/13
A3 II SPORTBACK 2.0 TDI quattro	CBBB, CJZA	03/06 →	03/13
A3 III 1.2 TFSI	CJZA, CMBA	02/13 →	
A3 III 1.4 TFSI	CMBA, CLHA	04/12 →	
A3 III 1.4 TFSI g-tron	CPWA	11/13 →	
A3 III 1.4 TSI	CZEA	05/14 →	
A3 III 1.6 TDI	CLHA, CJSA	10/12 →	
A3 III 1.6 TDI quattro	CXXB	05/15 →	
A3 III 1.8 TFSI	CJSA, CRBD	04/12 →	
A3 III 1.8 TFSI quattro	CJSB	08/12 →	
A3 III 2.0 quattro	CNTC	11/13 →	
A3 III 2.0 TDI	CRBD, CRBC	09/12 →	
A3 III 2.0 TDI quattro	CRBC, CHHB	10/12 →	
A3 III 2.0 TFSI	CHHB, CJXF	01/13 →	
A3 III 2.0 TFSI quattro	CNTC	05/14 →	
A3 III S3 quattro	CJXB, CHPB	11/12 →	
Q3 1.4 TSI	CHPB, CFFA	10/13 →	10/18
Q3 2.0 TDI	CFFA, CFFB	06/11 →	
Q3 2.0 TDI quattro	CFFB, CCTA	06/11 →	10/18
Q3 2.0 TFSI	CCTA, CCZC	10/13 →	
Q3 2.0 TFSI quattro	CCZC, CESA	06/11 →	10/18
TT II 2.0 TDI quattro	CFGB	06/08 →	06/14
TT II 2.0 TFSI	CESA	05/10 →	06/14
TT II 2.0 TFSI quattro	CESA, CDLA	05/10 →	06/14

AUDI		
TT II 2.0 TTS quattro	CDLA, CJSA	05/08 → 06/14
TT III 1.8 TFSI	CJSA, CHHC	08/15 →
TT III 2.0 TDI	CUNA	07/14 →
TT III 2.0 TFSI	CHHC	07/14 →
TT III 2.0 TFSI quattro	CHHC, CJXF	07/14 →
TT III 2.0 TTS quattro	CJXF, CAVA	11/14 →

SEAT		
ALHAMBRA III 1.4 TSI	CAVA, CFFA	06/10 →
ALHAMBRA III 1.8 TSI	CDA A	11/12 →
ALHAMBRA III 2.0 TDI	CFFA, CFFB	06/10 →
ALHAMBRA III 2.0 TDI 4Drive	CFFB, CCZA	05/11 →
ALHAMBRA III 2.0 TSI	CCZA, BSE	11/10 →
ALTEA 1.2 TSI	CBZB	04/10 →
ALTEA 1.4 TSI	CAXC	11/07 →
ALTEA 1.6	BSE, CAYB	03/04 →
ALTEA 1.6 LPG	CHGA	09/09 →
ALTEA 1.6 TDI	CAYB, BMM	10/09 →
ALTEA 1.8 TFSI	CDA A	01/07 →
ALTEA 1.9 TDI	BLS	04/04 →
ALTEA 2.0 TDI	BMM, BKD	11/05 →
ALTEA 2.0 TDI 16V	BKD, BSE	03/04 →
ALTEA XL 1.2 TSI	CBZB	04/10 →
ALTEA XL 1.4 TSI	CAXC	11/07 →
ALTEA XL 1.6	BSE, CAYB	10/06 →
ALTEA XL 1.6 LPG	CHGA	09/09 →
ALTEA XL 1.6 Multifuel	CCSA	10/06 →
ALTEA XL 1.6 TDI	CAYB, BMM	10/09 →
ALTEA XL 1.8 TFSI	CDA A	01/07 →
ALTEA XL 1.9 TDI	BLS	10/06 →
ALTEA XL 1.9 TDI 4x4	BLS	06/09 → 12/10
ALTEA XL 2.0 TDI	BMM, BKD	10/06 →
ALTEA XL 2.0 TDI 16V	BKD, BMM	10/06 →
ALTEA XL 2.0 TDI 16V 4x4	CFHC	10/10 →
ALTEA XL 2.0 TDI 4x4	BMM, CHZB	06/07 →
ALTEA XL 2.0 TFSI 4x4	CCZB	05/09 →
IBIZA IV 1.0	CHYB	05/15 →
IBIZA IV 1.0 TSI	CHZB, BZG	05/15 →
IBIZA IV 1.2	BZG, CBZA	03/08 →
IBIZA IV 1.2 TDI	CFWA	04/10 →
IBIZA IV 1.2 TSI	CBZA, BXW	09/10 →
IBIZA IV 1.4	BXW, CUSA	03/08 →
IBIZA IV 1.4 TDI	CUSA, CAVF	05/15 →
IBIZA IV 1.4 TSI	CAVE, CAVE	06/09 →
IBIZA IV 1.4 TSI Cupra	CAVE, CWVA	06/09 →
IBIZA IV 1.6	BTS	05/08 →
IBIZA IV 1.6 LPG	CNKA	05/11 →
IBIZA IV 1.6 SRE	CWVA, CAYB	07/15 →
IBIZA IV 1.6 TDI	CAYB, BMM	05/09 →
IBIZA IV 1.8 TSI Cupra	DAJA	11/15 →
IBIZA IV 1.9 TDI	BMT	03/08 →
IBIZA IV 2.0	CEKA	10/08 →
IBIZA IV 2.0 TDI	CFHD	01/10 →
LEON II 1.2 TSI	CBZB	02/10 → 12/12
LEON II 1.4 TSI	CAXC	11/07 → 12/12
LEON II 1.8 TSI	CDA A	06/07 → 12/12
LEON II 2.0 Cupra R	CDLA	09/09 → 12/12
LEON II 2.0 TDI	BMM, BKD	10/05 → 12/12
LEON II 2.0 TDI 16V	BKD, CCZB	07/05 → 12/12
LEON II 2.0 TFSI	CCZB, CJZA	11/06 → 12/12
LEON III 1.0 TSI	CHZD	05/15 →
LEON III 1.2 TSI	CJZA, CHPA	12/12 →
LEON III 1.4 TSI	CPWA	02/13 →
LEON III 1.4 TDI	CHPA, CLHA	11/12 →
LEON III 1.6 TDI	CLHA, CLHA	11/12 →
LEON III 1.6 TDI 4Drive	CLHA, CRGA	04/14 →
LEON III 1.6 TSI	CWVA	05/15 →
LEON III 1.8 TSI	CJSA	02/13 →
LEON III 2.0 TDI	CRGA, CRBC	02/13 →
LEON III 2.0 TDI 4Drive	CRBC, CHYA	04/14 →
MII 1.0	CHYA, CBZA	10/11 →
MII 1.0 EcoFuel	CPGA	11/12 →
TOLEDO IV 1.2	CGPC	07/12 →
TOLEDO IV 1.2 TSI	CBZA, CAXA	07/12 →
TOLEDO IV 1.4 TDI	CUSB	05/15 →
TOLEDO IV 1.4 TSI	CAXA, CAYB	07/12 →
TOLEDO IV 1.6 TDI	CAYB, CHYA	07/12 →

SKODA		
CITIGO 1.0	CHYA, CHYA	10/11 →
CITIGO 1.0 CNG	CPGA	11/12 →
FABIA III 1.0	CHYA, CJZC	08/14 →
FABIA III 1.2 TSI	CJZC, CUSA	08/14 →
FABIA III 1.4 TDI	CUSA, CDA A	08/14 →
FABIA III 1.6	CWVB	01/15 →
OCTAVIA II 1.2 TSI	CBZB	02/10 → 06/13
OCTAVIA II 1.4 TSI	CAXA	11/08 → 06/13
OCTAVIA II 1.6 TDI	CAYC	06/09 → 04/13
OCTAVIA II 1.6 TDI 4x4	CAYC	06/09 → 02/13
OCTAVIA II 1.8 TSI	CDA A	06/07 → 04/13

SKODA		
OCTAVIA II 1.8 TSI 4x4	CDAA, BMM	11/08 → 02/13
OCTAVIA II 2.0 4x4	CCZA	11/08 →
OCTAVIA II 2.0 RS	CCZA	10/05 → 02/13
OCTAVIA II 2.0 TDI	BMM, BKD	11/05 → 06/13
OCTAVIA II 2.0 TDI 16V	BKD, BMM	02/04 → 05/13
OCTAVIA II 2.0 TDI 16V 4x4	CFHC	05/10 → 02/13
OCTAVIA II 2.0 TDI 4x4	BMM, CJZA	07/06 → 02/13
OCTAVIA II 2.0 TDI RS	CEGA	04/06 → 02/13
OCTAVIA III 1.2 TSI	CJZA, CHPA	11/12 →
OCTAVIA III 1.4 [CHN]	CSSA	02/14 →
OCTAVIA III 1.4 TSI	CHPA, CLHA	11/12 →
OCTAVIA III 1.6 [CHN]	CSRA	02/14 →
OCTAVIA III 1.6 TDI	CLHA, CLHA	11/12 →
OCTAVIA III 1.6 TDI 4x4	CLHA, CUSA	11/12 →
OCTAVIA III 1.8 TSI	CJSA, CBZA	11/12 →
OCTAVIA III 1.8 TSI 4x4	CJSA	11/12 →
OCTAVIA III 2.0 TDI	CYKA	05/15 →
OCTAVIA III 2.0 TDI / TDI RS 4x4	CUPA	09/14 →
OCTAVIA III 2.0 TDI 4x4	CKFC	11/12 →
ROOMSTER 1.2	CGPA	01/07 → 05/15
ROOMSTER 1.2 TDI	CFWA	03/10 → 05/15
ROOMSTER 1.2 TSI	CBZA, CAYA	03/10 → 05/15
ROOMSTER 1.4	CGGB	09/06 → 05/15
ROOMSTER 1.6 TDI	CAYA, BZB	03/10 → 05/15
SUPERB II 1.4 TSI	CAXC	07/08 → 05/15
SUPERB II 1.6 TDI	CAYC	09/10 → 05/15
SUPERB II 1.8 TSI	CFB, CDAA	03/08 → 05/15
SUPERB II 1.8 TSI 4x4	CDAA, BMP	11/08 → 05/15
SUPERB II 2.0 TDI	BMP, CFFB	03/08 → 05/15
SUPERB II 2.0 TDI 16V	CFFB, CBBB	01/09 → 05/15
SUPERB II 2.0 TDI 16V 4x4	CFFB	11/10 → 05/15
SUPERB II 2.0 TDI 4x4	CBBB, --	09/08 → 05/15
SUPERB II 2.0 TSI	CCZA	05/10 → 05/15
SUPERB II 3.6 FSI 4x4	--, CZCA	11/08 → 05/15
SUPERB II 3.6 V6 4x4	CDVA	10/09 → 05/15
SUPERB III 1.4 TSI	CZCA, CZDA	03/15 →
SUPERB III 1.4 TSI 4x4	CZDA, CVRA.	03/15 →
SUPERB III 1.6 TDI	CVRA., CJSA	03/15 →
SUPERB III 1.8 TSI	CJSA, CRGA	03/15 →
SUPERB III 2.0 TDI	CRGA, CRLB	03/15 →
SUPERB III 2.0 TDI 4x4	CRLB, CBZB	03/15 →
YETI 1.2 TSI	CBZB, CAXA	09/09 → 12/17
YETI 1.4 TSI	CAXA, CDAA	06/10 → 12/17
YETI 1.4 TSI 4x4	CZDA	05/15 → 12/17
YETI 1.6 TDI	CAYC	11/10 → 05/15
YETI 1.8	CDAB	02/11 →
YETI 1.8 TSI 4x4	CDAA, CFHA	05/09 → 12/17
YETI 2.0 TDI	CFHA, CBDB	11/09 →
YETI 2.0 TDI 4x4	CBDB, CAVD	05/09 → 12/17

VW		
BEETLE 1.2 TSI	CBZB	07/11 →
BEETLE 1.4 TSI	CAVD, CBZA	10/11 →
CADDY III 1.0 TSI	CHZG	11/15 →
CADDY III 1.2 TSI	CADZA, BRY	09/10 →
CADDY III 1.4 TGI CNG	CPWA	06/15 →
CADDY III 1.4 TSI	CZCB	05/15 →
CADDY III 1.6	BRY, CAYD	04/04 →
CADDY III 1.6 BiFuel	CHGA	05/11 → 05/15
CADDY III 1.6 TDI	CAVD, CFHC	08/10 →
CADDY III 2.0 EcoFuel	BSX	04/06 → 05/15
CADDY III 2.0 TDI	CFHC, CFHC	08/10 →
CADDY III 2.0 TDI 16V	CFHC, CFHC	11/10 → 05/15
CADDY III 2.0 TDI 16V 4motion	CFHC	11/10 → 05/15
CADDY III 2.0 TDI 4motion	CFHC, CTHD	08/10 →
CC 1.4 TSI	CTHD, CDAA	11/11 → 12/16
CC 1.4 TSI MultiFuel	CKMA	11/11 → 12/16
CC 1.8 TSI	CDAA, CFFA	11/11 → 12/16
CC 2.0 TDI	CFFA, CFFB	11/11 → 12/16
CC 2.0 TDI 4motion	CFFB, CBFA	11/11 → 12/16
CC 2.0 TSI	CBFA, CAVD	11/11 →
CC 3.6 FSI	CNNA	11/11 →
CC 3.6 FSI 4motion	BWS	11/11 → 12/16
EOS 1.4 TSI	CAVD, CBAB	11/07 → 08/15
EOS 2.0 TDI	CFFA	11/10 → 08/15
EOS 2.0 TDI 16V	CBAB, BPY	05/08 → 08/15
EOS 2.0 TFSI	BPY, CJZA	03/06 → 08/15
EOS 2.0 TSI	CCZB	11/09 → 08/15
GOLF VI 1.2 TSI	CBZB	03/11 → 05/16
GOLF VI 1.2 TSI 16V	CJZA, CAVD	11/13 → 05/16
GOLF VI 1.4 TSI	CAVD, BSE	03/11 → 05/16
GOLF VI 1.6	BSE, CAYB	01/09 →
GOLF VI 1.6 MultiFuel	CHGA	05/09 →
GOLF VI 1.6 TDI	CAYB, CBDA	02/09 →
GOLF VI 2.0 GTI	CCZB	05/12 → 05/16
GOLF VI 2.0 R	CDLA	01/13 → 05/16
GOLF VI 2.0 TDI	CBDA, CDLC	01/09 → 05/16

VW		
GOLF VII 2.0 TSI	CDLC, CJZA	01/13 →
GOLF VII 1.0 TSI	CHZD	05/15 →
GOLF VII 1.2 TSI	CJZA, CPWA	08/12 →
GOLF VII 1.4 GTE Hybrid	CUKB	05/14 →
GOLF VII 1.4 TGI CNG	CPWA, CHPA	06/13 →
GOLF VII 1.4 TSI	CHPA, CPVA	08/12 →
GOLF VII 1.4 TSI MultiFuel	CPWA, CLHA	04/13 →
GOLF VII 1.6	CWVA	05/14 →
GOLF VII 1.6 TDI	CLHA, CLHA	08/12 →
GOLF VII 1.6 TDI 4motion	CLHA, CJXB	11/12 →
GOLF VII 1.8 TSI 4motion	CJSB	12/14 →
GOLF VII 2.0 GTI	CXCA	11/13 →
GOLF VII 2.0 R 4motion	CJXB, CRBC	11/13 →
GOLF VII 2.0 TDI	CRBC, CKFC	08/12 →
GOLF VII 2.0 TDI 4motion	CKFC, CBZB	11/12 →
GOLF VII 2.0 TFSI	CYFB	11/13 →
JETTA VI 1.2 TSI	CBZB, CAVA	10/10 →
JETTA VI 1.4 TSI	CAVA, CNLA	04/11 →
JETTA VI 1.4 TSI Hybrid	CNLA, CWVA	04/11 →
JETTA VI 1.6	CFNB	03/13 →
JETTA VI 1.6 [RUS]	CWVA, CFHC	01/15 →
JETTA VI 1.6 TDI	CAYC	04/10 → 07/14
JETTA VI 2.0	CKJA	06/10 → 12/17
JETTA VI 2.0 TDI	CFHC, CAXA	10/10 →
PASSAT V 1.4 TSI	CDAA, CDAA	08/10 → 12/14
PASSAT V 1.4 TSI EcoFuel	CDGA	08/10 → 12/14
PASSAT V 1.4 TSI MultiFuel	CKMA	11/10 → 12/14
PASSAT V 1.6 TDI	CAYC	08/10 → 12/14
PASSAT V 1.8 TSI	CDAA, CFFA	08/10 → 12/14
PASSAT V 2.0 TDI	CFFA, CFFB	08/10 →
PASSAT V 2.0 TDI 4motion	CFFB, CZCA	08/10 → 12/14
PASSAT V 2.0 TSI	CCZB	11/10 → 05/15
PASSAT V 2.0 TSI 4motion	CCZB	01/12 → 12/14
PASSAT V 3.6 FSI 4motion	BWS	01/11 → 12/14
PASSAT VI 1.4 GTE Hybrid	CUKC	06/15 →
PASSAT VI 1.4 TSI	CZCA, DCXA	11/14 →
PASSAT VI 1.4 TSI 4motion	CZEA	02/15 →
PASSAT VI 1.6 TDI	DCXA, CJSA	08/14 →
PASSAT VI 1.8 TSI	CJSA, CRGA	02/15 →
PASSAT VI 2.0 TDI	CRGA, CRLB	11/14 →
PASSAT VI 2.0 TDI 4motion	CRLB, CHHB	08/14 →
PASSAT VI 2.0 TSI	CHHB, CHYA	02/15 →
PASSAT VI 2.0 TSI 4motion	CHHB	05/15 →
POLO V 1.0	CHYA, CHZB	01/14 →
POLO V 1.0 TSI	CHZB, CGPA	11/14 →
POLO V 1.2	CGPA, CBZB	06/09 →
POLO V 1.2 [IND]	CJLA	08/11 →
POLO V 1.2 TDI	CFWA	10/09 →
POLO V 1.2 TSI	CBZB, CDDA	11/09 →
POLO V 1.2 TSI 16V	CJZC	02/14 →
POLO V 1.4	CDDA, CUSA	03/09 → 05/14
POLO V 1.4 BiFuel	CMAA	03/10 → 01/11
POLO V 1.4 GTI	CAVE	05/10 →
POLO V 1.4 TDI	CUSA, CPTA	02/14 →
POLO V 1.4 TSI	CPTA, CWXA	10/12 →
POLO V 1.4 TSI [RUS]	CZCA	05/14 →
POLO V 1.5 TDI [IND]	CWXA, CFNA	05/14 →
POLO V 1.6	CFNA, CAYA	01/10 →
POLO V 1.6 BiFuel	CNKA	01/11 →
POLO V 1.6 TDI	CAYA, CWYA	06/09 →
POLO V 1.8 GTI	CWYA, CAVD	11/14 →
POLO V 2.0 R WRC	CDLJ	08/13 →
SCIROCCO III 1.4 TSI	CDLA, CDLA	05/08 →
SCIROCCO III 2.0 R	CDLA, CBBB	11/09 → 11/17
SCIROCCO III 2.0 TDI	CBBB, CAWB	08/08 → 11/17
SCIROCCO III 2.0 TSI	CAWB, CAVA	05/08 → 11/17
SHARAN II 1.4 TSI	CAVA, CFFA	05/10 →
SHARAN II 1.8 TSI	CDAA	11/11 →
SHARAN II 2.0 TDI	CFFA, CFFA	05/10 →
SHARAN II 2.0 TDI 4motion	CFFA, CCZA	05/11 →
SHARAN II 2.0 TSI	CCZA, BWK	12/10 →
TIGUAN I 1.4 [CHN]	CFBA	11/11 →
TIGUAN I 1.4 TSI	BWK, BWK	05/08 →
TIGUAN I 1.4 TSI 4motion	BWK, CBAB	09/07 →
TIGUAN I 1.8 [CHN]	CEAA	12/09 →
TIGUAN I 2.0 TDI	CBAB, CBAA	03/08 →
TIGUAN I 2.0 TDI 4motion	CBAA, CAWA	09/07 →
TIGUAN I 2.0 TFSI	CCTB	05/08 →
TIGUAN I 2.0 TFSI 4motion	CAWA, CCZB	09/07 →
TIGUAN I 2.0 TSI 4motion	CCZB, CZCA	05/11 →
TIGUAN II 1.4 TSI	CZCA, CZDA	01/16 →
TIGUAN II 1.4 TSI 4motion	CZDA, CRFD	05/16 →
TIGUAN II 1.6 TDI	DGDB	05/16 →
TIGUAN II 2.0 TDI	CRFD, CUAA	05/15 →
TIGUAN II 2.0 TDI 4motion	CUAA, CHHB	01/16 →
TIGUAN II 2.0 TSI 4motion	CHHB, CAVB	01/16 →
TOURAN I 1.2 TSI	CBZB	05/10 → 05/15
TOURAN I 1.4 FSI	CAVB	11/06 → 05/10

VW		
TOURAN I 1.4 TSI	CAVB, CAYB	02/06 → 05/15
TOURAN I 1.4 TSI EcoFuel	CDGA	05/09 → 05/15
TOURAN I 1.6 TDI	CAYB, CFHC	05/10 → 05/15
TOURAN I 2.0 TDI	CFHC, CRKB	05/10 → 05/15
TOURAN II 1.2 TSI	CYVB	05/15 →
TOURAN II 1.4 TSI	CZDA	05/15 →
TOURAN II 1.6 TDI	CRKB, CRVA	05/15 →
TOURAN II 1.8 TSI	CJSA	11/15 →
TOURAN II 2.0 TDI	CRVA, AXA	05/15 →
TRANSPORTER V 2.0	AXA, CAAA	11/03 →
TRANSPORTER V 2.0 BitDI	CFCA	09/09 → 08/15
TRANSPORTER V 2.0 BitDI 4motion	CFCA	09/09 → 08/15
TRANSPORTER V 2.0 TDI	CAAA, CAAC	09/09 → 08/15
TRANSPORTER V 2.0 TDI 4motion	CAAC, CJKA	09/09 → 08/15
TRANSPORTER V 2.0 TSI	CJKA, CAAA	05/11 → 08/15
TRANSPORTER V 2.0 TSI 4motion	CJKA	07/11 → 08/15
TRANSPORTER VI 2.0 TDI	CAAA, CAAC	04/15 →
TRANSPORTER VI 2.0 TDI 4motion	CAAC, CJKA	06/15 →
TRANSPORTER VI 2.0 TSI	CJKA, --	04/15 →
TRANSPORTER VI 2.0 TSI 4motion	CJKA	06/15 →
UP 1.0	--, EE20	08/11 →
UP 1.0 EcoFuel	CPGA	11/12 →

9.0775

3

REVOLUTION AND TIMING (CKP AND CMP) SENSORS

Adatt./Suitable:

FIAT
9948811
MITSUBISHI
G4T07571
SUBARU
31937-KA060

MARKET DIFFUSION: MEDIUM



L	L1		+ OUT -
---	36,5	Hall Effect	

FIAT		
PALIO 1.2	188A5.000	09/01 →
PUNTO II 1.2 16V	188A5.000	06/03 →
PUNTO II 1.2 16V 80	188A5.000	09/99 → 12/06
PUNTO II 1.2 60	188A4.000	09/99 → 12/10
PUNTO II 1.8 130 HGT	183A1.000	09/99 → 03/12
SIENA 1.2	188A5.000	09/01 → 12/09
SUBARU		
FORESTER III 2.0 D AWD	EE20Z	09/08 → 09/13
FORESTER IV 2.0 D	EJ20Z	08/12 →
FORESTER IV 2.0 D AWD	EE20Z	03/13 →
IMPREZA 1.6 [ExtraEU]	FB16A	10/16 →
IMPREZA V 1.6 [ExtraEU]	FB16A	10/16 →
IMPREZA V 1.6 i	FB16A	07/17 →
IMPREZA V 2.0 i AWD	FB20C	10/16 →
LEGACY 3.6 [ExtraEU]	EZ36D	01/15 →
LEGACY V 2.0 D	EJ20Z	05/09 →
LEGACY V 2.0 D AWD	EE20, --	09/09 → 12/14
LEGACY V 3.6 AWD	EZ36D	09/09 → 12/14
LEGACY VI 2.5 [ExtraEU]	FB25B	01/15 →
OUTBACK IV 2.0 D AWD	--, CAYB	09/09 →
OUTBACK IV 3.6 R AWD	EZ36D	09/09 →
XV 1.6 i AWD	FB16A	08/17 →
XV 2.0 i AWD	FB20C	04/17 →

9.0778



1

REVOLUTION AND TIMING (CKP AND CMP) SENSORS

Adatt./Suitable:

AUDI

02T 906 207

SEAT02T 906 207
02T 906 207 C**SKODA**

02T 906 207

VW02T 906 207
02T 906 207 CMARKET DIFFUSION: **HIGH**

L	L1		
---	24	Hall Effect	

AUDI

A1 1.2 TFSI	CBZA	05/10 → 04/15
A1 1.6 TDI	CAYB, CFHB	05/10 → 04/15
A1 2.0 TDI	CFHB, CAYB	09/11 → 04/15
A1 2.0 TFSI quattro	CDLH	03/12 → 11/12
A3 II 1.6 TDI	CAYB, BLS	05/09 → 05/13
A3 II 1.9 TDI	BLS, CAYB	05/03 → 05/10
A3 II SPORTBACK 1.6 TDI	CAYB, BLS	05/09 → 03/13
A3 II SPORTBACK 1.9 TDI	BLS, CJZA	09/04 → 05/10
A3 III 1.2 TFSI	CJZA, CMBA	02/13 →
A3 III 1.4 TFSI	CMBA, CLHA	04/12 →
A3 III 1.4 TFSI g-tron	CPWA	11/13 →
A3 III 1.4 TSI	CZEA	05/14 →
A3 III 1.6 TDI	CLHA, CUSA	10/12 →
A3 III 1.6 TDI quattro	CXXB	05/15 →
A3 III 1.8 TFSI	CJSA, CRBD	04/12 →
A3 III 1.8 TFSI quattro	CJSB	08/12 →
A3 III 2.0 quattro	CNTC	11/13 →
A3 III 2.0 TDI	CRBD, CRBC	09/12 →
A3 III 2.0 TDI quattro	CRBC, CHHB	10/12 →
A3 III 2.0 TFSI	CHHB, CJXB	01/13 →
A3 III S3 quattro	CJXB, BXW	11/12 →
TT II 1.8 TFSI	CDA A	06/08 → 06/14

SEAT

ALTEA 1.2 TSI	CBZB	04/10 →
ALTEA 1.4 16V	BXW, BGU	05/06 →
ALTEA 1.4 TSI	CAXC	11/07 →
ALTEA 1.6	BGU, CAYB	03/04 →
ALTEA 1.6 LPG	CHGA	09/09 →
ALTEA 1.6 TDI	CAYB, BKC	10/09 →
ALTEA 1.8 TFSI	CDA A	01/07 →
ALTEA 1.9 TDI	BKC, BMM	04/04 →
ALTEA 2.0 TDI	BMM, BKD	11/05 →
ALTEA 2.0 TDI 16V	BKD, BXW	03/04 →
ALTEA XL 1.2 TSI	CBZB	04/10 →
ALTEA XL 1.4 16V	BXW, BSE	10/06 →
ALTEA XL 1.4 TSI	CAXC	11/07 →
ALTEA XL 1.6	BSE, CAYB	10/06 →
ALTEA XL 1.6 LPG	CHGA	09/09 →
ALTEA XL 1.6 Multifuel	CCSA	10/06 →
ALTEA XL 1.6 TDI	CAYB, BKC	10/09 →
ALTEA XL 1.8 TFSI	CDA A	01/07 →
ALTEA XL 1.9 TDI	BKC, BMM	10/06 →
ALTEA XL 1.9 TDI 4x4	BLS	06/09 → 12/10
ALTEA XL 2.0 TDI	BMM, BKD	10/06 →
ALTEA XL 2.0 TDI 16V	BKD, BMM	10/06 →
ALTEA XL 2.0 TDI 16V 4x4	CFHC	10/10 →
ALTEA XL 2.0 TDI 4x4	BMM, BXW	06/07 →
ALTEA XL 2.0 TFSI 4x4	CCZB	05/09 →
LEON II 1.2 TSI	CBZB	02/10 → 12/12

SEAT

LEON II 1.4 16V	BXW, BSE	06/06 → 12/12
LEON II 1.6	BSE, BKC	07/05 → 12/12
LEON II 1.6 LPG	CHGA	12/09 → 12/12
LEON II 1.6 MultiFuel	BSE	11/10 → 12/12
LEON II 1.6 TDI	CAYC	02/10 → 12/12
LEON II 1.9 TDI	BKC, CBZA	07/05 → 12/10
TOLEDO IV 1.2	CGPC	07/12 →
TOLEDO IV 1.2 TSI	CBZA, CAXA	07/12 →
TOLEDO IV 1.4 TDI	CUSB	05/15 →
TOLEDO IV 1.4 TSI	CAXA, CAYB	07/12 →
TOLEDO IV 1.6 TDI	CAYB, CGPA	07/12 →

SKODA

FABIA II 1.2	CGPA, CBZA	12/06 →
FABIA II 1.2 12V	CGPB	11/11 → 12/14
FABIA II 1.2 TSI	CBZA, CAYA	03/10 → 12/14
FABIA II 1.4	CGGB	01/07 → 12/14
FABIA II 1.6 TDI	CAYA, BUD	03/10 → 12/14
OCTAVIA II 1.4	BUD, CCSA	06/04 → 06/13
OCTAVIA II 1.6	CMXA	09/04 → 06/13
OCTAVIA II 1.6 LPG	CHGA	08/09 → 11/12
OCTAVIA II 1.6 MultiFuel	CCSA, CBZA	01/08 → 06/13
OCTAVIA II 1.6 TDI	CAYC	06/09 → 04/13
OCTAVIA II 1.6 TDI 4x4	CAYC	06/09 → 02/13
OCTAVIA II 2.0 TDI	CLCA	03/10 → 06/13
ROOMSTER 1.2	CGPA	01/07 → 05/15
ROOMSTER 1.2 TDI	CFWA	03/10 → 05/15
ROOMSTER 1.2 TSI	CBZA, CAYA	03/10 → 05/15
ROOMSTER 1.4	CGGB	09/06 → 05/15
ROOMSTER 1.6 TDI	CAYA, CDA A	03/10 → 05/15
SUPERB II 1.4 TSI	CAXC	07/08 → 05/15
SUPERB II 1.6 TDI	CAYC	09/10 → 05/15
SUPERB II 1.8 TSI	CDA A	03/08 → 05/15
SUPERB II 1.8 TSI 4x4	CDA A, BLS	11/08 → 05/15
SUPERB II 1.9 TDI	BLS, CFFB	03/08 → 11/10
SUPERB II 2.0 TDI	CFGB	07/08 → 05/15
SUPERB II 2.0 TDI 16V	CFFB, --	01/09 → 05/15
SUPERB II 2.0 TDI 16V 4x4	CFFB	11/10 → 05/15
SUPERB II 2.0 TDI 4x4	CFGB	09/08 → 05/15
SUPERB II 2.0 TSI	CCZA	05/10 → 05/15
SUPERB II 3.6 FSI 4x4	--, CBZB	11/08 → 05/15
SUPERB II 3.6 V6 4x4	CDVA	10/09 → 05/15
YETI 1.2 TSI	CBZB, CAXA	09/09 → 12/17
YETI 1.4 TSI	CAXA, CDA A	06/10 → 12/17
YETI 1.4 TSI 4x4	CZDA	05/15 → 12/17
YETI 1.6 TDI	CAYC	11/10 → 05/15
YETI 1.8	CDAB	02/11 →
YETI 1.8 TSI 4x4	CDA A, CFHA	05/09 → 12/17
YETI 2.0 TDI	CFHA, CFHC	11/09 →
YETI 2.0 TDI 4x4	CFHC, CAVD	05/09 → 12/17

VW

BEETLE 1.2 TSI	CBZB	07/11 →
BEETLE 1.4 TSI	CAVD, CPKA	10/11 →
BEETLE 1.6 TDI	CAYC	10/11 → 07/16
BEETLE 1.8 TSI	CPKA, CBZA	12/13 →
CADDY III 1.0 TSI	CHZG	11/15 →
CADDY III 1.2 TSI	CBZB, CAYD	09/10 →
CADDY III 1.4 TGI CNG	CPWA	06/15 →
CADDY III 1.4 TSI	CZCB	05/15 →
CADDY III 1.6	BSF	04/04 →
CADDY III 1.6 BiFuel	CHGA	05/11 → 05/15
CADDY III 1.6 TDI	CAYD, CFHC	08/10 →
CADDY III 2.0 EcoFuel	BSX	04/06 → 05/15
CADDY III 2.0 TDI	CFHC, CFHC	08/10 →
CADDY III 2.0 TDI 16V	CFHC, CFHC	11/10 → 05/15
CADDY III 2.0 TDI 16V 4motion	CFHC, CJZA	11/10 → 05/15
CADDY III 2.0 TDI 4motion	CFHC, CJZA	08/10 →
GOLF VI 1.2 TSI	CBZB	03/11 → 05/16
GOLF VI 1.2 TSI 16V	CJZA, CAVD	11/13 → 05/16
GOLF VI 1.4 TSI	CAVD, BSE	03/11 → 05/16
GOLF VI 1.6	BSE, CAYB	01/09 →
GOLF VI 1.6 MultiFuel	CHGA	05/09 →
GOLF VI 1.6 TDI	CAYB, CBDA	02/09 →
GOLF VI 2.0 GTI	CCZB	05/12 → 05/16
GOLF VI 2.0 R	CDLA	01/13 → 05/16
GOLF VI 2.0 TDI	CBDA, CDLC	01/09 → 05/16
GOLF VI 2.0 TSI	CDLC, CBZB	01/13 →
GOLF VII 2.0 GTI	CXCA	11/13 →
GOLF VII 2.0 TDI	CRUA	11/12 →
JETTA VI 1.2 TSI	CBZB, CAXA	10/10 →
JETTA VI 1.4 TSI	CAXA, CNLA	04/11 →
JETTA VI 1.4 TSI Hybrid	CNLA, CLCA	04/11 →
JETTA VI 1.6 TDI	CAYC	04/10 → 07/14
JETTA VI 2.0	CKJA	06/10 → 12/17
JETTA VI 2.0 TDI	CLCA, CAXA	10/10 →
PASSAT V 1.4 TSI	CAXA, CDA A	08/10 → 12/14
PASSAT V 1.4 TSI EcoFuel	CDGA	08/10 → 12/14
PASSAT V 1.4 TSI MultiFuel	CKMA	11/10 → 12/14

VW

PASSAT V 1.6 TDI	CAYC	08/10 → 12/14
PASSAT V 1.8 TSI	CDA A, CFFA	08/10 →
PASSAT V 2.0 TDI	CFFA, CFFB	08/10 → 12/14
PASSAT V 2.0 TDI 4motion	CFFB, CBTA	08/10 → 12/14
PASSAT V 2.0 TSI	CCZB	11/10 → 12/15
PASSAT V 2.0 TSI 4motion	CCZB	01/12 → 12/14
PASSAT V 3.6 SRE	CBTA, CGPA	01/11 →
PASSAT V 3.6 FSI 4motion	BWS	01/11 → 12/14
POLO V 1.2	CGPA, CBZB	06/09 →
POLO V 1.2 [IND]	CJLA	08/11 →
POLO V 1.2 TDI	CFWA	10/09 →
POLO V 1.2 TSI	CBZB, CDDA	11/09 →
POLO V 1.4	CDDA, CWXA	03/09 → 05/14
POLO V 1.4 BiFuel	CMAA	03/10 → 01/11
POLO V 1.4 GTI	CAVE	05/10 →
POLO V 1.5 TDI [IND]	CWXA, CAYA	05/14 →
POLO V 1.6 BiFuel	CNKA	01/11 →
POLO V 1.6 TDI	CAYA, CAVB	06/09 →
TOURAN I 1.2 TSI	CBZB	05/10 → 05/15
TOURAN I 1.4 FSI	CAVB	11/06 → 05/10
TOURAN I 1.4 TSI	CAVB, CAYB	02/06 → 05/15
TOURAN I 1.4 TSI EcoFuel	CDGA	05/09 → 05/15
TOURAN I 1.6 TDI	CAYB, CFHC	05/10 → 05/15
TOURAN I 2.0 TDI	CFHC, CHZB	05/10 → 05/15

9.0793



1

REVOLUTION AND TIMING (CKP AND CMP) SENSORS

Adatt./Suitable:

AUDI04C 907 601
06M 907 601**BENTLEY**04C 907 601
04C 907 601 A
06M 907 601**PORSCHE**958 907 601 00
9A7 907 601 00**SEAT**

04C 907 601

SKODA04C 907 601
04C 907 601 A**VW**04C 907 601
06M 907 601MARKET DIFFUSION: **HIGH**

L	L1		
---	24,2	Hall Effect	

AUDI

A1 1.0 TFSI	CHZB, CPTA	03/15 → 10/18
A1 1.4 TFSI	CPTA, CHZL	04/12 → 10/18
A1 1.4 TSI	CZEA	11/14 → 10/18
A1 1.8 TFSI	DAJB	02/15 → 10/18
A1 25 TFSI	CHZL, DKJA	11/18 →
A1 30 TFSI	DKJA, CHZD	07/18 →
A1 S1 quattro	CWZA	03/14 → 10/18
A3 III 1.0 TFSI	CHZD, CJZA	07/16 →
A3 III 1.2 TFSI	CJZA, CMBA	02/13 →
A3 III 1.4 TFSI	CMBA, CUKB	04/12 →
A3 III 1.4 TFSI e-tron	CUKB, CJSA	05/14 →
A3 III 1.4 TFSI g-tron	CPWA	11/13 →
A3 III 1.4 TSI	CZEA	05/14 →
A3 III 1.8 TFSI	CJSA, CHHB	04/12 →
A3 III 1.8 TFSI quattro	CJSB	08/12 →
A3 III 2.0 quattro	CNTC	11/13 →
A3 III 2.0 TFSI	CHHB, CHHB	01/13 →
A3 III 2.0 TFSI [ExtraEU]	CHHB, CNTC	05/14 →
A3 III 2.0 TFSI quattro	CNTC, CHZD	05/14 →

			AUDI			SEAT		
A3 III 30 TFSI	CHZD, CJXB	07/18 →	Q2 2.0 TFSI quattro	CZPB, CHZJ	05/17 →	LEON ST 1.2 TSI	CJZB, CZDA	01/13 →
A3 III RS3 quattro	DAZA	04/17 →	Q2 30 TFSI	CHZJ, CZPB	07/18 →	LEON ST 1.4 TSI	CZDA, CJXA	05/14 →
A3 III S3 quattro	CJXB, CMUA	11/12 →	Q2 40 TFSI quattro	CZPB, CHPB	09/18 →	LEON ST 1.8 TFSI	CJSA	10/13 →
A4 IV 1.8 TFSI	CJEB	11/11 → 12/15	Q3 1.4 TFSI	CZDB	07/16 → 10/18	LEON ST 2.0 Cupra	CJXA, CHYA	10/13 →
A4 IV 1.8 TFSI quattro	CJEB	11/11 → 12/15	Q3 1.4 TSI	CHPB, CDNB	10/13 → 10/18	LEON ST 2.0 Cupra 4Drive	CJXC	11/16 →
A4 IV 2.0 TFSI	CNCD	05/13 → 12/15	Q5 1.2.0 TFSI quattro	CDNB, DAXB	08/09 →	MII 1.0	CHYA, CJZC	10/11 →
A4 IV 2.0 TFSI quattro	CNCD	05/13 → 12/15	Q5 II 2.0 TFSI quattro	DAXB, CRTC	06/16 →	MII 1.0 EcoFuel	CPGA	11/12 →
A4 IV 3.0 TFSI quattro	CMUA, CVKB	02/12 → 12/15	Q5 II SQ5 TFSI quattro	CWGD	11/16 →	TOLEDO IV 1.2 TSI	CJZC, CHYA	05/15 →
A4 IV S4 quattro	CREC	11/08 → 12/15	Q7 1.2.0 TFSI quattro	CYRB	08/15 →	TOLEDO IV 1.4 TSI	CZCA	05/15 →
A4 IV ALLROAD 2.0 TFSI quattro	CNCD	05/13 → 05/16	Q7 II 3.0 TDI e-tron quattro	CVZA	08/15 →	TOLEDO IV 1.6	CWVA	05/15 →
A4 V 1.4 TFSI	CVNA	08/15 →	Q7 II 3.0 TDI quattro	CRTC, CSPA	05/15 →	SKODA		
A4 V 2.0 TFSI	CVKB, DKYA	05/15 →	Q7 II 3.0 TFSI quattro	CREC	01/15 →	CITIGO 1.0	CHYA, CHYA	10/11 →
A4 V 2.0 TFSI g-tron	CVLA	11/16 →	Q8 3.0 45 TDi Mild Hybrid quattro	DHXC	07/18 →	CITIGO 1.0 CNG	CPGA	11/12 →
A4 V 2.0 TFSI Mild Hybrid	DKYA, CYMC	01/18 →	Q8 3.0 50 TDi Mild Hybrid quattro	DHXA	07/18 →	FABIA III 1.0	CHYA, CHZB	08/14 →
A4 V 2.0 TFSI Mild Hybrid quattro	DLHB	11/18 →	Q8 3.0 55 TFSI Mild Hybrid quattro	DCBD	02/18 →	FABIA III 1.0 TSI	CHZB, CJZC	08/14 →
A4 V 2.0 TFSI quattro	CYMC, CRTC	05/15 →	Q8 3.0 TDI quattro	CVMD	02/18 →	FABIA III 1.2 TSI	CJZC, CUSB	08/14 →
A4 V 3.0 TDI	CSWB	09/15 →	R8 5.2 FSI quattro	CSPA, CJSA	07/15 →	FABIA III 1.4 TDI	CUSB, CWVA	08/14 →
A4 V 3.0 TDI quattro	CRTC, CYMC	05/15 →	R8 5.2 FSI RWS	DKAB	09/17 →	FABIA III 1.6	CWVA, CZCA	01/15 →
A4 V 35 TFSI Mild Hybrid	DLVB	12/18 →	TT III 1.8 TFSI	CJSA, CHHC	08/15 →	KAROQ 1.0 TSI	CHZJ	07/17 →
A4 V 45 TFSI	DKNA	07/18 →	TT III 2.0 TFSI	CHHC	07/14 →	KODIAQ 1.4 TSI	CZCA, CZDA	10/16 →
A4 V 45 TFSI quattro	DKNA	07/18 →	TT III 2.0 TFSI quattro	CHHC, CJXF	07/14 →	KODIAQ 1.4 TSI 4x4	CZDA, CHZD	10/16 →
A4 V RS4 quattro	DECA	10/17 →	TT III 2.0 TFSI quattro	CJXF, DAZA	11/14 →	KODIAQ 2.0 TSI 4x4	CZPA	10/16 →
A4 V S4 quattro	CWGD	05/16 →	TT III 2.0 TTS quattro	DAZA, CMMC	10/16 →	OCTAVIA III 1.0 TSI	CHZD, CJZA	05/16 →
A4 V ALLROAD 2.0 TFSI quattro	CYMC, CRTC	01/16 →	TT III 2.5 RS quattro	DAZA, CMMC	10/16 →	OCTAVIA III 1.2 TSI	CJZA, CHPA	11/12 →
A4 V ALLROAD 3.0 TDI quattro	CRTC, CABD	01/16 →	TT 2.0 TFSi [ExtraEU]	CYFB	07/15 →	OCTAVIA III 1.4 [CHN]	CSSA	02/14 →
A4 2.0 45 TFSi	DKNA	07/18 →	BENTLEY			OCTAVIA III 1.4 TSI	CHPA, CJSA	11/12 →
A5 I 1.8 TFSI	CABD, CNCD	10/07 → 01/17	BENTAYGA 4.0	DCUA	01/18 →	OCTAVIA III 1.4 TSI G-TEC	CPWA	11/13 →
A5 I 2.0 TFSI	CNCD, CNCD	05/13 → 01/17	BENTAYGA 6.0	DDBB	10/15 →	OCTAVIA III 1.6	CWVA	01/14 →
A5 I 2.0 TFSI quattro	CNCD, CAKA	05/13 → 01/17	CONTINENTAL 4.0	CMMC, CMMD	09/11 →	OCTAVIA III 1.6 [CHN]	CSRA	02/14 →
A5 I S5 quattro	CAKA, CVKB	10/11 → 01/17	CONTINENTAL 4.0 FLEX	CMMD, CMMC	12/13 →	OCTAVIA III 1.8 TSI	CJSA, CJSA	11/12 →
A5 II 1.4 TFSI	CVNA	11/16 →	CONTINENTAL 4.0 FLEX AWD	CMMC, CMMC	04/12 →	OCTAVIA III 1.8 TSI 4x4	CJSA, CHHA	11/12 →
A5 II 2.0 TFSI	CVKB, DKYA	09/16 →	CONTINENTAL 4.0 FlexFuel [ExtraEU]	CMMC	09/11 →	OCTAVIA III 2.0 TSI RS	CHHA, CZCA	11/12 →
A5 II 2.0 TFSI g-tron	CVLA	02/17 →	CONTINENTAL 4.0 GT	CMMC, CMMC	04/12 →	RAPID 1.4 TSI	CZCA	05/15 →
A5 II 2.0 TFSI Mild Hybrid	DKYA, CYMC	07/18 →	CONTINENTAL 6.0 AWD	DDBD	09/17 →	RAPID 1.6	CWVA	05/15 →
A5 II 2.0 TFSI quattro	CYMC, CSWB	06/16 →	FLYING SPUR 4.0	CYCB	03/13 →	RAPID 1.6 SRE	CWVA	05/15 →
A5 II 3.0 TDI	CSWB	03/17 →	FLYING SPUR 4.0 FLEX	CMMC, MCN.CC	03/13 →	SUPERB III 1.4 TSI	CZCA, CZDA	03/15 →
A5 II 3.0 TDI quattro	CSWB, CYNB	09/16 →	FLYING SPUR V8 S 4.0	CYCA	05/16 →	SUPERB III 1.4 TSI 4x4	CZDA, CJSA	03/15 →
A5 II RS5 quattro	DECA	04/17 →	PORSCHE			SUPERB III 1.8 TSI	CJSA, DDXA	03/15 →
A5 II S5 quattro	CWGD	07/16 →	CAYENNE III 2.9 S	MDC.AB	05/17 →	SUPERB III 2.0 TSI	CHHB	03/15 →
A6 IV 1.8 TFSI	CYGA	09/14 → 09/18	CAYENNE III 3.0 AWD	MDC.BE	05/17 →	SUPERB III 2.0 TSI 4x4	CJXA	03/15 →
A6 IV 2.0 TFSI	CYNB, CYNB	05/14 → 09/18	CAYENNE III 3.0 E-Hybrid AWD	MDC.BE	05/17 →	YETI 1.2 TSI	CYVB	05/15 → 12/17
A6 IV 2.0 TFSI quattro	CYNB, CTCC	09/14 → 09/18	CAYENNE III 4.0 Turbo	MDC.UA	05/17 →	YETI 1.6	CWVA	04/14 → 12/17
A6 IV 3.0 TDI	CTCC, CRTD	09/14 → 09/18	MACAN 2.0	MCN.CC, CZDA	07/14 →	VW		
A6 IV 3.0 TDI quattro	CRTD, CRDB	09/14 → 09/18	PANAMERA 2.9 4 E-Hybrid	MDG.PA	11/16 →	AMAROK 3.0 TDI	DDXA	06/16 →
A6 IV 3.0 TFSI	CREH	09/14 →	PANAMERA 2.9 4S	MCS.ZA	11/16 →	AMAROK 3.0 TDI 4motion	DDXA, CZPB	06/16 →
A6 IV 3.0 TFSI quattro	CREC	09/14 → 09/18	PANAMERA 3.0	MCX.TA	11/16 →	AMAROK 3.0 TDi BlueMotion	DDXB	06/16 →
A6 IV RS6 performance quattro	CWUC	11/15 → 09/18	PANAMERA 3.0 4	MCX.TA	11/16 →	ARTEON 2.0 TSI	CZPB, CPKA	05/17 →
A6 IV RS6 quattro	CRDB, CEUC	01/13 → 09/18	PANAMERA 4.0 4S Diesel	MDB.UC	11/16 →	ARTEON 2.0 TSI 4motion	DJHC	04/17 →
A6 IV S6 quattro	CEUC, DDVE	02/12 → 09/18	PANAMERA 4.0 Turbo	MCV.DA	11/16 →	BEETLE 1.2 TSI 16V	CYVD	12/14 →
A6 V 3.0 45 TDI Mild Hybrid quattro	DDVE, DKNA	05/18 →	PANAMERA 4.0 Turbo	MCV.DA	10/17 →	BEETLE 1.4 TSI	CZDA	12/14 →
A6 V 3.0 50 TDI Mild Hybrid quattro	DDVB	02/18 →	PANAMERA 4.0 Turbo S E-Hybrid	MCV.DA	07/17 →	BEETLE 1.8 TSI	CPKA, CPLA	12/13 →
A6 V 3.0 55 TFSi Mild Hybrid quattro	DLZA	02/18 →	SEAT			BEETLE 2.0 TSI	CPLA, CHZG	12/12 →
A6 V 45 TFSI Mild Hybrid	DKNA, DKNA	08/18 →	ALHAMBRA III 1.4 TSI	CZDA, CHZJ	05/15 →	CADDY III 1.0 TSI	CHZG, CJZA	11/15 →
A6 V 45 TFSI Mild Hybrid quattro	DKNA, DDVE	08/18 →	ALHAMBRA III 2.0 TSI	DEDA	05/15 →	CADDY III 1.2 TSI	CYVC	06/15 →
A7 SPORTBACK 2.0 TFSI	CYPA	09/14 → 05/18	ARONA 1.0 TGI	DBYA	11/18 →	CADDY III 1.4 TGI CNG	CPWA	06/15 →
A7 SPORTBACK 2.0 TFSI quattro	CYNB, CRTD	05/15 → 05/18	ARONA 1.0 TSI	CHZJ, CHZJ	07/17 →	CADDY III 1.4 TSI	CZCB	05/15 →
A7 SPORTBACK 3.0 TDI quattro	CRTD, CRDB	05/14 → 05/18	ARONA 1.6 SRE	CWVA	07/17 →	CADDY III 1.6	CWVA	11/15 →
A7 SPORTBACK RS7 performance quattro	CWUC	11/15 → 04/18	ATECA 1.0 TSI	CHZJ, CZPB	05/16 →	CC 1.4 TSI	CZDA	05/15 → 12/16
A7 SPORTBACK RS7 quattro	CRDB, CGWA	10/13 → 04/18	ATECA 1.4 TSI	CZEA	06/16 →	GOLF VI 1.2 TSI 16V	CJZA, CHPB	11/13 → 05/16
A7 SPORTBACK S7 quattro	CEUC	02/12 → 03/15	ATECA 1.4 TSI 4Drive	CZEA	06/16 →	GOLF VI 1.4 TSI	CHPB, CHZC	11/13 → 05/16
A7 45 TDI Mild Hybrid quattro	DDVE, DKNA	04/18 →	ATECA 2.0 TSI 4Drive	CZPB, CHZB	05/17 →	GOLF VI 2.0 TSI	CULC	11/13 → 05/16
A7 45 TFSI	DKNA, DKNA	07/18 →	IBIZA 1.6 SRE [ExtraEU]	CWVA	05/17 →	GOLF VII 1.0 TSI	CHZC, CJZA	05/15 →
A7 45 TFSI quattro	DKNA, CYNB	07/18 →	IBIZA IV 1.0	CHYB	05/15 →	GOLF VII 1.2 TSI	CJZA, CPWA	08/12 →
A7 50 TDI Mild Hybrid quattro	DDVB	10/17 →	IBIZA IV 1.0 TSI	CHZB, CJZC	05/15 →	GOLF VII 1.4 TSI	CPWA, CHPA	08/12 →
A7 55 TFSI Mild Hybrid quattro	DLZA	10/17 →	IBIZA IV 1.0 TSI	CJZC, CPTA	05/15 →	GOLF VII 1.4 TSI MultiFuel	CPVA, CHHA	04/13 →
A8 III 2.0 TFSI quattro	CYPA	09/16 → 01/18	IBIZA IV 1.2 TSI	CJZC, CPTA	05/15 →	GOLF VII 1.4 TSI	CWVA	05/14 →
A8 III 3.0 TFSI quattro	CGWA, CEUA	06/10 → 01/18	IBIZA IV 1.4 TSI	CPTA, CWVA	10/13 →	GOLF VII 1.8 TSI 4motion	CJSB	12/14 →
A8 III 4.0 TFSI	CTGF	11/15 →	IBIZA IV 1.6 SRE	CWVA, CHYB	07/15 →	GOLF VII 2.0 GTI	CHHA, CJXB	04/13 →
A8 III 4.0 TFSI quattro	CEUA, CGTA	03/12 → 12/15	IBIZA IV 1.8 TSI Cupra	DAJA	11/15 →	GOLF VII 2.0 GTI Clubsport	CJXE	02/16 →
A8 III 55 TFSI Mild Hybrid quattro	CZSE	06/17 →	IBIZA V 1.0	CHYB, CHZJ	01/17 →	GOLF VII 2.0 GTI Clubsport S	CJXG	09/16 →
A8 III S8 plus quattro	DDTA	11/15 → 01/18	IBIZA V 1.0 MPI	DFNA	07/18 →	GOLF VII 2.0 R 4motion	CJXB, CRVA	11/13 →
A8 III S8 quattro	CGTA, CHZJ	04/12 → 01/18	IBIZA V 1.0 TGI	DBYA	11/17 →	GOLF VII 2.0 TDI	CRVA, CZCA	11/12 →
Q2 1.0 TFSI	CHZJ, CZPB	10/16 →	IBIZA V 1.0 TSI	CHZJ, CHZD	01/17 →	GOLF VII 2.0 TFSI	CYFB	11/13 →
Q2 1.4 TFSI	CZEA	06/16 →	LEON III 1.0 TSI	CHZD, CJZA	05/15 →	GOLF 1.2 TSI BlueMotion	CJZA, CHPA	08/12 →
			LEON III 1.2 TSI	CJZA, CHPA	12/12 →	GOLF 1.4 TSI BlueMotion	CHPA, CHHA	08/12 →
			LEON III 1.4 TGI	CPWA	02/13 →	GOLF 2.0 GTI	CHHA, CJZA	04/13 →
			LEON III 1.4 TSI	CHPA, CJSA	09/12 →	GOLF VAN 1.2 TSI BlueMotion	CJZA, CHPA	04/13 → 03/17
			LEON III 1.6 TSI	CWVA	05/15 →	GOLF VAN 1.4 TSI BlueMotion	CHPA, CJZA	05/13 → 03/17
			LEON III 1.8 TFSI	CJSA	02/13 →	JETTA VI 1.2 TSI	CYVD	02/11 →
			LEON III 1.8 TSI	CJSA	02/13 →	JETTA VI 1.2 TSI 16V	CYVD	08/14 →
			LEON III 1.8 TSI 4Drive	CJSA, CJXA	11/14 →	JETTA VI 1.4 TSI	CZCA, CNLA	08/14 →
			LEON III 2.0 Cupra	CJXA, CJXC	10/13 →	JETTA VI 1.4 TSI Hybrid	CNLA, CWVA	04/11 →
			LEON III 2.0 Cupra 4Drive	CJXC, CJZB	11/16 →	JETTA VI 1.6	CWVA	09/15 →
			LEON ST 1.0 TSI	CHZD	05/15 →	JETTA VI 1.6 [RUS]	CWVA, CPLA	01/15 →
						JETTA VI 1.6 MPI	CWVB	09/15 → 04/18
						JETTA VI 2.0 TSI	CPLA, CPKA	12/12 →

VW			
UP 1.0	--, CNEA	08/11	⇒
UP 1.0 BlueMotion	CHYB	05/16	⇒
UP 1.0 EcoFuel	CPGA	11/12	⇒
UP 1.0 GTI	DKRA	11/17	⇒
UP 1.0 TSI	CHZA	05/16	⇒
UP 1.0 TSi BlueMotion	CHZA	05/16	⇒
PASSAT 2.0 TFSi BlueMotion	DNVA	09/18	⇒
PASSAT V 1.8 TSI	CPKA, CZCA	06/13	⇒
PASSAT VI 1.4 GTE Hybrid	CUKC	06/15	⇒
PASSAT VI 1.4 TSI	CZCA, CJSA	11/14	⇒
PASSAT VI 1.4 TSI 4motion	CZEA	02/15	⇒
PASSAT VI 1.8 TSI	CJSA, CRGA	02/15	⇒
PASSAT VI 2.0 TDI	CRGA, CHHB	11/14	⇒
PASSAT VI 2.0 TSI	CHHB, CHHB	02/15	⇒
PASSAT VI 2.0 TSI 4motion	CHHB, CHYA	05/15	⇒
POLO V 1.0	CHYA, CHZB	01/14	⇒
POLO V 1.0 TSI	CHZB, CJZC	11/14	⇒
POLO V 1.2 TSI	CJZC, CPTA	01/14	⇒
POLO V 1.2 TSI 16V	CJZC	02/14	⇒
POLO V 1.4 TSI	CPTA, CWVA	10/12	⇒
POLO V 1.4 TSI [RUS]	CZCA	05/14	⇒
POLO V 1.6	CWVA, DAJA	07/14	⇒
POLO V 1.8 GTI	DAJA, CHYB	11/14	⇒
POLO VI 1.0	CHYB, CHZJ	06/17	⇒
POLO VI 1.0 TGI	DBYA	09/17	⇒
POLO VI 1.0 TSI	CHZJ, CZPC	06/17	⇒
POLO VI 2.0 GTI	CZPC, CZCA	11/17	⇒
T-ROC 1.0 TSI	CHZJ	07/17	⇒
T-ROC 2.0 TSI 4motion	CZPB	07/17	⇒
SCIROCCO III 1.4 TSI	CZCA, CULA	11/13	⇒
SCIROCCO III 2.0 TSI	CULA, CZDA	11/13	⇒ 11/17
SHARAN II 1.4 TSI	CZDA	05/15	⇒
SHARAN II 2.0 TSI	DEDA	05/15	⇒
TIGUAN I 1.4 TSI	CZDA, CZCA	05/15	⇒
TIGUAN II 1.4 TSI	CZCA, CZDA	01/16	⇒
TIGUAN II 1.4 TSI 4motion	CZDA, CHHB	05/16	⇒
TIGUAN II 2.0 TSI 4motion	CHHB, --	01/16	⇒
TOUAREG II 3.0 TDI	DENA	11/17	⇒
TOUAREG II 3.0 TDI 4motion	DEND	05/18	⇒
TOURAN II 1.2 TSI	CYVB	05/15	⇒
TOURAN II 1.4 TSI	CZDA	05/15	⇒
TOURAN II 1.8 TSI	CJSA	11/15	⇒

VW			
CRAFTER 2.0 TDI 4motion	CKUB, G4FG	11/11	⇒ 12/16

9.0810



04,5

REVOLUTION AND TIMING (CKP AND CMP) SENSORS

Adatt./Suitable:

HYUNDAI
39180-2B030**KIA**
39180-2B030

L	L1	ohm	
415	46,2	1035	

HYUNDAI

ELANTRA V 1.6 T-GDi [ExtraEU]	G4FJ	02/16	⇒
I30 II 1.6	G4FG, G4FG	12/11	⇒
I30 II 1.6 T-GDI	G4FJ	01/15	⇒
TUCSON 1.6 T-GDi	G4FJ	06/15	⇒
TUCSON 1.6 T-GDi Trazione integrale	G4FJ	06/15	⇒
VELOSTER 1.6	G4FG	06/11	⇒
VELOSTER 1.6 T-GDI	G4FJ	10/12	⇒

KIA

CEED II 1.6 GT	G4FJ	06/13	⇒
CERATO III 1.6	--	07/12	⇒
CERATO 1.6 T-GDI [ExtraEU]	G4FJ	09/14	⇒
FORTE III 1.6	--	07/12	⇒
PRO CEE'D II 1.6 GT	G4FJ	06/13	⇒
SOUL II 1.6 TGDI	G4FJ	11/16	⇒
SPORTAGE IV 1.6 GDI	G4FJ	09/15	⇒
SPORTAGE IV 1.6 GDI AWD	G4FJ	09/15	⇒

9.0794



04,5

REVOLUTION AND TIMING (CKP AND CMP) SENSORS

Adatt./Suitable:

VW
03L 957 147 B**NEW - AVAILABLE FROM:**

- NUOVO - DISPONIBILE DA:
- NOUVEAU - DISPONIBLE EN:
- NEU - VERFUEGBAR AB:
- NUEVO - DISPONIBLE EN:

19/Q3



L	L1		
400	---	Hall Effect	

VW			
AMAROK 2.0 BiTDI	CNEA, CNEA	11/11	⇒
AMAROK 2.0 BiTDI 4motion	CNEA, CDBA	11/11	⇒
AMAROK 2.0 TDI	CDBA, CDBA	09/10	⇒
AMAROK 2.0 TDI 4motion	CDBA, CNEA	09/10	⇒
AMAROK 2.0 TDi/TDi BlueMotion [ExtraEU]	CNEA, CKTB	09/11	⇒
CRAFTER 2.0 TDI	CKTB, CKUB	05/11	⇒



KNOCK SENSORS

·SENSORI DI DETONAZIONE ·CAPTEURS DE CLIQUETIS ·KLOPFSENSOREN ·SENSORES DE PICADO

(A) P/NRS. - NOTES

- CODICI - NOTE
- RÉFS. - NOTES
- ARTIKEL-NR. - ANMERKUNGEN
- CODIGOS - NOTAS

(B) PICTURE + TECHNICAL INFO

- FOTO + INFORMAZIONE TECNICA
- ILLUSTRATION + INFORMATION TECHNIQUE
- BILD + TECHNISCHE INFO
- FOTO + INFORMACIÓN TÉCNICA

(C) APPLICATION LIST

- GUIDA APPLICAZIONI
- LISTE D'APPLICATIONS
- ANWENDUNGSTABELLE
- LISTA DE APLICACIONES

9.3187

04,5

Adatt./Suitable:

FORD

1 357 496
1 362 065
1 374 710
4M51-12A699-BA

NEW - AVAILABLE FROM:

· NUOVO - DISPONIBILE DA:
· NOUVEAU - DISPONIBLE EN:
· NEU - VERFUEGBAR AB:
· NUEVO - DISPONIBLE EN:

01/11



2	3	4	5
L	mV/g		
350	27		

FORD

C-MAX 1.8 TDCi	KKDA	02/07 ⇨
FOCUS C-MAX 1.8 TDCi	KKDA	01/05 ⇨ 03/07
FOCUS II 1.8 TDCi	KKDA, KKDB	11/04 ⇨
FOCUS III 1.8 TDCi	—	12/07 ⇨
GALAXY 1.8 TDCi	FFWA, QYWA	05/06 ⇨
MONDEO IV 1.8 TDCi	KHBA, QYBA	06/07 ⇨
S-MAX 1.8 TDCi	QYWA	05/06 ⇨
TOURNEO 1.8 Di	BHPA, BHPB	06/02 ⇨

(A)

1 # FACET

2 OEM P/NRS.
· CODICI ORIGINALI
· RÉFS. D'ORIGINE
· ORIGINALTEILE-NR.
· CODIGOS ORIGINALES

3 PACKAGING SIZE
· FORMATO CONFEZIONE
· FORMAT DU CONDITIONNEMENT
· ABPACKENSGROESSE
· TAMAÑO DEL ENVASE

4 PRODUCT AVAILABILITY DATE
· DATA DI DISPONIBILITÀ DEL PRODOTTO
· DISPONIBILITÉ DU PRODUIT
· PRODUKTVERFUEGBARKEITSDATUM
· DISPONIBILIDAD ARTÍCULO

5 NOTE
· NOTE
· NOTES
· BEMERKUNGEN
· NOTAS

(B)

1 PICTURE

- FOTO
- PHOTO
- BILD
- FOTO

2 WIRE LENGTH

- LUNGHEZZA CAVO
- LONGUEUR DU CÂBLE
- KABELLAENGE
- LARGO DEL CABLE

3 SENSOR SENSITIVITY

- SENSIBILITÀ SENSORE
- SENSIBILITÉ DU CAPTEUR
- SENSOREMPFINDLICHKEIT
- SENSIBILIDAD DEL SENSOR

4 TYPE OF CONNECTION

- TIPO DI CONNESSIONE
- TYPE DE CONNEXION
- ANSCHLUSSART
- TIPO DE ENCHUFE

5 CIRCUIT

·CIRCUITO ·CIRCUIT ·STROHMKREIS ·CIRCUITO

	Sensor with shielded cable · Sensore con cavo schermato · Capteur avec câble blindé · Sensor mit Abschirmkabel · Sensor con cable protegido		Simple sensor · Sensore semplice · Capteur simple · Einfacher Sensor · Sensor simple
	Sensor with resistor and shielded cable · Sensore con resistenza e cavo schermato · Capteur avec résistance et câble blindé · Sensor mit Widerstand und Abschirmkabel · Sensor con resistencia y cable protegido		Sensor with resistor · Sensore con resistenza · Capteur avec résistance · Sensor mit Widerstand · Sensor con resistencia
	Double sensor · Sensore doppio · Capteur double · Doppelsensor · Sensor doble		Double sensor with resistance · Sensore doppio con resistenza · Capteur double avec résistance · Doppelsensor mit Widerstand · Sensor doble con resistencia
	Double sensor with three terminals · Sensore doppio con tre terminali · Capteur double avec trois terminaux · Doppelsensor mit drei Anschlüssen · Sensor doble con tres terminales		

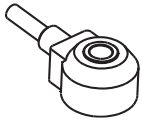

9.3XXX Knock sensors

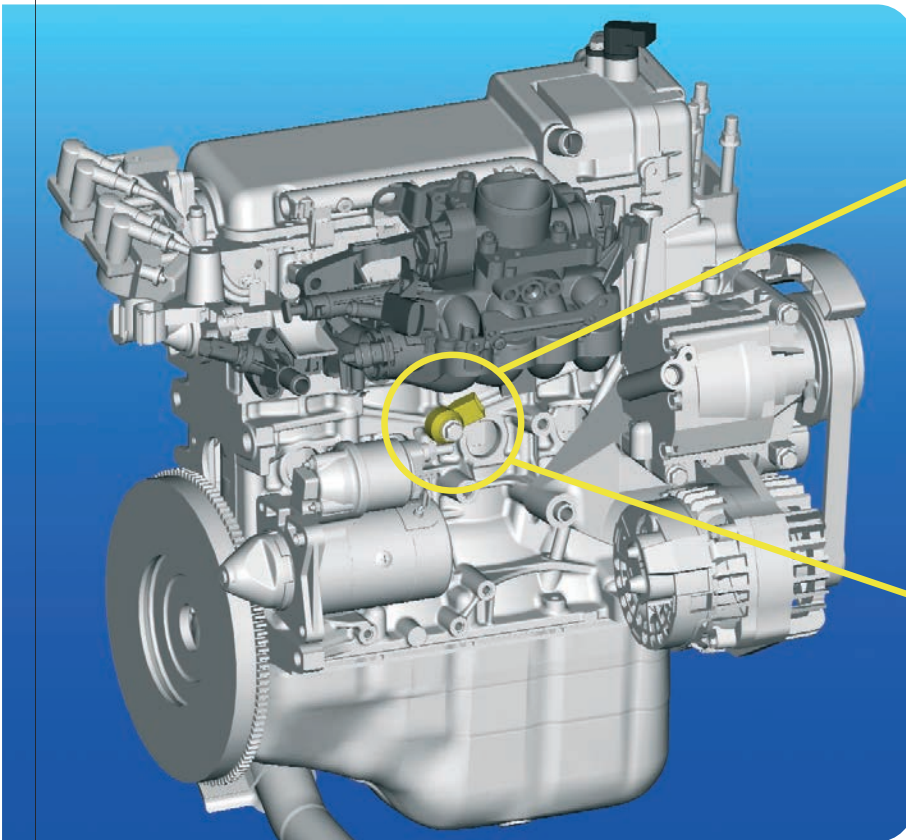

Rendering: by kind concession of FIAT POWERTRAIN TECHNOLOGIES

Knock sensors, **installed on the engine block, detect if the explosion of the mixture** inside the cylinders occurs in an incorrect manner (detonation or pinging) thus transmitting a signal to the electronic control unit of the engine. In case of detonation, the unit corrects the ignition parameters (delay, enrichment of the mixture) by protecting the engine against possible damage.

Knock sensors are **used with any spark ignition engine** (hence not diesel engines), including engines with alternative fuels. Furthermore, depending on the type of engine and control unit, one or more sensors may be used simultaneously. Depending on the specific application, the **connector of the knock sensor** may be integrated or connected to the body of the sensor with a cable. Connectors may have 2 terminals or 3 terminals if there is an interference suppression.

The main **reasons for failures** are:

- jets of water at high pressure (e.g. during washing of the engine) may cause deterioration of the electrical insulation
- deterioration of the piezoelectric disk

Signs of malfunctions of the sensor are indicated by illumination of the engine warning lamp, knocking in the cylinder head, difficulty in starting the vehicle, high fuel consumption, increased exhaust

gas emissions.

Knock sensors are designed and built to withstand the critical installation conditions on the engine block. In particular, the following **requirements** shall be met:

- *operating temperature*: $-40^{\circ}\text{C} \div +150^{\circ}\text{C}$
- *degree of protection*: IP68 (entrance of dust not allowed and protection against continuous water immersion effects).

The knock sensors undergo **qualification and endurance tests** to determine if the product is suitable for construction and sale:

- Resistance to sinusoidal and random vibrations for a total of 250 hours
- resistance to thermal shocks
- resistance to impacts
- cable traction resistance
- resistance to water immersion

When these tests have been passed and after the approval to manufacture has been given, the product, in the assembly process, is strictly checked through a series of cycles which include a **100%** sensor resistance **test** as well as a sensitivity and performance test.

Structural elements and operation

The explosion of the air-fuel mixture inside the cylinders generates engine vibrations, the frequency of which depends on the phenomena occurring during combustion. In case of detonation, the engine vibrates at a well-defined frequency (the frequency of the detonation vibrations is typical of every engine, generally between 5.2 ÷ 8 kHz).

The engine vibrations are transferred from a *spring washer* and a *seismic mass* to the sensitive element of the sensor which transforms the vibrations into an electric potential difference that can be measured at the ends of the sensor. This is possible because the sensitive element is a *piezoelectric ceramic ring* which electrically polarizes to the mechanical deformation undergone to a proportionate degree.

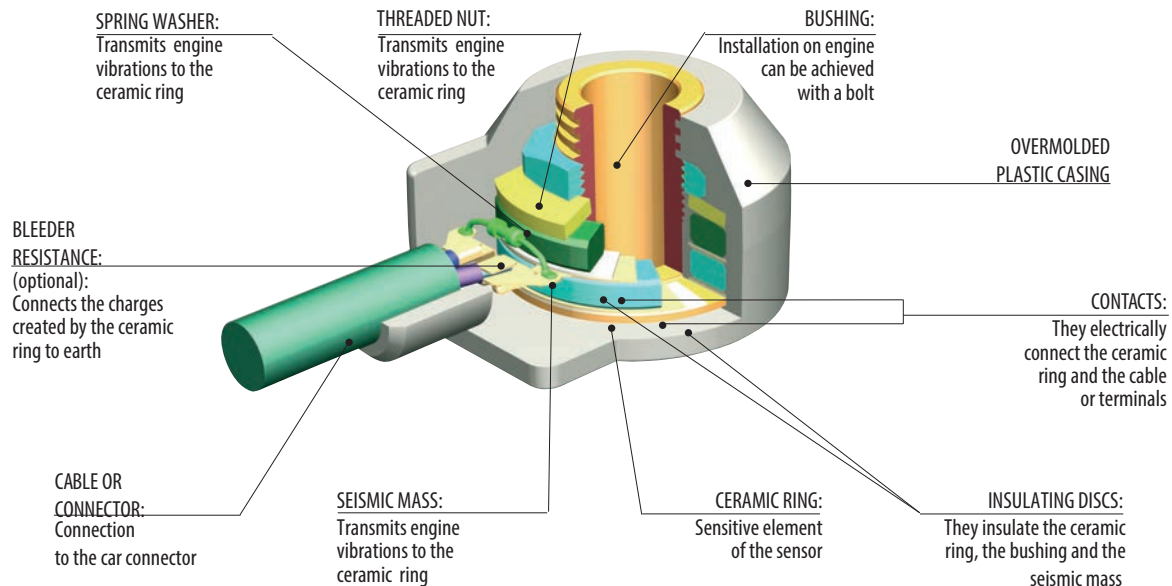

The sensor transmits the electric signals generated by each engine vibration to the engine control unit (ECU). The ECU filters the signals not relevant to detonation vibration frequencies and corrects the ignition parameters. The characteristic of knock sensors is expressed by the sensitivity (ratio between the tension generated on the sensor terminals and the acceleration to which it is subjected) of the sensor as the frequency changes:

$$S = \frac{\text{voltage}}{\text{acceleration}} \left[\frac{\text{mVolt}}{\text{g}} \right]$$

(1 g = 9.81 m · s⁻²)

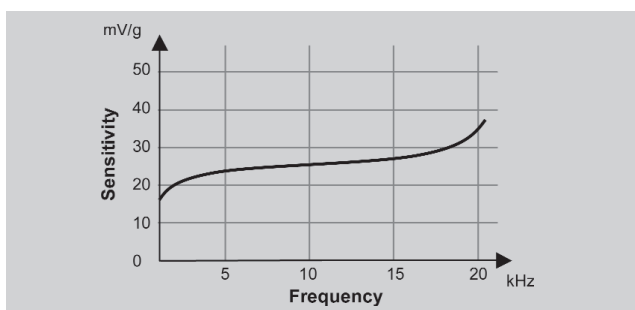

Non resonant sensors have a **flat** response: sensitivity is almost constant within the operation band. Sensitivity varies according to the mass of the seismic mass; this is calibrated in order to achieve the required values.

Installation instructions

Tightening torque for knock sensors on the engine block: **20 ± 5 Nm**.

In order to improve mechanical coupling and thus the transmission of the vibrations between the engine block and the sensor, it is recommended to apply a thin layer of **gel** (e.g. silicone).

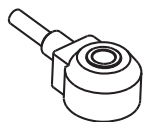

9.3XXX

Sensori di detonazione

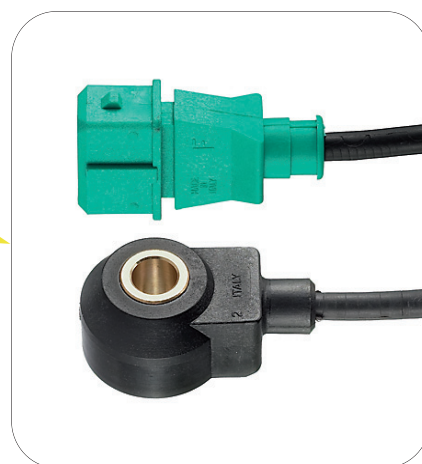
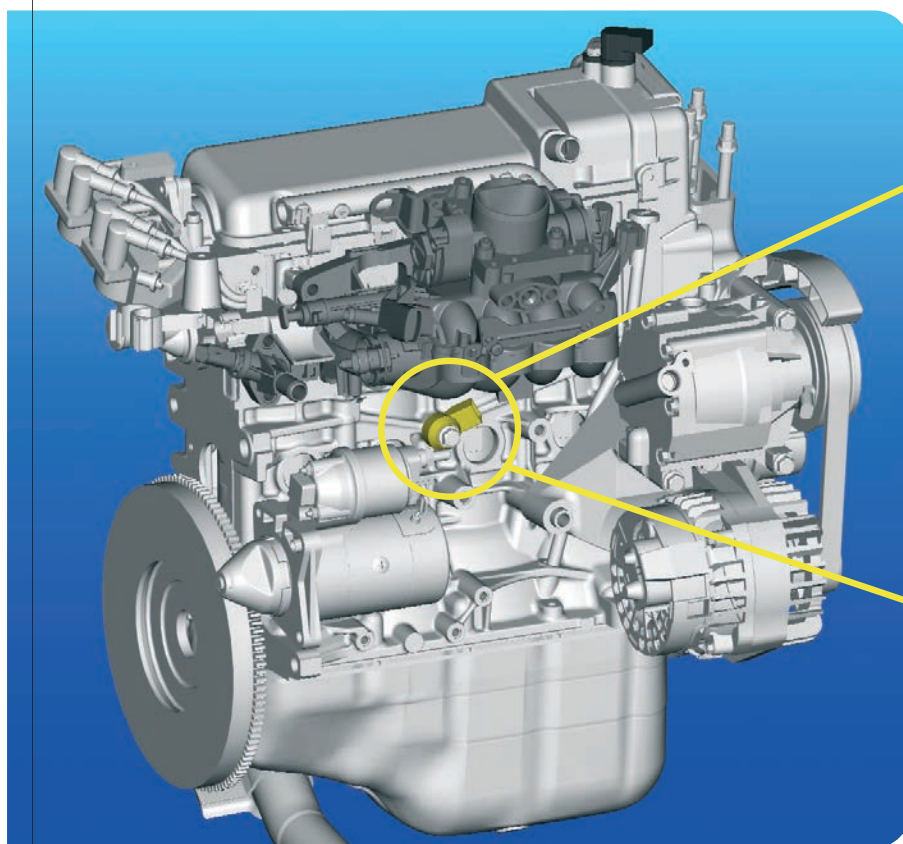

Rendering: per gentile concessione di FIAT POWERTRAIN TECHNOLOGIES

I sensori di detonazione, **montati sul monoblocco del motore, rilevano se lo scoppio della miscela nei cilindri avviene in modo non corretto** (detonazione o battito in testa) e trasmettono un segnale alla centralina elettronica di controllo motore. In caso di detonazione, la centralina corregge i parametri dell'accensione (ritardo, arricchimento della miscela) proteggendo il motore da possibili danni.

I sensori di detonazione **sono applicati a qualsiasi motore con accensione a scintilla** (quindi non diesel), inclusi motori con combustibili alternativi. Inoltre, in funzione della tipologia di motore e della centralina di controllo, possono essere impiegati uno o più sensori contemporaneamente.

Le principali **cause di guasto** sono:

- spruzzi di acqua ad alta pressione (es. durante il lavaggio del motore) possono causare la riduzione dell'isolamento termico
- deterioramento delle caratteristiche del disco piezoelettrico

I **segnali di malfunzionamento** del sensore sono ravvisabili nell'accensione della spia motore, nel battito in testa, nella difficoltà di avviamento del veicolo, nell'elevato consumo di carburante e nell'aumento delle emissioni di gas di scarico.

I sensori di detonazione sono progettati e costruiti per sopportare le condizioni critiche di montaggio sul blocco motore. In particolare devono soddisfare i seguenti **requisiti**:

- *temperatura di funzionamento*: $-40^{\circ}\text{C} \div +150^{\circ}\text{C}$
- *grado di protezione*: IP68 (ingresso di polveri non consentito e protezione contro gli effetti dell'immersione continua in acqua)

I sensori di detonazione sono sottoposti a rigorose **prove di qualificazione e di durata** per stabilire se il prodotto è idoneo per essere costruito e venduto:

- resistenza alle vibrazioni sinusoidali e casuali per un totale di 250 ore
- resistenza agli shock termici
- resistenza agli urti
- resistenza alla trazione del cavo
- resistenza all'immersione in acqua

Superate tali prove e concesso il benessere a produrre, durante l'assemblaggio il prodotto viene sottoposto a severi cicli di controllo che prevedono il **collaudo al 100%** di sensibilità, capacità e resistenza dei sensori.

Elementi costruttivi e principio di funzionamento

Lo scoppio della miscela aria-carburante nei cilindri genera vibrazioni del motore la cui frequenza dipende dai fenomeni che si verificano durante la combustione. In caso di detonazione il motore vibra ad una frequenza ben precisa (la frequenza delle vibrazioni di detonazione è una caratteristica propria di ogni motore, generalmente compresa tra $5,2 \div 8$ kHz).

Le vibrazioni del motore sono trasferite da una *rondella elastica* e una *massa sismica* all'elemento sensibile del sensore che trasforma le vibrazioni in una differenza di potenziale elettrico misurabile ai capi del sensore. Ciò è possibile poiché l'elemento sensibile è un *anello ceramico piezoelettrico* che si polarizza elettricamente in modo proporzionale alla deformazione meccanica subita.

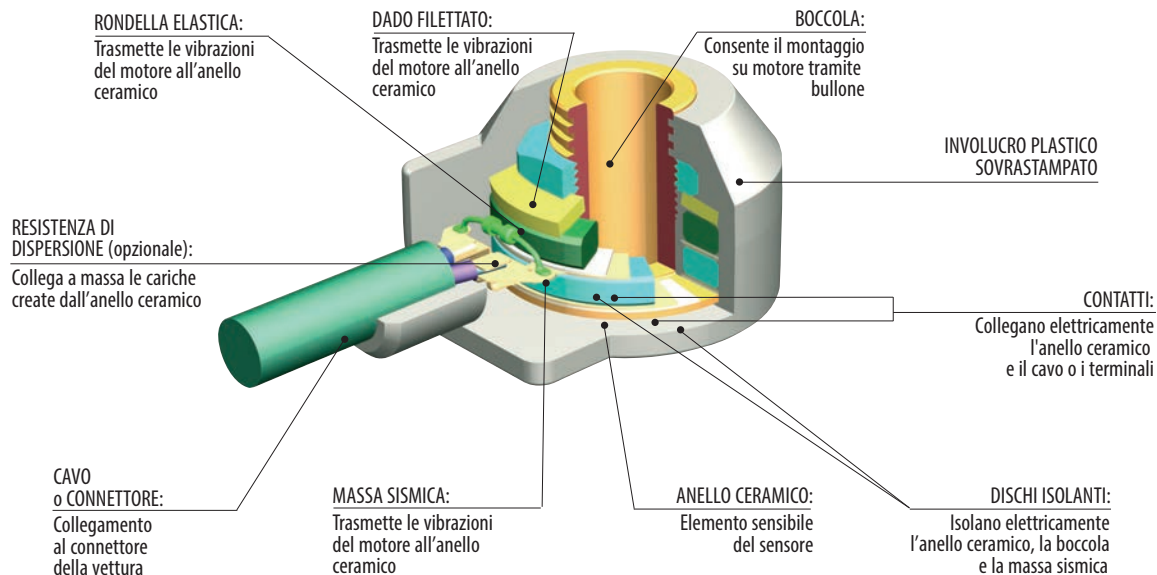

Il sensore trasmette alla centralina di controllo motore (ECU) i segnali elettrici generati da ogni vibrazione del motore. La ECU filtra i segnali non relativi a frequenze di vibrazione di detonazione e corregge i parametri dell'accensione.

La caratteristica dei sensori di detonazione è espressa dalla sensibilità (rapporto tra tensione generata sui terminali del sensore e accelerazione a cui è sottoposto) del sensore al variare della frequenza:

$$S = \frac{\text{tensione}}{\text{accelerazione}} \left[\frac{\text{mVolt}}{\text{g}} \right]$$

$$(1 \text{ g} = 9.81 \text{ m} \cdot \text{s}^{-2})$$

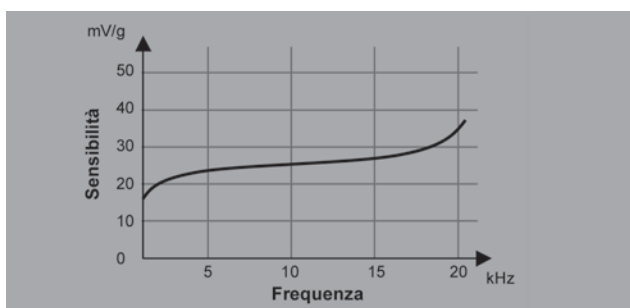

I sensori di tipo non risonante hanno un andamento **piatto**: la sensibilità è quasi costante all'interno della banda di funzionamento.

La sensibilità varia in funzione della massa della massa sismica, questa è calibrata in modo da ottenere i valori richiesti.

Istruzioni di montaggio

Coppia di serraggio dei sensori di detonazione sul monoblocco del motore: 20 ± 5 Nm

Per migliorare l'accoppiamento meccanico e, quindi, la trasmissione delle vibrazioni tra il basamento del motore e il sensore si consiglia di applicare un sottile strato di **gel** (ad esempio siliconico).

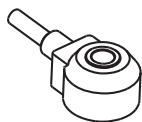

9.3XXX

Capteurs de cliquetis

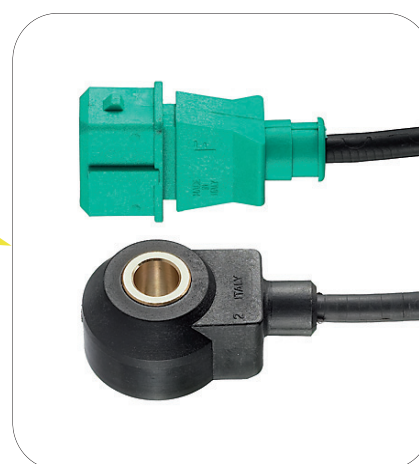
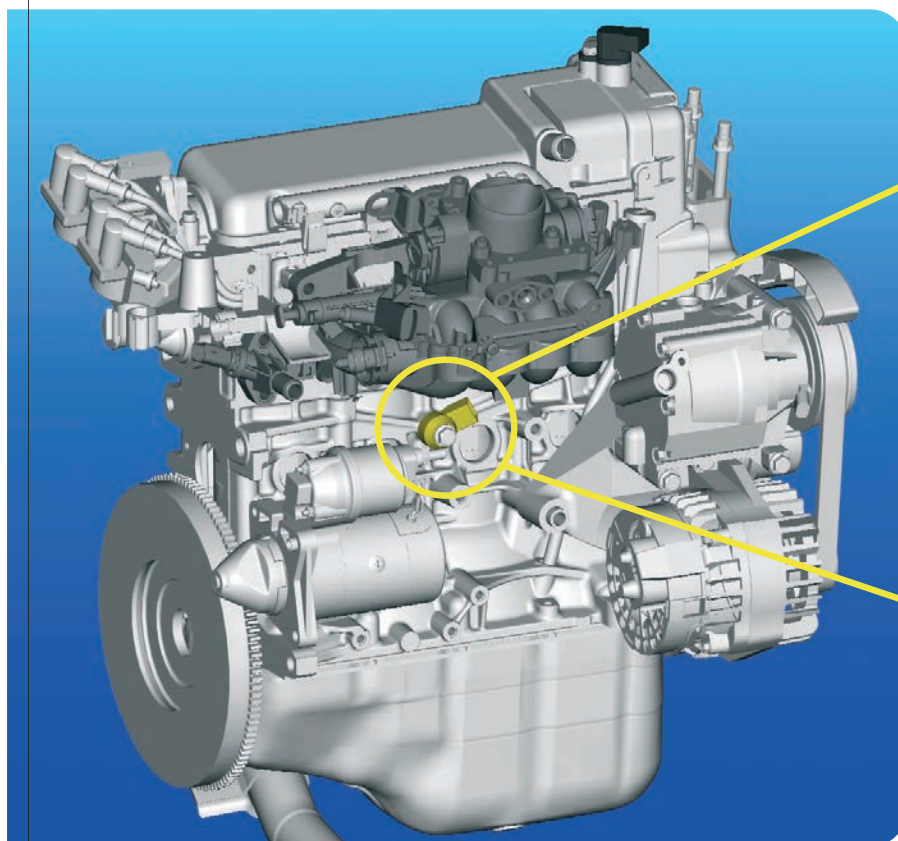

Rendering: par aimable concession de FIAT POWERTRAIN TECHNOLOGIES

Les capteurs de cliquetis, **montés sur le bloc cylindres du moteur, se chargent de détecter les possibles anomalies d'explosion du mélange** dans les cylindres (détonation ou cognement en tête) et de transmettre un signal à l'unité électronique de contrôle du moteur. En cas de détonation, l'unité électronique corrige les paramètres d'allumage (retard, enrichissement du mélange) et protège le moteur contre tous endommagements éventuels.

Les capteurs de cliquetis: trouvent leur **application dans tous les moteurs avec allumage par étincelle** (les Diesel sont exclus), y compris les moteurs à combustibles alternatifs. De plus, en fonction de la typologie du moteur et l'unité de contrôle, un ou plusieurs capteurs peuvent être utilisés en simultanéité.

Selon l'application spécifique à laquelle il est destiné, le **connecteur du capteur de cliquetis** peut être intégré ou raccordé sur le corps du capteur à l'aide d'un câble. Les connecteurs disposent de 2 bornes ou, en cas de présence d'un blindage antiparasite, de 3 bornes.

Les **principales causes de défaut** sont :

- des jets d'eau à haute pression (ex. pendant le lavage du moteur) peuvent causer une réduction de l'isolation électrique
- la détérioration des caractéristiques du disque piézoélectrique

Les **signaux de dysfonctionnement** du capteur sont reconnaissables par l'allumage du témoin du moteur, un cognement du

moteur, des difficultés de démarrage du véhicule, une consommation élevée de carburant et une augmentation des émissions de gaz d'échappement .

Les capteurs de cliquetis sont conçus et fabriqués pour supporter les conditions de montage critiques sur le blocmoteur.

En particulier, ils doivent répondre aux **caractéristiques** suivantes:

- *température de fonctionnement*: -40°C ÷ +150°C
- *degré de protection*: IP68 (entrée de poussières non admis et protection contre les effets de l'immersion continue dans l'eau)

Les capteurs de cliquetis sont soumis à des **essais de qualification et de durée rigoureux** pour établir si le produit est adéquat à la fabrication et à la vente:

- résistance aux vibrations sinusoïdales et casuelles pendant 250 heures au total
- résistance aux chocs thermiques
- résistance aux coups
- résistance à la traction du câble
- résistance à l'immersion dans l'eau

A l'issue positive de ces essais et une fois l'autorisation de production accordée, le produit est soumis tout au long de son assemblage à de sévères cycles de contrôle envisageant le **test à 100%** de la sensibilité, de la capacité et de la résistance des capteurs.

Éléments constitutifs et principe de fonctionnement

L'explosion du mélange air-carburant dans les cylindres donne lieu à des vibrations du moteur dont la fréquence dépend des phénomènes qui se produisent pendant la combustion. En cas de détonation le moteur vibre à une fréquence bien précise (la fréquence des vibrations de détonation est une caractéristique propre à chaque moteur et est généralement comprise entre $5,2 \div 8$ kHz). Les vibrations du moteur sont transmises par une *rondele élastique* et une *masse sismique* à l'élément sensible du capteur qui transforme les vibrations en une différence de potentiel électrique mesurable aux extrémités du capteur. Cela est possible étant donné que l'élément sensible est un *anneau de céramique piézoélectrique* qui se polarise électriquement d'une manière proportionnelle à la déformation mécanique subie.

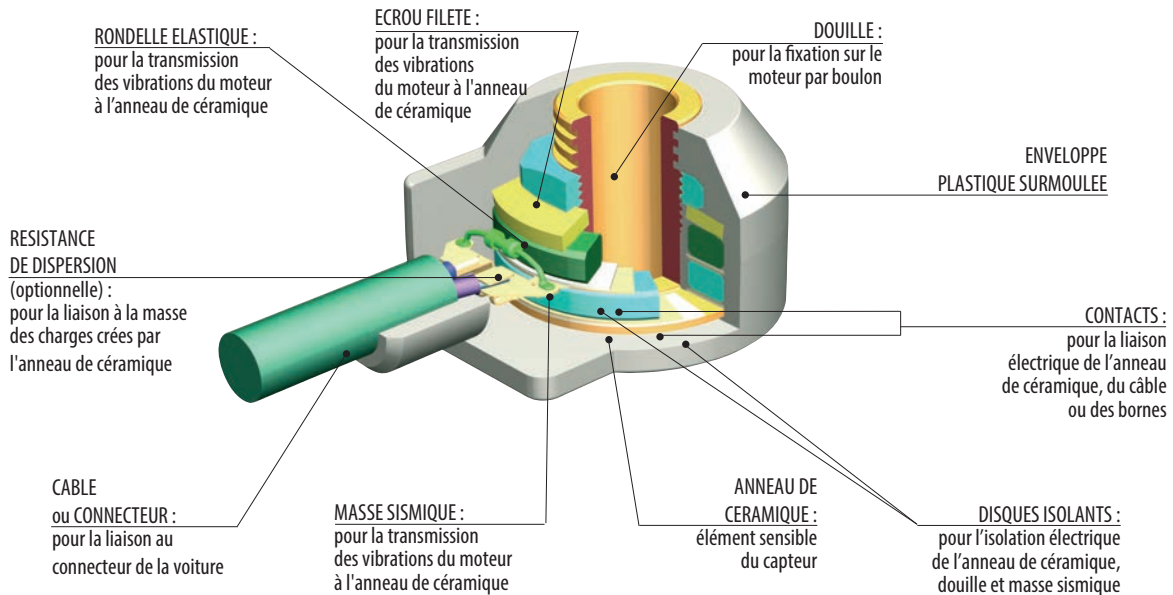

Le capteur transmet à l'unité de contrôle du moteur (ECU) les signaux électriques qui sont générés par chaque vibration du moteur. L'unité ECU filtre les signaux qui ne se rapportent pas aux fréquences de vibration de détonation et corrige les paramètres d'allumage.

La caractéristique des capteurs de cliquetis s'exprime par la sensibilité (rapport entre la tension qui est générée sur les bornes du capteur et l'accélération à laquelle il est soumis) du capteur lors de toute variation de fréquence:

$$S = \frac{\text{tension}}{\text{accélération}} \left[\frac{\text{mVolt}}{\text{g}} \right]$$

$$(1 \text{ g} = 9.81 \text{ m} \cdot \text{s}^{-2})$$

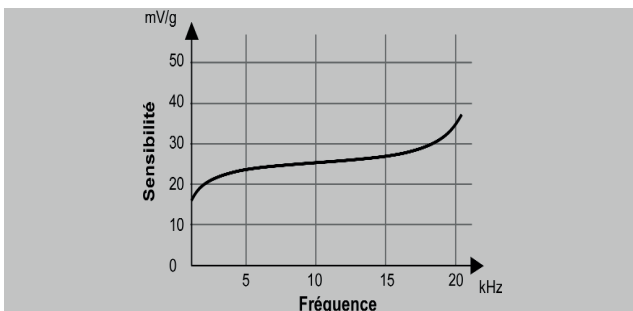

Les capteurs de type non résonant ont un tracé **plat**: la sensibilité est quasiment constante dans la bande de fonctionnement.

La sensibilité varie en fonction de la masse sismique qui est calibrée pour obtenir les valeurs souhaitées.

Instruction de montage

Couple de serrage des capteurs de cliquetis sur le bloc cylindres du moteur: 20 ± 5 Nm.

Pour améliorer l'accouplement mécanique et, donc, la transmission des vibrations entre le soubassement du moteur et le capteur, il est conseillé d'appliquer une légère couche de **gel** (de silicone par exemple).

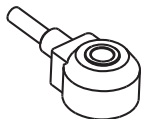

9.3XXX Klopfsensoren

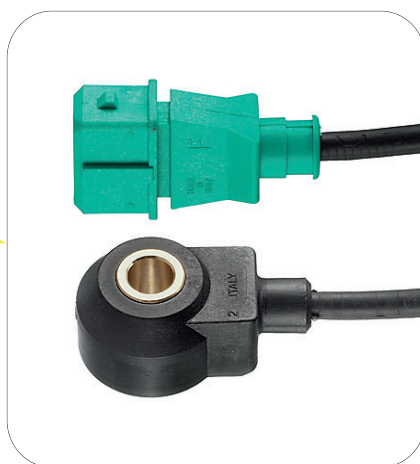
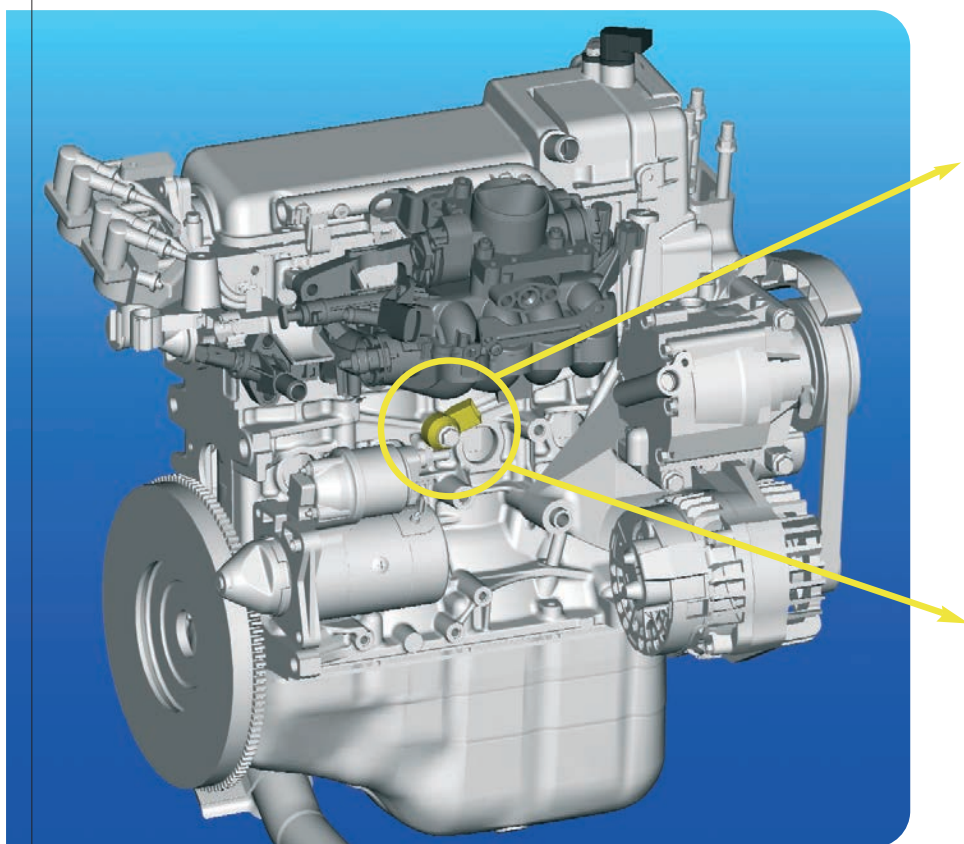

Rendering: bei freundlichem Zugeständnis von FIAT POWERTRAIN TECHNOLOGIES

Die Klopfsensoren sind **auf dem Motorblock montiert, detektieren, wenn die Explosion des Brennstoffs in den Zylindern nicht ordnungsgemäß erfolgt** (Klopfen) und senden dem elektronischen Steuergerät des Motors ein Signal. Bei Klopfen korrigiert das Steuergerät die Parameter der Zündung (Verzögerung, Anreicherung des Brennstoffs) und schützt so den Motor vor eventuellen Schäden.

Die Klopfsensoren werden **für jeden beliebigen ottomotor** (also keine Dieselmotoren) **angewendet**, einschließlich Motoren mit alternativen Brennstoffen. Je nach Art des Motors und des Steuergeräts können außerdem einer oder mehrere Sensoren gleichzeitig eingesetzt werden. Je nach spezifischer Anwendung kann das **Anschlussstück des Klopfsensors** integriert oder an den Körper des Sensors mit einem Kabel angeschlossen sein. Die Anschlüsse können 2 Klemmen aufweisen oder 3 bei Störabschirmung.

Die Hauptursachen für Defekte sind:

- Wasserspritzer unter hohem Druck (z. B. während des Reinigens des Motors) können zur Verringerung der Elektroisolierung führen
- Beeinträchtigung der Eigenschaften der Piezoplatte

Die **Anzeichen für Funktionsstörungen** sind: Klopfen, Startprobleme und eine blinkende oder leuchtende Motorkontrollleuchte.

Im Hinblick auf Planung und Bau sind die Klopfsensoren so ausgelegt, dass sie den kritischen Montagebedingungen auf dem Motorblock standhalten. Insbesondere müssen sie die nachfolgenden **Anforderungen** erfüllen:

- **Betriebstemperatur:** $-40^{\circ}\text{C} \div +150^{\circ}\text{C}$
- **Schutzart:** IP68 (staubdicht und geschützt gegen die Wirkungen beim ständigen Untertauchen in Wasser)

Die Klopfsensoren werden **Qualitäts- und Haltbarkeitstests** unterzogen, um festzulegen, ob das Produkt für Bau und Verkauf geeignet ist

- Beständigkeit gegen sinusförmige und zufällige Schwingungen für insgesamt 250 Stunden
- Beständigkeit gegen starke Temperaturschwankungen
- Stoßfestigkeit
- Widerstand gegen den Kabelzug
- Beständigkeit beim Eintauchen in Wasser

Bei positiven Prüfergebnissen und nach Erteilen der Produktionsgenehmigung erfolgen während der Montage strenge Kontrollzyklen auf dem Produkt, mit der **100% Abnahmeprüfung** in Bezug auf Empfindlichkeit, Leistungsfähigkeit und Widerstand der Sensoren.

Bauteile und Funktionsprinzip

Die Zündung der Luft-Treibstoffmischung in den Zylindern generiert Schwingungen des Motors, dessen Frequenz von den Phänomenen abhängt, die während der Verbrennung eintreten. Beim Klopfen schwingt der Motor bei einer ganz bestimmten Frequenz (die Frequenz der Klopferschwingungen ist eine spezifische Eigenschaft jedes einzelnen Motors und beträgt in der Regel $5,2 \div 8$ kHz).

Die Schwingungen des Motors werden von einer Federscheibe und einer seismischen Masse an den Fühler des Sensors übertragen, der die Schwingungen in eine elektrische Potentialdifferenz umwandelt, die an den Enden des Sensors gemessen werden kann. Dies ist möglich, da es sich beim Fühler um einen piezoelektrischen Keramikring handelt, der sich elektrisch proportional zur erlittenen mechanischen Verformung polarisiert.

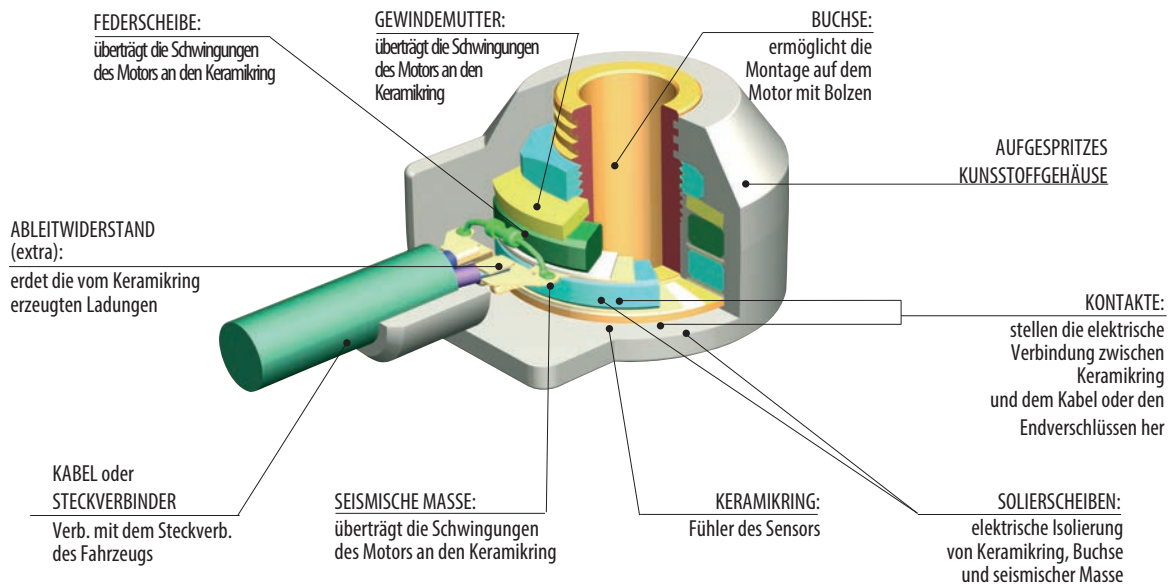

Der Sensor sendet dem Steuergerät des Motors (ECU) die elektrischen, durch jede Schwingung des Motors generierten Signale. Die Steuerreinheit ECU filtert die Signale, die sich nicht auf Klopferschwingungsfrequenzen beziehen und korrigiert die Parameter der Zündung.

Die Eigenschaft der Klopfensensoren ist durch die Empfindlichkeit des Sensors (Verhältnis zwischen der an den Enden des Sensors generierten Spannung und der Beschleunigung, der dieser ausgesetzt ist) bei der Änderung der Frequenz::

$$S = \frac{\text{Spannung}}{\text{Beschleunigung}} \left[\frac{\text{mVolt}}{g} \right]$$

(1 g = 9.81 m · s⁻²)

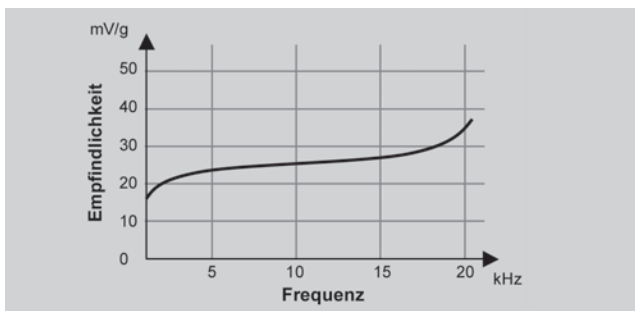

Die Sensoren, die nicht als Hall-Sensoren ausgelegt sind, haben einen **flachen** Verlauf: Die Empfindlichkeit innerhalb der Betriebsbandbreite ist nahezu konstant. Die Empfindlichkeit ändert sich je nach der Masse der seismischen Masse, wobei diese so kalibriert ist, dass die geforderten Werte erzielt werden.

Montageanweisungen

Anzugsmoment der Klopfensensoren auf dem Motorblock: **20 ± 5 Nm.**

Zur Verbesserung der mechanischen Kupplung und somit der Übertragung der Schwingungen zwischen Kurbelgehäuse und Sensor wird empfohlen, eine dünne **Gelschicht** aufzutragen (z.B. Silikon).

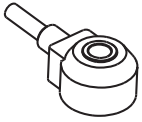

9.3XXX

Sensores de picado

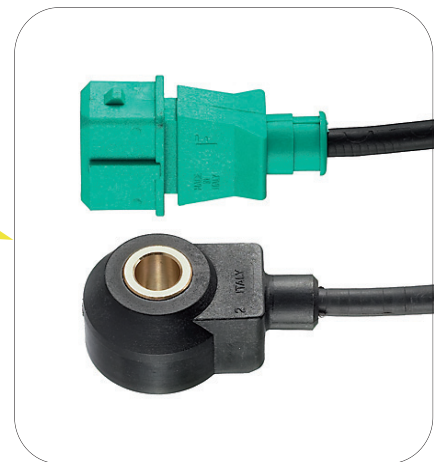
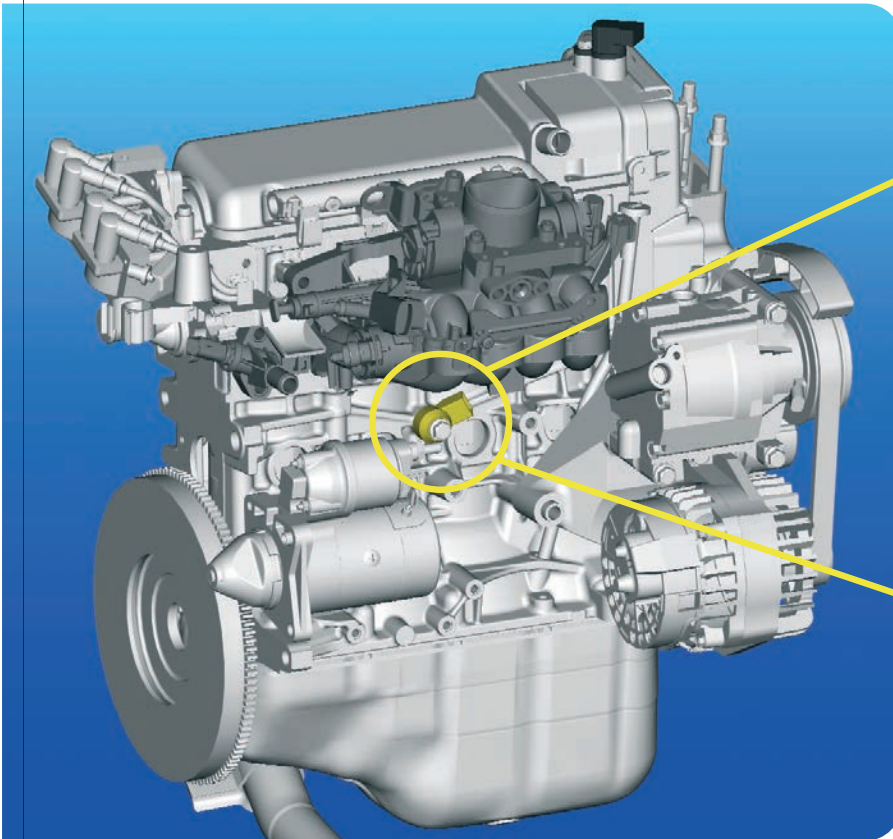

Rendering: por amable concesion de FIAT POWERTRAIN TECHNOLOGIES

Los sensores de picado, **montados en el monobloque del motor, detectan si la explosión de la mezcla** en los cilindros se produce incorrectamente (detonación o golpeteo) y transmiten una señal a la centralita electrónica de control del motor. En caso de detonación, la centralita corrige los parámetros del encendido (retardo, enriquecimiento de la mezcla), protegiendo el motor contra los posibles daños.

Los sensores de picado **se colocan en cualquier motor con encendido de chispa** (por lo tanto, no diesel), incluyendo los motores para combustibles alternativos. Además, de acuerdo con el tipo de motor y de centralita de control, se pueden utilizar uno o varios sensores simultáneamente.

Las principales **causas de avería** del producto son:

- las salpicaduras de agua a alta presión (por ejemplo, durante el lavado del motor), que pueden provocar la disminución del aislamiento eléctrico
- el deterioro de las características del disco piezoelectrico

Las señales de **problemas de funcionamiento** del sensor se pueden observar por el encendido del testigo del motor, el autoencendido, la dificultad de arranque del vehículo, un elevado consumo

de combustible, el aumento de las emisiones de gases de escape.

Los sensores de picado están diseñados y fabricados para soportar las condiciones críticas de montaje en el bloque motor. En especial, deben cumplir con los siguientes **requisitos**:

- *temperatura de funcionamiento*: $-40^{\circ}\text{C} \div +150^{\circ}\text{C}$
- *grado de protección*: IP68 (entrada de polvo no permitida y protección contra los efectos de la inmersión continua en agua).

Los sensores de picado son sometidos a rigurosos **ensayos de calificación y de duración**, para determinar si el producto es apropiado para ser fabricado y vendido:

- resistencia a las vibraciones sinusoidales y casuales por un total de 250 horas
- resistencia a los choques térmicos
- resistencia a los golpes
- resistencia a la tracción del cable
- resistencia a la inmersión en agua

Después que ha superado estas pruebas y obtenido la aprobación para la producción, durante el ensamblaje el producto se somete a severos ciclos de control que prevén el **ensayo al 100%** de sensibilidad, capacidad y resistencia de los sensores.

Elementos de construcción y principio de funcionamiento

La explosión de la mezcla aire-combustible en los cilindros genera vibraciones del motor, cuya frecuencia depende de los fenómenos que se comprueban durante la combustión. En caso de detonación, el motor vibra a una frecuencia muy precisa (la frecuencia de las vibraciones de detonación es una característica propia de cada motor, generalmente en una gama de 5,2 ÷ 8 kHz). Las vibraciones del motor son transferidas por una *arandela elástica* y una *masa sísmica* al elemento sensible del sensor, que trasforma las vibraciones en una diferencia de potencial eléctrico que se puede medir en los extremos del sensor. Esto es posible puesto que el elemento sensible es un *anillo de cerámica piezoeléctrico* que se polariza eléctricamente de manera proporcional a la deformación mecánica sufrida.

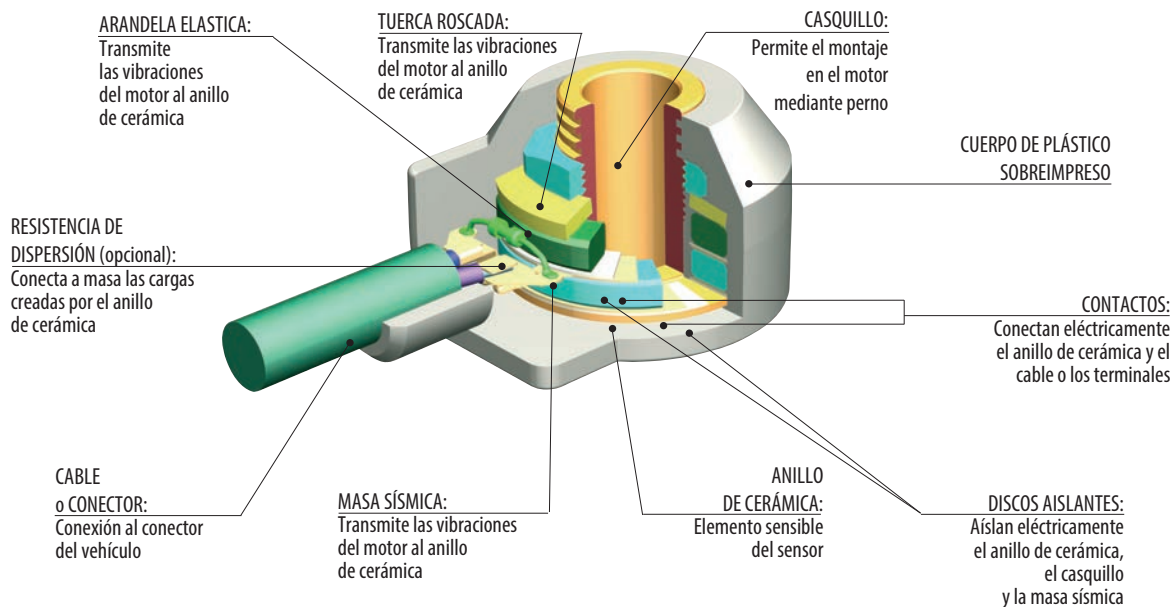

El sensor transmite a la centralita de control del motor (ECU) las señales eléctricas generadas por cada vibración del motor. La ECU filtra las señales no referidas a frecuencias de vibración de detonación y corrige los parámetros del encendido. La característica de los sensores de picado está expresada por la sensibilidad (relación entre la tensión generada en los terminales del sensor y la aceleración a la que está sometido) del sensor a medida que varía la frecuencia:

$$S = \frac{\text{tensión}}{\text{aceleración}} \left[\frac{\text{mVolt}}{g} \right]$$

$$(1 g = 9.81 \text{ m} \cdot \text{s}^{-2})$$

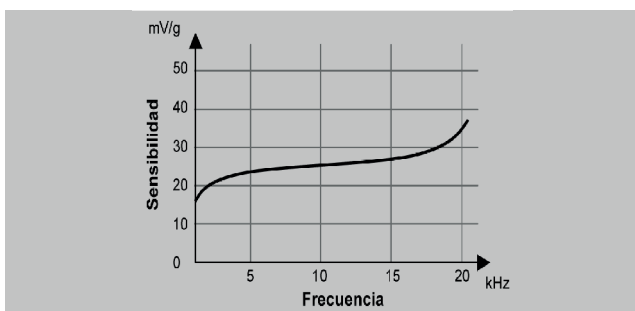

Los sensores de tipo no resonante tienen una **marcha plana**: la sensibilidad es casi constante en el interior de la banda de funcionamiento. La sensibilidad varía de acuerdo con la masa de la masa sísmica, ésta está calibrada de modo tal que se obtengan los valores necesarios.

Instrucciones de montaje

Par de torsión de los sensores de picado en el monobloque del motor: **20 ± 5 Nm**.

Para mejorar el acoplamiento mecánico y, por lo tanto, la transmisión de las vibraciones entre la base del motor y el sensor, se recomienda aplicar una fina capa de **gel** (por ejemplo, de silicona).

9.3001



1

KNOCK SENSORS

Adatt./Suitable:

BOSCH

0 261 231 045
0 261 231 046
0 261 231 108
0 261 231 188
0 261 231 189

CITROËN

5946 21

MERCEDES-BENZ

0031538928
0041534628
0041539028
0061533628
A 004 153 90 28

PEUGEOT

5946 21

RENAULT

74 31 367 644
77 00 871 678

SAAB

91 42 415

SEAT

030 905 377 A

SKODA

030 905 377 A

SSANGYONG

1611533028

VW

030 905 377 A

MARKET DIFFUSION: MEDIUM



mV/g		
28		

CITROËN

XANTIA I 2.0i 16V RFV(XU10J4R) 06/95 → 04/03

MERCEDES-BENZ

CLASSE C II C 230	M272.920	01/05 → 05/08
CLASSE C II C 280	M272.940	01/05 → 08/07
CLASSE C II C 280 4-matic	M272.941	01/05 → 08/07
CLASSE C II C 350	M272.960	01/05 → 05/08
CLASSE C II C 350 4-matic	M272.970	01/05 → 08/07
CLASSE C III C 230	M272.921	01/07 → 08/14
CLASSE C III C 230 4-matic	M272.911	07/07 → 01/14
CLASSE C III C 250	M272.921	01/07 →
CLASSE C III C 250 4-matic	M272.911	07/07 →
CLASSE C III C 280	M272.947	01/07 → 08/14
CLASSE C III C 280 4-matic	M272.948	07/07 → 01/14
CLASSE C III C 300	M272.947	08/07 → 08/14
CLASSE C III C 300 4-matic	M272.948	07/07 → 01/14
CLASSE C III C 350	M272.961	01/07 → 08/14
CLASSE C III C 350 4-matic	M272.971	07/07 → 01/14
CLASSE C III C 350 CGI	M272.982	09/08 → 01/14
CLASSE C III C 63 AMG	--, --	02/08 →
CLASSE C III C 63 AMG DR 520	--, M156.982	07/10 → 01/14
CLASSE CLC CLC 230	M272.920	05/08 → 06/11
CLASSE CLC CLC 350	M272.960	05/08 → 06/11
CLASSE CLC CLC250 [ExtraEU]	M272.920	06/09 → 06/11
CLASSE CLK II 280	M272.940	01/05 → 05/09
CLASSE CLK II 350	M272.960	01/05 → 05/09
CLASSE CLK II 500	M273.967	06/06 →
CLASSE CLK II 550	M273.967	06/06 →
CLASSE CLK II 63 AMG	M156.982, M272.964	04/06 → 05/09
CLASSE CLK II CLK 280	M272.940	01/05 → 03/10
CLASSE CLK II CLK 350	M272.960	01/05 → 03/10
CLASSE CLK II CLK 63 AMG	M156.982	04/06 → 03/10
CLASSE CLS I CLS 280	M272.943	07/08 → 12/10
CLASSE CLS I CLS 300	M272.943	04/09 → 12/10
CLASSE CLS I CLS 350	M272.964, M272.944	10/04 → 12/10
CLASSE CLS I CLS 500	M273.960	04/06 → 12/10
CLASSE CLS I CLS 550	M273.960	04/06 → 02/11
CLASSE CLS I CLS 63 AMG	M156.983	04/06 → 12/10
CLASSE E III 350 CGI	M272.985	05/06 → 07/09
CLASSE E III E 230	M272.922	09/07 → 12/08
CLASSE E III E 230 T	M272.922	05/07 → 07/09
CLASSE E III E 250	M272.922	09/07 → 12/08

MERCEDES-BENZ

CLASSE E III E 280	M272.943	03/05 → 12/08
CLASSE E III E 280 4-matic	M272.944, M272.972	03/05 → 12/08
CLASSE E III E 280 T	M272.943	03/05 → 07/09
CLASSE E III E 280 T 4-matic	M272.944	03/05 → 07/09
CLASSE E III E 300	M272.943	03/05 → 12/08
CLASSE E III E 300 T 4-matic	M272.944	03/05 → 07/09
CLASSE E III E 350	M272.964	03/05 → 12/08
CLASSE E III E 350 4-matic	M272.972, M272.952	08/04 → 12/08
CLASSE E III E 350 CGI	M272.985	09/07 → 12/08
CLASSE E III E 350 T	M272.964	03/05 → 07/09
CLASSE E III E 350 T 4-matic	M272.972	03/05 → 07/09
CLASSE E III E 500	M273.960	04/06 → 12/08
CLASSE E III E 500 4-matic	M273.962	04/06 → 12/08
CLASSE E III E 500 T	M273.960	04/06 → 07/09
CLASSE E III E 500 T 4-matic	M273.962	04/06 → 07/09
CLASSE E III E 550 4-matic	M273.962	04/06 → 12/08
CLASSE E III E 550 T 4-matic	M273.962	04/06 → 07/09
CLASSE E III E 63 AMG	M156.983	03/06 → 07/09
CLASSE E IV E 250	M272.923	01/10 →
CLASSE E IV E 300	M272.952, M272.961	01/09 →
CLASSE E IV E 350	M272.961, M272.982	01/09 →
CLASSE E IV E 350 4-matic	M272.977	01/09 →
CLASSE E IV E 350 CGI	M272.982, M272.961	01/09 →
CLASSE E IV E 500	M273.966	01/09 →
CLASSE E IV E 500 4-matic	M273.970	01/09 →
CLASSE E IV E 550 [USA]	M273.966	01/09 →
CLASSE E IV E 550 [USA] [CAN] [JPN]	M273.971	01/09 →
CLASSE E IV E 550 4-matic [USA] [CAN]	M273.970	01/09 →
CLASSE E IV E 63 AMG	M156.985	08/09 →
CLASSE E IV E350 [ExtraEU]	M272.961, M273.963	05/11 →
CLASSE G II G 500	M273.963, M273.963	01/07 →
CLASSE G II G 500 GUARD	M273.963	06/10 →
CLASSE G II G 550	M273.963, M272.966	06/10 →
CLASSE GL I GL 450 4-matic	M273.923	09/06 →
CLASSE GL I GL 500 4-matic	M273.963	09/06 →
CLASSE GL I GL 550 4-matic	M273.963	09/06 →
CLASSE GLK 280 4-matic	M272.948	06/08 → 06/09
CLASSE GLK 300 4-matic	M272.948	07/09 → 04/11
CLASSE GLK 350	M272.991	04/09 → 06/15
CLASSE GLK 350 4-matic	M272.971	06/08 → 04/11
CLASSE M II ML 300	M272.945	07/09 →
CLASSE M II ML 300 4-matic	M272.945	03/10 → 12/11
CLASSE M II ML 350	M272.967	07/05 →
CLASSE M II ML 350 4-matic	M272.967	02/05 → 12/11
CLASSE M II ML 450 4-matic Hybrid	M272.973	07/05 →
CLASSE M II ML 500 4-matic	M273.963	12/07 → 12/11
CLASSE M II ML 550 4-matic	M273.963	12/07 →
CLASSE M II ML 63 AMG 4-matic	M156.980	01/06 → 12/11
CLASSE R R 280	M272.945	01/07 →
CLASSE R R 280 4-matic	M272.945	05/07 →
CLASSE R R 300	M272.945	07/09 →
CLASSE R R 300 4-matic	M272.945	07/09 →
CLASSE R R 350	M272.967	01/07 →
CLASSE R R 350 4-matic	M272.967	01/06 →
CLASSE R R 500 4-matic	M273.963	01/07 →
CLASSE R R 550 4-matic	M273.963	01/07 →
CLASSE R R 63 AMG 4-matic	M156.980	02/06 →
CLASSE SV CL 500	M273.961	06/06 → 12/13
CLASSE SV CL 500 4-matic	M273.968	02/08 → 12/13
CLASSE SV CL 550 [JPN]	M273.961	06/06 →
CLASSE SV CL 550 [USA]	M273.961	06/06 →
CLASSE SV CL 550 4-matic [JPN]	M273.968	02/08 →
CLASSE SV CL 550 4-matic [USA]	M273.968	02/08 →
CLASSE SV CL 63 AMG	M156.984	10/06 → 12/13
CLASSE SV S 280	M272.946	08/06 → 12/13
CLASSE SV S 300	M272.946	08/06 → 12/13
CLASSE SV S 350	M272.965	10/05 → 12/13
CLASSE SV S 350 4-matic	M272.975	02/08 → 12/13
CLASSE SV S 400 Hybrid	M272.974	01/09 → 12/13
CLASSE SV S 450	M273.922	12/05 → 12/13
CLASSE SV S 450 4-matic	M273.924	12/05 → 12/13
CLASSE SV S 500	M273.961	10/05 → 12/13
CLASSE SV S 500 4-matic	M273.968	10/05 → 12/13
CLASSE SV S 550 [JPN]	M273.961	10/05 →
CLASSE SV S 550 [USA]	M273.961	10/05 →
CLASSE SV S 550 4-matic [JPN]	M273.968	10/05 →
CLASSE SV S 550 4-matic [USA]	M273.968	10/05 →
CLASSE SV S 63 AMG	M156.984	10/06 → 12/13
CLASSE SL V 280	M272.949	03/08 → 01/12
CLASSE SL V 300	M272.949	04/09 → 01/12
CLASSE SL V 350	M272.966, M272.963	03/06 → 01/12

MERCEDES-BENZ

CLASSE SL V 500	M273.965	03/06 → 01/12
CLASSE SL V 550	M273.965	03/06 → 01/12
CLASSE SL V 63 AMG	M156.981	03/08 → 01/12
CLASSE SLK II 280	M272.942	01/05 → 02/11
CLASSE SLK II 300	M272.942	04/09 → 02/11
CLASSE SLK II 350	M272.963, M159.980	06/04 → 02/11
CLK-SERIES CLK63 AMG Black Series	M156.982	05/07 → 05/09
E-SERIES E250	M272.922	05/07 → 12/08
R-SERIES R300	M272.945	07/09 → 12/11
SLS AMG 6.2	M159.980, N7Q700	03/10 →
SLS AMG 6.2 GT	M159.980	06/13 →
SPRINTER II 224	M272.979	06/06 →
SPRINTER II 324	M272.979	06/06 → 12/13
SPRINTER II 424	M272.979	06/06 → 12/13
SPRINTER II 524	M272.979	06/06 → 12/13
VIANO 3.5	M272.978	09/07 →
VIANO 3.7	M112.976	06/04 → 07/07
VITO II 123	M112.976	06/04 → 07/08
VITO II 126	M272.978	09/07 →

PEUGEOT

106 I 1.3 TU2J2 10/93 → 04/96

RENAULT

LAGUNA I 2.0	N7Q700, N7Q700	06/95 → 02/01
LAGUNA I 2.0 16V	N7Q700, F7R710	06/95 → 03/01
MEGANE I 2.0 16V	F7R710, N7Q710	03/96 → 08/03
SAFRANE II 2.0 16V	N7Q710, N7U700	07/96 → 12/00
SAFRANE II 2.5 20V	N7U700, F7R712	07/96 → 12/00
SPORT SPIDER 2.0	F7R710	12/95 → 08/96
SPORT SPIDER 2.0 16V	F7R712, B204I	03/95 → 10/99

SAAB

9-3 2.0 i	B204I	02/98 → 08/03
9-3 2.0 SE Turbo	B204R	02/98 → 08/03
9-3 2.0 Turbo	B204E, AER	02/98 → 08/03
9-3 2.3	B235R	09/99 → 01/02
9-3 2.3 i	B234I	02/98 → 08/03
9-3 2.3 Turbo	B235R	10/98 → 08/03
900 II 2.0 i	B204I, B204E	07/93 → 02/98
900 II 2.3 -16	B234I	07/93 → 02/98

SEAT

AROSA 1.0	AER, AEX	05/97 → 06/04
AROSA 1.4	AEX, APE	05/97 → 06/04
CORDOBA I 1.0 i	AER	09/96 → 10/02
CORDOBA I 1.4	ANX	12/97 → 04/99
CORDOBA I 1.4 16V	APE, AEX	06/99 → 12/02
CORDOBA I 1.4 i	AEX, AEE	06/94 → 12/02
CORDOBA I 1.4 i 16V	AFH	09/96 → 10/02
CORDOBA I 1.6 i	AEE, ALD	02/93 → 12/02
IBIZA II 1.0	ALD, AKK	08/99 → 02/02
IBIZA II 1.0 i	AER	09/96 → 02/02
IBIZA II 1.4	AKK, APE	12/97 → 02/02
IBIZA II 1.4 16V	APE, ABD	08/99 → 02/02
IBIZA II 1.4 i	ABD, AEE	09/93 → 02/02
IBIZA II 1.4 i 16V	AFH	06/97 → 02/02
IBIZA II 1.6	ALM	08/99 → 02/02
IBIZA II 1.6 i	AEE, AEX	03/93 → 02/02
INCA 1.4 16V	AUA	04/00 → 06/03
INCA 1.4 i	AEX, 135	11/95 → 06/03
INCA 1.6 i	AEE	06/97 → 09/00
LEON I 1.6 16V	AUS	09/00 → 06/06
TOLEDO II 1.6 16V	AUS	06/00 → 05/06

SKODA

BETA 1.3	135, AEG	10/95 → 04/02
FELICIA 1.6	AEE	06/97 → 04/02
FELICIA 1.6 GLX	AEE	08/95 → 03/98
FELICIA 1.6 LX	AEE	08/95 → 03/98
OCTAVIA I 1.6	AEE	09/96 → 09/04
OCTAVIA I 2.0	AEG, AEG	04/99 → 05/07

SSANGYONG

KORANDO 3.2	E32	01/99 → 11/02
REXTON I 3.2 4x4	G32D	04/02 →

VOLKSWAGEN (BR)

GOL 1.0i 16v Turbo	512	06/00 →
GOLF A4 2.0i	AEG, AHW	08/99 →
PARATI 1.0i 16v Turbo	512	06/00 →

VW

BORA 1.4 16V	AHW, ATN	03/00 → 05/05
BORA 1.6 16V	ATN, APK	02/00 → 05/05
BORA 2.0	APK, AZH	10/98 → 05/05
BORA 2.0 4motion	AZH, AEX	04/00 → 05/05
CADDY II 1.4	AEX, AEX	11/95 → 01/04
CADDY II 1.4 16V	AUA	08/00 → 01/04
CADDY II 1.6	AEE	06/96 → 12/00
CADDY II 60 1.4	AEX, AEX	11/95 → 01/04
CADDY II 75 1.6	AEE	11/95 → 09/00
GOLF III 1.4	AEX, AEA	10/91 → 04/99
GOLF III 1.6	AEA, AHW	09/92 → 08/97
GOLF IV 1.4 16V	AHW, AUS	08/97 → 06/06

VW			
GOLF IV 1.6	AUS, ATN	05/00	⇒ 06/06
GOLF IV 1.6 16V	ATN, APK	02/00	⇒ 06/06
GOLF IV 2.0	APK, AZH	07/98	⇒ 06/06
GOLF IV 2.0 4motion	AZH, AER	10/00	⇒ 06/06
LUPO 1.0	AER, AFK	09/98	⇒ 07/05
LUPO 1.4	AUD	10/00	⇒ 07/05
LUPO 1.4 16V	AFK, AGU	09/98	⇒ 07/05
LUPO 1.6 GTI	AVY	09/00	⇒ 07/05
NEW BEETLE 1.8 T	AGU, AER	10/99	⇒ 09/10
NEW BEETLE 2.0	AQY	09/02	⇒ 10/10
NEW BEETLE RSI 3.2 4motion	AXJ	04/00	⇒ 05/01
POLO 1.0 [ExtraEU]	AER, AER	07/95	⇒ 09/01
POLO III 1.0	AER, AEX	10/99	⇒ 09/01
POLO III 1.4	AEX, AFH	05/97	⇒ 09/01
POLO III 1.4 16V	AFH, AEA	10/99	⇒ 09/01
POLO III 1.4 TDI	AMF	10/99	⇒ 09/01
POLO III 1.6	AEA, ARC	09/94	⇒ 09/01
POLO III 1.6 16V GTI	ARC, AFH	10/99	⇒ 09/01
POLO III 100 1.4 16V	AFH, AER	04/96	⇒ 10/99
POLO III 120 1.6 16V GTI	AJV	09/98	⇒ 10/99
POLO III 50 1.0	AER, AEX	09/96	⇒ 10/99
POLO III 54 1.4	ANX	01/98	⇒ 08/99
POLO III 55 1.3	ADX	10/94	⇒ 07/95
POLO III 55 1.4	AEX, AEX	08/95	⇒ 10/99
POLO III 60 1.4	AEX, APE	07/95	⇒ 09/01
POLO III 75 1.4 16V	APE, AEA	10/99	⇒ 09/01
POLO III 75 1.6	AEA, SFZ(ZPJ/Z)	10/94	⇒ 09/01
POLO IV 1.0	AER	08/96	⇒ 12/01

9.3002

04,5

KNOCK SENSORS

Adatt./Suitable:

ALFA ROMEO

60808063
60811202
7669123

BOSCH

0 261 231 007
0 261 231 033
0 261 231 070

CITROËN

5946 16
5946 20
96 037 068

FIAT

60808063
60811202
7401367643
7669123
9617755980

GENERAL MOTORS

92 061 913

HOLDEN

92061913

HYUNDAI

39250-22003
39250-22010

IVECO

76691230

LANCIA

60808063
60811202
7401367643
7669123
9617755980

OPEL

62 38 353

PEUGEOT

5946 11
5946 16
5946 20

RENAULT

96 12 765 780
96 12 765 880

VOLVO

136764-3



L	mV/g		
400	27		

ALFA ROMEO

156 2.5 V6 24V	AR32401	02/97	⇒ 08/03
156 2.5 V6 24V [BRA]	AR32402	10/97	⇒ 12/01
166 2.0 V6	AR34102	09/98	⇒ 10/00
166 2.5 V6 24V	AR34201	09/98	⇒ 12/06
166 3.0 V6 24V	AR34301	09/98	⇒ 06/07
166 3.0 V6 24V [BRA]	AR34302	08/98	⇒ 09/00
GTV 3.0 V6 24V	AR16102	10/96	⇒ 10/00
SPIDER II 3.0 12V [BRA]	AR16199	09/97	⇒
SPIDER II 3.0 V6	AR16101	06/95	⇒ 04/05

CITROËN

XM I 3.0	UFZ(ZPJ/Z)	05/89	⇒ 05/94
XM I 3.0 V6	SFZ(ZPJ/Z), SKZ(ZPJ4/Z)	05/89	⇒ 06/94
XM I 3.0 V6 24V	SKZ(ZPJ4/Z), SFZ(ZPJ/Z)	07/90	⇒ 06/94
XM II 3.0 V6	SFZ(ZPJ/Z), SKZ(ZPJ4/Z)	05/94	⇒ 10/00
XM II 3.0 V6 24V	SKZ(ZPJ4/Z), 182B2.000	05/94	⇒ 10/00

FIAT

BRAVA 1.2 16V	182B2.000	12/98	⇒ 12/02
BRAVA 1.2 16V 80	188A5.000	10/00	⇒ 10/01
BRAVA 1.4	182A5.000	10/95	⇒ 10/01
BRAVA 1.4 12V	182A3.000	10/95	⇒ 08/98
BRAVO I 1.2 16V 80	182B2.000, 182A3.000	12/98	⇒ 10/01
BRAVO I 1.4	182A3.000, 176A4.000	10/95	⇒ 10/01
COUPE 2.0 20V Turbo	175A3.000	08/96	⇒ 08/00
MAREA 1.2 16V	182B2.000	10/98	⇒ 05/02
MAREA 1.4 80 12V	182A3.000	09/96	⇒ 05/02
PUNTO I 1.4 GT Turbo	176A4.000, G4ER	10/93	⇒ 07/99
ULYSSE I 2.0	RFU(XU10J2C)	06/94	⇒ 08/02
ULYSSE I 2.0 Turbo	RGX(XU10J2CTE)	06/94	⇒ 08/02
ULYSSE II 3.0	XFW	08/02	⇒ 06/11

HOLDEN

FRONTERA UT 2.0i	X20SE	10/95	⇒ 03/99
------------------	-------	-------	---------

HYUNDAI

ACCENT I 1.5	G4EK	10/94	⇒ 07/99
ACCENT I 1.5 i 12V	G4EK	10/94	⇒ 01/00
ACCENT I 1.5 i 16V	G4ER, ES9J4S	10/95	⇒ 01/00
EXCEL 1.5 i 12V	G4EK	09/94	⇒ 08/99
EXCEL 1.5 i 16V GT	G4ER	10/96	⇒ 08/99
LANTRA I 1.5 12V	G4EK	12/96	⇒ 10/00
S COUPE 1.5 i	G4EK	04/92	⇒ 05/96
S COUPE 1.5 i Turbo	G4EK-TC	04/91	⇒ 05/96

LANCIA

KAPPA 2.0 20V Turbo	175A3.000	06/98	⇒ 10/01
PHEDRA 3.0 V6	ES9J4S, 840A2.000	09/02	⇒
THEMA 2850 V6 i.e.	834E.146	06/88	⇒ 05/92
THEMA 3000 V6	834F.000	08/92	⇒ 07/94
Y 1.4 12V	840A2.000, RGX	03/96	⇒ 09/03
ZETA 2.0 Turbo	RGX, UFZ(ZPJ)	05/95	⇒ 09/02

OPEL

FRONTERA A 2.0 i	X20SE	03/92	⇒ 10/98
FRONTERA A 2.2 i	X22XE	03/95	⇒ 10/98

PEUGEOT

605 3.0	UFZ(ZPJ), Z7X760	08/89	⇒ 09/99
605 3.0 SV 24	UKZ(ZPJ4/Z)	08/89	⇒ 09/99

RENAULT

ESPACE III 3.0	Z7X775	11/96	⇒ 10/98
LAGUNA I 3.0	Z7X760, Z7X721	11/93	⇒ 03/01
SAFRANE I 3.0	Z7X723	02/93	⇒ 06/96
SAFRANE I 3.0 Biturbo 4x4	Z7X726	02/93	⇒ 07/96
SAFRANE I 3.0 V6	Z7X721, Z7X721	12/92	⇒ 07/96
SAFRANE I 3.0 V6 4x4	Z7X721, Z7X755	12/92	⇒ 07/96
SAFRANE II 3.0 V6	Z7X755, B280E	07/96	⇒ 12/00

VAUXHALL

FRONTERA A 2.0	X20SE	04/95	⇒ 08/98
FRONTERA A 2.0 i	X20SE	03/92	⇒ 10/98
FRONTERA A 2.2 i	X22XE	03/95	⇒ 10/98

VOLVO

760 2.8	B280E, B280E	08/81	⇒ 08/91
960 1.2 8 GL	B280E, ES9J4SHP	09/90	⇒ 05/92

9.3004

04,5

KNOCK SENSORS

Adatt./Suitable:

BOSCH

0 261 231 109
0 261 231 130

CITROËN

5946 22
5946 30

FIAT

9621334480
9628648280

LANCIA

9621334480
9628648280

PEUGEOT

5946 22
5946 30

RENAULT

96 28 648 280

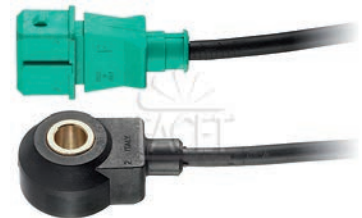

L	mV/g		
250	23		

CITROËN

C5 I 3.0 Carlsson	ES9J4SHP, ES9A	09/03	⇒ 08/04
C5 I 3.0 V6	ES9A, ES9A	03/01	⇒
C5 II 3.0 V6	ES9A, ES9A	02/08	⇒
C5 3.0 [ExtraEU]	ES9AHP	09/04	⇒ 01/08
C6 3.0 V6	ES9A, ES9J4S	09/05	⇒ 12/12
C8 3.0 V6	ES9J4S, RFU(XU10J2/C)	07/02	⇒
EVASION 2.0	RFU(XU10J2/C), RFV(XU10J4R)	06/94	⇒ 07/02
EVASION 2.0 16V	RFV(XU10J4R), RGX(XU10J2TE)	05/98	⇒ 04/00

CITROËN		
EVASION 2.0 Turbo C.T.	RGX(XU10J2TE), RGX(XU10J2TE)	06/94 ⇒ 07/02
XANTIA I 2.0 i 16V	RFV(XU10J4R)	06/95 ⇒ 04/03
XANTIA II 1.8 i 16V	LFY(XU7JP4)	01/98 ⇒ 04/03
XANTIA II 2.0 i 16V	RFV(XU10J4R)	01/98 ⇒ 04/03
XANTIA II 2.0 Turbo	RGX(XU10J2TE)	01/98 ⇒ 04/03
XM I 2.0 i Turbo	RGY(XU10J2TE/Z)	09/92 ⇒ 06/94
XM I 2.0 Turbo	RGY(XU10J2TE/Z)	09/92 ⇒ 04/94
XM II 2.0 i 16V	RFV(XU10J4R)	05/94 ⇒ 10/00
XM II 2.0 Turbo	RGX(XU10J2TE), RFV(XU10J4R)	05/94 ⇒ 10/00
XSARA 2.0 16V	RFV(XU10J4R), ES9J4S	07/98 ⇒ 09/00
ZX 1.8	LFY(XU7JP4)	04/96 ⇒ 10/97
ZX 1.8 i 16V	LFY(XU7JP4)	01/96 ⇒ 02/98

FIAT		
ULYSSE I 2.0	RFU(XU10J2C)	06/94 ⇒ 08/02
ULYSSE I 2.0 16V	RFV	05/98 ⇒ 09/00
ULYSSE I 2.0 Turbo	RGX(XU10J2CTE)	06/94 ⇒ 08/02
ULYSSE II 3.0	XFW	08/02 ⇒ 06/11

LANCIA		
PHEDRA 3.0 V6	ES9J4S, RFV	09/02 ⇒
ZETA 2.0 16V	RFV, RFV(XU10J4R)	05/98 ⇒ 07/00
ZETA 2.0 Turbo	RGX	05/95 ⇒ 09/02

PEUGEOT		
306 2.0	RFV(XU10J4R), RFV(XU10J4R)	03/97 ⇒ 04/02
306 2.0 16V	RFV(XU10J4R), LFY(XU7JP4)	03/97 ⇒ 04/02
406 1.8 16V	LFY(XU7JP4), RFV(XU10J4R)	11/95 ⇒ 10/00
406 2.0 16V	RFV(XU10J4R), ES9J4S	11/95 ⇒ 12/04
406 2.0 Turbo	XU10J2TE	04/96 ⇒ 10/04
406 3.0 V6	ES9J4S, ES9A	03/00 ⇒ 12/04
407 3.0	ES9A, ES9A	05/04 ⇒
407 3.0 V6	ES9A, ES9A	10/05 ⇒
607 3.0 V6 24V	ES9A, RFU(XU10J2)	02/00 ⇒ 07/11
806 2.0	RFU(XU10J2), RFV(XU10J4R)	06/94 ⇒ 08/02
806 2.0 16V	RFV(XU10J4R), RGX(XU10J2TE)	05/98 ⇒ 09/00
806 2.0 Turbo	RGX(XU10J2TE), ES9J4S	06/94 ⇒ 08/02
807 3.0 V6	ES9J4S, L7X720	06/02 ⇒

RENAULT		
AVANTIME 3.0 V6	L7X720, L7X760	09/01 ⇒ 05/03
AVANTIME 3.0i 24V	L7X722	05/01 ⇒
CLIO II 3.0 RS V6	L7X760, L7X760	01/03 ⇒
CLIO II 3.0 V6 Sport	L7X760, L7X760	11/00 ⇒
CLIO IV 3.0 RS V6	L7X760, L7X731	03/13 ⇒
LAGUNA II 2.9 V6 24V	L7X731, L7X731	03/01 ⇒ 12/07
LAGUNA II 3.0 V6 24V	L7X731, ES9J4	03/01 ⇒

9.3005



04,5

KNOCK SENSORS

Adatt./Suitable:

BOSCH
0 261 231 125

CITROËN
5946 25

PEUGEOT
5946 25

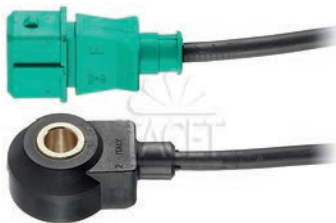
RENAULT
96 28 648 480

L	mV/g		
400	23		

CITROËN		
XANTIA I 3.0 i 24V	XFZ(ES9J4)	01/97 ⇒ 04/03
XANTIA I 3.0 V6	XFZ(ES9J4)	01/98 ⇒ 04/03
XANTIA II 3.0 V6	XFZ(ES9J4)	01/98 ⇒ 04/03
XM II 3.0 V6	XFZ(ES9J4)	04/97 ⇒ 10/00
PEUGEOT		
406 3.0 24V	ES9J4, ES9J4	10/96 ⇒ 10/04

PEUGEOT		
406 3.0 V6 24V	ES9J4, L7X700	03/97 ⇒ 12/04

RENAULT		
ESPACE III 3.0 V6 24V	L7X727	10/98 ⇒ 10/02
LAGUNA I 3.0 24V	L7X700, 312A1.000	03/97 ⇒ 03/01
SAFRANE II 2.9 24V	L7X713	03/99 ⇒ 12/00

9.3006



1

KNOCK SENSORS

Adatt./Suitable:

ABARTH
46552951
50046873
55187820
60816953

ALFA ROMEO
46552951
50046873
55187820
60816953

BOSCH
0 261 231 120
0 261 231 148
0 261 231 173
0 261 231 176
0 261 231 187
0 261 231 273
0 261 231 286
0 261 231 287

CHRYSLER
50046873

FIAT
46552951
50046873
55186669
55187820
60816953
K68070745AA
K68070745AB

FORD
H4P3-12A699-AA

GENERAL MOTORS
55 187 820
90 543 510
93 177 171
95 524 697

HONDA
30530-PWE-G01
30530-RPY-G01

JAGUAR
JDE 38638

JEEP
46552951
50046873
55187820
K68070745AA
K68070745AB

LANCIA
46552951
50046873
55187820
60816953

MAN
51.27421.0259

MITSUBISHI
MN163706

OPEL
12 47 489
55187820
62 35 619
62 38 102
90543510
93177171
95524697

PORSCHE
996 606 121 00
996 606 125 00
997 606 121 00

SAAB
93 177 171

SCANIA
1789360

SMART
A 005 153 60 28

TATA
570515209915

VAUXHALL
55187820
90543510
93177171
95524697

MARKET DIFFUSION: HIGH



mV/g		
31		

ABARTH		
124 1.4	55253268	03/16 ⇒
500 1.4	312A1.000, 312A1.000	08/08 ⇒
500 MY12 1.4	--	01/12 ⇒
500C / 595C 1.4	312A1.000, 199A8.000	05/08 ⇒
GRANDE PUNTO 1.4	199A8.000, 199A8.000	12/07 ⇒ 12/12

ABARTH			
PUNTO 1.4	199A8.000, 955A8.000	03/12 →	
PUNTO EVO 1.4	955A8.000, 932A2.000	07/08 →	02/12
ALFA ROMEO			
156 2.0 JTS	932A2.000, 198A4.000	01/02 →	05/06
159 1.8 Tbi	939B1.000	05/09 →	12/12
4C 1.8	960A1.000	03/13 →	
BRERA 1.8 Tbi	939B1.000	05/09 →	06/10
GIULIETTA II 1.4	198A4.000, 198A4.000	04/11 →	
GIULIETTA II 1.4 BiFuel	198A4.000	12/11 →	
GIULIETTA II 1.4 TB	198A4.000, 940A1.000	04/10 →	
GIULIETTA II 1.8	940A1.000	04/11 →	02/16
GIULIETTA II 1.8 Tbi	940A1.000, 932A2.000	04/10 →	
GT 2.0 JTS	932A2.000, 199B6.000	11/03 →	09/10
GTV 2.0 JTS	937A1.000	04/03 →	10/05
MITO 0.9	199B6.000	12/13 →	
MITO 0.9 TwinAir	199B6.000, 199A6.000	07/11 →	
MITO 1.4	199A6.000, 198A4.000	08/08 →	08/13
MITO 1.4 Bifuel	198A4.000, 940A2.000	01/09 →	
MITO 1.4 MultiAir	940A2.000, 198A1.000	09/09 →	
MITO 1.4 TB	955B1.000	12/13 →	
MITO 1.4 TJet	198A1.000, 955A2.000	08/08 →	
MITO 1.4 Turbo MultiAir	955A2.000, 312A2.000	10/09 →	
SPIDER II 2.0 JTS	937A1.000	04/03 →	04/05
SPIDER III 1.8 Tbi	939B1.000	05/09 →	03/11

CHRYSLER			
DELTA 1.4	198A4.000	08/11 →	
DELTA 1.4 16V	198A7.000	08/11 →	
YPSILON 0.9 Twinair	312A2.000	05/11 →	

FIAT			
124 1.4	55253268	03/16 →	
500 0.9	312A2.000, 199B6.000	07/10 →	
500 1.4	169A3.000	10/07 →	
500 1.4 [CHN]	--	01/10 →	
500 1.4 [USA]	--	01/10 →	
500 C 0.9	199B6.000, 169A3.000	09/09 →	
500 C 1.4	169A3.000, 199B6000CNG	09/09 →	
500 MY12 0.9	--	01/12 →	
500 MY12 1.4	--	01/12 →	
500 MY15 0.9	--	01/15 →	
500 MY15 1.4	--	01/15 →	
500L 0.9	199B6.000	09/12 →	
500L 0.9 Natural Power	199B6000CNG, 843A1.000	03/13 →	
500L 1.4	843A1.000, --	09/12 →	
500L 1.4 [CAN]	--	01/13 →	
500L 1.4 LPG	940B7.000	02/14 →	
500X 1.4	55263624	09/14 →	
500X 1.4 4x4	55263623	02/15 →	
500X 1.4 LPG	55277701	03/17 →	
BRAVA 1.2 16V 80	182B2.000	12/98 →	12/02
BRAVO I 1.2 16V 80	188A5.000	10/00 →	10/01
BRAVO II 1.4	192B2.000	04/07 →	12/14
BRAVO II 1.4 16V	--	04/07 →	
BRAVO II 1.4 LPG	--	12/08 →	
BRAVO II 1.4 T-Jet	--, 198A4.000	09/07 →	
DOBLO II 1.4	198A4.000, 198A4.000	02/10 →	
DOBLO II 1.4 Natural Power	198A4.000, --	02/10 →	
IDEA 1.2	--	01/08 →	
IDEA 1.2 16V	188A5.000	01/04 →	
IDEA 1.4	192B2.000	12/03 →	
IDEA 1.4 16V	--, 178F3.011	01/04 →	
LINEA 1.4 16V [IND]	--	06/07 →	
LINEA 1.4 16V TURBO [IND]	--	09/07 →	
LINEA 1.4 T-Jet	198A4.000	09/07 →	
PALIO 1.0 i	--	06/05 →	
PALIO 1.0 MPI	178F1.011	11/03 →	07/05
PALIO 1.2	188A5.000	03/00 →	
PALIO 1.2 16V	178D7.055	06/05 →	
PALIO 1.4	178F3.011, 312A2.000	10/05 →	
PANDA II 1.4	--	10/06 →	
PANDA III 0.9	312A2.000, 312A2.000	02/12 →	
PANDA III 0.9 4x4	312A2.000, 312A2.000	09/12 →	
PANDA III 0.9 Natural Power	312A2.000, 199A6.000	07/12 →	
PUNTO II 1.2 16V	188A5.000	06/03 →	
PUNTO II 1.2 16V 80	188A5.000	09/99 →	12/06
PUNTO II 1.4	199A6.000, 199B6.000	09/03 →	
PUNTO III / GRANDE PUNTO 1.4 16V	199A6.000	10/05 →	
PUNTO III / GRANDE PUNTO 1.4 16V [IND]	--	01/08 →	
PUNTO III / GRANDE PUNTO 1.4 T-Jet	198A4.000	09/07 →	
PUNTO III EVO 1.4 16V	955A2.000, 178F3.011	10/09 →	02/12
PUNTO III 0.9	199B6.000, 955A2.000	07/13 →	
PUNTO III 0.9 Bifuel	312A2.000	03/12 →	
PUNTO III 0.9 Twinair Turbo	312A2.000	03/12 →	
PUNTO III 1.4 Multi Air	955A6.000	03/12 →	
PUNTO III 1.4 Natural Power	350A1.000	03/12 →	

FIAT			
PUNTO III 1.4 Turbo Multi Air	955A2.000	03/12 →	
SIENA 1.2	188A5.000	09/01 →	12/09
SIENA 1.2 16V	178D7.055	01/02 →	
SIENA 1.4	178F3.011, 192B2.000	01/07 →	12/09
STILO 1.2 16V	188A5.000	02/02 →	11/06
STILO 1.4	843A1.000	01/04 →	08/08
STILO 1.4 16V	192B2.000, 843A1.000	01/04 →	08/08
TIPO II 1.4	843A1.000, P10A2	10/15 →	
TIPO II 1.4 LPG	940B7.000	05/16 →	

FIAT (BR)			
PALIO 1.0i 16v	1.0Mpi16vFire	01/01 →	
PALIO 1.3i 16v	1.3Mpi16vFire	01/00 →	
SIENA 1.3i 16v	1.3MpiFire	01/00 →	12/00

HONDA			
CIVIC IX 2.0 i-VTEC Type R	K20C1	08/15 →	
CIVIC X 1.0 iVTEC	P10A4	07/18 →	
CIVIC X 1.0 VTEC	P10A2, L12A1	02/17 →	
CIVIC X 2.0 Type-R	K20C1	06/17 →	
JAZZ I 1.2 i-DSI	L12A1, L13A1	03/02 →	07/08
JAZZ I 1.3	L13A1, L13A1	03/02 →	07/08
JAZZ I 1.4 iDSI	L13A1, L13Z1	12/06 →	10/08
JAZZ II 1.2	L12A4	01/06 →	
JAZZ II 1.4	L13A6	01/06 →	
JAZZ III 1.3 i	L13Z1, PT204	07/08 →	

JAGUAR			
E-PACE 2.0 AWD	PT204, PT204	09/17 →	
F-PACE 2.0 AWD	PT204, PT204	02/17 →	
T-Type 2.0 i4	PT204	07/17 →	
XE 2.0	PT204, PT204	02/17 →	
XE 2.0 AWD	PT204, PT204	02/17 →	
XF 2.0	PT204, PT204	03/17 →	
XF 2.0 AWD	PT204, 55263624	03/17 →	

JEEP			
COMPASS 1.4 MultiAir	EAQ(55263624)	03/17 →	
COMPASS 1.4 MultiAir Trazione integrale	EAQ(55263623)	03/17 →	
RENEGADE 1.4	55263624, EAM	07/14 →	
RENEGADE 1.4 4x4	EAM, 198A1.000	07/14 →	
RENEGADE 1.6	EJH(55263842)	07/14 →	

LANCIA			
DELTA III 1.4	198A1.000, 192B2.000	09/08 →	08/14
DELTA III 1.4 16V	198A7.000	07/10 →	08/14
DELTA III 1.4 BiFuel	198A4.000	07/11 →	08/14
DELTA III 1.8	939B1.000	01/09 →	08/14
MUSA 1.4	192B2.000, 176B9.000	10/04 →	09/12
MUSA 1.4 16V	--	01/11 →	12/12
THESIS 2.0 Turbo	841E.000	07/02 →	07/09
Y 1.2 16V	176B9.000, 312A2.000	10/00 →	09/03
YPSILON I 1.2	188A5.000	10/03 →	12/11
YPSILON I 1.4 16V	843A1.000	10/03 →	12/11
YPSILON II 0.9 CNG	312A2.000, 312A2.000	05/11 →	
YPSILON II 0.9 TwinAir	312A2.000, 4A90	05/11 →	

MAN			
NG	E2876LUH02	05/07 →	12/14

MITSUBISHI			
COLT VI 1.1	3A91	10/04 →	06/12
COLT VI 1.1 LPG	3A91	10/04 →	06/12
COLT VI 1.3	4A90, 4A91	06/04 →	
COLT VI 1.3 4WD	4A90	08/04 →	
COLT VI 1.3 Flexfuel	4A90	10/08 →	06/12
COLT VI 1.3 LPG	4A90	06/04 →	06/12
COLT VI 1.5	4A91, X12XE	06/04 →	
COLT VI 1.5 4WD	4A91	08/04 →	
LANCER IX 1.5	4A91	06/08 →	
LANCER IX 1.5 Bifuel	4A91	02/10 →	

OPEL			
AGILA A 1.0	Z10XEP	08/03 →	12/07
AGILA A 1.0 12V	Z10XE	09/00 →	12/07
AGILA A 1.2 16V	Z12XE	09/00 →	12/07
AGILA A 1.2 16V Twinport	Z12XEP	07/04 →	12/07
ASTRA G 1.2	X12XE	09/98 →	08/00
ASTRA G 1.2 16V	X12XE, Z14XEL	09/00 →	01/05
ASTRA G 1.4	Z14XEP	10/04 →	12/09
ASTRA H 1.2	Z12XEP	08/05 →	10/10
ASTRA H 1.4	Z14XEL, A16LET	03/04 →	10/10
ASTRA H 1.4 EcoTec	Z14XEP	12/04 →	12/12
ASTRA H 1.4 LPG	Z14XEP	08/09 →	10/10
ASTRA H 1.6 Turbo	A16LET, A14FC	02/07 →	10/10
ASTRA J 1.4	Z14XEP	01/09 →	
COMBO C 1.4	Z14XEP	10/04 →	12/11
COMBO C 1.4 16V	Z14XEP	08/05 →	
COMBO D 1.4	A14FC, A14FC	02/12 →	
COMBO D 1.4 CNG	A14FC, Z10XE	02/12 →	
CORSA B 1.0 i 12V	X10XE	11/96 →	09/00
CORSA B 1.2 i 16V	X12XE	03/98 →	09/00
CORSA C 1.0	Z10XE, Z12XEP	09/00 →	12/09
CORSA C 1.2	Z12XE	09/00 →	12/09
CORSA C 1.2 16V	Z12XE	09/00 →	07/03

OPEL			
CORSA C 1.2 Twinport	Z12XEP	07/04 →	12/09
CORSA C 1.4	Z14XEP	08/03 →	06/12
CORSA C 1.4 Twinport	Z14XEP	06/03 →	12/09
CORSA D 1.0	Z10XEP	07/06 →	08/14
CORSA D 1.2	Z12XEP	07/06 →	08/14
CORSA D 1.2 LPG	Z12XEP, A16LEL	08/06 →	08/14
CORSA D 1.4	Z14XEP	07/06 →	08/14
CORSA D 1.4 LPG	Z14XEP	08/06 →	12/11
CORSA D 1.6	Z16LER	07/12 →	08/14
CORSA D 1.6 Turbo	A16LEL, A16XNT	11/06 →	08/14
INSIGNIA 1.6 Turbo	A16LET	07/08 →	03/17
MERIVA A 1.4 16V Twinport	Z14XEP	07/04 →	05/10
MERIVA A 1.4 16V Twinport LPG	Z14XEP	07/04 →	05/10
MERIVA A 1.6 Turbo	Z16LET	09/05 →	05/10
TIGRA B 1.4	Z14XEP	06/04 →	12/10
ZAFIRA B 1.6 CNG Turbo	A16XNT, A16XNT	02/09 →	04/15
ZAFIRA C 1.6 CNG	A16XNT, MDJ.UA	10/11 →	

PORSCHE			
718 BOXSTER 2.0	MDD.PB	04/16 →	
718 BOXSTER 2.5 GTS	MDJ.UA, MDJ.UA	10/17 →	
718 BOXSTER S 2.5	MDD.NC	04/16 →	
718 CAYMAN 2.0	MDD.PB	04/16 →	
718 CAYMAN 2.5 GTS	MDJ.UA, MDC.HA	10/17 →	
718 CAYMAN S 2.5	MDD.NC	04/16 →	
911 3.0 Carrera 4 S	MDC.HA, MDC.HA	11/18 →	
911 3.0 Carrera S	MDC.HA, MDC.HA	11/18 →	
911 IV 3.4 Carrera	M96.01, M96.01	05/01 →	08/05
911 IV 3.4 Carrera 4	M96.01, M96.70	05/01 →	08/05
911 IV 3.6	M96.03	12/01 →	08/05
911 IV 3.6 Carrera	M96.03	10/01 →	08/05
911 IV 3.6 Carrera 4	M96.03	10/01 →	08/05
911 IV 3.6 Carrera 4S	M96.03	06/02 →	08/05
911 IV 3.6 Carrera S	M96.03	06/02 →	08/05
911 IV 3.6 GT2	M96.70, M96.76	04/01 →	08/05
911 IV 3.6 GT3	M96.76, M96.05	03/03 →	08/05
911 IV 3.6 S	M96.70	08/04 →	08/05
911 IV 3.6 S [ExtraEU]	M96.70	08/04 →	08/05
911 IV 3.6 Turbo 4	M96.70	06/00 →	08/05
911 IV 3.6 Turbo 4S	M96.70	02/03 →	08/05
911 V 3.6 Carrera	M96.05, M96.05	07/04 →	12/11
911 V 3.6 Carrera 4	M96.05, M97.01	07/04 →	

PORSCHÉ			
BOXSTER III 2.7	MA1.22	04/12 →	
BOXSTER III 3.8	MDB.XA	07/15 →	
BOXSTER III GTS 3.4	--, M48.50S	02/14 →	
BOXSTER III S 3.4	MA1.23	04/12 →	
CARRERA GT 5.7	M80.01	07/03 → 12/06	
CAYENNE I GTS 4.8	M48.01	10/07 → 09/10	
CAYENNE I S 4.5	M48.00	09/02 → 09/07	
CAYENNE I S 4.8	M48.01	02/07 → 09/10	
CAYENNE I Turbo 4.5	M48.50	09/02 → 09/07	
CAYENNE I Turbo S 4.5	M48.50S, M48.51	01/04 → 09/07	
CAYENNE I Turbo S 4.8	M48.51, M48.52	02/07 → 09/10	
CAYENNE II 3.6 GTS	MCX.ZA	02/15 →	
CAYENNE II 3.6 S	MCU.RA	10/14 →	
CAYENNE II 4.8 GTS	M48.02	06/12 →	
CAYENNE II 4.8 S	M48.02	06/10 →	
CAYENNE II 4.8 Turbo	M48.52, M48.52	06/10 →	
CAYENNE II 4.8 Turbo S	M48.52, MA1.20	10/12 →	
CAYMAN I 2.7	M97.20	07/06 → 12/09	
CAYMAN I 2.9	MA1.20, M97.21	02/09 → 06/13	
CAYMAN I R 3.4	MA1.21	11/10 → 12/12	
CAYMAN I S 3,4 Sport	M97.22	08/08 → 12/12	
CAYMAN I S 3.4	M97.21, --	11/05 → 06/13	
CAYMAN II 2.7	MA1.22	03/13 →	
CAYMAN II 3.8 GT4	MDB.XA	01/15 →	
CAYMAN II GTS 3.4	--, MCT.LA	02/14 →	
CAYMAN II S 3.4	MA1.23	03/13 →	
MACAN 3.0 GTS	MDC.NA	10/15 →	
MACAN 3.0 S	MCT.MA	02/14 →	
MACAN 3.6 Turbo	MCT.LA, MCW.DA	02/14 →	
PANAMERA 3.0 4S	MCW.DA	07/13 → 10/16	
PANAMERA 3.0 S	MCW.DA, M46.20	07/13 →	
PANAMERA 3.6	M46.20, M46.40	05/10 → 10/16	
PANAMERA 3.6 4	M46.40, M48.40	05/10 → 10/16	
PANAMERA 4.8 4S	M48.40	09/09 → 07/13	
PANAMERA 4.8 GTS	M48.40, M48.70	01/12 → 10/16	
PANAMERA 4.8 S	M48.20	09/09 → 07/13	
PANAMERA 4.8 Turbo	M48.70, M48.70	09/09 → 10/16	
PANAMERA 4.8 Turbo S	M48.70, M134.910	05/11 → 10/16	
SAAB			
9-5 1.6 Turbo	A16LET	05/10 → 01/12	
SMART			
FORFOUR 1.1	M134.910, Z10XE	01/04 → 06/06	
FORFOUR 1.3	M135.930	01/04 → 06/06	
FORFOUR 1.5	M135.950	01/04 → 06/06	
VAUXHALL			
AGILA A 1.0 12V	Z10XE, X12XE	02/00 → 11/06	
AGILA A 1.2 16V	Z12XE	09/00 → 03/08	
AGILA A 1.2 16V Twinport	Z12XEP	07/04 → 11/06	
ASTRA IV 1.2 16V	X12XE, Z14XEL	09/00 → 05/05	
ASTRA V 1.2	Z12XEP	08/05 → 10/10	
ASTRA V 1.4	Z14XEL, A16LET	01/04 → 10/10	
ASTRA V 1.4 i 16V	Z14XEP	03/05 → 11/10	
ASTRA V 1.6	A16LET, A16LET	08/04 → 11/10	
ASTRA V 1.6 Turbo	A16LET, Z10XE	09/06 → 09/09	
ASTRAVAN III 1.4 i	Z14XEP	03/05 →	
COMBO C 1.4	Z14XEP	10/04 → 09/10	
COMBO C 1.4 i 16V	Z14XEP	01/04 → 11/11	
COMBO D 1.4	A14FP	11/11 →	
COMBO D 1.4 CNG	A14FC	11/11 →	
CORSA B 1.0 i 12V	X10XE	11/96 → 09/00	
CORSA B 1.2 i 16V	X12XE	03/98 → 09/00	
CORSA C 1.0 12V	Z10XE, A16LEL	09/00 → 10/06	
CORSA C 1.2 16V	Z12XE	09/00 → 10/06	
CORSA C 1.2 16V Dualfuel	Z12XE	08/01 → 10/06	
CORSA C 1.2 Twinport	Z12XEP	07/04 → 10/06	
CORSA C 1.4 Twinport	Z14XEP	06/03 → 10/06	
CORSA D 1.0	Z10XEP	08/06 → 08/14	
CORSA D 1.2	Z12XEP	08/06 → 08/14	
CORSA D 1.2 LPG	Z12XEP	09/09 → 08/14	
CORSA D 1.4	Z14XEP	08/06 → 08/14	
CORSA D 1.4 LPG	Z14XEP	07/06 → 08/14	
CORSA D 1.6 SRi	A16LEL, A16LER	05/07 → 08/14	
CORSA D 1.6 VXR	A16LER, Z12XE	11/06 → 08/14	
CORSAVAN II 1.2 16V	Z12XE, Z12XE	09/00 → 11/06	
CORSAVAN II 1.2 16V Dualfuel	Z12XE, A16XNT	08/01 → 06/06	
CORSAVAN II 1.4	Z14XEP	11/03 → 06/06	
CORSAVAN III 1.2	Z12XEP	07/09 →	
INSIGNIA 1.6 Turbo	A16LET	01/09 → 05/17	
MERIVA I 1.4 16V Twinport	Z14XEP	01/03 → 06/10	
MERIVA I 1.6 Turbo	Z16LET	05/06 → 06/10	
TIGRA B 1.4	Z14XEP	06/04 → 08/09	
ZAFIRA B 1.6 CNG Turbo	A16XNT, 1KR	02/09 → 11/14	
ZAFIRA C 1.6 CNG	A16XNT	10/11 → 08/18	

9.3009



1

KNOCK SENSORS

Adatt./Suitable:

BOSCH
0 261 231 193

CITROËN
5946 35

PEUGEOT
5946 35

TOYOTA
89615-0H010

MARKET DIFFUSION: HIGH



mV/g		
31		

CITROËN

C1 I 1.0	1KR, 1KR	06/05 →
C1 II 1.0 VTi 68	1KR	04/14 →
C1 II 1.0 VTi 72	1KR	06/18 →

PEUGEOT

107 1.0	1KR, 1KR	06/05 →
108 1.0 VTi	1KR, 1KR-FE	05/14 →
108 1.0 VTi 72	1KR	05/18 →

TOYOTA

AYGO I 1.0	1KR-FE	07/05 → 05/14
AYGO I 1.0 GPL	1KR-FE	07/05 → 05/14
AYGO I 1.0 VVTi	1KR-FE	07/05 → 05/14
AYGO II 1.0	1KR-FE	05/14 →
AYGO II 1.0 VVTi [ExtraEU]	1KR-FE	03/18 →
VIOS / YARIS 1.0	1KR-FE	09/05 → 10/13
VITZ 1.0 VVTi [ExtraEU]	1KR-FE	11/05 → 11/10
YARIS II 1.0 GPL	1KR-FE	01/06 → 12/11
YARIS II 1.0 VVT-i	1KR-FE	01/05 → 12/11
YARIS III 1.0	1KR-FE, B38A15A	12/10 →
YARIS 1.0 VVTi	1KR-FE	07/14 →

9.3010



1

KNOCK SENSORS

Adatt./Suitable:

ALFA ROMEO
60512698

BMW
12 14 1 279 734
13 62 7 636 937

BOSCH
0 261 231 001
0 261 231 006
0 261 231 224

CITROËN
5946 03

GENERAL MOTORS
90 510 281

HOLDEN
90510281
V519457

MINI
13 62 7 636 937
7 636 937

OPEL
12 38 345
62 38 341

PEUGEOT
5946 03

PORSCHÉ
944 606 145 00

RENAULT
77 00 271 090

SAAB
75 68 801
93 58 037

SEAT
026 905 377 2

SSANGYONG
1611533028
1611533328
1611533628

VOLVO
132665-8
13676440
343334-7

VW
026 905 377 2



mV/g		
25		

ALFA ROMEO

75 1.8 i.e. Turbo America	61203	02/86 → 01/90
75 1.8 Turbo	AR06134	09/86 → 02/92

BMW

1 II 116 i	B38B15A	03/15 →
1 II 118 i	B38B15A	03/15 →
1 II 120 i	B48B20A	09/15 →
1 II 125 i	B48B20B	09/15 →
1 II M 140 i	B58B30A	09/15 →
1 II M 140 i xDrive	B58B30A	09/15 →
1 SERIES 120i [ExtraEU]	B48B20A	10/15 →
2 216 i	B38A15A, B38A15A	09/14 →
2 218 i	B38A15A, B46B20B	07/14 →
2 220 i	B48A20A	03/14 →
2 225 i	B48A20B	11/13 →
2 225 i xDrive	B48A20B	03/14 →
2 225 xe	B38A15A	11/14 →
2 230 i	B46B20B, B46B20B	09/15 →
2 M 240 i	B58B30A	09/15 →
2 M 240 i xDrive	B58B30A	09/15 →
3 VI 318 i	B38B15A	01/15 →
3 VI 320 i	B48B20A	09/14 →
3 VI 320 i xDrive	B48B20A	09/14 →
3 VI 330 e	B48B20A	11/15 → 10/18
3 VI 330 i	B46B20B, B58B30A	09/14 →
3 VI 330 i xDrive	B46B20B	10/14 →
3 VI 340 i	B58B30A	10/14 →
3 VI 340 i xDrive	B58B30A, B46B20B	10/14 →
4 418 i	B38B15A	07/15 →
4 420 i	B48B20A	02/16 →
4 420 i xDrive	B48B20A	02/16 →
4 430 i	B48B20B	03/16 →
4 430 i xDrive	B46B20B, B48B16A	03/16 →

BMW		
4 440 i	B58B30A	03/16 →
4 440 i xDrive	B58B30A	03/16 →
5 VII 520 i	B48B16A, B46B20B	07/17 →
5 VII 530 e iPerformance	B48B20B	03/17 →
5 VII 530 i	B46B20B, B46B20B	09/16 →
5 VII 530 i xDrive	B46B20B, M30B32(326TA)	09/16 →
5 VII 540 i	B58B30A	09/16 →
5 VII 540 i xDrive	B58B30A	09/16 →
6 IV GT 630 i	B48B20B	06/17 →
6 IV GT 640 i	B58B30A	06/17 →
6 IV GT 640 i xDrive	B58B30A	06/17 →
7 I 745 i	M30B32(326TA), B38K15A	04/80 → 08/86
7 VI 730 i, Li	B48B20B	11/15 → 02/19
7 VI 740 e, Le	B48B20B	07/16 → 02/19
7 VI 740 i, Li	B58B30A	07/15 → 02/19
7 VI 740 Le xDrive	B48B20B	07/16 → 02/19
7 VI 740 Li xDrive	B58B30A	03/16 → 02/19
7 VI M 760 Li xDrive	N74B66B	12/16 → 02/19
I8 hybrid	B38K15A, B48A20A	03/14 →
X1 sDrive 18 i	B38A15A	06/17 →
X1 sDrive 20 i	B48A20A	11/14 →
X1 sDrive 20 i	B48A20A, B58B30A	11/14 →
X1 sDrive 25 i	B48A20B	11/14 →
X2 M35 i	B48A20E	11/18 →
X2 sDrive 18 i	B38A15A	03/18 →
X2 sDrive 20 i	B48A20A	11/17 →
X2 sDrive 20 i	B48A20A	03/18 →
X3 III sDrive 20 i	B48B20A	12/17 →
X3 III sDrive 20 i 1.6	B48B16A	12/17 →
X3 III sDrive 20 i	B48B20A	03/18 →
X3 III xDrive 30 i	B48B20B	12/17 →
X3 III xDrive M40 i	B58B30A, B46B20B	10/17 →
X4 M40 i xDrive	B58B30A	04/18 →
X4 sDrive 20 i	B48B20A	04/18 →
X4 sDrive 30 i	B48B20B	04/18 →
X5 IV xDrive 40 i	B58B30C	08/18 →
X7 xDrive 40 i	B58B30C	03/19 →
Z4 M40 i	B58B30C	11/18 →
Z4 sDrive 20 i	B46B20B, 159K	11/18 →
Z4 sDrive 30 i	B48B20B	11/18 →

CITROËN		
BX 1.9 GTi 16V	159K, D6C(XU9J4)	01/87 → 12/94
BX 19 GTi 16V	D6C(XU9J4), B36A15A	09/87 → 02/93

HOLDEN		
CALIBRA_YE 2.0i 16V	C20XE	09/91 → 07/95
CALIBRA_YE 2.0i 16V Turbo	C20LET	06/94 → 10/97

MINI		
MINI III Cooper	B36A15A, B46A20A	09/13 →
MINI III Cooper ALL4	B38A15A	10/16 →
MINI III Cooper S	B46A20A, B46A20A	09/13 →
MINI III Cooper S ALL4	B46A20A, B46A20A	04/15 →
MINI III Cooper S JCW	B46A20A, B38A12A	09/13 →
MINI III Cooper S JCW ALL4	B48A20A	11/14 →
MINI III Cooper SE ALL4	B38A15A	01/17 →
MINI III John Cooper Works	B48A20B	03/15 →
MINI III John Cooper Works ALL4	B48A20B	01/17 →
MINI III One	B38A12A, B38A12A	04/14 →
MINI III One First	B38A12A, M44.43	06/14 →

OPEL		
ASTRA F 1.8 i 16V	18SE	09/95 → 09/96
ASTRA F 2.0 GSI 16V	C20XE	09/91 → 01/98
ASTRA F 2.0 i 16V	C20XE	03/93 → 01/98
CALIBRA A 2.0 i 16V	C20XE	06/90 → 02/94
CALIBRA A 2.0 i 16V 4x4	C20XE	06/90 → 02/94
CALIBRA A 2.0 i Turbo 4x4	C20LET	08/91 → 07/97
KADETT E 2.0 GSI 16V Cat	C20XE	03/88 → 08/91
OMEGA A 3.0 24V	C30SE	09/89 → 03/94
OMEGA A 3.0 24V Omega 3000	C30SE	09/88 → 04/94
OMEGA B 2.0	X20SE	03/94 → 09/99
VECTRA A 2.0 i 16V	20XEJ	02/89 → 10/90
VECTRA A 2.0 i 16V 4x4	C20XE	08/89 → 08/95
VECTRA A 2.0 i 16V Cat	C20XE	02/90 → 11/95
VECTRA A 2.0 i Turbo 4x4	C20LET	06/94 → 11/95
VECTRA A 2000 16V 4x4	20XEJ	01/89 → 10/90
VECTRA A 2000/GT 16V	20XEJ	01/89 → 06/94
VECTRA A 2000/GT 16V Cat	C20XE	02/90 → 11/95
VECTRA A 2000/GT 16V Cat 4x4	C20XE	02/90 → 11/95
VECTRA B 2.0 i	20NEJ	10/95 → 04/02

PORSCHÉ		
968 3.0	M44.43, F3N743	06/91 → 11/95

RENAULT		
19 I 1.7	F3N746	08/88 → 12/92
19 I 1.7	F3N743, B202S	04/92 → 12/95

SAAB		
900 I 2.0 S Turbo-16	B202S, B201XL	07/91 → 06/94
900 I 2.0 Turbo	B201XL, B202L	01/86 → 12/91
900 I 2.0 Turbo-16	B202L, B202I	11/85 → 06/94
900 I 2.0 Turbo-16 S	B202XL	01/84 → 06/94
900 I 2.0 Turbo-16 S Cat	B202XL	01/89 → 12/93
9000 2.0 -16	B202I, B202	12/85 → 01/93
9000 2.0 -16 CS	B202I	01/89 → 12/98
9000 2.0 -16 Turbo	B202, AST	09/84 → 08/93
9000 2.0 -16 Turbo CD	B202XL	09/88 → 08/93
9000 2.3 -16 CD	B234I	08/89 → 12/98
9000 2.3 -16 CD Turbo	B234L	07/90 → 12/98
9000 2.3 -16 CS	B234I	09/89 → 12/98
9000 2.3 -16 Turbo	B234L	09/90 → 12/98

SEAT		
CORDOBA I 1.0 16V	AST, AST	05/00 → 10/02
IBIZA II 1.0 16V	AST, D20DT	10/99 → 02/02

SSANGYONG		
ACTYON I 2.0 Xdi	D20DT, G23D	11/05 →
ACTYON I 2.0 Xdi 4WD	D20DT	04/07 →
ACTYON I 2.3	G23D, G23D	11/06 →
ACTYON I 2.3 4WD	G23D	09/11 →
ACTYON I 2.3 4x4	G23D, D20DT	11/06 →
ACTYON I 200 Xdi 4WD	D20DT, --	10/06 →
ACTYON II 2.0	G20DF	08/12 →
ACTYON II 2.0 4x4	G20DF	08/12 →
CHAIRMAN 3.2 [ExtraEU]	G32D	06/07 →
KORANDO 2.0	G20D	02/12 →
KORANDO 2.0 4WD	G20D	02/12 →
KORANDO 2.0 e-XGi	G20D	02/12 →
KORANDO 2.0 e-XGi [ExtraEU]	G20D	02/12 →
KORANDO 2.0 GPL	G20D	05/15 →
KORANDO 2.0 GPL 4WD	G20D	09/15 →
KORANDO 2.0 LPG	G20D	02/12 →
KORANDO 2.0 LPG AWD	G20D	02/12 →
KORANDO 2.3	--, D20DT	01/99 → 11/06
KORANDO 3.2	E32	01/99 → 11/02
KYRON 2.0 Xdi	D20DT, D20DT	05/05 →
KYRON 2.0 XDi [ExtraEU]	D20DT	05/05 →
KYRON 2.0 Xdi 4x4	D20DT, D20DT	05/05 →
KYRON 2.3	E23	01/10 →
KYRON 2.3 4x4	E23	11/06 →
KYRON 2.7 Xdi 4x4	D20DT, D27DT	05/05 →
KYRON 3.2 M320 4x4	G32D	03/08 →
MUSSO 2.0	M111E20	10/96 → 05/05
MUSSO 2.3	M161E23	04/03 → 08/06
MUSSO 3.2	M104.992	06/96 → 09/04
REXTON 2.7 RX270 Xdi	D27DT	05/04 → 04/13
REXTON 3.2 RX320	M162E32	09/06 → 04/13
REXTON I 2.3 RX230 4x4	G32D	05/02 →
REXTON I 2.7 D 4x4	D27DTP	05/06 →
REXTON I 2.7 Xdi	D27DT, D27DT	08/04 →
REXTON I 2.7 Xdi 4x4	D27DT, D27DT	03/06 →
REXTON I 2.7 Xdi Trazione integrale	D27DT, 540	07/12 →
REXTON I 3.2 4x4	G32D	04/02 →
RODIUS 2.7 Xdi	D27DT	05/05 →
RODIUS 2.7 Xdi 4WD	D27DT	05/05 →
RODIUS 3.2	M162E32	05/05 →
RODIUS 3.2 [ExtraEU]	M162E32	06/12 →
RODIUS 3.2 4WD	G32D	07/07 →

VAUXHALL		
ASTRA III 1.8 i 16V	18SE	09/95 → 02/98
ASTRA III 2.0 i 16V	C20XE	09/91 → 02/98
CALIBRA 2.0 i 16V	C20XE	06/90 → 02/94
CALIBRA 2.0 i 16V 4x4	C20XE	06/90 → 02/94
CALIBRA 2.0 i Turbo 4x4	C20LET	03/92 → 07/97
OMEGA B 2.0	X20SE	03/94 → 09/99
VECTRA B 2.0 i	20NEJ	10/95 → 03/02

VOLKSWAGEN (BR)		
CADDY 1.6i	MY4	11/98 →
GOL 1.6i	540, 542	10/96 →
GOL 1.8i	542, 546	10/96 →
GOL 2.0i	546, 546	10/96 →
PARATI 1.6i	540, 546	10/96 →
PARATI 1.8i	542	10/96 →
PARATI 2.0i	546, MJ3	10/96 →
POLO 1.6	MJ3, MJ2	07/00 →
POLO 1.8	MJ2, 540	12/96 →
SAVEIRO 1.6i	540, 542	10/96 →
SAVEIRO 1.8i	542, 546	10/96 →
SAVEIRO 2.0i	546, B230FD	10/96 →

VOLVO		
440 1.7	B18E, B18FT	08/88 → 12/96
440 1.7 Turbo	B18FT, B18U	08/88 → 12/96
440 1.8	B18U, B20F	08/91 → 12/96
440 2.0	B20F, B18EP	08/92 → 07/96
460 1.6	B16F	07/92 → 07/96
460 1.7	B18EP, B18FT	09/88 → 07/96
460 1.7 Turbo	B18FT, B20F	08/89 → 07/96
460 1.8	B18U	08/91 → 07/96
460 2.0	B20F, B18E	08/92 → 07/96
480 1.7	B18E, B18FT	04/86 → 07/96
480 1.7 Turbo	B18FT, B200E	08/87 → 07/96
480 2.0	B20F	08/92 → 09/95
740 2.0	B200E, B204FT	08/85 → 07/92
740 2.0 16V	B204E	09/87 → 08/90
740 2.0 16V Turbo	B204FT, B230E	08/89 → 07/90
740 2.0 GLE	B204E	09/87 → 08/90
740 2.0 Turbo	B200FT	09/90 → 08/91
740 2.3	B230E, B230FT	08/84 → 12/92
740 2.3 GL	B230E	08/84 → 08/87
740 2.3 Turbo	B230FT, B230ET	08/86 → 08/91
760 2.3	B230ET, B23FT	08/84 → 07/92
760 2.3 Turbo	B23FT, B200E	08/83 → 08/90
940 I 2.0	B200E, B230E	08/90 → 07/94
940 I 2.0 GL	B204E	09/90 → 04/92
940 I 2.0 Turbo	B200FT	08/90 → 07/95
940 I 2.3	B230E, B230FD	08/90 → 07/95
940 I 2.3 16V	B234G	08/90 → 07/92
940 I 2.3 Turbo	B230FT	08/90 → 07/94
940 II 2.0 GLT	B200GT	10/94 → 05/97
940 II 2.0 Turbo	B200FT	04/96 → 10/98
940 II 2.3	B230FD, B230FT	08/94 → 05/97
940 II 2.3 ti	B230FK	01/95 → 10/98
940 II 2.3 Turbo	B230FT, B6304F	08/94 → 12/98
960 I 2.0	B204FT	08/90 → 09/93
960 I 2.3	B230GT	08/90 → 07/94
960 I 2.3 Turbo	B230FT	09/90 → 08/93
960 I 2.9	B6304F, B6254FS	08/90 → 07/94
960 II 2.4	B6244FS	01/95 → 08/97
960 II 2.5	B6254S	07/94 → 12/96
960 II 2.5 24V	B6254FS, B6304FS	01/95 → 08/97
960 II 2.9	B6304FS, B6254FS	07/94 → 08/97
S90 2.5 24V	B6254FS, B6304G	01/97 → 05/98
S90 2.9	B6304G, B6304G	01/97 → 05/98
S90 2.9 24V	B6304FS, B6304G	01/97 → 05/98
V90 2.5 24V	B6254GS	01/97 → 12/97
V90 2.9	B6304G, B6304FS	01/97 → 12/98
V90 2.9 24V	B6304FS, Z28NET	01/97 → 12/98

VW		
CADDY III 1.6 [ARG]	UVC	10/05 →

9.3012



1

KNOCK SENSORS

Adatt./Suitable:

ALFA ROMEO
71739674**BOSCH**
0 261 231 174**CHEVROLET**
12618603**GENERAL MOTORS**
12 566 845
12 618 603
93 189 202**OPEL**
12566845
12618603
48 14 155
62 35 712
62 35 746
93189202**SAAB**
93 189 202**VAUXHALL**
12566845
12618603
93189202

mV/g		
31		

ALFA ROMEO

159 1.9 JTS	939A6.000	09/05 → 11/11
159 2.2 JTS	939A5.000	09/05 → 11/11
159 3.2 JTS	939A.000	01/08 → 11/11
159 3.2 JTS Q4	939A.000	12/05 → 11/11
159 MY2011 2.2 JTS	--	01/10 →
159 MY2011 3.2 JTS	--	01/10 →
BRERA 2.2 JTS	939A5.000	01/06 → 05/11
BRERA 3.2 JTS	939A.000	03/08 → 06/10
BRERA 3.2 JTS Q4	939A.000	01/06 → 05/11
SPIDER III 2.2 JTS	939A5.000	03/06 → 03/11
SPIDER III 3.2 JTS	939A.000	03/08 → 03/11
SPIDER III 3.2 JTS Q4	939A.000	03/06 → 03/11

CADILLAC

BLS 2.8 T	Z28NET, Z28NEL	04/06 →
BLS 2.8 T AWD	Z28NET	10/08 →

CHEVROLET

CAPTIVA 3.2 4WD	LU1	06/06 →
-----------------	-----	---------

OPEL

ANTARA 3.2 V6	Z32SEE	07/06 → 12/11
SIGNUM 2.8	Z28NET	10/06 →
SIGNUM 2.8 V6 Turbo	Z28NEL, Z28NEL	09/05 → 12/08
VECTRA C 2.8 V6 Turbo	Z28NEL, B284	08/05 → 10/08
VECTRA C 2.8 V6 Turbo OPC	Z28NET	09/06 → 08/08

SAAB

9-3 2.8 Turbo V6	B284, B284R	03/05 →
9-3 2.8 Turbo V6 XWD	B284R	05/08 → 12/11
9-3 2.8 V6 T	B284R, Z28NEL	09/07 → 02/15

VAUXHALL

SIGNUM 2.8 V6 Turbo	Z28NEL, Z28NEL	07/05 → 10/08
VECTRA C 2.8 V6 Turbo	Z28NEL, NF	08/05 → 05/09

9.3013



04,5

KNOCK SENSORS

Adatt./Suitable:

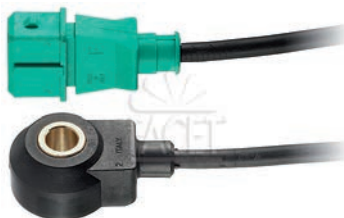
AUDI
034 905 377 A
054 905 377 A**BOSCH**
0 261 231 004
0 261 231 005
0 261 231 038
0 261 231 039**SIEMENS**
G855302990800Z**VW**
034 905 377 A
053 905 377 2
054 905 377 A

L	mV/g		
800	25		

AUDI

80 II 1.8 GTE	PV	08/85 → 07/86
80 III 1.8	SD	09/86 → 07/88
80 III 2.0 E	3A	08/88 → 10/90
80 III 2.0 E 16V	6A	03/90 → 09/91
80 IV 2.0 E 16V	6A, NG	09/91 → 01/96
80 IV 2.3 E	NG	09/91 → 01/96
80 IV 2.6	ABC	07/92 → 01/96
80 IV 2.6 E	ACZ	05/93 → 05/95
80 IV 2.8	AAH	09/91 → 01/96
90 I 2.0	SK	03/86 → 03/87
90 II 2.0	PS	07/88 → 09/91
90 II 2.3 E	NG, ADP	04/87 → 09/91
100 III 2.0 Cat	RT	01/88 → 11/90
100 III 2.0 E Cat	RT	01/88 → 11/90
100 III 2.3	NF, NF	08/86 → 11/90
100 III 2.3 E	NF, AAD	10/86 → 11/90
100 IV 2.0 E	AAD, 6A	12/90 → 07/94
100 IV 2.0 E 16V	ACE	01/92 → 07/94
100 IV 2.3 E	AAR	12/90 → 07/94
A4 I 1.6	ADP, ADR	11/94 → 09/01
A4 I 1.8	ADR, ADR	11/94 → 09/01
A4 I 1.8 quattro	ADR, AEB	01/95 → 09/01
A4 I 1.8 T	AEB, AEB	01/95 → 09/01
A4 I 1.8 T quattro	AEB, AFY	01/95 → 09/01
A6 I 1.8	ADR	12/95 → 12/97
A6 I 2.0	ABK	06/94 → 12/97
A6 I 2.0 16V	ACE	06/94 → 12/97
A6 I 2.0 16V quattro	ACE	06/94 → 12/97
A6 I 2.3	AAR	06/94 → 12/95
A6 I 2.3 quattro	AAR	06/94 → 12/95
A6 I S6 4.2 quattro	AEC	06/94 → 12/97
A6 I S6 Turbo quattro	AAN	06/94 → 12/97
A6 II 1.8	AFY, AEB	05/97 → 01/05
A6 II 1.8 T	AEB, AEB	01/97 → 01/05
A6 II 1.8 T quattro	AEB, ARS	02/97 → 01/05
A6 II 4.2 quattro	ARS, ANK	11/98 → 01/05
A6 II RS6 plus quattro	BRV	04/04 → 01/05
A6 II RS6 quattro	BCY	07/02 → 01/05
A6 II S6 quattro	ANK, AEW	09/99 → 01/05
A8 I 3.3 TDI quattro	AKF	06/00 → 09/02
A8 I 3.7	AEW, AEW	07/95 → 12/98
A8 I 3.7 quattro	AEW, ABZ	07/95 → 11/98
A8 I 4.2 quattro	ABZ, AQH	03/94 → 12/99
A8 I S 8 quattro	AQH, AHC	06/99 → 09/02
A8 I S8 quattro	AHC, 3A	09/00 → 06/99
CABRIOLET 1.8	ADR	01/97 → 08/00
CABRIOLET 2.0 16V	ACE	06/95 → 07/96
CABRIOLET 2.0 E	ABK	01/93 → 07/98
CABRIOLET 2.3 E	NG	05/91 → 07/94
CABRIOLET 2.6	ABC	06/93 → 08/00
CABRIOLET 2.8	AAH	11/92 → 08/00
COUPE 2.0	3A, 6A	05/89 → 07/90

AUDI

COUPE 2.0 16V	6A, NG	01/92 → 12/96
COUPE 2.3	NG, NG	10/88 → 12/96
COUPE 2.3 quattro	NG, 3B	11/88 → 12/96
COUPE 2.6 quattro	ABC	08/92 → 12/96
COUPE 2.8 quattro	AAH	08/91 → 12/96
COUPE S2	3B	09/90 → 09/92
COUPE S2 quattro	3B, 528	09/90 → 12/96

VOLKSWAGEN (BR)

GOL 2.0i	528, 526	09/94 → 01/97
LOGUS 2.0i	526, 526	12/92 → 12/96
POINTER 2.0i	526, RV	11/93 → 12/96

VW

CORRADO 1.8 G60	PG	09/88 → 09/93
CORRADO 2.0 i 16V	9A	08/91 → 12/95
GOLF I 1.8	2H	08/89 → 03/93
GOLF II 1.8	RV, PB	08/87 → 07/89
GOLF II 1.8 GTI	PB, PB	08/83 → 10/91
GOLF II 1.8 GTI 16V	PL	02/86 → 10/91
GOLF II 1.8 GTI Cat	PF	01/87 → 10/91
GOLF II 1.8 GTI G60 Syncro	1H	08/88 → 12/91
GOLF II 1.8 Syncro	1P	08/88 → 07/91
JETTA II 1.8	PB, PB	01/84 → 10/91
JETTA II 1.8 16V	PL	08/86 → 10/91
JETTA II 1.8 Cat	PF	01/87 → 10/91
PASSAT IV 1.6	ADP, ADR	10/96 → 11/00
PASSAT IV 1.8	ADR, ANQ	10/96 → 03/05
PASSAT IV 1.8 [CHN]	ANQ, ADR	03/00 →
PASSAT IV 1.8 Syncro/4motion	ADR, AEB	10/96 → 11/00
PASSAT IV 1.8 T	AEB, AAA	10/96 → 11/00
PASSAT IV 1.8 T 20V	AWL	11/00 → 05/05
PASSAT IV 1.8 T Syncro	AEB	11/96 → 08/00
PASSAT III 1.8	PB, ADP	04/88 → 07/93
PASSAT III 2.0 16V	9A	08/88 → 09/93
SCIROCCO II 1.8 16V	PL	03/86 → 07/92
TOUAREG I 4.2 V8	AXQ	12/02 → 11/06

9.3015



04,5

KNOCK SENSORS

Adatt./Suitable:

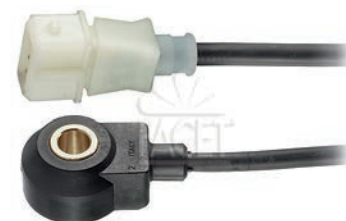
BOSCH
0 261 231 047
0 261 231 048**FORD**
1 029 801
95VW-12A699-AA**VW**
021 905 377

L	mV/g		
570	24		

FORD

GALAXY I 2.8 iV6	AAA, AAA	11/95 → 04/00
GALAXY I 2.8 iV6 4x4	AAA, AAA	04/96 → 04/00

VW

CORRADO 2.9 VR6	ABV	08/91 → 12/95
GOLF III 2.8 VR6	AAA, AAA	01/92 → 09/97
GOLF III 2.9 VR6	ABV	10/94 → 04/99
GOLF III 2.9 VR6 Syncro	ABV	10/94 → 04/99
PASSAT III 2.8 VR6	AAA	06/91 → 05/97
SHARAN I 2.8 VR6	AAA, AAA	09/95 → 04/00
SHARAN I 2.8 VR6 Syncro	AAA, S50B30(30651)	11/96 → 04/00

9.3016



04,5

KNOCK SENSORS

Adatt./Suitable:

BMW
1 401 238
12 14 1 401 238

BOSCH
0 261 231 066
0 261 231 067
0 261 231 092

VW
030 905 377



L	mV/g		
350	25		

BMW			
3 III M3 3.0	S50B30(306S1), S50B32(326S1)	10/92 ⇨	10/95
3 III M3 3.2	S50B32(326S1)	09/95 ⇨	04/99
Z3 M	S50B32(326S1), S50B32(326S1)	02/98 ⇨	06/01
Z3 M 3.2	S50B32(326S1), 211	03/97 ⇨	06/01
VOLKSWAGEN (BR)			
GOL 1.0i	211, ACU	11/96 ⇨	
GOL 1.0i 16v Turbo	512	06/00 ⇨	
PARATI 1.0i 16v Turbo	512	06/00 ⇨	
VW			
POLO II 1.3 G40	PY	08/90 ⇨	09/94
TOURAN I 2.0 TDI [CHN]	CGZA	04/09 ⇨	
TRANSPORTER IV 2.5	ACU, ACU	11/90 ⇨	06/03
TRANSPORTER IV 2.5 Syncro	ACU, K3-VE	10/92 ⇨	04/03

9.3018



1

KNOCK SENSORS

Adatt./Suitable:

ASTON MARTIN
89615-02020

DAIHATSU
89615-20090
89615-20090-000

DENSO
171000-1050
171000-1110
171000-1111

LEXUS
89615-02020
89615-06010
89615-20090

SUBARU
89615-20090

TOYOTA
89615-02020
89615-06010
89615-20090
89615-BZ030

MARKET DIFFUSION: **HIGH**



mV/g		
24		

ASTON MARTIN		
CYGNET 1.3	1NR-FE	04/11 ⇨ 10/13

DAIHATSU			
CHARADEVI 1.33 16V	1NR-FE	05/11 ⇨	
COPEN 1.3	K3-VE	03/06 ⇨	09/12
CUORE VII 1.0	1KR-FE	04/07 ⇨	
CUORE VII 1.0 LPG	1KR-FE	09/11 ⇨	12/12
MATERIA 1.3	K3-VE	10/06 ⇨	
MATERIA 1.5	3SZ-VE	10/06 ⇨	
MATERIA 1.5 ECO 4WD	3SZ-VE	10/06 ⇨	
MATERIA 1.5 LPG	3SZ-VE	01/10 ⇨	12/11
SIRION 1.0	1KR-FE	01/05 ⇨	06/13
SIRION 1.0 LPG	1KR-FE	01/05 ⇨	06/13
SIRION 1.3	K3-VE, K3-VE	01/05 ⇨	
SIRION 1.3 4WD	K3-VE, 3SZ-VE	04/05 ⇨	
SIRION 1.5	3SZ-VE	03/08 ⇨	
TERIOS II 1.3 VVT-i 4x4	K3-VE	11/05 ⇨	
TERIOS II 1.3 VVT-i LPG 4x4	K3-VE	01/09 ⇨	12/09
TERIOS II 1.5 4x4	3SZ-VE	05/06 ⇨	
TERIOS II 1.5 LPG 4x4	3SZ-VE	06/09 ⇨	
TERIOS II 1.5 VVT-i 4x4	3SZ-VE	09/10 ⇨	
TERIOS II 1.5 VVT-i RWD	3SZ-VE, 2GR-FSE	11/05 ⇨	

LEXUS			
CT 200h	2ZR-FXE	12/10 ⇨	
ES 200	6AR-FSE	08/15 ⇨	
ES 250	2AR-FE	06/12 ⇨	
ES 3.5	2GR-FE	05/06 ⇨	06/12
ES 300h	2AR-FXE	06/12 ⇨	
ES 350	2GR-FE	06/12 ⇨	
GS 2.0 VVTi [ExtraEU]	8AR-FTS	09/17 ⇨	
GS 200t	8AR-FTS	09/15 ⇨	
GS 250	4GR-FSE	01/12 ⇨	
GS 3.5 VVTi	2GR-FSE	04/05 ⇨	12/12
GS 3.5 VVTi [ExtraEU]	2GR-FSE, 3GR-FE	09/06 ⇨	11/11
GS 300	3GR-FE, 2GR-FSE	04/05 ⇨	11/11
GS 300h	2AR-FSE	10/13 ⇨	
GS 350	2GR-FSE, 2GR-FSE	01/12 ⇨	
GS 350 AWD	2GR-FSE	09/06 ⇨	
GS 430	3UZ-FE	04/05 ⇨	11/11
GS 450h	2GR-FSE, 4GR-FSE	02/06 ⇨	
GS 460	1UR-FSE	09/07 ⇨	11/11
GS F	2UR-GSE	09/15 ⇨	
GX 460 4WD	1UR-FE	01/10 ⇨	
GX 470	2UZ-FE	11/01 ⇨	11/09
HS 2.4 VVTi Hybrid [ExtraEU]	2AZ-FXE	06/09 ⇨	
IS II 250	4GR-FSE, 4GR-FSE	08/05 ⇨	
IS II 250 AWD	4GR-FSE, 2GR-FSE	10/05 ⇨	03/13
IS II 350	2GR-FSE, 2UR-GSE	01/08 ⇨	
IS II IS F	2UR-GSE	11/07 ⇨	03/13
IS III 200t	8AR-FTS	08/15 ⇨	
IS III 250	4GR-FSE	04/13 ⇨	
IS III 300	8AR-FTS	10/17 ⇨	
IS III 300h	2AR-FSE	04/13 ⇨	
LC 500	2UR-GSE, 1LR-GUE	11/16 ⇨	
LC 500h	8GR-FXS	11/16 ⇨	
LFA 4.8	1LR-GUE, 1UR-FE	12/10 ⇨	11/12
LS III 430	3UZ-FE	10/00 ⇨	08/06
LS IV 460	1UR-FE, 1UR-FSE	04/06 ⇨	
LS IV 460 4WD	1UR-FSE	08/06 ⇨	
LS IV 460 AWD	1UR-FSE, 2UR-FSE	12/08 ⇨	
LS IV 600h AWD	2UR-FSE, 3UR-FE	04/07 ⇨	
LS V 350	8GR-FKS	10/18 ⇨	
LS V 500	V35A-FTS	10/17 ⇨	
LS V 500 AWD	V35A-FTS	12/17 ⇨	
LS V 500h	8GR-FXS	10/17 ⇨	
LS V 500h AWD	8GR-FXS	10/17 ⇨	
LS 4.6 VVTi [ExtraEU]	1UR-FSE	10/09 ⇨	
LS 5.0 VVTi Hybrid [ExtraEU]	2UR-FSE	04/07 ⇨	
LX 570	3UR-FE, 2UR-GSE	08/07 ⇨	
NX 2.5 VVTi Hybrid [ExtraEU]	2AR-FXE	07/14 ⇨	
NX 200	3ZR-FAE	11/14 ⇨	
NX 200 AWD	3ZR-FAE	11/14 ⇨	
NX 200t	8AR-FTS	07/14 ⇨	
NX 200t AWD	8AR-FTS	07/14 ⇨	
NX 300	8AR-FTS	09/17 ⇨	
NX 300 AWD	8AR-FTS	09/17 ⇨	
NX 300h	2AR-FXE	07/14 ⇨	
NX 300h AWD	2AR-FXE	07/14 ⇨	
RC 200t	8AR-FTS	08/15 ⇨	
RC 3.5 [ExtraEU]	2GR-FSE	08/14 ⇨	
RC 300	8AR-FTS	11/17 ⇨	
RC 300h	2AR-FSE	09/14 ⇨	
RC F	2UR-GSE, 2GR-FE	08/14 ⇨	
RX II 300	1M2-FE	05/03 ⇨	12/08
RX II 350	2GR-FE	01/06 ⇨	12/08
RX II 350 AWD	2GR-FE	02/06 ⇨	12/08
RX II 400h	3M2-FE	09/05 ⇨	12/08
RX II 400h AWD	3M2-FE	09/04 ⇨	12/08
RX III 270	1AR-FE	12/08 ⇨	10/15
RX III 350	2GR-FE	01/09 ⇨	09/15
RX III 350 AWD	2GR-FE, 3UZ-FE	12/08 ⇨	08/15

LEXUS			
RX III 450h	2GR-FXE	12/08 ⇨	10/15
RX III 450h AWD	2GR-FXE	12/08 ⇨	10/15
RX IV 200t	8AR-FTS	10/15 ⇨	12/17
RX IV 200t AWD	8AR-FTS	10/15 ⇨	12/17
RX IV 3.5 VVTi Hybrid [ExtraEU]	2GR-FXS	10/15 ⇨	
RX IV 300	8AR-FTS	12/17 ⇨	
RX IV 300 AWD	8AR-FTS	12/17 ⇨	
RX IV 350 4WD	2GR-FKS	10/15 ⇨	
RX IV 450h AWD	2GR-FXS	11/15 ⇨	
SC 430	3UZ-FE, 1NR-FE	01/01 ⇨	07/10
UX 200	M20A-FKS	10/18 ⇨	
UX 250h	M20A-FXS	10/18 ⇨	
UX 250h E-Four	M20A-FXS	10/18 ⇨	
SUBARU			
JUSTY IV 1.0	1KR-FE	01/07 ⇨	
JUSTY IV 1.0 BiFuel	1KR-FE	09/07 ⇨	03/12
TREZIA 1.3	1NR-FE	03/11 ⇨	
TOYOTA			
AQUA 1.5 Hybrid	1N2-FXE	12/11 ⇨	
AURION 3.5	2GR-FE	03/06 ⇨	09/11
AURION 3.5 VVTi [ExtraEU]	2GR-FE	09/11 ⇨	
AURIS I 1.33 Dual-VVTi	1NR-FE, 1ZR-FAE	05/09 ⇨	09/12
AURIS I 1.6	1ZR-FAE, 2ZR-FAE	03/07 ⇨	09/12
AURIS I 1.8	2ZR-FAE, 1AZ-FE	10/06 ⇨	09/12
AURIS I 1.8 4WD	2ZR-FAE	02/09 ⇨	09/12
AURIS I 1.8 Hybrid	2ZR-FXE	09/10 ⇨	09/12
AURIS II 1.2	8NR-FTS	03/15 ⇨	
AURIS II 1.3	1NR-FE	10/12 ⇨	
AURIS II 1.6	1ZR-FAE	10/12 ⇨	
AURIS II 1.8 Hybrid	2ZR-FXE	10/12 ⇨	
AVENSIS II 1.6 VVT-i	3ZZ-FE	04/03 ⇨	11/08
AVENSIS II 1.8	1ZZ-FE	03/03 ⇨	11/08
AVENSIS II 2.0	1AZ-FE	08/01 ⇨	11/09
AVENSIS II 2.0 VVTi	1AZ-FE, 2AZ-FE	04/03 ⇨	11/08
AVENSIS II 2.4	2AZ-FE, 1AZ-FE	08/01 ⇨	11/08
AVENSIS II 2.4 4WD	2AZ-FE	11/03 ⇨	08/06
AVENSIS III 1.6	1ZR-FAE	11/08 ⇨	
AVENSIS III 1.8	2ZR-FAE	11/08 ⇨	
AVENSIS III 2.0	1AZ-FE, 1AZ-FE	11/08 ⇨	
CAMRY 2.0	1AZ-FE, 2AZ-FXE	01/06 ⇨	
CAMRY 2.0 VVTi [ExtraEU]	1AZ-FE	09/11 ⇨	
CAMRY 2.4	2AZ-FE	01/06 ⇨	09/11
CAMRY 2.4 [CHN]	3AZ-FXE	03/10 ⇨	
CAMRY 2.4 Hybrid	2AZ-FXE, 2AR-FE	01/06 ⇨	09/11
CAMRY 2.4 VVTi LE	2AZ-FE	01/06 ⇨	11/06
CAMRY 2.5	2AR-FE, 2GR-FE	01/10 ⇨	
CAMRY 2.5 [CHN]	5AR-FE	12/11 ⇨	
CAMRY 2.5 Hybrid	2AR-FXE	09/11 ⇨	
CAMRY 2.5 Hybrid [CHN]	4AR-FXE	05/12 ⇨	
CAMRY 3.5	2GR-FE, 2ZR-FXE	01/06 ⇨	
CAMRY 3.5 VVTi [ExtraEU]	2GR-FE	01/06 ⇨	12/11
CELICA VII 1.8 16V TS	2ZZ-GE	08/99 ⇨	09/05
C-HR 1.2	8NR-FTS	10/16 ⇨	
C-HR 1.2 4WD	8NR-FTS	10/16 ⇨	
C-HR 1.8 Hybrid	2ZR-FXE, 2ZZ-GE	10/16 ⇨	
C-HR 2.0	3ZR-FAE	11/16 ⇨	
COROLLA 1.2	8NR-FTS	01/19 ⇨	
COROLLA 1.8 Hybrid	2ZR-FXE	10/18 ⇨	
COROLLA IX 1.6	1ZR-FE	11/06 ⇨	07/07
COROLLA IX 1.6 VVT-i	3ZZ-FE	10/01 ⇨	03/08
COROLLA IX 1.6 VVT-i TS	2ZZ-GE, 1ZR-FAE	01/02 ⇨	02/07
COROLLA X 1.3 VVT-i	2N2-FE	03/08 ⇨	
COROLLA X 1.33	1NR-FE	12/08 ⇨	07/14
COROLLA X 1.5	1N2-FE	09/06 ⇨	
COROLLA X 1.5 4WD	1N2-FE	09/06 ⇨	
COROLLA X 1.6	1ZR-FAE, 1ZR-FE	11/06 ⇨	11/13
COROLLA X 1.6 Dual VVTi	1ZR-FE	01/07 ⇨	07/14
COROLLA X 1.6 VVTi	1ZR-FE, 2ZR-FAE	03/07 ⇨	05/14
COROLLA X 1.8	2ZR-FAE, 2ZR-FBE	09/06 ⇨	
COROLLA X 1.8 16V	1ZZ-FE	08/07 ⇨	
COROLLA X 1.8 4WD	2ZR-FAE	09/06 ⇨	
COROLLA X 1.8 CNG	1ZZ-FE	06/09 ⇨	
COROLLA X 1.8 FlexFuel [BRA]	1ZZ-FBE	03/08 ⇨	
COROLLA X 1.8 VVTi	2ZR-FBE, 1ZR-FAE	01/08 ⇨	
COROLLA X 2.0	3ZR-FE	04/10 ⇨	
COROLLA X 2.0 FlexFuel	3ZR-FBE	04/10 ⇨	
COROLLA X 2.0 VVTi	3ZR-FE	08/10 ⇨	
COROLLA X 2.4	2AZ-FE	01/08 ⇨	
COROLLA XI 1.3	1NR-FE	05/12 ⇨	
COROLLA XI 1.5	1N2-FE	05/12 ⇨	
COROLLA XI 1.5 4WD	1N2-FE	05/12 ⇨	
COROLLA XI 1.5 Hybrid	1N2-FXE	10/14 ⇨	
COROLLA XI 1.6	1ZR-FAE, 1GR-FE	06/13 ⇨	
COROLLA XI 1.6 BiFuel	1ZR-FE	06/13 ⇨	
COROLLA XI 1.8	2ZR-FAE	05/12 ⇨	
COROLLA XI 1.8 [USA] [CAN]	2ZR-FAE	08/13 ⇨	

TOYOTA		
COROLLA XI 1.8 VVTi	2ZR-FE	06/13 →
COROLLA XI 1.8 VVT-i	2ZR-FE	12/13 →
COROLLA VERSO I 1.6 VVT-i	3ZZ-FE	08/01 → 05/04
COROLLA VERSO I 1.8 VVT-i	1ZZ-FE	12/01 → 05/04
COROLLA VERSO I 1.8 VVTi 4WD	1ZZ-FE	07/01 → 02/04
COROLLA VERSO II 1.6	3ZZ-FE	04/04 → 03/09
COROLLA VERSO II 1.8	1ZZ-FE	04/04 → 03/09
FJ CRUISER 4.0	1GR-FE, 1GR-FE	06/05 → 06/14
FJ CRUISER 4.0 4WD	1GR-FE, 2GR-FE	06/05 →
FORTUNER 2.7 4x4	2TR-FE	05/15 →
PRIUS 1.8 Hybrid	2ZR-FXE	03/12 →
HIACE 2.7 VVTi [ExtraEU]	2TR-FE	01/05 →
HIACE IV 2.7	2TR-FE	01/05 →
HIACE IV 2.7 VVTi	2TR-FE	01/05 →
HIGHLANDER / KLUGER 2.7 VVTi [ExtraEU]	1AR-FE	09/16 →
HIGHLANDER / KLUGER 3.5 AWD	2GR-FE, 1NR-FE	09/14 →
HILUX VII 2.0	1TR-FE	02/05 →
HILUX VII 2.7	2TR-FE	02/05 →
HILUX VII 2.7 4WD	2TR-FE	08/05 → 05/15
HILUX VII 4.0	1GR-FE	02/05 →
HILUX VII 4.0 4WD	1GR-FE	02/05 →
IQ 1.0	1KR-FE	01/09 → 12/15
IQ 1.33	1NR-FE, 1GR-FE	01/09 →
LAND CRUISER 120 2.7 [ExtraEU]	2TR-FE	11/03 → 02/10
LAND CRUISER 120 4.0	1GR-FE, 1GR-FE	09/02 → 12/10
LAND CRUISER 120 4.0 V6 VVT-i	1GR-FE	01/03 → 07/09
LAND CRUISER 200 4.0	1GR-FE	01/10 →
LAND CRUISER 200 4.5 D V8	1VD-FTV	01/08 →
LAND CRUISER 200 4.5 D-4D	1VD-FTV	01/08 →
LAND CRUISER 200 4.5 D4-D	1VD-FTV	08/07 →
LAND CRUISER 200 4.6 V8	1UR-FE, 2UZ-FE	09/10 →
LAND CRUISER 200 4.7 V8	2UZ-FE, 3UR-FE	08/07 →
LAND CRUISER 200 5.7 V8	3UR-FE, 2AZ-FE	08/07 →
LAND CRUISER 150 3.5	7GR-FKS	09/15 →
LAND CRUISER 150 4.0 V6 Dual VVTi	1GR-FE	08/09 →
LAND CRUISER 150 4.0 V6 VVTi	1GR-FE, 1UR-FE	08/09 →
LAND CRUISER 150 4.0 V6 VVT-i	1GR-FE	08/09 →
LAND CRUISER PRADO 120 2.7	2TR-FE	08/04 → 08/09
LAND CRUISER PRADO 120 4.0	1GR-FE	01/03 → 08/09
LAND CRUISER PRADO 150 2.7	2TR-FE	08/09 →
LAND CRUISER PRADO 150 4.0 V6 VVTi	1GR-FE	08/09 →
MATRIX 1.8	2ZR-FE	01/08 → 05/14
MATRIX 2.4	2AZ-FE	01/08 → 05/14
MATRIX 2.4 4WD	2AZ-FE	01/09 → 12/10
PICNIC II 2.0 VVTi	1AZ-FE	05/01 → 08/06
PICNIC II 2.4 VVTi	2AZ-FE	11/03 → 08/06
PREVIA II 2.4	2AZ-FE, 2ZR-FXE	02/00 → 02/06
PREVIA II 2.4 4WD	2AZ-FE	02/00 → 01/06
PREVIA III 2.4	2AZ-FE	10/05 →
PREVIA III 3.5	2GR-FE	01/06 →
PREVIA III 3.5 4WD	2GR-FE	01/06 →
PRIUS II 1.5	1NZ-FXE	09/03 → 12/09
PRIUS III 1.8 Hybrid	2ZR-FXE, 3ZR-FAE	06/08 →
PRIUS III 1.8 Hybrid [ExtraEU]	2ZR-FXE	06/08 →
PRIUS III 1.8 Plug-in Hybrid	2ZR-FXE	01/12 →
PRIUS IV 1.8 Hybrid	2ZR-FXE	09/15 →
PRIUS IV 1.8 Plug-in Hybrid	2ZR-FXE	01/16 →
PRIUS C 1.5 Hybrid	1NZ-FXE	12/11 →
RACTIS 1.3 VVTi [ExtraEU]	1NR-FE	07/10 → 04/14
RACTIS 1.5 VVTi [ExtraEU]	1NZ-FE	07/11 →
RAV 4 II 2.4	2AZ-FE	08/00 → 11/05
RAV 4 II 2.4 4WD	2AZ-FE	08/03 → 11/05
RAV 4 II 2.4 VVTi [ExtraEU]	2AZ-FE	08/03 → 11/05
RAV 4 IV 2.0	3ZR-FE	12/12 →
RAV 4 IV 2.0 4WD	3ZR-FAE, 2AR-FXE	12/12 →
RAV 4 IV 2.0 VVTi [ExtraEU]	3ZR-FE	12/12 →
RAV 4 IV 2.5	2AR-FE	12/12 →
RAV 4 IV 2.5 4WD	2AR-FE	12/12 →
RAV 4 IV 2.5 Hybrid	2AR-FXE, 2AR-FXE	10/15 →
RAV 4 IV 2.5 Hybrid 4WD	2AR-FXE, 1NR-FE	10/15 →
RAV 4 III 2.0	3ZR-FAE, 1AZ-FE	12/08 → 06/13
RAV 4 III 2.0 4WD	1AZ-FE, 2GR-FE	02/06 → 06/13
RAV 4 III 2.0 VVT-i [CHN]	1AZ-FE	03/09 →
RAV 4 III 2.4	2AZ-FE	11/05 → 06/13
RAV 4 III 2.4 4WD	2AZ-FE	11/05 → 06/13
RAV 4 III 2.4 VVTi [CHN]	2AR-FE	03/09 →
RAV 4 III 2.5	2AR-FE	12/08 →

TOYOTA		
RAV 4 III 3.5 4WD	2GR-FE, 3ZR-FAE	11/05 →
RAV 4 V 2.0	M20A-FKS	12/18 →
RAV 4 V 2.0 AWD	M20A-FKS	12/18 →
RAV 4 V 2.5 Hybrid	A25A-FXS	12/18 →
RAV 4 V 2.5 Hybrid AWD	A25A-FXS	12/18 →
SIENNA 2.7 VVTi [ExtraEU]	1AR-FE	09/10 → 07/13
SIENNA 3.5	2GR-FE	01/10 →
SIENNA 3.5 4WD	2GR-FE	01/10 →
SIENNA 3.5 VVTi [ExtraEU]	2GR-FE	01/10 →
TARAGO MPV / SPACE 2.4 VVTi	2AZ-FE	02/00 → 12/05
URBAN CRUISER 1.33	1NR-FE, 2NZ-FE	01/09 → 03/16
VELLFIRE 3.5	2GR-FE	04/08 → 12/14
VENZA 2.7	1AR-FE	11/08 → 11/16
VENZA 2.7 4WD	1AR-FE	11/08 → 11/16
VENZA 2.7 VVTi [ExtraEU]	1AR-FE	11/08 → 04/12
VENZA 3.5	2GR-FE	11/08 → 11/16
VENZA 3.5 4WD	2GR-FE	11/08 → 11/16
VERSO 1.6	1ZR-FAE	04/09 →
VERSO 1.8	2ZR-FAE	04/09 →
VERSO S 1.33	1NR-FE	11/10 → 10/16
VIOS / YARIS 1.3	2NZ-FE, 1NZ-FE	09/05 → 10/13
VIOS / YARIS 1.3 4WD	2NZ-FE	09/05 → 04/13
VIOS / YARIS 1.5	1NZ-FE, 1SZ-FE	08/07 →
VITZ 1.0 VVTi [ExtraEU]	1KR-FE	11/05 → 11/10
YARIS I 1.0	1SZ-FE, 2NZ-FE	03/03 → 09/05
YARIS I 1.3	2SZ-FE	04/02 → 09/05
YARIS II 1.3 4WD	2NZ-FE	08/07 → 11/10
YARIS II 1.3 VVT-i	2NZ-FE, 1NR-FE	08/05 → 12/12
YARIS II 1.3 VVT-i	1NR-FE, 1NZ-FE	11/08 → 12/11
YARIS II 1.5	1NZ-FE, 1NR-FE	11/05 →
YARIS II 1.6 [CHN]	1ZR-FE	05/08 →
YARIS II 1.8 VVTi	2ZR-FE	01/07 → 12/11
YARIS III 1.3	1NR-FE, 1NZ-FE	09/11 →
YARIS III 1.3 4WD	1NR-FE	12/10 →
YARIS III 1.5	1NZ-FE, 1NZ-FXE	12/10 →
YARIS III 1.5 Hybrid	1NZ-FXE, AR32102	03/12 →
YARIS III 1.8 GRMN	2ZR-FE	09/17 →
YARIS 1.3 VVTi	1NR-FE	10/12 →

9.3023  **04,5**

KNOCK SENSORS

Adatt./Suitable:

ALFA ROMEO

60548743
60592752
60810791
7765599

BOSCH

0 261 231 095

CHEVROLET

96253615

DAEWOO

96253615

FIAT

60592752
60810791
7765599

LANCIA

60592752
7765599

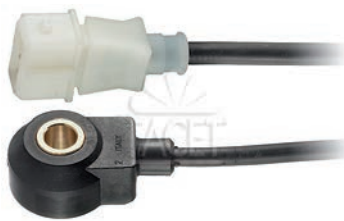

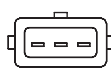
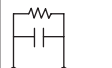
L	mV/g		
450	25		

ALFA ROMEO

145 1.4 i.e. 16V T.S.	AR33503	12/96 → 01/01
145 1.6 i.e. 16V T.S.	AR32102, AR32102	12/96 → 01/01
145 1.6 LPG	AR32102	01/98 → 01/01
145 1.8 i.e. 16V T.S.	AR67106	12/96 → 12/98
145 1.8 i.e. 16V T.S. [BRA]	AR67199	10/96 → 02/99
145 2.0 16V T.S.	AR67204	10/95 → 01/01
145 2.0 16V T.SPARK [BRA]	AR67299	10/96 → 02/99

ALFA ROMEO		
145 2.0 16V T.SPARK Q.V. [BRA]	AR67299	10/95 → 09/96
146 1.4 i.e. 16V T.S.	AR33503	11/96 → 01/01
146 1.6 i.e. 16V T.S.	AR32102, AR67204	11/96 → 01/01
146 1.8 i.e. 16V T.S.	AR67106	11/96 → 01/01
146 2.0 16V T.S.	AR67204	10/95 → 01/01
155 1.6 16V T.S.	AR67601	05/96 → 12/97
155 1.7 T.S. 16V	AR67106	05/96 → 12/97
155 2.0 T.S. 16V	AR67204, AR32102	03/95 → 12/97
156 1.6 16V T.SPARK	AR32102, AR32104	09/97 → 09/05
156 1.6 16V T.SPARK.	AR32104, AR64101	05/00 → 05/06
164 2.0 Turbo	AR64102	07/90 → 10/92
164 2.0 V6 Turbo	AR64101, AR16201	03/91 → 09/98
166 2.0 V6	AR34102	09/98 → 10/00
166 2.5 V6 24V	AR34201	09/98 → 12/06
166 3.0 V6 24V	AR34301	09/98 → 06/07
166 3.0 V6 24V [BRA]	AR34302	08/98 → 09/00
GTV 2.0 T.SPARK 16V	AR16201, AR16201	06/95 → 10/05
GTV 2.0 V6 Turbo	AR16202	06/95 → 09/98
GTV 3.0 V6 24V	AR16102	10/96 → 10/00
SPIDER II 2.0 T.SPARK 16V	AR16201, A135M	06/95 → 04/05
SPIDER II 2.0 V6 Turbo	AR16202	05/98 → 04/05
SPIDER II 3.0 12V [BRA]	AR16199	09/97 →
SPIDER II 3.0 V6	AR16101	06/95 → 04/05

CHEVROLET

LANOS 1.3	--	01/97 →
LANOS 1.6 16V	A16DMS	11/05 →

DAEWOO

ASSOL 1.3	C14L	04/97 → 06/99
ASSOL 1.5	Y15L	04/97 → 06/99
ASSOL 1.6	616L	02/98 → 06/99
LANOS 1.3	A135M, A15DMS	05/97 →
LANOS 1.5	A15DMS, 616L	05/97 →
LANOS 1.6	A16DMS	10/97 → 12/02
LANOS 1.6 16V	616L, 175A4.000	02/97 →

FIAT

BRAVO I 2.0 HGT 20V	182A1.000	10/95 → 07/98
COUPE 2.0 16V Turbo	175A1.000	11/93 → 08/96
COUPE 2.0 20V	182A1.000	08/96 → 09/98
CROMA I 2000 16V	154E1.000	08/92 → 08/96
CROMA I 2000 i.e. 16V	154E1.027	03/95 → 12/96
MAREA 2.0 150 20V	182A1.000	09/96 → 04/99
MAREA 2.0i 20V [BRA]	182A1.011	10/96 → 04/99

FIAT (BR)

MAREA 2.0i 20v	2.0Mpi	01/99 → 12/00
MAREA 2.0i 20v Turbo	2.0MpiTurbo	01/99 →
TIPO 1.6i	1.6Mpi	01/96 → 12/97
UNO 1.6i	1.6Mpi	01/95 → 12/96
UNO 1.6iR	1.6Mpi	01/93 → 12/94

LANCIA

DELTA I 2.0 16V HF Evo Integrale	831E5.046	06/93 → 01/94
DELTA II 2.0 16V Turbo	175A4.000, 834A4.000	06/93 → 08/99
KAPPA 2.0 16V Turbo	834A4.000, 838A1.000	02/95 → 10/01
KAPPA 2.0 20V	838A1.000, 838A2.000	10/94 → 10/01
KAPPA 2.4 20V	838A2.000, L7X720	08/94 → 10/01
THEMA 2000 16V	834F1.000	05/92 → 07/94
THEMA 2000 16V Turbo	834F2.000	10/92 → 07/94
THEMA 2000 Turbo 16V	834F2.000	11/92 → 07/94
THEMA 3000 V6	834F.000	08/92 → 07/94

9.3029



04,5

KNOCK SENSORS

Adatt./Suitable:

BOSCH

0 261 231 127

RENAULT

96 28 648 380

⁰³ Supplied until depletion

- Fornibile fino ad esaurimento delle scorte
- Fourni jusqu'à épuisement du stock
- Lieferbar solange vorrat reicht
- Suministrado hasta el stock termina

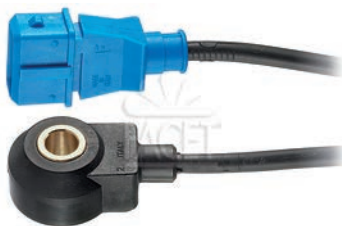

L	mV/g		
400	22		

RENAULT

Model	Code	Start	End
AVANTIME 3.0 V6	L7X720, L7X760	09/01	⇒ 05/03
AVANTIME 3.0i 24V	L7X722	05/01	⇒
CLIO II 3.0 RS V6	L7X760, L7X760	01/03	⇒
CLIO II 3.0 V6 Sport	L7X760, L7X760	11/00	⇒
CLIO IV 3.0 RS V6	L7X760, L7X731	03/13	⇒
LAGUNA II 2.9 V6 24V	L7X731, L7X731	03/01	⇒ 12/07
LAGUNA II 3.0 V6 24V	L7X731, AR32102	03/01	⇒

9.3030



04,5

KNOCK SENSORS

Adatt./Suitable:

ALFA ROMEO

46469867

BOSCH

0 261 231 131

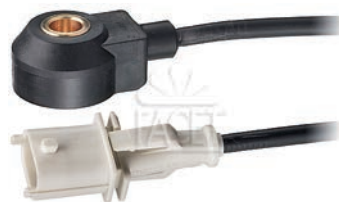

L	mV/g		
500	24		

ALFA ROMEO

Model	Code	Start	End
145 1.4 i.e. 16V T.S.	AR33503	12/96	⇒ 01/01
145 1.6 16V T.S.	AR32102	09/97	⇒ 12/00
145 1.6 i.e. 16V T.S.	AR32102, AR32102	12/96	⇒ 01/01
145 1.6 LPG	AR32102	01/98	⇒ 01/01
145 1.8 i.e. 16V	AR32201	03/98	⇒ 01/01
145 2.0 16V	AR32301	03/98	⇒ 01/01
146 1.4 i.e. 16V T.S.	AR33503	11/96	⇒ 01/01
146 1.6 16V T.S.	AR32102	09/97	⇒ 12/00
146 1.6 i.e. 16V T.S.	AR32102, AR32104	11/96	⇒ 10/01
146 1.8 i.e. 16V T.S.	AR32201	03/98	⇒ 01/01
146 2.0 16V	AR32301	03/97	⇒ 10/01
147 1.6 16V T.SPARK	AR32104	01/01	⇒ 03/10
147 1.6 16V T.SPARK ECO	AR37203	01/01	⇒ 03/10
147 1.6 LPG	AR32104, AR32102	03/01	⇒ 03/10
147 2.0 16V T.SPARK	AR32310	01/01	⇒ 03/10
156 1.6 16V T.SPARK	AR32102, AR32102	09/97	⇒ 09/05
156 1.6 16V T.SPARK.	AR32102, AR32201	05/00	⇒ 05/06
156 1.8 16V T.SPARK	AR32201, AR32301	05/00	⇒ 05/06
156 2.0 16V T.SPARK	AR32301, AR34103	05/00	⇒ 06/02
156 2.0 Twin Spark	AR32303	11/97	⇒ 04/00

ALFA ROMEO

Model	Code	Start	End
166 2.0 T.SPARK	AR34103, AR16201	10/00	⇒ 06/07
GT 1.8 TS	AR32205	11/03	⇒ 09/10
GTV 1.8 16V	AR32201	05/98	⇒ 10/05
GTV 2.0 T.SPARK 16V	AR16201, AR16201	06/95	⇒ 10/05
SPIDER II 1.8 16V	AR32201	05/98	⇒ 04/05
SPIDER II 2.0 T.SPARK 16V	AR16201, 838A2.000	06/95	⇒ 04/05

9.3032



04,5

KNOCK SENSORS

Adatt./Suitable:

BOSCH

0 261 231 144

0 261 231 212

FIAT

46525288

LANCIA

46525288

MAN

51.27421.0333

MASERATI

246803

246805

290128

294471

⁰³ Supplied until depletion

- Fornibile fino ad esaurimento delle scorte
- Fourni jusqu'à épuisement du stock
- Lieferbar solange vorrat reicht
- Suministrado hasta el stock termina



L	mV/g		
570	24		

FIAT

Model	Code	Start	End
BRAVO I 2.0 HGT 20V	182B7.000	07/98	⇒ 10/01
COUPE 2.0 20V	182B3.000	04/98	⇒ 08/00
MAREA 2.0 150 20V	185A8.000	01/01	⇒ 05/02
MAREA 2.0 155 20V	182B7.000	04/99	⇒ 02/03
STILO 2.4 20V	192A2.000	10/01	⇒ 04/07

FIAT (BR)

Model	Code	Start	End
MAREA 2.4i 20v	2.4Mpi	01/01	⇒

LANCIA

Model	Code	Start	End
KAPPA 2.0 20V	838A6.000	07/96	⇒ 10/01
KAPPA 2.4 20V	838A2.000, 182B7.000	08/94	⇒
LYBRA 2.0 20V	182B7.000, M156D	09/00	⇒ 10/05
LYBRA 2.4 20V	192A2.000	10/01	⇒ 10/05
THESIS 2.4	841D.000	07/02	⇒ 07/09

MASERATI

Model	Code	Start	End
GHIBLI 3.0	M156D, M156B	08/13	⇒
GHIBLI 3.0 S	M156B, M156B	08/13	⇒
GHIBLI 3.0 S Q4	M156B, M139S	08/13	⇒
GRANCABRIO 4.7	M139S, M156D	03/10	⇒
GRAN TURISMO 4.2	M139P	08/08	⇒
GRAN TURISMO 4.7	M145T	05/12	⇒
GRAN TURISMO 4.7 S	M139S	08/08	⇒ 12/12
LEVANTE 3.0 S Trazione integrale	M156E	06/16	⇒
LEVANTE 3.0 Trazione integrale	M156D	06/16	⇒
QUATTROPORTE 3.0	M156D, M156B	03/13	⇒
QUATTROPORTE 3.0 S	M156B	05/13	⇒
QUATTROPORTE 3.0 S [ExtraEU]	M156B	05/13	⇒
QUATTROPORTE 3.0 S Q4	M156B, M139P	05/13	⇒
QUATTROPORTE 4.2	M139P, M139R	03/04	⇒
QUATTROPORTE 4.7 GT S	M145T	11/11	⇒
QUATTROPORTE 4.7 S	M139R, AGN	06/08	⇒

9.3034



04,5

KNOCK SENSORS

Adatt./Suitable:

BOSCH

0 261 231 149

TOYOTA

89615-02010



L	mV/g		
225	30		

TOYOTA

Model	Code	Start	End
AURIS I 1.4	4ZZ-FE	03/07	⇒ 09/12
COROLLA VIII 1.4	4ZZ-FE	10/99	⇒ 01/02
COROLLA VIII 1.4 16V	4ZZ-FE	02/00	⇒ 11/01
COROLLA IX 1.4 VVT-i	4ZZ-FE	10/01	⇒ 02/07
COROLLA IX 1.8 VVT-i TS	2ZZ-GE	01/02	⇒ 02/07
COROLLA X 1.4 VVT-i	4ZZ-FE	11/06	⇒ 11/13

9.3035



04,5

KNOCK SENSORS

Adatt./Suitable:

AUDI

06A 905 377 F

SEAT

06A 905 377 F

VW

06A 905 377 F

⁰³ Supplied until depletion

- Fornibile fino ad esaurimento delle scorte
- Fourni jusqu'à épuisement du stock
- Lieferbar solange vorrat reicht
- Suministrado hasta el stock termina



L	mV/g		
250	23		

AUDI

Model	Code	Start	End
A3 I 1.8	AGN, AQX	09/96	⇒ 05/03

SEAT

Model	Code	Start	End
CORDOBA I 1.8 T 20V Cupra	AQX	07/00	⇒ 10/02
IBIZA II 1.8 T 20V Cupra	AQX, AGU	07/00	⇒ 02/02

VW

Model	Code	Start	End
BORA 1.8 T	AGU, AGU	05/00	⇒ 05/05
GOLF IV 1.8 T	AGU, AVU	08/97	⇒ 06/06

9.3036



04,5

KNOCK SENSORS

Adatt./Suitable:

AUDI

06A 905 377 C

SEAT

06A 905 377 C

SKODA

06A 905 377 C

VW

06A 905 377 C



L	mV/g		
225	24		

AUDI			
A3 I 1.6	AVU, AGN	08/00	⇒ 05/03
A3 I 1.8	AGN, AGU	09/96	⇒ 05/03
A3 I 1.8T	AGU, AGU	12/96	⇒ 05/03
A3 I 1.8T quattro	AGU, AMK	12/96	⇒ 05/03
A3 I S3 quattro	AMK, AJQ	03/99	⇒ 04/02
TT I 1.8T	AJQ, AJQ	10/98	⇒ 06/06
TT I 1.8T quattro	AJQ, AQX	10/98	⇒ 06/06

SEAT			
CORDOBA I 1.8T 20V Cupra	AQX	07/00	⇒ 10/02
IBIZA II 1.8T 20V Cupra	AQX, APP	07/00	⇒ 02/02
LEON I 1.8 20V T	APP, AJQ	11/99	⇒ 06/06
LEON I 1.8 20V T 4	AJQ, APP	11/99	⇒ 06/06
TOLEDO II 1.8 20VT	APP, AQV	09/00	⇒ 07/04
TOLEDO II 1.8 4x4	AJQ	05/01	⇒ 04/04

SKODA			
FABIA I 1.0	AQV, AME	12/99	⇒ 08/02
FABIA I 1.4	AME, AVU	04/00	⇒ 05/03
OCTAVIA I 1.6	AVU, AGU	09/00	⇒ 12/10
OCTAVIA I 1.8T	AGU, AEH	08/97	⇒ 12/10
OCTAVIA I 1.8T 4x4	ARX	05/01	⇒ 05/06

VOLKSWAGEN (BR)			
GOLF A4 1.8i Turbo 20v	AGU	10/99	⇒

VW			
BORA 1.6	AEH, AEH	08/00	⇒ 05/05
BORA 1.8 4motion	AGN	02/99	⇒ 05/05
CARAVELLE 2.0 EcoFuel	AXACNG	01/06	⇒ 03/14
GOLF IV 1.6	AEH, AGU	08/00	⇒ 06/06
GOLF IV 1.8 4motion	AGN	05/98	⇒ 06/06
GOLF IV 1.8T	AGU, AWH	08/97	⇒ 06/06
MULTIVAN 2.0	AXA	11/03	⇒ 08/15
NEW BEETLE 1.6	AWH, AXACNG	06/00	⇒ 09/10
TRANSPORTER 2.0 EcoFuel	AXACNG, AXW	11/03	⇒ 08/15
TRANSPORTER V 2.0	AXA	11/03	⇒ 08/15
TRANSPORTER V 2.0 BiFuel	AXACNG	05/11	⇒ 08/15

9.3037



04,5

KNOCK SENSORS

Adatt./Suitable:

AUDI

021 905 377 E

SEAT

021 905 377 E

SKODA

021 905 377 E

VW

021 905 377 E



L	mV/g		
225	25		

AUDI			
A3 II 2.0 FSI	AXW, AXW	05/03	⇒ 06/08
A3 II SPORTBACK 2.0 FSI	AXW, BLR	09/04	⇒ 06/08

SEAT			
ALTEA 2.0 FSI	BLR, BVY	05/04	⇒ 03/09
ALTEA XL 2.0 FSI	BVY, BLR	10/06	⇒ 03/09
LEON II 2.0 FSI	BLR, BLR	07/05	⇒ 05/10
TOLEDO III 2.0 FSI	BLR, BVY	10/04	⇒ 05/09

VW			
EOS 2.0 FSI	BVY, AXW	03/06	⇒ 05/08
GOLF V 2.0 FSI	AXW, BLX	01/04	⇒ 11/08
GOLF V 2.0 FSI 4motion	BLX, BLR	08/04	⇒ 11/08
JETTA V 2.0 FSI	BLR, BLR	08/05	⇒ 10/10
PASSAT V 2.0 FSI	BLR, BLX	03/05	⇒ 11/10
PASSAT V 2.0 FSI 4motion	BLX, AXW	09/05	⇒ 11/10
TOURAN I 2.0 FSI	AXW, AEH	10/03	⇒ 01/07

9.3038



04,5

KNOCK SENSORS

Adatt./Suitable:

VW

066 905 377 A

⁰³ Supplied until depletion

- Fornibile fino ad esaurimento delle scorte
- Fourni jusqu'à épuisement du stock
- Lieferbar solange vorrat reicht
- Suministrado hasta el stock termina



L	mV/g		
1500	20		

VW			
PASSAT IV 2.3 V5	AZX	11/00	⇒ 05/05
PASSAT IV 2.3 V5 4motion	AZX	11/00	⇒ 05/05
PASSAT IV 2.3 VR5	AZX	11/00	⇒ 05/05
PASSAT IV 2.3 VR5 4motion	AZX	11/00	⇒ 05/05

9.3040



04,5

KNOCK SENSORS

Adatt./Suitable:

AUDI

06D 905 377

VW

06D 905 377

⁰³ Supplied until depletion

- Fornibile fino ad esaurimento delle scorte
- Fourni jusqu'à épuisement du stock
- Lieferbar solange vorrat reicht
- Suministrado hasta el stock termina



L	mV/g		
450	23		

AUDI			
A4 II 2.0 FSI	AWA	07/02	⇒ 12/04

9.3043



04,5

KNOCK SENSORS

Adatt./Suitable:

AUDI

06D 905 377 A

VW

06D 905 377 A

⁰³ Supplied until depletion

- Fornibile fino ad esaurimento delle scorte
- Fourni jusqu'à épuisement du stock
- Lieferbar solange vorrat reicht
- Suministrado hasta el stock termina



L	mV/g		
400	23		

AUDI			
A4 II 2.0 FSI	AWA	07/02	⇒ 12/04

9.3044



04,5

KNOCK SENSORS

Adatt./Suitable:

AUDI
06A 905 377 B

SEAT
06A 905 377 B

SKODA
06A 905 377 B

VW
06A 905 377 B



L	mV/g		
175	22		

AUDI

A3 I 1.6	AEH, AGN	09/96 ⇒ 05/03
A3 I 1.8	AGN, AGU	09/96 ⇒ 05/03
A3 I 1.8 T	AGU, AGU	12/96 ⇒ 05/03
A3 I 1.8 T quattro	AGU, AMK	12/96 ⇒ 05/03
A3 I S3 quattro	AMK, AJQ	03/99 ⇒ 04/02
TT I 1.8 T	AJQ, AJQ	10/98 ⇒ 06/06
TT I 1.8 T quattro	AJQ, AEH	10/98 ⇒ 06/06

SEAT

CORDOBA I 1.6 i	AKL	07/96 ⇒ 10/02
CORDOBA I 1.8 T 20V Cupra	AQX	07/00 ⇒ 10/02
IBIZA II 1.6	AEH, AQX	08/99 ⇒ 02/02
IBIZA II 1.8 T 20V Cupra	AQX, AEH	07/00 ⇒ 02/02
LEON I 1.6	AEH, APP	11/99 ⇒ 06/06
LEON I 1.8 20V T	APP, AEH	11/99 ⇒ 06/06
TOLEDO II 1.6	AEH, APP	10/98 ⇒ 07/04
TOLEDO II 1.8 20VT	APP, AEH	09/00 ⇒ 07/04
TOLEDO II 1.8 4x4	AJQ	05/01 ⇒ 04/04

SKODA

OCTAVIA I 1.6	AEH, AGU	02/97 ⇒ 12/07
OCTAVIA I 1.8 T	AGU, AEH	08/97 ⇒ 12/10
OCTAVIA I 1.8 T 4x4	ARX	05/01 ⇒ 05/06

VOLKSWAGEN (BR)

GOLF A4 1.8i Turbo 20v	AGU	10/99 ⇒
------------------------	-----	---------

VW

BORA 1.6	AEH, AEH	10/98 ⇒ 05/05
BORA 1.8 4motion	AGN	02/99 ⇒ 05/05
GOLF IV 1.6	AEH, AGU	05/01 ⇒ 05/04
GOLF IV 1.8 4motion	AGN	05/98 ⇒ 06/06
GOLF IV 1.8 T	AGU, AEH	08/97 ⇒ 06/06
POLO III 1.6	AEH, AEH	05/97 ⇒ 09/01
POLO III 100 1.6	AEH, AGN	12/95 ⇒ 09/01
POLO 1.6 [ExtraEU]	AKL	10/99 ⇒ 09/01

9.3045



04,5

KNOCK SENSORS

Adatt./Suitable:

AUDI
06A 905 377 D

SEAT
06A 905 377 D

SIEMENS
S107583005Z

SKODA
06A 905 377 D

VW
06A 905 377 D

MARKET DIFFUSION: MEDIUM



L	mV/g		
225	22		

AUDI

A3 I 1.8	AGN, AZQ	09/96 ⇒ 05/03
----------	----------	---------------

SEAT

CORDOBA II 1.2	AZQ, AZQ	10/02 ⇒ 06/06
IBIZA III 1.2	AZQ, AGN	02/02 ⇒ 06/06
LEON I 1.8 20V	AGN, AGN	11/99 ⇒ 06/06
TOLEDO II 1.8 20V	AGN, AZQ	10/98 ⇒ 07/04

SKODA

FABIA I 1.2	AZQ, AWY	01/03 ⇒ 03/08
-------------	----------	---------------

VW

POLO IV 1.2	AWY, AZQ	01/02 ⇒ 05/07
POLO IV 1.2 12V	AZQ, AZM	10/01 ⇒ 07/07

9.3046



04,5

KNOCK SENSORS

Adatt./Suitable:

SKODA
06B 905 377 A

VW
06B 905 377 A

03 Supplied until depletion

- Fornibile fino ad esaurimento delle scorte
- Fourni jusqu'à épuisement du stock
- Lieferbar solange vorrat reicht
- Suministrado hasta el stock termina



L	mV/g		
650	21		

SKODA

SUPERB I 2.0	AZM	12/01 ⇒ 03/08
--------------	-----	---------------

VW

PASSAT IV 2.0	AZM, BFF	11/00 ⇒ 05/05
PASSAT IV 2.0 [CHN]	BFF, BMM	06/03 ⇒
PASSAT IV 2.0 4motion	AZM	11/00 ⇒ 05/05
PASSAT IV 2.3 V5	AZX	11/00 ⇒ 05/05
PASSAT IV 2.3 V5 4motion	AZX	11/00 ⇒ 05/05
PASSAT IV 2.3 VR5	AZX	11/00 ⇒ 05/05
PASSAT IV 2.3 VR5 4motion	AZX	11/00 ⇒ 05/05

9.3047



04,5

KNOCK SENSORS

Adatt./Suitable:

AUDI
077 905 377 D

VW
077 905 377 D
077 905 377 F

03 Supplied until depletion

- Fornibile fino ad esaurimento delle scorte
- Fourni jusqu'à épuisement du stock
- Lieferbar solange vorrat reicht
- Suministrado hasta el stock termina



L	mV/g		
870	23		

AUDI

A3 II 2.0 TDI	BMM, BMM	06/05 ⇒ 08/12
A3 II 2.0 TDI quattro	BMM, BMM	01/06 ⇒ 08/12
A3 II SPORTBACK 2.0 TDI	BMM, BMM	06/05 ⇒ 03/13
A3 II SPORTBACK 2.0 TDI quattro	BMM, BGH	01/06 ⇒ 03/13
A6 III 2.0 TFSI	BYK	06/05 ⇒ 03/11
A8 II 3.7 quattro	BFL	10/02 ⇒ 05/06
A8 II 4.2 quattro	BFM	10/02 ⇒ 07/10

VW

PHAETON 4.2 V8 4motion	BGH, AEB	05/03 ⇒ 03/16
------------------------	----------	---------------

9.3048



04,5

KNOCK SENSORS

Adatt./Suitable:

AUDI
06C 905 377

SEAT
06C 905 377

SIEMENS
S107583009Z

SKODA
06C 905 377

VW
06C 905 377



L	mV/g		
570	20		

AUDI

A4 II 1.8 T	AMB, AMB	07/01 ⇒ 03/09
A4 II 1.8 T quattro	AMB, AMM	07/01 ⇒ 03/09
A4 II 2.0	ALT	11/00 ⇒ 12/05
A4 II 2.4	AMM, ASN	09/01 ⇒ 12/05
A4 II 3.0	ASN, ASN	11/00 ⇒ 12/05
A4 II 3.0 quattro	ASN, AEB	11/00 ⇒ 12/05
A4 I 1.8 T	AEB, AMB	01/95 ⇒ 09/01
A4 I 1.8 T quattro	AWT	01/95 ⇒ 11/00
A4 III 1.8 T	BFB	11/04 ⇒ 06/08
A4 III 1.8 T quattro	BFB	11/04 ⇒ 06/08
A4 III 2.0	ALT	11/04 ⇒ 06/08
A4 III 3.0	BBJ	11/04 ⇒ 05/06

AUDI		
A4 III 3.0 quattro	BBJ	11/04 ⇒ 07/06
A6 II 1.8 T	AEB, AEB	01/97 ⇒ 01/05
A6 II 1.8 T quattro	AEB, AJG	02/97 ⇒ 01/05
A6 II 2.0	ALT	08/01 ⇒ 01/05
A6 II 2.4	AJG, ARE	08/01 ⇒ 01/05
A6 II 2.4 quattro	BDV	08/01 ⇒ 01/05
A6 II 2.7 T quattro	ARE, ASN	08/01 ⇒ 01/05
A6 II 3.0	ASN, ASN	06/01 ⇒ 01/05
A6 II 3.0 quattro	ASN, ASN	06/01 ⇒ 01/05
A6 III 3.0	BBJ	08/04 ⇒ 05/06
A6 III 3.0 quattro	BBJ	05/04 ⇒ 05/06
A8 II 3.0	ASN, ASN	07/03 ⇒ 05/06
A8 II 3.0 quattro	ASN, ARE	07/03 ⇒ 05/05
ALLROAD 2.7 T quattro	ARE, BGC.	05/00 ⇒ 08/05

SEAT		
EXEO 1.8 T	CFMA	12/08 ⇒ 05/10

SKODA		
SUPERB I 1.8 T	AWT	12/01 ⇒ 03/08
SUPERB I 2.8 V6	BBG	06/02 ⇒ 03/08

VW		
PASSAT IV 1.8 [CHN]	BGC., F8CV	06/01 ⇒
PASSAT IV 1.8 T 20V	AWT	11/00 ⇒ 05/05
PASSAT IV 2.0	ALT	11/01 ⇒ 05/05

9.3050



04,5

KNOCK SENSORS

Adatt./Suitable:

CHEVROLET
96508199**DAEWOO**
90411972
94580819
96508199**GENERAL MOTORS**
90 411 972**HOLDEN**
90411972**OPEL**
62 38 312
90411972**SIEMENS**
5WK 90561
S103057001Z**VAUXHALL**
90411972

L	mV/g		
350	25		

CHEVROLET		
SPARK I 0.8	F8CV	09/00 ⇒ 12/04

DAEWOO		
MATIZ 0.8	F8CV, C18SEL	08/98 ⇒
MATIZ 1.0	B10S	01/03 ⇒

HOLDEN		
ASTRA_TR 1.8i 16v Hatchback	C18SEL	09/96 ⇒ 09/98
ASTRA_TR 1.8i 16v Sedan	C18SEL	09/96 ⇒ 09/98
ASTRA_TR 2.0i 16v Hatchback	X20XEV	09/96 ⇒ 09/98
CALIBRA_YE 2.0i 16V	X20XEV	08/95 ⇒ 10/97

OPEL		
ASTRA F 1.8 i 16V	C18SEL, C20SEL	06/93 ⇒ 03/01
ASTRA F 2.0 i 16V	X20XEV	02/95 ⇒ 08/00
CALIBRA A 2.0 i 16V	X20XEV	02/94 ⇒ 07/97
CALIBRA A 2.0 i 16V 4x4	X20XEV	02/94 ⇒ 07/97
OMEGA B 2.0 16V	X20XEV	03/94 ⇒ 09/99
VECTRA 2.0	C20SEL	10/95 ⇒ 04/02
VECTRA A 2.0 i 16V	X20XEV	08/92 ⇒ 08/95
VECTRA A 2.0 i 16V 4x4	X20XEV	06/94 ⇒ 11/95
VECTRA B 1.8 FlexFuel	X18XE	01/99 ⇒ 09/00
VECTRA B 1.8 i 16V	X18XE	10/95 ⇒ 09/00
VECTRA B 2.0 i 16V	C20SEL, C18XEL	10/95 ⇒ 07/03

VAUXHALL		
ASTRA III 1.8	C18XE	09/94 ⇒ 08/96
ASTRA III 1.8 16V	C18XEL, C18XE	11/94 ⇒ 03/01
ASTRA III 1.8 i 16V	C18XE, X18XE	06/93 ⇒ 02/98
ASTRA III 2.0 i 16V	X20XEV	01/94 ⇒ 09/98
CALIBRA 2.0 i 16V	X20XEV	06/90 ⇒ 07/97
CALIBRA 2.0 i 16V 4x4	X20XEV	02/94 ⇒ 07/97
OMEGA B 2.0 16V	X20XEV	03/94 ⇒ 07/01
VECTRA B 1.8 i 16V	X18XE, 183A1.000	09/95 ⇒ 09/00
VECTRA B 2.0 Dualfuel	X20XEV	05/98 ⇒ 01/01
VECTRA B 2.0 i 16V	X20XEV	10/95 ⇒ 01/01

9.3051



04,5

KNOCK SENSORS

Adatt./Suitable:

FIAT
46522740**LANCIA**
46522740**NTK (NGK-GROUP)**
KNE03A

L	mV/g		
350	27		

FIAT		
BARCETTA 1.8 16V	183A1.000, 183A1.000	04/95 ⇒ 05/05
BRAVO I 1.8 GT	182A2.000	10/95 ⇒ 10/01
COUPE 1.8 16V	183A1.000	03/96 ⇒ 08/00
MAREA 1.8 115 16V	182A2.000	09/96 ⇒ 05/02
PUNTO II 1.8 130 HGT	183A1.000, 839A4.000	09/99 ⇒ 03/12
PUNTO II 1.8 16V	188A6.000	06/03 ⇒

FIAT (BR)		
BRAVA 1.8i 16v	1.8Mpi	01/00 ⇒
MAREA 1.8i 16v	1.8Mpi	01/00 ⇒ 12/01

LANCIA		
DELTA II 1.8 i.e. 16V GT	183A1.000	03/96 ⇒ 08/99
LYBRA 1.8 16V	839A4.000, B12S1	07/99 ⇒ 10/05

9.3052



04,5

KNOCK SENSORS

Adatt./Suitable:

CHEVROLET
96253545**DAEWOO**
96253545**GENERAL MOTORS**
96 253 545**OPEL**
48 05 506
96253545**VAUXHALL**
96253545

MARKET DIFFUSION: MEDIUM

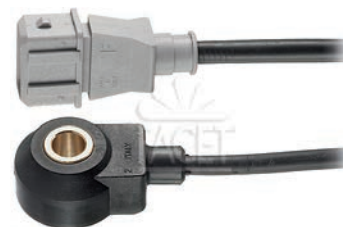

L	mV/g		
350	25		

CHEVROLET

AVEO I 1.2	B12S1, LMU	01/04 ⇒
AVEO I 1.2 LPG	LMU, L14	04/08 ⇒
AVEO I 1.4	L14, F15S3	05/03 ⇒
AVEO I 1.4 16V	L14(85CUL4)	05/03 ⇒ 05/08
AVEO I 1.4 CNG	L95	01/10 ⇒
AVEO I 1.5	F15S3, A16DMS	10/04 ⇒
AVEO I 1.6	A16DMS, L88	09/03 ⇒
CAPTIVA 2.4	LD9(147CUL4)	06/06 ⇒
CAPTIVA 2.4 4WD	LD9(147CUL4)	06/06 ⇒
CRUZE 1.6	LXT	05/09 ⇒
EPICA 2.0	L88, LF4	01/05 ⇒
EPICA 2.5	LF4, L88	06/06 ⇒
EVANDA 2.0	L88, LDA	03/05 ⇒
KALOS 1.2 LPG	LY4	01/05 ⇒ 05/08
KALOS 1.4	L14(85CUL4)	03/05 ⇒ 05/08
LACETTI 1.4	F14D3	03/05 ⇒
LACETTI 1.4 16V	L14(85CUL4)	03/05 ⇒
LACETTI 1.4 LPG	L14(85CUL4)	01/05 ⇒ 12/12
LACETTI 1.6	LXT	03/05 ⇒
LACETTI 1.6 LPG	LXT	06/09 ⇒ 12/11
LACETTI 1.8	LDA, LBF(49CUL3)	05/03 ⇒
LACETTI 2.0	U20SED	03/05 ⇒
LEGANZA 2.0	--	01/98 ⇒
LEGANZA 2.2	--	01/98 ⇒
MATIZ 0.8	LBF(49CUL3), B10S	03/05 ⇒ 12/13
MATIZ 1.0	B10S, LA2	03/05 ⇒
MATIZ 1.0 LPG	LA2, L14(85CUL4)	03/05 ⇒ 03/11
NUBIRA 1.4	L14(85CUL4), L44(96CUL4)	01/05 ⇒ 12/08
NUBIRA 1.6	L44(96CUL4), L44(96CUL4)	03/05 ⇒
NUBIRA 1.6 LPG	L44(96CUL4), LDA	03/05 ⇒ 12/10
NUBIRA 1.8	LDA, F16D3	03/05 ⇒ 12/11
OPTRA 1.4 16V	F14D3	03/05 ⇒
OPTRA 1.6	F16D3, F18D3	08/03 ⇒ 12/08
OPTRA 1.6 SRV	F16D3	06/06 ⇒
OPTRA 1.8	F18D3, L44(96CUL4)	08/03 ⇒
OPTRA 1.8 SRV	T18SED	06/06 ⇒
OPTRA 2.0	U20SED	06/99 ⇒
REZZO 1.6	L44(96CUL4), L88	03/05 ⇒
REZZO 2.0	L88, LBF(49CUL3)	03/05 ⇒
SPARK I 0.8	F8CV	09/00 ⇒ 12/04
SPARK I 1.0	G10CV	11/02 ⇒ 12/04
SPARK II 0.8	LBF(49CUL3), B10S	05/05 ⇒ 02/10
SPARK II 1.0 LPG	B10S	05/05 ⇒
SPARK II 1.0 SX	B10S, LMT	05/05 ⇒
SPARK III 1.0	LMT	03/10 ⇒
SPARK III 1.0 LPG	LMT, LMU	03/10 ⇒
SPARK III 1.2	LMU, L88	03/10 ⇒
SPARK III 1.2 LPG	LMU	03/10 ⇒
TACUMA 1.6	A16DMS	02/05 ⇒
TACUMA 2.0	X20SED	02/05 ⇒
VIVANT 1.6	A16DMS	08/01 ⇒

CHEVROLET		
VIVANT 1.8	F18S2	05/00 →
VIVANT 2.0	X20SED	08/00 →
VIVANT 2.0 CX	T20SED	01/05 →
DAEWOO		
ASSOL 1.3	C14L	04/97 → 06/99
ASSOL 1.5	Y15L	04/97 → 06/99
ASSOL 1.6	616L	02/98 → 06/99
EVANDA 2.0	L88, B1251	08/02 →
KALOS 1.2	B1251, F14D3	04/03 →
KALOS 1.5	F1553	11/02 → 12/04
KALOS 1.6	F1654	02/03 →
LACETTI 1.4	F14D3, A13SM	06/02 →
LACETTI 1.6	A16DMS	06/99 →
LACETTI 1.8	T18SED	02/04 →
LANOS 1.3	A13SM, A15DMS	05/97 →
LANOS 1.5	A15DMS, 616L	05/97 →
LANOS 1.6	A16DMS	10/97 → 12/02
LANOS 1.6 16V	616L, T20SED	02/97 →
LEGANZA 2.0	T20SED	01/01 → 12/02
LEGANZA 2.0 16V	T20SED, T20SED	07/00 → 04/04
LEGANZA 2.2 16V	T22SED	04/99 → 12/02
MAGNUS 2.0	X20SED	07/99 → 01/06
MATIZ 0.8	F8CV	08/98 →
MATIZ 1.0	B10S	04/03 → 12/04
NUBIRA 1.6	A16DMS	08/02 → 07/03
NUBIRA 1.6 [ExtraEU]	A16DMS	08/02 → 07/03
NUBIRA 1.6 16V	A16DMS	06/99 →
NUBIRA 1.2.0 16V	T20SED, A16DMS	06/99 →
NUBIRA 1.2.0 CDX	T20SED	08/02 → 07/03
NUBIRA II 1.4	F14D3	10/03 → 12/04
NUBIRA II 1.6	F16D3	07/03 →
NUBIRA II 1.8	T18SED	07/03 →
REZZO 1.6	A16DMS, A16SMS	09/00 →
REZZO 1.6 SX	A16SMS, --	08/01 → 12/04
REZZO 1.8	--, T20SED	09/00 →
REZZO 2.0	T20SED, Z24XE	09/00 →
TACUMA 1.6	A16DMS	09/00 → 01/05
TACUMA 1.8	F18S2	09/00 →
TACUMA 2.0	X20SED	09/00 → 01/05
TOSCA 2.0 XT	X20D1	02/06 →
TOSCA 2.5 Executive	X25D1	02/06 →
OPEL		
ANTARA 2.4	Z24XE, AGA	07/06 → 12/11
ANTARA 2.4 4x4	Z24XE	08/06 → 12/11
ANTARA 2.4 LPG	Z24XE	10/08 →
ANTARA 2.4 LPG 4x4	Z24XE	08/06 → 12/10
VAUXHALL		
ANTARA 2.4	Z24XE	08/06 → 04/15
ANTARA 2.4 4x4	Z24XE	08/06 → 04/15
ANTARA 2.4 LPG 4x4	Z24XE	08/06 →

9.3053



04,5

KNOCK SENSORS

Adatt./Suitable:

AUDI

078 905 377

SKODA

078 905 377

VW

078 905 377



L	mV/g		
570	25		

AUDI

A4 I 2.4	AGA, AGA	03/97 → 09/01
A4 I 2.4 quattro	AGA, ACK	03/97 → 09/01
A4 I 2.8	ACK, ACK	10/96 → 09/01
A4 I 2.8 quattro	ACK, ASJ	10/96 → 09/01
A4 I RS4 quattro	ASJ, AGB	05/00 → 09/01

AUDI		
A4 I S4 quattro	AGB, AGE	09/97 → 09/01
A6 II 2.4	AGA, AGA	02/97 → 01/05
A6 II 2.4 quattro	AGA, AJK	02/97 → 01/05
A6 II 2.7 T	AJK	02/99 → 01/05
A6 II 2.7 T quattro	AJK, ACK	08/01 → 01/05
A6 II 2.8	ACK, ACK	02/97 → 01/05
A6 II 2.8 quattro	ACK, ARE	02/97 → 01/05
A6 2.8	AGE, AGA	04/98 → 05/01
ALLROAD 2.7 T quattro	ARE, AMX	05/00 → 08/05

SKODA

SUPERB I 2.8 V6	AMX, AMX	12/01 → 03/08
-----------------	----------	---------------

VW

PASSAT IV 2.8	AMX, AMX	10/00 →
PASSAT IV 2.8 [CHN]	BBG	09/01 →
PASSAT IV 2.8 4motion	AMX, AGE	10/00 →
PASSAT IV 2.8 Syncro	AGE	05/97 → 09/99
PASSAT IV 2.8 V6	AGE, ACK	08/96 → 09/99
PASSAT IV 2.8 V6 Syncro/4motion	ACK, NF	10/96 → 11/00
PASSAT 2.8 [ExtraEU]	BBG	10/00 → 05/05

9.3054



04,5

KNOCK SENSORS

Adatt./Suitable:

AUDI

054 905 377

054 905 377 G

BOSCH

0 261 231 036

0 261 231 037

PORSCHE

928 606 144 00

SEAT

054 905 377

054 905 377 G

VW

054 905 377

054 905 377 G

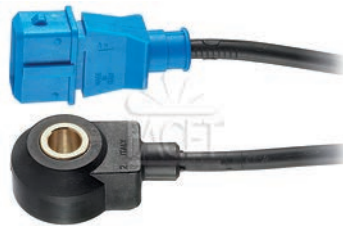

L	mV/g		
570	25		

AUDI

80 III 2.0	AAD	10/90 → 08/91
80 III 2.0 E	3A	08/88 → 10/90
80 III 2.0 E 16V	6A	03/90 → 09/91
80 IV 1.6 E	ADA	06/93 → 01/96
80 IV 2.0 E	ABK	09/91 → 01/96
80 IV 2.0 E 16V	6A, NG	09/91 → 01/96
80 IV 2.3 E	NG	09/91 → 01/96
80 IV 2.6	ABC	07/92 → 01/96
80 IV 2.8	AAH	09/91 → 01/96
90 II 2.0	PS	07/88 → 09/91
90 II 2.3 E	NG, ADR	04/87 → 09/91
100 III 2.0 Cat	RT	01/88 → 11/90
100 III 2.0 E Cat	RT	01/88 → 11/90
100 III 2.3	NF, NF	08/86 → 11/90
100 III 2.3 E	NF, AAD	10/86 → 11/90
100 IV 2.0 E	AAD, 6A	12/90 → 07/94
100 IV 2.0 E 16V	ACE	01/92 → 07/94
100 IV 2.6	ABC	03/92 → 07/94
100 IV 2.8 E	AAH	12/90 → 07/94
A4 I 1.8	ADR, ADR	11/94 → 09/01
A4 I 1.8 quattro	ADR, AEB	01/95 → 09/01
A4 I 1.8 T	AEB, AEB	01/95 → 09/01
A4 I 1.8 T quattro	AEB, AFM	01/95 → 09/01
A4 I 2.4	AFM, AGA	07/95 → 07/97
A4 I 2.4 quattro	AGA, ABC	03/97 → 09/01
A4 I 2.6	ABC, AAH	01/95 → 09/01
A4 I 2.6 quattro	ABC	01/95 → 09/01
A4 I 2.8	AAH, AAH	09/95 → 07/97
A4 I 2.8 quattro	AAH, AGB	01/95 → 07/97

AUDI		
A4 I S4 quattro	AGB, ABC	09/97 → 09/01
A4 2.6 [ExtraEU]	ACZ	01/96 → 07/97
A6 I 1.8	ADR	12/95 → 12/97
A6 I 2.0	ABK	06/94 → 12/97
A6 I 2.0 16V	ACE	06/94 → 12/97
A6 I 2.0 16V quattro	ACE	06/94 → 12/97
A6 I 2.4	AFM	07/95 → 12/97
A6 I 2.6	ABC	06/94 → 12/97
A6 I 2.6 quattro	ABC, AAH	06/94 → 12/97
A6 I 2.8	AAH, AAH	06/94 → 12/97
A6 I 2.8 quattro	AAH, AFY	06/94 → 12/97
A6 I S6 Turbo quattro	AAN	06/94 → 12/97
A6 II 1.8	AFY, AEB	05/97 → 01/05
A6 II 1.8 T	AEB, AEB	01/97 → 01/05
A6 II 1.8 T quattro	AEB, AGA	02/97 → 01/05
A6 II 2.4	AGA, AGA	02/97 → 01/05
A6 II 2.4 quattro	AGA, AJK	02/97 → 01/05
A6 II 2.7 T	AJK	02/99 → 01/05
A6 II 2.7 T quattro	AJK, ACK	12/97 → 01/05
A6 II 2.8	ACK, ACK	02/97 → 01/05
A6 II 2.8 quattro	ACK, AFB	02/97 → 01/05
A6 2.8	AGE	04/98 → 05/01
A8 I 2.5 TDI	AFB, AFB	09/00 → 09/02
A8 I 2.5 TDI quattro	AFB, AAH	09/00 → 09/02
A8 I 2.8	AAH, AAH	03/94 → 03/96
A8 I 2.8 quattro	AAH, 3A	03/94 → 03/96
CABRIOLET 1.8	ADR	01/97 → 08/00
CABRIOLET 2.0 E	ABK	01/93 → 07/98
CABRIOLET 2.3 E	NG	05/91 → 07/94
CABRIOLET 2.6	ABC	06/93 → 08/00
CABRIOLET 2.8	AAH	11/92 → 08/00
COUPE 2.0	3A, NG	05/89 → 12/96
COUPE 2.3	NG, NG	10/88 → 12/96
COUPE 2.3 quattro	NG, M28.49	11/88 → 12/96
COUPE 2.6	ABC	08/92 → 12/96
COUPE 2.6 quattro	ABC	08/92 → 12/96
COUPE 2.8	AAH	09/91 → 12/96
COUPE 2.8 quattro	AAH	08/91 → 12/96
COUPE S2	ABY	10/92 → 05/95
COUPE S2 quattro	ABY	10/92 → 12/96
PORSCHE		
928 5.4 GTS	M28.49, AEK	08/91 → 11/95
SEAT		
CORDOBA I 1.6 i	AFT	07/96 → 12/02
IBIZA II 1.6 i	AFT	04/96 → 02/02
TOLEDO I 1.6 i	AFT	11/96 → 03/99
TOLEDO I 1.9 TDI	AHU	08/95 → 03/99
VW		
GOLF II 1.8	RV	08/89 → 10/91
GOLF II 1.8 GTI G60	PG	04/90 → 07/91
GOLF II 1.8 GTI G60 Syncro	PG	08/88 → 12/91
GOLF III 1.6	AEK, AFT	07/94 → 04/99
GOLF IV 1.6	AFT, AGG	06/98 → 06/02
GOLF IV 2.0	AGG, AEK	06/98 → 06/02
JETTA II 1.8	RV	08/87 → 10/91
JETTA II 1.8 G60	PG	04/90 → 07/91
PASSAT III 1.6	AEK, 2E	07/94 → 08/96
PASSAT III 2.0	2E, ADR	02/90 → 05/97
PASSAT III 2.0 Syncro	2E	10/90 → 05/97
PASSAT III 2.0i	ACX	08/92 → 12/96
PASSAT IV 1.8	ADR, ANQ	10/96 → 03/05
PASSAT IV 1.8 [CHN]	ANQ, ADR	03/00 →
PASSAT IV 1.8 Syncro/4motion	ADR, AEB	10/96 → 11/00
PASSAT IV 1.8 T	AEB, ACK	10/96 → 11/00
PASSAT IV 1.8 T 20V	AWL	11/00 → 05/05
PASSAT IV 2.3 VR5	AGZ	10/96 → 11/00
PASSAT IV 2.3 VR5 Syncro/4motion	AGZ	10/97 → 11/00
PASSAT IV 2.8 Syncro	AGE	05/97 → 09/99
PASSAT IV 2.8 V6	ACK, ACK	08/96 → 09/99
PASSAT IV 2.8 V6 Syncro/4motion	ACK, AEH	10/96 → 11/00
POLO III 1.6	AEH, AEH	05/97 → 09/01
POLO III 100 1.6	AEH, LFY(XU7JPA)	12/95 → 09/01
POLO III 2.0	ADC	08/99 → 09/01
VENTO 1.6	AKS	04/97 → 02/99

9.3057



04,5

KNOCK SENSORS

Adatt./Suitable:

CITROËN

5946 24
96 233 678 80

PEUGEOT

5946 24



L	mV/g		
250	28		

CITROËN

XANTIA I 1.8 i 16V	LFY(XU7JP4)	06/95 ⇒ 04/03
XSARA 1.8 BiFuel	XU7JP4	07/97 ⇒ 08/00
XSARA 1.8 i 16V	LFY(XU7JP4), RFS(XU10J4RS)	04/97 ⇒ 09/00
XSARA 2.0 16V	RFS(XU10J4RS)	04/97 ⇒ 09/00
XSARA 2.0 i 16V	RFS(XU10J4RS), LFY(XU7JP4)	02/98 ⇒ 03/05
ZX 2.0	RFS(XU10J4RS)	09/96 ⇒ 10/97
ZX 2.0 i 16V	RFS(XU10J4RS)	05/96 ⇒ 06/97

PEUGEOT

306 1.8 16V	LFY(XU7JP4), LFY(XU7JP4)	03/97 ⇒ 10/03
306 2.0 S16	RFS(XU10J4RS)	06/96 ⇒ 05/01
406 1.8	XU7JB	05/97 ⇒ 10/04
406 1.8 16V	LFY(XU7JP4), AEB	11/95 ⇒ 10/00

9.3060



04,5

KNOCK SENSORS

Adatt./Suitable:

AUDI

07D 905 377

SEAT

07D 905 377

SIEMENS

S107583008Z

SKODA

07D 905 377

VW

07D 905 377



L	mV/g		
800	20		

AUDI

A4 II 1.6	ALZ	11/00 ⇒ 12/04
A4 II 1.8 T	AMB, AMB	11/00 ⇒ 03/09
A4 II 1.8 T quattro	AMB, AEB	11/00 ⇒ 03/09
A4 II 2.0	ALT	11/00 ⇒ 12/05
A4 I 1.8 T	AEB, AMB	01/95 ⇒ 09/01
A4 I 1.8 T quattro	AWT	01/95 ⇒ 11/00
A4 III 1.6	ALZ	11/04 ⇒ 06/08
A4 III 1.8 T	BFB	11/04 ⇒ 06/08
A4 III 1.8 T quattro	BFB	11/04 ⇒ 06/08

AUDI

A4 III 2.0	ALT	11/04 ⇒ 06/08
A6 II 1.8 T	AEB, AEB	01/97 ⇒ 01/05
A6 II 1.8 T quattro	AEB, BGC	02/97 ⇒ 01/05
A6 II 2.0	ALT	08/01 ⇒ 01/05

SEAT

EXEO 1.6	ALZ	03/09 ⇒ 09/10
----------	-----	---------------

SKODA

SUPERB I 1.8 T	AWT	12/01 ⇒ 03/08
SUPERB I 2.0	AZM	12/01 ⇒ 03/08

VW

PASSAT IV 1.6	ALZ	11/00 ⇒ 05/05
PASSAT IV 1.8 [CHN]	BGC, ALT	06/01 ⇒
PASSAT IV 1.8 T 20V	AWT	11/00 ⇒ 05/05
PASSAT IV 2.0	ALT, BFF	11/00 ⇒ 05/05
PASSAT IV 2.0 [CHN]	BFF, 183A1.000	06/03 ⇒
PASSAT IV 2.0 4motion	AZM	11/00 ⇒ 05/05

9.3061



04,5

KNOCK SENSORS

Adatt./Suitable:

FIAT

60602832

LANCIA

60602832

NTK (NGK-GROUP)

KNE03



L	mV/g		
200	27		

FIAT

BARCETTA 1.8 16V	183A1.000, 182A4.000	04/95 ⇒ 05/05
BRAVA 1.6 16V	182A4.000	02/96 ⇒ 10/01
BRAVA 1.8 GT 16V	182A2.000	10/95 ⇒ 08/01
BRAVO I 1.6 16V	178A8.011	09/98 ⇒ 10/01
BRAVO I 1.8 GT	182A2.000	10/95 ⇒ 10/01
COUPE 1.8 16V	183A1.000	03/96 ⇒ 08/00
MAREA 1.6	185A3.000	03/99 ⇒ 08/00
MAREA 1.6 100 16V	182A4.000	09/96 ⇒ 05/02
MAREA 1.6 100 16V Bipower	182A4.000, 186A3.000	04/99 ⇒ 05/02
MAREA 1.8 115 16V	182A2.000	09/96 ⇒ 05/02
MULTIPLA 1.6 100 16V	182A4.000	04/99 ⇒ 06/10
MULTIPLA 1.6 16V Bipower	186A4.000	04/99 ⇒ 06/10
MULTIPLA 1.6 16V Blupower	186A3.000, 178B3.000	04/99 ⇒ 06/10
PALIO 1.6	178C7.098	07/97 ⇒ 10/00
PALIO 1.6 16V	178B3.000, G4EA	06/96 ⇒
SIENA 1.6 16V	178B3.000	09/98 ⇒
STRADA 1.6 MPI	178D2.011	07/05 ⇒

FIAT (BR)

PALIO 1.0i	1.0Mpi	01/96 ⇒
PALIO 1.5i	1.5Mpi	01/96 ⇒ 12/98
PALIO 1.6i	1.6Mpi	01/99 ⇒ 12/00
PALIO 1.6i 16v	1.6Mpi16v	01/96 ⇒ 12/00
SIENA 1.6i	1.6Mpi	01/99 ⇒ 12/00
STRADA 1.5i	1.5Mpi	01/99 ⇒ 12/01
STRADA 1.6i 16v	1.6Mpi	01/99 ⇒
STRADA 1.6i 8v	1.6Mpi	01/99 ⇒ 12/00
UNO 1.5i Furgoneta	1.5Mpi	01/97 ⇒

LANCIA

DEDRA 1.6 16V	182A4.000	01/96 ⇒ 07/99
DEDRA 1.8 16V LE	182A2.000	03/96 ⇒ 07/99
DEDRA 1.8 GT 16V	183A1.000	03/96 ⇒ 07/99
DELTA II 1.6 i.e. 16V	182A4.000	01/96 ⇒ 08/99
DELTA II 1.8 i.e. 16V	182A2.000	03/96 ⇒ 08/99
DELTA II 1.8 i.e. 16V GT	183A1.000	03/96 ⇒ 08/99
LYBRA 1.6 16V	182A4.000	07/99 ⇒ 10/05

9.3062



04,5

KNOCK SENSORS

Adatt./Suitable:

HYUNDAI

39250-22600



L	mV/g		
400	30		

HYUNDAI

ACCENT II 1.3	G4EA, G4EB	01/00 ⇒ 11/05
ACCENT II 1.5	G4EB, ADY	01/00 ⇒ 12/06
VERNA I 1.3	G4EA	09/99 ⇒
VERNA I 1.5	G4EB	09/99 ⇒

9.3064



04,5

KNOCK SENSORS

Adatt./Suitable:

BOSCH

0 261 231 075
0 261 231 076
0 261 231 077

SEAT

037 905 377
037 905 377 A

SIEMENS

5WM 1530

VW

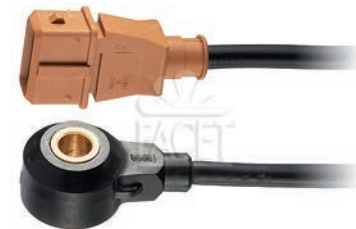
037 905 377
037 905 377 A

L	mV/g		
350	30		

SEAT

ALHAMBRA I / II 2.0 i	ADY, 2E	04/96 ⇒ 03/10
CORDOBA I 1.8 i 16V	ADL	10/93 ⇒ 08/96
CORDOBA I 2.0 i	2E, 1F	02/93 ⇒ 06/99
CORDOBA I 2.0 i 16V	ABF	08/96 ⇒ 06/99
IBIZA II 1.0 i	AER	09/96 ⇒ 02/02
IBIZA II 1.4 i	AEX	09/93 ⇒ 02/02
IBIZA II 1.6 i	1F, 2E	09/94 ⇒ 06/99
IBIZA II 1.8 i 16V	ADL	11/93 ⇒ 08/96
IBIZA II 2.0 i	2E, 2E	03/93 ⇒ 08/99
IBIZA II 2.0 i 16V	ABF	08/96 ⇒ 08/99
TOLEDO I 2.0 i	AGG	05/91 ⇒ 03/99

VOLKSWAGEN (BR)

GOL 2.0i 16V	112	10/95 ⇒
PARATI 2.0i 16V	112	02/96 ⇒

VW

CORRADO 2.0 i	2E	04/93 ⇒ 12/95
CORRADO 2.9 VR6	ABV	08/91 ⇒ 12/95
GOLF III 2.0	2E, AAA	11/91 ⇒ 04/99
GOLF III 2.0 GL	AEP	08/95 ⇒ 09/97

VW		
GOLF III 2.0 GTI 16V	ABF	08/92 → 08/97
GOLF III 2.0 Syncro	AGG	08/95 → 04/99
GOLF III 2.8 VR6	AAA, AGG	01/92 → 09/97
GOLF III 2.9 VR6	ABV	10/94 → 04/99
GOLF III 2.9 VR6 Syncro	ABV	10/94 → 04/99
GOLF IV 2.0	AGG, 2E	06/98 → 06/02
PASSAT III 2.0	2E, 2E	02/90 → 05/97
PASSAT III 2.0 16V	ABF	01/94 → 05/97
PASSAT III 2.0 Syncro	2E, ADY	10/90 → 05/97
PASSAT III 2.0i	ACX	08/93 → 12/96
PASSAT III 2.8 VR6	AAA	06/91 → 05/97
POLO III 1.4	AGY	05/96 → 07/02
POLO III 1.6	AFX	01/98 → 08/00
SHARAN I 2.0	ADY, AAA	09/95 → 03/10
SHARAN I 2.8 VR6	AAA, AAA	09/95 → 04/00
SHARAN I 2.8 VR6 Syncro	AAA, ACU	11/96 → 04/00
TRANSPORTER IV 2.5	ACU, ACU	11/90 → 06/03
TRANSPORTER IV 2.5 Syncro	ACU, AGN	10/92 → 04/03

9.3065

04,5

KNOCK SENSORS

Adatt./Suitable:

- AUDI**
06A 905 377 A
- SEAT**
06A 905 377 A
- SIEMENS**
G85530299160Z
- SKODA**
06A 905 377 A
- VW**
06A 905 377 A



L	mV/g	Diagram	Diagram
250	30		

AUDI		
A3 I 1.8	AGN, AGU	09/96 → 05/03
A3 I 1.8 T	AGU, AGU	12/96 → 05/03
A3 I 1.8 T quattro	AGU, AMK	12/96 → 05/03
A3 I S3 quattro	AMK, AJQ	03/99 → 04/02
TT I 1.8 T	AJQ, AJQ	10/98 → 06/06
TT I 1.8 T quattro	AJQ, AJH	10/98 → 06/06
SEAT		
ALHAMBRA I / II 1.8 T 20V	AJH, AGN	10/97 → 03/10
LEON I 1.8 20V	AGN, APP	11/99 → 06/06
LEON I 1.8 20V T	APP, AJQ	11/99 → 06/06
LEON I 1.8 20V T 4	AJQ, AGN	11/99 → 06/06
TOLEDO II 1.8 20V	AGN, APP	10/98 → 07/04
TOLEDO II 1.8 20VT	APP, AQV	09/00 → 07/04
TOLEDO II 1.8 4x4	AJQ	05/01 → 04/04
SKODA		
FABIA I 1.0	AQV, AME	12/99 → 08/02
FABIA I 1.4	AME, AGU	08/99 → 05/03
OCTAVIA I 1.4	AMD	04/99 → 03/01
OCTAVIA I 1.8	AGN	09/96 → 07/00
OCTAVIA I 1.8 20V	AGN	07/98 → 07/00
OCTAVIA I 1.8 T	AGU, AGU	07/98 → 12/10
VOLKSWAGEN (BR)		
GOLF A4 1.6i	AKL	10/99 →
VW		
BORA 1.8 4motion	AGN	02/99 → 05/05
GOLF IV 1.8	AGN	08/97 → 06/05
GOLF IV 1.8 T	AGU, AJH	08/97 → 06/05
LUPO 1.0	AHT	10/98 → 05/00
SHARAN I 1.8 T 20V	AJH, X18XE1	09/97 → 03/10

9.3066

04,5

KNOCK SENSORS

Adatt./Suitable:

- GENERAL MOTORS**
9 158 720
- OPEL**
62 38 181
91 58 720
- SAAB**
91 58 720
- SIEMENS**
S105722003Z
- VAUXHALL**
9158720

MARKET DIFFUSION: MEDIUM



L	mV/g	Diagram	Diagram
400	30		

OPEL			
ASTRA G 1.8	Z18XEL	02/03 → 07/04	
ASTRA G 1.8 16V	Z18XE	06/00 → 10/05	
ASTRA H 1.8	Z18XE	01/04 → 10/10	
CORSA C 1.8	Z18XE	09/00 → 12/09	
MERIVA A 1.8	Z18XE	05/03 → 05/10	
SIGNUM 1.8	Z18XE	05/03 → 07/05	
TIGRA B 1.8	Z18XE	06/04 → 12/10	
VECTRA B 1.8 i 16V	X18XE1, Z18XE	10/95 → 09/00	
VECTRA C 1.8	Z18XE	04/02 → 07/08	
VECTRA C 1.8 16V	Z18XE, Z18XE	04/02 → 09/08	
ZAFIRA A 1.8	Z18XEL	02/03 → 06/05	
ZAFIRA A 1.8 16V	Z18XE	09/00 → 06/05	
SAAB			
9-3 1.8 i	Z18XE	01/04 → 02/15	
VAUXHALL			
ASTRA IV 1.8 16V	Z18XE	02/98 → 10/05	
ASTRA IV 1.8 16V Dualfuel	Z18XE, Y22XE	07/02 → 08/05	
ASTRA V 1.8	Z18XE	01/04 → 11/10	
CORSA C 1.8 16V	Z18XE	08/00 → 09/06	
MERIVA I 1.8 i 16V	Z18XE	05/03 → 06/10	
SIGNUM 1.8	Z18XE	06/03 → 07/05	
TIGRA B 1.8	Z18XE	06/04 → 08/09	
VECTRA B 1.8 i 16V	Z18XEL	10/95 → 09/00	
VECTRA C 1.8	Z18XEL	04/02 → 07/08	
VECTRA C 1.8 16V	Z18XE	04/02 → 07/08	
VECTRA C 1.8 16V Dualfuel	Z18XE	04/02 → 07/08	
ZAFIRA A 1.8 16V	Z18XE	09/00 → 08/05	
ZAFIRA A 1.8 Dualfuel	Z18XE	09/00 → 08/05	

9.3068

04,5

KNOCK SENSORS

Adatt./Suitable:

- GENERAL MOTORS**
90 530 585
- OPEL**
62 38 081
90530585
- VAUXHALL**
90530585



L	mV/g	Diagram	Diagram
450	28		

OPEL			
ASTRA G 2.0 16V	X20XEV	02/98 → 01/05	
OMEGA B 2.2 16V	Y22XE, Y22XE	09/99 → 07/03	
VECTRA B 1.8 i 16V	Z18XE	09/00 → 07/03	
VAUXHALL			
ASTRA IV 2.0 16V	X20XEV	02/98 → 05/05	
OMEGA B 2.2 16V	Y22XE, 4G61	01/94 → 06/03	
VECTRA B 1.8 Dualfuel	Z18XE	09/00 → 07/03	
VECTRA B 1.8 i 16V	Z18XE	09/00 → 07/03	

9.3069

04,5

KNOCK SENSORS

Adatt./Suitable:

- HYUNDAI**
39250-23010
- KIA**
0K01D-18921



L	mV/g	Diagram	Diagram
250	24		

HYUNDAI			
ACCENT I 1.3	G4EH	10/94 → 01/00	
ACCENT I 1.5 i 16V	G4ER	12/95 → 01/00	
COUPE 2.0	G4DF	04/96 → 08/99	
COUPE I 1.6 16V	G4GR	03/98 → 04/02	
COUPE I 1.6 i 16V	4G61, G4DF	12/96 → 04/02	
COUPE I 2.0	G4DF	08/99 → 01/02	
COUPE I 2.0 16V	G4DF, G4GL	03/01 → 04/02	
COUPE I F2 Evolution	G4GF	01/99 → 12/01	
ELANTRA 1.6	G4GR	08/95 → 02/98	
ELANTRA II 1.6 i 16V	G4GR	06/95 → 05/00	
ELANTRA II 1.8 i 16V	G4GM	05/95 → 05/00	
ELANTRA II 2.0 i 16V	G4DF	06/97 → 05/00	
LANTRA II 1.6 16V	G4GR	11/95 → 10/00	
LANTRA II 1.6 i	G4GR	11/95 → 10/00	
LANTRA II 1.8 16V	G4GM	11/95 → 10/00	
LANTRA II 1.9 D	DJY	03/98 → 10/00	
LANTRA II 2.0	G4JPE	04/97 → 05/00	
LANTRA II 2.0 16V	G4GF	11/95 → 10/00	

HYUNDAI			
LANTRA 1.9	DJY	04/97	⇒ 05/00
TIBURON 1.6i 16V	G4GL, FE	08/00	⇒
TIBURON 2.0i 16V	G4DF	08/99	⇒
KIA			
RETONA 2.0 16V	FE, FE	05/00	⇒
SPORTAGE I 2.0	FE, FE	10/00	⇒ 08/03
SPORTAGE I 2.0 4WD	FE, FE	10/00	⇒ 08/03
SPORTAGE I 2.0i 16V	FE, AEH	10/99	⇒ 08/03
SPORTAGE I 2.0i 16V 4WD	FE	04/94	⇒ 08/03

9.3072



04,5

KNOCK SENSORS

Adatt./Suitable:

AUDI
06A 905 377

SEAT
06A 905 377

SIEMENS
G85530299150Z

SKODA
06A 905 377

VW
06A 905 377



L	mV/g		
175	30		

AUDI			
A3 I 1.6	AEH, AGN	09/96	⇒ 05/03
A3 I 1.8	AGN, AGU	09/96	⇒ 05/03
A3 I 1.8 T	AGU, AGU	12/96	⇒ 05/03
A3 I 1.8 T quattro	AGU, AMK	12/96	⇒ 05/03
A3 I S3 quattro	AMK, AJQ	03/99	⇒ 04/02
TT I 1.8 T	AJQ, AJQ	10/98	⇒ 06/06
TT I 1.8 T quattro	AJQ, AJH	10/98	⇒ 06/06

SEAT			
ALHAMBRA I / II 1.8 T 20V	AJH, AEH	10/97	⇒ 03/10
CORDOBA I 1.6 i	AKL	07/96	⇒ 10/02
IBIZA II 1.6	AEH, AEH	08/99	⇒ 02/02
LEON I 1.6	AEH, APP	11/99	⇒ 06/06
LEON I 1.8 20V T	APP, AJQ	11/99	⇒ 06/06
LEON I 1.8 20V T 4	AJQ, AEH	11/99	⇒ 06/06
TOLEDO II 1.6	AEH, APP	10/98	⇒ 07/04
TOLEDO II 1.8 20VT	APP, AEH	09/00	⇒ 07/04
TOLEDO II 1.8 4x4	AJQ	05/01	⇒ 04/04

SKODA			
OCTAVIA I 1.6	AEH, AGU	02/97	⇒ 12/07
OCTAVIA I 1.8	AGN	09/96	⇒ 07/00
OCTAVIA I 1.8 20V	AGN	07/98	⇒ 07/00
OCTAVIA I 1.8 T	AGU, AEH	07/98	⇒ 12/10

VW			
BORA 1.6	AEH, AEH	10/98	⇒ 05/05
BORA 1.8 4motion	AGN	02/99	⇒ 05/05
GOLF IV 1.6	AEH, AGU	05/01	⇒ 05/04
GOLF IV 1.8	AGN	08/97	⇒ 06/05
GOLF IV 1.8 4motion	AGN	05/98	⇒ 06/05
GOLF IV 1.8 T	AGU, AEH	08/97	⇒ 06/05
POLO III 1.6	AEH, AEH	05/97	⇒ 09/01
POLO III 100 1.6	AEH, AJH	12/95	⇒ 09/01
POLO 1.6 [ExtraEU]	AKL	10/99	⇒ 09/01
SHARAN I 1.8 T 20V	AJH, BDB	09/97	⇒ 03/10

9.3073



04,5

KNOCK SENSORS

Adatt./Suitable:

AUDI
022 905 377

FORD
1 120 191
YM21-12A699-AA

PORSCHE
955 606 125 10

SEAT
022 905 377

VW
022 905 377



L	mV/g		
300	23		

AUDI			
A3 I [USA] 3.2 24V	CBRA	07/08	⇒ 05/09
A3 I [USA] 3.2 24V AWD	--	01/06	⇒ 12/09
A3 II SPORTBACK 3.2 V6 quattro	BDB, BHE	09/04	⇒ 05/09
TT I 3.2 VR6 quattro	BHE, AAA	07/03	⇒ 06/06
TT II 3.2 V6 quattro	BUB	08/06	⇒ 06/10
FORD			
GALAXY I 2.8 i V6	AAA, AUE	11/95	⇒ 04/00
GALAXY I 2.8 V6	AYL	04/00	⇒ 05/06

SEAT			
ALHAMBRA I / II 2.8 V6	AUE, AUE	06/00	⇒ 03/10
ALHAMBRA I / II 2.8 V6 4motion	AUE, AUE	06/00	⇒ 03/10
LEON I 2.8	BDE	05/02	⇒ 06/04
LEON I 2.8 Cupra 4	AUE, AQP	02/01	⇒ 06/06

VW			
BORA 2.8 V6 4motion	AQP, BUB	03/99	⇒ 05/05
BORA 2.8 VR6	AUE	03/00	⇒ 05/00
CARAVELLE 3.2	BDL	11/03	⇒ 11/09
EOS 3.2 V6	BUB, AQP	06/06	⇒ 05/09
GOLF IV 2.8 V6 4motion	AQP, AQP	05/99	⇒ 06/06
GOLF IV 2.8 VR6 4motion	AQP, BFH	03/99	⇒ 06/05
GOLF IV 3.2 R32 4motion	BFH, BUB	09/02	⇒ 06/05
GOLF V 3.2	BUB, BUB	09/05	⇒ 11/08
GOLF V 3.2 R32 4motion	BUB, BDL	11/05	⇒ 11/08
MULTIVAN 3.2 V6	BDL, BKK	02/04	⇒ 11/09
MULTIVAN 3.2 V6 4motion	BKK, AYT	07/04	⇒ 11/09
PHAETON 3.2 V6	AYT, BKL	04/02	⇒ 05/05
PHAETON 3.2 V6 4motion	BKL, AZZ	02/04	⇒ 11/08
SHARAN I 2.8 V6 24V	AYL	04/00	⇒ 03/10
SHARAN I 2.8 V6 24V 4motion	AYL	04/00	⇒ 03/10
TOUAREG I 3.2 V6	AZZ, BDL	10/02	⇒ 11/06
TRANSPORTER 3.2	BDL	03/04	⇒ 06/05
TRANSPORTER IV 2.8 VR6	AMV	04/00	⇒ 04/03
TRANSPORTER V 3.2 4motion	BDL, BDL	11/03	⇒ 11/09
TRANSPORTER V 3.2 V6	BDL, BKK	04/03	⇒ 11/09
TRANSPORTER V 3.2 V6 4motion	BKK, X18XE1	11/03	⇒ 11/09

9.3074



04,5

KNOCK SENSORS

Adatt./Suitable:

GENERAL MOTORS
24 456 516
90 536 392

OPEL
24456516
62 38 099
62 38 221
90536392

SIEMENS
5WK 96063

VAUXHALL
24456516
90536392



L	mV/g		
350	27		

OPEL			
ASTRA F 1.8 i	X18XE1	03/98	⇒ 08/00
ASTRA G 1.8 16V	X18XE1	02/98	⇒ 10/00
SIGNUM 2.2 direct	Z22YH	05/03	⇒ 09/08
VECTRA B 1.8 i 16V	X18XE1, W11B16A	10/95	⇒ 09/00
VECTRA C 2.2 DGi	Z22YH	10/03	⇒ 08/08
VECTRA C 2.2 direct	Z22YH	10/03	⇒ 08/08
ZAFIRA B 2.2	Z22YH	07/05	⇒ 12/12

VAUXHALL			
ASTRA IV 1.8 16V	X18XE1	02/98	⇒ 08/05
SIGNUM 2.2 i	Z22YH	05/03	⇒ 05/08
VECTRA B 1.8 i 16V	X18XE1	10/95	⇒ 09/00
VECTRA C 2.2 direct	Z22YH	01/02	⇒ 10/08
ZAFIRA B 2.2	Z22YH	07/05	⇒ 11/14

9.3075



04,5

KNOCK SENSORS

Adatt./Suitable:

MINI
12 14 1 487 246

NTK (NGK-GROUP)
KNE10



L	mV/g		
450	27		

MINI			
MINI I Cooper	W10B16A	06/01	⇒ 11/07
MINI I Cooper S	W11B16A, W10B14A	03/02	⇒ 11/07
MINI I John Cooper Works	W11B16A	07/04	⇒ 11/07
MINI I One	W10B14A, A135M	06/01	⇒ 11/07
MINI I S Works	W11B16A	11/03	⇒ 06/05
MINI I Works	W11B16A	11/03	⇒ 09/06



KNOCK SENSORS

Adatt./Suitable:

CHEVROLET

10456240
10456669

DAEWOO

10456240
10456669

FIAT

7083326

GENERAL MOTORS

10 456 240

OPEL

10456240
62 38 370

VAUXHALL

10456240

MARKET DIFFUSION: MEDIUM



L	mV/g		
400	37		

CHEVROLET

LANOS 1.3	--	01/97 →
LANOS 1.6 16V	A16DMS	11/05 →
LEGANZA 2.0	--	01/98 →
LEGANZA 2.2	--	01/98 →

DAEWOO

ASSOL 1.3	C14L	04/97 → 06/99
ASSOL 1.5	Y15L	04/97 → 06/99
ASSOL 1.6	616L	02/98 → 06/99
LANOS 1.3	A13SM, A15DMS	05/97 →
LANOS 1.5	A15DMS, 616L	05/97 →
LANOS 1.6	A16DMS	10/97 → 12/02
LANOS 1.6 16V	616L, T20SED	02/97 →
LEGANZA 2.0	T20SED, T20SED	01/01 → 12/02
LEGANZA 2.0 16V	T20SED, 616L	07/00 → 04/04
LEGANZA 2.2 16V	T22SED	04/99 → 12/02
NUBIRA I 1.6 16V	616L, X20SED	05/97 →
NUBIRA I 2.0 16V	X20SED, X16SZR	05/97 →
NUBIRA I 2.0 CDX	T20SED	08/02 → 07/03
ORION 1.6	616L	04/99 → 08/00

OPEL

ASTRA F 1.4 i 16V	X14XE	01/96 → 03/01
ASTRA F 1.6	16NZR	09/95 → 09/98
ASTRA F 1.6 i	X16SZR, X14XE	09/91 → 01/05
ASTRA F 1.6 i 16V	X16XEL	08/94 → 01/05
ASTRA G 1.4	X14XE, X14XE	09/98 → 04/05
ASTRA G 1.4 16V	X14XE, X14XE	02/98 → 01/05
ASTRA G 1.4 LPG	X14XE, C16SEL	02/98 → 01/05
ASTRA G 1.6	C16SEL, X16XEL	09/00 → 07/09
ASTRA G 1.6 16V	X16XEL, X16XEL	02/98 → 10/05
ASTRA G 1.6 CNG	Z16YNG	03/03 → 07/04
ASTRA G 1.6 LPG	X16XEL, Y16YNG	03/98 → 01/05
ASTRA H 1.4 16V	Z14XE	05/04 → 07/09
ASTRA H 1.6	Z16XE	06/04 → 02/06
ASTRA H 1.6 16V	Z16XE	03/04 → 01/08
COMBO B 1.4	X14SZ	07/94 → 10/01
COMBO B 1.4 16V	X14XE	08/99 → 10/01
COMBO C 1.6	Z16SE	10/01 →
COMBO C 1.6 CNG	Y16YNG, Y16YNG	04/05 → 12/11
COMBO C 1.6 CNG 16V	Y16YNG, C14SEL	04/05 →
CORSA B 1.4 i	X14SZ	03/93 → 09/00
CORSA B 1.4 i 16V	C14SEL, C16SEL	09/94 → 12/02
CORSA B 1.6 GSI 16V	C16XE	03/93 → 09/00
CORSA B 1.6 i 16V	C16SEL, X22SE	09/94 → 09/00
CORSA C 1.4	Z14XE	07/00 →
CORSA C 1.6	Z16SE	09/00 →
CORSA C 1.6 CNG	Y16YNG	05/03 → 12/09
CORSA C 1.6 X	Z16YNG	08/05 →
FRONTERA B 2.2 i	X22SE, X14XE	10/98 → 07/04
MERIVA A 1.6	Z16SE	05/03 → 05/10

OPEL

MERIVA A 1.6 16V	Z16XE	05/03 → 01/06
TIGRA A 1.4 16V	X14XE, C16SEL	07/94 → 12/00
TIGRA A 1.6 16V	C16SEL, 16LZ2	07/94 → 08/98
VECTRA B 1.6 i	16LZ2, X16XEL	10/95 → 07/03
VECTRA B 1.6 i 16V	X16XEL, X16XEL	10/95 → 07/02
VECTRA C 1.6	Z16XE	08/05 → 08/08
VECTRA C 1.6 16V	Z16XE	06/04 → 09/08
ZAFIRA A 1.6 16V	X16XEL, X16XEL	09/02 → 06/05
ZAFIRA A 1.6 CNG	Z16YNG	09/01 → 06/05
ZAFIRA A 1.6 LPG	X16XEL, X14XE	04/99 → 06/05
ZAFIRA A 1.8 16V	X18XE1	04/99 → 09/00
ZAFIRA B 1.6 CNG	Z16YNG	07/05 → 04/15

VAUXHALL

ASTRA III 1.4 i 16V	X14XE	01/96 → 03/01
ASTRA III 1.6 i	X16SZR	03/92 → 03/01
ASTRA III 1.6 i 16V	X16XEL	01/94 → 09/98
ASTRA IV 1.4 16V	X14XE, X14XE	02/98 → 05/05
ASTRA IV 1.4 16V Dualfuel	X14XE, X16SZR	09/99 → 06/03
ASTRA IV 1.6	X16SZR, X16XEL	03/98 → 05/05
ASTRA IV 1.6 16V	X16XEL, X16SZR	02/98 → 10/05
ASTRA IV 1.6 Dualfuel	X16SZR, X16SZR	07/00 → 05/05
ASTRAVAN II 1.4 16V	Z14XE	09/00 → 05/05
ASTRAVAN II 1.6 Dualfuel	X16SZR, X16SZR	07/00 → 08/05
ASTRAVAN II 1.6 i	X16SZR, Z16SE	09/00 → 08/06
COMBO B 1.4 16V	X14XE	08/99 → 10/01
COMBO C 1.4 16V	Z14XE	10/01 → 05/07
COMBO C 1.6	Z16SE, Z16YNG	09/01 → 11/11
COMBO C 1.6 CNG	Z16YNG, Y16YNG	04/05 → 02/12
COMBO C 1.6 CNG 16V	Y16YNG, X22SE	04/05 → 02/12
CORSA B 1.4 i	X14SZ	03/93 → 09/00
CORSA B 1.4 i 16V	X14XE	09/94 → 09/00
CORSA B 1.6 GSI 16V	C16XE	03/93 → 09/00
CORSA B 1.6 i 16V	X16XE	09/94 → 09/00
CORSA C 1.4 16V	Z14XE	09/00 → 10/06
FRONTERA B 2.2 i	X22SE, X16XEL	10/98 → 10/04
MERIVA I 1.6 i	Z16SE	01/03 → 06/10
MERIVA I 1.6 i 16V	Z16XE	01/03 → 09/05
TIGRA A 1.4 16V	X14XE	07/94 → 12/00
TIGRA A 1.6 16V	X16XE	07/94 → 12/00
VECTRA B 1.6 i	X16SZR	08/95 → 03/02
VECTRA B 1.6 i 16V	X16XEL, X16XEL	08/95 → 03/02
VECTRA C 1.6 16V	Z16XE	06/04 → 07/08
ZAFIRA A 1.6 16V	X16XEL, BDN	04/99 → 08/05
ZAFIRA A 1.6 CNG	Z16YNG	09/01 → 06/05
ZAFIRA A 1.6 Dualfuel	X16XEL	11/98 → 08/05
ZAFIRA A 1.8 16V	X18XE1	05/99 → 08/00
ZAFIRA B 1.6 CNG	Z16YNG	07/05 → 11/14

9.3083



KNOCK SENSORS

Adatt./Suitable:

VW

07D 905 376 E
07D 905 377 L

03 Supplied until depletion

- Fornibile fino ad esaurimento delle scorte
- Fourni jusqu'à épuisement du stock
- Lieferbar solange vorrat reicht
- Suministrado hasta el stock termina



L	mV/g		
650	24		

VW

PASSAT IV 4.0 W8 4motion	BDN, BDN	09/01 → 09/04
--------------------------	----------	---------------



KNOCK SENSORS

Adatt./Suitable:

VW

07D 905 376 C
07D 905 377 H

03 Supplied until depletion

- Fornibile fino ad esaurimento delle scorte
- Fourni jusqu'à épuisement du stock
- Lieferbar solange vorrat reicht
- Suministrado hasta el stock termina



L	mV/g		
650	23		

VW

PASSAT IV 4.0 W8 4motion	BDN, BDN	09/01 → 09/04
--------------------------	----------	---------------

9.3085



KNOCK SENSORS

Adatt./Suitable:

VW

07D 905 376 F
07D 905 377 J

L	mV/g		
500	23		

VW

PASSAT IV 4.0 W8 4motion	BDN, BDN	09/01 → 09/04
--------------------------	----------	---------------

9.3086



04,5

9.3090



04,5

9.3091



04,5

KNOCK SENSORS

Adatt./Suitable:

VW

07D 905 376 D
07D 905 377 K⁰³ Supplied until depletion

- Fornibile fino ad esaurimento delle scorte
- Fourni jusqu'à épuisement du stock
- Lieferbar solange vorrat reicht
- Suministrado hasta el stock termina



L	mV/g		
570	24		

VW

PASSAT IV 4.0 W8 4motion | BDN, G4EC-G | 09/01 ⇨ 09/04

9.3088



04,5

KNOCK SENSORS

Adatt./Suitable:

VW

07C 905 377 Q

⁰⁰ Eliminated on 04-03-2019. Please verify the availability through our local distributors

- Eliminato il 04-03-2019. Verificare la disponibilità presso i nostri distributori
- Éliminé le 04-03-2019. Vérifier la disponibilité auprès de nos distributeurs sur place
- Am 04-03-2019 gestrichen. Evtl. Verfügbarkeit bitte bei unseren Händlern prüfen
- Eliminado en fecha 04-03-2019. Verificar la disponibilidad a través de nuestros distribuidores locales



L	mV/g		
300	25		

VW

PHAETON 6.0 W12 4motion | BAN | 04/02 ⇨ 12/05

KNOCK SENSORS

Adatt./Suitable:

HYUNDAI

39250-26600 *1

KIA

39250-26600 *1

*1 without fastening clamp

- senza staffa fissaggio
- sans bride de fixation
- ohne Befestigungsbügel
- sin estribo de sujeción



L	mV/g		
255	25		

HYUNDAI

ACCENT II 1.5	G4EC-G, G4ED	09/99 ⇨ 10/02
ACCENT II 1.6	G4ED, 4G61	12/02 ⇨ 11/05
COUPE I 1.6 16V	G4GR	03/98 ⇨ 04/02
COUPE I 1.6 i 16V	4G61, G4ED	12/96 ⇨ 04/02
COUPE II 1.6 16V	G4ED, G4GC	03/02 ⇨ 08/09
COUPE II 2.0	G4GC, G4ED	08/01 ⇨ 08/09
COUPE II 2.0 GLS	G4GC-G	02/03 ⇨ 08/09
ELANTRA 1.6 [ExtraEU]	G4GA	08/03 ⇨ 05/06
ELANTRA 1.8 [ExtraEU]	G4BB	06/00 ⇨ 07/03
ELANTRA III 1.6	G4ED, G4BB	06/00 ⇨ 07/06
ELANTRA III 1.8	G4BB, G4GC	06/00 ⇨ 07/06
ELANTRA III 2.0	G4GC, G4ED	06/00 ⇨ 07/06
GETZ 1.4 i	G4EE	08/05 ⇨ 12/10
GETZ 1.6	G4ED, G4ED	09/02 ⇨ 12/06
LANTRA II 1.8	G4GB	06/00 ⇨
LANTRA II 2.0	G4GC-G	06/00 ⇨
MATRIX 1.6	G4ED, G4GB	06/01 ⇨ 08/10
MATRIX 1.6 [TUR]	G4ED	04/08 ⇨
MATRIX 1.8	G4GB, SPJD	06/01 ⇨ 08/10
VERNA I 1.5	G4EC-G	09/99 ⇨
VERNA I 1.6	G4ED-G	12/02 ⇨

KIA

CERATO I 1.6 | G4ED | 04/04 ⇨

KNOCK SENSORS

Adatt./Suitable:

FORD

1 068 159
1 141 998
98MF-12A699-AB
98MF-12A699-BA

JAGUAR

LRA 1692DB

MAZDA

C201-18-921

VOLVO

30711662

MARKET DIFFUSION: HIGH



L	mV/g		
450	25		

FORD

B-MAX 1.4	SPJD, RJTC	10/12 ⇨
B-MAX 1.4 LPG	RJTC, IQJA	08/13 ⇨
B-MAX 1.6 Ti	IQJA, HWDA	10/12 ⇨
C-MAX I 1.6	HWDA, --	02/07 ⇨ 09/10
C-MAX I 1.6 Ti-VCT	--, M8DB	03/07 ⇨
C-MAX II 1.5 16V	--	03/15 ⇨
C-MAX II 1.5 EcoBoost	M8DB, JQDA	03/15 ⇨
C-MAX II 1.6	--	12/10 ⇨
C-MAX II 1.6 CNG	MUDACNG	01/13 ⇨
C-MAX II 1.6 EcoBoost	JQDA, MUDA	12/10 ⇨
C-MAX II 1.6 Flexifuel	MUDA, MUDA	02/11 ⇨
C-MAX II 1.6 LPG	MUDA, IQDA	02/12 ⇨
C-MAX II 1.6 Ti	IQDA, UEJB	12/10 ⇨
ECOSPORT 1.5 Ti	UEJB, UEJB	10/13 ⇨
ECOSPORT 1.5 Ti-VCT [ExtraEU]	UEJB, HXJD	10/13 ⇨
ECOSPORT 1.6 Ti-VCT	HXJD, HXJB	08/12 ⇨
FIESTA 1.6 Ti-VCT [ExtraEU]	HXJB, FUJA	03/15 ⇨
FIESTA V 1.25 16V	FUJA, A9JA	05/02 ⇨ 06/08
FIESTA V 1.3	A9JA, FXJA	11/01 ⇨ 08/08
FIESTA V 1.4	FXJA	05/02 ⇨ 09/05
FIESTA V 1.4 16V	FXJA, FYJA	11/01 ⇨ 06/08
FIESTA V 1.6 16V	FYJA, P4JA	11/01 ⇨ 06/08
FIESTA VI 1.0	P4JA, SNJA	10/12 ⇨
FIESTA VI 1.25	SNJA, --	06/08 ⇨
FIESTA VI 1.4	--, RTJA	06/08 ⇨
FIESTA VI 1.4 LPG	RTJA, F6JB	01/09 ⇨
FIESTA VI 1.4 TDCi	F6JB, JTJA	01/09 ⇨
FIESTA VI 1.6	XTJA	03/15 ⇨
FIESTA VI 1.6 EcoBoost	--	01/13 ⇨
FIESTA VI 1.6 ST	JTJA, HHJC	03/13 ⇨
FIESTA VI 1.6 ST200	JTJC	04/16 ⇨
FIESTA VI 1.6 TDCi	HHJC, --	01/09 ⇨
FIESTA VI 1.6 Ti	--, HXJA	06/08 ⇨
FIESTA VI 1.6 Ti-VCT	HXJA, HWDA	10/08 ⇨ 12/12
FOCUS I 1.4	FXDA, FXDA	04/99 ⇨ 03/05
FOCUS I 1.4 16V	FXDA, FYDA	10/98 ⇨ 11/04
FOCUS I 1.6	FYDA, FYDA	04/99 ⇨ 03/05
FOCUS I 1.6 16V	FYDA, ASDA	10/98 ⇨ 11/04
FOCUS I 1.6 16V Flexifuel	FYDH	01/02 ⇨ 11/04
FOCUS II 1.4	ASDA, HWDA	07/04 ⇨ 09/12
FOCUS II 1.6	HWDA, G8DC	07/04 ⇨ 09/12
FOCUS II 1.6 LPG	SIDA	10/09 ⇨ 09/12
FOCUS II 1.6 TDCi	G8DC, HXDA	07/04 ⇨ 09/12
FOCUS II 1.6 Ti	HXDA, ASDA	07/04 ⇨ 09/12
FOCUS II 1.6 Ti-VCT	--	12/07 ⇨
FOCUS II CASSONE / FURGONATO / PROMISCOU 1.4	ASDA, HXDA	09/05 ⇨ 07/11
FOCUS II CASSONE / FURGONATO / PROMISCOU 1.6	HWDA	09/05 ⇨ 07/11
FOCUS II CASSONE / FURGONATO / PROMISCOU 1.6 Ti-VCT	HXDA, M8DA	09/05 ⇨ 07/11

FORD		
FOCUS III 1.5 Di TC SIGMA A	--	09/14 ⇨
FOCUS III 1.5 EcoBoost	M8DA, JQDA	09/14 ⇨
FOCUS III 1.6 EcoBoost	JQDA, MUDA	07/10 ⇨
FOCUS III 1.6 Flexifuel	MUDA, MUDA	07/10 ⇨
FOCUS III 1.6 LPG	MUDA, IQDA	02/12 ⇨
FOCUS III 1.6 Ti	IQDA, --	07/10 ⇨
FOCUS III 1.6 Ti-VCT	--	07/10 ⇨
FOCUS C-MAX 1.6	HWDA, HXDA	10/03 ⇨ 03/07
FOCUS C-MAX 1.6 Ti	HXDA, FXDA	08/04 ⇨ 03/07
FUSION 1.25	--, --	10/02 ⇨
FUSION 1.3	BAJA	11/02 ⇨ 07/05
FUSION 1.4	--, FYJA	08/02 ⇨
FUSION 1.4 LPG	UTJA	01/10 ⇨ 12/12
FUSION 1.6	FYJA, --	08/02 ⇨ 11/08
GALAXY II 1.6 EcoBoost	--, C15HDTX	11/10 ⇨
GALAXY III 1.5 EcoBoost	C15HDTX, M8DB	01/15 ⇨
GRAND C-MAX 1.5 EcoBoost	M8DB, JQDA	03/15 ⇨
GRAND C-MAX 1.6 EcoBoost	JQDA, IQDA	12/10 ⇨
GRAND C-MAX 1.6 Ti	IQDA, B2KA	12/10 ⇨
KA+ 1.2	B2KA, YSKD	06/16 ⇨
KA+ 1.2 Ti-VCT	YSKD, BNMA	06/16 ⇨
KUGA II 1.5 16V	--	03/13 ⇨
KUGA II 1.5 EcoBoost	BNMA, C15HDTX	09/14 ⇨
KUGA II 1.5 EcoBoost 4x4	C15HDTX, --	09/14 ⇨
KUGA II 1.6 EcoBoost	--, JQMA	01/13 ⇨
KUGA II 1.6 EcoBoost 4x4	JQMA, JTBA	10/12 ⇨
MONDEO III 1.6 EcoBoost	JTBA, KGBA	11/10 ⇨ 01/15
MONDEO III 1.6 Ti	KGBA, UNCA	03/07 ⇨ 01/15
MONDEO IV 1.5 EcoBoost	UNCA, --	09/14 ⇨
MONDEO IV 1.5 GTDI	--	09/14 ⇨
MONDEO 1.6 EcoBoost	JTBA	11/10 ⇨ 09/14
S-MAX I 1.6 EcoBoost	--, C15HDTX	02/11 ⇨
S-MAX II 1.5 EcoBoost	C15HDTX, --	01/15 ⇨
TOURNEO CONNECT II 1.6 EcoBoost	--, --	09/13 ⇨
TRANSIT CONNECT II 1.6 EcoBoost	--, AJ25	02/13 ⇨

JAGUAR		
S-TYPE 2.5 V6	AJ25, AJ-V6	04/02 ⇨ 10/07
S-TYPE 3.0 V6	AJ-V6, AJ8	01/99 ⇨ 10/07
S-TYPE 4.0 V8	AJ8, AJ6WG	01/99 ⇨ 12/02
XF 3.0	AJ6WG, AJ30FD	03/08 ⇨ 04/15
XJ 3.0	AJ30FD, FXJA	05/03 ⇨

MAZDA		
2 I 1.2	FUJA	02/03 ⇨ 06/07
2 I 1.25	FUJA	04/03 ⇨ 06/07
2 I 1.3 L	ZJ-04	04/03 ⇨ 06/07
2 I 1.4	FXJA, FYJA	02/03 ⇨ 06/07
2 I 1.5	ZY-VE	04/03 ⇨ 06/07
2 I 1.6	FYJA, LE5	02/03 ⇨ 06/07

VOLVO		
C30 1.6	B4164S3	10/06 ⇨ 12/12
S40 II 1.6	B4164S3	01/05 ⇨ 12/12
S60 II T3	B4164T3	04/10 ⇨ 12/15
S60 II T4	B4164T	04/10 ⇨ 12/15
S60 II T4F	B4164T2	04/11 ⇨ 12/15
S80 II T4	B4164T	10/10 ⇨
S80 II T4F	B4164T2	05/11 ⇨
V40 II T2 GTDi	B4164T4	03/13 ⇨ 12/15
V40 II T3 GTDi	B4164T3	03/12 ⇨
V40 II T4	B4164T	04/14 ⇨
V40 II T4 GTDi	B4164T	03/12 ⇨
V50 1.6	B4164S3	01/05 ⇨ 12/12
V60 I T3	B4164T3	09/10 ⇨ 12/15
V60 I T4	B4164T	09/10 ⇨ 12/15
V60 I T4F	B4164T2	04/11 ⇨ 12/15
V70 III 1.6 T4F	B4164T2	01/11 ⇨ 12/15
V70 III T4	B4164T	10/10 ⇨ 12/15

9.3093

04,5

KNOCK SENSORS

Adatt./Suitable:

CHEVROLET
12567711
24577244

FIAT

71739266

GENERAL MOTORS12 567 711
24 577 244**OPEL**12567711
2457724462 38 157
62 38 197**SIEMENS**

S107200003

VAUXHALL12567711
24577244

L	mV/g		
350	26		

CHEVROLET

HHR 2.2	L61	09/05 ⇨ 12/06
HHR 2.2 [ExtraEU]	L61	09/05 ⇨ 12/08
HHR 2.4	LE5, BJN	01/06 ⇨ 12/11

FIAT

CROMA II 2.2 16V	194A1.000	06/05 ⇨
------------------	-----------	---------

OPEL

ASTRA G 2.2 16V	Z22SE	06/00 ⇨ 10/05
SPEEDSTER 2.2	Z22SE	06/00 ⇨ 08/05
VECTRA B 2.2 i 16V	Z22SE	09/00 ⇨ 07/03
VECTRA C 2.2 16V	Z22SE	04/02 ⇨ 12/08
ZAFIRA A 2.2 16V	Z22SE	09/00 ⇨ 06/05

VAUXHALL

ASTRA IV 2.2 16V	Z22SE	03/00 ⇨ 10/05
SPEEDSTER 2.2	Z22SE	03/01 ⇨ 09/06
VECTRA B 2.2 i 16V	Z22SE	08/95 ⇨ 07/03
VECTRA C 2.2 16V	Z22SE	01/02 ⇨ 10/08
VX220 2.2 i	Z22SE	09/00 ⇨ 07/05
ZAFIRA A 2.2 16V	Z22SE	11/98 ⇨ 08/04

9.3096

04,5

KNOCK SENSORS

Adatt./Suitable:

VW

07C 905 377 M

Eliminated on 04-03-2019. Please verify the availability through our local distributors

- Eliminato il 04-03-2019. Verificare la disponibilità presso i nostri distributori
- Éliminé le 04-03-2019. Vérifier la disponibilité auprès de nos distributeurs sur place
- Am 04-03-2019 gestrichen. Evtl. Verfügbarkeit bitte bei unseren Händlern prüfen
- Eliminado en fecha 04-03-2019. Verificar la disponibilidad a través de nuestros distribuidores locales



L	mV/g		
450	24		

VW

PHAETON 6.0 W12 4motion	BAN	04/02 ⇨ 12/05
TOUAREG I 6.0 W12	BJN, BAN	08/04 ⇨ 05/10

9.3098

04,5

KNOCK SENSORS

Adatt./Suitable:

VW

07C 905 377 P

Eliminated on 04-03-2019. Please verify the availability through our local distributors

- Eliminato il 04-03-2019. Verificare la disponibilità presso i nostri distributori
- Éliminé le 04-03-2019. Vérifier la disponibilité auprès de nos distributeurs sur place
- Am 04-03-2019 gestrichen. Evtl. Verfügbarkeit bitte bei unseren Händlern prüfen
- Eliminado en fecha 04-03-2019. Verificar la disponibilidad a través de nuestros distribuidores locales



L	mV/g		
400	21		

VW

PHAETON 6.0 W12 4motion	BAN	04/02 ⇨ 12/05
-------------------------	-----	---------------

9.3099



04,5

KNOCK SENSORS

Adatt./Suitable:

VW
07C 905 377 AP
07C 905 377 N

⁰³ Supplied until depletion

- Fornibile fino ad esaurimento delle scorte
- Fourni jusqu'à épuisement du stock
- Lieferbar solange vorrat reicht
- Suministrado hasta el stock termina



L	mV/g		
800	24		

VW			
PHAEON 6.0 W12 4motion	BAN, AM11	04/02	⇒ 03/16

9.3105



04,5

KNOCK SENSORS

Adatt./Suitable:

ASTON MARTIN
CD33-12A699-BA

FORD
1 119 941
1 358 032
157A-12A699-BA
157A-12A699-BB

FORD USA
1 358 032
157A-12A699-BB
157Z-12A699-BB

JAGUAR
AJ8 13101

LAND ROVER
LR025005

MAZDA
LF01-18-921
LF02-18-921

VOLVO
30658180
30757381

MARKET DIFFUSION: MEDIUM



L	mV/g		
300	26		

ASTON MARTIN

DB9 6.0	AM11	09/15	⇒ 10/16
DB9 6.0 V12	AM11, QQDA	07/12	⇒ 10/16
RAPIDE 6.0 S	AM11	02/13	⇒ 02/14
VANQUISH 6.0	AM11	10/12	⇒
VANTAGE 6.0 V12S	AM28	01/13	⇒

FORD

C-MAX I 1.8	QQDA, AODA	02/07	⇒ 09/10
C-MAX I 1.8 Flexifuel	Q7DA	02/07	⇒ 09/10
C-MAX I 2.0	AODA, SYDA	02/07	⇒ 09/10
C-MAX I 2.0 CNG	SYDA, --	04/09	⇒ 09/10
C-MAX I 2.0 LPG	SYDA	06/08	⇒ 09/10
C-MAX II 2.0 Energi	--, CSDA	01/15	⇒

FORD			
ECOSPORT 2.0 4x4	C20HDEA	08/12	⇒
FIESTA V ST150	N4JB	03/05	⇒ 06/08
FOCUS I ST170	ALDA	03/02	⇒ 11/04
FOCUS II 1.8	Q7DA, --	03/06	⇒ 09/12
FOCUS II 1.8 Flexifuel	--, AODA	12/05	⇒ 09/12
FOCUS II 2.0	AODA, SYDA	07/04	⇒ 09/12
FOCUS II 2.0 CNG	SYDA, Q7DA	04/09	⇒ 07/11
FOCUS II 2.0 Flex	SYDA	10/08	⇒ 03/10
FOCUS II 2.0 LPG	SYDA	06/08	⇒ 07/11
FOCUS II CASSONE / FURGONATO / PROMISCUO 1.8 Flexifuel	Q7DA, R9DA	06/09	⇒ 07/11
FOCUS III 2.0	XQDA	10/13	⇒
FOCUS III 2.0 DI TIVCT	--	04/11	⇒
FOCUS III 2.0 GDi	MGDA	08/11	⇒
FOCUS III 2.0 ST	R9DA, AOWA	07/12	⇒
FOCUS III 2.0 Ti-GDi	MGDA	07/10	⇒
FOCUS III 2.3 RS AWD	YVDA	07/15	⇒
FOCUS C-MAX 1.8	CSDA, AODA	10/03	⇒ 03/07
FOCUS C-MAX 1.8 Flexifuel	Q7DA	01/06	⇒ 03/07
FOCUS C-MAX 2.0	AODA, Q7DA	03/04	⇒ 03/07
FUSION 2.0	--	11/04	⇒
GALAXY II 2.0	AOWA, TNWA	05/06	⇒ 06/15
GALAXY II 2.0 EcoBoost	TNWA, TBWA	03/10	⇒
GALAXY II 2.0 Flexifuel	TBWA, R9CD	05/06	⇒ 06/15
GALAXY II 2.0 TDCi	AZWA	05/06	⇒ 06/15
GALAXY II 2.3	SEWA	09/07	⇒ 06/15
GALAXY III 2.0 EcoBoost	R9CD, --	01/15	⇒
KUGA II 2.0 4x4	--	03/13	⇒ 06/16
KUGA II 2.0 EcoBoost	--	03/13	⇒
KUGA II 2.0 EcoBoost 4x4	R9MA	08/17	⇒
KUGA II 2.5	--, TNBA	01/14	⇒
KUGA II 2.5 PFI	--	03/13	⇒
MAVERICK 2.3	--	05/06	⇒
MAVERICK 2.3 16V	ZH23HYU	03/04	⇒
MONDEO II 1.8 16V	CGBA, CJBA	10/00	⇒ 03/07
MONDEO II 2.0 16V	CJBA, AOBA	10/00	⇒ 03/07
MONDEO III 2.0	AOBA, TBBA	03/07	⇒ 01/15
MONDEO III 2.0 EcoBoost	TPBA	03/10	⇒ 01/15
MONDEO III 2.0 Flexifuel	TBBA, --	03/09	⇒ 01/15
MONDEO III 2.0 LPG	TBBA	07/09	⇒ 01/15
MONDEO III 2.0 SCTi	TNBA	03/10	⇒ 01/15
MONDEO III 2.3	SEBA	07/07	⇒ 01/15
MONDEO IV 2.0 EcoBoost	--, --	09/12	⇒
MONDEO IV 2.0 EcoBoost 4x4	--	09/12	⇒ 07/16
MONDEO IV 2.0 hybrid	--, --	09/14	⇒
MONDEO IV 2.5	--, GBVAF	09/13	⇒
MONDEO 2.0	AOBC	03/07	⇒ 09/14
MONDEO 2.0 EcoBoost	TNBA, CGBA	03/10	⇒ 09/14
RANGER VI 2.2 TDCi	--	05/15	⇒
RANGER VI 2.2 TDCi 4x4	--	05/15	⇒
RANGER VI 2.5 i	GBVAF, GBVAF	11/11	⇒
RANGER VI 2.5 i 4x4	GBVAF, AODA	11/11	⇒
S-MAX I 2.0	AODA, TNWA	05/06	⇒ 12/14
S-MAX I 2.0 EcoBoost	TNWA, TBWA	03/10	⇒ 12/14
S-MAX I 2.0 Flexifuel	TBWA, R9CD	05/06	⇒ 12/14
S-MAX I 2.3	SEWA	07/07	⇒ 12/14
S-MAX II 2.0 EcoBoost	R9CD, GZFCNG	01/15	⇒
TOURNEO CONNECT II 2.5	--	09/13	⇒
TRANSIT III 2.3 16V CNG RWD	GZFCNG, GZFA	04/06	⇒ 08/14
TRANSIT III 2.3 16V LPG RWD	GZFC	04/06	⇒ 08/14
TRANSIT III 2.3 16V RWD	GZFA, C23HD0D	04/06	⇒ 08/14
TRANSIT III 2.4 TDCi	H9FA	03/04	⇒ 05/06
TRANSIT CONNECT II 2.5	--	02/13	⇒

FORD USA

MUSTANG 2.3 EcoBoost	C23HD0D, 204PT	01/15	⇒
----------------------	----------------	-------	---

JAGUAR

XE 2.0	204PT	03/15	⇒
XF 2.0	204PT	06/12	⇒
XJ 2.0	204PT	05/12	⇒

LAND ROVER

DISCOVERY IV 2.0 4x4	204PT, 204PT	11/14	⇒
FREELANDER 2.2.0 Si4 4x4	204PT	10/11	⇒ 10/14
RANGE ROVER EVOQUE 2.0 [ExtraEU]	204PT	09/11	⇒
RANGE ROVER EVOQUE 2.0 4x4	204PT, LF17	06/11	⇒

MAZDA

3 I 2.0	LF17, LF17	09/03	⇒ 12/09
3 II 2.0 MZR	LF17, LF-5H	01/09	⇒ 09/14
3 II 2.0 MZR DISI	LF-5H, LFD7	12/08	⇒ 05/13
3 II 2.5	LS-VE	03/09	⇒ 09/14
5 I 1.8	L823	02/05	⇒ 05/10
5 I 2.0	LFD7, LF-5H	02/05	⇒ 05/10
5 I 2.0 CD	RF7J	02/05	⇒ 05/10
5 I 2.0 MZR	LFS	09/07	⇒
5 II 1.8 MZR	L850	09/10	⇒
5 II 2.0	LF-5H, L813	09/10	⇒

MAZDA

6 I 1.8	L813, LF17	08/02	⇒ 08/07
6 I 2.0	LF17, L333	06/02	⇒ 08/07
6 I 2.3	L333, L333	01/02	⇒ 02/08
6 I 2.3 AWD	L333, L813	11/02	⇒ 08/07
6 I 2.3 MPS Turbo	L3KG	12/05	⇒ 08/07
6 II 1.8 MZR	L813, LF17	08/07	⇒ 07/13
6 II 2.0 MZR	LF17, L501	08/07	⇒ 07/13
6 II 2.5 MZR	L501, LS-VE	08/07	⇒ 07/13
CX-7 2.5 MZR	LS-VE, L3	07/09	⇒ 03/13
MPV II 2.3	L3, L828	07/02	⇒ 02/06
MX-5 III 1.8	L828, --	03/05	⇒ 12/14
MX-5 III 2.0	--, B42047	03/05	⇒
TRIBUTE 2.3 AWD	L3-VE	04/04	⇒ 05/08
TRIBUTE 2.3 GX	L3-VE	12/03	⇒ 10/04

VOLVO

C30 1.8	B4184511	10/06	⇒ 12/12
C30 1.8 FlexFuel	B418458	01/07	⇒ 12/12
C30 2.0	B420453	10/06	⇒ 12/12
C30 2.0 FlexFuel	B420454	01/10	⇒ 12/12
S40 II 1.8	B4184511	04/04	⇒ 12/10
S40 II 1.8 FlexFuel	B418458	01/06	⇒ 12/10
S40 II 2.0	B420453	10/06	⇒ 12/12
S40 II 2.0 F	B420454	10/09	⇒ 12/12
S60 II 2.0 T	B420476	04/10	⇒ 12/11
S60 II 2.0 T5 DRIVE	B420477	09/14	⇒ 12/15
S60 III T5	B420477	04/10	⇒ 12/14
S80 II 2.0	B420453	01/08	⇒ 09/12
S80 II 2.0 FlexFuel	B420454	01/08	⇒ 12/11
S80 II 2.0 T	B420476	01/10	⇒
S80 III T5	B420477	10/10	⇒
S80L 2.0 T	B420476	01/10	⇒
S80L T5	B420477	01/12	⇒
V50 1.8	B4184511	04/04	⇒ 12/10
V50 1.8 BiFuel	B418458	01/09	⇒ 09/10
V50 1.8 FlexFuel	B418458	01/05	⇒ 12/10
V50 2.0	B420453	10/06	⇒ 12/12
V50 2.0 FlexFuel	B420454	01/10	⇒ 12/12
V60 I 2.0 T	B420476	07/10	⇒ 12/12
V60 I T5	B420477, VQ35DE	09/10	⇒
V70 III 2.0	B420453	10/07	⇒ 12/11
V70 III 2.0 FlexiFuel	B420454	01/08	⇒ 12/11
V70 III 2.0 T	B420476	09/09	⇒ 12/11
V70 III T5	B420477	01/10	⇒ 12/14
XC60 I 2.0 T	B420476	12/09	⇒ 12/12
XC60 I T5	B420477	09/10	⇒ 12/14

9.3109



1

KNOCK SENSORS

Adatt./Suitable:

INFINITI
22060-2A000

NISSAN
22060-2A000

NTK (NGK-GROUP)
KNE20
KNE29

RENAULT
22 06 02A 000

SUBARU
22060-AA081
22060-AA130



mV/g		
37		

INFINITI

FX 35	VQ35DE	02/03	⇒ 12/08
FX 35 Trazione integrale	VQ35DE	01/03	⇒ 12/08
FX 45	VK45DE	02/03	⇒ 12/08
FX 45 AWD	VK45DE	10/08	⇒
FX 45 Trazione integrale	VK45DE	01/03	⇒ 12/08
M35 3.5	VQ35DE	01/05	⇒

INFINITI		
M35 3.5 [ExtraEU]	VQ35DE	01/05 ⇨
M35 3.5 X	VQ35DE	01/05 ⇨
M SERIES 3.5 [ExtraEU]	VQ35DE	01/05 ⇨ 08/08
M SERIES 4.5 [ExtraEU]	VK45DE	01/05 ⇨ 05/10
M45 4.5	VK45DE	01/05 ⇨
NISSAN		
350 Z 3.5	VQ35DE, VQ35DE	09/02 ⇨ 12/08
MURANO 1.3.5	VQ35DE, VQ35DE	08/03 ⇨
MURANO 1.3.5 4x4	VQ35DE, VQ35	08/03 ⇨
PATHFINDER II 3.5 V6 4WD	VQ35, V4Y711	11/00 ⇨ 12/04
TEANA 1.2.3	VQ23DE	10/03 ⇨ 06/08
TEANA 1.3.5	VQ35DE	10/03 ⇨ 06/08
TERRANO II 3.5 4WD	VQ35DE	10/94 ⇨ 06/03
RENAULT		
ESPACE IV 3.5 V6	V4Y711, V4Y701	11/02 ⇨
VEL SATIS 3.5	V4Y715	10/04 ⇨
VEL SATIS 3.5 V6	V4Y701, EZ30	06/02 ⇨
SUBARU		
LEGACY III 3.0	EZ30D	08/00 ⇨ 08/03
LEGACY III 3.0 H6 AWD	EZ30	08/00 ⇨ 08/03
LEGACY IV 3.0	EZ30D	05/03 ⇨
LEGACY IV 3.0 R AWD	EZ30	09/03 ⇨ 06/09
LEGACY V 3.6 AWD	EZ36D	09/09 ⇨ 12/14
OUTBACK II 3.0 H6 AWD	EZ30, M50B20(206S1)	10/00 ⇨ 08/03
OUTBACK III 3.0 AWD	EZ30	11/03 ⇨ 09/09

9.3111



KNOCK SENSORS

Adatt./Suitable:

- SEAT**
066 905 377
- VW**
066 905 377



L	mV/g		
300	21		

9.3113



KNOCK SENSORS

Adatt./Suitable:

- CITROËN**
16 075 784 80
- INFINITI**
22060-7S000
- MITSUBISHI**
1865A014
E1T52271
- NISSAN**
22060-7S000
22060-AU010
- PEUGEOT**
16 075 784 80
- RENAULT**
77 01 065 379
- SIEMENS**
S119337001
- SMART**
A 132 153 01 28

MARKET DIFFUSION: HIGH



mV/g		
21		

9.3110



KNOCK SENSORS

Adatt./Suitable:

- BMW**
1 703 276
12 14 1 703 276
- LAND ROVER**
1703276
- SIEMENS**
S103541001Z



L	mV/g		
200 - 300	28		

BMW		
3 III 320 i	M50B20(206S1), M52B25(256S3)	09/90 ⇨ 10/99
3 III 323 i	M52B25(256S3)	03/95 ⇨ 10/99
3 III 323 i 2.5	M52B25(256S3)	03/95 ⇨ 02/98
3 III 323 ti	M52B25(256S3), M52B20(206S3)	06/97 ⇨ 09/00
3 III 328 i	M52B28(286S1)	08/94 ⇨ 12/99
5 IV 520 i	M52B20(206S3), M52B25(256S3)	09/00 ⇨ 12/03
5 IV 523 i	M52B25(256S3), M52B28(286S1)	11/95 ⇨ 09/00
5 IV 528 i	M52B28(286S1), M52B28(286S1)	11/95 ⇨ 09/00
7 III 728 i, iL	M52B28(286S1), M52B28(286S1)	08/95 ⇨ 11/01
7 III 728i X	M52B28(286S1)	11/95 ⇨ 09/01
Z3 2.8 i	M52B28(286S1), VQ35	01/96 ⇨ 07/00
LAND ROVER		
DEFENDER 2.8 90, 110	--	09/00 ⇨

9.3112



KNOCK SENSORS

Adatt./Suitable:

- NISSAN**
22060-2Y000
- NTK (NGK-GROUP)**
KNE08



mV/g		
36		

NISSAN		
CEFIRO 2.0	VQ20DE	01/00 ⇨ 09/03
CEFIRO 3.0	VQ30DE	01/00 ⇨ 09/03
MAXIMA QX 2.0 V6 24V	VQ20DE	03/00 ⇨ 11/03
MAXIMA QX 3.0 V6 24V	VQ30DE	03/00 ⇨ 11/03
PATHFINDER II 3.5 V6 4WD	VQ35, TB48DE	11/00 ⇨ 12/04
PATROL GR II 4.8	TB48DE, QR20DE	03/00 ⇨
QX 2.0	VQ20DE	01/00 ⇨ 10/01
TERRANO II 3.5 4WD	VQ35DE	10/94 ⇨ 06/03
X-TRAIL 1.2.0	QR20DE, QR20DE	07/01 ⇨ 01/13
X-TRAIL 1.2.0 4x4	QR20DE, QR25DE	07/01 ⇨ 01/13
X-TRAIL 1.2.5 4x4	QR25DE, 4A92	09/01 ⇨ 01/13
X-TRAIL 1.2.5 FWD	QR25DE	06/01 ⇨ 12/07

CITROËN		
C4 AIRCROSS 1.6	4A92	04/12 ⇨
INFINITI		
QX56 5.6 [ExtraEU]	VK56DE	09/03 ⇨ 12/09
QX56 5.6 V8	VK56DE	04/08 ⇨
MITSUBISHI		
ASX 1.6 LPG	4A92	06/10 ⇨
ASX 1.6 MIVEC	4A92, 4A90	05/10 ⇨
COLT VI 1.1	3A91	10/04 ⇨ 06/12
COLT VI 1.1 LPG	3A91	10/04 ⇨ 06/12
COLT VI 1.3	4A90, 3A92	06/04 ⇨
COLT VI 1.3 4WD	4A90	08/04 ⇨
COLT VI 1.3 LPG	4A90	06/04 ⇨ 06/12
ECLIPSE CROSS 1.5	4B40	10/17 ⇨
ECLIPSE CROSS 1.5 4WD	4B40	10/17 ⇨
ECLIPSE CROSS 1.5 T-Mivec	4B40	10/17 ⇨
ECLIPSE CROSS 1.5 T-Mivec 4WD	4B40	10/17 ⇨
I 0.7	3B20	02/07 ⇨
LANCER IX 1.5	4A91	06/08 ⇨
LANCER IX 1.5 Bifuel	4A91	02/10 ⇨
LANCER IX 1.6 MIVEC	4A92	05/10 ⇨
MIRAGE VI 1.0	--	05/12 ⇨
MIRAGE VI 1.0 Bifuel	3A90	04/14 ⇨
MIRAGE VI 1.2	3A92, 6G72(SOHC24V)	01/12 ⇨
MONTERO 3.0 V6	6G72(SOHC12V)	09/06 ⇨
MONTERO 3.8 V6	6G75	09/07 ⇨
PAJERO IV 3.0 4WD	6G72(SOHC24V), 6G75	02/07 ⇨
PAJERO IV 3.8 V6	6G75, QG15DE	10/06 ⇨
PAJERO 3.5	6G74SOHC	09/08 ⇨
PAJERO SPORT II 3.5	6G74(SOHC24V)	01/10 ⇨
PAJERO SPORT II 3.5 V6 24V	6G74(SOHC24V)	09/08 ⇨
SPACE STAR 1.2	3A92	05/12 ⇨
NISSAN		
ALMERA 1.8	QG18DE	07/95 ⇨ 05/00
ALMERA II 1.5	QG15DE, QG18DE	03/00 ⇨
ALMERA II 1.5 XL	QG15DE	03/01 ⇨
ALMERA II 1.8	QG18DE, QG16	01/00 ⇨
ALMERA III 1.6	QG16	01/06 ⇨
ALMERA III 1.6 16V	QG16, QG18DE	03/06 ⇨
ALMERA TINO 1.8	QG18DE, CR12DE	08/00 ⇨ 02/06
CUBE 1.6 16V	HR16DE	03/10 ⇨
FRONTIER 2.5 i [USA]	QR25DE	10/04 ⇨
FRONTIER 4.0 [USA]	VQ40DE	10/04 ⇨
MICRA III 1.0 16V	CG10DE	01/03 ⇨ 06/10
MICRA III 1.2	CR12DE, CG12DE	10/03 ⇨ 06/10
MICRA III 1.2 16V	CG12DE, CG12DEPLG	01/03 ⇨ 06/10
MICRA III 1.2 LPG	CG12DEPLG, YD25DDTi	10/02 ⇨ 06/10
MICRA III 1.3	CGA3DE	08/04 ⇨
MICRA III 1.4 16V	CR14DE	01/03 ⇨ 06/10
MICRA III 160 SR	HR16DE	05/05 ⇨ 06/10

NISSAN			
MICRA C+C 1.4 16V	CR14DE	08/05	→
MICRA C+C 1.6 160 SR	HR16DE	08/05	→
NAVARA II 2.5 i [THA]	QR25DE	08/07	→
NAVARA II 4.0	VQ40DE	05/07	→
NOTE I 1.4	CR14DE	03/06	→ 06/12
NOTE I 1.4 LPG	CR14DE	01/06	→ 08/13
NOTE I 1.6	HR16DE	03/06	→ 06/12
NV200 / EVALIA 1.6 16V	HR16DE	07/10	→
NV200 / EVALIA 2.0	MR20DE	07/10	→
NV200 1.6 16V	HR16DE	02/10	→
PATHFINDER III 2.5 dCi	YD25DDTi	01/05	→
PATHFINDER III 2.5 dCi 4WD	YD25DDTi, QG16DE	01/05	→
PATHFINDER III 4.0 4WD	VQ40DE	09/05	→
PRIMERA III 1.6	QG16DE, HR16DE	01/02	→ 08/08
PRIMERA III 1.6 Visia	QG16DE	01/02	→ 04/06
PRIMERA III 1.8	QG18DE	03/02	→ 10/08
PRIMERA III 1.8 LPG	QG18DE	03/02	→
PRIMERA III 2.0	QR20DE	03/02	→
QASHQAI 1.6 CVTC	HR16DE, HR16DE	08/08	→ 11/13
QASHQAI 2.0	MR20DE	08/08	→ 04/14
QASHQAI I 1.6	HR16DE, MR20DE	02/07	→ 12/13
QASHQAI I 1.6 LPG	HR16DE	11/10	→ 12/13
QASHQAI I 2.0	MR20DE, MR20DE	02/07	→ 04/14
QASHQAI I 2.0 Trazione integrale	MR20DE, MR18DE	02/07	→ 04/14
TEANA I 2.0	QR20DE	10/03	→ 06/08
TIIDA 1.8 [ExtraEU]	MR18DE	01/07	→ 06/11
TIIDA I 1.6	HR16DE	09/07	→ 12/12
TIIDA I 1.8	MR18DE, QR20DE	05/04	→ 12/12
VERSA 1.6 CVTC [ExtraEU]	HR16DE	01/09	→ 06/13
VERSA 1.6 FlexFuel [ExtraEU]	HR16DE	01/11	→ 06/13
X-TRAIL I 2.0	QR20DE, QR20DE	07/01	→ 01/13
X-TRAIL I 2.0 4x4	QR20DE, QR25DE	07/01	→ 01/13
X-TRAIL I 2.5 4x4	QR25DE, MR20DE	09/01	→ 01/13
X-TRAIL I 2.5 FWD	QR25DE	06/01	→ 12/07
X-TRAIL II 2.0	MR20DE, MR20DE	06/07	→ 02/14
X-TRAIL II 2.0 dCi FWD	M9R	06/07	→ 11/13
X-TRAIL II 2.0 FWD	MR20DE, --	03/07	→ 11/13
PEUGEOT			
4008 1.6	--, M4R700	05/12	→
RENAULT			
CLIO 2.0	M4R700, M4R700	11/07	→ 12/12
CLIO III 2.0 16V	M4R700, H4M738	09/06	→
FLUENCE 1.6	H4M738, M4R711	01/13	→
GRAND SCÉNIC III 2.0 16V	M4R711, M4R704	02/09	→
LAGUNA III 2.0 16V	M4R704	10/07	→ 12/15
LAGUNA III 2.0 16V Hi-Flex	M4R704, M4R711	10/07	→ 12/15
MEGANE III 2.0 CVT	M4R711, M4R711	02/09	→
MEGANE CC 2.0 CVT	M4R711, M4R711	06/10	→
SCÉNIC III 2.0 16V	M4R711, M132.930	12/08	→
SMART			
FORTWO II 1.0	M132.910	01/07	→
FORTWO II 1.0 Brabus	M132.930, 35D	01/08	→
FORTWO II 1.0 Turbo	M132.930	01/07	→
FORTWO II 1.0 Turbo Brabus	M132.930	07/10	→

9.3114



1

KNOCK SENSORS

Adatt./Suitable:

BOSCH

0 261 231 133
0 261 231 134
0 261 231 140

LAND ROVER

NSC100650

MERCEDES-BENZ

0041530928
A 004 153 09 28

SMART

Q 0003120V002000000



mV/g		
26		

LAND ROVER

DISCOVERY II 4.0 V8 4x4	35D, 42D	11/98	→ 06/04
DISCOVERY II 4.6 V8 [USA]	--	01/03	→ 06/04
RANGE ROVER II 3.9 4x4	42D	07/94	→ 03/02
RANGE ROVER II 4.0 4x4	42D, 46D	01/95	→ 03/02
RANGE ROVER II 4.6 4x4	46D, M160E6ALB03	07/94	→ 03/02

SMART

CABRIO 0.6	M160E6ALB03, M160.910	03/00	→ 01/04
CABRIO 0.7	M160.910, M160E6ALB03	01/03	→ 01/04
CITY-COUPÉ 0.6	M160E6ALB03, M160.910	01/01	→ 01/04
CITY-COUPÉ 0.7	M160.910, M160.910	01/03	→ 01/04
CITY COUPÉ 0.6	M160.910	12/99	→ 04/03
CROSSBLADE 0.6	M160.910, M160.910	06/02	→ 12/03
FORTWO I 0.6	M160.910	01/04	→ 02/07
FORTWO I 0.7	M160.910, M160.921	01/04	→ 01/07
FORTWO 0.6 [ExtraEU]	M160.910	01/04	→ 12/06
ROADSTER 0.7	M160.921, 350A1.000	04/03	→ 11/05
ROADSTER 0.7 Brabus	M160.923	12/03	→ 11/05

9.3115



1

KNOCK SENSORS

Adatt./Suitable:

ALFA ROMEO

46538111
55269065

CHRYSLER

46538111
55269065

FIAT

46538111
46815152
55190562
55269065

FORD

1 535 715
1 563 287
1 592 423
9551-12A699-AB

LANCIA

46538111
46815152
55190562
55269065

NTK (NGK-GROUP)

KNE11
KNE11C
KNE21

MARKET DIFFUSION: HIGH



mV/g		
22		

ALFA ROMEO

MITO 1.4 350A1.000, 183A1.000 03/11 →

CHRYSLER

YPSILON 1.2 169A4.000 05/11 →

FIAT

500 1.2	169A4.000	10/07	→
500 1.2 LPG	169A4.000	12/10	→
500 C 1.2	169A4.000	09/09	→
500 MY12 1.2	--	01/12	→
500 MY15 1.2	--	01/15	→
500 MY15 1.2 LPG	--	01/15	→
BARCETTA 1.8 16V	183A1.000, 182B6.000	04/95	→ 05/05
BRAVA 1.6 16V	182B6.000	01/99	→ 12/02
BRAVO I 1.6	182B6.000	09/00	→ 10/01
DOBLO 1.6 Natural Power	182B6000CNG	02/04	→ 07/09
DOBLO I 1.2	223A5.000	03/01	→
DOBLO I 1.4	350A1.000	10/05	→
DOBLO I 1.6	182B6.000	09/02	→
DOBLO I 1.6 16V	182B6.000	10/01	→
DOBLO I 1.6 Natural Power	182B6.000, 350A1.000	09/02	→
FIORINO II 1.2 MPI	178E8.011	01/04	→
FIORINO III 1.4	350A1.000	10/09	→
FIORINO III 1.4 Natural Power	350A1.000, 182B6.000	06/08	→
GRANDE PUNTO 1.4	350A1.000	02/06	→ 06/13
GRANDE PUNTO 1.4 LPG	350A1.000	03/09	→ 12/12
GRANDE PUNTO 1.4 Natural Power	350A1000CNG	03/09	→ 12/12
IDEA 1.4	350A1.000	10/05	→
IDEA 1.4 LPG	350A1.000	03/09	→
LINEA 1.4	350A1.000	06/07	→
MAREA 1.6	182B6.000	09/00	→ 08/02
MULTIPLA 1.6	182B6.000, 17887.045	09/00	→ 06/10
MULTIPLA 1.6 16V	182B6.000	04/02	→ 06/10
MULTIPLA 1.6 16V Bipower	182B6.000	10/01	→ 06/10
MULTIPLA 1.6 16V GPL	182B6.000	10/01	→ 06/10
MULTIPLA 1.6 Natural Power	182B6000CNG	11/08	→ 06/10
PALIO 1.0	178A1.000	04/96	→ 10/03
PALIO 1.0 GLX	--	07/98	→ 10/03
PALIO 1.1	187A1.000	06/06	→
PALIO 1.2	178B7.045, 350A1.000	07/97	→ 10/04
PALIO 1.3 JTD Multijet	188A9.000	06/03	→
PALIO 1.4	350A1.000, 169A4.000	10/02	→
PALIO 1.5	178E5.022	02/02	→
PALIO 1.5 MPI	178E5.027	08/01	→
PALIO 1.6 16V	182B6.000	02/01	→
PALIO 1.6 16V Sport	178E7.000	10/01	→

FIAT		
PALIO 1.7 TD	176A5.000	09/01 →
PANDA I 1.1	187A1.000	09/00 → 02/04
PANDA I 1.1 AWD	187A1.000	09/00 → 02/04
PANDA I 1100	187A1.000	02/95 → 09/03
PANDA I 1100 i.e. 4x4	187A1.000	12/00 →
PANDA II 1.1	--	09/03 →
PANDA II 1.2	169A4.000, 169A4.000	09/03 →
PANDA II 1.2 4x4	169A4.000, 169A4.000	09/04 →
PANDA II 1.2 Bipower	188A4.000	09/04 → 12/11
PANDA II 1.2 Bi-Power / Natural Power	--	04/09 →
PANDA II 1.2 Euro 4	--	04/09 →
PANDA II 1.2 Euro 5	--	04/09 →
PANDA II 1.2 LPG	169A4.000, 188A4.000	04/09 →
PANDA II 1.2 Natural Power	188A4.000, 350A1.000	01/07 → 12/11
PANDA II 1.4 16V	--	01/10 →
PANDA II 1.4 Natural Power	350A1.000, 188A4.000	10/09 →
PANDA III 1.2	169A4.000	02/12 →
PANDA III 1.2 LPG	169A4.000	06/12 →
PUNTO II 1.2	188A4.000	06/03 →
PUNTO II 1.2 60	188A4.000	09/99 → 12/10
PUNTO II 1.2 Bifuel	188A4.000	08/07 → 03/12
PUNTO II 1.2 Bipower	188A4.000	08/01 → 05/03
PUNTO II 1.2 Natural Power	188A4.000, 183A1.000	01/03 → 03/12
PUNTO II 1.8 130 HGT	183A1.000, 169A4.000	09/99 → 03/12
PUNTO II 1.8 16V	188A6.000	06/03 →
PUNTO III EVO 1.2	169A4.000, 199A7.000	10/09 → 02/12
PUNTO III EVO 1.4	199A7.000, 350A1.000	03/09 →
PUNTO III EVO 1.4 LPG	350A1.000	06/09 → 02/12
PUNTO III EVO 1.4 Natural Power	350A1.000, 350A1.000	10/09 → 02/12
PUNTO III / GRANDE PUNTO 1.2	169A4.000, 199A7.000	10/05 →
PUNTO III / GRANDE PUNTO 1.2 Actual	--	09/09 →
PUNTO III / GRANDE PUNTO 1.2 LPG	199A4.000	07/08 →
PUNTO III / GRANDE PUNTO 1.4	199A7.000, 350A1.000	06/05 → 12/15
PUNTO III / GRANDE PUNTO 1.4 Actual	--	09/09 →
PUNTO III / GRANDE PUNTO 1.4 LPG	350A1.000	12/08 →
PUNTO III / GRANDE PUNTO 1.4 Natural Power	350A1.000, 169A4.000	07/08 →
PUNTO III 1.2	169A4.000, 199A7.000	03/12 →
PUNTO III 1.4	199A7.000, 350A1.000	04/08 →
PUNTO III 1.4 Bifuel	350A1.000	03/12 →
PUNTO III 1.4 LPG	350A1.000	03/09 →
PUNTO III 1.4 Natural Power	350A1.000, 169A4.000	03/09 →
PUNTO 1.4	350A1.000	03/12 →
PUNTO 1.4 LPG	350A1.000	03/09 → 02/12
PUNTO 1.4 Natural Power	350A1000CNG	03/09 → 02/12
QUBO 1.4	350A1.000	10/09 →
QUBO 1.4 Natural Power	350A1.000, 176B2.000	10/09 →
SEICENTO / 600 1.1	176B2.000, 178E5.022	01/98 → 01/10
SIENA 1.2	188A4.000	09/01 → 12/12
SIENA 1.3 JTD	188A9.000	09/03 → 12/09
SIENA 1.4	--	01/02 →
SIENA 1.5	178E5.022, --	09/02 →
SIENA 1.6	182B6.000	11/00 → 12/09
SIENA 1.6 16V	178D2.011	03/99 →
SIENA 1.7 [CHN]	--	01/06 →
STILO 1.6	--, FP4	04/05 → 08/08
STILO 1.6 16V	182B6.000	10/01 → 08/08
STILO 1.8 16V	192A4.000	10/01 → 08/08
STRADA 1.2	188A4.000	04/03 →
FIAT (BR)		
BRAVA 1.6i 16v	1.6Mpi	01/02 →
PALIO 1.0i	1.0MpiFire	01/01 →
PALIO 1.6i 16v	1.6Mpi16v	01/01 →
STRADA 1.6i 16v	1.6Mpi	01/02 →
UNO MILLE 1.0i	1.0MpiFire	01/02 →
FORD		
KA II 1.2	FP4, 839A4.000	10/08 →
LANCIA		
LYBRA 1.6	182B6.000	10/00 → 10/05
LYBRA 1.8 16V	839A4.000, 188A4.000	07/99 → 10/05
MUSA 1.4	350A1.000	09/05 → 09/12
MUSA 1.4 8V	--	01/11 → 12/12
MUSA 1.4 LPG	350A1.000	11/10 → 09/12
Y 1.2	188A4.000, 169A4.000	03/96 → 09/03
YPSILON I 1.2	169A4.000, M43B18(184E2)	10/03 → 12/11
YPSILON I 1.4	350A1.000	02/06 → 12/11
YPSILON I 1.4 LPG	350A1.000	11/10 → 12/11
YPSILON II 1.2	169A4.000	05/11 →
YPSILON II 1.2 Bi-fuel	169A4.000	05/11 →

9.3118

04,5

KNOCK SENSORS

Adatt./Suitable:

VW
 037 905 377 B

L	mV/g		
350	23		

VW

BORA 1.6 APF 05/99 → 05/05

9.3120

04,5

KNOCK SENSORS

Adatt./Suitable:

BMW
 12 14 1 247 993
BOSCH
 0 261 231 112

L	mV/g		
225 - 315	22		

BMW

3 III 316 g	M43B16(164E2)	03/94 → 08/00
3 III 316 i	M43B16(164E2)	07/93 → 08/00
3 III 318 i	M43B18(184E2)	10/93 → 10/99
3 III 318 is	M44B19(19451)	09/95 → 04/99
3 III 318 ti	M44B19(19451)	07/95 → 08/00
Z3 1.8 i	M43B18(184E2), M44B19(19451)	10/95 → 10/98
Z3 1.9 i	M44B19(19451), G6BA	10/95 → 03/99

9.3122

04,5

KNOCK SENSORS

Adatt./Suitable:

HYUNDAI
 39250-37150
 39250-4X000

KIA
 39250-37150
 39250-4X000

L	mV/g		
300	23		

HYUNDAI

COUPE II 2.7 V6	G6BA, G6BA	01/01 → 08/09
SANTA FE I 2.7 4x4	G6BA	09/02 → 12/04
SANTA FE I 2.7 V6 4x4	G6BA, G6BV	02/01 → 03/06
SONATA IV 2.5 V6 24V	G6BV, G6BA	06/98 → 10/01
SONATA IV 2.7 V6	G6BA, J3	10/01 → 11/04
SONATA V 2.7 V6 [RUS]	--	01/05 → 12/10
TERRACAN 2.9 CRDi	J3	11/01 → 07/03
TERRACAN 2.9 CRDi 4WD	J3, G6BA	12/01 → 12/06
TIBURON 2.7 CVVT [ExtraEU]	G6BA	02/02 → 12/08
TRAJET 2.7 V6	G6BA, G6BA	09/00 → 07/08
TUCSON 2.7 Trazione integrale	G6BA, K5	08/04 →

KIA

CARNIVAL I 2.9 CRDi	J3	10/01 → 06/06
CARNIVAL I 2.9 TD	J3	01/99 → 09/07
MAGENTIS I 2.5 V6	G6BV	05/01 →
SEDONA 2.9 CRDi	--	07/01 →
SPORTAGE II 2.7 V6 4WD	G6BA	09/04 →

9.3123

04,5

KNOCK SENSORS

Adatt./Suitable:

KIA
 0K0AF-18921

L	mV/g		
350	23		

KIA

CARENS II 1.6	GA6D	07/02 →
CARNIVAL I 2.5 V6	K5, G6BA	08/99 → 06/06
CERATO I 1.6	B4ZE	04/04 → 12/09
SEDONA 2.5 V6	--	07/01 →
SEPHIA II 1.6 i 16V	--	07/00 →
SHUMA I 1.6	GA6D	01/01 → 12/01
SHUMA II 1.6	GA6D	05/01 → 08/04

KIA		
SHUMA II 1.8	T8D	04/03 ⇨ 08/04
SPECTRA 1.6 i 16V	--	07/00 ⇨

9.3124



04,5

KNOCK SENSORS

Adatt./Suitable:

HYUNDAI
39250-37100
KIA
39250-37100

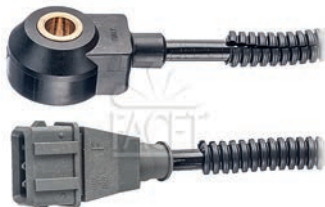

L	mV/g		
300	23		

HYUNDAI

COUPE II 2.7 V6	G6BA, G6BA	01/01 ⇨ 08/09
HIGHWAY VAN 2.7 V6 24V	G6BA	03/00 ⇨ 03/04
SANTA FE I 2.7 4x4	G6BA	09/02 ⇨ 12/04
SANTA FE I 2.7 V6 4x4	G6BA, G6BV	02/01 ⇨ 03/06
SONATA IV 2.5 V6 24V	G6BV, G6BA	06/98 ⇨ 10/01
SONATA IV 2.7 V6	G6BA, G6BA	10/01 ⇨ 11/04
SONATA V 2.7 V6 [RUS]	--	01/05 ⇨ 12/10
TIBURON 2.7 CVT [ExtraEU]	G6BA	02/02 ⇨ 12/08
TRAJET 2.7 V6	G6BA, G6BA	09/00 ⇨ 07/08
TUCSON 2.7 Trazione integrale	G6BA, T8	08/04 ⇨
XG 250	G6AV	12/98 ⇨ 12/05

KIA

SPORTAGE II 2.7 V6 4WD	G6BA	09/04 ⇨
------------------------	------	---------

9.3127



04,5

KNOCK SENSORS

Adatt./Suitable:

KIA
0K2CC-18921



L	mV/g		
450	26		

KIA

CARENS 1.8 [ExtraEU]	T8, OK24N	03/00 ⇨ 08/06
CARENS I 1.8 i	T8, OK24N	11/00 ⇨ 07/02
CARENS I 1.8 i 16V	T8D	03/00 ⇨ 05/02
CARENS II 1.8	T8	07/02 ⇨
CERATO I 1.8	T8	10/01 ⇨ 07/04
SEPHIA I 1.8 i 16V	OK24N, T8	01/95 ⇨ 10/97
SEPHIA II 1.8 i 16V	--	09/97 ⇨
SHUMA I 1.8 i 16V	T8, T8	10/97 ⇨ 03/01
SHUMA II 1.8	T8, B5244S	05/01 ⇨ 08/04

KIA		
SPECTRA 1.8 i 16V	--	09/97 ⇨

9.3130



04,5

KNOCK SENSORS

Adatt./Suitable:

DENSO
171000-1030
VOLVO
949703-0



L	mV/g		
510 - 550	20		

VOLVO

S60 I 2.4	B5244S, B5244S	07/00 ⇨ 04/10
S60 I 2.4 Bifuel	B5244S62	07/01 ⇨ 04/10
S80 I 2.4	B5244S, B5244SG	01/99 ⇨ 07/06
S80 I 2.4 Bifuel	B5244SG, B5244S	09/01 ⇨ 07/06
V70 II 2.3	B523417	10/00 ⇨ 09/04
V70 II 2.3 T5	B5234T3	11/99 ⇨ 12/04
V70 II 2.4	B5244S, B5204T3	03/00 ⇨ 08/07
V70 II 2.4 Bifuel	B5244S62	09/01 ⇨ 08/07
XC90 I V8 AWD	B8444S	01/05 ⇨ 12/10

9.3131



04,5

KNOCK SENSORS

Adatt./Suitable:

BOSCH
0 261 231 142
VOLVO
943257-0



L	mV/g		
500 - 570	27		

VOLVO

C70 I 2.0T	B5204T3, B5234T3	03/00 ⇨ 10/05
C70 I 2.3 T5	B5234T3, B5244T	07/02 ⇨ 10/05

VOLVO		
C70 I 2.3 T-5	B5234T3	03/97 ⇨ 09/02
C70 I 2.4	B5244S	05/99 ⇨ 09/02
C70 I 2.4 T	B5244T, B5202FS	03/97 ⇨ 10/05
S60 I 2.0 T	B5204T5	07/00 ⇨ 04/10
S60 I 2.3 T5	B5234T7	07/00 ⇨ 09/02
S60 I 2.4 AWD	B5244T5	02/04 ⇨ 04/10
S60 I 2.4 T	B5244T3	07/00 ⇨ 04/10
S60 I 2.4 T AWD	B5244T3	06/01 ⇨ 04/10
S60 I 2.5 AWD	B5254T4	09/03 ⇨ 04/10
S60 I 2.5 T	B5254T2	01/03 ⇨ 04/10
S60 I 2.5 T AWD	B5254T2	07/02 ⇨ 04/10
S60 I T5	B5234T3	07/00 ⇨ 04/10
S70 2.0	B5202FS, B5244T	01/97 ⇨ 11/00
S70 2.3	B5234T7	04/99 ⇨ 09/00
S70 2.3 AWD	B5234T7	04/99 ⇨ 09/00
S70 2.4	B5252FS	01/97 ⇨ 11/00
S70 2.4 AWD	B5252FS	11/96 ⇨ 05/99
S70 2.4 Bifuel	GB5252S	10/98 ⇨ 11/00
S70 2.4 T5 AWD	B5254T	11/96 ⇨ 04/99
S70 2.4 Turbo	B5244T, B5204T3	01/97 ⇨ 11/00
S70 2.5 Bifuel	GB5252S2	01/99 ⇨ 12/99
S80 I 2.0	B5204T4	06/98 ⇨ 07/06
S80 I 2.0 T	B5204T3, B6294S	06/98 ⇨ 07/06
S80 I 2.3 R	B5234T7	04/00 ⇨ 08/05
S80 I 2.4 LTP	B5244T4	06/04 ⇨ 07/06
S80 I 2.4 T	B5244T3	06/00 ⇨ 07/06
S80 I 2.4 T5 AWD	B5244T3	04/00 ⇨ 09/03
S80 I 2.5 T	B5254T2	03/03 ⇨ 07/06
S80 I 2.5 T AWD	B5254T2	07/03 ⇨ 07/06
S80 I 2.8 T6	B6284T	05/98 ⇨ 07/06
S80 I 2.9	B6294S, B5202FS	05/98 ⇨ 07/06
S80 I 3.0	B6294S2	06/01 ⇨ 07/06
S80 I 3.0 T6	B6294T	06/01 ⇨ 07/06
V70 I 2.0	B5202FS, B5234T7	12/95 ⇨ 12/00
V70 I 2.3 AWD	B5234T7, B5244T	12/98 ⇨ 02/00
V70 I 2.3 T-5	B5234T3	11/96 ⇨ 12/00
V70 I 2.3 T-5 AWD	B5234T3	01/97 ⇨ 12/00
V70 I 2.4	B5252FS	12/95 ⇨ 03/00
V70 I 2.4 Bifuel	GB5252S	05/98 ⇨ 12/99
V70 I 2.4 Turbo	B5244T, B5244T	04/96 ⇨ 12/00
V70 I 2.4 Turbo AWD	B5244T, B5244T3	04/96 ⇨ 12/00
V70 I 2.5	B5252FS	01/97 ⇨ 03/00
V70 I 2.5 Bifuel	GB5252S2	01/99 ⇨ 12/99
V70 II 2.0 T	B5204T5	11/99 ⇨ 08/07
V70 II 2.3 AWD	B5234T7	10/00 ⇨ 09/04
V70 II 2.4 T	B5244T3, B5244T	01/05 ⇨ 12/05
V70 II 2.4 T AWD	B5244T3	09/01 ⇨ 08/02
V70 II 2.4 T5	B5244T5	04/04 ⇨ 08/07
V70 II 2.5 AWD	B5254T2	09/02 ⇨ 12/04
V70 II 2.5 R Sport	B5254T4	12/02 ⇨ 08/07
V70 II 2.5 T	B5254T2	07/01 ⇨ 08/07
V70 II 2.5 T AWD	B5254T2	07/02 ⇨ 08/07
V70 II R 2,5 T AWD	B5254T4	03/03 ⇨ 08/07
XC70 I 2.3 T XC AWD	B5234T7	01/01 ⇨ 07/04
XC70 I 2.4 T XC AWD	B5244T, B5254T2	03/00 ⇨ 12/06
XC70 I 2.5 T XC AWD	B5254T2	09/02 ⇨ 08/07
XC90 I 2.5 T AWD	B5254T2, N43B16A	10/02 ⇨ 09/14
XC90 I T6 AWD	B6294T	10/02 ⇨ 12/06



KNOCK SENSORS

Adatt./Suitable:

BMW

12 14 1 435 485
13 62 7 568 422
7 568 422

SIEMENS

S107126001Z

MARKET DIFFUSION: **MEDIUM**



L	mV/g		
225 - 315	23		

BMW

11116 i	N43B16A, N43B20A	11/03 ⇨ 12/11
11118 d	M47D20(204D4)	11/03 ⇨ 02/07
11118 i	N43B20A, N43B20A	07/04 ⇨ 12/13
11120 i	N43B20A, M43B16(164E3)	11/03 ⇨ 12/13
11123 d	N47D20D	10/07 ⇨ 12/13
1 SERIES 118i [ExtraEU]	N46B20B	09/04 ⇨ 02/08
3 III 316 i	M43B19(194E1)	12/98 ⇨ 08/00
3 IV 316 Ci	M43B16(164E3), M43B16(164E3)	04/00 ⇨
3 IV 316 i	M43B16(164E3), N40B16A	04/00 ⇨ 02/05
3 IV 316 ti	N40B16A, M43B19(194E1)	06/01 ⇨ 02/05
3 IV 318 Ci	M43B19(194E1), M43B19(194E1)	12/00 ⇨ 12/07
3 IV 318 i	M43B19(194E1), N42B20A	09/01 ⇨ 02/05
3 IV 318 ti	N42B20A, M52B20(206S4)	03/01 ⇨ 12/04
3 IV 320 Ci	M52B20(206S4), M52B20(206S4)	01/00 ⇨ 12/07
3 IV 320 i	M52B20(206S4), M52B25(256S4)	09/00 ⇨ 02/05
3 IV 323 Ci	M52B25(256S4), -(246S3)	04/99 ⇨ 09/00
3 IV 323 i	-(246S3), M54B25(256S5)	03/98 ⇨ 12/03
3 IV 325 Ci	M54B25(256S5), -(246S4)	09/00 ⇨
3 IV 325 i	-(246S4), M54B25(256S5)	09/00 ⇨
3 IV 325 ti	M54B25(256S5), M52B28(286S2)	06/01 ⇨ 02/05
3 IV 325 xi	M54B25(256S5)	09/00 ⇨ 02/05
3 IV 328 Ci	M52B28(286S2), M52B28(286S2)	04/99 ⇨ 06/00
3 IV 328 i	M52B28(286S2), M54B30(306S3)	02/98 ⇨ 06/00
3 IV 330 Ci	M54B30(306S3), M54B30(306S3)	06/00 ⇨ 12/07
3 IV 330 i	M54B30(306S3), M54B30(306S3)	06/00 ⇨ 04/05
3 IV 330 xi	M54B30(306S3), N43B16A	06/00 ⇨ 07/06
3 V 316 i	N43B16A, N43B20A	09/05 ⇨ 12/13
3 V 318 i	N43B20A, N43B20A	03/05 ⇨ 12/13
3 V 320 i	N43B20A, M52B20(206S3)	03/05 ⇨ 12/13
3 V 320 si	N45B20A	09/05 ⇨ 08/06
3 SERIES 316i Coupe	M43164E3	04/99 ⇨ 02/02
3 SERIES 320i Touring [ExtraEU]	N43B20A	06/07 ⇨ 10/12
5 IV 520 i	M52B20(206S3), M52B25(256S3)	09/00 ⇨ 05/04
5 IV 523 i	M52B25(256S3), M54B25(256S5)	11/95 ⇨ 09/00
5 IV 525 i	M54B25(256S5), M52B28(286S1)	09/00 ⇨ 05/04
5 IV 528 i	M52B28(286S1), M54B30(306S3)	11/95 ⇨ 09/00
5 IV 530 i	M54B30(306S3), M54226S1	09/00 ⇨ 05/04



KNOCK SENSORS

Adatt./Suitable:

BOSCH

0 261 231 110
0 261 231 111

INFiniti

22060-HG00B
22060-HG00F

LADA

21120-3855020-00
21120-3855020-01
21120-3855020-02
21120-3855020-03
2112-3855020
2112-3855020-01
2112-3855020-02
2112-3855020-03

MERCEDES-BENZ

0031538628
A 003 153 86 28
A 270 905 02 00
A 270 905 09 00

MARKET DIFFUSION: **HIGH**



mV/g		
23		



KNOCK SENSORS

Adatt./Suitable:

BOSCH

0 261 231 103

TOYOTA

89615-05010



mV/g		
30		

TOYOTA

AVENSIS I 1.6	4A-FE, 4A-FE	09/97 ⇨ 10/00
CARINA E 1.6	4A-FE, 1SZ-FE	04/92 ⇨ 09/97
CARINA E 1.6 16V	4A-FE	12/94 ⇨ 09/97
CARINA E 1.6 GLI	4A-FE	04/92 ⇨ 09/97
CARINA E 1.6 i	4A-FE	02/95 ⇨ 09/97
YARIS I 1.0	1SZ-FE, 270910	03/03 ⇨ 09/05

INFiniti

Q30 1.6	270910, 2110	11/15 ⇨
Q30 2.0T	270920	11/15 ⇨
Q30 2.0T AWD	270920	11/15 ⇨
Q50 2.0T	M274	04/14 ⇨
Q60 2.0T	0M274	09/16 ⇨
QX30 2.0 AWD	270920	09/16 ⇨

LADA

110 1.5	2110, 2112	10/00 ⇨ 12/05
110 1.5 16V	2112, 21104	10/00 ⇨ 12/10
110 1.6	21104, 21124	01/00 ⇨ 12/12
110 1.6 16V	21124, 21114	10/04 ⇨ 12/10
110 1.6 LPG	21114, 2110	10/04 ⇨ 03/07
111 1.5	2110, 2112	10/00 ⇨ 12/05
111 1.5 16V	2112, 2111	10/00 ⇨ 12/05
112 1.5	2111, 2112	10/00 ⇨ 12/05
112 1.5 16V	2112, VAZ-11186	10/00 ⇨ 12/05
112 1.6	21104	03/06 ⇨ 12/08

GRANTA 1.6	VAZ-11186, 11186	10/11 ⇨
KALINA 1.4 16V	VAZ1118	11/08 ⇨ 12/13
KALINA 1.4 16V LPG	VAZ1118	11/08 ⇨
KALINA 1.6	11186, VAZ-21114	10/04 ⇨
KALINA 1.6 NFR	21126	09/16 ⇨
KALINA 1.6 Sport	21126	06/13 ⇨

NADESCHDA 1.7	UAZ2121	12/97 ⇨ 12/06
NADESCHDA 1.7 i	UAZ21214	12/97 ⇨ 12/06
NADESCHDA 1.8	VAZ-2130	12/97 ⇨ 12/06
NIVA III 1.7 i	--	01/07 ⇨
PRIORA 1.6	VAZ-21114, 11194	04/07 ⇨
PRIORA 1.6 LPG	11194, 211182	12/08 ⇨

SAMARA 1.5	211182, M178.980	08/03 ⇨ 12/13
SAMARA 1.6	B321842	02/09 ⇨ 12/13

MAYBACH

57 5.5	285950	09/02 ⇨ 12/12
57 6.0	285980	01/11 ⇨ 12/12
57 S 6.0	285980	09/05 ⇨ 12/12
62 5.5	285950	09/02 ⇨ 12/12
62 6.0	285980	01/11 ⇨ 12/12
62 S 6.0	285980	09/05 ⇨ 12/12

MERCEDES-BENZ

AMG GT 63 4-matic+	M177.980	07/18 ⇨
AMG GT 63 S 4-matic+	M177.980	07/18 ⇨
AMG GT GT	M178.980, M178.980	08/15 ⇨
AMG GT GT C	M178.980	11/16 ⇨
AMG GT GT R	M178.980	11/16 ⇨
AMG GT GT S	M178.980, M270.920	10/14 ⇨
CLA-SERIES CLA250 Flexfuel	M270.920	01/13 ⇨
CLASSE A III A 160	M270.910	07/15 ⇨
CLASSE A III A 180	M270.910	06/12 ⇨

MERCEDES-BENZ		
CLASSE A III A 200	M270.910	06/12 →
CLASSE A III A 220 4-matic	M270.920	05/14 →
CLASSE A III A 250	M270.920	07/15 →
CLASSE A III A 250 4-matic	M270.920, 270920NGT	06/12 →
CLASSE A III A 45 AMG	M133.980	06/13 → 06/15
CLASSE A III AMG A 45 4-matic	M133.980	07/15 →
CLASSE B II B 180	M270.910	11/11 →
CLASSE B II B 200	M270.910	11/11 →
CLASSE B II B 200 Natural Gas Drive / B 200 c	270920NGT, M112.910	11/12 →
CLASSE B II B 220 4-matic	M270.920	05/13 →
CLASSE B II B 250	M270.920	05/12 →
CLASSE B II B 250 4-matic	M270.920	08/14 →
CLASSE C I C 240	M112.910	06/97 → 05/00
CLASSE C I C 240 T	M112.910, M274.910	09/00 → 03/01
CLASSE C I C 280	M112.920	06/97 → 05/00
CLASSE C I C 280 T	M112.920	06/97 → 03/01
CLASSE C I C 43 AMG	M113.944	08/97 → 03/01
CLASSE C II C 240	M112.912	05/00 → 08/07
CLASSE C II C 240 4-matic	M112.916	07/02 → 08/07
CLASSE C II C 32 AMG Kompressor	M112.961	02/01 → 08/07
CLASSE C II C 320	M112.946	05/00 → 05/08
CLASSE C II C 320 4-matic	M112.953	07/02 → 08/07
CLASSE C II C 55 AMG	M113.988	02/04 → 08/07
CLASSE C III C 180	M274.910	02/12 →
CLASSE C III C 180 CGI	M274.910	01/08 → 01/14
CLASSE C IV AMG C 63	M177.980	10/14 →
CLASSE C IV AMG C 63 S	M177.980	10/14 →
CLASSE C IV C 160	M274.910	04/15 →
CLASSE C IV C 180	M274.910, M270.910	03/14 →
CLASSE C IV C 200	M274.920	12/13 →
CLASSE C IV C 200 4-matic	M274.920	04/15 →
CLASSE C IV C 250	M274.920	03/14 →
CLASSE C IV C 300	M274.920	09/15 →
CLASSE C IV C300 [ExtraEU]	M274.920	12/13 →
CLASSE CLA AMG CLA 45 4-matic	M133.980	07/15 →
CLASSE CLA CLA 180	M270.910	01/13 →
CLASSE CLA CLA 200	M270.910, M270.910	01/13 →
CLASSE CLA CLA 220 4-matic	M270.910, M270.920	01/15 →
CLASSE CLA CLA 250	M270.920, M270.920	01/13 →
CLASSE CLA CLA 250 4-matic	M270.920, M113.968	07/13 →
CLASSE CLA CLA 45 AMG 4-matic	M133.980	07/13 →
CLASSE CLK I 320	M112.940	06/97 → 06/02
CLASSE CLK I 430	M113.943	07/98 → 06/02
CLASSE CLK I 55 AMG	M113.984	08/99 → 06/02
CLASSE CLK II 240	M112.912	06/02 → 05/09
CLASSE CLK II 320	M112.955	06/02 → 05/09
CLASSE CLK II 500	M113.968, M113.968	06/02 → 05/09
CLASSE CLK II 55 AMG	M113.987	09/02 → 05/09
CLASSE CLK II CLK 240	M112.912	02/03 → 03/10
CLASSE CLK II CLK 320	M112.955	02/03 → 03/10
CLASSE CLK II CLK 500	M113.968, M112.911	02/03 → 03/10
CLASSE CLK II CLK 55 AMG	M113.987	02/03 → 03/10
CLASSE CLK II CLK AMG DTM	M113.987	06/04 → 03/10
CLASSE CLK II DTM AMG	M113.987	06/04 → 05/09
CLASSE CLS I CLS 500	M113.967	10/04 → 12/10
CLASSE CLS I CLS 55 AMG	M113.990	01/05 → 12/10
CLASSE CLS II CLS 250	M274.920	05/14 →
CLASSE E II E 240	M112.911, M112.911	08/00 → 03/02
CLASSE E II E 240 T	M112.911, M119.980	08/00 → 03/03
CLASSE E II E 280	M112.921	12/96 → 03/02
CLASSE E II E 280 4-matic	M112.921	12/96 → 03/02
CLASSE E II E 280 T	M112.921	12/96 → 03/03
CLASSE E II E 280 T 4-matic	M112.921	12/96 → 03/03
CLASSE E II E 320	M112.941	06/97 → 03/02
CLASSE E II E 320 4-matic	M112.941	06/97 → 03/02
CLASSE E II E 320 T	M112.941	12/96 → 03/03
CLASSE E II E 320 T 4-matic	M112.941	12/96 → 03/03
CLASSE E II E 420	M119.980, M119.980	01/96 → 06/97
CLASSE E II E 420 T	M119.985	06/96 → 06/97
CLASSE E II E 430	M113.940	06/97 → 03/02
CLASSE E II E 430 4-matic	M113.940	05/99 → 03/02
CLASSE E II E 430 T	M113.940	06/97 → 03/03
CLASSE E II E 430 T 4-matic	M113.940	05/99 → 03/03
CLASSE E II E 50 AMG	M119.980, M274.910	02/96 → 08/97
CLASSE E II E 55 AMG	M113.980	08/97 → 03/02
CLASSE E II E 55 T AMG	M113.980	08/97 → 03/03
CLASSE E III E 240	M112.913	03/02 → 12/08
CLASSE E III E 240 4-matic	M112.917	03/03 → 12/08
CLASSE E III E 240 T	M112.913	03/03 → 07/09
CLASSE E III E 240 T 4-matic	M112.917	07/03 → 07/09
CLASSE E III E 320	M112.949	03/02 → 12/08
CLASSE E III E 320 4-matic	M112.954	03/03 → 12/08
CLASSE E III E 320 T	M112.949	03/03 → 07/09

MERCEDES-BENZ		
CLASSE E III E 320 T 4-matic	M112.954	07/03 → 07/09
CLASSE E III E 500	M113.967	03/02 → 12/08
CLASSE E III E 500 4-matic	M113.969	10/03 → 12/08
CLASSE E III E 500 T	M113.967	10/03 → 07/09
CLASSE E III E 500 T 4-matic	M113.969	10/03 → 07/09
CLASSE E III E 55 AMG Kompressor	M113.990	10/02 → 12/08
CLASSE E III E 55 T AMG Kompressor	M113.990	07/03 → 07/09
CLASSE E IV E 180	M274.910, M112.945	12/12 →
CLASSE E IV E 200	M274.920	11/12 →
CLASSE E IV E 200 NGT	M274.920	07/13 →
CLASSE E IV E 250	M274.920	11/12 →
CLASSE E V AMG E 63 4-matic+	M177.980	01/17 →
CLASSE E V AMG E 63 S 4-matic+	M177.980	01/17 →
CLASSE E V E 180	M274.910	01/17 →
CLASSE E V E 200	M274.920	01/16 →
CLASSE E V E 200 4-matic	M274.920	07/16 →
CLASSE E V E 250	M274.920	07/16 →
CLASSE E V E 300	M274.920	07/16 →
CLASSE E V E 300 e	M274.920	11/18 →
CLASSE E V E 350 e	M274.920	07/16 →
CLASSE E E 280	M112.921	07/99 → 11/02
CLASSE G AMG G 63	M177.980	03/18 →
CLASSE G G 500	M176.980	01/18 →
CLASSE G II G 320	M112.945, M113.962	06/97 →
CLASSE G II G 500	M113.962	04/98 →
CLASSE G II G 55 AMG	M113.962, M270.910	04/98 →
CLASSE GLA AMG GLA 45 4-matic	M133.980	07/15 →
CLASSE GLA GLA 180	M270.910	02/15 →
CLASSE GLA GLA 200	M270.910, M112.970	12/13 →
CLASSE GLA GLA 220 4-matic	M270.920	01/17 →
CLASSE GLA GLA 250	M270.920	12/13 →
CLASSE GLA GLA 250 4-matic	M270.920	12/13 →
CLASSE GLC 250 4-matic	M274.920	06/15 →
CLASSE GLC 300 4-matic	M274.920	07/15 →
CLASSE GLC 350 e 4-matic	M274.920	01/16 →
CLASSE GLC AMG 63 4-matic+	M177.980	06/17 →
CLASSE GLC AMG 63 S 4-matic+	M177.980	06/17 →
CLASSE GLK 200	M274.920	08/13 → 06/15
CLASSE GLK 250	M274.920	08/13 → 06/15
CLASSE GLK 250 4-matic	M274.920	08/13 → 06/15
CLASSE M I ML 320	M112.942	02/98 → 08/02
CLASSE M I ML 350	M112.970, M113.960	08/02 → 06/05
CLASSE M I ML 430	M113.942	02/98 → 06/05
CLASSE M I ML 500	M113.965	09/01 → 06/05
CLASSE M I ML 55 AMG	M113.981	02/00 → 06/05
CLASSE M II ML 500 4-matic	M113.964	07/05 → 12/11
CLASSE R R 500 4-matic	M113.971	01/06 →
CLASSE S III 400 SE, SEL/S420	M119.981	01/93 → 09/98
CLASSE S III 600 SE, SEL	M120.982	04/91 → 12/92
CLASSE S III S 500	M119.980	01/93 → 10/98
CLASSE S III S 600	M120.982	01/93 → 09/99
CLASSE S III SEC/CL 420	M119.981	10/94 → 02/99
CLASSE S III SEC/CL 600	M120.982	09/92 → 02/99
CLASSE S IV CL 500	M113.960	03/99 → 03/06
CLASSE S IV CL 55 AMG	M113.986	10/99 → 03/06
CLASSE S IV CL 55 AMG Kompressor	M113.991	06/02 → 03/06
CLASSE S IV CL 600	M275.950	09/02 → 03/06
CLASSE S IV CL 65 AMG	M275.980	09/03 → 03/06
CLASSE S IV S 280	M112.922	10/98 → 08/05
CLASSE S IV S 320	M112.944	10/98 → 08/05
CLASSE S IV S 350	M112.972	09/02 → 08/05
CLASSE S IV S 350 4-matic	M112.975	06/03 → 08/05
CLASSE S IV S 430	M113.941	10/98 → 08/05
CLASSE S IV S 430 4-matic	M113.948	09/02 → 08/05
CLASSE S IV S 500	M113.960, M275.982	10/98 → 08/05
CLASSE S IV S 500 4-matic	M113.966	09/02 → 08/05
CLASSE S IV S 55 AMG	M113.986	04/99 → 08/05
CLASSE S IV S 55 AMG Kompressor	M113.991	06/02 → 08/05
CLASSE S IV S 600	M275.950	09/02 → 08/05
CLASSE S IV S 65 AMG	M275.980	03/04 → 08/05
CLASSE SV CL 600	M275.953	05/06 → 12/13
CLASSE SV CL 65 AMG	M275.982, M275.982	10/06 → 12/13
CLASSE SV S 600	M275.953	12/05 → 12/13
CLASSE SV S 65 AMG	M275.982, M113.961	12/05 → 12/13
CLASSE S VI AMG S 63 4-matic+	M177.980	05/17 →
CLASSE S VI AMG S 63	M177.980	05/17 →
CLASSE S VI S 560	M176.980	07/17 →
CLASSE S VI S 560 4-matic	M176.980	05/17 →
CLASSE S VI S 560 Maybach	M176.980	07/17 →

MERCEDES-BENZ		
CLASSE S VI S 560 Maybach 4-matic	M176.980	07/17 →
CLASSE S VI S 63 AMG	M177.980	12/18 →
CLASSE S VI S 63 AMG 4-matic+	M177.980	10/17 →
CLASSE SL IV 280	M112.923	05/98 → 10/01
CLASSE SL IV 320	M112.943	05/98 → 10/01
CLASSE SL IV 500	M113.961, M113.992	09/92 → 10/01
CLASSE SL IV 600	M120.983	07/92 → 10/01
CLASSE SL IV 600 SL	M120.983	02/92 → 08/94
CLASSE SL V 350	M112.973	03/03 → 01/12
CLASSE SL V 500	M113.963	10/01 → 01/12
CLASSE SL V 55 AMG	M113.992, M275.951	10/01 → 01/12
CLASSE SL V 55 AMG Kompressor	M113.992	06/02 → 01/12
CLASSE SL V 600	M275.951, M113.989	04/03 → 01/12
CLASSE SL V 65 AMG	M275.981	03/04 → 01/12
CLASSE SL V 65 AMG Black Series	M275.983	07/08 → 01/12
CLASSE SLC 180	M274.910	01/16 →
CLASSE SLC 200	M274.920	01/16 →
CLASSE SLC 300	M274.920	01/16 →
CLASSE SLK I 32 AMG Kompressor	M112.960	03/01 → 04/04
CLASSE SLK I 320	M112.947	03/00 → 04/04
CLASSE SLK II 55 AMG	M113.989, M155.980	06/04 → 02/11
CLASSE SLK III 200	M274.920	04/15 →
CLASSE SLK III 300	M274.920	07/15 →
GLA-SERIES GLA180 Flexfuel	M270.910	02/15 →
GLC-SERIES GLC250 CNG	274920CNG	06/15 →
GLC-SERIES GLC250 Flexfuel	M274.920	06/15 →
SLK-SERIES SLK200 CNG	274920CNG	04/15 →
SLK-SERIES SLK200 Flexfuel	M274.920	04/15 →
SLR McLaren 5.4	M155.980, --	04/04 →
SLR McLaren 5.4 722 Edition	M155.980	10/06 →
SLR-SERIES SLR McLaren Kompressor Stirling Moss	M155.980	06/09 → 12/11
VIANO 3,0	M112.951	09/03 →
VIANO 3.2	M112.951	09/03 →
VIANO 3.7	M112.976	06/04 →
VITO II 119	M112.951	09/03 →
VITO II 122	M112.951	09/03 →
VITO II 123	M112.976	06/04 →
PUCH		
G-MODELL G 500	M113.962	12/97 → 11/00
G-MODELL G 55 AMG	M113.982	04/99 → 03/01

9.3138

1

KNOCK SENSORS

Adatt./Suitable:

CITROËN

5946 31

96 327 549 80

DS

5946 31

FIAT

9632754980

LANCIA

9632754980

MINI

13 62 7 535 067

PEUGEOT

5946 31

TOYOTA

SU001-01118

MARKET DIFFUSION: HIGH



mV/g		
21		

CITROËN

BERLINGO II 1.2 PureTech 110

--, 5F5(EP6C)

02/16 →

BERLINGO II 1.6 VTI 120

5F5(EP6C), 5FK(EP6CB)

11/09 →

BERLINGO II 1.6 VTI 95

5FK(EP6CB), EB2D

07/10 →

CITROËN		
BERLINGO III 1.2 PureTech 110	EB2ADT	06/18 →
BERLINGO 1.6	EP6CB	04/08 → 12/10
C1 II 1.2 VTi 82	EB2D, EB2ADT	04/14 →
C3 I 1.4 i	KFV(TU3JP)	02/02 →
C3 II 1.0 VTi 68	EB0, EB2DT	08/12 →
C3 II 1.2 THP 110	EB2DT, EB2	10/14 →
C3 II 1.2 VTi 82	EB2, 8FN(EP3)	06/12 →
C3 II 1.4 16V	EP3C	11/09 →
C3 II 1.4 LPG	8FN(EP3), 8FR(EP3)	06/13 →
C3 II 1.4 VTi	8FR(EP3), 8FP(EP3)	11/09 →
C3 II 1.4 VTi 95	8FP(EP3), 5FS(EP6C)	11/09 →
C3 II 1.6 VTi 120	5FS(EP6C), EB2ADT	11/09 →
C3 III 1.2 PureTech 82	EB2FA	05/18 →
C3 III 1.2 THP 110	EB2ADT, EB2DT	07/16 →
C3 III 1.2 VTi 68	EB2FB	07/16 →
C3 III 1.2 VTi 82	EB2F	07/16 →
C3 AIRCROSS 1.2 PureTech 110	EB2ADT, EB2F	06/17 →
C3 AIRCROSS 1.2 PureTech 130	EB2DTS	07/17 →
C3 AIRCROSS 1.2 PureTech 82	EB2F, EB0	06/17 →
C3 PICASSO 1.2 THP 110	EB2DT, 8FN(EP3)	01/15 →
C3 PICASSO 1.4	EP3C	02/09 →
C3 PICASSO 1.4 VTi 95	8FN(EP3), 8FN(EP3)	02/09 →
C3 PICASSO 1.4 VTi 95 LPG	8FN(EP3), 5FS(EP6C)	01/12 →
C3 PICASSO 1.6 VTi	EP6	07/09 →
C3 PICASSO 1.6 VTi 120	5FS(EP6C), EB2ADT	02/09 →
C4 I 1.6 VTi 120	5FW(EP6), EW10J4	07/08 → 07/11
C4 I 2.0 16V	EW10J4, EB2DT	11/04 → 12/10
C4 II 1.2 THP 110	EB2DT, EB2DTS	02/15 →
C4 II 1.2 THP 130	EB2DTS, 8FP(EP3)	04/14 →
C4 II 1.4 16V	EP3C	11/09 →
C4 II 1.4 VTi 95	8FP(EP3), 5FS(EP6C)	11/09 →
C4 II 1.6 VTi 120	5FS(EP6C), 5FW(EP6)	09/11 →
C4 CACTUS 1.2 PureTech 130	EB2DTS	11/17 →
C4 CACTUS 1.2 THP 110	EB2ADT, EB2D	09/14 →
C4 CACTUS 1.2 VTi 75	EB2D, EB2	09/14 →
C4 CACTUS 1.2 VTi 82	EB2, 5FW(EP6)	09/14 →
C4 GRAND PICASSO I 1.6 16V	EP6C	07/08 →
C4 GRAND PICASSO I 1.6 VTi 120	5FW(EP6), EB2DTS	07/08 → 08/13
C4 GRAND PICASSO II 1.2 THP 130	EB2DTS, 5FS(EP6C)	04/14 →
C4 GRAND PICASSO II 1.6 VTi 120	5FS(EP6C), 5FW(EP6)	09/13 →
C4 PICASSO I 1.6 VTi 120	5FW(EP6), EB2DTS	07/08 →
C4 PICASSO II 1.2 THP 110	EB2ADT	04/16 →
C4 PICASSO II 1.2 THP 130	EB2DTS, 5FS(EP6C)	04/14 →
C4 PICASSO II 1.6 VTi 120	5FS(EP6C), EB2ADTS	02/13 →
C5 I 1.8	EW7J4	09/04 → 08/05
C5 I 1.8 16V	6FZ(EW7J4), EW10J4	03/01 → 08/04
C5 I 2.0 16V	EW10J4, EW10D	03/01 → 08/04
C5 I 2.0 16V HPI	EW10D, 5FS(EP6C)	03/01 → 08/04
C4 SPACETOURER 1.2 PureTech 110	EB2DTS	04/18 →
C4 SPACETOURER 1.2 PureTech 130	EB2ADTS, 6FZ(EW7J4)	04/18 →
C5 II 1.6 VTi 120	5FS(EP6C), EB2M	07/10 →
C5 AIRCROSS 1.2 PureTech 130	EB2ADTS	11/18 →
C8 2.0	RFN(EW10J4)	07/02 →
C-ELYSEE 1.2 VTi 72	EB2M, EB2DT	11/12 →
C-ELYSEE 1.2 VTi 82	EB2F	12/14 →
DS3 1.2 THP 110	EB2DT, EB2	10/14 → 07/15
DS3 1.2 VTi 82	EB2, 8FP(EP3)	01/13 → 07/15
DS3 1.4 VTi 95	8FP(EP3), 8FN(EP3)	04/10 → 07/15
DS3 1.4 VTi 95 LPG	8FN(EP3), 8FR(EP3)	08/12 → 07/15
DS3 1.4 VTi 98	8FR(EP3), 5FS(EP6C)	11/09 → 07/15
DS3 1.6 VTi 120	5FS(EP6C), EB2DTS	04/10 → 07/15
DS4 1.2 THP 130	EB2DTS, 5FS(EP6C)	07/14 → 07/15
DS4 1.6 VTi 120	5FS(EP6C), EB2ADTS	04/11 → 07/15
GRAND C4 SPACETOURER 1.2 PureTech 130	EB2ADTS, EW10J4	04/18 →
XSARA 2.0 [ExtraEU]	EW10J4	02/04 → 10/04
XSARA 2.0 16V	EW10J4, 6FZ(EW7J4)	09/00 → 08/05
XSARA PICASSO 1.8 16V	6FZ(EW7J4), EW10J4	02/00 →
XSARA PICASSO 2.0 16V	EW10J4, EB2ADT	01/03 →
DS		
DS 7 PureTech 130	EB2ADTS	10/18 →
DS3 1.2 THP 110	EB2ADT, EB2	04/15 →
DS3 1.2 THP 130	EB2DTS	09/15 →
DS3 1.2 VTi 82	EB2, EB2DTS	04/15 →
DS4 / DS4 CROSSBACK 1.2 THP 130	EB2DTS, RFN	07/15 →
FIAT		
ULYSSE II 2.0	RFN, N12B16A	08/02 → 06/11

LANCIA		
PHEDRA 2.0	RFN(EW10J4)	09/02 → 11/10
MINI		
MINI II Cooper	N12B16A, N16B16A	09/06 → 10/16
MINI II Cooper ALL4	N16B16A, N12B14A	11/12 → 10/16
MINI II One	N12B14A, EB2D	11/06 → 09/16
MINI II One LPG	N12B14A	03/09 → 03/10
PEUGEOT		
108 1.2	EB2D, EB2DT	05/14 →
108 1.2 VTi	HMZ(EB2)	05/14 →
108 108 1.2	HMZ(EB2F)	05/14 →
206 1.4	KFW(TU3JP)	07/02 → 02/07
206 1.4 BiFuel [ExtraEU]	TU3JP	07/02 → 02/07
206 1.4 i	KFW(TU3JP)	09/98 →
206 2.0 16V	EW10J4, EW10J4S	07/02 → 02/07
206 2.0 RC	EW10J4S, EW10J4	07/03 →
206 2.0 S16	EW10J4, 8FR(EP3)	06/99 →
207 1.4 16V	8FR(EP3), 5FS(EP6C)	06/07 →
207 1.6 16V	5FS(EP6C), 5FS(EP6C)	06/07 →
207 1.6 16V VTi	5FS(EP6C), 5FS(EP6C)	02/07 →
207 1.6 VTi	EP6	03/07 → 12/12
207 1.6 VTi [ExtraEU]	EP6	09/08 → 12/12
207 CC 1.6 16V	5FS(EP6C), EB0	02/07 →
208 1.0	EB0, EB2	03/12 →
208 1.2	EB2, EB2F	03/12 →
208 1.2 GPL	EB2F, EB2F	06/15 →
208 1.2 PureTech 82	EB2F, EB2ADT	03/18 →
208 1.2 THP	EB2ADT, 8FS(EP3)	01/13 →
208 1.2 VTi	HMZ(EB2)	09/13 →
208 1.4 GPL	EP3C	10/13 →
208 1.4 VTi	8FS(EP3), 5FS(EP6C)	03/12 →
208 1.6	5FS(EP6C), EB2DTS	03/12 →
301 1.2	HMZ(EB2F)	11/12 →
301 1.2 VTi 72	EB2M, EW10J4	11/12 →
301 1.2 VTi 82	EB2F	12/14 →
307 2.0	EW10J4, EW10J4	03/02 → 06/05
307 2.0 16V	EW10J4, 8FS(EP3)	08/00 → 04/09
308 I 1.4 16V	8FS(EP3), 5FW(EP6)	09/07 →
308 I 1.6 16V	5FW(EP6), EB2ADT	09/07 →
308 II 1.2 THP 110	EB2ADT, EB2DTS	11/13 →
308 II 1.2 THP 130	EB2DTS, EB2	11/13 →
308 II 1.2 VTi 72	EB2, 6FZ(EW7J4)	09/13 →
406 1.8 16V	6FZ(EW7J4), XU10J4R	10/00 → 10/04
406 1.8 BiFuel	EW7J4	09/00 → 05/04
406 2.0 16V	XU10J4R, EW10D	11/95 → 12/04
406 2.0 16V HPI	EW10D, EW10J4	05/01 → 10/04
407 1.8	6FZ(EW7J4)	05/04 →
407 2.0	EW10J4, EB2ADTS	03/04 →
508 I 1.6 VTi	5FH(EP6C), EW10J4	11/10 →
607 2.0	EW10J4, 5FK(EP6CB)	02/00 → 08/05
807 2.0	RFN(EW10J4)	06/02 →
2008 1.2 PureTech 82	EB2FA	03/18 →
2008 1.2 THP 110	EB2DT, EB2DTS	01/15 →
2008 1.2 THP 130	EB2DTS, EB2	01/15 →
2008 1.2 VTi	EB2, 5FS(EP6C)	03/13 →
2008 1.6 VTi	5FS(EP6C), EW10J4	03/13 →
3008 1.2	EB2DTS, 5FS(EP6C)	01/15 → 08/16
3008 1.2 PureTech 130	EB2DTS	05/16 →
3008 1.6 VTi	5FS(EP6C), EB2M	06/09 → 08/16
5008 1.2	EB2ADTS, 5FS(EP6C)	01/15 →
5008 1.6 16V	5FS(EP6C), 5FH(EP6C)	09/09 →
PARTNER II 1.6	5FK(EP6CB), EB2DT	04/10 →
PARTNER II TEPEE 1.2 THP	EB2DT, 5FK(EP6CB)	02/16 →
PARTNER II TEPEE 1.6 VTi	5FK(EP6CB), AM6U5	09/09 →
RIFTER 1.2 PureTech 110	EB2ADT	09/18 →
TOYOTA		
AYGO II 1.2	1PP	05/14 →



KNOCK SENSORS

Adatt./Suitable:

ASTON MARTIN
6G43-03-10009

FORD

1 132 002
1N1A-12A699-AA

JAGUAR

JD6 1212

LAND ROVER

LRO08877

MARKET DIFFUSION: **MEDIUM**

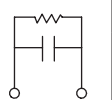

mV/g		
22		

ASTON MARTIN

VANTAGE 4.3	AM6U5, AM07	10/05 → 12/10
VANTAGE 4.3 N400	AM6U5	01/08 → 12/10
VANTAGE 4.7	AM07, M1JA	10/08 →
VANTAGE 4.7 GT8	AM15	07/13 →
VANTAGE 4.7 S	AM15	01/11 →

FORD

B-MAX 1.0 EcoBoost	M1JA, --	10/12 →
C-MAX II 1.0 EcoBoost	--, 10FDOX	10/12 →
ECOSPORT 1.0 EcoBoost	10FDOX, M1JE	10/13 →
FIESTA VI 1.0 EcoBoost	M1JE, Y1JA	09/12 →
FIESTA VI 1.0 Sport	Y1JA, M1JL	05/14 →
FIESTA VII 1.0 EcoBoost	M1JL, F9DA	01/17 →
FOCUS I 1.8 TDCi	F9DA, M1DA	03/01 → 03/05
FOCUS III 1.0 EcoBoost	M1DA, B7DA	02/12 →
FOCUS III 1.0 GTDI	--	07/12 →
GRAND C-MAX 1.0 EcoBoost	B7DA, D6BA	10/12 →
MONDEO II 2.0 16V DI / TDDi / TDCi	SDBA	10/00 → 03/07
MONDEO II 2.0 16V TDDi / TDCi	D6BA, --	10/00 → 03/07
MONDEO II 2.0 DI	PD20FMCR	10/00 → 03/07
MONDEO II 2.0 TDCi	--, QJBA	10/01 → 03/07
MONDEO II 2.2 TDCi	QJBA, M1CA	09/04 → 03/07
MONDEO IV 1.0 EcoBoost	M1CA, HCPA	02/15 →
TOURNEO CONNECT I 1.8 TDCi	HCPA, BHPA	06/02 → 12/13
TOURNEO CONNECT I 1.8 TDCi / TDDi / DI	BHPA, M2GA	06/02 → 12/13
TOURNEO CONNECT II 1.0 EcoBoost	M2GA, SFCA	11/13 →
TOURNEO COURIER 1.0 EcoBoost	SFCA, BHPA	02/14 →
TRANSIT III 2.0 TDCi	FIFA	08/02 → 05/06
TRANSIT CONNECT I 1.8 Di	BHPA, HCPA	06/02 → 12/13
TRANSIT CONNECT I 1.8 TDCi	HCPA, M2GA	06/02 → 12/13
TRANSIT CONNECT II 1.0 EcoBoost	M2GA, SFCA	02/13 →
TRANSIT COURIER 1.0 EcoBoost	SFCA, 508PS	02/14 →
TRANSIT TOURNEO 2.0	FIFA	03/02 → 03/06

JAGUAR

F-PACE 3.0 AWD	306PS	09/15 →
F-PACE 5.0 SVR AWD	508PS	08/18 →
F-TYPE 3.0	306PS	10/12 →
F-TYPE 3.0 S	306PS	10/12 →
F-TYPE 3.0 S AWD	306PS	12/14 →
F-TYPE 400	306PS	11/16 →
F-TYPE 400 AWD	306PS	11/16 →
F-TYPE 5.0 R	508PS	10/13 →
F-TYPE 5.0 R AWD	508PS	12/14 →
F-TYPE 5.0 S	508PS	10/12 →
F-TYPE 5.0 SVR	508PS, 306PS	05/15 →
XE 3.0 S	306PS, 306PS	03/15 →
XE 5.0 SVO PROJECT 8	508PS	03/18 →
XF 3.0	306PS, 508PS	03/08 →
XF 3.0 AWD	306PS	10/12 →
XF 3.0 D	306DT	03/09 → 04/15
XF 3.0 D AWD	AJV6D	03/12 →

JAGUAR		
XF 3.0 Supercharged [ExtraEU]	306PS	05/15 →
XF 5.0	508PN	03/09 → 04/15
XF 5.0 Kompressor	508PS, 508PS	01/09 → 04/15
XF 5.0 XFR-S	508PS	10/12 → 04/15
XJ 3.0	306PS	03/12 →
XJ 3.0 AWD	306PS	10/12 →
XJ 5.0	508PN	08/12 →
XJ 5.0 R575	508PS	07/17 →
XJ 5.0 V 8	508PN	10/09 →
XJ 5.0 V8	508PS, 508PS	10/09 →
XK 5.0 V8	508PN	01/09 → 07/14
XK 5.0 XKR	508PS, LJ46B	01/09 → 07/14
XK 5.0 XKR-S	508PS	01/11 → 07/14
X-TYPE 2.0 D	LJ46B, LJ46G	07/03 → 12/09
X-TYPE 2.2 D	LJ46G, 508PN	10/05 → 12/09

LAND ROVER		
DISCOVERY IV 3.0 4x4	306PS	08/13 →
DISCOVERY IV 5.0 V8 4x4	508PN	09/09 →
DISCOVERY V 3.0 4x4	306PS	09/16 →
RANGE ROVER III 5.0 4x4	508PN, 508PN	09/09 → 08/12
RANGE ROVER IV 3.0 4x4	306PS	10/13 →
RANGE ROVER IV 5.0 4x4	508PN, 508PN	08/12 →
RANGE ROVER SPORT I 5.0 4x4	508PN, 306PS	04/09 → 03/13
RANGE ROVER SPORT II 3.0 4x4	306PS, 508PS	04/13 →
RANGE ROVER SPORT II 5.0 4x4	508PS, TU32	04/13 →
RANGE ROVER VELAR 3.0 P340 4x4	306PS	04/18 →
RANGE ROVER VELAR 3.0 P380 4x4	306PS	03/17 →

9.3143



KNOCK SENSORS

Adatt./Suitable:

BOSCH
0 261 231 128

CITROËN
5946 28

DACIA
23 46 015 900

MERCEDES-BENZ
0041536228
A 004 153 62 28

NISSAN
23460-15900

PEUGEOT
5946 28

RENAULT
23 46 015 900

MARKET DIFFUSION: MEDIUM



mV/g		
21		

CITROËN

BERLINGO I 1.1 i	HFX(TU1JP), KFW(TU3JP)	07/96 → 05/08
BERLINGO I 1.4	KFW(TU3JP)	11/02 → 10/05
BERLINGO I 1.4 bivalent	TU3JPCNG	11/02 → 12/11
BERLINGO I 1.4 CNG	KFW(TU3JP)	11/02 → 03/08
BERLINGO I 1.4 i	KFW(TU3JP), NFU(TU5JP4)	07/96 → 12/11
BERLINGO I 1.4 i bivalent	KFW(TU3JP)	04/03 → 10/05
BERLINGO I 1.6 16V	NFU(TU5JP4), HFX(TU1JP)	10/00 → 12/11
BERLINGO 1.4	TU32, HFX(TU1JP)	07/96 → 12/11
C2 1.1	HFX(TU1JP), KFW(TU3JP)	09/03 →
C2 1.4	KFW(TU3JP), HFX(TU1JP)	09/03 →
C3 I 1.1 i	HFX(TU1JP), KFW(TU3JP)	02/02 →
C3 I 1.4 i	KFW(TU3JP), N6A(TU5JP4)	02/02 →
C3 I 1.4 i Bivalent	TU3JPCNG	02/02 →
C3 I 1.6 16V	N6A(TU5JP4), KFW(TU3A)	02/02 →
C3 I PLURIEL 1.4	KFW(TU3A), KFW(TU3JP)	05/03 →
C3 I PLURIEL 1.4 Hybrid	KFW(TU3JP)	05/05 →
SAXO 1.4 VTS	KFW(TU3JP), NFT(TU5JP)	05/96 → 06/03

CITROËN

SAXO 1.6	NFT(TU5JP), NFZ(TU5JP)	02/01 → 04/04
SAXO 1.6 VTL, VTR	NFZ(TU5JP), NFT(TU5JP)	05/96 → 06/03
SAXO 1.6 VTS	NFT(TU5JP), KFW(TU3JP)	09/00 → 09/03
XSARA 1.4	TU3JP	05/98 → 03/05
XSARA 1.4 BiFuel [ExtraEU]	TU3JP	05/98 → 08/00
XSARA 1.4 i	KFW(TU3JP), NFU(TU5JP4)	04/97 → 08/05
XSARA 1.4 LPG	TU3JP	05/98 → 08/00
XSARA 1.6 16V	NFU(TU5JP4), NFZ(TU5JP)	09/00 → 08/05
XSARA 1.6 i	NFZ(TU5JP), NFV(TU5JP)	04/97 → 09/00
XSARA PICASSO 1.6	NFU(TU5JP), H4M738	06/02 →
XSARA PICASSO 1.6 Chrono	TU5JP	04/01 → 10/04

DACIA

DOKKER 1.6	H4M738, H4M740	11/12 →
DOKKER 1.6 LPG	H4M740, H4M438	04/15 →
DUSTER 1.6 S Ce 115	H4M438, H4M430	06/15 →
DUSTER 1.6 S Ce 115 4x4	H4M430, H4M740	06/15 →
DUSTER 1.6 S Ce 115 LPG	H4M740	06/15 →
LODGY 1.6	H4M738	03/12 →
LODGY 1.6 LPG	H4M740, H4M738	04/15 →
LODGY 1.6 S Ce 115	H4M738, M476.930	06/15 →

MERCEDES-BENZ

CITARO	M476.930, KFW(TU3JP)	04/00 →
--------	----------------------	---------

NISSAN

TERRANO III 1.6	H4M	12/15 →
TERRANO III 1.6 4x4	H4M	12/15 →

PEUGEOT

106 II 1.4 i	KFW(TU3JP), TU3A	05/96 → 07/04
206 1.4	TU3A, KFX(TU3JP)	07/02 →
206 1.4 i	KFX(TU3JP), NFZ(TU5JP)	09/98 →
206 1.6 8V	TU5JP	05/99 → 10/03
206 1.6 i	NFZ(TU5JP), KFW(TU3JP)	09/98 → 12/00
306 1.4	KFW(TU3JP), KFW(TU3JP)	04/93 → 04/02
306 1.4 SL	KFW(TU3JP), NFT(TU5JP)	06/94 → 05/01
306 1.6	NFT(TU5JP), HFX(TU1JP)	10/00 → 04/02
306 1.6 SR	NFZ(TU5JP)	06/94 → 10/00
PARTNER 1.4	TU3JP	09/99 → 10/02
PARTNER 1.6 Bioflex	TU5JP4	09/00 → 10/02
PARTNER I 1.1	HFX(TU1JP), K6D(TU3A)	06/96 → 09/05
PARTNER I 1.4	K6D(TU3A), N6A(TU5JP4)	06/96 →
PARTNER I 1.6	N6A(TU5JP4), NFU(TU5JP4)	09/00 →
PARTNER I 1.6 [ExtraEU]	TU5JP4	09/00 → 05/08
PARTNER I 1.6 16V	NFU(TU5JP4), NFU(TU5JP4)	07/01 → 03/08
PARTNER I 1.6 Bioflex	TU5JP4	09/00 → 10/02
PARTNER I 1.6 Flexfuel	NFU(TU5JP4), K6C(TU3JP)	09/00 → 10/02
RANCH 1.1	HFX(TU1JP)	06/96 →
RANCH 1.4	K6C(TU3JP), N6A(TU5JP4)	06/96 →
RANCH 1.4 BiFuel	KFW(TU3JP)	04/03 →
RANCH 1.6 16V	N6A(TU5JP4), M4R714	07/01 →

RENAULT

DUSTER 1.6 16V	H4M438	06/15 →
DUSTER 1.6 16V 4x4	H4M430	06/15 →
FLUENCE 1.6	H4M729	01/13 →
FLUENCE 2.0 [ExtraEU]	M4R714, M4R714	01/10 →
FLUENCE 2.0 16V	M4R714, M4R714	02/10 →
FLUENCE 2.0 Hi-Flex [ExtraEU]	M4R714, M4R711	02/10 → 11/18
GRAND SCÉNIC III 2.0 16V	M4R711, H4M429	02/09 →
KAPTUR 1.6	H4M429, M4R735	03/16 →
KOLEOS 2.0 [ExtraEU]	M4R737	08/13 →
LATITUDE 2.0 16V	M4R735, H4M429	02/11 →
LATITUDE 2.0 16V eco2 Flexfuel	M4R746	02/11 →
LOGAN/STEPWAY 1.6	H4M429, M4R711	09/16 →
MEGANE III 2.0	M4R710, M4R711	01/11 →
MEGANE III 2.0 CVT	M4R711, H4M738	02/09 →
MEGANE IV 1.6 16V	H4M738, H4M738	11/15 →
MEGANE IV 1.6 S Ce	H4M738, M4R711	10/16 →
MEGANE CC 2.0 CVT	M4R711, M4R710	06/10 →
SANDERO II 1.6	H4M438	09/16 →
SCÉNIC III 2.0 16V	M4R711, CHZB	01/09 →

9.3144



KNOCK SENSORS

Adatt./Suitable:

AUDI
030 905 377 C

BENTLEY
030 905 377 C
030 905 377 D

BOSCH
0 261 231 146

FORD
1 205 185
YM21-12A699-BA

MAN
030 905 377 C

PORSCHE
955 606 125 00

SEAT
030 905 377 C

SIEMENS
S107646001Z

SKODA
030 905 377 C

VW
030 905 377 C

MARKET DIFFUSION: HIGH



mV/g		
24		

AUDI

A1 1.0 TFSI	CHZB, CAVG	03/15 → 10/18
A1 1.2 TFSI	CBZA	05/10 → 04/15
A1 1.4 TDI	CUSB	11/14 → 10/18
A1 1.4 TFSI	CAVG, CHZL	05/10 → 10/18
A1 1.4 TSI	CZEA	11/14 → 10/18
A1 25 TFSI	CHZL, DKJA	11/18 →
A1 30 TFSI	DKJA, AUA	07/18 →
A1 35 TFSI	DADA	09/18 →
A2 1.2 TDI	ANY	03/01 → 08/05
A2 1.4	AUA, AMF	02/00 → 08/05
A2 1.4 TDI	AMF, AJQ	02/00 → 08/05
A2 1.6 FSI	BAD	05/02 → 08/05
A3 I [USA] 3.2 24V	CBRA	07/08 → 05/09
A3 I [USA] 3.2 24V AWD	--	01/06 → 12/09
A3 I 1.8 T	AJQ, AGU	12/98 → 05/03
A3 I 1.8 T quattro	AGU, AMK	12/96 → 05/03
A3 I S3 quattro	AMK, CAXC	10/01 → 05/03
A3 II 1.2 TFSI	CBZB	03/10 → 05/13
A3 II 1.2 TSI	CBZB	04/10 → 08/12
A3 II 1.4 TFSI	CAXC, BCU	09/07 → 05/13
A3 II 1.6	BGU, CCSA	05/03 → 08/12
A3 II 1.6 E-Power	CCSA, BAG	01/11 → 08/12
A3 II 1.6 FSI	BAG, AXW	08/03 → 09/07
A3 II 2.0 FSI	AXW, BDB	05/03 → 06/08
A3 II 3.2 V6 quattro	BDB, CAXC	07/03 → 05/09
A3 II SPORTBACK 1.2 TSI	CBZB	04/10 → 03/13
A3 II SPORTBACK 1.4 TFSI	CAXC, BCU	09/07 → 03/13
A3 II SPORTBACK 1.6	BGU, CCSA	09/04 → 03/13
A3 II SPORTBACK 1.6 E-Power	CCSA, BLF	01/11 → 03/13
A3 II SPORTBACK 1.6 FSI	BLF, AXW	09/04 → 09/07
A3 II SPORTBACK 2.0 FSI	AXW, BDB	09/04 → 06/08
A3 II SPORTBACK 3.2 V6 quattro	BDB, CHZD	09/04 → 05/09
A3 III 1.0 TFSI	CHZD, CJZA	07/16 →
A3 III 1.2 TFSI	CJZA, CMBA	02/13 →
A3 III 1.4 TFSI	CMBA, CUKB	04/12 →
A3 III 1.4 TFSI e-tron	CUKB, CHZD	05/14 →
A3 III 1.4 TFSI g-tron	CPWA	11/13 →
A3 III 1.4 TSI	CZEA	05/14 →
A3 III 1.5 TFSI	DADA	05/17 →
A3 III 30 TFSI	CHZD, BWE	07/18 →
A3 III 35 TFSI	DADA	10/18 →
A4 II 2.0 TFSI 16V	BWE, BGB	01/06 → 03/09
A4 II 2.0 TFSI quattro	BWT	11/05 → 03/09
A4 III 2.0 TFSI	BGB, BGB	11/04 → 06/08
A4 III 2.0 TFSI quattro	BGB, BPJ	11/04 → 06/08

AUDI		
A4 V 1.4 TFSI	CVNA	08/15 →
A4 V RS4 quattro	DECA	10/17 →
A4 V S4 quattro	CWGD	05/16 →
A5 II 1.4 TFSI	CVNA	11/16 →
A5 II RS5 quattro	DECA	04/17 →
A5 II S5 quattro	CWGD	07/16 →
A6 III 2.0 TFSI	BPJ, CRDB	06/05 → 08/11
A6 IV RS6 performance quattro	CWUC	11/15 → 09/18
A6 IV RS6 quattro	CRDB, CEUC	01/13 → 09/18
A6 IV S6 quattro	CEUC, CRDB	02/12 → 09/18
A6 V 3.0 55 TFSI Mild Hybrid quattro	DLZA	02/18 →
A7 SPORTBACK RS7 performance quattro	CWUC	11/15 → 04/18
A7 SPORTBACK RS7 quattro	CRDB, CEUC	10/13 → 04/18
A7 SPORTBACK S7 quattro	CEUC, CEUA	02/12 → 05/18
A7 55 TFSI Mild Hybrid quattro	DLZA	10/17 →
A8 III 4.0 TFSI	CTGF	11/15 →
A8 III 4.0 TFSI quattro	CEUA, CEJA	03/12 → 12/15
A8 III 55 TFSI Mild Hybrid quattro	CZSE	06/17 →
A8 III 6.3 W12 quattro	CEJA, CGTA	01/11 → 01/18
A8 III S8 plus quattro	DDTA	11/15 → 01/18
A8 III S8 quattro	CGTA, CHZJ	04/12 → 01/18
Q2 1.0 TFSI	CHZJ, CHZJ	10/16 →
Q2 1.4 TFSI	CZEA	06/16 →
Q2 30 TFSI	CHZJ, CHPB	07/18 →
Q2 35 TFSI	DADA	07/18 →
Q3 1.4 TFSI	CZDB	07/16 → 10/18
Q3 1.4 TSI	CHPB, AJQ	10/13 → 10/18
Q3 35 TFSI	DADA	08/18 →
Q5 II SQ5 TFSI quattro	CWGD	11/16 →
Q7 I 3.6 FSI quattro	BHK	08/06 → 05/10
Q8 3.0 55 TFSI Mild Hybrid quattro	DCBD	02/18 →
TT I 1.8 T	AJQ, AJQ	01/01 → 06/06
TT I 1.8 T quattro	AJQ, BHE	02/00 → 06/06
TT I 3.2 VR6 quattro	BHE, CMMC	07/03 → 06/06
TT II 3.2 V6 quattro	BUB	08/06 → 06/10

BENTLEY		
BENTAYGA 4.0	DCUA	01/18 →
BENTAYGA 6.0	DDBB	10/15 →
CONTINENTAL 4.0	CMMC, CMMD	09/11 →
CONTINENTAL 4.0 FLEX	CMMC, CMMC	12/13 →
CONTINENTAL 4.0 FLEX AWD	CMMC, CMMC	04/12 →
CONTINENTAL 4.0 FlexFuel [ExtraEU]	CMMC	09/11 →
CONTINENTAL 4.0 GT	CMMC, CMMC	04/12 →
CONTINENTAL 6.0 AWD	DDBD	09/17 →
FLYING SPUR 4.0	CYCB	03/13 →
FLYING SPUR 4.0 FLEX	CMMC, CKBB	03/13 →
FLYING SPUR V8 S 4.0	CYCA	05/16 →
MULSANNE 6.8	CKBB, AAA	09/09 →

FORD		
GALAXY I 2.8 i V6	AAA, DAUA	11/95 → 04/00
GALAXY I 2.8 V6	AYL	04/00 → 05/06

MAN		
TGE 2.0 TDI	DAUA, DAUA	11/16 →
TGE 2.0 TDI AWD	DAUA, DASA	02/17 →
TGE 2.0 TDI RWD	DASA, M02.2Y	05/17 →

PORSCHE		
CAYENNE I 3.2	M02.2Y, M55.02	08/03 → 09/07
CAYENNE I 3.6	M55.01	02/07 → 09/10
CAYENNE II 3.6	M55.02, AJH	06/10 →
CAYENNE III 2.9 S	MDC.AB	05/17 →
CAYENNE III 3.0 AWD	MDC.BE	05/17 →
CAYENNE III 3.0 E-Hybrid AWD	MDC.BE	05/17 →
CAYENNE III 4.0 Turbo	MDC.UA	05/17 →
MACAN 3.0 S [ExtraEU]	DLZB	07/18 →
PANAMERA 2.9 4 E-Hybrid	MDG.PA	11/16 →
PANAMERA 2.9 4S	MCS.ZA	11/16 →
PANAMERA 3.0	MCX.TA	11/16 →
PANAMERA 3.0 4	MCX.TA	11/16 →
PANAMERA 4.0 Turbo	MCV.DA	11/16 →
PANAMERA 4.0 Turbo E-Hybrid	MCV.DA	10/17 →
PANAMERA 4.0 Turbo S E-Hybrid	MCV.DA	07/17 →

SEAT		
ALHAMBRA I / II 1.8 T 20V	AJH, ADY	10/97 → 03/10
ALHAMBRA I / II 2.0 i	ADY, AUE	04/96 → 03/10
ALHAMBRA I / II 2.8 V6	AUE, AUE	06/00 → 03/10
ALHAMBRA I / II 2.8 V6 4motion	AUE, CAVA	06/00 → 03/10
ALHAMBRA III 1.4 TSI	CAVA, BXW	06/10 →
ALTEA 1.2 TSI	CBZB	04/10 →

SEAT		
ALTEA 1.4 16V	BXW, BGU	05/06 →
ALTEA 1.4 TFSI	CAXC	05/10 → 04/11
ALTEA 1.4 TSI	CAXC	11/07 →
ALTEA 1.6	BGU, BXW	03/04 →
ALTEA 1.6 LPG	CHGA	09/09 →
ALTEA 1.6 Multifuel	CMXA	11/10 → 05/11
ALTEA 2.0 TDI	CEGA	03/06 →
ALTEA XL 1.2 TSI	CBZB	04/10 →
ALTEA XL 1.4 16V	BXW, BGU	10/06 →
ALTEA XL 1.4 TSI	CAXC	11/07 →
ALTEA XL 1.6	BGU, BSE	10/06 →
ALTEA XL 1.6 LPG	CHGA	09/09 →
ALTEA XL 1.6 Multifuel	BSE, CHZJ	10/06 →
ALTEA XL 2.0 TDI	CEGA	06/07 →
ALTEA XL 2.0 TDI 4x4	CEGA	06/07 →
ARONA 1.0 TGI	DBYA	11/18 →
ARONA 1.0 TSI	CHZJ, CHZJ	07/17 →
ARONA 1.6 SRE	CWVA	07/17 →
ATECA 1.0 TSI	CHZJ, AZQ	05/16 →
ATECA 1.4 TSI	CZEA	06/16 →
ATECA 1.4 TSI 4Drive	CZEA	06/16 →
CORDOBA II 1.2	AZQ, BBY	10/02 → 06/06
CORDOBA II 1.2 12V	BXV	05/06 → 11/09
CORDOBA II 1.4 16V	BBY, AZL	09/02 → 11/09
CORDOBA II 1.6	BAH	04/03 → 11/09
CORDOBA II 1.6 16V	BTS	11/06 → 11/09
CORDOBA II 2.0	AZL, AZQ	09/02 → 11/09
EXEO 2.0 TFSI	BWE	03/09 →
IBIZA 1.2	CGPA	04/08 →
IBIZA 1.2 TDi	CFWA	05/10 →
IBIZA 1.6 SRE [ExtraEU]	CWVA	05/17 →
IBIZA III 1.2	AZQ, AUB	02/02 → 05/08
IBIZA III 1.2 12V	BXV	05/06 → 11/09
IBIZA III 1.4 16V	AUB, BBU	02/02 → 11/09
IBIZA III 1.6	BAH	02/03 → 11/09
IBIZA III 1.6 16V	BTS	11/06 → 11/09
IBIZA III 1.8 T Cupra R	BBU, BJX	01/04 → 02/08
IBIZA III 1.8 T FR	BJX, AZL	12/03 → 05/08
IBIZA III 2.0	AZL, CHZB	04/02 → 11/09
IBIZA IV 1.0	CHYB	05/15 →
IBIZA IV 1.0 TSI	CHZB, BZG	05/15 →
IBIZA IV 1.2	BZG, CBZA	03/08 →
IBIZA IV 1.2 LPG	BZG	03/08 →
IBIZA IV 1.2 TDI	CFWA	04/10 →
IBIZA IV 1.2 TSI	CBZA, BXW	09/10 →
IBIZA IV 1.4	BXW, CUSA	03/08 →
IBIZA IV 1.4 LPG	BXW	03/08 → 05/11
IBIZA IV 1.4 TDI	CUSA, CAVF	05/15 →
IBIZA IV 1.4 TSI	CAVF, CAVE	06/09 →
IBIZA IV 1.4 TSI Cupra	CAVE, CWVA	06/09 →
IBIZA IV 1.6	BTS	05/08 →
IBIZA IV 1.6 LPG	CNKA	05/11 →
IBIZA IV 1.6 SRE	CWVA, CHYB	07/15 →
IBIZA IV 2.0	CEKA	10/08 →
IBIZA V 1.0	CHYB, CHZJ	01/17 →
IBIZA V 1.0 TGI	DBYA	11/17 →
IBIZA V 1.0 TSI	CHZJ, AHW	01/17 →
LEON I 1.4 16V	AHW, AUS	11/99 → 06/06
LEON I 1.6	BFQ	10/05 → 06/06
LEON I 1.6 16V	AUS, AMK	09/00 → 06/06
LEON I 1.8 T Cupra R	AMK, BXW	02/02 → 06/06
LEON I 1.8 Turbo 4x4	AMK	05/02 → 05/03
LEON I 2.3 V5	AGZ	10/98 → 11/00
LEON I 2.3 VR5	AQN	09/00 → 11/03
LEON II 1.2 TSI	CBZB	02/10 → 12/12
LEON II 1.4 16V	BXW, BSE	06/06 → 12/12
LEON II 1.4 TSI	CAXC	11/07 → 12/12
LEON II 1.6	BSE, BSE	07/05 → 12/12
LEON II 1.6 LPG	CHGA	12/09 → 12/12
LEON II 1.6 MultiFuel	BSE, BLR	11/10 → 12/12
LEON II 2.0 FSI	BLR, CHZD	07/05 → 05/10
LEON II 2.0 TFSI	CCZB	06/09 → 12/12
LEON III 1.0 TSI	CHZD, CJZA	05/15 →
LEON III 1.2 TSI	CJZA, CHPA	12/12 →
LEON III 1.4 TGI	CPWA	02/13 →
LEON III 1.4 TSI	CHPA, CJZB	09/12 →
LEON III 1.6 TSI	CWVA	05/15 →
LEON ST 1.0 TSI	CHZD	05/15 →
LEON ST 1.2 TSI	CJZB, CZDA	01/13 →
LEON ST 1.4 TSI	CZDA, CHYA	05/14 →
MII 1.0	CHYA, AHW	10/11 →
MII 1.0 EcoFuel	CPGA	11/12 →
TARRACO 1.5 TSI ACT	DADA	09/18 →
TOLEDO II 1.4 16V	AHW, AUS	01/00 → 05/02
TOLEDO II 1.6 16V	AUS, BGU	06/00 → 05/06
TOLEDO II 2.3 V5	AGZ	10/98 → 11/00
TOLEDO III 1.4 16V	BXW	05/06 → 05/09
TOLEDO III 1.4 TSI	CAXC	11/07 → 05/09

SEAT		
TOLEDO III 1.6	BGU, CBZA	10/04 → 05/09
TOLEDO IV 1.2	CGPC	07/12 →
TOLEDO IV 1.2 TSI	CBZA, CFNA	07/12 →
TOLEDO IV 1.4 TDI	CUSB	05/15 →
TOLEDO IV 1.4 TSI	CAXA	07/12 →
TOLEDO IV 1.6	CFNA, CAYC	07/13 →
TOLEDO IV 1.6 TDI	CAYC, CHYA	07/12 →

SKODA		
CITIGO 1.0	CHYA, AWY	10/11 →
CITIGO 1.0 CNG	CPGA	11/12 →
FABIA I 1.2	AWY, AUA	07/01 → 03/08
FABIA I 1.4	BKY	05/04 → 12/07
FABIA I 1.4 16V	AUA, BBM	12/99 → 03/08
FABIA I 2.0	AZL	12/99 → 03/08
FABIA II 1.2	BBM, CGPA	12/06 → 12/14
FABIA II 1.2 [IND]	CJLA	09/10 →
FABIA II 1.2 LPG	CGPA, CBZA	07/07 → 11/14
FABIA II 1.2 TDI	CFWA	05/10 → 12/14
FABIA II 1.2 TSI	CBZA, BXW	03/10 → 12/14
FABIA II 1.4	BXW, BXW	01/07 → 12/14
FABIA II 1.4 LPG	BXW, CAVE	01/07 → 11/14
FABIA II 1.4 TSI RS	CAVE, BTS	05/10 → 12/14
FABIA II 1.6	BTS, CHYA	04/07 → 12/14
FABIA III 1.0	CHYA, CJZC	08/14 →
FABIA III 1.2 TSI	CJZC, CUSA	08/14 →
FABIA III 1.4 TDI	CUSA, CZCA	08/14 →
FABIA III 1.4 TSI R5	CZCA	02/18 →
FABIA III 1.6	CWVA	01/15 →
KAROQ 1.0 TSI	CHZJ	07/17 →
KAROQ 1.5 TSI	DADA	07/17 →
KAROQ 1.5 TSI 4x4	DADA	07/17 →
KODIAQ 1.4 TSI	CZCA, CZDA	10/16 →
KODIAQ 1.4 TSI 4x4	CZDA, AXP	10/16 →
KODIAQ 1.5 TSI	DADA	07/18 →
KODIAQ 1.5 TSI 4x4	DADA	07/18 →
OCTAVIA I 1.4 16V	AXP, AVU	08/00 → 12/10
OCTAVIA I 1.6	AVU, AEG	09/00 → 12/10
OCTAVIA I 2.0	AGE, AZH	04/99 → 05/07
OCTAVIA I 2.0 4x4	AZH, BCA	08/00 → 09/04
OCTAVIA I RS 1.8 T	AUO	05/01 → 01/06
OCTAVIA II 1.4	BCA, BGU	05/04 → 06/13
OCTAVIA II 1.4 TSI	CAXA	11/08 → 06/13
OCTAVIA II 1.6	BGU, BSE	06/04 → 06/13
OCTAVIA II 1.6 FSI	BLF	02/04 → 10/08
OCTAVIA II 1.6 LPG	BSE, CCSA	08/09 → 11/12
OCTAVIA II 1.6 MultiFuel	CCSA, BLR	01/08 → 06/13
OCTAVIA II 2.0 [CHN]	BXX	04/07 →
OCTAVIA II 2.0 FSI	BLR, BLX	11/04 → 10/08
OCTAVIA II 2.0 FSI 4x4	BLX, CHZD	11/04 → 10/08
OCTAVIA III 1.0 TSI	CHZD, CJZA	05/16 →
OCTAVIA III 1.2 TSI	CJZA, CBZA	11/12 →
OCTAVIA III 1.4 TSI	CHPA	11/12 →
OCTAVIA III 1.4 TSI G-TEC	CPWA	11/13 →
OCTAVIA III 1.6	CWVA	01/14 →
RAPID 1.2	CGPC	07/12 →
RAPID 1.2 LPG	CBZA, CBZA	07/12 →
RAPID 1.2 TSI	CBZA, BME	07/12 →
RAPID 1.4 TSI	CAXA	07/12 →
RAPID 1.6	CFNA	07/12 →
ROOMSTER 1.2	BME, CBZA	05/06 → 05/15
ROOMSTER 1.2 LPG	CGPA	03/09 → 05/15
ROOMSTER 1.2 TDI	CFWA	03/10 → 05/15
ROOMSTER 1.2 TSI	CBZA, BXW	03/10 → 05/15
ROOMSTER 1.4	BXW, BXW	09/06 → 05/15
ROOMSTER 1.4 LPG	BXW, BTS	03/10 → 05/15
ROOMSTER 1.6	BTS, --	09/06 → 05/15
ROOMSTER 1.6 LPG	BTS	06/06 → 07/10
SUPERB II 1.4 TSI	CAXC	07/08 → 05/15
SUPERB II 3.6 FSI 4x4	--, CZCA	11/08 → 05/15
SUPERB II 3.6 V6 4x4	CDVA	10/09 → 05/15
SUPERB III 1.4 TSI	CZCA, CZDA	03/15 →
SUPERB III 1.4 TSI 4x4	CZDA, DADA	03/15 →
SUPERB III 1.5 TSI	DADA, CBZB	03/15 →
SUPERB III 2.0 TSI 4x4	DNUA	03/15 →
YETI 1.2 TSI	CBZB, BAH	09/09 → 12/17
YETI 1.4 TSI	CAXA	06/10 → 05/15
YETI 1.6	CWVA	04/14 → 12/17

VOLKSWAGEN (BR)		
POLO 1.0	ARA	07/02 → 01/04
POLO 1.4	BKY	07/06 →
POLO 1.4 16V	BBY	09/02 →
POLO 1.6	BAH, CAVD	02/02 →
POLO 2.0	BBX	05/02 →

VW		
ARTEON 1.5 Tsi	DADA	11/17 →
ATLAS 3.6 FSI 4motion	CDVC	12/16 →
BETLE 1.2 TSI	CBZB	07/11 →
BETLE 1.2 TSI 16V	CYVD	12/14 →

VW			VW			VW		
BEETLE 1.4 TSI	CAVD, AHW	10/11 →	GOLF VI 1.4 TSI	CAVD, BSE	10/08 →	POLO V 1.0	CHYA, CHZB	01/14 →
BORA 1.4 16V	AHW, AVU	03/00 → 05/05	GOLF VI 1.6	BSE, CCSA	10/08 →	POLO V 1.0 TSI	CHZB, CGPA	11/14 →
BORA 1.6	AVU, ATN	08/00 → 05/05	GOLF VI 1.6 BiFuel	BSF	03/09 →	POLO V 1.2	CGPA, CBZB	03/09 →
BORA 1.6 16V	ATN, AGU	02/00 → 05/05	GOLF VI 1.6 MultiFuel	CCSA, CBDA	10/08 →	POLO V 1.2 [IND]	CJLA	08/11 →
BORA 1.6 FSI	BAD	01/02 → 05/05	GOLF VI 2.0 TDI	CCBA, CHZC	07/09 → 07/13	POLO V 1.2 BlueMotion	CGPA	03/09 → 05/14
BORA 1.8 T	AGU, APK	05/00 → 05/05	GOLF VII 1.0 TSI	CHZC, CJZA	05/15 →	POLO V 1.2 TDI	CFWA	10/09 →
BORA 2.0	APK, AZH	10/98 → 05/05	GOLF VII 1.2 TSI	CJZA, CPWA	08/12 →	POLO V 1.2 TDi BlueMotion	CFWA	10/09 → 05/14
BORA 2.0 4motion	AZH, AGZ	04/00 → 05/05	GOLF VII 1.4 GTE Hybrid	CUKB	05/14 →	POLO V 1.2 TSI	CBZB, CGGB	11/09 →
BORA 2.3 V5	AGZ, AGZ	05/99 → 05/05	GOLF VII 1.4 TGI CNG	CPWA, CHPA	06/13 →	POLO V 1.2 TSI 16V	CJZC	02/14 →
BORA 2.3 V5 4motion	AGZ, AQP	10/00 → 05/05	GOLF VII 1.4 TSI	CHPA, CPVA	08/12 →	POLO V 1.2 TSi BlueMotion	CBZB	11/09 → 05/14
BORA 2.8 V6 4motion	AQP, CHZG	03/99 → 05/05	GOLF VII 1.4 TSi MultiFuel	CPVA, DACA	04/13 →	POLO V 1.4	CGGB, CAVE	03/09 → 05/14
BORA 2.8 VR6	AUE	03/00 → 05/00	GOLF VII 1.5 TGI	DACA	07/17 →	POLO V 1.4 BiFuel	CMAA	03/10 → 01/11
CADDY III 1.0 TSI	CHZG, CBZA	11/15 →	GOLF VII 1.5 TSI	DACA, BLG	04/17 →	POLO V 1.4 GTI	CAVE, CUSA	05/10 →
CADDY III 1.2 TSI	CBZA, BCA	09/10 →	GOLF VII 1.6	CWVA	05/14 →	POLO V 1.4 TDI	CUSA, CPTA	02/14 →
CADDY III 1.4	BCA, CZCB	03/04 → 08/10	GOLF VAN 1.2 TSi BlueMotion	CJZA, CAVD	04/13 → 03/17	POLO V 1.4 TSI	CPTA, CFNA	10/12 →
CADDY III 1.4 TGI CNG	CPWA	06/15 →	GOLF VAN 1.4 TSi	CAVD, CHPA	07/09 → 05/14	POLO V 1.6	CFNA, CHYB	01/10 →
CADDY III 1.4 TSi	CZCB, BGU	05/15 →	GOLF VAN 1.4 TSi BlueMotion	CHPA, CBDDB	05/13 → 03/17	POLO V 1.6 BiFuel	CNKA	01/11 →
CADDY III 1.6	BGU, BSF	04/04 →	GOLF VAN 2.0 TDi	CBDDB, CBZA	07/09 → 05/19	POLO V 1.6 TDI	CLNA	06/09 →
CADDY III 1.6 BiFuel	BSF, CAAB	05/11 → 05/15	JETTA V 1.4 TSI	BLG, BSE	07/06 → 10/10	POLO VI 1.0	CHYB, CHZJ	06/17 →
CADDY III 1.8 [ARG]	BUR	10/05 →	JETTA V 1.6	BSE, BLR	10/05 → 10/10	POLO VI 1.0 TGI	DBYA	09/17 →
CADDY III 2.0 EcoFuel	BSX	04/06 → 05/15	JETTA V 1.6 [CHN]	BJG	01/05 →	POLO VI 1.0 TSI	CHZJ, CAVD	06/17 →
CAMPMOBILE 2.0 TDi BlueMotion	CAAB, CKMA	04/15 →	JETTA V 1.6 FSI	BLF	09/05 → 10/10	T-ROC 1.0 TSi	CHZJ	07/17 →
CARAVELLE 2.0 EcoFuel	AXACNG	01/06 → 03/14	JETTA V 1.6 MultiFuel	CCSA	01/08 → 10/10	T-ROC 1.5 TSi	DADA	11/17 →
CARAVELLE 3.2	BDL	11/03 → 11/09	JETTA V 2.0	BEV	06/01 → 05/05	SCIROCCO III 1.4 TSI	CAVD, AJH	05/08 →
CC 1.4 TSI	CKMA, DASB	11/11 → 12/16	JETTA V 2.0 FSI	BLR, AZV	08/05 → 10/10	SCIROCCO 1.4 TSi	CAVD, CAVD	06/08 → 05/14
CC 1.4 TSi MultiFuel	CKMA	11/11 → 12/16	JETTA V 2.0 TDI	AZV, BKD	09/05 → 10/10	SHARAN I 1.8 T 20V	AJH, ADY	09/97 → 03/10
CC 3.6 FSI	CNNA	11/11 →	JETTA V 2.0 TDI 16V	BKD, CBZB	08/05 → 10/10	SHARAN I 2.0	ADY, CAVA	09/95 → 03/10
CC 3.6 FSI 4motion	BWS	11/11 → 12/16	JETTA VI 1.2 TSI	CBZB, CAVA	10/10 →	SHARAN I 2.0 LPG	ATM	04/06 → 03/10
CRAFTER 2.0 TDI	DASB, DAUA	09/16 →	JETTA VI 1.2 TSi	CYVD	08/14 →	SHARAN I 2.8 V6 24V	AYL	04/00 → 03/10
CRAFTER 2.0 TDI 4motion	DAUA, DASA	03/17 →	JETTA VI 1.4 TSI	CAVA, CNLA	04/11 →	SHARAN I 2.8 V6 24V 4motion	AYL	04/00 → 03/10
CRAFTER 2.0 TDI RWD	DAUA, CAVD	11/16 →	JETTA VI 1.4 TSi Hybrid	CNLA, CFNA	04/11 →	SHARAN II 1.4 TSI	CAVA, BAH	05/10 →
EOS 1.4 TSI	CAVD, BVY	11/07 → 08/15	JETTA VI 1.6	CFNA, CWVA	12/11 →	SPACEFOX / SPACE CROSS 1.6	BAH, BPA	03/06 →
EOS 1.6 FSI	BLF	06/06 → 05/08	JETTA VI 1.6 [RUS]	CWVA, CBPA	01/15 →	SPACEFOX / SPACE CROSS 1.6 FSI	BPA, BPA	03/06 →
EOS 2.0 FSI	BVY, BUB	03/06 → 05/08	JETTA VI 1.6 MPi	CWVB	09/15 → 04/18	SPACEFOX / SPACE CROSS 1.6 Total Flex	BPA, BWK	03/06 →
EOS 3.2 V6	BUB, --	06/06 → 05/09	JETTA VI 2.0	CBPA, CAAB	06/10 → 12/17	SPACEFOX / SPACE CROSS 1.9 SDI	ASY	09/07 →
EOS 3.6 V6	CDVA	05/09 → 11/10	UP 1.0	--, TU32	08/11 →	TIGUAN 1.5 TSi ACT	DACA	11/18 →
FOX 1.0	--, BMD	10/03 →	UP 1.0 BlueMotion	CHYB	05/16 →	TIGUAN I 1.4 TSI	BWK, BWK	05/08 →
FOX 1.0 Alcohol	BNX	10/03 →	UP 1.0 GTI	DKRA	11/17 →	TIGUAN I 1.4 TSi 4motion	BWK, CZCA	09/07 →
FOX 1.0 Total Flex	CCNA	03/08 →	UP 1.0 TSI	CHZA	05/16 →	TIGUAN I 1.5	DADA	11/18 →
FOX 1.2	BMD, BAH	04/05 → 12/11	UP 1.0 TSi BlueMotion	CHZA	05/16 →	TIGUAN II 1.4 TSI	CZCA, CZDA	01/16 →
FOX 1.4	BKR	04/05 → 12/09	LUPO 1.4 FSI	ARR	02/01 → 07/05	TIGUAN II 1.4 TSi 4motion	CZDA, AZZ	05/16 →
FOX 1.6	BAH, BJA	10/03 → 08/14	MULTIVAN 2.0	AXA	11/03 → 08/15	TIGUAN II 1.5	DADA	11/18 →
FOX 1.6 Alcohol	--	10/03 →	MULTIVAN 2.0 TDI	CAAB, CXEB	04/15 →	TIGUAN II 1.5	DCBE	03/18 →
FOX 1.6 Total Flex	BJA, CBZB	10/03 → 08/14	MULTIVAN 2.0 TDI 4motion	CXEB, BDL	06/15 →	TOUAREG 3.0 TSi	DCBE	03/18 →
GOLF 1.2 TSi	CBZB	11/09 → 08/14	MULTIVAN 3.2 V6	BDL, BKK	02/04 → 11/09	TOUAREG I 3.2 V6	AZZ, CGRA	10/02 → 11/06
GOLF 1.2 TSi BlueMotion	CBZB, CAVD	05/09 →	MULTIVAN 3.2 V6 4motion	BKK, AYD	07/04 → 11/09	TOUAREG I 3.6 V6 FSI	BHK	10/05 → 05/10
GOLF 1.4 TSi	CAVD, CHPA	10/08 → 08/14	MULTIVAN 3.2 V6 4motion	BKA, AYD	07/04 → 11/09	TOUAREG II 3.6 V6 FSI	CGRA, BLG	04/10 → 03/18
GOLF 1.4 TSi BlueMotion	CHPA, CAYB	08/12 →	NEW BEETLE 1.4	BCA	11/01 → 09/10	TOURAN I 1.2 TSi	CBZB	05/10 → 05/15
GOLF 1.6 TDi	CAYB, AXP	02/09 → 08/14	NEW BEETLE 1.6	AYD, AGU	06/00 → 09/10	TOURAN I 1.4 FSI	BLG, BMY	11/06 → 05/10
GOLF 1.6 TDi BiFuel	BEH	05/02 → 05/03	NEW BEETLE 1.8 T	AGU, AEG	11/01 → 09/10	TOURAN I 1.4 TSI	BMY, BGU	02/06 → 05/15
GOLF TSi	CAXA	10/08 → 11/12	NEW BEETLE 2.0	AEG, BLV	01/98 → 10/10	TOURAN I 1.4 TSi EcoFuel	CDGA	05/09 → 05/15
GOLF IV 1.4	AXP, AHW	05/00 → 06/06	NEW BEETLE 2.3 V5	AQN	10/00 → 09/10	TOURAN I 1.6	BGU, BAG	07/03 → 05/10
GOLF IV 1.4 16V	AHW, AUS	08/97 → 06/06	PASSAT V 1.4 TSI	CAXA, BSE	05/07 → 12/14	TOURAN I 1.6 BiFuel	BSF	11/06 → 05/10
GOLF IV 1.6	AUS, ATN	05/00 → 06/06	PASSAT V 1.4 TSi MultiFuel	CDGA	01/09 → 12/14	TOURAN I 1.6 FSI	BAG, BPL	02/03 → 01/07
GOLF IV 1.6 16V	ATN, BAD	02/00 → 06/06	PASSAT V 1.6 FSI	CKMA	11/10 → 12/14	TOURAN I 1.8 [CHN]	BPL, AXW	02/08 →
GOLF IV 1.6 FSI	BAD, AGU	01/02 → 06/06	PASSAT V 1.6	BSE, BLR	05/05 → 11/10	TOURAN I 2.0 EcoFuel	BSX	02/06 → 05/09
GOLF IV 1.8 T	AGU, APK	08/97 → 06/06	PASSAT V 1.6 FSI	BLF	03/05 → 06/08	TOURAN I 2.0 FSI	AXW, AXACNG	10/03 → 05/10
GOLF IV 1.8 T GTI	AUQ	08/01 → 06/05	PASSAT V 2.0 FSI	BLR, BLX	03/05 → 11/10	TOURAN II 1.2 TSI	CYVB	05/15 →
GOLF IV 2.0	APK, AZH	07/98 → 06/06	PASSAT V 2.0 FSI 4motion	BLX, CZCA	09/05 → 11/10	TOURAN II 1.4 TSi	CZDA	05/15 →
GOLF IV 2.0 4motion	AZH, AGZ	10/00 → 06/06	PASSAT V 3.2 FSI 4motion	AXZ	11/05 → 11/10	TOURAN II TSi	DADA	11/18 →
GOLF IV 2.0 Bi-Fuel	BEH	02/02 → 06/06	PASSAT V 3.6 FSI	BLV	06/05 →	TRANSPORTER 2.0 EcoFuel	AXACNG, BDL	11/03 → 08/15
GOLF IV 2.3 V5	AGZ, AGZ	10/00 → 06/06	PASSAT V 3.6 FSI 4motion	BLV	06/05 →	TRANSPORTER 2.0 TDi BlueMotion	CXEC	08/18 →
GOLF IV 2.3 V5 4motion	AGZ, AQP	10/00 → 06/06	PASSAT V 3.6 R36 4motion	BWS	04/07 → 11/10	TRANSPORTER 3.2	BDL	03/04 → 06/05
GOLF IV 2.8 V6 4motion	AQP, AQP	05/99 → 06/06	PASSAT VI 1.4 GTE Hybrid	CUKC	06/15 →	TRANSPORTER V 1.4 Brasile	BTJ	12/05 →
GOLF IV 2.8 VR6 4motion	AQP, BFH	03/99 → 06/05	PASSAT VI 1.4 TSI	CZCA, AYT	11/14 →	TRANSPORTER V 2.0	AXA	11/03 → 08/15
GOLF IV 3.2 R32 4motion	BFH, CBZA	09/02 → 06/05	PASSAT VI 1.4 TSi 4motion	CZEA	02/15 →	TRANSPORTER V 2.0 BiFuel	AXACNG	05/11 → 08/15
GOLF V 1.2 TSI	CBZA, BCA	11/09 → 12/13	PASSAT CC 1.4 TSi MultiFuel	CKMA	01/11 → 01/12	TRANSPORTER V 3.2 4motion	BDL, BDL	11/03 → 11/09
GOLF V 1.4	BUD	06/07 → 07/09	PASSAT CC 3.6 FSI	BLV, BLV	06/08 →	TRANSPORTER V 3.2 V6	BDL, BKK	04/03 → 11/09
GOLF V 1.4 16V	BCA, BKG	10/03 → 12/13	PASSAT CC 3.6 FSI 4motion	BLV, CAXA	02/08 → 01/12	TRANSPORTER V 3.2 V6 4motion	BKK, CAAA	11/03 → 11/09
GOLF V 1.4 FSI	BKG, BLG	10/03 → 11/06	PASSAT 1.4 TSi BlueMotion	CAXA	08/10 → 12/14	TRANSPORTER VI 2.0 TDI	CAAA, CXEB	04/15 →
GOLF V 1.4 TSI	BLG, BGU	11/05 → 12/13	PHAETON 3.0 V6 FSI 4motion	CPFA	11/11 →	TRANSPORTER VI 2.0 TDI 4motion	CXEB, --	06/15 →
GOLF V 1.6	BGU, BAG	01/04 →	PHAETON 3.2 V6	AYT, BKL	04/02 → 05/05			
GOLF V 1.6 BiFuel	CHGA	05/09 → 12/13	PHAETON 3.2 V6 4motion	BKL, CHNA	02/04 → 11/08			
GOLF V 1.6 FSI	BAG, CCSA	10/03 → 07/08	PHAETON 3.6 V6 4motion	CHNA, BRN	11/08 → 03/16			
GOLF V 1.6 MultiFuel	CCSA, CAYB	10/07 → 12/13	PHAETON 6.0 W12 4motion	BRN, AWY	05/05 → 03/16			
GOLF V 1.6 TDI	CAYB, AXW	02/09 → 12/13	POLO 1.6 [ExtraEU]	BAH	11/02 → 07/06			
GOLF V 2.0	BHY	08/06 → 11/08	POLO IV 1.0	ARA	02/03 → 10/03			
GOLF V 2.0 FSI	AXW, BLX	01/04 → 11/08	POLO IV 1.2	AWY, AZQ	01/02 → 11/09			
GOLF V 2.0 FSI 4motion	BLX, BKD	08/04 → 11/08	POLO IV 1.2 12V	AZQ, BBY	10/01 → 11/09			
GOLF V 2.0 TDI	CBDA	07/08 →	POLO IV 1.4	BBY, AUA	08/02 →			
GOLF V 2.0 TDI 16V	BKD, BUB	06/07 → 07/09	POLO IV 1.4 16V	AUA, BAH	10/01 → 11/09			
GOLF V 3.2	BUB, BUB	09/05 → 11/08	POLO IV 1.4 BiFuel	BUD	05/06 → 11/09			
GOLF V 3.2 R32 4motion	BUB, CJZA	11/05 → 11/08	POLO IV 1.4 FSI	AXU	02/02 → 07/06			
GOLF VI 1.2 TSI	CBZA, CJZA	11/08 →	POLO IV 1.6	BAH, CHYA	08/02 →			
GOLF VI 1.2 TSi 16V	CJZA, BUD	11/13 → 05/16	POLO IV 1.6 [ExtraEU]	BAH	09/02 →			
GOLF VI 1.4	BUD, BUD	10/08 →	POLO IV 1.6 16V	BTS	05/06 → 11/09			
GOLF VI 1.4 16V	BUD, CAVD	01/09 → 05/11	POLO IV 1.8 GTI	BJX	09/05 → 11/09			
			POLO IV 1.8 GTi Cup Edition	BBU	05/06 → 11/09			
			POLO IV 2.0	BBX	09/02 →			

9.3148



1

KNOCK SENSORS

Adatt./Suitable:

ALFA ROMEO
55353316**CITROËN**
5946 23**DAEWOO**
0031538928**FIAT**
55353316
9617756080
9638423480**GENERAL MOTORS**
55 353 316**LANCIA**
9617756080**MERCEDES-BENZ**
A 003 153 89 28**OPEL**
55353316
62 35 703**PEUGEOT**
5946 23**SAGEM**
2 576 032 A**SIEMENS**
S103995001Z**SSANGYONG**
0031538928**VAUXHALL**
55353316MARKET DIFFUSION: **HIGH**

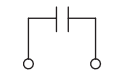
mV/g		
24		

ALFA ROMEO

159 1.8 MPI	939A4.000	06/05 ⇒ 11/11
-------------	-----------	---------------

CITROËN

BERLINGO I 1.1 i	HFX(TU1JP), KFW(TU3JP)	07/96 ⇒ 05/08
BERLINGO I 1.4	TU3JP	11/02 ⇒ 10/05
BERLINGO I 1.4 BiFuel	TU3JP	07/96 ⇒ 10/02
BERLINGO I 1.4 bivalent	KFW(TU3JP), KFW(TU3JP)	11/02 ⇒ 12/11
BERLINGO I 1.4 GNC	KFW(TU3JP)	11/02 ⇒
BERLINGO I 1.4 i	KFW(TU3JP), KFW(TU3JP)	07/96 ⇒ 12/11
BERLINGO I 1.4 i bivalent	KFW(TU3JP), LFX(XU7JB)	04/03 ⇒ 10/08
BERLINGO I 1.8 i	LFX(XU7JB), EW10J4	05/97 ⇒ 10/02
BERLINGO I 1.8 i 4WD	LFX(XU7JB)	04/97 ⇒ 10/01
BERLINGO 1.4	TU32, HFX(TU1JP)	07/96 ⇒ 12/11
BERLINGO 1.4 BiFuel	TU3JP	07/96 ⇒ 10/02
BERLINGO 1.4 Bivalent	TU3JPCNG	04/03 ⇒ 10/05
C5 1.2 16V	EW10J4, EW10J4	03/01 ⇒ 08/04
C8 2.0	EW10J4, 3FZ(EW12J4)	07/02 ⇒
C8 2.2	3FZ(EW12J4), EW10J4	07/02 ⇒
EVASION 2.0 16V	EW10J4, EW10J4	05/00 ⇒ 07/02
JUMPER 2.0	XU10J2	02/02 ⇒ 06/06
JUMPER 2.0 BiFuel	XU10J2	02/02 ⇒ 06/06
JUMPER II 2.0	XU10J2	04/02 ⇒
JUMPER II 2.0 bivalent	XU10J2	02/03 ⇒
JUMPY I 2.0	EW10J4, EW10J4	04/00 ⇒ 12/06
JUMPY I 2.0 i 16V	EW10J4, HFX(TU1JP)	03/00 ⇒ 10/06
SAXO 1.1 X,SX	HFX(TU1JP), KFW(TU3JP)	05/96 ⇒ 09/03
SAXO 1.4 VTS	KFW(TU3JP), NFX(TU5JP4)	05/96 ⇒ 06/03
SAXO 1.6	NFX(TU5JP4), NFX(TU5JP4)	02/96 ⇒ 04/04
SAXO 1.6 VTR	NFX(TU5JP4)	05/96 ⇒ 07/99
SAXO 1.6 VTS	NFX(TU5JP4), KFX(TU3JP)	06/96 ⇒ 09/03
XANTIA I 1.8 i	LFX(XU7JB)	04/97 ⇒ 04/03
XANTIA I 1.8 i 16V	LFY(XU7JP4)	06/95 ⇒ 04/03
XANTIA II 1.8 i	LFX(XU7JB)	01/98 ⇒ 04/03
XANTIA II 1.8 i 16V	LFY(XU7JP4)	01/98 ⇒ 04/03
XSARA 1.4	TU3JP	05/98 ⇒ 03/05
XSARA 1.4 BiFuel [ExtraEU]	TU3JP	05/98 ⇒ 08/00
XSARA 1.4 i	KFX(TU3JP), LFX(XU7JB)	04/97 ⇒ 08/05
XSARA 1.4 LPG	TU3JP	05/98 ⇒ 08/00
XSARA 1.8 BiFuel	XU7JP4	07/97 ⇒ 08/00
XSARA 1.8 i	LFY(XU7JB), LFY(XU7JP4)	04/97 ⇒ 09/00
XSARA 1.8 i 16V	LFY(XU7JP4), EW10J4	04/97 ⇒ 09/00

CITROËN

XSARA 1.8 LPG	XU7JP4	01/98 ⇒ 08/00
XSARA 2.0 [ExtraEU]	EW10J4	02/04 ⇒ 10/04
XSARA 2.0 16V	EW10J4, RFS(XU10J4RS)	09/00 ⇒ 08/05
XSARA 2.0 i 16V	RFS(XU10J4RS), EW10J4	02/98 ⇒ 03/05
XSARA PICASSO 2.0 16V	EW10J4, E23	01/03 ⇒
ZX 1.4 i	KFX(TU3JP)	03/91 ⇒ 10/97

DAEWOO

KORANDO 2.3	E23, E32	01/99 ⇒
KORANDO 3.2 4x4	E32, M104.992	01/99 ⇒
MUSSO 2.3	M111.970	01/99 ⇒
MUSSO 3.2 4x4	M104.992, RFLCNG	01/99 ⇒

FIAT

CROMA II 1.8 16V	939A4.000	12/05 ⇒
DUCATO II 2.0	RFL	04/02 ⇒
DUCATO II 2.0 4x4	RFL	05/02 ⇒ 07/06
DUCATO II 2.0 Bipower	RFL	11/02 ⇒
DUCATO 2.0 LPG	RFL	12/01 ⇒ 10/04
DUCATO 2.0 Natural Power	RFLCNG, RFN	06/03 ⇒ 07/12
SCUDO 2.0	RFN	09/99 ⇒ 10/06
SCUDO I 2.0	RFN, RFN	05/00 ⇒ 12/06
SCUDO I 2.0 16V	RFN, RFN	06/00 ⇒ 12/06
ULYSSE I 2.0 16V	RFN(EW10J4)	09/00 ⇒ 08/02
ULYSSE II 2.0	RFN, RFN	08/02 ⇒ 06/11

LANCIA

PHEDRA 2.0	RFN, M166.940	09/02 ⇒ 11/10
ZETA 2.0 16V	RFN	07/00 ⇒ 09/02

MERCEDES-BENZ

CLASSE A I A 140	M166.940, M111.921	01/01 ⇒ 08/04
CLASSE A I A 160	M166.960	07/97 ⇒ 08/04
CLASSE A I A 190	M166.990	03/99 ⇒ 08/04
CLASSE A I A 210	M166.995	12/01 ⇒ 08/04
CLASSE C I C 180	M111.921, M111.944	03/93 ⇒ 05/00
CLASSE C I C 180 T	M111.921	06/96 ⇒ 09/00
CLASSE C I C 200	M111.945	01/94 ⇒ 05/00
CLASSE C I C 200 Kompressor	M111.944, M104.992(AMG3.6)	10/95 ⇒ 05/00
CLASSE C I C 200 T	M111.945	06/96 ⇒ 03/01
CLASSE C I C 200 T Kompressor	M111.944	11/96 ⇒ 03/01
CLASSE C I C 220	M111.961	03/93 ⇒ 05/00
CLASSE C I C 230	M111.974	06/96 ⇒ 06/97
CLASSE C I C 230 Kompressor	M111.975	10/95 ⇒ 05/00
CLASSE C I C 230 T	M111.974	06/96 ⇒ 06/98
CLASSE C I C 230 T Kompressor	M111.975	06/97 ⇒ 09/00
CLASSE C I C 280	M104.941	05/93 ⇒ 05/00
CLASSE C I C 36 AMG	M104.941(AMG3.6)	05/94 ⇒ 05/00
CLASSE V V 200	M111.950	02/97 ⇒ 07/03
CLASSE V V 230	M111.978, 111979NGT	10/96 ⇒ 07/03
CLASSE CLK I 200	M111.945	06/97 ⇒ 06/02
CLASSE CLK I 200 Kompressor	M111.944	06/97 ⇒ 06/00
CLASSE CLK I 230 Kompressor	M111.975	06/97 ⇒ 06/00
CLASSE E I E 220	M111.960	06/93 ⇒ 03/98
CLASSE E I E 220 T	M111.960	06/93 ⇒ 06/96
CLASSE E I E 280	M104.942	06/93 ⇒ 06/95
CLASSE E I E 280 T	M104.942	06/93 ⇒ 06/96
CLASSE E I E 320	M104.992	06/93 ⇒ 03/98
CLASSE E I E 320 T	M104.992	06/93 ⇒ 06/96
CLASSE E I E 36 AMG	M104.992(AMG3.6), M111.978	06/93 ⇒ 03/98
CLASSE E I E 36 T AMG	M104.992(AMG3.6)	05/94 ⇒ 06/96
CLASSE E II E 200	M111.942	06/95 ⇒ 08/00
CLASSE E II E 200 Kompressor	M111.947	06/97 ⇒ 03/02
CLASSE E II E 200 T	M111.942	06/96 ⇒ 08/00
CLASSE E II E 200 T Kompressor	M111.947	06/97 ⇒ 03/03
CLASSE E II E 230	M111.970	06/95 ⇒ 06/97
CLASSE E II E 230 T	M111.970	06/96 ⇒ 06/97
CLASSE E II E 280	M104.945	01/96 ⇒ 06/97
CLASSE E II E 320	M104.995	06/95 ⇒ 06/97
CLASSE E II E 36 AMG	M104.995AMG	04/96 ⇒ 01/98
CLASSE G II G 320 GE	M104.996	09/94 ⇒ 11/97
CLASSE G II G 320	M104.996	09/94 ⇒ 12/97
CLASSE G II G 36 AMG	M104.996(AMG3.6)	01/95 ⇒ 07/98
CLASSE M I ML 230	M111.977	02/98 ⇒ 06/05
CLASSE S III 300 SE 2.8	M104.944	01/93 ⇒ 10/98
CLASSE S III 300 SE, SEL/S320	M104.994	03/91 ⇒ 10/98
CLASSE S III S 280	M104.944	02/93 ⇒ 10/98
CLASSE SL IV 280	M104.943	08/93 ⇒ 10/01
CLASSE SL IV 320	M104.991	09/93 ⇒ 10/01
CLASSE SLK I 200	M111.946	09/96 ⇒ 03/00
CLASSE SLK I 200 Kompressor	M111.943	10/96 ⇒ 03/00
CLASSE SLK I 230 Kompressor	M111.973	09/96 ⇒ 03/00
COUPE 220 CE	M111.960	10/92 ⇒ 05/93
COUPE 320 CE	M104.992	10/92 ⇒ 05/93
KOMBI II 220 TE	M111.960	10/92 ⇒ 05/93
KOMBI II 280 TE	M104.942	10/92 ⇒ 06/93
KOMBI II 320 TE	M104.992	10/92 ⇒ 06/93
SPRINTER I 214	M111.984	02/95 ⇒ 05/06

MERCEDES-BENZ

SPRINTER I 214 NGT	111979NGT, M111.979	02/95 ⇒ 05/06
SPRINTER I 314	M111.979, 111979NGT	02/95 ⇒ 05/06
SPRINTER I 314 4x4	M111.984	08/02 ⇒ 05/06
SPRINTER I 314 NGT	111979NGT, 111979NGT	02/95 ⇒ 05/06
SPRINTER I 414 NGT	111979NGT, A16XER	02/95 ⇒ 05/06
TRE VOLUMI II 220 E	M111.960	10/92 ⇒ 06/93
TRE VOLUMI II 280 E	M104.942	10/92 ⇒ 06/93
TRE VOLUMI II 320 E	M104.992	10/92 ⇒ 06/93
VANEO 1.6	M166.961	02/02 ⇒ 07/05
VANEO 1.9	M166.991	02/02 ⇒ 07/05
VITO I 113 2.0	M111.950	02/96 ⇒ 07/03

OPEL

ASTRA H 1.6	A16XER, A18XER	12/06 ⇒ 05/14
ASTRA H 1.6 EcoTec	Z16XER	10/06 ⇒ 12/10
ASTRA H 1.6 LPG	Z16XER	08/09 ⇒ 10/10
ASTRA H 1.8	A18XER, A16XER	08/05 ⇒ 05/14
ASTRA J 1.6	Z16XER	12/06 ⇒
ASTRA J 1.8	Z18XER	02/07 ⇒
SIGNUM 1.8	Z18XER	09/05 ⇒ 12/08
VECTRA C 1.8	Z18XER	08/05 ⇒ 08/08
ZAFIRA B 1.6	A16XER, A18XER	01/08 ⇒ 04/15
ZAFIRA B 1.6 FlexFuel	Z16XER	08/08 ⇒ 12/12
ZAFIRA B 1.8	A18XER, HFX(TU1JP)	07/05 ⇒ 04/15
ZAFIRA B 1.8 LPG	Z18XER	07/09 ⇒ 04/15
ZAFIRA B 1.8 ECOTEC	A18XER	01/11 ⇒

PEUGEOT

106 II 1.1 i	HFX(TU1JP), KFW(TU3JP)	05/96 ⇒ 07/04
106 II 1.4 i	KFW(TU3JP), NFX(TU5J4)	05/96 ⇒ 07/04
106 II 1.6 S16	NFX(TU5J4), HFX(TU1JP)	05/96 ⇒ 07/04
206 1.1	HFX(TU1JP), HFX(TU1JP)	08/98 ⇒
206 1.1 i	HFX(TU1JP), KFW(TU3JP)	09/98 ⇒
206 1.4	KFW(TU3JP), K6C(TU3JP)	07/02 ⇒ 02/07
206 1.4 i	K6C(TU3JP), N6A(TU5JP4)	09/98 ⇒
206 1.6	NFU(TU5JP4)	09/01 ⇒ 12/08
206 1.6 16V	N6A(TU5JP4), EW10J4	07/00 ⇒
206 1.6 BiFuel	TU5JP4	07/00 ⇒ 04/09
206 1.6 LPG	NFU(TU5JP4)	07/02 ⇒
206 2.0 16V	EW10J4, EW10J4	07/02 ⇒ 02/07
206 2.0 S16	EW10J4, KFW(TU3JP)	04/99 ⇒
306 1.4	KFW(TU3JP), K6C(TU3JP)	04/93 ⇒ 04/02
306 1.4 SL	KFW(TU3JP), LFY(XU7JP4)	06/94 ⇒ 05/01
306 1.8 16V	LFY(XU7JP4), K6D(TU3JP)	03/97 ⇒ 10/03
307 1.4	K6D(TU3JP), N6A(TU5JP4)	08/00 ⇒
307 1.6 16V	N6A(TU5JP4), EW10J4	08/00 ⇒
307 2.0	EW10J4, EW10J4	03/02 ⇒ 06/05
307 2.0 16V	EW10J4, LFX(XU7JB)	08/00 ⇒ 04/08
406 1.8	LFX(XU7JB), LFY(XU7JP4)	05/97 ⇒ 10/04
406 1.8 16V	LFY(XU7JP4), EW10J4	11/95 ⇒ 10/00
406 1.8 BiFuel	XU7JP4	04/99 ⇒ 05/03
406 2.0 16V	EW10J4, 3FZ(EW12J4)	08/00 ⇒ 12/04
406 2.2	3FZ(EW12J4), EW10J4	07/00 ⇒ 12/04
407 2.2	3FZ(EW12J4)	05/04 ⇒
607 2.0	EW10J4, 3FY(EW12J4)	02/00 ⇒ 08/05
607 2.2 16V	3FY(EW12J4), EW10J4	02/00 ⇒ 06/10
806 2.0 16V	EW10J4, EW10J4	09/00 ⇒ 08/02
807 2.0	EW10J4, 3FZ(EW12J4)	06/02 ⇒
807 2.2	3FZ(EW12J4), RFL(XU10J2U)	06/02 ⇒
BOXER 2.0 CNG	XU10J2CNG	07/03 ⇒ 03/06
BOXER I 2.0	RFL(XU10J2U), EW10J4	12/01 ⇒
BOXER I 2.0 BiFuel	XU10J2	12/01 ⇒ 06/06
EXPERT I 2.0	EW10J4, HFX(TU1JP)	07/00 ⇒ 12/06
PARTNER 1.4	TU3JP	09/99 ⇒ 10/02
PARTNER 1.4 CNG	TU3JPCNG	11/02 ⇒ 10/06
PARTNER 1.8	XU7JB	03/97 ⇒ 08/00
PARTNER I 1.1	HFX(TU1JP), K6D(TU3A)	06/96 ⇒ 09/05
PARTNER I 1.4	K6D(TU3A), LFX(XU7JB)	06/96 ⇒
PARTNER I 1.8	LFX(XU7JB), K6C(TU3JP)	03/97 ⇒ 12/03
RANCH 1.1	HFX(TU1JP)	06/96 ⇒
RANCH 1.4	K6C(TU3JP), M104.995	06/96 ⇒
RANCH 1.4 BiFuel	KFW(TU3JP)	04/03 ⇒
RANCH 1.8	LFX(XU7JB)	05/97 ⇒

PUCH

G-MODELL G 320	M104.996	02/94 ⇒ 12/97
G-MODELL G 36 AMG	M104.952(AMG3.6)	01/95 ⇒ 04/98

SSANGYONG

KORANDO 3.2	M104.995, A16XER	12/96 ⇒ 11/02
-------------	------------------	---------------

VAUXHALL

9.3161



04,5

KNOCK SENSORS

Adatt./Suitable:

BOSCH

0 261 231 121

VOLVO

127049-2



L	mV/g		
460 - 540	26		

VOLVO

850 2.0	B5202S, B5204FT	06/91 → 12/96
850 2.0 10V	B5202FS	08/94 → 12/97
850 2.0 Turbo	B5204FT, B5252	02/93 → 10/97
850 2.3	B5234FS	01/96 → 10/96
850 2.3 T5	B5234FT	02/93 → 12/96
850 2.3 T5-R	B5234T4	08/95 → 12/96
850 2.3 Turbo R	B5234T5	06/95 → 10/97
850 2.4	B5252, B5252FS	06/91 → 12/96
850 2.4 AWD	B5254T	04/96 → 12/96
850 2.4 GLE	B5254T	09/93 → 10/97
850 2.5 10V	B5252FS, B5202FS	06/91 → 12/97
850 2.5 20V	B5254FS	08/91 → 12/97
C70 I 2.0	B5204T2	03/97 → 10/05
C70 I 2.4 T	B5254T	03/98 → 10/05
S70 2.0	B5202FS, B5204T2	01/97 → 11/00
S70 2.0 Turbo	B5204T2, B5234FS	01/97 → 11/00
S70 2.3	B5234FS, B5234T3	11/96 → 07/99
S70 2.3 AWD	B5234T7	04/99 → 09/00
S70 2.3 T-5	B5234T3	01/97 → 11/00
S70 2.3 T5 AWD	B5234T3, B5234FT+	11/96 → 09/98
S70 2.3 T5-R AWD	B5234T2	11/96 → 09/98
S70 2.3 Turbo	B5234FT+, B5244S	01/97 → 11/00
S70 2.4	B5244S, B5244T	01/97 → 11/00
S70 2.4 AWD	B5252FS	11/96 → 05/99
S70 2.4 Bifuel	GB5252S	10/98 → 11/00
S70 2.4 T5 AWD	B5254T	11/96 → 04/99
S70 2.4 Turbo	B5244T, B5202FS	01/97 → 11/00
S70 2.5 20V	B5254FS	01/97 → 12/98
V70 I 2.0	B5202FS, B5204T2	12/95 → 03/00
V70 I 2.0 Turbo	B5204T2, B5234FS	12/95 → 12/00
V70 I 2.0 Turbo AWD	B5204T3	11/96 → 12/00
V70 I 2.3	B5234FS, B5234T3	11/96 → 07/99
V70 I 2.3 AWD	B5234T3, B5234FT+	04/97 → 09/98
V70 I 2.3 T AWD	B5234FT+, B5234T2	04/97 → 12/98
V70 I 2.3 T-5	B5234T2, B5234T2	11/96 → 12/00
V70 I 2.3 T-5 AWD	B5234T2, B5234FT+	01/97 → 12/00
V70 I 2.3 Turbo	B5234FT+, B5244S	12/95 → 12/98
V70 I 2.4	B5244S, B5244T	12/95 → 12/99
V70 I 2.4 Bifuel	GB5252S	05/98 → 12/99
V70 I 2.4 Turbo	B5244T, B5244T	04/96 → 12/00
V70 I 2.4 Turbo AWD	B5244T, BYT	04/96 → 12/00
V70 I 2.5	B5252FS	01/97 → 03/00
V70 I 2.5 20V	B5254FS	01/97 → 12/99
V70 2.0 T5 [ExtraEU]	B5204T3	10/97 → 03/99

9.3162



04,5

KNOCK SENSORS

Adatt./Suitable:

AUDI

06C 905 377 B

VW

06C 905 377 B



L	mV/g		
650	23		

AUDI

A6 III 3.0	BBJ	08/04 → 05/06
A6 III 3.0 quattro	BBJ	05/04 → 05/06

9.3163



04,5

KNOCK SENSORS

Adatt./Suitable:

AUDI

06E 905 376

06E 905 376 A

06E 905 377 A

PORSCHE

958 606 121 10

958 606 121 11

SEAT

06E 905 376

06E 905 376 A

06E 905 377 A

SKODA

06E 905 376

06E 905 376 A

06E 905 377 A

VW

06E 905 376

06E 905 376 A

06E 905 377 A

MARKET DIFFUSION: MEDIUM



L	mV/g		
500	23		

AUDI

A1 2.0 TFSI quattro	CDLH	03/12 → 11/12
A3 II 1.6 TDI	CAYC	05/09 → 05/13
A3 II 1.8 TFSI	BYT, AXX	11/06 → 05/13
A3 II 1.8 TFSI quattro	CDA	07/08 → 08/12
A3 II 2.0 TFSI	AXX, AXX	09/04 → 05/13
A3 II 2.0 TFSI quattro	AXX, BHZ	09/04 → 08/12
A3 II S3 quattro	BHZ, BYT	11/06 → 08/12
A3 II SPORTBACK 1.8 TFSI	BYT, AXX	11/06 → 03/13
A3 II SPORTBACK 1.8 TFSI quattro	CDA	07/08 → 03/13
A3 II SPORTBACK 2.0 TFSI	AXX, AXX	09/04 → 03/13
A3 II SPORTBACK 2.0 TFSI quattro	AXX, BHZ	09/04 → 03/13
A3 II SPORTBACK S3 quattro	BHZ, AUK	06/08 → 03/13
A4 II 3.2 FSI	AUK	01/06 → 03/09
A4 II 3.2 FSI quattro	AUK	01/06 → 03/09

AUDI		
A4 III 3.2 FSI	AUK	01/05 → 06/08
A4 III 3.2 FSI quattro	AUK, CABA	01/05 → 06/08
A4 IV 1.8 TFSI	CABA, CAEA	11/07 → 12/15
A4 IV 1.8 TFSI quattro	CDHB	09/08 → 03/12
A4 IV 2.0 TFSI	CAEA, CAEB	06/08 → 12/15
A4 IV 2.0 TFSI flexible fuel	CFKA	11/09 → 12/15
A4 IV 2.0 TFSI flexible fuel quattro	CFKA	11/09 → 12/15
A4 IV 2.0 TFSI quattro	CAEB, CMUA	06/08 → 12/15
A4 IV 3.0 TFSI quattro	CMUA, CDNC	02/12 → 12/15
A4 IV 3.2 FSI	CALA	09/08 → 03/12
A4 IV 3.2 FSI quattro	CALA	11/07 → 03/12
A4 IV S4 quattro	CAKA, CABD	11/08 → 12/15
A4 IV ALLROAD 2.0 TDI quattro	GLC	11/11 → 05/16
A4 IV ALLROAD 2.0 TFSI quattro	CDNC, CAKA	04/09 → 05/16
A4 2.0 TFSI [ExtraEU]	CFKA	11/09 → 03/13
A5 I 1.8 TFSI	CABD, CAEA	10/07 → 01/17
A5 I 2.0 TFSI	CAEA, CAEB	06/08 → 12/14
A5 I 2.0 TFSI quattro	CAEB, CHMB	06/08 →
A5 I 3.0 TFSI quattro	CHMB, CAKA	08/11 →
A5 I 3.2 FSI	CALA	06/07 → 03/12
A5 I 3.2 FSI quattro	CALA	06/07 → 03/12
A5 I S5 quattro	CAKA, BDX	06/09 → 01/17
A6 III 2.4	BDW	05/04 → 10/08
A6 III 2.4 [CHN]	BDW	04/05 →
A6 III 2.4 quattro	BDW	01/05 → 10/08
A6 III 2.8 FSI	BDX, BDX	11/06 → 08/11
A6 III 2.8 FSI quattro	BDX, CAJA	06/07 → 08/11
A6 III 3.0 [CHN]	BBJ	04/05 →
A6 III 3.0 TFSI quattro	CAJA, AUK	10/08 → 08/11
A6 III 3.2 FSI	AUK, AUK	05/04 → 03/11
A6 III 3.2 FSI quattro	AUK, CAEB	05/04 → 10/08
A6 IV 2.0 TFSI	CAEB, CHVA	03/11 →
A6 IV 2.0 TFSI hybrid	CHJA	11/11 → 09/18
A6 IV 2.0 TFSI quattro	CAEB	05/12 → 05/13
A6 IV 2.8 FSI	CHVA	11/10 → 04/15
A6 IV 2.8 FSI quattro	CHVA, CGWB	11/10 → 09/18
A6 IV 3.0 TFSI quattro	CGWB, CHVA	11/10 → 09/18
A7 SPORTBACK 2.5 FSI	CLXB	05/12 →
A7 SPORTBACK 2.8 FSI	CHVA	02/11 → 03/15
A7 SPORTBACK 2.8 FSI quattro	CHVA, CGWB	10/10 → 05/18
A7 SPORTBACK 2.8 TFSI	CVPA	09/14 →
A7 SPORTBACK 3.0 TFSI quattro	CGWB, BDX	10/10 → 03/15
A8 II 2.8 FSI	BDX, CPAA	08/07 → 07/10
A8 II 3.2 FSI	BPK	06/05 → 07/10
A8 II 3.2 FSI quattro	BPK	06/05 → 07/10
A8 III 2.0 TFSI hybrid	CHJA	02/12 → 11/15
A8 III 2.5 TFSI	CPAA, CGWA	07/12 → 06/16
A8 III 3.0 TFSI quattro	CGWA, CCTA	06/10 → 01/18
Q3 2.0 TFSI	CCTA, CCZC	10/13 →
Q3 2.0 TFSI [ExtraEU]	CCTA	09/14 → 10/18
Q3 2.0 TFSI quattro	CCZC, CAEB	06/11 → 10/18
Q5 I 2.0 TFSI hybrid quattro	CHJA	06/11 →
Q5 I 2.0 TFSI quattro	CAEB, CTUC	11/08 →
Q5 I 2.0 TFSI quattro [CHN]	CADA	09/09 →
Q5 I 3.0 TFSI quattro	CTUC, CTUD	06/12 →
Q5 I 3.2 FSI quattro	CALB	11/08 →
Q5 I SQ5 TFSI quattro	CTUD, CJTB	05/13 →
Q7 I 3.0 TFSI quattro	CJTB, BUJ	05/10 → 08/15
R8 5.2 FSI quattro	BUJ, BPY	04/09 →
R8 5.2 FSI RWS	DKAB	09/17 →
TT II 1.8 TFSI	CDA	06/08 → 06/14
TT II 2.0 TFSI	BPY, BWA	08/06 → 06/14
TT II 2.0 TFSI quattro	BWA, CDLA	06/08 → 06/14
TT II 2.0 TFSI quattro	CDLA, M06.EC	05/08 → 06/14

PORSCHE

CAYENNE II 3.0 S E-Hybrid	M06.EC, MCG.EA	06/10 →
PANAMERA 3.0 S E-Hybrid	MCG.EA, BYT	03/11 → 10/16

SEAT

ALHAMBRA III 1.8 TSI	CDA	11/12 →
ALHAMBRA III 2.0 TSI	CCZA	11/10 →
ALTEA 1.8 TFSI	BYT, BYT	01/07 →
ALTEA 2.0 TFSI	BWA	04/06 → 05/09
ALTEA 2.0 TFSI [ExtraEU]	CCZB	05/09 →
ALTEA XL 1.8 TFSI	BYT, BWA	01/07 →
ALTEA XL 2.0 TFSI	BWA	10/06 → 05/09
ALTEA XL 2.0 TFSI 4x4	BWA, BZB	06/07 →
EXEO 1.8 TSI	CDHA	09/10 →
EXEO 2.0 TFSI	CDND	05/10 →
LEON II 1.8 TSI	BZB, BWA	06/07 → 12/12
LEON II 2.0 Cupra R	CDLA	09/09 → 12/12
LEON II 2.0 TFSI	BWA, BYT	05/05 → 05/11
TOLEDO III 1.8 TFSI	BYT, BZB	01/07 → 05/09
TOLEDO III 2.0 TFSI	BWA	11/05 → 05/09

SKODA		
OCTAVIA II 1.8 TSI	BZB, CDA	06/07 → 06/13
OCTAVIA II 1.8 TSI 4x4	CDA, BWA	11/08 → 02/13
OCTAVIA II 2.0 4x4	CCZA	11/08 →
OCTAVIA II 2.0 RS	BWA, BZB	10/05 → 02/13
SUPERB II 1.8 TSI	BZB, CDA	03/08 → 05/15
SUPERB II 1.8 TSI 4x4	CDA, CDA	11/08 → 05/15
SUPERB II 2.0 TSI	CCZA	05/10 → 05/15
YETI 1.8	CDAB	02/11 →
YETI 1.8 TSI 4x4	CDA, CBFA	05/09 → 12/17

VW		
AMAROK 2.0 TSI	CFPA	12/10 →
BEETLE 2.0 TSI	CBFA, CKA	04/11 → 07/16
CAMPMOBILE 2.0 TSi BlueMotion	CKA, CDA	04/15 →
CC 1.8 TSI	CDA, CBFA	11/11 → 12/16
CC 2.0 TSI	CBFA, BPY	11/11 →
EOS 2.0 TFSI	BPY, BWA	03/06 → 08/15
EOS 2.0 TSI	CCZB	11/09 → 08/15
GOLF V 2.0	BWA, AX	06/07 → 07/09
GOLF V 2.0 GTI	AX, CBFA	10/04 → 02/09
GOLF VI 1.8 TSI	CDA	06/09 → 01/11
GOLF VI 2.0	CDLF	05/11 →
GOLF VI 2.0 GTi	CBFA, CDLA	04/09 → 05/16
GOLF VI 2.0 R	CDLA	01/13 → 05/16
GOLF VI 2.0 R 4motion	CDLA, CBFA	11/09 → 11/13
GOLF VI 2.0 TFSi	CRZA	11/11 →
GOLF VI 2.0 TFSi Gti	CBFA, BPY	05/11 →
GOLF VI 2.0 TSI	CDLC	01/13 →
GOLF 2.0 GTi	CCZB	02/09 → 11/12
GOLF 2.0 TSi R 4motion	CDLF	11/09 → 11/12
JETTA V 2.0 TFSi	BPY, CBFA	10/05 → 10/10
JETTA VI 2.0 TSI	CBFA, CKA	12/10 →
MULTIVAN 2.0 TSI	CKA, BZB	05/11 →
MULTIVAN 2.0 TSI 4motion	CKA	07/11 →
PASSAT V 1.8 TSI	BZB, AX	05/07 → 12/14
PASSAT V 2.0 FSI	AX, CAWB	07/05 → 11/10
PASSAT V 2.0 TSI	CCZB	11/10 → 12/15
PASSAT V 2.0 TSI 4motion	CCZB	01/12 → 12/14
PASSAT CC 1.8 TSI	BZB, CAWB	06/08 → 01/12
PASSAT CC 2.0 TSI	CAWB, BZB	06/08 → 01/12
PASSAT 1.8 TFSi	CDA	08/10 → 12/14
PASSAT 2.0 TFSi	CCZB	11/10 → 12/14
POLO V 2.0 R WRC	CDLJ	08/13 →
SCIROCCO III 2.0 R	CDLA	11/09 → 11/17
SCIROCCO III 2.0 TSI	CAWB, CAWA	05/08 → 11/17
SCIROCCO 2.0 TFSi	CCZB	11/09 → 05/14
SHARAN II 1.8 TSI	CDA	11/11 →
SHARAN II 2.0 TSI	CCZA	12/10 →
TIGUAN I 2.0 TFSi	CCTB	05/08 →
TIGUAN I 2.0 TFSi 4motion	CAWA, CCZB	09/07 →
TIGUAN I 2.0 TSI 4motion	CCZB, CGEA	05/11 →
TOUAREG II 3.0 TFSi	CYJA	01/15 →
TOUAREG II 3.0 V6 TSI	CJTA	08/10 → 03/18
TOUAREG II 3.0 V6 TSI Hybrid	CGEA, CKA	04/10 → 03/18
TRANSPORTER V 2.0 TSI	CKA, CKA	05/11 → 08/15
TRANSPORTER V 2.0 TSI 4motion	CKA	07/11 → 08/15
TRANSPORTER VI 2.0 TSI	CKA, N13B16A	04/15 →
TRANSPORTER VI 2.0 TSI 4motion	CKA	06/15 →

9.3165



KNOCK SENSORS

Adatt./Suitable:

- BMW**
13 62 7 552 114
- BOSCH**
0 261 231 168
0 261 231 169
0 261 231 197
0 261 231 198

- CITROËN**
1920 FR
1920 LT
96 453 114 80

- DS**
1920 LT

- FIAT**
9645311480

- MINI**
13 62 7 552 114

- PEUGEOT**
1920 FR
1920 LT

MARKET DIFFUSION: HIGH

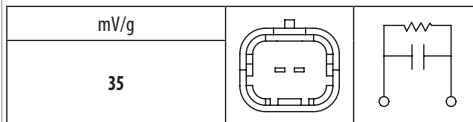

BMW

1 II 114 i	N13B16A	11/11 →
1 II 116 i	N13B16A	12/10 →
1 II 118 i	N13B16A, HFX(TU1JP)	11/10 →
1 II 120 i	N13B16A	03/15 →
3 Vi 316 i	N13B16A	03/12 → 08/16
3 Vi 316 Li (CHN)	N13B16A	10/12 →
3 Vi 320 i	N13B16A	04/12 → 06/16

CITROËN

BERLINGO I 1.1 i	HFX(TU1JP), K6D(TU3A)	07/96 → 05/08
BERLINGO I 1.4	K6D(TU3A), KFW(TU3JP)	11/02 →
BERLINGO I 1.4 bivalent	KFW(TU3JP), TU3A	11/02 → 12/11
BERLINGO I 1.4 CNG	KFW(TU3JP)	11/02 → 03/08
BERLINGO I 1.4 GNC	KFW(TU3JP)	11/02 →
BERLINGO I 1.4 Hybrid	KFW(TU3JP)	05/05 →
BERLINGO I 1.4 i	TU3A, NFU(TU5JP4)	07/96 → 12/11
BERLINGO I 1.4 i bivalent	KFW(TU3JP)	04/03 → 10/08
BERLINGO I 1.6 16V	NFU(TU5JP4), N6A(TU5JP4)	10/00 → 12/11
BERLINGO II 1.6	N6A(TU5JP4), HFX(TU1A)	04/08 →
BERLINGO 1.4 Hybrid	TU3JPHYBRID	05/05 → 05/08
C2 1.1	HFX(TU1A), KFW(TU3JP)	09/03 →
C2 1.4	KFW(TU3JP), ET3J4	09/03 →
C2 1.4 16V	ET3J4, NFU(TU5JP4)	06/06 →
C2 1.6	NFU(TU5JP4), NFS(TU5JP4S)	09/03 →
C2 1.6 VTS	NFS(TU5JP4S), HFX(TU1A)	01/05 →
C3 I 1.1 i	HFX(TU1A), ET3J4	02/02 →
C3 I 1.1 LPG	TU1A	06/06 → 12/09
C3 I 1.4 16V	ET3J4, KFW(TU3A)	12/03 →
C3 I 1.4 i	KFW(TU3A), KFW(TU3JP)	02/02 →
C3 I 1.4 i Bivalent	KFW(TU3JP), N6A(TU5JP4)	02/02 →
C3 I 1.6 16V	N6A(TU5JP4), KFW(TU3A)	02/02 →
C3 I PLURIEL 1.4	KFW(TU3A), NFU(TU5JP4)	05/03 →
C3 I PLURIEL 1.4 Hybrid	KFW(TU3JP)	05/05 →
C3 I PLURIEL 1.6	NFU(TU5JP4), HFX(TU1JP)	05/03 →
C3 II 1.1	HFX(TU1JP), HFX(TU1A)	11/09 →
C3 II 1.1 BiFuel	HFX(TU1A), K6E(TU3A)	11/10 →
C3 II 1.4	K6E(TU3A), KFT(TU3A)	11/09 →
C3 II 1.4 LPG	KFT(TU3A), 5FT(EP6DT)	07/10 →
C3 II 1.6 Flex	NFX(TU5JP4)	11/09 →
C3 III 1.6 Vti	ECSF	02/17 →
C4 I 1.4 16V	ET3J4, NFU(TU5JP4)	11/04 → 07/11
C4 I 1.6 16V	NFU(TU5JP4), N6A(TU5JP4)	11/04 → 07/11
C4 I 1.6 16V Bio-Flex	N6A(TU5JP4), 5FT(EP6DT)	09/07 →
C4 I 1.6 16V Flex Fuel	N6A(TU5JP4)	02/09 →
C4 I 1.6 Flex	--	02/09 → 07/11
C4 I 1.6 THP	EP6DT	06/08 → 07/11
C4 I 1.6 THP 140	5FT(EP6DT), 5FX(EP6DT)	07/08 → 07/11
C4 I 1.6 THP 150	5FX(EP6DT), 5FV(EP6CDT)	07/08 → 07/11
C4 II 1.6 16V	EP6FDTX	10/10 →

CITROËN

C4 II 1.6 Flex	NFX(TU5JP4)	11/09 →
C4 II 1.6 THP 155	5FV(EP6CDT), 5FX(EP6DT)	11/09 →
C4 GRAND PICASSO I 1.6 16V	5FT(EP6DT), 5FV(EP6CDT)	07/08 → 08/13
C4 GRAND PICASSO I 1.6 THP 155	5FV(EP6CDT), 5FX(EP6DT)	09/10 → 08/13
C4 GRAND PICASSO II 1.6 THP 150	5FX(EP6DT), 5FV(EP6CDT)	09/14 →
C4 GRAND PICASSO II 1.6 THP 155	5FV(EP6CDT), 5GZ(EP6FDT)	09/13 →
C4 GRAND PICASSO II 1.6 THP 165	5GZ(EP6FDT), ET3J4	07/14 →
C4 PICASSO I 1.6 16V	5FX(EP6DT), 5FT(EP6DT)	07/08 → 08/13
C4 PICASSO I 1.6 THP 140	5FT(EP6DT), 5FV(EP6CDT)	07/08 → 08/13
C4 PICASSO I 1.6 THP 155	5FV(EP6CDT), 5FX(EP6DT)	09/10 → 08/13
C4 PICASSO II 1.6 THP 150	5FX(EP6DT), 5FV(EP6CDT)	09/14 →
C4 PICASSO II 1.6 THP 155	5FV(EP6CDT), 5GZ(EP6FDT)	02/13 →
C4 PICASSO II 1.6 THP 165	5GZ(EP6FDT), 5FN(EP6CDT)	07/14 →
C4 SPACETOUREUR 1.6 THP 165	EP6FDT	04/18 →
C5 II 1.6 THP 150	5FN(EP6CDT), 5FV(EP6CDT)	04/09 →
C5 II 1.6 THP 155	5FV(EP6CDT), ECS	04/09 →
C5 AIRCROSS 1.6 PureTech 180	EP6FADTXD	11/18 →
C-ELYSEE 1.6 Vti 115	ECS, 5FM(EP6DT)	11/12 →
DS3 1.6	5FM(EP6DT), 5FD(EP6DTS)	02/11 → 07/15
DS3 1.6 Racing	5FD(EP6DTS), 5FN(EP6CDT)	02/11 → 07/15
DS3 1.6 THP 150	5FN(EP6CDT), 5FR(EP6DT)	01/10 → 07/15
DS3 1.6 THP 155	5FR(EP6DT), 5GZ(EP6FDT)	04/10 → 07/15
DS3 1.6 THP 165	5GZ(EP6FDT), 5FV(EP6CDT)	10/14 → 07/15
DS4 1.6 THP 150	EP6CDTMD	04/11 → 07/15
DS4 1.6 THP 155	5FV(EP6CDT), 5FM(EP6DT)	04/11 → 07/15
DS4 1.6 THP 160	5FM(EP6DT), 5FM(EP6DT)	04/12 → 07/15
DS4 1.6 THP 165	5FM(EP6DT), 5FU(EP6DXTX)	01/12 → 07/15
DS4 1.6 THP 200	5FU(EP6DXTX), 5FV(EP6CDT)	04/11 → 07/15
DS4 1.6 THP 210	5GM(EP6FDTX)	07/15 → 07/15
DS5 1.6 THP 150	EP6CDTMD	11/11 → 07/15
DS5 1.6 THP 155	5FV(EP6CDT), 5FM(EP6DT)	11/11 → 07/15
DS5 1.6 THP 165	5FM(EP6DT), 5GZ(EP6FDT)	01/12 → 07/15
DS5 1.6 THP 165 Hybrid	5GZ(EP6FDT), 5FU(EP6DXTX)	06/12 → 07/15
DS5 1.6 THP 200	5FU(EP6DXTX), KFT(TU3A)	11/11 → 07/15
DS5 1.6 THP 210	5GM(EP6FDTX)	11/14 → 07/15
GRAND C4 SPACETOUREUR 1.6 THP 165	EP6FDT	04/18 →
NEMO 1.4	KFT(TU3A), KFW(TU3JP)	02/08 →
SAXO 1.6	TU5JP	02/01 → 04/04
SAXO 1.6 VTS	TU5JP	09/00 → 09/03
XSARA 1.4	TU3JP	05/98 → 03/05
XSARA 1.4 i	KFW(TU3JP), NFU(TU5JP4)	04/97 → 08/05
XSARA 1.6 16V	NFU(TU5JP4), NFV(TU5JP)	09/00 → 08/05
XSARA PICASSO 1.6	NFV(TU5JP), N6A(TU5JP4)	12/99 →
XSARA PICASSO 1.6 16V	N6A(TU5JP4), 5GZ(EP6FDT)	03/05 →
XSARA PICASSO 1.6 16V LPG	TU5JP4	09/05 →
XSARA PICASSO 1.6 Chrono	TU5JP	04/01 → 10/04

DS

DS 5 1.6 THP 165	5GZ(EP6FDT), 5GM(EP6FDTX)	07/15 →
DS 5 1.6 THP 210	5GM(EP6FDTX), EP6FDT	04/15 →
DS 7 1.6 PureTech 180	EP6FADTXD	04/18 →
DS 7 1.6 PureTech 225	EP6FADTX	09/17 →
DS3 1.6 THP	EP6FDT, 5GZ(EP6FDT)	07/15 →
DS3 1.6 THP 165	5GZ(EP6FDT), 5GR(EP6FDTX)	07/15 →
DS3 1.6 THP 208	5GR(EP6FDTX), 5GZ(EP6FDT)	09/15 →
DS4 / DS4 CROSSBACK 1.6 THP 150	EP6CDTMD	10/16 →
DS4 / DS4 CROSSBACK 1.6 THP 165	5GZ(EP6FDT), 5GM(EP6FDTX)	07/15 →
DS4 / DS4 CROSSBACK 1.6 THP 210	5GM(EP6FDTX), KFT	07/15 →

FIAT

FIORINO III 1.4	KFT, KFT	11/07 →
QUBO 1.4	KFT, N16B16A	02/08 →

MINI

MINI II Cooper ALL4	N16B16A, N14B16A	11/12 → 10/16
MINI II Cooper S	N14B16A, N18B16A	10/06 → 10/16
MINI II Cooper S ALL4	N18B16A, N14B16A	08/10 → 10/16
MINI II Cooper S JCW	N18B16A	12/10 → 04/15
MINI II Cooper S John Cooper Works	N14B16A, N14B16C	11/06 → 02/10
MINI II John Cooper Works	N14B16C, N14B16C	11/07 → 09/16

MINI		
MINI II John Cooper Works ALL4	N18B16C	11/12 ⇒ 10/16
MINI II John Cooper Works GP	N14B16C, KFV(TU3A)	09/12 ⇒ 11/13
MINI II John Cooper Works ALL4	N18B16C	11/12 ⇒
PEUGEOT		
206 1.1	HFX(TU1JP), HFX(TU1JP)	07/02 ⇒
206 1.1 i	HFX(TU1JP), KFV(TU3A)	09/98 ⇒
206 1.4	KFV(TU3A), ET3J4	07/02 ⇒
206 1.4 16V	ET3J4, K6D(TU3A)	10/03 ⇒
206 1.4 CNG	TU3AF	05/06 ⇒ 09/07
206 1.4 i	K6D(TU3A), N6A(TU5JP4)	04/05 ⇒
206 1.6	NFU(TU5JP4)	09/01 ⇒ 12/08
206 1.6 16V	N6A(TU5JP4), HFX(TU1A)	07/00 ⇒
206 1.6 BiFuel	TU5JP4	07/00 ⇒ 04/09
206 1.6 BiFuel [ExtraEU]	TU5JP4	07/02 ⇒ 02/07
206 1.6 LPG	NFU(TU5JP4)	07/02 ⇒
206+ 1.1	HFX(TU1A), K6D(TU3A)	01/09 ⇒
206+ 1.1 LPG	TU1A	04/09 ⇒ 06/13
206+ 1.4 i	K6D(TU3A), KFT(TU3A)	01/09 ⇒
206+ 1.6 16V	NFU(TU5JP4)	07/10 ⇒
207 1.4	KFT(TU3A), ET3J4	02/06 ⇒
207 1.4 16V	ET3J4, NFU(TU5JP4)	02/06 ⇒
207 1.4 BiFuel	TU3A	08/07 ⇒ 12/13
207 1.4 Flex	KFV(TU3A)	11/08 ⇒
207 1.4 LPG	TU3A	08/07 ⇒ 12/12
207 1.6	N6A(TU5JP4)	08/08 ⇒
207 1.6 16V	NFU(TU5JP4), 5FY(EP6DTS)	02/06 ⇒
207 1.6 16V RC	5FY(EP6DTS), 5FR(EP6DT)	02/07 ⇒
207 1.6 16V Turbo	5FR(EP6DT), 5FR(EP6DT)	02/06 ⇒
207 1.6 Bioflex	N6A(TU5JP4)	01/08 ⇒
207 CC 1.6 16V Turbo	5FR(EP6DT), 5GZ(EP6FDT)	02/07 ⇒
208 1.6	5GZ(EP6FDT), 5FU(EP6CDTX)	02/12 ⇒
208 1.6 GTi	5FU(EP6CDTX), 5FV(EP6CDT)	08/12 ⇒
208 1.6 THP 165	EP6FDT	03/15 ⇒
208 1.6 THP 210	5GM(EP6FDTX)	04/15 ⇒
301 1.6 LPG	EC5	07/14 ⇒
301 1.6 VTi 115	EC5, K6D(TU3JP)	11/12 ⇒
307 1.4	K6D(TU3JP), ET3J4	08/00 ⇒
307 1.4 16V	ET3J4, N6A(TU5JP4)	11/03 ⇒ 07/07
307 1.6 16V	N6A(TU5JP4), --	08/00 ⇒
307 1.6 BioFlex	--, 5FT(EP6DT)	07/06 ⇒
308 1.6 VTi [ExtraEU]	EC5	05/15 ⇒
308 I 1.6 16V	5FT(EP6DT), N6A(TU5JP4)	09/07 ⇒
308 I 1.6 Bioflex	N6A(TU5JP4), EP6CDTM	04/08 ⇒
308 I 1.6 GTi	EP6CDTX	07/10 ⇒
308 I 1.6 THP	EP6CDTM, 5GZ(EP6FDT)	10/10 ⇒
308 II 1.6	5GZ(EP6FDT), 5GN(EP6FDT)	01/12 ⇒
308 II 1.6 GT 205	EP6FDTX	06/14 ⇒
308 II 1.6 GTi	5GN(EP6FDT), 5FA(EP6CDT)	06/15 ⇒
308 II 1.6 PureTech 225	EP6FADTX	01/18 ⇒
308 II 1.6 THP 125	5FA(EP6CDT), EP6CDTMD	09/13 ⇒
308 II 1.6 THP 150	EP6FDTMD	03/14 ⇒
308 II 1.6 THP 155	EP6CDT	03/14 ⇒
308 II 1.6 THP 210	5GM(EP6FDTX)	04/15 ⇒
308 II 1.6 VTi	EC5	03/14 ⇒
308 II 1.6 VTi 115	NFP(EC5)	11/12 ⇒
508 I 1.6	5GZ(EP6FDT), 5FN(EP6CDT)	09/11 ⇒
508 I 1.6 THP	5FN(EP6CDT), KFV(TU3A)	11/10 ⇒
508 II 1.6 PureTech 225	EP6FADTX	09/18 ⇒
1007 1.4	KFV(TU3A), ET3J4	04/05 ⇒
1007 1.4 16V	ET3J4, NFU(TU5JP4)	10/05 ⇒
1007 1.6 16V	NFU(TU5JP4), HFX(TU1JP)	04/05 ⇒
3008 1.6 THP	5FV(EP6CDT), 5GZ(EP6FDT)	06/09 ⇒
3008 1.6 THP [ExtraEU]	EP6CDTM	09/10 ⇒ 08/16
3008 1.6 THP 150	EP6FDTMD	11/17 ⇒
3008 1.6 THP 165	EP6FDT	05/16 ⇒
3008 1.6 Turbo	5GZ(EP6FDT), EC5	05/14 ⇒ 08/16
5008 1.6	EP6FDTMD	07/18 ⇒
5008 1.6 16V	EP6CDT	09/09 ⇒
5008 1.6 THP 150	EP6CDTMD, 5GZ(EP6FDT)	02/12 ⇒
5008 1.6 THP 163	5GZ(EP6FDT), 5GZ(EP6FDT)	02/12 ⇒
5008 1.6 THP 165	5GZ(EP6FDT), 5GZ(EP6FDT)	02/12 ⇒
BIPPER 1.4	KFV(TU3A), KFV(TU3A)	02/08 ⇒
BIPPER TEPEE 1.4	KFV(TU3A), TU5JP4	04/08 ⇒
PARTNER 1.4	TU3JP	10/05 ⇒
PARTNER 1.4 CNG	TU3JPCNG	11/02 ⇒ 10/06
PARTNER 1.6	TU5JP4, HFX(TU1JP)	09/11 ⇒
PARTNER I 1.1	HFX(TU1JP), TU32	06/96 ⇒ 09/05
PARTNER I 1.4	TU32, NFU(TU5JP4)	06/96 ⇒ 12/15
PARTNER I 1.4 BiFuel	TU3JP	04/03 ⇒ 10/06
PARTNER I 1.6	N6A(TU5JP4)	09/00 ⇒

PEUGEOT		
PARTNER I 1.6 [ExtraEU]	TU5JP4	09/00 ⇒ 05/08
PARTNER I 1.6 16V	NFU(TU5JP4), NFR(TU5JP4B)	07/01 ⇒ 03/08
PARTNER I 1.6 Flexfuel	NFU(TU5JP4)	09/00 ⇒ 10/02
PARTNER II 1.6	NFR(TU5JP4B), NFR(TU5JP4B)	04/08 ⇒
PARTNER II TEPEE 1.6 VTi	NFR(TU5JP4B), K6D(TU3A)	04/08 ⇒
RANCH 1.1	HFX(TU1JP)	06/96 ⇒
RANCH 1.4	K6D(TU3A), N6A(TU5JP4)	04/05 ⇒
RANCH 1.4 CNG	TU3JPCNG	01/97 ⇒ 12/12
RANCH 1.6 16V	N6A(TU5JP4), EP6CDT	07/01 ⇒
RCZ 1.6 16V	EP6CDT, 5FE(EP6CDTMD)	03/10 ⇒
RCZ 1.6 THP	EP6CDTM	01/11 ⇒
RCZ 1.6 THP 150	5FE(EP6CDTMD), 5FG(EP6CDTR)	03/11 ⇒ 12/15
RCZ 1.6 THP 270	5FG(EP6CDTR), A16DMS	06/13 ⇒ 12/15

9.3166



04,5

KNOCK SENSORS

Adatt./Suitable:

ALFA ROMEO
60662824BOSCH
0 261 231 153FIAT
60662824LANCIA
60662824

L	mV/g		
720	24		

ALFA ROMEO

147 3.2 GTA	932A.000	02/03 ⇒ 03/10
156 3.2 GTA	932A.000	03/02 ⇒ 05/06
166 2.5 V6 24V	AR36201	10/00 ⇒ 06/07
166 3.0 V6 24V	AR36101	10/00 ⇒ 06/07
166 3.2 V6 24V	936A.000	10/03 ⇒ 06/07
GT 3.2 GTA	936A.000	11/03 ⇒ 09/10
GTV 3.0 V6 24V	AR16105	10/00 ⇒ 10/05
GTV 3.2 V6 24V	936A6.000	04/03 ⇒ 10/05
SPIDER II 3.0 V6	AR16105	09/94 ⇒ 04/05
SPIDER II 3.2 V6 24V	936A6.000	04/03 ⇒ 04/05
LANCIA		
THESIS 3.0 V6	841A.000	07/02 ⇒ 07/09
THESIS 3.2 V6	841L.000	05/03 ⇒ 07/09

9.3169



04,5

KNOCK SENSORS

Adatt./Suitable:

CHEVROLET
96386710DAEWOO
96386710GENERAL MOTORS
96 386 710

- 03 Supplied until depletion**
- Fornibile fino ad esaurimento delle scorte
 - Fourni jusqu'à épuisement du stock
 - Lieferbar solange vorrat reicht
 - Suministrado hasta el stock termina

1006 After depletion of stock this part is replaced by:

- Esaurite le scorte questo pezzo sarà sostituito da:
- Après épuisement du stock, cette pièce est remplacée par:
- Nach Vorraterschöpfung wird ersetzt durch:
- Después agotamiento stock, sera sustituido por:

9.3052



L	mV/g		
350	23		

CHEVROLET

AVEO I 1.4	L14	03/05 ⇒ 12/07
AVEO I 1.4 CNG	L95	01/10 ⇒
AVEO I 1.5	F1553	05/05 ⇒
AVEO I 1.6	A16DMS, F14D3	09/03 ⇒

DAEWOO

KALOS 1.4	F14D3, BBK	09/02 ⇒
KALOS 1.4 16V	F14D3	04/03 ⇒
KALOS 1.5	F1553	11/02 ⇒ 12/04
KALOS 1.6	F1654	02/03 ⇒

9.3170



04,5

KNOCK SENSORS

Adatt./Suitable:

AUDI

- 079 905 376 A
- 079 905 376 C
- 079 905 377 A
- 079 905 377 E
- 079 905 377 F
- 07L 905 376 B

BENTLEY

- 079 905 376 C
- 079 905 377 E

VW

- 079 905 376 A
- 079 905 376 C
- 079 905 377 A
- 079 905 377 E
- 079 905 377 F
- 07L 905 376 B
- 07L 905 377 E



L	mV/g		
350	26		

AUDI

A4 II RS4 quattro	BNS	06/06 ⇨ 03/09
A4 II S4 quattro	BBK	03/03 ⇨ 03/09
A4 III RS4 quattro	BNS	09/05 ⇨ 06/08
A4 III S4 quattro	BBK, CRDB	11/04 ⇨ 06/08
A4 IV RS4 quattro	CFSA	05/12 ⇨ 08/15
A5 I RS5 quattro	CFSA	03/10 ⇨ 08/15
A5 I S5 quattro	CAUA	06/07 ⇨ 03/12
A6 III 4.2 FSI quattro	BJV	05/06 ⇨ 08/11
A6 III 4.2 quattro	BAT	05/04 ⇨ 05/06
A6 III RS6 quattro	BUH	04/08 ⇨ 08/10
A6 IV RS6 performance quattro	CWUC	11/15 ⇨ 09/18
A6 IV RS6 quattro	CRDB, CEUC	01/13 ⇨ 09/18
A6 IV S6 quattro	CEUC, CRDB	02/12 ⇨ 09/18
A7 SPORTBACK RS7 performance quattro	CWUC	11/15 ⇨ 04/18
A7 SPORTBACK RS7 quattro	CRDB, CEUC	10/13 ⇨ 04/18
A7 SPORTBACK S7 quattro	CEUC, CEUA	02/12 ⇨ 05/18
A8 II 4.2 FSI quattro	BJV	06/06 ⇨ 07/10
A8 III 4.0 TFSI	CTGF	11/15 ⇨
A8 III 4.0 TFSI quattro	CEUA, CGTA	03/12 ⇨ 12/15
A8 III 4.2 FSI quattro	CDRA	11/09 ⇨ 12/12
A8 III S8 plus quattro	DDTA	11/15 ⇨ 01/18
A8 III S8 quattro	CGTA, BYH	04/12 ⇨ 01/18
ALLROAD 4.2 V8 quattro	BAS	07/02 ⇨ 08/05
Q7 I 4.2 FSI quattro	BAR	03/06 ⇨ 05/10
R8 4.2 FSI quattro	BYH, CMMC	04/07 ⇨ 07/15

BENTLEY

CONTINENTAL 4.0	CMMC, CMMD	09/11 ⇨
CONTINENTAL 4.0 FLEX	CMMD, CMMC	12/13 ⇨
CONTINENTAL 4.0 FLEX AWD	CMMC, CMMC	04/12 ⇨
CONTINENTAL 4.0 FlexFuel [ExtraEU]	CMMC	09/11 ⇨
CONTINENTAL 4.0 GT	CMMC, CMMC	04/12 ⇨
FLYING SPUR 4.0	CYCB	03/13 ⇨
FLYING SPUR 4.0 FLEX	CMMC, BYH	03/13 ⇨
FLYING SPUR V8 S 4.0	CYCA	05/16 ⇨

VW

TOUAREG I 4.2 V8 FSI	BAR	06/06 ⇨ 05/10
TOUAREG II 4.2 V8 FSI	CGNA	01/11 ⇨ 03/18

9.3171



04,5

KNOCK SENSORS

Adatt./Suitable:

AUDI

- 077 905 377 E
- 077 905 377 G
- 079 905 376 B

VW

- 077 905 377 E
- 077 905 377 G
- 079 905 376 B

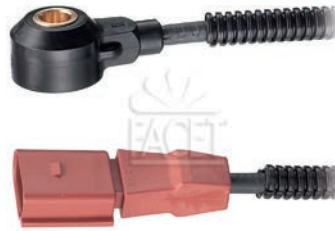

L	mV/g		
570	26		

AUDI

A4 II RS4 quattro	BNS	06/06 ⇨ 03/09
A4 III RS4 quattro	BNS	09/05 ⇨ 06/08
A4 IV RS4 quattro	CFSA	05/12 ⇨ 08/15
A5 I RS5 quattro	CFSA	03/10 ⇨ 08/15
A5 I S5 quattro	CAUA	06/07 ⇨ 03/12
A6 III 4.2 FSI quattro	BJV	05/06 ⇨ 08/11
A8 II 3.7 quattro	BFL	10/02 ⇨ 05/06
A8 II 4.2 FSI quattro	BJV	06/06 ⇨ 07/10
A8 II 4.2 quattro	BFM	10/02 ⇨ 07/10
A8 III 4.2 FSI quattro	CDRA	11/09 ⇨ 12/12
Q7 I 4.2 FSI quattro	BAR	03/06 ⇨ 05/10
R8 4.2 FSI quattro	BYH, BGH	04/07 ⇨ 07/15

VW

PHAETON 4.2 V8 4motion	BGH, AXX	05/03 ⇨ 03/16
TOUAREG I 4.2 V8 FSI	BAR	06/06 ⇨ 05/10
TOUAREG II 4.2 V8 FSI	CGNA	01/11 ⇨ 03/18

9.3173



04,5

KNOCK SENSORS

Adatt./Suitable:

AUDI

- 06F 905 377

SEAT

- 06F 905 377

SKODA

- 06F 905 377

VW

- 06F 905 377

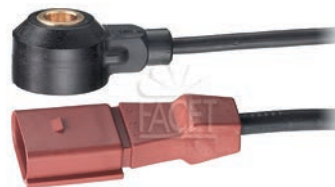

L	mV/g		
175	24		

AUDI

A1 2.0 TFSI quattro	CDLH	03/12 ⇨ 11/12
A3 II 2.0 TFSI	AXX, AXX	09/04 ⇨ 08/12
A3 II 2.0 TFSI quattro	AXX, BHZ	09/04 ⇨ 08/12
A3 II S3 quattro	BHZ, AXX	11/06 ⇨ 08/12
A3 II SPORTBACK 2.0 TFSI	AXX, AXX	09/04 ⇨ 03/13
A3 II SPORTBACK 2.0 TFSI quattro	AXX, BHZ	09/04 ⇨ 03/13

AUDI

A3 II SPORTBACK S3 quattro	BHZ, BPY	06/08 ⇨ 03/13
TT II 2.0 TFSI	BPY, CDLA	08/06 ⇨ 06/10
TT II 2.0 TFSI quattro	BWA	06/08 ⇨ 06/10
TT II 2.0 TTS quattro	CDLA, BWA	05/08 ⇨ 06/14

SEAT

ALTEA 2.0 TFSI	BWA	04/06 ⇨ 05/09
ALTEA XL 2.0 TFSI	BWA	10/06 ⇨ 05/09
ALTEA XL 2.0 TFSI 4x4	BWA	06/07 ⇨ 05/09
LEON II 2.0 Cupra R	CDLA	09/09 ⇨ 12/12
LEON II 2.0 TFSI	BWA	05/05 ⇨ 03/09
TOLEDO III 2.0 TFSI	BWA	11/05 ⇨ 05/09

SKODA

OCTAVIA II 2.0 RS	BWA, BPY	10/05 ⇨ 02/13
-------------------	----------	---------------

VW

EOS 2.0 TFSI	BPY, BWA	03/06 ⇨ 08/15
GOLF V 2.0	BWA, AXX	06/07 ⇨ 07/09
GOLF V 2.0 GTI	AXX, CDLA	10/04 ⇨ 02/09
GOLF VI 2.0	CDLF	05/11 ⇨
GOLF VI 2.0 GTI	CDLG	05/11 ⇨ 11/12
GOLF VI 2.0 R	CDLA	01/13 ⇨ 05/16
GOLF VI 2.0 R 4motion	CDLA, BPY	11/09 ⇨ 11/13
GOLF VI 2.0 TFSI	CRZA	11/11 ⇨
GOLF VI 2.0 TFSI Gti	CDLG	05/11 ⇨
GOLF VI 2.0 TSI	CDLC	01/13 ⇨
GOLF 2.0 TSI R 4motion	CDLF	11/09 ⇨ 11/12
JETTA V 2.0 TFSI	BPY, AXX	10/05 ⇨ 10/10
PASSAT V 2.0 FSI	AXX, CDLA	07/05 ⇨ 11/10
POLO V 2.0 R WRC	CDLJ	08/13 ⇨
SCIROCCO III 2.0 R	CDLA, HYDB	11/09 ⇨ 11/17

9.3174



04,5

KNOCK SENSORS

Adatt./Suitable:

BOSCH

- 0 261 231 178

FORD

- 1 371 593
- 6M5G-12A699-AA

VOLVO

- 865317-1



L	mV/g		
450 - 350	27		

FORD

FOCUS II 2.5 RS	JZDA	01/09 ⇨ 07/11
FOCUS II 2.5 RS 500	JZDA	05/10 ⇨ 07/11
FOCUS II 2.5 ST	HYDA	10/05 ⇨ 09/12
GALAXY II 2.5 ST	HUWA	05/06 ⇨
KUGA I 2.5	HYDB, HYDB	03/09 ⇨ 11/12
KUGA I 2.5 4x4	HYDB, B5254T3	02/08 ⇨ 11/12
MONDEO III 2.5	HUBA	03/07 ⇨ 01/15
S-MAX I 2.5 ST	HUWA	05/06 ⇨ 12/14

VOLVO

C30 2.5 T5 [ExtraEU]	B525477	03/12 ⇨ 12/13
C30 T5	B5254T3, B5254T3	10/06 ⇨ 12/12
C70 II T5	B5254T3, B5254T3	03/06 ⇨ 10/09
S40 II T5	B5254T3, B5254T3	01/04 ⇨ 12/12
S40 II T5 AWD	B5254T3, B5254T14	04/04 ⇨ 12/10
S60 II 2.5 T	B5254T14	01/13 ⇨
S60 II 2.5 T5	B5254T5	09/11 ⇨
S60 II 2.5 T5 AWD	B5254T14, B5254T10	09/12 ⇨
S60 II T5 AWD	B5254T12	08/15 ⇨

VOLVO		
S80 II 2.5 T	B5254T10, B5254T11	03/06 ⇨ 12/12
S80 II 2.5 T AWD	B5254T6	10/06 ⇨ 04/09
S80 II 2.5 T FlexFuel	B5254T11, B5204T9	05/08 ⇨ 12/11
S80L 2.5 T	B5254T6	01/08 ⇨
S80L 2.5 T5	B5254T12	01/12 ⇨
V40 II T4	B5204T8	07/13 ⇨ 12/15
V40 II T5	B5204T9, B5254T12	12/12 ⇨
V40 II T5 AWD	B5254T12, B5254T3	01/13 ⇨
V50 T5	B5254T3, B5254T3	04/04 ⇨ 12/12
V50 T5 AWD	B5254T3, B5254T12	04/04 ⇨ 12/10
V60 IT5 AWD	B5254T12, B5254T10	03/15 ⇨
V70 III 2.0 BiFuel	B5204T9	03/13 ⇨ 12/15
V70 III 2.5 T	B5254T10, B5254T11	08/07 ⇨ 12/12
V70 III 2.5 T FlexiFuel	B5254T11, BHT	05/08 ⇨ 12/11
XC70 II T5 AWD	B5254T12	08/15 ⇨
XC70 II T6 AWD	B5254T14	03/15 ⇨

9.3175

04,5

KNOCK SENSORS

Adatt./Suitable:

AUDI
07C 905 377 AA**BENTLEY**
07C 905 377 AA**VW**
07C 905 377 AA

L	mV/g		
500	22		

AUDI		
A8 II 6.0 W12 quattro	BHT, BEB	12/03 ⇨ 07/10
BENTLEY		
CONTINENTAL 6.0	BEB, BEB	06/03 ⇨
CONTINENTAL 6.0 AWD	BEB, CKHB	06/06 ⇨
CONTINENTAL 6.0 FLEX	CKHB, CKHA	11/10 ⇨
CONTINENTAL 6.0 FLEX AWD	CKHA, BWRB	03/10 ⇨
CONTINENTAL 6.0 FlexFuel	CKHC	01/10 ⇨ 07/10
CONTINENTAL 6.0 Flexfuel [ExtraEU]	BWRB, BWRA	02/08 ⇨
CONTINENTAL 6.0 ISR/ISR Flexfuel	CKHE	03/11 ⇨ 06/14
CONTINENTAL 6.0 Speed [ExtraEU]	DBDD	11/17 ⇨ 07/18
CONTINENTAL 6.0 Super-sports AWD	DJLA	09/17 ⇨ 05/18
CONTINENTAL 6.0 Trazione integrale	BWRA, BWR	08/07 ⇨ 04/11
CONTINENTAL FLYING SPUR 6.0	BWR, BEB	03/05 ⇨
CONTINENTAL FLYING SPUR 6.0 FLEX	BEB, CVAA	03/05 ⇨
FLYING SPUR 6.0	CVAA, BJN	03/13 ⇨
VW		
TOUAREG I 6.0 W12	BJN, BBK	08/04 ⇨ 05/10

9.3176

04,5

KNOCK SENSORS

Adatt./Suitable:

AUDI079 905 377 D
079 905 377 H
07L 905 376 C**VW**079 905 377 D
079 905 377 H
07L 905 376 C⁰³ Supplied until depletion

- Fornibile fino ad esaurimento delle scorte
- Fourni jusqu'à épuisement du stock
- Lieferbar solange vorrat reicht
- Suministrado hasta el stock termina



L	mV/g		
400	25		

AUDI

A4 II S4 quattro	BBK	03/03 ⇨ 03/09
A4 III S4 quattro	BBK, BSM	11/04 ⇨ 06/08
A4 IV RS4 quattro	CFSA	05/12 ⇨ 08/15
A5 I RS5 quattro	CFSA	03/10 ⇨ 08/15
A6 III 4.2 quattro	BAT	05/04 ⇨ 05/06
A6 III RS6 quattro	BUH	04/08 ⇨ 08/10
A6 III S6 quattro	BXA	03/06 ⇨ 08/11
A8 II S8 quattro	BSM, BSM	06/06 ⇨ 07/10
ALLROAD 4.2 V8 quattro	BAS	07/02 ⇨ 08/05

9.3177

04,5

KNOCK SENSORS

Adatt./Suitable:

AUDI
07L 905 377 B**VW**
07L 905 377 B⁰⁰ Eliminated on 04-03-2019. Please verify the availability through our local distributors

- Eliminato il 04-03-2019. Verificare la disponibilità presso i nostri distributori
- Éliminé le 04-03-2019. Vérifier la disponibilité auprès de nos distributeurs sur place
- Am 04-03-2019 gestrichen. Evtl. Verfügbarkeit bitte bei unseren Händlern prüfen
- Eliminado en fecha 04-03-2019. Verificar la disponibilidad a través de nuestros distribuidores locales



L	mV/g		
400	25		

AUDI

A6 III S6 quattro	BXA	03/06 ⇨ 08/11
A8 II S8 quattro	BSM, BSM	06/06 ⇨ 07/10

9.3178

04,5

KNOCK SENSORS

Adatt./Suitable:

AUDI079 905 376
07L 905 377 A**VW**079 905 376
07L 905 377 A

L	mV/g		
250	25		

AUDI

A4 IV RS4 quattro	CFSA	05/12 ⇨ 08/15
A5 I RS5 quattro	CFSA	03/10 ⇨ 08/15
A6 III S6 quattro	BXA	03/06 ⇨ 08/11
A8 II S8 quattro	BSM, BBK	06/06 ⇨ 07/10

9.3179

04,5

KNOCK SENSORS

Adatt./Suitable:

AUDI079 905 377 C
079 905 377 G**VW**
079 905 377 C
079 905 377 G⁰³ Supplied until depletion

- Fornibile fino ad esaurimento delle scorte
- Fourni jusqu'à épuisement du stock
- Lieferbar solange vorrat reicht
- Suministrado hasta el stock termina



L	mV/g		
200	27		

AUDI

A4 II S4 quattro	BBK	03/03 ⇨ 03/09
A4 III S4 quattro	BBK, AUK	11/04 ⇨ 06/08
A6 III 4.2 quattro	BAT	05/04 ⇨ 05/06
ALLROAD 4.2 V8 quattro	BAS	07/02 ⇨ 08/05

9.3180



04,5

KNOCK SENSORS

Adatt./Suitable:

AUDI

06E 905 376 B
06E 905 377 B
06E 905 377 C

PORSCHE

958 606 121 20
958 606 121 21

VW

06E 905 376 B
06E 905 377 B
06E 905 377 C



L	mV/g		
500	24		

AUDI

A4 II 3.2 FSI	AUK	01/06 ⇨ 03/09
A4 II 3.2 FSI quattro	AUK	01/06 ⇨ 03/09
A4 III 3.2 FSI	AUK	01/05 ⇨ 06/08
A4 III 3.2 FSI quattro	AUK, CMUA	01/05 ⇨ 06/08
A4 IV 3.0 TFSI quattro	CMUA, CAKA	02/12 ⇨ 12/15
A4 IV 3.2 FSI	CALA	09/08 ⇨ 03/12
A4 IV 3.2 FSI quattro	CALA	11/07 ⇨ 03/12
A4 IV S4 quattro	CAKA, CHMB	11/08 ⇨ 12/15
A5 I 3.0 TFSI quattro	CHMB, CAKA	08/11 ⇨
A5 I 3.2 FSI	CALA	06/07 ⇨ 03/12
A5 I 3.2 FSI quattro	CALA	06/07 ⇨ 03/12
A5 I S5 quattro	CAKA, BDX	06/09 ⇨ 01/17
A6 III 2.4	BDW	05/04 ⇨ 10/08
A6 III 2.4 [CHN]	BDW	04/05 ⇨
A6 III 2.4 quattro	BDW	01/05 ⇨ 10/08
A6 III 2.8 FSI	BDX, BDX	11/06 ⇨ 08/11
A6 III 2.8 FSI quattro	BDX, CAJA	06/07 ⇨ 08/11
A6 III 3.0 [CHN]	BBJ	04/05 ⇨
A6 III 3.0 TFSI quattro	CAJA, AUK	10/08 ⇨ 08/11
A6 III 3.2 FSI	AUK, AUK	05/04 ⇨ 03/11
A6 III 3.2 FSI quattro	AUK, CHVA	05/04 ⇨ 10/08
A6 III RS6 quattro	BUH	04/08 ⇨ 08/10
A6 IV 2.8 FSI	CHVA	11/10 ⇨ 04/15
A6 IV 2.8 FSI quattro	CHVA, CGWB	11/10 ⇨ 09/18
A6 IV 3.0 TFSI quattro	CGWB, CHVA	11/10 ⇨ 09/18
A7 SPORTBACK 2.5 FSI	CLXB	05/12 ⇨
A7 SPORTBACK 2.8 FSI	CHVA	02/11 ⇨ 03/15
A7 SPORTBACK 2.8 FSI quattro	CHVA, CGWB	10/10 ⇨ 05/18
A7 SPORTBACK 2.8 TFSI	CVPA	09/14 ⇨
A7 SPORTBACK 3.0 TFSI quattro	CGWB, BDX	10/10 ⇨ 03/15
A8 II 2.8 FSI	BDX, CPAA	08/07 ⇨ 07/10
A8 II 3.2 FSI	BPK	06/05 ⇨ 07/10
A8 II 3.2 FSI quattro	BPK	06/05 ⇨ 07/10
A8 III 2.5 TFSI	CPAA, CGWA	07/12 ⇨ 06/16
A8 III 3.0 TFSI quattro	CGWA, CTUC	06/10 ⇨ 01/18
Q5 I 3.0 TFSI quattro	CTUC, CTUD	06/12 ⇨
Q5 I 3.2 FSI quattro	CALB	11/08 ⇨
Q5 I SQ5 TFSI quattro	CTUD, CJTB	05/13 ⇨
Q7 I 3.0 TFSI quattro	CJTB, BUJ	05/10 ⇨ 08/15
R8 5.2 FSI quattro	BUJ, M06.EC	04/09 ⇨
R8 5.2 FSI RWS	DKAB	09/17 ⇨

PORSCHE

CAYENNE II 3.0 S E-Hybrid M06.EC, CGEA 06/10 ⇨

VW

TOUAREG II 3.0 TFSI	CYJA	01/15 ⇨
TOUAREG II 3.0 V6 TSI	CJTA	08/10 ⇨ 03/18
TOUAREG II 3.0 V6 TSI Hybrid	CGEA, BSM	04/10 ⇨ 03/18

9.3181



04,5

KNOCK SENSORS

Adatt./Suitable:

AUDI

07L 905 377

VW

07L 905 377

03 Supplied until depletion

- Fornibile fino ad esaurimento delle scorte
- Fourni jusqu'à épuisement du stock
- Lieferbar solange vorrat reicht
- Suministrado hasta el stock termina



L	mV/g		
225	26		

AUDI

A6 III S6 quattro	BXA	03/06 ⇨ 08/11
A8 II S8 quattro	BSM, BLV	06/06 ⇨ 07/10

9.3182



04,5

KNOCK SENSORS

Adatt./Suitable:

SKODA

022 905 376

VW

022 905 376
022 905 377 B



L	mV/g		
350	24		

SKODA

SUPERB II 3.6 FSI 4x4	--	04/09 ⇨ 05/15
VW		
CC 3.6 FSI	CNNA	11/11 ⇨
CC 3.6 FSI 4motion	BWS	11/11 ⇨ 12/16
EOS 3.6 V6	CDVA	05/09 ⇨ 11/10
PASSAT V 3.6 FSI	BLV	06/05 ⇨
PASSAT V 3.6 FSI 4motion	BLV	09/05 ⇨ 12/14
PASSAT CC 3.6 FSI	BLV, BLV	06/08 ⇨
PASSAT CC 3.6 FSI 4motion	BLV, BHT	02/08 ⇨ 01/12
PASSAT 3.6 FSI 4motion	BWS	01/11 ⇨ 12/14

9.3183



04,5

KNOCK SENSORS

Adatt./Suitable:

AUDI

07C 905 377 AD

VW

07C 905 377 AD



L	mV/g		
650	21		

AUDI

A8 II 6.0 W12 quattro | BHT, BHT | 12/03 ⇨ 07/10

9.3184



04,5

KNOCK SENSORS

Adatt./Suitable:

AUDI

07C 905 377 AG

07C 905 377 AJ

VW

07C 905 377 AJ



L	mV/g		
570	23		

AUDI

A8 II 6.0 W12 quattro | BHT, BHT | 12/03 ⇨ 07/10

9.3186



04,5

KNOCK SENSORS

Adatt./Suitable:

AUDI

07C 905 377 AF
07C 905 377 AH
07L 905 376
07L 905 377 C

VW

07C 905 377 AH
07L 905 376
07L 905 377 C

⁰⁰Eliminated on 04-03-2019. Please verify the availability through our local distributors

• Eliminato il 04-03-2019. Verificare la disponibilità presso i nostri distributori

• Éliminé le 04-03-2019. Vérifier la disponibilité auprès de nos distributeurs sur place

• Am 04-03-2019 gestrichen. Evtl. Verfügbarkeit bitte bei unseren Händlern prüfen

• Eliminado en fecha 04-03-2019. Verificar la disponibilidad a través de nuestros distribuidores locales



L	mV/g		
570	23		

AUDI

A6 III RS6 quattro	BUH	04/08 ⇨ 08/10
A8 II 6.0 W12 quattro	BHT, CEJA	12/03 ⇨ 07/10
A8 III 6.3 W12 quattro	CEJA, BUJ	01/11 ⇨ 01/18
R8 5.2 FSI quattro	BUJ, AM11	04/09 ⇨
R8 5.2 FSI RWS	DKAB	09/17 ⇨

9.3187



04,5

KNOCK SENSORS

Adatt./Suitable:

ASTON MARTIN

CD33-12A699-AA
FORD
1 357 496
1 362 065
1 374 710
4M51-12A699-AB
4M51-12A699-BA

MARKET DIFFUSION: MEDIUM



L	mV/g		
350	27		

ASTON MARTIN

DB9 6.0	AM11	09/15 ⇨ 10/16
DB9 6.0 V12	AM11, KKDA	07/12 ⇨ 10/16
RAPIDE 6.0 S	AM11	02/13 ⇨ 02/14
VANQUISH 6.0	AM11	10/12 ⇨
VANTAGE 6.0 V12S	AM28	01/13 ⇨

FORD

C-MAX I 1.8 TDCi	KKDA, KKDA	02/07 ⇨ 09/10
FOCUS II 1.8 TDCi	KKDA, FFWA	07/04 ⇨ 09/12
FOCUS C-MAX 1.8 TDCi	KKDA, KKDA	01/05 ⇨ 03/07
GALAXY II 1.8 TDCi	FFWA, FFBA	05/06 ⇨ 06/15

FORD

MONDEO III 1.8 TDCi	FFBA, FFWA	03/07 ⇨ 01/15
S-MAX I 1.8 TDCi	FFWA, HCPA	05/06 ⇨ 12/14
TOURNEO CONNECT I 1.8 TDCi	HCPA, BHPA	06/02 ⇨ 12/13
TOURNEO CONNECT I 1.8 TDCi /TDDi /Di	BHPA, BHPA	06/02 ⇨ 12/13
TRANSIT CONNECT I 1.8 Di	BHPA, HCPA	06/02 ⇨ 12/13
TRANSIT CONNECT I 1.8 TDCi	HCPA, CSDA	06/02 ⇨ 12/13

9.3188



04,5

KNOCK SENSORS

Adatt./Suitable:

AUDI

07C 905 377 G

VW

07C 905 377 G

⁰³Supplied until depletion

• Fornibile fino ad esaurimento delle scorte

• Fourni jusqu'à épuisement du stock

• Lieferbar solange vorrat reicht

• Suministrado hasta el stock termina



L	mV/g		
650	23		

AUDI

A8 I 6.0 W12 quattro | AZC | 01/01 ⇨ 09/02

9.3189



04,5

KNOCK SENSORS

Adatt./Suitable:

AUDI

07C 905 377 E

VW

07C 905 377 E

⁰³Supplied until depletion

• Fornibile fino ad esaurimento delle scorte

• Fourni jusqu'à épuisement du stock

• Lieferbar solange vorrat reicht

• Suministrado hasta el stock termina



L	mV/g		
570	23		

AUDI

A8 I 6.0 W12 quattro | AZC | 01/01 ⇨ 09/02

9.3190



04,5

KNOCK SENSORS

Adatt./Suitable:

AUDI

07C 905 377 F

VW

07C 905 377 F

⁰³Supplied until depletion

• Fornibile fino ad esaurimento delle scorte

• Fourni jusqu'à épuisement du stock

• Lieferbar solange vorrat reicht

• Suministrado hasta el stock termina



L	mV/g		
720	23		

AUDI

A8 I 6.0 W12 quattro | AZC | 01/01 ⇨ 09/02

9.3191



04,5

KNOCK SENSORS

Adatt./Suitable:

FORD

1 322 472
4M5G-12A699-EA



L	mV/g		
300	26		

FORD

FOCUS C-MAX 1.8 | CSDA, N52B30A | 10/03 ⇨ 03/07

9.3192



04,5

KNOCK SENSORS

Adatt./Suitable:

AUDI
07C 905 377 D
VW
07C 905 377 D

⁰³ Supplied until depletion

- Fornibile fino ad esaurimento delle scorte
- Fourni jusqu'à épuisement du stock
- Lieferbar solange vorrat reicht
- Suministrado hasta el stock termina



L	mV/g		
870	22		

AUDI		
A8 I 6.0 W12 quattro	AZC	01/01 ⇨ 09/02

9.3193



04,5

KNOCK SENSORS

Adatt./Suitable:

BMW
13 62 7 525 039
13 62 7 566 785
7 525 039
7 566 785



L	mV/g		
500 - 600	25		

BMW		
1 I 125 i	N52B30A, N51B30A	10/07 ⇨
1 I 128 i	N51B30A, N52B30A	03/08 ⇨
1 I 130 i	N52B30A, N52B25A	03/05 ⇨ 09/12
3 V 323 i	N52B25A, N52B25A	09/05 ⇨
3 V 325 i	N52B25A, N52B25A	12/04 ⇨
3 V 325 i xDrive	N52B25A, N52B25A	09/08 ⇨ 12/13
3 V 325 xi	N52B25A, N51B30A	01/05 ⇨
3 V 328 i	N51B30A, N51B30A	07/05 ⇨
3 V 328 xi	N51B30A, N52B30A	09/06 ⇨
3 V 330 i	N52B30A, N52B30A	12/04 ⇨ 12/13
3 V 330 i xDrive	N53B30A	09/07 ⇨ 06/13
3 V 330 xi	N52B30A, N54B30A	09/05 ⇨ 12/13
3 V 335 i	N54B30A, N54B30A	11/05 ⇨ 10/13
3 V 335 xi	N54B30A, N52B25A	09/06 ⇨ 02/10
3 SERIES 325i Coupe [ExtraEU]	N52B25A, N52B25A	03/10 ⇨ 06/13

BMW		
3 SERIES 330i Coupe Xi [ExtraEU]	N52B30A	09/06 ⇨ 09/08
5 VI 520Li [CHN]	N52B25AF	01/09 ⇨
5 VI 523 i	N52B25A, N52B30BF	01/09 ⇨ 08/11
5 VI 523Li [CHN]	N52B25AF	01/09 ⇨
5 VI 528 i	N52B30BF, N52B30A	11/09 ⇨
5 VI 528Li [CHN]	N52B30AF	09/10 ⇨
5 VI 530 i	N52B30A, N52B30A	06/09 ⇨ 06/13
5 VI 530Li [CHN]	N52B30AF	09/10 ⇨
5 V 523 i	N52B25A, N52B25A	10/04 ⇨
5 V 523Li	N52B25A, N52B25A	07/05 ⇨
5 V 525 i	N52B25A, N52B25A	10/04 ⇨
5 V 525 i xDrive	N53B30A	09/08 ⇨ 12/10
5 V 525 xi	N52B25A, N52B25A	07/05 ⇨
5 V 525Li	N52B25A, N52B30A	07/05 ⇨
5 V 528 i	N52B30A	09/08 ⇨ 12/09
5 V 528 xi	N52B30A	03/07 ⇨
5 V 530 i	N52B30A, N52B30A	09/04 ⇨ 12/10
5 V 530 i xDrive	N53B30A	09/08 ⇨ 05/10
5 V 530 xi	N52B30A, N52B30A	09/04 ⇨ 05/10
5 V 530Li	N52B30A, N52B25A	07/05 ⇨
6 II 630 i	N52B30A, N52B30A	02/04 ⇨ 07/10
7 IV 730 i, Li	N52B30A, N52B30A	03/05 ⇨ 07/08
7 IV 730 i, Li	N52B30B	03/05 ⇨
7 V 730 i, Li	N52B30A, N52B25A	06/08 ⇨ 12/15
X1 xDrive 25 i	N52B30A	01/10 ⇨ 06/15
X1 xDrive 28 i	N52B30A	10/09 ⇨ 06/15
X3 I 2.5 si	N52B25A, N52B25A	08/06 ⇨ 08/08
X3 I 2.5 si xDrive	N52B25A, N52B30A	08/06 ⇨ 08/08
X3 I 3.0 si	N52B30A, N52B25A	09/06 ⇨ 08/08
X3 I xDrive 2.5si	N52B25BF	09/06 ⇨
X3 I xDrive 25 i	N52B25A, N52B30A	09/08 ⇨ 08/10
X3 I xDrive 3.0si	N52B30B	09/06 ⇨
X3 I xDrive 30 i	N52B30A, N52B30A	09/08 ⇨ 12/11
X3 II xDrive 28 i	N52B30A, N52B30A	01/11 ⇨ 10/12
X5 II 3.0 si	N52B30A, N52B30A	02/06 ⇨ 09/08
X5 II xDrive 30 i	N52B30A, N52B25A	09/08 ⇨ 12/10
Z4 I 2.5 i	N52B25A, N52B25A	09/05 ⇨
Z4 I 2.5 si	N52B25A, N52B30A	09/05 ⇨
Z4 I 3.0 i	N52B30A	01/06 ⇨
Z4 I 3.0 si	N52B30A, N52B25A	01/06 ⇨
Z4 II sDrive 23 i	N52B25A, N52B30A	03/09 ⇨ 08/11
Z4 II sDrive 30 i	N52B30A, N52B30B	02/09 ⇨ 08/11
Z4 II sDrive30i	N52B30B, N54B30A	05/09 ⇨

9.3196



04,5

KNOCK SENSORS

Adatt./Suitable:

BMW
13 62 7 566 786
7 566 786



L	mV/g		
570 - 400	26		

BMW		
1 I 135 i	N54B30A, N55B30A	10/07 ⇨ 12/13
1 I M	N54B30A	04/11 ⇨ 06/12
1 I II M 135 i	N55B30A, N55B30A	11/11 ⇨
1 I II M 135 i xDrive	N55B30A, N54B30A	02/12 ⇨
2 M 235 i	N55B30A	10/13 ⇨
2 M 235 i xDrive	N55B30A	07/14 ⇨
2 M2	N55B30A	11/15 ⇨ 06/18
2 M2 Competition	S55B30A	06/18 ⇨
3 V 335 i	N54B30A, N54B30A	11/05 ⇨ 10/13

9.3198



04,5

KNOCK SENSORS

Adatt./Suitable:

AUDI
07K 905 377 A
07K 905 377 C
VW
07K 905 377 A
07K 905 377 C



L	mV/g		
800	21		

AUDI		
A3 II SPORTBACK RS3 quattro	CEPA	01/11 ⇨ 12/12
A3 III RS3 quattro	CZGB	03/15 ⇨
Q3 RS 2.5 quattro	CTSA, CEPA	05/13 ⇨ 10/18
TT II 2.5 RS quattro	CEPA, CBTA	07/09 ⇨ 06/14

VW		
GOLF V 2.5	CBTA, BGP	05/07 ⇨ 11/08
GOLF V 2.5 FSI	BGP, CBTA	06/05 ⇨ 11/08
GOLF VI 2.5	CBTA, BGQ	07/09 ⇨
JETTA V 2.5	BGQ, CBTA	01/05 ⇨
PASSAT V 2.5 SRE	CBTA, CTSA	01/11 ⇨

9.3199



04,5

KNOCK SENSORS

Adatt./Suitable:

AUDI

07K 905 377 B

VW07K 905 377
07K 905 377 B

L	mV/g		
720	22		

AUDI

A3 II SPORTBACK RS3 quattro	CEPA	01/11 → 12/12
A3 III RS3 quattro	CZGB	03/15 →
Q3 RS 2.5 quattro	CTSA, CEPA	05/13 → 10/18
TT II 2.5 RS quattro	CEPA, CBTA	07/09 → 06/14

VW

BEETLE 2.5	CBTA, CBTA	04/11 →
GOLF V 2.5	CBTA, BGP	05/07 → 11/08
GOLF V 2.5 FSI	BGP, CBTA	06/05 → 11/08
GOLF VI 2.5	CBTA, BGP	07/09 →
JETTA V 2.5	BGP, CBTA	01/05 →
JETTA VI 2.5	CBTA, BPR	04/10 →
NEW BEETLE 2.5	BPR, CBTA	07/05 → 09/10
PASSAT V 2.5 SRE	CBTA, BJJ	01/11 →

9.3200



04,5

KNOCK SENSORS

Adatt./Suitable:

VW

07C 905 377 AN

Supplied until depletion

- Fornibile fino ad esaurimento delle scorte
- Fourni jusqu'à épuisement du stock
- Lieferbar solange vorrat reicht
- Suministrado hasta el stock termina



L	mV/g		
450	20		

VW

TOUAREG I 6.0 W12	BJN, BJJ	08/04 → 05/10
-------------------	----------	---------------

9.3201



04,5

KNOCK SENSORS

Adatt./Suitable:

VW

07C 905 377 AM

Supplied until depletion

- Fornibile fino ad esaurimento delle scorte
- Fourni jusqu'à épuisement du stock
- Lieferbar solange vorrat reicht
- Suministrado hasta el stock termina



L	mV/g		
350	19		

VW

TOUAREG I 6.0 W12	BJN, G6BA	08/04 → 05/10
-------------------	-----------	---------------

9.3203



04,5

KNOCK SENSORS

Adatt./Suitable:

BOSCH

0 261 231 230

HYUNDAI

39250-3E110

KIA

39250-3E110

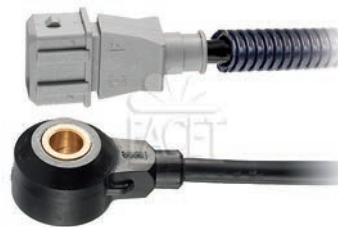

L	mV/g		
400	28		

HYUNDAI

GRANDEUR 2.7	G6BA	05/06 → 10/10
SANTA FE I 2.7	G6EA	10/05 → 03/06
SANTA FE I 2.7 4x4	G6EA	10/05 → 03/06
SANTA FE II 2.7	G6BA	03/06 → 12/12
SANTA FE II 2.7 4x4	G6BA, G6BA	03/06 → 12/12
SANTA FE II 2.7 V6 GLS	G6EA	03/06 → 12/09
SANTA FE II 2.7 V6 GLS 4x4	G6EA	03/06 → 12/09

KIA

CARNIVAL II 2.7 V6	G6EA	06/06 →
MAGENTIS II 2.7	G6BA, G4HD	11/05 →
MAGENTIS II 2.7 V6	G6EA	07/09 →
OPTIMA II 2.7	G6EA	09/07 →

9.3205

9.3204



04,5

KNOCK SENSORS

Adatt./Suitable:

HYUNDAI

39250-02400

KIA

39250-02400

MARKET DIFFUSION: MEDIUM



L	mV/g		
225	23		

HYUNDAI

GETZ 1.1	G4HD, --	09/02 → 06/09
----------	----------	---------------

KIA

PICANTO I 1.0	--, G4GC	04/04 →
PICANTO I 1.0 LPG	G4HE	01/09 → 04/11
PICANTO I 1.1	G4HG	04/04 →

9.3205



04,5

KNOCK SENSORS

Adatt./Suitable:

HYUNDAI

39250-23500

KIA

39250-23500



L	mV/g		
250	25		

HYUNDAI

COUPE II 2.0	G4GC, G4GC	08/01 → 08/09
COUPE II 2.0 GLS	G4GC, G4BB	02/03 → 08/09
ELANTRA 1.8 [ExtraEU]	G4BB	06/00 → 07/03
ELANTRA III 1.8	G4BB, G4GC	06/00 → 07/06
ELANTRA III 2.0	G4GC, G4GB	06/00 → 07/06
LANTRA II 1.8	G4GB	06/00 →
LANTRA II 2.0	G4GC-G	06/00 →
LAVITA 1.8	--	01/07 →
MATRIX 1.8	G4GB, G4GC	06/01 → 08/10
MATRIX 1.8 [TUR]	G4GB	04/08 →
SONATA V 2.0 i [RUS]	--	04/06 → 12/10
TIBURON 2.0 CVVT	G4GC	10/06 → 12/08
TRAJET 2.0	G4GC, G4GC	03/00 → 07/08
TRAJET 2.0 CRDi	D4EA	08/05 → 07/08
TUCSON 2.0	G4GC, G4GC	08/04 →
TUCSON 2.0 CVVT LPG	G4GC, G4GC	06/04 → 03/10
TUCSON 2.0 Trazione integrale	G4GC, HJ3	08/04 → 11/10

KIA

CARENS II 2.0 CVVT	G4GC	08/04 →
--------------------	------	---------

KIA			
CERATO I 2.0	G4GC	04/04 →	
SPORTAGE II 2.0	G4KD	01/09 → 05/10	
SPORTAGE II 2.0 16V 4WD	G4GC	09/04 →	
SPORTAGE II 2.0 i 16V	G4GC	09/04 →	
SPORTAGE II 2.0 LPG	G4GC	06/09 → 05/10	

9.3206



04,5

KNOCK SENSORS

Adatt./Suitable:

KIA

39250-4X410

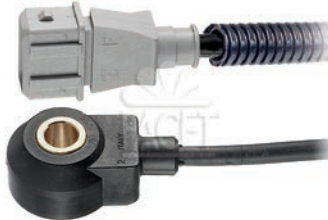

L	mV/g		
250	23		

KIA			
BONGO IV 2.9 CRDi	J3	04/07 →	
BONGO IV 2.9 TDiC	HJ3	10/03 →	
BONGO IV 2.9 TDiC 4WD	HJ3	10/03 →	
CARNIVAL II 2.9 CRDi	HJ3, G6BA	06/06 →	
CARNIVAL II 2.9 CRDi LX	J3	09/06 →	
K-SERIES 2.9 CRDi	J3	08/07 →	
K2900 2.9 D	J3	01/08 →	

9.3207



04,5

KNOCK SENSORS

Adatt./Suitable:

BOSCH

0 261 231 232

HYUNDAI

39250-3E120

KIA

39250-3E120



L	mV/g		
400	28		

HYUNDAI			
GRANDEUR 2.7	G6BA	05/06 → 10/10	
SANTA FE I 2.7	G6EA	10/05 → 03/06	
SANTA FE I 2.7 4x4	G6EA	10/05 → 03/06	
SANTA FE II 2.7	G6BA	03/06 → 12/12	
SANTA FE II 2.7 4x4	G6BA, G6BA	03/06 → 12/12	
SANTA FE II 2.7 V6 GLS	G6EA	03/06 → 12/09	
SANTA FE II 2.7 V6 GLS 4x4	G6EA	03/06 → 12/09	

KIA			
CARNIVAL II 2.7 V6	G6EA	06/06 →	
MAGENTIS II 2.7	G6BA, G4FC	11/05 →	
MAGENTIS II 2.7 V6	G6EA	07/09 →	

KIA			
OPTIMA II 2.7	G6EA	09/07 →	

9.3208



04,5

KNOCK SENSORS

Adatt./Suitable:

BOSCH

0 261 231 228

HYUNDAI

39250-03AA0

39250-04100

39250-2B000

KIA

39250-03AA0

39250-04100

39250-2B000

MARKET DIFFUSION: MEDIUM



L	mV/g		
300	27		

HYUNDAI			
ACCENT IV 1.4	G4FA	11/10 →	
ACCENT IV 1.6	G4FC, G4FG	11/10 →	
CRETA 1.6	G4FG	01/16 →	
CRETA 1.6 4WD	G4FG	08/16 →	
ELANTRA IV 1.6 CVVT	G4FC	06/06 → 06/11	
ELANTRA V 1.6	G4FG, G4FA	06/11 →	
I20 1.4 CVVT LPG	G4FA	12/08 → 12/12	
I20 I 1.4	G4FA	09/08 → 12/15	
I20 I 1.6	G4FC	09/08 → 12/12	
I20 II 1.0-T-GDI	G3LC	09/15 →	
I30 1.4 CVVT LPG	G4FA, G4FD	01/09 → 06/12	
I30 1.4 LPG	G4FA	01/13 →	
I30 1.6 CVVT	G4FC	06/14 →	
I30 1.6 GDi	G4FD, G4FA	07/14 →	
I30 I 1.4	G4FA, G4FC	10/07 → 06/12	
I30 I 1.6	G4FC, G4FA	10/07 → 06/12	
I30 II 1.4	G4FA, G4FC	12/11 →	
I30 II 1.6	G4FC, G4FC	12/11 →	
I30 II 1.6 CVVT [ExtraEU]	G4FC	03/16 →	
I30 II 1.6 GDi	G4FD	12/11 →	
I30 II 1.6 MPI	G4FC	11/16 →	
I30 III 1.4-T-GDI	G4LD	11/16 →	
I40 1.6 GDi	G4FD	07/11 →	
IX20 1.4	G4FA	11/10 →	
IX20 1.4 CVVT [ExtraEU]	G4FA	11/10 →	
IX20 1.4 LPG	G4FA	11/10 →	
IX20 1.6	G4FC	11/10 →	
IX20 1.6 LPG ECONEXT	G4FC	03/15 →	
IX35 1.6	G4FD	11/10 →	
SB 11 1.4	--	01/11 →	
SB 11 1.6	--	01/11 →	
SOLARIS 1.4 16V	--	01/11 →	
SOLARIS 1.6	G4FC, G4FC	01/17 →	
SOLARIS 1.6 16V	--	01/11 →	
TUCSON 1.6 GDi	G4FD	06/15 →	
VELOSTER 1.6	G4FG	06/11 →	
VELOSTER 1.6 GDi	G4FD	03/11 →	
VELOSTER 1.6 GDi [ExtraEU]	G4FD	01/11 →	
VELOSTER 1.6 MPI	G4FC	04/11 →	

KIA			
CARENS III 1.6 CVVT	G4FC, G4FA	08/09 →	
CARENS IV 1.6 GDi	G4FD	03/13 →	
CEED I 1.4	G4FA, G4FA	12/06 → 12/12	
CEED I 1.4 CVVT	G4FA, G4FA	07/09 → 12/12	
CEED I 1.4 LPG	G4FA, G4FC	01/09 → 04/12	
CEED I 1.6	G4FC, G4FC	12/06 → 12/12	
CEED I 1.6 CVVT	G4FC	06/09 → 12/12	

KIA			
CEED I 1.6 LPG	G4FC, G4FA	06/07 → 09/12	
CEED II 1.0-T-GDI	G3LC	04/15 →	
CEED II 1.4 CVVT	G4FA, G4FC	05/12 →	
CEED II 1.4 LPG	G4FA	05/12 →	
CEED II 1.6 CVVT	G4FC, G4ED	05/12 →	
CEED II 1.6 GDi	G4FD	05/12 →	
CEED III 1.4-T-GDI	G4LD	04/18 →	
CEED III 1.4-T-GDi [ExtraEU]	G4LD	03/18 →	
CEED III 1.6	G4FG	03/18 →	
CERATO 1.6 CVVT [ExtraEU]	G4FC	06/13 →	
CERATO I 1.6	G4ED, G4FC	04/04 →	
CERATO II 1.6	G4FC	01/10 →	
CERATO II 1.6 CVVT	G4FC, G4FA	02/09 →	
CERATO III 1.6	--	07/12 →	
CERATO III 1.6 CVVT	G4FC	07/16 →	
FORTE III 1.6	--	07/12 →	
PROCEED 1.4-T-GDI	G4LD	10/18 →	
PRO CEE'D I 1.4	G4FA	02/08 → 09/12	
PRO CEE'D I 1.4 CVVT	G4FA, G4FC	06/10 → 09/12	
PRO CEE'D I 1.6	G4FC	02/08 → 09/12	
PRO CEE'D I 1.6 CVVT	G4FC, G4FA	02/08 → 02/13	
PRO CEE'D II 1.0-T-GDI	G3LC	07/15 →	
PRO CEE'D II 1.4 CVVT	G4FA, G4FA	03/13 →	
PRO CEE'D II 1.4 MPI	G4LC	07/13 →	
PRO CEE'D II 1.6 CVVT	G4FC	03/13 →	
PRO CEE'D II 1.6 GDi	G4FD	03/13 →	
PRO CEE'D 1.4 CVVT	G4FA	05/12 →	
PRO CEE'D 1.6 GDi	G4FD	04/15 →	
RIO III 1.4 CVVT	G4FA, G4FC	06/11 →	
RIO III 1.6 CVVT	G4FC	06/12 →	
RIO 1.4 CVVT	G4FA	04/15 →	
RIO IV 1.0-T-GDI 100	G3LC	01/17 →	
RIO IV 1.0-T-GDI 120	G3LC	01/17 →	
RIO IV 1.6	G4FG	07/17 →	
SOUL 1.6 LPG	G4FG	12/14 →	
SOUL I 1.6	G4FC	09/09 → 12/14	
SOUL I 1.6 CVVT	G4FC, G4FC	02/09 →	
SOUL I 1.6 Flex	--	01/11 →	
SOUL I 1.6 GDi	G4FD	06/11 →	
SOUL I 1.6 LPG	G4FC, G4FC	02/09 → 12/14	
SOUL II 1.6 CVVT	G4FC, G4FC	02/14 →	
SOUL II 1.6 GDi	G4FD	02/14 →	
SOUL II 1.6 MPI [ExtraEU]	G4FC, G3LC	07/16 →	
SPORTAGE III 1.6 LPG	G4FD	02/11 →	
SPORTAGE IV 1.6 GDi	G4FD	09/15 →	
STONIC 1.0-T-GDi	G3LC, G4FA	07/17 →	
VENGA 1.4 CVVT	G4FA, G4FA	02/10 →	
VENGA 1.4 LPG	G4FA	02/10 →	
VENGA 1.6 CVVT	G4FC	02/10 →	
VENGA CVVT	G4FA, G4HG	02/15 →	

9.3209



04,5

KNOCK SENSORS

Adatt./Suitable:

BOSCH

0 261 231 226
0 261 231 242
0 261 231 260

HYUNDAI

39250-02900
39250-05000
39250-26900 *1
39252-26870 *1

KIA

39250-02900
39250-26900 *1

*1 without fastening clamp

- senza staffa fissaggio
- sans bride de fixation
- ohne Befestigungsbügel
- sin estribo de sujeción

MARKET DIFFUSION: MEDIUM



L	mV/g		
250	28		

HYUNDAI

Model	Code	Period
ACCENT III 1.4 GL	G4EE	11/05 ⇨ 11/10
ACCENT III 1.6 GLS	G4ED	11/05 ⇨ 11/10
I10 1.1 LPG	G4HG	01/10 ⇨ 12/13
I10 I 1.1	G4HG, --	12/07 ⇨ 12/13
I10 I 1.1 LPG	G4HG	04/11 ⇨ 12/13
VERNA II 1.4 GL	--	11/05 ⇨
VERNA II 1.6 GLS	--	11/05 ⇨

KIA

Model	Code	Period
PICANTO I 1.0	--, --	09/06 ⇨
PICANTO I 1.1	--, G4EA	04/04 ⇨
PICANTO I 1.1 LPG	G4HG	01/09 ⇨ 04/11
RIO II 1.4	G4EE	01/10 ⇨ 12/11
RIO II 1.4 16V	G4EE	03/05 ⇨
RIO II 1.6 16V	G4ED	03/05 ⇨
RIO II 1.6 CVT	G4ED	03/05 ⇨

9.3210



04,5

KNOCK SENSORS

Adatt./Suitable:

HYUNDAI

39250-22610



L	mV/g		
450	26		

HYUNDAI

Model	Code	Period
GETZ 1.3	G4EA, G4HD	09/03 ⇨ 06/09
GETZ 1.3 i	G4EA	09/02 ⇨ 03/04

9.3213



04,5

KNOCK SENSORS

Adatt./Suitable:

HYUNDAI

39250-02600



L	mV/g		
300	27		

HYUNDAI

Model	Code	Period
ATOS 1.1	G4HD, G4HD	06/03 ⇨ 12/10
ATOS PRIME 1.1	G4HD, G4GC	08/03 ⇨ 12/08
SANTRO 1.1	G4HD	01/03 ⇨

9.3216



04,5

KNOCK SENSORS

Adatt./Suitable:

HYUNDAI

39250-23900

KIA

39250-23900



L	mV/g		
250	28		

HYUNDAI

Model	Code	Period
ELANTRA 2.0 CVVT [ExtraEU]	G4GC	06/06 ⇨ 05/11
ELANTRA IV 2.0 CVVT	G4GC, G4GC	06/06 ⇨ 06/11
I30 I 2.0	G4GC, K10B	10/07 ⇨ 06/12
I30 2.0 CVVT LPG	G4GC	01/10 ⇨ 06/12

KIA

Model	Code	Period
CEED I 2.0	G4GC	12/06 ⇨ 12/12
CERATO I 2.0	G4GC	04/04 ⇨
CERATO II 2.0 CVVT	--	01/09 ⇨
PRO CEE'D I 2.0	G4GC	02/08 ⇨ 09/12
PRO CEE'D I 2.0 LPG	G4GC	01/09 ⇨ 12/09

9.3222



04,5

KNOCK SENSORS

Adatt./Suitable:

BOSCH

0 261 231 199

GENERAL MOTORS

93 193 710

OPEL

47 08 879

93193710

SUZUKI

18640-73KA0

18640-73KA0-000

VAUXHALL

93193710



L	mV/g		
350	25		

OPEL

Model	Code	Period
AGILA B 1.0	K10B, K12B	04/08 ⇨ 07/14
AGILA B 1.0 LPG	K10B	01/10 ⇨ 06/11
AGILA B 1.2	K12B, K10B	04/08 ⇨ 10/14
AGILA B 1.2 LPG	K12B	04/08 ⇨ 10/10

SUZUKI

Model	Code	Period
SPLASH 1.0	K10B, K12B	01/08 ⇨
SPLASH 1.2	K12B	01/08 ⇨
SPLASH 1.2 LPG	K12B	04/08 ⇨ 12/14
SPLASH 1.2 VVT	K12B, Z20LET	09/10 ⇨

VAUXHALL

Model	Code	Period
AGILA B 1.0 12V	K10B	01/08 ⇨ 11/14
AGILA B 1.0 i	K10B	08/11 ⇨ 11/14
AGILA B 1.2 i 16V	K12B	01/08 ⇨ 11/14

9.3223



04,5

KNOCK SENSORS

Adatt./Suitable:

BOSCH

0 261 231 116

GENERAL MOTORS

90 541 521

OPEL

62 38 415

90541521

VAUXHALL

90541521



L	mV/g		
650	25		

OPEL

Model	Code	Period
ASTRA G 2.0 16V Turbo	Z20LET, Z20LET	09/00 ⇨ 10/05
ASTRA G 2.0 OPC	Z20LET, Z20LET	03/02 ⇨ 10/05
OMEGA B 2.5 V6	X25XE	03/94 ⇨ 09/00
OMEGA B 2.6	--	05/94 ⇨ 05/99

OPEL			
OMEGA B 2.6 V6	Y26SE	09/00 → 07/03	
OMEGA B 3.0 V6	X30XE	04/94 → 02/01	
OMEGA B 3.2 V6	Y32SE	02/01 → 07/03	
SIGNUM 3.2 V6	Z32SE	05/03 → 07/05	
SPEEDSTER 2.0	Z20LET	10/03 → 08/06	
SPEEDSTER 2.0 Turbo	Z20LET	08/02 → 08/06	
VECTRA B 2.6 i V6	Y26SE	09/00 → 07/03	
VECTRA C 3.2 V6	Z32SE	08/02 → 07/06	
ZAFIRA A 2.0 OPC	Z20LET, Z20LET	09/01 → 06/05	

VAUXHALL			
ASTRA IV 2.0	Z20LET	08/02 → 10/05	
ASTRA IV 2.0 16V Turbo	Z20LET	09/00 → 08/05	
ASTRA IV 2.0 SRI Turbo	Z20LET	11/01 → 05/05	
ASTRA IV 2.0 Turbo	Z20LET, K9K830	03/02 → 10/05	
OMEGA B 2.5 V6	X25XE	03/94 → 09/00	
OMEGA B 2.6 V6	Y26SE	08/00 → 07/03	
OMEGA B 3.0 V6	X30XE	04/94 → 07/00	
OMEGA B 3.2 V6	Y32SE	02/01 → 07/03	
SIGNUM 3.2 V6	Z32SE	05/03 → 05/08	
SPEEDSTER 2.0 Turbo	Z20LET	03/01 → 09/06	
SPEEDSTER VXR20	Z20LET	03/01 → 09/06	
VECTRA B 2.6 i V6	Y26SE	09/00 → 07/03	
VECTRA C 3.2 V6	Z32SE	08/02 → 07/08	
VX220 2.0 i Turbo	Z20LET	03/01 → 07/05	
VX220 2.0 VXR	Z20LET	10/03 → 07/05	
ZAFIRA A 2.0	Z20LET	06/02 → 06/05	
ZAFIRA A 2.0 GSI Turbo	Z20LET	09/01 → 06/05	

DACIA			
DUSTER 1.6	K4M642, K4M490	04/10 →	
DUSTER 1.6 16V	K4M490, K4M490	04/10 →	
DUSTER 1.6 16V 4x4	K4M490, K4M616	06/10 →	
DUSTER 1.6 16V Hi-Flex	K4M696	08/10 →	
DUSTER 1.6 16V LPG	K4M616, --	04/11 →	
LOGGY 1.5 dCi	--, K4M845	03/12 →	
LOGGY 1.5 dCi [ExtraEU]	K9K830	11/12 →	
LOGGY 1.6	K4M845, K7M812	03/12 →	
LOGGY 1.6 LPG	K7M812, K7J710	11/13 →	
LOGAN 1.6	K7M812	06/13 → 08/16	
LOGAN 1.6 Hi-Flex	K7M714	01/11 → 10/12	
LOGAN 1.0	D4D760	12/05 →	
LOGAN 1.0 Hi-Flex	D4D760	01/11 → 10/12	
LOGAN 1.2 16V	D4F732	02/06 →	
LOGAN 1.2 16V LPG	D4F734	02/06 →	
LOGAN 1.4	K7J710	09/04 →	
LOGAN 1.4 MPI LPG	K7J710, K9K790	02/06 →	
LOGAN 1.5 dCi	K9K790, K7M710	09/05 →	
LOGAN 1.6	K7M710, K4M690	09/04 →	
LOGAN 1.6 16V	K4M690, K4M690	12/05 →	
LOGAN 1.6 16V Flexifuel	K4M696	07/10 →	
LOGAN 1.6 16V Hi-Flex	K4M690, K7M710	11/09 →	
LOGAN 1.6 Bifuel	K7M710, D4F732	11/08 →	
LOGAN 1.6 LPG	K7M718	08/04 → 12/12	
LOGAN 1.6 MPI 85	K7M800	05/10 →	
LOGAN II 1.0	D4D754	10/12 →	
LOGAN II 1.2	D4F732, D4F732	10/12 →	
LOGAN II 1.2 LPG	D4F732, K9K830	10/12 →	
LOGAN II 1.5 dCi	K9K830, K4M842	10/12 →	
LOGAN II 1.6 16V	K4M842, D4F732	10/12 →	
LOGAN II MCV 1.2	D4F732, D4F732	02/13 →	
LOGAN II MCV 1.2 LPG	D4F732, K9K830	02/13 →	
LOGAN II MCV 1.5 dCi	K9K830, D4F732	02/13 →	
LOGAN II MCV 1.6	K7M812	06/13 →	
SANDERO I 1.0 Hi-Flex	D4D760	01/11 → 12/12	
SANDERO I 1.2 16V	D4F732	11/08 →	
SANDERO I 1.2 16V LPG	D4F732, K9K790	11/08 →	
SANDERO I 1.4	K7J710	06/08 →	
SANDERO I 1.4 MPI LPG	K7J714	01/09 →	
SANDERO I 1.5 dCi	K9K790, K7M710	06/08 →	
SANDERO I 1.6	K7M710, K4M690	06/08 →	
SANDERO I 1.6 16V	K4M690, K4M690	07/11 →	
SANDERO I 1.6 16V Bifuel	K4M690, K7M718	01/11 →	
SANDERO I 1.6 Hi-Flex	K7M732	06/08 → 12/12	
SANDERO I 1.6 LPG	K7M718, D4F732	06/08 → 12/12	
SANDERO I 1.6 MPI 85	K7M800	05/10 →	
SANDERO II 1.0	D4D754	10/12 →	
SANDERO II 1.2	D4F732, D4F732	10/12 →	
SANDERO II 1.2 LPG	D4F732, K9K626	10/12 →	
SANDERO II 1.5 dCi	K9K626, K4M842	10/12 →	
SANDERO II 1.6	K7M812	11/12 →	
SANDERO II 1.6 16V	K4M842, 11189	01/13 →	
SANDERO II 1.6 i	K7M764	10/12 →	
SOLENZA 1.4	E7J262	02/03 →	

LADA

LARGUS 1.6	11189, K4M490	03/12 →	
NISSAN			
ALMERA II 1.5 dCi	K9K722	01/03 → 09/06	
ALMERA III 1.5 dCi	K9K	08/12 →	
ALMERA III 1.6	K4M	11/12 →	
BLUEBIRD SYLPHY 1.6	K4M490, K9K	12/12 →	
CUBE 1.5 dCi	K9K, K9K410	03/10 →	
JUKE 1.5 dCi	K9K410, D7F726	06/10 →	
KUBISTAR 1.2	D7F726, D4F712	08/03 →	
KUBISTAR 1.2 16V	D4F712, K7J700	04/06 →	
KUBISTAR 1.2 LPG	D7F764	10/03 → 08/05	
KUBISTAR 1.4	K7J700, K9K702	08/03 → 10/09	
KUBISTAR 1.5 dCi	K9K702, K4M750	08/03 →	
KUBISTAR 1.5 dCi 70	K9K700	09/05 → 10/09	
KUBISTAR 1.5 dCi 85	K9K276	04/06 → 10/09	
KUBISTAR 1.6 16V	K4M750, K9K716	08/03 →	
KUBISTAR dCi 85	K9K716, K9K276	04/06 → 10/09	
MICRA III 1.5 dCi	K9K276, K9K276	01/03 → 06/10	
MICRA IV 1.5 dCi	K9K	05/10 →	
NOTE I 1.5 dCi	K9K276, K9K608	03/06 → 06/12	
NOTE II 1.5 dCi	K9K608, K9K	06/13 →	
NV200 / EVALIA 1.5 dCi	K9K, K9K	07/10 →	
NV200 1.5 dCi	K9K, F4R720	02/10 →	
PRIMASTAR 2.0	F4R720, K9K	03/01 →	
QASHQAI 1.5 dCi	K9K, K9K	08/08 → 11/13	
QASHQAI 1.5 dCi	K9K, K9K636	02/07 → 12/13	
QASHQAI II 1.5 dCi	K9K636, K4M	11/13 →	
TERRANO III 1.6	K4M, K4M606	09/13 →	
TERRANO III 1.6 4x4	K4M606, K9K	03/14 →	
TIDA I 1.5 dCi	K9K, F3N742	01/07 → 06/13	

OPEL

VIVARO A 2.0 16V	F4R720	08/01 →	
VIVARO A 2.0 ECOTEC	F4R820	08/06 →	

RENAULT			
19 I 1.4	E7J700	09/90 → 04/92	
19 I 1.7	F3N742, F7P700	07/88 → 04/92	
19 I 1.8 16V	F7P700, E7J706	06/89 → 09/92	
19 II 1.4	E7J706, F3N742	01/92 → 12/95	
19 II 1.7	F3N742, F3P682	04/92 → 12/95	
19 II 1.8	F3P682, F7P704	04/92 → 06/96	
19 II 1.8 16V	F7P704, F2N722	04/92 → 06/96	
21 1.7	F2N722, J7R740	03/86 → 06/94	
21 2.0	J7R740, J7R740	03/86 → 06/94	
21 2.0 4x4	J7R740, J7R752	03/89 → 02/94	
21 2.0 Turbo	J7R752, J7R752	04/87 → 10/92	
21 2.0 Turbo 4x4	J7R752, J7R740	08/89 → 10/93	
21 2.0 Txi	J7R740, J7T754	07/89 → 05/93	
21 2.2	J7T754, J7T754	04/86 → 12/95	
21 2.2 4x4	J7T754, J7R722	06/86 → 06/94	
25 2.0	J7R722, J7R720	03/87 → 12/93	
25 2.0 12V	J7R720, J7T706	06/88 → 12/93	
25 2.2	J7T706, Z7W700	04/84 → 12/92	
25 2.8 V6	Z7W700, Z7W706	06/87 → 02/90	
25 2.8 V6 Injection	Z7W706, F4R760	06/87 → 12/92	
AVANTIME 2.0 16V Turbo	F4R760, K9K608	11/01 → 05/03	
CAPTUR 1.5 dCi	K9K830	06/13 →	
CAPTUR 1.5 dCi 90	K9K608, D4F728	06/13 →	
CLIO 1.2	D4F728, K9K830	08/98 →	
CLIO 1.2 BiFuel	D7F722	03/98 → 10/01	
CLIO 1.2 Hi-Flex	D4F742	11/07 → 12/09	
CLIO 1.4	K7J700	08/00 → 02/09	
CLIO 1.5 dCi	K9K830, K4M734	11/12 →	
CLIO 1.6	K4M734, D7F730	07/00 → 02/10	
CLIO 1.6 [ExtraEU]	K4M708	03/99 → 12/08	
CLIO I 1.2	D7F730, E7J601	05/90 → 09/98	
CLIO I 1.4	E7J601, F3P710	01/90 → 09/98	
CLIO I 1.8	F3P710, F7P720	08/90 → 09/98	
CLIO I 1.8 16V	F7P720, F3P712	01/91 → 03/96	
CLIO I 1.8 Rsi	F3P712, D7F710	01/93 → 09/98	
CLIO I Williams	F7R700	01/94 → 09/98	
CLIO II 1.0	D7D760	02/00 → 05/01	
CLIO II 1.0 16V	D4D700	01/01 →	
CLIO II 1.2	D7F710, D4F706	03/98 →	
CLIO II 1.2 16V	D4F706, D7F722	06/01 →	
CLIO II 1.2 LPG	D7F722, E7J634	09/98 → 06/09	
CLIO II 1.4	E7J634, K4J700	09/98 →	
CLIO II 1.4 16V	K4J700, K9K700	02/00 →	
CLIO II 1.5 dCi	K9K700, K4M746	06/01 →	
CLIO II 1.6	K4M746, K4M708	09/98 →	
CLIO II 1.6 16V	K4M708, F4R730	09/98 →	
CLIO II 1.6 Hi-Flex	K4M748	01/05 → 02/10	
CLIO II 1.6 i	K4M736	11/04 →	
CLIO II 2.0 16V	F4R732	06/01 →	
CLIO II 2.0 16V Sport	F4R730, D4F740	02/00 →	
CLIO III 1.2	D4F740, D4F706	10/05 →	
CLIO III 1.2 16V	D4F706, D4F740	06/05 →	
CLIO III 1.2 16V Hi-Flex	D4F740, K9K750	07/08 →	
CLIO III 1.2 Ethanol	D4F742	07/08 →	
CLIO III 1.4 16V	K4J780	06/05 →	
CLIO III 1.5 dCi	K9K750, K4M800	05/05 →	
CLIO III 1.6 16V	K4M800, --	06/05 →	
CLIO III 1.6 16V GT	K4M862	06/09 →	
CLIO III 2.0 16V Sport	--, D4F740	02/06 →	
CLIO IV 1.2 16V	D4F740, K9K830	11/12 →	
CLIO IV 1.2 16V LPG	D4F744	01/14 →	
CLIO IV 1.2 LPG	D4F744	01/14 →	
CLIO IV 1.2 LPG 16V	D4F744	11/12 → 06/15	
CLIO IV 1.5 dCi	K9K830, K9K608	11/12 →	
CLIO IV 1.5 dCi 90	K9K608, K9K612	11/12 →	
DOKKER 1.5 dCi	K9K612, J7T772	12/13 →	
DOKKER 1.6	K7M812	12/13 →	
DUSTER 1.5 dCi [ExtraEU]	K9K796	06/11 →	
DUSTER 1.5 dCi 4x4	K9K884	06/11 →	
DUSTER 1.6 16V	K4M616	02/12 →	
DUSTER 1.6 16V 4x4	K4M616	06/11 → 05/15	
ESPACE I 2.0 i	J7R760	01/89 → 12/90	
ESPACE I 2.0 i Quadra	J7R760	03/88 → 12/92	
ESPACE I 2.2	J7T770	07/86 → 12/90	
ESPACE I 2.2 Quadra	J7T770	01/88 → 12/90	
ESPACE II 2.0	J7R768	01/91 → 10/96	
ESPACE II 2.2	J7T772, J7T772	01/91 → 10/96	
ESPACE II 2.2 4x4	J7T772, Z7W712	03/91 → 12/96	
ESPACE II 2.8 V6	Z7W712, F3R728	01/91 → 10/96	
ESPACE III 2.0	F3R728, F4R700	09/01 → 10/02	
ESPACE III 2.0 16V	F4R700, F9Q680	10/98 → 10/02	
ESPACE IV 1.9 dCi	F9Q680, F4R790	11/02 →	
ESPACE IV 2.0	F4R790, F4R794	11/02 →	
ESPACE IV 2.0 Turbo	F4R794, K9K656	11/02 →	
FLUENCE 1.5 dCi	K9K656, K4M838	02/10 →	
FLUENCE 1.6 16V	K4M838, K9K728	02/10 →	
FLUENCE 1.6 LPG 16V	K4M839	01/12 →	
GRAND SCÉNIC II 1.5 dCi	K9K728, K4M761	04/04 →	

9.3224



1

KNOCK SENSORS

Adatt./Suitable:

- DACIA**
- 60 01 543 613
- 77 00 735 564
- 77 00 866 055
- 82 00 639 103
- 82 00 680 689
- GENERAL MOTORS**
- 91 159 930
- 93 198 199

- LADA**
- 82006-80689

- NISSAN**
- 22060-000QA
- 22060-000QA
- 22060-000QB
- 22060-000QA
- 22060-BN700
- 77008-66055
- 82006-80689

RENAULT				RENAULT				RENAULT			
GRAND SCÉNIC II 1.6	K4M761, F4R770	04/04	⇒	MEGANE II 1.6 LPG 16V	K4M760	01/06	⇒ 08/09	SCÉNIC II 2.0	F4R770, K9K636	06/03	⇒
GRAND SCÉNIC II 1.6 Flex	K4M766	06/06	⇒ 11/08	MEGANE II 2.0	F4R770, F4R770	08/03	⇒	SCÉNIC II 2.0 16V Turbo	F4R776	05/04	⇒
GRAND SCÉNIC II 2.0	F4R770, K9K636	04/04	⇒	MEGANE II 2.0 16V	F4R770, F4R774	11/02	⇒ 02/08	SCÉNIC III 1.5 dCi	K9K636, K4M866	02/09	⇒
GRAND SCÉNIC III 1.5 dCi	K9K636, K4M866	02/09	⇒	MEGANE II 2.0 16V Turbo	F4R776	05/04	⇒ 03/09	SCÉNIC III 1.6 16V	K4M858	02/09	⇒
GRAND SCÉNIC III 1.6 16V	K4M858	02/09	⇒	MEGANE II 2.0 Renault Sport	F4R774, K9K636	05/04	⇒ 10/09	SCÉNIC III 1.6 16V Bifuel	K4M866, K4M744	02/09	⇒
GRAND SCÉNIC III 1.6 16V Bifuel	K4M866, D7D700	02/09	⇒	MEGANE 1.4	K4J714, K9K636	04/01	⇒ 07/03	SCÉNIC III 1.6 E85	K4M866	02/09	⇒
GRAND SCÉNIC III 1.6 E85	K4M866	02/09	⇒	MEGANE 1.5 dCi	K9K636, K4M704	01/09	⇒ 08/15	SCENIC 1.5 dCi	K9K728, K4M812	06/07	⇒ 11/08
KANGOO 1.0	D7D700, D4D700	07/01	⇒ 06/03	MEGANE 1.6 BiFuel	K4M704, F4R740	10/96	⇒ 08/15	SCENIC 1.6	K4M812, K4J714	07/07	⇒ 05/09
KANGOO 1.0 [ExtraEU]	D4D700, D4F712	01/02	⇒ 01/07	MEGANE 1.6 VVT	K4M858	01/13	⇒ 08/15	SUPER 5 1.7 i	F3N702	10/86	⇒ 08/91
KANGOO 1.2	D4F712, D7F710	07/01	⇒ 10/03	MEGANE 1.8	F4P722	04/01	⇒ 07/03	SYMBOL 1.2 LPG [ExtraEU]	D4F734	12/13	⇒
KANGOO 1.2 BiFuel	D7F710, K4M708	06/97	⇒ 06/03	MEGANE 2.0	F4R740, K9K636	08/95	⇒ 02/99	SYMBOL 1.6 [ExtraEU]	K4M744, K7J700	01/09	⇒ 06/14
KANGOO 1.6	K4M836	02/12	⇒	MEGANE I 1.4	E7J626, K4J700	09/96	⇒ 08/03	THALIA I 1.2 16V	D4F728	04/02	⇒
KANGOO 1.6 [ExtraEU]	K4M708, K4M830CNG	06/01	⇒ 03/09	MEGANE I 1.4 16V	K4J700, E7J626	03/99	⇒ 08/03	THALIA I 1.2 16V	D4F728	04/04	⇒
KANGOO 1.6 BiFuel	K4M750	06/05	⇒ 06/08	MEGANE I 1.4 e	E7J626, K4M700	01/96	⇒ 08/03	THALIA I 1.4	K7J700, K4J712	05/00	⇒
KANGOO 1.6 CNG	K4M830CNG, K4M834	10/07	⇒	MEGANE I 1.4 Eco	E7J624	01/96	⇒ 03/99	THALIA I 1.4 16V	K4J712, K9K700	08/00	⇒
KANGOO 1.6 Hi-Flex	K4M834	02/12	⇒	MEGANE I 1.6	K7M704	02/00	⇒ 09/00	THALIA I 1.5 dCi	K9K700, K4M670	01/01	⇒
KANGOO 1.6 Hi-Flex [ExtraEU]	K4M850	03/07	⇒	MEGANE I 1.6 16V	K4M700, K7M702	05/00	⇒	THALIA I 1.5 dCi	K4M670, K4M742	01/01	⇒
KANGOO 1.6 LPG	K4M834, D4D700	02/12	⇒	MEGANE I 1.6 Bifuel	K4M712	03/99	⇒ 09/00	THALIA I 1.6 16V	K7M734	04/02	⇒
KANGOO I 1.0	D4D700, D4D700	09/98	⇒	MEGANE I 1.6 e	K7M702, K4M704	01/96	⇒ 08/03	THALIA I 1.6 Authentique Hi-Flex	K4M742, D4F728	11/04	⇒ 02/09
KANGOO I 1.0 16V	D4D700, D7F710	03/98	⇒	MEGANE I 1.6 i	K7M720	01/96	⇒ 03/99	THALIA II 1.2 16V	D4F728, K4J712	09/08	⇒
KANGOO I 1.2	D7F710, D4F712	08/97	⇒	MEGANE I 1.6 LPG	K4M704, F4P260	10/00	⇒ 03/99	THALIA II 1.2 LPG	D4F728	01/10	⇒ 12/13
KANGOO I 1.2 16V	D4F712, D7F710	06/01	⇒	MEGANE I 1.8 16V	F4P260, F3R750	07/00	⇒ 08/03	THALIA II 1.4	K4J712, K9K700	09/08	⇒ 06/14
KANGOO I 1.2 BiFuel	D7F710, E7J634	07/98	⇒ 07/01	MEGANE I 2.0	F3R750, F4R276	04/97	⇒ 08/03	THALIA II 1.4	K9K700, K4M670	09/08	⇒
KANGOO I 1.4	E7J634, K9K700	08/97	⇒	MEGANE I 2.0 16V	F4R276, F4R746	05/00	⇒	THALIA II 1.5 dCi	K4M670, K4M720	09/08	⇒
KANGOO I 1.5 dCi	K9K700, K4M730	02/01	⇒	MEGANE I 2.0 16V IDE	F4R746, F3R750	11/99	⇒ 08/03	THALIA II 1.6 16V	K4M670, F4R720	09/08	⇒
KANGOO I 1.6	K4M730, K4M708	09/01	⇒	MEGANE I 2.0 i	F3R750, F3R750	01/96	⇒ 08/03	THALIA III 1.2 16V	D4F732	12/13	⇒
KANGOO I 1.6 16V	K4M708, K4M708	06/01	⇒	MEGANE I 2.0 RT	F3R750, K4J730	03/01	⇒ 02/99	TRAFIC I 2.2	J7T600	06/94	⇒ 04/98
KANGOO I 1.6 16V 4x4	K4M708, K9K608	02/01	⇒	MEGANE III 1.5 dCi	K9K636, K4M848	11/08	⇒	TRAFIC I 2.2 4x4	J7T600	06/94	⇒ 04/98
KANGOO I 1.6 16V bivalent	K4M850CNG	06/05	⇒	MEGANE III 1.6 16V	K4M848, K9K834	11/08	⇒	TRAFIC II 2.0	F4R720, D7F700	03/01	⇒
KANGOO II 1.5 dCi	K9K608, K9K636	02/08	⇒	MEGANE III 1.6 16V Bifuel	K4M866	11/08	⇒	TRAFIC II 2.0 16V	F4R820	08/06	⇒
KANGOO II 1.5 dCi 110	K9K636, K9K608	09/10	⇒	MEGANE III 1.6 Bifuel	K4M866	11/08	⇒	TWINGO 1.2	D4F770	09/10	⇒ 09/14
KANGOO II 1.5 dCi 75	K9K608, K9K800	09/10	⇒	MEGANE III HATCHBACK VAN 1.5 dCi	K9K834, K4M700	11/08	⇒ 08/15	TWINGO 1.2 16V	K9K820	10/10	⇒ 09/14
KANGOO II 1.5 dCi 85	K9K800, K9K608	02/08	⇒	MEGANE CC 1.5 dCi	K9K636, E7J626	06/10	⇒	TWINGO I 1.0	D7D740	01/00	⇒
KANGOO II 1.5 dCi 90	K9K608, K4M830	06/09	⇒	MEGANE CC 1.6 16V	K4M858	06/10	⇒	TWINGO I 1.0 16V	D4D712	01/01	⇒
KANGOO II 1.6	K4M830, K4M830	02/08	⇒	MEGANE CC 1.6 16V Hi-Flex	K4M866	06/10	⇒	TWINGO I 1.2	D7F700, D4F702	05/96	⇒
KANGOO II 1.6 16V	K4M830, K4M834	02/08	⇒	MEGANE SCÉNIC I 1.4 i	E7J764	01/97	⇒ 09/99	TWINGO I 1.2 16V	D4F702, D4F764	01/01	⇒ 06/07
KANGOO II 1.6 16V Flex	K4M834	02/08	⇒	MEGANE SCÉNIC I 1.6 16V	K4M700, K7M702	04/98	⇒ 10/99	TWINGO II 1.2	D7F800	03/07	⇒
KANGOO II 1.6 16V Hi-Flex	K4M834	02/08	⇒	MEGANE SCÉNIC I 1.6 e	K7M702, F3R750	10/96	⇒ 10/99	TWINGO II 1.2 16V	D4F764, D4F780	03/07	⇒
KANGOO II 1.6 16V LPG	K4M834, K4M720	12/08	⇒	MEGANE SCÉNIC I 1.6 i	K7M702	01/97	⇒ 09/99	TWINGO II 1.2 Turbo	D4F780, K9K718	03/07	⇒
LAGUNA I 1.6 16V	K4M720, F3P670	11/97	⇒ 03/01	MEGANE SCÉNIC I 2.0 i	F3R750, D4F740	01/97	⇒ 09/99	TWINGO II 1.5 dCi	K9K718, F4R766	03/07	⇒
LAGUNA I 1.8	F3P670, --	11/93	⇒ 03/01	MEGANE SCÉNIC I 2.0 RXE 4x4	F3R750	05/97	⇒ 10/99	TWINGO II 1.5 dCi 75	K9K820	10/10	⇒
LAGUNA I 1.8 16V	F4P760	04/98	⇒ 03/01	MODUS 1.4	K4J770, E7J720	04/06	⇒ 12/13	TWINGO II 1.5 dCi 90	K9K820	10/10	⇒
LAGUNA I 2.0	--, K4M710	11/93	⇒ 03/01	MODUS / GRAND MODUS 1.2	D4F740, D4F740	12/04	⇒	TWINGO II 1.6 RS	K4M854	05/08	⇒
LAGUNA I 2.0 16V	F4R780	09/99	⇒ 03/01	MODUS / GRAND MODUS 1.2 16V	D4F784	05/07	⇒	VEL SATIS 2.0 16V Turbo	F4R766, F4R762	04/04	⇒
LAGUNA II 1.6	K4M710	03/01	⇒ 10/05	MODUS / GRAND MODUS 1.2 16V Hi-Flex	D4F740, K4J770	10/08	⇒	VEL SATIS 2.0 16V Turbo	F4R762, F4R767	06/02	⇒
LAGUNA II 1.6 16V	K4M710, F4P770	03/01	⇒ 12/07	MODUS / GRAND MODUS 1.2 GPL	D4F744	05/08	⇒ 12/12	VEL SATIS 2.0 Turbo	F4R767, D4F780	04/05	⇒
LAGUNA II 1.6 Bifuel	K4M714	06/05	⇒ 12/07	MODUS / GRAND MODUS 1.4	K4J770, K9K750	12/04	⇒	WIND 1.2	D4F780, K9K	07/10	⇒
LAGUNA II 1.6 LPG	K4M714	03/01	⇒ 05/05	MODUS / GRAND MODUS 1.5 dCi	K9K750, K9K750	09/04	⇒	WIND 1.2 TcE 100	D4F780	02/11	⇒
LAGUNA II 1.8 16V	F4P770, F4R712	03/01	⇒	MODUS / GRAND MODUS 1.5 dCi 75	K9K770	10/10	⇒	WIND 1.6	K4M854	07/10	⇒
LAGUNA II 2.0 16V	F4R712, F5R700	08/02	⇒ 12/07	MODUS / GRAND MODUS 1.5 dCi 90	K9K750, K4M790	10/10	⇒				
LAGUNA II 2.0 16V IDE	F5R700, F4R764	04/01	⇒ 09/07	MODUS / GRAND MODUS 1.6	K4M790, K4J770	12/04	⇒				
LAGUNA II 2.0 16V Turbo	F4R764, K9K780	01/03	⇒ 08/05	RAPID 1.4	E7J720, J7R732	09/91	⇒ 03/98				
LAGUNA III 1.5 dCi	K9K780, F4R811	10/07	⇒	SAFRANE I 2.0	J7R732, J7R734	08/92	⇒ 09/96				
LAGUNA III 1.6 16V	K4M824	10/07	⇒ 12/15	SAFRANE I 2.0 12V	J7R734, J7T760	04/92	⇒ 07/96				
LAGUNA III 2.0	F4R813	02/08	⇒	SAFRANE I 2.2	J7T760, K4M697	04/92	⇒ 07/96				
LAGUNA III 2.0 16V Turbo	F4R811, F4R800	10/07	⇒ 12/15	SANDERO I 1.2 16V	D4F732	11/08	⇒				
LAGUNA III 2.0 GT	F4R800, K9K782	03/08	⇒ 12/15	SANDERO I 1.4	K7J710	02/09	⇒				
LATITUDE 1.5 dCi	K9K782, K9K830	07/10	⇒	SANDERO I 1.4 LPG	K7J714	02/09	⇒				
LODGY 1.5 dCi [ExtraEU]	K9K830, K7M812	11/14	⇒	SANDERO I 1.5 dCi	K9K790	04/07	⇒				
LODGY 1.6	K7M812, D4F732	07/13	⇒	SANDERO I 1.5 dCi	K9K790	04/07	⇒				
LOGAN 1.0	D4D760	12/05	⇒	SANDERO I 1.6	K4M697, D4F732	12/07	⇒				
LOGAN 1.2 16V	D4F732, D4F732	02/06	⇒	SANDERO I 1.6 MPI 85	K7M800	05/10	⇒				
LOGAN 1.2 16V LPG	D4F732, K9K790	12/13	⇒	SANDERO II 1.2 16V	D4F732, K9K612	12/13	⇒				
LOGAN 1.4	K7J710	09/04	⇒	SANDERO II 1.2 16V LPG	D4F734	12/13	⇒				
LOGAN 1.4 LPG	K7J714	02/08	⇒ 10/13	SANDERO II 1.5 dCi	K9K612, K4M842	12/13	⇒				
LOGAN 1.5 dCi	K9K790, K4M690	09/05	⇒	SANDERO II 1.6	K7M812	11/13	⇒				
LOGAN 1.6	K4M690, D4F732	09/04	⇒	SANDERO II 1.6 16V	K4M842, K9K728	04/14	⇒				
LOGAN 1.6 16V	K4M694	12/05	⇒	SCÉNIC I 1.4 16V	K4J714, K4M700	09/99	⇒ 08/03				
LOGAN 1.6 MPI 85	K7M800	05/10	⇒	SCÉNIC I 1.6	K4M700, K4M704	03/01	⇒ 09/03				
LOGAN EXPRESS 1.5 dCi	K9K792	04/07	⇒	SCÉNIC I 1.6 16V	K4M712	05/00	⇒ 08/03				
LOGAN EXPRESS 1.6	K7M710	04/07	⇒	SCÉNIC I 1.6 BiFuel	K4M704, F4P720	03/01	⇒ 08/03				
LOGAN/STEPWAY 1.2	D4F732, D4F732	11/13	⇒	SCÉNIC I 1.8 16V	F4P720, F3R791	01/01	⇒ 08/03				
LOGAN/STEPWAY 1.2 16V LPG	D4F732, K4M842	11/13	⇒	SCÉNIC I 1.8 4x4	F4P722	07/00	⇒ 04/01				
LOGAN/STEPWAY 1.5 dCi	K9K838	12/13	⇒	SCÉNIC I 2.0	F3R791, F4R740	09/99	⇒ 08/03				
LOGAN/STEPWAY 1.6	K4M842, J7T782	11/13	⇒	SCÉNIC I 2.0 16V	F4R740, F4R744	07/00	⇒ 08/03				
MASTER I 2.2	J7T788	08/93	⇒ 02/98	SCÉNIC I 2.0 16V RX4	F4R744, K4J730	06/00	⇒ 08/03				
MASTER I 30 2,2	J7T782, K4J714	08/80	⇒ 07/98	SCÉNIC II 1.4	K4J730, K9K722	06/03	⇒				
MEGANE II 1.4	K4J730, K4J730	08/03	⇒	SCÉNIC II 1.5 dCi	K9K722, K4M761	06/03	⇒				
MEGANE II 1.4 16V	K4J730, K9K722	11/02	⇒ 02/08	SCÉNIC II 1.6	K4M761, K4M764	06/03	⇒				
MEGANE II 1.5 dCi	K9K722, K4M760	09/02	⇒ 12/10	SCÉNIC II 1.6 16V	K4M764, F4R770	05/03	⇒				
MEGANE II 1.6	K4M760, K4M760	08/03	⇒	SCÉNIC II 1.6 Bifuel	K4M764	08/03	⇒ 05/06				
MEGANE II 1.6 16V	K4M760, F4R770	11/02	⇒	SCÉNIC II 1.6 Hi-Flex	K4M766	03/05	⇒ 07/10				
MEGANE II 1.6 16V Hi-Flex	K4M856	02/08	⇒ 07/09								
MEGANE II 1.6 Bifuel	K4M788	06/05	⇒ 02/08								
MEGANE II 1.6 Flex-Fuel	K4M856	01/07	⇒ 02/08								

9.3234



1

KNOCK SENSORS

Adatt./Suitable:

CONTINENTAL
A2C53324618
A2C53344012

INFINITI
22060-1KTOA
22060-ZV00A

NISSAN
22060-1KTOA
22060-JA10A
22060-ZV00A

RENAULT
22 06 01K TOA

SIEMENS
S130112001

MARKET DIFFUSION: MEDIUM



mV/g		
22		

INFINITI

JX 3.5 AWD	VQ35DE	11/12 ⇌ 09/13
QX56 5.6 AWD	VK56VD	03/10 ⇌
QX60 3.5 AWD	VQ35DE	10/13 ⇌
QX80 5.6 AWD	VK56VD	09/13 ⇌

NISSAN

FRONTIER 2.5 dCi [BRA]	YD25DDTi	08/08 ⇌
FRONTIER 2.5 i	QR25DE	11/14 ⇌
FRONTIER 4.0 [USA]	VQ40DE	10/04 ⇌
JUKE 1.5	HR15DE	10/13 ⇌
JUKE 1.6	HR16DE, VQ35DE	06/10 ⇌
JUKE 1.6 CVTC	HR16DE	08/14 ⇌
JUKE 1.6 DIG-T	MR16DDT	06/10 ⇌
JUKE 1.6 DIG-T 4x4	MR16DDT	06/10 ⇌
JUKE 1.6 DIG-T NISMO	MR16DDT	03/13 ⇌ 07/14
JUKE 1.6 DIG-T NISMO 4x4	MR16DDT	02/13 ⇌ 07/14
JUKE 1.6 DIG-T NISMO RS	MR16DDT	08/14 ⇌
JUKE 1.6 DIG-T NISMO RS 4x4	MR16DDT	08/14 ⇌
JUKE 1.6 LPG	HR16DE	01/12 ⇌
MURANO II 2.5 dCi 4x4	YD25DDTi	01/10 ⇌ 09/14
MURANO III 2.5 HEV ALL MODE 4x4-i	QR25DER	01/16 ⇌
MURANO III 3.5 V6 ALL MODE 4x4-i	VQ35DE, YD25DDTi	10/14 ⇌
NAVARA II 2.5 dCi	YD25DDTi, YD25DDTi	07/05 ⇌
NAVARA II 2.5 dCi [THA]	YD25DDTi	12/06 ⇌
NAVARA II 2.5 dCi 4WD	YD25DDTi, QR25DE	07/05 ⇌
NAVARA III 2.5	QR25DE, YD25DDTi	07/14 ⇌
NAVARA III 2.5 DDti	YD25DDTi	01/15 ⇌
NOTE II 1.6 NISMO S	HR16DE	06/13 ⇌
NP300 2.5 i	QR25DE	06/14 ⇌
NV200 / EVALIA 1.5	HR15DE	01/12 ⇌
PATHFINDER 2.5 Hybrid Supercharged [ExtraEU]	QR25DER	08/14 ⇌
PATHFINDER IV 2.5 Hybrid	QR25DER	10/13 ⇌
PATHFINDER IV 2.5 Hybrid 4WD	QR25DER	10/13 ⇌
PATHFINDER III 2.5 dCi 4WD	YD25DDTi, HR16DE	10/06 ⇌
PATROL GR III 5.6	VK56VD	04/10 ⇌
PULSAR 1.6 DIG-T	MR16DDT	02/15 ⇌
QASHQAI I 1.6 LPG	HR16DE	11/10 ⇌ 12/13
QASHQAI II 1.6 DIG-T	MR16DDT	10/14 ⇌
QASHQAI II 2.0	MR20DD	06/14 ⇌
QASHQAI II 2.0 ALL MODE 4x4-i	MR20DD	10/15 ⇌
SENTRA VII 1.6	HR16DE	08/14 ⇌
SENTRA VII 1.6 DIG-T	MR16DDT	07/12 ⇌
SENTRA VII 1.6 i	HR16DE	07/12 ⇌
SENTRA VII 1.8	MRA8DE	08/12 ⇌
SENTRA VII 1.8 [TWN]	MRA8DE	08/13 ⇌
SENTRA VII 1.8 i	MRA8DE	07/12 ⇌
SENTRA VII 2.0	MR20DE	09/12 ⇌
SYLPHY III 1.6	HR16DE	08/12 ⇌
SYLPHY III 1.6 DIG-T	MR16DDT	07/12 ⇌
SYLPHY III 1.8	MRA8DE	08/12 ⇌

NISSAN

TEANA III 2.5	QR25DE	09/13 ⇌
TIIDA II 1.6	HR16DE, M5M400	08/11 ⇌
TIIDA II 1.6 [RUS]	HR16DE	01/15 ⇌
TIIDA II 1.6 CVTC	HR16DE	08/12 ⇌
TIIDA II 1.6 DIG-T	MR16DDT	08/11 ⇌
TIIDA II 1.8	MRA8DE	08/12 ⇌
X-TRAIL III 1.6 DIG-T	MR16DDT	06/15 ⇌
X-TRAIL III 2.0	MR20DD	09/14 ⇌
X-TRAIL III 2.0 ALL MODE 4x4-i	MR20DD	09/14 ⇌
X-TRAIL III 2.5	QR25DE	12/13 ⇌
X-TRAIL III 2.5 ALL MODE 4x4-i	QR25DE	12/13 ⇌

RENAULT

CLIO IV 1.6 RS	M5M400, M5P403	03/13 ⇌
CLIO IV 1.6 RS Trophy	M5M401	03/15 ⇌
ESPACE V 1.6 TCe 200	M5M450	02/15 ⇌
ESPACE V 1.8 TCe 225	M5P403, M5P402	10/16 ⇌
KADJAR 1.6 TCe 165	M5M460	11/16 ⇌
KOLEOS 2.5 Sce 4WD	ZTR707	08/16 ⇌
MEGANE IV 1.6 TCe 165	M5M450	07/17 ⇌
MEGANE IV 1.6 TCe 205	M5M450	11/15 ⇌
MEGANE IV 1.8 RS TCe 280	M5P402, ES9J4SHP	10/17 ⇌
TALISMAN 1.6 TCe 150	M5M450	11/15 ⇌
TALISMAN 1.6 TCe 200	M5M450	11/15 ⇌
TALISMAN 1.8 TCe 225	M5P403	09/18 ⇌

9.3235



04,5

KNOCK SENSORS

Adatt./Suitable:

BOSCH
0 261 231 071

CITROËN

5946 15

5946 19

PEUGEOT

5946 10

5946 15

5946 19

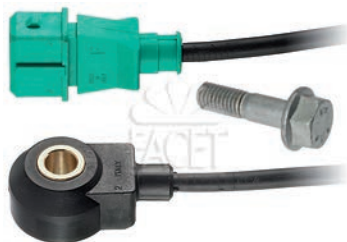

L	mV/g		
375	27		

CITROËN

C5 I 3.0 Carlsson	ES9J4SHP, ES9A	09/03 ⇌ 08/04
C5 I 3.0 V6	ES9A, ES9A	03/01 ⇌
C5 II 3.0 V6	ES9A, ES9A	02/08 ⇌
C5 3.0 [ExtraEU]	ES9AHP	09/04 ⇌ 01/08
C6 3.0 V6	ES9A, ES9J4S	09/05 ⇌ 12/12
C8 3.0 V6	ES9J4S, RFU(XU10J2/C)	07/02 ⇌
EVASION 2.0	RFU(XU10J2/C), RGZ(XU10J2TE)	06/94 ⇌ 07/02
EVASION 2.0 Turbo C.T.	RGX(XU10J2TE), RFT(XU10J4/Z)	06/94 ⇌ 07/02
XANTIA I 2.0	RFXXU10J2C/ZL3	03/93 ⇌ 05/95
XANTIA I 2.0 i	RFX(XU10J2C)	03/93 ⇌ 04/03
XANTIA I 2.0 i 16V	RFT(XU10J4/Z), SFZ(ZPJ/Z)	03/93 ⇌ 01/98
XANTIA I 2.0 i SX 16V	XU10J4D	04/94 ⇌ 05/95
XANTIA I 2.0 i VSX 16V	XU10J4D	03/93 ⇌ 05/95
XANTIA I 2.0 Turbo	RGX(XU10J2TE)	06/95 ⇌ 04/03
XANTIA II 2.0 i	RFX(XU10J2C)	01/98 ⇌ 04/03
XANTIA II 2.0 Turbo	RGX(XU10J2TE)	01/98 ⇌ 04/03
XM I 3.0	UFZ(ZPJ/Z)	05/89 ⇌ 05/94
XM I 3.0 V6	SFZ(ZPJ/Z), SKZ(ZPJ4/Z)	05/89 ⇌ 06/94
XM I 3.0 V6 24V	SKZ(ZPJ4/Z), SFZ(ZPJ/Z)	07/90 ⇌ 06/94
XM II 3.0 V6	SFZ(ZPJ/Z), SKZ(ZPJ4/Z)	05/94 ⇌ 10/00
XM II 3.0 V6 24V	SKZ(ZPJ4/Z), RFX(XU10J2C)	05/94 ⇌ 10/00
ZX 2.0	RFX(XU10J2C)	07/94 ⇌ 10/97
ZX 2.0 i	RFX(XU10J2C), RFT(XU10J4/Z)	07/92 ⇌ 10/97

9.3236



1

KNOCK SENSORS

Adatt./Suitable:

INFINITI
22060-1HCOA

NISSAN
22060-1HCOA

NTK (NGK-GROUP)
KNE36
KNE38

SUBARU
22060-AA160

TOYOTA
SU003-00415

ITEM NOW AVAILABLE FROM PRODUCTION

- ARTICOLO ORA DISPONIBILE PER LA VENDITA
- ARTICLE DISPONIBLE EN PRODUCTION COURANTE
- JETZT ZUM VERKAUF VERFÜGBARER ARTIKEL
- ARTICULO AHORA DISPONIBLE EN PRODUCCION



L	mV/g		
---	25		

INFINITI

FX 50 AWD	VK50VE, HR15DE	10/08 ⇌
M 56	VK56VD	03/10 ⇌
M 56 X	VK56VD	03/10 ⇌
Q70 5.6 AWD	VK56VD	01/15 ⇌
QX70 50 AWD	VK50VE	08/13 ⇌

NISSAN

ALMERA III 1.2 i	HR12DE	09/11 ⇌
ALMERA III 1.5 i	HR15DE, HR12DR	01/12 ⇌
MICRA IV 1.2	HR12DR, HR12DR	05/10 ⇌
MICRA IV 1.2 4WD	HR12DE	05/10 ⇌
MICRA IV 1.2 DIG-S	HR12DR, HR15DE	04/11 ⇌
MICRA IV 1.2 LPG	HR12DE	05/10 ⇌
MICRA IV 1.5	HR15DE, HR12DR	11/10 ⇌
MICRA IV 1.5 NISMO S	HR15DE	06/13 ⇌
NOTE II 1.2	HR12DR, HR12DR	06/13 ⇌
NOTE II 1.2 4WD	HR12DE	06/13 ⇌
NOTE II 1.2 DIG-S	HR12DR, FA20C	06/13 ⇌
NOTE II 1.2 LPG	HR12DE	03/15 ⇌
SUNNY IV 1.5	HR15DE	01/11 ⇌

SUBARU

BRZ 2.0	FA20C, FA20E	06/12 ⇌
FORESTER 2.0 [ExtraEU]	FA20E, FB20	08/12 ⇌
FORESTER III 2.0 AWD	FB20, FB20	01/10 ⇌
FORESTER III 2.5	FB25	01/09 ⇌
FORESTER III 2.5 AWD	EJ25	01/09 ⇌ 09/13
FORESTER IV 2.0 BiFuel AWD	FB20B	03/13 ⇌
FORESTER IV 2.0 i AWD	FB20, FA20	03/13 ⇌
FORESTER IV 2.0 XT	EJ20(Turbo)	08/12 ⇌

SUBARU		
FORESTER IV 2.0 XT AWD	FA20, FB16A	03/13 →
FORESTER IV 2.5	EJ25	08/12 →
FORESTER IV 2.5 [ExtraEU]	FB25B	07/14 →
IMPREZA 2.0 [ExtraEU]	FB20B	08/11 → 12/16
IMPREZA IV 1.6 AWD	FB16A, FB16	06/12 →
IMPREZA IV 1.6 i	FB16, FB16	12/11 → 10/16
IMPREZA IV 1.6 i AWD	FB16, EJ20A	12/11 →
IMPREZA IV 2.0	FB20	01/12 →
IMPREZA IV 2.0 AWD	FB20B	01/12 →
LEGACY 2.5 [ExtraEU]	FB25B	03/12 → 12/14
LEGACY 3.6 [ExtraEU]	EZ36D	01/15 →
LEGACY V 2.0	EJ20A, EJ25A	05/09 →
LEGACY V 2.0 i AWD	FB20B	06/12 → 12/14
LEGACY V 2.5	EJ25A, FB16E	05/09 →
LEGACY V 2.5 CNG AWD	FB25BCNG	04/13 → 12/14
LEGACY V 2.5 i AWD	FB25B	07/12 → 12/14
LEGACY V 3.6 AWD	EZ36D	09/09 → 12/14
LEVORG 1.6 AWD	FB16E, FB25A	09/15 →
OUTBACK 2.5 [ExtraEU]	FB25A, FB25A	03/12 → 12/15
OUTBACK 3.6 [ExtraEU]	EZ36D	01/15 →
OUTBACK IV 2.5 BiFuel AWD	FB25B	01/13 → 12/14
OUTBACK IV 2.5 CNG AWD	FB25BCNG	06/14 → 12/14
OUTBACK IV 2.5 i AWD	FB25A, FB16A	01/13 →
OUTBACK IV 3.6 AWD	EZ36D	06/11 → 12/14
OUTBACK IV 3.6 R AWD	EZ36D	09/09 →
WRX 2.0 [ExtraEU]	FA20F	06/14 →
XV 1.6 BiFuel AWD	FB16B	03/12 →
XV 1.6 i AWD	FB16A, FB20A	03/12 →
XV 2.0 BiFuel AWD	FB20B	03/12 →
XV 2.0 i AWD	FB20A, FA20	03/12 →
TOYOTA		
GT 86 2.0	FA20, A20NFT	03/12 →

9.3238



04,5

KNOCK SENSORS

Adatt./Suitable:

CHEVROLET
12614342
12621820**GENERAL MOTORS**
12 614 342
12 621 820**OPEL**
12 36 841
12614342
12621820
48 12 902**SAAB**
12 621 820**VAUXHALL**
12614342
12621820

L	mV/g		
270	26		

CHEVROLET

HHR 2.2	L61	01/06 → 12/11
---------	-----	---------------

OPEL

ASTRA J 2.0	A20NFT, LNF	04/12 →
GT 2.0	LNF, A20NFT	06/07 → 12/11
INSIGNIA 2.0 E85 Turbo	A20NFT, A20NFT	09/10 → 03/17
INSIGNIA 2.0 Turbo	A20NHT	07/08 → 03/17
INSIGNIA 2.0 Turbo 4x4	A20NFT, A20NFT	07/08 → 03/17
INSIGNIA 2.0 Turbo E85	A20NFT	07/08 → 03/17

SAAB

9-3 2.0 t	A20NFT	01/11 → 02/15
9-3 2.0 t Bio Power	A20NFT	01/11 → 02/15

SAAB

9-3 2.0 t BioPower	A20NFT	01/11 → 02/15
9-3 2.0 t BioPower XWD	A20NFT	01/08 → 02/15
9-3 2.0 t XWD	A20NFT	01/08 → 02/15
9-3 2.0 T16	A20NFT	01/11 → 02/15
9-5 2.0 t BioPower	A20NFT	05/10 → 01/12
9-5 2.0 t BioPower XWD	A20NFT	05/10 → 01/12
9-5 2.0 Turbo	A20NHT	05/10 → 01/12
9-5 2.0 Turbo XWD	A20NHT	05/10 → 01/12
9-3X 2.0 t BioPower XWD	A20NFT	01/11 → 12/12

VAUXHALL

ASTRA VI 2.0 VXR	A20NFT, A20NFT	04/12 →
INSIGNIA 2.0 E85 Turbo	A20NHT	09/10 → 05/17
INSIGNIA 2.0 Turbo	A20NFT, A20NFT	07/08 → 05/17
INSIGNIA 2.0 Turbo 4x4	A20NFT, K10B	07/08 → 05/17

9.3241



04,5

KNOCK SENSORS

Adatt./Suitable:

GENERAL MOTORS
95 509 085**NISSAN**
22060-4A00A**OPEL**
47 00 141
47 11 677
95509085**SUZUKI**18640-60P00
18640-60P00-000
18640-60P00-000-000
18640-69L00
18640-69L00-000
18640-71L00
18640-71L00-000
18640-85LA0
18640-85LA0-000
18640M68K00
18640M68K00-000**VAUXHALL**

95509085

MARKET DIFFUSION: MEDIUM



L	mV/g		
350	21		

NISSAN

PIXO 1.0	K10B	06/09 →
PIXO 1.0 LPG	K10B	06/09 →

OPEL

AGILA B 1.0	K10B, K12B	04/08 → 07/14
AGILA B 1.0 LPG	K10B	01/10 → 06/11
AGILA B 1.2	K12B, K12B	04/08 → 10/14
AGILA B 1.2 LPG	K12B	04/08 → 10/10

SUZUKI

ALTO VII 1.0	K10B	01/09 →
ALTO VII 1.0 LPG	K10B	04/09 →
SPLASH 1.2	K12B	01/08 →
SPLASH 1.2 LPG	K12B	04/08 → 12/14
SPLASH 1.2 VVT	K12B, K12B	09/10 →
SWIFT V 1.2	K12B, K12B	10/10 →
SWIFT V 1.2 4WD	K12B	08/12 →
SWIFT V 1.2 4x4	K12B, D4FC	10/10 →
SWIFT V 1.4	K14B	02/11 →

VAUXHALL

AGILA B 1.0 12V	K10B	01/08 → 11/14
AGILA B 1.0 i	K10B	08/11 → 11/14
AGILA B 1.2 i 16V	K12B	01/08 → 11/14

9.3244



04,5

KNOCK SENSORS

Adatt./Suitable:

HYUNDAI
39250-2A700**KIA**
39250-2A700

L	mV/g		
200	29		

HYUNDAI

I20 1.1 CRDi	D3FA	05/15 →
I20 I 1.1 CRDi	D3FA	03/12 → 12/15
I20 I 1.4 CRDi	D4FC, D4FC	08/08 → 12/15
I20 II 1.1 CRDi	D3FA	11/14 →
I20 II 1.4 CRDi	D4FC	11/14 →
I30 II 1.4 CRDi	D4FC	12/11 →
IX20 1.4 CRDi	D4FC, G4LA	11/10 →

KIA

CEED II 1.4 CRDi 90	D4FC	05/12 →
PRO CEE'D II 1.4 CRDi 90	D4FC	03/13 →
RIO III 1.1 CRDi	D3FA	09/11 →
RIO III 1.4 CRDi	D4FC	09/11 →
RIO 1.1 CRDi	D3FA	09/11 →
VENGA 1.4 CRDi 75	D4FC	02/10 →
VENGA 1.4 CRDi 90	D4FC	02/10 →
VENGA 1.6 CRDi 115	D4FB	02/10 →
VENGA 1.6 CRDi 128	D4FB	02/10 →
VENGA CRDi	D4FC	04/15 →

9.3245



04,5

KNOCK SENSORS

Adatt./Suitable:

BOSCH
0 261 231 283**HYUNDAI**
39250-03000
39250-03020**KIA**
39250-03000
39250-03020

MARKET DIFFUSION: MEDIUM



L	mV/g		
450	27		

HYUNDAI

I10 1.2 LPG	G4LA	01/10 → 12/13
I10 I 1.2	G4LA, G4LA	11/08 → 12/13
I10 II 1.2	G4LA	12/13 →

HYUNDAI		
I20 1.2	G4AG	12/08 → 08/14
I20 1.2 CVT	G4LA	05/15 →
I20 1.2 LPG	G4LA	01/09 → 08/14
I20 I 1.2	G4LA, G4LA	09/08 → 12/15
I20 II 1.2	G4LA, 199B6.000	11/14 →
I20 II 1.2 LPGI	G4LA	11/14 →
KIA		
PICANTO II 1.2	G4LA	09/11 →
RIO III 1.2	G4LA	09/11 →
RIO III 1.2 CVVT	G4LA	11/14 →
RIO III 1.25 CVVT	G4LA	09/11 →
RIO III 1.25 LPG	G4LA	09/11 →
RIO 1.2 CVVT	G4LA	04/15 →
RIO IV 1.25	G4LA	01/17 →
STONIC 1.2 CVVT	G4LA	07/17 →

9.3247



1

KNOCK SENSORS

Adatt./Suitable:

FIAT
55233965
MAZDA
P31E-18-921



mV/g		
28		

FIAT		
500 0.9	199B6.000, 312A4.000	09/12 →
500 C 0.9	312A4.000, 312A4.000	09/12 →
500 MY12 0.9	--	01/12 →
500 MY15 0.9	--	01/15 →
PANDA III 0.9	312A4.000, P5X0	02/12 →
PANDA III 0.9 4x4	312A2.000	06/14 →
MAZDA		
2 1.5 [ExtraEU]	P5Y4	11/14 →
2 III 1.5	P5X0, PYZ8	08/14 →
6 III 2.5	PYZ8, PYZ8	03/18 →
6 III 2.5 [ExtraEU]	PYZ8, PEXB	03/18 →
CX-3 2.0	PEXB, PEX3	02/18 →
CX-5 2.0	PEX3, PEX3	05/17 →
CX-5 2.0 AWD	PEX3, PYZ8	05/17 →
CX-5 2.5	PYZ8, PY-Y8	05/17 →
CX-5 2.5 AWD	PY-Y8, CBTA	05/17 →
CX-9 2.5 T AWD	PYZ4	06/16 →
MX-5 IV 1.5	P5X1	05/18 →
MX-5 IV 2.0	PEXF	05/18 →

9.3251



04,5

KNOCK SENSORS

Adatt./Suitable:

AUDI
07K 905 377 E
VW
07K 905 377 E



L	mV/g		
775	21		

VW		
BEETLE 2.5	CBTA, CBTA	04/11 →
GOLF VI 2.5	CBTA, BGP	07/09 →
JETTA V 2.5	BGP, CBTA	01/06 → 10/10
JETTA VI 2.5	CBTA, CBTA	04/10 →
PASSAT V 2.5 SRE	CBTA, G4LC	01/11 →

9.3252



04,5

KNOCK SENSORS

Adatt./Suitable:

BOSCH
0 261 231 280
HYUNDAI
39250-03030
KIA
39250-03030



L	mV/g		
370	28		

HYUNDAI		
ACCENT 1.4	G4LC	07/18 →
I20 1.4 CVVT	G4LC	05/15 →
I20 II 1.4	G4LC	05/15 →
I30 1.4 CVVT	G4LC	05/15 →
I30 II 1.4	G4LC	12/14 →
I30 III 1.4 MPI	G4LC, G4LC	11/16 →
SOLARIS 1.4	G4LC	01/17 →
KIA		
CEED II 1.4 MPI	G4LC	04/15 →
CEED III 1.4	G4LC	04/18 →
CEED III 1.4 LPG	G4LC	12/18 →
CEED III 1.4 MPi [ExtraEU]	G4LC	03/18 →
PRO CEE'D II 1.4 MPI	G4LC, P5X0	07/13 →
RIO IV 1.4	G4LC	01/17 →
STONIC 1.4 CVVT	G4LC	07/17 →
STONIC 1.4 LPG	G4LC	11/18 →

9.3257



1

KNOCK SENSORS

Adatt./Suitable:

MAZDA
PE01-18-921



L	mV/g		
...	25		

MAZDA		
2 1.5 [ExtraEU]	P5Y4	11/14 →
2 III 1.5	P5X0, P5-VPS	08/14 →
3 III 1.5	P5-VPS, LFX	09/13 →
3 III 2.0	LFX, --	09/13 →
3 III 2.0 Hybrid	--, PE-VPR	10/14 →
6 III 2.0	PE-VPR, PYY1	12/12 →
6 III 2.5	PYY1, PEX3	12/12 →
CX-3 2.0	PEX3, PEX3	05/15 → 01/18
CX-3 2.0 AWD	PEX3, PE-VPS	05/15 →
CX-5 2.0	PE-VPS, PEY4	11/11 →
CX-5 2.0 [ExtraEU]	PEY4, PE-VPS	07/12 → 02/17
CX-5 2.0 AWD	PE-VPS, PY-VPS	11/11 →
CX-5 2.5	PY-VPS, PYY1	02/13 →
CX-5 2.5 4WD	PY-VPS	07/14 →
CX-5 2.5 AWD	PYY1, P5-VPR	02/15 →
CX5 2.0 [ExtraEU]	PEY4, PEY4	11/11 → 02/17
MX-5 IV 1.5	P5-VPR, PEX4	06/15 →
MX-5 IV 2.0	PEX4, PEX6	06/15 →



MASS AIR FLOW METERS (MAF)

·SENSORI DI PORTATA ARIA (MAF) ·CAPTEURS DE MASSE D'AIR ·LUFTMASSENMESSER ·CAUDALIMETROS

(A) P/NRS. - NOTES

- CODICI - NOTE
- RÉFS. - NOTES
- ARTIKEL-NR. - ANMERKUNGEN
- CODIGOS - NOTAS

(B) PICTURE + TECHNICAL INFO

- FOTO + INFORMAZIONE TECNICA
- ILLUSTRATION + INFORMATION TECHNIQUE
- BILD + TECHNISCHE INFO
- FOTO + INFORMACIÓN TÉCNICA

(C) APPLICATION LIST

- GUIDA APPLICAZIONI
- LISTE D'APPLICATIONS
- ANWENDUNGSTABELLE
- LISTA DE APLICACIONES

10.1302 07

MASS AIR FLOW METERS (MAF)

Adatt./Suitable: **2**

CITROËN
1920 GN
96 459 487 80

FORD
4R8Q-12B579-AC

JAGUAR
C2C 12919

LAND ROVER
PHF500090

PEUGEOT
1920 GN
96 459 487 80

SIEMENS
5WK9 7001
5WK9 7011
5WK97001Z

NEW - AVAILABLE FROM:

- NUOVO - DISPONIBILE DA:
- NOUVEAU - DISPONIBLE EN:
- NEU - VERFUEGBAR AB:
- NUEVO - DISPONIBLE EN:

18/Q2

MARKET DIFFUSION: MEDIUM

3

2	3	4	5
Ø in	Ø out	L=mm	
70	70	96	

CITROËN

C4 I 2.0 HDi	DW10BTE4, DW10CFAPDTR	11/04 →
C4 II 2.0 HDi	DW10CFAPDTR, DW10CTED4	10/10 →
C4 II 2.0 HDi / BlueHDi 150	DW10CTED4, DW10BTE4	11/09 →

(A)

1 # FACET

2 OEM P/NRS.

- CODICI ORIGINALI
- RÉFS. D'ORIGINE
- ORIGINALTEILE-NR.
- CODIGOS ORIGINALES

3 PACKAGING SIZE

- FORMATO CONFEZIONE
- FORMAT DU CONDITIONNEMENT
- ABPACKENSGROSSE
- TAMAÑO DEL ENVASE

4 PRODUCT AVAILABILITY DATE

- DATA DI DISPONIBILITÀ DEL PRODOTTO
- DISPONIBILITÉ DU PRODUIT
- PRODUKTVERFUEGBARKEITSDATUM
- DISPONIBILIDAD ARTÍCULO

5 NOTE

- NOTE
- NOTES
- BERMERKUNGEN
- NOTAS

(B)

1 PICTURE

- FOTO
- PHOTO
- BILD
- FOTO

5 TYPE OF CONNECTION

- TIPO DI CONNESSIONE
- TYPE DE CONNEXION
- ANSCHLUSSART
- TIPO DE ENCHUFE

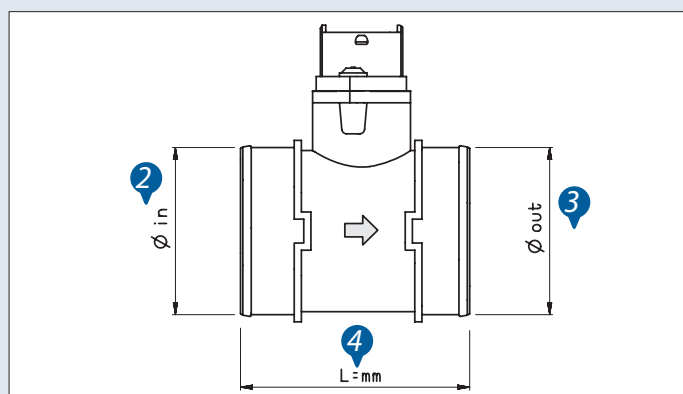

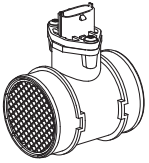

10.1XXX

Mass air flow meters (MAF)

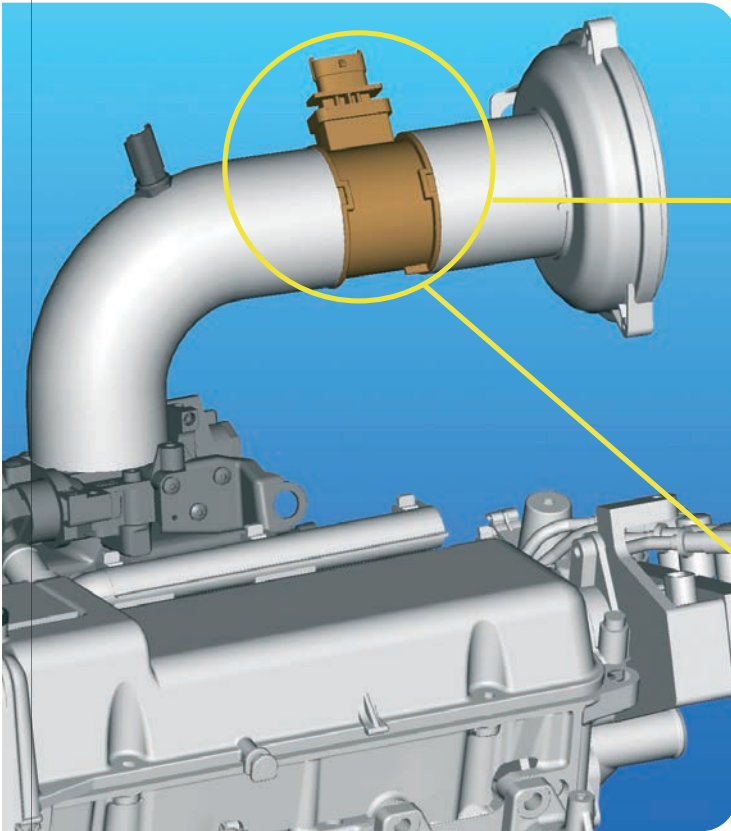

Rendering: by kind concession of FIAT POWERTRAIN TECHNOLOGIES

Air flow sensors (MAF: *Mass Air Flow*; also called **debimeters**), **installed in the intake manifold of the engine** located after the air filter, **measure the amount of air sucked in by the engine**, thereby converting it into a proportional tension (or into another electrical parameter) which is sent to the engine control unit in order to determine the correct air/fuel ratio (*direct* method). Air flow sensors can thus guarantee optimum thermal efficiency as well as controlling exhaust gases emissions.

MAF sensors **can be used with gasoline, diesel and hybrid powered engines**. Furthermore, depending on the type of engine and control unit, MAF sensors may:

- Include a (integrated) temperature probe for the air sucked in*1
- Be used together with an absolute pressure sensor MAP*2

*1 (FACET P/NRS 10.4XXX);*2 (FACET P/NRS 10.3XXX).

The main **reasons for failures** in the product are:

- impurities in the air tubing
- dirty air filter
- malfunction of the EGR valve

Signs of malfunctions of the sensor are indicated by high fuel consumption, smokey exhaust, clogging of the DPF/FAP and related warning light on, lack of smoothness at certain engine revs and

misfiring under acceleration.

MAF sensors are designed and assembled to withstand the critical installation conditions inside the engine compartment.

In particular, the following **requirements** shall be met:

- *Operating temperature*: $-40^{\circ}\text{C} \div +125^{\circ}\text{C}$
- *Electromagnetic immunity*
- *Resistance to hydrocarbons*

The MAF sensors undergo **qualification and endurance tests** to determine if the product is suitable for construction and sale:

- High and low air flow cyclic operation during high and low temperature conditions
- susceptibility to electromagnetic radiofrequency interference induced on the cables
- Resistance to vibrations
- Resistance to thermal shocks
- Resistance to impacts

When these tests have been passed and after the approval to manufacture, the product, in the assembly process, is strictly checked through a series of cycles which include a **100% testing** of the sensor output at high and low flow as well as of the absorbed current.

Structural elements and operation

Air flow sensors consist of a *conduit* and of a *plug in sensor*.

The conduit is placed in the intake manifold. There is a *grid* located at its entrance which is used to decrease the flow turbulences. The plug in sensor is fit into the conduit, including the sensitive elements of the sensor and the *electronic processing circuit*.

In some cases, the MAF only includes the plug-in sensor, for example a sensor installed on the air filter cover. The MAF detects the air flow by measuring the electric current necessary to keep the temperature difference constant between a thermodependent heated resistor ("*hot wire*") and a resistor which measures the temperature of the air flow ("*cold wire*"). The heat exchange between the hot wire and the air flow which tends to reduce the temperature is compensated by the electronic circuit which keeps the temperature of the resistor constant by increasing its electrical power.

In addition to holding the temperature of the "*hot wire*" constant, the *electronic circuit* amplifies and keeps the air flow signal at a stable, predetermined temperature. The circuit is achieved in a *clean room* (environment with a controlled temperature, humidity and impurity level) through *thick-film hybrid technology*: the electronic components are installed at the surface, on a screen printed ceramic substrate with conductive and resistive pastes. Once the circuit is achieved, it is protected with *silicone gel*. Finally, the completed MAF is calibrated to the requested values through software programming.

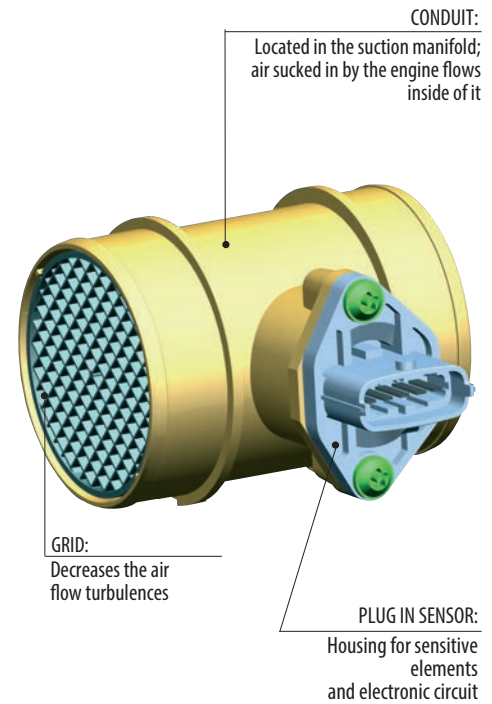

There are 3 types of air flow sensors, which are based on the technology of the sensitive element:

- **chip sensors:** the sensitive elements are achieved on a *micromechanical silicon chip*. This chip has a thin membrane (achieved through etching) onto which the measurement resistors are deposited through *thin-film* technology. MAF chip sensors are *bi-directional*; in addition to having a direct flow, they can also detect the reverse flow (exiting the engine toward the air filter), which occurs when the engine is under full load and at slow running conditions. The reverse flow is signaled to the unit with an output value lower than the value at idle (generally, the null flow output is equal to 1V). The ratio between the air flow and the sensor output is **not linear**.

- **film sensors:** the sensitive elements are thin film silkscreen resistors or thick-film resistors screen printed on a ceramic substrate. MAF film sensors are *unidirectional*; they cannot recognize the reverse flow. The ratio between the air flow and the film sensor output is **not linear**.

- **wire sensors:** the sensitive elements are *cylindrical layer* resistors or platinum or nickel filaments. MAF wire sensors are *unidirectional*; they cannot recognize the reverse flow. The ratio between the air flow and the wire sensor output is **not linear**.

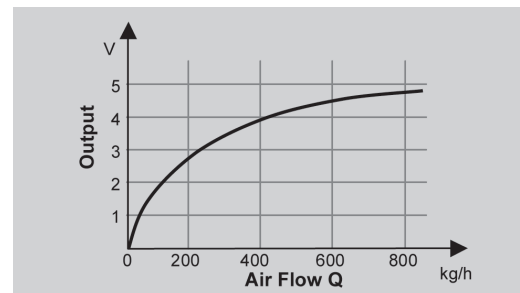
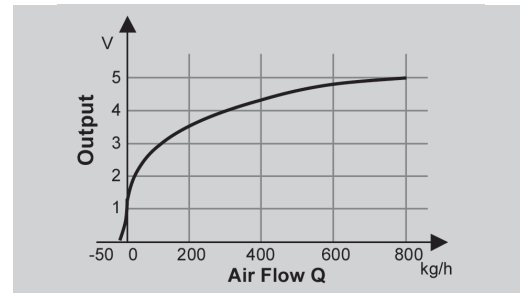

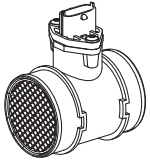

10.1XXX

Sensori di portata aria (MAF)

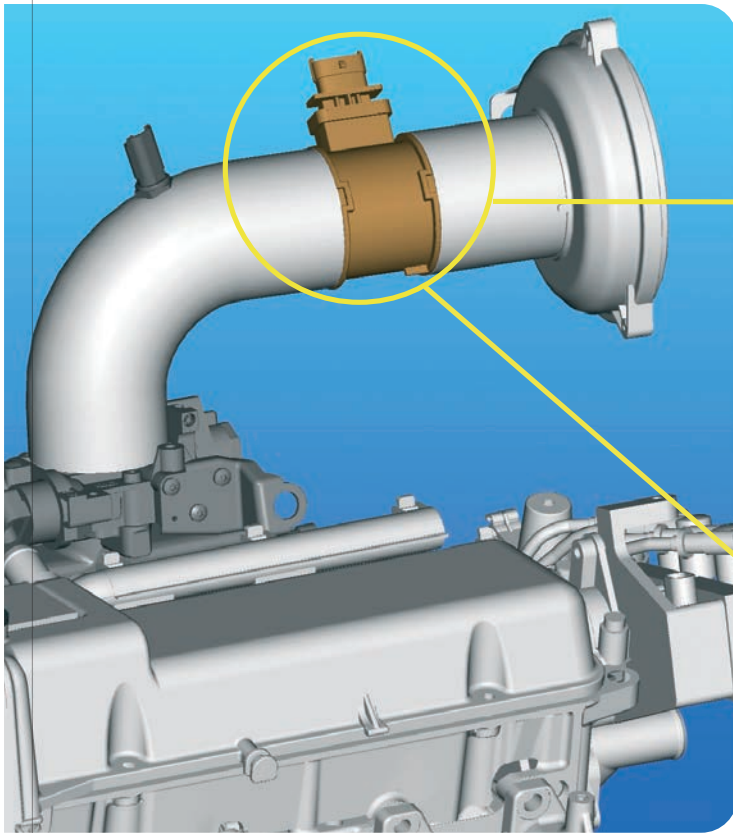

Rendering: per gentile concessione di FIAT POWERTRAIN TECHNOLOGIES

I sensori di portata aria (MAF: *Mass Air Flow*; anche chiamati **debimetri**), **montati nel collettore di aspirazione del motore** a valle del filtro dell'aria, **misurano la quantità d'aria aspirata dal motore convertendola in una tensione**, oppure in un'altra grandezza elettrica proporzionale, per poter stabilire il corretto rapporto aria/carburante (metodo diretto). I sensori di portata aria pertanto garantiscono un buon rendimento termico e permettono di controllare le emissioni di gas tossici esausti.

I sensori MAF **si possono applicare a veicoli con alimentazione a benzina, a gasolio e ibrida**. Inoltre, in funzione della tipologia di motore e della centralina di controllo, i sensori MAF possono:

- includere una sonda (integrata) di temperatura dell'aria aspirata*¹
- essere affiancati ad un sensore di pressione assoluta*²

*¹ (articolo FACET 10.4XXX); *² (articolo FACET 10.3XXX).

Le principali **cause di guasto** del prodotto sono:

- impurità nelle tubazioni dell'aria
- filtro dell'aria sporco
- malfunzionamento della valvola EGR

I **segnali di malfunzionamento** del sensore sono ravvisabili nei consumi elevati di carburante, nella fumosità dello scarico, nell'intasamento del DPF/FAP con relativa accensione spia, nella mancanza di

fluidità a determinati regimi e nei vuoti in accelerazione.

I sensori MAF sono progettati e costruiti per sopportare le condizioni critiche di montaggio nel vano motore. In particolare devono soddisfare i seguenti **requisiti**:

- **temperatura di funzionamento**-4: 0°C ÷ +125°C
- **immunità elettromagnetica**
- **resistenza agli idrocarburi**

I sensori MAF sono sottoposti a rigorose **prove di qualificazione e di durata** per stabilire se il prodotto è idoneo per essere ostruito e venduto:

- funzionamento ciclico ad alto e basso flusso d'aria in condizioni di alta e bassa temperatura
- suscettibilità elettromagnetica ai disturbi a radiofrequenza indotti sui cavi
- resistenza alle vibrazioni
- resistenza agli shock termici
- resistenza agli urti

Superate tali prove e concesso il benessere a produrre, durante la produzione il prodotto viene sottoposto a severi cicli di controllo che prevedono il **collaudo al 100%** dell'uscita del sensore a basso e alto flusso e della corrente assorbita.

Elementi costruttivi e principio di funzionamento

Il sensori di portata aria sono formati da un *condotto* e da un *innesto*.

Il condotto è inserito nel collettore d'aspirazione. E all'ingresso presenta una *griglia* per diminuire le turbolenze presenti nel flusso. All'interno del condotto si inserisce l'innesto, comprendente gli elementi sensibili del sensore e il *circuito elettronico di elaborazione*.

In alcuni casi il MAF è composto solo dall'innesto, ad esempio sensore montato sul coperchio del filtro dell'aria. Il MAF rileva il flusso d'aria misurando la corrente elettrica necessaria a mantenere costante la differenza di temperatura tra un resistore termodipendente riscaldato ("*filo caldo*") e uno che misura la temperatura del flusso d'aria ("*filo freddo*"). Lo scambio di calore tra il filo caldo e il flusso d'aria che tende ad abbassare la temperatura del resistore viene compensato dal circuito elettronico che mantiene costante la temperatura del resistore aumentandone la corrente di alimentazione.

Il *circuito elettronico* oltre a mantenere costante la temperatura del "*filo caldo*", amplifica e mantiene stabile in temperatura il segnale relativo alla portata dell'aria. Il circuito è realizzato in *camera bianca* (ambiente con temperatura, umidità e livello di impurità controllati) con *tecnologia ibrida a film spesso*: i componenti elettronici sono montati superficialmente su un substrato ceramico serigrafato con paste conduttive e resistive. Una volta realizzato il circuito viene protetto con un *gel siliconico*. Infine il MAF completo è calibrato sui valori richiesti attraverso programmazione software.

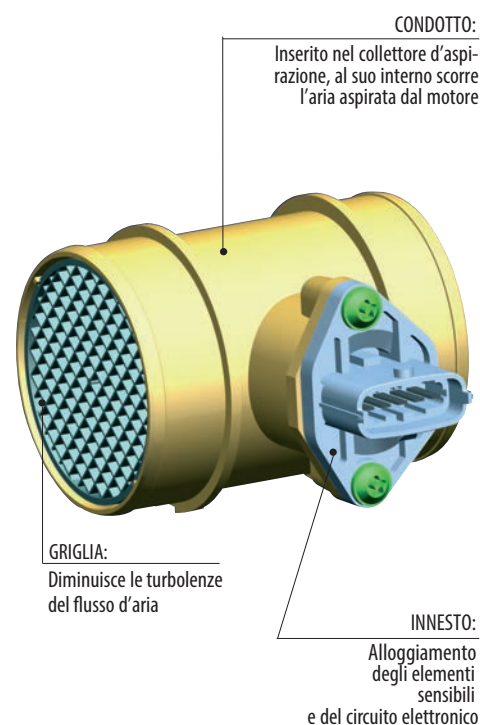

Esistono 3 tipologie di sensori portata aria in funzione della tecnologia dell'elemento sensibile:

- **a chip**: gli elementi sensibili sono realizzati su un chip di silicio di tipo micro-meccanico. Il chip presenta una membrana sottile (ottenuta mediante incisione) sulla quale sono depositati, con la tecnologia del film sottile, i resistori di misura. I MAF a chip sono bidirezionali, oltre al flusso diretto possono rilevare anche il flusso inverso (in uscita dal motore diretto al filtro dell'aria), che si verifica in condizione di motore a pieno carico e bassi regimi. Il flusso inverso viene segnalato alla centralina con un valore dell'uscita inferiore a quello a riposo (generalmente l'uscita a flusso nullo vale 1V).

La relazione tra la portata dell'aria e uscita del sensore è **non lineare**.

- **a film**: gli elementi sensibili sono resistori a film sottile serigrafati su vetro o a film spesso serigrafati su substrato ceramico.

I MAF a film sono monodirezionali, non possono riconoscere il flusso inverso. La relazione tra la portata dell'aria e uscita dei sensori a film è **non lineare**.

- **a filo**: gli elementi sensibili sono resistori cilindrici a strato oppure filamenti di platino o nickel. I MAF a filo sono monodirezionali, non possono riconoscere il flusso inverso.

La relazione tra la portata dell'aria e uscita dei sensori a filo è **non lineare**.

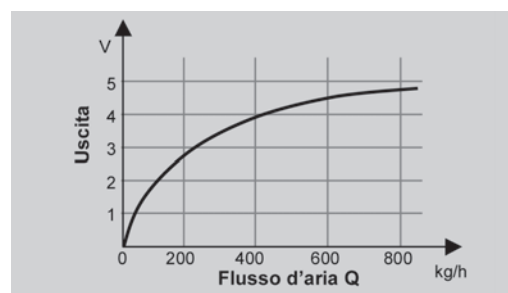
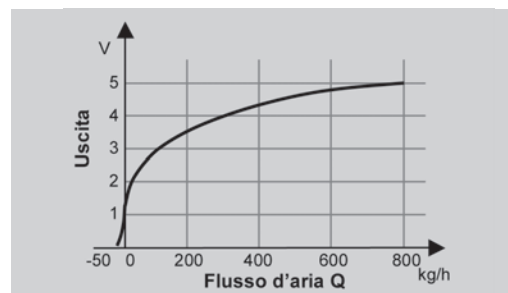

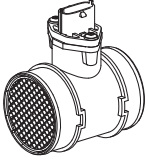

10.1XXX

Capteurs de Masse d'air (MAF)

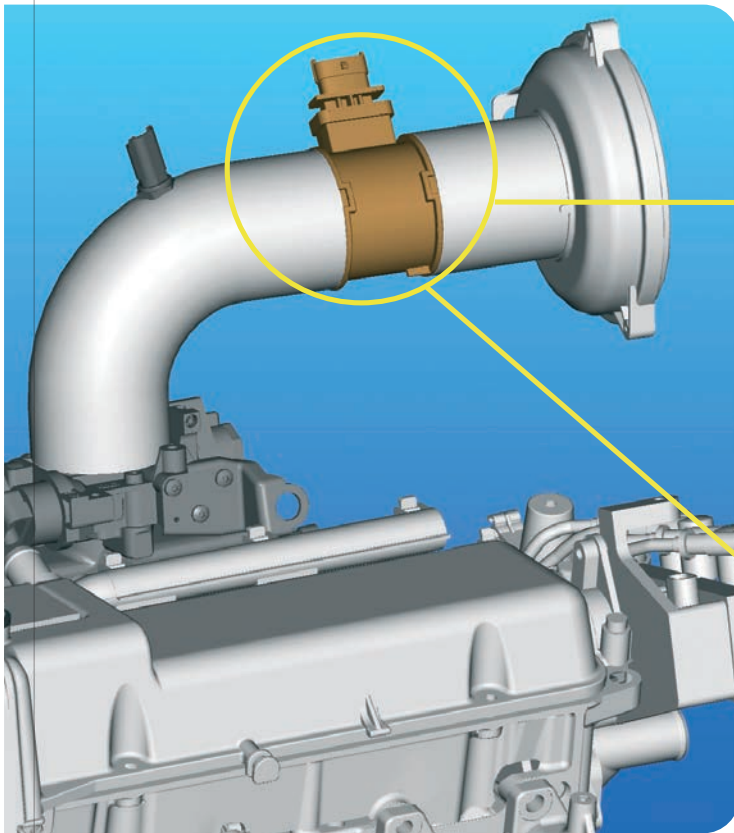

Rendering: par aimable concession de FIAT POWERTRAIN TECHNOLOGIES

Les capteurs de masse d'air (MAF: *Mass Air Flow*; aussi appelés **débitmètres**), **montés dans le collecteur d'admission du moteur** en aval du filtre à air, sont chargés de **mesurer la quantité d'air aspiré par le moteur** et de la convertir en tension ou autre grandeur électrique proportionnelle à envoyer à l'unité de contrôle du moteur pour établir le bon rapport air/carburant (méthode *directe*). Les capteurs de masse d'air garantissent donc un bon rendement thermique et permettent de maintenir les gaz toxiques produits par la combustion dans les pourcentages définis par les normes antipollution.

Les capteurs MAF **trouvent leur application dans les véhicules alimentés à essence, gasoil et hybrides**. En fonction de la typologie des moteurs et des unités de contrôle, les capteurs MAF peuvent:

- inclure une sonde (intégrée) de température de l'air aspiré*1
- être associés à un capteur de pression absolue*2

*1 (article FACET 10.4XXX);*2 (article FACET 10.3XXX).

Les principales **causes de défaut** sont :

- impuretés dans les tuyaux d'air
- filtre à air sale
- dysfonctionnement de la vanne EGR

Les **signaux de dysfonctionnement** du capteur sont reconnais-

sables par une consommation élevée de carburant, une forte émission de fumée à l'échappement, le colmatage du DPF/FAP et l'allumage du témoin correspondant, le manque de fluidité à certains régimes et dans les vides en accélération.

Les capteurs MAF sont conçus et fabriqués pour supporter les conditions de montage critiques dans le compartiment moteur. En particulier, ils doivent répondre aux **caractéristiques** suivantes:

- *température de fonctionnement* : $-40^{\circ}\text{C} \div +125^{\circ}\text{C}$
- *immunité électromagnétique*
- *résistance aux hydrocarbures*

Les capteurs MAF sont soumis à des **essais de qualification et de durée rigoureux** pour établir si le produit est adéquat à la fabrication et à la vente:

- fonctionnement cyclique à flux d'air haut et bas dans des conditions de haute et basse température
- susceptibilité électromagnétique aux parasites en radio-fréquence induits sur les câbles
- résistance aux vibrations
- résistance aux chocs thermiques
- résistance aux coups

À l'issue positive de ces essais et une fois l'autorisation de production accordée, le produit est soumis tout au long de son assemblage à de sévères cycles de contrôle envisageant le **test à 100%** de la sortie du capteur à flux bas et haut et du courant absorbé.

Éléments constitutifs et principe de fonctionnement

Les capteurs de masse d'air sont constitués d'un *conduit* et d'un *accouplement*. Le conduit est inséré dans le collecteur d'admission et dispose d'une *grille* en entrée pour réduire les turbulences présentes dans le flux. L'accouplement, comportant les éléments sensibles du capteur et le *circuit électronique de traitement*, est implanté dans le conduit.

Le capteur MAF peut également être constitué uniquement de l'accouplement comme, par exemple, dans le cas où le capteur serait monté sur le couvercle du filtre à air.

Le capteur MAF détecte le flux de l'air à travers la mesure du courant électrique qui est nécessaire pour maintenir la différence de température constante entre un résistor thermo-dépendant chauffé ("*fil chaud*") et un autre ayant la tâche de mesurer la température du flux d'air ("*fil froid*"). L'échange de chaleur entre le fil chaud et le flux d'air tendant à abaisser la température du résistor est compensé par un circuit électronique qui maintient la température du résistor constante à travers l'augmentation du courant d'alimentation.

Le *circuit électronique* ne se limite pas seulement à maintenir la température du "*fil chaud*" constante, mais amplifie aussi, en le conservant stable vis-à-vis de la température, le signal relatif au débit de l'air. Ce circuit est réalisé en *salle blanche* (environnement avec température, humidité et niveau d'impuretés contrôlés) selon la *technologie hybride à film épais*: les composants électroniques sont montés superficiellement sur un substrat céramique sérigraphié à l'aide de pistes conductrices et résistives. Une fois réalisé, le circuit est protégé avec un *gel de silicone* spécial. Le capteur MAF complet est par la suite calibré

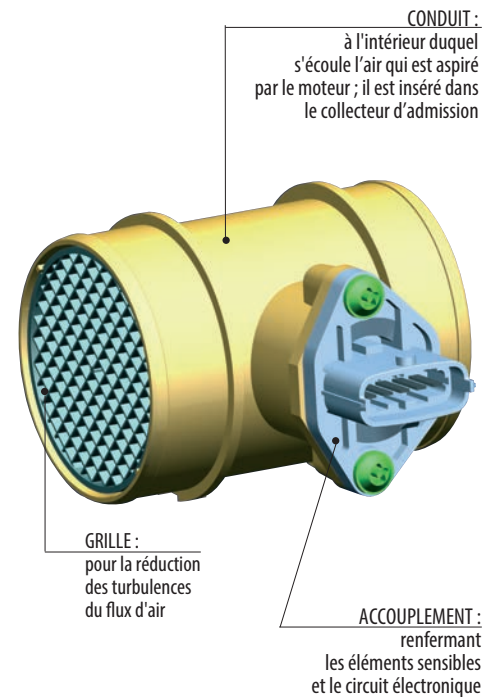

Il y a 3 typologies de capteurs de masse d'air, en fonction de la technologie de l'élément sensible:

- **à puce :** les éléments sensibles sont réalisés sur une *puce en silicium de type micromécanique*. La puce présente une membrane fine (obtenue par incision) sur laquelle sont déposés, d'après la technologie du *film mince*, les résistors de mesure.

Les capteurs MAF à puce sont *bidirectionnels*: outre le flux direct ils peuvent également détecter le flux inversé (en sortie du moteur vers le filtre à air) dans la condition de moteur à pleine charge et bas régimes. Le flux inversé est signalé à l'unité de contrôle par une valeur de sortie inférieure à celle de repos (généralement la sortie à flux nul vaut 1V).

La relation entre le masse de l'air et la sortie du capteur est **non linéaire**.

- **à film :** Les éléments sensibles sont résistances à film mince sérigraphiées sur verre ou à film épais sur substrat céramique.

Les capteurs MAF à film sont *monodirectionnels* et ne peuvent pas reconnaître le flux inversé. La relation entre le débit de l'air et la sortie des capteurs à film est **non linéaire**.

- **à fil :** les éléments sensibles sont des *résistors cylindriques à couche* ou des *filaments* de platine ou nickel.

Les capteurs MAF à fil sont *monodirectionnels* et ne peuvent pas reconnaître le flux inversé. La relation entre le débit de l'air et la sortie des capteurs à fil est **non linéaire**.

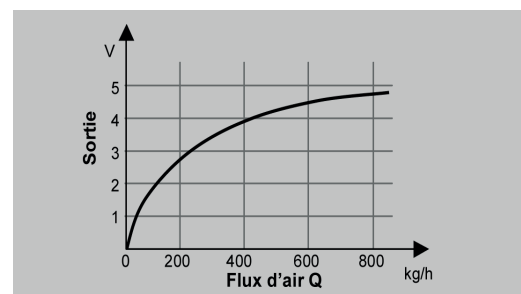
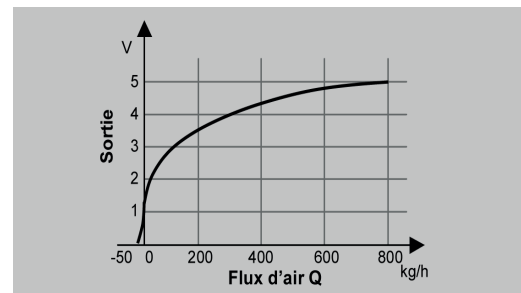

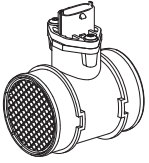

10.1XXX

Luftmassenmesser

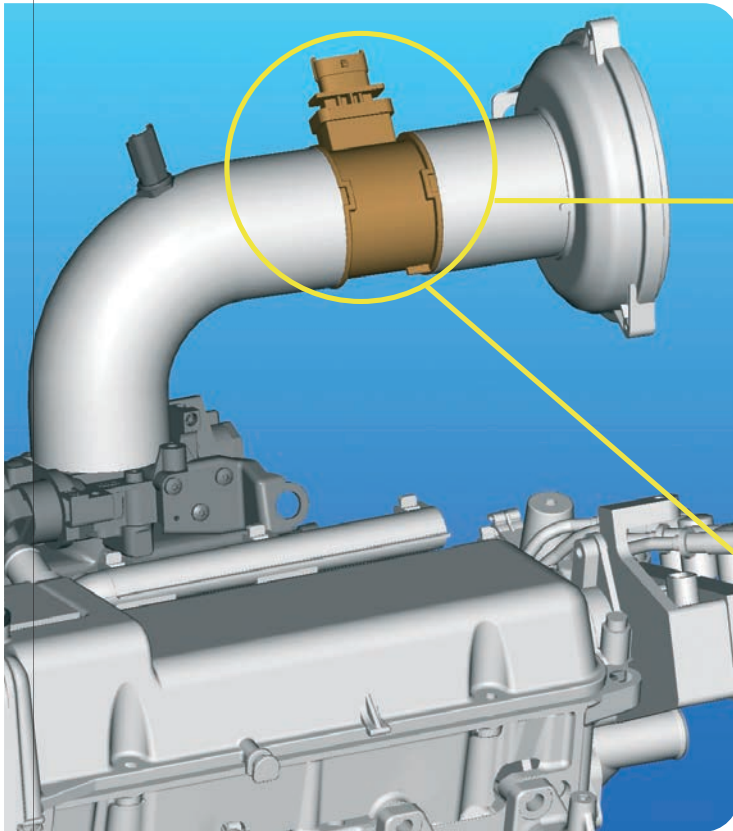

Rendering: by kind concession of FIAT POWERTRAIN TECHNOLOGIES

Die Luftmassenmesser (MAF: *Mass Air Flow*; auch **Luftmengenmesser** genannt) sind **auf dem Ansaugkrümmer des Motors** vor dem Luftfilter montiert, **messen die vom Motor angesaugte Luft** und wandeln sie in eine Spannung oder in eine andere elektrische proportionale Größe um, die dem Steuergerät des Motors gesendet wird, um das korrekte Verhältnis Luft/Treibstoff (*direkte Methode*) bestimmen zu können. Die Luftmassenmesser gewährleisten daher eine gute thermische Leistung und ermöglichen die Beibehaltung der Werte der giftigen Abgase innerhalb der von den Umweltschutzbestimmungen festgelegten Anteile.

Die Luftmassenmesser MAF **können bei bezinbetriebenen, dieselbetriebenen und wasserstoffbetriebenen Fahrzeugen eingesetzt werden**. Je nach Art des Motors und des Steuergeräts bestehen für die Luftmassenmesser MAF folgende Möglichkeiten:

- Sie können einen (integrierten) Fühler für die Temperatur der angesaugten Luft beinhalten*1
- Sie können zusammen mit einem Drucksensor eingesetzt werden*1

*1 (FACET P/NRS 10.4XXX);*2 (FACET P/NRS 10.3XXX).

Die **Hauptursachen für Defekte** des Produkts sind:

- Verunreinigungen in den Luftleitungen
- verschmutzter Luftfilter
- Funktionsstörung des AGR-Ventils

Die **Anzeichen für Funktionsstörungen** des Sensors sind durch hohen Kraftstoffverbrauch, Rauchentwicklung des Auspuffs,

Verstopfung des Partikelfilters unter entsprechendem Aufleuchten der Anzeige und am Mangel an Fluidität bei bestimmten Drehzahlen und Ausfällen beim Beschleunigen erkennbar.

Die Luftmassenmesser MAF werden im Hinblick auf Planung und Bau so ausgelegt, dass sie den kritischen Montagebedingungen im Motorraum standhalten.

Insbesondere müssen sie folgende **Anforderungen** erfüllen:

- *Betriebstemperatur*: -40°C ÷ +125°C
- *Elektromagnetische Störfestigkeit*
- *Beständigkeit gegen Kohlenwasserstoffe*

Die Luftmassenmesser MAF werden **Qualitäts- und Haltbarkeitstests unterzogen**, um festzulegen, ob das Produkt für Bau und Verkauf geeignet ist:

- Zyklusbetrieb bei hoher und bei geringer Luftmenge bei hoher und bei niedriger Temperatur
- Elektromagnetische Empfindlichkeit auf die Kabel induzierte Funkfrequenzstörungen
- Schwingungsfestigkeit
- Beständigkeit gegen starke Temperaturschwankungen
- Stoßfestigkeit

Bei positiven Prüfergebnissen und nach Erteilung der Produktionsgenehmigung wird das Produkt in strengen Kontrollzyklen geprüft, mit der **100%-Abnahmeprüfung** des Ausgangs des Sensors bei geringer und bei hoher Luftmenge und der aufgenommenen Stromstärke.

Bauteile und Funktionsprinzip

Die Luftmassenmesser bestehen aus einem *Kanal* und einem *Steckerteil*. Der Kanal ist in den Ansaugkrümmer eingefügt und weist am Eingang ein *Gitter* auf, um die im Fluss enthaltenen Turbulenzen abzuschwächen. In den Kanal wird das Steckerteil mit den Fühlern des Sensors sowie der *Messelektronik* eingesetzt.

In einigen Fällen besteht der Luftmassensensor MAF nur aus dem Steckerteil, zum Beispiel wenn der Sensor auf der Abdeckung des Luftfilters montiert ist. Der Luftmassensensor MAF detektiert die Luftmasse und misst den zur konstanten Beibehaltung des Temperaturunterschieds zwischen einem temperaturabhängigen Halbleiterwiderstand („*Heißleiter*“) und einem, der die Temperatur der Luftmenge misst („*Kaltleiter*“), erforderlichen Strom. Der Wärmeaustausch zwischen dem Heißleiter und der Luftmenge, der die Temperatur des Widerstands tendenziell absenkt, wird von der elektronischen Schaltung ausgeglichen, die die Temperatur des Widerstands konstant beibehält und den Versorgungsstrom erhöht.

Die *Elektronik* sorgt für die Beibehaltung der konstanten Temperatur des „*Heißleiters*“ und sorgt ebenfalls für die Erweiterung und die stabile Beibehaltung der Temperatur des Signals in Bezug auf die Luftmenge. Die Schaltung wird in einem *Reinraum* (Umgebung mit kontrollierter Temperatur, Feuchtigkeit und Kontamination) mit *Dickschicht-Hybrid technologie* hergestellt. Die elektronischen Bauteile werden mit Leitpasten und Widerstandspasten auf ein im Siebdruckverfahren hergestelltes Keramiksubstrat aufgebracht. Nach der Herstellung wird die Schaltung mit *Silikon* geschützt.

Der komplette Luftmassensensor MAF wird schließlich durch die Software-Programmierung auf die geforderten Werte kalibriert.

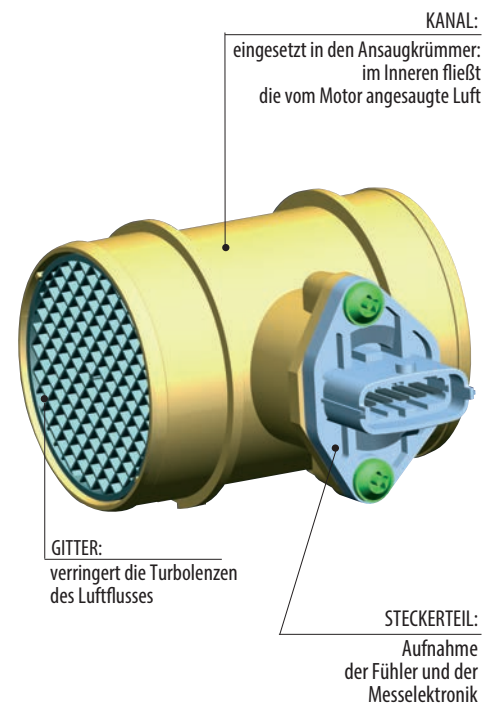

Je nach Technologie des Fühlers gibt es drei verschiedene Arten von Luftmassenmesser::

- **Chipsensoren:** Die Fühler sind auf einem *mikromechanischen Siliziumchip* hergestellt. Der Chip weist eine (durch Gravur erhaltene) dünne Membran auf, auf der die Messwiderstände mit *Dünnschichttechnologie* aufgebracht sind. Die als Chip ausgelegten Luftmassenmesser MAF sind *2-kanalig* und können neben dem direkten Fluss auch den Rückfluss (vom Motor zum Luftfilter) detektieren, der bei voll belastetem Motor mit niedriger Drehzahl auftritt. Der Rückfluss wird vom Steuergerät mit einem Ausgangswert unter dem Ruhewert signalisiert (in der Regel hat der Ausgang mit Fluss Null den Wert 1 V). Das Verhältnis zwischen Luftmenge und Ausgang des Sensors ist **nicht linear**.

- **Foliensensor:** bei den sensiblen Elementen handelt es sich um auf Glas gedruckte Dünnschichtwiderstände oder Dickschichtwiderstände Siebdruckverfahren auf einen Keramik substrat aufgebracht werden. Die als Foliensensoren ausgelegten Luftmassenmesser MAF sind *1-kanalig* und können den Rückfluss nicht detektieren. Das Verhältnis zwischen Luftmenge und Ausgang der Foliensensoren ist **nicht linear**.

- **Drahtsensoren:** Die Fühler sind *zylindrische Schichtwiderstände* oder Platin- oder *Nickeldrähte*. Die als Drahtsensoren ausgelegten Luftmassenmesser MAF sind *1-kanalig* und können den Rückfluss nicht detektieren. Das Verhältnis zwischen Luftmenge und Ausgang der Drahtsensoren ist **nicht linear**.

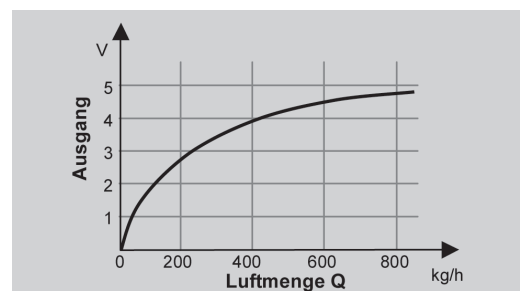
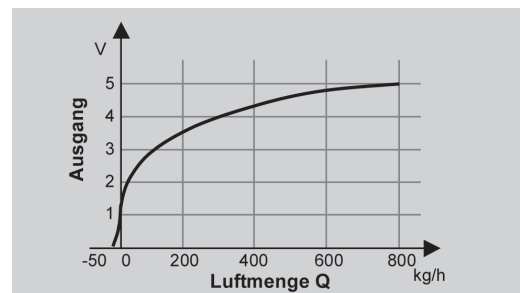

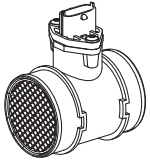

10.1XXX

Caudalímetros

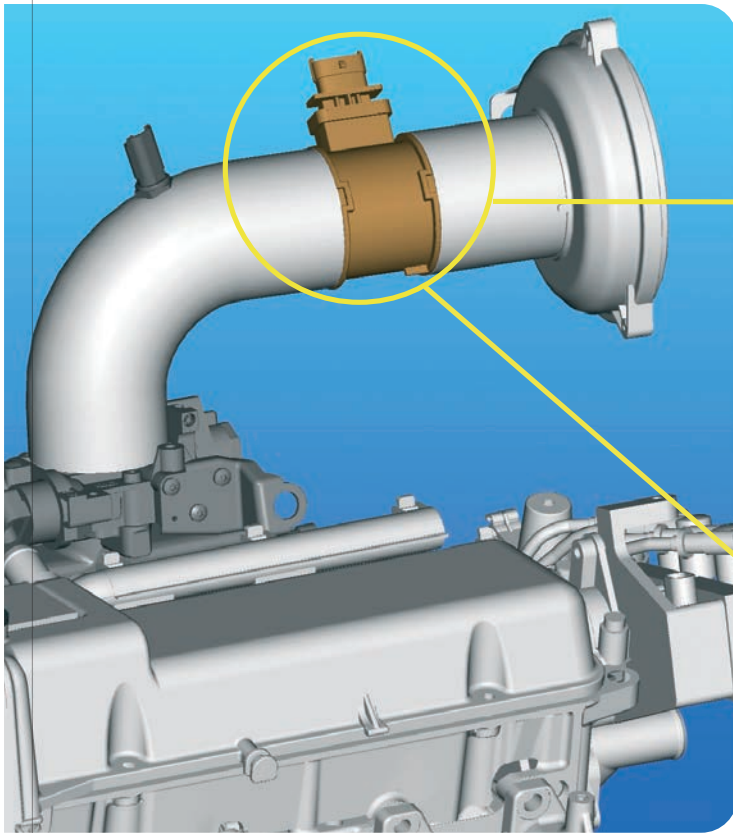

Rendering: por amable concesion de FIAT POWERTRAIN TECHNOLOGIES

Las sondas de masa de aire (MAF: *Mass Air Flow*; también llamados **fluxómetros**), **montadas en el colector de aspiración del motor** que se encuentra antes del filtro de aire, **miden la cantidad de aire aspirado** por el motor, convirtiéndola en una tensión, o en otra magnitud eléctrica proporcional, que se envía a la centralita de control del motor para poder determinar la correcta relación aire/combustible (método *directo*). Por lo tanto, las sondas de masa de aire garantizan un buen rendimiento térmico y permiten mantener los gases tóxicos de combustión dentro de los porcentajes establecidos por las normas de control de la contaminación.

Las sondas MAF se **pueden instalar en vehículos con alimentación de gasolina, de gasoleo e híbrida**. Además, e acuerdo con el tipo de motor y de centralita de control, las sondas MAF pueden:

- tener una termoresistencia (incorporada) para temperatura del aire aspirado*1
- estar combinados con un sensor de presión*2

*1 (artículo FACET 10.4XXX);*2 (artículo FACET 10.3XXX).

Las principales **causas de avería** del producto son:

- impurezas en las tuberías de aire
- filtro de aire sucio
- problemas de funcionamiento de la válvula EGR

Las **señales de problemas** de funcionamiento del sensor se

pueden observar por el elevado consumo de combustible, el humo del escape, el atascamiento del DPF/FAP con el encendido del testigo correspondiente, la falta de fluidez a determinados regímenes y los vacíos en aceleración.

Las sondas MAF están diseñadas y fabricadas para soportar las condiciones críticas de montaje en el espacio del motor. En especial, deben cumplir con los siguientes **requisitos**:

- *temperatura de funcionamiento*: $-40^{\circ}\text{C} \div +125^{\circ}\text{C}$
- *inmunidad electromagnética*
- *resistencia a los hidrocarburos*

Las sondas MAF son sometidos a rigurosos **ensayos de calificación y de duración**, para determinar si el producto es apropiado para ser fabricado y vendido:

- funcionamiento cíclico con flujo de aire alto y bajo en condiciones de alta y baja temperatura
- susceptibilidad electromagnética a los ruidos parasitarios de radiofrecuencia inducidos en los cables
- resistencia a las vibraciones
- resistencia a los choques térmicos
- resistencia a los golpes

Después que ha superado estas pruebas y obtenido la aprobación para la producción, durante el ensamblaje el producto se somete a severos ciclos de control que prevén el **ensayo al 100%** de la salida del sensor con bajo y alto flujo y de la corriente absorbida.

Elementos de construcción y principio de funcionamiento

Las sondas de masa de aire están formados por un *conducto* y por un *acoplamiento*.

El conducto está introducido en el colector de aspiración y en la entrada tiene una *rejilla* para disminuir las turbulencias presentes en el flujo. En el interior del conducto se introduce el acoplamiento, que incluye los elementos sensibles del sensor y el *circuito electrónico* de procesamiento.

En algunos casos, el MAF está formado sólo por el acoplamiento, por ejemplo, el sensor montado en la tapa del filtro de aire. El MAF detecta el flujo de aire midiendo la corriente eléctrica necesaria para mantener constante la diferencia de temperatura entre una resistencia termodependiente calentada ("*hilo caliente*") y una que mide la temperatura del flujo de aire ("*hilo frío*"). El intercambio de calor entre el hilo caliente y el flujo de aire que tiende a reducir la temperatura de la resistencia es compensado por el circuito electrónico que mantiene constante la temperatura de la resistencia, aumentándole la corriente de alimentación.

El *circuito electrónico*, además de mantener constante la temperatura del "*hilo caliente*", amplifica y mantiene a temperatura estable la señal correspondiente al caudal de aire. El circuito está realizado en *sala blanca* (ambiente con temperatura, humedad y nivel de impurezas controlados) con *tecnología híbrida de película gruesa*: los componentes electrónicos están montados superficialmente sobre una capa de cerámica serigrafiada con pastas conductoras y resistivas. Cuando se ha realizado el circuito, se lo protege con un gel de silicona. Por último, el MAF completo se calibra con los valores necesarios a través de una programación software.

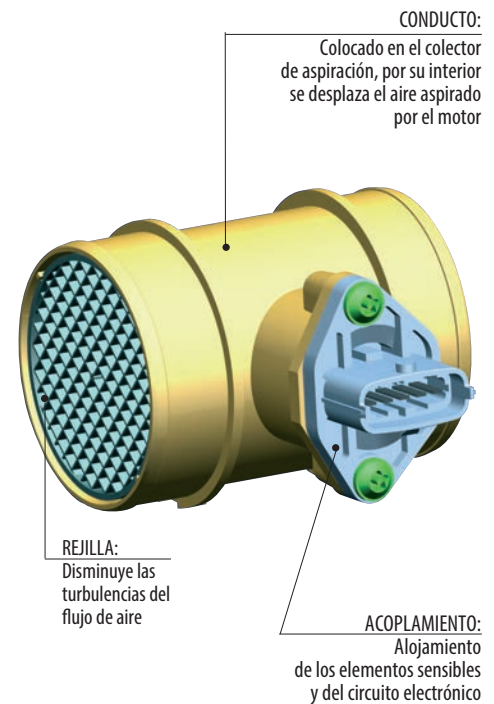

Existen tres tipos de sondas de masa de aire, de acuerdo con la tecnología del elemento sensible:

- **de chip:** los elementos sensibles están realizados sobre un *chip de silicio* de tipo *micromecánico*. El chip tiene una membrana fina (obtenida mediante incisión) en la que están depositados, con tecnología de *película fina*, las resistencias de medición. Los MAF de chip son *bidireccionales*, además del flujo directo pueden detectar el flujo inverso (en salida del motor dirigido al filtro de aire), que se comprueba en condición de motor a plena carga y a bajos regímenes. El flujo inverso se indica a la centralita con un valor de salida inferior al valor en reposo (generalmente, la salida de flujo cero vale 1V). La relación entre el caudal de aire y la salida del sensor es **no lineal**.

- **de película:** los elementos sensibles son resistores de película delgada serigrafiados sobre vidrio o de película *gruesa* serigrafiadas sobre una capa de cerámica. Los MAF de película son *monodireccionales*, no pueden reconocer el flujo inverso. La relación entre el caudal de aire y la salida de las sondas de película es **no lineal**.

- **de hilo:** los elementos sensibles son *resistencias cilíndricas de capa o filamentos* de platino o níquel. Los MAF de hilo son *monodireccionales*, no pueden reconocer el flujo inverso. La relación entre el caudal de aire y la salida de las sondas de hilo es **no lineal**.

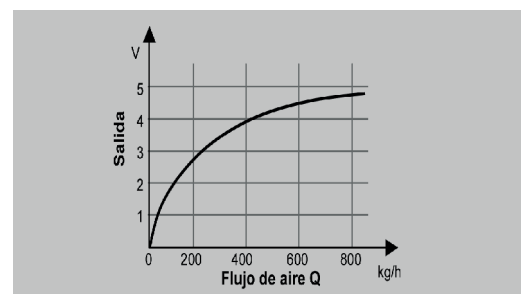
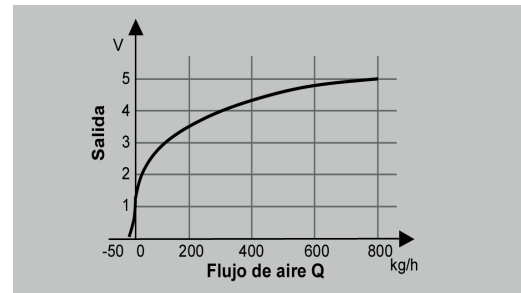

10.1005



07

10.1017



07

10.1031



07

MASS AIR FLOW METERS (MAF)

Adatt./Suitable:

BMW
13 62 7 788 744
7 788 744

BOSCH
0 928 400 504
0 928 400 529

MARKET DIFFUSION: MEDIUM



Ø in	Ø out	L=mm	+B - T 0
110x55	123x67	85	

BMW		
11118 d	M47D20(204D4), M47D20(204D4)	11/03 ⇒ 02/07
11120 d	M47D20(204D4), M47D20(204D4)	03/03 ⇒ 12/11
3 IV 318 d	M47D20(204D4), M47D20(204D4)	03/03 ⇒ 02/05
3 IV 318 td	M47D20(204D4), M47D20(204D4)	03/03 ⇒ 02/05
3 IV 320 Cd	M47D20(204D4), M47D20(204D4)	11/03 ⇒ 12/07
3 IV 320 d	M47D20(204D4), M47D20(204D4)	09/01 ⇒ 02/05
3 IV 320 td	M47D20(204D4), M57D30(306D2)	09/01 ⇒ 02/05
3 IV 330 Cd	M57D30(306D2), M57D30(306D2)	03/03 ⇒ 12/07
3 IV 330 d	M57D30(306D2), M57D30(306D2)	03/03 ⇒ 02/05
3 IV 330 xd	M57D30(306D2), M47D20(204D4)	08/02 ⇒ 05/05
3 V 318 d	M47D20(204D4), M47D20(204D4)	03/05 ⇒ 08/07
3 V 320 d	M47D20(204D4), M57D30(306D3)	12/04 ⇒ 06/12
3 V 325 d	M57D30(306D3), M57D30(306D3)	09/06 ⇒ 06/12
3 V 330 d	M57D30(306D3), M57D30(306D3)	12/04 ⇒ 12/13
3 V 330 xd	M57D30(306D3), M47D20(204D4)	09/05 ⇒ 06/12
5 V 520 d	M47D20(204D4), M57D25(256D2)	02/05 ⇒ 02/08
5 V 525 d	M57D25(256D2), M57D30(306D3)	03/04 ⇒
5 V 525 d xDrive	M57D30(306D3), M57D30(306D3)	09/07 ⇒ 05/10
5 V 525 xd	M57D30(306D3), M57D30(306D2)	11/06 ⇒ 09/08
5 V 530 d	M57D30(306D2), M57D30(306D3)	09/02 ⇒ 05/10
5 V 530 d xDrive	M57D30(306D3), M57D30(306D3)	09/07 ⇒ 05/10
5 V 530 xd	M57D30(306D3), M57D30(306D2)	02/05 ⇒ 08/07
7 IV 730 d	M57D30(306D2), M57D30(306D3)	06/02 ⇒ 07/08
7 IV 730 Ld	M57D30(306D3), M47D20(204D4)	07/05 ⇒ 08/08
X3 I 2.0 d	M47D20(204D4), M57D30(306D2)	11/03 ⇒ 08/07
X3 I 3.0 d	M57D30(306D2), M57D30(306D2)	01/04 ⇒ 08/08
X5 I 3.0 d	M57D30(306D2), M57D30(306D3)	09/03 ⇒ 12/06
X5 II 3.0 d	M57D30(306D3), G6CT	02/07 ⇒ 09/08
X5 II xDrive 30 d	M57D306D3	10/08 ⇒ 03/10
X6 I 30 d	M57D30(306D3)	05/08 ⇒ 08/08
X6 I xDrive 30 d	M57D306D3	04/08 ⇒ 03/10

MASS AIR FLOW METERS (MAF)

Adatt./Suitable:

BOSCH
0 280 218 029
0 280 218 030
0 281 002 212

HYUNDAI
28100-39000

SAAB
46 62 888

SCANIA
4662888



Ø in	Ø out	L=mm	NTC +B - +R 0
86	84	100	

HYUNDAI		
EQUUS / CENTENNIAL I 3.5	G6CU	10/99 ⇒ 03/09
XG 3.0	G6CT	10/01 ⇒ 05/05
XG 30	G6CT, D223L	12/98 ⇒ 12/05
XG-SERIES 3.0	G6CT	09/99 ⇒ 09/03
SAAB		
9-3 2.2 T1D	D223L, 182B9.000	11/00 ⇒ 09/02

MASS AIR FLOW METERS (MAF)

Adatt./Suitable:

ALFA ROMEO
46811122
71788046 *RG

BOSCH
0 280 218 116
0 280 218 120
0 281 002 482

FIAT
46811122
71788046 *RG

HONDA
16400-PLZ-E01

LADA
21083-1130010-20
2112-1130010
2112-1130010-01

*RG **Corresponds to the original re-manufactured part**

- Corrisponde al pezzo originale rigenerato
- Correspond à la pièce d'origine reconditionnée
- Entspricht dem neuwertigen OE-Teil
- Corresponde a la pieza original remanufacturada

MARKET DIFFUSION: HIGH



Ø in	Ø out	L=mm	NTC +B - +R 0
70	70	96	

ALFA ROMEO		
147 1.9 JTD	182B9.000, 192A5.000	04/01 ⇒ 03/10
147 1.9 JTD 16V	192A5.000, 937A2.000	11/02 ⇒ 03/10
147 1.9 JTDM	937A2.000, 932A2.000	10/04 ⇒ 03/10
147 1.9 JTDM 16V	937A5.000	09/04 ⇒ 03/10
GT 1.9 JTD	937A5.000	11/03 ⇒ 09/10
GT 2.0 JTS	932A2.000, 192A5.000	11/03 ⇒ 09/10
FIAT		
MULTIPLA 1.9 JTD 115	186A8.000	07/02 ⇒ 06/10
STILO 1.9 JTD	192A5.000, 2111	09/03 ⇒ 08/08
HONDA		
CIVIC VII 1.7 CTDi	4EE-2	01/02 ⇒ 09/05
LADA		
110 1.5	2111, 2112	10/00 ⇒ 12/05
110 1.5 16V	2112, 21104	10/00 ⇒ 12/10
110 1.6	21104, 21124	01/00 ⇒ 12/12
110 1.6 16V	21124, 21114	10/04 ⇒ 12/10
110 1.6 LPG	21114, 2111	10/04 ⇒ 03/07
111 1.5	2111, 2112	10/00 ⇒ 12/05
111 1.5 16V	2112, 2111	10/00 ⇒ 12/05
112 1.5	2111, 2112	10/00 ⇒ 12/05
112 1.5 16V	2112, 11193	10/00 ⇒ 12/05
112 1.6	21104	03/06 ⇒ 12/08
KALINA 1.4 16V	VAZ1118	11/08 ⇒ 12/13
KALINA 1.4 16V LPG	VAZ1118	11/08 ⇒
KALINA 1.6	11193, VAZ-21114	10/04 ⇒
KALINA 1.6 Sport	VAZ-21126-77	06/13 ⇒ 12/13
NADESCHDA 1.7	UAZ2121	12/97 ⇒ 12/06
NADESCHDA 1.7 i	UAZ21214	12/97 ⇒ 12/06
NADESCHDA 1.8	VAZ-2130	12/97 ⇒ 12/06
NIVA III 1.7 i	--	01/07 ⇒
PRIORA 1.6	VAZ-21114, 11194	04/07 ⇒
PRIORA 1.6 LPG	11194, AR32401	12/08 ⇒
SAMARA 1.5	--	01/97 ⇒
SAMARA 1.6	B321842	02/09 ⇒ 12/13

10.1033



07,5

10.1034



07

MASS AIR FLOW METERS (MAF)

Adatt./Suitable:

ALFA ROMEO

46808221

BOSCH
0 281 002 533

Ø in	Ø out	L=mm	NTC +B - +R 0
86	84	100	

ALFA ROMEO

147 3.2 GTA	932A.000	02/03 ⇨ 03/10
156 3.2 GTA	932A.000	03/02 ⇨ 05/06
GT 3.2 GTA	936A.000	11/03 ⇨ 09/10
GTV 3.2 V6 24V	936A6.000	04/03 ⇨ 10/05
SPIDER II 3.0 V6 24V	AR16102	01/99 ⇨ 10/03
SPIDER II 3.2 V6 24V	936A6.000	04/03 ⇨ 04/05

MASS AIR FLOW METERS (MAF)

Adatt./Suitable:

ALFA ROMEO

46444287

60663029

60815616

71787999 *RG

71788002 *RG

BOSCH

0 280 217 531

0 280 218 036

0 281 002 184

CITROËN

1192 W5

FIAT

1324369080

46444287

60815616

GENERAL MOTORS

93 171 760

IVECO

0000500332364

0000504051082

500332364

504051082

LANCIA

60815616

OPEL

8 36 585

8 36 593

91 93 533

93171760

PEUGEOT

1192 W5

VAUXHALL

9193533

93171760

*RG Corresponds to the original re-manufactured part

• Corrisponde al pezzo originale rigenerato

• Correspond à la pièce d'origine reconditionnée

• Entspricht dem neuwertigen OE-Teil

• Corresponde a la pieza original remanufacturada



Ø in	Ø out	L=mm	NTC +B - +R 0
80	80	130	

ALFA ROMEO

156 2.5 V6 24V	AR32401, AR34301	02/97 ⇨ 05/06
156 2.5 V6 24V [BRA]	AR32402	10/97 ⇨ 12/01
166 2.0 V6	AR34102	09/98 ⇨ 10/00
166 2.5 V6 24V	AR34201	09/98 ⇨ 12/06
166 3.0 V6 24V	AR34301, 8140.435	10/00 ⇨ 06/07
166 3.0 V6 24V [BRA]	AR34302	08/98 ⇨ 09/00
GTV 3.0 V6 24V	AR16102	10/96 ⇨ 10/00

CITROËN

JUMPER I 2.8 HDi	8140.435, 8140.435	09/00 ⇨ 04/02
JUMPER I 2.8 HDi 4x4	8140.435	09/00 ⇨ 04/02
JUMPER II 2.8 HDi	8140.435	04/02 ⇨
JUMPER II 2.8 HDi 4x4	8140.435, 8140.435	02/02 ⇨
JUMPER II 2.8 HDi Trazione integrale	8140.435	04/02 ⇨

FIAT

DUCATO II 2.8 JTD	8140.435, X22DTH	11/00 ⇨
DUCATO II 2.8 JTD 4x4	8140.435	11/00 ⇨ 04/02

IVECO

EURO CARGO I-III	F4BE0611A	09/06 ⇨ 09/15
------------------	-----------	---------------

LANCIA

KAPPA 3.0 24V	838B.000	08/94 ⇨ 10/01
---------------	----------	---------------

OPEL

FRONTERA B 2.2 DTI	X22DTH, 8140.43N	09/02 ⇨ 07/04
OMEGA B 2.6	--	05/94 ⇨ 05/99
OMEGA B 2.6 V6	Y265E	09/00 ⇨ 07/03
OMEGA B 3.2 V6	Y325E	02/01 ⇨ 07/03
SINTRA 2.2 DTI	X22DTH	07/97 ⇨ 04/99
VECTRA B 2.6 i V6	Y265E	09/00 ⇨ 07/03

PEUGEOT

BOXER I 2.8 HDi	8140.43N, 8140.435(F28DTCR)	10/00 ⇨
BOXER I 2.8 HDi 4x4	8140.435(F28DTCR), X22DTH	10/00 ⇨
BOXER I 2.8 HDi Trazione integrale	8140.435(F28DTCR)	10/00 ⇨ 11/01

VAUXHALL

FRONTERA B 2.2 DTI	X22DTH, X12XE	09/00 ⇨ 10/04
OMEGA B 2.6 V6	Y265E	08/00 ⇨ 07/03
OMEGA B 3.2 V6	Y325E	02/01 ⇨ 07/03
SINTRA 2.2 DTI	X22DTH	07/97 ⇨ 04/99
VECTRA B 2.6 i V6	Y265E	09/00 ⇨ 07/03

10.1038



07

MASS AIR FLOW METERS (MAF)

Adatt./Suitable:

ALFA ROMEO

46469917

BOSCH

0 280 217 123

0 280 218 001

0 280 218 031

GENERAL MOTORS

9 193 149

90 529 673

90 543 282

OPEL

8 36 584

8 36 627

8 38 628

90529673

90543282

91 93 149

VAUXHALL

9193149

MARKET DIFFUSION: MEDIUM



Ø in	Ø out	L=mm	NTC +B - +R 0
60	60	96	

ALFA ROMEO

145 1.4 i.e. 16V T.S.	AR33503	12/96 ⇨ 01/01
146 1.4 i.e. 16V T.S.	AR33503	11/96 ⇨ 01/01

OPEL

AGILA A 1.0 12V	Z10XE	09/00 ⇨ 12/07
AGILA A 1.2 16V	Z12XE	09/00 ⇨ 12/07
ASTRA G 1.2	X12XE	09/98 ⇨ 08/00
ASTRA G 1.2 16V	X12XE, X12XE	09/00 ⇨ 01/05
CORSA B 1.0 i 12V	X10XE	11/96 ⇨ 09/00
CORSA B 1.2 i 16V	X12XE	03/98 ⇨ 09/00
CORSA C 1.0	Z10XE	09/00 ⇨ 06/03
CORSA C 1.2	Z12XE	09/00 ⇨ 12/09
CORSA C 1.2 16V	Z12XE	09/00 ⇨ 07/03

VAUXHALL

AGILA A 1.0 12V	Z10XE	09/00 ⇨ 08/05
AGILA A 1.2 16V	Z12XE	09/00 ⇨ 03/08
ASTRA IV 1.2 16V	X12XE, M112.910	09/00 ⇨ 05/05
CORSA B 1.0 i 12V	X10XE	11/96 ⇨ 09/00
CORSA B 1.2 i 16V	X12XE	03/98 ⇨ 09/00
CORSA C 1.0 12V	Z10XE	09/00 ⇨ 10/03
CORSA C 1.2 16V	Z12XE	09/00 ⇨ 10/06
CORSA C 1.2 16V Dualfuel	Z12XE	08/01 ⇨ 10/06
CORSAVAN II 1.2 16V	Z12XE	09/00 ⇨ 06/06
CORSAVAN II 1.2 16V Dualfuel	Z12XE	08/01 ⇨ 06/06

10.1064



07

10.1076



07,5

10.1088



07

MASS AIR FLOW METERS (MAF)

Adatt./Suitable:

BOSCH
0 280 217 515
0 280 217 516
0 280 218 082

CHRYSLER
5101204AA
K05101204AA

MERCEDES-BENZ
1120940048
A 112 094 00 48
A 112 094 01 48



MASS AIR FLOW METERS (MAF)

Adatt./Suitable:

BOSCH
0 280 217 810
0 280 217 811

MERCEDES-BENZ
1130940048
A 113 094 00 48

PUCH
113 094 00 48
A 113 094 00 48



MASS AIR FLOW METERS (MAF)

Adatt./Suitable:

BOSCH
0 280 218 088

VOLVO
31342362
31342414
867011-5
867039-8
944514
944514-8



Ø in	Ø out	L=mm	NTC +B - +R 0
86	84	100	

Ø in	Ø out	L=mm	NTC +B - +R 0
86	84	100	

Ø in	Ø out	L=mm	NTC +B - +R 0
80	80	100	

CHRYSLER

CROSSFIRE 3.2	EGX	07/03 ⇒ 12/08
CROSSFIRE SRT-6	EGZ	09/04 ⇒ 12/07

MERCEDES-BENZ

CLASSE C I C 240	M112.910	06/97 ⇒ 05/00
CLASSE C I C 240 T	M112.910, M112.911	09/00 ⇒ 03/01
CLASSE C I C 280	M112.920	06/97 ⇒ 05/00
CLASSE C I C 280 T	M112.920	06/97 ⇒ 03/01
CLASSE C II C 240	M112.912	05/00 ⇒ 08/07
CLASSE C II C 240 4-matic	M112.916	07/02 ⇒ 08/07
CLASSE C II C 320	M112.946	05/00 ⇒ 05/08
CLASSE C II C 320 4-matic	M112.953	07/02 ⇒ 08/07
CLASSE CLK II 240	M112.912	06/02 ⇒ 05/09
CLASSE CLK II 320	M112.955	06/02 ⇒ 05/09
CLASSE CLK II CLK 240	M112.912	02/03 ⇒ 03/10
CLASSE CLK II CLK 320	M112.955	02/03 ⇒ 03/10
CLASSE E II E 240	M112.911, M112.911	08/00 ⇒ 03/02
CLASSE E II E 240 T	M112.911, M112.945	08/00 ⇒ 03/03
CLASSE E II E 280	M112.921	12/96 ⇒ 03/02
CLASSE E II E 280 4-matic	M112.921	12/96 ⇒ 03/02
CLASSE E II E 280 T	M112.921	12/96 ⇒ 03/03
CLASSE E II E 280 T 4-matic	M112.921	12/96 ⇒ 03/03
CLASSE E II E 320	M112.941	06/97 ⇒ 03/02
CLASSE E II E 320 4-matic	M112.941	06/97 ⇒ 03/02
CLASSE E II E 320 T	M112.941	12/96 ⇒ 03/03
CLASSE E II E 320 T 4-matic	M112.941	12/96 ⇒ 03/03
CLASSE E III E 240	M112.913	03/02 ⇒ 12/08
CLASSE E III E 240 4-matic	M112.917	03/03 ⇒ 12/08
CLASSE E III E 240 T	M112.913	03/03 ⇒ 07/09
CLASSE E III E 240 T 4-matic	M112.917	07/03 ⇒ 07/09
CLASSE E III E 320	M112.949	03/02 ⇒ 12/08
CLASSE E III E 320 4-matic	M112.954	03/03 ⇒ 12/08
CLASSE E III E 320 T	M112.949	03/03 ⇒ 07/09
CLASSE E III E 320 T 4-matic	M112.954	07/03 ⇒ 07/09
CLASSE E E 280	M112.921	07/99 ⇒ 11/02
CLASSE G II G 320	M112.945, M112.970	06/97 ⇒
CLASSE M I ML 320	M112.942	02/98 ⇒ 08/02
CLASSE M I ML 350	M112.970, M112.976	08/02 ⇒ 06/05
CLASSE S IV S 280	M112.922	10/98 ⇒ 08/05
CLASSE S IV S 320	M112.944	10/98 ⇒ 08/05
CLASSE S IV S 320 CDI	OM613.960	08/99 ⇒ 09/02
CLASSE S IV S 350	M112.972	09/02 ⇒ 08/05
CLASSE S IV S 350 4-matic	M112.975	06/03 ⇒ 08/05
CLASSE SL IV 280	M112.923	05/98 ⇒ 10/01
CLASSE SL IV 320	M112.943	05/98 ⇒ 10/01
CLASSE SL V 350	M112.973	03/03 ⇒ 01/12
CLASSE SLK I 320	M112.947	03/00 ⇒ 04/04
VIANO 3,0	M112.951	09/03 ⇒
VIANO 3.2	M112.951	09/03 ⇒
VIANO 3.7	M112.976, M112.976	06/04 ⇒
VITO II 119	M112.951	09/03 ⇒
VITO II 122	M112.951	09/03 ⇒
VITO II 123	M112.976, M113.962	06/04 ⇒

MERCEDES-BENZ

CLASSE C I C 43 AMG	M113.944	08/97 ⇒ 03/01
CLASSE C II C 55 AMG	M113.988	02/04 ⇒ 08/07
CLASSE CLK I 230 Kompressor	M111.982	06/00 ⇒ 06/02
CLASSE CLK I 320	M112.940	06/97 ⇒ 06/02
CLASSE CLK I 430	M113.943	07/98 ⇒ 06/02
CLASSE CLK I 55 AMG	M113.984	08/99 ⇒ 06/02
CLASSE CLK II 500	M113.968	06/02 ⇒ 05/09
CLASSE CLK II 55 AMG	M113.987	09/02 ⇒ 05/09
CLASSE CLK II CLK 500	M113.968	02/03 ⇒ 03/10
CLASSE CLK II CLK 55 AMG	M113.987	02/03 ⇒ 03/10
CLASSE CLK II CLK AMG DTM	M113.987	06/04 ⇒ 03/10
CLASSE CLK II DTM AMG	M113.987	06/04 ⇒ 05/09
CLASSE CLS I CLS 500	M113.967	10/04 ⇒ 12/10
CLASSE E II E 430	M113.940	06/97 ⇒ 03/02
CLASSE E II E 430 4-matic	M113.940	05/99 ⇒ 03/02
CLASSE E II E 430 T	M113.940	06/97 ⇒ 03/03
CLASSE E II E 430 T 4-matic	M113.940	05/99 ⇒ 03/03
CLASSE E II E 55 AMG	M113.980	08/97 ⇒ 03/02
CLASSE E II E 55 T AMG	M113.980	08/97 ⇒ 03/03
CLASSE E III E 500	M113.967	03/02 ⇒ 12/08
CLASSE E III E 500 4-matic	M113.969	10/03 ⇒ 12/08
CLASSE E III E 500 T	M113.967	10/03 ⇒ 07/09
CLASSE E III E 500 T 4-matic	M113.969	10/03 ⇒ 07/09
CLASSE E III E 55 AMG Kompressor	M113.990	10/02 ⇒ 12/08
CLASSE E III E 55 T AMG Kompressor	M113.990	07/03 ⇒ 07/09
CLASSE G II G 500	M113.962	04/98 ⇒
CLASSE G II G 55 AMG	M113.962, M113.960	04/98 ⇒
CLASSE M I ML 430	M113.942	02/98 ⇒ 06/05
CLASSE M I ML 500	M113.965	09/01 ⇒ 06/05
CLASSE M I ML 55 AMG	M113.981	02/00 ⇒ 06/05
CLASSE M II ML 500 4-matic	M113.964	07/05 ⇒ 12/11
CLASSE R R 500 4-matic	M113.971	01/06 ⇒
CLASSE S IV CL 500	M113.960	03/99 ⇒ 03/06
CLASSE S IV CL 55 AMG	M113.986	10/99 ⇒ 03/06
CLASSE S IV CL 600	M137.970	03/99 ⇒ 03/06
CLASSE S IV S 430	M113.941	10/98 ⇒ 08/05
CLASSE S IV S 430 4-matic	M113.948	09/02 ⇒ 08/05
CLASSE S IV S 500	M113.960, M113.989	10/98 ⇒ 08/05
CLASSE S IV S 500 4-matic	M113.966	09/02 ⇒ 08/05
CLASSE S IV S 55 AMG	M113.986	04/99 ⇒ 08/05
CLASSE S IV S 600	M137.970	01/00 ⇒ 08/05
CLASSE SL IV 500	M113.961	05/98 ⇒ 10/01
CLASSE SL V 500	M113.963	10/01 ⇒ 01/12
CLASSE SLK II 55 AMG	M113.989, B5204T3	06/04 ⇒ 02/11

PUCH

G-MODELL G 500	M113.962	12/97 ⇒ 11/00
G-MODELL G 55 AMG	M113.982	04/99 ⇒ 03/01

VOLVO

C70 I 2.0 T	B5204T3, B5234T3	03/00 ⇒ 10/05
C70 I 2.3 T5	B5234T3, B5244T	07/02 ⇒ 10/05
C70 I 2.3 T-5	B5234T3	03/97 ⇒ 09/02
C70 I 2.4	B5244S	05/99 ⇒ 09/02
C70 I 2.4 T	B5244T, B5234T3	03/97 ⇒ 10/05
S60 I 2.0 T	B5204T5	07/00 ⇒ 04/10
S60 I 2.3 T5	B5234T7	07/00 ⇒ 09/02
S60 I 2.4 CDI	D5244T3	10/03 ⇒ 12/05
S60 I 2.4 D	D5244T2	05/01 ⇒ 04/10
S60 I 2.4 D5	D5244T	01/01 ⇒ 04/10
S60 I 2.4 T	B5244T3	07/00 ⇒ 04/10
S60 I 2.4 T AWD	B5244T3	06/01 ⇒ 04/10
S60 I 2.5 T	B5254T2	01/03 ⇒ 04/10
S60 I 2.5 T AWD	B5254T2	07/02 ⇒ 04/10
S60 I T5	B5234T3	07/00 ⇒ 04/10
S70 2.0	B5204T4	01/97 ⇒ 11/00
S70 2.0 Turbo	B5204T3	01/97 ⇒ 11/00
S70 2.3	B5234T3, B5244T	11/96 ⇒ 11/00
S70 2.4 T5 AWD	B5254T	11/96 ⇒ 04/99
S70 2.4 Turbo	B5244T, B5204T3	01/97 ⇒ 11/00
S70 2.5 TDI	D5252T	01/97 ⇒ 11/00
S70 2.5 TDI AWD	D5252T	10/99 ⇒ 09/00
S80 I 2.0	B5204T4	06/98 ⇒ 07/06
S80 I 2.3 R	B5234T7, B6294S	04/00 ⇒ 08/05
S80 I 2.4 D	D5244T2	10/01 ⇒ 07/06
S80 I 2.4 D5	D5244T	08/01 ⇒ 07/06
S80 I 2.4 LTP	B5244T4	06/04 ⇒ 07/06
S80 I 2.4 T	B5244T3	06/00 ⇒ 07/06
S80 I 2.4 T5 AWD	B5244T3	04/00 ⇒ 09/03
S80 I 2.5 T	B5254T2	03/03 ⇒ 07/06
S80 I 2.5 T AWD	B5254T2	07/03 ⇒ 07/06
S80 I 2.5 TDI	D5252T	01/99 ⇒ 07/06
S80 I 2.9	B6294S, B5234T3	05/98 ⇒ 07/06
S80 I 3.0	B6294S2	06/01 ⇒ 07/06
V70 I 2.0	B5204T4	01/97 ⇒ 12/00
V70 I 2.0 Turbo	B5204T3	11/96 ⇒ 12/00
V70 I 2.0 Turbo AWD	B5204T3	11/96 ⇒ 12/00
V70 I 2.3	B5234T3	11/96 ⇒ 11/00
V70 I 2.3 AWD	B5234T3, B5244T	04/97 ⇒ 09/98
V70 I 2.3 Turbo	B5234T4	12/95 ⇒ 03/00
V70 I 2.4 Turbo	B5244T, B5244T	04/96 ⇒ 12/00
V70 I 2.4 Turbo AWD	B5244T, D5244T2	04/96 ⇒ 12/00
V70 I 2.5 TDI	D5252T	12/95 ⇒ 12/00
V70 I 2.5 TDI AWD	D5252T	11/96 ⇒ 02/00
V70 II 2.0 T	B5204T5	11/99 ⇒ 08/07
V70 II 2.3 AWD	B5234T7	10/00 ⇒ 09/04
V70 II 2.4 Bifuel	B5244S6	09/01 ⇒ 08/07
V70 II 2.4 D	D5244T2, D5244T	07/01 ⇒ 08/07
V70 II 2.4 D5	D5244T	01/01 ⇒ 12/08
V70 II 2.4 D5 AWD	D5244T, B5244T	07/02 ⇒ 08/07
V70 II 2.4 T	B5244T3	11/99 ⇒ 08/03

VOLVO			
V70 II 2.4 AWD	B5244T3	09/01 → 08/02	
V70 II 2.5 AWD	B5254T2	09/02 → 12/04	
V70 II 2.5 T	B5254T2	07/01 → 08/07	
V70 II 2.5 T AWD	B5254T2	07/02 → 08/07	
V70 II 2.5 TDI	D5252T	11/99 → 08/07	
V70 2.0 T5 [ExtraEU]	B5204T3	10/97 → 03/99	
XC70 I 2.3 T XC AWD	B5234T7	01/01 → 07/04	
XC70 I 2.4 D5 AWD	D5244T4	12/05 → 08/07	
XC70 I 2.4 D5 XC AWD	D5244T	09/02 → 08/07	
XC70 I 2.4 T XC AWD	B5244T, B5254T2	03/00 → 09/02	
XC70 I 2.5 T XC AWD	B5254T2	09/02 → 08/07	
XC90 I 2.5 T AWD	B5254T2, N47D20A	10/02 → 09/14	
XC90 I D5 AWD	D5244T	10/02 → 12/06	

10.1155



MASS AIR FLOW METERS (MAF)

Adatt./Suitable:

ALFA ROMEO

46447508	*RG
46541253	*RG
46559804	*RG
46811312	*RG
55193048	*RG
60802028	*RG
60814852	*RG
60816137	*RG
71724092	*RG
71787950	*RG
71787966	*RG
71787969	*RG
71788003	*RG
71788006	*RG
71788745	*RG
71788747	*RG
71793935	*RG

BOSCH

0 280 218 019
0 280 218 113
0 281 002 180
0 281 002 199
0 281 002 309
0 281 002 428
0 281 002 451

CHRYSLER

5293155AB
K05293155AB

FIAT

46447508	*RG
46541253	*RG
46559804	*RG
46811312	*RG
55193048	*RG
60802028	*RG
60814852	*RG
60816137	*RG
71724092	*RG
71787950	*RG
71787951	*RG
71787953	*RG
71788003	*RG
71788006	*RG

GENERAL MOTORS

9 201 425
90 543 463
93 171 355
93 171 356

LANCIA

46541253
46559804
55193048
60802028
60814852
71724092

MOPAR PARTS

05293155AB

OPEL

8 36 586
8 36 588
8 36 591
8 36 592
8 36 629
90543463
91 95 729
92 01 425
93171355
93171356

VAUXHALL

90543463
9195729
9201425
93171355
93171356

*RG Corresponds to the original re-manufactured part

- Corrisponde al pezzo originale rigenerato
- Correspond à la pièce d'origine reconditionnée
- Entspricht dem neuwertigen OE-Teil
- Corresponde a la pieza original remanufacturada

10.1126



MASS AIR FLOW METERS (MAF)

Adatt./Suitable:

BMW

13 62 7 788 743
13 62 8 509 724
7 788 743
8 509 724

BOSCH

0 281 002 567
0 281 002 585
0 281 002 586
0 281 006 146

MERCEDES-BENZ

0000942048
A 000 094 20 48

MARKET DIFFUSION: MEDIUM



Ø in	Ø out	L=mm	+B - T 0
80	80	105	

BMW

11 116 d	N47D20A, N47D20A	11/08 → 09/12
11 118 d	N47D20A, N47D20A	09/06 → 12/13
11 120 d	N47D20A, N47D20B	03/03 → 12/13
11 123 d	N47D20B, N47D20A	03/07 → 12/13
3 V 316 d	N47D20C	07/09 → 12/11
3 V 318 d	N47D20A, M47D204D4	02/07 → 06/12
3 V 320 d	M47D204D4, N47D20C	12/04 → 12/13
3 V 320 d xDrive	N47D20C, --	02/08 → 06/13
3 V 320 xd	--, M67D39(398D1)	03/07 →
7 IV 740 d	M67D39(398D1), M67D44(448D1)	10/02 → 02/05
7 IV 745 d	M67D44(448D1), N47D20C	03/05 → 07/08
X1 sDrive 18 d	N47D20C, N47D20C	03/09 → 06/15
X1 sDrive 20 d	N47D20C, N47D20C	10/09 → 06/15
X1 xDrive 18 d	N47D20C, N47D20C	03/09 → 06/15
X1 xDrive 20 d	N47D20C, N47D20C	10/09 → 06/15
X1 xDrive 23 d	N47D20C, OM646.981	10/09 → 06/15

MERCEDES-BENZ

VIANO CDI 2.0	OM646.981, OM646.982	09/03 →
VIANO CDI 2.0 4-matic	OM646.982, OM646.980	07/05 →
VIANO CDI 2.2	OM646.980, OM646.980	09/03 →
VIANO CDI 2.2 4-matic	OM646.982	07/05 →
VITO II 109 CDI	OM646.980, OM646.980	09/03 →
VITO II 109 CDI 4x4	OM646.981	09/07 →
VITO II 110 CDI	OM651.940	09/10 →
VITO II 111 CDI	OM646.980, OM646.980	09/03 →
VITO II 111 CDI 4x4	OM646.982	09/07 →
VITO II 115 CDI	OM646.980, AR32102	09/03 →
VITO II 115 CDI 4x4	OM646.982	07/06 →

MARKET DIFFUSION: MEDIUM



Ø in	Ø out	L=mm	NTC +B - +R 0
70	70	96	

ALFA ROMEO

145 1.6 16V T.S.	AR32102	09/97 → 12/00
145 1.6 i.e.	AR33201	10/94 → 12/96

ALFA ROMEO

145 1.6 i.e. 16V T.S.	AR32102, AR32102	12/96 → 01/01
145 1.6 LPG	AR32102	01/98 → 01/01
145 1.8 i.e. 16V	AR32201	03/98 → 01/01
145 1.9 JTD	AR32302	02/99 → 01/01
145 2.0 16V	AR32301	03/98 → 01/01
146 1.6 16V T.S.	AR32102	09/97 → 12/00
146 1.6 i.e. 16V T.S.	AR32102, AR32104	11/96 → 10/01
146 1.8 i.e. 16V T.S.	AR32201	03/98 → 01/01
146 1.9 JTD	AR32302	02/99 → 01/01
146 2.0 16V	AR32301	03/97 → 10/01
147 1.6 16V T.SPARK	AR32104	01/01 → 03/10
147 1.6 16V T.SPARK ECO	AR37203	01/01 → 03/10
147 1.6 LPG	AR32104, AR32102	03/01 → 03/10
147 2.0 16V T.SPARK	AR32310	01/01 → 03/10
156 1.6 16V T.SPARK	AR32102, AR32102	09/97 → 09/05
156 1.6 16V T.SPARK.	AR32102, AR32201	05/00 → 05/06
156 1.8 16V T.SPARK	AR32201, 192B1.000	05/00 → 05/06
156 1.9 JTD	192B1.000, AR32301	05/00 →
156 1.9 JTD 16V	192A5.000	11/02 → 05/06
156 1.9 JTD 16V 04	937A5.000	07/04 → 05/06
156 2.0 16V T.SPARK	AR32301, 932A2.000	05/00 → 06/02
156 2.0 JTS	932A2.000, 839A6.000	01/02 → 05/06
156 2.0 Twin Spark	AR32303	11/97 → 04/00
156 2.4 JTD	839A6.000, AR34103	05/00 → 05/06
166 2.0 T.SPARK	AR34103, 839A6.000	10/00 → 06/07
166 2.4 JTD	839A6.000, AR16201	10/00 → 06/07
GT 1.8 TS	AR32205	11/03 → 09/10
GTV 1.8 16V	AR32201	05/98 → 10/05
GTV 2.0 JTS	937A1.000	04/03 → 10/05
GTV 2.0 T.SPARK 16V	AR16201, AR16201	06/95 → 10/05
SPIDER II 1.8 16V	AR32201	05/98 → 04/05
SPIDER II 2.0 JTS	937A1.000	04/03 → 04/05
SPIDER II 2.0 T.SPARK 16V	AR16201, ENJ	06/95 → 04/05

CHRYSLER

VOYAGER III 2.5 CRD	ENJ, 182B9.000	02/00 → 12/08
VOYAGER III 2.8 CRD	ENR	06/04 → 12/08

FIAT

BRAVA 1.9 JTD 105	182B4.000	12/98 → 10/01
BRAVO I 1.9 D	160A7.000	10/95 → 10/01
BRAVO I 1.9 JTD 105	182B4.000	12/98 → 10/01
BRAVO I 1.9 TD 75 S	182A8.000	03/96 → 10/01
BRAVO I 2.0 HGT 20V	182B7.000	07/98 → 10/01
COUPE 2.0 20V	182B3.000	04/98 → 08/00
DOBLO I 1.9 JTD	182B9.000, 182A7.000	10/01 →
MAREA 1.9 JTD	182B9.000	01/01 → 12/07
MAREA 1.9 JTD 105	182B4.000	12/98 → 12/02
MAREA 1.9 TD 100	182A7.000, 188A7.000	09/96 → 06/03
MAREA 2.0 150 20V	185A8.000	01/01 → 05/02
MAREA 2.0 155 20V	182B7.000	04/99 → 02/03
MARENGO 1.9 JTD	182B4.000	03/99 → 08/02
PUNTO II 1.9 JTD	188A7.000, 838A2.000	02/00 → 03/12
PUNTO II 1.9 JTD 80	188A2.000	09/99 → 03/12

FIAT (BR)

MAREA 2.4i 20v	2.4Mpi	01/01 →
----------------	--------	---------

LANCIA

KAPPA 2.0 20V	838A6.000	07/96 → 10/01
KAPPA 2.4 20V	838A2.000, 937A2.000	08/94 →
KAPPA 2.4 JTD	838A8.000	06/98 → 10/01
LYBRA 1.9 JTD	937A2.000, 182B7.000	09/00 → 10/05
LYBRA 2.0 20V	182B7.000, 839A5.000	09/00 → 10/05
LYBRA 2.4 20V	192A2.000	10/01 → 10/05
LYBRA 2.4 JTD	839A5.000, Z20LET	09/00 → 10/05
THESIS 2.4	841D.000	07/02 → 07/09
THESIS 2.4 JTD	841C.000	07/02 → 07/09

OPEL

ASTRA F 2.0 Di	X20DTL	03/98 → 08/00
ASTRA G 1.7 DTI 16V	Y17DT	02/00 → 04/05
ASTRA G 1.7 TD	X17DTL	02/98 → 04/05
ASTRA G 2.0 16V Turbo	Z20LET, X20DTL	09/00 → 10/05
ASTRA G 2.0 Di	X20DTL, X20DTH	02/98 → 04/05
ASTRA G 2.0 DTI	Y20DTH	09/00 → 04/05
ASTRA G 2.0 DTI 16V	X20DTH, Z20LET	08/99 → 01/05
ASTRA G 2.0 OPC	Z20LET, X20DTH	03/02 → 10/05
ASTRA G 2.2 DTI	Y22DTR	09/02 → 10/05
COMBO C 1.7 Di 16V	Y17DTL	10/01 →
COMBO C 1.7 DTI 16V	Y17DT	10/01 →
CORSA C 1.7 Di	Y17DTL	09/00 → 12/09
CORSA C 1.7 Di 16V	Y17DTL	09/00 → 07/03
CORSA C 1.7 DTI	Y17DT	09/00 →
CORSA C 1.7 DTI 16V	Y17DT	09/00 → 07/03
OMEGA B 2.0 DTI 16V	X20DTH	09/97 → 09/00
OMEGA B 2.2 DTI 16V	Y22DTH	09/00 → 07/03
SPEEDSTER 2.0	Z20LET	10/03 → 08/06
SPEEDSTER 2.0 Turbo	Z20LET	08/02 → 08/06
VECTRA B 2.0 Di 16V	X20DTL	11/96 → 04/02
VECTRA B 2.0 DTI 16V	X20DTH, Y22DTR	06/97 → 07/03
VECTRA B 2.2 DTI 16V	Y22DTR, X20DTL	09/00 → 07/03
ZAFIRA A 2.0 Di	X20DTL, X20DTL	07/99 → 06/00

OPEL			
ZAFIRA A 2.0 DI 16V	X20DTL, Z20LET	07/99 ⇒ 06/05	
ZAFIRA A 2.0 DTI 16V	Y20DTH	09/00 ⇒ 06/05	
ZAFIRA A 2.0 OPC	Z20LET, X20DTL	09/01 ⇒ 06/05	
ZAFIRA A 2.2 DTI 16V	Y22DTR	01/02 ⇒ 06/05	
VAUXHALL			
ASTRA IV 1.7 DTI 16V	Y17DT	02/00 ⇒ 05/05	
ASTRA IV 1.7 TD	X17DTL	02/98 ⇒ 08/00	
ASTRA IV 2.0	Z20LET	08/02 ⇒ 10/05	
ASTRA IV 2.0 16V Turbo	Z20LET	09/00 ⇒ 08/05	
ASTRA IV 2.0 DI	X20DTL, Z20LET	02/98 ⇒ 05/05	
ASTRA IV 2.0 DTI 16V	Y20DTH	02/98 ⇒ 05/05	
ASTRA IV 2.0 SRI Turbo	Z20LET	11/01 ⇒ 05/05	
ASTRA IV 2.0 Turbo	Z20LET, X20DTL	03/02 ⇒ 10/05	
ASTRAVAN II 1.7 DTI 16V	Y17DT	04/01 ⇒ 08/06	
ASTRAVAN II 1.7 TD	X17DTL	08/98 ⇒ 08/06	
ASTRAVAN II 2.0 DI	X20DTL, X20DTH	08/98 ⇒ 08/06	
ASTRAVAN II 2.0 DTI	Y20DTH	04/04 ⇒ 08/06	
COMBO C 1.7 DI 16V	Y17DTL	09/01 ⇒ 11/11	
COMBO C 1.7 DTI 16V	Y17DT	10/01 ⇒ 02/12	
CORSA C 1.7 DI 16V	Y17DTL	08/00 ⇒ 09/06	
CORSA C 1.7 DTI 16V	Y17DT	08/00 ⇒ 09/06	
CORSAVAN II 1.7 DI 16V	Y17DTL	09/00 ⇒ 06/06	
CORSAVAN II 1.7 DTI 16V	Y17DT	09/00 ⇒ 06/06	
OMEGA B 2.0 DTI 16V	X20DTH	01/98 ⇒ 09/00	
OMEGA B 2.0 DTI 16V	Y22DTH	08/00 ⇒ 07/03	
SPEEDSTER 2.0 Turbo	Z20LET	03/01 ⇒ 09/06	
SPEEDSTER 2.2	Z22SE	03/01 ⇒ 09/06	
SPEEDSTER VXR20	Z20LET	03/01 ⇒ 09/06	
VECTRA B 2.0 DI 16V	X20DTL	08/95 ⇒ 10/01	
VECTRA B 2.0 DTI 16V	X20DTH, 188A8.000	08/95 ⇒ 10/01	
VECTRA B 2.2 DTI 16V	Y22DTR	08/95 ⇒ 10/01	
VX220 2.0 i Turbo	Z20LET	03/01 ⇒ 07/05	
VX220 2.0 VXR	Z20LET	10/03 ⇒ 07/05	
VX220 2.2 i	Z22SE	09/00 ⇒ 07/05	
ZAFIRA A 2.0	Z20LET	06/02 ⇒ 06/05	
ZAFIRA A 2.0 DI 16V	X20DTL	10/99 ⇒ 08/05	
ZAFIRA A 2.0 DTI 16V	Y20DTH	04/99 ⇒ 08/05	
ZAFIRA A 2.0 GSI Turbo	Z20LET	09/01 ⇒ 06/05	



MASS AIR FLOW METERS (MAF)

Adatt./Suitable:

BOSCH

0 281 002 528
0 281 002 529
0 281 002 613
0 281 002 619

*RG **Corresponds to the original re-manufactured part**

• Corrisponde al pezzo originale rigenerato

• Correspond à la pièce d'origine reconditionnée

• Entspricht dem neuwertigen OE-Teil

• Corrisponde a la pieza original remanufacturada

FIAT

46784582
51774531
71789487

GENERAL MOTORS

55 350 045
93 178 244

HYUNDAI

28164-27500

LANCIA

46784582
51774531
71789487

OPEL

8 36 640
93178244

SUBARU

13800-84E50

SUZUKI

13800-84E50
13800-84E50-000

MARKET DIFFUSION: MEDIUM



Ø in	Ø out	L=mm	NTC +B - +R 0
60	60	96	

FIAT

DOBLO I 1.3 JTD 16V	188A8.000, --	05/04 ⇒ 12/06
IDEA 1.2 D	--	01/08 ⇒
IDEA 1.3 D Multijet	188A9.000	01/04 ⇒
PALIO 1.3	--	06/03 ⇒
PALIO 1.3 JTD Multijet	188A9.000	06/03 ⇒
PALIO 1.7 TD	176A5.000	09/01 ⇒
PANDA II 1.3 D Multijet	--, 188A8.000	09/03 ⇒
PANDA II 1.3 D Multijet 4x4	188A8.000, D3DA	10/04 ⇒
PUNTO II 1.3 D Multijet	188A9.000	02/05 ⇒ 10/09
PUNTO II 1.3 JTD	188A9.000	06/03 ⇒ 10/05
PUNTO II 1.3 JTD 16V	188A9.000	06/03 ⇒ 03/12
SIENA 1.2 MJTD	--	01/02 ⇒
SIENA 1.3 JTD	188A9.000	09/03 ⇒ 12/09

HYUNDAI

ACCENT II 1.5 CRDi	D3DA, D13A	01/02 ⇒ 11/05
GETZ 1.5 CRDi	D3EA	03/03 ⇒ 09/05
GETZ 1.5 CRDi GLS	D4FA	07/04 ⇒ 08/05
MATRIX 1.5 CRDi	D4FA	12/04 ⇒ 08/10
VERNA I 1.5 CRDi	D3EA	01/02 ⇒

LANCIA

MUSA 1.3 D Multijet	188A9.000	10/04 ⇒ 09/12
YPSILON I 1.3 JTD	188A9.000	10/03 ⇒ 12/11

OPEL

AGILA A 1.3 CDTi	Z13DT	08/03 ⇒ 12/07
------------------	-------	---------------

SUBARU

JUSTY III 1.3 CDTi	Z13DT	12/03 ⇒ 08/07
--------------------	-------	---------------

SUZUKI

IGNIS II 1.3 DDiS	Z13DT	09/03 ⇒
SWIFT IV 1.3 DDiS	D13A, 2111	08/05 ⇒
WAGON R+ II 1.3 DDiS	Z13DT	09/03 ⇒

VAUXHALL

AGILA A 1.3 CDTi	Z13DT	08/03 ⇒ 03/08
------------------	-------	---------------



MASS AIR FLOW METERS (MAF)

Adatt./Suitable:

BOSCH

0 280 218 004

FIAT

46533308

LADA

21083-1130010
21083-1130010-01
21083-1130010-10

MARKET DIFFUSION: MEDIUM



Ø in	Ø out	L=mm	NTC +B - +R 0
70	70	96	

FIAT

MAREA 2.4 JTD 130	185A6.000	04/99 ⇒ 05/02
MULTIPLA 1.9 JTD 105	182B4.000	04/99 ⇒ 06/10

LADA

110 1.5	2111, 2112	10/00 ⇒ 12/05
110 1.5 16V	2112, 21124	10/00 ⇒ 12/10
110 1.6 16V	21124, 2111	10/04 ⇒ 12/10
111 1.5	2111, 2112	10/00 ⇒ 12/05
111 1.5 16V	2112, 2111	10/00 ⇒ 12/05
112 1.5	2111, 2112	10/00 ⇒ 12/05
112 1.5 16V	2112, 211182	10/00 ⇒ 12/05
RIVA 1.5	--	01/85 ⇒
RIVA 1.6	--	01/85 ⇒
SAMARA 1.5	211182, WL-T	08/03 ⇒ 12/13



MASS AIR FLOW METERS (MAF)

Adatt./Suitable:

DENSO

197400-2010
197400-2030
197400-2260
197400-4030
MB197400-3000
MB197400-3010
MB197400-3021
MB197400-3070
MB197400-3080
MB197400-3090
MB197408-0040
MB197408-0041
VN197400-4000

FIAT
71742070

FORD

1 448 816
1X43-12B579-AB
4 399 275
4 505 196
XM34-12B579-DA

FORD USA

4 505 196
XM34-12B579-DA

JAGUAR

C2S 2670

LAND ROVER

LR002141
PHF000140

LEXUS

22204-0D030
22204-22010
22204-30010

MAZDA

WLS1-13-215
WLS1-13-215A
ZL01-13-215
ZLY1-13-215

MITSUBISHI

MRS47077

SUZUKI

13800-84E00
13800-84E00-000

TOYOTA

22204-0C020
22204-0D020
22204-0D030
22204-0J010
22204-0L010
22204-0N010
22204-22010
22204-30010
22204-33010

VOLVO

30713512 *1b
865847-1 *1b
920219-9 *1b

AVAILABLE FROM:

- DISPONIBLE DA:
- DISPONIBLE EN:
- VERFUEGBAR AB:
- DISPONIBLE EN:

19/Q3

*1b Only supplied the sensor without a conduit

• Fornito solo sensore senza condotto

• Seulement fourni le capteur sans conduit

• Liefert den Sensor nur ohne Leitung

• Solo se suministró el sensor sin un conducto

*1b

*1b

MARKET DIFFUSION: HIGH

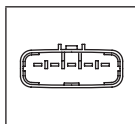

FORD		
ENDEAVOUR 2.5 TDdi HPCR	--	10/06 ⇨
ENDEAVOUR 3.0 TDdi	--	10/06 ⇨
EVEREST 2.5 TDdi HPCR	--	10/06 ⇨
EVEREST 3.0 TDdi	--	10/06 ⇨
RANGER IV 2.5 DT	--	10/06 ⇨
RANGER IV 2.5 TD	WL-T	04/02 ⇨ 06/06
RANGER IV 2.5 TD 4x4	WL-T, MD30DITC	04/02 ⇨ 06/06
RANGER IV 2.5 TDdi	--	04/02 ⇨ 09/05
RANGER IV 2.5 TDdi 4x4	--	04/02 ⇨ 09/05
RANGERV 2.5 TDCi 4x4	WLAA	05/06 ⇨ 07/12
RANGERV 2.5 TDdi	WLAA	05/06 ⇨ 07/12
RANGERV 3.0 TDCi	MD30DITC, MD30DITC	05/06 ⇨ 07/12
RANGERV 3.0 TDCi 4x4	MD30DITC, AJ126	05/06 ⇨ 07/12
JAGUAR		
S-TYPE 2.5 V6	AJ6	04/02 ⇨ 10/07
S-TYPE 3.0 V6	XR8	01/99 ⇨ 10/07
S-TYPE 4.2 V8	AJ8FT	04/02 ⇨ 10/07

JAGUAR		
XF 3.0	AJ126, SV82G	03/08 ⇨ 04/15
XF 4.2	SV82G, AJ30FD	03/08 ⇨
XJ 3.0	AJ30FD, AJ36NG	05/03 ⇨
XJ 3.6	AJ36NG, AJ26	05/03 ⇨ 03/09
XJ 4.2	AJ8FT	05/03 ⇨ 03/09
XK 8 4.0	AJ26, AJ8FT	03/96 ⇨ 07/05
XK 8 4.2	AJ8FT, AJNYB	08/02 ⇨ 12/06
X-TYPE 2.1 V6	AJNYB, AJMxB	03/02 ⇨ 11/09
X-TYPE 2.5	AJMxB, AJMxB	02/04 ⇨ 12/09
X-TYPE 2.5 V6 Trazione integrale	AJMxB, AJLWB	06/01 ⇨ 11/09
X-TYPE 3.0	AJLWB, AJLWB	02/04 ⇨ 12/09
X-TYPE 3.0 Trazione integrale	AJ-V6	09/02 ⇨ 12/08
X-TYPE 3.0 V6 Trazione integrale	AJLWB, --	06/01 ⇨ 12/08

LAND ROVER		
DISCOVERY III 4.0 4x4	--, 32PDP	02/05 ⇨ 09/09
DISCOVERY III 4.0 V6 4x4	406PN	10/04 ⇨ 09/09
DISCOVERY III 4.4 4x4	448PN	07/04 ⇨ 09/09
DISCOVERY IV 4.0 4x4	--	09/09 ⇨
FREELANDER 2 3.2 4x4	32PDP, 428PS	10/06 ⇨ 10/14
RANGE ROVER III 4.2 4x4	428PS, 448PN	05/05 ⇨ 08/12
RANGE ROVER III 4.4 4x4	448PN, 428PS	05/05 ⇨ 08/12
RANGE ROVER SPORT I 4.2 4x4	428PS, 2JZ-GE	02/05 ⇨ 03/13
RANGE ROVER SPORT I 4.4 4x4	448PN	02/05 ⇨ 03/13

LEXUS		
GS 300	2JZ-GE, ZJ06	10/00 ⇨ 11/11
GS 430	3UZ-FE	04/05 ⇨ 11/11
GS 450h	2GR-FSE	02/06 ⇨ 11/11
IS I 300	2JZ-GE	09/01 ⇨ 10/05
IS II 220d	2AD-FHV	08/05 ⇨ 07/12
LS III 430	3UZ-FE	10/00 ⇨ 08/06
RX II 300	1MZ-FE	05/03 ⇨ 12/08
RX II 330	3MZ-FE	04/03 ⇨ 01/06
RX II 330 AWD	3MZ-FE	04/03 ⇨ 12/08
RX II 400h	3MZ-FE	09/05 ⇨ 12/08
RX II 400h AWD	3MZ-FE	09/04 ⇨ 12/08

MAZDA		
2 II 1.3	ZJ06, ZJ-46	07/07 ⇨ 06/15
2 II 1.3 BiFuel	ZJ-46	05/11 ⇨ 11/14
2 II 1.3 MZR	ZJ-46, ZY05	01/10 ⇨ 06/15
2 II 1.5	ZY05, ZY05	10/07 ⇨ 06/15
2 II 1.5 i	ZY-DE	05/10 ⇨ 06/15
2 II 1.5 MZR	ZY05, FXJA	06/11 ⇨ 06/15
3 III 1.6	Z6Y1, ZL05	09/13 ⇨
3 I 1.4	FXJA, B6ZE	10/03 ⇨ 06/09
3 I 1.6	B6ZE, LF17	10/03 ⇨ 06/09
3 I 2.0	LF17, RF7J	09/03 ⇨ 12/09
3 I 2.0 MZR-CD	RF7J, Z6	12/06 ⇨ 06/09
3 II 1.6 MZR	Z6, LF17	12/08 ⇨ 09/14
3 II 2.0 MZR	LF17, LF-5H	01/09 ⇨ 09/14
3 II 2.0 MZR DISI	LF-5H, R2AA	12/08 ⇨ 05/13
3 II 2.2 MZR CD	R2AA, Z6Y1	01/09 ⇨ 09/14
3 II 2.5	L5-VE	03/09 ⇨ 09/14
5 I 1.8	L823	02/05 ⇨ 05/10
5 I 2.0	LF07, LF-5H	02/05 ⇨ 05/10
5 I 2.0 CD	RF7J	02/05 ⇨ 05/10
5 I 2.0 MZR	LF5	09/07 ⇨
5 I 2.0 MZR-CD	RF	09/07 ⇨
5 II 1.8 MZR	L850	09/10 ⇨
5 II 2.0	LF-5H, L813	09/10 ⇨
6 I 1.8	L813, LF17	08/02 ⇨ 08/07
6 I 2.0	LF17, RF5C	06/02 ⇨ 08/07
6 I 2.0 CiTD 4x4	RF5C	10/02 ⇨ 02/05
6 I 2.0 DI	RF5C, L333	06/02 ⇨ 08/07
6 I 2.3	L333, L333	01/02 ⇨ 02/08
6 I 2.3 AWD	L333, L813	11/02 ⇨ 08/07
6 I 2.3 MPS Turbo	L3KG	12/05 ⇨ 08/07
6 I 1.8 MZR	L813, LF17	08/07 ⇨ 07/13
6 II 2.0 MZR	LF17, R2AA	08/07 ⇨ 07/13
6 II 2.0 MZR-CD	RF7J	08/07 ⇨ 12/10
6 II 2.2 D	R2AA, R2AA	01/10 ⇨ 07/13
6 II 2.2 MZR-CD	R2AA, L501	08/08 ⇨ 07/13
6 II 2.5 MZR	L501, RF2A	08/07 ⇨ 07/13
323 VIII F 1.4	B3(16V)	01/01 ⇨ 05/04
323 VIII F 1.4 16V	B3ME	09/98 ⇨ 01/01
323 VIII F 1.5 16V	ZL05, ZM	09/98 ⇨ 01/01
323 VIII F 1.6	ZM, ZL05	01/01 ⇨ 05/04
323 VIII S 1.4	B3(16V)	01/01 ⇨ 05/04
323 VIII S 1.4 16V	B3ME	09/98 ⇨ 01/01
323 VIII S 1.5 16V	ZL05, LFD7	09/98 ⇨ 01/01
323 VIII S 1.6	ZM	01/01 ⇨ 05/04
626 VI 2.0 DI TD	RF3F	04/98 ⇨ 10/02
626 VI 2.0 DITD	RF3F	04/98 ⇨ 10/02
626 VI 2.0 TD	RF4F	10/00 ⇨ 10/02
626 VI 2.0 Turbo DI	RF2A, R587	04/98 ⇨ 10/02

MAZDA		
B-SERIE 2.5 D	R587, WL81	12/02 ⇨ 11/06
B-SERIE 2.5 D 4WD	WL81, WL84	12/02 ⇨ 11/06
B-SERIE 2.5 TD 4WD	WL84, WE01	06/99 ⇨ 07/06
BT-50 2.5 MRZ-CD	WLAA	08/06 ⇨ 06/13
BT-50 2.5 MRZ-CD 4x4	WLAA	12/06 ⇨ 12/15
BT-50 3.0 CDVi	WE01, WEA1	12/06 ⇨ 12/15
BT-50 3.0 CDVi 4x4	WEA1, --	10/06 ⇨ 12/15
CX-7 2.2 MZR	--, L5-VE	07/09 ⇨
CX-7 2.5 MZR	L5-VE, L3	07/09 ⇨ 03/13
MPV II 2.0 DI	RF5C	07/02 ⇨ 02/06
MPV II 2.3	L3, L828	07/02 ⇨ 02/06
MX-5 III 1.8	L828, --	03/05 ⇨ 12/14
MX-5 III 2.0	--, RF2A	03/05 ⇨
PREMACY 2.0 TD	RF2A, 13B	07/00 ⇨ 03/05
PROTEGE 1.6i [USA]	--	06/98 ⇨
RX-8 1.3	13B, 4D56T	10/03 ⇨ 06/12
RX-8 2.6	--	04/08 ⇨
RX-8 2.6 Wankel	13B-MSP	11/03 ⇨ 06/12

MITSUBISHI		
L200 / TRITON 2.5 DI-D	4D56DOHC	08/07 ⇨ 12/15
L200 III 2.5 TD 4WD	4D56T, 4D56HP	08/01 ⇨ 12/07
L200 IV 2.5 D	4D56TD	08/11 ⇨ 12/15
L200 IV 2.5 D 4WD	4D56	08/11 ⇨ 12/15
L200 IV 2.5 DiD	4D56HP, 4D56DOHC	11/05 ⇨ 12/15
L200 IV 2.5 DI-D	4D56DOHC, 4D56HP	08/07 ⇨ 12/15
L200 IV 2.5 DI-D 16V 4WD	4D56DOHC	04/07 ⇨ 12/15
L200 IV 2.5 DI-D 4WD	4D56HP, 4D56HP	11/05 ⇨ 12/15
PAJERO SPORT II 2.5 DI-D	4D56HP, 4D56HP	07/08 ⇨
PAJERO SPORT II 2.5 DI-D 4WD	4D56HP, M13A	07/08 ⇨
PAJERO SPORT II 2.5 TD	4D56T	09/08 ⇨
PAJERO SPORT II 3.2 DiD [ExtraEU]	4M41R	07/08 ⇨
PAJERO SPORT II 3.2 DI-D 4WD	4M41	07/08 ⇨

SUZUKI		
SWIFT IV 1.3	M13A, M13A	02/05 ⇨
SWIFT IV 1.3 4x4	M13A, M16A	02/05 ⇨
SWIFT IV 1.3 LPG	M13A	09/08 ⇨ 12/10
SWIFT IV 1.5	M15A	02/05 ⇨
SWIFT IV 1.6	M16A	05/06 ⇨
SX4 I 1.5	M15A	06/06 ⇨ 07/10
SX4 I 1.5 VVT	M15A	07/10 ⇨
SX4 I 1.5 VVT 4x4	M15A	07/10 ⇨
SX4 I 1.5 VVTi	M15A	07/07 ⇨ 12/15
SX4 I 1.6	M16A	06/06 ⇨
SX4 I 1.6 AWD	M16A, M16A	10/07 ⇨
SX4 I 1.6 VVT	M16A, M16A	06/06 ⇨
SX4 I 1.6 VVT 4x4	M16A, 2AZ-FE	06/06 ⇨
WAGON R+ II 1.3	M13A	09/03 ⇨
WAGON R+ II 1.3 4WD	M13A	09/03 ⇨

TOYOTA		
AURIS I 1.4 D-4D	1ND-TV	03/07 ⇨ 04/13
AURIS I 2.0 D-4D	1AD-FTV	03/07 ⇨ 09/12
AURIS I 2.2 D	2AD-FHV	11/06 ⇨ 09/12
AVENSIS I 1.6	3ZZ-FE	07/00 ⇨ 02/03
AVENSIS I 1.6 VVT-i	3ZZ-FE	10/00 ⇨ 02/03
AVENSIS I 1.8	1ZZ-FE	10/00 ⇨ 02/03
AVENSIS I 1.8 VVT-i	1ZZ-FE	10/00 ⇨ 02/03
AVENSIS II 1.6 VVT-i	3ZZ-FE	04/03 ⇨ 11/08
AVENSIS II 1.8	1ZZ-FE	03/03 ⇨ 11/08
AVENSIS II 2.0	1AZ-FE	08/01 ⇨ 11/09
AVENSIS II 2.0 D-4D	1AD-FTV	03/06 ⇨ 11/08
AVENSIS II 2.0 VVTi	1AZ-FE	04/03 ⇨ 11/08
AVENSIS II 2.2 D-4D	2AD-FTV	10/05 ⇨ 11/08
AVENSIS II 2.2 D-CAT	2AD-FHV	07/05 ⇨ 11/08
AVENSIS II 2.4	2AZ-FE, 1MZ-FE	08/01 ⇨ 11/08
AVENSIS II 2.4 4WD	2AZ-FE	11/03 ⇨ 08/06
CAMRY 3.0	1MZ-FE, 2ZZ-GE	08/01 ⇨ 11/06
CELICA VII 1.8 16V TS	2ZZ-GE	08/99 ⇨ 09/05
CELICA VII 1.8 16V Vt-i	1ZZ-FE	08/99 ⇨ 07/05
COROLLA IX 1.4 D	1ND-TV	07/04 ⇨ 02/07
COROLLA IX 1.4 D-4D	1ND-TV	06/04 ⇨ 10/06
COROLLA IX 1.4 D4-D	1ND-TV	06/04 ⇨ 10/07
COROLLA IX 1.4 VVT-i	4ZZ-FE	10/01 ⇨ 02/07
COROLLA IX 1.6 VVT-i	3ZZ-FE	10/01 ⇨ 03/08
COROLLA IX 1.8 VVT-i TS	2ZZ-GE, 2AD-FHV	01/02 ⇨ 02/07
COROLLA X 1.4 D-4D	1ND-TV	10/06 ⇨ 07/14
COROLLA X 1.4 VVT-i	4ZZ-FE	11/06 ⇨ 11/13
COROLLA X 2.0 D-4D	1AD-FTV	11/06 ⇨ 07/14
COROLLA XI 1.5	1NZ-FE	05/12 ⇨
COROLLA XI 1.5 4WD	1NZ-FE	05/12 ⇨
COROLLA VERSO I 1.6 VVT-i	3ZZ-FE	08/01 ⇨ 05/04
COROLLA VERSO I 1.8 VVT-i	1ZZ-FE	12/01 ⇨ 05/04
COROLLA VERSO I 1.8 VVTi 4WD	1ZZ-FE	07/01 ⇨ 02/04
COROLLA VERSO II 1.6	3ZZ-FE	04/04 ⇨ 03/09
COROLLA VERSO II 1.8	1ZZ-FE	04/04 ⇨ 03/09

TOYOTA			
COROLLA VERSO II 2.2 D-4D	2AD-FHV, 2KD-FTV	10/05 → 03/09	
DYNA 2.5 D4d	2KD-FTV, 1KD-FTV	07/01 →	
DYNA 3.0 D4d	1KD-FTV, 1GR-FE	08/01 →	
DYNA 3.0 D4d 4WD	1KD-FTV	09/06 →	
FJ CRUISER 4.0	1GR-FE, 1GR-FE	06/05 → 12/11	
FJ CRUISER 4.0 4WD	1GR-FE, 2KD-FTV	06/05 →	
FUNCARGO 1.4 D4d	1ND-TV	09/00 → 09/05	
HIACE 3.0 [ExtraEU]	1KD-FTV	11/08 →	
HIACE IV 2.5 D-4D	2KD-FTV, 2KD-FTV	11/01 →	
HIACE IV 2.5 D-4D 4WD	2KD-FTV, 1KD-FTV	08/01 →	
HIACE IV 3.0 [ExtraEU]	1KD-FTV	05/10 →	
HIACE IV 3.0 D	1KD-FTV, 2KD-FTV	08/04 →	
HILUX 2.5 D4d	2KD-FTV	11/01 → 07/05	
HILUX VI 2.5 D-4D 4WD	2KD-FTV	11/01 → 07/05	
HILUX VII 2.0	1TR-FE	02/05 →	
HILUX VII 2.5 D 4WD	2KD-FTV	08/05 → 05/15	
HILUX VII 2.5 D-4D	2KD-FTV, 2KD-FTV	08/05 →	
HILUX VII 2.5 D-4D 4WD	2KD-FTV, 1KD-FTV	11/04 →	
HILUX VII 2.7	2TR-FE	02/05 →	
HILUX VII 2.7 4WD	2TR-FE	08/05 → 05/15	
HILUX VII 3.0 D	1KD-FTV, 1KD-FTV	11/04 →	
HILUX VII 3.0 D 4WD	1KD-FTV	02/05 →	
HILUX VII 3.0 D-4D 4WD	1KD-FTV, 1KD-FTV	08/05 → 05/15	
HILUX VII 4.0 4WD	1GR-FE	02/05 →	
HILUX VII 4.0 4WD	1GR-FE	02/05 →	
LAND CRUISER 90 3.0 D-4D 4WD	1KD-FTV	08/00 → 08/02	
LAND CRUISER 120 3.0 D-4D	1KD-FTV, 1GR-FE	09/02 → 12/10	
LAND CRUISER 120 4.0	1GR-FE, 2AZ-FE	09/02 → 12/10	
LAND CRUISER 120 4.0 V6	1GR-FE	01/03 → 07/09	
VVT-i			
LAND CRUISER 200 4.0	1GR-FE	01/10 →	
LAND CRUISER PRADO 120 3.0 D-4D	1KD-FTV	08/06 → 08/09	
LAND CRUISER PRADO 120 4.0	1GR-FE	01/03 → 08/09	
MR 2 III 1.8 16V VT-i	1ZZ-FE	10/99 → 06/07	
PICNIC II 2.0 VVTi	1AZ-FE	05/01 → 08/06	
PICNIC II 2.4 VVTi	2AZ-FE	11/03 → 08/06	
PREVIA II 2.4	2AZ-FE, 2AD-FHV	02/00 → 02/06	
PREVIA II 2.4 4WD	2AZ-FE	02/00 → 01/06	
PRIUS II 1.5	1NZ-FXE	09/03 → 12/09	
RACTIS 1.5 VVTi [ExtraEU]	1NZ-FE	07/11 →	
RAV 4 II 1.8	1ZZ-FE	08/00 → 11/05	
RAV 4 II 2.0	1AZ-FE	09/00 → 12/03	
RAV 4 II 2.0 4WD	1AZ-FE	05/00 → 11/05	
RAV 4 II 2.4	2AZ-FE	08/00 → 11/05	
RAV 4 II 2.4 4WD	2AZ-FE	08/03 → 11/05	
RAV 4 II 2.4 VVTi [ExtraEU]	2AZ-FE	08/03 → 11/05	
RAV 4 III 2.2 D 4WD	2AD-FHV, 2NZ-FE	11/05 → 06/13	
TARAGO MPV / SPACE 2.4 VVTi	2AZ-FE	02/00 → 12/05	
VIOS / YARIS 1.3	2NZ-FE, 1NZ-FE	09/05 → 10/13	
VIOS / YARIS 1.3 4WD	2NZ-FE	09/05 → 04/13	
VIOS / YARIS 1.5	1NZ-FE, 2NZ-FE	08/07 →	
YARIS I 1.0	1SZ-FE, 2NZ-FE	03/03 → 09/05	
YARIS I 1.3	2NZ-FE, 1ND-TV	04/02 → 10/05	
YARIS I 1.4 D-4D	1ND-TV, 1NZ-FE	10/01 → 10/05	
YARIS I 1.5	1NZ-FE, 2NZ-FE	03/00 → 11/05	
YARIS II 1.3 4WD	2NZ-FE	08/07 → 11/10	
YARIS II 1.3 VVT-i	1NZ-FE, 1NZ-FE	08/05 → 12/12	
YARIS II 1.4 D-4D	2ND-TV	08/05 → 12/12	
YARIS II 1.5	1NZ-FE, 2NZ-FE	11/05 →	
YARIS III 1.3	2NZ-FE	12/11 →	
YARIS III 1.5	1NZ-FE	12/10 →	
YARIS III 1.8 GRMN	2ZR-FE	09/17 →	
YARIS VERSO 1.3	2NZ-FE, 1NZ-FE	11/02 → 09/05	
YARIS VERSO 1.4 D-4D	1ND-TV	10/01 → 09/05	
YARIS VERSO 1.5	1NZ-FE, B524454	01/00 → 09/05	
YARIS 1.3 VVTi	2NZ-FE, 1SZ-FE	03/00 → 09/05	
YARIS 1.4 D4d	1ND-TV	10/01 → 09/05	
YARIS 1.5 VVTi	1NZ-FE	03/00 → 03/03	

VOLVO			
C30 2.4 i	B524454	10/06 → 12/12	
C70 II 2.4	B524455	03/06 → 10/09	
C70 II 2.4 i	B524454	03/06 → 10/09	
S40 II 2.4	B524454, B52445	01/04 → 12/12	
S40 II 2.4 AWD	B524454	08/06 → 12/12	
S60 I 2.4	B52445, B52445G	07/00 → 04/10	
S60 I 2.4 Bifuel	B52445G, B52445	07/01 → 04/10	
S60 I 2.4 T5	B5244T5	04/04 → 04/10	
S60 I R 2.5 T AWD	B5254T4	01/03 → 04/10	
S80 I 2.4	B52445, B52445G	01/99 → 07/06	
S80 I 2.4 Bifuel	B52445G, B63245	09/01 → 07/06	
S80 II 3.2	B63245, B63245	03/06 →	
S80 II 3.2 AWD	B63245, B524454	01/07 → 12/12	
S80 II 3.2 Flexifuel AWD	B63245	01/09 → 03/10	
S80 II 4.4 V8 AWD	B84445	03/06 → 03/12	

VOLVO			
V50 2.4	B524454, B52445	04/04 → 12/10	
V50 2.4 AWD	B524454	08/06 → 12/09	
V70 II 2.3	B523417	10/00 → 09/04	
V70 II 2.3 T5	B5234T3	11/99 → 12/04	
V70 II 2.4	B52445, B63245	03/00 → 08/07	
V70 II 2.4 Bifuel	B52445G2	09/01 → 08/07	
V70 III 3.2	B63245, B63245	08/07 → 12/14	
V70 III 3.2 AWD	B63245, B63245	04/07 → 12/15	
XC60 I 3.2 AWD	B63245, B63245	07/09 → 12/15	
XC70 II 3.2	B632455	08/07 →	
XC70 II 3.2 AWD	B63245, B63245	08/07 →	
XC90 I 3.2 AWD	B63245, AZV	03/06 → 12/12	
XC90 I V8 AWD	B84445	01/05 → 12/10	

10.1191  07

MASS AIR FLOW METERS (MAF)

Adatt./Suitable:

AUDI
074 906 461 B
074 906 461 BX *RG

BOSCH
0 281 002 461
0 281 002 462
0 281 002 779
0 281 002 780
0 986 284 007 *RG

CHRYSLER
5033320AA
K05033320AA

DODGE
5033320AA

FORD
1 209 109
3M21-12B529-AA

JEEP
5033320AA
K05033320AA

MERCEDES-BENZ
05033320AA

MINI
MN191135
MN980445

MOPAR PARTS
05033320AA

SEAT
074 906 461 B
074 906 461 BX *RG

SKODA
074 906 461 B
074 906 461 BX *RG

VW
074 906 461 B
074 906 461 BX *RG

*RG Corresponds to the original re-manufactured part

- Corrisponde al pezzo originale rigenerato
- Correspond à la pièce d'origine reconditionnée
- Entspricht dem neuwertigen OE-Teil
- Corresponde a la pieza original remanufacturada

MARKET DIFFUSION: HIGH

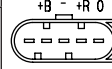

Ø in	Ø out	L=mm	
80	80	110	

AUDI			
A3 I 1.9 TDI	ASZ	08/00 → 05/03	
A3 I 1.9 TDI quattro	ASZ	08/00 → 05/03	
A3 II 2.0 TDI	AZV, BKD	05/03 → 08/12	
A3 II 2.0 TDI 16V	BKD, BKD	05/03 → 08/12	
A3 II 2.0 TDI 16V quattro	BKD, AZV	08/04 → 08/12	
A3 II 2.0 TDI quattro	AZV, AZV	05/03 → 08/12	
A3 II SPORTBACK 2.0 TDI	AZV, BKD	09/04 → 03/13	
A3 II SPORTBACK 2.0 TDI 16V	BKD, BKD	09/04 → 03/13	
A3 II SPORTBACK 2.0 TDI 16V quattro	BKD, BMM	11/05 → 03/13	
A3 II SPORTBACK 2.0 TDI quattro	BMM, AVF	01/06 → 03/13	
A4 II 1.9 TDI	AVF, BPW	11/00 → 12/04	
A4 II 1.9 TDI quattro	AVF	11/01 → 12/04	
A4 II 2.0 TDI	BPW, BKE	01/06 → 03/09	
A4 III 1.9 TDI	BKE, BNA	11/04 → 06/08	
A4 III 2.0 TDI	BNA, BLB	11/04 → 06/08	

AUDI			
A4 III 2.0 TDI 16V	BLB, BPW	11/04 → 06/08	
A4 III 2.0 TDI quattro	BPW, AVF	01/06 → 06/08	
A6 II 1.9 TDI	AVF, BLB	08/01 → 01/05	
A6 III 2.0 TDI	BLB, ECD	07/04 → 08/11	

CHRYSLER

SEBRING III 2.0 CRD	ECD	07/07 → 12/10	
---------------------	-----	---------------	--

DODGE

CALIBER 2.0 CRD	ECD, ECE	02/06 →	
JOURNEY 2.0 CRD	ECE, ASZ	06/08 →	

FORD

GALAXY I 1.9 TDI	ASZ, ECD	02/03 → 05/06	
------------------	----------	---------------	--

JEEP

COMPASS 2.0 CRD	ECD, ECD	08/06 →	
COMPASS 2.0 CRD 4x4	ECD, ECD	09/06 →	
PATRIOT 2.0 CRD	ECD, ECD	02/07 →	
PATRIOT 2.0 CRD 4x4	ECD, BSY	02/07 →	

MITSUBISHI

GRANDIS 2.0 DI-D	BSY, BKD	09/05 → 03/10	
LANCER VIII 2.0	--	01/01 →	
LANCER IX 2.0 DI-D	BKD, ASZ	01/08 →	
OUTLANDER II 2.0 DI-D	BSY	12/06 → 11/12	

SEAT

ALHAMBRA I / II 1.9 TDI	ASZ, AZV	11/02 → 11/08	
ALHAMBRA I / II 1.9 Tdi 4x4	ASZ	06/05 → 11/08	
ALHAMBRA I / II 2.0 TDI	BRT	11/05 → 03/10	
ALTEA 2.0 TDI	AZV, BKD	03/04 →	
ALTEA 2.0 TDI 16V	BKD, AZV	03/04 →	
ALTEA XL 2.0 TDI	AZV, BKD	10/06 →	
ALTEA XL 2.0 TDI 16V	BKD, BMM	10/06 →	
ALTEA XL 2.0 TDI 4x4	BMM, ASZ	06/07 →	
CORDOBA II 1.9 TDI	ASZ, ASZ	10/02 → 11/09	
IBIZA III 1.9 TDI	ASZ, BPX	02/02 → 11/09	
IBIZA III 1.9 TDI Cupra R	BPX, ARL	03/04 → 02/08	
LEON I 1.9 TDI	ARL, AZV	09/00 → 06/06	
LEON I 1.9 TDI Syncro	ARL	05/02 → 06/06	
LEON II 2.0 TDI	AZV, BKD	07/05 → 12/12	
LEON II 2.0 TDI 16V	BKD, ARL	07/05 → 12/12	
TOLEDO II 1.9 TDI	ARL, AZV	10/00 → 05/06	
TOLEDO II 1.9 TDI 4Drive	ARL	10/00 → 10/05	
TOLEDO III 2.0 TDI	AZV, AZV	09/04 → 05/09	
TOLEDO III 2.0 TDI 16V	BKD	04/04 → 05/09	

SKODA

OCTAVIA I 1.9 TDI	ASZ	09/02 → 09/04	
OCTAVIA II 2.0 TDI	AZV, AZV	02/04 → 05/10	
OCTAVIA II 2.0 TDI 16V	AZV, BMN	02/04 → 05/13	
OCTAVIA II 2.0 TDI 16V 4x4	CFHC	05/10 → 02/13	
OCTAVIA II 2.0 TDI 4x4	BMM	07/06 → 05/10	
OCTAVIA II 2.0 TDI RS	BMM, AVF	04/06 → 02/13	
SUPERB I 1.9 TDI	AVF, --	12/01 → 03/08	
SUPERB I 2.0	--, BKD	02/06 →	
SUPERB I 2.0 TDI	BSS	10/05 → 03/08	
SUPERB II 2.0 TDI	BMP	03/08 → 05/10	
SUPERB II 2.0 TDI 16V	BKD, ARL	01/09 → 05/15	

VW

BORA 1.9 TDI	ARL, ARL	05/00 → 05/05	
BORA 1.9 TDI 4motion	ARL, AXD	05/00 → 05/05	
CADDY III 2.0 TDI	BMM	09/07 → 08/10	
CAMPMOBILE 2.5 TDi	AXD, ARL	03/04 → 11/09	
EOS 2.0 TDI	BMM	06/06 → 05/08	
GOLF IV 1.9 TDI	ARL, ARL	05/00 → 06/06	
GOLF IV 1.9 TDI 4motion	ARL, AZV	02/00 → 06/06	
GOLF IV 1.9 TDI GTi	ARL	06/01 → 06/06	
GOLF V 2.0 TDI	AZV, BKD	10/03 → 12/13	
GOLF V 2.0 TDI 16V	BKD, AZV	10/03 → 12/13	
GOLF V 2.0 TDI 16V 4motion	BKD	08/04 → 11/08	
GOLF V 2.0 TDI 4motion	AZV	08/04 → 07/09	
GOLF VI 2.0 TDI	BMM	07/09 → 07/13	
JETTA V 2.0 TDI	AZV, BKD	09/05 → 10/10	
JETTA V 2.0 TDI 16V	BKD, AGK	08/05 → 10/10	
LT II 2.8 TDI	AGK, AXD	05/01 → 07/06	
MULTIVAN 2.5 TDI	AXD, AXD	04/03 →	

VW			
TOUAREG I 5.0 V10 TDI	AYH, AZV	10/02	⇒ 05/10
TOURAN I 2.0 TDI	AZV, AHY	02/03	⇒ 05/10
TOURAN I 2.0 TDI 16V	BKD	08/03	⇒ 05/10
TRANSPORTER IV 2.5 TDI	AHY, AXD	05/98	⇒ 04/03
TRANSPORTER V 2.5 TDI	AXD, AXD	04/03	⇒ 11/09
TRANSPORTER V 2.5 TDI 4motion	AXD, 1Z	04/04	⇒ 11/09

10.1192



07

MASS AIR FLOW METERS (MAF)

Adatt./Suitable:

- AUDI**
028 906 461
028 906 461 X *RG
- BOSCH**
0 281 002 216
0 281 002 217
0 986 284 001
0 986 284 101 *RG
- SEAT**
028 906 461
- SKODA**
028 906 461
- VW**
028 906 461
028 906 461 X *RG

- *RG **Corresponds to the original re-manufactured part**
- Corrisponde al pezzo originale rigenerato
- Correspond à la pièce d'origine reconditionnée
- Entspricht dem neuwertigen OE-Teil
- Corresponde a la pieza original remanufacturada



Ø in	Ø out	L=mm	NTC +B - +R 0
70	70	120	

AUDI			
A4 I 1.9 DUO	AHU	03/98	⇒ 09/01
A4 I 1.9 TDI	1Z, AFN	03/00	⇒ 09/01
A4 I 1.9 TDI quattro	AFN, AFN	03/00	⇒ 09/01
A6 II 1.9 TDI	AFN, AGR	07/00	⇒ 01/05
SEAT			
IBIZA II 1.9 TDI	AGR, 1Z	08/99	⇒ 02/02
VW			
CADDY II 1.9 TDI	1Z, AFN	09/96	⇒ 01/04
GOLF III 1.9 TDI	AFN, AHD	09/93	⇒ 04/99
GOLF III 1.9 TDI Syncro	AHU	07/95	⇒ 04/99
LT II 2.5 SDI	AGX	07/96	⇒ 07/06
LT II 2.5 TDI	AHD, AFN	05/96	⇒ 08/99
PASSAT IV 1.9 TDI	AFN, AJM	02/00	⇒ 05/05
PASSAT IV 1.9 TDI 4motion	AJM, AFN	08/99	⇒ 11/00
PASSAT IV 1.9 TDI Syncro/4motion	AFN	10/96	⇒ 11/00
POLO III 1.9 TDI	AFN, AFN	05/97	⇒ 09/01
POLO III 110 1.9 TDI	AFN, AGR	06/98	⇒ 01/02
POLO III 90 1.9 TDI	AGR, ACV	09/96	⇒ 09/01
TRANSPORTER IV 2.5 TDI	ACV, BDB	09/95	⇒ 04/03
TRANSPORTER IV 2.5 TDI Syncro	ACV	09/95	⇒ 04/03

10.1194



07

MASS AIR FLOW METERS (MAF)

Adatt./Suitable:

- AUDI**
07D 906 461
07D 906 461 X *RG
- BENTLEY**
07D 906 461
- BOSCH**
0 280 218 073
0 280 218 074
0 986 280 222
- VW**
07D 906 461
07D 906 461 X *RG

- *RG **Corresponds to the original re-manufactured part**
- Corrisponde al pezzo originale rigenerato
- Correspond à la pièce d'origine reconditionnée
- Entspricht dem neuwertigen OE-Teil
- Corresponde a la pieza original remanufacturada



Ø in	Ø out	L=mm	NTC +B - +R 0
86	84	100	

AUDI			
A3 I [USA] 3.2 24V	CBRA	07/08	⇒ 05/09
A3 I [USA] 3.2 24V AWD	--	01/06	⇒ 12/09
A3 II 3.2 V6 quattro	BDB, BDB	07/03	⇒ 05/09
A3 II SPORTBACK 3.2 V6 quattro	BDB, BHE	09/04	⇒ 05/09
TT I 3.2 VR6 quattro	BHE, BEB	07/03	⇒ 06/06
TT II 3.2 V6 quattro	BUB	08/06	⇒ 06/10
BENTLEY			
CONTINENTAL 6.0	BEB, BEB	06/03	⇒ 05/15
CONTINENTAL 6.0 AWD	BEB, CKHA	06/06	⇒
CONTINENTAL 6.0 FLEX	CKHB	11/10	⇒
CONTINENTAL 6.0 FLEX AWD	CKHA, BWRB	03/10	⇒
CONTINENTAL 6.0 FlexFuel	CKHC	01/10	⇒ 07/10
CONTINENTAL 6.0 Flexfuel [ExtraEU]	BWRB, BWRA	02/08	⇒
CONTINENTAL 6.0 ISR/ISR Flexfuel	CKHE	03/11	⇒ 06/14
CONTINENTAL 6.0 Trazione integrale	BWRA, BWR	08/07	⇒ 04/11
CONTINENTAL FLYING SPUR 6.0	BWR, BEB	03/05	⇒
CONTINENTAL FLYING SPUR 6.0 FLEX	BEB, BUB	03/05	⇒
VW			
CARAVELLE 3.2	BDL	11/03	⇒ 11/09
EOS 3.2 V6	BUB, BFH	06/06	⇒ 05/09
GOLF IV 3.2 R32 4motion	BFH, BUB	09/02	⇒ 06/05
GOLF V 3.2	BUB, BUB	09/05	⇒ 11/08
GOLF V 3.2 R32 4motion	BUB, BGP	11/05	⇒ 11/08
JETTA V 2.5	BGP, BDL	01/06	⇒ 10/10
MULTIVAN 3.2 V6	BDL, BKK	02/04	⇒ 11/09
MULTIVAN 3.2 V6 4motion	BKK, BPR	07/04	⇒ 11/09
NEW BEETLE 2.5	BPR, BDN	07/05	⇒ 09/10
PASSAT IV 4.0 W8 4motion	BDN, AYT	09/01	⇒ 09/04
PHAETON 3.2 V6	AYT, BKL	04/02	⇒ 05/05
PHAETON 3.2 V6 4motion	BKL, BAN	02/04	⇒ 11/08
PHAETON 6.0 W12 4motion	BAN, AZZ	04/02	⇒ 03/16
TOUAREG I 3.2 V6	AZZ, BJN	10/02	⇒ 11/06
TOUAREG I 6.0 W12	BJN, BDL	08/04	⇒ 05/10
TRANSPORTER 3.2	BDL	03/04	⇒ 06/05
TRANSPORTER V 3.2 4motion	BDL, BDL	11/03	⇒ 11/09
TRANSPORTER V 3.2 V6	BDL, BKK	04/03	⇒ 11/09
TRANSPORTER V 3.2 V6 4motion	BKK, AEB	11/03	⇒ 11/09

10.1212



07

MASS AIR FLOW METERS (MAF)

Adatt./Suitable:

- AUDI**
06A 906 461 N
06A 906 461 NX *RG
- BOSCH**
0 280 218 100
0 280 218 101
0 986 280 223
- SKODA**
06A 906 461 N
06A 906 461 NX *RG
- VW**
06A 906 461 N
06A 906 461 NX *RG

- *RG **Corresponds to the original re-manufactured part**
- Corrisponde al pezzo originale rigenerato
- Correspond à la pièce d'origine reconditionnée
- Entspricht dem neuwertigen OE-Teil
- Corresponde a la pieza original remanufacturada



Ø in	Ø out	L=mm	+B - +R 0
70	70	100	

AUDI			
A6 II 1.8 T	AEB, AEB	01/97	⇒ 01/05
A6 II 1.8 T quattro	AEB, AVF	02/97	⇒ 01/05
SKODA			
SUPERB I 1.8 T	AWT	12/01	⇒ 03/08
VW			
PASSAT IV 1.8 4motion	AWM	03/01	⇒ 05/05
PASSAT IV 1.8 T	AWM	02/01	⇒ 08/05
PASSAT IV 1.8 T 20V	AWT	11/00	⇒ 05/05
PASSAT IV 1.8 T 4motion	AWM	03/01	⇒ 05/05

10.1213



MASS AIR FLOW METERS (MAF)

Adatt./Suitable:

- AUDI**
071 906 461 A
071 906 461 AX *RG
- BOSCH**
0 280 217 529
0 280 217 530
0 986 280 204
0 986 280 304
- SEAT**
071 906 461 A
071 906 461 AX *RG
- VW**
071 906 461 A
071 906 461 AX *RG

- *RG **Corresponds to the original re-manufactured part**
- Corrisponde al pezzo originale rigenerato
- Correspond à la pièce d'origine reconditionnée
- Entspricht dem neuwertigen OE-Teil
- Corrisponde a la pieza original remanufacturada

MARKET DIFFUSION: MEDIUM



Ø in	Ø out	L=mm	NTC +B - +R 0
80	80	110	

AUDI			
A3 I 1.9 TDI	ASZ	08/00	⇒ 05/03
A3 I 1.9 TDI quattro	ASZ	08/00	⇒ 05/03
A4 II 1.9 TDI	AVF, ARL	11/00	⇒ 12/04
A4 II 1.9 TDI quattro	AVF	11/01	⇒ 12/04
SEAT			
LEON I 1.9 TDI	ARL	09/00	⇒ 06/06
LEON I 1.9 TDI Syncro	ARL	05/02	⇒ 06/06
LEON I 2.3 V5	AGZ	10/98	⇒ 11/00
TOLEDO II 1.9 TDI	ARL	10/00	⇒ 07/04
TOLEDO II 1.9 TDI 4Drive	ARL	10/00	⇒ 10/05
TOLEDO II 2.3 V5	AGZ	10/98	⇒ 11/00
VW			
BORA 1.9 TDI	ARL, ARL	05/00	⇒ 05/05
BORA 1.9 TDI 4motion	ARL, ARL	05/00	⇒ 05/05
BORA 2.3 V5	AGZ	10/98	⇒ 10/00
BORA 2.3 V5 4motion	AGZ	12/98	⇒ 10/00
GOLF IV 1.9 TDI	ARL, ARL	05/00	⇒ 06/06
GOLF IV 1.9 TDI 4motion	ARL, AVF	02/00	⇒ 06/06
GOLF IV 1.9 TDI GTi	ARL	06/01	⇒ 06/06
GOLF IV 2.3 V5	AGZ	08/97	⇒ 06/06
GOLF IV 2.3 V5 4motion	AGZ	12/98	⇒ 06/06
PASSAT IV 1.9 TDI	AVF, AMF	11/00	⇒ 05/05
PASSAT IV 1.9 TDI 4motion	AVF	11/00	⇒ 05/05
PASSAT IV 2.3 VR5	AGZ	10/96	⇒ 11/00
PASSAT IV 2.3 VR5 Syncro/4motion	AGZ	10/97	⇒ 11/00
TRANSPORTER IV 2.5 TDI	AHY	05/98	⇒ 04/03

10.1214



MASS AIR FLOW METERS (MAF)

Adatt./Suitable:

- AUDI**
057 906 461 A
057 906 461 AX
- BOSCH**
0 281 002 355
0 281 002 356
0 986 284 103 *RG
- VW**
057 906 461 A
057 906 461 AX

- *RG **Corresponds to the original re-manufactured part**
- Corrisponde al pezzo originale rigenerato
- Correspond à la pièce d'origine reconditionnée
- Entspricht dem neuwertigen OE-Teil
- Corrisponde a la pieza original remanufacturada



Ø in	Ø out	L=mm	NTC +B - +R 0
70	70	96	

AUDI			
A2 1.2 TDI	ANY	03/01	⇒ 08/05
A2 1.4 TDI	AMF, AMK	02/00	⇒ 08/05
A2 1.6 FSI	BAD	05/02	⇒ 08/05

10.1216



MASS AIR FLOW METERS (MAF)

Adatt./Suitable:

- AUDI**
06A 906 461 E
06A 906 461 EX
- BOSCH**
0 280 218 034
0 280 218 035
0 986 280 211
- VW**
06A 906 461 E
06A 906 461 EX



Ø in	Ø out	L=mm	NTC +B - +R 0
80	80	110	

AUDI			
A3 I 53 quattro	AMK, APX	03/99	⇒ 04/02
TT I 1.8 T quattro	APX, AGN	10/98	⇒ 06/06

10.1221



MASS AIR FLOW METERS (MAF)

Adatt./Suitable:

- AUDI**
06A 906 461 G
06A 906 461 GX
- BOSCH**
0 280 218 060
0 280 218 061
0 986 280 216
- SEAT**
06A 906 461 G
06A 906 461 GV
06A 906 461 GX
- SKODA**
06A 906 461 G
06A 906 461 GX
- VW**
06A 906 461 G
06A 906 461 GX



Ø in	Ø out	L=mm	NTC +B - +R 0
70	70	96	

AUDI		
A3 I 1.8	AGN, AJH	09/96 ⇒ 05/03
Q7 I 4.2 FSI quattro	BAR	03/06 ⇒ 05/10
SEAT		
ALHAMBRA I / II 1.8 T 20V	AJH, ADY	10/97 ⇒ 03/10
ALHAMBRA I / II 2.0 i	ADY, AZL	04/96 ⇒ 03/10
CORDOBA II 2.0	AZL, AZL	09/02 ⇒ 11/09
IBIZA III 2.0	AZL, AGN	04/02 ⇒ 11/09
LEON I 1.8 20V	AGN, AGN	11/99 ⇒ 06/06
TOLEDO II 1.8 20V	AGN, AEG	10/98 ⇒ 07/04
SKODA		
FABIA I 2.0	AZL	12/99 ⇒ 03/08
OCTAVIA I 2.0	AEG, AZH	04/99 ⇒ 05/07
OCTAVIA I 2.0 4x4	AZH, APK	08/00 ⇒ 09/04
VW		
BORA 1.6 FSI	BAD	01/02 ⇒ 05/05
BORA 2.0	APK, AZH	10/98 ⇒ 05/05
BORA 2.0 4motion	AZH, APK	04/00 ⇒ 05/05
CARAVELLE 2.0 EcoFuel	AXACNG	01/06 ⇒ 03/14
GOLF 2.0 BiFuel	BEH	05/02 ⇒ 05/03
GOLF IV 1.6 FSI	BAD	01/02 ⇒ 06/06
GOLF IV 2.0	APK, AZH	07/98 ⇒ 06/06
GOLF IV 2.0 4motion	AZH, AWU	10/00 ⇒ 06/06
GOLF IV 2.0 Bi-Fuel	BEH	02/02 ⇒ 06/06
JETTA V 2.0	BEV	06/01 ⇒ 05/05
MULTIVAN 2.0	AXA	11/03 ⇒ 08/15
NEW BEETLE 1.8 T	AWU, AEG	11/01 ⇒ 09/10
NEW BEETLE 2.0	AEG, BGH	01/98 ⇒ 10/10
PHAETON 4.2 V8 4motion	BGH, AJH	05/03 ⇒ 03/16
SHARAN I 1.8 T 20V	AJH, ADY	09/97 ⇒ 03/10
SHARAN I 2.0	ADY, AXACNG	09/95 ⇒ 03/10
SHARAN I 2.0 LPG	ATM	04/06 ⇒ 03/10
TOUAREG I 4.2 V8	AXQ	12/02 ⇒ 11/06
TOUAREG I 4.2 V8 FSI	BAR	06/06 ⇒ 05/10
TRANSPORTER 2.0 EcoFuel	AXACNG, AMK	11/03 ⇒ 08/15
TRANSPORTER V 2.0	AXA	11/03 ⇒ 08/15
TRANSPORTER V 2.0 BiFuel	AXACNG	05/11 ⇒ 08/15

10.1222



07

MASS AIR FLOW METERS (MAF)

Adatt./Suitable:

AUDI

06A 906 461 M
06A 906 461 MX

*RG

*RG **Corresponds to the original re-manufactured part**

• Corrisponde al pezzo originale rigenerato

• Correspond à la pièce d'origine reconditionnée

• Entspricht dem neuwertigen OE-Teil

• Corrisponde a la pieza original remanufacturada

BOSCH

0 280 218 065
0 280 218 066
0 986 280 218

SEAT

06A 906 461 M
06A 906 461 MX

*RG

VW

06A 906 461 M
06A 906 461 MX

*RG



Ø in	Ø out	L=mm	+B - +R 0
80	80	110	

AUDI

A3 S3 quattro	AMK, APX	10/01 ⇒ 05/03
A6 II RS6 plus quattro	BRV	04/04 ⇒ 01/05
A6 II RS6 quattro	BCY	07/02 ⇒ 01/05
TT I 1.8T quattro	APX, AMK	10/99 ⇒ 06/06

SEAT

LEON I 1.8 T Cupra R	AMK, AGB	02/02 ⇒ 06/06
LEON I 1.8 Turbo 4x4	AMK	05/02 ⇒ 05/03

10.1223



07

MASS AIR FLOW METERS (MAF)

Adatt./Suitable:

AUDI

071 906 461 B
071 906 461 BX

BOSCH

0 280 218 017
0 280 218 018
0 986 280 208
0 986 280 308

FORD

1 112 131
YM21-12B529-BA

SEAT

071 906 461 B
071 906 461 BX

VW

071 906 461 B
071 906 461 BX

Ø in	Ø out	L=mm	NTC +B - +R 0
80	80	110	

AUDI

A4 S4 quattro	AGB, AJK	09/97 ⇒ 09/01
A6 II 2.7 T quattro	AJK, AUE	12/97 ⇒ 01/05

SEAT

ALHAMBRA I / II 2.8 V6	AUE, AUE	06/00 ⇒ 03/10
ALHAMBRA I / II 2.8 V6 4motion	AUE, AUE	06/00 ⇒ 03/10
LEON 1.2.3 VR5	AQN	09/00 ⇒ 11/03
LEON 1.2.8	BDE	05/02 ⇒ 06/04
LEON 1.2.8 Cupra 4	AUE, AQP	02/01 ⇒ 06/06
TOLEDO II 2.3 V5 20V	AQN	09/00 ⇒ 11/03

VW

BORA 2.3 V5	AQN	10/00 ⇒ 05/05
BORA 2.3 V5 4motion	AQN	10/00 ⇒ 05/05
BORA 2.8 V6 4motion	AQP, AQP	03/99 ⇒ 05/05
BORA 2.8 VR6	AUE	03/00 ⇒ 05/00
GOLF IV 2.3 V5	AQN	10/00 ⇒ 06/06
GOLF IV 2.3 V5 4motion	AQN	10/00 ⇒ 06/06
GOLF IV 2.8 V6 4motion	AQP, AQP	05/99 ⇒ 06/06
GOLF IV 2.8 VR6 4motion	AQP, G4CS	03/99 ⇒ 06/05
NEW BEETLE 2.3 V5	AQN	10/00 ⇒ 09/10
NEW BEETLE RSI 3.2 4motion	AXJ	04/00 ⇒ 05/01
PASSAT IV 2.3 V5	AZX	11/00 ⇒ 05/05
PASSAT IV 2.3 V5 4motion	AZX	11/00 ⇒ 05/05
PASSAT IV 2.3 VR5	AZX	11/00 ⇒ 05/05
PASSAT IV 2.3 VR5 4motion	AZX	11/00 ⇒ 05/05
SHARAN I 2.8 V6 24V	AYL	04/00 ⇒ 03/10
SHARAN I 2.8 V6 24V 4motion	AYL	04/00 ⇒ 03/10
TRANSPORTER IV 2.8 VR6	AMV	04/00 ⇒ 04/03

10.1256



07

MASS AIR FLOW METERS (MAF)

Adatt./Suitable:

BOSCH

0 280 218 090
0 280 218 091

HYUNDAI

28100-39400
28100-39450

KIA

28100-39400
28100-39450

Ø in	Ø out	L=mm	NTC +B - +R 0
86	84	100	

HYUNDAI

EQUUS / CENTENNIAL I 3.5	G6CU	10/99 ⇒ 03/09
SANTA FE I 3.5	G6CU	09/03 ⇒ 02/06
SANTA FE I 3.5 4x4	G6CU	09/03 ⇒ 02/06
TERRACAN 3.5 i V6 4WD	G6CU	12/01 ⇒ 12/06
XG 3.0	G6CT	10/01 ⇒ 05/05
XG 30	G6CT-G	12/98 ⇒ 12/05
XG 300	G6CT	09/00 ⇒ 12/01
XG 350	G6CU	10/02 ⇒ 12/05
XG-SERIES 3.0	G6CT	09/99 ⇒ 09/03

KIA

AMANTI 3.5 [CAN] [USA]	--	09/03 ⇒
CARNIVAL I 3.5	G6CU	07/02 ⇒ 04/06
OPIRUS 3.0	--	05/04 ⇒ 08/06
OPIRUS 3.0 GH300	G6CT	09/03 ⇒
OPIRUS 3.5	G6CU	09/03 ⇒
SEDONA 3.5 [CAN] [USA]	--	04/01 ⇒
SORENTO I 3.5 V6 4WD	G6CU	08/02 ⇒

10.1257



07

MASS AIR FLOW METERS (MAF)

Adatt./Suitable:

BOSCH

0 280 218 020
0 280 218 021
0 280 218 111
0 280 218 112

HYUNDAI

28164-38080
28164-38200
28164-38210

KIA

28164-38080
28164-38210

Ø in	Ø out	L=mm	NTC +B - +R 0
70	70	96	

HYUNDAI

H-112.4	G4CS, G4CS	03/00 ⇒ 04/04
H-112.4 4WD	G4CS, G4JS	06/01 ⇒ 04/04
H1 2.4 [ExtraEU]	G4JS	11/01 ⇒ 08/07
H200 2.4	G4CS	09/00 ⇒ 10/06
SANTA FE I 2.4 16V	G4JS, G4JS	02/01 ⇒ 03/06
SANTA FE I 2.4 16V 4x4	G4JS, D4EA	02/01 ⇒ 03/06
SONATA IV 2.4 16V	G4BS	03/98 ⇒ 10/01

KIA

MAGENTIS I 2.4 [USA]	--	01/01 ⇒ 12/04
SORENTO I 2.4	G4JS	08/02 ⇒



MASS AIR FLOW METERS (MAF)

Adatt./Suitable:

BOSCH0 280 218 142
0 281 002 447
0 281 002 448**GENERAL MOTORS**

93 180 992

HYUNDAI

28164-27000

KIA

28164-27000

OPEL8 36 645
9 3180992**VAUXHALL**

93180992



Ø in	Ø out	L=mm	NTC +B - +R 0
70	70	96	

HYUNDAI

ELANTRA III 2.0 CRDi	D4EA	04/01 → 07/06
HIGHWAY VAN 2.0 CRDi	D4EA	03/01 → 03/04
LANTRA II 2.0 CRDi	D4EA	04/01 →
SANTA FE I 2.0 CRDi	D4EA	08/01 → 03/06
SANTA FE I 2.0 CRDi 4x4	D4EA, D4EA	04/01 → 03/06
SANTA FE I 2.0 CRDi Trazione integrale	D4EA	11/03 → 02/06
TRAJET 2.0 CRDi	D4EA, D4EA	04/01 → 07/08

KIA

CARENS II 2.0 CRDi	D4EA, A16LET	07/02 →
--------------------	--------------	---------

OPEL

ASTRA H 1.6 Turbo	A16LET, Z20LEL	02/07 → 10/10
ASTRA H 2.0 Turbo	Z20LEL, A16LEL	03/04 → 10/10
CORSA D 1.6	Z16LER	07/12 → 08/14
CORSA D 1.6 Turbo	A16LEL, A16LET	11/06 → 08/14
MERIVA A 1.6 Turbo	Z16LET	09/05 → 05/10
ZAFIRA B 2.0	Z20LER	07/05 → 12/10

VAUXHALL

ASTRA V 1.6	A16LET, A16LET	08/04 → 11/10
ASTRA V 1.6 Turbo	A16LET, Z20LEL	09/06 → 09/09
ASTRA V 2.0	Z20LEL	02/06 → 11/10
ASTRA V 2.0 Turbo	Z20LEL, A16LEL	01/04 → 11/10
CORSA D 1.6 SRI	A16LEL, A16LER	05/07 → 08/14
CORSA D 1.6 VXR	A16LER, D4CB	11/06 → 08/14
MERIVA I 1.6 Turbo	Z16LET	05/06 → 06/10
ZAFIRA B 2.0	Z20LER	07/05 → 11/14



MASS AIR FLOW METERS (MAF)

Adatt./Suitable:

BOSCH0 280 218 130
0 281 002 554
0 281 002 555
0 281 002 564
0 281 002 658**GENERAL MOTORS**24 462 266
93 174 628**HONDA**

37980-RBD-E01

HYUNDAI

28164-4A000

KIA

28164-4A000

OPEL

58 36 845

SIEMENS

A2C59512896

SSANGYONG6650943048
6650943248

Ø in	Ø out	L=mm	NTC +B - +R 0
80	80	110	

HONDA

ACCORD VII 2.2 i-CTDi	N22A1	01/04 → 05/08
-----------------------	-------	---------------

HYUNDAI

H-1 I 2.5 CRDi	D4CB, J3	07/01 →
H-1 I 2.5 CRDi 4x4	D4CB	12/02 →
H1 2.5 CRDi	D4CB, D4CB	12/02 → 08/07
TERRACAN 2.9 CRDi	J3	11/01 → 07/03
TERRACAN 2.9 CRDi 4WD	J3, HJ3	12/01 → 12/06

KIA

BONGO IV 2.9 TDiC	HJ3	10/03 →
BONGO IV 2.9 TDiC 4WD	HJ3	10/03 →
CARNIVAL I 2.9 CRDi	J3	10/01 → 06/06
CARNIVAL I 2.9 TD	HJ3, D27DT	01/99 → 09/07
K-SERIES 2.9 CRDi	J3	08/07 →
K2900 2.9 D	J3	01/08 →
SEDONA 2.9 CRDi	--	07/01 →
SORENTO I 2.5 CRDi	D4CB	08/02 →

OPEL

OMEGA B 2.5 DTI	Y25DT	09/01 → 07/03
-----------------	-------	---------------

SSANGYONG

ACTYON I 2.0 Xdi	D20DT	04/07 →
ACTYON I 2.0 Xdi 4WD	D20DT	04/07 →
KYRON 2.0 XDi [ExtraEU]	D20DT	05/05 →
KYRON 2.0 Xdi 4x4	D20DT	05/05 →
REXTON 2.7 RX270 Xdi	D27DT	05/04 → 08/06
REXTON I 2.7 Xdi	D27DT	03/05 → 08/06
REXTON I 2.7 Xdi Trazione integrale	D27DT, 937A4.000	07/12 →
REXTON I 2.9 TD	662925	04/02 →
REXTON I 3.2 4x4	G32D	04/02 →
RODIUS 2.7 Xdi	D27DT	05/05 →
RODIUS 2.7 Xdi 4WD	D27DT	05/05 →
RODIUS 3.2	M162E32	05/05 →
RODIUS 3.2 [ExtraEU]	M162E32	06/12 →
RODIUS 3.2 4WD	G32D	07/07 →

VAUXHALL

OMEGA B 2.5 DTI 24V	Y25DT	09/01 → 07/03
---------------------	-------	---------------



MASS AIR FLOW METERS (MAF)

Adatt./Suitable:

ALFA ROMEO51782033
55350048
71794484 *RG**BOSCH**0 281 002 618
0 281 002 683
0 281 002 861**CHEVROLET**

55350048

FIAT51782033
55350048
71743972
71792019 *RG
71792021 *RG
71794484 *RG**GENERAL MOTORS**55 350 048
93 178 243**LANCIA**

55350048

OPEL8 36 639
93178243**SAAB**

93 178 243

SUZUKI13800-79J50
13800-79J50-000**VAUXHALL**

93178243

***RG** Corrisponde al pezzo originale re-manufactured part

• Corrisponde al pezzo originale rigenerato

• Corresponde à la pièce d'origine reconditionnée

• Entspricht dem neuwertigen OE-Teil

• Corresponde a la pieza original remanufacturada

MARKET DIFFUSION: HIGH



Ø in	Ø out	L=mm	+B - T 0
70	70	96	

ALFA ROMEO

156 1.9 JTD	937A4.000, 937A8.000	11/03 → 05/06
156 1.9 JTD 16V	192A5.000	11/02 → 05/06
156 1.9 JTD 16V Q4	937A5.000	07/04 → 05/06
159 1.9 JTDM 16V	937A8.000, 937A7.000	09/05 → 11/11
159 1.9 JTDM 8V	937A7.000, Z20S	09/05 → 11/11
159 MY2011 1.9 8V JTD	--	01/10 →

CADILLAC

BLS 1.9 D	Z19DTH	04/06 →
-----------	--------	---------

CHEVROLET

CAPTIVA 2.0 D	Z20S, --	10/06 →
CAPTIVA 2.0 D 4WD	Z20S	10/06 →
LACETTI 2.0 D	--, LMN	01/07 →
NUBIRA 2.0 D	LMN, --	01/05 → 12/11
OPTRA 2.0 TCDi	Z20S1	01/07 →
OPTRA 2.0 TDCi	--, 939A1.000	08/06 →

FIAT

CROMA II 1.9 D Multijet	939A1.000, 182B9.000	06/05 →
CROMA II 1.9 MJTD	939A1.000	04/06 → 12/11
DOBLO I 1.9 D Multijet	186A9.000	10/05 →
DOBLO I 1.9 JTD	182B9.000, 199A5.000	10/01 →
DOBLO I 1.9 JTD 8V	--	10/05 →
DOBLO I 1.9 JTD Multijet	186A9.000	12/06 →
IDEA 1.9 D	--	01/08 →
IDEA 1.9 JTD	188B2.000	01/04 →
PUNTO III / GRANDE PUNTO 1.9 D Multijet	199A5.000, Z20DM	10/05 →
SEDICI 1.9 D Multijet	D19AA	06/06 → 10/11
SEDICI 1.9 D Multijet 4x4	D19AA	06/06 → 10/11

LANCIA

MUSA 1.9 D Multijet	188B2.000	10/04 → 09/12
---------------------	-----------	---------------

OPEL

ANTARA 2.0 CDTI	Z20DM, Z17DTH	08/06 → 12/11
ANTARA 2.0 CDTI 4x4	Z20DMH	07/06 → 12/11
ASTRA H 1.3 CDTi	Z13DTH	04/05 → 10/10
ASTRA H 1.7 CDTi	Z17DTH, Z19DT	03/04 → 10/10
ASTRA H 1.9 CDTI	Z19DT, A13DTC	06/04 → 12/12

OPEL			
ASTRA H 1.9 CDTi 16V	Z19DTJ	04/04 ⇒ 10/10	
ASTRA J 1.3 CDTi	Z13DTH	01/09 ⇒	
COMBO C 1.3 CDTi 16V	Z13DTJ	10/05 ⇒ 12/12	
CORSA D 1.3 CDTi	A13DTC, Z19DT	07/06 ⇒ 08/14	
SIGNUM 1.9 CDTi	Z19DT, Z19DT	04/04 ⇒	
VECTRA C 1.9 CDTi	Z19DT, Z19DT	04/04 ⇒ 01/09	
SAAB			
9-3 1.9 TiD	Z19DT, Z19DTH	09/04 ⇒ 02/15	
9-5 1.9 TiD	Z19DTH, Z20DM	01/06 ⇒ 12/09	
SUZUKI			
SX4 I 1.9 DDiS	D19AA	06/06 ⇒	
SX4 I 1.9 DDiS 4x4	D19AA	06/06 ⇒	
VAUXHALL			
ANTARA 2.0 CDTi	Z20DM, Z20DM	08/06 ⇒ 04/15	
ANTARA 2.0 CDTi 4x4	Z20DM, Z20DM	08/06 ⇒ 04/15	
ANTARA 2.0 CDTi FWD	Z20DM, Z17DTH	08/06 ⇒	
ASTRA V 1.3 CDTi	Z13DTH	01/04 ⇒ 11/10	
ASTRA V 1.7 CDTi	Z17DTH, Z19DT	01/04 ⇒ 11/10	
ASTRA V 1.9 CDTi	Z19DT, Z17DTH	01/04 ⇒ 11/10	
ASTRA V 1.9 CDTi 16V	Z19DTJ	01/04 ⇒ 05/09	
ASTRAVAN III 1.3 CDTi	Z13DTH	08/05 ⇒	
ASTRAVAN III 1.7 CDTi	Z17DTH, Z19DT	03/05 ⇒ 11/11	
ASTRAVAN III 1.9 CDTi	Z19DT, A13DTC	03/05 ⇒ 11/11	
COMBO C 1.3 CDTi 16V	Z13DTJ	10/05 ⇒ 02/12	
CORSA D 1.3 CDTi	A13DTC, A13DTC	08/06 ⇒ 08/14	
CORSAVAN III 1.3 CDTi	A13DTC, Z19DT	07/06 ⇒	
SIGNUM 1.9 CDTi	Z19DT	04/04 ⇒ 03/08	
SIGNUM 1.9 CDTi 16V	Z19DTH	04/04 ⇒ 03/08	
SIGNUM 1.9 Turbo	Z19DTL	01/05 ⇒ 05/08	
VECTRA C 1.9 CDTi	Z19DT, 182B9.000	04/02 ⇒ 09/08	
VECTRA C 1.9 CDTi 16V	Z19DTH	04/04 ⇒ 05/09	

10.1284



07

MASS AIR FLOW METERS (MAF)

Adatt./Suitable:

AUDI	06A 906 461	
	06A 906 461 X *RG	
BOSCH	0 280 217 121	
	0 280 217 122	
	0 986 280 202 *RG	
FORD	1 051 396	
	1 344 951	
	95VW-12B529-BB	
	RM95VW-12B529-BB	

*RG Corresponds to the original re-manufactured part

• Corrisponde al pezzo originale rigenerato

• Correspond à la pièce d'origine reconditionnée

• Entspricht dem neuwertigen OE-Teil

• Corresponde a la pieza original remanufacturada

SEAT	06A 906 461	
	06A 906 461 X *RG	
SKODA	06A 906 461	
VW	06A 906 461	
	06A 906 461 X *RG	

MARKET DIFFUSION: MEDIUM



Ø in	Ø out	L=mm	NTC +B - +R 0
70	70	96	

AUDI			
A3 I 1.8 T	AGU, AGU	12/96 ⇒ 05/03	
A3 I 1.8 T quattro	AGU, AGR	12/96 ⇒ 05/03	
A3 I 1.9 TDI	AGR, AJQ	10/00 ⇒ 05/03	
TT I 1.8 T	AJQ, AJQ	10/98 ⇒ 06/06	
TT I 1.8 T quattro	AJQ, 1Z	10/98 ⇒ 06/06	
FORD			
GALAXY I 1.9 TDI	1Z, 1Z	04/00 ⇒ 05/06	
SEAT			
ALHAMBRA I / II 1.9 TDI	1Z, AUY	06/00 ⇒ 03/10	
ALHAMBRA I / II 1.9 TDI 4motion	AUY, AGR	06/00 ⇒ 03/10	
VOLKSWAGEN (BR)			
GOLF A4 1.9 D	AGR, AGR	01/00 ⇒	
VW			
BORA 1.9 TDI	AGR, AGR	09/00 ⇒	
BORA 1.9 TDI 4motion	AGR, AHF	09/00 ⇒	
GOLF IV 1.9 TDI	AGR, AGR	02/00 ⇒ 06/06	
GOLF IV 1.9 TDI 4motion	AGR, AGG	09/00 ⇒ 06/06	
GOLF IV 2.0	AGG, ALH	06/98 ⇒ 06/02	
GOLF 1.9 TDi	AHF, AGR	01/00 ⇒ 05/04	
JETTA V 1.6 [CHN]	BJG	01/05 ⇒	
NEW BEETLE 1.9 TDI	ALH, Z14XEL	02/01 ⇒ 09/10	

10.1283



07

MASS AIR FLOW METERS (MAF)

Adatt./Suitable:

ALFA ROMEO	46559828	
	60816448	
	71787954	*RG
	71787955	*RG
	71787956	*RG
	71787957	*RG
BOSCH	0 281 002 308	
FIAT	46559828	
	60816448	
	71787954	*RG
	71787955	*RG
	71787956	*RG
	71787957	*RG

*RG Corresponds to the original re-manufactured part

• Corrisponde al pezzo originale rigenerato

• Correspond à la pièce d'origine reconditionnée

• Entspricht dem neuwertigen OE-Teil

• Corresponde a la pieza original remanufacturada



Ø in	Ø out	L=mm	NTC +B - +R 0
70	70	96	

ALFA ROMEO

147 1.9 JTD	182B9.000, 937A2.000	04/01 ⇒ 03/10
147 1.9 JTDM	937A2.000, 192A1.000	10/04 ⇒ 03/10

FIAT

MAREA 1.9 JTD 110	186A6.000	09/00 ⇒ 08/02
MARENGO 1.9 JTD	186A6.000	03/99 ⇒ 08/02
MULTIPLA 1.9 JTD 110	186A6.000	03/01 ⇒ 07/02
MULTIPLA 1.9 JTD 115	186A8.000	07/02 ⇒ 06/10
PALIO 1.9 JTD	188A2.000	09/01 ⇒
STILO 1.9 D Multijet	192A9.000	09/05 ⇒ 08/08
STILO 1.9 JTD	192A1.000, AGU	10/01 ⇒ 08/08
STILO 2.4 20V	192A2.000	10/01 ⇒ 04/07
STRADA 1.9 JTD	188A2.000	04/03 ⇒

10.1285



07

MASS AIR FLOW METERS (MAF)

Adatt./Suitable:

BOSCH	0 280 218 119
GENERAL MOTORS	93 179 927
OPEL	8 36 644
	93179927
VAUXHALL	93179927

MARKET DIFFUSION: MEDIUM



Ø in	Ø out	L=mm	NTC +B - +R 0
60	60	96	

OPEL

AGILA A 1.0	Z10XEP	08/03 ⇒ 12/07
AGILA A 1.2 16V Twinport	Z12XEP	07/04 ⇒ 12/07
ASTRA G 1.4	Z14XEP	10/04 ⇒ 12/09
ASTRA H 1.2	Z12XEP	08/05 ⇒ 10/10
ASTRA H 1.4	Z14XEL, Z14XEL	03/04 ⇒ 10/10
ASTRA H 1.4 EcoTec	Z14XEP	12/04 ⇒ 12/12
ASTRA H 1.4 LPG	Z14XEP	08/09 ⇒ 10/10
ASTRA J 1.4	Z14XEP	01/09 ⇒
COMBO C 1.4	Z14XEP	10/04 ⇒ 12/11
COMBO C 1.4 16V	Z14XEP	08/05 ⇒
CORSA C 1.0	Z10XEP	06/03 ⇒ 12/09
CORSA C 1.2	Z12XEP	07/05 ⇒ 06/06
CORSA C 1.2 Twinport	Z12XEP	07/04 ⇒ 12/09
CORSA C 1.4	Z14XEP	08/03 ⇒ 06/12
CORSA C 1.4 Twinport	Z14XEP	06/03 ⇒ 12/09
MERIVA A 1.4 16V Twinport	Z14XEP	07/04 ⇒ 05/10
MERIVA A 1.4 16V Twinport LPG	Z14XEP	07/04 ⇒ 05/10
TIGRA B 1.4	Z14XEP	06/04 ⇒ 12/10

VAUXHALL

AGILA A 1.0 12V	Z10XEP	02/00 ⇒ 11/06
AGILA A 1.2 16V Twinport	Z12XEP	07/04 ⇒ 11/06
ASTRA V 1.2	Z12XEP	08/05 ⇒ 10/10
ASTRA V 1.4	Z14XEL, D4EA	01/04 ⇒ 10/10
ASTRA V 1.4 i 16V	Z14XEP	03/05 ⇒ 11/10
ASTRAVAN III 1.4 i	Z14XEP	03/05 ⇒
COMBO C 1.4	Z14XEP	10/04 ⇒ 09/10
COMBO C 1.4 i 16V	Z14XEP	01/04 ⇒ 11/11
CORSA C 1.0 12V	Z10XEP	11/03 ⇒ 10/06
CORSA C 1.2 Twinport	Z12XEP	07/04 ⇒ 10/06
CORSA C 1.4 Twinport	Z14XEP	06/03 ⇒ 10/06
CORSAVAN II 1.2 16V	Z12XEP	07/04 ⇒ 11/06
CORSAVAN II 1.2 16V Dualfuel	Z12XEP	07/04 ⇒ 12/05
CORSAVAN II 1.4	Z14XEP	11/03 ⇒ 06/06
MERIVA I 1.4 16V Twinport	Z14XEP	01/03 ⇒ 06/10
TIGRA B 1.4	Z14XEP	06/04 ⇒ 08/09



MASS AIR FLOW METERS (MAF)

Adatt./Suitable:

BOSCH0 281 002 549
0 281 002 600
0 281 002 601**GENERAL MOTORS**24 439 252
93 177 718**HYUNDAI**

28164-27900

KIA

28164-27900

OPEL8 36 635
93177718**VAUXHALL**

93177718

MARKET DIFFUSION: MEDIUM



Ø in	Ø out	L=mm	NTC +B - +R 0
70	70	96	

HYUNDAI

SANTA FE I 2.0 CRDi	D4EA	08/01 ⇒ 03/06
SANTA FE I 2.0 CRDi 4x4	D4EA, D4EA	04/01 ⇒ 03/06
SANTA FE I 2.0 CRDi Trazione integrale	D4EA	11/03 ⇒ 02/06
TRAJET 2.0 CRDi	D4EA, D4EA	04/01 ⇒ 07/08
TUCSON 2.0 CRDi	D4EA, D4EA	08/04 ⇒ 03/10
TUCSON 2.0 CRDi Trazione integrale	D4EA, D4EA	08/04 ⇒ 03/10

KIA

SPORTAGE II 2.0 CRDi	D4EA, D4EA	02/05 ⇒
SPORTAGE II 2.0 CRDi 4WD	D4EA, Y13DT	09/04 ⇒

OPEL

ASTRA G 1.7 CDTi	Z17DTL	04/03 ⇒ 12/09
ASTRA H 1.7 CDTi	Z17DTL	05/04 ⇒ 07/09
COMBO C 1.3 CDTi 16V	Y13DT, Y13DT	06/04 ⇒
COMBO C 1.7 CDTi 16V	Z17DTH	07/04 ⇒
CORSA C 1.3 CDTi	Y13DT, Y13DT	06/03 ⇒
CORSA C 1.3 CDTi 16V	Z13DT	07/05 ⇒ 06/06
CORSA C 1.3 DTi	Y13DT	09/03 ⇒
CORSA C 1.7 CDTi	Z17DTH	06/03 ⇒ 12/12
TIGRA B 1.3 CDTi	Z13DT	06/04 ⇒ 12/10

VAUXHALL

ASTRA IV 1.7 CDTi 16V	Z17DTL	04/03 ⇒ 05/05
ASTRAVAN II 1.7 CDTi	Z17DTL	04/04 ⇒ 08/06
COMBO C 1.3 CDTi 16V	Y13DT, Y13DT	09/04 ⇒ 02/12
COMBO C 1.7 CDTi 16V	Z17DTH	12/04 ⇒ 11/11
CORSA C 1.3 CDTi 16V	Y13DT, X20DTH	08/00 ⇒ 09/06
CORSA C 1.7 CDTi 16V	Z17DTH	08/00 ⇒ 09/06
CORSAVAN II 1.3 CDTi 16V	Z13DT	04/04 ⇒ 06/06
TIGRA B 1.3 CDTi	Z13DT	06/04 ⇒ 08/09



MASS AIR FLOW METERS (MAF)

Adatt./Suitable:

BOSCH

0 281 002 478

GENERAL MOTORS24 437 502
93 171 527**OPEL**8 36 590
93171527**VAUXHALL**

93171527



Ø in	Ø out	L=mm	+B - +R 0
70	70	96	

OPEL

ASTRA G 2.0 DTi 16V	X20DTH, 939A3.000	08/99 ⇒ 01/05
ASTRA G 2.2 DTi	Y22DTR	09/02 ⇒ 01/05
ZAFIRA A 2.2 DTi 16V	Y22DTR	01/02 ⇒ 06/05

VAUXHALL

ASTRA IV 2.0 DTi 16V	Y20DTH	02/98 ⇒ 05/05
----------------------	--------	---------------



MASS AIR FLOW METERS (MAF)

Adatt./Suitable:

ALFA ROMEO51827033
55190587
71789478 *RG
71789479 *RG
71794087 *RG**BOSCH**0 281 002 763
0 281 002 764
0 281 006 048
0 281 006 050**CITROËN**1192 CE
1192 Y9**FGP**

55190587

FIAT51827033
55190587
71789478 *RG
71794087 *RG**GENERAL MOTORS**

55 190 587

IVECO0000069503670
0000504136035
500026735
504136035
69503670**LANCIA**

51827033

PEUGEOT1192 CE
1192 Y9**SAAB**

55 190 587

SCANIA

55190587

***RG** Corrisponds to the original re-manufactured part

• Corrisponde al pezzo originale rigenerato

• Corrispond à la pièce d'origine reconditionnée

• Entspricht dem neuwertigen OE-Teil

• Corrisponde a la pieza original remanufacturada

MARKET DIFFUSION: MEDIUM



Ø in	Ø out	L=mm	+B - T 0
80	80	90	

ALFA ROMEO

159 2.4 JTDM	939A3.000, 939A3.000	09/05 ⇒ 12/12
159 2.4 JTDM Q4	939A9.000	05/07 ⇒ 11/11
159 MY2011 2.4 JTD	--	01/10 ⇒
BRERA 2.4 JTDM 20V	939A3.000, 939A3.000	01/06 ⇒ 06/10
SPIDER III 2.4 JTDM	939A3.000, F30DTFAP	04/07 ⇒ 06/10

CADILLAC

BLS 1.9D	Z19DTR	12/07 ⇒
----------	--------	---------

CITROËN

JUMPER III 3.0 HdI 145	F30DT	07/10 ⇒
JUMPER III 3.0 HdI 155	F30DT	07/10 ⇒
JUMPER III 3.0 HdI 160	F30DTFAP, F1AE0481N	09/06 ⇒

FIAT

CROMA II 2.4 D Multijet	939A3.000	06/05 ⇒
DUCATO III 120 Multijet 2,3 D	F1AE0481D	07/06 ⇒
DUCATO III 130 Multijet 2,3 D	F1AE0481N, F1CE0481F	08/06 ⇒
DUCATO III 150 Multijet 3,0 D	F1CE3481N	04/10 ⇒
DUCATO III 160 Multijet 3,0 D	F1CE0481D	07/06 ⇒
DUCATO 2.3 Multijet	F1AE0481N	01/07 ⇒ 07/14

IVECO

DAILY IV 29L10	F1AE0481F	05/06 ⇒ 08/11
DAILY IV 29L10V	F1AE0481F	05/06 ⇒ 08/11
DAILY IV 29L12	F1AE0481G	05/06 ⇒ 08/11
DAILY IV 29L12 V, 29L12 V/P	F1AE0481G	05/06 ⇒ 08/11
DAILY IV 29L14	F1AE0481H	05/06 ⇒ 08/11
DAILY IV 29L14 C, 29L14 C/P, 29L14 V, 29L14 V/P	F1AE0481H	05/06 ⇒ 08/11
DAILY IV 35C10 K	F1AE0481F	05/06 ⇒ 08/11
DAILY IV 35C10, 35S10	F1AE0481F	05/06 ⇒ 08/11
DAILY IV 35C11 K, 35C11 DK, 35S11 K, 35S11 DK	F1AE0481F	07/07 ⇒ 08/11

IVECO			
DAILY IV 35C11 V, 35S11 V	F1AE0481F	07/07 → 08/11	
DAILY IV 35C11, 35S11, 35S11 D, 35S11 /P	F1AE0481F	07/07 → 08/11	
DAILY IV 35C12	F1AE0481G	05/06 → 08/11	
DAILY IV 35C12 V, 35C12 V/P, 35S12 V, 35S12 V/P	F1AE0481G	05/06 → 08/11	
DAILY IV 35C12, 35S12	F1AE0481G	05/06 → 08/11	
DAILY IV 35C13 K, 35C13 DK, 35S13 K, 35S13 DK	F1AE0481V	07/07 → 08/11	
DAILY IV 35C13 V, 35C13 V/P, 35S13 V, 35S13 V/P	F1AE0481V	07/07 → 08/11	
DAILY IV 35C13, 35C13 /P, 35S13 D, 35S13, 35S13 /P	F1AE0481V	07/07 → 08/11	
DAILY IV 35C14 G, 35C14 G/P, 35S14 G, 35S14 G/P, 35C14 GD,...	F1CE0441CNG	07/07 → 08/11	
DAILY IV 35C14 GV, 35C14 GV/P, 35S14 GV, 35S14 GV/P	F1CE0441CNG	07/07 → 08/11	
DAILY IV 35C14, 35S14, 35S14 /P	F1AE0481H	05/06 → 08/11	
DAILY IV 35C15	F1CE0481F	05/06 → 08/11	
DAILY IV 35C15 V, 35C15 V/P	F1CE0481F	05/06 → 08/11	
DAILY IV 35C18	F1CE0481H	05/06 → 08/11	
DAILY IV 35C18 V, 35C18 V/P, 35S18 V, 35S18 V/P	F1CE0481H, F1CE0481H	05/06 → 08/11	
DAILY IV 35C18, 35S18	F1CE0481H, F1CE0481H	05/06 → 08/11	
DAILY IV 35S14 C, 35S14 C/P, 35S14 V, 35S14 V/P, 35C14 V,...	F1AE0481H	05/06 → 08/11	
DAILY IV 35S14 K, 35S14 DK	F1AE0481H	07/07 → 08/11	
DAILY IV 35S14, 35S14 /P	F1AE0481H	05/06 → 08/11	
DAILY IV 40C10	F1AE0481F	05/06 → 08/11	
DAILY IV 40C10 V	F1AE0481F	05/06 → 08/11	
DAILY IV 40C11 V	F1AE0481F	07/07 → 08/11	
DAILY IV 40C11, 40C11 D	F1AE0481F	07/07 → 08/11	
DAILY IV 40C12	F1AE0481G	05/06 → 08/11	
DAILY IV 40C12 V, 40C14 V/P	F1AE0481G	05/06 → 08/11	
DAILY IV 40C13 V, 40C13 V/P	F1AE0481V	07/07 → 08/11	
DAILY IV 40C13, 40C13 /P	F1AE0481V	07/07 → 08/11	
DAILY IV 40C14 G, 40C14 G/P	F1CE0441CNG	07/07 → 08/11	
DAILY IV 40C14 GV, 40C14 GV/P	F1CE0441CNG	07/07 → 08/11	
DAILY IV 40C15	F1CE0481F	05/06 → 08/11	
DAILY IV 40C15 V, 40C15 V/P	F1CE0481F	05/06 → 08/11	
DAILY IV 40C18	F1CE0481H	05/06 → 08/11	
DAILY IV 40C18 V, 40C18 V/P	F1CE0481H	05/06 → 08/11	
DAILY IV 45C15	F1CE0481F	05/06 → 08/11	
DAILY IV 45C15 V	F1CE0481F	05/06 → 08/11	
DAILY IV 45C18	F1CE0481H	05/06 → 08/11	
DAILY IV 45C18, 45C18 /P, 45C18 D, 45C18 D/P	F1CE0481H	05/06 → 08/11	
DAILY IV 50C14 G, 50C14 G/P, 50C14 GD, 50C14 GD/P	F1CE0441CNG	07/07 → 08/11	
DAILY IV 50C14 GV, 50C14 GV/P	F1CE0441CNG	07/07 → 08/11	
DAILY IV 50C15	F1CE0481F	05/06 → 08/11	
DAILY IV 50C15 V, 50C15 V/P	F1CE0481F	05/06 → 08/11	
DAILY IV 50C18	F1CE0481H	05/06 → 08/11	
DAILY IV 50C18 V, 50C18 V/P	F1CE0481H, F1CE0481H	05/06 → 08/11	
DAILY IV 55S17 WD, 55S17 WD	F1CE3481C	07/07 → 08/11	
DAILY IV 55S18W	F1CE0481H	06/06 → 08/11	
DAILY IV 60C15	F1CE0481F	05/06 → 08/11	
DAILY IV 60C15 V	F1CE0481F	05/06 → 08/11	
DAILY IV 60C15 /P, 60C15 D, 60C15 D/P	F1CE0481F	05/06 → 08/11	
DAILY IV 60C18	F1CE0481H	05/06 → 08/11	
DAILY IV 65C14 G, 65C14 G/P, 65C14 GD, 65C14 GD/P	F1CE0441CNG	07/07 → 08/11	
DAILY IV 65C15	F1CE0481F	05/06 → 08/11	
DAILY IV 65C15 /P, 65C15 D, 65C15 D/P	F1CE0481F	05/06 → 08/11	
DAILY IV 65C18	F1CE0481H, F1CE0481D(F30DT)	05/06 → 08/11	
DAILY IV 70C15	F1CE0481L	07/08 → 08/11	
DAILY 2.3	F1AE0481H	09/09 → 08/11	
DAILY 3.0	F1CE0481F, F1CE0481H	06/06 → 08/11	
DAILY 3.0 CNG	F1CE0441CNG	06/06 → 08/11	
MASSIF 3.0 HPI	F1CE0481F	10/08 → 02/11	
MASSIF 3.0 HPT	F1CE0481H	10/08 → 02/11	
LANCIA			
THESIS 2.4 D Multijet	841P000	04/06 → 07/09	
PEUGEOT			
BOXER II 3.0 HDi	F1CE0481D(F30DT), F1CE0481D(F30DT)	07/06 →	
BOXER II 3.0 HDi 160	F1CE0481D(F30DT), F1CE0481D(F30DT)	04/06 →	
BOXER II 3.0 HDi 175	F1CE0481D(F30DT), A19DTR	03/11 →	
SAAB			
9-3 1.9 TTiD	A19DTR, DV6B	12/07 → 02/15	
9-3X 1.9 TTiD AWD	Z19DTR	02/09 → 12/12	

10.1298



MASS AIR FLOW METERS (MAF)

Adatt./Suitable:

CITROËN

16 108 746 80
1920 GV
96 500 107 80

FIAT

1610874680
71794490 *RG
71795063 *RG
9650010780

FORD

1 232 096
1 255 117
3M5A-12B579-BB

MAZDA

Y601-13-215

MINI

13 62 7 794 972

PEUGEOT

16 108 746 80

1920 GV

PIERBURG

7.28342.04

7.28342.06.0

SUZUKI

13800-69K00

13800-69K00-000

VOLVO

30622124

· AVAILABLE FROM:

- DISPONIBILE DA:
- DISPONIBILE EN:
- VERFUEGBAR AB:
- DISPONIBILE EN:

19/Q3

*RG Corresponds to the original re-manufactured part

- Corrisponde al pezzo originale rigenerato
- Correspond à la pièce d'origine reconditionnée
- Entspricht dem neuwertigen OE-Teil
- Corresponde a la pieza original remanufacturada

MARKET DIFFUSION: HIGH



Ø in	Ø out	L=mm	
83x55	83x55	90	

CITROËN

BERLINGO I 1.6 HDi 75	DV6B, 9HX(DV6ATED4)	07/05 → 12/11
BERLINGO I 1.6 HDi 90	9HX(DV6ATED4), 9HZ(DV6ATED4)	07/05 → 12/11
BERLINGO II 1.6 HDi 110	9HZ(DV6ATED4), 9HT(DV6ATED4)	04/08 →
BERLINGO II 1.6 HDi 75	9HT(DV6ATED4), 9HT(DV6ATED4)	04/08 →
BERLINGO II 1.6 HDi 75 16V	9HT(DV6ATED4), 9HX(DV6ATED4)	04/08 →
BERLINGO II 1.6 HDi 90	9HX(DV6ATED4), 9HS(DV6ATED4BU)	04/08 →
BERLINGO II 1.6 HDi 90 16V	9HS(DV6ATED4BU), 9HZ(DV6ATED4)	04/08 →
BERLINGO 1.6 HDi	DV6ATED4	06/08 → 12/11
C2 1.6 HDi	9HZ(DV6ATED4), 9HX(DV6ATED4)	09/05 →
C3 I 1.6 16V HDi	9HX(DV6ATED4), DV6ATED4	09/05 →
C3 II 1.6 HDi	DV6ATED4, 9HX(DV6ATED4)	11/09 →
C3 II 1.6 HDi 90	9HX(DV6ATED4), HNV(EB2DTM)	11/09 →
C3 III 1.2 THP 110	HNV(EB2DTM), 9HX(DV6ATED4)	07/16 →
C3 III 1.2 VTI 82	HMZ(EB2F)	07/16 →
C3 PICASSO 1.6 HDi	9HX(DV6ATED4), 9HY(DV6ATED4)	02/09 →
C4 I 1.6 HDi	9HV(DV6ATED4), 9HY(DV6ATED4)	11/04 →
C4 GRAND PICASSO I 1.6 HDi	9HY(DV6ATED4), 9HV(DV6ATED4)	10/06 → 06/11
C4 PICASSO I 1.6 HDi	9HY(DV6ATED4), 9HY(DV6ATED4)	02/07 → 08/13
C5 I 1.6 HDi	9HY(DV6ATED4), 9HZ(DV6ATED4)	09/04 →
C5 II 1.6 HDi 110	9HZ(DV6ATED4), 9HU(DV6ATED4)	02/08 →
DISPATCH 1.6 HDi	DV6ATED4	06/07 → 03/16
JUMPY 1.6 HDi	DV6ATED4	06/07 → 03/16
JUMPY II 1.6 HDi 90 16V	9HU(DV6ATED4), 9HX(DV6ATED4)	01/07 →
XSARA PICASSO 1.6 HDi	9HX(DV6ATED4), 9H07	05/04 →

FIAT

SCUDO II 1.6 D Multijet	9H07, HHJA	01/07 →
FORD		
FIESTA V 1.6 TDCi	HHJA, HHDA	11/04 → 09/09
FOCUS II 1.6 TDCi	G8DA, G8DA	07/04 → 09/12
FOCUS II CASSONE / FURGONATO / PROMISCUO 1.6 TDCi	G8DA, HHJA	07/04 → 07/11
FOCUS C-MAX 1.6 TDCi	HHDA, G8DA	02/05 → 03/07
FUSION 1.6 TDCi	HHJA, Y601	11/04 → 12/12
MAZDA		
3 I 1.6 DI Turbo	Y601, 9HZ	06/04 → 06/09
3 I 1.6 MZ-CD	Y406	06/06 → 12/09
MINI		
MINI II Cooper D	9HZ, 9HZ	11/06 → 09/10
MINI II One D	9HZ, 9HZ(DV6TED4)	06/09 → 07/10
PEUGEOT		
206 1.6 HDi 110	9HY(DV6ATED4), 9HV(DV6ATED4)	05/04 →
207 1.6 HDi	9HV(DV6ATED4), 9HZ(DV6ATED4)	02/06 →
207 CC 1.6 HDi	9HZ(DV6ATED4), 9HZ(DV6ATED4)	02/07 →
307 1.6 HDi	9HV(DV6ATED4), 9HY(DV6ATED4)	04/05 → 03/09
307 1.6 HDi 110	9HY(DV6ATED4), 9HV(DV6ATED4)	02/04 → 03/09
307 1.6 HDi 90	9HV(DV6ATED4), 9HV(DV6ATED4)	12/06 → 04/08
308 I 1.6 HDi	9HV(DV6ATED4), 9HZ(DV6ATED4)	09/07 →
407 1.6 HDi	DV6ATED4	08/04 → 12/10
407 1.6 HDi 110	9HZ(DV6ATED4), 9HZ(DV6ATED4)	05/04 →
407 2.0 HDi	DW10BTE4	08/08 →
407 2.0 HDi 135	DW10BTE4	05/04 →
1007 1.6 HDi	9HZ(DV6ATED4), 9HY(DV6ATED4)	06/07 →
3008 1.6 HDi	9HZ(DV6ATED4), 9HV(DV6ATED4)	06/09 → 08/16
5008 1.6 HDi	9HZ(DV6ATED4), 9HU(DV6ATED4)	09/09 →
EXPERT II 1.6 HDi 90 16V	9HU(DV6ATED4), 9HU(DV6ATED4)	01/07 →
EXPERT II TEPEE 1.6 HDi 90 16V	9HU(DV6ATED4), DV6ATED4	01/07 →
PARTNER 1.6 HDi	DV6ATED4, 9HW(DV6ATED4)	08/05 →
PARTNER I 1.6 HDi 75	9HW(DV6ATED4), 9HX(DV6ATED4)	02/06 →
PARTNER I 1.6 HDi 90	9HX(DV6ATED4), 9HT(DV6ATED4)	10/05 → 12/15
PARTNER II 1.6 HDi	9HT(DV6ATED4), 9HS(DV6ATED4BU)	04/08 →
PARTNER II 1.6 HDi 16V	9HS(DV6ATED4BU), 9HS(DV6ATED4BU)	04/08 →
PARTNER II 1.6 HDi 16V 4x4	9HS(DV6ATED4BU), 9HT(DV6ATED4)	04/12 →
PARTNER II TEPEE 1.6 HDi	9HT(DV6ATED4), 9HV(DV6ATED4)	04/08 →
PARTNER II TEPEE 1.6 HDi 16V	9HV(DV6ATED4), D4164T	04/08 →
RANCH 1.6 HDi 75	DV6B	02/06 →
RANCH 1.6 HDi 90	9HX(DV6ATED4)	02/06 →
SUZUKI		
SX4 I 1.6 DDIS	9HX	04/07 →
VOLVO		
C30 1.6 D	D4164T	10/06 → 12/12
S40 II 1.6 D	D4164T	01/05 → 12/12
V50 1.6 D	D4164T, AR32102	01/05 → 12/12

10.1299



07

MASS AIR FLOW METERS (MAF)

Adatt./Suitable:

ALFA ROMEO

- 51782034
- 55183650
- 71789484 *RG
- 71789485 *RG
- 71793250 *RG

*RG **Corresponds to the original re-manufactured part**

- Corrisponde al pezzo originale rigenerato
- Correspond à la pièce d'origine reconditionnée
- Entspricht dem neuwertigen OE-Teil
- Corresponde a la pieza original remanufacturada

BOSCH

- 0 281 002 792
- 0 281 002 793
- 0 281 002 873
- 0 281 002 874
- 0 281 002 980

CHEVROLET

- 96806111

DAEWOO

- 96806111

FGP

- 55183650
- 55206757

FIAT

- 51782034
- 55183650
- 71789484 *RG
- 71789485 *RG
- 71793250 *RG

FORD

- 1 542 478
- 9551-12B579-AA

GENERAL MOTORS

- 95 513 367
- 96 806 111

LANCIA

- 51782034
- 55183650
- 71789484 *RG
- 71789485 *RG
- 71793250 *RG

OPEL

- 8 36 016
- 95513367

VAUXHALL

- 95513367

MARKET DIFFUSION: **HIGH**



Ø in	Ø out	L=mm	+B - T 0
70	70	96	

ALFA ROMEO

145 1.6 16V T.S.	AR32102	09/97 ⇨ 12/00
145 1.6 i.e. 16V T.S.	AR32102, AR32102	12/96 ⇨ 01/01
145 1.6 LPG	AR32102	01/98 ⇨ 01/01
145 1.8 i.e. 16V	AR32201	03/98 ⇨ 01/01
145 1.9 JTD	AR32302	02/99 ⇨ 01/01
145 2.0 16V	AR32301	03/98 ⇨ 01/01
146 1.6 16V T.S.	AR32102	09/97 ⇨ 12/00
146 1.6 i.e. 16V T.S.	AR32102, 937A2.000	11/96 ⇨ 10/01
146 1.9 JTD	AR32302	02/99 ⇨ 01/01
146 2.0 16V	AR32301	03/97 ⇨ 10/01
147 1.9 JTD	937A2.000, 192B1.000	10/00 ⇨ 03/10
147 1.9 JTD 16V	192B1.000, 937A2.000	09/03 ⇨ 03/10
147 1.9 JTD M	937A2.000, AR32102	10/04 ⇨ 03/10
147 1.9 JTD M 16V	937A6.000	06/08 ⇨ 03/10
147 1.9 JTD M 8V	937A3.000	07/05 ⇨ 03/10
156 1.6 16V T.SPARK	AR32102, AR32104	09/97 ⇨ 09/05
156 1.6 16V T.SPARK.	AR32104, AR32201	05/00 ⇨ 05/06
156 1.8 16V T.SPARK	AR32201, AR32302	05/00 ⇨ 05/06
156 1.9 JTD	AR32302, AR32301	05/00 ⇨ 05/01
156 2.0 16V T.SPARK	AR32301, 937A5.000	05/00 ⇨ 06/02
156 2.0 Twin Spark	AR32303	11/97 ⇨ 04/00
GT 1.9 JTD	937A5.000, AR16201	11/03 ⇨ 09/10
GTV 2.0 T.SPARK 16V	AR16201, 199A3.000	06/95 ⇨ 10/05
MITO 1.3 Multijet	199A3.000, 192A1.000	08/08 ⇨
SPIDER II 2.0 T.SPARK 16V	AR32301	05/98 ⇨ 08/00

CHEVROLET

EPICA 2.0 D	LLW	01/07 ⇨
-------------	-----	---------

DAEWOO

TOSCA 2.0 TCDi [ExtraEU]	Z20DMH	02/06 ⇨ 12/10
--------------------------	--------	---------------

FIAT

500 1.3 D Multijet	169A1.000	10/07 ⇨
500 C 1.3 D Multijet	169A1.000	09/09 ⇨
BRAVO II 1.9 D Multijet	192A1.000, 199A3.000	11/06 ⇨ 12/14
BRAVO II 1.9 D Multijet 8V	--	01/10 ⇨
BRAVO II 1.9 D Multijet 16V	--	01/10 ⇨
DOBLO I 1.3 D Multijet	199A2.000	10/05 ⇨
DOBLO I 1.3 JTD	199A2.000	05/05 ⇨
DOBLO I 1.3 JTD 16V	188A9.000	05/04 ⇨ 12/06
DOBLO I 1.9 D Multijet	223A9.000	08/06 ⇨
DOBLO II 1.3 D Multijet	199A3.000, 199A2.000	02/10 ⇨
GRANDE PUNTO 1.3 JTD Multijet	199A2.000, 199A3.000	02/06 ⇨ 06/13
IDEA 1.3 D Multijet	199A3.000, --	10/05 ⇨
LINEA 1.3 D Multijet	--, --	06/07 ⇨
LINEA 1.3 JTD Multijet	199A3.000	10/06 ⇨
MULTIPLA 1.9 JTD	186A9.000	04/02 ⇨ 06/10
MULTIPLA 1.9 JTD 115	186A8.000	07/02 ⇨ 06/10
PALIO 1.3 JTD Multijet	188A9.000	06/03 ⇨
PALIO 1.3 Multijet INDIA	199A2.000	06/05 ⇨
PALIO 1.7 TD	176A5.000	09/01 ⇨
PANDA II 1.3 D Multijet	--, 169A1.000	09/03 ⇨
PANDA II 1.3 D Multijet 4x4	169A1.000, 199A2.000	10/04 ⇨
PUNTO III / GRANDE PUNTO 1.3 D Multijet	199A2.000, 199A2.000	10/05 ⇨
PUNTO III / GRANDE PUNTO 1.3 JTD	--	01/08 ⇨ 09/09
PUNTO III / GRANDE PUNTO 1.3 JTD Actual	--	09/09 ⇨
PUNTO III / GRANDE PUNTO 1.3 Multijet [IND]	--	01/08 ⇨
PUNTO III EVO 1.3 D Multijet	199A2.000, RHX	07/08 ⇨
PUNTO III 1.3 D Multijet	199A2.000, 199A2.000	04/08 ⇨
PUNTO III 1.3 JTD Multijet	955B2.000	05/18 ⇨
SCUDO I 2.0 JTD	RHX, 192A8.000	10/99 ⇨ 12/06
SCUDO I 2.0 JTD 16V	RHW	05/99 ⇨ 12/06
SIENA 1.3 JTD	188A9.000	09/03 ⇨ 12/09
STILO 1.9 D	192B5.000	09/04 ⇨ 08/08
STILO 1.9 D Multijet	192A8.000, 192A1.000	09/05 ⇨ 08/08
STILO 1.9 JTD	192A1.000, BAAA	10/01 ⇨ 08/08
STRADA 1.3 D Multijet	223A9.000	05/06 ⇨

FORD

KA II 1.3 TDCi	BAAA, 188A9.000	10/08 ⇨
----------------	-----------------	---------

LANCIA

MUSA 1.3 D Multijet	188A9.000, 199A2.000	10/04 ⇨ 09/12
YPSILON I 1.3 D Multijet	199A2.000, RHW	09/06 ⇨ 12/11
YPSILON I 1.3 JTD	188A9.000	10/03 ⇨ 12/11
ZETA 2.0 JTD	RHZ	04/00 ⇨ 09/02
ZETA 2.0 JTD 16V	RHW, A13FD	04/01 ⇨ 10/03

OPEL

COMBO D 1.3 CDTi	A13FD, A13FD	02/12 ⇨
------------------	--------------	---------

VAUXHALL

COMBO D 1.3 CDTi	A13FD, 8HT(DV4TD)	11/11 ⇨
------------------	-------------------	---------

10.1300



07

MASS AIR FLOW METERS (MAF)

Adatt./Suitable:

ALFA ROMEO

- 55187722
- 71788742 *RG

*RG **Corresponds to the original re-manufactured part**

- Corrisponde al pezzo originale rigenerato
- Correspond à la pièce d'origine reconditionnée

BOSCH

- 0 280 218 164
- 0 280 218 211

GENERAL MOTORS

- 93 181 894

OPEL

- 8 36 105
- 8 36 136
- 93181894
- 93186084

VAUXHALL

- 93181894
- 93186084



Ø in	Ø out	L=mm	NTC +B - +R 0
80	80	90	

ALFA ROMEO

159 1.9 JTS	939A6.000	09/05 ⇨ 11/11
159 2.2 JTS	939A5.000	09/05 ⇨ 11/11
159 MY2011 2.2 JTS	--	01/10 ⇨
BRERA 2.2 JTS	939A5.000	01/06 ⇨ 05/11
SPIDER III 2.2 JTS	939A5.000	03/06 ⇨ 03/11

OPEL

ASTRA H 2.0 Turbo	Z20LEH	03/05 ⇨ 10/10
ZAFIRA B 2.0	Z20LEH	01/06 ⇨ 12/10

VAUXHALL

ASTRA V 2.0 Turbo	Z20LEH	01/04 ⇨ 05/09
ASTRA V 2.0 VXR	Z20LEH	02/09 ⇨ 11/10
ZAFIRA B 2.0	Z20LEH	01/06 ⇨ 11/14

10.1301



05

MASS AIR FLOW METERS (MAF)

Adatt./Suitable:

CITROËN

1920 GG
96 471 440 80

CONTINENTAL

5WK9 7004

FORD

1 333 637
1 348 615
256Q-12B579-BA
256Q-12B579-BB

MAZDA

Y404-13-215

PEUGEOT

1920 GG
96 471 440 80

SIEMENS

5WK9 7004
5WK9 7004Z

TOYOTA

SU001-00643

MARKET DIFFUSION: HIGH



Ø in	Ø out	L=mm	
60	60	96	

CITROËN

C1 I 1.4 HDi	8HT(DV4TD), 8HX(DV4TD)	06/05 → 09/14
C2 1.4 HDi	8HX(DV4TD), 8HX(DV4TD)	09/03 →
C3 I 1.4 HDi	8HX(DV4TD), 8HX(DV4TD)	02/02 →
C3 I PLURIEL 1.4 HDi	8HX(DV4TD), 8HZ(DV4TD)	04/04 →
C3 II 1.4 HDi 70	8HZ(DV4TD), 8HS(DV4TED)	11/09 →
NEMO 1.4 HDi	8HS(DV4TED), F6JA	02/08 →

FORD

FIESTA V 1.4 TDCi	F6JA, F6JB	11/01 → 12/10
FIESTA VI 1.4 TDCi	F6JB, F6JA	01/09 →
FUSION 1.4 TDCi	F6JA, Y406	08/02 → 12/12

MAZDA

2 II 1.4 MZR-CD	Y404	01/08 → 06/15
2 II 1.6 MZ-CD	Y406, 8HX(DV4TD)	10/08 → 06/15

PEUGEOT

107 1.4 HDi	8HT(DV4TD), 8HX(DV4TD)	06/05 → 05/14
206 1.4 HDi	8HX(DV4TD), 8HX(DV4TD)	09/01 →
206 1.4 HDi eco 70	8HX(DV4TD), 8HX(DV4TD)	09/01 →
206+ 1.4 HDi eco 70	8HX(DV4TD), 8HZ(DV4TD)	01/09 →
207 1.4 HDi	8HZ(DV4TD), 8HS(DV4TED)	02/06 →
1007 1.4 HDi	8HX(DV4TD), 8HT(DV4TD)	04/05 →
BIPPER 1.4 HDi	8HS(DV4TED), 8HS(DV4TED)	02/08 →
BIPPER TEEPEE 1.4 HDi	8HS(DV4TED), DW10BTED4	04/08 →

TOYOTA

AYGO I 1.4 HDi	2WZ-TV	07/05 → 08/10
----------------	--------	---------------

10.1302



07

MASS AIR FLOW METERS (MAF)

Adatt./Suitable:

CITROËN

1920 GN
96 459 487 80

FORD

4R8Q-12B579-AC

JAGUAR

C2C 12919

LAND ROVER

PHF500090

PEUGEOT

1920 GN
96 459 487 80

SIEMENS

5WK9 7001
5WK9 7011
5WK97001Z

ITEM NOW AVAILABLE FROM PRODUCTION

- ARTICOLO ORA DISPONIBILE PER LA VENDITA
- ARTICLE DISPONIBLE EN PRODUCTION COURANTE
- JETZT ZUM VERKAUF VERFÜGBARER ARTIKEL
- ARTICULO AHORA DISPONIBLE EN PRODUCCION

MARKET DIFFUSION: MEDIUM



Ø in	Ø out	L=mm	
70	70	96	

CITROËN

C4 I 2.0 HDi	DW10BTED4, DW10CFAPDTR	11/04 → 07/11
C4 II 2.0 HDi	DW10CFAPDTR, DW10CTED4	10/10 →
C4 II 2.0 HDi / BlueHDi 150	DW10CTED4, DW10BTED4	11/09 →
C4 II 2.0 HDi / BlueHDi 160	DW10CTED4	10/10 →
C4 GRAND PICASSO I 2.0 HDi 138	DW10BTED4, DW10BTED4	10/06 → 12/13
C4 PICASSO I 2.0 HDi 138	DW10BTED4, DT17ED4	10/06 → 08/13
C5 II 2.7 HDi	DT17ED4, DT17ED4	02/08 →
C6 2.7 HDi	DT17ED4, RHD(DW10CTED4)	09/05 → 12/11
DS4 2.0 HDi / BlueHDi 135	RHD(DW10CTED4), DW10CTED4	09/11 → 07/15
DS4 2.0 HDi 165	DW10CTED4, 306DT	04/11 → 07/15

JAGUAR

S-TYPE 2.7 D	AJD	06/04 → 10/07
XF 2.7 D	AJD	03/08 → 04/15
XF 3.0 D	306DT, AJD	03/09 → 04/15
XF 3.0 D AWD	AJV6D	03/12 →
XJ 3.0 D	AJV6D	10/09 → 12/15
XJ D 2.7	AJD, 306DT	10/05 → 03/09

LAND ROVER

DISCOVERY IV 3.0 SDV6 4x4	306DT, 306DT	11/09 →
DISCOVERY IV 3.0 TD 4x4	306DT, 368DT	09/09 →
RANGE ROVER III 3.6 D 4x4	368DT, 30DDTX	04/06 → 08/12
RANGE ROVER SPORT I 3.0 D 4x4	30DDTX, 368DT	09/09 → 03/13
RANGE ROVER SPORT I 3.6 D 4x4	368DT, DW10CTED4	04/06 → 03/13
RANGE ROVER SPORT I 3.6 TDV8	306DT	09/09 →

PEUGEOT

307 2.0 HDi	DW10BTED4	04/04 → 11/07
307 2.0 HDi 135	DW10BTED4, DW10BTED4	10/03 → 04/09
308 I 2.0 HDi	DW10BTED4, DT17TED4	09/07 →
407 2.7 HDi	DT17TED4, DW10CTED4	10/05 →
607 2.7 HDi 24V	DT17TED4	12/04 → 07/11
3008 2.0 HDi	RHH(DW10CTED4)	06/09 → 08/16
3008 2.0 HDi 150 / BlueHDi 150	DW10CTED4, DW10BTED4	06/09 → 08/16
3008 2.0 HDi Hybrid4	RHC(DW10CTED4)	02/11 → 08/16
5008 2.0 HDi	RHH(DW10CTED4)	09/09 →
5008 2.0 HDi 136 / BlueHDi 136	RHD(DW10CTED4)	02/12 →
5008 2.0 HDi 150 / BlueHDi 150	DW10CTED4, DW10BTED4	06/09 →

10.1303



07

MASS AIR FLOW METERS (MAF)

Adatt./Suitable:

CITROËN

1920 HH
96 459 489 80

CONTINENTAL

5WK9 7002

FIAT

9645948780
9645948980

FORD

1 232 944
1 303 898
3M5A-12B579-AA
3M5A-12B579-AB

LANCIA

9645948980

MITSUBISHI

1525A015

PEUGEOT

1920 HH
96 459 489 80

SIEMENS

5WK9 7002
5WK97002Z

VOLVO

867009-3

MARKET DIFFUSION: MEDIUM



Ø in	Ø out	L=mm	
80	80	96	

CITROËN

C5 I 2.0 HDi	DW10BTED4, DW10BTED4	09/04 →
C5 II 2.0 HDi	DW10BTED4, DW10BTED4	02/08 →
C5 II 2.0 HDi 140	DW10BTED4, DW10CTED4	04/09 →
C5 II 2.0 HDi 150 / BlueHDi 150	DW10CTED4, DW10UTED4	04/09 →
C5 II 2.0 HDi 165	RHH(DW10CTED4)	04/09 →
C8 2.0 HDi	DW10UTED4, DW10BTED4	07/02 →
C8 2.0 HDi 135	DW10BTED4, 4HP(DW12BTED4)	03/06 →
C8 2.2 HDi	4HP(DW12BTED4), 4HN(DW12MTED4)	06/06 →
C-CROSSER 2.2 HDi	4HN(DW12MTED4), 4HN(DW12MTED4)	02/07 →
C-CROSSER ENTERPRISE 2.2 HDi	4HN(DW12MTED4), DW10UTED4	01/09 →
DISPATCH 2.0 HDi	DW10UTED4	06/07 → 03/16
JUMPY 2.0 HDi	DW10UTED4	06/07 → 03/16
JUMPY II 2.0 HDi 120	DW10UTED4, DW10BTED4	01/07 →
JUMPY II 2.0 HDi 120 4x4	RHK(DW10UTED4)	01/10 →
JUMPY II 2.0 HDi 140	DW10BTED4, DW10BTED4	01/07 →

FIAT

SCUDO II 2.0 D Multijet	DW10BTED4, RHK	01/07 →
ULYSSE II 2.0 D Multijet	RHK, 4H01	05/06 → 06/11
ULYSSE II 2.2 D Multijet	4H01, 4HP	10/07 →
ULYSSE II 2.2 JTD	4HP, G6DA	03/08 → 06/11

FORD

FOCUS II 2.0 TDCi	G6DA, RHR	07/04 → 09/12
FOCUS C-MAX 2.0 TDCi	G6DA, G6DA	10/03 → 03/07

LANCIA

PHEDRA 2.0 D Multijet	RHR, RHK	07/06 → 11/10
PHEDRA 2.0 JTD	RHK, 4HS	06/06 → 11/10
PHEDRA 2.2 D Multijet	4HS, 4H01	03/08 → 11/10
PHEDRA 2.2 JTD	4H01, 4HK	04/06 →

MITSUBISHI

OUTLANDER II 2.2 DI-D 4WD	4HK, 4HK(DW12MTED4)	08/07 → 11/12
---------------------------	---------------------	---------------

PEUGEOT

407 2.0 HDi	DW10BTED4, RHL(DW10BTED4)	11/04 →
407 2.0 HDi [ExtraEU]	DW10BTED4	11/04 → 10/07
407 2.0 HDi 135	RHL(DW10BTED4), DW10BTED4	05/04 →

PEUGEOT		
508 I 2.0 HDi	DW10BTED4, RHC(DW10CTED4)	11/10 →
508 I 2.0 HDi Hybrid4 AWC	RHC(DW10CTED4), DW10BTED4	11/10 →
508 I 2.0 HDi RXH Hybrid4	RHC(DW10CTED4)	11/10 →
607 2.0 HDi	DW10BTED4, 4HP(DW12BTED4)	09/05 → 07/11
607 2.0 HDi 135	RHL(DW10BTED4)	09/05 →
607 2.2 HDi	4HP(DW12BTED4), DW10UTED4	05/06 →
807 2.0 HDi	DW10UTED4, 4HT(DW12BTED4)	02/06 →
807 2.2 HDi	4HT(DW12BTED4), DW10UTED4	06/06 →
4007 2.2 HDi	4HK(DW12MTED4), DW10BTED4	02/07 →
EXPERT II 2.0 HDi 120	DW10UTED4, DW10BTED4	01/07 →
EXPERT II 2.0 HDi 120 4x4	RHK(DW10UTED4)	01/10 →
EXPERT II 2.0 HDi 140	DW10BTED4, DW10UTED4	01/07 →
EXPERT II TEPEE 2.0 HDi 120	DW10UTED4, DW10BTED4	01/07 →
EXPERT II TEPEE 2.0 HDi 120 4x4	RHK(DW10UTED4)	01/07 →
EXPERT II TEPEE 2.0 HDi 140	DW10BTED4, KS	01/07 →

VOLVO		
C30 2.0 D	D4204T	10/06 → 12/12
S40 II 2.0 CDI	D4204T2	07/05 → 12/06
S40 II 2.0 D	D4204T	01/04 → 12/10
S40 II 2.0 D4	D4204T2	07/05 → 12/12
V50 2.0 CDI	D4204T2	12/03 → 12/06
V50 2.0 D	D4204T	04/04 → 12/10
V50 2.0 D4	D4204T2	07/05 → 12/06

10.1311



07

MASS AIR FLOW METERS (MAF)

Adatt./Suitable:

- BOSCH**
0 280 218 092
0 280 218 093
0 280 218 104
0 280 218 105
0 281 002 501
- FORD**
1 223 521
257A-12B579-CA
- JEEP**
53013009AA
K53013009AA
- KIA**
0K0AA-13210
- MERCEDES-BENZ**
53013009AA
- MOPAR PARTS**
53013009AA



Ø in	Ø out	L=mm	NTC +B - +R 0
80	80	110	

FORD		
MONDEO II 1.8 SGI	CFBA	06/03 → 03/07

JEEP		
GRAND CHEROKEE 2.7 CRD 4x4	ENF	10/01 → 09/05

KIA		
CARNIVAL I 2.5 V6	KS, Y13DT	10/01 → 06/06
SEDONA 2.5 V6	--	07/01 →

10.1315



07

MASS AIR FLOW METERS (MAF)

Adatt./Suitable:

- BOSCH**
0 281 002 620
- GENERAL MOTORS**
55 350 047
93 178 050
- OPEL**
8 36 638
93178050
- VAUXHALL**
93178050



Ø in	Ø out	L=mm	NTC +B - +R 0
70	70	96	

OPEL		
MERIVA A 1.3 CDTI	Y13DT, Z17DT	04/05 → 05/10
MERIVA A 1.7 CDTI	Z17DT, Y13DT	09/03 → 05/10

VAUXHALL		
MERIVA I 1.3 CDTI	Y13DT, 1Z	04/05 → 06/10
MERIVA I 1.7 CDTi	Z17DTH	09/03 → 06/10

10.1325



07

MASS AIR FLOW METERS (MAF)

Adatt./Suitable:

- AUDI**
038 906 461 C
- BOSCH**
0 281 002 757
0 281 002 758
- FORD**
1 384 275
1 428 448
RM95VW-12B529-BC
- SEAT**
038 906 461 C
- SKODA**
038 906 461 C
- VW**
038 906 461 C

MARKET DIFFUSION: MEDIUM



Ø in	Ø out	L=mm	+B - +R 0
70	70	96	

AUDI		
A4 II 1.9 TDI	AVB	05/01 → 12/04

FORD		
GALAXY I 1.9 TDI	1Z, 1Z	04/00 → 05/06

SEAT		
ALHAMBRA I / II 1.9 TDI	1Z, ATD	04/96 → 03/10

SEAT		
IBIZA III 1.9 TDI	ATD, AGR	02/02 → 11/09
LEON I 1.9 TDI	AGR, AGR	11/99 → 06/06
TOLEDO II 1.9 TDI	AGR, ATD	10/98 → 07/04

SKODA		
FABIA I 1.9 TDI	ATD, AGR	01/00 → 03/08
OCTAVIA I 1.9 TDI	AGR, AGR	09/96 → 03/10
OCTAVIA I 1.9 TDI 4x4	AGR, AGR	09/00 → 02/06

VW		
BORA 1.9 TDI	AGR, AGR	07/01 →
BORA 1.9 TDI 4motion	AGR	07/01 →
GOLF IV 1.9 TDI	AGR, ALH	08/97 → 05/06
GOLF 1.9 TDi	AHF	10/97 → 05/04
NEW BEETLE 1.9 TDI	ALH, AMF	02/01 → 09/10
POLO IV 1.4 TDI	AMF, ATD	10/01 → 06/05
POLO IV 1.9 TDI	ATD, 1Z	10/01 → 11/09
SHARAN I 1.9 TDI	1Z, CDLA	04/00 → 03/10
SHARAN I 1.9 TDI 4motion	AUY	04/00 → 03/10

10.1329



07

MASS AIR FLOW METERS (MAF)

Adatt./Suitable:

- AUDI**
03H 906 461
- BENTLEY**
07V 906 461
- BOSCH**
0 280 218 175
0 280 218 176
0 280 218 253
- SKODA**
03H 906 461
- VW**
03H 906 461



Ø in	Ø out	L=mm	+B - NTC 0
86	84	100	

AUDI		
Q7 I 3.6 FSI quattro	BHK	08/06 → 05/10
TT II 2.0 TTS quattro	CDLA, CKHB	05/08 → 06/14

BENTLEY		
BENTAYGA 6.0	DBBB	10/15 →
CONTINENTAL 6.0	CKHB, CKHB	01/11 →
CONTINENTAL 6.0 AWD	CKHB, CVAA	11/10 →
CONTINENTAL 6.0 FLEX	CVAA, CVAC	09/12 →
CONTINENTAL 6.0 FLEX AWD	CVAC, CVAA	05/14 →
CONTINENTAL 6.0 Speed [ExtraEU]	DBDD	11/17 → 07/18
FLYING SPUR 6.0	CVAA, CKBB	03/13 →
MULSANNE 6.8	CKBB, --	09/09 →

SKODA		
SUPERB II 3.6 FSI 4x4	--, BLV	11/08 → 05/15
SUPERB II 3.6 V6 4x4	CDVA	10/09 → 05/15

VW		
CC 3.6 FSI 4motion	BWS	11/11 → 12/16
EOS 3.6 V6	CDVA	05/09 → 11/10
PASSAT V 3.2 FSI 4motion	AXZ	11/05 → 11/10
PASSAT V 3.6 FSI	BLV	06/05 → 11/10
PASSAT V 3.6 FSI 4motion	BLV	09/05 → 11/10
PASSAT V 3.6 R36 4motion	BWS	04/07 → 11/10
PASSAT CC 3.6 FSI	BLV	06/08 →
PASSAT CC 3.6 FSI 4motion	BLV, CHNA	02/08 → 01/12
PHAETON 3.6 V6 4motion	CHNA, BHK	11/08 → 03/16
TOUAREG I 3.6 V6 FSI	BHK, N43B16A	10/05 → 05/10

10.1331



07

MASS AIR FLOW METERS (MAF)

Adatt./Suitable:

BMW

13 62 7 531 702
13 62 7 566 989
7 566 989

BOSCH

0 280 218 159



Ø in	Ø out	L=mm	NTC +B - +R 0
80	80	96	

BMW			
11116 i	N43B16A, N43B20A	04/07 ⇒	12/11
11118 i	N43B20A, N43B20A	07/04 ⇒	12/13
11120 i	N43B20A, N43B20A	11/03 ⇒	12/13
3V 318 i	N43B20A, N43B20A	03/05 ⇒	12/13
3V 320 i	N43B20A, N46B20B	03/05 ⇒	12/13
3V 320 si	N45B20A	09/05 ⇒	08/06
3 SERIES 320i Touring [ExtraEU]	N43B20A	06/07 ⇒	10/12
X1 sDrive 18 i	N46B20B, N46B20A	03/09 ⇒	06/15
X3 1.2.0 i	N46B20B	07/05 ⇒	08/08
X3 1xDDrive 20 i	N46B20B	09/08 ⇒	08/11
Z4 1.2.0 i	N46B20A, HYDB	03/05 ⇒	02/09

10.1332



07

MASS AIR FLOW METERS (MAF)

Adatt./Suitable:

BOSCH

0 280 218 134

FORD

1 367 827
6G9N-9G760-AA

VOLVO

31342364
869262-4

Ø in	Ø out	L=mm	+B - +R 0
80	80	100	

FORD			
FOCUS II 2.5 ST	HYDA	10/05 ⇒	09/12
GALAXY II 2.5 ST	HUWA	05/06 ⇒	
KUGA I 2.5	HYDB, HYDB	03/09 ⇒	11/12
KUGA I 2.5 4x4	HYDB, B5254T3	02/08 ⇒	11/12
MONDEO III 2.5	HUBA	03/07 ⇒	01/15
S-MAX I 2.5 ST	HUWA	05/06 ⇒	12/14

VOLVO			
C30 2.5 T5 [ExtraEU]	B5254T7	03/12 ⇒	12/13
C30 T5	B5254T3, B5254T3	10/06 ⇒	12/12
C70 II T5	B5254T3, B5254T3	03/06 ⇒	10/09
S40 II T5	B5254T3, B5254T3	01/04 ⇒	12/12
S40 II T5 AWD	B5254T3, B5254T10	04/04 ⇒	12/10
S80 II 2.5 T	B5254T10, B5254T11	03/06 ⇒	
S80 II 2.5 T AWD	B5254T6	10/06 ⇒	04/09
S80 II 2.5 T FlexFuel	B5254T11, B5254T3	05/08 ⇒	12/11
V50 T5	B5254T3, B5254T3	04/04 ⇒	12/12
V50 T5 AWD	B5254T3, B5204T9	04/04 ⇒	12/10
V70 III 2.0 BiFuel	B5204T9, 1MZ-FE	03/13 ⇒	12/15
V70 III 2.5 T	B5254T6	08/07 ⇒	12/09
V70 III 2.5 T FlexFuel	B5254T8	05/08 ⇒	12/09

10.1335



04

MASS AIR FLOW METERS (MAF)

Adatt./Suitable:

DENSO

197400-2000
197400-2230
197400-2270

LEXUS

22204-21010

MINI

13 62 7 798 107*1b

MITSUBISHI

1525A016

SUZUKI

13800-63J00
13800-63J00-000

TOYOTA

22204-07010
22204-21010

NEW - AVAILABLE FROM:

- NUOVO - DISPONIBILE DA:
- NOUVEAU - DISPONIBLE EN:
- NEU - VERFUEGBAR AB:
- NUEVO - DISPONIBLE EN:

19/Q4

*1b Only supplied the sensor without a conduit

- Fornito solo sensore senza condotto
- Seulement fourni le capteur sans conduit
- Liefert den Sensor nur ohne Leitung
- Solo se suministró el sensor sin un conducto

MARKET DIFFUSION: MEDIUM

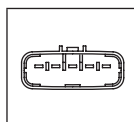

LEXUS			
RX I 300	1MZ-FE, 1MZ-FE	01/98 ⇒	02/03
RX I 300 AWD	1MZ-FE, 4M41R	10/00 ⇒	05/03
MINI			
MINI I One D	1ND-TV	06/03 ⇒	09/06
MITSUBISHI			
PAJERO 3.2 DiD	4M41R, 4M41	02/07 ⇒	
PAJERO IV 3.2 DI-D	4M41, 4M41	11/06 ⇒	
PAJERO IV 3.2 DI-D 4WD	4M41, 4M41	02/07 ⇒	
PAJERO IV 3.2 DI-D GLS	4M41	02/07 ⇒	
PAJERO IV 3.2 TD 4WD	4M41, 4M41R	01/10 ⇒	
SHOGUN 3.2 DiD	4M41R, M16A	11/06 ⇒	
SHOGUN IV 3.2 TD 4x4	4M41	01/09 ⇒	

SUZUKI			
GRAND VITARA 1.6 VVT [ExtraEU]	M16A	09/05 ⇒	02/15
GRAND VITARA II 1.6	M16A	10/05 ⇒	
GRAND VITARA II 1.6 4x4	M16A	09/05 ⇒	02/15
GRAND VITARA II 1.6 Trazione integrale	M16A	04/05 ⇒	
GRAND VITARA II 2.0	J20A	10/05 ⇒	02/15
GRAND VITARA II 2.0 Trazione integrale	J20A	10/05 ⇒	02/15
JIMNY III 1.3 16V 4WD	M13A	02/01 ⇒	
JIMNY III 1.3 16V 4x4	M13A	08/05 ⇒	
JIMNY III 1.3 4WD	M13A	03/13 ⇒	
LIANA 1.6	M16A, M16A	07/01 ⇒	
LIANA 1.6 4WD	M16A, M13A	07/01 ⇒	
LIANA 1.6 i	M16A	04/02 ⇒	
SWIFT IV 1.3	M13A	02/05 ⇒	
SWIFT IV 1.3 4x4	M13A, 2AZ-FE	02/05 ⇒	

SUZUKI			
SWIFT IV 1.3 LPG	M13A	09/08 ⇒	12/10
SWIFT IV 1.5	M15A	02/05 ⇒	
SWIFT IV 1.5 4x4	M15A	02/05 ⇒	
SWIFT IV 1.6	M16A	05/06 ⇒	
SWIFT IV 1.6 4x4	M16A	02/05 ⇒	
SX4 I 1.6	M16A	10/07 ⇒	
SX4 I 1.6 AWD	M16A	10/07 ⇒	
SX4 I 1.6 LPG	M16A	06/06 ⇒	12/12
SX4 I 1.6 VVT	M16A	11/10 ⇒	12/15
SX4 I 1.6 VVT 4x4	M16A	07/09 ⇒	

TOYOTA			
4 RUNNER 3.4 4WD	5VZ-FE	11/95 ⇒	11/02
CAMRY 2.0	1AZ-FE	08/01 ⇒	11/06
CAMRY 2.4	2AZ-FE, N04C-TQ	09/01 ⇒	11/06
CAMRY SOLARA II 2.4	2AZ-FE	07/03 ⇒	11/08
DYNA 4.0 D4d	N04C-TQ, N04C-UL	08/01 ⇒	
DYNA 4.0 D4d 4WD	N04C-UL, A17DTJ	10/06 ⇒	
DYNA 4.0 Hybrid	N04C-UL	05/11 ⇒	
LAND CRUISER 90 3.4 i 24V	5VZ-FE	03/96 ⇒	12/02
PRIUS I 1.5 Hybrid	1NZ-FXE	05/00 ⇒	01/04

10.1341



07

MASS AIR FLOW METERS (MAF)

Adatt./Suitable:

BOSCH

0 281 002 832
0 281 002 833

GENERAL MOTORS

55 561 301
93 188 724

OPEL

8 36 651
93188724

VAUXHALL

93188724



Ø in	Ø out	L=mm	+B - NTC T 0
70	70	96	

OPEL			
ASTRA H 1.7 CDTi	A17DTJ, Z17DTJ	02/07 ⇒	05/14
ASTRA J 1.7 CDTi	Z17DTJ, A17DTJ	01/09 ⇒	
CORSA D 1.7 CDTi	Z17DTR	08/06 ⇒	12/11
ZAFIRA B 1.7 CDTi	A17DTJ, A17DTJ	01/08 ⇒	04/15
VAUXHALL			
ASTRA V 1.7 CDTi	A17DTJ, A17DTJ	01/04 ⇒	10/12
ASTRAVAN III 1.7 CDTi	A17DTJ, A17DTJ	06/11 ⇒	
CORSA D 1.7 CDTi	Z17DTR	11/06 ⇒	08/14
ZAFIRA B 1.7 CDTi	A17DTJ, M57D30(306D5)	01/08 ⇒	11/14

10.1348



07

10.1354



07,5

10.1355



07

MASS AIR FLOW METERS (MAF)

Adatt./Suitable:

- BMW**
- 13 62 7 793 633
- 13 62 7 801 951
- 13 62 7 805 415
- 13 62 8 509 725
- 7 793 633
- 7 801 951
- 7 805 415
- 8 509 725

- BOSCH**
- 0 281 002 713
- 0 281 002 849
- 0 281 002 936
- 0 281 006 147



Ø in	Ø out	L=mm	+B - T 0
98x88	98x88	85	

BMW		
3 V 335 d	M57D30(306D5), N47D20A	03/06 ⇒ 03/13
5 V 520 d	N47D20A, M57D30(306D4)	02/05 ⇒ 05/10
5 V 535 d	M57D30(306D4), M57D30(306D5)	09/04 ⇒ 12/10
6 II 635 d	M57D30(306D5), N47D20A	07/07 ⇒ 07/10
X3 I 2.0 d	N47D20A, M57D30(306D3)	03/07 ⇒ 03/09
X3 I 3.0 d	M57D30(306D3), M57D30(306D5)	09/05 ⇒ 08/08
X3 I 3.0 sd	M57D30(306D5), N47D20C	09/06 ⇒ 08/08
X3 I xDrive 18 d	N47D20C, M57D30(306D3)	09/08 ⇒ 12/11
X3 I xDrive 20 d	N47D20C	09/07 ⇒ 08/10
X3 I xDrive 30 d	M57D30(306D3), M57D30(306D5)	09/08 ⇒ 08/10
X3 I xDrive 35 d	M57D306D5	09/08 ⇒ 08/11
X5 II 3.0 sd	M57D30(306D5), M57D30(306D5)	10/07 ⇒ 09/08
X5 II xDrive 35 d	M57D30(306D5), M57D30(306D5)	10/08 ⇒ 06/13
X6 I 35 d	M57D30(306D5)	05/08 ⇒ 08/08
X6 I xDrive 35 d	M57D30(306D5), OM611.962	01/08 ⇒ 03/10

MASS AIR FLOW METERS (MAF)

Adatt./Suitable:

- BOSCH**
- 0 281 002 535
- 0 281 002 536
- MERCEDES-BENZ**
- 6460940048
- A 646 094 00 48

MARKET DIFFUSION: MEDIUM



Ø in	Ø out	L=mm	NTC +B - +R 0
82	83	96	

MERCEDES-BENZ		
CLASSE C II C 200 CDI	OM611.962, OM611.962	02/01 ⇒
CLASSE C II C 220 CDI	OM611.962, OM646.811	03/01 ⇒ 05/08
CLASSE C II C 30 CDI AMG	OM612.990	09/02 ⇒ 05/08
CLASSE C III C 200 CDI	OM646.811, OM646.962	01/07 ⇒ 12/11
CLASSE C III C 220 CDI	OM646.811	01/07 ⇒ 11/08
CLASSE CLC CLC 200 CDI	OM646.962, OM647.961	05/08 ⇒ 06/11
CLASSE CLC CLC 220 CDI	OM646.963	05/08 ⇒ 06/11
CLASSE CLK II 220 CDI	OM646.966	01/05 ⇒ 05/09
CLASSE E III E 200 CDI	OM646.820, OM646.821	07/02 ⇒ 07/09
CLASSE E III E 220 CDI	OM646.821, OM646.821	03/02 ⇒ 07/09
CLASSE E III E 220 T CDI	OM646.821, M273.967	03/03 ⇒ 07/09
CLASSE E III E 270 CDI	OM647.961	03/02 ⇒ 12/08
CLASSE E III E 270 T CDI	OM647.961	03/03 ⇒ 07/09
CLASSE E III E 280 CDI	OM648.961	05/04 ⇒ 12/08
CLASSE E III E 280 T CDI	OM648.961	05/04 ⇒ 07/09
CLASSE E III E 320 CDI	OM648.961	11/02 ⇒ 12/08
CLASSE E III E 320 T CDI	OM648.961	03/03 ⇒ 07/09
CLASSE E E 270 CDI	OM647.961, OM646.820	03/03 ⇒ 07/09
CLASSE S IV S 320 CDI	OM648.960	09/02 ⇒ 08/05
CLC-SERIES CLC220 CDI	OM646.963	05/08 ⇒ 06/11

MASS AIR FLOW METERS (MAF)

Adatt./Suitable:

- BOSCH**
- 0 280 218 190
- 0 280 218 191
- MERCEDES-BENZ**
- 2730940548
- 2730940648
- 2730940948
- A 273 094 06 48
- A 273 094 07 48
- A 273 094 08 48
- A 273 094 09 48



Ø in	Ø out	L=mm	+B - NTC T 0
98x88	98x88	85	

MERCEDES-BENZ		
CLASSE C II C 230	M272.920	01/05 ⇒ 05/08
CLASSE C II C 280	M272.940	01/05 ⇒ 08/07
CLASSE C II C 280 4-matic	M272.941	01/05 ⇒ 08/07
CLASSE C II C 350	M272.960	01/05 ⇒ 05/08
CLASSE C II C 350 4-matic	M272.970	01/05 ⇒ 08/07
CLASSE C III C 230	M272.921	01/07 ⇒ 08/14
CLASSE C III C 230 4-matic	M272.911	07/07 ⇒ 01/14
CLASSE C III C 250	M272.921	01/07 ⇒
CLASSE C III C 250 4-matic	M272.911	07/07 ⇒
CLASSE C III C 280	M272.947	01/07 ⇒ 08/14
CLASSE C III C 280 4-matic	M272.948	07/07 ⇒ 01/14
CLASSE C III C 300	M272.947	08/07 ⇒ 08/14
CLASSE C III C 300 4-matic	M272.948	07/07 ⇒ 01/14
CLASSE C III C 350	M272.961	01/07 ⇒ 08/14
CLASSE C III C 350 4-matic	M272.971	07/07 ⇒ 01/14
CLASSE C III C 350 CGI	M272.982	09/08 ⇒ 01/14
CLASSE CLC CLC 230	M272.920	05/08 ⇒ 06/11
CLASSE CLC CLC 350	M272.960	05/08 ⇒ 06/11
CLASSE CLC CLC250 [ExtraEU]	M272.920	06/09 ⇒ 06/11
CLASSE CLK II 280	M272.940	01/05 ⇒ 05/09
CLASSE CLK II 350	M272.960	01/05 ⇒ 05/09
CLASSE CLK II 500	M273.967, M272.964	06/06 ⇒
CLASSE CLK II 550	M273.967	06/06 ⇒
CLASSE CLK II CLK 280	M272.940	01/05 ⇒ 03/10
CLASSE CLK II CLK 350	M272.960	01/05 ⇒ 03/10
CLASSE CLK II CLK 500	M273.967	06/06 ⇒ 03/10
CLASSE CLS I CLS 280	M272.943	07/08 ⇒ 12/10
CLASSE CLS I CLS 300	M272.943	04/09 ⇒ 12/10
CLASSE CLS I CLS 350	M272.964, M272.944	10/04 ⇒ 12/10
CLASSE CLS I CLS 500	M273.960	04/06 ⇒ 12/10
CLASSE CLS I CLS 550	M273.960	04/06 ⇒ 02/11
CLASSE E III 350 CGI	M272.985	05/06 ⇒ 07/09
CLASSE E III E 230	M272.922	09/07 ⇒ 12/08
CLASSE E III E 230 T	M272.922	05/07 ⇒ 07/09
CLASSE E III E 250	M272.922	09/07 ⇒ 12/08
CLASSE E III E 280	M272.943	03/05 ⇒ 12/08
CLASSE E III E 280 4-matic	M272.944, M272.972	03/05 ⇒ 12/08
CLASSE E III E 280 T	M272.943	03/05 ⇒ 07/09
CLASSE E III E 280 T 4-matic	M272.944	03/05 ⇒ 07/09
CLASSE E III E 300	M272.943	03/05 ⇒ 12/08
CLASSE E III E 300 T 4-matic	M272.944	03/05 ⇒ 07/09
CLASSE E III E 350	M272.964	03/05 ⇒ 12/08
CLASSE E III E 350 4-matic	M272.972, M272.952	08/04 ⇒ 12/08
CLASSE E III E 350 CGI	M272.985	09/07 ⇒ 12/08
CLASSE E III E 350 T	M272.964	03/05 ⇒ 07/09
CLASSE E III E 350 T 4-matic	M272.972	03/05 ⇒ 07/09
CLASSE E III E 500	M273.960	04/06 ⇒ 12/08

MERCEDES-BENZ

CLASSE E III E 500 4-matic	M273.962	04/06 → 12/08
CLASSE E III E 500 T	M273.960	04/06 → 07/09
CLASSE E III E 500 T 4-matic	M273.962	04/06 → 07/09
CLASSE E III E 550 4-matic	M273.962	04/06 → 12/08
CLASSE E III E 550 T 4-matic	M273.962	04/06 → 07/09
CLASSE E IV E 250	M272.923	01/10 →
CLASSE E IV E 300	M272.952, M272.961	01/09 →
CLASSE E IV E 350	M272.961, M272.982	01/09 →
CLASSE E IV E 350 4-matic	M272.977	01/09 →
CLASSE E IV E 350 CGI	M272.982, M272.961	01/09 →
CLASSE E IV E 500	M273.966	01/09 →
CLASSE E IV E 500 4-matic	M273.970	01/09 →
CLASSE E IV E 550 [USA]	M273.966	01/09 →
CLASSE E IV E 550 [USA] [CAN] [JPN]	M273.971	01/09 →
CLASSE E IV E 550 4-matic [USA] [CAN]	M273.970	01/09 →
CLASSE E IV E350 [ExtraEU]	M272.961, M273.963	05/11 →
CLASSE G II G 500	M273.963, M273.963	01/07 →
CLASSE G II G 500 GUARD	M273.963	06/10 →
CLASSE G II G 550	M273.963, M272.966	06/10 →
CLASSE GL I GL 450 4-matic	M273.923	09/06 →
CLASSE GL I GL 500 4-matic	M273.963	09/06 →
CLASSE GL I GL 550 4-matic	M273.963	09/06 →
CLASSE GLK 280 4-matic	M272.948	06/08 → 06/09
CLASSE GLK 300 4-matic	M272.948	07/09 → 04/11
CLASSE GLK 350	M272.991	04/09 → 06/15
CLASSE GLK 350 4-matic	M272.971	06/08 → 04/11
CLASSE M II ML 300	M272.945	07/09 →
CLASSE M II ML 300 4-matic	M272.945	03/10 → 12/11
CLASSE M II ML 350	M272.967	07/05 →
CLASSE M II ML 350 4-matic	M272.967	02/05 → 12/11
CLASSE M II ML 450 4-matic Hybrid	M272.973	07/05 →
CLASSE M II ML 500 4-matic	M273.963	12/07 → 12/11
CLASSE M II ML 550 4-matic	M273.963	12/07 →
CLASSE R R 280	M272.945	01/07 →
CLASSE R R 280 4-matic	M272.945	05/07 →
CLASSE R R 300	M272.945	07/09 →
CLASSE R R 300 4-matic	M272.945	07/09 →
CLASSE R R 350	M272.967	01/07 →
CLASSE R R 350 4-matic	M272.967	01/06 →
CLASSE R R 500 4-matic	M273.963	01/07 →
CLASSE R R 550 4-matic	M273.963	01/07 →
CLASSE S V CL 500	M273.961	06/06 → 12/13
CLASSE S V CL 500 4-matic	M273.968	02/08 → 12/13
CLASSE S V CL 550 [JPN]	M273.961	06/06 →
CLASSE S V CL 550 [USA]	M273.961	06/06 →
CLASSE S V CL 550 4-matic [JPN]	M273.968	02/08 →
CLASSE S V CL 550 4-matic [USA]	M273.968	02/08 →
CLASSE S V S 280	M272.946	08/06 → 12/13
CLASSE S V S 300	M272.946	08/06 → 12/13
CLASSE S V S 350	M272.965	10/05 → 12/13
CLASSE S V S 350 4-matic	M272.975	02/08 → 12/13
CLASSE S V S 400 Hybrid	M272.974	01/09 → 12/13
CLASSE S V S 450	M273.922	12/05 → 12/13
CLASSE S V S 450 4-matic	M273.924	12/05 → 12/13
CLASSE S V S 500	M273.961	10/05 → 12/13
CLASSE S V S 500 4-matic	M273.968	10/05 → 12/13
CLASSE S V S 550 [JPN]	M273.961	10/05 →
CLASSE S V S 550 [USA]	M273.961	10/05 →
CLASSE S V S 550 4-matic [JPN]	M273.968	10/05 →
CLASSE S V S 550 4-matic [USA]	M273.968	10/05 →
CLASSE SL V 280	M272.949	03/08 → 01/12
CLASSE SL V 300	M272.949	04/09 → 01/12
CLASSE SL V 350	M272.966, M272.963	03/06 → 01/12
CLASSE SL V 500	M273.965	03/06 → 01/12
CLASSE SL V 550	M273.965	03/06 → 01/12
CLASSE SLK II 280	M272.942	01/05 → 02/11
CLASSE SLK II 300	M272.942	04/09 → 02/11
CLASSE SLK II 350	M272.963, AZV	06/04 → 02/11
E-SERIES E250	M272.922	05/07 → 12/08
R-SERIES R300	M272.945	07/09 → 12/11
SPRINTER II 224	M272.979	06/06 →
SPRINTER II 324	M272.979	06/06 → 12/13
SPRINTER II 424	M272.979	06/06 → 12/13
SPRINTER II 524	M272.979	06/06 → 12/13
VIANO 3.5	M272.978	09/07 →
VITO II 126	M272.978	09/07 →

10.1357



07

MASS AIR FLOW METERS (MAF)

Adatt./Suitable:

AUDI
03G 906 461 C

BOSCH
0 281 002 735
0 281 002 736

SEAT
03G 906 461 C

SKODA
03G 906 461 C

VW
03G 906 461 C

MARKET DIFFUSION: HIGH



Ø in	Ø out	L=mm	+B - T 0
80	80	110	

AUDI

A3 I [USA] 2.0	CBEA	08/09 →
A3 I [USA] 2.0 16V	--	01/06 → 12/10
A3 II 1.6 TDI	CAYC	05/09 → 05/13
A3 II 2.0 TDI	AZV, BKD	05/03 → 05/13
A3 II 2.0 TDI 16V	BKD, BKD	05/03 → 08/12
A3 II 2.0 TDI 16V quattro	BKD, BMN	08/04 → 08/12
A3 II 2.0 TDI quattro	BMN, AZV	03/06 → 08/12
A3 II SPORTBACK 2.0 TDI	AZV, BKD	09/04 → 03/13
A3 II SPORTBACK 2.0 TDI 16V	BKD, BKD	09/04 → 03/13
A3 II SPORTBACK 2.0 TDI 16V quattro	BKD, CAGA	11/05 → 03/13
A4 IV 2.0 TDI	CAGA, CAGA	11/07 → 12/15
A4 IV 2.0 TDI quattro	CAGA, CAGA	01/08 → 12/15
A4 IV ALLROAD 2.0 TDI quattro	CAGA, CAGA	04/09 → 05/16
A5 I 2.0 TDI	CAGA, BNA	08/08 → 01/17
A5 I 2.0 TDI quattro	CAHA	08/08 → 03/12
A6 III 2.0 TDI	BNA, CAGA	07/04 → 08/11
Q5 I 2.0 TDI quattro	CAGA, CBBB	11/08 →
TT II 2.0 TDI quattro	CBBB, BMN	06/08 → 06/14

SEAT

ALTEA 2.0 TDI	BMN, BMN	03/06 →
ALTEA XL 2.0 TDI	BMN, BMN	06/07 →
ALTEA XL 2.0 TDI 4x4	BMN, CAGA	06/07 →
EXEO 2.0 TDI	CAGA, BMN	12/08 →
LEON II 2.0 TDI	BMN, BMN	05/06 → 12/12
TOLEDO III 2.0 TDI	BMN, BMN	01/06 → 05/09

SKODA

OCTAVIA II 2.0 TDI RS	BMN, CBBB	04/06 → 02/13
SUPERB II 2.0 TDI	CBBB, CBBB	07/08 → 05/15
SUPERB II 2.0 TDI 4x4	CBBB, CBDB	09/08 → 05/15
YETI 2.0 TDI 4x4	CBDB, CFFB	05/09 → 12/17

VW

BEETLE 2.0 TDI	CFFB, AXD	04/11 → 07/16
CAMPOMOBILE 2.5 TDi	AXD, CBAB	03/04 → 11/09
EOS 2.0 TDI 16V	CBAB, CFFB	05/08 → 08/15
GOLF V 2.0 TDI	AZV, BKD	05/05 →
GOLF V 2.0 TDI 16V	BKD, CBDB	01/05 → 12/13
GOLF VI 2.0 TDI	CBAA, CBAB	10/08 →
GOLF VI 2.0 TDI 4motion	CBAB, AXD	05/09 → 11/12
GOLF 2.0 TDi	CFFB, AZV	09/09 → 11/12
GOLF VAN 2.0 TDi	CBDB, CBAA	07/09 → 05/19
JETTA V 2.0 TDI 16V	CBEA	08/05 → 10/10
JETTA VI 2.0 TDI	CJAA	02/11 →
MULTIVAN 2.5 TDI	AXD, AXD	04/03 → 11/09
MULTIVAN 2.5 TDI 4motion	AXD, CBAA	07/04 → 11/09
PASSAT V 2.0 BlueTDI	CBAC	01/09 → 11/10
PASSAT V 2.0 TDI	BMA, BKP	03/05 → 11/10
PASSAT V 2.0 TDI 16V	BKP, BKP	03/05 → 07/10
PASSAT V 2.0 TDI 16V 4motion	BKP, CBBB	08/05 → 11/10

VW

PASSAT V 2.0 TDI 4motion	CBBB	05/09 → 11/10
PASSAT CC 2.0 BlueTDI	CBAC	05/09 → 11/10
PASSAT CC 2.0 TDI	CBAA, CBAB	06/08 → 01/12
PASSAT CC 2.0 TDI 4motion	CBAB, BMA	08/09 → 01/12
SCIROCCO III 2.0 TDI	CBBB, CBAB	08/08 → 11/17
SCIROCCO 2.0 TDi	CBBB, CBBB	08/08 → 05/14
TIGUAN I 2.0 TDI	CBAB, CBAA	03/08 →
TIGUAN I 2.0 TDI 4motion	CBAA, BAC	09/07 →
TOUAREG I 2.5 R5 TDI	BAC, CFHC	01/03 → 05/10
TOURAN I 2.0 TDI	CFHC, AXD	05/10 → 05/15
TRANSPORTER V 2.5 TDI	AXD, AXD	04/03 → 11/09
TRANSPORTER V 2.5 TDI 4motion	AXD, 605960	04/04 → 11/09

10.1358



07

MASS AIR FLOW METERS (MAF)

Adatt./Suitable:

CONTINENTAL
5WK9 7026

MERCEDES-BENZ
A 000 094 28 48
A 000 094 29 48
A 000 094 33 48

MITSUBISHI
1525A001

SIEMENS
5WK9 7003
5WK97003Z

SMART
A 000 094 29 48
A 000 094 33 48

ITEM NOW AVAILABLE FROM PRODUCTION

- ARTICOLO ORA DISPONIBILE PER LA VENDITA
- ARTICLO DISPONIBILE EN PRODUCTION COURANTE
- JETZT ZUM VERKAUF VERFÜGBARER ARTIKEL
- ARTICULO AHORA DISPONIBLE EN PRODUCCION

MARKET DIFFUSION: MEDIUM



Ø in	Ø out	L=mm	+B - T 0
70	70	96	

MERCEDES-BENZ

CLASSE A II A 160 CDI	OM640.942	09/04 → 06/12
CLASSE A II A 180 CDI	OM640.940	09/04 → 06/12
CLASSE A II A 200 CDI	OM640.941	09/04 → 06/12
CLASSE B I B 180 CDI	OM640.940	03/05 → 11/11
CLASSE B I B 200 CDI	OM640.941	03/05 → 11/11

MITSUBISHI

COLT VI 1.5 DiD	605910	08/04 → 06/12
COLT VI 1.5 Di-D	605960, EXL	08/04 → 06/12

SMART

FORFOUR 1.5 CDI	OM639.939	09/04 → 06/06
-----------------	-----------	---------------



MASS AIR FLOW METERS (MAF)

Adatt./Suitable:

BOSCH

0 281 002 656
0 281 002 657
0 281 002 896
0 281 002 897
0 281 002 978
0 281 002 979

CHRYSLER

53013673AA
K53013673AA

JEEP

53013673AA

MERCEDES-BENZ

0000942248
0000943248
0000943448
0040943448
A 000 094 22 48
A 000 094 32 48
A 000 094 34 48
A 004 094 34 48

MOPAR PARTS

53013673AA

VW

2E0 906 461
2E0 906 461 C

MARKET DIFFUSION: MEDIUM



Ø in	Ø out	L=mm	
82	83	96	

CHRYSLER

300C I 3.0 CRD	EXL	09/05 ⇨ 11/12
300C I 3.0 V6 CRD	EXL	11/10 ⇨ 11/12
300C II 3.0 CRD	EXL	09/05 ⇨ 12/10

JEEP

COMMANDER 3.0 CRD 4x4	EXL, EXL	09/05 ⇨ 12/10
GRAND CHEROKEE 3.0 CRD	EXL	06/05 ⇨ 12/10
GRAND CHEROKEE 3.0 CRD 4x4	EXL, OM651.955	06/05 ⇨ 12/10

MERCEDES-BENZ

CLASSE G II G 280 CDI	OM642.975	04/09 ⇨
SPRINTER II 213 CDI	OM651.955, OM651.955	06/06 ⇨
SPRINTER II 216 CDI	OM651.955, OM642.896	03/09 ⇨
SPRINTER II 219 CDI / BlueTEC	OM642.896, OM651.955	03/09 ⇨
SPRINTER II 311 CDI	OM646.701	09/13 ⇨
SPRINTER II 311 CDI 4x4	OM646.985	02/08 ⇨ 12/09
SPRINTER II 313 CDI	OM651.955, OM651.955	08/11 ⇨ 05/16
SPRINTER II 313 CDI 4x4	OM651.955, OM642.896	08/11 ⇨ 05/16
SPRINTER II 318 CDI	OM642.896, OM642.896	02/08 ⇨ 12/09
SPRINTER II 318 CDI 4x4	OM642.896, OM642.896	02/08 ⇨ 12/09
SPRINTER II 319 CDI / BlueTEC	OM642.896, OM642.896	03/09 ⇨
SPRINTER II 319 CDI / BlueTEC 4x4	OM642.896, OM646.986	03/09 ⇨
SPRINTER II 411 CDI	OM646.701	06/09 ⇨
SPRINTER II 413 CDI	OM646.986	06/06 ⇨ 05/16
SPRINTER II 415 CDI	OM646.986, OM642.896	06/06 ⇨ 12/09
SPRINTER II 418 CDI	OM642.896, OM642.896	06/06 ⇨ 05/16
SPRINTER II 419 CDI	OM642.896, OM646.986	03/09 ⇨
SPRINTER II 511 CDI 4x4	OM646.985	06/06 ⇨ 12/09
SPRINTER II 515 CDI	OM646.986, OM646.986	06/06 ⇨ 12/09
SPRINTER II 515 CDI 4x4	OM646.986, OM642.896	06/06 ⇨ 12/09
SPRINTER II 518 CDI 4x4	OM642.896, OM642.896	06/06 ⇨ 12/09
SPRINTER II 519 CDI / BlueTEC	OM642.896, OM642.896	03/09 ⇨
SPRINTER II 519 CDI / BlueTEC 4x4	OM642.896, OM642.896	03/09 ⇨
SPRINTER 319 CDI	OM642.899	02/18 ⇨
SPRINTER 419 CDI	OM642.899	02/18 ⇨

MERCEDES-BENZ

SPRINTER 519 CDI	OM642.899	02/18 ⇨
SPRINTER SERIES Sprinter 213D CDI	OM646.986	04/12 ⇨
SPRINTER SERIES Sprinter 318D CDI	OM642.896, OM642.890	03/09 ⇨
VIANO CDI 3.0	OM642.890, OM646.980	03/06 ⇨
VITO II 109 CDI	OM646.980, BJJ	08/06 ⇨
VITO II 109 CDI 4x4	OM646.981	09/07 ⇨
VITO II 120 CDI	OM642.990	07/06 ⇨
VITO II 122 CDI	OM642.890	09/10 ⇨
VW		
CRAFTER 2.5 TDI	BJJ, M9R740	04/06 ⇨



MASS AIR FLOW METERS (MAF)

Adatt./Suitable:

CONTINENTAL

5WK9 7005

RENAULT

82 00 280 065

H82 00 327 690

SIEMENS

5WK9 7005

SUZUKI

13800-67JA0

13800-67JA0-000

ITEM NOW AVAILABLE FROM PRODUCTION

- ARTICOLO ORA DISPONIBILE PER LA VENDITA
- ARTICLE DISPONIBLE EN PRODUCTION COURANTE
- JETZT ZUM VERKAUF VERFÜGBARER ARTIKEL
- ARTICULO AHORA DISPONIBLE EN PRODUCCION



Ø in	Ø out	L=mm	
80	80	106	

RENAULT

ESPACE IV 2.0 dCi	M9R740, M9R700	01/06 ⇨
GRAND SCÉNIC II 2.0 dCi	M9R700, M9R740	09/05 ⇨
LAGUNA II 2.0 dCi	M9R740, M9R742	08/05 ⇨ 12/07
LAGUNA III 2.0 dCi	M9R742, M9R816	10/07 ⇨
LAGUNA III 2.0 dCi GT	M9R816, M9R824	03/08 ⇨ 12/15
LATITUDE 2.0 dCi 130	M9R756	12/13 ⇨
LATITUDE 2.0 dCi 150	M9R824, M9R804	02/11 ⇨
LATITUDE 2.0 dCi 175	M9R804, M9R700	05/11 ⇨
MEGANE II 2.0 dCi	M9R700, M9R700	09/05 ⇨
SCÉNIC II 2.0 dCi	M9R700, M9R760	09/05 ⇨
VEL SATIS 2.0 dCi	M9R760, F9QB	08/05 ⇨

SUZUKI

GRAND VITARA II 1.9 DDiS	F9QB	03/06 ⇨ 08/08
GRAND VITARA II 1.9 DDiS Trazione integrale	F9QB, K9K276	10/05 ⇨ 02/15



MASS AIR FLOW METERS (MAF)

Adatt./Suitable:

NISSAN

22680-00QAA
22680-BC400

RENAULT

82 00 299 956
82 00 358 901

SIEMENS

5WK9 7007

MARKET DIFFUSION: MEDIUM



Ø in	Ø out	L=mm	
70	70	110	

NISSAN

MICRA III 1.5 dCi	K9K276, K9K276	09/03 ⇨ 06/10
NOTE I 1.5 dCi	K9K276, K9K	03/06 ⇨ 06/12
NV200 / EVALIA 1.5 dci	K9K, K9K	07/10 ⇨
NV200 1.5 dci	K9K, K9K	02/10 ⇨
TIIDA I 1.5 dCi	K9K, K9K764	01/07 ⇨ 06/13

RENAULT

CLIO III 1.5 dCi	K9K764, K9K780	06/05 ⇨
LAGUNA III 1.5 dCi	K9K780, K9K752	10/07 ⇨ 12/15
MODUS / GRAND MODUS 1.5 dCi	K9K752, G9U720	12/04 ⇨

10.1364



07,5

MASS AIR FLOW METERS (MAF)

Adatt./Suitable:

CONTINENTAL
5WK9 7008**GENERAL MOTORS**
93 856 812**NISSAN**
16580-00Q0A
22680-JD50A**OPEL**
44 16 861
93856812**RENAULT**
82 00 280 060
H82 00 300 002**SIEMENS**
5WK9 7008**SUZUKI**
13800-84A50
13800-84A50-000**VAUXHALL**
93856812

MARKET DIFFUSION: MEDIUM



Ø in	Ø out	L=mm	
70	70	110	

VAUXHALL

VIVARO 2.5 CDTI	G9U630, D4FB	04/03 → 07/14
VIVARO 2.5 DTI	G9U630	07/03 → 07/14

10.1372



07

MASS AIR FLOW METERS (MAF)

Adatt./Suitable:

BOSCH
0 281 002 723**HYUNDAI**
28164-2A401
28164-2A500**KIA**
28164-2A401
28164-2A500

MARKET DIFFUSION: MEDIUM

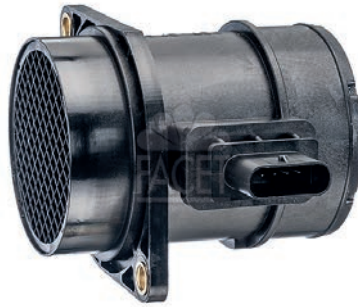

Ø in	Ø out	L=mm	+B - NTC T O
70	70	96	

HYUNDAI

ACCENT III 1.5 CRDi GLS	D4FA	11/05 → 11/10
ACCENT IV 1.6 CRDi	D4FB, D4FB	11/10 →
ELANTRA IV 1.6 CRDi	D4FB	02/06 →
ELANTRA V 1.6 CRDi	D4FB, D3EA	02/11 →
GETZ 1.5 CRDi	D3EA, D4FC	03/03 → 06/09
GETZ 1.5 CRDi GLS	D4FA	08/05 → 06/09
I10 I 1.1 CRDi	D3FA	01/08 → 12/11
I20 1.1 CRDi	D3FA	05/15 →
I20 1.4 CRDi	D4FC	05/15 →
I20 I 1.1 CRDi	D3FA	03/12 → 12/15
I20 I 1.4 CRDi	D4FC, D4FB	08/08 → 12/15
I20 I 1.6 CRDi	D4FB, D4FB	09/08 → 12/12
I20 II 1.1 CRDi	D3FA	11/14 →
I20 II 1.4 CRDi	D4FC	05/15 →
I30 1.6 CRDi	D4FB	05/15 →
I30 1.6 CRDi VGT	D4FB	10/07 → 11/11
I30 I 1.6 CRDi	D4FB, D4FB	10/07 → 06/12
I30 II 1.4 CRDi	D4FC	12/11 →
I30 II 1.6 CRDi	D4FB, D4FB	11/11 →
I30 III 1.6 CRDi	D4FB, D4FD	11/16 →
I30 III 1.6 CRDi VGT [ExtraEU]	D4FE	08/18 →
I40 1.6 CRDi	D4FE	07/18 →
I40 1.7 CRDi	D4FD, D4FC	07/11 →
IX20 1.4 CRDi	D4FC, D3EA	11/10 →
IX20 1.6 CRDi	D4FB	06/11 →
IX35 1.7 CRDi	D4FD	11/10 →
KONA 1.6 CRDi	D4FE	08/18 →
KONA 1.6 CRDi e-VGT	D4FE	08/18 →
KONA 1.6 CRDi e-VGT AWD	D4FE	08/18 →
LAVITA 1.5 CRDi	--	01/07 →
MATRIX 1.5 CRDi	D3EA, D4FD	10/01 → 08/10
MATRIX 1.5 CRDi VGT	D4FA	08/05 → 08/10
MATRIX 1.5 CRDi VGT [TUR]	D4FA	04/08 →
SB 11 1.6 CRDi	--	01/11 →
TUCSON 1.6 CRDi	D4FE	08/18 →
TUCSON 1.6 CRDi Trazione integrale	D4FE	08/18 →
TUCSON 1.7 CRDi	D4FD	06/15 →
VERNA II 1.5 CRDi GLS	--	11/05 →

KIA

CARENS III 1.6 CRDi 110	D4FB	10/10 →
CARENS III 1.6 CRDi 128	D4FB	10/10 →
CARENS IV 1.7 CRDi	D4FD, D4FB	03/13 →
CEED I 1.6 CRDi 115	D4FB	12/06 → 12/12
CEED I 1.6 CRDi 128	D4FB	10/10 → 12/12
CEED I 1.6 CRDi 90	D4FB, D4FA	12/06 → 12/12
CEED II 1.4 CRDi	D4FC	04/15 →

KIA

CEED II 1.4 CRDi 90	D4FC	05/12 →
CEED II 1.6 CRDi	D4FB	07/12 →
CEED II 1.6 CRDi 110	D4FB	05/12 →
CEED II 1.6 CRDi 115	D4FB	05/12 →
CEED II 1.6 CRDi 128	D4FB	05/12 →
CEED II 1.6 CRDi 136	D4FB	07/15 →
CEED II 1.6 CRDi 90	D4FB-L	05/12 →
CEED III 1.6 CRDi [ExtraEU]	D4FE	03/18 →
CEED III 1.6 CRDi 115	D4FE	05/18 →
CEED III 1.6 CRDi 136	D4FE	05/18 →
CERATO I 1.5 CRDi	D4FA, D4FD	07/05 →
CERATO I 1.6 CRDi	D4FB	06/05 →
OPTIMA III 1.7 CRDi	D4FD, D4FB	03/12 →
OPTIMA IV 1.6 CRDi	D4FE	01/18 →
OPTIMA IV 1.7 CRDi	D4FD	11/15 →
PROCEED 1.6 CRDi 136	D4FE	10/18 →
PRO CEE'D I 1.6 CRDi 115	D4FB	02/08 → 09/12
PRO CEE'D I 1.6 CRDi 128	D4FB	10/10 → 09/12
PRO CEE'D I 1.6 CRDi 90	D4FB, D4FA	02/08 → 09/12
PRO CEE'D II 1.4 CRDi 90	D4FC	03/13 →
PRO CEE'D II 1.6 CRDi 110	D4FB	03/13 →
PRO CEE'D II 1.6 CRDi 128	D4FB	03/13 →
PRO CEE'D II 1.6 CRDi 136	D4FB	07/15 →
PRO CEE'D 1.4 CRDi	D4FC	05/15 →
PRO CEE'D 1.6 CRDi	D4FB	10/12 →
RIO II 1.5 CRDi	D4FA, D4FD	03/05 →
RIO III 1.1 CRDi	D3FA	09/11 →
RIO III 1.4 CRDi	D4FC	09/11 →
RIO 1.1 CRDi	D3FA	09/11 →
RIO 1.4 CRDi	D4FC	04/15 →
RIO IV 1.4 CRDi 77	D4FC	01/17 →
RIO IV 1.4 CRDi 90	D4FC	01/17 →
SOUL I 1.6 CRDi 115	D4FB	02/09 →
SOUL I 1.6 CRDi 128	D4FB	02/09 →
SOUL I 1.6 CVVT	G4FC	02/09 →
SOUL I 1.6 LPG	G4FC	02/09 → 12/14
SOUL II 1.6 CRDi 128	D4FB	02/14 →
SOUL II 1.6 CRDi 136	D4FB	04/15 →
SPORTAGE III 1.7 CRDi	D4FD, D4FD	12/10 →
SPORTAGE IV 1.6 CRDi	D4FE	07/18 →
SPORTAGE IV 1.6 CRDi AWD	D4FE	07/18 →
SPORTAGE IV 1.7 CRDi	D4FD, D4FB	09/15 →
STONIC 1.6 CRDi	D4FB, D4EB	07/17 →
VENGA 1.4 CRDi 75	D4FC	02/10 →
VENGA 1.4 CRDi 90	D4FC	02/10 →
VENGA 1.6 CRDi 115	D4FB	02/10 →
VENGA 1.6 CRDi 128	D4FB	02/10 →
VENGA CRDi	D4FC	04/15 →

NISSAN

INTERSTAR dCi 100	G9U720, F4R720	11/03 →
INTERSTAR dCi 80	F9Q772	04/02 →
INTERSTAR dCi 90	G9T750	07/02 →
PRIMASTAR 1.9 dCi 100	F9Q760	07/02 →
PRIMASTAR 1.9 dCi 80	F9Q762	09/02 →
PRIMASTAR 2.0	F4R720, M9R630	03/01 →
PRIMASTAR 2.0 dCi 115	M9R630, M9R630	09/06 →
PRIMASTAR 2.0 dCi 90	M9R630, G9U630	09/06 →
PRIMASTAR 2.5 dCi 115	G9U630, G9U630	09/08 →
PRIMASTAR 2.5 dCi 140	G9U730	07/03 →
PRIMASTAR 2.5 dCi 150	G9U632	09/06 →
PRIMASTAR dCi 100	F9Q760	03/01 →
PRIMASTAR dCi 115	G9U630, M9R630	09/08 →
PRIMASTAR dCi 120	M9R630, M9R630	09/06 →
PRIMASTAR dCi 140	G9U730	07/03 →
PRIMASTAR dCi 150	G9U632	09/06 →
PRIMASTAR dCi 80	F9Q762	03/01 →
PRIMASTAR dCi 90	M9R630, K9K	09/06 →
QASHQAI 1.5 dCi	K9K, K9K	08/08 → 11/13
QASHQAI I 1.5 dCi	K9K, G9U632	02/07 → 12/13

OPEL

MOVANO A 2.5 CDTI	G9U632, M9R630	10/03 →
VIVARO A 2.0 CDTI	M9R630, G9MB6	01/06 →
VIVARO A 2.5 CDTI	G9MB6, K9K608	08/06 →

RENAULT

GRAND SCÉNIC II 1.5 dCi	K9K734	06/06 → 11/08
KANGOO II 1.5 dCi	K9K608, K9K636	02/08 →
KANGOO II 1.5 dCi 110	K9K636, K9K800	09/10 →
KANGOO II 1.5 dCi 85	K9K800, G9U632	02/08 →
MASTER II 2.5 dCi	G9U632, K9K724	08/06 →
MASTER II 2.5 dCi 100	G9U650	10/03 →
MEGANE II 1.5 dCi	K9K724, K9K732	08/03 → 12/10
SCÉNIC II 1.5 dCi	K9K732, M9R630	05/05 →
SCÉNIC 1.5 dCi	K9K734	06/07 → 11/08
TRAFIC II 2.0 dCi 115	M9R630, M9R630	08/06 →
TRAFIC II 2.0 dCi 90	M9R630, G9U632	08/06 →
TRAFIC II 2.5 dCi	G9U630	08/07 →
TRAFIC II 2.5 dCi 115	G9U630	02/08 →
TRAFIC II 2.5 dCi 145	G9U630	08/06 →

SUZUKI

JIMNY III 1.5 DDiS 4x4	K9K266	08/05 →
------------------------	--------	---------

VAUXHALL

MOVANO A 2.5 CDTI	G9U632, M9R630	10/01 → 12/10
VIVARO 2.0 CDTI	M9R630, G9U630	01/06 → 07/14



MASS AIR FLOW METERS (MAF)

Adatt./Suitable:

BOSCH0 280 218 199
0 281 002 721**HYUNDAI**28164-27800
28164-4A900**KIA**28164-27800
28164-4A900**SSANGYONG**6650943148
A6650943148

MARKET DIFFUSION: MEDIUM



Ø in	Ø out	L=mm	+B - NTC T O
80	80	96	

HYUNDAI

GRANDEUR 2.2 CRDi	D4EB, D4CB	06/06 → 12/11
H-1 I 2.5 CRDi	D4BE, D4CB	07/01 →
H-1 I 2.5 CRDi 4WD	D4CB	12/02 → 04/04
H-1 I 2.5 CRDi 4x4	D4CB	12/02 →
H-1 II 2.5 CRDi	D4CB, 4D56T	02/08 →
H1 2.5 CRDi	D4CB, D4BE	12/02 → 08/07
H100 2.5 CRDi	D4CB	01/04 →
H100 2.5 TCI	--	01/04 →
H100 2.5 TD	4D56T, D4CB	11/06 →
H200 2.5 CRDi	D4CB	02/03 → 04/04
H300 2.5 CRDi	D4CB, D4EA	09/07 →
H350 2.5 CRDi	D4CB	04/15 →
I30 I 2.0 CRDi	D4EA, D4EB	10/07 → 06/12
PORTER II 2.5 CRDi	D4CB	05/04 →
PORTER II 2.5 TCI	D4BH	05/04 →
SANTA FE I 2.2 CRDi	D4EB	10/05 → 03/06
SANTA FE II 2.2 CRDi	D4EB, D4EB	03/06 → 12/12
SANTA FE II 2.2 CRDi 4x4	D4EB, D4EA	10/05 → 12/12
SANTA FE II 2.2 CRDi GLS	D4EB	03/06 → 12/09
SANTA FE II 2.2 CRDi GLS 4x4	D4EB	03/06 → 12/09
SONATA V 2.0 CRDi	D4EA, D4EA	02/06 → 12/10
STAREX 2.5 CRDi	D4CB	09/07 →
TUCSON 2.0	G4GC	08/04 →
TUCSON 2.0 CRDi	D4EA, D4EA	01/06 → 03/10
TUCSON 2.0 CRDi Trazione integrale	D4EA, D4EA	01/06 → 03/10
TUCSON 2.0 CVT LPG	G4GC	06/04 → 03/10
TUCSON 2.7 Trazione integrale	G6BA	08/04 →

KIA

BONGO IV 2.5 CRDi	D4CB	01/12 →
BONGO IV 2.9 CRDi	J3	04/07 →
BONGO IV 2.9 TDiC	HJ3	10/03 →
BONGO IV 2.9 TDiC 4WD	HJ3	10/03 →
CARENS II 2.0 CRDi	D4EA, HJ3	07/02 →
CARENS III 2.0 CRDi 115	D4EA	05/07 →
CARENS III 2.0 CRDi 135	D4EA	08/09 →
CARENS III 2.0 CRDi 140	D4EA	09/06 →
CARNIVAL II 2.9 CRDi	HJ3, D4EA	06/06 →
CARNIVAL II 2.9 CRDi LX	J3	09/06 →
CEED I 2.0 CRDi	D4EA	06/07 → 12/12
CEED I 2.0 CRDi 140	D4EA, D4EA	07/07 → 12/12
K2500 2.5 CRDi	D4CB	01/10 →
K-SERIES 2.9 CRDi	J3	08/07 →
K2900 2.9 D	J3	01/08 →
MAGENTIS II 2.0 CRDi	D4EA, D4EA	11/05 →
OPTIMA II 2.0 CRDi	D4EA	09/06 →
PRO CEE'D I 2.0 CRDi 140	D4EA, D4CB	02/08 → 09/12
SORENTO 2.5 CRDi [ExtraEU]	D4CB	09/06 → 12/11

KIA

SORENTO I 2.5 CRDi	D4CB, D4EA	08/02 →
SPORTAGE II 2.0 CRDi	D4EA, D4EA	02/05 →
SPORTAGE II 2.0 CRDi 4WD	D4EA, D20DT	09/04 →

SSANGYONG

ACTYON I 2.0 Xdi	D20DT	11/05 →
ACTYON I 200 Xdi 4WD	D20DT	10/06 →
KYRON 2.0 Xdi	D20DT, D20DT	05/05 →
KYRON 2.0 Xdi [ExtraEU]	D20DT	05/05 →
KYRON 2.0 Xdi 4x4	D20DT, D20DT	05/05 →
KYRON 2.7 Xdi 4x4	D20DT, D27DTP	05/05 →
REXTON I 2.7 D 4x4	D27DTP, D27DT	05/06 →
REXTON I 2.7 Xdi	D27DT, D27DT	08/04 →
REXTON I 2.7 Xdi Trazione integrale	D27DT, D27DT	07/12 →
REXTON I 2.9 TD	OM60129TD	04/02 →
REXTON I 3.2 4x4	G32D	04/02 →
RODIUS 2.7 Xdi	D27DT, D27DT	05/05 →
RODIUS 2.7 Xdi 4WD	D27DT, EDJ	05/05 →
RODIUS 3.2	M162E32	05/05 →
RODIUS 3.2 [ExtraEU]	M162E32	06/12 →
RODIUS 3.2 4WD	G32D	07/07 →



MASS AIR FLOW METERS (MAF)

Adatt./Suitable:

BOSCH0 281 002 571
0 281 002 669
0 281 002 670**CHRYSLER**5033109AB
K05033109AB**HYUNDAI**

28164-27050

KIA

28164-27050

MOPAR PARTS

05033109AB



Ø in	Ø out	L=mm	NTC +B - +R O
70	70	96	

CHRYSLER

PT CRUISER 2.2 CRD	EDJ, EDT	03/02 → 12/10
PT CRUISER 2.4	EDT, EDT	09/04 → 12/10
PT CRUISER 2.4 GT	EDT, EDT	03/04 → 03/08
PT CRUISER GT 2.4	EDT, D3EA	08/03 → 12/10

HYUNDAI

MATRIX 1.5 CRDi	D3EA, D4FA	10/01 → 08/10
-----------------	------------	---------------

KIA

CERATO I 1.5 CRDi	D4FA, G4EA	07/05 →
CERATO I 2.0 CRDi	D4EA	04/04 →



MASS AIR FLOW METERS (MAF)

Adatt./Suitable:

HYUNDAI28164-22601
28164-22610

Ø in	Ø out	L=mm	NTC +B - +R O
60	60	96	

HYUNDAI

ACCENT II 1.3	G4EA, G4EB	01/00 → 11/05
ACCENT II 1.5	G4EB, AGN	01/00 → 12/06
VERNA I 1.3	G4EA	09/99 →
VERNA I 1.5	G4EB	09/99 →



MASS AIR FLOW METERS (MAF)

Adatt./Suitable:

AUDI06A 906 461 A
06A 906 461 AX**BOSCH**0 280 218 002
0 280 218 003
0 986 280 205 *RG**SEAT**

06A 906 461 A

SKODA06A 906 461 A
06A 906 461 AX**VW**06A 906 461 A
06A 906 461 AX***RG** Corresponds to the original re-manufactured part

• Corrisponde al pezzo originale rigenerato

• Correspond à la pièce d'origine reconditionnée

• Entspricht dem neuwertigen OE-Teil

• Corresponde a la pieza original remanufacturada



Ø in	Ø out	L=mm	NTC +B - +R O
70	70	96	

AUDI

A3 I 1.8	AGN, AGN	09/96 → 05/03
----------	----------	---------------

SEAT

LEON I 1.8 20V	AGN, AGN	11/99 → 06/06
TOLEDO II 1.8 20V	AGN, AEG	10/98 → 07/04

SKODA

OCTAVIA I 1.8	AGN	09/96 → 07/00
OCTAVIA I 1.8 20V	AGN	07/98 → 07/00

SKODA			
OCTAVIA I 2.0	AEG, AZH	04/99 → 05/07	
OCTAVIA I 2.0 4x4	AZH, AEG	08/00 → 09/04	
VOLKSWAGEN (BR)			
GOLF A4 2.0i	AEG, APK	08/99 →	
VW			
BORA 1.8 4motion	AGN	02/99 → 05/05	
BORA 2.0	APK, AZH	10/98 → 05/05	
BORA 2.0 4motion	AZH, APK	04/00 → 05/05	
GOLF IV 1.8	AGN	08/97 → 06/05	
GOLF IV 1.8 4motion	AGN	05/98 → 06/06	
GOLF IV 2.0	APK, AZH	07/98 → 06/06	
GOLF IV 2.0 4motion	AZH, ANY	10/00 → 06/06	
LUPO 1.2 TDI 3L	ANY, AGU	07/99 → 07/05	
NEW BEETLE 1.8 T	AGU, AEG	10/99 → 09/10	
NEW BEETLE 2.0	AEG, K9K796	01/98 → 10/10	

10.1384



07

MASS AIR FLOW METERS (MAF)

Adatt./Suitable:

00 Eliminated on 29-03-2019. Please verify the availability through our local distributors

- Eliminato il 29-03-2019. Verificare la disponibilità presso i nostri distributori
- Éliminé le 29-03-2019. Vérifier la disponibilité auprès de nos distributeurs sur place
- Am 29-03-2019 gestrichen. Evtl. Verfügbarkeit bitte bei unseren Händlern prüfen
- Eliminado en fecha 29-03-2019. Verificar la disponibilidad a través de nuestros distribuidores locales

1006 After depletion of stock this part is replaced by:

- Esaurite le scorte questo pezzo sarà sostituito da:
- Après épuisement du stock, cette pièce est remplacée par:
- Nach Vorraterschöpfung wird ersetzt durch:
- Después agotamiento stock, será sustituido por:

10.1556



Ø in	Ø out	L=mm	+B - T 0
80	80	100	

10.1388



07

MASS AIR FLOW METERS (MAF)

Adatt./Suitable:

CONTINENTAL
5WK9 7006

DACIA
82 00 280 056

NISSAN
16580-00QAD
82002-80056

RENAULT
82 00 280 056
H82 00 357 204

SIEMENS
5WK9 7006

MARKET DIFFUSION: MEDIUM



Ø in	Ø out	L=mm	
60	60	110	

DACIA			
DUSTER 1.5 dCi	K9K796, K9K792	04/10 →	
LOGAN I 1.5 dCi	K9K792, K9K792	01/06 →	
SANDERO I 1.5 dCi	K9K792, D7F726	11/08 →	
NISSAN			
KUBISTAR 1.2	D7F726, K9K704	08/03 →	
KUBISTAR 1.4	K7J700	08/03 → 10/09	
KUBISTAR 1.5 dCi	K9K704, K4M750	08/03 →	
KUBISTAR 1.5 dCi 70	K9K700	04/06 → 10/09	
KUBISTAR 1.5 dCi 85	K9K276	04/06 → 10/09	
KUBISTAR 1.6 16V	K4M750, K9K714	08/03 →	
TERRANO III 1.6	K4M	09/13 →	
RENAULT			
CLIO II 1.5 dCi	K9K714, K9K702	04/04 →	
DUSTER 1.5 dCi [ExtraEU]	K9K796	06/11 →	
KANGOO I 1.5 dCi	K9K702, K9K792	04/03 →	
LOGAN 1.5 dCi	K9K792, K9K714	04/07 →	
LOGAN EXPRESS 1.5 dCi	K9K792	04/07 →	
SANDERO I 1.5 dCi	K9K792	04/07 →	
THALIA I 1.5 dCi	K9K714, --	01/01 →	
THALIA II 1.5 dCi	K9K718	09/08 →	
TWINGO II 1.5 dCi	K9K718	04/08 →	

10.1407



04

MASS AIR FLOW METERS (MAF)

Adatt./Suitable:

DAIMLER
C2C 7636
LNE 1620CB *1b
LNE1620CA *1b

DENSO
197400-2240
197408-0011 *1b
MB197400-3031

FORD
2W93-12B579-AC

JAGUAR
C2C 1958
C2C 7636
LNE 1620CA *1b
LNE 1620CB *1b

MAZDA
L3K9-13-215

NEW - AVAILABLE FROM:

- NUOVO - DISPONIBILE DA:
- NOUVEAU - DISPONIBLE EN:
- NEU - VERFUEGBAR AB:
- NUEVO - DISPONIBLE EN:

19/Q4

*1b Only supplied the sensor without a conduit

- Fornito solo sensore senza condotto
- Seulement fourni le capteur sans conduit
- Liefert den Sensor nur ohne Leitung
- Solo se suministró el sensor sin un conducto

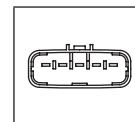

DAIMLER			
DAIMLER 4.0	AJ26	09/97 →	04/03
DAIMLER Six 4.0	AJ26	07/97 →	12/02
SUPER EIGHT 4.2	AJ8FT	09/05 →	12/09
JAGUAR			
SOVEREIGN 3.2	AJ32	10/97 →	03/03
S-TYPE 4.2 Supercharged	AJ8FT	11/01 →	12/08
S-TYPE 4.2 V8	AJ8FR	04/02 →	10/07
S-TYPE R 4.2 V8	AJ8FT	04/02 →	10/07
XJ 3.2	--, AJ8FR	07/97 →	05/03
XJ 4.0	BC	07/97 →	05/03
XJ 4.2	AJ8FR, AJ8FT	05/03 →	03/09
XJ R 4.2	AJ8FT	03/03 →	03/09
XJ SERIE 3.2	AJ32	11/97 →	06/03
XK 8 4.0	AJ26, AJ8FT	03/96 →	07/05
XK 8 4.2	AJ8FT	08/02 →	12/06
XK 8 R 4,2	AJ8FT, L3N9	08/02 →	12/06
XK 3.6	RG(AJ-V8)	07/07 →	07/14
XK 4.2 [ExtraEU]	AJ8N21B	02/08 →	07/14
XK 4.2 XK8	AJ8FT	03/06 →	07/14
XK 4.2 XKR	AJ8FT, AJ26	03/06 →	07/14
XK 5.0 V8	508PN	01/09 →	07/14
MAZDA			
3 I 2.3 DiSi Turbo MPS	L3YH	06/06 →	06/09
3 I 2.3 MPS Turbo	L3N9, L3KG	12/06 →	06/09
3 II 2.3 MPS Turbo	L3KG, L3K4	06/09 →	09/14
CX-7 2.3 AWD	L3Y6	06/06 →	12/12
CX-7 2.3 MZR DiSi Turbo AWD	L3K4, 844A2.000	06/06 →	12/14
CX7 2.3 DiSi [ExtraEU]	L3K7	06/06 →	06/09

10.1413



07

MASS AIR FLOW METERS (MAF)

Adatt./Suitable:

ALFA ROMEO

51782035
51831050
71794487 *RG
71795057

*RG **Corresponds to the original re-manufactured part**

• Corrisponde al pezzo originale rigenerato

BOSCH
0 281 002 860
0 281 002 917
0 281 006 054

• Correspond à la pièce d'origine reconditionnée

CHRYSLER
51831050

• Entspricht dem neuwertigen OE-Teil

CITROËN
1636 75

• Corrisponde a la pieza original remanufacturada

FIAT

51782035
51831050
71750589
71794487 *RG
71795057
K68083242AA

FORD

1 729 032
B551-12B579-AA

GENERAL MOTORS

95 510 006
95 510 015

JEEP

51831050
71795057
K68167871AA

LANCIA

51782035
51831050
71794487 *RG
71795057

MOPAR PARTS

68083242AA

OPEL

8 36 013
8 36 014
95510006
95510015

PEUGEOT

1636 75

SUZUKI

13800-68L50
13800-68L50-000
13800-79J80
13800-79J80-000

VAUXHALL

95510006
95510015

MARKET DIFFUSION: HIGH



Ø in	Ø out	L=mm	+B - NTC 0
70	70	96	

ALFA ROMEO

159 2.0 JTDm	844A2.000, 844A2.000	05/09 ⇨ 11/11
159 MY2011 2.0 JTD	--	01/10 ⇨
BRERA 2.0 JTDm	844A2.000, 940A2.000	03/08 ⇨ 06/10
GIULIETTA II 1.4 TB	940A2.000, 940A3.000	04/10 ⇨
GIULIETTA II 1.6 JTDm	940A3.000, 940A4.000	04/10 ⇨
GIULIETTA II 2.0 JTDm	940A4.000, 199A3.000	04/10 ⇨
MITO 1.3 Multijet	199A3.000, 198A2.000	08/08 ⇨
MITO 1.6 JTDm	198A2.000, F13DTE6	08/08 ⇨
SPIDER III 2.0 JTDm	844A2.000	04/09 ⇨ 06/10

CHRYSLER

DELTA 1.6 D Multijet	844A3000	08/11 ⇨
DELTA 2.0 D Multijet	198A5.000	08/11 ⇨
YPSILON 1.3 Multijet	199B1.000	05/11 ⇨

CITROËN

NEMO 1.3 BlueHdi 80	F13DTE6, F13DTE5	02/16 ⇨
NEMO 1.3 Hdi 75	F13DTE5, F13DTE6	10/10 ⇨
NEMO 1.3 Hdi 80	F13DTE6, 199B1.000	10/15 ⇨

FIAT

500 0.9	312A4.000	09/12 ⇨
500 1.3 D Multijet	199B1.000, 199B1.000	12/09 ⇨
500 C 1.3 D Multijet	199B1.000, 199B4.000	09/09 ⇨
500 MY12 1.3 JTD	--	01/12 ⇨
500L 1.3 D Multijet	199B4.000, 199B5.000	09/12 ⇨

FIAT

500L 1.4	843A1.000	09/12 ⇨
500L 1.6 D Multijet	199B5.000, 55263087	09/12 ⇨
500X 1.3 D Multijet	55266963	11/14 ⇨
500X 1.6 D Multijet	55260384	09/14 ⇨
500X 2.0 D Multijet 4x4	55263087, --	09/14 ⇨
BRAVO II 1.6 D Multijet	--, --	09/07 ⇨
BRAVO II 1.6 JTD	198A3.000	03/08 ⇨ 12/14
BRAVO II 2.0 D Multijet	--, 199A3.000	09/08 ⇨
DOBLO II 1.3 D Multijet	199A3.000, 198A3.000	02/10 ⇨
DOBLO II 1.6 D Multijet	198A3.000, F1AE0481N	02/10 ⇨
DOBLO II 2.0 D Multijet	263A1.000	01/10 ⇨
DUCATO III 110 Multijet 2,3 D	F1AE3481G	08/06 ⇨
DUCATO III 120 Multijet 2,3 D	FPT	07/06 ⇨
DUCATO III 120 Multijet 2,3 D 4x4	F1AE0481D	03/10 ⇨
DUCATO III 130 Multijet 2,3 D	F1AE0481N, F1AE3481E	07/06 ⇨
DUCATO III 150 Multijet 2,3 D	F1AE3481E, 199B1.000	06/11 ⇨
DUCATO III 180 Multijet 2,3 D	F1AGL411B	12/15 ⇨
DUCATO III 2.3	--	01/14 ⇨
FIORINO III 1.3 D Multijet	199B1.000, 939B5.000	11/07 ⇨
FREEMONT 2.0 JTD	939B5.000, 939B5.000	08/11 ⇨
FREEMONT 2.0 JTD 4x4	939B5.000, 169A1.000	08/11 ⇨
IDEA 1.3 D Multijet	199B1.000	05/08 ⇨ 12/12
IDEA 1.6 D Multijet	350A2.000	05/08 ⇨
LINEA 1.3 D Multijet	199A3.000	09/09 ⇨
LINEA 1.6 D Multijet	198A3.000	06/09 ⇨
PANDA II 1.2	169A4.000	03/10 ⇨ 08/13
PANDA II 1.2 4x4	169A4.000	11/09 ⇨
PANDA II 1.2 LPG	169A4.000	11/10 ⇨ 08/13
PANDA II 1.3 D Multijet	--	06/06 ⇨
PANDA II 1.3 JTD Multijet 4x4	169A1.000, 199A1.000	09/10 ⇨ 08/13
PANDA III 1.3 D Multijet	199A1.000, 199A1.000	02/12 ⇨
PANDA III 1.3 D Multijet 4x4	199A1.000, 199A2.000	06/12 ⇨
PUNTO III EVO 1.3 D Multijet	199A2.000, 199B1.000	07/08 ⇨
PUNTO III EVO 1.6 D Multijet	955A3.000	10/09 ⇨ 02/12
PUNTO III / GRANDE PUNTO 1.3 D Multijet	199A2.000, 199A2.000	06/09 ⇨
PUNTO III / GRANDE PUNTO 1.3 JTD Actual	--	09/09 ⇨
PUNTO III / GRANDE PUNTO 1.6 D Multijet	955A3.000	07/08 ⇨
PUNTO III 1.3 D Multijet	199A2.000, 199A2.000	04/08 ⇨
PUNTO III 1.3 JTD Multijet	955B2.000	05/18 ⇨
QUBO 1.3 D Multijet	199B1.000, 199B1.000	07/10 ⇨
SEDICI 2.0 D Multijet	D20AA	06/06 ⇨ 10/14
SEDICI 2.0 D Multijet 4x4	D20AA	06/06 ⇨ 10/14
SEDICI MY12 2.0 D	--	01/12 ⇨
STRADA 1.3 D	--	01/11 ⇨
STRADA 1.3 D Multijet	199B1.000	10/10 ⇨
TIPO II 1.3 D	199B1.000, BAAA	10/15 ⇨

FORD

KA II 1.3 TDCi	BAAA, EBS(55263087)	10/08 ⇨
----------------	---------------------	---------

JEEP

COMPASS 1.6 CRD	EJJ(5526384)	03/17 ⇨
COMPASS 2.0 CRD 4x4	EBS(55263087), EJJ(5526384)	12/16 ⇨

RENEGADE 1.6 CRD

EJJ(5526384), 55263088	07/14 ⇨
------------------------	---------

RENEGADE 2.0 CRD 4x4

55263088, 198A2.000	07/14 ⇨
---------------------	---------

LANCIA

DELTA III 1.6 D Multijet	198A2.000, 198A5.000	08/08 ⇨ 08/14
DELTA III 2.0 D Multijet	198A5.000, --	09/08 ⇨ 08/14
MUSA 1.3 D Multijet	--, --	10/04 ⇨ 12/12
MUSA 1.6 D Multijet	--, 199B1.000	07/08 ⇨ 12/12
YPSILON I 1.3 D Multijet	199A2.000	09/06 ⇨ 12/11
YPSILON II 1.3 D Multijet	199B1.000, A13FD	05/11 ⇨

OPEL

COMBO D 1.3 CDTi	A13FD, A16FDH	02/12 ⇨
COMBO D 1.6 CDTi	A16FDH, 199A9.000	02/12 ⇨
COMBO D 2.0 CDTi	A20FD	02/12 ⇨

PEUGEOT

BIPPER 1.3 BlueHdi 80	F13DTE6	12/15 ⇨
BIPPER 1.3 Hdi 75	199A9.000, 199A9.000	10/10 ⇨
BIPPER TEPEE 1.3 Hdi 75	199A9.000, F13DTE6	10/10 ⇨
BIPPER TEPEE 1.3 Hdi 80	F13DTE6, D13A	12/15 ⇨

SUZUKI

SWIFT V 1.3 DDiS	D13A, A13FD	10/10 ⇨
SX4 I 2.0 DDiS	D20AA	07/09 ⇨
SX4 I 2.0 DDiS 4x4	D20AA	07/09 ⇨
SX4 2.0 DDiS	D20AA	09/13 ⇨ 12/15

VAUXHALL

COMBO D 1.3 CDTi	A13FD, A16FDH	11/11 ⇨
COMBO D 1.6 CDTi	A16FDH, LLW	11/11 ⇨
COMBO D 2.0 CDTi	A20FD	11/11 ⇨

10.1438



07

MASS AIR FLOW METERS (MAF)

Adatt./Suitable:

BOSCH

0 280 218 427
0 280 218 428
0 281 002 912
0 281 002 913

CHEVROLET

55562426

GENERAL MOTORS

12 671 611
55 562 426

OPEL

12671611
55562426
8 36 457

SAAB

55 562 426

VAUXHALL

12671611
55562426

MARKET DIFFUSION: MEDIUM



Ø in	Ø out	L=mm	
80	80	92	

CHEVROLET

CRUZE 2.0 CDI	LLW, A20DTH	05/09 ⇨
CRUZE 2.0 TD	LNP	08/12 ⇨
MALIBU 2.0 D	LBS	04/12 ⇨
ORLANDO 2.0 D	LNP	02/11 ⇨

OPEL

ASTRA J 2.0 Biturbo CDTi	A20DTR	09/12 ⇨ 10/15
ASTRA J 2.0 CDTi	A20DTH, A20DTH	09/09 ⇨
CASCADA 2.0 CDTi	A20DTH, B16DTH	04/13 ⇨
INSIGNIA 1.6 CDTi	B16DTH, A20DTR	07/15 ⇨ 03/17
INSIGNIA 1.6 Turbo	A16LET	07/08 ⇨ 03/17
INSIGNIA 2.0 Biturbo CDTi	A20DTR, A20DTR	07/08 ⇨ 03/17
INSIGNIA 2.0 Biturbo CDTi 4x4	A20DTR, A20DT	07/08 ⇨ 03/17
INSIGNIA 2.0 CDTi	A20DT, A20DTH	07/08 ⇨ 03/17
INSIGNIA 2.0 CDTi 4x4	A20DTH, A20DT	06/10 ⇨ 03/17
ZAFIRA C 2.0 Biturbo CDTi	A20DTR	01/13 ⇨
ZAFIRA C 2.0 CDTi	A20DT, A20DTH	10/11 ⇨

SAAB

9-5 1.6 Turbo	A16LET	05/10 ⇨ 01/12
9-5 2.0 TiD	A20DTH	05/10 ⇨ 01/12
9-5 2.0 TTiD	A20DTR	05/10 ⇨ 01/12
9-5 2.0 TTiD XWD	A20DTR	05/10 ⇨ 01/12

VAUXHALL

ASTRA VI 2.0 Biturbo CDTi	A20DTR	12/12 ⇨
ASTRA VI 2.0 CDTi	A20DTH, A20DTH	12/09 ⇨
CASCADA 2.0 CDTi	A20DTH, A20DT	02/13 ⇨
INSIGNIA 1.6 CDTi	B16DTH	07/15 ⇨ 05/17
INSIGNIA 1.6 Turbo	A16LET	01/09 ⇨ 05/17
INSIGNIA 2.0 Biturbo CDTi	A20DTR	03/12 ⇨ 05/17
INSIGNIA 2.0 Biturbo CDTi 4x4	A20DTR	03/12 ⇨ 05/17
INSIGNIA 2.0 CDTi	A20DT, A20DTH	07/08 ⇨ 05/17
INSIGNIA 2.0 CDTi 4x4	A20DTH, A20DT	07/08 ⇨ 05/17
ZAFIRA C 2.0 Biturbo CDTi	A20DTR	11/12 ⇨ 08/18
ZAFIRA C 2.0 CDTi	A20DT, AGU	10/11 ⇨

10.1439



07

MASS AIR FLOW METERS (MAF)

Adatt./Suitable:

AUDI

06A 906 461 C
06A 906 461 CX *RG
06A 906 461 D
06A 906 461 DX *RG

*RG Corresponds to the original re-manufactured part

• Corrisponde al pezzo originale rigenerato

• Correspond à la pièce d'origine reconditionnée

• Entspricht dem neuwertigen OE-Teil

• Corrisponde a la pieza original remanufacturada

BOSCH

0 280 218 023
0 280 218 024
0 280 218 032
0 280 218 033
0 986 280 209
0 986 280 210

SEAT

06A 906 461 C
06A 906 461 CX *RG
06A 906 461 D
06A 906 461 DX *RG

SKODA

06A 906 461 D
06A 906 461 DX *RG

VW

06A 906 461 C
06A 906 461 CX *RG
06A 906 461 D
06A 906 461 DX *RG



Ø in	Ø out	L=mm	NTC +B - +R 0
70	70	96	

AUDI

A3 I 1.8 T	AGU, AGU	12/96 ⇒ 05/03
A3 I 1.8 T quattro	AGU, AGR	12/96 ⇒ 05/03
A3 I 1.9 TDI	AGR, AEB	10/00 ⇒ 05/03
A6 II 1.8 T	AEB, AEB	01/97 ⇒ 01/05
A6 II 1.8 T quattro	AEB, AJQ	02/97 ⇒ 01/05
TT I 1.8 T	AJQ, AJQ	10/98 ⇒ 06/06
TT I 1.8 T quattro	AJQ, IZ	10/98 ⇒ 06/06

SEAT

ALHAMBRA I / II 1.9 TDI	IZ, AUY	06/00 ⇒ 03/10
ALHAMBRA I / II 1.9 TDI 4motion	AUY, AQX	06/00 ⇒ 03/10

CORDOBA I 1.8 T 20V Cupra	AQX	07/00 ⇒ 10/02
IBIZA II 1.8 T 20V Cupra	AQX, APP	07/00 ⇒ 02/02
LEON I 1.8 20V T	APP, AJQ	11/99 ⇒ 06/06
LEON I 1.8 20V T 4	AJQ, APP	11/99 ⇒ 06/06
TOLEDO II 1.8 20VT	APP, AGU	09/00 ⇒ 07/04
TOLEDO II 1.8 4x4	AJQ	05/01 ⇒ 04/04

SKODA

OCTAVIA I 1.8 T	AGU, AGR	08/97 ⇒ 12/10
-----------------	----------	---------------

VW

BORA 1.9 TDI	AGR, AGR	09/00 ⇒ 05/05
BORA 1.9 TDI 4motion	AGR, AHF	09/00 ⇒ 05/05
GOLF IV 1.9 TDI	AGR, AGR	02/00 ⇒ 06/06
GOLF IV 1.9 TDI 4motion	AGR, AGG	09/00 ⇒ 06/06
GOLF IV 2.0	AGG, ALH	06/98 ⇒ 06/02
GOLF 1.9 TDI	AHF, AGR	01/00 ⇒ 05/04
NEW BEETLE 1.9 TDI	ALH, AEB	02/01 ⇒ 09/10
PASSAT IV 1.8 T	AEB, N43B16A	10/96 ⇒ 11/00

10.1440



07

MASS AIR FLOW METERS (MAF)

Adatt./Suitable:

BMW

1 438 687
13 62 1 438 687
13 62 7 566 986
7 566 986

BOSCH

0 280 218 075



Ø in	Ø out	L=mm	NTC +B - +R 0
70	70	96	

BMW

11 116 i	N43B16A, N40B16A	11/03 ⇒ 11/11
3 IV 316 Ci	N40B16A, N40B16A	10/01 ⇒
3 IV 316 i	N40B16A, N40B16A	02/02 ⇒ 02/05
3 IV 316 ti	N40B16A, N42B20A	06/01 ⇒ 02/05
3 IV 318 Ci	N42B20A, N42B20A	12/00 ⇒ 12/07
3 IV 318 i	N42B20A, N42B20A	09/01 ⇒ 02/05
3 IV 318 ti	N42B20A, N43B16A	03/01 ⇒ 12/04
3 V 316 i	N43B16A, AGU	09/05 ⇒ 12/13

10.1441



07

MASS AIR FLOW METERS (MAF)

Adatt./Suitable:

AUDI

06A 906 461 L
06A 906 461 LX *RG

*RG Corresponds to the original re-manufactured part

• Corrisponde al pezzo originale rigenerato

• Correspond à la pièce d'origine reconditionnée

• Entspricht dem neuwertigen OE-Teil

• Corrisponde a la pieza original remanufacturada

BOSCH

0 280 218 063
0 280 218 064
0 986 280 217

SEAT

06A 906 461 L
06A 906 461 LX *RG

SKODA

06A 906 461 L
06A 906 461 LX *RG

VW

06A 906 461 L
06A 906 461 LX *RG



Ø in	Ø out	L=mm	NTC +B - +R 0
70	70	96	

AUDI

A3 I 1.8 T	AGU, AGU	12/96 ⇒ 05/03
A3 I 1.8 T quattro	AGU, AEB	12/96 ⇒ 05/03
A4 II 1.8 T	AMB	07/01 ⇒ 03/09

AUDI

A4 II 1.8 T quattro	AMB	07/01 ⇒ 12/04
A4 I 1.8 T quattro	AWT	01/95 ⇒ 11/00
A4 III 1.8 T	BFB	11/04 ⇒ 06/08
A4 III 1.8 T quattro	BFB	11/04 ⇒ 06/08
A6 II 1.8 T	AEB, AEB	01/97 ⇒ 01/05
A6 II 1.8 T quattro	AEB, AJQ	02/97 ⇒ 01/05
TT I 1.8 T	AJQ, AJQ	10/98 ⇒ 06/06
TT I 1.8 T quattro	AJQ, BBU	10/98 ⇒ 06/06

SEAT

EXEO 1.8 T	CFMA	12/08 ⇒ 05/10
IBIZA III 1.8 T Cupra R	BBU, BJX	01/04 ⇒ 02/08
IBIZA III 1.8 T FR	BJX, APP	12/03 ⇒ 05/08
LEON I 1.8 20V T	APP, AJQ	11/99 ⇒ 06/06
LEON I 1.8 20V T 4	AJQ, APP	11/99 ⇒ 06/06
TOLEDO II 1.8 20VT	APP, AGU	09/00 ⇒ 07/04

SKODA

OCTAVIA I 1.8 T	AGU, AGU	08/97 ⇒ 12/10
OCTAVIA I 1.8 T 4x4	ARX	05/01 ⇒ 05/06
OCTAVIA I RS 1.8 T	AUQ	05/01 ⇒ 01/06

VW

BORA 1.8 T	AGU, AGU	05/00 ⇒ 05/05
NEW BEETLE 1.8 T	AGU, M111.920	11/01 ⇒ 09/10
PASSAT IV 1.8 [CHN]	AWL	06/01 ⇒
PASSAT IV 1.8 T 20V	AWL	11/00 ⇒ 05/05
POLO IV 1.8 GTI	BJX	09/05 ⇒ 11/09
POLO IV 1.8 GTI Cup Edition	BBU	05/06 ⇒ 11/09

10.1442



07

MASS AIR FLOW METERS (MAF)

Adatt./Suitable:

BOSCH

0 280 217 114
0 280 217 115
0 280 218 081

MERCEDES-BENZ

0000940948
0000941948
A 000 094 09 48
A 000 094 19 48

SSANGYONG

0000940948



Ø in	Ø out	L=mm	NTC +B - +R 0
70	70	130	

MERCEDES-BENZ

CLASSE C I C 180	M111.920, M111.920	03/93 ⇒ 05/00
CLASSE C I C 180 T	M111.920, M111.944	06/96 ⇒ 09/00
CLASSE C I C 200	M111.945	01/94 ⇒ 05/00
CLASSE C I C 200 CDI	OM611.960	03/98 ⇒ 05/00
CLASSE C I C 200 Kompressor	M111.944, E20M160	10/95 ⇒ 05/00
CLASSE C I C 200 T	M111.945	06/96 ⇒ 03/01
CLASSE C I C 200 T CDI	OM611.960	03/98 ⇒ 03/01
CLASSE C I C 200 T Kompressor	M111.944	11/96 ⇒ 03/01
CLASSE C I C 220 CDI	OM611.960	09/97 ⇒ 05/00
CLASSE C I C 220 T CDI	OM611.960	09/97 ⇒ 03/01
CLASSE C I C 230 Kompressor	M111.975	10/95 ⇒ 05/00
CLASSE C I C 230 T	M111.974	06/96 ⇒ 06/98
CLASSE C I C 230 T Kompressor	M111.975	06/97 ⇒ 09/00
CLASSE C I C 250 Turbo-D	OM605.960	06/96 ⇒ 03/01
CLASSE C I C 250 Turbo-D	OM605.960	10/95 ⇒ 05/00
CLASSE V V 200	M111.950	02/97 ⇒ 07/03
CLASSE CLK I 200	M111.945	06/97 ⇒ 06/02
CLASSE CLK I 200 Kompressor	M111.944	06/97 ⇒ 06/00
CLASSE CLK I 230 Kompressor	M111.975	06/97 ⇒ 06/00
CLASSE E II E 200 T Kompressor	M111.947	06/97 ⇒ 03/03
CLASSE E II E 230	M111.970	06/95 ⇒ 06/97
CLASSE SLK I 230 Kompressor	M111.973	09/96 ⇒ 03/00
SPRINTER I 214 NGT	M111.984	02/95 ⇒ 05/06

MERCEDES-BENZ			
SPRINTER I 314 4x4	M111.984	08/02 ⇨	05/06
SPRINTER I 314 NGT	M111.984	02/95 ⇨	05/06
SPRINTER I 414	M111.979	02/96 ⇨	05/06
SPRINTER I 414 4x4	M111.979	05/97 ⇨	05/06
VITO I 113 2.0	M111.950	02/96 ⇨	07/03

10.1443  **08**

MASS AIR FLOW METERS (MAF)

Adatt./Suitable:

- BOSCH**
0 281 002 152
0 281 002 153
- MERCEDES-BENZ**
0000941 248
A 000 094 12 48

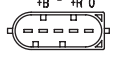

Ø in	Ø out	L=mm	+B - +R 0
80	80	120	

MERCEDES-BENZ			
CLASSE E II E 200 CDI	0M611.961, 0M611.961	06/98 ⇨	03/02
CLASSE E II E 220 CDI	0M611.961	06/98 ⇨	07/99
CLASSE E II E 220 T CDI	0M611.961, 841G.000	06/98 ⇨	07/99
CLASSE E II E 300 T Turbo-D	0M606.962	12/96 ⇨	07/99
CLASSE E II E 300 Turbo-D	0M606.962	12/96 ⇨	07/99
CLASSE E E 220 CDi	0M611.961	07/99 ⇨	12/02

10.1444  **07,5**

MASS AIR FLOW METERS (MAF)

Adatt./Suitable:

- AUDI**
078 906 461
078 906 461 B
078 906 461 BX *RG
 - BOSCH**
0 280 218 038
0 280 218 039
0 986 280 212
0 986 280 312 *RG
 - VW**
078 906 461 B
078 906 461 BX *RG
- *RG **Corresponds to the original re-manufactured part**
- Corrisponde al pezzo originale rigenerato
 - Correspond à la pièce d'origine reconditionnée
 - Entspricht dem neuwertigen OE-Teil
 - Corrisponde a la pieza original remanufacturada

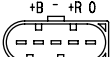

Ø in	Ø out	L=mm	+B - +R 0
86	84	100	

AUDI			
A6 II 2.7 T	AJK	02/99 ⇨	01/05

10.1445  **07**

MASS AIR FLOW METERS (MAF)

Adatt./Suitable:

- ALFA ROMEO**
46824377
60802037
71787995 *RG
71787998 *RG
 - BOSCH**
0 280 218 087
0 281 002 537
0 281 002 598
 - FIAT**
46824377
60802037
 - GENERAL MOTORS**
93 172 747
97 253 456
 - ISUZU**
8-97253456-0
8-97253456-1
97253456
 - LANCIA**
46824377
60802037
 - OPEL**
8 36 598
8 36 599
93172747
 - VAUXHALL**
93172747
- *RG **Corresponds to the original re-manufactured part**
- Corrisponde al pezzo originale rigenerato
 - Correspond à la pièce d'origine reconditionnée
 - Entspricht dem neuwertigen OE-Teil
 - Corrisponde a la pieza original remanufacturada



Ø in	Ø out	L=mm	NTC +B - +R 0
80	80	130	

ALFA ROMEO			
156 2.4 JTD	841G.000, 841G.000	06/03 ⇨	05/06

ALFA ROMEO			
166 2.4 JTD	841G.000, 841G.000	10/03 ⇨	06/07

ISUZU			
D-MAX 2.5 [ExtraEU]	4JA1-TC	06/03 ⇨	10/04
D-MAX 2.5 DiTD	4JA1-TC	10/02 ⇨	06/12
D-MAX 2.5 DiTD 4x4	4JA1-TC	05/02 ⇨	06/12
D-MAX 3.0 D 4WD	4JH1-TC	06/03 ⇨	10/04
D-MAX 3.0 DiTD 4x4	4JH1-TC	05/02 ⇨	06/12

LANCIA			
THEISIS 2.4 JTD	841G.000, CFHB	05/03 ⇨	

OPEL			
CAMPO 2.5 TD	4JA1-T	07/94 ⇨	06/01
CAMPO 2.5 TD 4x4	4JA1-T	07/94 ⇨	06/01
SIGNUM 3.2 V6	Z32SE	05/03 ⇨	07/05

VAUXHALL			
SIGNUM 3.2 V6	Z32SE	05/03 ⇨	05/08

10.1446  **07**

MASS AIR FLOW METERS (MAF)

Adatt./Suitable:

- AUDI**
03L 906 461 A
- BOSCH**
0 281 002 956
0 281 002 957
- MAN**
03L 906 461 A
- SEAT**
03L 906 461 A
- SKODA**
03L 906 461 A
- VW**
03L 906 461 A

MARKET DIFFUSION: HIGH

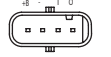

Ø in	Ø out	L=mm	+B - +R 0
80	80	110	

AUDI			
A1 2.0 TDI	CFHB, BKD	09/11 ⇨	04/15
A3 II 2.0 TDI 16V	BKD, BMN	05/03 ⇨	08/12
A3 II 2.0 TDI quattro	BMN, BKD	03/06 ⇨	08/12
A3 II SPORTBACK 2.0 TDI 16V	BKD, CRBC	09/04 ⇨	03/13
A3 III 2.0 TDI	CRBC, CRBC	04/12 ⇨	
A3 III 2.0 TDI quattro	CRBC, CAGA	10/12 ⇨	
A4 IV 2.0 TDI	CAGA, CAGA	11/07 ⇨	12/15
A4 IV 2.0 TDI quattro	CAGA, CAGA	04/08 ⇨	12/15
A4 IV ALLROAD 2.0 TDI quattro	CAGA, CZHA	04/09 ⇨	05/16
A4 V 2.0 TDI	CZHA, DESA	05/15 ⇨	
A4 V 2.0 TDI quattro	DESA, DESA	09/15 ⇨	
A4 V ALLROAD 2.0 TDI quattro	DESA, CAGA	01/16 ⇨	
A5 I 2.0 TDI	CAGA, CGLC	08/08 ⇨	01/17
A5 I 2.0 TDI quattro	CGLC, CZHA	12/11 ⇨	01/17
A5 II 2.0 TDI	CZHA, CZHA	07/16 ⇨	
A5 II 2.0 TDI quattro	CZHA, CGLC	10/16 ⇨	
A6 IV 2.0 TDI	CGLC, DFGA	03/11 ⇨	
A6 IV 2.0 TDI quattro	CNHA	04/15 ⇨	09/18
Q2 2.0 TDI	DCYA	09/16 ⇨	
Q2 2.0 TDI quattro	DFGA, CFFA	07/16 ⇨	
Q3 2.0 TDI	CFFA, CFFB	06/11 ⇨	
Q3 2.0 TDI quattro	CFFB, CICA	06/11 ⇨	10/18
Q3 35 TDI	DFGA	09/18 ⇨	
Q3 35 TDI quattro	DFGA	09/18 ⇨	
Q3 40 TDI quattro	DFHA	10/18 ⇨	
Q5 I 2.0 TDI	CICA, CAGA	11/10 ⇨	
Q5 I 2.0 TDI quattro	CAGA, DEUA	11/08 ⇨	
Q5 II 2.0 TDI	DEUA, DESA	01/17 ⇨	
Q5 II 2.0 TDI quattro	DESA, DESA	06/16 ⇨	08/18

AUDI			
Q5 II 35 TDi quattro	DETB	08/18	⇒
Q5 II 40 TDi quattro	DESA, CBBB	10/18	⇒
TT II 2.0 TDi quattro	CBBB, DAUA	06/08	⇒ 06/14
TT III 2.0 TDi	CUNA	07/14	⇒
TT III 2.0 TDi quattro	CUNA	01/17	⇒
MAN			
TGE 2.0 TDi	DAUA, DASA	11/16	⇒
TGE 2.0 TDi AWD	DAUA	02/17	⇒
TGE 2.0 TDi RWD	DASA, CFFA	05/17	⇒
SEAT			
ALHAMBRA III 2.0 TDi	CFFA, CFFB	06/10	⇒
ALHAMBRA III 2.0 TDi 4Drive	CFFB, BKD	05/11	⇒
ALTEA 2.0 TDi 16V	BKD, BKD	03/04	⇒
ALTEA 2.0 TDi 16V 4WD	CFHC	10/10	⇒
ALTEA XL 2.0 TDi 16V	BKD, BMN	10/06	⇒
ALTEA XL 2.0 TDi 16V 4x4	CFHC	10/10	⇒
ALTEA XL 2.0 TDi 4x4	BMN, CRVA	06/07	⇒
ATECA 2.0 TDi	CRVA, DFFA	04/16	⇒
ATECA 2.0 TDi 4Drive	DFFA, CAGA	04/16	⇒
EXEO 2.0 TDi	CAGA, BMN	12/08	⇒
IBIZA IV 2.0 TDi	CFHD	01/10	⇒
LEON II 2.0 TDi	BMN, BKD	05/06	⇒ 12/12
LEON II 2.0 TDi 16V	BKD, CKFC	07/05	⇒ 12/12
LEON III 2.0 TDi	CKFC, CRBC	09/12	⇒
LEON III 2.0 TDi 4Drive	CRBC, CKFC	04/14	⇒
LEON ST 2.0 TDi	CKFC, CRBC	04/13	⇒
LEON ST 2.0 TDi 4Drive	CRBC, DFGA	09/14	⇒
TARRACO 2.0 TDi	DFGA, DFFA	09/18	⇒
SKODA			
KAROQ 2.0 TDi 4x4	DFFA, DBGA	07/17	⇒
KODIAQ 2.0 TDi	DBGC	10/16	⇒
KODIAQ 2.0 TDi 4x4	DBGA, CFHF	10/16	⇒
OCTAVIA II 2.0 TDi	CFHF, BKD	03/10	⇒ 06/13
OCTAVIA II 2.0 TDi 16V	BKD, BKD	02/04	⇒ 05/13
OCTAVIA II 2.0 TDi 16V 4x4	BKD, CKFB	05/10	⇒ 02/13
OCTAVIA II 2.0 TDi 4x4	CFHF	05/11	⇒ 02/13
OCTAVIA III 2.0 TDi	CKFB, CUNA	11/12	⇒
OCTAVIA III 2.0 TDi /TDI RS 4x4	CUNA, CKFC	09/14	⇒
OCTAVIA III 2.0 TDi 4x4	CKFC, CUNA	11/12	⇒
OCTAVIA III 2.0 TDi RS	CUNA, CBBB	05/13	⇒
SUPERB II 2.0 TDi	CBBB, BKD	07/08	⇒ 05/15
SUPERB II 2.0 TDi 16V	BKD, CBBB	01/09	⇒ 05/15
SUPERB II 2.0 TDi 16V 4x4	CFHB	11/10	⇒ 05/15
SUPERB II 2.0 TDi 4x4	CBBB, CRGA	09/08	⇒ 05/15
SUPERB III 2.0 TDi	CRGA, CRLB	03/15	⇒
SUPERB III 2.0 TDi 4x4	CRLB, CFHA	03/15	⇒
YETI 2.0 TDi	CFHA, CBDB	11/09	⇒
YETI 2.0 TDi 4x4	CBDB, CDCA	05/09	⇒ 12/17
VW			
AMAROK 2.0 BiTDI	CDCA, CDCA	09/10	⇒
AMAROK 2.0 BiTDI 4motion	CDCA, CDBA	09/10	⇒
AMAROK 2.0 TDi	CDBA, CDBA	09/10	⇒
AMAROK 2.0 TDi 4motion	CDBA, CDBA	09/10	⇒
AMAROK 2.0 TDi/TDi BlueMotion	CDBA, CDBA	05/12	⇒ 10/13
AMAROK 2.0 TDi/TDi BlueMotion [ExtraEU]	CDBA, DBGA	09/11	⇒
AMAROK 2.0 TSi	CFPA	12/10	⇒
ARTEON 2.0 TDi	DBGA, CFFB	04/17	⇒
ARTEON 2.0 TDi 4motion	DFHA	05/17	⇒
BEETLE 2.0 TDi	CFFB, CFHC	04/11	⇒
CADDY III 2.0 TDi	CFHC, CFHC	08/10	⇒
CADDY III 2.0 TDi 16V	CFHC, CFHC	11/10	⇒ 05/15
CADDY III 2.0 TDi 16V 4motion	CFHC	11/10	⇒ 05/15
CADDY III 2.0 TDi 4motion	CFHC, CAAB	08/10	⇒
CAMPMOBILE 2.0 TDi	CCHB	05/10	⇒ 08/15
CAMPMOBILE 2.0 TDi BlueMotion	CAAB, CFFA	04/15	⇒
CC 2.0 TDi	CFFA, CFFB	11/11	⇒ 12/16
CC 2.0 TDi 4motion	CFFB, CKTB	11/11	⇒ 12/16
CRAFTER 2.0 TDi	CKTB, CKUB	05/11	⇒
CRAFTER 2.0 TDi 4motion	CKUB, DASA	11/11	⇒
CRAFTER 2.0 TDi RWD	DASA, CFFB	11/16	⇒
EOS 2.0 TDi	CFFA	11/10	⇒ 08/15
GOLF V 2.0 TDi	CBDC, CBDB	01/09	⇒ 12/13
GOLF VI 2.0 TDi	CBAA, CBAB	10/08	⇒
GOLF VI 2.0 TDi 4motion	CBAB, CUNA	05/09	⇒
GOLF VI 2.0 TDi Gtd	CFGB	05/11	⇒
GOLF 2.0 GTD	CUNA	04/13	⇒
GOLF 2.0 TDi	CFFB, CBDC	09/09	⇒ 08/14
GOLF 2.0 TDi BlueMotion 4motion	CRBC	05/13	⇒
GOLF VII 2.0 GTD	CUNA, CKFC	04/13	⇒
GOLF VII 2.0 TDi	CKFC, CKFC	08/12	⇒
GOLF VII 2.0 TDi 4motion	CKFC, CFFB	11/12	⇒
GOLF VAN 2.0 TDi	CBDB, CRBC	07/09	⇒ 05/19
GOLF VAN 2.0 TDi BlueMotion	CRBC, CRBC	04/13	⇒ 03/17

VW			
GOLF VAN 2.0 TDi BlueMotion 4motion	CRBC, CBAA	04/13	⇒ 03/17
JETTA V 2.0 TDi	CLCA	01/10	⇒ 10/10
JETTA VI 2.0 TDi	CFFB, CAAA	10/10	⇒
MULTIVAN 2.0 BitDi	CFFA	09/09	⇒ 08/15
MULTIVAN 2.0 BitDi 4motion	CFFA	09/09	⇒ 08/15
MULTIVAN 2.0 TDi	CAAA, CAAC	09/09	⇒
MULTIVAN 2.0 TDi 4motion	CAAC, CFFB	09/09	⇒
PASSAT 2.0 Blue TDi/TDi/TDi BlueMotion [ExtraEU]	CFFB, CBAA	08/10	⇒ 12/14
PASSAT 2.0 TDi	CFFA, CFFB	08/10	⇒
PASSAT V 2.0 TDi 4motion	CFFB, CRGA	08/10	⇒ 12/14
PASSAT VI 2.0 TDi	CRGA, CRLB	11/14	⇒
PASSAT VI 2.0 TDi 4motion	CRLB, CBBB	11/14	⇒
PASSAT CC 2.0 TDi	CBAA, CBAB	06/08	⇒ 01/12
PASSAT CC 2.0 TDi 4motion	CBAB, CFFA	08/09	⇒ 01/12
T-ROC 2.0 TDi	DFFA	03/18	⇒
T-ROC 2.0 TDi 4motion	DFFA	09/17	⇒
SCIROCCO III 2.0 TDi	CBBB, CFFA	08/08	⇒ 11/17
SCIROCCO 2.0 TDi	CBBB, CBBB	08/08	⇒ 05/14
SHARAN II 2.0 TDi	CFFA, CFFA	05/10	⇒
SHARAN II 2.0 TDi 4motion	CFFA, CBAB	05/11	⇒
TIGUAN I 2.0 TDi	CBAB, CBAA	03/08	⇒
TIGUAN I 2.0 TDi 4motion	CBAA, CRFD	09/07	⇒
TIGUAN II 2.0 TDi	CRFD, DBGC	05/15	⇒
TIGUAN II 2.0 TDi 4motion	DBGC, BMN	01/16	⇒
TOURAN I 2.0 TDi	BMN, CRVA	12/05	⇒ 05/15
TOURAN II 2.0 TDi	CRVA, CAAA	05/15	⇒
TRANSPORTER V 2.0 BitDi	CFFA	09/09	⇒ 08/15
TRANSPORTER V 2.0 BitDi 4motion	CFFA	09/09	⇒ 08/15
TRANSPORTER V 2.0 TDi	CAAA, CAAC	09/09	⇒ 08/15
TRANSPORTER V 2.0 TDi 4motion	CAAC, CAAA	09/09	⇒ 08/15
TRANSPORTER VI 2.0 TDi	CAAA, CAAC	04/15	⇒
TRANSPORTER VI 2.0 TDi 4motion	CAAC, K9K612	06/15	⇒

10.1448

07

MASS AIR FLOW METERS (MAF)

Adatt./Suitable:

CONTINENTAL
5WK9 7021DACIA
82 00 682 558NISSAN
22680-00QAB
22680-1FE0A
22680-BB50ARENAULT
82 00 682 558
H82 00 702 517SIEMENS
5WK9 7021SUZUKI
13800-80KA0
13800-80KA0-000ITEM NOW AVAILABLE FROM
PRODUCTION• ARTICOLO ORA DISPONIBILE PER LA
VENDITA• ARTICLE DISPONIBLE EN PRODUCTION
COURANTE• JETZ ZUM VERKAUF VERFÜGBARER
ARTIKEL• ARTICULO AHORA DISPONIBLE EN
PRODUCCION

MARKET DIFFUSION: HIGH



Ø in	Ø out	L=mm
70	70	110



DACIA			
DOKKER 1.5	K9K872	12/18	⇒
DOKKER 1.5 dCi	K9K612, K9K612	11/12	⇒
DOKKER 1.5 dCi [ExtraEU]	K9K830	11/12	⇒
DUSTER 1.5 dCi	K9K612, K9K656	10/10	⇒
DUSTER 1.5 dCi 110	K9K656, K9K658	10/17	⇒
DUSTER 1.5 dCi 110 4x4	K9K658	10/17	⇒
DUSTER 1.5 dCi 4x4	K9K658, --	10/10	⇒

DACIA			
DUSTER 1.5 dCi 90	K9K656	10/17	⇒
LODGY 1.5 dCi	--, K9K612	03/12	⇒
LOGAN II 1.5 dCi	K9K612, K9K612	10/12	⇒
LOGAN II MCV 1.5 dCi	K9K612, K9K612	02/13	⇒
SANDERO II 1.5 dCi	K9K612, K9K	10/12	⇒

NISSAN			
CUBE 1.5 dCi	K9K, K9K410	03/10	⇒
JUKE 1.5 dCi	K9K410, K9K276	06/10	⇒
NOTE I 1.5 dCi	K9K276, K9K	03/06	⇒ 06/12
NV200 / EVALIA 1.5 dCi	K9K, K9K	07/10	⇒
NV200 1.5 dCi	K9K, K9K628	02/10	⇒
PULSAR 1.5 dCi	K9K	10/14	⇒
QASHQAI 1.6 dCi	R9M	07/11	⇒ 11/13
QASHQAI 1.6 dCi	R9M	10/11	⇒ 12/13
QASHQAI 1.6 dCi Trazione integrale	R9M	10/11	⇒ 12/13

RENAULT			
CAPTUR 1.5 dCi	K9K628, K9K608	06/13	⇒
CAPTUR 1.5 dCi 110	K9K646	01/15	⇒
CAPTUR 1.5 dCi 90	K9K608, K9K764	06/13	⇒
CLIO III 1.5 dCi	K9K764, K9K612	02/08	⇒
CLIO IV 1.5 dCi	K9K628	11/12	⇒
CLIO IV 1.5 dCi 110	K9K646	06/16	⇒
CLIO IV 1.5 dCi 75	K9K612, K9K608	11/12	⇒
CLIO IV 1.5 dCi 90	K9K608, K9K612	11/12	⇒
CLIO 1.5 dCi	K9K612	01/14	⇒
DOKKER 1.5 dCi	K9K612, K9K656	12/13	⇒
FLUENCE 1.5 dCi	K9K656, K9K636	02/10	⇒
FLUENCE 1.6 dCi	R9M402	07/14	⇒
GRAND SCÉNIC III 1.5 dCi	K9K636, R9M402	02/09	⇒
GRAND SCÉNIC III 1.6 dCi	R9M402, F9Q870	04/11	⇒
GRAND SCÉNIC III 1.9 dCi	F9Q870, K9K780	02/09	⇒
LAGUNA III 1.5 dCi	K9K780, K9K782	10/07	⇒
LATITUDE 1.5 dCi	K9K782, K9K636	07/10	⇒
LOGAN 1.5 dCi	K9K612	06/11	⇒
LOGAN/STEPWAY 1.5 dCi	K9K612	12/13	⇒
MEGANE III 1.5 dCi	K9K636, R9M402	11/08	⇒
MEGANE III 1.6 dCi	R9M402, F9Q870	04/11	⇒
MEGANE III 1.9 dCi	F9Q870, K9K834	11/08	⇒
MEGANE 1.5 dCi	K9K656, K9K636	01/09	⇒ 08/15
MEGANE III HATCHBACK VAN 1.5 dCi	K9K834, K9K612	11/08	⇒ 08/15
MEGANE CC 1.5 dCi	K9K636, F9Q870	06/10	⇒
MEGANE CC 1.6 dCi	R9M402	04/11	⇒
MEGANE CC 1.9 dCi	F9Q870, K9K636	06/10	⇒
MODUS / GRAND MODUS 1.2	D4F764	12/04	⇒
MODUS / GRAND MODUS 1.5 dCi 75	K9K770	10/10	⇒
MODUS / GRAND MODUS 1.5 dCi 90	K9K770	10/10	⇒
SANDERO II 1.5 dCi	K9K612, K9K636	12/13	⇒
SCÉNIC III 1.5 dCi	K9K636, R9M402	02/09	⇒
SCÉNIC III 1.6 dCi	R9M402, F9Q870	04/11	⇒
SCÉNIC III 1.9 dCi	F9Q870, CAYB	02/09	⇒
THALIA II 1.5 dCi	K9K612	11/12	⇒ 06/14
THALIA III 1.5 dCi	K9K612	12/13	⇒
TWINGO 1.5 dCi	K9K820	10/10	⇒ 09/14
TWINGO II 1.5 dCi 75	K9K820	10/10	⇒
TWINGO II 1.5 dCi 90	K9K820	10/10	⇒

SUZUKI			
GRAND VITARA II 1.9 DDIS	F9QB	03/06	⇒ 08/08

10.1449



07

10.1450



07

10.1454



07

MASS AIR FLOW METERS (MAF)

Adatt./Suitable:

- AUDI**
03L 906 461
- CONTINENTAL**
5WK9 7023
- SEAT**
03L 906 461
- SKODA**
03L 906 461
- VW**
03L 906 461

MARKET DIFFUSION: MEDIUM



MASS AIR FLOW METERS (MAF)

Adatt./Suitable:

- CONTINENTAL**
5WK9 7022
A2C53252639
 - GENERAL MOTORS**
93 167 984
 - NISSAN**
16580-00Q0B
 - OPEL**
44 20 339
93167984
 - RENAULT**
82 00 914 647
H82 00 702 183
 - VAUXHALL**
93167984
- ITEM NOW AVAILABLE FROM PRODUCTION**
- ARTICOLO ORA DISPONIBILE PER LA VENDITA
 - ARTICLE DISPONIBLE EN PRODUCTION COURANTE
 - JETZT ZUM VERKAUF VERFÜGBARER ARTIKEL
 - ARTICULO AHORA DISPONIBLE EN PRODUCCION



MASS AIR FLOW METERS (MAF)

Adatt./Suitable:

- CONTINENTAL**
5WK9 7020
- DACIA**
82 00 651 315
- GENERAL MOTORS**
93 863 896
- MERCEDES-BENZ**
A 607 094 00 48
- NISSAN**
22680-00QAD
- OPEL**
44 06 095
93863896
- RENAULT**
82 00 651 315
H82 00 655 623
- SIEMENS**
5WK9 7020
- VAUXHALL**
93863896

MARKET DIFFUSION: MEDIUM



Ø in	Ø out	L=mm	
70	70	96	

Ø in	Ø out	L=mm	
80	80	106	

Ø in	Ø out	L=mm	
70	70	110	

AUDI			
A1 1.6 TDI	CAYB, CAYB	05/10 →	04/15
A3 II 1.6 TDI	CAYB, CAYB	05/09 →	08/12
A3 II SPORTBACK 1.6 TDI	CAYB, CAYB	05/09 →	03/13
SEAT			
ALTEA 1.6 TDI	CAYB, CAYB	10/09 →	
ALTEA XL 1.6 TDI	CAYB, CAYB	10/09 →	
IBIZA IV 1.6 TDI	CAYB, CAYB	05/09 →	
IBIZA 1.6 TDI	CAYB	05/09 →	
LEON II 1.6 TDI	CAYC	02/10 →	12/12
TOLEDO IV 1.6 TDI	CAYB, CAYA	07/12 →	
SKODA			
FABIA II 1.6 TDI	CAYA, CAYB	03/10 →	12/14
OCTAVIA II 1.6 TDI	CAYC	06/09 →	04/13
OCTAVIA II 1.6 TDI 4x4	CAYC	06/09 →	02/13
RAPID 1.6 TDI	CAYB, CAYA	07/12 →	
ROOMSTER 1.6 TDI	CAYA, CAYD	03/10 →	05/15
SUPERB II 1.6 TDI	CAYC	09/10 →	05/15
YETI 1.6 TDI	CAYC	11/10 →	05/15
VW			
BEETLE 1.6 TDI	CAYC	10/11 →	07/16
CADDY III 1.6 TDI	CAYD, CAYB	08/10 →	
GOLF V 1.6 TDI	CAYB, CAYB	02/09 →	12/13
GOLF VI 1.6 TDI	CAYB, CAYB	02/09 →	
GOLF VI 1.6 TDI 4motion	CAYC	02/09 →	07/13
GOLF 1.6 TDI	CAYB, CAYB	07/09 →	08/14
GOLF 1.6 TDi BlueMotion	CAYC	05/09 →	11/12
GOLF VAN 1.6 TDI	CAYB	12/09 →	10/12
GOLF VAN 1.6 TDi BlueMotion	CAYC	07/09 →	05/14
JETTA V 1.6 TDI	CAYB, CAYA	06/09 →	10/10
JETTA VI 1.6 TDI	CAYC	04/10 →	07/14
PASSAT V 1.6 TDI	CAYC	08/09 →	12/14
PASSAT 1.6 TDi BlueMotion	CAYC	08/10 →	12/14
POLO V 1.6 TDI	CAYA, CAYB	06/09 →	
POLO V 1.6 TDi BlueMotion	CAYB	06/09 →	05/14
TOURAN I 1.6 TDI	CAYB, M9T694	05/10 →	05/15

NISSAN			
NV400 2.3 dCi 145 RWD	M9T694, --	11/11 →	02/14
NV400 2.3 dCi 150	M9T880	02/14 →	09/16
NV400 2.3 dCi 165	M9T	06/14 →	09/16
NV400 dCi 110	--, M9T686	06/14 →	
NV400 dCi 125 RWD	M9T686, --	11/11 →	09/16
NV400 dCi 130	M9T704	06/16 →	
NV400 dCi 130 RWD	M9T710	06/16 →	
NV400 dCi 140	--, M9T696	06/14 →	09/16
NV400 dCi 140 RWD	M9T696, M9T694	06/14 →	09/16
NV400 dCi 145 RWD	M9T694, M9T	11/11 →	06/16
NV400 dCi 150	M9T880	02/14 →	09/16
NV400 dCi 150 RWD	M9T880	02/14 →	09/16
NV400 dCi 160	M9T	06/14 →	09/16
NV400 dCi 165	M9T	06/14 →	06/16
NV400 dCi 165 RWD	M9T, M9T	06/14 →	
NV400 dCi 170	M9T, M9T670	07/15 →	
OPEL			
MOVANO B 2.3 CDTI FWD	M9T670, M9T686	05/10 →	
MOVANO B 2.3 CDTI RWD	M9T686, M9R610	05/10 →	
RENAULT			
GRAND SCÉNIC III 2.0 dCi	M9R610, M9T676	02/09 →	
MASTER III 2.3 dCi 100 FWD	M9T670, M9T690	02/10 →	
MASTER III 2.3 dCi 100 RWD	M9T690, M9T870	02/10 →	
MASTER III 2.3 dCi 110 FWD	M9T870, M9T670	09/14 →	
MASTER III 2.3 dCi 125 FWD	M9T670, M9T686	02/10 →	
MASTER III 2.3 dCi 125 RWD	M9T686, M9T672	02/10 →	
MASTER III 2.3 dCi 130 FWD	M9T704	03/12 →	
MASTER III 2.3 dCi 130 RWD	M9T710	03/12 →	
MASTER III 2.3 dCi 145 FWD	M9T672, M9T694	02/10 →	
MASTER III 2.3 dCi 145 RWD	M9T694, M9T880	02/10 →	
MASTER III 2.3 dCi 150 FWD	M9T880, M9T694	10/12 →	
MASTER III 2.3 dCi 150 RWD	M9T694, M9R610	03/13 →	
MASTER III 2.3 dCi 170 FWD	M9T706	07/15 →	
MASTER 2.3 dCi	M9T676, M9T670	02/10 →	
MEGANE III 2.0 dCi	M9R610, M9R610	04/09 →	
MEGANE CC 2.0 dCi	M9R610	06/10 →	
SCÉNIC III 2.0 dCi	M9R610, M9T702	02/09 →	
VAUXHALL			
MOVANO 2.3 CDTi	M9T702, M9T686	05/10 →	
MOVANO B 2.3 CDTI [RWD]	M9T686, M9T670	07/10 →	
MOVANO B 2.3 CDTI FWD	M9T670, M9T670	05/10 →	
MOVANO B 2.3 CDTI RWD	M9T670, K9K612	05/10 →	

DACIA			
DUSTER 1.5 dCi	K9K612, K9K658	04/10 →	
DUSTER 1.5 dCi 4x4	K9K658, F4R720	06/10 →	
LOGAN I 1.5 dCi	K9K892	05/10 →	
SANDERO I 1.5 dCi	K9K892	05/10 →	
MERCEDES-BENZ			
CITAN 111 CDI	OM607.951	06/13 →	
NISSAN			
PRIMASTAR 1.9 dCi 100	F9Q760	07/02 →	
PRIMASTAR 1.9 dCi 80	F9Q762	09/02 →	
PRIMASTAR 2.0	F4R720, M9R630	03/01 →	
PRIMASTAR 2.0 dCi 115	M9R630, M9R630	09/06 →	
PRIMASTAR 2.0 dCi 90	M9R630, G9U630	09/06 →	
PRIMASTAR 2.5 dCi 115	G9U630, G9U630	09/08 →	
PRIMASTAR 2.5 dCi 140	G9U730	07/03 →	
PRIMASTAR 2.5 dCi 150	G9U632	09/06 →	
PRIMASTAR dCi 100	F9Q760	03/01 →	
PRIMASTAR dCi 115	G9U630, M9R630	09/08 →	
PRIMASTAR dCi 120	M9R630, M9R630	09/06 →	
PRIMASTAR dCi 140	G9U730	07/03 →	
PRIMASTAR dCi 150	G9U632	09/06 →	
PRIMASTAR dCi 80	F9Q762	03/01 →	
PRIMASTAR dCi 90	M9R630, K9K732	09/06 →	
QASHQAI 1.5 dCi	K9K	08/08 →	10/11
QASHQAI I 1.5 dCi	K9K732, M9R630	02/07 →	12/13
OPEL			
VIVARO A 2.0 CDTI	M9R630, K9K608	01/06 →	
RENAULT			
DUSTER 1.5 dCi [ExtraEU]	K9K898	09/13 →	
DUSTER 1.5 dCi 4x4	K9K884	06/11 →	
KANGOO II 1.5 dCi	K9K608, K9K636	06/08 →	
KANGOO II 1.5 dCi 110	K9K636, K9K608	09/10 →	
KANGOO II 1.5 dCi 75	K9K608, K9K608	09/10 →	
KANGOO II 1.5 dCi 90	K9K608, M9R630	06/09 →	
LOGAN 1.5 dCi	K9K892	05/10 →	
SANDERO I 1.5 dCi	K9K892	05/10 →	
TRAFIC 2.0 dCi	M9R630, M9R630	08/06 →	
TRAFIC II 2.0 dCi 115	M9R630, M9R630	08/06 →	
TRAFIC II 2.0 dCi 90	M9R630, M9R630	08/06 →	
VAUXHALL			
VIVARO 2.0 CDTI	M9R630, ENE	01/06 →	07/14

10.1455



07

MASS AIR FLOW METERS (MAF)

Adatt./Suitable:

CHRYSLER

5149208AB
68069532AA
K05149208AB

CONTINENTAL

5WK9 7017
5WK9 7028
5WK9 7817
5WK9 7917
A2C53303469

DODGE

5149208AB
K05149208AB

FIAT

K68069532AA

JEEP

5149208AB
68042575AA
68069532AA
K05149208AB
K68042575AA
K68069532AA

LANCIA

K68069532AA

MERCEDES-BENZ

A 651 090 00 48
A 651 090 01 48
A 651 090 02 48

MOPAR PARTS

05149208AB
68042575AA
68069532AA

MARKET DIFFUSION: MEDIUM



Ø in	Ø out	L=mm
82	82	100

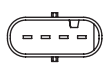

CHRYSLER

300C II 3.0 CRD EXF 09/11 ⇨

DODGE

CALIBER 2.2 CRD ENE 07/10 ⇨

JEEP

COMPASS 2.2 CRD ENE 05/11 ⇨

COMPASS 2.2 CRD 4x4 ENE, EXF 12/10 ⇨

GRAND CHEROKEE 3.0 CRD EXF 09/13 ⇨

GRAND CHEROKEE 3.0 CRD EXF, OM651.911 01/11 ⇨

V6 4x4

PATRIOT 2.2 CRD ENE 01/11 ⇨

PATRIOT 2.2 CRD 4x4 ENE 01/11 ⇨

LANCIA

THEMA 2011 3.0 D EXF 09/11 ⇨ 10/14

MERCEDES-BENZ

CLASSE C III C 180 CDI OM651.913 01/11 ⇨ 08/14

CLASSE C III C 200 CDI OM651.913 08/10 ⇨ 08/14

CLASSE C III C 220 CDI OM651.911, OM651.913 10/08 ⇨

CLASSE C III C 220 CDI OM651.912 02/13 ⇨ 08/14

4-matic

CLASSE C III C 250 CDI OM651.911 08/08 ⇨

CLASSE C III C 250 CDI OM651.912 04/10 ⇨ 08/14

4-matic

CLASSE CLS II CLS 220 OM651.924 05/14 ⇨

BlueTEC / d

CLASSE CLS II CLS 250 OM651.924 05/14 ⇨

BlueTEC / d 4-matic

CLASSE CLS II CLS 250 CDI / OM651.924 04/11 ⇨

BlueTEC / d

CLASSE E IV E 200 CDI / OM651.925 01/09 ⇨

BlueTEC

CLASSE E IV E 220 BlueTEC OM651.924 12/14 ⇨

4-matic

CLASSE E IV E 220 CDI OM651.911 01/09 ⇨

CLASSE E IV E 220 CDI / OM651.924 01/09 ⇨

BlueTEC

MERCEDES-BENZ

CLASSE E IV E 220 CDI / OM651.911 01/10 ⇨

BlueTEC / d

CLASSE E IV E 220 CDI / d OM651.911 01/10 ⇨

CLASSE E IV E 250 BlueTEC OM651.911 01/09 ⇨

CLASSE E IV E 250 CDI / OM651.924 01/09 ⇨

BlueTEC

CLASSE E IV E 250 CDI / OM651.911 01/09 ⇨

BlueTEC / d

CLASSE E IV E 250 CDI / OM651.924 01/09 ⇨

BlueTEC 4-matic

CLASSE GLC 250 d 4-matic OM651.960 04/15 ⇨

CLASSE GLK 200 CDI OM651.913, OM646.985 07/10 ⇨ 06/15

CLASSE GLK 220 CDI OM651.916 12/08 ⇨ 06/15

CLASSE GLK 220 CDI 4-matic OM651.912 12/08 ⇨ 06/15

CLASSE GLK 250 CDI 4-matic OM651.912 09/09 ⇨ 06/15

CLASSE M III ML 250 CDI / OM651.960 06/11 ⇨ 12/15

BlueTEC 4-matic

CLASSE SV S 250 CDI OM651.961 01/11 ⇨ 12/13

CLASSE SLK 250 d OM651.980 01/16 ⇨ 10/17

CLASSE SLK III 250 CDI / d OM651.980 01/12 ⇨

C-SERIES C200 CdI OM651.913 01/10 ⇨ 01/14

SPRINTER II 209 CDI OM646.984 06/06 ⇨ 12/09

SPRINTER II 210 CDI OM651.955 03/09 ⇨

SPRINTER II 211 CDI OM646.985, OM646.986 06/06 ⇨

SPRINTER II 213 CDI OM646.986, OM646.986 06/06 ⇨ 05/16

SPRINTER II 214 CDI OM651.955 04/16 ⇨

SPRINTER II 215 CDI OM646.986, OM651.955 06/06 ⇨ 12/09

SPRINTER II 216 CDI OM651.955, OM642.896 06/06 ⇨

SPRINTER II 218 CDI OM642.896, OM651.955 06/06 ⇨ 12/09

SPRINTER II 209 CDI OM646.984 06/06 ⇨ 12/09

SPRINTER II 310 CDI OM651.955, OM646.986 03/09 ⇨

SPRINTER II 311 CDI OM646.985 06/06 ⇨ 12/09

SPRINTER II 311 CDI 4x4 OM646.985 02/08 ⇨ 12/09

SPRINTER II 313 CDI OM646.986, OM651.955 06/06 ⇨

SPRINTER II 313 CDI 4x4 OM651.955, OM646.986 06/06 ⇨

SPRINTER II 314 CDI 4x4 OM651.955 05/16 ⇨

SPRINTER II 315 CDI OM646.986, OM646.986 06/06 ⇨ 12/09

SPRINTER II 315 CDI 4x4 OM646.986, OM651.955 02/08 ⇨ 12/09

SPRINTER II 316 CDI OM651.955, OM651.955 03/09 ⇨

SPRINTER II 316 CDI 4x4 OM651.955, OM642.896 03/09 ⇨

SPRINTER II 318 CDI OM642.896, OM651.955 06/06 ⇨ 12/09

SPRINTER II 411 CDI OM646.985 06/09 ⇨ 12/18

SPRINTER II 413 CDI OM651.955, OM646.986 06/06 ⇨

SPRINTER II 415 CDI OM646.986, OM646.986 06/06 ⇨ 12/09

SPRINTER II 416 CDI OM651.957 03/09 ⇨

SPRINTER II 509 CDI OM646.984 06/06 ⇨ 12/09

SPRINTER II 510 CDI OM651.955 03/09 ⇨

SPRINTER II 511 CDI OM646.985 06/06 ⇨ 12/09

SPRINTER II 513 CDI OM646.986, OM651.955 06/06 ⇨

SPRINTER II 513 CDI 4x4 OM651.955, OM646.986 06/06 ⇨

SPRINTER II 515 CDI OM646.986, OM651.955 06/06 ⇨ 12/09

SPRINTER II 516 CDI OM651.955, OM651.955 03/09 ⇨

SPRINTER II 516 CDI 4x4 OM651.955, OM642.896 06/06 ⇨

SPRINTER II 518 CDI OM642.896, OM646.980 06/06 ⇨ 12/09

SPRINTER SERIES Sprinter OM651.957 11/13 ⇨

416D CdI

SPRINTER SERIES Sprinter OM651.957 03/09 ⇨

519D CdI

VIANO CDI 2.0 OM651.940 07/10 ⇨

VIANO CDI 2.0 4-matic OM651.940 07/10 ⇨

VIANO CDI 2.2 OM651.940 07/10 ⇨

VIANO CDI 2.2 4-matic OM651.940 07/10 ⇨

VITO II 113 CDI OM651.940 09/10 ⇨

VITO II 113 CDI 4x4 OM651.940 09/10 ⇨

VITO II 115 CDI OM646.980, LKR 09/03 ⇨

VITO II 116 CDI OM651.940 09/10 ⇨

VITO II 116 CDI 4x4 OM651.940 09/10 ⇨

10.1465



07

MASS AIR FLOW METERS (MAF)

Adatt./Suitable:

BOSCH

0 280 218 207
0 280 218 208
0 281 002 940
0 281 002 941

CHEVROLET

55561912

GENERAL MOTORS

13 262 124
55 561 912

OPEL

13262124
55561912
8 36 456
8 36 655

VAUXHALL

13262124
55561912

MARKET DIFFUSION: MEDIUM



Ø in	Ø out	L=mm
70	70	92

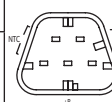

CHEVROLET

CRUZE 1.7 D LUD 01/12 ⇨

CRUZE 1.7 TD LKR, A17DTC 08/12 ⇨

OPEL

ASTRA J 1.3 CDTi A13DTE 12/09 ⇨ 10/15

ASTRA J 1.4 A14XEL 12/09 ⇨ 10/15

ASTRA J 1.7 CDTi A17DTC, A13DTE 09/09 ⇨ 10/15

CORSA D 1.3 CDTi A13DTE, A13DTC 06/09 ⇨ 08/14

CORSA D 1.7 CDTi A17DTS 12/09 ⇨ 08/14

INSIGNIA 1.4 B18XER 04/11 ⇨

MERIVA B 1.3 CDTi A13DTC, A14NEL 06/10 ⇨ 11/14

MERIVA B 1.4 A14NEL, A14NEL 06/10 ⇨ 03/17

MERIVA B 1.4 LPG A14NEL, A17DT 06/11 ⇨ 03/17

MERIVA B 1.7 CDTi A17DT, A14XEL 06/10 ⇨ 01/17

VAUXHALL

ASTRA VI 1.3 CDTi A13DTE 12/09 ⇨

ASTRA VI 1.4 A14XEL, A17DTC 12/09 ⇨

ASTRA VI 1.7 CDTi A17DTC, A13DTC 12/09 ⇨

CORSA D 1.3 CDTi A13DTC, A13DTC 08/06 ⇨ 08/14

CORSA D 1.7 CDTi A17DTS 03/07 ⇨ 08/14

CORSAVAN III 1.3 CDTi A13DTC, A13DTC 07/06 ⇨

INSIGNIA 1.6 A16XER 07/08 ⇨ 05/17

INSIGNIA 1.8 B18XER 07/08 ⇨ 05/17

MERIVA II 1.3 CDTi A13DTC, A14NEL 06/10 ⇨

MERIVA II 1.4 A14NEL, A14NEL 06/10 ⇨

MERIVA II 1.4 LPG A14NEL, A17DT 06/11 ⇨

MERIVA II 1.7 CDTi A17DT, 940A1.000 06/10 ⇨

10.1483



07

MASS AIR FLOW METERS (MAF)

Adatt./Suitable:

ALFA ROMEO

51792729
55243210

BOSCH

0 280 218 216
0 280 218 237
0 280 218 299
0 280 218 300
0 281 006 056
0 281 006 057
0 281 006 073
0 281 006 154

CHRYSLER

51792729

CITROËN

1192 CK

FIAT

51792729
51830257
71794496
71795145
71795146

FUSO (MITSUBISHI)

ME422096
ME422856

IVECO

504301164
55220331

LANCIA

51792729

MERCEDES-BENZ

ME422856

PEUGEOT

1192 CK

MARKET DIFFUSION: MEDIUM



Ø in	Ø out	L=mm	+B - NTC 0
80	80	90	

ALFA ROMEO

159 1.8 MPI	939A4.000	06/05 ⇨ 11/11
159 1.8 Tbi	939B1.000	05/09 ⇨ 12/12
4C 1.8	960A1.000	03/13 ⇨
BRERA 1.8 Tbi	939B1.000	05/09 ⇨ 06/10
GIULIETTA II 1.8	940A1.000	04/11 ⇨ 02/16
GIULIETTA II 1.8 Tbi	940A1.000, F300FAP	04/10 ⇨
SPIDER III 1.8 Tbi	939B1.000	05/09 ⇨ 03/11

CITROËN

JUMPER III 3.0 HdI 145	F300FAP, F30DTFAP	07/10 ⇨
JUMPER III 3.0 HdI 155	F30DTFAP, 250A1.000	07/10 ⇨
JUMPER III 3.0 HdI 180	F30DT	07/11 ⇨

FIAT

DUCATO III 110 Multijet 2,3 D	F1AE3481G	10/11 ⇨
DUCATO III 115 Multijet 2,0 D	250A1.000, F1AE0481N	06/11 ⇨
DUCATO III 120 Multijet 2,3 D	FPT	07/06 ⇨
DUCATO III 120 Multijet 2,3 D 4x4	F1AE0481D	03/10 ⇨
DUCATO III 130 Multijet 2,3 D	F1AE0481N, F1AE3481E	07/06 ⇨
DUCATO III 140 Natural Power	F1CFA401A	04/09 ⇨
DUCATO III 150 Multijet 2,3 D	F1AE3481E, F1CE0481D	06/11 ⇨
DUCATO III 160 Multijet 3,0 D	F1CE0481D, 4P10T2	07/06 ⇨
DUCATO III 180 Multijet 2,3 D	F1AGL411B	12/15 ⇨
DUCATO III 180 Multijet 3,0 D	F1CE3481E	06/11 ⇨
DUCATO III 2.0	--	01/14 ⇨
DUCATO III 2.3	--	01/14 ⇨
DUCATO III 3.0	--	01/14 ⇨
DUCATO 2.3 Multijet	F1AE0481N	12/09 ⇨ 07/14

FUSO (MITSUBISHI)

CANTER 3.0 DiTD	4P10T2, F1CE3481B	04/06 ⇨
-----------------	-------------------	---------

IVECO

DAILY IV 26L11, 26L11D, 35C11D, 35S11, 40C11	F1AE3481A	09/11 ⇨ 02/14
DAILY IV 29L11V, 35C11V, 35S11V, 40C11V	F1AE3481A	09/11 ⇨ 02/14

IVECO

DAILY IV 29L13 V, 35C13 V, 35S13 V, 40C13 V, 40S13 V	F1AE3481B	09/11 ⇨ 02/14
DAILY IV 29L13, 29L13D, 35C13D, 40C13	F1AE3481B	09/11 ⇨ 02/14
DAILY IV 29L15 V, 35C15L V, 40C15L V, 50C15L V	F1AE3481C	09/11 ⇨ 02/14
DAILY IV 29L15 V, 35S15 V, 35C15L V, 40C15L V, 50C15L V	F1AE3481C	09/11 ⇨ 02/14
DAILY IV 35C11K, 35S11DKP	F1AE3481A	09/11 ⇨ 02/14
DAILY IV 35C13K, 35C13DKP	F1AE3481B	09/11 ⇨ 02/14
DAILY IV 35C14 K, 35C14 DK, 35S14 K, 35S14 DK	F1CE3481L	07/07 ⇨ 08/11
DAILY IV 35C14 V, 35C14 V/P, 35S14 V, 35S14 V/P	F1CE3481L	07/07 ⇨ 08/11
DAILY IV 35C14 /P, 35S14 /P, 35S14 D, 35S14 D/P	F1CE3481L	07/07 ⇨ 08/11
DAILY IV 35C15 V, 40C15 V, 50C15 V, 60C15 V	F1CE3481B, F1CE3481B	09/11 ⇨ 02/14
DAILY IV 35C15, 35C15D, 35S15, 40C15, 45C15, 50C15, 60C15, 70C15	F1CE3481B	09/11 ⇨ 02/14
DAILY IV 35C15K, 35S15DKP, 50C15K, 60C15K, 65C15DK, 70C15K	F1CE3481B	09/11 ⇨ 02/14
DAILY IV 35C17 K, 35C17 DK, 35S17 K, 35S17 DK	F1CE3481C	07/07 ⇨ 08/11
DAILY IV 35C17 V, 35C17 V/P, 35S17 V, 35S17 V/P	F1CE3481C	07/07 ⇨ 08/11
DAILY IV 35C17 V, 35S17 V, 40C17 V, 45C17 V, 50C17 V, 60C17 V	F1CE3481C	09/11 ⇨ 02/14
DAILY IV 35C17 /P, 35S17 /P, 35S17 D	F1CE3481C	07/07 ⇨ 08/11
DAILY IV 35C17, 35C17D, 35S17, 40C17, 45C17, 50C17, 60C17, 70C17	F1CE3481C	09/11 ⇨ 02/14
DAILY IV 35C17K, 35S17DKP, 50C17K, 65C17DK 70C17K	F1CE3481C, F1CE3481J	09/11 ⇨ 02/14
DAILY IV 35C21 V, 35S21 V, 40C21 V, 45C21 V, 50C21 V	F1CE3481D	09/11 ⇨ 02/14
DAILY IV 35C21, 35S21, 40C21, 45C21, 50C21, 60C21, 70C21	F1CE3481D	09/11 ⇨ 02/14
DAILY IV 35S17 W, 35S17 WD	F1CE3481C	07/07 ⇨ 08/11
DAILY IV 40C14 K, 40C14 DK	F1CE3481L	07/07 ⇨ 08/11
DAILY IV 40C14 V, 40C14 V/P	F1CE3481L	07/07 ⇨ 08/11
DAILY IV 40C14, 40C14 /P	F1CE3481L	07/07 ⇨ 08/11
DAILY IV 40C17 K, 40C17 DK	F1CE3481C	07/07 ⇨ 08/11
DAILY IV 40C17 V, 40C17 V/P	F1CE3481C	07/07 ⇨ 08/11
DAILY IV 40C17, 40C17 /P	F1CE3481C	07/07 ⇨ 08/11
DAILY IV 45C14, 45C14 /P	F1CE3481L	07/07 ⇨ 08/11
DAILY IV 45C17 V, 45C17 V/P	F1CE3481C	07/07 ⇨ 08/11
DAILY IV 45C17, 45C17 /P	F1CE3481C	07/07 ⇨ 08/11
DAILY IV 50C14 K, 50C14 DK	F1CE3481L	07/07 ⇨ 08/11
DAILY IV 50C14 V, 50C14 V/P	F1CE3481L	07/07 ⇨ 08/11
DAILY IV 50C14, 50C14 /P	F1CE3481L	07/07 ⇨ 08/11
DAILY IV 50C17 K, 50C17 DK	F1CE3481C	07/07 ⇨ 08/11
DAILY IV 50C17 V, 50C17 V/P	F1CE3481C	07/07 ⇨ 08/11
DAILY IV 50C17, 50C17 /P	F1CE3481C	07/07 ⇨ 08/11
DAILY IV 55C17	F1CE3481C	08/07 ⇨ 03/12
DAILY IV 60C14 K, 60C14 DK	F1CE3481L	07/07 ⇨ 08/11
DAILY IV 60C14, 60C14 /P	F1CE3481L	07/07 ⇨ 08/11
DAILY IV 60C17 K, 60C17 DK	F1CE3481C	07/07 ⇨ 08/11
DAILY IV 60C17 V, 60C17 V/P	F1CE3481C	07/07 ⇨ 08/11
DAILY IV 60C17, 60C17 /P	F1CE3481C	07/07 ⇨ 08/11
DAILY IV 65C14 K, 65C14 DK	F1CE3481L	07/07 ⇨ 08/11
DAILY IV 65C14 V, 65C14 V/P	F1CE3481L	07/07 ⇨ 08/11
DAILY IV 65C14, 65C14 /P	F1CE3481L	07/07 ⇨ 08/11
DAILY IV 65C17 K, 65C17 DK, 65C17KK	F1CE3481C	07/07 ⇨ 08/11
DAILY IV 65C17 V, 65C17 V/P	F1CE3481C	07/07 ⇨ 08/11
DAILY IV 65C17, 65C17 /P	F1CE3481C	07/07 ⇨ 08/11
DAILY IV 70C14 K, 70C14 DK, 70C14 KK	F1CE3481L	07/07 ⇨ 08/11
DAILY IV 70C14 V, 70C14 V/P	F1CE3481L	07/07 ⇨ 08/11
DAILY IV 70C14, 70C14 /P	F1CE3481L	07/07 ⇨ 08/11
DAILY IV 70C17 K, 70C17 DK, 70C17 KK	F1CE3481C	07/07 ⇨ 08/11
DAILY IV 70C17, 70C17 /P	F1CE3481C	07/07 ⇨ 08/11
DAILY IV 70C17V, 70C17V/P	F1CE3481C	07/07 ⇨ 08/11
DAILY V 33S11, 35S11, 35C11	F1AFL411A	03/14 ⇨ 04/16
DAILY V 33S13, 35S13, 35C13	F1AFL411B	03/14 ⇨ 04/16
DAILY V 33S15, 35S15, 35C15	F1AFL411C	03/14 ⇨ 04/16
DAILY V 35S14, 35S15, 35C15, 40S14, 40C15, 50C15, 65C15, 70C15	F1CE3481J	03/14 ⇨ 04/16
DAILY V 35S15, 35C15, 40C15, 50C15, 65C15, 70C15	F1CE3481J, F1CFL411F	03/14 ⇨ 04/16

IVECO

DAILY V 35S17, 35C17, 40C17, 45S17, 45C17, 50C17, 55C17, 65C17...	F1CFL411F	03/14 ⇨ 04/16
DAILY V 35S17, 35C17, 40C17, 50C17, 55C17, 65C17, 70C17	F1CFL411F, F1CFL411G	03/14 ⇨ 04/16
DAILY V 35S17, 55S17 4x4	F1CFL411F	08/15 ⇨ 04/16
DAILY V 35S21, 35C21, 40C21, 50C21, 65C21, 70C21	F1CFL411G, F1CE3481J	03/14 ⇨
DAILY V 40C15, 50C15, 60C15	F1CFL411E	06/14 ⇨ 10/16
DAILY V 40C15, 50C15, 65C15	F1CE3481J, F1CFL411F	03/14 ⇨ 04/16
DAILY V 40C17, 50C17, 60C17	F1CFL411F	06/14 ⇨ 10/16
DAILY V 40C17, 50C17, 65C17	F1CFL411F, F1CE0481D(F30DT)	03/14 ⇨ 04/16
DAILY V 50C15	F1CFL411E	06/14 ⇨ 10/16
DAILY V 50C17	F1CFL411F	06/14 ⇨ 10/16
DAILY V 50C17, 65C17	F1CFL411F	06/14 ⇨ 10/16
DAILY 2.3	F1AE3481C	09/11 ⇨ 02/14
DAILY 3.0	F1CE3481B, F1CE3481B	09/09 ⇨

10.1492



07

MASS AIR FLOW METERS (MAF)

Adatt./Suitable:

BOSCH

0 280 218 108

VOLVO

860239-1
867011-2
867026-3
943875-7
947064-0



Ø in	Ø out	L=mm	NTC +B - +R 0
80	80	100	

VOLVO

C70 1.2 4T	B5254T	03/98 ⇨ 10/05
S60 1.2 3 T5	B5234T7	07/00 ⇨ 09/02
S70 2.3 AWD	B5234T7	04/99 ⇨ 09/00
S70 2.3 T5 AWD	B5234T4	07/97 ⇨ 09/00
S70 2.3 Turbo	B5234FT+	01/97 ⇨ 11/00
S80 1.2 3 R	B5234T7	04/00 ⇨ 08/05
V70 1.2 3 AWD	B5234T7	12/98 ⇨ 02/00
V70 1.2 3 T AWD	B5234FT+	04/97 ⇨ 03/00
V70 1.2 3 T-5	B5234T3	11/96 ⇨ 12/00
V70 1.2 3 T-5 AWD	B5234T3	01/97 ⇨ 12/00
V70 1.2 3 Turbo	B5234FT+	12/95 ⇨ 03/00
V70 II 2.3 AWD	B5234T7	10/00 ⇨ 09/04
XC70 1.2 3 XC AWD	B5234T7	01/01 ⇨ 07/04

10.1495



07

MASS AIR FLOW METERS (MAF)

Adatt./Suitable:

ALFA ROMEO

46749246
55193049
60816693
71724093
71787958
71787961
71787974
71793937

*RG **Corresponds to the original re-manufactured part**

- Corrisponde al pezzo originale rigenerato
- Correspond à la pièce d'origine reconditionnée
- Entspricht dem neuwertigen OE-Teil
- Corrisponde a la pieza original remanufacturada

BOSCH

0 280 218 054

FIAT

46749246
55193049
60816693

LANCIA

46749246
55193049
60816693
71724093



Ø in	Ø out	L=mm	NTC +B - +R 0
80	80	130	

ALFA ROMEO

156 2.5 V6 24V	AR32401, ATD	02/97 ⇨ 05/06
166 2.5 V6 24V	AR36201	10/00 ⇨ 06/07
166 3.2 V6 24V	936A.000	10/03 ⇨ 06/07
GTV 3.0 V6 24V	AR16105	10/00 ⇨ 10/05
SPIDER II 3.0 V6	AR16105	09/94 ⇨ 04/05

LANCIA

THESIS 2.0 Turbo	841E.000	07/02 ⇨ 07/09
THESIS 2.4	841D.000	07/02 ⇨ 07/09
THESIS 3.0 V6	841A.000	07/02 ⇨ 07/09
THESIS 3.2 V6	841L.000	05/03 ⇨ 07/09

10.1499



07,5

MASS AIR FLOW METERS (MAF)

Adatt./Suitable:

BOSCH

0 280 218 083

MERCEDES-BENZ

1130940148
A 113 094 01 48



Ø in	Ø out	L=mm	NTC +B - +R 0
86	84	100	

MERCEDES-BENZ

CLASSE C I C 43 AMG	M113.944	08/97 ⇨ 03/01
CLASSE CLK I 55 AMG	M113.984	08/99 ⇨ 06/02

MERCEDES-BENZ

CLASSE E II E 430	M113.940	06/97 ⇨ 03/02
CLASSE E II E 430 4-matic	M113.940	05/99 ⇨ 03/02
CLASSE E II E 55 AMG	M113.980	08/97 ⇨ 03/02
CLASSE G II G 500	M113.962	04/98 ⇨
CLASSE G II G 55 AMG	M113.962	04/98 ⇨
CLASSE S IV CL 500	M113.960	03/99 ⇨ 03/06
CLASSE S IV S 500	M113.960	10/98 ⇨ 12/03
CLASSE SL IV 500	M113.961	05/98 ⇨ 10/01

PUCH

G-MODELL G 500	M113.962	12/97 ⇨ 11/00
----------------	----------	---------------

10.1500



07

MASS AIR FLOW METERS (MAF)

Adatt./Suitable:

00 Eliminated on 08-01-2019. Please verify the availability through our local distributors

- Eliminato il 08-01-2019. Verificare la disponibilità presso i nostri distributori
- Éliminé le 08-01-2019. Vérifier la disponibilité auprès de nos distributeurs sur place
- Am 08-01-2019 gestrichen. Evtl. Verfügbarkeit bitte bei unseren Händlern prüfen
- Eliminado en fecha 08-01-2019. Verificar la disponibilidad a través de nuestros distribuidores locales

1006 After depletion of stock this part is replaced by:

- Esaurite le scorte questo pezzo sarà sostituito da:
- Après épuisement du stock, cette pièce est remplacée par:
- Nach Vorraterschöpfung wird ersetzt durch:
- Despues agotamiento stock, sera sustituido por:

10.1556



Ø in	Ø out	L=mm	+B - T 0
80	80	100	

10.1509



07

MASS AIR FLOW METERS (MAF)

Adatt./Suitable:

AUDI

038 906 461 B
038 906 461 BX *RG

BOSCH

0 281 002 531
0 281 002 532
0 986 284 009

SEAT

038 906 461 B
038 906 461 BX *RG

SKODA

038 906 461 B
038 906 461 BX *RG

VW

038 906 461 B
038 906 461 BX *RG

*RG **Corresponds to the original re-manufactured part**

- Corrisponde al pezzo originale rigenerato
- Correspond à la pièce d'origine reconditionnée
- Entspricht dem neuwertigen OE-Teil
- Corrisponde a la pieza original remanufacturada

MARKET DIFFUSION: HIGH



Ø in	Ø out	L=mm	+B - +R 0
70	70	96	

AUDI

A3 I 1.9 TDI	ATD, BKC	10/00 ⇨ 05/03
A3 II 1.9 TDI	BKC, BKC	05/03 ⇨ 05/10
A3 II SPORTBACK 1.9 TDI	BKC, AUY	09/04 ⇨ 05/10
A4 II 1.9 TDI	AVB	05/01 ⇨ 12/04

SEAT

ALHAMBRA I / II 1.9 TDI	AUY, BJB	06/00 ⇨ 03/10
ALTEA 1.9 TDI	BJB, BKC	04/04 ⇨
ALTEA XL 1.9 TDI	BKC, AMF	10/06 ⇨
ALTEA XL 1.9 TDI 4x4	BLS	06/09 ⇨ 12/10
CORDOBA II 1.4 TDI	AMF, ATD	10/02 ⇨ 11/09
CORDOBA II 1.9 TDI	ATD, AMF	09/02 ⇨ 11/09
IBIZA III 1.4 TDI	AMF, ATD	05/02 ⇨ 11/09
IBIZA III 1.9 TDI	ATD, BLS	02/02 ⇨ 11/09
IBIZA IV 1.4 TDI	BMS	07/08 ⇨ 06/10
IBIZA IV 1.9 TDI	BLS, AGR	03/08 ⇨ 06/10
LEON I 1.9 TDI	AGR, BKC	10/05 ⇨ 06/06
LEON II 1.9 TDI	BKC, AGR	07/05 ⇨ 12/10
TOLEDO II 1.9 TDI	AGR, BJB	10/98 ⇨ 07/04
TOLEDO III 1.9 TDI	BJB, AMF	10/04 ⇨ 05/09

SKODA

FABIA I 1.4 TDI	AMF, ATD	04/03 ⇨ 03/08
FABIA I 1.9 TDI	ATD, ASZ	01/00 ⇨ 03/08
FABIA I 1.9 TDI RS	ASZ, BMS	06/03 ⇨ 03/08
FABIA II 1.4 TDI	BMS, BLS	01/07 ⇨ 03/10
FABIA II 1.9 TDI	BLS, AGR	04/07 ⇨ 03/10
OCTAVIA I 1.9 TDI	AGR, BJB	08/00 ⇨ 12/10
OCTAVIA I 1.9 TDI 4x4	ATD	09/00 ⇨ 01/06
OCTAVIA II 1.9 TDI	BJB, BKC	06/04 ⇨ 12/10
OCTAVIA II 1.9 TDI 4x4	BKC, BMS	11/04 ⇨ 12/10
ROOMSTER 1.4 TDI	BMS, AXR	07/06 ⇨ 03/10
ROOMSTER 1.9 TDI	AXR, BLS	03/06 ⇨ 03/10
SUPERB II 1.9 TDI	BLS, AGR	03/08 ⇨ 11/10

VW

BORA 1.9 TDI	AGR, BJB	09/00 ⇨
BORA 1.9 TDI 4motion	ATD	09/00 ⇨ 05/05
CADDY III 1.9 TDI	BJB, BDJ	04/04 ⇨ 08/10
CADDY III 1.9 TDI 4motion	BLS	05/08 ⇨ 08/10
CADDY III 2.0 SDI	BDJ, AXB	03/04 ⇨ 08/10
CAMPMOBILE 1.9 TDi	AXB, AGR	03/04 ⇨ 11/09
FOX 1.4 TDI	BNM	04/05 ⇨ 12/09
GOLF IV 1.9 TDI	AGR, BKC	02/00 ⇨ 06/06
GOLF IV 1.9 TDI 4motion	ATD	09/00 ⇨ 06/06
GOLF V 1.9 TDI	BKC, BKC	10/03 ⇨ 07/09
GOLF V 1.9 TDI 4motion	BKC, BKC	08/04 ⇨ 07/09
GOLF V 2.0 SDI	BDK	01/04 ⇨ 11/08
JETTA V 1.9 TDI	BKC, AXB	01/05 ⇨

VW			
MULTIVAN 1.9 TDI	AXB, ATD	04/03 →	11/09
NEW BEETLE 1.9 TDI	ATD, BKC	02/01 →	09/10
PASSAT V 1.9 TDI	BKC, AMF	03/05 →	11/10
POLO 1.9 TDi [ExtraEU]	ATD	07/03 →	06/05
POLO IV 1.4 TDI	AMF, ATD	10/01 →	
POLO IV 1.9 TDI	ATD, AUY	10/01 →	11/09
SHARAN I 1.9 TDI	AUY, AVQ	04/00 →	03/10
SHARAN I 1.9 TDI 4motion	BVK	04/00 →	03/10
TOURAN I 1.9 TDI	AVQ, AXB	02/03 →	05/10
TRANSPORTER V 1.9 TDI	AXB, EJ205	04/03 →	11/09

10.1527



04

MASS AIR FLOW METERS (MAF)

Adatt./Suitable:

DENSO
197400-2090
SUBARU
22680-AA310

- NEW - AVAILABLE FROM:**
- NUOVO - DISPONIBILE DA:
 - NOUVEAU - DISPONIBLE EN:
 - NEU - VERFUEGBAR AB:
 - NUEVO - DISPONIBLE EN:

19/Q4

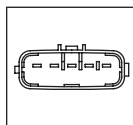

SUBARU			
FORESTER I 2.0 S Turbo AWD	EJ205, EJ20	04/01 →	09/02
FORESTER II 2.0 S Turbo AWD	EJ20, EJ255	09/02 →	05/05
FORESTER II 2.5	EJ253	02/02 →	
FORESTER II 2.5 AWD	EJ255, EJ205	12/03 →	12/09
FORESTER II 2.5 XT AWD	EJ255	06/05 →	05/08
IMPREZA II 2.0 AWD	EJ205	10/05 →	03/07
IMPREZA II 2.0 i AWD	EJ205	12/01 →	11/02
IMPREZA II 2.0 i WRX AWD	EJ205	12/02 →	09/05
IMPREZA II 2.0 Turbo AWD	EJ205	12/00 →	12/05
IMPREZA II 2.0 WRX STi AWD	EJ207	11/01 →	09/05
IMPREZA II 2.0 WRX STi Prodrive Performance Package AWD	EJ207	04/01 →	10/02
IMPREZA II 2.0 WRX Turbo AWD	EJ205, EJ255	12/00 →	03/07
IMPREZA II 2.5 AWD	EJ257	10/05 →	03/07
IMPREZA II 2.5 GB270 AWD	EJ255	07/07 →	12/07
IMPREZA II 2.5 i WRX AWD	EJ255	09/05 →	12/08
IMPREZA II 2.5 WRX AWD	EJ255	09/05 →	12/08
IMPREZA II 2.5 WRX STi AWD	EJ257	09/05 →	12/07
IMPREZA III 2.5 AWD	EJ255, EJ25	01/07 →	12/07
LEGACY III 2.0	EJ208	08/00 →	08/03
LEGACY III 2.0 RSK AWD	EJ206	08/00 →	08/03
LEGACY IV 2.0 Turbo	EJ20X	05/03 →	
LEGACY IV 2.0 Turbo HP	EJ20Y	05/03 →	
LEGACY IV 2.5 AWD	EJ25, EJ252	09/03 →	04/09
LEGACY IV 2.5 i	EJ252, EJ252	05/03 →	
LEGACY IV 2.5 i AWD	EJ25	09/07 →	12/09
LEGACY IV 2.5 Turbo	EJ255	05/03 →	
LEGACY IV 3.0	EZ30D	05/03 →	
LEGACY IV 3.0 R AWD	EZ30	09/03 →	06/09
OUTBACK III 2.5	EJ252, EJ252	09/08 →	09/09
OUTBACK III 2.5 AWD	EJ252, M16A	11/03 →	09/09
OUTBACK III 3.0 AWD	EZ30	11/03 →	09/09

10.1537



07

MASS AIR FLOW METERS (MAF)

Adatt./Suitable:

BOSCH
0 281 006 374
SUZUKI
13800-62M00
13800-62M00-000



Ø in	Ø out	L=mm	+B - NTC 0
70	70	96	

SUZUKI		
SX4 II 1.6 DDiS	D16AA	08/13 →
SX4 II 1.6 DDiS AllGrip	D16AA	08/13 →
VITARA IV 1.6	M16A, M16A	02/15 →
VITARA IV 1.6 AllGrip	M16A, D5244T13	02/15 →
VITARA IV 1.6 DDiS	D16AA	02/15 →
VITARA IV 1.6 DDiS AllGrip	D16AA	02/15 →

10.1556



08

MASS AIR FLOW METERS (MAF)

Adatt./Suitable:

BOSCH
0 281 002 730
0 281 002 731
0 281 006 184
0 281 006 185
0 281 006 248
0 281 006 877

- ITEM NOW AVAILABLE FROM PRODUCTION**
- ARTICOLO ORA DISPONIBILE PER LA VENDITA
 - ARTICLE DISPONIBLE EN PRODUCTION COURANTE
 - JETZT ZUM VERKAUF VERFUEGBARER ARTIKEL
 - ARTICULO AHORA DISPONIBLE EN PRODUCCION

MARKET DIFFUSION: MEDIUM



Ø in	Ø out	L=mm	+B - T 0
80	80	100	

VOLVO		
C30 D5	D5244T13, D5244T13	10/06 → 12/12
C70 II 2.4 D	D5244T9	03/07 → 06/13
C70 II D5	D5244T8	03/06 → 06/13
S40 II 2.4 CDI	D5244T9	03/07 → 12/10
S40 II 2.4 D5	D5244T13, D5244T5	03/06 → 12/10
S60 I 2.4 D	D5244T5, D5244T19	03/05 → 04/10

ILLUSTRATED SECTION -Parte figurata -Partie illustrée -Bildteil -Parte ilustrada

FA-SEN19Q2



ABSOLUTE PRESSURE SENSORS (MAP)

·SENSORI DI PRESSIONE ARIA ASSOLUTA ·CAPTEURS DE PRESSION D'AIR ABSOLU
·ABSOLUTLUFTDRUCKSENSOREN ·SENSORES DE PRESIÓN ABSOLUTA (MAP)

(A) P/NRS. - NOTES

- CODICI - NOTE
- RÉFS. - NOTES
- ARTIKEL-NR. - ANMERKUNGEN
- CODIGOS - NOTAS

10.3335

3

ABSOLUTE PRESSURE SENSORS (MAP)

Adatt./Suita

CITROËN

96 753 330 80

DENSO

079 800-9830

DS

96 753 330 80

PEUGEOT

96 753 330 80

· NEW - AVAILABLE FROM:

· NUOVO - DISPONIBILE DA:

· NOUVEAU - DISPONIBLE EN:

· NEU - VERFUEGBAR AB:

· NUEVO - DISPONIBLE EN:

18/Q4

(B) PICTURE + TECHNICAL INFO

- FOTO + INFORMAZIONE TECNICA
- ILLUSTRATION + INFORMATION TECHNIQUE
- BILD + TECHNISCHE INFO
- FOTO + INFORMACIÓN TÉCNICA

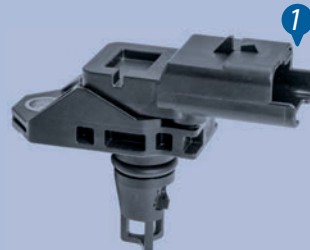

kPa

mV

NTC + - 0

37,50 - 312,50

379 - 4672



(C) APPLICATION LIST

- GUIDA APPLICAZIONI
- LISTE D'APPLICATIONS
- ANWENDUNGSTABELLE
- LISTA DE APLICACIONES

CITROËN

BERLINGO II 1.2 PureTech 110	→, HNV(EB2DTM)	02/16 ⇔
C3 II 1.2 THP 110	HNZ(EB2DT)	10/14 ⇔
C3 PICASSO 1.2 THP 110	HNZ(EB2DT)	01/15 ⇔
C4 II 1.2 THP 110	HNZ(EB2DT)	02/15 ⇔
C4 II 1.2 THP 130	HNV(EB2DTS)	04/14 ⇔
C4 CACTUS 1.2 THP 110	HNZ(EB2DT)	09/14 ⇔

(A)

1 # FACET

2 OEM P/NRS.

- CODICI ORIGINALI
- RÉFS. D'ORIGINE
- ORIGINALTEILE-NR.
- CODIGOS ORIGINALES

3 PACKAGING SIZE

- FORMATO CONFEZIONE
- FORMAT DU CONDITIONNEMENT
- ABPACKENSGROSSE
- TAMAÑO DEL ENVASE

4 PRODUCT AVAILABILITY DATE

- DATA DI DISPONIBILITÀ DEL PRODOTTO
- DISPONIBILITÉ DU PRODUIT
- PRODUKTVERFUEGBARKEITSDATUM
- DISPONIBILIDAD ARTÍCULO

5 NOTE

- NOTE
- NOTES
- BEMERKUNGEN
- NOTAS

(B)

1

PICTURE

- FOTO
- PHOTO
- BILD
- FOTO

2

AIR PRESSURE

- PRESSIONE DELL'ARIA
- PRESSION DE L'AIR
- LUFTDRUCK
- PRESION DEL AIRE

3

OUTPUT VOLTAGE/FREQUENCY

- TENSIONE/FREQUENZA D'USCITA
- VOLTAGE/FREQUENCE EN SORTIE
- AUSGANGSSPANNUNG BZW. FREQUENZ
- VOLTAJE/FRECUENCIA DE SALIDA

4

TYPE OF CONNECTION

- TIPO DI CONNESSIONE
- TYPE DE CONNEXION
- ANSCHLUSSART
- TIPO DE ENCHUFE

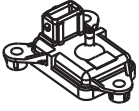

10.3XXX

Absolute Air pressure sensors (MAP)

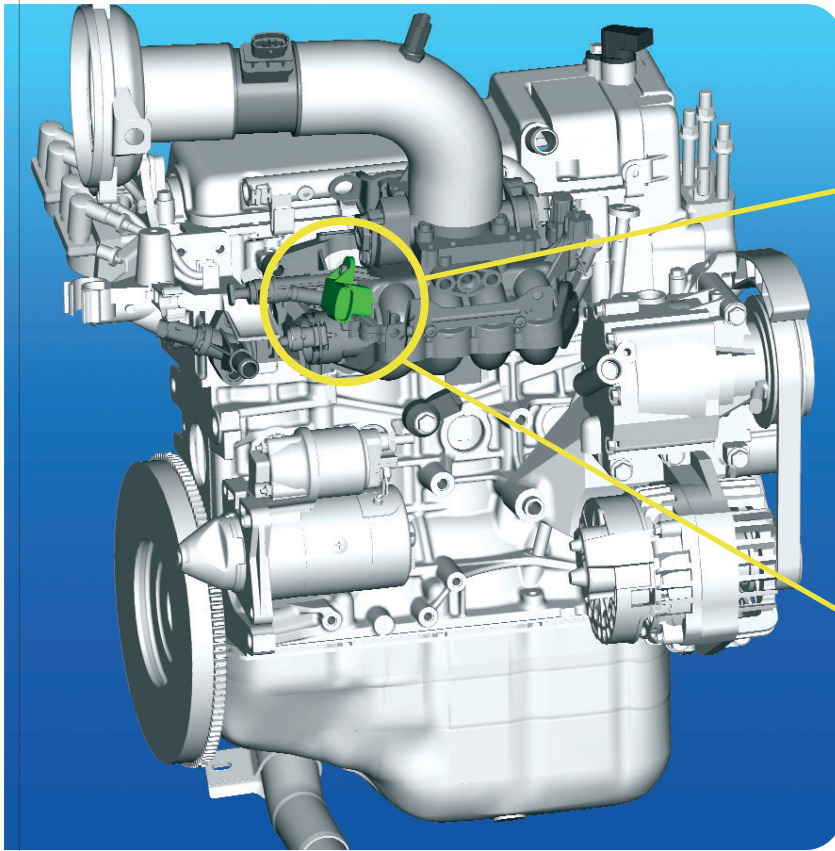

Rendering: by kind concession of FIAT POWERTRAIN TECHNOLOGIES

MAP (Manifold Absolute Pressure) sensors **detect the pressure of the air sucked in by the intake manifold** of the engine converting it into an electrical signal (generally tension) and sending it to the engine control unit. Electronic fuel injection systems *indirectly* calculate the amount of air sucked in (starting from measurements of the pressure and air temperature, RPM and engine timing), thus determining the correct fuel quantity. MAPs can thus guarantee optimum thermal efficiency as well as keep exhaust gases within the percentages established by the anti-pollution standards.

MAP sensors can be used with **gasoline, diesel and hybrid powered engines**. Depending on the type of engine and control unit, MAP sensors may:

- include a (integrated) temperature probe for the air sucked in*¹
- be used together with an air flow sensor*²

*¹ (Facet PNRS 10.4XXX); *² (Facet PNRS 10.1XXX).

The main **reasons for failures** in the product are:

- infiltration of humidity in the connection due to wiring
- malfunction of the ventilation system, sending dirty air onto the device

Signs of malfunctions of the sensor are indicated by illumination of the engine warning lamp, reduced performance, increased consumption and emissions, engine stopping at idling speed.

MAP sensors are designed and assembled to withstand the critical installation conditions inside the engine compartment.

In particular, the following **requirements** shall be met:

- Operating temperature: $-40^{\circ}\text{C} \div +125^{\circ}\text{C}$
- Electromagnetic immunity
- Resistance to hydrocarbons

The MAP sensors undergo **qualification and endurance tests** to determine if the product is suitable for construction and sale:

- High and low pressure cyclic operation during high and low temperature conditions for a total of 400h
- Hermetic seal
- Susceptibility to electromagnetic radiofrequency interference induced on the cables
- Resistance to vibrations
- Resistance to impacts

When these tests have been passed and after the approval to manufacture has been given, the product, in the assembly process, is strictly checked through a series of cycles which include a **100% testing** of the sensor output at high and low pressure as well as of the absorbed current of the hermetic seal.

Structural elements and operation

The plastic body is provided with a *pressure connection* which connects the sensitive element of the MAP to the air sucked in by the engine. The pressure connection is connected to the intake manifold by means of a flexible tube. The pressure sensors which integrate the temperature probe are installed directly on the intake manifold; here, the pressure connection is fit into the air duct and contains the temperature probe.

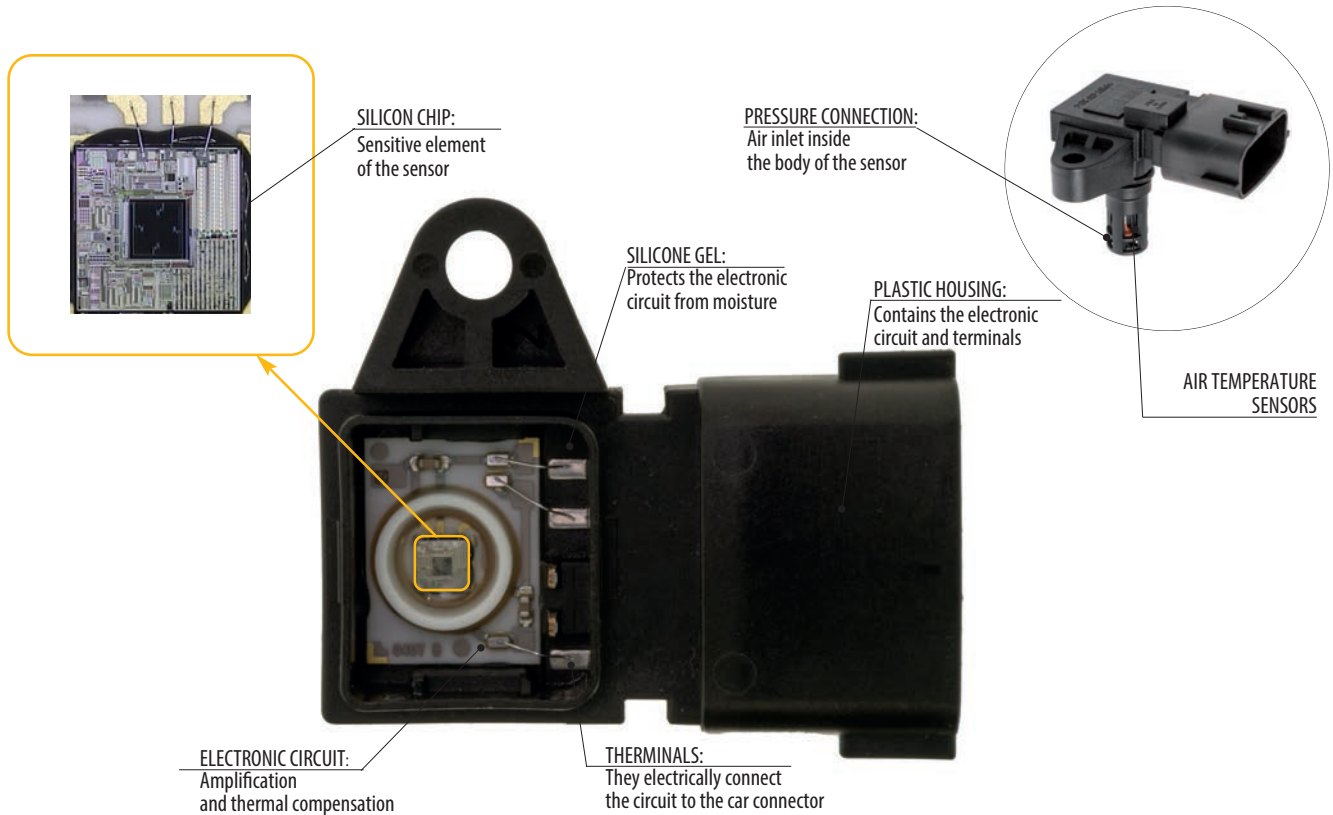

The sensitive element of the MAP is a *silicon chip* provided with a thin diaphragm on top of which there are *piezoresistive resistors* which are able to change their own electrical resistance according to the mechanical deformations generated by the air pressure. The powered chip sends a weak electrical signal as the pressure changes. An *electronic circuit* amplifies this signal and keeps it stable as the temperature changes. This circuit is achieved in a clean room (environment with a controlled temperature, humidity and impurity level) through *thick-film hybrid technology*: the electronic components are mounted at the surface, on a screen printed ceramic substrate with conductive and resistive pastes. Once achieved, the circuit is calibrated according to the required values, calibrating specific resistances with a laser beam, and thus protected with special *silicone gel*. The ratio between the electrical output value (generally tension) and the air pressure sucked in, is **linear**.

$$U = A \cdot P + B \quad [V]$$

U: electrical output quantity [V]

P: pressure of the air drawn in [kPa]

A: amplification [V/kPa]

B: offset (constant voltage) [V]

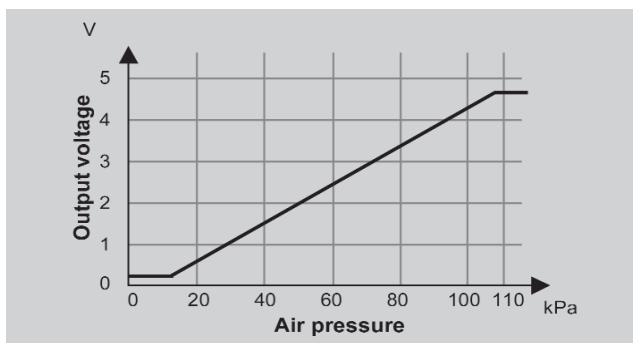

The output voltage is limited by a minimum value, nearly 0 V (typically 250 mV), and a maximum value, nearly equal to the power (typically 4750 mV).

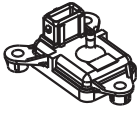

10.3XXX

Sensori di Pressione Aria Assoluta (MAP)

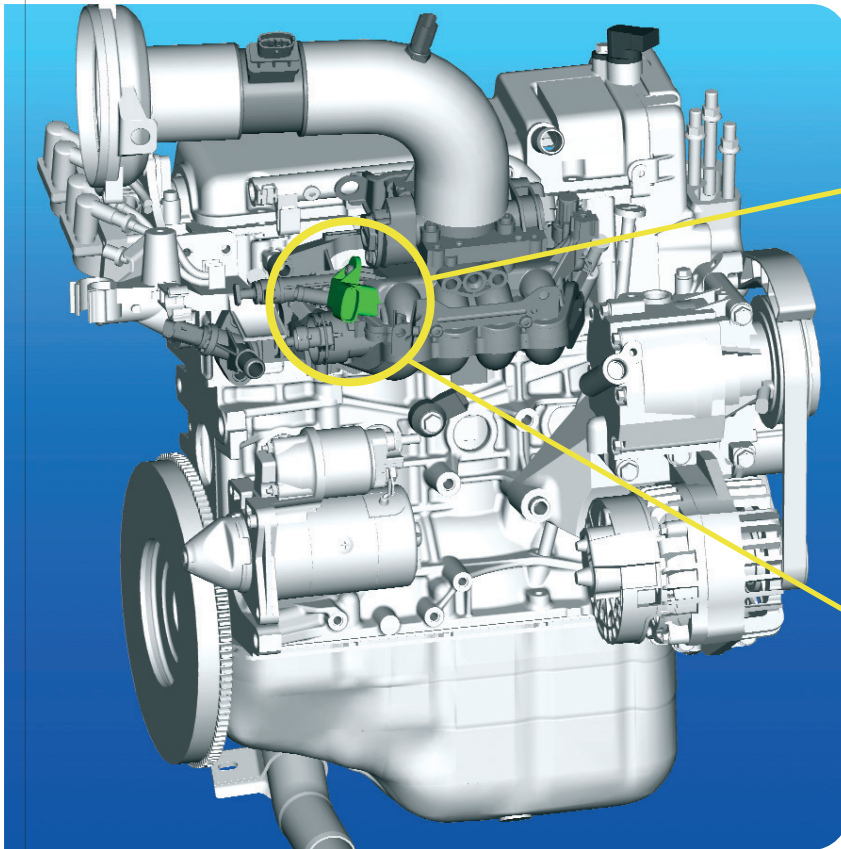

Rendering: per gentile concessione di FIAT POWERTRAIN TECHNOLOGIES

Il sensori MAP (*Manifold Absolute Pressure*) **rilevano la pressione dell'aria aspirata dal collettore d'aspirazione** del motore convertendola in un segnale elettrico (generalmente tensione) e lo inviano alla centralina controllo motore. I sistemi di iniezione elettronica calcolano in modo *indiretto* la quantità di aria aspirata e stabiliscono il corretto dosaggio di carburante. I MAP pertanto garantiscono un buon rendimento termico e permettono di mantenere i gas tossici esausti di combustione entro le percentuali stabilite dalle norme anti-inquinamento.

I sensori MAP si possono applicare a **veicoli con alimentazione a benzina, a gasolio e ibrida**. Inoltre, in funzione della tipologia di motore e della centralina di controllo, i sensori MAP possono:

- includere una sonda (integrata) di temperatura dell'aria aspirata*¹
- essere affiancati ad un sensore di portata aria*²

*¹ (articolo Facet 10.4XXX); *²(articolo Facet 10.1XXX).

Le principali **cause di guasto** del prodotto sono:

- infiltrazioni di umidità nella connessione dovuta al cablaggio
- malfunzionamento dell'impianto di aspirazione che manda aria sporca sul dispositivo

I **segnali di malfunzionamento** del sensore sono ravvisabili nell'accensione della spia motore, nella riduzione delle prestazioni, nell'aumento dei consumi e delle emissioni, e nello spegnimento al

minimo.

I sensori MAP sono progettati e costruiti per sopportare le condizioni critiche di montaggio nel vano motore. In particolare devono soddisfare i seguenti **requisiti**:

- *temperatura di funzionamento*: -40°C ÷ +125°C
- *immunità elettromagnetica*
- *resistenza agli idrocarburi*

I sensori MAP sono sottoposti a rigorose **prove di qualificazione e di durata** per stabilire se il prodotto è idoneo per essere costruito e venduto:

- funzionamento ciclico ad alta e bassa pressione in condizioni di alta e bassa temperatura per un totale di 400h
- resistenza ai cicli rapidi di temperatura
- tenuta ermetica
- suscettibilità elettromagnetica ai disturbi a radiofrequenza indotti sui cavi
- resistenza alle vibrazioni
- resistenza agli urti

Superate tali prove e concesso il benessere a produrre, durante l'assemblaggio il prodotto viene sottoposto a severi cicli di controllo che prevedono il **collaudo al 100%** dell'uscita del sensore a bassa e alta pressione, della corrente assorbita e della tenuta ermetica.

Elementi costruttivi e principio di funzionamento

Il corpo plastico è dotato di una *pipetta* che collega l'elemento sensibile del MAP all'aria aspirata dal motore. La pipetta è collegata al collettore di aspirazione tramite un tubicino flessibile. I sensori di pressione che integrano la sonda di temperatura sono montati direttamente sul collettore d'aspirazione, in questo caso la pipetta è inserita nel condotto dell'aria e contiene la sonda di temperatura.

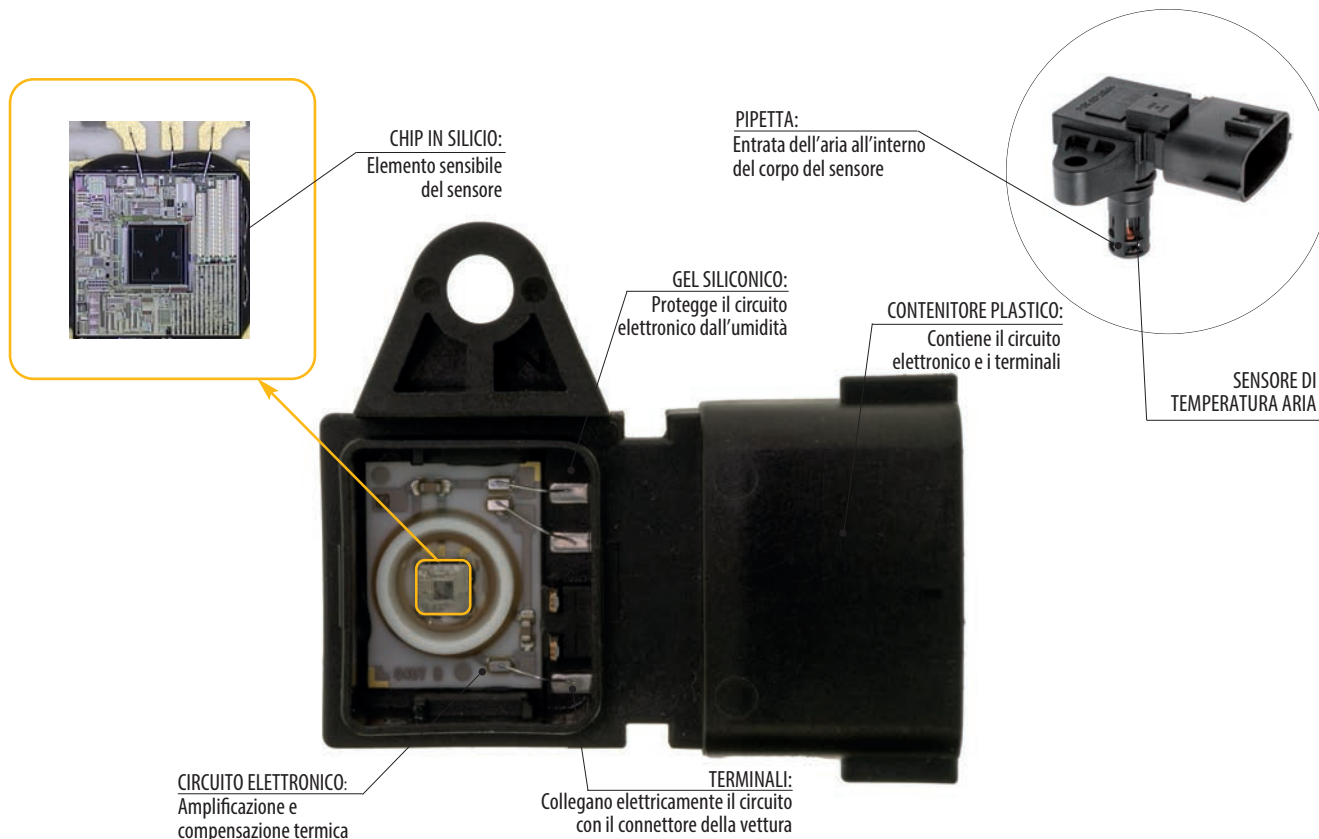

L'elemento sensibile del MAP è un *chip in silicio* dotato di un sottile diaframma sulla cui superficie sono realizzati resistori *piezoresistivi* che variano la propria resistenza elettrica in funzione delle deformazioni meccaniche generate dalla pressione dell'aria. Il chip alimentato fornisce un debole segnale elettrico al variare della pressione. Un *circuito elettronico* amplifica questo segnale e lo mantiene stabile al variare della temperatura. Tale circuito è realizzato in *camera bianca* (ambiente con temperatura, umidità e livello di impurità controllati) con *tecnologia ibrida a film spesso*: i componenti elettronici sono montati superficialmente su un substrato ceramico serigrafato con paste conduttive e resistive. Una volta realizzato, il circuito viene calibrato sui valori richiesti tarando specifiche resistenze con un fascio laser e quindi protetto con un apposito *gel siliconico*. La relazione tra la grandezza elettrica in uscita (generalmente tensione) e la pressione dell'aria aspirata è **lineare**:

$$U = A \cdot P + B \quad [V]$$

- U**: grandezza elettrica di uscita [V]
- P**: pressione dell'aria aspirata [kPa]
- A**: amplificazione [V/kPa]
- B**: offset (tensione costante) [V]

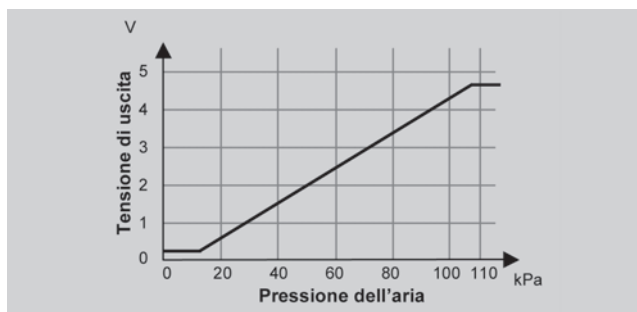

La tensione di uscita è limitata da un valore minimo, quasi 0 V (tipicamente 250 mV), e un valore massimo, quasi uguale all'alimentazione (tipicamente 4750 mV).

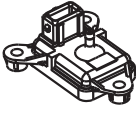

10.3XXX

Capteurs de pression d'air absolue (MAP)

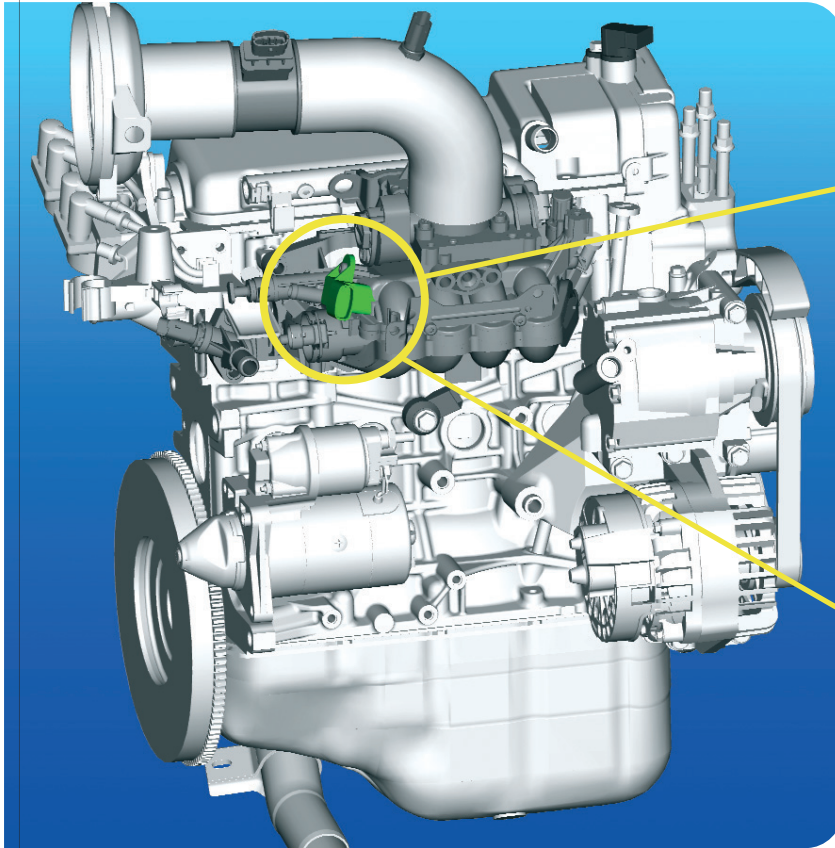

Rendering: par aimable concession de FIAT POWERTRAIN TECHNOLOGIES

Les capteurs MAP (*Manifold Absolute Pressure*) se chargent de **détecter la pression de l'air qui est aspiré par le collecteur d'admission** du moteur en la convertissant en signal électrique (généralement une tension) qui est délivré à l'unité de contrôle du moteur.

Les systèmes d'injection électronique calculent de façon *indirecte* la quantité d'air aspiré et établissent le dosage correct du carburant. Les capteurs MAP garantissent donc un bon rendement thermique et permettent de maintenir les gaz toxiques produits par la combustion dans les pourcentages définis par les normes antipollution.

Les capteurs MAP trouvent leur application dans les **véhicules alimentés à essence, au gasoil et hybrides**. En fonction de la typologie des moteurs et des unités de contrôle, les capteurs MAP peuvent:

- comporter une sonde (intégrée) de température de l'air aspiré*¹
- être associés à un capteur de débit d'air*².

*¹ (article Facet 10.4XXX); *² (article Facet 10.1XXX).

Les **principales causes de défaut** du produit sont :

- infiltrations d'humidité dans la connexion due au câblage
- dysfonctionnement du système d'aspiration qui envoie de l'air sale vers le dispositif

Les **signaux de dysfonctionnement** du capteur sont reconnaissables par l'allumage du témoin du moteur, la réduction des perfor-

mances, l'augmentation des consommations et des émissions, l'arrêt au ralenti.

Les capteurs MAP sont conçus et fabriqués pour supporter les conditions de montage critiques dans le compartiment moteur. En particulier, ils doivent répondre aux **caractéristiques** suivante:

- *température de fonctionnement*: -40°C ÷ +125°C
- *immunité électromagnétique*
- *résistance aux hydrocarbures*

Les capteurs MAP sont soumis à des **essais de qualification et de durée rigoureux** pour établir si le produit est adéquat à la fabrication et à la vente:

- fonctionnement cyclique à haute et basse pression dans des conditions de haute et basse température pendant 400 heures au total
- résistance aux cycles rapides de température
- étanchéité hermétique
- susceptibilité électromagnétique aux parasites en radio-fréquence induits sur les câbles
- résistance aux vibrations
- résistance aux coups

A l'issue positive de ces essais et une fois l'autorisation de production accordée, le produit est soumis tout au long de son assemblage à de sévères cycles de contrôle envisageant le **test à 100%** de la sortie du capteur à basse et haute pression, du courant absorbé et de l'étanchéité hermétique.

Éléments constitutifs et principe de fonctionnement

Le corps en plastique dispose d'une *pipe* pour le raccordement de l'élément sensible du capteur MAP à l'air aspiré par le moteur. La pipe est reliée au collecteur d'admission par un tuyau souple. Les capteurs de pression qui intègrent la sonde de température sont montés directement sur le collecteur d'admission et, dans ce cas, la pipe est insérée dans le conduit d'air et renferme la sonde de température.

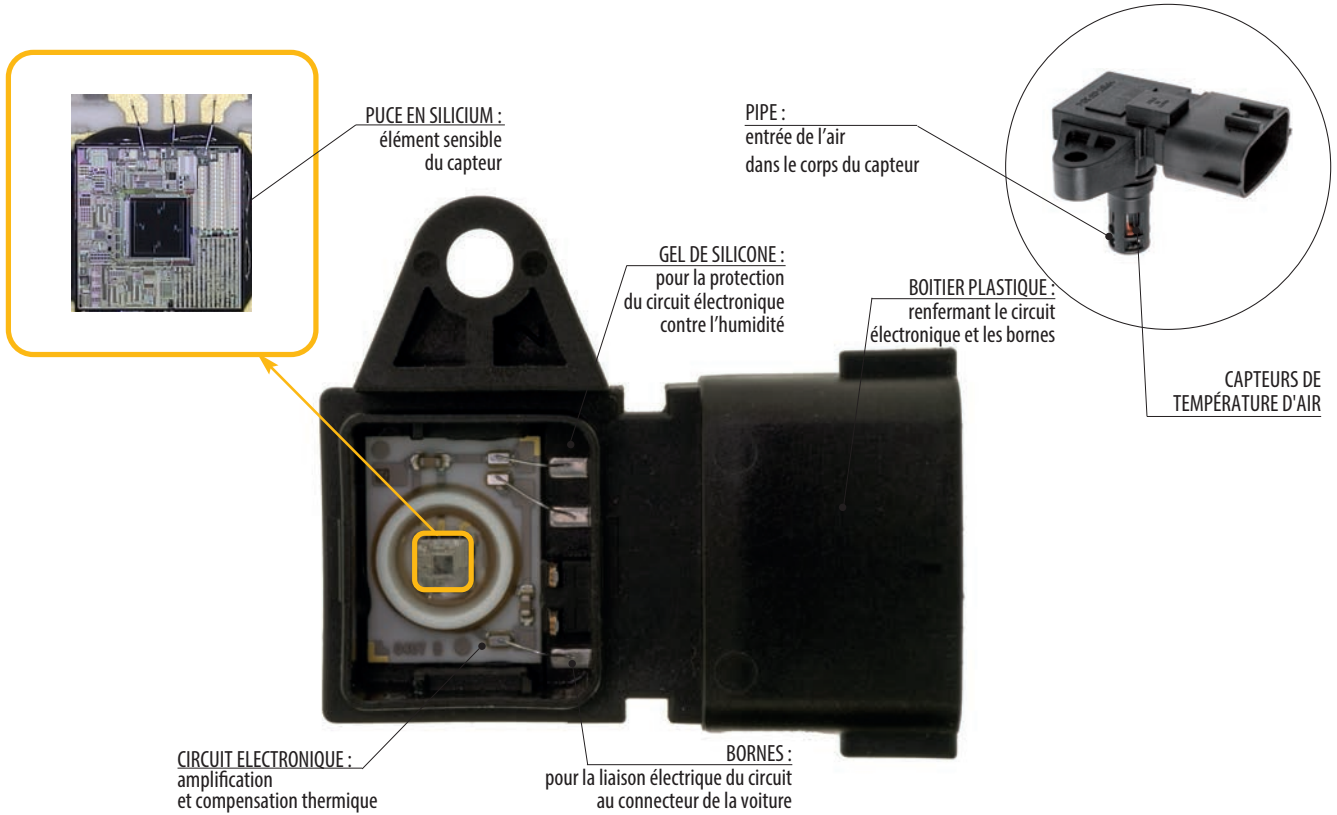

L'élément sensible du capteur MAP est représenté par une *puce en silicium* dotée d'un diaphragme fin, dont la surface comporte des *résistors piézorésistifs* en mesure de varier leur propre résistance électrique en fonction des déformations mécaniques qui sont générées par la pression de l'air. La puce alimentée délivre un signal électrique faible lorsque la pression varie.

Un *circuit électronique* amplifie ce signal et le maintient stable lors de toute variation de la température. Ce circuit est réalisé en *salle blanche* (environnement avec température, humidité et niveau d'impuretés contrôlés) selon la technologie *hybride à film épais* : les composants électroniques sont montés superficiellement sur un substrat céramique sérigraphié à l'aide de pâtes conductrices et résistives. Une fois réalisé, le circuit est calibré sur les valeurs souhaitées, par étalonnage de résistances spécifiques au faisceau laser, et protégé avec un *gel de silicone* spécial. La relation entre la grandeur électrique de sortie (généralement une tension) et la pression de l'air aspiré est **linéaire** :

$$U = A \cdot P + B \quad [V]$$

U : grandeur électrique de sortie [V]

P : pression de l'air aspiré [kPa]

A : amplification [V/kPa]

B : offset (tension constante) [V]

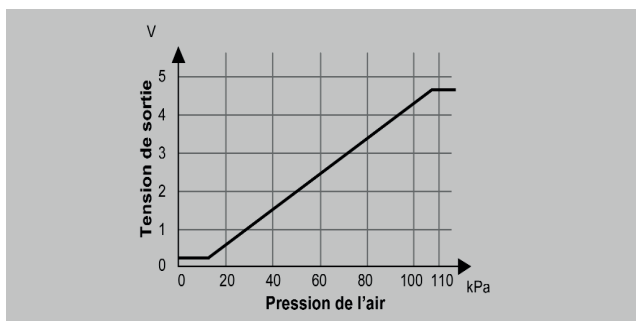

La tension de sortie est limitée par une valeur minimale, presque 0 V (typiquement 250 mV), et par une valeur maximale, presque égale à l'alimentation (typiquement 4750 mV).

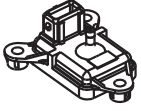

10.3XXX

Absolutluftdrucksensoren (MAP)

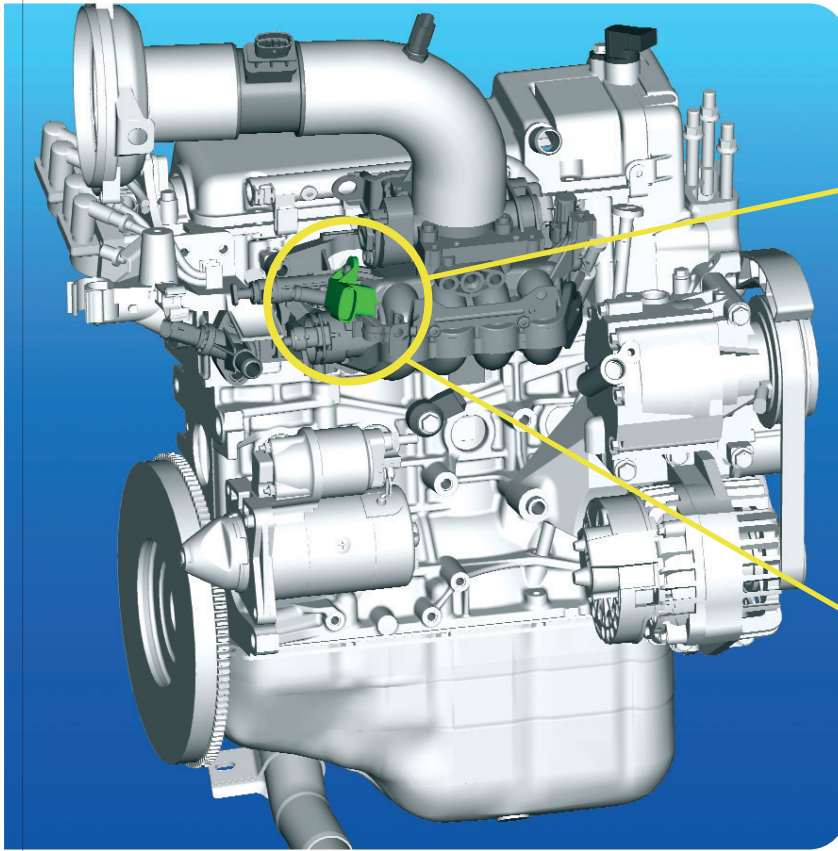

Rendering: bei freundlichem Zugeständnis von FIAT POWERTRAIN TECHNOLOGIES

Die MAP-Sensoren (*Manifold Absolute Pressure*) detektieren **den Druck der vom Ansaugkrümmer des Motors angesaugten Luft**, wandeln ihn in ein elektrisches Signal (in der Regel Spannung) um und senden dieses an das Steuergerät des Motors.

Die elektronischen Einspritzsysteme berechnen *indirekt* die Menge der angesaugten Luft und bestimmen die korrekte Kraftstoffdosierung. Die MAP-Sensoren gewährleisten daher eine gute thermische Leistung und ermöglichen die Beibehaltung der Werte der giftigen Abgase innerhalb der von den Umweltschutzbestimmungen festgelegten Anteile.

Die MAP-Sensoren können bei **bezinbetriebenen, dieselbetriebenen und wasserstoffbetriebenen Fahrzeugen** eingesetzt werden. Je nach Art des Motors und des Steuergeräts bestehen für die MAP-Sensoren folgende Möglichkeiten:

- Sie können einen (integrierten) Fühler für die Temperatur der angesaugten Luft beinhalten*¹
- Sie können zusammen mit einem Luftmassensensor eingesetzt werden*².

*¹ (Artikel Facet 10.4XXX); *² (Artikel Facet 10.1XXX)

Die **Hauptursachen für Defekte** des Produktes sind:

- Eindringen von Feuchtigkeit in den Anschluss aufgrund der Verkehlung
- Funktionsstörung der Absauganlage, die verschmutzte Luft auf das Gerät leitet

Die **Anzeichen einer Funktionsstörung** des Sensors sind am

Aufleuchten der Motoranzeige, der Leistungsverringerung, der Erhöhung von Verbrauch und Emissionen und dem Ausschalten beim Mindestwert erkennbar.

Die MAP-Sensoren werden im Hinblick auf Planung und Bau so ausgelegt, dass sie den kritischen Montagebedingungen im Motorraum standhalten. Insbesondere müssen sie folgende **Anforderungen** erfüllen:

- *Betriebstemperatur*: -40°C ÷ +125°C
- *Elektromagnetische Störfestigkeit*
- *Beständigkeit gegen Kohlenwasserstoffe*

Die MAP-Sensoren werden **Qualitäts- und Haltbarkeitstests** unterzogen, um festzustellen, ob das Produkt für Bau und Verkauf geeignet ist:

- Zyklusbetrieb bei hohem und bei geringem Druck bei hoher und bei niedriger Temperatur für insgesamt 400 Stunden
- Beständigkeit bei schnellen Temperaturwechseln
- hermetische Abdichtung
- elektromagnetische Empfindlichkeit auf die Kabel induzierte Funkfrequenzstörungen
- Schwingungsfestigkeit
- Stoßfestigkeit

Bei positiven Prüfergebnissen und nach Erteilung der Produktionsgenehmigung erfolgen während der Montage strenge Kontrollzyklen auf dem Produkt, mit der **100% Abnahmeprüfung** des Ausgangs des Sensors bei geringem und bei hohem Druck, der aufgenommenen Stromstärke und der hermetischen Abdichtung.

Bauteile und Funktionsprinzip

Der Kunststoffkörper ist mit einem *Stecker* ausgerüstet, der den Fühler des MAP-Sensors mit der vom Motor angesaugten Luft verbindet. Der Stecker ist mit Hilfe eines Schlauchs an den Ansaugkrümmer angeschlossen. Die Drucksensoren, die den Temperaturfühler ergänzen, sind direkt auf dem Ansaugkrümmer montiert. In diesem Fall befindet sich der Stecker im Luftkanal und enthält den Temperaturfühler.

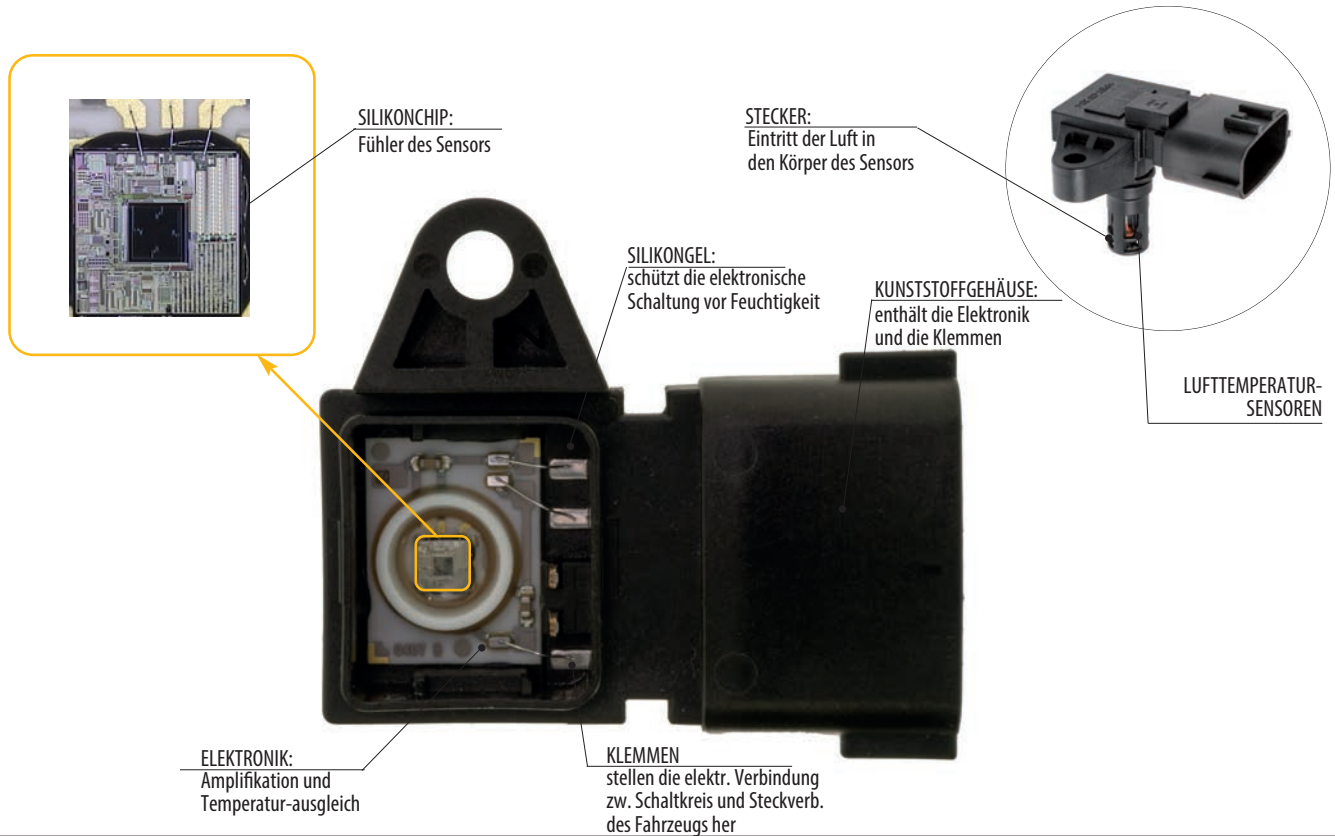

Der Fühler des MAP-Sensors ist ein *Siliziumchip* mit einer dünnen Membran, auf deren Oberfläche *piezoresistive Widerstände* gestellt sind, die ihren elektrischen Widerstand je nach den durch den Luftdruck generierten mechanischen Verformungen ändern. Der gespeiste Chip liefert bei der Änderung des Drucks ein schwaches elektrisches Signal. Eine *elektronische Schaltung* amplifiziert dieses Signal und sorgt für dessen stabile Beibehaltung bei der Änderung der Temperatur. Diese Schaltung wurde in einem *Reinraum* (Umgebung mit kontrollierter Temperatur, Feuchtigkeit und Kontamination) mit *Dickschicht-Hybridtechnologie* hergestellt. Die elektronischen Bauteile werden mit Leitpasten und Widerstandspasten auf ein im Siebdruckverfahren hergestelltes Keramiksubstrat aufgebracht. Nach der Herstellung wird die Schaltung auf die geforderten Werte kalibriert, wobei die spezifischen Widerstände mit einem Laserstrahl geeicht und dann mit einem entsprechenden *Silikongel* geschützt werden. Das Verhältnis zwischen der elektrischen Größe am Ausgang (in der Regel Spannung) und dem Druck der angesaugten Luft ist **linear**:

$$U = A \cdot P + B \quad [V]$$

U: elektrische Ausgangsgröße [V]

P: Druck der angesaugten Luft [kPa]

A: Amplifikation [V/kPa]

B: Offset (konstante Spannung) [V]

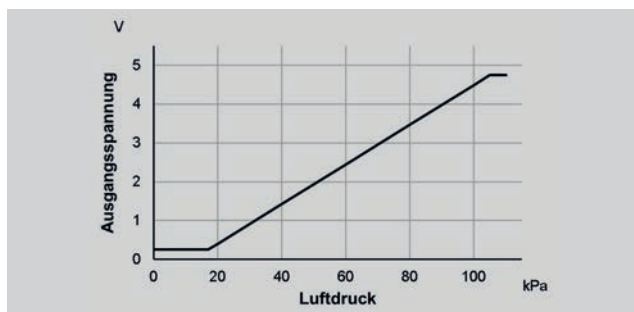

Die Ausgangsspannung ist durch einen Mindestwert - fast 0 V (in der Regel 250 mV) - und einen Höchstwert - fast entsprechend der Versorgungsleistung (in der Regel 4750 mV) - begrenzt.

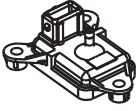

10.3XXX

Sensores de Presión Aire Absoluta (MAP)

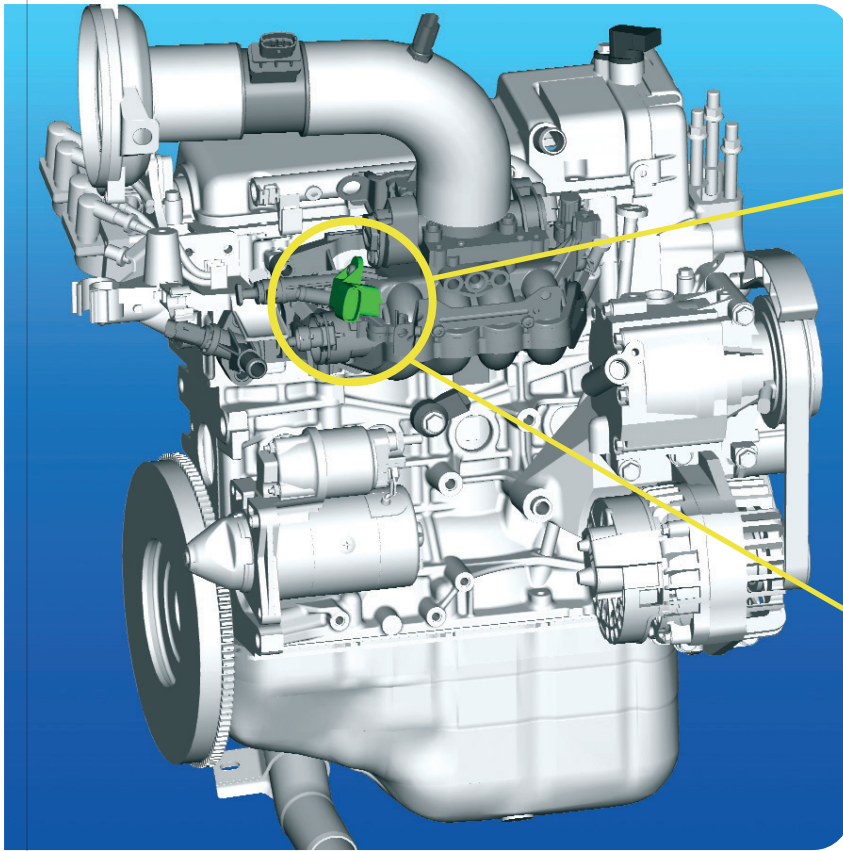

Rendering: por amable concesion de FIAT POWERTRAIN TECHNOLOGIES

Los sensores MAP (*Manifold Absolute Pressure*) **detectan la presión del aire aspirado por el colector de aspiración** del motor, convirtiéndola en una señal eléctrica (generalmente tensión), y la envían a la centralita de control del motor. Los sistemas de inyección electrónica calculan de manera *indirecta* la cantidad de aire aspirado (a partir de mediciones de la presión y de la temperatura del aire, número de revoluciones y fase del motor), y determinan la correcta dosificación de combustible. Por lo tanto, los MAP garantizan un buen rendimiento térmico y permiten mantener los gases tóxicos de combustión dentro de los porcentajes establecidos por las normas de control de la contaminación.

Los sensores MAP se pueden instalar en **vehículos con alimentación de gasolina, de gasoleo e híbrida**. De acuerdo con el tipo de motor y de centralita de control, los sensores MAP pueden:

- contener una sonda (incorporada) de temperatura del aire aspirado*¹
- estar combinados con un sensor de caudal de aire*²

*¹ (artículo Facet 10.4XXX); *² (artículo Facet 10.1XXX).

Las principales **causas de avería** del producto son:

- filtraciones de humedad en la conexión debido al cableado
- problemas de funcionamiento del sistema de admisión que envía aire sucio al dispositivo

Las **señales de problemas** de funcionamiento del sensor se notan

por el encendido del testigo del motor, la disminución de las prestaciones, el aumento del consumo y de las emisiones, y por el apagado al ralentí.

Los sensores MAP están diseñados y fabricados para soportar las condiciones críticas de montaje en el espacio motor. En especial, deben cumplir con los siguientes **requisitos**:

- *temperatura de funcionamiento*: -40°C ÷ +125°C
- *inmunidad electromagnética*
- *resistencia a los hidrocarburos*

Los sensores MAP son sometidos a rigurosos **ensayos de calificación y de duración**, para determinar si el producto es apropiado para ser fabricado y vendido:

Lorem ipsum

- funcionamiento cíclico a alta y baja presión en condiciones de alta y baja temperatura por un total de 400 horas-hermeticidad
- resistencia a los ciclos rápidos de temperatura
- susceptibilidad electromagnética a los ruidos parasitarios de radiofrecuencia inducidos en los cables
- resistencia a las vibraciones
- resistencia a los golpes

Después que ha superado estas pruebas y obtenido la aprobación para la producción, durante el ensamblaje el producto se somete a severos ciclos de control que prevén el **ensayo al 100%** de la salida del sensor a baja y alta presión, de la corriente absorbida y de la hermeticidad.

Elementos de construcción y principio de funcionamiento

El cuerpo de plástico tiene una *pipeta* que conecta el elemento sensible del MAP con el aire aspirado por el motor. La pipeta está conectada con el colector de aspiración mediante un pequeño tubo flexible. Los sensores de presión que forman la sonda de temperatura están montados directamente en el colector de aspiración; en este caso, la pipeta está introducida en el conducto de aire y contiene la sonda de temperatura.

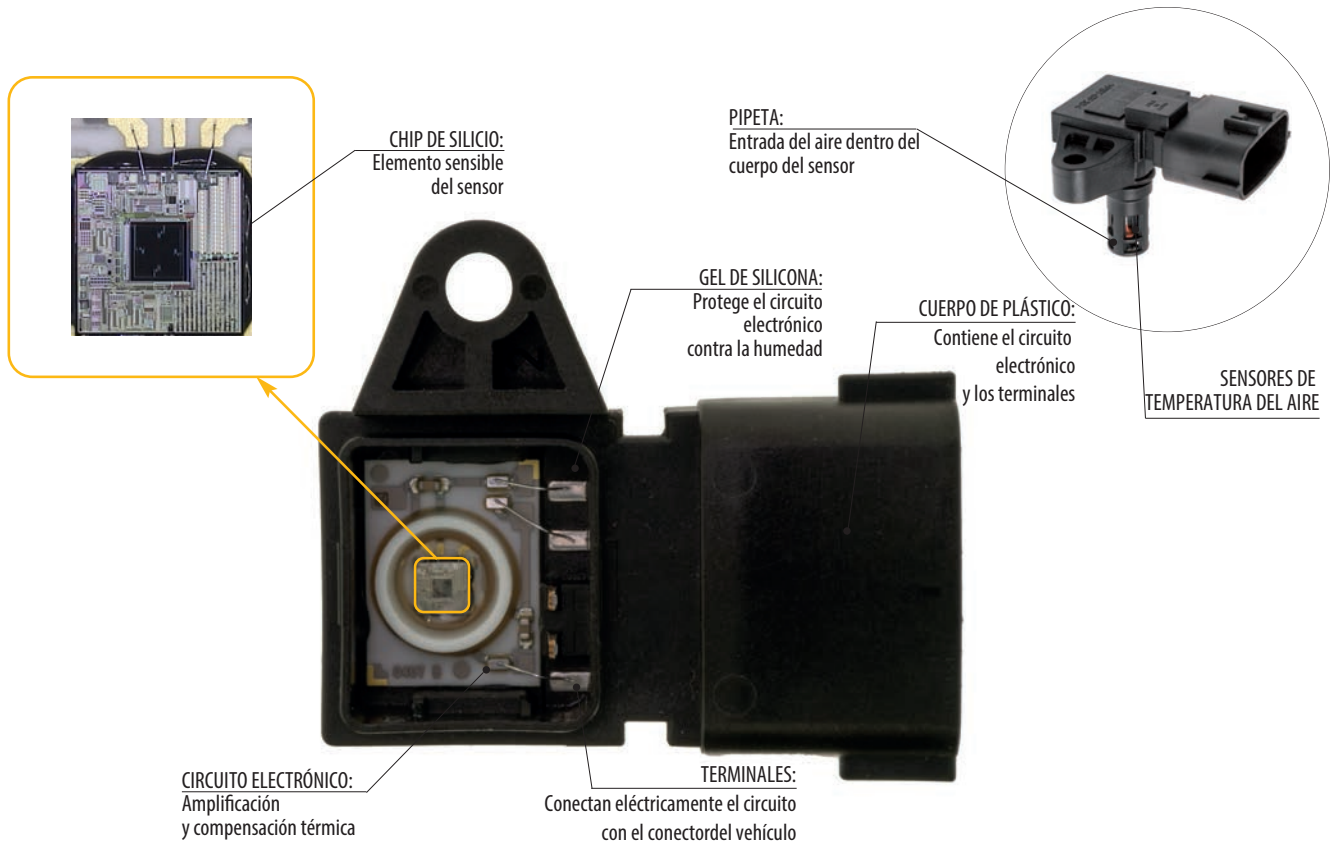

El elemento sensible del MAP es un *chip de silicio* con un fino diafragma, sobre cuya superficie están realizadas las *resistencias piezorresistentes* que varían su capacidad de resistencia eléctrica según las deformaciones mecánicas generadas por la presión del aire. El chip alimentado suministra una débil señal eléctrica cuando varía la presión.

Un *circuito electrónico* amplifica esta señal y la mantiene estable cuando que varía la temperatura. Dicho circuito está realizado en *sala blanca* (ambiente con temperatura, humedad y nivel de impurezas controlados) con *tecnología híbrida de película gruesa*: los componentes electrónicos están montados superficialmente en una capa de cerámica serigrafiada con pastas conductoras y resistivas. Cuando está realizado, el circuito se calibra con los valores necesarios, tarando resistencias específicas con un haz de láser y luego se protege con el correspondiente *gel de silicona*. La relación entre la magnitud eléctrica en salida (generalmente tensión) y la presión del aire aspirado es **lineal**:

$$U = A \cdot P + B \quad [V]$$

- U : magnitud eléctrica de salida [V]
- P : presión del aire aspirado [kPa]
- A : amplificación [V/kPa]
- B : offset (tensión constante) [V]

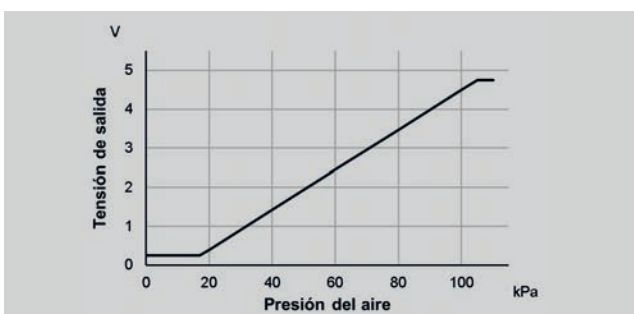

La tensión de salida está limitada por un valor mínimo, casi 0 V (normalmente 250 mV), y por un valor máximo, casi igual a la alimentación (normalmente 4750 mV).

10.3001



3,5

ABSOLUTE PRESSURE SENSORS (MAP)

Adatt./Suitable:

ALFA ROMEO

60811534
7696064

BOSCH

F 000 99P 169

CHEVROLET

12569240
16137039

CITROËN

1920 4S
1920 FC
5946 07
5946 09

DAEWOO

12569240
16137039

FIAT

7696064

FORD

1 144 809
1C1Y-9F479-AA

GENERAL MOTORS

12 569 240
16 137 039
9 389 131

HOLDEN

16017460
16137039
8161370390

HYUNDAI

39330-24750

JEEP

8933000153

KIA

0K950-18211
39330-24750

LANCIA

7696064

MERCEDES-BENZ

A 023 545 45 32

OPEL

12 38 788
12569240
16017460
16137039
62 38 927
8 15 701

PEUGEOT

1920 4S
1920 FC
5946 09

RENAULT

77 00 706 876
89 33 000 153

VAUXHALL

12569240
16017460
16137039

VOLVO

137816-2
31303211
341140-0

MARKET DIFFUSION: MEDIUM



kPa	mV	
15 - 102	261 - 4958	

ALFA ROMEO

145 1.6 i.e.	AR33201	10/94 ⇨ 12/96
146 1.6 i.e.	AR33201	12/94 ⇨ 12/96

CHEVROLET

LANOS 1.3	--	01/97 ⇨
LANOS 1.5	A15SMS	11/05 ⇨
LANOS 1.6 16V	A16DMS	11/05 ⇨
SPARK I 0.8	F8CV	09/00 ⇨ 12/04

CITROËN

BERLINGO I 1.4 BiFuel	TU3JP	07/96 ⇨ 10/02
BERLINGO I 1.4 bivalent	KFW(TU3JP)	11/02 ⇨ 12/11
BERLINGO I 1.4 GNC	KFW(TU3JP)	11/02 ⇨

CITROËN

BERLINGO I 1.4 i bivalent	KFW(TU3JP), SFZ(ZPJ/Z)	04/03 ⇨ 10/08
BERLINGO 1.4 BiFuel	TU3JP	07/96 ⇨ 10/02
BERLINGO 1.4 Bivalent	TU3JPCNG	04/03 ⇨ 10/05
BX 19	DDZ(XU9M)	06/88 ⇨ 12/94
BX 19 4x4	DDZ(XU9M)	10/90 ⇨ 05/91
BX 19 E	DDZ(XU9M)	06/88 ⇨ 02/93
XANTIA II 1.8 i 16V	LFY(XU7JP4)	01/98 ⇨ 04/03
XM 13.0	UFZ(ZPJ/Z)	05/89 ⇨ 05/94
XM 13.0 V6	SFZ(ZPJ/Z), SKZ(ZPJ4/Z)	05/89 ⇨ 06/94
XM 13.0 V6 24V	SKZ(ZPJ4/Z), SFZ(ZPJ/Z)	07/90 ⇨ 06/94
XM II 3.0 V6	SFZ(ZPJ/Z), SKZ(ZPJ4/Z)	05/94 ⇨ 10/00
XM II 3.0 V6 24V	SKZ(ZPJ4/Z), EYPA	05/94 ⇨ 10/00
XSARA 1.8 BiFuel	XU7JP4	07/97 ⇨ 08/00
XSARA 1.8 i 16V	LFY(XU7JP4)	04/97 ⇨ 09/00
XSARA 1.8 LPG	XU7JP4	01/98 ⇨ 08/00

DAEWOO

LANOS 1.3	A14SMS	05/97 ⇨
LANOS 1.5	A15SMS	05/97 ⇨
MATIZ 0.8	F8CV	08/98 ⇨
NUBIRA I 1.6	A16DMS	08/02 ⇨ 07/03

FIAT

PUNTO I 1.6	176A9.000	01/94 ⇨ 04/97
PUNTO I 90 1.6	176A9.000	04/94 ⇨ 04/97
TEMPRA 1.6 i.e.	159B9.000	06/94 ⇨ 08/96

FORD

TOURNEO CONNECT I 1.8 16V	EYPA, EYPA	06/02 ⇨ 12/13
TRANSIT III 2.0 DI	ABFA	08/00 ⇨ 05/06
TRANSIT III 2.0 TDCi	FIFA	08/02 ⇨ 05/06
TRANSIT III 2.3	E5FA	08/00 ⇨ 03/06
TRANSIT III 2.3 16V RWD	E5FC	08/00 ⇨ 05/06
TRANSIT III 2.3 BiFuel	E5FC	03/01 ⇨ 03/06
TRANSIT III 2.6 CNG	EYPCNG	05/02 ⇨ 12/13
TRANSIT CONNECT I 1.8 16V	EYPA, 3.8V6EFI	06/02 ⇨ 12/13
TRANSIT CONNECT I 1.8 16V LPG	EYPC	06/02 ⇨ 12/13

HOLDEN

BARINA 1.4 i	C14NZ	04/94 ⇨ 07/97
BARINA 1.6	X16XE	05/97 ⇨ 08/00
BARINA_SB 1.2i	C12NZ	04/94 ⇨ 07/97
BARINA_SB 1.6i	X16XE	12/95 ⇨ 09/98
CALAIS_VN 3.8i	3.8V6EFI, 3.8V6EFI	08/88 ⇨ 09/91
CALAIS_VN 5.0i	5.0V8EFI	08/88 ⇨ 09/91
CALAIS_VP 3.8i Sedan	3.8V6EFI	10/91 ⇨ 07/93
CALAIS_VP 5.0i Sedan	5.0V8EFI	10/91 ⇨ 07/93
CALAIS_VR 3.8i Sedan	3.8PFIV6	07/93 ⇨ 04/95
CALAIS_VR 5.0i Sedan	5.0PFIV8	07/93 ⇨ 04/95
CAPRICE_VQ 3.8i Sedan	3.8V6EFI	03/90 ⇨ 11/93
CAPRICE_VQ 5.0i Sedan	5.0V8EFI	03/90 ⇨ 11/93
CAPRICE_VR 3.8i Sedan	3.8PFIV6	12/93 ⇨ 04/95
CAPRICE_VR 5.0i Sedan	5.0PFIV8	12/93 ⇨ 04/95
COMBO 1.4 i	C14NZ	03/96 ⇨ 07/97
COMBO_SB 1.4i	C14NZ	04/94 ⇨ 07/97
COMMODORE 3.8 i V6	LN3	08/93 ⇨ 04/95
COMMODORE VR 5.0i	5.0PFIV8	07/93 ⇨ 04/95
COMMODORE VR 5.0i Wagon	5.0PFIV8	07/93 ⇨ 04/95
COMMODORE_VN 3.8i	3.8V6EFI, 3.8V6EFI	08/88 ⇨ 09/91
COMMODORE_VN 5.0i	5.0V8EFI	08/88 ⇨ 09/91
COMMODORE_VN 5.0i Group A SS	5.0V8EFI	08/88 ⇨ 09/91
COMMODORE_VP 3.8i	3.8V6EFI	10/91 ⇨ 07/93
COMMODORE_VP 5.0i	5.0V8EFI	10/91 ⇨ 07/93
FORMULA_VR 3.8i	3.8PFIV6	07/93 ⇨ 04/95
FORMULA_VR 5.0i	5.0PFIV8	07/93 ⇨ 04/95
JACKAROO_UBS 3.2i 24v 4x4	--	04/92 ⇨ 12/97
MONTEREY_UBS 3.2i 24v 4x4	--	11/93 ⇨ 12/97
STATESMAN_VQ 3.8i	3.8V6EFI	03/90 ⇨ 11/93
STATESMAN_VQ 5.0i	5.0V8EFI	03/90 ⇨ 11/93
STATESMAN_VR 3.8i	3.8PFIV6	12/93 ⇨ 04/95
STATESMAN_VR 5.0i	5.0PFIV8	12/93 ⇨ 04/95
UTILITY_VG 3.8i	3.8V6EFI, G15B	08/88 ⇨ 09/91
UTILITY_VG 5.0i	5.0V8EFI	08/88 ⇨ 09/91
UTILITY_VP 3.8i	3.8V6EFI	10/91 ⇨ 07/93
UTILITY_VP 5.0i	5.0V8EFI	10/91 ⇨ 07/93
UTILITY_VR COUPÉ 3.8i	3.8PFIV6	07/93 ⇨ 04/95
UTILITY_VR COUPÉ 5.0i	5.0PFIV8	07/93 ⇨ 04/95

HYUNDAI

COUPE I 1.6 i 16V	4G61	12/96 ⇨ 04/02
ELANTRA I 1.5 i GL	G4DJ	12/90 ⇨ 08/94
ELANTRA II 1.6 i 16V	G4GR	06/95 ⇨ 05/00
ELANTRA II 1.8 i 16V	G4GM	05/95 ⇨ 05/00
EXCEL 1.3 i 12V	G4EH	09/94 ⇨ 08/99
LANTRA I 1.5 i.e.	G4DJ	10/90 ⇨ 11/95
PONY 1.5 i	G15B, B3	10/89 ⇨ 01/95
PONY / EXCEL 1.5 i	G15B, G15B	01/90 ⇨ 01/95

JEEP

CHEROKEE II 2.1 TD	J8S	06/89 ⇨ 03/92
WRANGLER 2.5	EPE	12/91 ⇨ 08/96
WRANGLER 4.0	ERH	12/91 ⇨ 08/96

KIA

AVELLA 1.3	B3	11/95 ⇨ 12/01
AVELLA 1.5	--	02/97 ⇨ 12/01
PRIDE 1.3	B3A5	08/98 ⇨ 05/01
PRIDE 1.3 16V	B3, BFD	01/90 ⇨ 09/01
SEPHIA I 1.5 i	B5	02/96 ⇨ 10/97
SEPHIA I 1.8 i 16V	--	01/95 ⇨ 10/97
SEPHIA II 1.5 i 16V	--	09/97 ⇨
SHUMAI 1.5	OK280	03/96 ⇨ 12/98
SHUMAI 1.5 i 16V	BFD, 831B3.000	10/97 ⇨ 10/01
SPECTRA 1.5 i	--	09/97 ⇨
SPECTRA 1.5 i 16V	--	09/97 ⇨

LANCIA

DE德拉 1.6 16V	182A4.000	01/96 ⇨ 07/99
DELTA I 1.6 GT i.e.	149C2.000	05/87 ⇨ 08/92
DELTA I 1.6 HF Turbo	831B3.000, 16L22	08/86 ⇨ 03/89

MERCEDES-BENZ

CLASSE C1C 230T	M111.974	06/96 ⇨ 06/98
-----------------	----------	---------------

OPEL

ASTRA F 1.4	14SE	09/92 ⇨ 09/98
ASTRA F 1.4 i	C14NZ	09/91 ⇨ 01/05
ASTRA F 1.4 i 16V	X14XE	01/96 ⇨ 03/01
ASTRA F 1.4 Si	C14SE	03/92 ⇨ 03/01
ASTRA F 1.6	16L2Z, C16NZ	09/94 ⇨ 09/98
ASTRA F 1.6 i.e.	C16NZ, X14XE	09/91 ⇨ 01/05
ASTRA F 1.6 i 16V	X16XEL	08/94 ⇨ 01/05
ASTRA F 1.6 Si	C16SE	03/92 ⇨ 12/94
ASTRA F 1.8 i	C18NZ	09/91 ⇨ 09/98
ASTRA F 1.8 i 16V	C18XE	06/93 ⇨ 01/98
ASTRA G 1.4	X14XE, X14XE	09/98 ⇨ 04/05
ASTRA G 1.4 16V	X14XE, C16SEL	02/98 ⇨ 01/05
ASTRA G 1.6	C16SEL, X16XEL	02/98 ⇨ 07/09
ASTRA G 1.6 16V	X16XEL, X16XEL	02/98 ⇨ 05/05
ASTRA G 1.6 LPG	X16XEL, C12NZ	03/98 ⇨ 01/05
COMBO B 1.2	C12NZ, C14NZ	07/94 ⇨ 10/01
COMBO B 1.4	C14NZ, 13NB	07/94 ⇨ 10/01
COMBO B 1.4 16V	X14XE	08/99 ⇨ 10/01
CORSA A 1.2 i	C12NZ	09/89 ⇨ 03/93
CORSA A 1.3	13NB, C14NZ	09/85 ⇨ 10/89
CORSA A 1.3 i	C13N	09/86 ⇨ 09/90
CORSA A 1.4 i	C14NZ, 12NZ	01/85 ⇨ 03/93
CORSA A 1.4 Si	C14SE	09/91 ⇨ 03/93
CORSA A 1.6 GSI	E16SE	05/88 ⇨ 03/92
CORSA A 1.6 GSI Cat	C16SE	02/92 ⇨ 03/93
CORSA B 1.2 i	12NZ, C14NZ	03/93 ⇨ 09/00
CORSA B 1.4	C14SE	04/93 ⇨ 08/94
CORSA B 1.4 i	C14NZ, C14SEL	03/93 ⇨ 09/00
CORSA B 1.4 i 16V	C14SEL, C16SEL	09/94 ⇨ 12/02
CORSA B 1.4 Si	C14SE	03/93 ⇨ 09/00
CORSA B 1.6 i 16V	C16SEL, 16SV	09/94 ⇨ 09/00
KADETT E 1.3 i Cat	C13N	09/85 ⇨ 08/91
KADETT E 1.4 i	C14NZ	01/90 ⇨ 07/94
KADETT E 1.6	16SV	09/86 ⇨ 12/91
KADETT E 1.6 i	16SV, C16LZ	09/86 ⇨ 07/94
KADETT E 1.6 i Cat	C16LZ, X14XE	09/86 ⇨ 02/93
KADETT E 1.6 S	16SV	09/86 ⇨ 08/91
OMEGA A 1.8 S	18SV	09/86 ⇨ 03/94
TIGRA 1.4 16V	X14XE, C16SEL	07/94 ⇨ 12/00
TIGRA 1.6 16V	C16SEL, 16SV	07/94 ⇨ 08/98
VECTRA A 1.6	16SV, C16NZ	09/88 ⇨ 07/93
VECTRA A 1.6 i	C16NZ, C16NZ	09/88 ⇨ 11/95
VECTRA A 1.6 i Cat	C16NZ, 16L22	09/88 ⇨ 11/95
VECTRA A 1.6 S	16SV	09/88 ⇨ 05/93
VECTRA A 1.8 i	18SV	09/88 ⇨ 10/90
VECTRA A 1.8 i Cat	C18NZ	03/90 ⇨ 11/95
VECTRA A 1.8 S	18SV	09/89 ⇨ 10/90
VECTRA B 1.6 i	16L2Z, X16XEL	10/95 ⇨ 07/03
VECTRA B 1.6 i 16V	X16XEL, 6FZ(EW714)	10/95 ⇨ 07/02
ZAFIRA A 1.6 16V	X16XEL	04/99 ⇨ 06/05

PEUGEOT

406 1.8 16V	6FZ(EW714), EW714	10/00 ⇨ 10/04
406 1.8 Bifuel	EW714, KFW(TU3JP)	09/00 ⇨ 05/04
605 3.0	UKZ(ZPJ4/Z)	08/89 ⇨ 06/94
605 3.0 SV 24	UKZ(ZPJ4/Z)	08/89 ⇨ 09/99
PARTNER 1.4 CNG	TU3JPCNG	11/02 ⇨ 10/06
PARTNER I 1.4	KFW(TU3JP), C3J710	11/02 ⇨ 12/15
RANCH 1.4	KFW(TU3JP)	06/96 ⇨
RANCH 1.4 BiFuel	KFW(TU3JP)	04/03 ⇨
RANCH 1.4 CNG	TU3JPCNG	01/97 ⇨ 12/12

RENAULT

19 I 1.4	C3J710, F3N740	07/88 ⇨ 04/92
19 I 1.4 Cat	C3J710	01/89 ⇨ 04/92
19 I 1.7	F3N740, F7P700	07/88 ⇨ 12/92
19 I 1.8 16V	F7	

RENAULT			
21 1.7	F2N722, J7R740	03/86 ⇒ 06/94	
21 1.7 Cat	F3N726	05/88 ⇒ 06/93	
21 2.0	J7R740, J7R740	03/86 ⇒ 06/94	
21 2.0 4x4	J7R740, J7R740	03/89 ⇒ 02/94	
21 2.0 TXi	J7R740, J7T754	07/89 ⇒ 05/93	
21 2.2	J7T754, J7T754	04/86 ⇒ 12/95	
21 2.2 4x4	J7T754, J7R722	06/86 ⇒ 06/94	
25 2.0	J7R722, J7R720	03/87 ⇒ 12/93	
25 2.0 12V	J7R720, J7T706	06/88 ⇒ 12/93	
25 2.2	J7T706, Z7W700	04/84 ⇒ 12/92	
25 2.8 V6	Z7W700, Z7W706	06/87 ⇒ 02/90	
25 2.8 V6 Injection	Z7W706, C3G720	06/87 ⇒ 12/92	
CLIO I 1.2	C3G720, E7J601	05/90 ⇒ 09/98	
CLIO I 1.4	E7J601, F3P710	01/90 ⇒ 09/98	
CLIO I 1.8	F3P710, F7P720	08/90 ⇒ 09/98	
CLIO I 1.8 16V	F7P720, F3P712	01/91 ⇒ 03/96	
CLIO I 1.8 Rsi	F3P712, D7F710	01/93 ⇒ 09/98	
CLIO I Williams	F7R700	01/94 ⇒ 09/98	
CLIO II 1.2	D7F710, E7J634	09/98 ⇒	
CLIO II 1.4	E7J634, K7M744	09/98 ⇒ 05/05	
CLIO II 1.6	K7M744, J7T772	09/98 ⇒ 05/05	
ESPACE I 2.0 i	J7R760	01/89 ⇒ 12/90	
ESPACE I 2.0 i Quadra	J7R760	03/88 ⇒ 12/92	
ESPACE II 2.0	J7R768	01/91 ⇒ 10/96	
ESPACE II 2.2	J7T772, J7T772	01/91 ⇒ 10/96	
ESPACE II 2.2 4x4	J7T772, Z7W712	03/91 ⇒ 12/96	
ESPACE II 2.8 V6	Z7W712, F3R728	01/91 ⇒ 10/96	
ESPACE III 2.0	F3R728, G8T714	11/96 ⇒ 10/00	
ESPACE III 2.2 12V TD	G8T714, G8T714	11/96 ⇒ 10/00	
ESPACE III 2.2 D	G8T714, C3G710	11/97 ⇒ 01/00	
ESPACE III 3.0	Z7X775	11/96 ⇒ 10/98	
EXPRESS 1.2	C3G710, D7F710	07/95 ⇒ 10/99	
KANGOO 1.2 BiFuel	D7F710, D7F710	06/97 ⇒ 06/03	
KANGOO I 1.2	D7F710, D7F710	08/97 ⇒	
KANGOO I 1.2 BiFuel	D7F710, E7J634	07/98 ⇒ 07/01	
KANGOO I 1.4	E7J634, F3P670	08/97 ⇒	
LAGUNA I 1.8	F3P670, --	11/93 ⇒ 03/01	
LAGUNA I 2.0	--, N7Q700	11/93 ⇒ 03/01	
LAGUNA I 2.0 16V	N7Q700, Z7X760	06/95 ⇒ 03/01	
LAGUNA I 3.0	Z7X760, J7T782	11/93 ⇒ 03/01	
MASTER I 2.2	J7T788	08/93 ⇒ 02/98	
MASTER I 30 2,2	J7T782, E7J626	08/80 ⇒ 07/98	
MEGANE I 1.4	E7J626, K7M702	09/96 ⇒ 08/03	
MEGANE I 1.4 Eco	E7J624	01/96 ⇒ 03/99	
MEGANE I 1.6 e	K7M702, K7M720	01/96 ⇒ 08/03	
MEGANE I 1.6 i	K7M720, F3R750	01/96 ⇒ 03/99	
MEGANE I 1.6 LPG	K7M702	08/95 ⇒ 03/99	
MEGANE I 2.0	F3R750, F7R710	04/97 ⇒ 08/03	
MEGANE I 2.0 16V	F7R710, F3R750	03/96 ⇒ 08/03	
MEGANE I 2.0 i	F3R750, F3R750	01/96 ⇒ 08/03	
MEGANE I 2.0 RT	F3R750, K7M702	10/96 ⇒ 02/99	
MEGANE SCÉNIC I 1.4 i	E7J764	01/97 ⇒ 09/99	
MEGANE SCÉNIC I 1.6 e	K7M702, F3R750	10/96 ⇒ 10/99	
MEGANE SCÉNIC I 1.6 i	K7M720	01/97 ⇒ 09/99	
MEGANE SCÉNIC I 2.0 i	F3R750, C3G710	01/97 ⇒ 09/99	
MEGANE SCÉNIC I 2.0 RXE 4x4	F3R750	05/97 ⇒ 10/99	
MEGANE 1.6 BiFuel	K7M702	10/96 ⇒ 10/99	
RAPID 1.2	C3G710, E7J720	09/91 ⇒ 03/98	
RAPID 1.4	E7J720, C3J700	09/91 ⇒ 03/98	
RAPID 1.4 Cat	C3J700, J7R732	08/88 ⇒ 03/98	
SAFRANE I 2.0	J7R732, J7R734	08/92 ⇒ 09/96	
SAFRANE I 2.0 12V	J7R734, J7T760	04/92 ⇒ 07/96	
SAFRANE I 2.2	J7T760, Z7X721	04/92 ⇒ 07/96	
SAFRANE I 3.0	Z7X723	02/93 ⇒ 06/96	
SAFRANE I 3.0 V6	Z7X721, Z7X721	12/92 ⇒ 07/96	
SAFRANE I 3.0 V6 4x4	Z7X721, N7Q710	12/92 ⇒ 07/96	
SAFRANE II 2.0 16V	N7Q710, F3R791	07/96 ⇒ 12/00	
SAFRANE II 3.0 V6	Z7X755	07/96 ⇒ 12/00	
SCÉNIC I 2.0	F3R791, F7R712	09/99 ⇒ 08/03	
SPORT SPIDER 2.0	F7R710	12/95 ⇒ 08/96	
SPORT SPIDER 2.0 16V	F7R712, C3J700	03/95 ⇒ 10/99	
SUPER 5 1.4	C3J700	09/85 ⇒ 07/86	
SUPER 5 1.4 Cat	C3J700, F3N716	10/85 ⇒ 12/96	
SUPER 5 1.7	F3N716, J7T600	10/86 ⇒ 03/95	
SUPER 5 1.7 i	F3N702	10/86 ⇒ 08/91	
TRAFIC I 2.2	J7T600, J7T600	05/89 ⇒ 04/98	
TRAFIC I 2.2 4x4	J7T600, C3G700	05/89 ⇒ 04/98	
TWINGO I 1.2	C3G700, C14NZ	03/93 ⇒	

VAUXHALL			
ASTRA III 1.4 i	C14NZ, C16NZ	03/91 ⇒ 09/98	
ASTRA III 1.4 i 16V	X14XE	01/96 ⇒ 03/01	
ASTRA III 1.6	C16SE	03/94 ⇒ 08/95	
ASTRA III 1.6 i	C16NZ, X14XE	09/91 ⇒ 12/98	
ASTRA III 1.6 i 16V	X16XEL	01/94 ⇒ 09/98	
ASTRA III 1.6 Si	C16SE	03/91 ⇒ 12/94	
ASTRA III 1.8	C18XE	09/94 ⇒ 08/96	
ASTRA III 1.8 i	C18NZ	09/91 ⇒ 09/98	

VAUXHALL			
ASTRA III 1.8 i 16V	C18XE	06/93 ⇒ 02/98	
ASTRA IV 1.4 16V	X14XE, X16XEL	02/98 ⇒ 05/05	
ASTRA IV 1.6	X16SZR	02/98 ⇒ 04/04	
ASTRA IV 1.6 16V	X16XEL, X16SZR	02/98 ⇒ 10/05	
ASTRA IV 1.6 Dualfuel	X16SZR, C16NZ	02/98 ⇒ 08/04	
ASTRAVAN I 1.4 i	C14NZ	09/91 ⇒ 08/95	
ASTRAVAN I 1.6 i	C16NZ, C12NZ	10/91 ⇒ 08/98	
ASTRAVAN II 1.4 16V	Z14XE	09/00 ⇒ 05/05	
ASTRAVAN II 1.6 Dualfuel	X16SZR	02/98 ⇒ 12/00	
ASTRAVAN II 1.6 i	X16SZR	08/98 ⇒ 09/00	
COMBO B 1.2	C12NZ, C14NZ	07/94 ⇒ 10/01	
COMBO B 1.4	C14NZ, C12NZ	07/94 ⇒ 10/01	
COMBO B 1.4 16V	X14XE	08/99 ⇒ 10/01	
CORSA B 1.2 i	C12NZ, C14NZ	03/93 ⇒ 09/00	
CORSA B 1.4 i	C14NZ, X16XEL	03/93 ⇒ 09/00	
CORSA B 1.4 i 16V	X14XE	09/94 ⇒ 09/00	
CORSA B 1.4 i S	C14SE	03/93 ⇒ 09/00	
CORSA B 1.6 i 16V	X16XE	09/94 ⇒ 09/00	
CORSAVAN I 1.4 i	C14NZ	01/94 ⇒ 09/00	
TIGRA A 1.4 16V	X14XE	07/94 ⇒ 12/00	
TIGRA A 1.6 16V	X16XE	07/94 ⇒ 12/00	
VECTRA B 1.6 i	X16SZR	08/95 ⇒ 03/02	
VECTRA B 1.6 i 16V	X16XEL, X16XEL	08/95 ⇒ 03/02	
ZAFIRA A 1.6 16V	X16XEL, B18E	04/99 ⇒ 08/05	
ZAFIRA A 1.6 Dualfuel	X16XEL	11/98 ⇒ 08/05	

VOLVO			
240 2.3	B230K	08/86 ⇒ 12/88	
440 1.6	B16F	09/88 ⇒ 12/96	
440 1.7	B18E, B18U	08/88 ⇒ 12/96	
440 1.8	B18U, B20F	08/91 ⇒ 12/96	
440 2.0	B20F, B18EP	08/92 ⇒ 07/96	
460 1.6	B16F	07/92 ⇒ 07/96	
460 1.7	B18EP, B20F	08/89 ⇒ 07/95	
460 1.8	B18U	08/91 ⇒ 07/96	
460 2.0	B20F, B18E	08/92 ⇒ 07/96	
480 1.7	B18E, B5252	04/86 ⇒ 07/96	
480 2.0	B20F	08/92 ⇒ 09/95	
850 2.0	B5202S	08/94 ⇒ 12/96	
850 2.0 10V	B5202FS	08/94 ⇒ 12/97	
850 2.4	B5252, B5252FS	06/91 ⇒ 12/96	
850 2.5 10V	B5252FS, B418453	06/91 ⇒ 12/97	
S40 I 1.8	B418453, B5202FS	03/99 ⇒ 12/03	
S40 I 1.8 16V	B4184510	08/00 ⇒	
S70 2.0	B5202FS, B5202FS	01/97 ⇒ 11/00	
S70 2.5 Bifuel	GB525252	01/99 ⇒ 12/99	
V40 I 1.8	B418453	03/99 ⇒ 06/04	
V40 I 1.8 16V	B4184510	08/00 ⇒	
V70 I 2.0	B5202FS, LAC	12/95 ⇒ 03/00	
V70 I 2.5	B5252FS	01/97 ⇒ 03/00	
V70 I 2.5 Bifuel	GB525252	01/99 ⇒ 12/99	

10.3002

04

ABSOLUTE PRESSURE SENSORS (MAP)

Adatt./Suitable:

FORD
1 648 138
E6EF-9F479-A2A



kPa	Hz	+ -
15 - 115	90,5 - 169,7	

FORD			
P 100 2.0	NAE	10/87 ⇒ 12/92	
TRANSIT II 1.6	LAC, N6TS	09/85 ⇒ 09/92	
TRANSIT II 2.0	N6TS, NAW	09/85 ⇒ 09/92	
TRANSIT II 2.0 Cat	N6T	11/85 ⇒ 09/92	

FORD			
TRANSIT II 2.0 L	NAW, BDY(XU5M)	10/85 ⇒ 03/91	
TRANSIT II 2.9 i	BRT	01/91 ⇒ 09/94	

10.3003

3,5

ABSOLUTE PRESSURE SENSORS (MAP)

Adatt./Suitable:

ALFA ROMEO
46531222
60575356
60814507

BOSCH
F 000 99P 003

CITROËN
1563 J4
1920 J7
96 092 693

FIAT
46531222
500309838
5965772
60811067
60814507
7546509
7714662
7733627
9609992380

INNOCENTI
7714662

IVECO
46531222
500309838

LANCIA
46531222
60811067
7714662
7733627
9609992380

MAGNETI MARELLI
215810001604
PRT 03/02
PRT 03/04

PEUGEOT
1563 J4
1920 J7
96 092 693

VW
377 906 309 C

MARKET DIFFUSION: MEDIUM

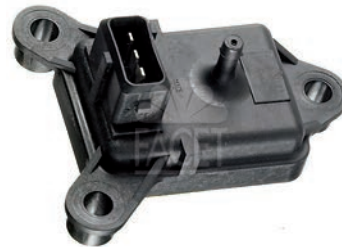

kPa	mV	+ -
17 - 105	250 - 4750	

ALFA ROMEO		
33 II 1.4 i.e.	AR30753	06/91 ⇒ 09/94

CITROËN		
AX 11	HDZ(TU1M)	09/86 ⇒ 12/97
BX 16	BDY(XU5M), BDY(XU5M)	05/89 ⇒ 12/94
BX 16 E	BDY(XU5M), LFZ(XU7JP)	05/89 ⇒ 02/93
EVASION 1.8	LFZ(XU7JP), RFU(XU10J2/C)	02/96 ⇒ 12/96
EVASION 2.0	RFU(XU10J2/C), 8140.43S	06/94 ⇒ 07/02
JUMPER 2.0	XU10J2	02/02 ⇒ 06/06
JUMPER 2.0 BiFuel	XU10J2	02/02 ⇒ 06/06
JUMPER I 2.0	RFW(XU10J2U)	02/94 ⇒ 04/02
JUMPER I 2.0 4x4	RFW(XU10J2U)	08/96 ⇒ 04/02
JUMPER I 2.0 HDI	RHV(DW10UTD)	11/01 ⇒ 04/02
JUMPER I 2.8 D	8140.63(F28D)	01/99 ⇒ 02/02
JUMPER I 2.8 HDi	8140.43S, DW10TD	09/00 ⇒ 04/02
JUMPER I 2.8 HDi 4x4	8140.43S	09/00 ⇒ 04/02
JUMPER II 2.0	XU10J2	04/02 ⇒
JUMPER II 2.0 bivalent	XU10J2	02/03 ⇒
JUMPER II 2.0 HDi	DW10TD, 4HY(DW12UTED)	04/02 ⇒
JUMPER II 2.2 HDi	4HY(DW12UTED), 8140.43N	02/02 ⇒
JUMPER II 2.8 HDi	8140.43N, RDZ(XU10MZ)	04/02 ⇒
JUMPER II 2.8 HDi 4x4	8140.43S	02/02 ⇒
JUMPER II 2.8 HDi Trazione integrale	8140.43S	04/02 ⇒
JUMPER II 2.8 TD	8140.43	04/02 ⇒

CITROËN

XANTIA 1.8 i	LFZ(XU7JP)	03/93 → 01/98
XM I 2.0 i	RDZ(XU10MZ), LFZ(XU7JP)	05/89 → 06/94
XM II 2.0 i	XU10J2	07/94 → 07/99
XSARA 1.8 i	LFZ(XU7JP), LFZ(XU7JP)	02/98 → 09/00
XSARA 1.8 i Aut.	LFZ(XU7JP), KDX(TU3M/Z)	04/97 → 09/00
ZX 1.4	KDZ(TU3M/Z)	03/91 → 06/97
ZX 1.4 i	KDX(TU3M/Z), BDY(XU5M)	03/91 → 10/97
ZX 1.6	BDY(XU5M), BDY(XU5M)	07/94 → 10/97
ZX 1.6 i	BDY(XU5M), RFX(XU10J2C)	03/91 → 10/97
ZX 1.8	LFZ(XU7JP)	07/94 → 10/97
ZX 1.8 i	LFZ(XU7JP)	07/92 → 10/97
ZX 2.0	RFX(XU10J2C)	07/94 → 10/97
ZX 2.0 i	RFX(XU10J2C), 182A4.000	07/92 → 10/97

FIAT

BRAVA 1.6 16V	182A4.000, 178A8.011	10/95 → 12/02
BRAVO I 1.6 16V	178A8.011, 154C3.000	10/95 → 10/01
CINQUECENTO 0.9 i.e.	170A1.046	07/91 → 09/94
CINQUECENTO 0.9 i.e. S	1170A1.046	07/91 → 07/99
CINQUECENTO 1.1 Sporting	176B2.000	10/94 → 01/98
COUPE 2.0 16V	836A3.000	11/93 → 08/96
COUPE 2.0 16V [BRA]	836A3.011	11/93 → 08/96
CROMA I 1900 Turbo D i.d.	154D1.000	11/92 → 12/96
CROMA I 2000 i.e.	154C3.000, RFLCNG	03/87 → 09/92
DUCATO II 2.0	RFL	03/94 →
DUCATO II 2.0 4x4	RFL	11/94 → 07/06
DUCATO II 2.0 Bipower	RFL	11/02 →
DUCATO II 2.0 JTD	RHV(DW10)	07/01 → 04/02
DUCATO II 2.0 Panorama/ Combinato	RFW	03/94 → 04/02
DUCATO II 2.8 D	8140.63	02/98 → 04/02
DUCATO II 2.8 D 4x4	8140.63	08/98 → 04/02
DUCATO II 2.8 iDTD 4x4	8140.43	05/98 → 09/01
DUCATO II 2.8 JTD	8140.43S, 176A8.000	11/00 → 04/02
DUCATO II 2.8 JTD 4x4	8140.43S	11/00 →
DUCATO II 2.8 TD 4x4	8140.43	05/98 → 11/01
DUCATO II 2.8 TDI	8140.43	10/97 → 04/02
DUCATO II 2.8 TDI 4x4	8140.43	06/99 → 04/02
DUCATO 2.0 LPG	RFL	12/01 → 10/04
DUCATO 2.0 Natural Power	RFLCNG, 8140.43S	06/03 → 07/12
MAREA 1.6	185A3.000	03/99 → 08/00
MAREA 1.6 100 16V	182A4.000	09/96 → 05/02
MAREA 1.6 16V	185A3.000	04/97 → 02/99
MAREA 1.6 SX	182B5.098	09/00 → 08/02
PALIO 1.0 GLX	--	07/98 → 10/03
PALIO 1.2	176A8.000, 178C7.098	04/96 →
PALIO 1.2 75	178B7.045	03/98 →
PALIO 1.4	178B2.000	04/96 → 10/02
PALIO 1.4 Cat	178B2.016	04/96 → 08/01
PALIO 1.6	178C7.098, 178B3.000	07/97 →
PALIO 1.6 16V	178B3.000, 141C2.000	02/01 →
PALIO 1.6 16V 100	178C8.098	01/98 →
PANDA I 1.1	156C.046	05/91 → 03/95
PANDA I 1000 4x4	141C2.000	05/86 → 12/94
PANDA I 1000 i.e.	156A2.246	08/92 → 02/04
PANDA I 1000 i.e. Cat	141C2.000, 156C.046	10/87 → 08/98
PANDA I 1100	156C.046, 176A6.000	05/91 → 12/99
PANDA I 1100 4x4	176B2.000	02/95 → 07/04
PANDA I 1100 Trekking 4x4	156C.046	10/91 → 07/04
PANDA I 900	1170A1.046	04/92 → 12/96
PANDA I 900 i.e.	1170A1.046	01/98 →
PUNTO I 1.1	176B2.000	04/96 → 02/00
PUNTO I 55 1.1	176A6.000, 176A7.000	09/93 → 09/99
PUNTO I 60 1.2	176A7.000, 176B2.000	09/93 → 06/00
PUNTO I 75 1.2	176A8.000	10/93 → 09/99
SEICENTO / 600 0.9	1170A1.046	11/97 → 01/10
SEICENTO / 600 1.1	176B2.000, 178B5.000	01/98 → 01/10
SIENA 1.2	178B5.000, 178B2.000	01/98 →
SIENA 1.4	178B2.000, 178B2.000	04/96 → 12/09
SIENA 1.4 Cat	178B2.000, 178B5.000	04/96 → 12/09
SIENA 1.6 16V	178B3.000	09/98 →
STRADA 1.2	178B5.000, --	04/03 →
STRADA 1.2 Trekking	--, 159A4.000	11/05 →
TEMPRA 1.8 4x4	159A4.000	07/92 → 06/93
TEMPRA 1.8 i.e.	159A4.000, 159A6.046	03/90 → 08/96
TEMPRA 2.0	159A6.046	04/90 → 06/93
TEMPRA 2.0 i.e.	159A6.046	10/90 → 08/96
TEMPRA 2.0 i.e. [BRA]	159A6.011	04/93 → 12/96
TEMPRA 2.0 i.e. 4x4	159A6.046	03/92 → 03/95
TIPO I 1.8 i.e.	835C2.000	04/93 → 04/95
TIPO I 1.8 i.e. 16V Sport	160A5.000	11/89 → 06/92
TIPO I 2.0	159A6.046, 835A1.000	10/90 → 04/95
TIPO I 2.0 16V	160A8.046	07/91 → 04/95
TIPO I 2.0 i.e.	159A6.046	03/90 → 04/95
TIPO I 2.0 i.e. [BRA]	159A6.011	03/93 → 10/95
TIPO I 2.0 i.e. 16V Sport	836A3.000	03/93 → 04/95
ULYSSE I 1.8	LFW	05/97 → 08/02

FIAT

ULYSSE I 2.0	RFU(XU10J2C)	06/94 → 08/02
UNO 1.0	156A2.000	06/89 → 02/92
UNO 1.0 i.e.	146C7.000	09/89 → 03/94
UNO Mondo 1.2 i.e. [IND]	178D5.066	01/96 →

FIAT (BR)

BRAVA 1.6i 16v	1.6Mpi	01/00 → 12/01
BRAVA 1.8i 16v	1.8Mpi	01/00 →
PALIO 1.0i	1.0Mpi	01/96 →
PALIO 1.5i	1.5Mpi	01/96 → 12/00
PALIO 1.6i	1.6Mpi	01/99 → 12/00
PALIO 1.6i 16v	1.6Mpi16v	01/96 →
SIENA 1.0i	1.0Mpi	01/99 → 12/00
SIENA 1.5i	1.5Mpi	01/99 → 12/00
SIENA 1.6i	1.6Mpi	01/99 → 12/00
SIENA 1.6i 16v	1.6Mpi	01/98 → 12/99
STRADA 1.5i	1.5Mpi	01/99 → 12/01
STRADA 1.6i 16v	1.6Mpi	01/99 →
STRADA 1.6i 8v	1.6Mpi	01/99 → 12/00
TIPO 2.0i 16V	2.0Mpi	01/94 → 12/95
TIPO 2.0i 8v	2.0Mpi	01/94 → 12/95
UNO 1.5i	1.5Spi	01/92 → 12/96
UNO 1.5i Furgoneta	1.5Mpi	01/92 →
UNO CS 1.5i	1.5Spi	01/92 → 12/96
UNO MILLE 1.0	1.0	05/93 → 12/95
UNO MILLE 1.0i	1.0Mpi	01/96 →

INNOCENTI

MILLE 1.0	146C7.000	07/95 → 05/97
MILLE 1.0i	146C7.000	02/93 → 02/98

IVECO

DAILY II 2.8 CNG	814903CNG	05/99 → 07/07
DAILY II 29 L 9	8140.63	05/99 → 04/06
DAILY II 29 L 9 V	8140.63	05/99 → 07/07
DAILY II 35 S 9 V,35 C 9 V	8140.63	05/99 → 07/07
DAILY II 35 S 9,35 C 9	8140.63	05/99 → 04/06
DAILY II 50 C 11 Natural Power	814903CNG	05/99 → 04/06
DAILY III 50 C 11 Natural Power	814903CNG	05/02 → 05/06
DAILY 2.8 CNG	814903CNG	07/99 → 12/06

LANCIA

DEDRA 1.6	835A1000	07/94 → 02/97
DEDRA 1.6 i.e.	835A1.000, 835A2.000	08/89 → 06/94
DEDRA 1.8 i.e.	835A2.000, 835A5.000	09/89 → 07/99
DEDRA 2.0 16V	836A3.000	07/94 → 07/99
DEDRA 2.0 i.e.	835A5.000, 188A4.000	09/89 → 07/99
DEDRA 2.0 Integrale	836A3.000	07/94 → 07/99
DELTA I 1.6 GT i.e.	831B7.000	08/86 → 08/88
DELTA II 1.6 i.e.	182A6.000	03/96 → 08/99
DELTA II 1.6 i.e. 16V	182A4.000	01/96 → 08/99
DELTA II 2.0 16V	836A3.000	06/93 → 08/99
Y 1.1	176B2.000	11/95 → 09/03
Y 1.2	188A4.000, LFW(XU7JP)	03/96 → 09/03

PEUGEOT

106 I 1.1	HDZ(TU1M)	09/91 → 04/96
806 1.8	LFW(XU7JP), RFU(XU10J2)	07/95 → 08/02
806 2.0	RFU(XU10J2), RFL(XU10J2U)	06/94 → 08/02
BOXER 2.0 CNG	XU10J2CNG	07/03 → 03/06
BOXER I 2.0	RFL(XU10J2U), DW10TD	12/01 →
BOXER I 2.0 4x4	--	03/96 → 09/98
BOXER I 2.0 BiFuel	XU10J2	12/01 → 06/06
BOXER I 2.0 HDi	DW10TD, 4HY(DW12UTED)	08/01 →
BOXER I 2.0 i	RFW(XU10J2)	03/94 → 04/02
BOXER I 2.0 i 4x4	RFW(XU10J2)	08/96 → 04/02
BOXER I 2.2 HDi	4HY(DW12UTED), 8140.43N	04/02 →
BOXER I 2.8 D	8140.63(F28D)	01/99 → 02/02
BOXER I 2.8 HDi	8140.43N, 8140.43S(F28DTCR)	10/00 →
BOXER I 2.8 HDi 4x4	8140.43S(F28DTCR), L6B(XU7JP)	10/00 →
BOXER I 2.8 HDi Trazione integrale	8140.43S(F28DTCR)	10/00 → 11/01
BOXER I 2.8 TD	8140.43(F28DT)	12/01 → 03/05
EXPERT I 1.8	L6B(XU7JP), S9W700	09/96 →

VOLKSWAGEN (BR)

GOL 2.0i 16V	112	10/95 →
PARATI 2.0i 16V	112	02/96 →

10.3004



3,5

ABSOLUTE PRESSURE SENSORS (MAP)

Adatt./Suitable:

GENERAL MOTORS

12 569 241
16 040 609
9 160 331

ISUZU

8-12569241-0
8-16040609-0

OPEL

12 38 572
12 38 786
45 00 031
62 35 695

RENAULT

77 00 267 701

VOLVO

133638-4



kPa	mV	+ -
20 - 200	273 - 4827	

OPEL

MONTEREY B 3.0 DTI	4JX1	07/98 → 08/99
MOVANO A 2.8 DTI	S9W700, J7R752	07/98 → 10/01
OMEGA A 3.6 24V Lotus	C36GET	08/90 → 09/92

RENAULT

21 2.0 Turbo	J7R752, J7R752	04/87 → 10/92
21 2.0 Turbo 4x4	J7R752, B200ET	08/89 → 10/93
25 2.4 V6 Turbo	Z7U02	10/84 → 05/90
25 2.5 V6 Turbo	Z7U00	01/90 → 12/92
SAFRANE I 3.0 Biturbo 4x4	Z7X726	02/93 → 07/96

VAUXHALL

MONTEREY II 3.0 DTI	4JX1	07/98 → 08/99
MOVANO A 2.8 DTI	S9W702	10/98 → 10/01
MOVANO A 2.8 TDI	S9W702	10/98 → 10/01

VOLVO

740 2.0	B200ET, B204FT	01/85 → 08/92
740 2.0 16V	B204E	09/87 → 08/90
740 2.0 16V Turbo	B204FT, B230F	08/89 → 07/90
740 2.0 GLE	B204E	09/87 → 08/90
740 2.0 Turbo	B200ET	09/87 → 08/90
740 2.3	B230FT, B230ET	08/84 → 07/92
740 2.3 Turbo	B230ET, KFW(TU3JP)	08/85 → 08/91
760 2.3	B230ET	08/84 → 08/87
760 2.3 Turbo	B230ET	08/84 → 08/90

10.3005



3

ABSOLUTE PRESSURE SENSORS (MAP)

Adatt./Suitable:

BOSCH

0 261 230 034
0 261 230 057

CITROËN

1920 1K
1920 AN
96 394 188 80

FIAT

9631813680
9639418880

LANCIA

9631813680
9639418880

PEUGEOT

1920 1K
1920 AN

RENAULT

96 31 813 680
96 39 418 880

MARKET DIFFUSION: MEDIUM



kPa	mV	O - +
20 - 105	390.5 - 4750	

CITROËN

BERLINGO I 1.4 i	KFW(TU3JP), RFN(EW10J4)	07/96 ⇨ 12/11
BERLINGO I 1.4 i bivalent	KFW(TU3JP)	04/03 ⇨ 10/05
BERLINGO I 1.8 i	LFX(XU7JB)	05/97 ⇨ 10/02
BERLINGO I 1.8 i 4WD	LFX(XU7JB)	04/97 ⇨ 10/01
C5 I 1.8 16V	6FZ(EW7J4)	03/01 ⇨ 08/04
C5 I 2.0 16V	RFN(EW10J4)	03/01 ⇨ 08/04
C8 2.2	3FZ(EW12J4)	07/02 ⇨
EVASION 2.0 16V	RFN(EW10J4), KFW(TU3JP)	05/00 ⇨ 07/02
JUMPY I 2.0	RFN(EW10J4)	04/00 ⇨ 12/06
JUMPY I 2.0 i 16V	RFN(EW10J4)	03/00 ⇨ 10/06
SAXO 1.4 VTS	KFW(TU3JP), NFX(TU5JP4)	05/96 ⇨ 06/03
SAXO 1.6	NFX(TU5JP4), RFN(EW10J4)	02/96 ⇨ 04/04
SAXO 1.6 VTL,VTR	NFZ(TU5JP)	05/96 ⇨ 06/03
SAXO 1.6 VTR	NFX(TU5JP4)	05/96 ⇨ 07/99
SAXO 1.6 VTS	NFX(TU5JP4)	06/96 ⇨ 09/03
XANTIA I 3.0 V6	XFZ(ES9J4)	01/98 ⇨ 04/03
XANTIA II 1.8 i	LFX(XU7JB)	01/98 ⇨ 04/03
XANTIA II 1.8 i 16V	LFY(XU7JP4)	01/98 ⇨ 04/03
XANTIA II 2.0 i 16V	RFV(XU10J4R)	01/98 ⇨ 04/03
XANTIA II 3.0 V6	XFZ(ES9J4)	01/98 ⇨ 04/03
XM II 2.0 i 16V	RFV(XU10J4R)	05/94 ⇨ 10/00
XM II 3.0 V6	XFZ(ES9J4)	04/97 ⇨ 10/00
XSARA 1.4 i	KFX(TU3JP)	04/97 ⇨ 08/05
XSARA 1.6 i	NFZ(TU5JP)	04/97 ⇨ 09/00
XSARA 1.8 i	LFX(XU7JB)	04/97 ⇨ 09/00
XSARA 1.8 i 16V	LFY(XU7JP4)	04/97 ⇨ 09/00
XSARA 2.0 16V	RFN(EW10J4), NFZ(TU5JP)	09/00 ⇨ 08/05
XSARA 2.0 i 16V	RFS(XU10J4RS)	02/98 ⇨ 03/05
XSARA PICASSO 1.6	NFZ(TU5JP), RFN	06/02 ⇨
XSARA PICASSO 1.8 16V	6FZ(EW7J4)	02/00 ⇨
XSARA PICASSO 2.0 16V	RFN(EW10J4)	01/03 ⇨

FIAT

SCUDO 2.0	RFN	09/99 ⇨ 10/06
SCUDO I 2.0	RFN, RFN	05/00 ⇨ 12/06
SCUDO I 2.0 16V	RFN, RFN(EW10J4)	06/00 ⇨ 12/06
ULYSSE I 2.0 16V	RFN(EW10J4), RFN	09/00 ⇨ 08/02

LANCIA

ZETA 2.0 16V	RFN, KFW(TU3JP)	07/00 ⇨ 09/02
--------------	-----------------	---------------

PEUGEOT

106 II 1.4 i	KFW(TU3JP), K6C(TU3JP)	05/96 ⇨ 07/04
106 II 1.6 516	NFX(TU5J4)	05/96 ⇨ 07/04
206 1.1	HFY(TU1JP)	08/98 ⇨ 07/00
206 1.1 i	HFZ(TU1JP)	09/98 ⇨

PEUGEOT

206 1.4 i	K6C(TU3JP), RFN(EW10J4)	09/98 ⇨
206 1.6 i	NFZ(TU5JP)	09/98 ⇨ 12/00
206 2.0 16V	RFN(EW10J4)	07/02 ⇨ 02/07
206 2.0 516	RFN(EW10J4), KFW(TU3JP)	04/99 ⇨
306 1.4	KFW(TU3JP), KFW(TU3JP)	04/93 ⇨ 04/02
306 1.4 5L	KFW(TU3JP), LFY(XU7JP4)	06/94 ⇨ 05/01
306 1.6	NFZ(TU5JP)	05/93 ⇨ 10/00
306 1.6 SR	NFZ(TU5JP)	06/94 ⇨ 10/00
306 1.8 16V	LFY(XU7JP4), RFV(XU10J4R)	03/97 ⇨ 10/03
306 2.0	RFV(XU10J4R), RFV(XU10J4R)	03/97 ⇨ 04/02
306 2.0 16V	RFV(XU10J4R), RFN(EW10J4)	03/97 ⇨ 04/02
306 2.0 516	RFS(XU10J4RS)	06/96 ⇨ 05/01
307 2.0	RFN(EW10J4)	03/02 ⇨ 06/05
307 2.0 16V	RFN(EW10J4), 6FZ(EW7J4)	08/00 ⇨ 04/08
406 1.8	LFX(XU7JB)	05/97 ⇨ 10/04
406 1.8 16V	6FZ(EW7J4), RFN(EW10J4)	10/00 ⇨ 10/04
406 2.0 16V	RFN(EW10J4), XFZ(ES9J4)	08/00 ⇨ 12/04
406 2.2	3FZ(EW12J4)	07/00 ⇨ 12/04
406 3.0 24V	XFZ(ES9J4), 3FY(EW12J4)	10/96 ⇨ 10/04
406 3.0 V6 24V	XFZ(ES9J4)	03/97 ⇨ 12/04
407 2.2	3FZ(EW12J4)	05/04 ⇨
607 2.0	RFN(EW10J4)	02/00 ⇨ 08/05
607 2.2 16V	3FY(EW12J4), RFN(EW10J4)	02/00 ⇨ 06/10
806 2.0 16V	RFN(EW10J4), KFX(TU3JP)	09/00 ⇨ 08/02
807 2.2	3FZ(EW12J4)	06/02 ⇨
EXPERT I 2.0	RFN(EW10J4)	07/00 ⇨ 12/06
PARTNER I 1.4	KFX(TU3JP), K6C(TU3JP)	06/96 ⇨ 12/15
PARTNER I 1.8	LFX(XU7JB)	03/97 ⇨ 12/03
RANCH 1.4	K6C(TU3JP), L7X700	06/96 ⇨
RANCH 1.8	LFX(XU7JB)	05/97 ⇨

RENAULT

ESPACE III 3.0 V6 24V	L7X727	10/98 ⇨ 10/02
LAGUNA I 3.0 24V	L7X700, B204E	03/97 ⇨ 03/01
SAFRANE II 2.9 24V	L7X713	03/99 ⇨ 12/00

10.3006



3,5

ABSOLUTE PRESSURE SENSORS (MAP)

Adatt./Suitable:

GENERAL MOTORS

16 172 899

SAAB

91 32 374



kPa	mV	- O +
20 - 251	356 - 4750	

SAAB

9-3 2.0 SE Turbo	B204R	02/98 ⇨ 08/03
9-3 2.0 Turbo	B204E, 12S	02/98 ⇨ 08/03
900 II 2.0 -16 Turbo	B204L	07/93 ⇨ 02/98
9000 2.0 -16 CD	B204E, B204E	09/93 ⇨ 12/98
9000 2.0 -16 CS	B204I	09/93 ⇨ 12/98
9000 2.0 -16 ND Turbo	B204E	09/93 ⇨ 12/98
9000 2.0 -16 Turbo CD	B204E, B204E	09/92 ⇨ 12/98
9000 2.3 -16 Aero CS	B234R	02/93 ⇨ 12/98
9000 2.3 -16 CD	B234I	08/89 ⇨ 12/98
9000 2.3 -16 CD Turbo	B234L	07/90 ⇨ 12/98
9000 2.3 -16 CDE	B234I	09/93 ⇨ 12/98
9000 2.3 -16 CDE Eco-Power	B234E	09/93 ⇨ 12/98
9000 2.3 -16 CS	B234I	09/89 ⇨ 12/98

SAAB

9000 2.3 -16 CSE	B234I	09/93 ⇨ 12/98
9000 2.3 -16 CSE Eco Power	B234E	09/93 ⇨ 12/98
9000 2.3 -16 Turbo	B234L	09/90 ⇨ 12/98
9000 2.3 -16 Turbo CSE	B234L	09/93 ⇨ 12/98

10.3007



3,5

ABSOLUTE PRESSURE SENSORS (MAP)

Adatt./Suitable:

OPEL

12 11 230

03 Supplied until depletion

- Fornibile fino ad esaurimento delle scorte
- Fourni jusqu'à épuisement du stock
- Lieferbar solange vorrat reicht
- Suministrado hasta el stock termina



kPa	mV	+ O -
20 - 105	4730 - 191.5	

OPEL

CORSA A 1.2	12S, 12S	09/82 ⇨ 08/90
CORSA A 1.2 N	12NV	01/90 ⇨ 03/93
CORSA A 1.2 S	12S, 13N	09/82 ⇨ 03/93
CORSA A 1.3	13SB	02/86 ⇨ 04/89
CORSA A 1.3 GL	13S	09/82 ⇨ 03/93
CORSA A 1.3 S	13SB	09/82 ⇨ 10/89
CORSA A 1.6 GSI	E16SE	05/88 ⇨ 03/92
KADETT E 1.3 N	13N, AR67203	09/84 ⇨ 08/91
KADETT E 1.3 S	13S	09/84 ⇨ 02/93
KADETT E 1.6	16SV	09/86 ⇨ 12/91
KADETT E 1.6 i	16SV	07/89 ⇨ 02/93
KADETT E 1.6 S	16SV	09/86 ⇨ 08/91

10.3008



3,5

ABSOLUTE PRESSURE SENSORS (MAP)

Adatt./Suitable:

ALFA ROMEO
7750716FIAT
60809804FORD
6 742 049
V92AB-9F479-AALANCIA
60809804MAGNETI MARELLI
215810001900
PRT 06/00
PRT 06/00 2006AA

kPa	mV	
20 - 250	240 - 4775	

ALFA ROMEO

155 2.0 16V Turbo Q4 AR67203, 175A4.000 01/92 ⇨ 12/97

FIAT

COUPE 2.0 16V Turbo 175A1.000 11/93 ⇨ 08/96

FIAT (BR)

COUPE 2.0i 16V 2.0Mpi 01/95 ⇨ 12/97

FORD

ESCORT V RS Cosworth 4x4 NSF 09/92 ⇨ 01/95

LANCIA

DELTA I 2.0 16V HF Evo 831E5.046 06/93 ⇨ 01/94

Integrale

DELTA II 2.0 16V Turbo 175A4.000, P8C(XUD11BTE) 06/93 ⇨ 08/99

10.3009



3

ABSOLUTE PRESSURE SENSORS (MAP)

Adatt./Suitable:

CITROËN
1920 X0
96 191 149 80DENSO
079800-3310FIAT
9619114980LANCIA
9619114980PEUGEOT
1920 X0

kPa	mV	
10 - 213	933 - 4750	

CITROËN

EVASION 2.1 TD P8C(XUD11BTE), P8C(XUD11BTE) 05/96 ⇨ 07/02

CITROËN

XANTIA I 2.1 Turbo D 12V P8C(XUD11BTE) 06/95 ⇨ 02/99

XANTIA II 2.1 Turbo D 12V P8C(XUD11BTE) 01/98 ⇨ 02/99

XM II 2.1 TD 12V P8C(XUD11BTE) 05/94 ⇨ 10/00

FIAT

ULYSSE I 2.1 TD P8C 03/96 ⇨ 10/99

LANCIA

ZETA 2.1 TD P8C 05/96 ⇨ 09/99

PEUGEOT

406 2.1 TD 12V XUD11BTE 01/96 ⇨ 10/04

605 2.1 Turbo Diesel PHZ(XUD11ATE) 06/89 ⇨ 09/99

806 2.1 td 12V P8C(XUD11BTE), TU32 06/96 ⇨ 08/99

10.3010



3

ABSOLUTE PRESSURE SENSORS (MAP)

Adatt./Suitable:

BOSCH
0 261 230 012CITROËN
1920 OE
1920 9HFIAT
9618261580LANCIA
9618261580

PEUGEOT

1920 OE

1920 9H

RENAULT

96 18 261 580

MARKET DIFFUSION: MEDIUM



kPa	mV	
20 - 100	385 - 4485	

CITROËN

BERLINGO I 1.4 i KFW(TU3JP), RFV(XU10J4R) 07/96 ⇨ 12/11

BERLINGO I 1.4 i bivalent KFW(TU3JP) 04/03 ⇨ 10/05

BERLINGO I 1.8 i LFX(XU7JB) 05/97 ⇨ 10/02

BERLINGO I 1.8 i 4WD LFX(XU7JB) 04/97 ⇨ 10/01

BERLINGO 1.4 TU32, KFW(TU3JP) 07/96 ⇨ 10/02

EVASION 2.0 16V RFV(XU10J4R), KFW(TU3JP) 05/98 ⇨ 04/00

SAXO 1.4 VTS KFW(TU3JP), NFX(TU5JP4) 05/96 ⇨ 06/03

SAXO 1.6 NFX(TU5JP4), NFZ(TU5JP) 02/96 ⇨ 04/04

SAXO 1.6 VTL, VTR NFZ(TU5JP), NFX(TU5JP4) 05/96 ⇨ 06/03

SAXO 1.6 VTR NFX(TU5JP4) 05/96 ⇨ 07/99

SAXO 1.6 VTS NFX(TU5JP4), KFX(TU3JP) 06/96 ⇨ 09/03

XANTIA I 1.8 i LFX(XU7JB) 04/97 ⇨ 04/03

XANTIA I 1.8 i 16V LFX(XU7JB) 06/95 ⇨ 04/03

XANTIA I 2.0 i 16V RFV(XU10J4R) 06/95 ⇨ 04/03

XANTIA I 3.0 i 24V XFZ(ES9J4) 01/97 ⇨ 04/03

XANTIA I 3.0 V6 XFZ(ES9J4) 01/98 ⇨ 04/03

XANTIA II 1.8 i LFX(XU7JB) 01/98 ⇨ 04/03

XANTIA II 1.8 i 16V LFX(XU7JB) 01/98 ⇨ 04/03

XANTIA II 2.0 i 16V RFV(XU10J4R) 01/98 ⇨ 04/03

XANTIA II 3.0 V6 XFZ(ES9J4) 01/98 ⇨ 04/03

XM II 2.0 i 16V RFV(XU10J4R) 05/94 ⇨ 10/00

XM II 3.0 V6 XFZ(ES9J4) 04/97 ⇨ 10/00

XSARA 1.4 TU3JP 05/98 ⇨ 10/04

XSARA 1.4 BiFuel [ExtraEU] TU3JP 05/98 ⇨ 08/00

XSARA 1.4 i KFX(TU3JP), NFZ(TU5JP) 04/97 ⇨ 08/05

XSARA 1.4 LPG TU3JP 05/98 ⇨ 08/00

XSARA 1.6 i NFZ(TU5JP), LFX(XU7JB) 04/97 ⇨ 09/00

XSARA 1.8 i LFX(XU7JB), LFX(XU7JP4) 04/97 ⇨ 09/00

XSARA 1.8 i 16V LFX(XU7JP4), RFS(XU10J4RS) 04/97 ⇨ 09/00

XSARA 2.0 16V RFS(XU10J4RS), RFS(XU10J4RS) 04/97 ⇨ 09/00

XSARA 2.0 i 16V RFS(XU10J4RS), RFV 02/98 ⇨ 03/05

ZX 1.4 i KFX(TU3JP) 03/91 ⇨ 10/97

CITROËN

ZX 1.8 LFX(XU7JP4) 04/96 ⇨ 10/97

ZX 1.8 i 16V LFX(XU7JP4) 01/96 ⇨ 02/98

ZX 2.0 RFS(XU10J4RS) 09/96 ⇨ 10/97

ZX 2.0 i 16V RFS(XU10J4RS) 05/96 ⇨ 06/97

FIAT

ULYSSE I 2.0 16V RFV 05/98 ⇨ 09/00

LANCIA

ZETA 2.0 16V RFV, KFW(TU3JP) 05/98 ⇨ 07/00

PEUGEOT

106 II 1.4 i KFW(TU3JP), NFX(TU5J4) 05/96 ⇨ 07/04

106 II 1.6 S16 NFX(TU5J4), HFY(TU1JP) 05/96 ⇨ 07/04

206 1.1 HFY(TU1JP), HFZ(TU1JP) 08/98 ⇨ 02/07

206 1.1 i HFZ(TU1JP), K6C(TU3JP) 09/98 ⇨

206 1.4 i K6C(TU3JP), NFZ(TU5JP) 09/98 ⇨

206 1.6 i NFZ(TU5JP), KFW(TU3JP) 09/98 ⇨ 12/00

306 1.4 KFW(TU3JP), KFW(TU3JP) 04/93 ⇨ 04/02

306 1.4 SL KFW(TU3JP), LFX(XU7JP4) 06/94 ⇨ 05/01

306 1.6 NFZ(TU5JP) 05/93 ⇨ 10/00

306 1.6 SR NFZ(TU5JP) 06/94 ⇨ 10/00

306 1.8 16V LFX(XU7JP4), RFV(XU10J4R) 03/97 ⇨ 10/03

306 2.0 RFV(XU10J4R), RFV(XU10J4R) 03/97 ⇨ 04/02

306 2.0 16V RFV(XU10J4R), RFV(XU10J4R) 03/97 ⇨ 04/02

306 2.0 S16 RFS(XU10J4RS) 06/96 ⇨ 05/01

406 1.8 XU7JB 05/97 ⇨ 10/04

406 2.0 16V XU10J4R 11/95 ⇨ 10/04

406 3.0 24V ES9J4 10/96 ⇨ 10/04

406 3.0 V6 24V ES9J4 03/97 ⇨ 12/04

806 2.0 16V RFV(XU10J4R), KFX(TU3JP) 05/98 ⇨ 09/00

PARTNER 1.8 XU7JB 03/97 ⇨ 08/00

PARTNER I 1.4 KFX(TU3JP), LFX(XU7JB) 06/96 ⇨ 12/15

PARTNER I 1.8 LFX(XU7JB), K6C(TU3JP) 03/97 ⇨ 12/03

RANCH 1.4 K6C(TU3JP), L7X700 06/96 ⇨

RANCH 1.8 LFX(XU7JB) 05/97 ⇨

RENAULT

ESPACE III 3.0 V6 24V L7X727 10/98 ⇨ 10/02

LAGUNA I 3.0 24V L7X700, LE5 03/97 ⇨ 03/01

10.3011



3

ABSOLUTE PRESSURE SENSORS (MAP)

Adatt./Suitable:

CHEVROLET

12614970
16212460

DAEWOO

12614970
16212460

FIAT

71739292

GENERAL MOTORS

12 614 970
16 212 460
16 258 659
28 074 365
28 074 367
90 063 543
98 131 025

ISUZU

16212460
8-16212460-0
8-28074365-0

OPEL

12 35 046
12 47 047
16212460
28074365
62 38 120
62 38 159

RENAULT

77 00 106 644

SAAB

16 212 460

VAUXHALL

16212460
28074365

MARKET DIFFUSION: MEDIUM



kPa	mV	
20 - 100	516 - 4775	

CHEVROLET

EPICA 2.0	L88	01/05 → 12/06
HHR 2.4	LE5, L88	01/06 → 12/11
LEGANZA 2.0	--	01/98 →
LEGANZA 2.2	--	01/98 →
REZZO 2.0	L88, T20SED	03/05 →
TACUMA 2.0	X20SED	02/05 →
VIVANT 2.0	X20SED	08/00 →
VIVANT 2.0 CX	T20SED	01/05 →

DAEWOO

LEGANZA 2.0	T20SED, T20SED	01/01 → 12/02
LEGANZA 2.0 16V	T20SED, T20SED	07/00 → 04/04
LEGANZA 2.2 16V	T22SED	04/99 → 12/02
NUBIRA I 2.0	C20SED	06/99 → 07/03
NUBIRA I 2.0 16V	T20SED, T20SED	06/98 →
NUBIRA I 2.0 CDX	T20SED	08/02 → 07/03
REZZO 2.0	T20SED, Z16SE	09/00 →
TACUMA 2.0	X20SED	09/00 → 01/05

FIAT

CROMA II 2.2 16V	194A1.000	06/05 →
------------------	-----------	---------

ISUZU

TROOPER 3.5 V6 24V	6VE1	04/00 → 08/04
TROOPER 3.5 V6 24V AWD	6VE1	04/00 → 08/04

OPEL

ASTRA G 1.6	Z16SE, X16XEL	09/00 → 12/09
ASTRA G 1.6 16V	Z16XE	09/98 → 10/05
ASTRA G 1.6 CNG	Z16YNG	03/03 → 07/04
ASTRA G 1.6 LPG	X16XEL, Z16XE	06/02 → 06/07
ASTRA G 2.2 16V	Z22SE	06/00 → 10/05
ASTRA H 1.4 16V	Z14XE	05/04 → 07/09
ASTRA H 1.6	Z16XE, Y16YNG	03/04 → 10/10
ASTRA H 1.6 16V	Z16XE	05/04 → 02/06
ASTRA H 1.6 EcoTec	Z16XEP	02/04 → 11/04
COMBO C 1.6	Z16SE	10/01 →
COMBO C 1.6 CNG	Y16YNG, Y16YNG	04/05 → 12/11
COMBO C 1.6 CNG 16V	Y16YNG, X22SE	04/05 →
CORSA C 1.4	Z14XE	07/00 →
CORSA C 1.6	Z16SE	09/00 →
CORSA C 1.6 CNG	Y16YNG	05/03 → 12/09
CORSA C 1.6 X	Z16YNG	08/05 →

OPEL

FRONTERA B 2.2 i	X22SE, 6VD1	10/98 → 07/04
FRONTERA B 3.2 i	6VD1, Z16XE	10/98 → 07/04
MERIVA A 1.6	Z16SE	05/03 → 05/10
MERIVA A 1.6 16V	Z16XE	05/03 → 01/06
MONTEREY B 3.5 V6 24V	6VE1	07/98 → 08/99
SIGNUM 2.2 direct	Z22YH	05/03 → 09/08
SPEEDSTER 2.2	Z22SE	06/00 → 08/05
VECTRA B 2.2 i 16V	Z22SE	09/00 → 07/03
VECTRA C 1.6	Z16XE, Z16XE	08/05 → 08/08
VECTRA C 1.6 16V	Z16XE	06/04 → 09/08
VECTRA C 2.2 16V	Z22SE	04/02 → 12/08
VECTRA C 2.2 DGi	Z22YH	10/03 → 08/08
VECTRA C 2.2 direct	Z22YH	10/03 → 08/08
ZAFIRA A 1.6 16V	Z16XE, Z16XE1	09/02 → 06/05
ZAFIRA A 1.6 CNG	Z16YNG	09/01 → 06/05
ZAFIRA A 1.6 LPG	Z16XEP	10/03 → 06/05
ZAFIRA A 2.2 16V	Z22SE	09/00 → 06/05
ZAFIRA B 1.6	Z16XE1, D7F710	07/05 → 09/12
ZAFIRA B 1.6 CNG	Z16YNG	07/05 → 04/15
ZAFIRA B 2.2	Z22YH	07/05 → 12/12

RENAULT

KANGOO 1.2 BiFuel	D7F710, D7F710	06/97 → 06/03
KANGOO I 1.2	D7F710, D7F710	08/97 →
KANGOO I 1.2 BiFuel	D7F710, X14XE	07/98 → 07/01
LAGUNA I 1.6 16V	K4M724	11/97 → 03/01
TWINGO II 1.2	D7F800	03/07 →

SAAB

9-7X 4.2 AWD	LL8(254CUL6)	12/05 → 07/12
9-7X 5.3 AWD	LH6(325CUL8)	06/04 → 07/12

VAUXHALL

ASTRA IV 1.4 16V	X14XE, Z16SE	09/98 → 05/05
ASTRA IV 1.6	Z16SE, X16XEL	09/00 → 05/05
ASTRA IV 1.6 16V	X16XEL, X16XEL	09/98 → 10/05
ASTRA IV 1.6 Dualfuel	X16XEL, A16XER	03/98 → 05/05
ASTRA IV 2.2 16V	Z22SE	03/00 → 10/05
ASTRA V 1.6	A16XER, Z16SE	01/04 → 11/10
ASTRAVAN II 1.6 Dualfuel	Z16SE, Z16XE1	07/00 → 08/05
ASTRAVAN II 1.6 Dualfuel 16V	Z16XEP	10/04 → 12/05
ASTRAVAN II 1.6 i	Z16SE	09/00 → 08/06
ASTRAVAN III 1.6	Z16XE1, Z16SE	03/05 →
COMBO C 1.4 16V	Z14XE	10/01 → 05/07
COMBO C 1.6	Z16SE, Z16YNG	09/01 → 11/11
COMBO C 1.6 CNG	Z16YNG, Y16YNG	04/05 → 02/12
COMBO C 1.6 CNG 16V	Y16YNG, X22SE	04/05 → 02/12
CORSA C 1.4 16V	Z14XE	09/00 → 10/06
FRONTERA B 2.2 i	X22SE, 6VD1	10/98 → 10/04
FRONTERA B 3.2 i	6VD1, Y16XE	10/98 → 10/04
MERIVA I 1.6 i	Z16SE	01/03 → 06/10
MERIVA I 1.6 i 16V	Z16XE	01/03 → 09/05
MERIVA I 1.6 i 16V Twinport	Z16XEP	05/03 → 06/10
MERIVA I 1.7 CDTi	Z17DTH	09/03 → 06/10
MONTEREY II 3.5 V6 24V	6VE1	07/98 → 08/99
SIGNUM 2.2 i	Z22YH	05/03 → 05/08
SPEEDSTER 2.2	Z22SE	03/01 → 09/06
VECTRA B 1.6 i 16V	Y16XE, Z16XE	11/96 → 03/02
VECTRA B 2.2 i 16V	Z22SE	08/95 → 07/03
VECTRA C 1.6 16V	Z16XE, Z16XE1	06/04 → 07/08
VECTRA C 2.2 16V	Z22SE	01/02 → 10/08
VECTRA C 2.2 direct	Z22YH	01/02 → 10/08
VIVARO 2.0 16V	F4R720	08/01 → 12/06
VIVARO 2.0 ECOTEC	F4R820	08/06 → 07/14
VX220 2.2 i	Z22SE	09/00 → 07/05
VXR8 6.0	LS2(364CUL8)	02/07 →
ZAFIRA A 1.6 CNG	Z16YNG	09/01 → 06/05
ZAFIRA A 2.2 16V	Z22SE	11/98 → 08/04
ZAFIRA B 1.6	Z16XE1, AMF	07/05 → 11/14
ZAFIRA B 1.6 CNG	Z16YNG	07/05 → 11/14
ZAFIRA B 2.2	Z22YH	07/05 → 11/14

10.3012



3,5

ABSOLUTE PRESSURE SENSORS (MAP)

Adatt./Suitable:

AUDI

038 906 051
062 906 051

BOSCH

0 281 002 177
0 281 002 178

FORD

1 111 222
99VW-9E928-AA

SEAT

038 906 051
062 906 051

SKODA

038 906 051
062 906 051

VW

038 906 051
062 906 051

MARKET DIFFUSION: HIGH



kPa	mV	
11 - 254	250 - 4750	

AUDI

A2 1.2 TDI	ANY	03/01 → 08/05
A2 1.4 TDI	AMF, AGU	02/00 → 08/05
A3 I 1.8 T	AGU, AGU	12/96 → 05/03
A3 I 1.8 T quattro	AGU, AGR	12/96 → 05/03
A3 I 1.9 TDI	AGR, AMK	10/00 → 05/03
A3 I S3 quattro	AMK, AEB	03/99 → 04/02
A4 I 1.8 T	AEB, AEB	01/95 → 09/01
A4 I 1.8 T quattro	AEB, 1Z	01/95 → 09/01
A4 I 1.9 DUO	AHU	03/98 → 09/01
A4 I 1.9 TDI	1Z, AFN	03/00 → 09/01
A4 I 1.9 TDI quattro	AFN, AFB	03/00 → 09/01
A4 I 2.5 TDI	AFB, AFB	09/97 → 09/01
A4 I 2.5 TDI quattro	AFB, ASJ	09/97 → 09/01
A4 I RS4 quattro	ASJ, AEB	05/00 → 09/01
A6 II 1.8 T	AEB, AEB	01/97 → 01/05
A6 II 1.8 T quattro	AEB, AFN	02/97 → 01/05
A6 II 1.9 TDI	AFN, ARE	07/00 → 01/05
A6 II RS6 plus quattro	BRV	04/04 → 01/05
A6 II RS6 quattro	BCY	07/02 → 01/05
ALLROAD 2.7 T quattro	ARE, AJQ	05/00 → 08/05
TT I 1.8 T	AJQ, AJQ	01/01 → 06/06
TT I 1.8 T quattro	AJQ, ANU	02/00 → 06/06

FORD

GALAXY I 1.9 TDI	ANU, AJH	04/00 → 05/06
------------------	----------	---------------

SEAT

ALHAMBRA I / II 1.8 T 20V	AJH, 1Z	10/97 → 03/10
ALHAMBRA I / II 1.9 TDI	1Z, AUY	06/00 → 03/10
ALHAMBRA I / II 1.9 TDI 4motion	AUY, AQX	06/00 → 03/10
AROSA 1.4 TDI	AMF	01/00 → 06/04
CORDOBA I 1.8 T 20V Cupra	AQX	07/00 → 10/02
IBIZA II 1.8 T 20V Cupra	AQX, AGR	07/00 → 02/02
IBIZA II 1.9 TDI	AGR, AGN	08/99 → 02/02
LEON I 1.8 20V	AGN, APP	11/99 → 06/06
LEON I 1.8 20V T	APP, AJQ	11/99 → 06/06
LEON I 1.8 20V T 4	AJQ, AGR	11/99 → 06/06
LEON I 1.9 TDI	AGR, AGN	09/00 → 06/06
LEON I 1.9 TDI Syncro	ARL	05/02 → 06/06
TOLEDO II 1.8 20V	AGN, AGR	10/98 → 07/04
TOLEDO II 1.8 4x4	AJQ	05/01 → 04/04
TOLEDO II 1.9 TDI	AGR, ATD	10/00 → 07/04

SKODA

FABIA I 1.9 TDI	ATD, AGU	01/00 → 03/08
OCTAVIA I 1.8 T	AGU, AGR	08/97 → 12/10
OCTAVIA I 1.8 T 4x4	ARX	05/01 → 05/06
OCTAVIA I 1.9 TDI	AGR, AGR	09/96 → 03/10

SKODA			
OCTAVIA I 1.9 TDI 4x4	AGR, AGR	09/00 ⇒	02/06
OCTAVIA I RS 1.8 T	AUQ	05/01 ⇒	01/06
SUPERB I 1.8 T	AWT	12/01 ⇒	03/08
SUPERB I 1.9 TDI	AVB	08/02 ⇒	10/05
SUPERB I 2.5 TDI	AYM	12/01 ⇒	08/03
VOLKSWAGEN (BR)			
GOLF A4 1.9 D	AGR, AGU	01/00 ⇒	
VW			
BORA 1.8 T	AGU, AGR	05/00 ⇒	05/05
BORA 1.9 TDI	AGR, AGR	09/00 ⇒	
BORA 1.9 TDI 4motion	AGR, IZ	09/00 ⇒	
CADDY II 1.9 TDI	IZ, AHF	09/96 ⇒	01/04
GOLF IV 1.8 T	AGU, AGR	08/97 ⇒	06/06
GOLF IV 1.8 T GTI	AUQ	08/01 ⇒	06/05
GOLF IV 1.9 SDI	AGP	08/97 ⇒	06/06
GOLF IV 1.9 TDI	AGR, AGR	02/00 ⇒	06/06
GOLF IV 1.9 TDI 4motion	AGR, AHD	09/00 ⇒	06/06
GOLF 1.9 TDi	AHF, AGU	01/00 ⇒	05/04
LT II 2.5 TDI	AHD, AUH	05/96 ⇒	08/99
LT II 2.8 TDI	AUH, AGU	05/01 ⇒	07/06
LUPPO 1.4 TDI	AMF	01/99 ⇒	07/05
NEW BEETLE 1.8 T	AGU, AZJ	11/01 ⇒	09/10
NEW BEETLE 1.9 TDI	ALH	01/98 ⇒	06/04
NEW BEETLE 2.0	AZJ, AWL	09/02 ⇒	10/10
PASSAT IV 1.8 [CHN]	AWL, AEB	06/01 ⇒	
PASSAT IV 1.8 4motion	AWM	03/01 ⇒	05/05
PASSAT IV 1.8 T	AEB, AWL	10/96 ⇒	08/05
PASSAT IV 1.8 T 20V	AWL, AFN	11/00 ⇒	05/05
PASSAT IV 1.8 T 4motion	AWM	03/01 ⇒	05/05
PASSAT IV 1.9 [CHN]	BPZ	04/08 ⇒	
PASSAT IV 1.9 TDI	AFN, AJM	02/00 ⇒	05/05
PASSAT IV 1.9 TDI 4motion	AJM, AFB	08/99 ⇒	11/00
PASSAT IV 1.9 TDI Syncro/4motion	AFN	10/96 ⇒	11/00
PASSAT IV 2.5 TDI	AFB, AFN	07/98 ⇒	05/05
PASSAT IV 2.5 TDI 4motion	AKN	11/00 ⇒	05/05
PASSAT IV 2.5 TDI Syncro/4motion	AFB	12/98 ⇒	11/00
POLO III 1.4 TDI	AMF	10/99 ⇒	09/01
POLO III 1.9 TDI	AFN, AFN	05/97 ⇒	09/01
POLO III 110 1.9 TDI	AFN, AGR	06/98 ⇒	01/02
POLO III 90 1.9 TDI	AGR, AMF	09/96 ⇒	09/01
POLO IV 1.4 TDI	AMF, ATD	10/01 ⇒	
POLO IV 1.9 TDi	ATD, AJH	10/01 ⇒	
SHARAN I 1.8 T 20V	AJH, IZ	09/97 ⇒	03/10
SHARAN I 1.9 TDI	IZ, ACV	04/00 ⇒	03/10
SHARAN I 1.9 TDI 4motion	AUY	04/00 ⇒	03/10
TRANSPORTER IV 2.5 TDI	ACV, 937A2.000	09/95 ⇒	04/03

10.3013



3

ABSOLUTE PRESSURE SENSORS (MAP)

Adatt./Suitable:

ALFA ROMEO
46468682

BOSCH
0 261 230 029
0 281 002 215

FIAT
46468682

LANCIA
46468682

VOLVO
912546-2



kPa	mV	
15 - 255	304 - 4750	

ALFA ROMEO			
146 1.9 JTD	AR32302	02/99 ⇒	01/01
147 1.9 JTD	937A2.000, 937A2.000	04/01 ⇒	03/10
147 1.9 JTDM	937A2.000, AR32302	10/04 ⇒	03/10
156 1.9 JTD	AR32302, 839A6.000	05/00 ⇒	05/01
156 2.4 JTD	839A6.000, 182A7.000	05/00 ⇒	05/06
166 2.4 JTD	AR34202	09/98 ⇒	10/00
FIAT			
BRAVA 1.9 JTD	182B9.000	09/00 ⇒	10/01
BRAVA 1.9 JTD 105	182B4.000	12/98 ⇒	10/01
BRAVO I 1.9 JTD	182B9.000	09/00 ⇒	10/01
BRAVO I 1.9 JTD 105	182B4.000	12/98 ⇒	10/01
MAREA 1.9 JTD 105	182B4.000	12/98 ⇒	12/02
MAREA 1.9 JTD 110	186A6.000	09/00 ⇒	08/02
MAREA 1.9 TD 100	182A7.000, 182B4.000	09/96 ⇒	06/03
MAREA 2.4 JTD 130	185A6.000	04/99 ⇒	05/02
MARENGO 1.9 JTD	182B4.000, 937A2.000	03/99 ⇒	08/02
MULTIPLA 1.9 JTD 110	186A6.000	03/01 ⇒	07/02
PUNTO II 1.9 JTD 80	188A2.000	09/99 ⇒	03/12
LANCIA			
KAPPA 2.4 JTD	838A8.000	06/98 ⇒	10/01
LYBRA 1.9 JTD	937A2.000, 839A5.000	09/00 ⇒	10/05
LYBRA 2.4 JTD	839A5.000, B5204T3	07/99 ⇒	02/01
VOLVO			
C70 I 2.0 T	B5204T3, B5234T3	03/00 ⇒	10/05
C70 I 2.3 T5	B5234T3, B5244T	07/02 ⇒	10/05
C70 I 2.3 T-5	B5234T3	03/97 ⇒	09/02
C70 I 2.4 T	B5244T, B4194T	03/97 ⇒	10/05
S40 I 1.9 T4	B4194T, B4204T	05/97 ⇒	07/00
S40 I 2.0 T	B4204T, B5234T3	07/00 ⇒	12/03
S40 I 2.0 T4	B4204T5	07/00 ⇒	12/03
S60 I 2.0 T	B5204T5	07/00 ⇒	04/10
S60 I 2.3 T5	B5234T7	07/00 ⇒	09/02
S60 I 2.4 T	B5244T3	07/00 ⇒	04/10
S60 I 2.4 T AWD	B5244T3	06/01 ⇒	04/10
S60 I 2.5 T	B5254T2	01/03 ⇒	04/10
S60 I 2.5 T AWD	B5254T2	07/02 ⇒	04/10
S60 I R 2,5 T AWD	B5254T4	01/03 ⇒	04/10
S60 I T5	B5234T3	07/00 ⇒	04/10
S70 2.0	B5204T4	01/97 ⇒	11/00
S70 2.0 Turbo	B5204T3	01/97 ⇒	11/00
S70 2.3	B5234T3, B5244T	11/96 ⇒	11/00
S70 2.3 AWD	B5234T7	04/99 ⇒	09/00
S70 2.3 T-5	B5234T3	01/97 ⇒	11/00
S70 2.3 T5 AWD	B5234T3	11/96 ⇒	09/98
S70 2.3 Turbo	B5234T4	01/97 ⇒	11/00
S70 2.4 T5 AWD	B5254T	11/96 ⇒	04/99
S70 2.4 Turbo	B5244T, B5204T3	01/97 ⇒	11/00
S80 I 2.0	B5204T4	06/98 ⇒	07/06
S80 I 2.0 T	B5204T3, B4194T	06/98 ⇒	07/06
S80 I 2.3 R	B5234T7	04/00 ⇒	08/05
S80 I 2.4 T	B5244T3	06/00 ⇒	07/06
S80 I 2.4 T5 AWD	B5244T3	04/00 ⇒	09/03
S80 I 2.5 T	B5254T2	03/03 ⇒	07/06
S80 I 2.5 T AWD	B5254T2	07/03 ⇒	07/06
S80 I 2.8 T6	B6284T	05/98 ⇒	07/06
S80 I 3.0 T6	B6294T	06/01 ⇒	07/06
V40 I 1.9 T4	B4194T, B4204T	05/97 ⇒	07/00
V40 I 2.0 T	B4204T, B5234T3	06/01 ⇒	06/04
V40 I 2.0 T4	B4204T5	07/00 ⇒	06/04
V70 I 2.0	B5204T4	01/97 ⇒	12/00
V70 I 2.0 Turbo	B5204T3	11/96 ⇒	12/00
V70 I 2.0 Turbo AWD	B5204T3	11/96 ⇒	12/00
V70 I 2.3	B5234T3	11/96 ⇒	11/00
V70 I 2.3 AWD	B5234T3, B5234T2	04/97 ⇒	09/98
V70 I 2.3 T-5	B5234T2, B5234T2	11/96 ⇒	12/00
V70 I 2.3 T-5 AWD	B5234T2, B5244T	01/97 ⇒	12/00
V70 I 2.4 Turbo	B5244T, B5244T	04/96 ⇒	12/00
V70 I 2.4 Turbo AWD	B5244T, B5244T	04/96 ⇒	12/00
V70 II 2.0 T	B5204T5	11/99 ⇒	08/07
V70 II 2.3	B5234T7	10/00 ⇒	09/04
V70 II 2.3 AWD	B5234T7	10/00 ⇒	09/04
V70 II 2.3 T5	B5234T3	11/99 ⇒	12/04
V70 II 2.4 T	B5244T3	11/99 ⇒	08/03
V70 II 2.4 T AWD	B5244T3	09/01 ⇒	08/02
V70 II 2.5 T	B5254T2	07/01 ⇒	08/07
V70 II 2.5 T AWD	B5254T2	07/02 ⇒	08/07
V70 II R 2,5 T AWD	B5254T4	03/03 ⇒	08/07
XC70 I 2.3 T XC AWD	B5234T7	01/01 ⇒	07/04
XC70 I 2.4 T XC AWD	B5244T, X20DTL	03/00 ⇒	09/02
XC70 I 2.5 T XC AWD	B5254T2	09/02 ⇒	08/07

10.3014



3

ABSOLUTE PRESSURE SENSORS (MAP)

Adatt./Suitable:

BOSCH

0 281 002 137

GENERAL MOTORS
90 541 409

OPEL

62 38 391
62 38 412
90499610
90541409

SCANIA

4773800

VAUXHALL

90499610
90541409



kPa	mV	
15 - 255	304 - 4750	

OPEL

ASTRA F 2.0 Di	X20DTL	03/98 ⇒	08/00
ASTRA G 1.7 TD	X17DTL	02/98 ⇒	04/05
ASTRA G 2.0 DI	X20DTL, X20DTH	02/98 ⇒	04/05
ASTRA G 2.0 DTI	Y20DTH	09/00 ⇒	04/05
ASTRA G 2.0 DTI 16V	X20DTH, X22DTH	08/99 ⇒	01/05
FRONTERA B 2.2 DTI	X22DTH, X20DTH	09/02 ⇒	07/04
OMEGA B 2.0 DTI 16V	X20DTH	09/97 ⇒	09/00
SINTRA 2.2 DTI	X22DTH	07/97 ⇒	04/99
SPEEDSTER 2.0	Z20LET	10/03 ⇒	08/06
VECTRA B 2.0 DI 16V	X20DTL	11/96 ⇒	04/02
VECTRA B 2.0 DTI 16V	X20DTH, X20DTL	06/97 ⇒	07/03
ZAFIRA A 2.0 DI	X20DTL	07/99 ⇒	06/00
ZAFIRA A 2.0 DI 16V	X20DTL	07/99 ⇒	06/05
ZAFIRA A 2.0 DTI 16V	Y20DTH	09/00 ⇒	06/05

VAUXHALL

ASTRA IV 1.7 TD	X17DTL	02/98 ⇒	08/00
ASTRA IV 2.0 DI	X20DTL, X22DTH	02/98 ⇒	05/05
ASTRA IV 2.0 DTI 16V	Y20DTH	02/98 ⇒	05/05
ASTRAVAN II 1.7 TD	X17DTL	08/98 ⇒	08/06
ASTRAVAN II 2.0 DI	X20DTL	08/98 ⇒	08/06
ASTRAVAN II 2.0 DTI	Y20DTH	04/04 ⇒	08/06
FRONTERA B 2.2 DTI	X22DTH, X20DTH	09/00 ⇒	10/04
OMEGA B 2.0 DTI 16V	X20DTH	01/98 ⇒	09/00
SINTRA 2.2 DTI	X22DTH	07/97 ⇒	04/99
SPEEDSTER 2.0 Turbo	Z20LET	03/01 ⇒	09/06
SPEEDSTER VXR20	Z20LET	03/01 ⇒	09/06
VECTRA B 2.0 DI 16V	X20DTL	08/95 ⇒	10/01
VECTRA B 2.0 DTI 16V	X20DTH, NFT(TU5JP)	08/95 ⇒	10/01
ZAFIRA A 2.0 DI 16V	X20DTL	10/99 ⇒	08/05
ZAFIRA A 2.0 DTI 16V	Y20DTH	04/99 ⇒	08/05

10.3015



3,5

ABSOLUTE PRESSURE SENSORS (MAP)

Adatt./Suitable:

AUDI

3A0 906 051

BOSCH

0 261 230 004

0 261 230 008

CITROËN

1920 K8

96 107 893

PEUGEOT

1920 K8

96 107 893

ROLLS-ROYCE

UE75265

SEAT

3A0 906 051

VW

3A0 906 051



kPa	mV	
20 - 105	445 - 4674	

AUDI		
80 IV 1.9 TDI	1Z	09/91 ⇨ 01/96
CITROËN		
SAXO 1.6	NFT(TU5JP), NFZ(TU5JP)	02/01 ⇨ 04/04
SAXO 1.6 VTL_VTR	NFZ(TU5JP), NFZ(TU5JP)	05/96 ⇨ 06/03
SAXO 1.6 VTS	NFT(TU5JP)	09/00 ⇨ 09/03
XANTIA I 1.8 i	LFZ(XU7JP)	03/93 ⇨ 01/98
XM I 2.0 i	RFZ(XU10J2)	05/89 ⇨ 06/94
XSARA 1.6 i	NFZ(TU5JP), NFZ(TU5JP)	04/97 ⇨ 09/00
ZX 1.8	LFZ(XU7JP)	07/94 ⇨ 10/97
ZX 1.8 i	LFZ(XU7JP)	07/92 ⇨ 10/97
PEUGEOT		
106 I 1.6	NFZ(TU5JP)	06/93 ⇨ 04/96
106 II 1.6 i	NFZ(TU5JP), 1Z	05/96 ⇨ 10/99
306 1.6	NFZ(TU5JP)	05/93 ⇨ 10/00
306 1.6 SR	NFZ(TU5JP)	06/94 ⇨ 10/00
SEAT		
CORDOBA I 1.9 TDI	1Z, 1Z	08/96 ⇨ 12/02
IBIZA II 1.9 TDI	1Z, AFN	08/96 ⇨ 12/97
TOLEDO I 1.9 TDI	AFN, 1Z	08/95 ⇨ 03/99
VW		
CADDY II 1.9 TDI	1Z, SCC	09/96 ⇨ 01/04
PASSAT III 1.9 TDI	1Z	10/93 ⇨ 05/97

10.3016



3,5

ABSOLUTE PRESSURE SENSORS (MAP)

Adatt./Suitable:

BOSCH

0 281 002 119

0 281 002 122

CITROËN

1920 3L

DAF

1378484

FORD

1 041 355

V97GB-9F479-AB

HONDA

37830-P5T-G00

MG

MHK100410

ROVER

MHK100410



kPa	mV	
20 - 250	396 - 4610	

CITROËN		
XM II 2.5 TD	THY(DK5ATE)	05/94 ⇨ 10/00
FORD		
SCORPIO II 2.5 TD	SCC, B202I	10/94 ⇨ 08/98
HONDA		
ACCORD V 2.0 TDi	20T2N	04/96 ⇨ 10/98
ACCORD VI 2.0 TDi	20T2N	12/99 ⇨ 10/00
ACCORD VI 2.0 Turbo DI	20T2N	02/99 ⇨ 12/02
CIVIC VI 2.0 i D	20T2N	04/98 ⇨ 02/01
CIVIC VI 2.0 i TD	20T2R	01/97 ⇨ 02/01
CIVIC VI 2.0 TDI	20T2R	05/98 ⇨ 12/00
CIVIC VI 2.0 TDiC	20T2N	11/97 ⇨ 10/00
ROVER		
25 2.0 iDT	20T2N	10/99 ⇨ 05/05
45 2.0 iDT	20T2N	02/00 ⇨ 05/05
200 III 220 D/SD	20T2R	11/95 ⇨ 03/00
200 III 220 Sdi	20T2N	11/95 ⇨ 03/00
400 II 420 Di	20T2N	05/95 ⇨ 03/00
600 620 Sdi	20T2N	05/94 ⇨ 06/99

10.3017



3,5

ABSOLUTE PRESSURE SENSORS (MAP)

Adatt./Suitable:

FORD

1 638 311

MAGNETI MARELLI

215810000900

SAAB

75 38 697

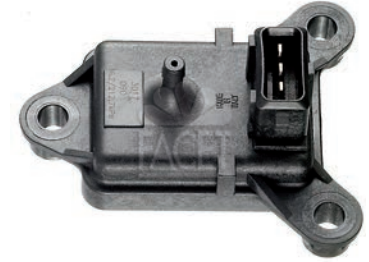

kPa	mV	
20 - 200	340 - 4460	

FORD		
FIESTA III 1.6 Turbo	LHA	03/90 ⇨ 10/92
SAAB		
9000 2.0 -16	B202I, B202	12/85 ⇨ 01/93
9000 2.0 -16 CS	B202I	01/89 ⇨ 12/98
9000 2.0 -16 Turbo	B202, NFW(TU5J2)	09/84 ⇨ 08/93
9000 2.0 -16 Turbo CD	B202XL	09/88 ⇨ 08/93
9000 2.3 -16 CD	B234I	08/89 ⇨ 12/98
9000 2.3 -16 CD Turbo	B234L	07/90 ⇨ 12/98
9000 2.3 -16 CS	B234I	09/89 ⇨ 12/98
9000 2.3 -16 Turbo	B234L	09/90 ⇨ 12/98

10.3020



04

ABSOLUTE PRESSURE SENSORS (MAP)

Adatt./Suitable:

1000 Eliminated on 05-09-2018. Please verify the availability through our local distributors

- Eliminato il 05-09-2018. Verificare la disponibilità presso i nostri distributori
- Éliminé le 05-09-2018. Vérifier la disponibilité auprès de nos distributeurs sur place
- Am 05-09-2018 gestrichen. Evtl. Verfügbarkeit bitte bei unseren Händlern prüfen
- Eliminado en fecha 05-09-2018. Verificar la disponibilidad a través de nuestros distribuidores locales

1006 After depletion of stock this part is replaced by:

- Esaurite le scorte questo pezzo sarà sostituito da:
- Après épuisement du stock, cette pièce est remplacée par:
- Nach Vorraterschöpfung wird ersetzt durch:
- Despues agotamiento stock, sera sustituido por:

10.3355



kPa	mV	
40 - 250	285 - 4500	

10.3021



3,5

ABSOLUTE PRESSURE SENSORS (MAP)

Adatt./Suitable:

CITROËN
1920 P2
MAGNETI MARELLI
230016070077
PRT 03E/04
PEUGEOT
1920 P2



kPa	mV	
17 - 105	250 - 4750	

CITROËN		
XANTIA I 1.6 i	BFZ(XU5JP)	03/93 ⇨ 03/01
XANTIA I 2.0	RFX(XU10J2C/ZL3)	03/93 ⇨ 05/95
XANTIA I 2.0 i	RFX(XU10J2C)	03/93 ⇨ 04/03
XANTIA II 1.6 i SX	BFZ(XU5JP)	01/98 ⇨ 03/01
XANTIA II 2.0 i	RFX(XU10J2C)	01/98 ⇨ 04/03

PEUGEOT		
106 I 1.1	HDZ(TU1M)	09/91 ⇨ 04/96
106 I 1.3	TU2J2	10/93 ⇨ 04/96
106 I 1.6	NFY(TU5J2)	01/94 ⇨ 04/96
106 II 1.6 i	NFW(TU5J2), --	05/96 ⇨ 01/01
306 1.8	--, BFZ(XU5JP)	05/93 ⇨ 04/02
306 1.8 ST	LFZ(XU7JP)	06/94 ⇨ 05/01
406 1.6	BFZ(XU5JP), Z17DTH	11/95 ⇨ 05/04
406 1.8	XU7JP	10/96 ⇨ 03/99

10.3022



3

ABSOLUTE PRESSURE SENSORS (MAP)

Adatt./Suitable:

BOSCH
0 281 002 487
GENERAL MOTORS
97 287 868
HONDA
37830-PLZ-D00
OPEL
62 35 606
97287868
VAUXHALL
97287868

MARKET DIFFUSION: MEDIUM



kPa	mV	
12 - 254,8	250 - 4750	

HONDA		
CIVIC VII 1.7 CTDi	4EE-2	01/02 ⇨ 09/05
OPEL		
ASTRA G 1.7 CDTI	Z17DTL	04/03 ⇨ 12/09
ASTRA H 1.7 CDTi	Z17DTH, Z17DT	03/04 ⇨ 10/10

OPEL		
COMBO C 1.7 CDTI 16V	Z17DTH	07/04 ⇨
CORSA C 1.7 CDTI	Z17DTH	06/03 ⇨ 12/12
MERIVA A 1.7 CDTI	Z17DT, Z17DTH	09/03 ⇨ 05/10
VAUXHALL		
ASTRA IV 1.7 CDTI 16V	Z17DTL	04/03 ⇨ 05/05
ASTRA V 1.7 CDTI	Z17DTH, Z17DTH	01/04 ⇨ 11/10
ASTRAVAN II 1.7 CDTI	Z17DTL	04/04 ⇨ 08/06
ASTRAVAN III 1.7 CDTi	Z17DTH, H4M738	03/05 ⇨ 11/11
COMBO C 1.7 CDTI 16V	Z17DTH	12/04 ⇨ 11/11
CORSA C 1.7 CDTI 16V	Z17DTH	08/00 ⇨ 09/06
MERIVA I 1.7 CDTI	Z17DTH	09/03 ⇨ 06/10

10.3023



1

ABSOLUTE PRESSURE SENSORS (MAP)

Adatt./Suitable:

DACIA
60 01 543 614
82 00 121 800
82 00 719 629
GENERAL MOTORS
93 160 018
93 198 487
LADA
82007-19629
NISSAN
25085-00Q0B
25085-00QAA
82007-19629
OPEL
44 09 668
44 35 200
93160018
93198487
RENAULT
60 01 543 614
77 00 101 762
82 00 105 165
82 00 121 800
82 00 719 629
SIEMENS
5WK 9881
5WK9 681
5WK9 681A
5WK9681Z
SMART
A 281 905 06 00
VAUXHALL
93160018
93198487

MARKET DIFFUSION: HIGH



kPa	mV	
20 - 100	520 - 4780	

DACIA		
DOKKER 1.6	H4M738, H4M740	11/12 ⇨
DOKKER 1.6 LPG	H4M740, K4M642	11/13 ⇨
DUSTER 1.6	K4M642, K4M490	04/10 ⇨
DUSTER 1.6 16V	K4M490, K4M490	04/10 ⇨
DUSTER 1.6 16V 4x4	K4M490, K4M616	06/10 ⇨
DUSTER 1.6 16V Hi-Flex	K4M696	08/10 ⇨
DUSTER 1.6 16V LPG	K4M616, H4M438	04/11 ⇨
DUSTER 1.6 S Ce 115	H4M438, H4M430	06/15 ⇨
DUSTER 1.6 S Ce 115 4x4	H4M430, F4R400	06/15 ⇨
DUSTER 1.6 S Ce 115 LPG	H4M740	06/15 ⇨
DUSTER 2.0	F4R400, H4M738	04/10 ⇨
LODGY 1.6	H4M738, H4M740	03/12 ⇨
LODGY 1.6 LPG	H4M740, H4M738	11/13 ⇨
LODGY 1.6 S Ce 115	H4M738, K7J710	06/15 ⇨
LOGAN 1.6	K7M812	06/13 ⇨ 08/16
LOGAN 1.6 Hi-Flex	K7M714	01/11 ⇨ 10/12
LOGAN I 1.0	D4D760	12/05 ⇨
LOGAN I 1.0 Hi-Flex	D4D760	01/11 ⇨ 10/12
LOGAN I 1.2 16V	D4F732	02/06 ⇨
LOGAN I 1.2 16V LPG	D4F734	02/06 ⇨
LOGAN I 1.4	K7J710	09/04 ⇨
LOGAN I 1.4 MPI LPG	K7J710, K7M710	02/06 ⇨
LOGAN I 1.6	K7M710, K4M690	09/04 ⇨
LOGAN I 1.6 16V	K4M690, K4M690	12/05 ⇨
LOGAN I 1.6 16V Flexifuel	K4M696	07/10 ⇨
LOGAN I 1.6 16V Hi-Flex	K4M690, K7M710	11/09 ⇨

DACIA			
LOGAN I 1.6 BiFuel	K7M710, D4F732	11/08	⇒
LOGAN I 1.6 LPG	K7M718	08/04	⇒ 12/12
LOGAN I 1.6 MPI 85	K7M800	05/10	⇒
LOGAN II 1.0	D4D754	10/12	⇒
LOGAN II 1.2	D4F732, D4F732	10/12	⇒
LOGAN II 1.2 LPG	D4F732, K4M842	10/12	⇒
LOGAN II 1.6 16V	K4M842, F4R412	10/12	⇒
LOGAN II 2.0	F4R412, D4F732	10/12	⇒
LOGAN II MCV 1.2	D4F732, D4F732	02/13	⇒
LOGAN II MCV 1.2 LPG	D4F732, D4F732	02/13	⇒
LOGAN II MCV 1.6	K7M812	06/13	⇒
SANDERO I 1.0 Hi-Flex	D4D760	01/11	⇒ 12/12
SANDERO I 1.2 16V	D4F732	11/08	⇒
SANDERO I 1.2 16V LPG	D4F732, K7M710	11/08	⇒
SANDERO I 1.4	K7J710	06/08	⇒
SANDERO I 1.4 MPI LPG	K7J714	01/09	⇒
SANDERO I 1.6	K7M710, K4M690	06/08	⇒
SANDERO I 1.6 16V	K4M690, K4M690	07/11	⇒
SANDERO I 1.6 16V BiFuel	K4M690, K7M718	01/11	⇒
SANDERO I 1.6 Hi-Flex	K7M732	06/08	⇒ 12/12
SANDERO I 1.6 LPG	K7M718, D4F732	06/08	⇒ 12/12
SANDERO I 1.6 MPI 85	K7M800	05/10	⇒
SANDERO II 1.0	D4D754	10/12	⇒
SANDERO II 1.2	D4F732, D4F732	10/12	⇒
SANDERO II 1.2 LPG	D4F732, K4M842	10/12	⇒
SANDERO II 1.6	K7M812	11/12	⇒
SANDERO II 1.6 16V	K4M842, 11189	01/13	⇒
SANDERO II 1.6 I	K7M764	10/12	⇒
SANDERO II 2.0	F4R416	10/12	⇒
SANDERO II 2.0 LPG	F4R412	10/12	⇒
SOLENZA 1.4	E7J262	02/03	⇒

LADA

LARGUS 1.6	11189, K4M490	03/12	⇒
------------	---------------	-------	---

NISSAN

ALMERA III 1.6	K4M	11/12	⇒
BLUEBIRD SYLPHY 1.6	K4M490, D7F726	12/12	⇒
KUBISTAR 1.2	D7F726, D4F712	08/03	⇒
KUBISTAR 1.2 16V	D4F712, K7J700	04/06	⇒
KUBISTAR 1.2 LPG	D7F764	10/03	⇒ 08/05
KUBISTAR 1.4	K7J700, K4M750	08/03	⇒ 10/09
KUBISTAR 1.6 16V	K4M750, F4R720	08/03	⇒
PRIMASTAR 2.0	F4R720, H4M	03/01	⇒
TERRANO III 1.6	H4M, H4M	09/13	⇒
TERRANO III 1.6 4x4	H4M, F4R	03/14	⇒
TERRANO III 2.0	F4R	09/13	⇒
TERRANO III 2.0 4x4	F4R, D4F728	03/14	⇒

OPEL

VIVARO A 2.0 16V	F4R720	08/01	⇒
VIVARO A 2.0 ECOTEC	F4R820	08/06	⇒

RENAULT

CLIO 1.2	D4F728, K4M734	08/98	⇒
CLIO 1.2 BiFuel	D7F722	03/98	⇒ 10/01
CLIO 1.2 Hi-Flex	D4F742	11/07	⇒ 12/09
CLIO 1.4	K7J700	08/00	⇒ 02/09
CLIO 1.6	K4M734, M4R700	07/00	⇒ 02/10
CLIO 1.6 [ExtraEU]	K4M708	03/99	⇒ 12/08
CLIO 2.0	M4R700, D7F710	11/07	⇒ 12/12
CLIO II 1.0	D7D760	02/00	⇒ 05/01
CLIO II 1.0 16V	D4D700	01/01	⇒
CLIO II 1.2	D7F710, D4F706	03/98	⇒
CLIO II 1.2 16V	D4F706, D7F722	06/01	⇒
CLIO II 1.2 LPG	D7F722, E7J634	09/98	⇒ 06/09
CLIO II 1.4	E7J634, K4J700	09/98	⇒
CLIO II 1.4 16V	K4J700, K4M746	02/00	⇒
CLIO II 1.6	K4M746, K4M708	09/98	⇒
CLIO II 1.6 16V	K4M708, F4R730	09/98	⇒
CLIO II 1.6 Hi-Flex	K4M748	01/05	⇒ 02/10
CLIO II 1.6i	K4M736	11/04	⇒
CLIO II 2.0 16V	F4R732	06/01	⇒
CLIO II 2.0 16V Sport	F4R730, D4F706	02/00	⇒
CLIO III 1.2	D4F740	10/05	⇒
CLIO III 1.2 16V	D4F706, D4F740	06/05	⇒
CLIO III 1.2 16V Hi-Flex	D4F740, K4M800	07/08	⇒
CLIO III 1.2 Ethanol	D4F742	07/08	⇒
CLIO III 1.4 16V	K4J780	06/05	⇒
CLIO III 1.6 16V	K4M800, M4R700	06/05	⇒
CLIO III 1.6 16V GT	K4M862	06/09	⇒
CLIO III 2.0 16V	M4R700, --	09/06	⇒
CLIO III 2.0 16V Sport	--, D4F740	02/06	⇒
CLIO IV 1.2 16V	D4F740, H4M438	11/12	⇒
CLIO IV 1.2 16V LPG	D4F744	01/14	⇒
CLIO IV 1.2 LPG	D4F744	01/14	⇒
CLIO IV 1.2 LPG 16V	D4F744	11/12	⇒ 06/15
DOKKER 1.6	K7M812	12/13	⇒
DUSTER 1.6 16V	H4M438, H4M430	02/12	⇒
DUSTER 1.6 16V 4x4	H4M430, F4R403	06/11	⇒
DUSTER 2.0	F4R403, F4R410	02/12	⇒
DUSTER 2.0 [ExtraEU]	F4R410, F4R400	10/11	⇒

RENAULT			
DUSTER 2.0 4x4	F4R400, F4R700	02/12	⇒
ESPACE III 2.0	F4R700, F4R700	09/01	⇒ 10/02
ESPACE III 2.0 16V	F4R700, F4R790	10/98	⇒ 10/02
ESPACE IV 2.0	F4R790, V4Y711	11/02	⇒
ESPACE IV 3.5 V6	V4Y711, H4M729	11/02	⇒
FLUENCE 1.6	H4M729, K4M838	01/13	⇒
FLUENCE 1.6 16V	K4M838, M4R714	02/10	⇒
FLUENCE 1.6 LPG 16V	K4M839	01/12	⇒
FLUENCE 2.0 [ExtraEU]	M4R711, M4R714	01/10	⇒
FLUENCE 2.0 16V	M4R714, M4R714	02/10	⇒
FLUENCE 2.0 Hi-Flex [ExtraEU]	M4R714, K4M761	02/10	⇒ 11/18
GRAND SCÉNIC II 1.6	K4M761, F4R770	04/04	⇒
GRAND SCÉNIC II 1.6 Flex	K4M766	06/06	⇒ 11/08
GRAND SCÉNIC II 2.0	F4R770, K4M866	04/04	⇒
GRAND SCÉNIC III 1.6 16V	K4M858	02/09	⇒
GRAND SCÉNIC III 1.6 16V BiFuel	K4M866, M4R711	02/09	⇒
GRAND SCÉNIC III 1.6 E85	K4M866	02/09	⇒
GRAND SCÉNIC III 2.0 16V	M4R711, D7D700	02/09	⇒
KANGOO 1.0	D7D700, D4D700	07/01	⇒ 06/03
KANGOO 1.0 [ExtraEU]	D4D700, D4F712	01/02	⇒ 01/07
KANGOO 1.2	D4F712, D7F710	07/01	⇒ 10/03
KANGOO 1.2 BiFuel	D7F710, K4M708	06/97	⇒ 06/03
KANGOO 1.6	K4M836	02/12	⇒
KANGOO 1.6 [ExtraEU]	K4M708, K4M830CNG	06/01	⇒ 03/09
KANGOO 1.6 BiFuel	K4M750	06/05	⇒ 06/08
KANGOO 1.6 CNG	K4M830CNG, K4M834	10/07	⇒
KANGOO 1.6 Hi-Flex	K4M834	02/12	⇒
KANGOO 1.6 Hi-Flex [ExtraEU]	K4M850	03/07	⇒
KANGOO 1.6 LPG	K4M834, D4D700	02/12	⇒
KANGOO I 1.0	D4D700, D4D700	09/98	⇒
KANGOO I 1.0 16V	D4D700, D7F710	03/98	⇒
KANGOO I 1.2	D7F710, D4F712	08/97	⇒
KANGOO I 1.2 16V	D4F712, E7J634	06/01	⇒
KANGOO I 1.4	E7J634, K4M730	08/97	⇒
KANGOO I 1.6	K4M730, K4M708	09/01	⇒
KANGOO I 1.6 16V	K4M708, K4M708	06/01	⇒
KANGOO I 1.6 16V 4x4	K4M708, K4M830	02/01	⇒
KANGOO I 1.6 16V bivalent	K4M850CNG	06/05	⇒
KANGOO II 1.6	K4M830, K4M830	02/08	⇒
KANGOO II 1.2 16V	K4M830, K4M834	02/08	⇒
KANGOO II 1.6 16V Flex	K4M834	02/08	⇒
KANGOO II 1.6 16V Hi-Flex	K4M834	02/08	⇒
KANGOO II 1.6 16V LPG	K4M834, H4M429	12/08	⇒
KAPTUR 1.6	H4M429, K4M710	03/16	⇒
KAPTUR 2.0 4WD	F4R410	03/16	⇒
LAGUNA 1.1 16V	K4M720	11/97	⇒ 03/01
LAGUNA 1.1 8V	F4P760	04/98	⇒ 03/01
LAGUNA 1.2 0	F4R780	09/99	⇒ 02/01
LAGUNA 1.2 0 16V	F4R780	09/99	⇒ 03/01
LAGUNA II 1.6	K4M710	03/01	⇒ 10/05
LAGUNA II 1.6 16V	K4M710, F4P770	03/01	⇒ 12/07
LAGUNA II 1.6 BiFuel	K4M714	06/05	⇒ 12/07
LAGUNA II 1.6 LPG	K4M714	03/01	⇒ 05/05
LAGUNA II 1.8 16V	F4P770, F4R712	03/01	⇒
LAGUNA II 2.0 16V	F4R712, F5R700	08/02	⇒ 12/07
LAGUNA II 2.0 16V IDE	F5R700, M4R704	04/01	⇒ 09/07
LAGUNA III 1.6 16V	K4M824	10/07	⇒ 12/15
LAGUNA III 2.0 16V	M4R704	10/07	⇒ 12/15
LAGUNA III 2.0 16V Hi-Flex	M4R704, M4R735	10/07	⇒ 12/15
LATITUDE 2.0 16V	M4R735, K7M812	02/11	⇒
LATITUDE 2.0 16V eco2 Flexfuel	M4R746	02/11	⇒
LODGY 1.6	K7M812, D4F732	07/13	⇒
LOGAN 1.0	D4D760	12/05	⇒
LOGAN 1.2 16V	D4F732, D4F732	02/06	⇒
LOGAN 1.2 16V LPG	D4F732, K4M690	12/13	⇒
LOGAN 1.4	K7J710	09/04	⇒
LOGAN 1.4 LPG	K7J714	02/08	⇒ 10/13
LOGAN 1.6	K4M690, D4F732	09/04	⇒
LOGAN 1.6 16V	K4M694	12/05	⇒
LOGAN 1.6 MPI 85	K7M800	05/10	⇒
LOGAN EXPRESS 1.6	K7M710	04/07	⇒
LOGAN/STEPWAY 1.2	D4F732, D4F732	11/13	⇒
LOGAN/STEPWAY 1.2 16V LPG	D4F732, H4M429	11/13	⇒
LOGAN/STEPWAY 1.6	H4M429, K4J714	11/13	⇒
MEGANE II 1.4	K4J730, K4J730	08/03	⇒
MEGANE II 1.4 16V	K4J730, K4M760	11/02	⇒ 02/08
MEGANE II 1.6	K4M760, K4M760	08/03	⇒
MEGANE II 1.6 16V	K4M760, F4R770	11/02	⇒
MEGANE II 1.6 16V Hi-Flex	K4M856	02/08	⇒ 07/09
MEGANE II 1.6 BiFuel	K4M788	06/05	⇒ 02/08
MEGANE II 1.6 Flex-Fuel	K4M856	01/07	⇒ 02/08
MEGANE II 1.6 LPG 16V	K4M760	01/06	⇒ 08/09
MEGANE II 2.0	F4R770, F4R770	08/03	⇒

RENAULT			
MEGANE II 2.0 16V	F4R770, K4M848	11/02	⇒ 02/08
MEGANE 1.4	K4J714, K4M700	04/01	⇒ 07/03
MEGANE 1.6	K4M700, K4M704	04/01	⇒ 07/03
MEGANE 1.6 BiFuel	K4M704, F4R740	04/01	⇒ 08/15
MEGANE 1.6 VVT	K4M858	01/13	⇒ 08/15
MEGANE 1.8	F4P722	04/01	⇒ 07/03
MEGANE 2.0	F4R740, M4R711	08/95	⇒ 02/99
MEGANE I 1.4 16V	K4J700, E7J626	03/99	⇒ 08/03
MEGANE I 1.4 e	E7J626, K4M700	01/96	⇒ 08/03
MEGANE I 1.6	K7M704	02/00	⇒ 09/00
MEGANE I 1.6 16V	K4M700, K4M704	05/00	⇒
MEGANE I 1.6 BiFuel	K4M712	03/99	⇒ 09/00
MEGANE I 1.6 LPG	K4M704, F4P260	10/00	⇒ 08/02
MEGANE I 1.8 16V	F4P260, F4R700	07/00	⇒ 08/03
MEGANE I 2.0 16V	F4R700, F4R746	05/00	⇒
MEGANE I 2.0 16V IDE	F4R746, F4R740	11/99	⇒ 08/03
MEGANE I 2.0 RT	F4R740, K4J730	03/01	⇒ 08/03
MEGANE III 1.6 16V	K4M848, M4R710	11/08	⇒
MEGANE III 1.6 16V BiFuel	K4M866	11/08	⇒
MEGANE III 1.6 BiFuel	K4M866	11/08	⇒
MEGANE III 2.0	M4R710, M4R711	01/11	⇒
MEGANE III 2.0 CVT	M4R711, H4M738	02/09	⇒
MEGANE IV 1.6 16V	H4M738, H4M738	11/15	⇒
MEGANE IV 1.6 ScE	H4M738, K4M700	10/16	⇒
MEGANE CC 1.6 16V	K4M858	06/10	⇒
MEGANE CC 1.6 16V Hi-Flex	K4M866	06/10	⇒
MEGANE CC 2.0 CVT	M4R711, K4J700	06/10	⇒
MEGANE SCÉNIC I 1.6 16V	K4M700, D4F740	04/98	⇒ 10/99
MODUS 1.4	K4J770, K4M697	04/06	⇒ 12/13
MODUS / GRAND MODUS 1.2	D4F740, D4F740	12/04	⇒
MODUS / GRAND MODUS 1.2 16V Hi-Flex	D4F740, K4J770	10/08	⇒
MODUS / GRAND MODUS 1.2 GPL	D4F744	05/08	⇒ 12/12
MODUS / GRAND MODUS 1.4	K4J770, K4M790	12/04	⇒
MODUS / GRAND MODUS 1.6	K4M790, K4J770	12/04	⇒
SANDERO I 1.2 16V	D4F732	11/08	⇒
SANDERO I 1.4	K7J710	02/09	⇒
SANDERO I 1.4 LPG	K7J714	02/09	⇒
SANDERO I 1.6	K4M697, D4F732	12/07	⇒
SANDERO I 1.6 MPI 85	K7M800	05/10	⇒
SANDERO II 1.2 16V	D4F732, H4M438	12/13	⇒
SANDERO II 1.2 16V LPG	D4F734	12/13	⇒
SANDERO II 1.6	H4M438, K4M842	11/13	⇒
SANDERO II 1.6 16V	K4M842, K4M812	04/14	⇒
SCÉNIC I 1.4 16V	K4J714, K4M700	09/99	⇒ 08/03
SCÉNIC I 1.6	K4M700, K4M704	03/01	⇒ 09/03
SCÉNIC I 1.6 16V	K4M712	05/00	⇒ 08/03
SCÉNIC I 1.6 BiFuel	K4M704, F4P720	03/01	⇒ 08/03
SCÉNIC I 1.8 16V	F4P720, F4R740	01/01	⇒ 08/03
SCÉNIC I 1.8 4x4	F4P722	07/00	⇒ 04/01
SCÉNIC I 2.0 16V	F4R740, F4R744	07/00	⇒ 08/03
SCÉNIC I 2.0 16V RX4	F4R744, K4J730	06/00	⇒ 08/03
SCÉNIC II 1.4	K4J730, K4M761	06/03	⇒
SCÉNIC II 1.6	K4M761, K4M764	06/03	⇒
SCÉNIC II 1.6 16V	K4M764, F4R770	05/03	⇒
SCÉNIC II 1.6 BiFuel	K4M764	08/03	⇒ 05/06
SCÉNIC II 1.6 Hi-Flex	K4M766	03/05	⇒ 07/10
SCÉNIC II 2.0	F4R770, K4M866	06/03	⇒
SCÉNIC III 1.6 16V	K4M858	02/09	⇒
SCÉNIC III 1.6 16V BiFuel	K4M866, M4R711	02/09	⇒
SCÉNIC III 1.6 E85	K4M866	02/09	⇒
SCÉNIC III 2.0 16V	M4R711, K4M744		

RENAULT		
TWINGO III 1.0 SCe 70	H4D400, V4Y701	09/14 →
VEL SATIS 3.5	V4Y715	10/04 →
VEL SATIS 3.5 V6	V4Y701, M281.920	06/02 →
WIND 1.6	K4M854	07/10 →
SMART		
FORFOUR III 1.0	M281.920, M281.920	07/14 →
FORTWO III 1.0	M281.920, K20A6	07/14 →
VAUXHALL		
VIVARO 2.0 16V	F4R720	04/03 → 07/14
VIVARO 2.0 ECOTEC	F4R820	08/06 → 07/14

10.3024



3

ABSOLUTE PRESSURE SENSORS (MAP)

Adatt./Suitable:

GENERAL MOTORS

16 235 939
97 180 655
98 131 026

OPEL

12 47 049
62 38 166
97 180 655
98 131 026

VAUXHALL

97 180 655
98 131 026



kPa	mV	
20 - 200	287 - 4805	

OPEL

ASTRA G 1.7 DTI 16V	Y17DT	02/00 → 01/05
COMBO C 1.7 DI 16V	Y17DTL	10/01 →
COMBO C 1.7 DTI 16V	Y17DT	10/01 →
CORSA C 1.7 DI	Y17DTL	09/00 → 12/09
CORSA C 1.7 DI 16V	Y17DTL	09/00 → 07/03
CORSA C 1.7 DTI	Y17DT	09/00 →
CORSA C 1.7 DTI 16V	Y17DT	09/00 → 07/03

VAUXHALL

ASTRA IV 1.7 DTI 16V	Y17DT	02/00 → 05/05
ASTRAVAN II 1.7 DTI 16V	Y17DT	04/01 → 08/06
COMBO C 1.7 DI 16V	Y17DTL	09/01 → 11/11
COMBO C 1.7 DTI 16V	Y17DT	10/01 → 02/12
CORSA C 1.7 DI 16V	Y17DTL	08/00 → 09/06
CORSA C 1.7 DTI 16V	Y17DT	08/00 → 09/06
CORSAVAN II 1.7 DI 16V	Y17DTL	09/00 → 06/06
CORSAVAN II 1.7 DTI 16V	Y17DT	09/00 → 06/06

10.3026



1

ABSOLUTE PRESSURE SENSORS (MAP)

Adatt./Suitable:

DENSO

079800-5410
079800-7240

HONDA

37830-PGK-A01
37830-PNC-003

MARKET DIFFUSION: MEDIUM



kPa	mV	
10 - 169	405 - 4750	

HONDA

ACCORD VII 2.0	K20A6, K24A	02/03 → 08/08
ACCORD VII 2.0 Trazione integrale	K20A6	02/03 → 05/08
ACCORD VII 2.4	K24A, L12A2	02/03 → 05/08
CITY 1.2	L12A2, L15A1	05/03 →
CITY 1.3	L13A3	10/05 → 07/08
CITY 1.5 FF	L15A1, D14Z5	09/04 → 07/08
CITY 1.5 i-DSI	L15A2	11/02 →
CIVIC 1.5 [ExtraEU]	D15Y3	02/03 → 09/05
CIVIC VII 1.3 IMA	LDA1	10/03 → 09/05
CIVIC VII 1.4	D14Z5	12/00 → 09/05
CIVIC VII 1.4 i	D14Z6	02/01 → 09/05
CIVIC VII 1.4 iS	D14Z5, D15Y2	02/01 → 09/05
CIVIC VII 1.4i 16V	D14Z6	02/01 →
CIVIC VII 1.5 i 16V	D15Y2, D16V1	01/01 →
CIVIC VII 1.6	D16V1, D16V1	02/01 → 09/05
CIVIC VII 1.6 i	D16V1, D17A5	02/01 → 12/05
CIVIC VII 1.6i 16V	D16W7	04/01 →
CIVIC VII 1.6i 16V Vtec	D16V3	04/01 →
CIVIC VII 1.7	D17A6	01/00 → 09/05
CIVIC VII 1.7 i	D17A8	05/01 → 12/05
CIVIC VII 1.7 i 16V VTi	D17A5, D17A5	02/01 →
CIVIC VII 1.7 i VTEC	D17A5, LDA2	05/01 → 12/05
CIVIC VII 2.0	K20A3	10/03 → 09/05
CIVIC VII 2.0 i Sport	K20A3	09/01 → 09/05
CIVIC VII 2.0 Type-R	K20A2	09/01 → 09/05
CIVIC VIII 1.3 Hybrid	LDA2, K20A4	01/06 →
CIVIC VIII 1.4	L13A7	09/05 →
CR-V II 2.0	K20A4, L12A1	09/01 → 03/07
CR-V II 2.4 Vtec 4WD	K24A1	09/01 → 09/06
FR-V 1.7	D17A2	08/04 →
FR-V 2.0	K20A9	02/05 →
JAZZ I 1.2 i-DSI	L12A1, L13A1	03/02 → 07/08
JAZZ I 1.3	L13A1, L13A1	03/02 → 07/08
JAZZ I 1.4	L13A5	04/05 → 07/08
JAZZ I 1.4 iDSI	L13A1, L13Z1	12/06 → 10/08
JAZZ I 1.5	L15A	04/02 → 07/08
JAZZ I 1.5 FF	L15A1	03/02 → 09/07
JAZZ II 1.4	L13A6	01/06 →
JAZZ III 1.3 i	L13Z1, J35A4	07/08 →
LEGEND 3.7 Vtec [ExtraEU]	J37A3	08/08 → 12/12
LEGEND IV 3.5 i	J35A8	10/04 →
LEGEND IV 3.5 V6 4WD	J35A8	05/06 → 12/12
LEGEND IV 3.5 VTEC V6	C35A8	10/04 → 06/09
MR-V 3.5	J35A4, J35A4	01/03 →
ODYSSEY 3.5	J35A4, 256T(BMW)	01/02 →
STREAM 1.7 16V	D17A2	05/01 →
STREAM 2.0 16V	K20A1	05/01 →

10.3029



3

ABSOLUTE PRESSURE SENSORS (MAP)

Adatt./Suitable:

BMW

13 62 2 244 674
2 244 674

DENSO

079800-3260

GENERAL MOTORS

90 467 558

LAND ROVER

ERR3561

OPEL

62 38 332

VOLVO

127517-0

VW

046 130 385 A



kPa	mV	
26 - 250	270 - 4750	

BMW

5 IV 525 tds	M51D25(256T1)	01/96 → 05/04
7 III 725 tds	M51D25(256T1)	04/96 → 11/01

LAND ROVER

RANGE ROVER II 2.5 D 4x4	256T(BMW), 25DT	07/94 → 03/02
--------------------------	-----------------	---------------

OPEL

OMEGA B 2.5 TD	25DT, 25DT	04/94 → 07/03
----------------	------------	---------------

VAUXHALL

OMEGA B 2.5 TD	25DT, DW10	04/94 → 07/01
----------------	------------	---------------

VOLVO

850 2.5 TDI	D5252T	08/95 → 12/96
S70 2.5 TDI	D5252T	01/97 → 11/00
S70 2.5 TDi AWD	D5252T	10/99 → 09/00
S80 I 2.5 TDI	D5252T	01/99 → 07/06
V70 I 2.5 TDI	D5252T	12/95 → 12/00
V70 I 2.5 TDi AWD	D5252T	11/96 → 02/00
V70 II 2.5 TDI	D5252T	11/99 → 08/07

10.3030



3

ABSOLUTE PRESSURE SENSORS (MAP)

Adatt./Suitable:

CITROËN1920 7T
96 317 166 80**DENSO**079800-4480
079800-5780**FIAT**

9631716680

LANCIA

9631716680

PEUGEOT

1920 7T

SUZUKI

18590-67G00-000

MARKET DIFFUSION: MEDIUM



kPa	mV	+	-	0
10 - 250	944 - 4750			

CITROËN

C5 I 2.0 HDi	DW10, 4HX(DW12TED4/FAP)	03/01 ⇒ 08/04
C5 I 2.2 HDi	4HX(DW12TED4/FAP), DW10ATED4	03/01 ⇒ 08/04
C8 2.0 HDi	DW10ATED4, 4HW(DW12TED4)	07/02 ⇒
C8 2.2 HDi	4HW(DW12TED4), DW10ATED	07/02 ⇒
EVASION 2.0 HDi	DW10ATED, DW10ATED4	08/99 ⇒ 07/02
EVASION 2.0 HDi 16V	DW10ATED4, DW10ATED	09/99 ⇒ 07/02
JUMPY I 2.0 HDi 110	DW10ATED, DW10BTED	03/00 ⇒ 10/06
JUMPY I 2.0 HDi 110 16V	RHW(DW10ATED4)	12/03 ⇒ 10/06
JUMPY I 2.0 HDi 95	DW10BTED, RHX	10/99 ⇒ 10/06
XANTIA I 2.0 HDi 109	RHZ(DW10ATED)	02/99 ⇒ 04/03
XANTIA I 2.0 HDi 90	RHY(DW10TD)	03/99 ⇒ 04/03

FIAT

SCUDO I 2.0 JTD	RHX, RHK(DW10UTED4)	10/99 ⇒ 12/06
SCUDO I 2.0 JTD 16V	RHK(DW10UTED4), RHW	05/99 ⇒ 12/06
ULYSSE I 2.0 JTD	RHZ	10/99 ⇒ 08/02
ULYSSE I 2.0 JTD 16V	RHW(DW10ATED4)	05/99 ⇒ 08/02
ULYSSE II 2.0 JTD	RHW(DW10ATED4)	08/02 ⇒ 08/06
ULYSSE II 2.2 JTD	4HW(DW12ATED4)	08/02 ⇒ 08/06

LANCIA

PHEDRA 2.0 JTD	RHW, 4HP	09/02 ⇒ 11/10
PHEDRA 2.2 JTD	4HP, RHZ	09/02 ⇒ 11/10
ZETA 2.0 JTD	RHZ, RHW	04/00 ⇒ 09/02
ZETA 2.0 JTD 16V	RHW, DW10ATED	04/01 ⇒ 10/03

PEUGEOT

406 2.0 HDi 110	DW10ATED, 4HX(DW12TED4/FAP)	08/01 ⇒ 10/04
406 2.2 HDi	4HX(DW12TED4/FAP), DW10ATED	03/00 ⇒ 12/04
607 2.0 HDi	DW10ATED, 4HX(DW12TED4/FAP)	05/00 ⇒ 09/05
607 2.2 HDi	4HX(DW12TED4/FAP), DW10ATED	02/00 ⇒ 02/06
806 2.0 HDi	DW10ATED, DW10ATED4	08/99 ⇒ 08/02
806 2.0 HDi 16V	DW10ATED4, DW10ATED4	08/99 ⇒ 08/02
807 2.0 HDi	DW10ATED4, 4HX(DW12TED4/FAP)	06/02 ⇒
807 2.2 HDi	4HX(DW12TED4/FAP), DW10ATED4	06/02 ⇒
EXPERT I 2.0 HDi	DW10ATED4, DW10ATED4	07/00 ⇒ 12/06
EXPERT I 2.0 HDi 16V	DW10ATED4, C35A2	07/00 ⇒ 12/06

SUZUKI

GRAND VITARA I 2.0 HDi 110 16V 4x4	RHW	07/01 ⇒ 09/05
GRAND VITARA I 2.0 HDi 110 4x4	RHZ	07/01 ⇒ 09/05
GRAND VITARA I 2.0 TD 4x4	RFM	04/00 ⇒ 09/05

10.3031



3

ABSOLUTE PRESSURE SENSORS (MAP)

Adatt./Suitable:

ACURA

37830-P13-003

DENSO079800-2990
079800-4960**HONDA**37830-P13-003
37830-PHM-003

kPa	mV	+	-	0
10 - 169	403 - 4750			

ACURA

NSX 3.2	C32B2	08/97 ⇒ 12/05
NSX R 3.0	C30A4	01/92 ⇒ 08/97
NSX T 3.0	C30A4	01/95 ⇒ 12/97
VIGOR 3.2	C32A7	01/96 ⇒

HONDA

ACCORD V 1.8 16V	F18A3	01/94 ⇒ 12/95
ACCORD V 1.9 i	F18A3	02/96 ⇒ 10/98
ACCORD V 2.0 i	F20Z2	03/93 ⇒ 01/96
ACCORD V 2.0 i LS	F20Z1	02/96 ⇒ 10/98
ACCORD V 2.0 i S	F20Z1	03/93 ⇒ 01/96
ACCORD V 2.2 16V	F22Z1	01/96 ⇒ 09/98
ACCORD V 2.3 i SR	H23A3	03/93 ⇒ 01/96
CIVIC V 1.5 i 16V	D15B2	10/91 ⇒ 11/95
INSIGHT 1.0 Hybrid	ECA1	04/00 ⇒ 12/06
INSIGHT 1.0 Vtec	ECA1	04/00 ⇒ 10/04
LEGEND III 3.5 i 24V	C35A2, F22B1	02/96 ⇒ 10/97
NSX 3.0 24V Vtec Automatic	C30A4	03/95 ⇒ 09/05
NSX 3.0 24V Vtec Automatic	C30A4	06/90 ⇒ 09/05
NSX 3.2 24V Vtec	C32B2	01/97 ⇒ 09/05
PRELUDE IV 2.0 i 16V	F20A4	02/92 ⇒ 09/96
PRELUDE IV 2.2 i 16V Vtec	H22A2	02/93 ⇒ 09/96
PRELUDE IV 2.3 i 16V	H23A2	02/92 ⇒ 09/96

10.3032



3

ABSOLUTE PRESSURE SENSORS (MAP)

Adatt./Suitable:

DENSO079800-3000
079800-4250**HONDA**37830-P05-A01
37830-P0G-S00
37830-P7A-N11
37830-PAA-S00**ROVER**

MHK100590



kPa	mV	+	-	0
10 - 169	403 - 4750			

HONDA

ACCORD V 2.0	F20B3	09/93 ⇒ 12/97
ACCORD V 2.0 i LS 16V	F20B3	09/93 ⇒ 02/98
ACCORD V 2.2	F22B1, F18B2	10/93 ⇒ 12/97
ACCORD V 2.2 i 16V	F22B4	08/95 ⇒ 12/97
ACCORD V 2.2 i ES	F22B5	09/93 ⇒ 02/98
ACCORD V 2.2 i VTEC	F22Z2	02/96 ⇒ 10/98
ACCORD VI 1.8 16V Vtec	F18B2, F18B2	04/99 ⇒
ACCORD VI 1.8 i	F18B2, F20B5	10/98 ⇒ 12/02
ACCORD VI 1.8 i 16V Vtec	F18B4	11/98 ⇒ 12/99
ACCORD VI 2.0	F20B6	11/99 ⇒ 12/02
ACCORD VI 2.0 16V Vtec	F20B6	04/99 ⇒
ACCORD VI 2.0 i	F20B6	10/98 ⇒ 01/01
ACCORD VI 2.0 i 16V	F20B5, B16A6	02/98 ⇒ 06/03
ACCORD VI 2.2 Type-R	H22A7	02/99 ⇒ 12/02
ACCORD VI 2.3	F23Z5	11/00 ⇒ 06/03
ACCORD VI 2.3 i 16V Vtec	F23Z5	11/00 ⇒
ACCORD VI 2.3 VTi	F23A3	02/98 ⇒ 10/02
ACCORD VI 3.0 V6 24V	J30A1	02/98 ⇒ 06/03
ACCORD VI 3.0 Vtec	J30A1	03/97 ⇒ 12/03
BALLADE 1.5	D15Z4	01/97 ⇒
BALLADE 1.6i	B16A6, D16Z6	01/96 ⇒ 02/01
BALLADE 1.8 i	B18B4	01/96 ⇒ 02/01
CIVIC 1.4 BiFuel	D14A8	04/98 ⇒ 02/01
CIVIC 1.6 [ExtraEU]	D16Y2	11/95 ⇒ 12/96
CIVIC V 1.5	D15B7	08/93 ⇒ 12/95
CIVIC V 1.5 i 16V	D15Z1	10/91 ⇒ 11/95
CIVIC V 1.5 i LSi	D15B7	08/93 ⇒ 11/95
CIVIC V 1.6 16V Vtec	D16Z6, B16A2	10/91 ⇒ 11/95
CIVIC V 1.6 4x4	D16Z7	01/92 ⇒ 10/95
CIVIC V 1.6 EX	D16A7	08/93 ⇒ 10/95
CIVIC V 1.6 i	D16V7	01/94 ⇒ 11/95
CIVIC V 1.6 i Vtec	B16A2, D14A7	01/94 ⇒ 03/96
CIVIC V 1.6 VTi 16V	B16A2	10/91 ⇒ 11/95
CIVIC VI 1.4	D14A4	11/95 ⇒ 10/98
CIVIC VI 1.4 16V	D14A7, D14A2	01/97 ⇒ 02/01
CIVIC VI 1.4 i	D14A2, D14A2	06/95 ⇒ 02/01
CIVIC VI 1.4 i S	D14A2, D14A4	11/95 ⇒ 02/01
CIVIC VI 1.4 LPG	D14A4, D14Z1	01/97 ⇒ 02/01
CIVIC VI 1.4i	D14A6	01/99 ⇒ 12/00
CIVIC VI 1.4i 16V	D14Z1, D15Z6	11/98 ⇒ 03/01
CIVIC VI 1.4i 16V Vtec	D14Z4	01/99 ⇒
CIVIC VI 1.5	D15Z3	11/95 ⇒ 12/96
CIVIC VI 1.5 16V	D15Z6, D15Z6	01/97 ⇒ 02/01
CIVIC VI 1.5 i Vtec-E	D15Z3	09/94 ⇒ 01/97
CIVIC VI 1.6	--, D16B2	10/95 ⇒ 10/00
CIVIC VI 1.6 16V	D16B2, B16A2	01/97 ⇒ 02/01
CIVIC VI 1.6 i	D16V3	09/94 ⇒ 02/01
CIVIC VI 1.6 i Vtec	B16A2, D16W3	09/94 ⇒ 02/01
CIVIC VI 1.6 VTi	B16A2	11/95 ⇒ 02/01
CIVIC VI 1.6i 16V	D16W3, B20B	01/96 ⇒
CIVIC VI 1.6i 16V Vtec	D16V8	01/96 ⇒ 09/99
CIVIC VI 1.8 16V	B18C4	01/97 ⇒ 02/01
CIVIC VI 1.8 i 16V VTi Vtec	D18C4	01/97 ⇒ 12/98
CR-V I 2.0	B20Z1	04/99 ⇒ 02/02

HONDA		
CR-V 1.2.0 16V 4WD	B20B, B20B3	10/95 → 02/02
CR-V 1.2.0 i 16V	B20B3, D16Y8	02/97 → 04/99
CRX III 1.6 ESi	D16Y8, D16W1	03/92 → 12/98
CRX III 1.6 i VTi	B16A2	03/92 → 12/98
HR-V 1.6 16V	D16W1	03/99 →
HR-V 1.6 16V 4WD	D16W1, B18B1	03/99 →
HR-V 1.6i 16V	D16W2	04/99 →
INTEGRA 1.8 i	B18B1, H22A5	01/98 →
INTEGRA 1.8 Type-R	B18C6	11/97 → 10/01
LOGO 1.3	D13B7	03/99 → 03/02
ODYSSEY 2.2	F22B6	01/95 → 12/97
ODYSSEY 2.3	F23A	10/97 → 09/03
ODYSSEY 2.3 4x4	F23A	10/97 → 09/03
ODYSSEY 2.3 i 16V Vtec	F23A8	01/98 →
ODYSSEY 3.5	J35A2	01/00 → 12/01
PRELUDE V 2.0 16V	F20A4	10/96 → 10/00
PRELUDE V 2.2 16V	H22A5, H22A4	10/96 → 10/00
PRELUDE V 2.2 i 16V	F22A2	10/96 → 10/01
PRELUDE V 2.2 i 16V VTi-R	H22A4, F20CVTEC	10/96 → 12/98
PRELUDE V 2.2 Si	F22Z6	03/97 → 07/02
S2000 2.0	F20CVTEC, F20C2	06/99 →
S2000 2.0 i 16V Vtec	F20C2, F23A7	01/05 →
S2000 2.0 Vtec	F20C1	03/99 → 10/03
SHUTTLE 2.2 16V	F22B8	10/94 → 02/98
SHUTTLE 2.3 16V	F23A7, D16Y2	10/97 → 06/04
ROVER		
400 II 416 Si	D16Y2, DV6B	03/95 → 03/00

10.3034



3

ABSOLUTE PRESSURE SENSORS (MAP)

Adatt./Suitable:

CITROËN

1920 CZ
96 390 274 80
96 394 692 80

DENSO

079800-5600
079800-5602
079800-7450

FIAT

9639469280

FORD

1 231 463
1 256 481
1 376 309
1 439 044
1 468 879
2 248 108
3M5A-12T551-AC
6G91-12T551-AA
6G91-12T551-AB
6G91-12T551-AC

JAGUAR

AJ8 10830
AJ8 11717
AJ8 13840

LANCIA

9639469280

LAND ROVER

LR008881
LR087236

MAZDA

Y601-18-211A
Y601-18-211B

MINI

13 62 7 794 981

PEUGEOT

1920 CZ

SIEMENS

5WK9 700

SUZUKI

18590-69K00
18590-69K00-000
18590-73J00
18590-73J00-000

VOLVO

30777601
31216185
867029-2

MARKET DIFFUSION: HIGH



kPa	mV	
10 - 250	950 - 4710	

CITROËN

BERLINGO I 1.6 HDi 75	DV6B, 9HX(DV6ATED4)	07/05 → 12/11
BERLINGO I 1.6 HDi 90	9HX(DV6ATED4), 9HZ(DV6ATED4)	07/05 → 12/11
BERLINGO II 1.6 HDi 110	9HZ(DV6ATED4), 9HT(DV6ATED4)	04/08 →
BERLINGO II 1.6 HDi 75	9HT(DV6ATED4), 9HT(DV6ATED4)	04/08 →
BERLINGO II 1.6 HDi 75 16V	9HT(DV6ATED4), 9HX(DV6ATED4)	04/08 →
BERLINGO II 1.6 HDi 90	9HX(DV6ATED4), 9HS(DV6ATED4BU)	04/08 →
BERLINGO II 1.6 HDi 90 16V	9HS(DV6ATED4BU), 9HZ(DV6ATED4)	04/08 →
BERLINGO 1.6 HDi	DV6BTE4	06/08 → 12/11
C2 1.6 HDi	9HZ(DV6ATED4), 8HY(DV4ATED4)	09/05 →
C3 I 1.4 16V HDi	8HY(DV4ATED4), 9HX(DV6ATED4)	02/02 →
C3 I 1.6 16V HDi	9HX(DV6ATED4), DV6DTE4	09/05 →
C3 II 1.6 HDi	DV6DTE4, 9HX(DV6ATED4)	11/09 →
C3 II 1.6 HDi 110	DV6C	11/09 →
C3 II 1.6 HDi 90	9HX(DV6ATED4), HNV(EB2DTM)	11/09 →
C3 III 1.2 THP 110	HNV(EB2DTM), 9HX(DV6ATED4)	07/16 →
C3 III 1.2 VTi 82	HMZ(EB2F)	07/16 →
C3 PICASSO 1.6 HDi	9HX(DV6ATED4), 9HY(DV6ATED4)	02/09 →
C3 PICASSO 1.6 HDi 110	DV6C	05/10 →

CITROËN

C4 I 1.6 HDi	9HV(DV6TED4), DW10ATED	11/04 →
C4 I 2.0 HDi	DW10ATED, 9HY(DV6TED4)	11/04 → 07/11
C4 GRAND PICASSO I 1.6 HDi	9HY(DV6TED4), DW10ATED4	10/06 → 06/11
C4 GRAND PICASSO I 1.6 HDi 110	DV6C	09/10 → 08/13
C4 GRAND PICASSO I 2.0 HDi 138	DW10ATED4, 9HV(DV6TED4)	10/06 → 12/13
C4 PICASSO I 1.6 HDi	9HY(DV6TED4), DW10ATED4	02/07 → 08/13
C4 PICASSO I 1.6 HDi 110	DV6C	09/10 → 08/13
C4 PICASSO I 2.0 HDi 138	DW10ATED4, 9HY(DV6TED4)	10/06 → 08/13
C5 I 1.6 HDi	9HY(DV6TED4), DW10ATED4	09/04 →
C5 I 2.0 HDi	DW10ATED4, 9HZ(DV6TED4)	09/04 →
C5 II 1.6 HDi 110	9HZ(DV6TED4), DW10ATED4	02/08 →
C5 II 1.6 HDi 115	DV6C	01/12 →
C5 II 2.0 HDi	DW10ATED4, DW10ATED4	02/08 →
C5 II 2.0 HDi 140	DW10ATED4, DW10ATED4	04/09 →
C8 2.0 HDi	DW10ATED4, DW10ATED4	07/02 →
C8 2.0 HDi 135	DW10ATED4, 9HU(DV6ATED4)	03/06 →
DISPATCH 1.6 HDi	DV6UTED4	06/07 → 03/16
DISPATCH 2.0 HDi	DW10ATED4	06/07 → 03/16
JUMPY 1.6 HDi	DV6UTED4	06/07 → 03/16
JUMPY 2.0 HDi	DW10ATED4	06/07 → 03/16
JUMPY II 1.6 HDi 90 16V	9HU(DV6ATED4), DW10ATED4	01/07 →
JUMPY II 2.0 HDi 120	DW10ATED4, DW10ATED4	01/07 →
JUMPY II 2.0 HDi 120 4x4	RHK(DW10ATED4)	01/10 →
JUMPY II 2.0 HDi 140	DW10ATED4, DW10ATED4	01/07 →
XSARA 2.0 HDi	DW10TD	09/00 → 03/05
XSARA 2.0 HDi 109	DW10ATED, 9HX(DV6ATED4)	05/01 → 08/05
XSARA 2.0 HDi 90	DW10TD	02/99 → 08/05
XSARA PICASSO 1.6 HDi	9HX(DV6ATED4), 9H07	05/04 →

FIAT

SCUDO II 1.6 D Multijet	9H07, DW10ATED4	01/07 →
SCUDO II 2.0 D Multijet	DW10ATED4, RHK	01/07 →
ULYSSE II 2.0 D Multijet	RHK, G8DA	05/06 → 06/11

FORD

C-MAX I 1.6 TDCi	G8DA, G6DA	02/07 → 09/10
C-MAX I 2.0 TDCi	G6DA, HHJA	02/07 → 09/10
FIESTA V 1.6 TDCi	HHJA, HHJC	04/07 → 09/09
FIESTA VI 1.6 TDCi	HHJC, G8DA	06/08 →
FOCUS II 1.6 TDCi	G8DA, G6DA	07/04 → 09/12
FOCUS II 2.0 TDCi	G6DA, G8DA	07/04 → 09/12
FOCUS II CASSONE / FURGONATO / PROMISCO 1.6 TDCi	G8DA, G6DB	07/04 → 07/11
FOCUS II CASSONE / FURGONATO / PROMISCO 2.0 TDCi	G6DB, HHJA	09/05 → 07/11
FOCUS C-MAX 1.6 TDCi	G8DA, G6DA	10/03 → 03/07
FOCUS C-MAX 2.0 TDCi	G6DA, G8DA	10/03 → 03/07
FUSION 1.6 TDCi	HHJA, AZWA	11/04 → 12/12
GALAXY II 2.0 TDCi	AZWA, G6DG	05/06 → 06/15
KUGA I 2.0 TDCi	G6DG, G6DG	03/08 → 11/12
KUGA I 2.0 TDCi 4x4	G6DG, AZBA	03/08 → 11/12
MONDEO III 2.0 TDCi	AZBA, AZWA	03/07 → 01/15
MONDEO 2.0 TDCi	KLBA	11/07 → 09/14
S-MAX 1.2.0 TDCi	AZWA, 508PS	05/06 → 12/14

JAGUAR

F-PACE 3.0 AWD	306PS	09/15 →
F-PACE 5.0 SVR AWD	508PS	08/18 →
F-TYPE 3.0	306PS	10/12 →
F-TYPE 3.0 S	306PS	10/12 →
F-TYPE 3.0 S AWD	306PS	12/14 →
F-TYPE 400	306PS	11/16 →
F-TYPE 400 AWD	306PS	11/16 →
F-TYPE 5.0 R	508PS	10/13 →
F-TYPE 5.0 S	508PS	10/12 →
F-TYPE 5.0 SVR	508PS, 306PS	05/15 →
XE 3.0 S	306PS, 306PS	03/15 →
XE 5.0 SVO PROJECT 8	508PS	03/18 →
XF 3.0	306PS, 508PS	03/08 →
XF 3.0 AWD	306PS	10/12 →
XF 3.0 D	306DT	09/12 → 04/14
XF 3.0 D AWD	AJV6D	03/12 →
XF 3.0 Supercharged [ExtraEU]	306PS	05/15 →
XF 5.0 Kompressor	508PS, 508PS	01/09 → 04/15
XF 5.0 XFR-S	508PS	10/12 → 04/15
XJ 3.0	306PS	03/12 →
XJ 3.0 AWD	306PS	10/12 →
XJ 5.0	508PN	08/12 →

JAGUAR		
XJ 5.0 R575	508PS	07/17 →
XJ 5.0 V 8	508PN	10/09 →
XJ 5.0 V8	508PS, 508PS	10/09 →
XK 5.0 XKR	508PS, 508PN	01/09 → 07/14
XK 5.0 XKR-S	508PS	01/11 → 07/14
LANCIA		
PHEDRA 2.0 D Multijet	RHR(DW10BTED4)	07/06 → 11/10
PHEDRA 2.0 JTD	RHK(DW10UTED4)	06/06 → 11/10
LAND ROVER		
DISCOVERY IV 3.0 4x4	306PS	08/13 →
DISCOVERY IV 5.0 V8 4x4	508PN	09/09 →
DISCOVERY V 3.0 4x4	306PS	09/16 →
RANGE ROVER III 5.0 4x4	508PS	09/09 → 08/12
RANGE ROVER IV 3.0 4x4	306PS	06/15 →
RANGE ROVER IV 5.0 4x4	508PN, 508PS	08/12 →
RANGE ROVER SPORT I 5.0 4x4	508PS, 306PS	04/09 → 03/13
RANGE ROVER SPORT II 3.0 4x4	306PS, 508PS	04/13 →
RANGE ROVER SPORT II 5.0 4x4	508PS, Y406	04/13 →
RANGE ROVER VELAR 3.0 P340 4x4	306PS	04/18 →
RANGE ROVER VELAR 3.0 P380 4x4	306PS	03/17 →
MAZDA		
2 II 1.6 MZ-CD	Y406, Y601	10/08 → 06/15
3 I 1.6 DI Turbo	Y601, Y601	06/04 → 06/09
3 I 1.6 MZ-CD	Y406	06/06 → 12/09
3 II 1.6 MZR CD	Y601, 9HZ	12/08 → 05/13
MINI		
MINI II Cooper D	9HZ, 9HZ	11/06 → 09/10
MINI II One D	9HZ, 9HZ(DV6TED4)	06/09 → 07/10
PEUGEOT		
206 1.6 HDi 110	9HY(DV6TED4), 9HV(DV6TED4)	05/04 →
207 1.6 HDi	9HV(DV6TED4), 9HZ(DV6TED4)	02/06 →
207 CC 1.6 HDi	9HZ(DV6TED4), 9HZ(DV6TED4)	02/07 →
307 1.6 HDi	9HV(DV6ATED4), 9HY(DV6ATED4)	04/05 → 03/09
307 1.6 HDi 110	9HY(DV6ATED4), 9HV(DV6ATED4)	02/04 → 03/09
307 1.6 HDi 90	9HV(DV6ATED4), DW10ATED	12/06 → 04/08
307 2.0 HDi	DW10ATED, DW10ATED	01/03 →
307 2.0 HDi 110	DW10ATED, DW10BTED4	08/00 → 12/09
307 2.0 HDi 135	DW10BTED4, DW10TD	10/03 → 04/09
307 2.0 HDi 90	DW10TD, 9HV(DV6ATED4)	08/00 → 04/08
308 I 1.6 HDi	9HV(DV6ATED4), DW10BTED4	09/07 →
308 I 2.0 HDi	DW10BTED4, DW10BTED4	09/07 →
407 1.6 HDi	DV6TED4	08/04 → 12/10
407 1.6 HDi 110	9HZ(DV6ATED4)	05/04 →
407 2.0 HDi	DW10BTED4, RHL(DW10BTED4)	11/04 →
407 2.0 HDi [ExtraEU]	DW10BTED4	11/04 → 10/07
407 2.0 HDi 135	RHL(DW10BTED4), 9HZ(DV6ATED4)	05/04 →
508 I 2.0 HDi	DW10BTED4, DW10BTED4	11/10 →
607 2.0 HDi	DW10BTED4, DW10UTED4	09/05 → 07/11
607 2.0 HDi 135	RHL(DW10BTED4)	09/05 →
807 2.0 HDi	DW10UTED4, 9HU(DV6UTED4)	02/06 →
1007 1.6 HDi	9HZ(DV6ATED4), 9HY(DV6ATED4)	06/07 →
3008 1.6 HDi	9HZ(DV6ATED4), 9HV(DV6ATED4)	06/09 → 08/16
5008 1.6 HDi	9HZ(DV6ATED4), DW10BTED4	09/09 →
EXPERT II 1.6 HDi 90 16V	9HU(DV6UTED4), DW10UTED4	01/07 →
EXPERT II 2.0 HDi 120	DW10UTED4, DW10BTED4	01/07 →
EXPERT II 2.0 HDi 120 4x4	RHK(DW10UTED4)	01/10 →
EXPERT II 2.0 HDi 140	DW10BTED4, 9HU(DV6UTED4)	01/07 →
EXPERT II TEPEE 1.6 HDi 90 16V	9HU(DV6UTED4), DW10UTED4	01/07 →
EXPERT II TEPEE 2.0 HDi 120	DW10UTED4, DW10BTED4	01/07 →
EXPERT II TEPEE 2.0 HDi 120 4x4	RHK(DW10UTED4)	01/07 →
EXPERT II TEPEE 2.0 HDi 140	DW10BTED4, DV6AUTED4	01/07 →
PARTNER 1.6 HDi	DV6AUTED4, 9HW(DV6BTED4)	08/05 →
PARTNER I 1.6 HDi 75	9HW(DV6BTED4), 9HX(DV6ATED4)	02/06 →
PARTNER I 1.6 HDi 90	9HX(DV6ATED4), 9HT(DV6BTED4)	10/05 → 12/15
PARTNER II 1.6 HDi	9HT(DV6BTED4), 9HS(DV6TED4BU)	04/08 →
PARTNER II 1.6 HDi 16V	9HS(DV6TED4BU), 9HS(DV6TED4BU)	04/08 →

PEUGEOT		
PARTNER II 1.6 HDi 16V 4x4	9HS(DV6TED4BU), 9HT(DV6BTED4)	04/12 →
PARTNER II TEPEE 1.6 HDi	9HT(DV6BTED4), 9HV(DV6TED4)	04/08 →
PARTNER II TEPEE 1.6 HDi 16V	9HV(DV6TED4), D4164T	04/08 →
RANCH 1.6 HDi 75	DV6B	02/06 →
RANCH 1.6 HDi 90	9HX(DV6ATED4)	02/06 →
SUZUKI		
LIANA 1.4 DDiS	8HY	04/04 →
SX4 I 1.6 DDiS	9HX	04/07 →
VOLVO		
C30 1.6 D	D4164T	10/06 → 12/12
C30 1.6 D2	D4162T	10/10 → 12/12
C30 2.0 D	D4204T	10/06 → 12/12
C70 II 2.0 D	D4204T	01/08 → 10/09
S40 II 1.6 D	D4164T	01/05 → 12/12
S40 II 1.6 D2	D4162T	10/10 → 12/12
S40 II 2.0 CDI	D4204T2	07/05 → 12/06
S40 II 2.0 D	D4204T	01/04 → 12/10
S40 II 2.0 D4	D4204T2	07/05 → 12/12
S80 II 1.6 D DRIVE	D4164T	01/10 → 12/11
S80 II 2.0 TDi	D4204T	02/08 → 03/11
V50 1.6 D	D4164T, G16B	01/05 → 12/12
V50 1.6 D2	D4162T	01/10 → 12/12
V50 2.0 CDI	D4204T2	12/03 → 12/06
V50 2.0 D	D4204T	04/04 → 12/10
V50 2.0 D4	D4204T2	07/05 → 12/06
V70 III 1.6 D	D4164T	07/09 → 12/11
V70 III 2.0 D	D4204T	10/07 → 12/15

SUZUKI		
JIMNY III 1.3 16V	M13A	02/01 →
JIMNY III 1.3 16V 4WD	M13A	02/01 →
JIMNY III 1.3 16V 4x4	M13A	08/05 →
JIMNY III 1.3 4WD	M13A	03/13 →
LIANA 1.3	M13A	07/01 →
LIANA 1.6	M16A, M16A	07/01 →
LIANA 1.6 4WD	M16A, M13A	07/01 →
LIANA 1.6 i	M16A	04/02 →
LIANA 1.8 i	M18A	10/01 →
SWIFT IV 1.3	M13A, M13A	02/05 →
SWIFT IV 1.3 4x4	M13A, M16A	02/05 →
SWIFT IV 1.3 LPG	M13A	09/08 → 12/10
SWIFT IV 1.5	M15A	02/05 →
SWIFT IV 1.5 4x4	M15A	02/05 →
SWIFT IV 1.6	M16A	05/06 →
SWIFT IV 1.6 4x4	M16A	02/05 →
SX4 I 1.5	M15A	06/06 → 07/10
SX4 I 1.5 VVT	M15A	07/10 →
SX4 I 1.5 VVT 4x4	M15A	07/10 →
SX4 I 1.5 VVTi	M15A	07/07 → 12/15
SX4 I 1.6	M16A	06/06 →
SX4 I 1.6 AWD	M16A, M16A	10/07 →
SX4 I 1.6 LPG	M16A	06/06 → 12/12
SX4 I 1.6 VVT	M16A, M16A	06/06 →
SX4 I 1.6 VVT 4x4	M16A, G13BB	06/06 →
VITARA I 1.6 16V	G16B	10/99 → 10/02
WAGON R+ II 1.3	G13BB, G13BB	05/00 →
WAGON R+ II 1.3 4WD	G13BB, F9Q1	10/01 →
WAGON R III 1.3	M13A	09/03 → 12/10
WAGON R 1.3 [ExtraEU]	G13BB	04/99 → 08/03

10.3042



3

ABSOLUTE PRESSURE SENSORS (MAP)

Adatt./Suitable:

- FIAT 71742176
- MITSUBISHI E1T26571A
- SUZUKI 18590-72F21, 18590-72F21-000

MARKET DIFFUSION: MEDIUM



kPa	mV	+	-	0
10 - 120	390 - 4740			

FIAT		
SEDCI 1.6 16V	M16A	06/06 → 10/14
SEDCI 1.6 16V 4x4	M16A	06/06 → 10/14
SUZUKI		
ALTO IV 1.0	G10BB	09/94 → 09/98
ALTO V 1.0	G10BB	01/00 → 06/02
GRAND VITARA I 1.6 4x4	G16B, J20A	02/00 → 07/03
GRAND VITARA I 2.0	J20A	08/98 → 12/00
GRAND VITARA I 2.0 4x4	J20A, H27A	03/98 → 08/05
GRAND VITARA I 2.7	H27A, H27A	06/01 → 08/06
GRAND VITARA I 2.7 4x4	H27A, M16A	09/01 → 07/03
GRAND VITARA II 1.6	M16A	10/05 →
GRAND VITARA II 1.6 4x4	M16A	09/05 → 02/15
GRAND VITARA II 1.6 Trazione integrale	M16A	04/05 →
GRAND VITARA II 2.0 Trazione integrale	J20A	10/05 → 02/15
GRAND VITARA II 2.4 Trazione integrale	J24B	01/09 →
IGNIS I 1.3	M13A	10/00 → 09/03
IGNIS I 1.3 4WD	M13A	10/00 → 09/03
IGNIS II 1.3	M13A	09/03 →
IGNIS II 1.3 4x4	M13A	09/03 →
IGNIS II 1.5	M15A	09/03 →
IGNIS II 1.5 4x4	M15A	09/03 →
IGNIS II 1.5 Sport	M15A	12/03 →
JIMNY III 1.3	M13A	08/04 →

10.3051



3

ABSOLUTE PRESSURE SENSORS (MAP)

Adatt./Suitable:

- GENERAL MOTORS 16 255 839
- MITSUBISHI M889795
- RENAULT 77 00 106 886
- VOLVO 30889795



kPa	mV	+	0	-
15 - 255	298 - 4750			

MITSUBISHI		
SPACE STAR 1.9 DI-D	F9Q1, F4R760	02/01 → 12/04
RENAULT		
AVANTIME 2.0 16V Turbo	F4R760, G9T642	11/01 → 05/03
ESPACE III 2.2 dCi	G9T642, F4R794	07/00 → 10/02
ESPACE IV 2.0 Turbo	F4R794, F9Q650	11/02 →
LAGUNA II 1.9 dCi	F9Q650, F4R786	03/01 →
LAGUNA II 2.0 16V Turbo	F4R786, F4R760	01/03 → 08/05
MEGANE I 2.0 16V	F4R760, F4R770	11/00 →
MEGANE II 2.0	F4R770	12/06 → 01/11
SCENIC II 2.0	F4R770, F4R762	06/03 → 07/10
VEL SATIS 2.0 16V Turbo	F4R762, D4192T3	06/02 →
VOLVO		
S40 I 1.9 DI	D4192T3, D4192T3	07/00 → 12/03
V40 I 1.9 DI	D4192T3, D223L	07/00 → 06/04

10.3053



3

ABSOLUTE PRESSURE SENSORS (MAP)

Adatt./Suitable:

BOSCH
0 261 230 020

HONDA
37830-PDF-E01

SAAB
51 67 895

SCANIA
5167895

kPa	mV	
17 - 117	250 - 4750	

HONDA

ACCORD 1.6	D16B7	10/98 ⇨ 12/01
ACCORD VI 1.6	D16B6	12/99 ⇨ 12/02
ACCORD VI 1.6 16V	D16B7	10/01 ⇨
ACCORD VI 1.6 i	D16B6	10/98 ⇨ 12/02
ACCORD VI 1.6 LS	D16B7	10/98 ⇨ 12/02

SAAB

9-3 2.2 TiD	D223L, A16LET	11/00 ⇨ 02/15
-------------	---------------	---------------

10.3054



3,5

ABSOLUTE PRESSURE SENSORS (MAP)

Adatt./Suitable:

BOSCH
0 261 230 009

GENERAL MOTORS
9 117 763

OPEL
62 38 084
91 17 763

VAUXHALL
9117763

kPa	mV	
15 - 117	580 - 4750	

OPEL

ASTRA H 1.6 Turbo	A16LET, Z20LEH	02/07 ⇨ 10/10
ASTRA H 2.0 Turbo	Z20LEH, A16LER	03/04 ⇨ 10/10

OPEL

CORSA D 1.6	Z16LER	07/12 ⇨ 08/14
CORSA D 1.6 Turbo	A16LER, X22DTH	11/06 ⇨ 08/14
FRONTERA B 2.2 DTI	X22DTH, Z20LEH	09/02 ⇨ 07/04
MERIVA A 1.6 Turbo	Z16LET	09/05 ⇨ 05/10
SINTRA 2.2 DTI	X22DTH	07/97 ⇨ 04/99
SINTRA 2.2 i 16V	X22XE	11/96 ⇨ 04/99
SPEEDSTER 2.0 Turbo	Z20LET	08/02 ⇨ 08/06
ZAFIRA B 2.0	Z20LEH, Z20LET	07/05 ⇨ 12/10

VAUXHALL

ASTRA IV 2.0	Z20LET	08/02 ⇨ 10/05
ASTRA IV 2.0 Turbo	Z20LET, A16LET	08/02 ⇨ 05/05
ASTRA V 1.6	A16LET, A16LET	08/04 ⇨ 11/10
ASTRA V 1.6 Turbo	A16LET, Z20LEH	09/06 ⇨ 09/09
ASTRA V 2.0	Z20LEL	02/06 ⇨ 11/10
ASTRA V 2.0 Turbo	Z20LEH, A16LER	01/04 ⇨ 11/10
ASTRA V 2.0 VXR	Z20LEH	02/09 ⇨ 11/10
CORSA D 1.6 VXR	A16LER, X22DTH	11/06 ⇨ 08/14
FRONTERA B 2.2 DTI	X22DTH, Z20LEH	09/00 ⇨ 10/04
MERIVA I 1.6 Turbo	Z16LET	05/06 ⇨ 06/10
SINTRA 2.2 DTI	X22DTH	07/97 ⇨ 04/99
SINTRA 2.2 i 16 V	X22XE	11/96 ⇨ 04/99
VX220 2.0 i Turbo	Z20LET	03/01 ⇨ 07/05
VX220 2.0 VXR	Z20LET	10/03 ⇨ 07/05
ZAFIRA A 2.0 GSI Turbo	Z20LET	09/01 ⇨ 06/05
ZAFIRA B 2.0	Z20LEH, 312A1.000	07/05 ⇨ 11/14

10.3055



3

ABSOLUTE PRESSURE SENSORS (MAP)

Adatt./Suitable:

ABARTH
4681 1235
55206796
55219294

ALFA ROMEO
4681 1235
55206796
55219294

BOSCH
0 261 230 284
0 281 002 510
0 281 002 552
0 281 002 844

BOSCH
0 261 230 020
0 281 002 510
0 281 002 552
0 281 002 844

FIAT
4681 1235
55206796
55219294

FIAT
4681 1235
55206796
55219294

FORD
1 539 497
1 721 462
9551-9J559-AA
B551-9J559-AA

GENERAL MOTORS
55 219 294
9 109 593
93 177 414
93 190 052
93 194 115

LANCIA
4681 1235
55206796
55219294

NISSAN
22365-00QAA
22365-00QAJ
22365-BN701

OPEL
12 35 083
12 35 258
44 01 593
47 09 264
55219294
62 35 631
91 09 593
93177414
93190052
93194115

RENAULT
22 36 537 95R
82 00 155 613

SMART
Q 0003121V002000000
Q 0003121V003000000

SUBARU
18590-84E50

SUZUKI
18590-84E50
18590-84E50-000
18590-84E51-000
18590-86J00
18590-86J00-000
18590-86J01
18590-86J01-000
18590M86J00
18590M86J00-000
18590M86J01
18590M86J01-000
18590N86J00
18590N86J00-000

VAUXHALL
55219294
9109593
93177414
93190052
93194115

MARKET DIFFUSION: HIGH



kPa	mV	
20 - 256	385.5 - 4750	

ABARTH

500 1.4	312A1.000, 312A1.000	08/08 ⇨
500 MY12 1.4	--	01/12 ⇨
500C / 595C 1.4	312A1.000, 199A8.000	05/08 ⇨
GRANDE PUNTO 1.4	199A8.000, 182B9.000	12/07 ⇨ 12/12
PUNTO EVO 1.4	955A8.000	07/08 ⇨ 02/12

ALFA ROMEO

147 1.9 JTD	182B9.000, 937A2.000	04/01 ⇨ 03/10
147 1.9 JTDM	937A2.000, 937A2.000	10/04 ⇨ 03/10

ALFA ROMEO			
156 1.9 JTD	937A2.000, 839A6.000	05/00 → 05/06	
156 2.4 JTD	841C000	03/02 → 05/06	
166 2.4 JTD	839A6.000, 198A4.000	10/00 → 06/07	
GIULIETTA II 1.4 BiFuel	198A4.000	12/11 →	
GIULIETTA II 1.4 TB	198A4.000, 198A1.000	04/10 →	
MITO 1.4 TJet	198A1.000, --	08/08 →	
FIAT			
500 1.3 D Multijet	169A1.000	10/07 →	
500 C 1.3 D Multijet	169A1.000	09/09 →	
BRAVA 1.9 JTD	182B9.000	09/00 → 10/01	
BRAVO I 1.9 JTD	182B9.000	09/00 → 10/01	
BRAVO II 1.4 T-Jet	--, 182B9.000	09/07 →	
DOBLO I 1.3 D Multijet	199A2.000	10/05 → 01/10	
DOBLO I 1.3 JTD	199A2.000	05/05 →	
DOBLO I 1.3 JTD 16V	188A9.000	05/04 → 12/06	
DOBLO I 1.9 JTD	182B9.000, 198A4.000	10/01 →	
DOBLO II 1.4	198A4.000	10/11 →	
DOBLO II 1.4 Natural Power	198A4.000, 199A2.000	02/10 →	
DOBLO II 1.6 D Multijet	940C1.000	02/16 →	
FIORINO III 1.3 D Multijet	199A2.000, 182A7.000	11/07 →	
IDEA 1.2 D	--	01/08 →	
IDEA 1.3 D Multijet	188A9.000	01/04 →	
LINEA 1.4 16V TURBO [IND]	--	09/07 →	
LINEA 1.4 T-Jet	198A4.000	09/07 →	
MAREA 1.9 JTD	182B9.000	01/01 → 12/07	
MAREA 1.9 JTD 110	186A6.000	09/00 → 08/02	
MAREA 1.9 TD 100	182A7.000, --	09/96 → 06/03	
MARENGO 1.9 JTD	186A6.000	03/99 → 08/02	
MULTIPLA 1.9 JTD 105	182B4.000	04/99 → 06/10	
MULTIPLA 1.9 JTD 110	186A6.000	03/01 → 07/02	
MULTIPLA 1.9 JTD 115	186A8.000	07/02 → 06/10	
PALIO 1.3	--	06/03 →	
PALIO 1.3 JTD Multijet	188A9.000	06/03 →	
PALIO 1.3 Multijet INDIA	199A2.000	06/05 →	
PALIO 1.7 TD	176A5.000	09/01 →	
PALIO 1.9 JTD	188A2.000	09/01 →	
PANDA II 1.3 D Multijet	--, 169A1.000	09/03 →	
PANDA II 1.3 D Multijet 4x4	169A1.000, 199A2.000	10/04 →	
PUNTO II 1.3 D Multijet	188A9.000	02/05 → 10/09	
PUNTO II 1.3 JTD	188A9.000	06/03 → 10/05	
PUNTO II 1.3 JTD 16V	188A9.000	06/03 → 03/12	
PUNTO II 1.9 JTD	188A7.000	02/00 → 03/12	
PUNTO II 1.9 JTD 80	188A2.000	09/99 → 03/12	
PUNTO III / GRANDE PUNTO 1.3 D Multijet	199A2.000, 199A2.000	10/05 →	
PUNTO III / GRANDE PUNTO 1.3 JTD	--	01/08 → 09/09	
PUNTO III / GRANDE PUNTO 1.3 JTD Actual	--	09/09 →	
PUNTO III / GRANDE PUNTO 1.4 T-Jet	198A4.000	09/07 →	
PUNTO III / GRANDE PUNTO 1.6 D Multijet	955A3.000	07/08 →	
PUNTO III EVO 1.3 D Multijet	199A2.000, 199A2.000	07/08 →	
PUNTO III EVO 1.6 D Multijet	955A3.000	10/09 → 02/12	
PUNTO III 1.3 D Multijet	199A2.000, 199A2.000	04/08 →	
PUNTO III 1.3 JTD Multijet	955B2.000	05/18 →	
QUBO 1.3 D Multijet	199A2.000, 192A1.000	02/08 →	
SIENA 1.2 MJTD	--	01/02 →	
SIENA 1.3 JTD	188A9.000	09/03 → 12/09	
STILO 1.9 D Multijet	192A9.000	09/05 → 08/08	
STILO 1.9 JTD	192A1.000, BAAA	10/01 → 08/08	
STRADA 1.9 JTD	188A2.000	04/03 →	
FORD			
KA II 1.3 TDCi	BAAA, 937A2.000	10/08 →	
LANCIA			
DELTA III 1.4	198A4.000	09/08 → 08/14	
DELTA III 1.4 Bifuel	198A4.000	07/11 → 08/14	
LYBRA 1.9 JTD	937A2.000, 839A6.000	09/00 → 10/05	
LYBRA 2.4 JTD	839A6.000, D13A	09/00 → 10/05	
MUSA 1.3 D Multijet	188A9.000	10/04 → 09/12	
THESIS 2.4 JTD	841C.000	07/02 → 07/09	
YPSILON I 1.3 D Multijet	199A2.000	09/06 → 12/11	
YPSILON I 1.3 JTD	188A9.000	10/03 → 12/11	
NISSAN			
ALMERA II 1.5 dCi	K9K722	01/03 → 09/06	
PRIMASTAR 2.5 dCi 115	G9U720	09/08 →	
PRIMASTAR 2.5 dCi 140	G9U730	07/03 →	
PRIMASTAR 2.5 dCi 150	G9U632	09/06 →	
PRIMASTAR dCi 115	G9U720	09/08 →	
PRIMASTAR dCi 140	G9U730	07/03 →	
PRIMASTAR dCi 150	G9U632	09/06 →	
OPEL			
AGILA A 1.3 CDTI	Z13DT	08/03 → 12/07	
AGILA B 1.3 CDTI	D13A, Y13DT	04/08 → 04/10	
COMBO C 1.3 CDTI 16V	Y13DT, Y13DT	06/04 →	
COMBO D 1.4	A14FC	02/12 →	
COMBO D 1.4 CNG	A14FC	02/12 →	

OPEL			
CORSA C 1.3 CDTI	Y13DT, Y13DT	06/03 →	
CORSA C 1.3 CDTI 16V	Z13DT	07/05 → 06/06	
CORSA C 1.3 DTI	Y13DT	09/03 →	
CORSA D 1.3 CDTI	Z13DTJ	07/06 → 08/14	
MERIVA A 1.3 CDTI	Y13DT, G9MB6	09/03 → 05/10	
TIGRA B 1.3 CDTI	Z13DT	06/04 → 12/10	
VIVARO A 2.5 CDTI	G9MB6, G9T642	08/06 →	
RENAULT			
AVANTIME 2.2 dCi	G9T712	05/02 → 05/03	
CLIO III 1.2 16V	D4F786	03/10 →	
ESPACE III 2.2 dCi	G9T642, F9Q820	07/00 → 10/02	
ESPACE IV 1.9 dCi	F9Q820, G9T645	11/02 →	
ESPACE IV 2.2 dCi	G9T645, F9Q650	11/02 →	
LAGUNA II 1.9 dCi	F9Q650, G9T700	03/01 →	
LAGUNA II 2.2 dCi	G9T700, D4F780	03/01 →	
MODUS / GRAND MODUS 1.2	D4F786	04/11 →	
THALIA I 1.5 dCi	K9K706	04/04 → 11/09	
TRAFIC II 2.5 dCi 135	G9U730	03/01 →	
TRAFIC II 2.5 DTI	G9U730	03/03 → 07/03	
TWINGO II 1.2 TCe 100	D4F780, D4F780	02/11 →	
TWINGO II 1.2 Turbo	D4F780, G9T702	03/07 →	
VEL SATIS 2.2 dCi	G9T702, D4F780	06/02 →	
WIND 1.2	D4F780, M160E6ALB03	07/10 →	
WIND 1.2 TCe 100	D4F780	02/11 →	
SMART			
CABRIO 0.6	M160E6ALB03, M160.910	03/00 → 01/04	
CABRIO 0.7	M160.910, M160E6ALB03	01/03 → 01/04	
CITY-COUPÉ 0.6	M160E6ALB03, M160.910	01/01 → 01/04	
CITY-COUPÉ 0.7	M160.910, M160.910	01/03 → 01/04	
CITY COUPÉ 0.6	M160.910	12/99 → 04/03	
CROSSBLADE 0.6	M160.910, M160.910	06/02 → 12/03	
FORTWO I 0.6	M160.910	01/04 → 02/07	
FORTWO I 0.7	M160.910, M160.921	01/04 → 01/07	
FORTWO 0.6 [ExtraEU]	M160.910	01/04 → 12/06	
ROADSTER 0.7	M160.921, D13A	04/03 → 11/05	
ROADSTER 0.7 Brabus	M160.923	12/03 → 11/05	
SUBARU			
JUSTY II 1.3 4x4	G13BB	04/01 → 11/03	
JUSTY II 1.3 GX 4x4	G13BA	10/95 → 11/03	
JUSTY III 1.3 CDTI	Z13DT	12/03 → 08/07	
SUZUKI			
SPLASH 1.3 CDTI	D13A, D13A	01/08 →	
SWIFT IV 1.3 DDIS	Z13DT	08/05 →	
WAGON R+ II 1.3 DDIS	Z13DT	09/03 →	
VAUXHALL			
AGILA A 1.3 CDTI	Z13DT	08/03 → 03/08	
AGILA B 1.3 CDTI	D13A, Y13DT	01/08 → 11/14	
COMBO C 1.3 CDTI 16V	Y13DT, Y13DT	09/04 → 02/12	
COMBO D 1.4 CNG	A14FC	11/11 →	
CORSA C 1.3 CDTI 16V	Y13DT, A13DTC	08/00 → 09/06	
CORSA D 1.3 CDTI	A13DTC, Y13DT	08/06 → 08/14	
CORSAVAN II 1.3 CDTI 16V	Z13DT	04/04 → 06/06	
MERIVA I 1.3 CDTI	Y13DT, G9U630	01/03 → 06/10	
TIGRA B 1.3 CDTI	Z13DT	06/04 → 08/09	
VIVARO 2.5 CDTI	G9U630, EW10J4	04/03 → 07/14	
VIVARO 2.5 DTI	G9U630	07/03 → 07/14	

10.3056

3

ABSOLUTE PRESSURE SENSORS (MAP)

Adatt./Suitable:

BOSCH

0 261 230 041

0 261 230 058

CITROËN

1920 AC

4574 03

4574 05

96 394 189 80

FIAT

9639418980

LANCIA

9639418980

PEUGEOT

1920 AC

4574 03

96 394 189 80

RENAULT

96 39 418 980

* without connector parts

• senza pezzi raccordo

• sans raccords

• ohne Anschlusssteile

• sin piezas de conexión

MARKET DIFFUSION: MEDIUM



kPa	mV	
20 - 117	789 - 4750	

CITROËN

C4 I 2.0 16V	EW10J4, 6FZ(EW7J4)	11/04 → 07/07
C5 I 1.8	EW7J4	09/04 → 08/05
C5 I 1.8 16V	6FZ(EW7J4), EW10J4	03/01 →
C5 I 2.0 16V	EW10J4, EW10D	03/01 → 08/04
C5 I 2.0 16V HPi	EW10D, ES9J4SHP	03/01 → 08/04
C5 I 3.0 Carlsson	ES9J4SHP, ES9A	09/03 → 08/04
C5 I 3.0 V6	ES9A, ES9A	03/01 →
C5 II 3.0 V6	ES9A, ES9A	02/08 →
C5 3.0 [ExtraEU]	ES9AHP	09/04 → 01/08
C6 3.0 V6	ES9A, EW10J4	09/05 → 12/12
C8 2.0	EW10J4, ES9J4S	07/02 →
C8 3.0 V6	ES9J4S, NFX(TU5JP4)	07/02 →
SAXO 1.6	NFX(TU5JP4), NFX(TU5JP4)	02/96 → 04/04
SAXO 1.6 VTR	NFX(TU5JP4)	05/96 → 07/99
SAXO 1.6 VTS	NFX(TU5JP4), EW10J4	06/96 → 09/03
XSARA 2.0 [ExtraEU]	EW10J4	02/04 → 10/04
XSARA 2.0 16V	EW10J4, 6FZ(EW7J4)	09/00 → 08/05
XSARA PICASSO 1.8 16V	6FZ(EW7J4), EW10J4	02/00 →
XSARA PICASSO 2.0 16V	EW10J4, RFN	01/03 →

FIAT

ULYSSE II 2.0	RFN, RFN	08/02 → 06/11
ULYSSE II 3.0	XFW	08/02 → 06/11

LANCIA

PHEDRA 2.0	RFN, ES9J4S	09/02 → 11/10
PHEDRA 3.0 V6	ES9J4S, NFX(TU5J4)	09/02 →

PEUGEOT

106 II 1.6 S16	NFX(TU5J4), EW10J4	05/96 → 07/04
206 2.0 16V	EW10J4, EW10J4	07/02 → 02/07
206 2.0 S16	EW10J4, EW10J4	06/99 →
307 2.0	EW10J4, EW10J4	03/02 → 06/05
307 2.0 16V	EW10J4, ES9J4S	08/00 → 04/08
406 2.0 16V HPi	EW10D	05/01 → 10/04
406 3.0 V6	ES9J4S, EW10J4	03/00 → 12/04
407 1.8	6FZ(EW7J4)	05/04 →
407 2.0	EW10J4, ES9A	03/04 →
407 3.0	ES9A, ES9A	05/04 →
407 3.0 V6	ES9A, EW10J4	10/05 →
607 2.0	EW10J4, ES9A	02/00 → 08/05
607 3.0 V6 24V	ES9A, EW10J4	02/00 → 07/11
807 2.0	EW10J4, ES9J4S	06/02 →
807 3.0 V6	ES9J4S, L7X720	06/02 →

RENAULT

AVANTIME 3.0 V6	L7X720, L7X760	09/01 → 05/03
AVANTIME 3.0i 24V	L7X722	05/01 →
CLIO II 3.0 RS V6	L7X760, L7X760	01/03 →
CLIO II 3.0 V6 Sport	L7X760, L7X760	11/00 →
CLIO IV 3.0 RS V6	L7X760, L7X731	03/13 →

RENAULT		
LAGUNA II 2.9 V6 24V	L7X731, L7X731	03/01 ⇨ 12/07
LAGUNA II 3.0 V6 24V	L7X731, 4HA	03/01 ⇨

10.3057  **3,5**

ABSOLUTE PRESSURE SENSORS (MAP)

Adatt./Suitable:

FORD
6 582 335
92VB-9F479-AA
GENERAL MOTORS
16 153 989



kPa	mV	
40 - 250	235 - 4477	

FORD		
TRANSIT II 2.5 DI	4ED, 4EA	10/92 ⇨ 03/00
TRANSIT II 2.5 TD	4EA, 4EB	05/91 ⇨ 07/00
TRANSIT II 2.5 TDI	4EB, 4EB	06/94 ⇨ 03/00
TRANSIT 2.5 TD	4HA, 4ED	08/94 ⇨ 06/00
TRANSIT TOURNEO 2.4 D	4HA	08/94 ⇨ 06/00
TRANSIT TOURNEO 2.5 DI	4HA	11/94 ⇨ 12/00
TRANSIT TOURNEO 2.5 TD	4EB, 4HA	11/94 ⇨ 12/00

10.3058  **04**

ABSOLUTE PRESSURE SENSORS (MAP)

Adatt./Suitable:

00 **Eliminated on 19-02-2019. Please verify the availability through our local distributors**

- Eliminato il 19-02-2019. Verificare la disponibilità presso i nostri distributori
- Éliminé le 19-02-2019. Vérifier la disponibilité auprès de nos distributeurs sur place
- Am 19-02-2019 gestrichen. Evtl. Verfügbarkeit bitte bei unseren Händlern prüfen
- Eliminado en fecha 19-02-2019. Verificar la disponibilidad a través de nuestros distribuidores locales

1006 **After depletion of stock this part is replaced by:**

- Esaurite le scorte questo pezzo sarà sostituito da:
- Après épuisement du stock, cette pièce est remplacée par:
- Nach Vorraterschöpfung wird ersetzt durch:
- Después agotamiento stock, será sustituido por:

10.3355



kPa	mV	
40 - 250	285 - 4500	

10.3059  **3,5**

ABSOLUTE PRESSURE SENSORS (MAP)

Adatt./Suitable:

FORD
1 023 008
97VB-9F479-BA



kPa	mV	
40 - 250	285 - 4500	

FORD		
TRANSIT II 2.5 DI	4ED, 4EA	10/92 ⇨ 03/00
TRANSIT II 2.5 TD	4EA, 4EB	05/91 ⇨ 07/00
TRANSIT II 2.5 TDI	4EB, 4EB	06/94 ⇨ 03/00
TRANSIT 2.5 TD	4HA, 4ED	08/94 ⇨ 12/00
TRANSIT TOURNEO 2.4 D	4HA	08/94 ⇨ 06/00
TRANSIT TOURNEO 2.5 DI	4HA	11/94 ⇨ 12/00
TRANSIT TOURNEO 2.5 TD	4EB, B5204T3	11/94 ⇨ 12/00

10.3062  **3**

ABSOLUTE PRESSURE SENSORS (MAP)

Adatt./Suitable:

BOSCH
0 261 230 018
VOLVO
127534-2
30850992



kPa	mV	
20 - 100	385 - 4485	

VOLVO		
850 2.4 AWD	B5254T	04/96 ⇨ 12/96
850 2.4 GLE	B5254T	09/93 ⇨ 10/97
C70 I 2.0	B5204T2	03/97 ⇨ 10/05
C70 I 2.0 T	B5204T3, B5234T3	03/00 ⇨ 10/05
C70 I 2.3 T5	B5234T3, B5244T	07/02 ⇨ 10/05
C70 I 2.3 T-5	B5234T3	03/97 ⇨ 09/02
C70 I 2.4 T	B5244T, B4194T	03/97 ⇨ 10/05
S40 I 1.9 T4	B4194T, B4204T	05/97 ⇨ 07/00
S40 I 2.0 T	B4204T, B5204T2	06/01 ⇨ 12/03
S40 I 2.0 T4	B4204T5	07/00 ⇨ 12/03
S70 2.0	B5204T2, B5244T	01/97 ⇨ 11/00
S70 2.0 Turbo	B5204T3	01/97 ⇨ 11/00
S70 2.3	B5234T7	04/99 ⇨ 09/00
S70 2.3 AWD	B5234T7	04/99 ⇨ 09/00
S70 2.3 T-5	B5234T3	01/97 ⇨ 11/00

VOLVO		
S70 2.3 T5 AWD	B5234T4	07/97 → 09/00
S70 2.3 T5-R AWD	B5234T2	11/96 → 09/98
S70 2.3 Turbo	B5234FT+	01/97 → 11/00
S70 2.4 T5 AWD	B5254T	11/96 → 04/99
S70 2.4 Turbo	B5244T, B4194T	01/97 → 11/00
V40 I 1.9 T4	B4194T, B4204T	05/97 → 07/00
V40 I 2.0 T	B4204T, B5204T2	06/01 → 06/04
V40 I 2.0 T4	B4204T5	07/00 → 06/04
V70 I 2.0	B5204T2, B5234T3	11/96 → 12/00
V70 I 2.0 Turbo	B5204T3	11/96 → 12/00
V70 I 2.0 Turbo AWD	B5204T3	11/96 → 12/00
V70 I 2.3 AWD	B5234T3, B5234FT+	04/97 → 09/98
V70 I 2.3 T AWD	B5234FT+, B5234FT+	04/97 → 12/98
V70 I 2.3 T-5	B5234T3	11/96 → 12/00
V70 I 2.3 T-5 AWD	B5234T3	01/97 → 12/00
V70 I 2.3 Turbo	B5234FT+, B5244T2	12/95 → 12/98
V70 I 2.4 Turbo	B5244T	04/96 → 12/00
V70 I 2.4 Turbo AWD	B5244T2, F9Q772	04/96 → 12/00

10.3068



3,5

ABSOLUTE PRESSURE SENSORS (MAP)

Adatt./Suitable:

DENSO
100798-4770
VOLVO
947000-7



kPa	mV	+	-	Q
10 - 139	890 - 4750			

VOLVO

C70 I 2.4	B5244S, B5244S	06/98 → 10/05
S70 2.3	B5234FS	01/97 → 07/99
S70 2.4	B5244S, B5244S	01/97 → 11/00
S70 2.4 AWD	B5244S, B5244SG	10/98 → 05/99
S70 2.4 Bifuel	B5244SG, B5244S2	07/99 → 11/00
S70 2.4 Blu-Fuel	B5244S2, B5244S	07/97 → 09/00
V70 I 2.3	B5234FS	01/97 → 07/99
V70 I 2.4	B5244S, B5244SG	12/95 → 12/99
V70 I 2.4 AWD	B5254SDENS	06/98 → 12/99
V70 I 2.4 Bifuel	B5244SG, B5244SG	08/99 → 12/00

10.3069



3,5

ABSOLUTE PRESSURE SENSORS (MAP)

Adatt./Suitable:

DENSO
100798-5012
VOLVO
920270-1



kPa	mV	+	-	Q
10 - 139	890 - 4750			

VOLVO

S60 I 2.4 Bifuel	B5244SG, B5244S	07/01 → 04/10
S80 I 2.4	B5244S, B5244SG	01/99 → 07/06
S80 I 2.4 Bifuel	B5244SG, B5244SG	09/01 → 07/06
V70 II 2.4 Bifuel	B5244SG, AER	09/01 → 08/07

10.3071



3,5

ABSOLUTE PRESSURE SENSORS (MAP)

Adatt./Suitable:

BOSCH
0 261 230 010
0 261 230 011
SEAT
030 906 051 A
VW
030 906 051 A



kPa	mV	Q	+	NTC	-
17 - 117	250 - 4750				

SEAT

AROSA 1.0	AER, AEX	05/97 → 06/04
AROSA 1.4	AEX, ALD	05/97 → 06/04
IBIZA II 1.0	ALD, AEX	08/99 → 02/02
INCA 1.4 i	AEX, AEX	11/95 → 06/03

VOLKSWAGEN (BR)

GOL 1.0i	510	11/96 →
GOL 1.9 D	221	06/98 →
SAVEIRO 1.9 D	221	06/98 →

VW

CADDY II 1.4	AEX, AEX	11/95 → 01/04
CADDY II 1.4 16V	AUA	08/00 → 01/04
CADDY II 60 1.4	AEX, AEX	11/95 → 01/04
GOLF III 1.4	AEX, AER	10/91 → 04/99
LUPO 1.0	AER, AER	09/98 → 07/05
POLO 1.0 [ExtraEU]	AER, AER	07/95 → 09/01
POLO III 1.0	AER, AEX	10/99 → 09/01
POLO III 1.4	AEX, AER	05/97 → 09/01
POLO III 50 1.0	AER, AEX	09/96 → 10/99
POLO III 54 1.4	ANX	01/98 → 08/99
POLO III 55 1.4	AEX, BGU	08/95 → 10/99
POLO IV 1.0	AER	08/96 → 12/01

10.3064



3

ABSOLUTE PRESSURE SENSORS (MAP)

Adatt./Suitable:

GENERAL MOTORS
91 167 213

NISSAN
22365-00QAB

OPEL
44 10 279

RENAULT
77 00 111 957

MARKET DIFFUSION: MEDIUM



kPa	mV	+	Q	-
15 - 255	298 - 4750			

NISSAN

INTERSTAR dCi 80	F9Q772, F9Q762	04/02 →
PRIMASTAR 1.9 dCi 100	F9Q760	07/02 →
PRIMASTAR 1.9 dCi 80	F9Q762	07/02 →
PRIMASTAR dCi 100	F9Q760	03/01 →
PRIMASTAR dCi 80	F9Q762	03/01 →

OPEL

MOVANO A 1.9 DTI	F9Q772	10/01 →
VIVARO A 1.9 DI	F9Q762, K9K700	08/01 →
VIVARO A 1.9 DTI	F9Q760	08/01 →

RENAULT

CLIO II 1.5 dCi	K9K700, K9K700	06/01 →
KANGOO I 1.5 dCi	K9K700, F9Q772	02/01 →
MASTER II 1.9 dCi 80	F9Q772, F9Q732	11/01 →
MEGANE I 1.9 dCi	F9Q732, F9Q732	02/01 → 08/03
SCÉNIC I 1.9 dCi	F9Q732, F9Q760	09/99 → 08/03
SCÉNIC I 1.9 dCi RX4	F9Q740	11/00 → 08/03
THALIA I 1.5 dCi	K9K700	04/02 →
TRAFIC II 1.9 dCi	F9Q760, F9Q760	03/01 →
TRAFIC II 1.9 dCi 100	F9Q760	03/01 →
TRAFIC II 1.9 dCi 80	F9Q760, B5244S	03/01 →

VAUXHALL

VIVARO 1.9 DI	F9Q762	08/01 → 07/14
VIVARO 1.9 DTI	F9Q760	08/01 → 12/06

10.3072



3,5

ABSOLUTE PRESSURE SENSORS (MAP)

Adatt./Suitable:

AUDI

06B 906 051

BOSCH

0 261 230 031

0 261 230 032

SEAT

06B 906 051

SKODA

06B 906 051

VW

06B 906 051

MARKET DIFFUSION: HIGH



kPa	mV	O + NTC -
17 - 117	250 - 4750	

AUDI

A3 II 1.6	BGU, CCSA	05/03 ⇨ 08/12
A3 II 1.6 E-Power	CCSA, BAG	01/11 ⇨ 08/12
A3 II 1.6 FSI	BAG, AXW	08/03 ⇨ 09/07
A3 II 2.0 FSI	AXW, BGU	05/03 ⇨ 06/08
A3 II SPORTBACK 1.6	BGU, BLF	09/04 ⇨ 03/13
A3 II SPORTBACK 1.6 FSI	BLF, AXW	09/04 ⇨ 09/07
A3 II SPORTBACK 2.0 FSI	AXW, BGU	09/04 ⇨ 06/08

SEAT

ALTEA 1.6	BGU, BGU	03/04 ⇨
ALTEA 1.6 LPG	CHGA	09/09 ⇨
ALTEA 1.6 Multifuel	CMXA	11/10 ⇨ 05/11
ALTEA XL 1.6	BGU, BSE	10/06 ⇨
ALTEA XL 1.6 LPG	CHGA	09/09 ⇨
ALTEA XL 1.6 Multifuel	BSE, AER	10/06 ⇨
AROSA 1.0	AER, AEX	05/97 ⇨ 06/04
AROSA 1.4	AEX, AZQ	05/97 ⇨ 06/04
CORDOBA II 1.2	AZQ, AKK	10/02 ⇨ 06/06
CORDOBA II 1.2 12V	BXV	05/06 ⇨ 11/09
IBIZA II 1.0	AUC	08/99 ⇨ 02/02
IBIZA II 1.4	AKK, AZQ	08/99 ⇨ 02/02
IBIZA III 1.2	AZQ, BZG	02/02 ⇨ 06/06
IBIZA III 1.2 12V	BXV	05/06 ⇨ 11/09
IBIZA IV 1.2	BZG, AEX	03/08 ⇨
IBIZA IV 1.2 LPG	BZG	03/08 ⇨
IBIZA 1.2	CGPA	04/08 ⇨
INCA 1.4 i	AEX, APE	11/95 ⇨ 06/03
LEON I 1.4 16V	APE, BSE	11/99 ⇨ 06/06
LEON II 1.6	BSE, BSE	07/05 ⇨ 12/12
LEON II 1.6 LPG	CHGA	12/09 ⇨ 12/12
LEON II 1.6 MultiFuel	BSE, BLR	11/10 ⇨ 12/12
LEON II 2.0 FSI	BLR, APE	07/05 ⇨ 05/10
TOLEDO II 1.4 16V	APE, BGU	01/00 ⇨ 05/02
TOLEDO III 1.6	BGU, BLR	10/04 ⇨ 05/09
TOLEDO III 2.0 FSI	BLR, AZQ	10/04 ⇨ 05/09

SKODA

FABIA I 1.2	AZQ, BZG	01/03 ⇨ 03/08
FABIA II 1.2	BZG, BGU	01/07 ⇨
FABIA II 1.2 [IND]	CJLA	09/10 ⇨
FABIA II 1.2 LPG	CGPA	07/07 ⇨ 11/14
OCTAVIA II 1.6	BGU, BSE	06/04 ⇨ 06/13
OCTAVIA II 1.6 LPG	BSE, BLR	08/09 ⇨ 11/12
OCTAVIA II 2.0 FSI	BLR, BLX	11/04 ⇨ 10/08
OCTAVIA II 2.0 FSI 4x4	BLX, BMN	11/04 ⇨ 10/08
OCTAVIA II 2.0 TDI RS	BMN, BME	04/06 ⇨ 02/13
ROOMSTER 1.2	BME, CBZA	05/06 ⇨ 05/15
ROOMSTER 1.2 LPG	CGPA	03/09 ⇨ 05/15
ROOMSTER 1.2 TSI	CBZA, AHW	03/10 ⇨ 05/15

VOLKSWAGEN (BR)

POLO 2.0	BBX	05/02 ⇨
----------	-----	---------

VW

BORA 1.4 16V	AHW, AEX	03/00 ⇨ 05/05
CADDY II 1.4	AEX, AEX	11/95 ⇨ 01/04
CADDY II 60 1.4	AEX, BGU	11/95 ⇨ 01/04

VW

CADDY III 1.6	BGU, BSF	04/04 ⇨ 05/15
CADDY III 1.6 BiFuel	BSF, BVY	05/11 ⇨ 05/15
EOS 2.0 FSI	BVY, AXP	03/06 ⇨ 05/08
GOLF IV 1.4	AXP, AHW	05/00 ⇨ 06/06
GOLF V 1.4 16V	AHW, BGU	08/97 ⇨ 06/06
GOLF V 1.6	BGU, CCSA	01/04 ⇨ 12/13
GOLF V 1.6 MultiFuel	CCSA, AXW	11/07 ⇨ 12/13
GOLF V 2.0 FSI	AXW, BLX	01/04 ⇨ 11/08
GOLF V 2.0 FSI 4motion	BLX, BSE	08/04 ⇨ 11/08
GOLF VI 1.6	BSE, BSE	10/08 ⇨
GOLF VI 1.6 BiFuel	BSF	03/09 ⇨
GOLF VI 1.6 MultiFuel	CHGA	10/08 ⇨
JETTA V 1.6	BSE, AER	10/05 ⇨ 10/10
JETTA V 1.6 MultiFuel	CCSA	01/08 ⇨ 10/10
LUPO 1.0	AER, BSE	09/98 ⇨ 07/05
LUPO 1.4	AUD	10/00 ⇨ 07/05
NEW BEETLE 1.4	BCA	11/01 ⇨ 09/10
PASSAT V 1.6	BSE, BLR	05/05 ⇨ 11/10
PASSAT V 2.0 FSI	BLR, BLX	03/05 ⇨ 11/10
PASSAT V 2.0 FSI 4motion	BLX, AER	09/05 ⇨ 11/10
POLO 1.0 [ExtraEU]	AER, AER	07/95 ⇨ 09/01
POLO III 1.0	AER, AEX	10/99 ⇨ 09/01
POLO III 1.4	AEX, AER	05/97 ⇨ 09/01
POLO III 50 1.0	AER, AEX	09/96 ⇨ 10/99
POLO III 55 1.4	AEX, AEX	08/95 ⇨ 10/99
POLO III 60 1.4	AEX, AZQ	07/95 ⇨ 09/01
POLO IV 1.2 12V	AZQ, CGPA	10/01 ⇨ 11/09
POLO V 1.2	CGPA, BGU	03/09 ⇨
POLO V 1.2 [IND]	CJLA	08/11 ⇨
POLO V 1.2 BlueMotion	CGPA	03/09 ⇨ 05/14
TOURAN I 1.6	BGU, AXW	07/03 ⇨ 05/10
TOURAN I 1.6 BiFuel	BSF	11/06 ⇨ 05/10
TOURAN I 2.0 FSI	AXW, AQV	10/03 ⇨ 01/07

10.3073



3,5

ABSOLUTE PRESSURE SENSORS (MAP)

Adatt./Suitable:

BOSCH

0 281 002 394

0 281 002 395

SEAT

038 906 051 A

VW

038 906 051 A



kPa	mV	O + NTC -
10 - 306	250 - 4750	

SEAT

TOLEDO II 1.9 TDI	ARL	10/00 ⇨ 07/04
-------------------	-----	---------------

VW

BORA 1.9 TDI	ARL	05/00 ⇨ 05/05
BORA 1.9 TDI 4motion	ARL	05/00 ⇨ 05/05
GOLF IV 1.9 TDI	ARL	05/00 ⇨ 06/06
GOLF IV 1.9 TDI 4motion	ARL	02/00 ⇨ 06/05
GOLF IV 1.9 TDI GTI	ARL	06/01 ⇨ 06/06

10.3074



3,5

ABSOLUTE PRESSURE SENSORS (MAP)

Adatt./Suitable:

AUDI

03D 906 051

SEAT

03D 906 051

SIEMENS

5WK 9693

A2C53300430

SKODA

03D 906 051

03D 906 051 A

VW

03D 906 051

03D 906 051 A

MARKET DIFFUSION: MEDIUM



kPa	mV	O + NTC -
15 - 120	250 - 4750	

AUDI

A4 II 2.0	ALT	11/00 ⇨ 12/05
A4 II 2.0 FSI	AWA	07/02 ⇨ 12/04

SEAT

IBIZA III 1.2	BBM	06/07 ⇨ 05/08
---------------	-----	---------------

SKODA

FABIA I 1.0	AQV, AWY	12/99 ⇨ 08/02
FABIA I 1.2	AWY, AME	07/01 ⇨ 12/07
FABIA I 1.4	AME, BBM	04/00 ⇨ 05/03
FABIA II 1.2	BBM, BMD	12/06 ⇨ 12/14
FABIA II 1.2 LPG	CHFA	03/09 ⇨ 11/11
OCTAVIA I 1.4	AMD	04/99 ⇨ 03/01

VW

FOX 1.2	BMD, AWY	04/05 ⇨ 12/11
POLO IV 1.2	AWY, CAVG	01/02 ⇨ 11/09

10.3075



3,5

ABSOLUTE PRESSURE SENSORS (MAP)

Adatt./Suitable:

AUDI

- 03G 906 051 C
- 03G 906 051 E
- 03G 906 051 F
- 03G 906 051 M
- 04E 906 051

BENTLEY

- 03G 906 051 E
- 3Y0 906 051
- 3Y0 906 051 A

BOSCH

- 0 261 230 388
- 0 261 230 389
- 0 261 230 566
- 0 281 002 401
- 0 281 002 402
- 0 281 002 837
- 0 281 002 838
- 0 281 002 976
- 0 281 002 977

FORD

- 1 209 552
- 3M21-9E928-AA

MITSUBISHI

- MN191138

PORSCHE

- 03G 906 051 E
- 955 606 180 10

SEAT

- 038 906 051 C
- 03G 906 051 E
- 03G 906 051 M
- 04E 906 051

SKODA

- 038 906 051 C
- 03G 906 051 E
- 04E 906 051

VW

- 038 906 051 C
- 03G 906 051 E
- 03G 906 051 F
- 03G 906 051 M
- 04E 906 051

MARKET DIFFUSION: HIGH



kPa	mV	O + NTC -
11 - 307	250 - 4750	

AUDI

A1 1.4 TFSI	CAVG, CAYB	01/11 → 10/18
A1 1.4 TSI	CZEA	11/14 → 10/18
A1 1.6 TDI	CAYB, CFHB	05/10 → 04/15
A1 1.8 TFSI	DAJB	02/15 → 10/18
A1 2.0 TDI	CFHB, CHZL	09/11 → 04/15
A1 2.0 TFSI quattro	CDLH	03/12 → 11/12
A1 25 TFSI	CHZL, DKJA	11/18 →
A1 30 TFSI	DKJA, CZPC	07/18 →
A1 40 TFSI	CZPC, CAYB	09/18 →
A1 S1 quattro	CWZA	03/14 → 10/18
A2 1.4 TDI	ATL	11/03 → 08/05
A3 I [USA] 2.0	CBEA	08/09 →
A3 I [USA] 2.0 16V	--	01/06 → 12/10
A3 I 1.9 TDI	ASZ	08/00 → 05/03
A3 I 1.9 TDI quattro	ASZ	08/00 → 05/03
A3 II 1.6 TDI	CAYB, AZV	05/09 → 05/13
A3 II 2.0 TDI	AZV, BKD	05/03 → 05/13
A3 II 2.0 TDI 16V	BKD, BKD	05/03 → 08/12
A3 II 2.0 TDI 16V quattro	BKD, AZV	08/04 → 08/12
A3 II 2.0 TDI quattro	AZV, BHZ	05/03 → 08/12
A3 II 2.0 TFSI	CAWB	09/04 → 05/13
A3 II S3 quattro	BHZ, CAYB	11/06 → 08/12
A3 II SPORTBACK 1.6 TDI	CAYB, AZV	05/09 → 03/13
A3 II SPORTBACK 2.0 TDI	AZV, BKD	09/04 → 03/13
A3 II SPORTBACK 2.0 TDI 16V	BKD, BKD	09/04 → 03/13
A3 II SPORTBACK 2.0 TDI 16V quattro	BKD, BMM	11/05 → 03/13
A3 II SPORTBACK 2.0 TDI quattro	BMM, BHZ	01/06 → 03/13
A3 II SPORTBACK 2.0 TFSI	CAWB	09/04 → 03/13

A3 II SPORTBACK RS3 quattro	CEPA	01/11 → 12/12
A3 II SPORTBACK S3 quattro	BHZ, CHZD	06/08 → 03/13
A3 III 1.0 TFSI	CHZD, CJZA	07/16 →
A3 III 1.2 TFSI	CJZA, CMBA	02/13 →
A3 III 1.4 TFSI	CMBA, CUKB	04/12 →
A3 III 1.4 TFSI e-tron	CUKB, CJSA	05/14 →
A3 III 1.4 TFSI g-tron	CPWA	11/13 →
A3 III 1.4 TFSI	CZEA	05/14 →
A3 III 1.8 TFSI	CJSA, CZPB	04/12 →
A3 III 1.8 TFSI quattro	CJSB	08/12 →
A3 III 2.0 TFSI	CZPB, CNTC	05/16 →
A3 III 2.0 TFSI quattro	CNTC, CHZD	05/14 →
A3 III 30 TFSI	CHZD, CJXB	07/18 →
A3 III RS3 quattro	CZGB	03/15 →
A3 III S3 quattro	CJXB, BPW	11/12 →
A4 II 2.0 TDI	BPW, ASB	01/06 → 03/09
A4 II 2.7 TDI	BPP	06/06 → 03/09
A4 II 3.0 TDI quattro	ASB, BNA	01/06 → 03/09
A4 III 2.0 TDI	BNA, BLB	11/04 → 06/08
A4 III 2.0 TDI 16V	BLB, BPW	11/04 → 06/08
A4 III 2.0 TDI quattro	BPW, BPP	01/06 → 06/08
A4 III 2.7 TDI	BPP, ASB	11/05 → 06/08
A4 III 3.0 TDI quattro	ASB, CAGA	11/04 → 06/08
A4 IV 1.8 TFSI	CJEB	11/11 → 12/15
A4 IV 1.8 TFSI quattro	CJEB	11/11 → 12/15
A4 IV 2.0 TDI	CAGA, CAGA	11/07 → 12/15
A4 IV 2.0 TDI quattro	CAGA, CAMA	01/08 → 12/15
A4 IV 2.0 TFSI	CNCD	05/13 → 12/15
A4 IV 2.0 TFSI quattro	CNCD	05/13 → 12/15
A4 IV 2.7 TDI	CAMA, CAPA	11/07 → 03/12
A4 IV 3.0 TDI	CLAB	11/11 → 12/15
A4 IV 3.0 TDI quattro	CAPA, CAGA	11/07 → 12/15
A4 IV ALLROAD 2.0 TDI quattro	CAGA, CCWA	04/09 → 05/16
A4 IV ALLROAD 2.0 TFSI quattro	CNCD	05/13 → 05/16
A4 IV ALLROAD 3.0 TDI quattro	CCWA, CYRB	04/09 → 05/16
A4 V 1.4 TFSI	CVNA	08/15 →
A4 V 2.0 TFSI	CYRB, DKYA	11/15 →
A4 V 2.0 TFSI g-tron	CVLA	11/16 →
A4 V 2.0 TFSI Mild Hybrid	DKYA, CYRB	01/18 →
A4 V 2.0 TFSI quattro	CYRB, CJEB	08/15 →
A4 V 35 TFSI Mild Hybrid	DLVB	12/18 →
A4 V 45 TFSI	DKNA	07/18 →
A4 V 45 TFSI quattro	DKNA	07/18 →
A4 V ALLROAD 2.0 TFSI quattro	CYRC	05/16 →
A4 2.0 45 TFSI	DKNA	07/18 →
A5 I 1.8 TFSI	CJEB, CAGA	10/07 → 01/17
A5 I 2.0 TDI	CAGA, CAHA	08/08 → 01/17
A5 I 2.0 TDI quattro	CAHA, CNCD	08/08 → 01/17
A5 I 2.0 TFSI	CNCD, CAEB	05/13 → 01/17
A5 I 2.0 TFSI quattro	CAEB, CAMA	06/08 → 01/17
A5 I 2.7 TDI	CAMA, CAPA	06/07 → 01/17
A5 I 3.0 TDI	CLAB	10/11 → 01/17
A5 I 3.0 TDI quattro	CAPA, AVF	06/07 → 01/17
A5 II 1.4 TFSI	CVNA	01/17 →
A6 II 1.9 TDI	AVF, BLB	08/01 → 01/05
A6 III 2.0 TDI	BLB, BSG	07/04 → 08/11
A6 III 2.7 TDI	BSG, BSG	11/04 → 08/11
A6 III 2.7 TDI quattro	BSG, BNG	06/05 → 08/11
A6 III 3.0 TDI quattro	BNG, CGLC	05/04 → 08/11
A6 IV 1.8 TFSI	CYGA	09/14 → 09/18
A6 IV 2.0 TDI	CGLC, CYNB	03/11 → 09/18
A6 IV 2.0 TFSI	CYNB, CYNB	09/14 → 09/18
A6 IV 2.0 TFSI quattro	CYNB, CLAB	05/14 → 09/18
A6 IV 3.0 TDI	CLAB, CDUC	11/10 → 09/18
A6 IV 3.0 TDI quattro	CDUC, DKNA	03/11 →
A6 V 45 TFSI Mild Hybrid	DKNA, DKNA	08/18 →
A6 V 45 TFSI Mild Hybrid quattro	DKNA, DKNA	08/18 →
A7 SPORTBACK 1.8 TFSI	CYGA	04/15 → 05/18
A7 SPORTBACK 2.0 TFSI	CYPA	09/14 → 05/18
A7 SPORTBACK 2.0 TFSI quattro	CYNB, CLAB	05/15 → 05/18
A7 SPORTBACK 3.0 TDI	CLAB, CDUC	11/10 → 05/18
A7 SPORTBACK 3.0 TDI quattro	CDUC, BMC	10/10 → 05/18
A7 45 TFSI	DKNA, DKNA	07/18 →
A7 45 TFSI quattro	DKNA, CYNB	07/18 →
A8 II 4.2 TDI quattro	BMC, CDTA	01/05 → 07/10
A8 III 2.0 TFSI quattro	CYPA	09/16 → 01/18
A8 III 3.0 TDI	CLAB	09/11 → 09/13
A8 III 3.0 TDI quattro	CDTA, CDSB	07/10 →
A8 III 4.2 TDI quattro	CDSB, CHZJ	11/09 → 01/18
Q2 1.0 TFSI	CHZJ, CZPB	10/16 →
Q2 1.4 TFSI	CZEA	06/16 →
Q2 2.0 TFSI quattro	CZPB, CHZJ	05/17 →

AUDI	CHZI, CZPB	07/18 →
Q2 30 TFSI	CZPB, CHPB	09/18 →
Q2 40 TFSI quattro	DNUe	08/18 →
Q2 SQ2 TFSI quattro	DNUe	08/18 →
Q3 1.4 TSI	CHPB, CFFA	10/13 → 10/18
Q3 2.0 TDI	CFFA, CFFB	06/11 → 10/18
Q3 2.0 TDI quattro	CFFB, CCTA	06/11 → 10/18
Q3 2.0 TFSI	CCTA, CULB	10/13 →
Q3 2.0 TFSI quattro	CULB, C TSA	11/14 → 10/18
Q3 45 TFSI	DKTA	07/18 →
Q3 45 TFSI quattro	DKTA	07/18 →
Q3 RS 2.5 quattro	C TSA, CJC B	05/13 → 10/18
Q3 RS performance 2.5 quattro	CZGB	01/15 → 10/18
Q5 I 2.0 TDI	CJCB, CAGB	11/10 →
Q5 I 2.0 TDI quattro	CAGB, CDN B	11/08 →
Q5 I 2.0 TFSI quattro	CDN B, CCWA	08/09 →
Q5 I 3.0 TDI	CTBC	06/12 →
Q5 I 3.0 TDI quattro	CCWA, DAXB	11/08 →
Q5 II 2.0 TFSI quattro	DAXB, BUG	06/16 →
Q7 I 3.0 TDI quattro	BUG, BTR	03/06 → 08/15
Q7 I 4.2 TDI quattro	BTR, CB B B	03/07 → 08/15
Q7 I 6.0 TDI quattro	CCGA	09/08 → 05/14
Q7 II 2.0 TFSI quattro	CYRB	08/15 →
TT II 2.0 TDI quattro	CB B B, CDLA	06/08 → 06/14
TT II 2.0 TTS quattro	CDLA, CEPA	05/08 → 06/14
TT II 2.5 RS quattro	CEPA, CISA	07/09 → 06/14
TT III 1.8 TFSI	CJSA, CHHC	08/15 →
TT III 2.0 TFSI	CHHC	07/14 →
TT III 2.0 TFSI quattro	CHHC, CJXF	07/14 →
TT III 2.0 TTS quattro	CJXF, CKBB	11/14 →
BENTLEY		
BENTAYGA 6.0	DDBB	10/15 →
CONTINENTAL 6.0 AWD	DDBD	09/17 →
MULSANNE 6.8	CKBB, ASZ	09/09 →
FORD		
GALAXY I 1.9 TDI	ASZ, BSY	02/03 → 05/06
MITSUBISHI		
GRANDIS 2.0 DI-D	BSY, BKD	09/05 → 03/10
LANCER VIII 2.0	--	01/01 →
LANCER IX 2.0 DI-D	BKD, M05.9E	06/08 →
OUTLANDER II 2.0 DI-D	BSY	12/06 → 11/12
PORSCHE		
CAYENNE I 3.0 TDI	M05.9D	02/09 → 09/10
CAYENNE II 3.0 Diesel	M05.9E, MCU.DB	06/10 →
CAYENNE II 4.2 S Diesel	MCU.DB, MCN.CC	10/12 →
MACAN 2.0	MCN.CC, MCD.UD	07/14 →
MACAN 3.0 S [ExtraEU]	MCD.UD	02/14 →
MACAN 3.0 S Diesel	MCD.UD, MCR.C	02/14 →
PANAMERA 3.0 D	MCR.C, ASZ	08/11 → 07/13
SEAT		
ALHAMBRA I / II 1.9 TDI	ASZ, CAVA	11/02 → 11/08
ALHAMBRA I / II 1.9 Tdi 4x4	ASZ	06/05 → 11/08
ALHAMBRA I / II 2.0 TDI	BRT	11/05 → 03/10
ALHAMBRA III 1.4 TSI	CAVA, CFFA	06/10 →
ALHAMBRA III 2.0 TDI	CFFA, CAYB	06/10 →
ALHAMBRA III 2.0 TDI 4Drive	CFFB	05/11 →
ALHAMBRA III 2.0 TSI	DEDA	05/15 →
ALTEA 1.6 TDI	CAYB, BJB	10/09 →
ALTEA 1.9 TDI	BJB, AZV	04/04 →
ALTEA 2.0 TDI	AZV, BKD	03/04 →
ALTEA 2.0 TDI 16V	BKD, CAYB	03/04 →
ALTEA 2.0 TDI 16V 4WD	CFHC	10/10 →
ALTEA XL 1.6 TDI	CAYB, BKC	10/09 →
ALTEA XL 1.9 TDI	BKC, AZV	10/06 →
ALTEA XL 1.9 TDI 4x4	BLS	06/09 → 12/10
ALTEA XL 2.0 TDI	AZV, BKD	10/06 →
ALTEA XL 2.0 TDI 16V	BKD, BMM	10/06 →
ALTEA XL 2.0 TDI 16V 4x4	CFHC	10/10 →
ALTEA XL 2.0 TDI 4x4	BMM, CHZJ	06/07 →
ATECA 1.0 TSI	CHZJ, CZPB	05/16 →
ATECA 1.4 TSI	CZEA	06/16 →
ATECA 1.4 TSI 4Drive	CZEA	06/16 →
ATECA 2.0 TSI 4Drive	CZPB, ASZ	05/17 →
CORDOBA II 1.9 SDI	ASY	09/02 → 11/09
CORDOBA II 1.9 TDI	ASZ, CAGA	10/02 → 11/09
EXEO 2.0 TDI	CAGA, ASZ	12/08 →
IBIZA III 1.9 TDI	ASZ, BPX	02/02 → 11/09
IBIZA III 1.9 TDI Cupra R	BPX, CJZC	03/04 → 02/08
IBIZA IV 1.2 TDI	CFWA	04/10 →
IBIZA IV 1.2 TSI	CJZC, CAVF	05/15 →
IBIZA IV 1.4 TSI	CAVE, CAVE	06/09 →
IBIZA IV 1.4 TSI Cupra	CAVE, CAYB	06/09 →
IBIZA IV 1.6 TDI	CAYB, ARL	05/09 →
IBIZA IV 1.8 TSI Cupra	DAJA	11/15 →
IBIZA IV 2.0 TDI	CFHD	01/10 →
IBIZA V 1.0 TGI	DBYA	11/17 →
IBIZA 1.2 TDI	CFWA	05/10 →
IBIZA 1.6 Tdi	CAYB	05/09 →

SEAT			
LEON I 1.9 TDI	ARL, CAYB	09/00	⇒ 06/06
LEON I 1.9 TDI Syncro	ARL	05/02	⇒ 06/06
LEON II 1.6 TDI	CAYB, AZV	02/10	⇒ 12/12
LEON II 2.0 Cupra R	CDLA	09/09	⇒ 12/12
LEON II 2.0 TDI	AZV, BKD	07/05	⇒ 12/12
LEON II 2.0 TDI 16V	BKD, BWJ	07/05	⇒ 12/12
LEON II 2.0 TFSI	BWJ, CHZD	11/06	⇒ 05/11
LEON III 1.0 TSI	CHZD, CJZA	05/15	⇒
LEON III 1.2 TSI	CJZA, CHPA	12/12	⇒
LEON III 1.4 TGI	CPWA	02/13	⇒
LEON III 1.4 TSI	CHPA, CJSA	09/12	⇒
LEON III 1.8 TFSI	CJSA	02/13	⇒
LEON III 1.8 TSI	CJSA	02/13	⇒
LEON III 1.8 TSI 4Drive	CJSA, CJXA	11/14	⇒
LEON III 2.0 Cupra	CJXA, CJXC	10/13	⇒
LEON III 2.0 Cupra 4Drive	CJXC, CJZB	11/16	⇒
LEON III 2.0 Cupra R	CJXC	11/17	⇒
LEON III 2.0 TSI	DKZA	09/18	⇒
LEON ST 1.0 TSI	CHZD	05/15	⇒
LEON ST 1.2 TSI	CHZB, CZDA	01/13	⇒
LEON ST 1.4 TSI	CJZA, CJXA	05/14	⇒
LEON ST 1.8 TFSI	CJSA	10/13	⇒
LEON ST 2.0 Cupra	CJXA, ARL	10/13	⇒
LEON ST 2.0 Cupra 4Drive	CJXC	11/16	⇒
TARRACO 2.0 TSi	DKZA	11/18	⇒
TOLEDO II 1.9 TDI	ARL, AZV	10/00	⇒ 05/06
TOLEDO III 2.0 TDI	AZV, CHZB	09/04	⇒ 05/09
TOLEDO III 2.0 TDI 16V	BKD	04/04	⇒ 05/09
TOLEDO IV 1.0 TSI	CHZB, CJZC	05/17	⇒
TOLEDO IV 1.2 TSI	CJZC, CAYB	05/15	⇒
TOLEDO IV 1.4 TSI	CZCA	05/15	⇒
TOLEDO IV 1.6 TDI	CAYB, ASZ	07/12	⇒

SKODA

FABIA I 1.9 TDI RS	ASZ, CAVE	06/03	⇒ 03/08
FABIA II 1.2 TDI	CFWA	05/10	⇒ 12/14
FABIA II 1.4 TSI RS	CAVE, CAYA	05/10	⇒ 12/14
FABIA II 1.6 TDI	CAYA, CHZB	03/10	⇒ 12/14
FABIA III 1.0 TSI	CHZB, CJZC	08/14	⇒
FABIA III 1.2 TSI	CJZC, CZCA	08/14	⇒
FABIA III 1.4 TSI R5	CZCA	02/18	⇒
KAROQ 1.0 TSI	CHZJ	07/17	⇒
KODIAQ 1.4 TSI	CZCA, CZDA	10/16	⇒
KODIAQ 1.4 TSI 4x4	CZDA, AZV	10/16	⇒
KODIAQ 2.0 TSI 4x4	CZPA	10/16	⇒
OCTAVIA I 1.9 TDI	ASZ	09/02	⇒ 09/04
OCTAVIA II 1.6 TDI	CAYC	06/09	⇒ 04/13
OCTAVIA II 1.6 TDI 4x4	CAYC	06/09	⇒ 02/13
OCTAVIA II 2.0 TDI	AZV, AZV	02/04	⇒ 06/13
OCTAVIA II 2.0 TDI 16V	AZV, BKD	02/04	⇒ 05/13
OCTAVIA II 2.0 TDI 16V 4x4	BKD, BMM	05/10	⇒ 02/13
OCTAVIA II 2.0 TDI 4x4	BMM, BMN	07/06	⇒ 02/13
OCTAVIA II 2.0 TDI RS	BMN, CHZD	04/06	⇒ 02/13
OCTAVIA III 1.0 TSI	CHZD, CJZA	05/16	⇒
OCTAVIA III 1.2 TSI	CJZA, CHPA	11/12	⇒
OCTAVIA III 1.4 [CHN]	CSSA	02/14	⇒
OCTAVIA III 1.4 TSI	CHPA, CJSA	11/12	⇒
OCTAVIA III 1.4 TSI G-TEC	CPWA	11/13	⇒
OCTAVIA III 1.8 TSI	CJSA, CJSA	11/12	⇒
OCTAVIA III 1.8 TSI 4x4	CJSA, CHHA	11/12	⇒
OCTAVIA III 2.0 TSI	DKZA	02/17	⇒
OCTAVIA III 2.0 TSI RS	CHHA, CHZB	11/12	⇒
RAPID 1.0 TSI	CHZB, CJZC	07/12	⇒
RAPID 1.2 TSI	CJZC, CAYB	05/15	⇒
RAPID 1.4 TSI	CZCA	05/15	⇒
RAPID 1.6 TDI	CAYB, CAYA	07/12	⇒
ROOMSTER 1.2 TDI	CFWA	03/10	⇒ 05/15
ROOMSTER 1.6 TDI	CAYA, AVF	03/10	⇒ 05/15
SUPERB I 1.9 TDI	AVF, --	12/01	⇒ 03/08
SUPERB I 2.0	--, BMP	02/06	⇒
SUPERB I 2.0 TDI	BSS	10/05	⇒ 03/08
SUPERB II 1.6 TDI	CAYC	09/10	⇒ 05/15
SUPERB II 2.0 TDI	BMP, BKD	03/08	⇒ 05/15
SUPERB II 2.0 TDI 16V	BKD, CBBB	01/09	⇒ 05/15
SUPERB II 2.0 TDI 16V 4x4	CFFB	11/10	⇒ 05/15
SUPERB II 2.0 TDI 4x4	CBBB, CZCA	09/08	⇒ 05/15
SUPERB III 1.4 TSI	CZCA, CZDA	03/15	⇒
SUPERB III 1.4 TSI 4x4	CZDA, CJSA	03/15	⇒
SUPERB III 1.8 TSI	CJSA, CFHA	03/15	⇒
SUPERB III 2.0 TSI	CHHB	03/15	⇒
SUPERB III 2.0 TSI 4x4	CJXA	03/15	⇒
YETI 1.2 TSI	CYVB	05/15	⇒ 12/17
YETI 1.4 TSI	CZCA	05/15	⇒ 12/17
YETI 1.4 TSI 4x4	CZDA	05/15	⇒ 12/17
YETI 1.6 TDI	CAYC	11/10	⇒ 05/15
YETI 2.0 TDI	CFHA, CBDB	11/09	⇒ 12/17
YETI 2.0 TDI 4x4	CBDB, CZPB	05/09	⇒ 12/17

VW

AMAROK 2.0 TSI	CFPA	12/10	⇒
----------------	------	-------	---

VW

ARTEON 2.0 TSI	CZPB, CAVD	05/17	⇒
ARTEON 2.0 TSI 4motion	DJHC	04/17	⇒
ATLAS 2.0 TSI 4motion	CXDA	12/17	⇒
BEEBLE 1.2 TSI 16V	CYVD	12/14	⇒
BEEBLE 1.4 TSI	CAVD, CPKA	10/11	⇒
BEEBLE 1.6 TDI	CAYC	10/11	⇒ 07/16
BEEBLE 1.8 TSI	CPKA, CFFB	12/13	⇒
BEEBLE 2.0 TDI	CFFB, CCTA	04/11	⇒ 07/16
BEEBLE 2.0 TSI	CCTA, ARL	04/11	⇒
BORA 1.9 TDI	ARL, ARL	05/00	⇒ 05/05
BORA 1.9 TDI 4motion	ARL, CHZG	05/00	⇒ 05/05
CADDY III 1.0 TSI	CHZG, CZCB	11/15	⇒
CADDY III 1.2 TSI	CYVC	06/15	⇒
CADDY III 1.4 TSI CNG	CPWA	06/15	⇒
CADDY III 1.4 TSI	CZCB, CAYD	05/15	⇒
CADDY III 1.6 TDI	CAYD, BMM	08/10	⇒
CADDY III 2.0 TDI	BMM, CFHC	09/07	⇒
CADDY III 2.0 TDI 16V	CFHC, CFHC	11/10	⇒ 05/15
CADDY III 2.0 TDI 16V 4motion	CFHC, CAAB	11/10	⇒ 05/15
CADDY III 2.0 TDI 4motion	CFHC, CAAB	08/10	⇒
CAMPMOBILE 2.0 TDi	CCHB	05/10	⇒ 08/15
CAMPMOBILE 2.0 TDi BlueMotion	CAAB, AXD	04/15	⇒
CAMPMOBILE 2.5 TDi	AXD, CKMA	03/04	⇒ 11/09
CC 1.4 TSI	CKMA, CFFA	11/11	⇒ 12/16
CC 1.4 TSI MultiFuel	CKMA	11/11	⇒ 12/16
CC 2.0 TDI	CFFA, CFFB	11/11	⇒ 12/16
CC 2.0 TDI 4motion	CFFB, BJJ	11/11	⇒ 12/16
CRAFTER 2.5 TDI	BJJ, CAVD	04/06	⇒
EOS 1.4 TSI	CAVD, BMM	05/08	⇒ 08/15
EOS 2.0 TDI	BMM, CBAB	06/06	⇒ 08/15
EOS 2.0 TDI 16V	CBAB, CJZA	05/08	⇒ 08/15
GOLF IV 1.9 TDI	ASZ	11/00	⇒ 06/06
GOLF IV 1.9 TDI 4motion	ARL, BLG	11/00	⇒ 06/06
GOLF V 1.4 TSI	BLG, AZV	11/05	⇒ 12/13
GOLF V 2.0 GTI	BYD	09/06	⇒ 12/08
GOLF V 2.0 TDI	AZV, BKD	10/03	⇒
GOLF V 2.0 TDI 16V	BKD, CJZA	10/03	⇒ 12/13
GOLF V 2.0 TDI 16V 4motion	BKD	08/04	⇒ 11/08
GOLF V 2.0 TDI 4motion	AZV	08/04	⇒ 07/09
GOLF VI 1.2 TSI 16V	CYVD	11/13	⇒ 05/16
GOLF VI 1.4	CNWA	04/11	⇒ 05/12
GOLF VI 1.4 TSI	CAVD, CAYB	10/08	⇒
GOLF VI 1.6 TDI	CAYB, CDLA	02/09	⇒
GOLF VI 1.6 TDI 4motion	CAYC	07/09	⇒ 07/13
GOLF VI 2.0	CDLF	05/11	⇒
GOLF VI 2.0 GTi	CDLG	05/11	⇒ 11/12
GOLF VI 2.0 R	CDLA	01/13	⇒ 05/16
GOLF VI 2.0 R 4motion	CDLA, BMM	11/09	⇒ 11/13
GOLF VI 2.0 TDI	BMM, CBAB	10/08	⇒
GOLF VI 2.0 TDI 4motion	CBAB, CDLC	05/09	⇒
GOLF VI 2.0 TDI Gtd	CFGB	05/11	⇒
GOLF VI 2.0 TFSi	CRZA	11/11	⇒
GOLF VI 2.0 TFSi Gti	CDLG	05/11	⇒
GOLF VI 2.0 TSI	CDLC, CHZC	01/13	⇒
GOLF 1.2 TSI BlueMotion	CJZA, CHPA	08/12	⇒
GOLF 1.4 TSI	CAVD	10/08	⇒ 11/12
GOLF 1.4 TSI BlueMotion	CHPA, CHHA	08/12	⇒
GOLF 1.6 TDi	CAYB	02/09	⇒ 11/12
GOLF 1.6 TDi BlueMotion	CAYC	05/09	⇒ 11/12
GOLF 2.0 GTi	CHHA, CFFB	04/13	⇒
GOLF 2.0 TDi	CFFB, ARL	09/09	⇒ 08/14
GOLF 2.0 TSi R 4motion	CDLF	11/09	⇒ 11/12
GOLF VII 1.0 TSI	CHZC, CJZA	05/15	⇒
GOLF VII 1.2 TSI	CJZA, CPWA	08/12	⇒
GOLF VII 1.4 GTE Hybrid	CUKB	05/14	⇒
GOLF VII 1.4 TGI CNG	CPWA, CHPA	06/13	⇒
GOLF VII 1.4 TSI	CHPA, CPVA	08/12	⇒
GOLF VII 1.4 TSI MultiFuel	CPVA, CHHA	04/13	⇒
GOLF VII 1.8 TSI 4motion	CJSB	12/14	⇒
GOLF VII 2.0 GTI	CHHA, CJXB	04/13	⇒
GOLF VII 2.0 GTI Clubsport	CJXE	02/16	⇒
GOLF VII 2.0 GTI Clubsport S	CJXB	09/16	⇒
GOLF VII 2.0 R 4motion	CJXB, BLG	11/13	⇒
GOLF VII 2.0 TFSi	CYFB	11/13	⇒
GOLF VAN 1.2 TSI BlueMotion	CJZA, CHPA	04/13	⇒ 03/17
GOLF VAN 1.4 TSI	CAVD	07/09	⇒ 10/12
GOLF VAN 1.4 TSI BlueMotion	CHPA, CBDB	05/13	⇒ 03/17
GOLF VAN 1.6 TDi	CAYB	12/09	⇒ 10/12
GOLF VAN 1.6 TDi BlueMotion	CAYC	07/09	⇒ 05/14
GOLF VAN 2.0 TDi	CBDB, CAVD	07/09	⇒ 05/19
JETTA V 1.4 TSI	BLG, CAYB	07/06	⇒ 10/10
JETTA V 1.6 TDI	CAYB, AZV	06/09	⇒ 10/10
JETTA V 2.0 TDI	AZV, BKD	09/05	⇒ 10/10
JETTA V 2.0 TDI 16V	BKD, CJZD	08/05	⇒ 10/10
JETTA VI 1.2 TSI	CJZD, CAVA	02/11	⇒
JETTA VI 1.2 TSI 16V	CYVD	08/14	⇒

VW

JETTA VI 1.4 TSI	CAVA, CNLA	04/11	⇒
JETTA VI 1.4 TSI Hybrid	CNLA, CPKA	04/11	⇒
JETTA VI 1.6 TDI	CAYC	04/10	⇒ 07/14
JETTA VI 1.8 TSI	CPKA, CFFB	07/14	⇒
JETTA VI 2.0 TDI	CFFB, CPLA	10/10	⇒
JETTA VI 2.0 TSI	CPLA, CAAA	12/12	⇒
UP 1.0 GTI	DKRA	11/17	⇒
UP 1.0 TSI	CHZA	05/16	⇒
UP 1.0 TSi BlueMotion	CHZA	05/16	⇒
MULTIVAN 2.0 TDI	CAAA, CAAC	09/09	⇒
MULTIVAN 2.0 TDI 4motion	CAAC, AXD	09/09	⇒
MULTIVAN 2.5 TDI	AXD, AXD	04/03	⇒ 11/09
MULTIVAN 2.5 TDI 4motion	AXD, CFFB	07/04	⇒ 11/09
NEW BEETLE 1.8 T	AWP	11/01	⇒ 06/05
NEW BEETLE 1.9 TDI	ALH	01/98	⇒ 06/04
PASSAT 1.6 TDi BlueMotion	CAYC	08/10	⇒ 12/14
PASSAT 2.0 Blue TDi/TDi/TDi BlueMotion [ExtraEU]	CFFB	08/10	⇒ 12/14
PASSAT 2.0 TDi BlueMotion	CFFB, CBAA	08/10	⇒ 12/14
PASSAT 2.0 TFSi BlueMotion	DNUA	09/18	⇒
PASSAT IV 1.9 TDI	AVF, CKMA	11/00	⇒ 05/05
PASSAT IV 1.9 TDI 4motion	AVF	11/00	⇒ 05/05
PASSAT IV 2.0 TDI	BGW	12/03	⇒ 05/05
PASSAT V 1.4 TSI	CKMA, CPKA	11/12	⇒ 12/14
PASSAT V 1.4 TSi EcoFuel	CDGA	01/09	⇒ 12/14
PASSAT V 1.4 TSi MultiFuel	CKMA	11/10	⇒ 12/14
PASSAT V 1.6 TDI	CAYC	08/09	⇒ 12/14
PASSAT V 1.8 TSI	CPKA, BMA	06/13	⇒
PASSAT V 2.0 BlueTDI	CBAC	01/09	⇒ 11/10
PASSAT V 2.0 TDI	BMA, BKP	03/05	⇒
PASSAT V 2.0 TDI 16V	BKP, BKP	03/05	⇒ 11/10
PASSAT V 2.0 TDI 16V 4motion	BKP, BMP	03/05	⇒ 11/10
PASSAT V 2.0 TDI 4motion	BMP, CZCA	03/05	⇒ 12/14
PASSAT VI 1.4 GTE Hybrid	CUKC	06/15	⇒
PASSAT VI 1.4 TSI	CZCA, CJSA	11/14	⇒
PASSAT VI 1.4 TSI 4motion	CZEA	02/15	⇒
PASSAT VI 1.8 TSI	CJSA, CHHB	02/15	⇒
PASSAT VI 2.0 TSI	CHHB, CHHB	02/15	⇒
PASSAT VI 2.0 TSi 4motion	CHHB, BMK	05/15	⇒
PASSAT CC 1.4 TSi MultiFuel	CKMA	01/11	⇒ 01/12
PASSAT CC 2.0 BlueTDI	CBAC	05/09	⇒ 11/10
PASSAT CC 2.0 TDI	CBAA, CBAB	06/08	⇒ 01/12
PASSAT CC 2.0 TDI 4motion	CBAB, AVF	08/09	⇒ 01/12
PHAETON 3.0 V6 TDI 4motion	BMK, ASZ	09/04	⇒ 03/16
PHAETON 5.0 V10 TDI 4motion	AJS	11/02	⇒ 10/06
POLO IV 1.9 TDI	ASZ, CJZC	11/03	⇒ 11/09
POLO V 1.0 TSI	CHZB	11/14	⇒
POLO V 1.2 TDI	CFWA	10/09	⇒
POLO V 1.2 TDi BlueMotion	CFWA	10/09	⇒ 05/14
POLO V 1.2 TSI	CJZC, CAVE	01/14	⇒
POLO V 1.2 TSI 16V	CJZC	02/14	⇒
POLO V 1.4 GTI	CAVE, CPTA	05/10	⇒
POLO V 1.4 TSI	CPTA, CWXA	10/12	⇒
POLO V 1.4 TSI [RUS]	CZCA	05/14	⇒
POLO V 1.5 TDI [IND]	CWXA, CAYA	05/14	⇒
POLO V 1.6 TDI	CAYA, DAJA	06/09	⇒
POLO V 1.6 TDi BlueMotion	CAYB	06/09	⇒ 05/14
POLO V 1.8 GTI	DAJA, CHZJ	11/14	⇒
POLO V 2.0 R WRC	CDLJ	08/13	⇒
POLO VI 1.0 TGI	DBYA	09/17	⇒
POLO VI 1.0 TSI	CHZI, CZPC	06/17	⇒
POLO VI 2.0 GTI	CZPC, CBBB	11/17	⇒
T-ROC 1.0 TSi	CHZI	07/17	⇒
T-ROC 2.0 TSi 4motion	CZPB	07/17	⇒
SCIROCCO III 1.4 TSI	CAVD, CDLA	05/08	⇒
SCIROCCO III 2.0 R	CDLA, CBBB	11/09	⇒ 11/17
SCIROCCO III 2.0 TDI	CBBB, CULA	08/08	⇒ 11/17
SCIROCCO III 2.0 TSi	CULA, ASZ	11/13	⇒ 11/17
SCIROCCO 1.4 TSi	CAVD	06/08	⇒ 05/14
SCIROCCO 2.0 TDi	CBBB, CAVD	08/08	⇒ 05/14
SHARAN I 1.9 TDI	ASZ, BRT	11/02	⇒ 03/10
SHARAN I 2.0 TDI	BRT, CAVA	11/05	⇒ 03/10
SHARAN II 1.4 TSI	CAVA, BWK	05/10	⇒
SHARAN II 2.0 TDI	CFGC	01/13	⇒
SHARAN II 2.0 TDI 4motion	CFFA	05/11	⇒ 05/12
SHARAN II 2.0 TSI	DEDA	05/15	⇒
TIGUAN 2.0 TSi	DKZA	09/18	⇒
TIGUAN I 1.4 TSI	BWK, BWK	05/08	⇒
TIGUAN I 1.4 TSi 4motion	BWK, CBAB	09/07	⇒
TIGUAN I 2.0 TDI	CBAB, CBAA	03/08	⇒
T			

VW		
TOUAREG I 3.0 TDI	BUN, BKS	04/06 ⇒ 05/10
TOUAREG I 3.0 V6 TDI	BKS, AYH	11/04 ⇒ 05/10
TOUAREG I 4.2 V8	AXQ	12/02 ⇒ 11/06
TOUAREG I 5.0 R50 TDI	CBWA	08/07 ⇒ 05/10
TOUAREG II 5.0 V10 TDI	AYH, CASA	10/02 ⇒ 05/10
TOUAREG II 3.0 V6 TDI	CASA, BLG	01/10 ⇒ 03/18
TOUAREG II 4.2 V8 TDI	CKDA	01/10 ⇒ 03/18
TOURAN I 1.2 TSI	CBZB	05/10 ⇒ 05/15
TOURAN I 1.4 FSI	BLG, BMY	11/06 ⇒ 05/10
TOURAN I 1.4 TSI	BMY, CAYB	02/06 ⇒ 05/15
TOURAN I 1.4 TSI EcoFuel	CDGA	05/09 ⇒ 05/15
TOURAN I 1.6 TDI	CAYB, AZV	05/10 ⇒ 05/15
TOURAN I 2.0 TDI	AZV, CAAA	02/03 ⇒ 05/15
TOURAN I 2.0 TDI 16V	BKD	08/03 ⇒ 05/10
TOURAN II 1.2 TSI	CYVB	05/15 ⇒
TOURAN II 1.4 TSI	CZDA	05/15 ⇒
TOURAN II 1.8 TSI	CJSA	11/15 ⇒
TRANSPORTER V 2.0 BiTDI	CFCA	09/09 ⇒ 08/15
TRANSPORTER V 2.0 BiTDI 4motion	CFCA	09/09 ⇒ 08/15
TRANSPORTER V 2.0 TDI	CAAA, CAAC	09/09 ⇒ 08/15
TRANSPORTER V 2.0 TDI 4motion	CAAC, AXD	09/09 ⇒ 08/15
TRANSPORTER V 2.5 TDI	AXD, AXD	04/03 ⇒ 11/09
TRANSPORTER V 2.5 TDI 4motion	AXD, CAAA	04/04 ⇒ 11/09
TRANSPORTER VI 2.0 TDI	CAAA, D5BA	04/15 ⇒
TRANSPORTER VI 2.0 TDI 4motion	CAAC	06/15 ⇒

10.3077



3,5

ABSOLUTE PRESSURE SENSORS (MAP)

Adatt./Suitable:

ATE
25.1722-0026.3

FORD
1 113 276
1 879 414
1S4A-9F479-BA
E54A-9F479-BA



kPa	mV	O + NTC -
10 - 117	405 - 4750	

FORD

FOCUS I 1.4	FXDA, FXDA	04/99 ⇒ 03/05
FOCUS I 1.4 16V	FXDA, FYDA	10/98 ⇒ 11/04
FOCUS I 1.6	FYDA, FYDA	04/99 ⇒ 03/05
FOCUS I 1.6 16V	FYDA, B5254T3	10/98 ⇒ 11/04
FOCUS I 1.6 16V Flexifuel	FYDH	01/02 ⇒ 11/04

10.3076



3,5

ABSOLUTE PRESSURE SENSORS (MAP)

Adatt./Suitable:

FORD
1C1A-9F479-AA
4 138 350

JAGUAR
AJ8 2719

MARKET DIFFUSION: MEDIUM



kPa	mV	O + NTC -
36 - 261	250 - 4750	

FORD		
MONDEO II 2.0 16V DI / TDDi / TDCi	D5BA, D6BA	10/00 ⇒ 03/07
MONDEO II 2.0 16V TDDi / TDCi	D6BA, --	10/00 ⇒ 03/07
MONDEO II 2.0 TDCi	--, ABFA	10/01 ⇒ 03/07
TRANSIT III 2.0 DI	ABFA, ESFA	08/00 ⇒ 05/06
TRANSIT III 2.0 TDCi	FIFA	08/02 ⇒ 05/06
TRANSIT III 2.3	ESFA, ESFA	08/00 ⇒ 03/06
TRANSIT III 2.3 16V	ESFA, ESFA	04/01 ⇒ 05/06
TRANSIT III 2.3 16V RWD	ESFA, D2FA	08/00 ⇒ 05/06
TRANSIT III 2.4 DI	D2FA, D4FA	01/00 ⇒ 05/06
TRANSIT III 2.4 DI RWD	D4FA, D2FE	01/00 ⇒ 05/06
TRANSIT III 2.4 TD	F4FA	08/00 ⇒ 08/03
TRANSIT III 2.4 TD 4x4	F4FA	08/00 ⇒ 08/03
TRANSIT III 2.4 TDCi	H9FA	03/04 ⇒ 05/06
TRANSIT III 2.4 TDDi	D2FE, D0FA	08/00 ⇒ 03/06
TRANSIT III 2.4 TDE	D0FA, ABFA	07/01 ⇒ 05/06
TRANSIT TOURNEO 2.0	ABFA, LJ46B	06/00 ⇒ 03/06
TRANSIT 2.0 TDi	F3FA	06/00 ⇒ 03/06
TRANSIT 2.3	ESFA	09/00 ⇒ 03/06
TRANSIT 2.4 TDDi	D4FA	08/00 ⇒ 08/03

JAGUAR

X-TYPE 2.0 D	LJ46B, FXDA	07/03 ⇒ 12/09
X-TYPE 2.2 D	LJ46G	10/05 ⇒ 12/09

10.3078



3,5

ABSOLUTE PRESSURE SENSORS (MAP)

Adatt./Suitable:

BOSCH
0 261 230 090
0 261 230 091

FORD
1 367 813
6M5Y-9F479-AA

VOLVO
31355464
867728-8



kPa	mV	O + NTC -
11 - 254	250 - 4750	

FORD

FOCUS II 2.5 ST	HYDA	10/05 ⇒ 09/12
-----------------	------	---------------

VOLVO

C30 2.5 T5 [ExtraEU]	B5254T7	03/12 ⇒ 12/13
C30 T5	B5254T3, B5254T3	10/06 ⇒ 12/12
C70 II T5	B5254T3, B5254T3	03/06 ⇒ 10/09
S40 II T5	B5254T3, B5254T3	01/04 ⇒ 12/12
S40 II T5 AWD	B5254T3, B5204T3	04/04 ⇒ 12/10
S60 I 2.0 T	B5204T5	07/00 ⇒ 04/10
S60 I 2.3 T5	B5234T7	07/00 ⇒ 09/02
S60 I 2.4 CDI	D5244T3	10/03 ⇒ 12/05
S60 I 2.4 D	D5244T2	05/01 ⇒ 04/10
S60 I 2.4 D5	D5244T	01/01 ⇒ 04/10
S60 I 2.4 T	B5244T3	07/00 ⇒ 04/10

10.3080



3

ABSOLUTE PRESSURE SENSORS (MAP)

Adatt./Suitable:

BOSCH
0 261 230 043

CITROËN
1920 AJ
96 393 814 80

FIAT
9639381480

PEUGEOT
1920 AJ
96 393 814 80

MARKET DIFFUSION: HIGH



kPa	mV	O + NTC -
10 - 117	405 - 4750	

CITROËN

BERLINGO I 1.1 i	HFV(TU1JP), K6D(TU3A)	07/96 ⇒ 05/08
BERLINGO I 1.4	K6D(TU3A), KFW(TU3JP)	11/02 ⇒
BERLINGO I 1.4 BiFuel	TU3JP	07/96 ⇒ 10/02
BERLINGO I 1.4 bivalent	KFW(TU3JP), KFW(TU3JP)	11/02 ⇒ 12/11
BERLINGO I 1.4 CNG	KFW(TU3JP)	11/02 ⇒ 03/08
BERLINGO I 1.4 GNC	KFW(TU3JP)	11/02 ⇒
BERLINGO I 1.4 Hybrid	KFW(TU3JP)	05/05 ⇒
BERLINGO I 1.4 i	KFW(TU3JP), KFW(TU3JP)	07/96 ⇒ 12/11
BERLINGO I 1.4 i bivalent	KFW(TU3JP), NFU(TU5JP4)	04/03 ⇒ 10/08
BERLINGO I 1.6 16V	NFU(TU5JP4), N6A(TU5JP4)	10/00 ⇒ 12/11
BERLINGO II 1.6	N6A(TU5JP4), HFV(TU1A)	04/08 ⇒
BERLINGO 1.4	TU32, HFX(TU1JP)	07/96 ⇒ 12/11
BERLINGO 1.4 BiFuel	TU3JP	07/96 ⇒ 10/02

CITROËN			
BERLINGO 1.4 Bivalent	TU3JPCNG	04/03 →	10/05
BERLINGO 1.4 Hybrid	TU3JPHYBRID	05/05 →	05/08
C2 1.1	HFX(TU1A), KFU(TU3JP)	09/03 →	
C2 1.4	KFU(TU3JP), ET3J4	09/03 →	
C2 1.4 16V	ET3J4, NFU(TU5JP4)	06/06 →	
C2 1.6	NFU(TU5JP4), NFS(TU5JP4S)	09/03 →	
C2 1.6 VTS	NFS(TU5JP4S), HFX(TU1A)	01/05 →	
C3 1.1 i	HFX(TU1A), ET3J4	02/02 →	
C3 1.1 i LPG	TU1A	06/06 →	12/09
C3 1.1.4 16V	ET3J4, KFU(TU3A)	12/03 →	
C3 1.4 BiFuel	TU3JP	09/08 →	12/09
C3 1.4 i	KFU(TU3A), KFU(TU3JP)	02/02 →	
C3 1.4 i Bivalent	KFU(TU3JP), N6A(TU5JP4)	02/02 →	
C3 1.1.6 16V	N6A(TU5JP4), KFU(TU3A)	02/02 →	
C3 I PLURIEL 1.4	KFU(TU3A), NFU(TU5JP4)	05/03 →	
C3 I PLURIEL 1.4 Hybrid	KFU(TU3JP)	05/05 →	
C3 I PLURIEL 1.6	NFU(TU5JP4), HFX(TU1JP)	05/03 →	
C3 II 1.1	HFX(TU1JP), HFX(TU1A)	11/09 →	
C3 II 1.1 BiFuel	HFX(TU1A), K6E(TU3A)	11/10 →	
C3 II 1.4	K6E(TU3A), KFT(TU3A)	11/09 →	
C3 II 1.4 LPG	KFT(TU3A), 6FY(EW7A)	07/10 →	
C3 II 1.6 Flex	NFX(TU5JP4)	11/09 →	
C3 III 1.6 VTi	EC5F	02/17 →	
C4 1.4 16V	ET3J4, NFU(TU5JP4)	11/04 →	07/11
C4 1.6 16V	NFU(TU5JP4), N6A(TU5JP4)	11/04 →	07/11
C4 1.6 16V Bio-Flex	N6A(TU5JP4), EW10A	09/07 →	
C4 1.6 16V Flex Fuel	N6A(TU5JP4)	02/09 →	
C4 1.6 Flex	--	02/09 →	07/11
C4 1.2.0 16V	EW10A, 6FY(EW7A)	11/04 →	07/11
C4 1.2.0 VTR	EW10A	10/06 →	12/07
C4 II 1.6 Flex	NFX(TU5JP4)	11/09 →	
C4 II 2.0 Flex	RFJ(EW10A)	11/09 →	
C4 GRAND PICASSO I 1.8 i 16V	6FY(EW7A), EW10A	10/06 →	12/10
C4 GRAND PICASSO I 1.8 i 16V CNG	EW7ACNG	03/09 →	12/11
C4 GRAND PICASSO I 1.8 i 16V Flex	EW7A	06/09 →	01/13
C4 GRAND PICASSO I 2.0 i 16V	EW10A, ET3J4	10/06 →	08/13
C4 PICASSO I 1.8 Bifuel	6FY(EW7A), 6FY(EW7A)	01/09 →	10/12
C4 PICASSO I 1.8 i 16V	6FY(EW7A), EW10A	02/07 →	12/11
C4 PICASSO I 2.0 i 16V	EW10A, 6FY(EW7A)	09/07 →	08/13
C5 1.8 16V	6FY(EW7A), EW10A	09/05 →	
C5 1.2.0	EW10A	11/04 →	01/08
C5 1.2.0 16V	EW10A, 6FY(EW7A)	09/04 →	
C5 II 1.8 16V	6FY(EW7A), EW10A	02/08 →	
C5 II 2.0 16V	EW10A, EW10A	02/08 →	
C5 II 2.0 16V BioFlex	EW10A, EW10A	02/08 →	
C8 2.0 16V	EW10A, EC5	09/05 →	
C-ELYSEE 1.6 VTi 115	EC5, EW10A	11/12 →	
JUMPY II 2.0 i	EW10A, KFT(TU3A)	01/07 →	
NEMO 1.4	KFT(TU3A), HFX(TU1JP)	02/08 →	
SAXO 1.1 BiFuel	TU1M+	07/00 →	06/03
SAXO 1.1 X,SX	HFX(TU1JP), KFW(TU3JP)	05/96 →	09/03
SAXO 1.4 VTS	KFW(TU3JP), NFT(TU5JP)	05/96 →	06/03
SAXO 1.6	NFT(TU5JP), NFT(TU5JP)	02/01 →	04/04
SAXO 1.6 VTS	NFT(TU5JP), KFU(TU3JP)	09/00 →	09/03
XSARA 1.4	TU3JP	05/98 →	03/05
XSARA 1.4 i	KFU(TU3JP), NFU(TU5JP4)	04/97 →	08/05
XSARA 1.6 16V	NFU(TU5JP4), NFV(TU5JP)	09/00 →	08/05
XSARA PICASSO 1.6	NFU(TU5JP), N6A(TU5JP4)	12/99 →	
XSARA PICASSO 1.6 16V	N6A(TU5JP4), KFT	03/05 →	
XSARA PICASSO 1.6 16V LPG	TU5JP4	09/05 →	
XSARA PICASSO 1.6 Chrono	TU5JP	04/01 →	10/04

FIAT			
FIORINO III 1.4	KFT, KFT	11/07 →	
QUBO 1.4	KFT, KFU(TU3A)	02/08 →	

PEUGEOT			
106 II 1.1 i	HFX(TU1JP), KFU(TU3JP)	05/96 →	07/04
106 II 1.4 i	KFU(TU3JP), HFX(TU1JP)	05/96 →	07/04
206 1.1	HFX(TU1JP), HFX(TU1JP)	08/98 →	
206 1.1 i	HFX(TU1JP), KFU(TU3A)	09/98 →	
206 1.4	KFU(TU3A), ET3J4	07/02 →	
206 1.4 16V	ET3J4, K6D(TU3A)	10/03 →	
206 1.4 BiFuel [ExtraEU]	TU3JP	07/02 →	02/07
206 1.4 CNG	TU3AF	05/06 →	09/07
206 1.4 i	K6D(TU3A), N6A(TU5JP4)	04/05 →	
206 1.4 LPG	TU3JP	05/06 →	09/07
206 1.6	NFU(TU5JP4)	09/01 →	12/08
206 1.6 16V	N6A(TU5JP4), EW10J4S	07/00 →	
206 1.6 BiFuel	TU5JP4	07/00 →	04/09
206 1.6 BiFuel [ExtraEU]	TU5JP4	07/02 →	02/07
206 1.6 LPG	NFU(TU5JP4)	07/02 →	
206 2.0 RC	EW10J4S, HFX(TU1A)	07/03 →	
206+ 1.1	HFX(TU1A), K6D(TU3A)	01/09 →	

PEUGEOT			
206+ 1.1 LPG	TU1A	04/09 →	06/13
206+ 1.4 i	K6D(TU3A), KFT(TU3A)	01/09 →	
206+ 1.6 16V	NFU(TU5JP4)	07/10 →	
207 1.4	KFT(TU3A), ET3J4	02/06 →	
207 1.4 16V	ET3J4, NFU(TU5JP4)	02/06 →	
207 1.4 BiFuel	TU3A	08/07 →	12/13
207 1.4 Flex	KFW(TU3A)	11/08 →	
207 1.4 LPG	TU3A	08/07 →	12/12
207 1.6	N6A(TU5JP4)	08/08 →	
207 1.6 16V	NFU(TU5JP4), EC5	02/06 →	
207 1.6 Bioflex	N6A(TU5JP4)	01/08 →	
301 1.6 LPG	EC5	07/14 →	
301 1.6 VTi 115	EC5, KFU(TU3JP)	11/12 →	
306 1.4	KFU(TU3JP), KFU(TU3JP)	04/93 →	04/02
306 1.4 SL	KFU(TU3JP), K6D(TU3JP)	06/94 →	05/01
306 1.6	NFT(TU5JP)	10/00 →	04/02
307 1.4	K6D(TU3JP), ET3J4	08/00 →	
307 1.4 16V	ET3J4, N6A(TU5JP4)	11/03 →	07/07
307 1.6	TU5JP4	07/06 →	04/12
307 1.6 16V	N6A(TU5JP4), --	08/00 →	
307 1.6 BioFlex	--, EW10A	07/06 →	
307 2.0 16V	EW10A, N6A(TU5JP4)	10/03 →	04/09
308 1.6 VTi [ExtraEU]	EC5	05/15 →	
308 I 1.6 16V	N6A(TU5JP4)	07/08 →	
308 I 1.6 Bioflex	N6A(TU5JP4), EW10A	04/08 →	
308 I 2.0 Bioflex	EW10A, EW10A	01/08 →	
308 I 2.0 CVVT	EW10A, 6FY(EW7A)	07/09 →	11/14
308 II 1.6 VTi	EC5	03/14 →	
308 II 1.6 VTi 115	NFP(EC5)	11/12 →	
407 1.8	EW7J4	05/04 →	
407 1.8 16V	6FY(EW7A), EW10A	09/05 →	
407 2.0 16V	EW10A, EW10A	09/05 →	
407 2.0 Bioflex	EW10A, EW10A	09/07 →	
407 2.0 CVVT [ExtraEU]	EW10A	08/05 →	12/10
407 2.0 Flex [ExtraEU]	EW10A	10/05 →	02/11
407 2.2 16V	3FY(EW12J4)	09/05 →	
807 2.0 16V	EW10A, KFU(TU3A)	09/05 →	
1007 1.4	KFU(TU3A), ET3J4	04/05 →	
1007 1.4 16V	ET3J4, NFU(TU5JP4)	10/05 →	
1007 1.6 16V	NFU(TU5JP4), HFX(TU1JP)	04/05 →	
BIPPER 1.4	KFU(TU3A), KFU(TU3A)	02/08 →	
BIPPER 1.4 HDi	DV4TED	02/08 →	
BIPPER TEPEE 1.4	KFU(TU3A), EW10A	04/08 →	
EXPERT II 2.0 16V	EW10A, EW10A	01/07 →	
EXPERT II TEPEE 2.0 16V	EW10A, TU3JP	01/07 →	
PARTNER 1.4	TU3JP, TU5JP4	10/05 →	
PARTNER 1.4 CNG	TU3JPCNG	11/02 →	10/06
PARTNER 1.6	TU5JP4, HFX(TU1JP)	09/11 →	
PARTNER 1.6 Bioflex	TU5JP4	09/00 →	10/02
PARTNER I 1.1	HFX(TU1JP), K6D(TU3A)	06/96 →	09/05
PARTNER I 1.4	K6D(TU3A), N6A(TU5JP4)	06/96 →	
PARTNER I 1.4 BiFuel	TU3JP	04/03 →	10/06
PARTNER I 1.6	N6A(TU5JP4), NFU(TU5JP4)	09/00 →	
PARTNER I 1.6 [ExtraEU]	TU5JP4	09/00 →	05/08
PARTNER I 1.6 16V	NFU(TU5JP4), NFU(TU5JP4)	07/01 →	03/08
PARTNER I 1.6 Bioflex	TU5JP4	09/00 →	10/02
PARTNER I 1.6 Flexfuel	NFU(TU5JP4), NFR(TU5JP4B)	09/00 →	10/02
PARTNER II 1.6	NFR(TU5JP4B), NFR(TU5JP4B)	04/08 →	
PARTNER II TEPEE 1.6 VTi	NFR(TU5JP4B), K6D(TU3A)	04/08 →	
RANCH 1.1	HFX(TU1JP)	06/96 →	
RANCH 1.4	K6D(TU3A), N6A(TU5JP4)	04/05 →	
RANCH 1.4 BiFuel	KFU(TU3JP)	04/03 →	
RANCH 1.4 CNG	TU3JPCNG	01/97 →	12/12
RANCH 1.6 16V	N6A(TU5JP4), 182A4.000	07/01 →	

10.3081



ABSOLUTE PRESSURE SENSORS (MAP)

Adatt./Suitable:

BOSCH
F 000 99P 218

FIAT

46451792
55221402
71714218
71718233
71718678
71728656

LANCIA

71714218
71718233
71718678

MAGNETI MARELLI

806001563801
KIT PRPT05
T-PR05/A

MARKET DIFFUSION: MEDIUM



kPa	mV	O + NTC -
17 - 104	250 - 4750	

FIAT

BRAVA 1.6 16V	182A4.000, 182B6.000	10/95 →	10/01
BRAVO I 1.6	182B6.000	09/00 →	10/01
BRAVO I 1.6 16V	182A4.000	03/96 →	10/01
DOBLO 1.6 Natural Power	182B6000CNG	02/04 →	07/09
DOBLO I 1.2	223A5.000	03/01 →	
DOBLO I 1.6	182B6.000	09/02 →	
DOBLO I 1.6 16V	182B6.000	10/01 →	
DOBLO I 1.6 Natural Power	182B6.000, F1CE0441A	09/02 →	
DUCATO III 140 Natural Power	F1CE0441A, 182B6.000	04/09 →	
MAREA 1.6	182B6.000, 182B6.000	09/00 →	08/02
MAREA 1.6 100 16V	182A4.000	09/96 →	05/02
MAREA 1.6 100 16V Bipower	182A4.000	04/99 →	05/02
MULTIPLA 1.6	182B6.000, 182B6.000	09/00 →	06/10
MULTIPLA 1.6 100 16V	182A4.000	04/99 →	06/10
MULTIPLA 1.6 16V	182B6.000	04/02 →	06/10
MULTIPLA 1.6 16V Bipower	182B6.000, 186A3.000	10/01 →	06/10
MULTIPLA 1.6 16V Blupower	186A3.000, 178B7.045	04/99 →	06/10
MULTIPLA 1.6 16V GPL	182B6.000	10/01 →	06/10
MULTIPLA 1.6 Natural Power	182B6000CNG	11/08 →	06/10
PALIO 1.0	178A1.000	04/96 →	10/03
PALIO 1.2	178B7.045, 178B3.000	07/97 →	10/04
PALIO 1.5	178E5.022	02/02 →	
PALIO 1.5 MPI	178E5.027	08/01 →	
PALIO 1.6	178D2.011	07/97 →	10/00
PALIO 1.6 16V	178B3.000, 188A4.000	02/01 →	
PALIO 1.6 16V 100	178C8.098	01/98 →	
PANDA I 1100	187A1.000	02/95 →	09/03
PANDA I 1100 i.e. 4x4	187A1.000	12/00 →	
PANDA II 1.2 Bi-Power / Natural Power	--	04/09 →	
PANDA II 1.2 Natural Power	188A4.000, 176B2.000	01/07 →	12/11
PUNTO II 1.2 60	188A4.000	09/99 →	12/10
PUNTO II 1.2 Bipower	188A4.000	08/01 →	05/03
PUNTO II 1.2 Natural Power	188A4.000	09/03 →	03/12
SEICENTO / 600 1.1	176B2.000, 178E5.022	01/98 →	01/10
SIENA 1.5	178E5.022, --	09/02 →	
SIENA 1.6	182B6.000	11/00 →	12/09
SIENA 1.6 16V	178B3.000	09/98 →	
STILO 1.6	--, 188A4.000	04/05 →	08/08
STILO 1.6 16V	182B6.000	10/01 →	08/08
STRADA 1.2	188A4.000	04/03 →	
STRADA 1.6 MPI	178D2.011	07/05 →	

FIAT (BR)

PALIO 1.0i	1.0Mpi	01/96 →
------------	--------	---------

10.3082



3,5

ABSOLUTE PRESSURE SENSORS (MAP)

Adatt./Suitable:

FIAT (BR)		
PALIO 1.5i	1.5Mpi	01/96 ⇨ 12/00
PALIO 1.6i 16v	1.6Mpi16v	01/96 ⇨
SIENA 1.0i	1.0Mpi	01/99 ⇨ 12/00
SIENA 1.5i	1.5Mpi	01/99 ⇨ 12/00
SIENA 1.6i	1.6Mpi	01/99 ⇨ 12/00
SIENA 1.6i 16v	1.6Mpi	01/98 ⇨ 12/99
STRADA 1.5i	1.5Mpi	01/99 ⇨ 12/01
STRADA 1.6i 16v	1.6Mpi	01/99 ⇨
STRADA 1.6i 8v	1.6Mpi	01/99 ⇨ 12/00
UNO 1.5i Furgoneta	1.5Mpi	01/92 ⇨
UNO MILLE 1.0i	1.0Mpi	01/96 ⇨
LANCIA		
DEDRA 1.6 16V	182A4.000	01/96 ⇨ 07/99
DELTA II 1.6 i.e. 16V	182A4.000	01/96 ⇨ 08/99
LYBRA 1.6	182B6.000	10/00 ⇨ 10/05
LYBRA 1.6 16V	182A4.000	07/99 ⇨ 10/05
Y 1.2	188A4.000, 312A1.000	03/96 ⇨ 09/03
Y 1.2 16V	176B9.000	04/97 ⇨ 09/03

ABARTH
55206797
55219298
73503657
77365393
K04627187AA

ALFA ROMEO
55206797
55219298
73503657
77365393

BOSCH
0 261 230 280
0 261 230 281
0 261 230 427
0 261 230 428
0 281 002 437
0 281 002 680
0 281 002 845
0 281 006 028
0 281 006 029
0 281 006 076
0 281 006 077
0 281 006 095
0 281 006 118
F 01C 600 110

CHEVROLET
55219298
55568175

CHRYSLER
5140331AA
55219298
68031593AA
68153918AA
K05140331AA
K68031593AA
K68153918AA

CITROËN
16 114 324 80
1636 39
1636 61
1920 55

DACIA
22 36 500 02R

DODGE
68031593AA
K68031593AA

FIAT
504088431
504245257
504369148
55206797
55219298
73503657
77365393
77366685
K04627187AA
K68093409AA
K68141820AA
K68153918AA

FORD
1 448 387
1 723 819
5 094 154
H4P3-12B676-AA

FUSO (MITSUBISHI)
MK667153
QC000165

GENERAL MOTORS
55 206 797
55 219 298
55 568 175
93 171 176

HONDA
37830-R3L-G01
37830-RBD-E01

IVECO
0000500303029
0000504245257
500303029
504088431
504245257
504360148
504360149
504369148
73503657

JAGUAR
T2R 17754

JEEP
4627187AA
5140331AA
55206797
55219298
68031593AA
68153918AA
77366685
K04627187AA
K05140331AA
K68031593AA
K68093409AA
K68153918AA

LANCIA
73503657

MASERATI
272880

MAZDA
WE01-18-211

MERCEDES-BENZ
1571530128
A 157 153 01 28
A 671 542 00 17

NISSAN
22365-00QAL

OPEL
12 35 029
12 35 084
55206797
55219298
55568175
62 38 210
62 38 865
93171176

PEUGEOT
16 114 324 80
1636 39
1636 61

MARKET DIFFUSION: HIGH



kPa	mV	O + NTC -
11 - 307	250 - 4750	

ABARTH

500 1.4	312A1.000, 312A1.000	08/08 →
500 MY12 1.4	--	01/12 →
500C / 595C 1.4	312A1.000, 199A8.000	05/08 →
GRANDE PUNTO 1.4	199A8.000, 199A8.000	12/07 → 12/12
PUNTO 1.4	199A8.000, 937A2.000	03/12 →
PUNTO EVO 1.4	955A8.000	10/09 → 02/12

ALFA ROMEO

147 1.9 JTD	937A2.000, 192A5.000	10/00 → 03/10
147 1.9 JTD 16V	192A5.000, 937A2.000	11/02 → 03/10
147 1.9 JTDM	937A2.000, 937A5.000	10/04 → 03/10
147 1.9 JTDM 16V	937A5.000, 192B1.000	09/04 → 03/10
147 1.9 JTD 8V	937A3.000	07/05 → 03/10
156 1.9 JTDM	192B1.000, 841G.000	11/02 →
156 1.9 JTD 16V	192A5.000	11/02 → 05/06
156 1.9 JTD 16V Q4	937A5.000	07/04 → 05/06
156 2.4 JTD	841G.000, 937A8.000	06/03 → 05/06
159 1.8 Tbi	939B1.000	07/09 → 11/11
159 1.9 JTDM 16V	937A8.000, 937A7.000	09/05 → 11/11
159 1.9 JTDM 8V	937A7.000, 844A2.000	09/05 → 11/11
159 1.9 JTS	939A6.000	09/05 → 11/11
159 2.0 JTDM	844A2.000, 939A3.000	05/09 → 11/11
159 2.4 JTDM	939A3.000, 841G.000	09/05 → 12/12
159 2.4 JTDM Q4	939A9.000	05/07 → 11/11
159 MY2011 1.9 8V JTD	--	01/10 →
159 MY2011 2.0 JTD	--	01/10 →
159 MY2011 2.4 JTD	--	01/10 →
166 2.4 JTD	841G.000, 939A3.000	10/03 → 06/07
4C 1.8	960A1.000	03/13 →
BRERA 2.4 JTDM 20V	939A3.000, 940A2.000	01/06 → 06/10
GIULIA 2.9	670050436	10/15 →
GIULIETTA II 1.4	940A2.000	04/11 →
GIULIETTA II 1.4 TB	940A2.000, 940A3.000	04/10 →
GIULIETTA II 1.6 JTDM	940A3.000, 940A1.000	04/10 →
GIULIETTA II 1.8 Tbi	940A1.000, 940A4.000	04/10 →
GIULIETTA II 2.0 JTDM	940A4.000, 937A5.000	04/10 →
GT 1.9 JTD	937A5.000, 199B6.000	11/03 → 09/10
MITO 0.9	199B6.000	12/13 →
MITO 0.9 TwinAir	199B6.000, 199A3.000	07/11 →
MITO 1.3 Multijet	199A3.000, 955A2.000	08/08 →
MITO 1.4 MultiAir	940A2.000	09/09 →
MITO 1.4 TB	955B1.000	12/13 →
MITO 1.4 Turbo MultiAir	955A2.000, 198A2.000	10/09 →
MITO 1.6 JTDM	198A2.000, 844A2.000	08/08 →
SPIDER III 2.0 JTDM	844A2.000, 939A3.000	04/09 → 06/10
SPIDER III 2.4 JTDM	939A3.000, LDV	04/07 → 06/10
STELVIO 2.9 Q4	670050436	11/17 →

CADILLAC

BLS 1.9 D	Z19DTH	04/06 →
-----------	--------	---------

CHEVROLET

AVEO II 1.3 D	LDV, LKR	07/11 →
CRUZE 1.4	LUJ	09/10 →
CRUZE 1.7 D	LUD	01/12 →
CRUZE 1.7 TD	LKR, ENJ	08/12 →
CRUZE 2.0 CDI	Z20DMH	05/09 →
CRUZE 2.0 TD	LNP	08/12 →
MALIBU 2.0 D	LBS	04/12 →
TRAX 1.4	A14NET	12/12 →
TRAX 1.4 AWD	LUJ	12/12 →

CHRYSLER

300C II 3.0 CRD	EXF	09/11 →
DELTA 1.6 D Multijet	844A3000	08/11 →
DELTA 2.0 D Multijet	198A5.000	08/11 →
GRAND VOYAGER V 2.8 CRD	ENS	10/07 →
VOYAGER III 2.5 CRD	ENJ, F300FAP	02/00 → 12/08
VOYAGER III 2.8 CRD	ENR	06/04 → 12/08
YPSILON 1.3 Multijet	199B1.000	05/11 →

CITROËN

JUMPER III 3.0 HdI 145	F300FAP, F30DTFAP	07/10 →
JUMPER III 3.0 HdI 155	F30DTFAP, F30DTFAP	07/10 →
JUMPER III 3.0 HdI 160	F30DTFAP, F13DTE6	09/06 →
JUMPER III 3.0 HdI 180	F30DT	07/11 →
NEMO 1.3 BlueHdI 80	F13DTE6, F13DTE5	02/16 →
NEMO 1.3 HdI 75	F13DTE5, F13DTE6	10/10 →
NEMO 1.3 HdI 80	F13DTE6, H5F402	10/15 →

DACIA

DOKKER 1.2 TCe	H5F402, --	11/12 →
DOKKER 1.2 TCe 115	--, H5F404	12/12 →
DUSTER 1.2 TCe 125	H5F404, H5F402	01/12 →
DUSTER 1.2 TCe 125 4x4	H5F404	10/13 →
LODGY 1.2 TCe	H5F402, H4B400	03/12 →
LOGAN II TCe 90	H4B400, --	10/12 →
LOGAN II TCe 90 LPG	H4B410	09/15 →
LOGAN II MCV TCe 90	H4B400, H4B405	02/13 →
LOGAN II MCV TCe 90 LPG	H4B405, H4B400	09/15 →
SANDERO II TCe 90	--, ENR	10/12 →
SANDERO II TCe 90 LPG	H4B410	09/15 →

DODGE

NITRO 2.8 CRD	ENR, ENR	10/06 → 12/12
NITRO 2.8 CRD 4WD	ENR, 199B6.000	06/07 → 12/12

FIAT

500 0.9	199B6.000, 199B1.000	07/10 →
500 1.3 D Multijet	199B1.000, 199B6.000	12/09 →
500 C 0.9	199B6.000, 199B1.000	09/09 →
500 C 1.3 D Multijet	199B1.000, 199B6000CNG	09/09 →
500 MY12 0.9	--	01/12 →
500 MY12 1.3 JTD	--	01/12 →
500 MY15 1.3 JTD	--	01/15 →
500L 0.9	199B6.000	09/12 →
500L 0.9 Natural Power	199B6000CNG, 199B8A.000	03/13 →
500L 1.3 D Multijet	199B8A.000, 199B5.000	09/12 →
500L 1.6 D Multijet	199B5.000, 55263087	09/12 →
500X 1.3 D Multijet	55266963	11/14 →
500X 1.4	55263624	09/14 →
500X 1.4 4x4	55263623	02/15 →
500X 1.4 LPG	55277701	03/17 →
500X 2.0 4x4	--	09/15 →
500X 2.0 D Multijet 4x4	55263087, --	09/14 →
BRAVO II 1.4 16V	--, --	04/07 →
BRAVO II 1.6 D Multijet	--, 192A1.000	09/07 →
BRAVO II 1.6 JTD	198A3.000	03/08 → 12/14
BRAVO II 1.9 D Multijet	192A1.000, --	11/06 → 12/14
BRAVO II 1.9 D Multijet 8V	--	01/10 →
BRAVO II 1.9 D Multijet 16V	--	01/10 →
BRAVO II 2.0 D Multijet	--, 939A1.000	09/08 →
CROMA II 1.9 D Multijet	939A1.000, 182B9.000	06/05 →
CROMA II 2.4 D Multijet	939A3.000	06/05 →
DOBLO I 1.3 D Multijet	223A9.000	10/05 →
DOBLO I 1.3 JTD 16V Multijet	223A9.000	08/06 →
DOBLO I 1.9 D Multijet	186A9.000	10/05 →
DOBLO I 1.9 JTD	182B9.000, 199A3.000	10/01 →
DOBLO I 1.9 JTD 8V	--	10/05 →
DOBLO I 1.9 JTD Multijet	186A9.000	12/06 →
DOBLO II 1.3 D Multijet	199A3.000, 198A3.000	02/10 →
DOBLO II 1.4	198A4.000	10/11 →
DOBLO II 1.4 Natural Power	198A4.000	02/10 →
DOBLO II 1.6 D Multijet	198A3.000, F1AE0481D	02/10 →
DOBLO II 2.0 D Multijet	263A1.000	01/10 →
DUCATO III 100 Multijet 2,2 D	4HV(P22DTE)	07/06 →
DUCATO III 110 Multijet 2,3 D	F1AE0481D, 250A1.000	08/06 →
DUCATO III 115 Multijet 2,0 D	250A1.000, F1AE0481D	06/11 →
DUCATO III 120 Multijet 2,3 D	F1AE0481D, F1AE0481N	07/06 →
DUCATO III 120 Multijet 2,3 D 4x4	F1AE0481D	03/10 →
DUCATO III 130 Multijet 2,3 D	F1AE0481N, F1AE3481E	07/06 →
DUCATO III 150 Multijet 2,3 D	F1AE3481E, F1CE0481D	06/11 →
DUCATO III 150 Multijet 3,0 D	F1CE3481N	04/10 →
DUCATO III 160 Multijet 3,0 D	F1CE0481D, 199A2.000	07/06 →
DUCATO III 180 Multijet 2,3 D	F1AGL411B	12/15 →
DUCATO III 180 Multijet 3,0 D	F1CE3481E	06/11 →
DUCATO III 2.0	--	01/14 →
DUCATO III 2.3	--	01/14 →
DUCATO III 3.0	--	01/14 →
DUCATO 2.3 Multijet	F1AE0481N	01/07 → 07/14
FIORINO III 1.3 D Multijet	199A2.000, 939B5.000	11/07 →
FREEMONT 2.0 JTD	939B5.000, 939B5.000	08/11 →
FREEMONT 2.0 JTD 4x4	939B5.000, 199A3.000	08/11 →
IDEA 1.3 D Multijet	199A3.000, --	10/05 →
IDEA 1.6 D Multijet	350A2.000	05/08 →
IDEA 1.9 D	--	01/08 →
IDEA 1.9 JTD	188B2.000	01/04 →
LINEA 1.3 D Multijet	--, 169A1.000	06/07 →
LINEA 1.3 JTD Multijet	199A3.000	10/06 →
LINEA 1.6 D Multijet	198A3.000	06/09 →
LINEA 1.8 Flex	370A0.011	09/10 →

FIAT

MULTIPLA 1.9 JTD	186A9.000	04/02 → 06/10
MULTIPLA 1.9 JTD 115	186A8.000	07/02 → 06/10
PANDA II 1.2	169A4.000	03/10 → 08/13
PANDA II 1.2 4x4	169A4.000	11/09 →
PANDA II 1.2 LPG	169A4.000	11/10 → 08/13
PANDA II 1.3 D Multijet	--	06/06 →
PANDA II 1.3 JTD Multijet 4x4	169A1.000, 312A2.000	09/10 → 08/13
PANDA III 0.9	312A2.000, 312A2.000	02/12 →
PANDA III 0.9 4x4	312A2.000, 312A2.000	06/14 →
PANDA III 0.9 Natural Power	312A2.000, 199A1.000	07/12 →
PANDA III 1.3 D Multijet	199A1.000, 199A1.000	02/12 →
PANDA III 1.3 D Multijet 4x4	199A1.000, 199A3.000	06/12 →
PUNTO II 1.9 JTD	188B2.000	06/03 → 03/12
PUNTO III / GRANDE PUNTO 1.3 D Multijet	199A3.000, 199A5.000	10/05 →
PUNTO III / GRANDE PUNTO 1.3 JTD	--	01/08 → 09/09
PUNTO III / GRANDE PUNTO 1.3 JTD Actual	--	09/09 →
PUNTO III / GRANDE PUNTO 1.3 Multijet [IND]	--	01/08 →
PUNTO III / GRANDE PUNTO 1.6 D Multijet	955A3.000	07/08 →
PUNTO III / GRANDE PUNTO 1.9 D Multijet	199A5.000, 199B6.000	10/05 →
PUNTO III EVO 1.3 D Multijet	199A2.000, 199A2.000	07/08 →
PUNTO III EVO 1.4 16V	955A2.000	10/09 → 02/12
PUNTO III EVO 1.6 D Multijet	955A3.000	10/09 → 02/12
PUNTO III 0.9	199B6.000, 199A2.000	07/13 →
PUNTO III 0.9 Bifuel	312A2.000	03/12 →
PUNTO III 0.9 Twinair Turbo	312A2.000	03/12 →
PUNTO III 1.3 D Multijet	199A2.000, 199A2.000	03/09 →
PUNTO III 1.3 JTD Multijet	955B2.000	05/18 →
PUNTO III 1.4 Turbo Multi Air	955A2.000	03/12 →
QUBO 1.3 D Multijet	199A2.000, 192A8.000	02/08 →
SEDICI 1.9 D Multijet	D19AA	06/06 → 10/11
SEDICI 1.9 D Multijet 4x4	D19AA	06/06 → 10/11
SEDICI 2.0 D Multijet	D20AA	06/06 → 10/14
SEDICI 2.0 D Multijet 4x4	D20AA	06/06 → 10/14
SEDICI MY12 2.0 D	--	01/12 →
STILO 1.9 D	192B5.000	09/04 → 08/08
STILO 1.9 D Multijet	192A8.000, 192A1.000	09/05 → 08/08
STILO 1.9 JTD	192A1.000, 199B1.000	10/01 → 08/08
STRADA 1.3 D	--	01/11 →
STRADA 1.3 D Multijet	199B1.000	05/06 →
TIPO II 1.3 D	199B1.000, JQDA	10/15 →

FORD

C-MAX III 1.6 EcoBoost	JQDA, M1DA	12/10 →
ENDEAVOUR 2.5 TDi HPCR	--	10/06 →
ENDEAVOUR 3.0 TDi	--	10/06 →
EVEREST 2.5 TDi HPCR	--	10/06 →
EVEREST 3.0 TDi	--	10/06 →
FOCUS III 1.0 EcoBoost	M1DA, JQDA	02/12 →
FOCUS III 1.0 GTDi	--	07/12 →
FOCUS III 1.5 Di TC SIGMA A	--	09/14 →
FOCUS III 1.5 EcoBoost	M8DA	09/14 →
FOCUS III 1.6 EcoBoost	JQDA, --	07/10 →
FOCUS III 1.6 Flexifuel	YUDA	07/13 →
GALAXY II 1.6 EcoBoost	--, JQDA	11/10 →
GRAND C-MAX 1.0 EcoBoost	M2DA	10/12 →
GRAND C-MAX 1.6 EcoBoost	F1DA, BAAA	12/10 →
KA II 1.3 TDCi	BAAA, JTBA	10/08 →
MONDEO III 1.6 EcoBoost	JTBA, MD30DITC	11/10 → 01/15
RANGER V 2.5 TDCi 4x4	WLAA	05/06 → 07/12
RANGER V 2.5 TDCi	WLAA	05/06 → 07/12
RANGER V 3.0 TDCi	MD30DITC, MD30DITC	05/06 → 07/12
RANGER V 3.0 TDCi 4x4	MD30DITC, --	05/06 → 07/12
S-MAX I 1.6 EcoBoost	--, M2GA	02/11 →
TOURNEO CONNECT II 1.0 EcoBoost	M2GA, 4P10T2	11/13 →
TOURNEO CONNECT II 1.6 EcoBoost	JQGA	11/13 →
TRANSIT CONNECT II 1.0 EcoBoost	M2GA	02/13 →
TRANSIT CONNECT II 1.6 EcoBoost	JQGA	02/13 →

FUSO (MITSUBISHI)

IVECO		
DAILY II 35 C 17, 35 S 17	F1CE0481B	01/05 ⇒ 04/06
DAILY II 40 C 14	F1CE0481A	09/04 ⇒ 04/06
DAILY II 40 C 17, 40 S 17	F1CE0481B	01/05 ⇒ 04/06
DAILY II 45 C 14	F1CE0481A	07/99 ⇒ 04/06
DAILY II 50 C 14	F1CE0481A, F1CE0481A	09/04 ⇒ 04/06
DAILY II 50 C 17	F1CE0481B	09/04 ⇒ 04/06
DAILY II 65 C 14	F1CE0481A, F1CE0481A	09/04 ⇒ 04/06
DAILY II 65 C 17	F1CE0481B	09/04 ⇒ 04/06
DAILY III 35 S 14, 50 C 14	F1CE0481A, F1CE3481B	01/04 ⇒ 05/06
DAILY III 40 C 17, 50 C 17	F1CE0481B	01/04 ⇒ 05/06
DAILY IV 26L11, 26L11D, 35C11D, 35S11, 40C11	F1AE3481A	09/11 ⇒ 02/14
DAILY IV 29L10	F1AE0481F	05/06 ⇒ 08/11
DAILY IV 29L10 V	F1AE0481F	05/06 ⇒ 08/11
DAILY IV 29L11 V, 35C11 V, 35S11 V, 40C11 V	F1AE3481A	09/11 ⇒ 02/14
DAILY IV 29L12	F1AE0481G	05/06 ⇒ 08/11
DAILY IV 29L12 V, 29L12 V/P	F1AE0481G	05/06 ⇒ 08/11
DAILY IV 29L13 V, 35C13 V, 35S13 V, 40C13 V, 40S13 V	F1AE3481B	09/11 ⇒ 02/14
DAILY IV 29L13, 29L13D, 35C13D, 40C13	F1AE3481B	09/11 ⇒ 02/14
DAILY IV 29L14	F1AE0481H	05/06 ⇒ 08/11
DAILY IV 29L14 C, 29L14 C/P, 29L14 V, 29L14 V/P	F1AE0481H	05/06 ⇒ 08/11
DAILY IV 29L15 V, 35C15L V, 40C15L V, 50C15L V	F1AE3481C	09/11 ⇒ 02/14
DAILY IV 29L15 V, 35S15 V, 35C15L V, 40C15L V, 50C15L V	F1AE3481C	09/11 ⇒ 02/14
DAILY IV 35C10 K	F1AE0481F	05/06 ⇒ 08/11
DAILY IV 35C10, 35S10	F1AE0481F	05/06 ⇒ 08/11
DAILY IV 35C11 K, 35C11 DK, 35S11 K, 35S11 DK	F1AE0481F	07/07 ⇒ 08/11
DAILY IV 35C11 V, 35S11 V	F1AE0481F	07/07 ⇒ 08/11
DAILY IV 35C11, 35S11, 35S11 D, 35S11 /P	F1AE0481F	07/07 ⇒ 08/11
DAILY IV 35C11K, 35S11DKP	F1AE3481A	09/11 ⇒ 02/14
DAILY IV 35C12	F1AE0481G	05/06 ⇒ 08/11
DAILY IV 35C12 V, 35C12 V/P, 35S12 V, 35S12 V/P	F1AE0481G	05/06 ⇒ 08/11
DAILY IV 35C12, 35S12	F1AE0481G	05/06 ⇒ 08/11
DAILY IV 35C13 K, 35C13 DK, 35S13 K, 35S13 DK	F1AE0481V	07/07 ⇒ 08/11
DAILY IV 35C13 V, 35C13 V/P, 35S13 V, 35S13 V/P	F1AE0481V	07/07 ⇒ 08/11
DAILY IV 35C13, 35C13 /P, 35S13 D, 35S13, 35S13 /P	F1AE0481V	07/07 ⇒ 08/11
DAILY IV 35C13K, 35C13DKP	F1AE3481B	09/11 ⇒ 02/14
DAILY IV 35C14, 35S14, 35S14 /P	F1AE0481H	05/06 ⇒ 08/11
DAILY IV 35C15	F1CE0481F	05/06 ⇒ 08/11
DAILY IV 35C15 V, 35C15 V/P	F1CE0481F	05/06 ⇒ 08/11
DAILY IV 35C15 V, 40C15 V, 50C15 V, 60C15 V	F1CE3481B, F1CE3481B	09/11 ⇒ 02/14
DAILY IV 35C15, 35C15D, 35S15, 40C15, 45C15, 50C15, 60C15, 70C15	F1CE3481B	09/11 ⇒ 02/14
DAILY IV 35C15K, 35S15DKP, 50C15K, 60C15K, 65C15DK, 70C15K	F1CE3481B	09/11 ⇒ 02/14
DAILY IV 35C17 V, 35S17 V, 40C17 V, 45C17 V, 50C17 V, 60C17 V	F1CE3481C	09/11 ⇒ 02/14
DAILY IV 35C17, 35C17D, 35S17, 40C17, 45C17, 50C17, 60C17, 70C17	F1CE3481C	09/11 ⇒ 02/14
DAILY IV 35C17K, 35S17DKP, 50C17K, 65C17DK 70C17K	F1CE3481C, F1CE0481H	09/11 ⇒ 02/14
DAILY IV 35C18	F1CE0481H	05/06 ⇒ 08/11
DAILY IV 35C18 V, 35C18 V/P, 35S18 V, 35S18 V/P	F1CE0481H, F1CE0481H	05/06 ⇒ 08/11
DAILY IV 35C18, 35S18	F1CE0481H, F1CE0481H	05/06 ⇒ 08/11
DAILY IV 35S14 C, 35S14 C/P, 35S14 V, 35S14 V/P, 35C14 V,...	F1AE0481H	05/06 ⇒ 08/11
DAILY IV 35S14 K, 35S14 DK	F1AE0481H	07/07 ⇒ 08/11
DAILY IV 35S14 /P	F1AE0481H	05/06 ⇒ 08/11
DAILY IV 40C10	F1AE0481F	05/06 ⇒ 08/11
DAILY IV 40C10 V	F1AE0481F	05/06 ⇒ 08/11
DAILY IV 40C11 V	F1AE0481F	07/07 ⇒ 08/11
DAILY IV 40C11, 40C11 D	F1AE0481F	07/07 ⇒ 08/11
DAILY IV 40C12	F1AE0481G	05/06 ⇒ 08/11
DAILY IV 40C12 V, 40C14 V/P	F1AE0481G	05/06 ⇒ 08/11
DAILY IV 40C13 V, 40C13 V/P	F1AE0481V	07/07 ⇒ 08/11
DAILY IV 40C13, 40C13 /P	F1AE0481V	07/07 ⇒ 08/11
DAILY IV 40C15	F1CE0481F	05/06 ⇒ 08/11
DAILY IV 40C15 V, 40C15 V/P	F1CE0481F	05/06 ⇒ 08/11
DAILY IV 40C18	F1CE0481H	05/06 ⇒ 08/11
DAILY IV 40C18 V, 40C18 V/P	F1CE0481H	05/06 ⇒ 08/11
DAILY IV 45C15	F1CE0481F	05/06 ⇒ 08/11

IVECO		
DAILY IV 45C15 V	F1CE0481F	05/06 ⇒ 08/11
DAILY IV 45C18	F1CE0481H	05/06 ⇒ 08/11
DAILY IV 45C18, 45C18 /P, 45C18 D, 45C18 D/P	F1CE0481H	05/06 ⇒ 08/11
DAILY IV 50C15	F1CE0481F	05/06 ⇒ 08/11
DAILY IV 50C15 V, 50C15 V/P	F1CE0481F	05/06 ⇒ 08/11
DAILY IV 50C18	F1CE0481H	05/06 ⇒ 08/11
DAILY IV 50C18 V, 50C18 V/P	F1CE0481H, F1CE0481H	05/06 ⇒ 08/11
DAILY IV 55S18W	F1CE0481H	06/06 ⇒ 08/11
DAILY IV 60C15	F1CE0481F	05/06 ⇒ 08/11
DAILY IV 60C15 V	F1CE0481F	05/06 ⇒ 08/11
DAILY IV 60C15, 60C15 /P, 60C15 D, 60C15 D/P	F1CE0481F	05/06 ⇒ 08/11
DAILY IV 60C18	F1CE0481H	05/06 ⇒ 08/11
DAILY IV 65C15	F1CE0481F	05/06 ⇒ 08/11
DAILY IV 65C15, 65C15 /P, 65C15 D, 65C15 D/P	F1CE0481F	05/06 ⇒ 08/11
DAILY IV 65C18	F1CE0481H, F1CE3481J	05/06 ⇒ 08/11
DAILY IV 70C15	F1CE0481L	07/08 ⇒ 08/11
DAILY V 33S11, 35S11, 35C11	F1AFL411A	03/14 ⇒ 04/16
DAILY V 33S12, 35S12	F1AGL411H	04/16 ⇒
DAILY V 33S12, 35S12, 35C12	F1AGL411H	04/16 ⇒
DAILY V 33S13, 35S13, 35C13	F1AFL411B	03/14 ⇒ 04/16
DAILY V 33S14, 35S14	F1AGL411J	04/16 ⇒
DAILY V 33S14, 35S14, 35C14	F1AGL411J	04/16 ⇒
DAILY V 33S15, 35S15, 35C15	F1AFL411C	03/14 ⇒ 04/16
DAILY V 33S16, 35S16	F1AGL411G	04/16 ⇒
DAILY V 33S16, 35S16, 35C16	F1AGL411G	04/16 ⇒
DAILY V 35S14, 35S15, 35C15, 40S14, 40C15, 50C15, 65C15, 70C15	F1AGL411G	03/14 ⇒ 04/16
DAILY V 35S15, 35C15, 40C15, 50C15, 65C15, 70C15	F1CGL411A	04/16 ⇒
DAILY V 35S15, 35C15, 40C15, 50C15, 65C15, 70C15	F1CE3481J, F1CFL411F	03/14 ⇒
DAILY V 35S15, 35C15, 40C15, 50C15, 65C15, 70C15, 72C15	F1CGL411A	04/16 ⇒
DAILY V 35S17, 35C17, 40C17, 45S17, 45C17, 50C17, 55C17, 65C17,...	F1CFL411F	03/14 ⇒ 04/16
DAILY V 35S17, 35C17, 40C17, 50C17, 55C17, 65C17, 70C17	F1CFL411F, F1CFL411W	03/14 ⇒ 04/16
DAILY V 35S17, 55S17 4x4	F1CFL411F	08/15 ⇒ 04/16
DAILY V 35S18, 35C18, 40C18, 50C18	F1CGL411B	04/16 ⇒
DAILY V 35S18, 35C18, 40C18, 50C18, 65C18, 70C18	F1CGL411B	04/16 ⇒
DAILY V 35S18, 35C18, 40C18, 50C18, 65C18, 70C18, 72C18	F1CFL411W, F1CFL411W	04/16 ⇒
DAILY V 35S18, 55S18 4x4	F1CFL411W, F1CE3481J	09/16 ⇒
DAILY V 40C15, 50C15, 60C15	F1CE3481J, F1CE3481J	06/14 ⇒ 10/16
DAILY V 40C15, 50C15, 65C15	F1CE3481J, F1CFL411F	03/14 ⇒ 04/16
DAILY V 40C17, 50C17, 60C17	F1CFL411F	06/14 ⇒ 10/16
DAILY V 40C17, 50C17, 65C17	F1CFL411F, F1CE3481J	03/14 ⇒ 04/16
DAILY V 50C15	F1CE3481J, PT204	06/14 ⇒ 10/16
DAILY V 50C17	F1CFL411F	06/14 ⇒ 10/16
DAILY V 50C17, 65C17	F1CFL411F	06/14 ⇒ 10/16
DAILY 2.3	F1AE0481H	09/09 ⇒ 02/14
DAILY 3.0	F1CE0481A, F1CE0481A	07/99 ⇒
EURO CARGO IV	F4GFE601A	09/15 ⇒
MASSIF 3.0 HPI	F1CE0481F	10/08 ⇒ 02/11
MASSIF 3.0 HPT	F1CE0481H	10/08 ⇒ 02/11

JAGUAR

E-PACE 2.0 AWD	PT204, PT204	09/17 ⇒
F-PACE 2.0 AWD	PT204, PT204	02/17 ⇒
F-TYPE 2.0 i4	PT204	07/17 ⇒
XE 2.0	PT204, PT204	02/17 ⇒
XE 2.0 AWD	PT204, PT204	02/17 ⇒
XF 2.0	PT204, PT204	03/17 ⇒
XF 2.0 AWD	PT204, ENS	03/17 ⇒

JEEP

CHEROKEE III 2.5 CRD 4x4	ENJ	09/01 ⇒ 01/08
CHEROKEE III 2.8 CRD 4x4	ENR	11/04 ⇒ 01/08
CHEROKEE IV 2.8 CRD 4x4	ENS, EBS	05/08 ⇒
CHEROKEE V 2.0 CRD	EBS, EBS	04/14 ⇒
CHEROKEE V 2.0 CRD [ExtraEU]	EBS, EBS	04/14 ⇒
CHEROKEE V 2.0 CRD 4x4	EBS, EBS(55263087)	04/14 ⇒
CHEROKEE V 2.2 CRD 4x4	LAU61	08/15 ⇒
COMPASS 2.0 CRD 4x4	EBS(55263087), EXF	12/16 ⇒
GRAND CHEROKEE 3.0 CRD	EXF	09/13 ⇒
GRAND CHEROKEE 3.0 CRD V6 4x4	EXF, 55263624	01/11 ⇒
RENEGADE 1.4	55263624, EAM	07/14 ⇒
RENEGADE 1.4 4x4	EAM, EJJ(55260384)	07/14 ⇒

JEEP		
RENEGADE 1.6 CRD	EJJ(55260384), 55263088	07/14 ⇒
RENEGADE 2.0 CRD 4x4	55263088, ENS	07/14 ⇒
WRANGLER 2.8 CRD	ENS, 198A2.000	04/07 ⇒
WRANGLER 2.8 CRD RWD	ENS	04/07 ⇒ 02/10
LANCIA		
DELTA III 1.4 16V	198A7.000	07/10 ⇒ 08/14
DELTA III 1.6 D Multijet	198A2.000, 198A5.000	08/08 ⇒ 08/14
DELTA III 2.0 D Multijet	198A5.000, --	09/08 ⇒ 08/14
MUSA 1.3 D Multijet	--	10/04 ⇒ 12/12
MUSA 1.6 D Multijet	--, 841G.000	07/08 ⇒ 12/12
MUSA 1.9 D Multijet	188B2.000	10/04 ⇒ 09/12
THEMA 2011 3.0 D	EXF	09/11 ⇒ 10/14
THESIS 2.4 D Multijet	841P000	04/06 ⇒ 07/09
THESIS 2.4 JTD	841G.000, ENS	05/03 ⇒
VOYAGER 2.8 CRD	ENS, 199A2.000	09/11 ⇒ 12/14
YPSILON I 1.3 D Multijet	199A2.000, 312A2.000	09/06 ⇒ 12/11
YPSILON II 0.9 CNG	312A2.000, 312A2.000	05/11 ⇒
YPSILON II 0.9 TwinAir	312A2.000, 199B1.000	05/11 ⇒
YPSILON II 1.3 D Multijet	199B1.000, M156D	05/11 ⇒
MASERATI		
GHIBLI 3.0	M156D, M156B	08/13 ⇒
GHIBLI 3.0 S	M156B, M156B	08/13 ⇒
GHIBLI 3.0 S Q4	M156B, M156D	08/13 ⇒
LEVANTE 3.0 S Trazione integrale	M156E	06/16 ⇒
LEVANTE 3.0 Trazione integrale	M156D	06/16 ⇒
QUATTROPORTE 3.0	M156D, M156B	03/13 ⇒
QUATTROPORTE 3.0 S	M156B	05/13 ⇒
QUATTROPORTE 3.0 S [ExtraEU]	M156B	05/13 ⇒
QUATTROPORTE 3.0 S Q4	M156B, HR12DDT	05/13 ⇒
QUATTROPORTE 3.8 GT S	M156A	01/13 ⇒
MAZDA		
BT-50 2.5 MRZ-CD 4x4	WLAA	12/06 ⇒ 12/15
BT-50 3.0 CDVi	WEAT	12/06 ⇒ 12/15
BT-50 3.0 CDVi 4x4	WEAT	10/06 ⇒ 12/15
NISSAN		
JUKE 1.2 DIG-T	HR12DDT, H5FT	05/14 ⇒
MICRA V 0.9 IG-T	HR09DET	12/16 ⇒
PULSAR 1.2 DIG-T	HRA2DDT	10/14 ⇒
QASHQAI II 1.2 DIG-T	H5FT, X20DTH	11/13 ⇒
OPEL		
ADAM 1.4 S	B14NEH	11/14 ⇒
ASTRA G 2.0 DTI	Y20DTH	09/00 ⇒ 04/05
ASTRA G 2.0 DTI 16V	X20DTH, Z19DT	08/99 ⇒ 01/05
ASTRA G 2.2 DTI	Y22DTR	09/02 ⇒ 10/05
ASTRA H 1.3 CDTi	Z13DTH	04/05 ⇒ 10/10
ASTRA H 1.9 CDTi	Z19DT, A14NEL	06/04 ⇒ 12/12
ASTRA H 1.9 CDTi 16V	Z19DTJ	04/04 ⇒ 10/10
ASTRA J 1.3 CDTi	A13DTE	01/09 ⇒
ASTRA J 1.4	A14NEL, A14NEL	10/11 ⇒
ASTRA J 1.4 LPG	A14NET	12/11 ⇒
ASTRA J 1.4 Turbo	A14NEL, A17DTC	12/09 ⇒
ASTRA J 1.7 CDTi	A17DTC, A20DTH	09/09 ⇒ 10/15
ASTRA J 2.0 CDTi	A20DTH, A14NEL	09/09 ⇒
CASCADA 1.4	A14NEL, A14NET	03/13 ⇒
CASCADA 1.4 Turbo	A14NET, A13FD	03/13 ⇒
CASCADA 2.0 CDTi	A20DTH	04/13 ⇒
COMBO D 1.3 CDTi	A13FD, A16FDH	02/12 ⇒
COMBO D 1.4	A14FC	02/12 ⇒
COMBO D 1.4 CNG	A14FC	02/12 ⇒
COMBO D 1.6 CDTi	A16FDH, A13DTC	02/12 ⇒
COMBO D 2.0 CDTi	A20FD	02/12 ⇒
CORSA D 1.3 CDTi	A13DTC, B13DTC	07/06 ⇒ 08/14
CORSA D 1.4	A14NEL	07/12 ⇒ 08/14
CORSA D 1.7 CDTi	A17DTS	12/09 ⇒ 08/14
CORSA E 1.3 CDTi	B13DTC, B14NEH	09/14 ⇒
CORSA E 1.4 Turbo	B14NEH, X22DTH	09/14 ⇒
CORSA E 1.6 Turbo	B16LES	03/15 ⇒
FRONTERA B 2.2 DTI	X22DTH, A14NET	09/02 ⇒ 07/04
INSIGNIA 1.4	A14NET, A14NET	04/11 ⇒ 03/17
INSIGNIA 1.4 LPG	A14NET, A20DT	07/12 ⇒ 03/17
INSIGNIA 2.0 CDTi	A20DT, A20DTH	07/08 ⇒ 03/17
INSIGNIA 2.0 CDTi 4x4	A20DTH, A13DTC	06/10 ⇒ 03/17
MERIVA B 1.3 CDTi	A13DTC, A14NEL	06/10 ⇒ 11/14
MERIVA B 1.4	A14NEL, A17DTC	06/10 ⇒ 03/17
MERIVA B 1.4 LPG	B14NEL	06/11 ⇒ 03/17
MERIVA B 1.7 CDTi	A17DTC, A14NET	06/10 ⇒ 06/15
MOKKA 1.4	A14NET, A14NET	04/13 ⇒
MOKKA 1.4 4x4	A14NET, A14NET	06/12 ⇒
MOKKA 1.4 LPG	A14NET, Z19DT	04/13 ⇒
MOKKA 1.6 CDTi	B16DTH	01/15 ⇒
MOKKA 1.6 CDTi 4x4	B16DTH	01/15 ⇒
MOKKA 1.7 CDTi	A17DTS	06/12 ⇒
MOKKA 1.7 CDTi 4x4	A17DTS	06/12 ⇒
SIGNUM 1.9 CDTi	Z19DT, Z19DT	04/04 ⇒
SIGNUM 2.0 DTI	Y20DTH	05/03 ⇒ 04/04

OPEL			
SIGNUM 2.2 DTI	Y22DTR	05/03 → 04/04	
SIGNUM 2.2 DTI 16V	Y22DTR	05/03 → 06/08	
VECTRA C 1.9 CDTi	Z19DT, Z19DT	04/04 → 01/09	
VECTRA C 2.2 DTI	Y22DTR	10/03 → 06/08	
VECTRA C 2.2 DTI 16V	Y22DTR	04/02 → 06/08	
ZAFIRA A 2.0 DTI 16V	Y20DTH	09/00 → 06/05	
ZAFIRA A 2.2 DTI 16V	Y22DTR	01/02 → 06/05	
ZAFIRA B 1.9 CDTi	Z19DT, A14NEL	07/05 → 04/15	
ZAFIRA C 1.4	A14NET, A14NET	10/11 →	
ZAFIRA C 1.4 LPG	A14NET, A20DT	10/11 →	
ZAFIRA C 2.0 CDTi	A20DT, 199A9.000	10/11 →	

PEUGEOT			
BIPPER 1.3 BlueHDi 80	F13DTE6	12/15 →	
BIPPER 1.3 HDi 75	199A9.000, 199A9.000	10/10 →	
BIPPER TEEPEE 1.3 HDi 75	199A9.000, F13DTE6	10/10 →	
BIPPER TEEPEE 1.3 HDi 80	F13DTE6, F1CE0481D(F30DT)	12/15 →	
BOXER II 3.0 D	F30DT	09/08 → 12/09	
BOXER II 3.0 HDi	F1CE0481D(F30DT), F1CE3481N(F30DTE)	07/06 →	
BOXER II 3.0 HDi 145	F1CE3481N(F30DTE), F1CE0481D(F30DT)	04/10 →	
BOXER II 3.0 HDi 160	F1CE0481D(F30DT), F1CE0481D(F30DT)	04/06 →	
BOXER II 3.0 HDi 175	F1CE0481D(F30DT), H4B400	03/11 →	

RENAULT			
CAPTUR 0.9 Tce 90	H4B400, H5F403	06/13 →	
CAPTUR 1.2 T	H5F403	06/13 →	
CAPTUR 1.2 Tce 120	H5F403, H4B400	06/13 →	
CLIO IV 0.9 Tce 75	H4B408	10/18 →	
CLIO IV 0.9 Tce 90	H4B400, H5F403	11/12 →	
CLIO IV 0.9 Tce 90 LPG	H4B410	08/15 →	
CLIO IV 1.2 Tce 120	H5F403, H5F400	03/13 →	
GRAND SCÉNIC III 1.2 Tce	H5F400, H5F400	04/12 →	
GRAND SCÉNIC III 1.4 16V	H4J700	02/09 →	
GRAND SCÉNIC IV 1.2 Tce 115	H5F408	09/16 →	
GRAND SCÉNIC IV 1.2 Tce 130	H5F408	09/16 →	
KADJAR 1.2 Tce 130	H5F408	06/15 →	
KANGOO II 1.2 Tce 115	H5F400, H5F400	07/13 →	
KANGOO 1.2 LPG	H5F400	07/13 →	
MEGANE III 1.2 Tce	H5F400, H5F400	03/12 →	
MEGANE III 1.4 Tce	H4J700	04/09 →	
MEGANE IV 1.2 Tce 100	H5F408	11/15 →	
MEGANE IV 1.2 Tce 130	H5F408	11/15 →	
MEGANE CC 1.2 Tce	H5F400, H5F400	09/12 →	
MEGANE CC 1.4 Tce	H4J700	06/10 →	
SCÉNIC III 1.2 Tce	H5F400, D223L	04/12 →	
SCÉNIC III 1.4 16V	H4J700	02/09 →	
SCÉNIC IV 1.2 Tce 115	H5F408	09/16 →	
SCÉNIC IV 1.2 Tce 130	H5F408	09/16 →	
THALIA II 0.9 Tce	H4B400	11/12 → 06/14	

SAAB			
9-3 1.9 TiD	Z19DTH	09/04 → 02/15	
9-3 2.2 TiD	D223L, D20DTF	11/00 → 02/15	
9-5 1.9 TiD	Z19DTH	01/06 → 12/09	
9-5 2.0 TiD	A20DTH	05/10 → 01/12	
9-5 2.2 TiD	D223L	03/02 → 12/09	

SSANGYONG			
ACTYON I 2.0 Xdi	D20DTR	09/11 →	
ACTYON I 2.0 Xdi 4WD	D20DTR	09/11 →	
ACTYON II 2.0 Xdi	D20DTF, D20DTR	08/12 →	
ACTYON II 2.0 Xdi 4WD	D20DTR, D20DTF	10/12 →	
ACTYON II 2.0 Xdi 4x4	D20DTF, D20DTF	08/12 →	
ACTYON II 2.2 Xdi	D22DTR	07/15 →	
ACTYON II 2.2 Xdi 4WD	D22DTR	07/15 →	
KORANDO 2.0 e-Xdi	D20DTF, D20DTF	11/10 →	
KORANDO 2.0 e-Xdi 4WD	D20DTF, D20DTR	11/10 →	
KORANDO 2.2 Xdi	D22DTF	07/15 →	
KORANDO 2.2 Xdi 4WD	D22DTF	07/15 →	
REXTON I 2.0 Xdi	D20DTR, D20DTR	07/12 →	
REXTON I 2.0 Xdi Trazione integrale	D20DTR, D20DTR	07/12 →	
REXTON I 2.2 Xdi	D22DTR	07/15 →	
REXTON I 2.2 Xdi Trazione integrale	D22DTR	07/15 →	
REXTON II 2.0	G20DTR	07/18 →	
REXTON II 2.0 Trazione integrale	G20DTR	07/18 →	
REXTON II 2.2 e-Xdi	D22DTR	01/18 →	
REXTON II 2.2 e-Xdi 4WD	D22DTR	01/18 →	
REXTON II 2.2 Xdi	D22DTR	07/17 →	
REXTON II 2.2 Xdi Trazione integrale	D22DTR	07/17 →	
RODIUS 2.0 Xdi	D20DTR, D13A	06/13 →	
RODIUS 2.0 Xdi 4WD	D20DTR	07/13 →	
RODIUS 2.2 Xdi	D22DTR	07/15 →	
RODIUS 2.2 Xdi 4WD	D22DTR	07/15 →	
STAVIC 2.0 200 Xdi	D20DTR	06/13 →	
TIVOLI 1.6 e-Xdi [ExtraEU]	D16DTF	04/15 →	

SSANGYONG			
TIVOLI 1.6 XDi 160	D16DTF	04/15 →	
TIVOLI 1.6 XDi 160 Trazione integrale	D16DTF	04/15 →	
XLV e-XDi 160	D16DTF	04/16 →	
XLV e-XDi 160 Trazione integrale	D16DTF	04/16 →	

SUZUKI			
SWIFT V 1.3 DDiS	D13A, Z19DT	10/10 →	
SX4 I 1.9 DDiS	D19AA	06/06 →	
SX4 I 1.9 DDiS 4x4	D19AA	06/06 →	
SX4 I 2.0 DDiS	D20AA	07/09 →	
SX4 I 2.0 DDiS 4x4	D20AA	07/09 →	
SX4 II 1.6 DDiS	D16AA	08/13 →	
SX4 II 1.6 DDiS AllGrip	D16AA	08/13 →	
SX4 2.0 DDiS	D20AA	09/13 → 12/15	

VAUXHALL			
ADAM 1.4 S	B14NEH	11/14 →	
ASTRA IV 2.0 DTI 16V	Y20DTH	02/98 → 05/05	
ASTRA IV 2.2 DTI	Y22DTR	09/02 → 05/05	
ASTRA V 1.3 CDTi	Z13DTH	01/04 → 11/10	
ASTRA V 1.9 CDTi	Z19DT, A14NEL	01/04 → 11/10	
ASTRA V 1.9 CDTi 16V	Z19DTJ	01/04 → 05/09	
ASTRA VI 1.3 CDTi	A13DTE	12/09 →	
ASTRA VI 1.4	A14NEL, A14NEL	10/11 →	
ASTRA VI 1.4 Turbo	A14NEL, A17DTC	12/09 →	
ASTRA VI 1.7 CDTi	A17DTC, A20DTH	12/09 →	
ASTRA VI 2.0 CDTi	A20DTH, Z19DT	12/09 →	
ASTRAVAN II 2.0 DTI	Y20DTH	04/04 → 08/06	
ASTRAVAN III 1.3 CDTi	Z13DTH	08/05 →	
ASTRAVAN III 1.9 CDTi	Z19DT, A14NEL	03/05 → 11/11	
CASCADA 1.4	A14NEL, A13FD	02/13 →	
CASCADA 2.0 CDTi	A20DTH	02/13 →	
COMBO D 1.3 CDTi	A13FD, A16FDH	11/11 →	
COMBO D 1.4 CNG	A14FC	11/11 →	
COMBO D 1.6 CDTi	A16FDH, A13DTC	11/11 →	
COMBO D 2.0 CDTi	A20FD	11/11 →	
CORSA D 1.3 CDTi	A13DTC, B13DTC	08/06 → 08/14	
CORSA D 1.4	A14NEL	08/12 → 08/14	
CORSA D 1.7 CDTi	A17DTS	03/07 → 08/14	
CORSA E 1.3 CDTi	B13DTC, B14NEH	08/14 →	
CORSA E 1.4	B14NEH, A13DTC	08/14 →	
CORSA E 1.6 VXR	B16LES	04/15 →	
CORSAVAN III 1.3 CDTi	A13DTC, B13DTC	07/06 →	
CORSAVAN IV 1.3 CDTi	B13DTC, X22DTH	10/14 →	
FRONTERA B 2.2 DTI	X22DTH, A14NET	09/00 → 10/04	
INSIGNIA 1.4	A14NET, A20DT	04/11 → 05/17	
INSIGNIA 1.4 LPG	A14NET	07/12 → 05/17	
INSIGNIA 2.0 CDTi	A20DT, A20DTH	07/08 → 05/17	
INSIGNIA 2.0 CDTi 4x4	A20DTH, A13DTC	07/08 → 05/17	
MERIVA II 1.3 CDTi	A13DTC, A14NEL	06/10 →	
MERIVA II 1.4	A14NEL, A14NEL	06/10 →	
MERIVA II 1.4 LPG	A14NEL, A17DTC	06/11 →	
MERIVA II 1.7 CDTi	A17DTC, A14NET	06/10 →	
MOKKA / MOKKA X 1.4	A14NET, A14NET	04/13 →	
MOKKA / MOKKA X 1.4 4x4	A14NET, Z19DT	06/12 →	
MOKKA / MOKKA X 1.7 CDTi	A17DTS	06/12 →	
MOKKA / MOKKA X 1.7 CDTi 4x4	A17DTS	06/12 →	

SIGNUM 1.9 CDTi	Z19DT	04/04 → 03/08	
SIGNUM 1.9 CDTi 16V	Z19DTH	04/04 → 03/08	
SIGNUM 1.9 Turbo	Z19DTL	01/05 → 05/08	
SIGNUM 2.0 DTI	Y20DTH	05/03 → 05/08	
SIGNUM 2.2 DTI	Y22DTR	05/03 → 05/08	
VECTRA C 1.9 CDTi	Z19DT, Z19DT	04/02 → 09/08	
VECTRA C 1.9 CDTi 16V	Z19DTH	04/04 → 05/09	
VECTRA C 2.2 DTI 16V	Y22DTR	08/02 → 07/08	
ZAFIRA A 2.0 DTI 16V	Y20DTH	04/99 → 08/05	
ZAFIRA A 2.2 D	Y22DTR	06/01 → 06/05	
ZAFIRA B 1.9 CDTi	Z19DT, A14NEL	07/05 → 11/14	
ZAFIRA C 1.4	A14NEL, A20DT	10/11 → 08/18	
ZAFIRA C 1.4 LPG	A14NET	10/11 → 08/18	
ZAFIRA C 2.0 CDTi	A20DT, CAXA	10/11 →	

VOLVO			
V70 III 1.6 T4F	B4164T2	01/11 → 12/15	
V70 III T4	B4164T	10/10 → 12/15	

ABSOLUTE PRESSURE SENSORS (MAP)

Adatt./Suitable:

AUDI

038 906 051 B
03G 906 051 D

BOSCH

0 261 230 266
0 261 230 267
0 281 002 400

FORD

1 136 735
99VW-9E928-AB

PORSCHE

03G 906 051 D

ROLLS-ROYCE

038906051B
PF100636PB

SEAT

038 906 051 B
03G 906 051 D

SKODA

038 906 051 B
03G 906 051 D

VW

038 906 051 B
03F 145 673 F
03G 906 051 D

* without connector parts

- senza pezzi raccordo
- sans raccords
- ohne Anschlusssteile
- sin piezas de conexión

MARKET DIFFUSION: HIGH



kPa	mV	O + NTC -
11 - 254	250 - 4750	

AUDI

A1 1.2 TFSI	CBZA	05/10 → 04/15
A1 1.4 TFSI	CAXA, AMF	05/10 → 04/15
A2 1.2 TDI	ANY	03/01 → 08/05
A2 1.4 TDI	AMF, AJQ	02/00 → 08/05
A3 I 1.8 T	AJQ, AGU	12/98 → 05/03
A3 I 1.8 T quattro	AGU, ATD	12/96 → 05/03
A3 I 1.9 TDI	ATD, CAXC	10/00 → 05/03
A3 II 1.2 TFSI	CBZB	03/10 → 05/13
A3 II 1.2 TSI	CBZB	04/10 → 08/12
A3 II 1.4 TFSI	CAXC, BKC	09/07 → 05/13
A3 II 1.9 TDI	BKC, CAXC	05/03 → 05/10
A3 II SPORTBACK 1.2 TSI	CBZB	04/10 → 03/13
A3 II SPORTBACK 1.4 TFSI	CAXC, BKC	09/07 → 03/13
A3 II SPORTBACK 1.9 TDI	BKC, BCZ	09/04 → 05/10
A4 II 2.5 TDI	BCZ, BKE	08/02 → 12/05
A4 III 1.9 TDI	BKE, BPP	11/04 → 06/08
A4 III 2.5 TDI	BDG	11/04 → 05/06
A6 III 2.7 TDI	BPP, BPP	11/04 → 08/11
A6 III 2.7 TDI quattro	BPP, ASB	11/04 → 08/11
A6 III 3.0 TDI	ASB	06/06 → 08/11
A6 III 3.0 TDI quattro	ASB, ASB	05/04 → 08/11
A8 II 3.0 TDI quattro	ASB, ANU	08/03 → 07/10
A8 II 4.0 TDI quattro	ASE	05/03 → 07/05

FORD

GALAXY I 1.9 TDI ANU, AJH 04/00 → 05/06

PORSCHE

911 VI 3.8 Carrera 4S / 4 GTS MA1.03 05/14 →
911 VI 3.8 Carrera S / GTS MA1.03 07/12 →

SEAT

ALHAMBRA I / II 1.8 T 20V	AJH, IZ	10/97 → 03/10
ALHAMBRA I / II 1.9 TDI	IZ, AUY	06/00 → 03/10
ALHAMBRA I / II 1.9 TDI 4motion	AUY, BJB	06/00 → 03/10
ALTEA 1.2 TSI	CBZB	04/10 →
ALTEA 1.4 TFSi	CAXC	05/10 → 04/11
ALTEA 1.4 TSI	CAXC	11/07 →
ALTEA 1.9 TDI	BJB, BKC	04/04 →
ALTEA XL 1.2 TSI	CBZB	04/10 →
ALTEA XL 1.4 TSI	CAXC	11/07 →
ALTEA XL 1.9 TDI	BKC, AMF	10/06 →
ALTEA XL 1.9 TDI 4x4	BLS	06/09 → 12/10
CORDOBA II 1.4 TDI	AMF, ATD	10/02 → 11/09

SEAT		
CORDOBA II 1.9 TDI	ATD, AUB	09/02 → 11/09
IBIZA III 1.4 16V	AUB, AMF	02/02 → 11/09
IBIZA III 1.4 TDI	AMF, BBU	05/02 → 11/09
IBIZA III 1.8 T Cupra R	BBU, BJX	01/04 → 02/08
IBIZA III 1.8 T FR	BJX, ATD	12/03 → 05/08
IBIZA III 1.9 TDI	ATD, AZL	02/02 → 11/09
IBIZA III 2.0	AZL, CBZA	04/02 → 11/09
IBIZA IV 1.2 TSI	CBZA, BLS	09/10 →
IBIZA IV 1.4 TDI	BMS	07/08 → 06/10
IBIZA IV 1.9 TDI	BLS, APP	03/08 → 06/10
LEON I 1.8 20V T	APP, AJQ	11/99 → 06/06
LEON I 1.9 TDI	AJQ, AGR	11/99 → 06/06
LEON I 2.0 TDI	AGR, BKC	10/05 → 06/06
LEON II 1.2 TSI	CBZB	02/10 → 12/12
LEON II 1.4 TSI	CAXC	11/07 → 12/12
LEON II 1.9 TDI	BKC, APP	07/05 → 12/10
TOLEDO II 1.8 20VT	APP, AGR	09/00 → 07/04
TOLEDO II 1.9 TDI	AGR, BJB	10/98 → 07/04
TOLEDO III 1.4 TSI	CAXC	11/07 → 05/09
TOLEDO III 1.9 TDI	BJB, CBZA	10/04 → 05/09
TOLEDO IV 1.2 TSI	CBZA, AMF	07/12 →
TOLEDO IV 1.4 TSI	CAXA	07/12 →

SKODA		
FABIA I 1.4 TDI	AMF, ATD	04/03 → 03/08
FABIA I 1.9 TDI	ATD, CBZA	01/00 → 03/08
FABIA II 1.2 TSI	CBZA, BMS	03/10 → 12/14
FABIA II 1.4 TDI	BMS, BLS	01/07 → 03/10
FABIA II 1.9 TDI	BLS, AGU	04/07 → 03/10
OCTAVIA I 1.8 T	AGU, AGR	08/97 → 12/10
OCTAVIA I 1.8 T 4x4	ARX	05/01 → 05/06
OCTAVIA I 1.9 TDI	AGR, AGR	08/00 → 12/10
OCTAVIA I 1.9 TDI 4x4	AGR, BJB	09/00 → 02/06
OCTAVIA I RS 1.8 T	AUQ	05/01 → 01/06
OCTAVIA II 1.2 TSI	CBZB	02/10 → 06/13
OCTAVIA II 1.4 [CHN]	CFBA.	03/10 →
OCTAVIA II 1.4 TSI	CAXA	11/08 → 06/13
OCTAVIA II 1.9 TDI	BJB, BKC	06/04 → 12/10
OCTAVIA II 1.9 TDI 4x4	BKC, CBZA	11/04 → 12/10
RAPID 1.2	CGPC	07/12 →
RAPID 1.2 LPG	CBZA	07/12 →
RAPID 1.2 TSI	CBZA, CBZA	07/12 →
RAPID 1.4 TSI	CAXA	07/12 →
RAPID 1.6 SRE	CWVA	05/15 →
ROOMSTER 1.2 TSI	CBZA, BMS	03/10 → 05/15
ROOMSTER 1.4 TDI	BMS, AXR	07/06 → 03/10
ROOMSTER 1.9 TDI	AXR, AVB	03/06 → 03/10
SUPERB I 1.8 T	AWT	12/01 → 03/08
SUPERB I 1.9 TDI	AVB, BLS	08/02 → 03/08
SUPERB I 2.5 TDI	BDG	06/03 → 03/08
SUPERB II 1.4 [CHN]	CFBA.	03/10 →
SUPERB II 1.4 TSI	CAXC	07/08 → 05/15
SUPERB II 1.9 TDI	BLS, AGU	03/08 → 11/10
YETI 1.2 TSI	CBZB	09/09 → 05/15
YETI 1.4 TSI	CAXA	06/10 → 05/15

VW		
BEETLE 1.2 TSI	CBZB	07/11 →
BORA 1.8 T	AGU, AGR	05/00 → 05/05
BORA 1.9 TDI	AGR, AGR	09/00 →
BORA 1.9 TDI 4motion	AGR, CBZA	09/00 →
CADDY III 1.2 TSI	CBZA, BJB	09/10 → 05/15
CADDY III 1.9 TDI	BJB, BDJ	04/04 → 08/10
CADDY III 1.9 TDI 4motion	BLS	05/08 → 08/10
CADDY III 2.0 SDI	BDJ, AXB	03/04 → 08/10
CADDY III 2.0 TDI	BMM	09/07 → 08/10
CAMPMOBILE 1.9 TDi	AXB, AGU	03/04 → 11/09
EOS 1.4 TSI	CAXA	11/07 → 08/15
FOX 1.4 TDI	BNM	04/05 → 12/09
GOLF IV 1.8 T	AGU, AGR	08/97 → 06/06
GOLF IV 1.8 T GTI	AUQ	08/01 → 06/05
GOLF IV 1.9 TDI	AGR, AGR	02/00 → 06/06
GOLF IV 1.9 TDI 4motion	AGR, CBZA	09/00 → 06/06
GOLF V 1.2 TSI	CBZA, BKC	11/09 → 12/13
GOLF V 1.4 TSI	CAXA	05/07 → 12/13
GOLF V 1.9 TDI	BKC, BKC	10/03 → 07/09
GOLF V 1.9 TDI 4motion	BKC, CBZA	08/04 → 07/09
GOLF V 2.0 SDI	BDK	01/04 → 11/08
GOLF VI 1.2 TSI	CBZA, CAXA	11/08 →
GOLF VI 1.4 TSI	CAXA, BKC	10/08 →
GOLF 1.2 TSI	CBZA	11/09 → 08/14
GOLF 1.2 TSI BlueMotion	CBZB	05/09 → 11/12
GOLF 1.4 TSI	CAXA	01/09 → 08/14
GOLF 1.9 TDI	AHF	10/97 → 05/04
GOLF TSi	CAXA	10/08 → 11/12
GOLF VAN 1.2 TSi	CBZB	09/09 → 05/14
GOLF VAN 1.4 TSi	CAXA	07/09 → 05/14
JETTA V 1.4 TSI	CAXA	05/07 → 10/10
JETTA V 1.6 TDI	CAYB	12/09 → 10/10
JETTA V 1.9 TDI	BKC, BWA	01/05 →

VW		
JETTA V 2.0 TFSI	BWA, CAXA	10/05 → 10/10
JETTA VI 1.2 TSI	CBZB	10/10 →
JETTA VI 1.4 TSI	CAXA, ANJ	05/11 →
LT II 2.5 TDI	ANJ, AXB	05/01 → 07/06
LUPO 1.4 TDI	AMF	01/99 → 07/05
MULTIVAN 1.9 TDI	AXB, ATD	04/03 → 11/09
NEW BEETLE 1.9 TDI	ATD, BAU	02/01 → 09/10
PASSAT IV 1.9 [CHN]	BPZ	04/08 →
PASSAT IV 1.9 TDI	AVB	11/00 → 05/05
PASSAT IV 2.5 TDI	BDG	05/03 → 05/05
PASSAT IV 2.5 TDI 4motion	BAU, BKC	01/03 → 05/05
PASSAT V 1.4 TSI	CAXA	05/07 → 12/14
PASSAT V 1.9 TDI	BKC, AMF	03/05 → 11/10
PASSAT 1.4 TSi BlueMotion	CAXA	08/10 → 12/14
POLO 1.9 TDi [ExtraEU]	ATD	07/03 → 06/05
POLO IV 1.4 TDI	AMF, ATD	10/01 →
POLO IV 1.8 GTI	BJX	09/05 → 11/09
POLO IV 1.8 GTi Cup Edition	BBU	05/06 → 11/09
POLO IV 1.9 TDi	ATD, CBZB	10/01 →
POLO V 1.2 TSI	CBZB, CAXA	11/09 →
POLO V 1.2 TSi BlueMotion	CBZB	11/09 → 05/14
SCIROCCO III 1.4 TSI	CAXA, AJH	08/08 → 11/17
SCIROCCO 1.4 TSI	CAXA	08/08 → 05/14
SHARAN I 1.8 T 20V	AJH, 1Z	09/97 → 03/10
SHARAN I 1.9 TDI	1Z, AUY	04/00 → 03/10
SHARAN I 1.9 TDI 4motion	AUY, AVQ	04/00 → 03/10
TIGUAN I 1.4 [CHN]	CFBA.	11/11 →
TIGUAN I 1.4 TSI	CAXA	08/10 →
TOURAN I 1.2 TSI	CBZB	05/10 → 05/15
TOURAN I 1.4 [CHN]	CFBA.	04/09 →
TOURAN I 1.9 TDI	AVQ, ACV	02/03 → 05/10
TRANSPORTER IV 2.5 TDI	ACV, AXB	09/95 → 04/03
TRANSPORTER IV 2.5 TDI Syncro	ACV	09/95 → 04/03
TRANSPORTER V 1.9 TDI	AXB, AUA	04/03 → 11/09

10.3084



3,5

ABSOLUTE PRESSURE SENSORS (MAP)

Adatt./Suitable:

- AUDI**
036 906 051
- MAGNETI MARELLI**
T-PRTO4
T-PRTO4/B
- SEAT**
027 998 041 1
036 906 051
036 998 041 1
- SIEMENS**
5WK9693Z
- SKODA**
036 906 051
- VW**
027 998 041 1
036 906 051
036 906 051 D
036 998 041 1

MARKET DIFFUSION: MEDIUM



kPa	mV	O + NTC -
15 - 120	250 - 4750	

AUDI		
A2 1.4	AUA, AHT	02/00 → 08/05
SEAT		
AROSA 1.0	AHT, AFK	10/98 → 01/01
AROSA 1.4 16V	AFK, APE	01/00 → 06/04
CORDOBA I 1.4 16V	APE, BBY	06/99 → 12/02
CORDOBA II 1.4 16V	BBY, APE	09/02 → 11/09
CORDOBA II 1.6	BAH	04/03 → 11/09

SEAT		
IBIZA II 1.4 16V	APE, AUB	08/99 → 02/02
IBIZA II 1.6	ALM	08/99 → 02/02
IBIZA III 1.4 16V	AUB, AUS	02/02 → 11/09
IBIZA III 1.6	BAH	02/03 → 11/09
INCA 1.4 16V	AUA	04/00 → 06/03
INCA 1.6 i	AEE	06/97 → 09/00
LEON I 1.4 16V	AHW	11/99 → 06/06
LEON I 1.6 16V	AUS, AUS	09/00 → 06/06
TOLEDO II 1.4 16V	AHW	01/00 → 05/02
TOLEDO II 1.6 16V	AUS, 135	06/00 → 05/06

SKODA		
BETA 1.3	135, AOV	10/95 → 04/02
FABIA I 1.0	AQV, AME	12/99 → 08/02
FABIA I 1.4	AME, AUA	04/00 → 05/03
FABIA I 1.4 16V	AUA, AXP	10/99 → 03/08
FELICIA 1.6	AEE	06/97 → 04/02
FELICIA 1.6 GLX	AEE	08/95 → 03/98
FELICIA 1.6 LX	AEE	08/95 → 03/98
OCTAVIA I 1.4 16V	AXP, 540	08/00 → 12/10
OCTAVIA I 1.6	AEE	09/96 → 09/04

VOLKSWAGEN (BR)		
CADDY 1.6i	MY4	11/98 →
GOL 1.0i 16v	511	09/97 →
GOL 1.6i	540, 542	10/96 →
GOL 1.8i	542, 546	10/96 →
GOL 2.0i	546, 540	10/96 →
PARATI 1.0i 16v	511	09/97 →
PARATI 1.6i	540, 546	10/96 →
PARATI 1.8i	542	10/96 →
PARATI 2.0i	546, BAH	10/96 →
POLO 1.0	ARA	07/02 → 01/04
POLO 1.4	BKY	07/06 →
POLO 1.4 16V	BBY	09/02 →
POLO 1.6	BAH, MJ2	07/00 →
POLO 1.8	MJ2, 540	12/96 →
SAVEIRO 1.6i	540, 542	10/96 →
SAVEIRO 1.8i	542, 546	10/96 →
SAVEIRO 2.0i	546, AHW	10/96 →

VW		
BORA 1.4 16V	AHW, ATN	03/00 → 05/05
BORA 1.6 16V	ATN, BAH	02/00 → 05/05
CADDY II 1.6	AEE	06/96 → 12/00
CADDY II 75 1.6	AEE	11/95 → 09/00
CADDY III 1.6 [ARG]	UVC	10/05 →
CADDY III 1.8 [ARG]	BUR	10/05 →
FOX 1.6	BAH, AHW	10/03 → 08/14
GOLF III 1.6	AEE	09/92 → 08/97
GOLF IV 1.4 16V	AHW, AUS	08/97 → 06/06
GOLF IV 1.6	AUS, ATN	05/00 → 06/06
GOLF IV 1.6 16V	ATN, AFK	02/00 → 06/06
LUPO 1.4 16V	AFK, AFH	09/98 → 07/05
LUPO 1.6 GTI	AVY	09/00 → 07/05
POLO 1.6 [ExtraEU]	BAH	11/02 → 07/06
POLO III 1.4	AUA	06/00 → 09/01
POLO III 1.4 16V	AFH, AEE	10/99 → 09/01
POLO III 1.6	AEE, ARC	05/97 → 09/01
POLO III 1.6 16V GTI	ARC, AFH	10/99 → 09/01
POLO III 100 1.4 16V	AFH, APE	04/96 → 10/99
POLO III 120 1.6 16V GTI	AJV	09/98 → 10/99
POLO III 75 1.4 16V	APE, AEA	10/99 → 09/01
POLO III 75 1.6	AEA, BBY	10/94 → 09/01
POLO IV 1.0	ARA	02/03 → 10/03
POLO IV 1.4	BBY, AUA	08/02 →
POLO IV 1.4 16V	AUA, BAH	10/01 → 05/08
POLO IV 1.6	BAH, BAH	08/02 →
POLO IV 1.6 [ExtraEU]	BAH	09/02 →
SPACEFOX / SPACE CROSS 1.6	BAH, 135	03/06 →
SPACEFOX / SPACE CROSS 1.6 FSI	BPA	03/06 →
SPACEFOX / SPACE CROSS 1.6 Total Flex	BPA	03/06 →

10.3085



3,5

ABSOLUTE PRESSURE SENSORS (MAP)

Adatt./Suitable:

SKODA
047 906 051



kPa	mV	O + NTC -
14 - 104	250 - 4750	

SKODA		
BETA 1.3	135, 135	10/95 ⇨ 04/02
FELICIA 1.3	135, 135	10/94 ⇨ 04/02
FELICIA 1.3 LX	135, 136l	08/95 ⇨ 03/98
FELICIA 1.3 LXI	136l, DHA	08/95 ⇨ 03/98

10.3086



3,5

ABSOLUTE PRESSURE SENSORS (MAP)

Adatt./Suitable:

FORD
1 110 963
YS6A-9F479-AA



kPa	mV	O + NTC -
15 - 120	250 - 4750	

FORD		
FIESTA IV 1.25 i 16V	DHA, FHA	08/95 ⇨ 01/02
FIESTA IV 1.4 i 16V	FHA, W10B14A	04/96 ⇨ 01/02
FIESTA 1.2	DHA, DHA	01/96 ⇨ 04/02

10.3087



3,5

ABSOLUTE PRESSURE SENSORS (MAP)

Adatt./Suitable:

BMW
0 872 648
LAND ROVER
MHK100820L
MG
MHK100820
MINI
12 14 0 872 648
ROVER
MHK100820

MARKET DIFFUSION: MEDIUM



kPa	mV	O + NTC -
10 - 118	310 - 4750	

LAND ROVER		
FREELANDER 1.8 16V 4x4	18K4F	11/00 ⇨ 10/06
FREELANDER 1.8 4x4	18K4F	10/00 ⇨ 10/06
FREELANDER 1.8 i 16V 4x4	18K4F	02/98 ⇨ 10/06
FREELANDER 2.5 V6 4x4	25KV6	11/00 ⇨ 10/06
MG		
EXPRESS 1.4	14K4F	03/03 ⇨ 05/05
EXPRESS 1.8	18K4F	03/03 ⇨ 05/05
EXPRESS 160	18K4K	03/03 ⇨ 05/05
MGF 1,8 i VVC	18K4K	10/01 ⇨ 03/02
MGF 1.6	16K4F	02/00 ⇨ 03/02
MGF 1.8 i 16V	18K4F	03/95 ⇨ 03/02
MGF 1.8 i VVC	18K4K	03/95 ⇨ 03/02
MG TF 115	16K4F	03/02 ⇨ 12/09
MG TF 120	18K4F	03/02 ⇨ 12/09
MG TF 135	18K4F	03/02 ⇨ 12/09
MG TF 160	18K4K	03/02 ⇨ 12/09
MG ZR 105	14K4F	06/01 ⇨ 04/05
MG ZR 120	18K4F	06/01 ⇨ 04/05
MG ZR 160	18K4K	06/01 ⇨ 04/05
MG ZS 1.6	16K4F	07/03 ⇨ 04/05
MG ZS 120	18K4F	07/01 ⇨ 10/05
MG ZS 180	25K4F	07/01 ⇨ 10/05
MG ZT 1.8 16V	18K4F	01/03 ⇨ 07/05
MG ZT 1.8 T 16V	18K4G	01/03 ⇨ 07/05
MG ZT 160	25K4F	06/01 ⇨ 07/05
MG ZT 180	25K4F	02/04 ⇨ 10/05
MG ZT 190	25K4F	06/01 ⇨ 07/05
MG ZT-T 1.8 16V	18K4F	01/03 ⇨ 07/05
MG ZT-T 1.8 T 16V	18K4G	01/03 ⇨ 07/05
MG ZT-T 160	25K4F	10/01 ⇨ 07/05
MG ZT-T 180	25K4F	02/04 ⇨ 10/05
MG ZT-T 190	25K4F	10/01 ⇨ 07/05
ZS 1.4	14K4F	08/01 ⇨ 12/05

MINI		
MINI I Cooper	W10B16A	06/01 ⇨ 11/07
MINI I One	W10B14A, 11K4F	06/01 ⇨ 11/07

ROVER		
25 1.1	11K4F, 14K4F	09/99 ⇨ 05/05
25 1.1 16V	11K4F	01/04 ⇨ 05/05
25 1.4 16V	14K4F, 18K4F	10/99 ⇨ 05/05
25 1.6 16V	16K4F	10/99 ⇨ 05/05
25 1.8 16V	18K4F	10/99 ⇨ 05/05
45 1.4	14K4F	02/00 ⇨ 05/05
45 1.6	16K4F	02/00 ⇨ 05/05
45 1.8	18K4F	02/00 ⇨ 05/05
45 2.0 V6	20K4F	02/00 ⇨ 05/05
75 1.8	18K4F, 25K4F	02/99 ⇨ 05/05
75 2.0 V6	20K4F	02/99 ⇨ 05/05

ROVER		
75 2.5 V6	25K4F, 14K4F	08/01 ⇨ 05/05
200 II 216	16K4F	01/96 ⇨ 12/97
200 II 216 1.6i 16V	16K4F	01/96 ⇨ 11/99
200 III 211	11K2D	01/98 ⇨ 03/00
200 III 214 i	14K2F	11/95 ⇨ 03/00
200 III 214 Si	14K4F	11/95 ⇨ 03/00
200 III 216 Si	16K4F	11/95 ⇨ 06/99
200 III 218 Si	18K4K	08/99 ⇨ 03/00
200 SERIES 1.4 [ExtraEU]	14K4D	01/96 ⇨ 12/97
200 SERIES 1.8	18K4K	01/96 ⇨ 06/99
400 II 414	14K2F	03/96 ⇨ 12/99
400 II 414 Si	14K4F	05/95 ⇨ 03/00
400 II 416 Si	16K4F	05/95 ⇨ 03/00
400 II 420 Si Lux	20M4F	12/95 ⇨ 03/00
COMMERCE 1.4	14K4M	01/03 ⇨ 12/05
COUPE 1.6 16 V	16K4F	03/96 ⇨ 11/99
COUPE 1.8 16 V	18K4K	03/96 ⇨ 11/99
STREETWISE 1.4	14K4F, EGG	08/03 ⇨ 05/05
STREETWISE 1.6	16K4F	01/04 ⇨ 05/05
STREETWISE 1.8	18K4F	08/03 ⇨ 05/05

10.3088



3,5

ABSOLUTE PRESSURE SENSORS (MAP)

Adatt./Suitable:

CHRYSLER
5269565
5293985AA



kPa	mV	O + NTC -
15 - 105	300 - 4800	

CHRYSLER		
300M 3.5 V6 24V	EGG, ECB	08/00 ⇨ 09/04
CIRRUS 2.0 LX	ECB	10/97 ⇨ 09/00
NEON I 2.0	ECC	10/96 ⇨ 09/00
NEON I 2.0 16V	ECB, B204E	05/94 ⇨ 08/99
NEON II 2.0 16V	ECB	08/99 ⇨ 12/06

10.3089



3,5

ABSOLUTE PRESSURE SENSORS (MAP)

Adatt./Suitable:

GENERAL MOTORS
55 563 262**SAAB**
55 560 162
55 563 262
91 97 948

kPa	mV	O + NTC -
10 - 265	660 - 4750	

SAAB

Model	Part No.	Year Range
9-3 2.0 SE Turbo	B204R	02/98 → 08/03
9-3 2.0 Turbo	B204E, B205E	02/98 → 08/03
9-3 2.3 Turbo	B235R	10/99 → 08/03
9-5 2.0 t	B205E, B205E	07/00 → 12/09
9-5 2.0 t BioPower	B205E, B235E	01/05 → 12/09
9-5 2.0 Turbo SE	B205E	10/98 → 07/00
9-5 2.3 t	B235E, --	01/01 → 12/09
9-5 2.3 t BioPower	--, B235E	11/06 → 12/09
9-5 2.3 Turbo	B235E, CCSA	09/01 → 12/09
9-5 3.0 V6t	B308E	01/98 → 12/09

10.3090



3,5

ABSOLUTE PRESSURE SENSORS (MAP)

Adatt./Suitable:

AUDI
03C 906 051
03C 906 051 F**BOSCH**
0 261 230 095
0 261 230 096
0 261 230 234
0 261 230 235**PORSCHE**
958 606 180 10**SEAT**
03C 906 051
03C 906 051 E
03C 906 051 F**SKODA**
03C 906 051
03C 906 051 E
03C 906 051 F
06G 906 051**VW**
03C 906 051
03C 906 051 E
03C 906 051 F

MARKET DIFFUSION: HIGH



kPa	mV	O + NTC -
10 - 117	405 - 4750	

AUDI

Model	Part No.	Year Range
A3 II SPORTBACK 1.6 E-Power	CCSA, AUK	01/11 → 03/13
A4 II 3.2 FSI	AUK	01/06 → 03/09
A4 II 3.2 FSI quattro	AUK	01/06 → 03/09
A4 III 3.2 FSI	AUK	01/05 → 06/08
A4 III 3.2 FSI quattro	AUK, CMUA	01/05 → 06/08
A4 IV 3.0 TFSI quattro	CMUA, CAKA	02/12 → 12/15
A4 IV 3.2 FSI	CALA	09/08 → 03/12
A4 IV 3.2 FSI quattro	CALA	11/07 → 03/12
A4 IV RS4 quattro	CFSA	05/12 → 08/15
A4 IV S4 quattro	CAKA, CHMB	11/08 → 12/15
A5 I 3.0 TFSI quattro	CHMB, CAKA	08/11 →
A5 I 3.2 FSI	CALA	06/07 → 03/12
A5 I 3.2 FSI quattro	CALA	06/07 → 03/12
A5 I RS5 quattro	CFSA	03/10 → 08/15
A5 I S5 quattro	CAKA, BDX	06/09 → 01/17
A6 III 2.4	BDW	05/04 → 10/08
A6 III 2.4 [CHN]	BDW	04/05 →
A6 III 2.4 quattro	BDW	01/05 → 10/08
A6 III 2.8 FSI	BDX, BDX	11/06 → 08/11
A6 III 2.8 FSI quattro	BDX, CAJA	06/07 → 08/11
A6 III 3.0 TFSI quattro	CAJA, AUK	10/08 → 08/11
A6 III 3.2 FSI	AUK, AUK	05/04 → 03/11
A6 III 3.2 FSI quattro	AUK, CHVA	05/04 → 10/08
A6 IV 2.8 FSI	CHVA	11/10 → 04/15
A6 IV 2.8 FSI quattro	CHVA, CGWB	11/10 → 09/18
A6 IV 3.0 TFSI	CREH	09/14 →
A6 IV 3.0 TFSI quattro	CGWB, CHVA	11/10 → 09/18
A7 SPORTBACK 2.5 FSI	CLXB	05/12 →
A7 SPORTBACK 2.8 FSI	CHVA	02/11 → 03/15
A7 SPORTBACK 2.8 FSI quattro	CHVA, CGWB	10/10 → 05/18
A7 SPORTBACK 2.8 TFSI	CVPA	09/14 →
A7 SPORTBACK 3.0 TFSI	CREH	05/14 →
A7 SPORTBACK 3.0 TFSI quattro	CGWB, BDX	10/10 → 05/18
A8 II 2.8 FSI	BDX, CPAA	08/07 → 07/10
A8 II 3.2 FSI	BPK	06/05 → 07/10
A8 II 3.2 FSI quattro	BPK	06/05 → 07/10
A8 III 2.5 TFSI	CPAA, CGWA	07/12 → 06/16
A8 III 3.0 TFSI quattro	CGWA, CTUC	06/10 → 01/18
A8 III 4.2 FSI quattro	CDRA	11/09 → 12/12
Q5 I 3.0 TFSI quattro	CTUC, CTUD	06/12 →
Q5 I 3.2 FSI quattro	CALB	11/08 →
Q5 I SQ5 TFSI quattro	CTUD, CJTB	05/13 →

AUDI

Q7 I 3.0 TFSI quattro	CJTB, M06.EC	05/10 → 08/15
Q7 II 3.0 TFSI quattro	CREC	01/15 →

PORSCHE

CAYENNE II 3.0 S E-Hybrid	M06.EC, MCG.EA	06/10 →
PANAMERA 3.0 S E-Hybrid	MCG.EA, BXW	03/11 → 10/16

SEAT

ALTEA 1.4 16V	BXW, BXW	05/06 →
ALTEA XL 1.4 16V	BXW, BBY	10/06 →
ARONA 1.6 SRE	CWWA	07/17 →
CORDOBA II 1.4 16V	BBY, AZL	09/02 →
CORDOBA II 1.6 16V	BTS	11/06 → 11/09
CORDOBA II 2.0	AZL, BBY	09/02 → 11/09
IBIZA 1.2	CGPA	04/08 →
IBIZA 1.6 SRE [ExtraEU]	CWWA	05/17 →
IBIZA III 1.4 16V	BBY, AZL	02/02 → 11/09
IBIZA III 1.6 16V	BTS	11/06 → 11/09
IBIZA III 2.0	AZL, BZG	04/02 → 11/09
IBIZA IV 1.0	CHYB	05/15 →
IBIZA IV 1.2	BZG, BXW	03/08 →
IBIZA IV 1.2 LPG	BZG	03/08 →
IBIZA IV 1.4	BXW, CWWA	03/08 →
IBIZA IV 1.4 LPG	BXW	03/08 → 05/11
IBIZA IV 1.6	BTS	05/08 →
IBIZA IV 1.6 LPG	CNKA	05/11 →
IBIZA IV 1.6 SRE	CWWA, CHYB	07/15 →
IBIZA IV 2.0	CEKA	10/08 →
IBIZA V 1.0	CHYB, BXW	01/17 →
LEON II 1.4 16V	BXW, CHYA	06/06 → 12/12
LEON II 2.0 TFSI	CCZB	06/09 → 12/12
LEON III 1.6 TSI	CWWA	05/15 →
MII 1.0	CHYA, BJB	10/11 →
MII 1.0 EcoFuel	CPGA	11/12 →
TOLEDO III 1.4 16V	BXW	05/06 → 05/09
TOLEDO III 1.9 TDI	BJB, CFNA	10/04 → 05/09
TOLEDO IV 1.2	CGPC	07/12 →
TOLEDO IV 1.6	CFNA, CHYA	07/13 →

SKODA

CITIGO 1.0	CHYA, AUA	10/11 →
CITIGO 1.0 CNG	CPGA	11/12 →
FABIA I 1.4	BKY	05/04 → 12/07
FABIA I 1.4 16V	AUA, BZG	12/99 → 03/08
FABIA II 1.2	BZG, BXW	01/07 →
FABIA II 1.2 [IND]	CJLA	09/10 →
FABIA II 1.2 12V	CGPB	11/11 → 12/14
FABIA II 1.4	BXW, BXW	01/07 → 12/14
FABIA II 1.4 [CHN]	CDDA	12/08 →
FABIA II 1.4 LPG	BXW, BTS	01/07 → 11/14
FABIA II 1.6	BTS, CDEA	04/07 → 12/14
FABIA II 1.6 [CHN]	CDEA, CHYA	12/08 →
FABIA III 1.0	CHYA, CWWA	08/14 →
FABIA III 1.6	CWWA, BCA	01/15 →
OCTAVIA II 1.4	BCA, BGU	05/04 → 06/13
OCTAVIA II 1.6	BGU, CDFA	09/04 → 06/13
OCTAVIA II 1.6 [CHN]	CDFA, CCSA	09/07 →
OCTAVIA II 1.6 FSI	BLF	02/04 → 10/08
OCTAVIA II 1.6 MultiFuel	CCSA, CFNA	01/08 → 06/13
OCTAVIA III 1.6	CWWA	01/14 →
OCTAVIA III 1.6 [CHN]	CSRA	02/14 →
RAPID 1.2	CGPC	07/12 →
RAPID 1.2 LPG	CGPC	07/12 →
RAPID 1.6	CFNA, BZG	07/12 →
RAPID 1.6 SRE	CWWA	05/15 →
ROOMSTER 1.2	BZG, CBZA	01/07 → 05/15
ROOMSTER 1.2 LPG	CGPA	03/09 → 05/15
ROOMSTER 1.2 TSI	CBZA, BXW	03/10 → 05/15
ROOMSTER 1.4	BXW, BXW	09/06 → 05/15
ROOMSTER 1.4 LPG	BXW, BTS	03/10 → 05/15
ROOMSTER 1.6	BTS, CDCA	09/06 → 05/15
ROOMSTER 1.6 LPG	BTS	06/06 → 07/10
YETI 1.6	CWWA	04/14 → 12/17

VOLKSWAGEN (BR)

POLO 1.6	BPA	10/04 →
POLO 2.0	BBX	05/02 →

VW

AMAROK 2.0 BitDi	CDCA, CDCA	09/10 →
AMAROK 2.0 BitDi 4motion	CDCA, CDCA	09/10 →
AMAROK 2.0 TDI	CDCA, CDCA	09/10 →
AMAROK 2.0 TDI 4motion	CDCA, DDXB	09/10 →
AMAROK 2.0 TSI	CFPA	12/10 →
AMAROK 3.0 TDI 4motion	DDXB, CBTA	06/16 →
AMAROK 3.0 TDi BlueMotion	DDXB	06/16 →
BEEETLE 2.5	CBTA, BCA	04/11 →
CADDY III 1.4	BCA, CAAC	03/04 → 08/10
CADDY III 1.6	CWWA	11/15 →
CADDY III 2.0 EcoFuel	BSX	04/06 → 05/15
CAMPMOBILE 2.0 TDi	CCHB	05/10 → 08/15
CAMPMOBILE 2.0 TDi BlueMotion	CAAC, --	04/15 →

VW		
EOS 1.6 FSI	BLF	06/06 → 05/08
FOX 1.0	--, BJE	10/03 →
FOX 1.0 Alcohol	BJE, BAH	10/03 →
FOX 1.0 Total Flex	CCNA	03/08 →
FOX 1.4	BKR	04/05 → 12/09
FOX 1.6	BAH, BJA	10/03 → 08/14
FOX 1.6 Alcohol	--	10/03 →
FOX 1.6 Total Flex	BJA, BCA	10/03 → 08/14
GOLF IV 1.6 FSI	BAG	10/03 → 07/04
GOLF V 1.4	BUD	06/07 → 07/09
GOLF V 1.4 16V	BCA, BKG	10/03 → 12/13
GOLF V 1.4 FSI	BKG, BGU	10/03 → 11/06
GOLF V 1.6	BGU, BAG	01/04 → 12/13
GOLF V 1.6 BiFuel	CHGA	05/09 → 12/13
GOLF V 1.6 FSI	BAG, CCSA	10/03 → 07/08
GOLF V 1.6 MultiFuel	CCSA, CBTA	10/07 → 12/13
GOLF V 2.0	BHY	08/06 → 11/08
GOLF V 2.5	CBTA, BUD	05/07 → 11/08
GOLF VI 1.4	BUD, BUD	10/08 →
GOLF VI 1.4 16V	BUD, BSE	01/09 → 05/11
GOLF VI 1.6	BSE, CBTA	10/08 →
GOLF VI 1.6 MultiFuel	CCSA	10/08 → 11/12
GOLF VI 2.5	CBTA, BGQ	07/09 →
GOLF VII 1.6	CWVA	05/14 →
JETTA V 1.6 FSI	BLF	09/05 → 10/10
JETTA V 2.5	BGQ, CFNA	01/05 →
JETTA VI 1.6	CFNA, CWVA	12/11 →
JETTA VI 1.6 [RUS]	CWVA, CBPA	01/15 →
JETTA VI 1.6 MPI	CWVB	09/15 → 04/18
JETTA VI 2.0	CBPA, CBTA	06/10 → 12/17
JETTA VI 2.5	CBTA, CAAA	04/10 →
UP 1.0	--, 199A6.000	08/11 →
UP 1.0 BlueMotion	CHYB	05/16 →
UP 1.0 EcoFuel	CPGA	11/12 →
MULTIVAN 2.0 BitDI	CFCA	09/09 → 08/15
MULTIVAN 2.0 BitDI 4motion	CFCA	09/09 → 08/15
MULTIVAN 2.0 TDI	CAAA, CAAC	09/09 →
MULTIVAN 2.0 TDI 4motion	CAAC, AEG	09/09 →
NEW BEETLE 2.0	AEG, BPR	01/98 → 09/10
NEW BEETLE 2.5	BPR, CBTA	07/05 → 09/10
PASSAT V 1.6 FSI	BLF	03/05 → 06/08
PASSAT V 2.5 SRE	CBTA, BBY	01/11 →
POLO IV 1.4	BBY, AUA	08/02 →
POLO IV 1.4 16V	AUA, BAH	10/01 → 11/09
POLO IV 1.4 BiFuel	BUD	05/06 → 11/09
POLO IV 1.4 FSI	AXU	02/02 → 07/06
POLO IV 1.6	BAH, CHYA	08/02 →
POLO IV 1.6 16V	BTS	05/06 → 11/09
POLO IV 2.0	BBX	09/02 →
POLO V 1.0	CHYA, CGPA	01/14 →
POLO V 1.0 TSI	CHZC	11/14 →
POLO V 1.2	CGPA, CGGB	03/09 →
POLO V 1.2 [IND]	CJLA	08/11 →
POLO V 1.2 BlueMotion	CGPA	03/09 → 05/14
POLO V 1.4	CGGB, CFNA	03/09 → 05/14
POLO V 1.4 BiFuel	CMAA	03/10 → 01/11
POLO V 1.6	CFNA, CHYB	01/10 →
POLO V 1.6 BiFuel	CNKA	01/11 →
POLO VI 1.0	CHYB, BPA	06/17 →
SPACEFOX / SPACE CROSS 1.6 FSI	BPA, BPA	03/06 →
SPACEFOX / SPACE CROSS 1.6 Total Flex	BPA, CGEA	03/06 →
TOUAREG II 3.0 TFSI	CYJA	01/15 →
TOUAREG II 3.0 V6 TSI	CJTA	08/10 → 03/18
TOUAREG II 3.0 V6 TSI Hybrid	CGEA, BAG	04/10 → 03/18
TOUAREG II 4.2 V8 FSI	CGNA	01/11 → 03/18
TOURAN I 1.6 FSI	BAG, CAAA	02/03 → 01/07
TOURAN I 2.0 EcoFuel	BSX	02/06 → 05/09
TOURAN I 2.0 FSI	BJZ	10/04 → 05/10
TOURAN I 2.0 TDI [CHN]	CGZA	04/09 →
TRANSPORTER 2.0 TDi BlueMotion	CXEC	08/18 →
TRANSPORTER V 1.4 Brasile	BTJ	12/05 →
TRANSPORTER V 2.0 BitDI	CFCA	09/09 → 08/15
TRANSPORTER V 2.0 BitDI 4motion	CFCA	09/09 → 08/15
TRANSPORTER V 2.0 TDI	CAAA, CAAC	09/09 → 08/15
TRANSPORTER V 2.0 TDI 4motion	CAAC, CAAA	09/09 → 08/15
TRANSPORTER VI 2.0 TDI	CAAA, CAAC	04/15 →
TRANSPORTER VI 2.0 TDI 4motion	CAAC, --	06/15 →

10.3091



ABSOLUTE PRESSURE SENSORS (MAP)

Adatt./Suitable:

- ABARTH**
46553045
77364869
- ALFA ROMEO**
46553045
71732447
77364145
77364869
- BOSCH**
0 261 230 030
0 261 230 118
0 261 230 174
0 261 230 268
F 01C 600 070
- FGP**
55209037
- FIAT**
46553045
55209037
55219296
71732447
77364145
77364869
- FORD**
1 562 724
1 580 533
9551-9J559-BB
- GENERAL MOTORS**
95 512 846
- JEEP**
55219296
- LANCIA**
46553045
71732447
77364869
- MERCEDES-BENZ**
0051536128
0061534728
A 005 153 61 28
A 006 153 47 28
MN195775
MR985032
- MITSUBISHI**
MN195775
MR985032
- MOPARTS**
68143574AA
- OPEL**
12 47 474
95512846
- SCANIA**
5166434
- SMART**
A 005 153 61 28
A 006 153 47 28
- VAUXHALL**
95512846

MARKET DIFFUSION: HIGH



kPa	mV	O + NTC -
10 - 118	385 - 4700	

ALFA ROMEO		
MITO 1.4	199A6.000, 312A4.000	08/08 →
MITO 1.4 MultiAir	955A6.000	09/09 → 08/13
FIAT		
500 0.9	312A4.000, 312A4.000	09/12 →
500 1.2	169A4.000	10/07 →
500 1.2 LPG	169A4.000	12/10 →
500 1.4	169A3.000	10/07 →
500 C 0.9	312A4.000, 169A3.000	09/12 →
500 C 1.2	169A4.000	09/09 →
500 C 1.4	169A3.000, 55263842	09/09 →
500 MY12 0.9	--	01/12 →
500 MY12 1.2	--	01/12 →
500 MY12 1.4	--	01/12 →
500L 1.4 LPG	940B7.000	02/14 →
500X 1.6	55263842, --	09/14 →
BRAVA 1.2 16V 80	182B2.000	12/98 → 12/02
BRAVO I 1.2 16V 80	188A5.000	10/00 → 10/01
BRAVO II 1.4	192B2.000	04/07 → 12/14
BRAVO II 1.4 16V	--, 198A1.000	04/07 →
BRAVO II 1.4 LPG	--	12/08 →

FIAT		
BRAVO II 1.4 T-Jet	198A1.000, 198A4.000	09/07 → 12/14
DOBLO I 1.4	350A1.000	10/05 →
DOBLO II 1.4	198A4.000, 350A1.000	02/10 →
DOBLO II 1.4 Natural Power	198A4000CNG	02/10 →
FIORINO II 1.2 MPI	178E8.011	01/04 →
FIORINO III 1.4	350A1.000	10/09 →
FIORINO III 1.4 Natural Power	350A1.000, --	06/08 →
IDEA 1.2	--	01/08 →
IDEA 1.2 16V	188A5.000	01/04 →
IDEA 1.4	192B2.000	12/03 →
IDEA 1.4 16V	--, 178F3.011	01/04 →
LINEA 1.4	350A1.000	06/07 →
LINEA 1.4 16V [IND]	--	06/07 →
LINEA 1.4 T-Jet	198A4.000	09/07 →
LINEA 1.6	--	10/11 →
LINEA 1.8 Flex	370A0.011	09/10 →
PALIO 1.0 GLX	--	07/98 → 10/03
PALIO 1.0 i	--	06/05 →
PALIO 1.0 MPI	178F1.011	11/03 → 07/05
PALIO 1.1	187A1.000	06/06 →
PALIO 1.2	188A5.000	03/00 →
PALIO 1.2 16V	178D7.055	06/05 →
PALIO 1.4	178F3.011, 169A4.000	10/02 →
PANDA I 1.1	187A1.000	09/00 → 02/04
PANDA I 1.1 AWD	187A1.000	09/00 → 02/04
PANDA II 1.1	--	09/03 →
PANDA II 1.2	169A4.000, 169A4.000	09/03 →
PANDA II 1.2 4x4	169A4.000, 169A4.000	09/04 →
PANDA II 1.2 Bipower	188A4.000	09/04 → 12/11
PANDA II 1.2 Euro 4	--	04/09 →
PANDA II 1.2 Euro 5	--	04/09 →
PANDA II 1.2 LPG	169A4.000, 350A1.000	04/09 →
PANDA II 1.4	--	10/06 →
PANDA II 1.4 16V	--	01/10 →
PANDA II 1.4 Natural Power	350A1.000, 312A2.000	10/09 →
PANDA III 0.9	312A2.000, 312A2.000	02/12 →
PANDA III 0.9 4x4	312A2.000, 188A4000CNG	09/12 →
PANDA III 1.2	169A4.000	02/12 →
PANDA III 1.2 LPG	169A4.000	06/12 →
PUNTO II 1.2	188A4.000	06/03 →
PUNTO II 1.2 16V	188A5.000	06/03 →
PUNTO III 1.2 16V 80	188A5.000	09/99 → 12/06
PUNTO II 1.2 60	188A4.000	09/99 → 12/10
PUNTO III 1.2 Bifuel	188A4.000	08/07 → 03/12
PUNTO II 1.2 Natural Power	188A4000CNG, 199A6.000	01/03 → 03/12
PUNTO II 1.4	199A6.000, 169A4.000	09/03 →
PUNTO III EVO 1.2	169A4.000, 199A7.000	10/09 → 02/12
PUNTO III EVO 1.4	199A7.000, 955A2.000	03/09 →
PUNTO III EVO 1.4 16V	955A2.000, 350A1.000	10/09 → 02/12
PUNTO III EVO 1.4 LPG	350A1.000	06/09 → 02/12
PUNTO III EVO 1.4 Natural Power	350A1.000, 350A1.000	10/09 → 02/12
PUNTO III / GRANDE PUNTO 1.2	169A4.000, 199A7.000	10/05 →
PUNTO III / GRANDE PUNTO 1.2 Actual	--	09/09 →
PUNTO III / GRANDE PUNTO 1.2 LPG	199A4.000	07/08 →
PUNTO III / GRANDE PUNTO 1.4	199A7.000, 350A1.000	06/05 → 12/15
PUNTO III / GRANDE PUNTO 1.4 16V	199A6.000	10/05 →
PUNTO III / GRANDE PUNTO 1.4 Actual	--	09/09 →
PUNTO III / GRANDE PUNTO 1.4 LPG	350A1.000	12/08 →
PUNTO III / GRANDE PUNTO 1.4 Natural Power	350A1.000, 169A4.000	07/08 →
PUNTO III 1.2	169A4.000, 199A7.000	03/12 →
PUNTO III 1.4	199A7.000, 350A1.000	04/08 →
PUNTO III 1.4 Bifuel	350A1.000	03/12 →
PUNTO III 1.4 LPG	350A1.000	03/09 →
PUNTO III 1.4 Multi Air	955A6.000	03/12 →
PUNTO III 1.4 Natural Power	350A1.000, 169A4.000	03/09 →
PUNTO III 1.4 Turbo Multi Air	955A2.000	03/12 →
QUBO 1.4	350A1.000	10/09 →
QUBO 1.4 Natural Power	350A1.000, --	10/09 →
SIENA 1.2	188A5.000	09/01 → 12/09
SIENA 1.2 16V	178D7.055	01/02 →
SIENA 1.4	--, 192B2.000	01/02 →
STILO 1.2 16V	188A5.000	02/02 → 11/06
STILO 1.4 16V	192B2.000, FP4	01/04 → 08/08
TIPO II 1.4	843A1.000	10/15 →
TIPO II 1.6	55268036	10/15 →
FIAT (BR)		
PALIO 1.0i 16v	1.0Mpi16vFire	01/01 →
PALIO 1.3i 16v	1.3Mpi16vFire	01/00 →

FORD		
KA II 1.2	FP4, 192B2.000	10/08 ⇨
JEEP		
RENEGADE 1.6	EJH(55263842)	07/14 ⇨
LANCIA		
MUSA 1.4	192B2.000, 169A4.000	10/04 ⇨ 09/12
MUSA 1.4 16V	--	01/11 ⇨ 12/12
MUSA 1.4 8V	--	01/11 ⇨ 12/12
MUSA 1.4 LPG	350A1.000	11/10 ⇨ 09/12
Y 1.2 16V	188A5.000	10/00 ⇨ 09/03
YPSILON I 1.2	169A4.000, 4A90	10/03 ⇨ 12/11
YPSILON I 1.4	350A1.000	02/06 ⇨ 12/11
YPSILON I 1.4 16V	843A1.000	10/03 ⇨ 12/11
YPSILON I 1.4 LPG	350A1.000	11/10 ⇨ 12/11
YPSILON II 1.2	169A4.000	05/11 ⇨
YPSILON II 1.2 Bi-fuel	169A4.000	05/11 ⇨
MITSUBISHI		
COLT VI 1.1	3A91	10/04 ⇨ 06/12
COLT VI 1.1 LPG	3A91	10/04 ⇨ 06/12
COLT VI 1.3	4A90, 4A91	06/04 ⇨
COLT VI 1.3 4WD	4A90	08/04 ⇨
COLT VI 1.3 Flexfuel	4A90	10/08 ⇨ 06/12
COLT VI 1.3 LPG	4A90	06/04 ⇨ 06/12
COLT VI 1.5	4A91, M134.910	06/04 ⇨
COLT VI 1.5 4WD	4A91	08/04 ⇨
LANCER IX 1.5	4A91	06/08 ⇨
LANCER IX 1.5 Bifuel	4A91	02/10 ⇨
OPEL		
COMBO D 1.4	A14FP	02/12 ⇨
SMART		
FORFOUR 1.1	M134.910, 312A1.000	01/04 ⇨ 06/06
FORFOUR 1.3	M135.930	01/04 ⇨ 06/06
FORFOUR 1.5	M135.950	01/04 ⇨ 06/06
VAUXHALL		
COMBO D 1.4	A14FP	11/11 ⇨

10.3092

3,5

ABSOLUTE PRESSURE SENSORS (MAP)

Adatt./Suitable:

ABARTH

46769978
55238125
77364543

ALFA ROMEO

46769978
55238125
77364543
77366191

BMW

13 62 7 966 237

BOSCH

0 261 230 042
0 261 230 283
0 261 230 298
0 261 230 302

FIAT

46769978
504064370
55238125
77364543
77366191

GENERAL MOTORS

55 238 125
55 576 223
93 170 309
95 512 870

IVECO

0000504064370
00005801699032
504064370
5801699032

LANCIA

46769978
55238125
77364543
77366191

OPEL

12 38 244
12 47 128
12 47 478
12 47 809
55238125
93170309
95512870

PORSCHE

955 606 180 00
996 606 180 00

SAAB

93 170 309

VAUXHALL

93170309

MARKET DIFFUSION: MEDIUM



kPa	mV	O + NTC -
20 - 253	390 - 4700	

ABARTH

500 1.4	312A1.000, 312A1.000	08/08 ⇨
500 MY12 1.4	--	01/12 ⇨
500C / 595C 1.4	312A1.000, 198A4.000	05/08 ⇨

ALFA ROMEO

GIULIETTA II 1.4	198A4.000	04/11 ⇨ 02/16
GIULIETTA II 1.4 BiFuel	198A4.000	12/11 ⇨
GIULIETTA II 1.4 TB	198A4.000, 198A4.000	04/10 ⇨
MITO 1.4 Bifuel	198A4.000, 198A1.000	01/09 ⇨
MITO 1.4 TJet	198A1.000, Z28NET	08/08 ⇨

BMW

7 IV B7 Alpina	H1	01/06 ⇨
----------------	----	---------

CADILLAC

BLS 2.8 T	Z28NET, --	04/06 ⇨
BLS 2.8 T AWD	Z28NET	10/08 ⇨

FIAT

BRAVO II 1.4 T-Jet	--, 198A4.000	09/07 ⇨
DOBLO II 1.4	198A4.000	10/11 ⇨
DOBLO II 1.4 Natural Power	198A4.000, F1CE0441A	02/10 ⇨
DUCCATO III 140 Natural Power	F1CE0441A, F1CE0441CNG	04/09 ⇨
LINEA 1.4 16V TURBO [IND]	--	09/07 ⇨
LINEA 1.4 T-Jet	198A4.000	09/07 ⇨
PUNTO III / GRANDE PUNTO 1.4 T-Jet	198A4.000	09/07 ⇨

IVECO

DAILY IV 35C14 G, 35C14 G/P, 35S14 G, 35S14 G/P, 35C14 GD,...	F1CE0441CNG	07/07 ⇨ 08/11
DAILY IV 35C14 GV, 35C14 GV/P, 35S14 GV, 35S14 GV/P	F1CE0441CNG	07/07 ⇨ 08/11
DAILY IV 40C14 G, 40C14 G/P	F1CE0441CNG	07/07 ⇨ 08/11
DAILY IV 40C14 GV, 40C14 GV/P	F1CE0441CNG	07/07 ⇨ 08/11
DAILY IV 50C14 G, 50C14 G/P, 50C14 GD, 50C14 GD/P	F1CE0441CNG	07/07 ⇨ 08/11
DAILY IV 50C14 GV, 50C14 GV/P	F1CE0441CNG	07/07 ⇨ 08/11
DAILY IV 65C14 G, 65C14 G/P, 65C14 GD, 65C14 GD/P	F1CE0441CNG	07/07 ⇨ 08/11
DAILY IV Natural Power 35S14, 35C14, 40C14, 50C14, 65C14, 70C14	F1CE0441CNG	09/11 ⇨ 02/14
DAILY IV NaturalPower 35S14, 35C14, 40C14, 50C14, 65C14, 70C14,.	F1CE0441CNG	09/11 ⇨ 02/14
DAILY V Natural Power 35S14, 35C14, 40C14, 50C14	F1CFA401A	04/16 ⇨
DAILY V Natural Power 35S14, 35C14, 40C14, 50C14, 65C14, 70C14	F1CFA401A	03/14 ⇨
DAILY V NaturalPower 35S14, 35C14, 40C14, 50C14, 65C14, 70C14,...	F1CFA401A	03/14 ⇨
DAILY 3.0	F1CE0441A	09/09 ⇨ 08/11
DAILY 3.0 CNG	F1CE0441CNG, 198A1.000	06/06 ⇨ 02/14

LANCIA

DELTA III 1.4	198A1.000, Z20LET	09/08 ⇨ 08/14
DELTA III 1.4 Bifuel	198A4.000	07/11 ⇨ 08/14
THESIS 2.0 Turbo	841E.000	07/02 ⇨ 07/09

OPEL

ASTRA G 2.0 16V Turbo	Z20LET, Z20LET	09/00 ⇨ 10/05
ASTRA G 2.0 OPC	Z20LET, A16LET	03/02 ⇨ 10/05
ASTRA H 1.6 Turbo	A16LET, A14NEL	02/07 ⇨ 10/10
ASTRA J 1.4	A14NEL, A14NEL	10/11 ⇨
ASTRA J 1.4 LPG	A14NET	12/11 ⇨
ASTRA J 1.4 Turbo	A14NEL, A14FC	12/09 ⇨
ASTRA J 1.6	A16LET	10/11 ⇨
ASTRA J 1.6 Turbo	A16LET	12/09 ⇨
COMBO D 1.4	A14FC	02/12 ⇨
COMBO D 1.4 CNG	A14FC, A16LEL	02/12 ⇨
CORSA D 1.6	Z16LER	07/12 ⇨ 08/14
CORSA D 1.6 Turbo	A16LET, A28NER	11/06 ⇨ 08/14
INSIGNIA 1.6 Turbo	A16LET	07/08 ⇨ 03/17
INSIGNIA 2.8 V6 Turbo 4x4	A28NET	07/08 ⇨ 03/17
INSIGNIA 2.8 V6 Turbo OPC 4x4	A28NER, A14NEL	07/09 ⇨ 03/17
MERIVA A 1.6 Turbo	Z16LET	09/05 ⇨ 05/10
MERIVA B 1.4	A14NEL, Z28NEL	06/10 ⇨ 03/17
MERIVA B 1.4 LPG	B14NEL	06/11 ⇨ 03/17
SIGNUM 2.8	Z28NET	10/06 ⇨
SIGNUM 2.8 V6 Turbo	Z28NEL, Z28NEL	09/05 ⇨ 12/08
SPEEDSTER 2.0	Z20LET	10/03 ⇨ 08/06
SPEEDSTER 2.0 Turbo	Z20LET	08/02 ⇨ 08/06
VECTRA C 2.8 V6 Turbo	Z28NEL, Z20LET	08/05 ⇨ 10/08
VECTRA C 2.8 V6 Turbo OPC	Z28NET	09/06 ⇨ 08/08
ZAFIRA A 2.0 OPC	Z20LET, A16XNT	09/01 ⇨ 06/05
ZAFIRA B 1.6 CNG Turbo	A16XNT, Z20LEH	02/09 ⇨ 04/15
ZAFIRA B 2.0	Z20LEH, A16XNT	07/05 ⇨ 12/10
ZAFIRA C 1.6 CNG	A16XNT, M96.70	10/11 ⇨

PORSCHE

911 IV 3.6 GT2	M96.70, M48.50S	04/01 ⇨ 08/05
911 IV 3.6 S	M96.70	08/04 ⇨ 08/05
911 IV 3.6 Turbo 4	M96.70	06/00 ⇨ 08/05
911 IV 3.6 Turbo 4S	M96.70	02/03 ⇨ 08/05
911 V 3.6 GT 2	M97.70S	09/07 ⇨ 12/12
911 V 3.6 GT2 RS	M97.70	05/10 ⇨ 12/12
911 V 3.6 Turbo	M97.70	03/06 ⇨ 12/09
911 V 3.8 Turbo	MA1.70	09/09 ⇨ 12/12
911 V 3.8 Turbo S	MA1.70	02/10 ⇨ 12/12
CAYENNE I Turbo 4.5	M48.50	09/02 ⇨ 09/07
CAYENNE I Turbo S 4.5	M48.50S, M48.51	01/04 ⇨ 09/07
CAYENNE I Turbo S 4.8	M48.51, M48.52	02/07 ⇨ 09/10
CAYENNE II 4.8 Turbo	M48.52, M48.52	06/10 ⇨
CAYENNE II 4.8 Turbo S	M48.52, M48.70	10/12 ⇨
PANAMERA 4.8 Turbo	M48.70, M48.70	09/09 ⇨ 10/16
PANAMERA 4.8 Turbo S	M48.70, B284	05/11 ⇨ 10/16

SAAB

9-3 2.8 Turbo V6	B284, B284R	03/05 ⇨
9-3 2.8 Turbo V6 XWD	B284R	05/08 ⇨ 12/11
9-3 2.8 V6 T	B284R, Z20LET	09/07 ⇨ 02/15

VAUXHALL

ASTRA IV 2.0	Z20LET	08/02 ⇨ 10/05
ASTRA IV 2.0 16V Turbo	Z20LET	09/00 ⇨ 08/05
ASTRA IV 2.0 SRI Turbo	Z20LET	11/01 ⇨ 05/05

VAUXHALL			
ASTRA IV 2.0 Turbo	Z20LET, A16LET	03/02 ⇨	10/05
ASTRA V 1.6	A16LET, A16LET	08/04 ⇨	11/10
ASTRA V 1.6 Turbo	A16LET, A14NEL	09/06 ⇨	09/09
ASTRA VI 1.4	A14NEL, A14NEL	10/11 ⇨	
ASTRA VI 1.4 Turbo	A14NEL, A16LEL	12/09 ⇨	
ASTRA VI 1.6	A16LET	10/11 ⇨	
ASTRA VI 1.6 Turbo	A16LET	12/09 ⇨	
COMBO D 1.4 CNG	A14FC	11/11 ⇨	
CORSA D 1.6 SRi	A16LEL, A16LER	05/07 ⇨	08/14
CORSA D 1.6 VXR	A16LER, A28NER	11/06 ⇨	08/14
INSIGNIA 1.6 Turbo	A16LET	01/09 ⇨	05/17
INSIGNIA 2.8 V6 Turbo	A28NET	08/08 ⇨	05/17
INSIGNIA 2.8 V6 Turbo 4x4	A28NET	07/08 ⇨	05/17
INSIGNIA 2.8 VXR	A28NER, A14NEL	07/09 ⇨	05/17
MERIVA I 1.6 Turbo	Z16LET	05/06 ⇨	06/10
MERIVA II 1.4	A14NEL, A14NEL	06/10 ⇨	
MERIVA II 1.4 LPG	A14NEL, Z28NEL	06/11 ⇨	
SIGNUM 2.8 V6 Turbo	Z28NEL, Z28NEL	07/05 ⇨	10/08
SPEEDSTER 2.0 Turbo	Z20LET	03/01 ⇨	09/06
SPEEDSTER VXR20	Z20LET	03/01 ⇨	09/06
VECTRA C 2.8 V6 Turbo	Z28NEL, A16XNT	08/05 ⇨	05/09
VX220 2.0 i Turbo	Z20LET	03/01 ⇨	07/05
VX220 2.0 VXR	Z20LET	10/03 ⇨	07/05
ZAFIRA A 2.0	Z20LET	06/02 ⇨	06/05
ZAFIRA A 2.0 GSI Turbo	Z20LET	09/01 ⇨	06/05
ZAFIRA B 1.6 CNG Turbo	A16XNT, Z20LEH	02/09 ⇨	11/14
ZAFIRA B 2.0	Z20LEH, DHA	07/05 ⇨	11/14
ZAFIRA C 1.6 CNG	A16XNT	10/11 ⇨	08/18

10.3097



ABSOLUTE PRESSURE SENSORS (MAP)

Adatt./Suitable:

DAIMLER
AJ812337
AJ85329

FORD
1 141 598
1 490 907
1 923 995
256A-9F479-BA
256A-9F479-BB
256A-9F479-BC

JAGUAR
AJ8 12337
AJ8 5329

LAND ROVER
1141598
LR008935

MAZDA
C201-18-211A

SIEMENS
5WK9 680
5WK9 6812
5WK96812Z

VOLVO
30711659
31339551

MARKET DIFFUSION: HIGH



kPa	mV	O + NTC -
10 - 117	405 - 4750	

DAIMLER
SUPER EIGHT 4.2

AJ8FT 09/05 ⇨ 12/09

FORD

C-MAX I 1.6 HWDA, -- 02/07 ⇨ 09/10

C-MAX I 1.6 Ti-VCT --, MUDA 03/07 ⇨

C-MAX II 1.6 Flexifuel MUDA, MUDA 02/11 ⇨

C-MAX II 1.6 LPG MUDA, FUJA 02/12 ⇨

FIESTA V 1.25 16V FUJA, A9JA 05/02 ⇨ 06/08

FIESTA V 1.3 A9JA, FXJA 11/01 ⇨ 06/08

FIESTA V 1.4 FXJA 05/02 ⇨ 09/05

FIESTA V 1.4 16V FXJA, FYJA 11/01 ⇨ 06/08

FIESTA V 1.6 16V FYJA, HXJA 11/01 ⇨ 06/08

FIESTA VI 1.6 Ti HXJA, HXJA 06/08 ⇨

FIESTA VI 1.6 Ti-VCT HXJA, HWDA 10/08 ⇨ 12/12

FOCUS II 1.4 ASDA, HWDA 07/04 ⇨ 09/12

FOCUS II 1.6 HWDA, G8DC 07/04 ⇨ 09/12

FOCUS II 1.6 LPG SIDA 10/09 ⇨ 09/12

FOCUS II 1.6 TDCi G8DC, HXDA 07/04 ⇨ 09/12

FOCUS II 1.6 Ti HXDA, ASDA 07/04 ⇨ 09/12

FOCUS II 1.6 Ti-VCT -- 12/07 ⇨

FOCUS II CASSONE / FURGO- ASDA, HXDA 09/05 ⇨ 07/11

NATO / PROMISCOU 1.4 HWDA 09/05 ⇨ 07/11

FOCUS II CASSONE / FURGO- HXDA, MUDA 09/05 ⇨ 07/11

NATO / PROMISCOU 1.6 Ti-VCT

FOCUS III 1.6 Flexifuel MUDA, MUDA 07/10 ⇨

FOCUS III 1.6 LPG MUDA, PNDA 02/12 ⇨

FOCUS III 1.6 Ti PNDA, -- 07/10 ⇨

FOCUS C-MAX 1.6 HWDA, HXDA 10/03 ⇨ 03/07

FOCUS C-MAX 1.6 Ti HXDA, ASDA 08/04 ⇨ 03/07

FUSION 1.25 --, -- 10/02 ⇨

FUSION 1.3 --, -- 08/02 ⇨

FUSION 1.4 --, FYJA 08/02 ⇨

FUSION 1.4 LPG UTJA 01/10 ⇨ 12/12

FUSION 1.6 FYJA, A9A 08/02 ⇨ 11/08

KA I 1.3 A9A, A9A 09/02 ⇨ 03/04

KA I 1.3 i A9A, CCA 08/02 ⇨ 11/08

KA I 1.6 i CCA, CDRA 02/01 ⇨ 11/08

STREET KA 1.6 CDRA, FXJA 05/03 ⇨ 07/05

10.3093



ABSOLUTE PRESSURE SENSORS (MAP)

Adatt./Suitable:

BOSCH
0 261 230 027

FORD
1 086 439
1 087 424
XS6F-9F479-AB



kPa	mV	O + NTC -
10 - 118	400 - 4700	

FORD

FIESTA IV 1.0 i ZH10JRB 02/97 ⇨ 09/99

FIESTA IV 1.25 i 16V DHA, J4C 08/95 ⇨ 01/02

FIESTA IV 1.3 J4C, J4C 02/96 ⇨ 08/03

FIESTA IV 1.3 i J4C, FHA 08/95 ⇨ 01/02

FIESTA IV 1.4 i 16V FHA, BAA 04/96 ⇨ 01/02

FIESTA 1.2 DHA, DHA 01/96 ⇨ 04/02

IKON 1.3 Rocam -- 10/00 ⇨

IKON 1.6 EFI Rocam -- 11/99 ⇨

KA I 1.3 i BAA, HWDA 09/96 ⇨ 11/08

FORD (BR)

FIESTA 1.0i ZL10 07/99 ⇨

FIESTA 1.6i ZL16 07/99 ⇨

10.3098



ABSOLUTE PRESSURE SENSORS (MAP)

Adatt./Suitable:

HYUNDAI
39300-22600
39300-38110

KIA
39300-22600
39300-38110
39300-38120

MARKET DIFFUSION: MEDIUM



kPa	mV	O + NTC -
10 - 119,7	398,8 - 4750	

HYUNDAI

ACCENT II 1.3 G4EA, G4EB 01/00 ⇨ 11/05

ACCENT II 1.5 G4EB, G4ED 01/00 ⇨ 12/06

ACCENT II 1.6 G4ED, G4AC 12/02 ⇨ 11/05

ACCENT III 1.4 GL G4EE 11/05 ⇨ 11/10

ACCENT III 1.6 GLS G4ED 11/05 ⇨ 11/10

ATOS 1.0 i G4AC, G4HD 03/01 ⇨ 07/03

ATOS 1.1 G4HD, G4HD 06/03 ⇨ 12/10

ATOS PRIME 1.0 i G4HC-E 03/01 ⇨ 07/03

ATOS PRIME 1.1 G4HD, 4G61 08/03 ⇨ 12/08

COUPE I 1.6 16V G4GR 03/98 ⇨ 04/02

COUPE I 1.6 16V 4G61, G4ED 08/00 ⇨ 04/02

COUPE II 1.6 16V G4ED, G4GC 03/02 ⇨ 08/09

COUPE II 2.0 G4GC, G4GC 08/01 ⇨ 08/09

COUPE II 2.0 GLS G4GC, G4ED 02/03 ⇨ 08/09

ELANTRA 1.6 [ExtraEU] G4GA 08/03 ⇨ 05/06

ELANTRA 1.8 [ExtraEU] G4BB 06/00 ⇨ 07/03

ELANTRA 2.0 CVT [ExtraEU] G4GC 06/06 ⇨ 05/11

ELANTRA III 1.6 G4ED, G4BB 06/00 ⇨ 07/06

ELANTRA III 1.8 G4BB, G4GC 06/00 ⇨ 07/06

ELANTRA III 2.0 G4GC, G4GC 06/00 ⇨ 07/06

ELANTRA IV 2.0 CVT G4GC, G4HD 06/06 ⇨ 06/11

GETZ 1.1 G4HD, G4EA 09/02 ⇨ 06/09

GETZ 1.3 G4EA, G4ED 09/03 ⇨ 06/09

GETZ 1.3 i G4EA 09/02 ⇨ 03/04

GETZ 1.4 i G4EE 08/05 ⇨ 12/10

GETZ 1.6 G4ED, G4HG 09/02 ⇨ 12/06

HIGHWAY VAN 2.0 16V G4CPDOHC 03/00 ⇨ 03/04

HIGHWAY VAN 2.0 CVT G4GC 11/03 ⇨ 03/04

110 1.1 LPG G4HG 01/10 ⇨ 12/13

110 I 1.1 G4HG, G4GC 12/07 ⇨ 12/13

130 I 2.0 G4GC, G4ED 10/07 ⇨ 06/12

130 2.0 CVT LPG G4GC 01/10 ⇨ 06/12

LANTRA II 1.8 G4GB 06/00 ⇨

LANTRA II 2.0 G4GC-G 06/00 ⇨

LAVITA 1.8 -- 01/07 ⇨

HYUNDAI		
MATRIX 1.6	G4ED, G4GB	06/01 ⇒ 08/10
MATRIX 1.6 [TUR]	G4ED	04/08 ⇒
MATRIX 1.8	G4GB, G4JP	06/01 ⇒ 08/10
MATRIX 1.8 [TUR]	G4GB	04/08 ⇒
SANTA FE 1.2.0	G4JP	08/01 ⇒ 03/06
SANTRO 1.1	G4HD	01/03 ⇒
SONATA IV 2.0 16V	G4JP, G4CPDOHC	10/01 ⇒ 11/04
SONATA V 2.0 [RUS]	--	01/05 ⇒ 04/06
SONATA V 2.0 i [RUS]	--	04/06 ⇒ 12/10
TIBURON 2.0 CVVT	G4GC	10/06 ⇒ 12/08
TRAJET 2.0	G4CPDOHC, G4GC	03/00 ⇒ 07/08
TUCSON 2.0	G4GC, G4GC	08/04 ⇒
TUCSON 2.0 CVVT LPG	G4GC	06/09 ⇒ 03/10
TUCSON 2.0 Trazione integrale	G4GC, G4EB	08/04 ⇒ 11/10
VERNA I 1.3	G4EA	09/99 ⇒
VERNA I 1.5	G4EB, --	09/99 ⇒
VERNA I 1.6	G4ED-G	12/02 ⇒
VERNA II 1.4 GL	--	11/05 ⇒
VERNA II 1.6 GLS	--	11/05 ⇒

KIA		
CEED I 2.0	G4GC	12/06 ⇒ 12/12
CERATO I 1.6	G4ED	04/04 ⇒
CERATO I 2.0	G4GC	04/04 ⇒
CERATO II 2.0 CVVT	--	01/09 ⇒
MAGENTIS I 2.0	G4JP	05/01 ⇒ 09/05
PICANTO I 1.0	--, --	04/04 ⇒
PICANTO I 1.0 LPG	G4HE	01/09 ⇒ 04/11
PICANTO I 1.1	--, QQDA	04/04 ⇒
PICANTO I 1.1 LPG	G4HG	01/09 ⇒ 04/11
PRO CEE'D I 2.0	G4GC	02/08 ⇒ 09/12
PRO CEE'D I 2.0 LPG	G4GC	01/09 ⇒ 12/09
RIO II 1.4	G4EE	01/10 ⇒ 12/11
RIO II 1.4 16V	G4EE	03/05 ⇒
RIO II 1.6 16V	G4ED	03/05 ⇒
RIO II 1.6 CVVT	G4ED	03/05 ⇒
SPORTAGE II 2.0	G4KD	01/09 ⇒ 05/10
SPORTAGE II 2.0 16V 4WD	G4GC	09/04 ⇒
SPORTAGE II 2.0 i 16V	G4GC	09/04 ⇒
SPORTAGE II 2.0 LPG	G4GC	06/09 ⇒ 05/10

10.3100



3,5

ABSOLUTE PRESSURE SENSORS (MAP)

Adatt./Suitable:

BOSCH
0 261 230 044
0 261 230 089**FORD**
1 119 939
1 439 900
157A-9F479-AB
157A-9F479-AC**FORD USA**
1 439 900
157A-9F479-AC**VOLVO**
30658184
31251242

MARKET DIFFUSION: MEDIUM



kPa	mV	O + NTC -
10 - 117.3	405 - 4750	

FORD		
C-MAX I 1.8	QQDA, AODA	02/07 ⇒ 09/10
C-MAX I 1.8 Flexifuel	Q7DA	02/07 ⇒ 09/10
C-MAX I 2.0	AODA, SYDA	02/07 ⇒ 09/10
C-MAX I 2.0 CNG	SYDA, CSDA	04/09 ⇒ 09/10
C-MAX I 2.0 LPG	SYDA	06/08 ⇒ 09/10
ECOSPORT 2.0 4x4	C20HDEA	08/12 ⇒
FIESTA V ST150	N4JB	03/05 ⇒ 06/08

FORD		
FOCUS II 1.8	Q7DA, --	03/06 ⇒ 09/12
FOCUS II 1.8 Flexifuel	--, AODA	12/05 ⇒ 09/12
FOCUS II 2.0	AODA, SYDA	07/04 ⇒ 09/12
FOCUS II 2.0 CNG	SYDA, Q7DA	04/09 ⇒ 07/11
FOCUS II 2.0 Flex	SYDA	10/08 ⇒ 03/10
FOCUS II 2.0 LPG	SYDA	06/08 ⇒ 07/11
FOCUS II 2.5 ST	HYDA	10/05 ⇒ 09/12
FOCUS II CASSONE / FURGONATO / PROMISCUO 1.8 Flexifuel	Q7DA, AOWA	06/09 ⇒ 07/11
FOCUS C-MAX 1.8	CSDA, AODA	10/03 ⇒ 03/07
FOCUS C-MAX 1.8 Flexifuel	Q7DA	01/06 ⇒ 03/07
FOCUS C-MAX 2.0	AODA, Q7DA	03/04 ⇒ 03/07
FUSION 2.0	--	11/04 ⇒
GALAXY II 2.0	AOWA, TBWA	05/06 ⇒ 06/15
GALAXY II 2.0 Flexifuel	TBWA, --	05/06 ⇒ 06/15
KUGA II 2.5	--, CGBA	01/14 ⇒
KUGA II 2.5 PFI	--	03/13 ⇒
MONDEO II 1.8 16V	CGBA, CJBA	10/00 ⇒ 03/07
MONDEO II 2.0 16V	CJBA, AOBA	10/00 ⇒ 03/07
MONDEO III 2.0	AOBA, TBBA	03/07 ⇒ 01/15
MONDEO III 2.0 Flexifuel	TBBA, --	03/09 ⇒ 01/15
MONDEO III 2.0 LPG	TBBA	07/09 ⇒ 01/15
MONDEO IV 2.0 hybrid	--, --	09/14 ⇒
MONDEO IV 2.5	--, GBVAF	09/13 ⇒
MONDEO 2.0	AOBC	03/07 ⇒ 09/14
RANGER VI 2.2 TDCi	--	05/15 ⇒
RANGER VI 2.2 TDCi 4x4	--	05/15 ⇒
RANGER VI 2.5 i	GBVAF, GBVAF	11/11 ⇒
RANGER VI 2.5 i 4x4	GBVAF, AODA	11/11 ⇒
S-MAX I 2.0	AODA, TBWA	05/06 ⇒ 12/14
S-MAX I 2.0 EcoBoost	TNWA	03/10 ⇒ 12/14
S-MAX I 2.0 Flexifuel	TBWA, GZFCACNG	05/06 ⇒ 12/14
TOURNEO CONNECT II 2.5	--	09/13 ⇒
TRANSIT III 2.3 16V CNG RWD	GZFCACNG, CHZB	04/06 ⇒ 08/14
TRANSIT III 2.3 16V LPG RWD	GZFC	04/06 ⇒ 08/14
TRANSIT CONNECT II 2.5	--	02/13 ⇒

VOLVO		
C30 1.8	B4184511	10/06 ⇒ 12/12
C30 1.8 FlexFuel	B418458	01/07 ⇒ 12/12
C30 2.0	B420453	10/06 ⇒ 12/12
C30 2.0 FlexFuel	B420454	01/10 ⇒ 12/12
S40 II 1.8	B4184511	04/04 ⇒ 12/10
S40 II 1.8 FlexFuel	B418458	01/06 ⇒ 12/10
S40 II 2.0	B420453	10/06 ⇒ 12/12
S40 II 2.0 F	B420454	10/09 ⇒ 12/12
S80 II 2.0	B420453	01/08 ⇒ 09/12
S80 II 2.0 FlexFuel	B420454	01/08 ⇒ 12/11
V50 1.8	B4184511	04/04 ⇒ 12/10
V50 1.8 BiFuel	B418458	01/09 ⇒ 09/10
V50 1.8 FlexFuel	B418458	01/05 ⇒ 12/10
V50 2.0	B420453	10/06 ⇒ 12/12
V50 2.0 FlexFuel	B420454	01/10 ⇒ 12/12
V70 III 2.0	B420453	10/07 ⇒ 12/11
V70 III 2.0 Flexifuel	B420454	01/08 ⇒ 12/11

10.3101



3,5

ABSOLUTE PRESSURE SENSORS (MAP)

Adatt./Suitable:

AUDI
036 906 051 E**BOSCH**
0 261 230 071
0 261 230 072**SEAT**
036 906 051 E**SKODA**
036 906 051 E**VW**
036 906 051 E

kPa	mV	O + -
14 - 119	250 - 4750	

AUDI		
A1 1.0 TFSI	CHZB, BLR	03/15 ⇒ 10/18
A2 1.6 FSI	BAD	05/02 ⇒ 08/05

SEAT		
ALTEA 2.0 FSI	BLR, BVY	05/04 ⇒ 03/09
ALTEA XL 2.0 FSI	BVY, CHZJ	10/06 ⇒ 03/09
ARONA 1.0 TSI	CHZJ, CHZB	07/17 ⇒
IBIZA IV 1.0 TSI	CHZB, CHZJ	05/15 ⇒
IBIZA V 1.0 TSI	CHZJ, BLR	01/17 ⇒
TOLEDO III 2.0 FSI	BLR, AXW	10/04 ⇒ 05/09

VW		
GOLF IV 1.6 FSI	BAD	01/02 ⇒ 06/06
GOLF V 2.0 FSI	AXW, BLX	01/04 ⇒ 11/08
GOLF V 2.0 FSI 4motion	BLX, BLR	08/04 ⇒ 11/08
JETTA V 2.0 FSI	BLR, BLR	08/05 ⇒ 10/10
LUPU 1.4 FSI	ARR	02/01 ⇒ 07/05
PASSAT V 2.0 FSI	BLR, BLX	03/05 ⇒ 11/10
PASSAT V 2.0 FSI 4motion	BLX, AXW	09/05 ⇒ 11/10
POLO V 1.0 TSI	CHZB	11/14 ⇒
TOURAN I 2.0 FSI	AXW, EDJ	10/03 ⇒ 01/07

10.3102



ABSOLUTE PRESSURE SENSORS (MAP)

Adatt./Suitable:

- BOSCH**
- 0 261 230 141
- 0 261 230 142
- 0 261 230 191
- 0 261 230 192

- CHRYSLER**
- 5080345AA
- 5080345AB
- 5080345AC
- 5137176AA
- K05080345AA
- K05080345AB
- K05080345AC
- K05137176AA
- K68000238AA

- JEEP**
- 5080345AA
- K05080345AA
- K05080345AB
- K05080345AC

- MERCEDES-BENZ**
- A 004 153 31 28
- A 004 153 33 28
- A 005 153 72 28
- A 006 153 14 28
- A 006 153 98 28

- MITSUBISHI**
- MB-16244349

- MOPAR PARTS**
- 05080345AC

- SMART**
- A 005 153 72 28
- A 006 153 14 28
- A 006 153 98 28

MARKET DIFFUSION: HIGH



kPa	mV	
10 - 265	314 - 4750	

CHRYSLER		
CROSSFIRE SRT-6	EGZ	09/04 ⇒ 12/07
PT CRUISER 2.2 CRD	EDJ, M166.940	03/02 ⇒ 12/10
JEEP		
GRAND CHEROKEE 2.7 CRD 4x4	ENF	10/01 ⇒ 09/05
MAYBACH		
57 5.5	285950	09/02 ⇒ 12/12
57 6.0	285980	01/11 ⇒ 12/12
57 5 6.0	285980	09/05 ⇒ 12/12
62 5.5	285950	09/02 ⇒ 12/12
62 6.0	285980	01/11 ⇒ 12/12
62 5 6.0	285980	09/05 ⇒ 12/12

MERCEDES-BENZ		
B-SERIE B150 BlueEFFICIENCY	M266.920	01/09 ⇒ 11/11
CLASSE A I A 140	M166.940, OM668.940	01/01 ⇒ 08/04
CLASSE A I A 160	M166.960	07/97 ⇒ 08/04
CLASSE A I A 160 CDI	OM668.940, OM668.940	02/01 ⇒ 08/04
CLASSE A I A 170 CDI	OM668.940, OM611.962	02/01 ⇒ 08/04
CLASSE A I A 190	M166.990	03/99 ⇒ 08/04
CLASSE A I A 210	M166.995	12/01 ⇒ 08/04
CLASSE A II A 150	M266.920	09/04 ⇒ 06/12
CLASSE A II A 160	M266.920	04/09 ⇒ 06/12
CLASSE A II A 170	M266.940	09/04 ⇒ 06/12
CLASSE A II A 180	M266.940	04/09 ⇒ 06/12
CLASSE A II A 200	M266.960	09/04 ⇒ 06/12
CLASSE A II A 200 TURBO	M266.980	09/05 ⇒ 06/12
CLASSE B I B 150	M266.920	03/05 ⇒ 11/11
CLASSE B I B 160	M266.920	04/09 ⇒ 11/11
CLASSE B I B 170	M266.940	03/05 ⇒ 11/11
CLASSE B I B 170 NGT	266960NGT	04/08 ⇒ 11/11
CLASSE B I B 180	M266.940	04/09 ⇒ 11/11
CLASSE B I B 180 NGT	266960NGT	04/08 ⇒ 11/11
CLASSE B I B 200	M266.960	03/05 ⇒ 11/11
CLASSE B I B 200 TURBO	M266.980	03/05 ⇒ 11/11
CLASSE B II B 180 CDI	OM651.901	11/11 ⇒

MERCEDES-BENZ		
CLASSE C I C 200 CDI	OM611.960	03/98 ⇒ 05/00
CLASSE C I C 200 T CDI	OM611.960	03/98 ⇒ 03/01
CLASSE C I C 220 CDI	OM611.960	09/97 ⇒ 05/00
CLASSE C I C 220 T CDI	OM611.960	09/97 ⇒ 03/01
CLASSE C II C 160 Kompressor	M271.921	05/02 ⇒ 05/08
CLASSE C II C 180 Kompressor	M271.946	05/02 ⇒ 05/08
CLASSE C II C 200 CDI	OM611.962, M111.955	09/00 ⇒
CLASSE C II C 200 CGI Kompressor	M271.942	03/03 ⇒ 05/08
CLASSE C II C 200 Kompressor	M111.955, OM611.962	05/00 ⇒ 05/08
CLASSE C II C 220	M271.948	05/02 ⇒ 05/08
CLASSE C II C 220 CDI	OM611.962, M111.981	05/00 ⇒ 05/08
CLASSE C II C 230	M272.920	01/05 ⇒ 05/08
CLASSE C II C 230 Kompressor	M111.981, M271.820	03/01 ⇒ 05/08
CLASSE C II C 240	M112.912	05/00 ⇒ 08/07
CLASSE C II C 240 4-matic	M112.916	07/02 ⇒ 08/07
CLASSE C II C 270 CDI	OM612.962	12/00 ⇒ 08/07
CLASSE C II C 280	M272.940	01/05 ⇒ 02/07
CLASSE C II C 280 4-matic	M272.941	01/05 ⇒ 02/07
CLASSE C II C 320 CDI AMG	OM612.990	01/03 ⇒ 08/07
CLASSE C II C 32 AMG Kompressor	M112.961	02/01 ⇒ 08/07
CLASSE C II C 320	M112.946	03/01 ⇒ 08/07
CLASSE C II C 320 4-matic	M112.953	07/02 ⇒ 08/07
CLASSE C II C 320 CDI	OM642.910	06/05 ⇒ 08/07
CLASSE C II C 350	M272.960	01/05 ⇒ 05/08
CLASSE C III C 55 AMG	M113.988	02/04 ⇒ 08/07
CLASSE C III C 180 CGI	M271.820, M271.820	01/07 ⇒ 08/14
CLASSE C III C 180 Kompressor	M271.820, M271.820	01/07 ⇒ 08/14
CLASSE C III C 200 CGI	M271.820, M271.820	01/07 ⇒ 08/14
CLASSE C III C 200 Kompressor	M271.820, M272.971	01/07 ⇒ 08/14
CLASSE C III C 220 CDI	OM651.911	10/08 ⇒ 01/14
CLASSE C III C 230	M272.921	01/07 ⇒ 08/14
CLASSE C III C 230 4-matic	M272.911	07/07 ⇒ 01/14
CLASSE C III C 250 CDI	OM651.911	01/09 ⇒ 08/14
CLASSE C III C 250 CDI 4-matic	OM651.912	04/10 ⇒ 08/14
CLASSE C III C 280	M272.947	01/07 ⇒ 01/14
CLASSE C III C 280 4-matic	M272.948	07/07 ⇒ 01/14
CLASSE C III C 300 4-matic	M272.948	07/07 ⇒ 01/14
CLASSE C III C 300 CDI	OM642.832	01/11 ⇒ 01/14
CLASSE C III C 300 CDI 4-matic		
CLASSE C III C 320 CDI	OM642.960	08/07 ⇒ 08/14
CLASSE C III C 320 CDI 4-matic	OM642.961	08/07 ⇒ 12/11
CLASSE C III C 350	M276.957	01/11 ⇒ 01/14
CLASSE C III C 350 4-matic	M272.971, M156.985	07/07 ⇒ 01/14
CLASSE C III C 350 CDI	OM642.834	06/11 ⇒ 01/14
CLASSE C III C 350 CGI	M272.982	09/08 ⇒ 01/14
CLASSE C III C 63 AMG	M156.985, M271.911	02/08 ⇒
CLASSE C III C 63 AMG DR 520	M156.985	07/10 ⇒ 01/14
CLASSE CLC CLC 160	M271.911, M271.940	02/09 ⇒ 06/11
CLASSE CLC CLC 180 Kompressor	M271.940, OM646.962	05/08 ⇒ 06/11
CLASSE CLC CLC 200 CDI	OM646.962, M271.940	05/08 ⇒ 06/11
CLASSE CLC CLC 200 Kompressor	M271.957	05/08 ⇒ 06/11
CLASSE CLC CLC 220 CDI	OM646.963	05/08 ⇒ 06/11
CLASSE CLC CLC 230	M272.920	05/08 ⇒ 06/11
CLASSE CLC CLC 350	M272.960	05/08 ⇒ 06/11
CLASSE CLC CLC250 [ExtraEU]	M272.920	06/09 ⇒ 06/11
CLASSE CLK I 200 Kompressor	M111.956	06/00 ⇒ 06/02
CLASSE CLK I 230 Kompressor	M111.982	06/00 ⇒ 06/02
CLASSE CLK I 55 AMG	M113.984	08/99 ⇒ 06/02
CLASSE CLK II 200 CGI	M271.942	07/03 ⇒ 05/09
CLASSE CLK II 200 Kompressor	M271.940, OM612.962	09/02 ⇒ 05/09
CLASSE CLK II 220 CDI	OM646.966	01/05 ⇒ 05/09
CLASSE CLK II 240	M112.912	06/02 ⇒ 05/09
CLASSE CLK II 270 CDI	OM612.962, M156.982	10/02 ⇒ 05/09
CLASSE CLK II 280	M272.940	01/05 ⇒ 05/09
CLASSE CLK II 350	M272.960	01/05 ⇒ 05/09
CLASSE CLK II 63 AMG	M156.982, M271.940	04/06 ⇒ 05/09
CLASSE CLK II CLK 200 CGI	M271.942	07/03 ⇒ 03/10
CLASSE CLK II CLK 200 Kompressor	M271.940, M272.964	02/03 ⇒ 03/10
CLASSE CLK II CLK 280	M272.940	01/05 ⇒ 03/10
CLASSE CLK II CLK 350	M272.960	01/05 ⇒ 03/10
CLASSE CLK II CLK 500	M113.968	02/03 ⇒ 03/10
CLASSE CLK II CLK 63 AMG	M156.982	04/06 ⇒ 03/10
CLASSE CLK II CLK AMG DTM	M113.987	06/04 ⇒ 03/10
CLASSE CLS I CLS 280	M272.943	07/08 ⇒ 12/10
CLASSE CLS I CLS 350	M272.964, M113.967	10/04 ⇒ 12/10
CLASSE CLS I CLS 500	M113.967, OM646.821	10/04 ⇒ 12/10
CLASSE CLS I CLS 55 AMG	M113.990	01/05 ⇒ 12/10
CLASSE CLS I CLS 63 AMG	M156.983	04/06 ⇒ 12/10
MERCEDES-BENZ		
CLASSE CLS II CLS 350 CDI / d	OM642.853	01/11 ⇒
CLASSE E II E 200 Kompressor	M111.957	08/00 ⇒ 03/02
CLASSE E II E 200 T Kompressor	M111.957	08/00 ⇒ 03/03
CLASSE E II E 270 CDI	OM612.961	07/99 ⇒ 03/02
CLASSE E II E 270 T CDI	OM612.961, M271.941	02/00 ⇒ 03/03
CLASSE E II E 320 CDI	OM613.961	07/99 ⇒ 03/02
CLASSE E II E 320 T CDI	OM613.961	07/99 ⇒ 03/03
CLASSE E III E 200 CDI	OM646.951	07/02 ⇒ 12/08
CLASSE E III E 200 Kompressor	M271.941, 271941NGT	11/02 ⇒ 07/09
CLASSE E III E 200 NGT	271941NGT, OM646.821	03/04 ⇒ 12/08
CLASSE E III E 200 T Kompressor	M271.941	03/03 ⇒ 07/09
CLASSE E III E 220 CDI	OM646.961	03/02 ⇒ 07/09
CLASSE E III E 220 T CDI	OM646.821, OM642.920	03/03 ⇒ 07/09
CLASSE E III E 230	M272.922	09/07 ⇒ 12/08
CLASSE E III E 230 T	M272.922	05/07 ⇒ 07/09
CLASSE E III E 240	M112.913	03/02 ⇒ 12/08
CLASSE E III E 240 4-matic	M112.917	03/03 ⇒ 12/08
CLASSE E III E 270 CDI	OM647.961	03/02 ⇒ 12/08
CLASSE E III E 270 T CDI	OM647.961	03/03 ⇒ 07/09
CLASSE E III E 280	M272.943	03/05 ⇒ 12/08
CLASSE E III E 280 4-matic	M272.944	01/06 ⇒ 12/08
CLASSE E III E 280 CDI	OM642.920, OM642.920	05/04 ⇒ 12/08
CLASSE E III E 280 CDI 4-matic	OM642.921	03/05 ⇒ 12/08
CLASSE E III E 280 T	M272.943	03/05 ⇒ 07/09
CLASSE E III E 280 T 4-matic	M272.944	03/05 ⇒ 07/09
CLASSE E III E 280 T CDI	OM648.961	05/04 ⇒ 07/09
CLASSE E III E 300 BlueTEC	OM642.920	09/07 ⇒ 12/08
CLASSE E III E 320 4-matic	M112.954	03/03 ⇒ 12/08
CLASSE E III E 320 CDI	OM642.920, M113.967	11/02 ⇒ 12/08
CLASSE E III E 320 CDI 4-matic	OM642.921	03/05 ⇒ 12/08
CLASSE E III E 320 T CDI	OM648.961	03/03 ⇒ 07/09
CLASSE E III E 350	M272.964	03/05 ⇒ 12/08
CLASSE E III E 350 4-matic	M272.972	03/05 ⇒ 12/08
CLASSE E III E 350 CGI	M272.985	09/07 ⇒ 12/08
CLASSE E III E 350 T	M272.964	03/05 ⇒ 07/09
CLASSE E III E 350 T 4-matic	M272.972	03/05 ⇒ 07/09
CLASSE E III E 400 CDI	OM628.961	02/03 ⇒ 12/08
CLASSE E III E 420 CDI	OM629.910	01/06 ⇒ 12/08
CLASSE E III E 500	M113.967, M113.969	03/02 ⇒ 12/08
CLASSE E III E 500 4-matic	M113.969, 271958NGT	10/03 ⇒ 12/08
CLASSE E III E 500 T	M273.960	04/06 ⇒ 07/09
CLASSE E III E 500 T 4-matic	M273.962	04/06 ⇒ 07/09
CLASSE E III E 55 AMG Kompressor	M113.990	10/02 ⇒ 12/08
CLASSE E III E 55 T AMG Kompressor	M113.990	07/03 ⇒ 07/09
CLASSE E III E 63 AMG	M156.983	03/06 ⇒ 12/08
CLASSE E IV E 200 NGT	271958NGT, M272.961	03/11 ⇒
CLASSE E IV E 300	M272.952	01/09 ⇒
CLASSE E IV E 350	M272.961, M272.982	01/09 ⇒
CLASSE E IV E 350 4-matic	M272.977	01/09 ⇒
CLASSE E IV E 350 CGI	M272.982, M272.961	01/09 ⇒
CLASSE E IV E 500	M273.966	01/09 ⇒
CLASSE E IV E 500 4-matic	M273.970	01/09 ⇒
CLASSE E IV E 63 AMG	M156.985	08/09 ⇒
CLASSE E IV E350 [ExtraEU]	M272.961, OM612.963	05/11 ⇒
CLASSE E E 220 CDI	OM646.821, OM647.961	10/03 ⇒ 07/09
CLASSE E E 270 CDI	OM647.961, OM612.961	03/03 ⇒ 07/09
CLASSE E E 280	M112.921	07/99 ⇒ 11/02
CLASSE G II G 270 CDI	OM612.963, M113.993	01/01 ⇒
CLASSE G II G 400 CDI	OM628.962	12/00 ⇒
CLASSE G II G 55 AMG	M113.993, OM642.822	06/04 ⇒
CLASSE GL I GL 320 CDI / 350 BlueTEC 4-matic	OM642.820	12/09 ⇒
CLASSE GL I GL 320 CDI 4-matic	OM642.940	09/06 ⇒ 05/09
CLASSE GL I GL 350 CDI 4-matic	OM642.822, M113.971	05/09 ⇒
CLASSE GLK 280 4-matic	M272.948	06/08 ⇒ 06/09
CLASSE GLK 300 4-matic	M272.948	07/09 ⇒ 04/11
CLASSE M I ML 320	M112.942	02/98 ⇒ 08/02
CLASSE M I ML 400 CDI	OM628.963	09/01 ⇒ 06/05
CLASSE M II ML 300 4-matic	M272.945	03/10 ⇒ 12/11
CLASSE M II ML 350 4-matic	M272.967	02/05 ⇒ 12/11
CLASSE M II ML 500 4-matic	M273.963	12/07 ⇒ 12/11
CLASSE M II ML 63 AMG 4-matic	M156.980	01/06 ⇒ 12/11
CLASSE R R 280	M272.945	01/07 ⇒
CLASSE R R 280 4-matic	M272.945	05/07 ⇒
CLASSE R R 300	M272.945	07/09 ⇒
CLASSE R R 350	M272.967	01/07 ⇒
CLASSE R R 350 4-matic	M272.967	01/06 ⇒
CLASSE R R 500 4-matic	M113.971, M137.970	01/06 ⇒
CLASSE R R 63 AMG 4-matic	M156.980	02/06 ⇒

MERCEDES-BENZ		
CLASSE S IV CL 55 AMG Kompressor	M113.991	06/02 ⇒ 03/06
CLASSE S IV CL 600	M137.970, OM613.960	09/02 ⇒ 03/06
CLASSE S IV CL 65 AMG	M275.980	09/03 ⇒ 03/06
CLASSE S IV S 280	M112.922	10/98 ⇒ 08/05
CLASSE S IV S 320	M112.944	10/98 ⇒ 08/05
CLASSE S IV S 320 CDI	OM613.960, OM628.960	09/02 ⇒ 08/05
CLASSE S IV S 350	M112.972	09/02 ⇒ 08/05
CLASSE S IV S 350 4-matic	M112.975	06/03 ⇒ 08/05
CLASSE S IV S 400 CDI	OM628.960, M137.970	06/00 ⇒ 08/05
CLASSE S IV S 430	M113.941	10/98 ⇒ 08/05
CLASSE S IV S 430 4-matic	M113.948	09/02 ⇒ 08/05
CLASSE S IV S 500	M113.960	10/98 ⇒ 08/05
CLASSE S IV S 500 4-matic	M113.966	09/02 ⇒ 08/05
CLASSE S IV S 55 AMG	M113.986	04/99 ⇒ 08/05
CLASSE S IV S 55 AMG Kompressor	M113.991	06/02 ⇒ 08/05
CLASSE S IV S 600	M137.970, M275.982	01/00 ⇒ 08/05
CLASSE S IV S 65 AMG	M275.980	03/04 ⇒ 08/05
CLASSE S V CL 600	M275.953	05/06 ⇒ 12/13
CLASSE S V CL 63 AMG	M156.984	10/06 ⇒ 12/13
CLASSE S V CL 65 AMG	M275.982, M275.982	10/06 ⇒ 12/13
CLASSE S V S 280	M272.946	08/06 ⇒ 12/13
CLASSE S V S 300	M272.946	08/06 ⇒ 12/13
CLASSE S V S 400 Hybrid	M272.974	01/09 ⇒ 12/13
CLASSE S V S 450	M273.922	12/05 ⇒ 12/13
CLASSE S V S 450 4-matic	M273.924	12/05 ⇒ 12/13
CLASSE S V S 500	M273.961	10/05 ⇒ 12/13
CLASSE S V S 500 4-matic	M273.968	10/05 ⇒ 12/13
CLASSE S V S 600	M275.953	12/05 ⇒ 12/13
CLASSE S V S 63 AMG	M156.984	10/06 ⇒ 12/13
CLASSE S V S 65 AMG	M275.982, M112.973	12/05 ⇒ 12/13
CLASSE SL V 280	M272.949	03/08 ⇒ 01/12
CLASSE SL V 300	M272.949	04/09 ⇒ 01/12
CLASSE SL V 350	M112.973, M113.963	03/03 ⇒ 01/12
CLASSE SL V 500	M113.963, M113.992	10/01 ⇒ 01/12
CLASSE SL V 55 AMG	M113.992, M275.951	10/01 ⇒ 01/12
CLASSE SL V 55 AMG Kompressor	M113.992	06/02 ⇒ 01/12
CLASSE SL V 600	M275.951, M271.944	04/03 ⇒ 01/12
CLASSE SL V 63 AMG	M156.981	03/08 ⇒ 01/12
CLASSE SL V 65 AMG	M275.981	03/04 ⇒ 01/12
CLASSE SL V 65 AMG Black Series	M275.983	07/08 ⇒ 01/12
CLASSE SLK I 200 Kompressor	M111.958	03/00 ⇒ 04/04
CLASSE SLK I 230 Kompressor	M111.983	03/00 ⇒ 04/04
CLASSE SLK I 32 AMG Kompressor	M112.960	03/01 ⇒ 04/04
CLASSE SLK II 200 Kompressor	M271.944, M272.963	03/04 ⇒ 02/11
CLASSE SLK II 280	M272.942	01/05 ⇒ 02/11
CLASSE SLK II 300	M272.942	04/09 ⇒ 02/11
CLASSE SLK II 350	M272.963, M155.980	06/04 ⇒ 02/11
CLASSE SLK III 55 AMG	M152.980	01/12 ⇒
CLC-SERIES CLC220 CDI	OM646.963	05/08 ⇒ 06/11
CLK-SERIES CLK63 AMG Black Series	M156.982	05/07 ⇒ 05/09
C-SERIES C160 Kompressor	M271.921	06/02 ⇒ 07/06
C-SERIES C200 CDI	OM651.913	01/10 ⇒ 01/14
C-SERIES C300 CDI/CDi BlueEFFICIENCY	OM642.832	01/11 ⇒ 01/14
E-SERIES E250	M272.922	05/07 ⇒ 12/08
R-SERIES R300	M272.945	07/09 ⇒ 12/11
SLR McLAREN 5.4	M155.980, M159.980	04/04 ⇒
SLR McLAREN 5.4 722 Edition	M155.980	10/06 ⇒
SLR-SERIES SLR McLaren Kompressor Stirling Moss	M155.980	06/09 ⇒ 12/11
SLS AMG 6.2	M159.980, OM601.943	03/10 ⇒
SLS AMG 6.2 GT	M159.980	06/13 ⇒
SPRINTER I 208 CDI	OM611.987	04/00 ⇒ 05/06
SPRINTER I 208 D	OM601.943, OM601.943	01/95 ⇒ 04/00
SPRINTER I 211 CDI	OM611.981	04/00 ⇒ 05/06
SPRINTER I 213 CDI	OM611.981	04/00 ⇒ 05/06
SPRINTER I 216 CDI	OM612.981	04/00 ⇒ 05/06
SPRINTER I 308 CDI	OM611.987	04/00 ⇒ 05/06
SPRINTER I 308 D	OM601.943	02/95 ⇒ 04/00
SPRINTER I 308 D 2.3	OM601.943, M111.979	02/95 ⇒ 04/00
SPRINTER I 311 CDI	OM611.981	04/00 ⇒ 05/06
SPRINTER I 311 CDI 4x4	OM611.981	08/02 ⇒ 05/06
SPRINTER I 313 CDI	OM611.981	04/00 ⇒ 05/06
SPRINTER I 313 CDI 4x4	OM611.981	08/02 ⇒ 05/06
SPRINTER I 316 CDI	OM612.981	04/00 ⇒ 05/06
SPRINTER I 316 CDI 4x4	OM612.981	08/02 ⇒ 05/06
SPRINTER I 408 CDI	OM611.987	04/00 ⇒ 05/06
SPRINTER I 410 D	OM602.980	02/96 ⇒ 05/06
SPRINTER I 410 D 4x4	OM602.980	05/97 ⇒ 05/06
SPRINTER I 411 CDI	OM611.981	04/00 ⇒ 05/06
SPRINTER I 411 CDI 4x4	OM611.981	04/00 ⇒ 05/06

MERCEDES-BENZ		
SPRINTER I 412 D	OM602.980	02/96 ⇒ 05/06
SPRINTER I 412 D 4x4	OM602.980	05/97 ⇒ 05/06
SPRINTER I 413 CDI	OM611.981	04/00 ⇒ 05/06
SPRINTER I 413 CDI 4x4	OM611.981	04/00 ⇒ 05/06
SPRINTER I 414	M111.979, OM651.955	02/95 ⇒ 05/06
SPRINTER I 414 4x4	M111.984	05/97 ⇒ 05/06
SPRINTER I 416 CDI	OM612.981	04/00 ⇒ 05/06
SPRINTER I 416 CDI 4x4	OM612.981	04/00 ⇒ 05/06
SPRINTER I 616 CDI	OM612.981	04/01 ⇒
SPRINTER II 213 CDI	OM651.955, OM646.986	06/06 ⇒
SPRINTER II 215 CDI	OM646.986, OM651.955	06/06 ⇒ 12/09
SPRINTER II 216	M271.951	09/08 ⇒
SPRINTER II 216 CDI	OM651.955, OM642.896	03/09 ⇒
SPRINTER II 219 CDI / BlueTEC	OM642.896, OM651.955	03/09 ⇒
SPRINTER II 224	M272.979	06/06 ⇒
SPRINTER II 310 CDI	OM651.955	03/09 ⇒
SPRINTER II 316	M271.951	09/08 ⇒
SPRINTER II 316 CDI	OM651.955, OM651.955	03/09 ⇒
SPRINTER II 316 CDI 4x4	OM651.955, 271951NGT	03/09 ⇒
SPRINTER II 316 LGT	M271.951	09/08 ⇒
SPRINTER II 316 NGT	271951NGT, OM646.986	09/08 ⇒
SPRINTER II 324	M272.979	06/06 ⇒ 12/13
SPRINTER II 415 CDI	OM646.986, OM646.986	06/06 ⇒ 12/09
SPRINTER II 424	M272.979	06/06 ⇒ 12/13
SPRINTER II 515 CDI	OM646.986, OM646.986	06/06 ⇒ 12/09
SPRINTER II 515 CDI 4x4	OM646.986, 271951NGT	06/06 ⇒ 12/09
SPRINTER II 516	M271.951	09/08 ⇒
SPRINTER II 516 NGT	271951NGT, M112.976	09/08 ⇒
SPRINTER II 524	M272.979	06/06 ⇒ 12/13
SPRINTER SERIES Sprinter 516 NGT Supercharged	271951NGT	03/09 ⇒
SPRINTER SERIES Sprinter 516 Supercharged	M271.951	03/09 ⇒
VANEO 1.6	M166.961	02/02 ⇒ 07/05
VANEO 1.7 CDI	OM668.914	02/02 ⇒ 07/05
VANEO 1.9	M166.991	02/02 ⇒ 07/05
VIANO 3,0	M112.951	09/03 ⇒
VIANO 3.2	M112.951	09/03 ⇒
VIANO 3.5	M272.978	09/07 ⇒
VIANO 3.7	M112.976, OM646.982	06/04 ⇒
VIANO CDI 2.0	OM646.982, OM646.980	09/03 ⇒
VIANO CDI 2.0 4-matic	OM646.982	07/05 ⇒
VIANO CDI 2.2	OM646.980, OM646.980	09/03 ⇒
VIANO CDI 2.2 4-matic	OM646.982	07/05 ⇒
VITO II 109 CDI	OM646.980, OM646.982	09/03 ⇒
VITO II 109 CDI 4x4	OM646.981	09/07 ⇒
VITO II 111 CDI	OM646.982, OM646.980	09/03 ⇒
VITO II 111 CDI 4x4	OM646.982	09/07 ⇒
VITO II 115 CDI	OM646.980, M132.930	09/03 ⇒
VITO II 115 CDI 4x4	OM646.982	07/06 ⇒
VITO II 123	M112.976	06/04 ⇒
VITO II 126	M272.978	09/07 ⇒
SMART		
CABRIO 0.8 CDI	OM660.940	03/01 ⇒ 01/04
CITY-COUPÉ 0.8 CDI	OM660.940	11/99 ⇒ 01/04
FORTWO I 0.8 CDI	OM660.940	01/04 ⇒ 01/07
FORTWO II 0.8 CDI	OM660.950	01/07 ⇒
FORTWO II 1.0 Brabus	M132.930, OM668.940	01/08 ⇒
FORTWO II 1.0 Turbo	M132.930	01/07 ⇒
FORTWO II 1.0 Turbo Brabus	M132.930	07/10 ⇒

10.3104

3

ABSOLUTE PRESSURE SENSORS (MAP)

Adatt./Suitable:

DENSO

11021-2841

MERCEDES-BENZ

A 011 542 07 17



kPa	mV	
38 - 263	250 - 4750	

MERCEDES-BENZ

CLASSE A I A 160 CDI	OM668.940, OM668.940	02/01 ⇒ 08/04
CLASSE A I A 170 CDI	OM668.940, OM611.961	02/01 ⇒ 08/04
CLASSE C I C 200 CDI	OM611.960	03/98 ⇒ 05/00
CLASSE C I C 200 T CDI	OM611.960	03/98 ⇒ 03/01
CLASSE C I C 220 CDI	OM611.960	09/97 ⇒ 05/00
CLASSE C I C 220 T CDI	OM611.960	09/97 ⇒ 03/01
CLASSE C I C 250 Turbo-D	OM605.960	06/96 ⇒ 03/01
CLASSE C I C 250 Turbo-D	OM605.960	10/95 ⇒ 05/00
CLASSE V V 230 TD	OM601.970	09/96 ⇒ 07/03
CLASSE E II E 200 CDI	OM611.961, OM611.961	06/98 ⇒ 03/02
CLASSE E II E 220 CDI	OM611.961, OM611.961	06/98 ⇒ 07/99
CLASSE E II E 220 T CDI	OM611.961, OM602.980	06/98 ⇒ 07/99
CLASSE E II E 250 Turbo-D	OM605.962	06/97 ⇒ 07/99
CLASSE E II E 250 Turbo-D	OM605.962	06/97 ⇒ 07/99
CLASSE E II E 290 Turbo-D	OM602.982	06/96 ⇒ 07/99
CLASSE E II E 290 Turbo-D	OM602.982	03/96 ⇒ 07/99
CLASSE E II E 300 Turbo-D	OM606.962	12/96 ⇒ 07/99
CLASSE E II E 300 Turbo-D	OM606.962	12/96 ⇒ 07/99
CLASSE E E 220 CDI	OM611.961	07/99 ⇒ 12/02
CLASSE E E 250 d	OM605.912	06/96 ⇒ 06/98
CLASSE G II G 300 TD	OM606.964	08/96 ⇒ 07/00
SPRINTER I 210 D	OM602.980	01/97 ⇒ 04/00
SPRINTER I 212 D	OM602.980	02/95 ⇒ 04/00
SPRINTER I 310 D	OM602.980	01/97 ⇒ 12/99
SPRINTER I 310 D 2.9	OM602.980	02/95 ⇒ 04/00
SPRINTER I 310 D 2.9 4x4	OM602.980	01/97 ⇒ 04/00
SPRINTER I 310 D 4x4	OM602.980	05/97 ⇒ 08/02
SPRINTER I 312 D 2.9	OM602.980, OM602.984	02/95 ⇒ 09/01
SPRINTER I 312 D 2.9 4x4	OM602.980	05/97 ⇒ 08/02
SPRINTER I 410 D	OM602.980	02/96 ⇒ 05/06
SPRINTER I 410 D 4x4	OM602.980	05/97 ⇒ 05/06
SPRINTER I 412 D	OM602.980	02/96 ⇒ 05/06
SPRINTER I 412 D 4x4	OM602.980	05/97 ⇒ 05/06
SPRINTER I 414 D 4x4	OM602.980	05/97 ⇒ 05/06
SPRINTER SERIES Sprinter 414	OM602.980	05/97 ⇒ 07/00
VARIO 512 D	OM602.984	09/96 ⇒ 12/10
VARIO 612 D	OM602.984, OM904.914	04/96 ⇒
VARIO 613 D, 614 D	OM904.908	09/96 ⇒
VARIO 614 D	OM904.914, OM602.984	04/96 ⇒
VARIO 615 D, 616 D	OM904.923	09/98 ⇒
VARIO 810 DT	OM904.961	09/96 ⇒
VARIO 812 D	OM602.984, OM904.914	04/96 ⇒
VARIO 813 D, 814 D	OM904.908	09/96 ⇒ 12/13
VARIO 813 DA, 814 DA 4x4	OM904.908	09/96 ⇒ 12/13
VARIO 814 D	OM904.914, OM904.914	04/96 ⇒
VARIO 814 DT	OM904.908	09/96 ⇒
VARIO 815 D	OM904.914, OM602.984	04/96 ⇒
VARIO 815 D, 816 D	OM904.923	09/96 ⇒ 12/13
VARIO 815 DA, 816 DA 4x4	OM904.923	09/96 ⇒ 12/13
VARIO O 812	OM602.984, ENR	09/96 ⇒ 12/10
VITO I 110 D 2.3	OM601.970	03/97 ⇒ 07/03
VITO I 110 TD 2.3	OM601.970	02/96 ⇒ 07/03

PUCH

G-MODELL G 300 Turbodiesel	OM606.964	01/96 ⇒ 11/00
----------------------------	-----------	---------------

10.3105



3,5

ABSOLUTE PRESSURE SENSORS (MAP)

Adatt./Suitable:

- AUDI**
036 906 051 F
- BOSCH**
0 261 230 079
0 261 230 080
- VW**
036 906 051 F



kPa	mV	
10 - 117	405 - 4750	

VW	BORA 1.6 FSI	BAD	01/02 ⇨ 05/05
-----------	--------------	-----	---------------

10.3106



3

ABSOLUTE PRESSURE SENSORS (MAP)

Adatt./Suitable:

- BOSCH**
0 261 230 139
0 261 230 140
0 261 230 189
0 261 230 190
- CHRYSLER**
5101120AA
56044591AA
K05101120AA
K05101120AB
K05149203AA
K56044591AA
- DODGE**
5101120AB
5149203AA
56044591AA
K05101120AB
K05149203AA
K56044591AA
- JEEP**
5101120AB
5149203AA
56044591AA
K05101120AA
K05101120AB
K05149203AA
K56044591AA

- MERCEDES-BENZ**
0041533228
0051535028
0061531328
0061539728
A 004 153 30 28
A 004 153 32 28
A 005 153 50 28
A 006 153 13 28
A 006 153 97 28

- MOPAR PARTS**
05101120AB
05149203AA
- VW**
2E0 906 051 A

MARKET DIFFUSION: HIGH



kPa	mV	
10 - 127	503 - 4750	

CHRYSLER			
300C I 3.0 CRD	EXL	09/05 ⇨	11/12
300C I 3.0 V6 CRD	EXL	11/10 ⇨	11/12
300C II 3.0 CRD	EXL	09/05 ⇨	12/10
CROSSFIRE 3.2	EGX	07/03 ⇨	12/08

DODGE			
CALIBER 2.2 CRD	ENE	07/10 ⇨	
NITRO 2.8 CRD	ENR, ENR	10/06 ⇨	12/12
NITRO 2.8 CRD 4WD	ENR, ENS	06/07 ⇨	12/12

JEEP			
CHEROKEE IV 2.8 CRD 4x4	ENS, EXL	05/08 ⇨	
COMMANDER 3.0 CRD 4x4	EXL, ENE	09/05 ⇨	12/10
COMPASS 2.2 CRD	ENE	05/11 ⇨	
COMPASS 2.2 CRD 4x4	ENE, EXL	12/10 ⇨	
GRAND CHEROKEE 3.0 CRD	EXL	06/05 ⇨	12/10
GRAND CHEROKEE 3.0 CRD 4x4	EXL, ENS	06/05 ⇨	12/10
PATRIOT 2.2 CRD	ENE	01/11 ⇨	
PATRIOT 2.2 CRD 4x4	ENE	01/11 ⇨	
WRANGLER 2.8 CRD	ENS, OM651.930	04/07 ⇨	
WRANGLER 2.8 CRD RWD	ENS	04/07 ⇨	02/10

MERCEDES-BENZ			
B-SERIES B180 CDI [ExtraEU]	OM651.930	07/14 ⇨	
CLASSE A III A 180 CDI	OM651.930	09/12 ⇨	
CLASSE A III A 200 CDI	OM651.901	06/12 ⇨	
CLASSE A III A 200 CDI / d 4-matic	OM651.930	02/14 ⇨	
CLASSE B I B 170 NGT	M266.960	04/08 ⇨	11/11
CLASSE B I B 180 NGT	M266.960	04/08 ⇨	11/11
CLASSE B I B 200 TURBO	M266.980	03/05 ⇨	11/11
CLASSE B II B 180 CDI	OM651.930	05/12 ⇨	
CLASSE B II B 220 CDI / d	OM651.930, OM611.962	11/11 ⇨	

MERCEDES-BENZ			
CLASSE B II B 220 CDI / d 4-matic	OM651.930	09/14 ⇨	
CLASSE C I C 240T	M112.915	09/00 ⇨	03/01
CLASSE C I C 280	M112.920	06/97 ⇨	05/00
CLASSE C I C 280T	M112.920	06/97 ⇨	03/01
CLASSE C I C 43 AMG	M113.944	08/97 ⇨	03/01
CLASSE C II C 200 CDI	OM611.962, M271.820	02/01 ⇨	
CLASSE C II C 220 CDI	OM646.963	02/03 ⇨	05/08
CLASSE C II C 280	M272.940	01/05 ⇨	08/07
CLASSE C II C 280 4-matic	M272.941	01/05 ⇨	08/07
CLASSE C II C 30 CDI AMG	OM612.990	01/03 ⇨	02/07
CLASSE C II C 320	M112.946	05/00 ⇨	05/08
CLASSE C II C 320 4-matic	M112.953	07/02 ⇨	02/07
CLASSE C II C 320 CDI	OM642.910	01/05 ⇨	02/07
CLASSE C II C 350	M272.960	01/05 ⇨	08/07
CLASSE C II C 350 4-matic	M272.970	01/05 ⇨	08/07
CLASSE C II C 55 AMG	M113.988	02/04 ⇨	02/07
CLASSE C III C 180 CDI	OM651.913	01/11 ⇨	08/14
CLASSE C III C 180 CGI	M271.820, M271.820	11/09 ⇨	08/14
CLASSE C III C 180 Kompressor	M271.820, OM646.811	08/07 ⇨	08/14
CLASSE C III C 200	M271.820	05/11 ⇨	01/14
CLASSE C III C 200 CDI	OM646.811, M271.820	08/07 ⇨	08/14
CLASSE C III C 200 CGI	M271.820, M271.820	08/07 ⇨	
CLASSE C III C 200 Kompressor	M271.820, OM646.811	08/07 ⇨	08/14
CLASSE C III C 220 CDI	OM646.811, OM642.830	01/07 ⇨	
CLASSE C III C 220 CDI 4-matic	OM651.912	02/13 ⇨	08/14
CLASSE C III C 250	M272.921	01/07 ⇨	
CLASSE C III C 250 4-matic	M272.911	07/07 ⇨	
CLASSE C III C 250 CDI	OM651.911	08/08 ⇨	
CLASSE C III C 250 CDI 4-matic	OM651.912	01/11 ⇨	01/14
CLASSE C III C 250 CGI	M271.860	07/09 ⇨	01/14
CLASSE C III C 280	M272.947	08/07 ⇨	08/14
CLASSE C III C 300	M272.947	08/07 ⇨	08/14
CLASSE C III C 320 CDI 4-matic	OM642.961	07/07 ⇨	01/14
CLASSE C III C 350	M272.961	01/07 ⇨	08/14
CLASSE C III C 350 CDI	OM642.830, OM642.832	07/09 ⇨	08/14
CLASSE C III C 350 CDI 4-matic	OM642.832, OM651.921	07/09 ⇨	08/14
CLASSE C III C 63 AMG	--	07/10 ⇨	08/14
CLASSE C III C 63 AMG DR 520	--	07/10 ⇨	01/14
CLASSE C IV C 200 d	OM651.921	10/15 ⇨	
CLASSE C IV C 220 BlueTEC / d	OM651.921, M113.968	12/13 ⇨	
CLASSE C IV C 220 d	OM651.921	06/16 ⇨	
CLASSE C IV C 220 d 4-matic	OM651.921	04/16 ⇨	
CLASSE C IV C 250 BlueTEC / d	OM651.921	02/14 ⇨	
CLASSE C IV C 250 BlueTEC / d 4-matic	OM651.921	02/14 ⇨	
CLASSE C IV C 250 d	OM651.921	06/16 ⇨	
CLASSE C IV C 250 d 4-matic	OM651.921	04/16 ⇨	
CLASSE C IV C 300 BlueTEC Hybrid / h	OM651.921	05/14 ⇨	
CLASSE CLA CLA 220 CDI / d 4-matic	OM651.930	01/15 ⇨	
CLASSE CLK I 320	M112.940	06/97 ⇨	06/02
CLASSE CLK I 430	M113.943	07/98 ⇨	06/02
CLASSE CLK II 220 CDI	OM646.966	01/05 ⇨	05/09
CLASSE CLK II 240	M112.912	06/02 ⇨	05/09
CLASSE CLK II 320	M112.955	06/02 ⇨	05/09
CLASSE CLK II 500	M113.968, OM642.852	06/02 ⇨	
CLASSE CLK II 55 AMG	M113.987	09/02 ⇨	05/09
CLASSE CLK II 550	M273.967	06/06 ⇨	
CLASSE CLK II CLK 240	M112.912	02/03 ⇨	03/10
CLASSE CLK II CLK 320	M112.955	02/03 ⇨	03/10
CLASSE CLK II CLK 500	M273.967	06/06 ⇨	03/10
CLASSE CLK II CLK 55 AMG	M113.987	02/03 ⇨	03/10
CLASSE CLS I CLS 300	M272.943	04/09 ⇨	12/10
CLASSE CLS I CLS 320 CDI	OM642.920	01/05 ⇨	12/10
CLASSE CLS I CLS 350 CDI	OM642.920	04/09 ⇨	12/10
CLASSE CLS I CLS 550	M273.960	04/06 ⇨	02/11
CLASSE CLS II CLS 250 CDI / BlueTEC / d	OM651.924	04/11 ⇨	
CLASSE CLS II CLS 350 BlueTEC	OM642.852	05/14 ⇨	
CLASSE CLS II CLS 350 BlueTEC / d	OM642.852, OM646.820	11/12 ⇨	
CLASSE CLS II CLS 350 BlueTEC / d 4-matic	OM642.858	11/12 ⇨	
CLASSE CLS II CLS 350 BlueTEC 4-matic	OM642.854	01/13 ⇨	
CLASSE CLS II CLS 350 CDI / d	OM642.853	10/12 ⇨	
CLASSE CLS II CLS 350 CDI / d 4-matic	OM642.854	09/11 ⇨	
CLASSE E II E 240	M112.914	08/00 ⇨	03/02
CLASSE E II E 240T	M112.914	08/00 ⇨	03/03
CLASSE E II E 280 4-matic	M112.921	12/96 ⇨	03/02

MERCEDES-BENZ			MERCEDES-BENZ			MERCEDES-BENZ		
CLASSE E II E 320	M112.941	06/97 → 03/02	CLASSE G II G 500 GUARD	M273.963	06/10 →	CLASSE S V S 550 4-matic [JPN]	M273.968	10/05 →
CLASSE E II E 320 4-matic	M112.941	06/97 → 03/02	CLASSE G II G 55 AMG	M113.962, M273.963	04/98 →	CLASSE S V S 550 4-matic [USA]	M273.968	10/05 →
CLASSE E II E 320 T	M112.941	12/96 → 03/03	CLASSE G II G 550	M273.963, OM651.913	06/10 →	CLASSE S VI S 300 BlueTEC Hybrid / h	OM651.921	02/14 →
CLASSE E II E 320 T 4-matic	M112.941	12/96 → 03/03	CLASSE G II G 65 AMG	M279.982	05/12 →	CLASSE S VI S 350 BlueTEC / d	OM642.861	05/13 →
CLASSE E II E 430	M113.940	06/97 → 03/02	CLASSE GL I GL 320 CDI BlueTEC 4-matic	OM642.820	12/09 →	CLASSE S VI S 350 BlueTEC / d 4-matic	OM642.867	02/14 →
CLASSE E II E 430 4-matic	M113.940	05/99 → 03/02	CLASSE GL I GL 420 CDI 4-matic	OM629.912	09/06 → 05/09	CLASSE S VI S 350 BlueTEC 4-matic	OM642.867	02/14 →
CLASSE E II E 430 T	M113.940	06/97 → 03/03	CLASSE GL I GL 450 4-matic	M273.923	09/06 →	CLASSE S VI S 350 CDI	OM642.861	05/13 →
CLASSE E II E 430 T 4-matic	M113.940	05/99 → 03/03	CLASSE GL I GL 450 CDI 4-matic	OM629.912	05/09 →	CLASSE SLV 550	M273.965	03/06 → 01/12
CLASSE E II E 55 AMG	M113.980	08/97 → 03/02	CLASSE GL I GL 500 4-matic	M273.963	09/06 →	CLASSE SLK I 320	M112.947	03/00 → 04/04
CLASSE E II E 55 T AMG	M113.980	08/97 → 03/03	CLASSE GL I GL 550 4-matic	M273.963	09/06 →	CLASSE SLK II 55 AMG	M113.989, OM651.955	06/04 → 02/11
CLASSE E III 350 CGI	M272.985	05/06 → 07/09	CLASSE GL II GL 350 CDI / BlueTEC 4-matic	OM642.826	07/12 → 10/15	CLC-SERIES CLC220 CDI	OM646.963	05/08 → 06/11
CLASSE E III E 200 CDI	OM646.820, OM646.821	07/02 → 12/08	CLASSE GLA GLA 200 CDI 4-matic	OM651.930	12/13 →	SPRINTER II 210 CDI	OM651.955	03/09 →
CLASSE E III E 220 CDI	OM646.821, M271.820	03/02 → 12/08	CLASSE GLA GLA 220 CDI	OM651.930	12/13 →	SPRINTER II 310 CDI	OM651.955, OM651.955	03/09 → 12/13
CLASSE E III E 240 4-matic	M112.917	03/03 → 12/08	CLASSE GLA GLA 220 CDI / d	OM651.930	12/13 →	SPRINTER II 311 CDI	OM646.701	09/13 →
CLASSE E III E 240 T	M112.913	03/03 → 07/09	CLASSE GLA GLA 220 CDI / d 4-matic	OM651.930	12/13 →	SPRINTER II 313 CDI	OM651.955, OM651.955	06/06 →
CLASSE E III E 240 T 4-matic	M112.917	07/03 → 07/09	CLASSE GLC 220 d 4-matic	OM651.921	06/16 →	SPRINTER II 313 CDI 4x4	OM651.955, OM651.955	05/09 →
CLASSE E III E 250	M272.922	09/07 → 12/08	CLASSE GLC 250 d 4-matic	OM651.921	06/15 →	SPRINTER II 316 CDI	OM651.955	03/09 →
CLASSE E III E 270 CDI	OM647.961	03/02 → 12/08	CLASSE GLK 200 CDI	OM651.913, OM642.832	07/10 → 06/15	SPRINTER II 316 CDI 4x4	OM651.955, OM642.896	08/11 →
CLASSE E III E 280 4-matic	M272.944	03/05 → 12/08	CLASSE GLK 220 CDI	OM651.916	12/08 → 06/15	SPRINTER II 318 CDI	OM642.896, OM642.896	02/08 → 12/09
CLASSE E III E 280 CDI	OM648.961	05/04 → 12/08	CLASSE GLK 220 CDI 4-matic	OM651.912	12/08 → 06/15	SPRINTER II 319 CDI / BlueTEC	OM642.896, OM646.989	03/09 →
CLASSE E III E 280 T 4-matic	M272.944	03/05 → 07/09	CLASSE GLK 250 CDI 4-matic	OM651.912	09/09 → 06/15	SPRINTER II 411 CDI	OM646.701	09/13 →
CLASSE E III E 300	M272.943	03/05 → 12/08	CLASSE GLK 320 CDI 4-matic	OM642.961	06/08 → 06/15	SPRINTER II 413 CDI	OM646.986	06/06 → 05/16
CLASSE E III E 300 T 4-matic	M272.944	03/05 → 07/09	CLASSE GLK 350	M272.991	04/09 → 06/15	SPRINTER II 415 CDI	OM646.989, OM642.896	06/06 → 12/09
CLASSE E III E 320	M112.949	03/02 → 12/08	CLASSE GLK 350 4-matic	M272.971	06/08 → 04/11	SPRINTER II 416 CDI	OM651.957	03/09 →
CLASSE E III E 320 CDI	OM648.961	11/02 → 12/08	CLASSE GLK 350 CDI 4-matic	OM642.832, M112.970	07/09 →	SPRINTER II 418 CDI	OM642.896, OM642.896	06/06 → 05/16
CLASSE E III E 320 CDI 4-matic	OM642.921	03/05 → 12/08	CLASSE M I ML 350	M112.970, OM642.820	08/02 → 06/05	SPRINTER II 419 CDI	OM642.896, OM646.986	03/09 →
CLASSE E III E 320 T	M112.949	03/03 → 07/09	CLASSE M I ML 430	M113.942	02/98 → 06/05	SPRINTER II 510 CDI	OM651.955	03/09 → 05/16
CLASSE E III E 320 T 4-matic	M112.954	07/03 → 07/09	CLASSE M I ML 500	M113.965	09/01 → 06/05	SPRINTER II 513 CDI	OM646.986, OM646.989	06/06 →
CLASSE E III E 320 T CDI 4-matic	OM642.921	03/05 → 07/09	CLASSE M II ML 280 CDI 4-matic	OM642.940	07/05 → 07/09	SPRINTER II 515 CDI 4x4	OM646.989, OM651.955	06/06 → 12/09
CLASSE E III E 350 4-matic	M272.972	08/04 → 08/06	CLASSE M II ML 300	M272.945	07/09 →	SPRINTER II 516 CDI	OM651.955, OM642.896	03/09 →
CLASSE E III E 500	M113.967	03/02 → 12/08	CLASSE M II ML 300 CDI 4-matic	OM642.820	02/10 → 12/11	SPRINTER II 518 CDI 4x4	OM642.896, OM642.896	06/06 → 12/09
CLASSE E III E 500 4-matic	M113.969	10/03 → 12/08	CLASSE M II ML 320 CDI 4-matic	OM642.820	02/10 →	SPRINTER II 519 CDI / BlueTEC	OM642.896, OM646.981	03/09 →
CLASSE E III E 500 T	M113.967	10/03 → 07/09	CLASSE M II ML 350	M272.967	07/05 →	VIANO CDI 2.0	OM646.981, OM646.982	09/03 →
CLASSE E III E 500 T 4-matic	M113.969	10/03 → 07/09	CLASSE M II ML 350 CDI 4-matic	OM642.820, OM642.870	07/05 →	VIANO CDI 2.0 4-matic	OM646.982, OM646.982	07/05 →
CLASSE E III E 550 4-matic	M273.962	04/06 → 12/08	CLASSE M II ML 420 CDI 4-matic	OM629.912	09/09 → 12/11	VIANO CDI 2.2	OM646.982, OM646.982	09/03 →
CLASSE E III E 550 T 4-matic	M273.962	04/06 → 07/09	CLASSE M II ML 450 4-matic Hybrid	M272.973	07/05 →	VIANO CDI 2.2 4-matic	OM646.982, OM642.890	07/05 →
CLASSE E III E 63 AMG	M156.983	03/06 → 07/09	CLASSE M III ML 350 CDI 4-matic	OM642.826	06/11 → 02/15	VIANO CDI 3.0	OM642.890, OM646.980	03/06 →
CLASSE E IV E 200 CDI / BlueTEC	OM651.925	01/09 →	CLASSE M III ML 350 CDI BlueEfficiency 4-matic	OM642.826	02/12 →	VITO II 109 CDI	OM646.980, OM646.980	09/03 →
CLASSE E IV E 200 CGI	M271.820, OM642.850	08/09 →	CLASSE R R 280 CDI	OM642.872	05/06 →	VITO II 109 CDI 4x4	OM646.981	09/07 →
CLASSE E IV E 220 BlueTEC	OM651.924	05/15 →	CLASSE R R 300 4-matic	M272.945	07/09 →	VITO II 110 CDI	OM651.940	09/10 →
CLASSE E IV E 220 BlueTEC 4-matic	OM651.924	12/14 →	CLASSE R R 300 CDI	OM642.870, OM642.870	07/09 →	VITO II 111 CDI	OM646.980, OM646.980	09/03 →
CLASSE E IV E 220 CDI	OM651.911	01/09 →	CLASSE R R 320 CDI 4-matic	OM642.870	01/06 →	VITO II 111 CDI 4x4	OM646.982	09/07 →
CLASSE E IV E 220 CDI / BlueTEC	OM651.924	01/09 →	CLASSE R R 350 CDI 4-matic	OM642.870, M137.970	01/06 →	VITO II 113 CDI	OM651.940	09/10 →
CLASSE E IV E 220 CDI / BlueTEC / d	OM651.911	01/10 →	CLASSE R R 550 4-matic	M273.963	01/07 →	VITO II 113 CDI 4x4	OM651.940	09/10 →
CLASSE E IV E 220 CDI / d	OM651.911	01/10 →	CLASSE S IV CL 500	M113.960	03/99 → 03/06	VITO II 115 CDI	OM646.980, CKTB	09/03 →
CLASSE E IV E 250	M272.923	01/10 →	CLASSE S IV CL 55 AMG	M113.986	10/99 → 03/06	VITO II 115 CDI 4x4	OM646.982	07/06 →
CLASSE E IV E 250 BlueTEC	OM651.911	01/09 →	CLASSE S IV S 320 CDI	OM648.960	09/02 → 08/05	VITO II 116 CDI	OM651.940	09/10 →
CLASSE E IV E 250 CDI / BlueTEC	OM651.924	01/09 →	CLASSE S IV S 500	M113.960	10/98 → 12/03	VITO II 116 CDI 4x4	OM651.940	09/10 →
CLASSE E IV E 250 CDI / BlueTEC / d	OM651.911	01/09 →	CLASSE S IV S 600	M137.970, M113.989	01/00 → 08/05	VITO II 119	M112.951	09/03 →
CLASSE E IV E 250 CDI / BlueTEC 4-matic	OM651.924	01/09 →	CLASSE S IV S 65 AMG	M275.980	03/04 → 08/05	VITO II 120 CDI	OM642.990	07/06 →
CLASSE E IV E 250 CGI	M271.860	01/09 →	CLASSE S V CL 500	M273.961	06/06 → 12/13	VITO II 122	M112.951	09/03 →
CLASSE E IV E 300	M272.980	01/10 →	CLASSE S V CL 500 4-matic	M273.968	02/08 → 12/13	VITO II 122 CDI	OM642.890	09/10 →
CLASSE E IV E 300 BlueTEC	OM642.852	03/11 →	CLASSE S V CL 550 [JPN]	M273.961	06/06 →	VITO II 123	M112.976	06/04 → 07/08
CLASSE E IV E 300 CDI	OM642.850, OM642.850	12/09 →	CLASSE S V CL 550 [USA]	M273.961	06/06 →			
CLASSE E IV E 300 CDI / BlueTEC	OM642.850, OM642.838	11/09 →	CLASSE S V CL 550 4-matic [JPN]	M273.968	02/08 →	PUCH		
CLASSE E IV E 300 Hybrid / BlueTEC Hybrid	OM651.924	12/11 →	CLASSE S V CL 550 4-matic [USA]	M273.968	02/08 →	G-MODELL G 500	M113.962	12/97 → 11/00
CLASSE E IV E 350	M272.961	04/11 →	CLASSE S V S 250 CDI	OM651.961	01/11 → 12/13	G-MODELL G 55 AMG	M113.982	04/99 → 03/01
CLASSE E IV E 350 BlueTEC	OM642.838, OM642.852	01/09 →	CLASSE S V S 320 CDI	OM642.930	12/05 → 06/09			
CLASSE E IV E 350 BlueTEC / d	OM642.838	05/14 →	CLASSE S V S 320 CDI 4-matic	OM642.932	10/05 → 12/13	VW		
CLASSE E IV E 350 BlueTEC 4-matic	OM642.852, OM642.836	11/12 →	CLASSE S V S 350	M272.965	10/05 → 12/13	CRAFTER 2.0 TDI	CKTB, CKUB	05/11 →
CLASSE E IV E 350 BlueTEC / d	OM642.838	05/14 →	CLASSE S V S 350 4-matic	M272.975	02/08 → 12/13	CRAFTER 2.0 TDI 4motion	CKUB, BJJ	11/11 → 12/16
CLASSE E IV E 350 CDI	OM642.836, OM642.856	01/09 →	CLASSE S V S 350 BlueTEC 4-matic	OM642.862	04/11 → 12/13	CRAFTER 2.5 TDI	BJJ, B52445	04/06 →
CLASSE E IV E 350 CDI 4-matic	OM642.856, M112.945	09/09 →	CLASSE S V S 350 BlueTEC	OM642.868	04/11 → 12/13			
CLASSE E IV E 550 [USA]	M273.966	01/09 →	CLASSE S V S 350 CDI	OM642.930	06/09 → 12/13			
CLASSE E IV E 550 [USA] [CAN] [JPN]	M273.971	01/09 →	CLASSE S V S 550 [JPN]	M273.961	10/05 →			
CLASSE E IV E 550 4-matic [USA] [CAN]	M273.970	01/09 →	CLASSE S V S 550 [USA]	M273.961	10/05 →			
CLASSE E IV E 63 AMG	M156.985	12/09 →						
CLASSE G II G 280 CDI	OM642.975	04/09 →						
CLASSE G II G 300 CDI	OM642.884	01/10 →						
CLASSE G II G 320	M112.945, M113.962	06/97 →						
CLASSE G II G 320 CDI	OM642.970	09/06 →						
CLASSE G II G 350 BlueTEC	OM642.970	07/09 →						
CLASSE G II G 350 CDI	OM642.886	07/11 →						
CLASSE G II G 400 CDI	OM628.962	12/00 →						
CLASSE G II G 500	M113.962, M113.962	01/07 →						

10.3108



3,5

ABSOLUTE PRESSURE SENSORS (MAP)

Adatt./Suitable:

DENSO
100798-5540

VOLVO
948620-9



kPa	mV	
10 - 139	890 - 4750	

VOLVO

S60 I 2.4	B5244S, B5244S	07/00 ⇨ 04/10
V70 II 2.4	B5244S, Z20NER	03/00 ⇨ 08/07

10.3109



3,5

ABSOLUTE PRESSURE SENSORS (MAP)

Adatt./Suitable:

GENERAL MOTORS
12 788 793
55 563 267

OPEL
12788793
55563267
62 35 635
62 38 680

SAAB
12 788 793
55 563 267

VAUXHALL
12788793
55563267



kPa	mV	
12 - 236	250 - 4750	

CADILLAC

BLS 2.0T	Z20NER, B207E	04/06 ⇨
BLS 2.0T AWD	B207R	04/06 ⇨
BLS 2.0T Flexpower	Z20LER	12/07 ⇨

OPEL

OMEGA B 2.2 DTI 16V	Y22DTH	09/00 ⇨ 07/03
SIGNUM 2.0 Turbo	Z20NET	05/03 ⇨ 12/08
VECTRA C 2.0 16V Turbo	Z20NET	03/03 ⇨ 08/08
VECTRA C 2.0 Turbo	Z20NET	10/03 ⇨ 08/08

SAAB

9-3 1.8t	B207E	09/02 ⇨ 02/15
9-3 1,8t BioPower	B207E, B207E	01/07 ⇨ 02/15

SAAB

9-3 1.8 i	Z18XE	01/04 ⇨ 02/15
9-3 1.8t 2.0	B207E	03/05 ⇨ 02/15
9-3 2.0	B207L	04/06 ⇨ 09/07
9-3 2.0 t	B207E, --	09/02 ⇨ 02/15
9-3 2.0 t Bio Power	B207H	01/07 ⇨ 02/15
9-3 2.0 t BioPower	--, B207H	09/02 ⇨
9-3 2.0 t BioPower XWD	B207H, B207G	01/08 ⇨ 02/15
9-3 2.0 t XWD	B207G, 8140.43S	01/07 ⇨ 02/15
9-3 2.0 T16	B207L	04/06 ⇨ 02/15
9-3 2.0 Turbo Performance	B207R	04/04 ⇨ 02/15
9-3 2.0 Turbo XWD	B207R	01/08 ⇨ 02/15

VAUXHALL

OMEGA B 2.2 DTI 16V	Y22DTH	08/00 ⇨ 07/03
SIGNUM 2.0 i Turbo	Z20NET	03/03 ⇨ 10/08
VECTRA C 2.0 16V Turbo	Z20NET	01/00 ⇨ 10/08

10.3110



3,5

ABSOLUTE PRESSURE SENSORS (MAP)

Adatt./Suitable:

BOSCH
0 281 002 514

CITROËN
1920 FT

FIAT
500351377

IVECO
0000500351377
500351377

PEUGEOT
1920 FT

RENAULT
50 01 859 016

RENAULT TRUCKS
50 01 859 016

ITEM NOW AVAILABLE FROM PRODUCTION

- ARTICOLO ORA DISPONIBILE PER LA VENDITA
- ARTICLE DISPONIBLE EN PRODUCTION COURANTE
- JETZT ZUM VERKAUF VERFÜGBARER ARTIKEL
- ARTICULO AHORA DISPONIBLE EN PRODUCCION



kPa	mV	
11,4 - 254,6	250 - 4750	

CITROËN

JUMPER I 2.8 HDi	8140.43S, --	09/00 ⇨ 04/02
JUMPER I 2.8 HDi 4x4	8140.43S	09/00 ⇨ 04/02
JUMPER II 2.8 HDi	--, 8140.43S	04/02 ⇨
JUMPER II 2.8 HDi 4x4	8140.43S, 8140.43S	02/02 ⇨
JUMPER II 2.8 HDi Trazione integrale	8140.43S	04/02 ⇨

FIAT

DUCATO II 2.3 JTD	F1AE0481C	04/02 ⇨
DUCATO II 2.8 JTD	8140.43S, 8140.43B	11/00 ⇨
DUCATO II 2.8 JTD 4x4	8140.43S	11/00 ⇨
DUCATO II 2.8 JTD Power	8140.43S	05/04 ⇨
DUCATO 2.8 JTD	8140.43S	04/04 ⇨ 07/06

IVECO

DAILY II 29 L 10	F1AE0481A	09/02 ⇨ 04/06
DAILY II 29 L 10 V	F1AE0481A	09/02 ⇨ 07/07
DAILY II 29 L 12	F1AE0481B	09/02 ⇨ 04/06
DAILY II 29 L 12 V	F1AE0481B	09/02 ⇨ 07/07
DAILY II 29 L 13	8140.43S	05/01 ⇨ 07/07
DAILY II 29 L 14	F1AE0481M	01/05 ⇨ 04/06
DAILY II 29 L 9	8140.43R	11/01 ⇨ 04/06
DAILY II 29 L 9 V	8140.43R	11/01 ⇨ 04/06
DAILY II 35 C 10 V, 35 S 10 V	F1AE0481A	09/02 ⇨ 04/06
DAILY II 35 C 12, 35 S 12	F1AE0481B	09/02 ⇨ 04/06
DAILY II 35 C 12 V, 35 S 12 V	F1AE0481B	09/02 ⇨ 07/07
DAILY II 35 C 14, 35 S 14	F1AE0481M	01/05 ⇨ 04/06
DAILY II 35 C 15	8140.43N	11/01 ⇨ 04/06
DAILY II 35 C 9, 35 S 9	8140.43R	11/01 ⇨ 04/06
DAILY II 35 S 10	F1AE0481A	09/02 ⇨ 07/07
DAILY II 35 S 13 V, 35 C 13 V	8140.43S	05/99 ⇨ 07/07
DAILY II 35 S 13, 35 C 13	8140.43S	05/99 ⇨ 04/06
DAILY II 35 S 15 V, 35 C 15 V	8140.43N	11/02 ⇨ 07/07
DAILY II 35 S 9 V	8140.43R	11/01 ⇨ 04/06
DAILY II 40 C 10	F1AE0481A	09/02 ⇨ 04/06
DAILY II 40 C 13	8140.43S	05/99 ⇨ 04/06

IVECO

DAILY II 40 C 15	8140.43N	11/01 ⇨ 04/06
DAILY II 50 C 13	8140.43S	05/99 ⇨ 07/07
DAILY II 50 C 15	8140.43N	01/01 ⇨ 04/06
DAILY II 65 C 13	8140.43.K	07/99 ⇨ 04/06
DAILY II 65 C 15	8140.43N	11/01 ⇨ 04/06
DAILY III 35 S 12, 35 C 12, 40 C 12	F1AE0481B	01/03 ⇨ 05/06
DAILY III 35 S 13, 40 C 13, 50 C 13	8140.43S	05/99 ⇨ 05/06
DAILY III 40 C 15, 50 C 15	8140.43N	05/99 ⇨ 05/06
DAILY 2.3	F1AE0481A	07/99 ⇨ 12/06
DAILY 2.8	8140.43B, 8140.43N	07/99 ⇨ 12/06

PEUGEOT

BOXER I 2.8 HDi	8140.43N, 8140.43S(F28DTCR)	10/00 ⇨
BOXER I 2.8 HDi 4x4	8140.43S(F28DTCR), S9W206	10/00 ⇨
BOXER I 2.8 HDi Trazione integrale	8140.43S(F28DTCR)	10/00 ⇨ 11/01

RENAULT

MASCOTT 110	S9W206	01/99 ⇨ 06/05
MASCOTT 150	S9W212	01/99 ⇨ 06/04
MASTER PRO 2.8 dCi	S9W206, 8140.43.B.3586	06/05 ⇨ 04/10

RENAULT TRUCKS

MASCOTT 110	8140.43.B.3586, 8140.43.B.3586	01/99 ⇨ 06/04
MASCOTT 110.35	8140.43.B.3586, 8140.43.B.3586	01/99 ⇨ 06/04
MASCOTT 110.50	8140.43.B.3586, 8140.43.B.3586	01/99 ⇨ 06/04
MASCOTT 110.55	8140.43.B.3586, 8140.43.S.2585	01/99 ⇨ 06/04
MASCOTT 130	8140.43.S.2585, 8140.43.S.2585	01/99 ⇨ 06/04
MASCOTT 130.35	8140.43.S.2585, 8140.43.S.2585	01/99 ⇨ 06/04
MASCOTT 130.55	8140.43.S.2585, AMK	01/99 ⇨ 06/04
MASCOTT 140	814043K2585	01/01 ⇨ 06/04
MASCOTT 140.35	814043K2585	01/01 ⇨ 06/04
MASCOTT 140.55	814043K2585	01/01 ⇨ 06/04
MASCOTT 150.35	8140.43N.3585	10/01 ⇨ 06/04
MASCOTT 150.55	8140.43N.3585	10/01 ⇨ 06/04
MASCOTT 150.65	8140.43N.3585	10/01 ⇨ 06/04

10.3111



3

ABSOLUTE PRESSURE SENSORS (MAP)

Adatt./Suitable:

DENSO
100798-5870

VOLVO
862746-6



kPa	mV	
10 - 139	890 - 4750	

VOLVO

S40 I 1.8	B4184S9	03/99 ⇨ 12/03
S40 I 1.8 16V	B4184S10	08/00 ⇨
V40 I 1.8	B4184S9	03/99 ⇨ 06/04
V40 I 1.8 16V	B4184S10	08/00 ⇨

10.3112



3,5

ABSOLUTE PRESSURE SENSORS (MAP)

Adatt./Suitable:

AUDI

038 906 051 D

BENTLEY

038 906 051 D

BOSCH

0 261 230 073

0 261 230 074

SEAT

038 906 051 D

SKODA

038 906 051 D

VW

038 906 051 D

MARKET DIFFUSION: MEDIUM



kPa	mV	
11 - 254	250 - 4750	

AUDI

A3 I S3 quattro	AMK, BYT	10/01 → 05/03
A3 II 1.8 TFSI	BYT, AXX	11/06 → 05/13
A3 II 1.8 TFSI quattro	CDA	07/08 → 08/12
A3 II 2.0 TFSI	AXX, AXX	09/04 → 05/13
A3 II 2.0 TFSI quattro	AXX, BYT	09/04 → 08/12
A3 II SPORTBACK 1.8 TFSI	BYT, AXX	11/06 → 03/13
A3 II SPORTBACK 1.8 TFSI quattro	CDA	07/08 → 03/13
A3 II SPORTBACK 2.0 TFSI	AXX, AXX	09/04 → 03/13
A3 II SPORTBACK 2.0 TFSI quattro	AXX, BWE	09/04 → 03/13
A4 II 1.8 T	BFB	07/02 → 03/09
A4 II 1.8 T quattro	BFB	05/03 → 03/09
A4 II 2.0 TFSI 16V	BWE, BGB	01/06 → 03/09
A4 II 2.0 TFSI quattro	BWT	11/05 → 03/09
A4 III 1.8 T	BFB	11/04 → 06/08
A4 III 1.8 T quattro	BFB	11/04 → 06/08
A4 III 2.0 TFSI	BGB, BGB	11/04 → 06/08
A4 III 2.0 TFSI quattro	BGB, CAEB	11/04 → 06/08
A4 IV 2.0 TFSI	CAEB, BPJ	06/08 → 12/15
A4 IV 2.0 TFSI quattro	CDNC	06/08 → 12/15
A6 III 2.0 TFSI	BPJ, CCZC	06/05 → 08/11
Q3 2.0 TFSI	CCTA	10/13 →
Q3 2.0 TFSI [ExtraEU]	CCTA	09/14 → 10/18
Q3 2.0 TFSI quattro	CCZC, AJQ	06/11 → 10/18
TT I 1.8 T	AJQ, AJQ	01/01 → 06/06
TT I 1.8 T quattro	AJQ, BWA	02/00 → 06/06
TT II 1.8 TFSI	CDA	06/08 → 06/14
TT II 2.0 TFSI	BWA, BWA	08/06 → 06/10
TT II 2.0 TFSI quattro	BWA, BEB	06/08 → 06/10

BENTLEY

CONTINENTAL 6.0	BEB, BEB	06/03 →
CONTINENTAL 6.0 AWD	BEB, CKHB	06/06 →
CONTINENTAL 6.0 FLEX	CKHB, CKHA	11/10 →
CONTINENTAL 6.0 FLEX AWD	CKHA, BWRB	03/10 →
CONTINENTAL 6.0 FlexFuel	CKHC	01/10 → 07/10
CONTINENTAL 6.0 Flexfuel [ExtraEU]	BWRB, BWRA	02/08 →
CONTINENTAL 6.0 ISR/ISR Flexfuel	CKHE	03/11 → 06/14
CONTINENTAL 6.0 Speed [ExtraEU]	DBDD	11/17 → 07/18
CONTINENTAL 6.0 Super-sports AWD	DJLA	09/17 → 05/18
CONTINENTAL 6.0 Trazione integrale	BWRA, BWR	08/07 → 04/11
CONTINENTAL FLYING SPUR 6.0	BWR, BEB	03/05 →
CONTINENTAL FLYING SPUR 6.0 FLEX	BEB, BYT	03/05 →

SEAT

ALHAMBRA III 1.8 TSI	CDA	11/12 →
ALHAMBRA III 2.0 TSI	CCZA	11/10 →
ALTEA 1.8 TFSI	BYT, BYT	01/07 →
ALTEA 2.0 TFSI	BWA	04/06 → 05/09
ALTEA 2.0 TFSI [ExtraEU]	CCZB	05/09 →
ALTEA XL 1.8 TFSI	BYT, BWA	01/07 →
ALTEA XL 2.0 TFSI	BWA	10/06 → 05/09
ALTEA XL 2.0 TFSI 4x4	BWA, AMK	06/07 →
EXEO 1.8 T	CFMA	12/08 → 05/10
EXEO 2.0 TFSI	BWE	03/09 →
LEON I 1.8 T Cupra R	AMK, BZB	02/02 → 06/06
LEON I 1.8 Turbo 4x4	AMK	05/02 → 05/03
LEON II 1.8 TSI	BZB, BWA	06/07 → 12/12
LEON II 2.0 TFSI	BWA, BYT	05/05 → 12/12
TOLEDO III 1.8 TFSI	BYT, BYJ	01/07 → 05/09
TOLEDO III 2.0 TFSI	BWA	11/05 → 05/09

SKODA

OCTAVIA II 1.8 [CHN]	BYJ, BZB	04/07 →
OCTAVIA II 1.8 TSI	BZB, CDA	06/07 → 06/13
OCTAVIA II 1.8 TSI 4x4	CDA, BWA	11/08 → 02/13
OCTAVIA II 2.0 [CHN]	CGMA	07/10 →
OCTAVIA II 2.0 4x4	CCZA	11/08 →
OCTAVIA II 2.0 RS	BWA, BZB	10/05 → 02/13
SUPERB I 1.8 T	AWT	12/01 → 03/08
SUPERB II 1.8 [CHN]	CEAA	04/09 →
SUPERB II 1.8 TSI	BZB, CDA	03/08 → 05/15
SUPERB II 1.8 TSI 4x4	CDA, CDA	11/08 → 05/15
SUPERB II 2.0 [CHN]	CGMA	04/09 →
SUPERB II 2.0 TSI	CCZA	05/10 → 05/15
YETI 1.8	CDAB	02/11 →
YETI 1.8 TSI 4x4	CDA, CBFA	05/09 → 12/17

VW

BEETLE 2.0 TSI	CBFA, CDA	04/11 → 07/16
CC 1.8 TSI	CDA, CBFA	11/11 → 12/16
CC 2.0 TSI	CBFA, BPY	11/11 →
EOS 2.0 TFSI	BPY, BLS	03/06 → 08/15
EOS 2.0 TSI	CCZB	11/09 → 08/15
GOLF V 1.9 TDI	BLS, BWA	06/07 → 07/09
GOLF V 1.9 TDI 4motion	BLS	01/08 → 07/09
GOLF V 2.0 GTI	BWA, AXX	06/07 → 07/09
GOLF VI 1.8 TSI	AXX, CBFA	10/04 → 02/09
GOLF VI 2.0 GTi	CDA	06/09 → 01/11
GOLF VI 2.0 TFSI	CBFA, CBFA	04/09 → 05/16
GOLF VI 2.0 TFSI Gti	CBFA, BPY	05/11 →
GOLF VI 2.0 TSI	CCZA	07/09 → 07/13
GOLF 2.0 GTi	CCZB	02/09 → 11/12
JETTA V 2.0 TFSI	BPY, CBFA	10/05 → 10/10
JETTA VI 2.0 TSI	CBFA, BZB	12/10 →
PASSAT IV 1.8 [CHN]	CEA	08/07 →
PASSAT IV 1.8 4motion	AWM	03/01 → 05/05
PASSAT IV 1.8 T	AWM	02/01 → 08/05
PASSAT IV 1.8 T 20V	AWT	11/00 → 05/05
PASSAT IV 1.8 T 4motion	AWM	03/01 → 05/05
PASSAT V 1.8 TSI	BZB, AXX	05/07 → 12/14
PASSAT V 2.0 FSI	AXX, CAWB	07/05 → 11/10
PASSAT V 2.0 TSI	CCZB	11/10 → 12/15
PASSAT V 2.0 TSI 4motion	CCZB	01/12 → 12/14
PASSAT CC 1.8 TSI	BZB, CAWB	06/08 → 01/12
PASSAT CC 2.0 TSI	CAWB, BZB	06/08 → 01/12
PASSAT 1.8 TFSI	CDA	08/10 → 12/14
PASSAT 2.0 TFSI	CCZB	11/10 → 12/14
SCIROCCO III 2.0 TSI	CAWB, CAWA	05/08 → 11/17
SCIROCCO 2.0 TFSI	CCZB	11/09 → 05/14
SHARAN II 1.8 TSI	CDA	11/11 →
SHARAN II 2.0 TSI	CCZA	12/10 →
TIGUAN I 1.8 [CHN]	CEAA	12/09 →
TIGUAN I 2.0 [CHN]	CGMA	12/09 →
TIGUAN I 2.0 TFSI	CCTB	05/08 →
TIGUAN I 2.0 TFSI 4motion	CAWA, CCZB	09/07 →
TIGUAN I 2.0 TSI 4motion	CCZB, BPL	05/11 →
TOURAN I 1.8 [CHN]	BPL., 8HT(DV4TD)	02/08 →

10.3113



3

ABSOLUTE PRESSURE SENSORS (MAP)

Adatt./Suitable:

CITROËN

1920 GH

96 427 899 80

DENSO

079800-7050

079800-7510

FIAT

9642789980

FORD

1 333 353

256Q-12T551-AA

LANCIA

9642789980

MAZDA

Y404-18-211

PEUGEOT

1920 GH

TOYOTA

SU001-00645

MARKET DIFFUSION: HIGH



kPa	mV	
10 - 252	942 - 4750	

CITROËN

C1 I 1.4 HDi	8HT(DV4TD), 8HX(DV4TD)	06/05 → 09/14
C2 1.4 HDi	8HX(DV4TD), 8HX(DV4TD)	09/03 →
C3 I 1.4 HDi	8HX(DV4TD), 8HX(DV4TD)	02/02 →
C3 I PLURIEL 1.4 HDi	8HX(DV4TD), 8HZ(DV4TD)	04/04 →
C3 II 1.4 HDi 70	8HZ(DV4TD), DW10	11/09 →
C5 I 2.0 HDi	DW10, 4HX(DW12TED4/FAP)	03/01 → 08/04
C5 I 2.2 HDi	4HX(DW12TED4/FAP), DW10ATED4	03/01 →
C8 2.0 HDi	DW10ATED4, 4HW(DW12TED4)	07/02 →
C8 2.2 HDi	4HW(DW12TED4), DW10ATED	07/02 →
JUMPY I 2.0 HDi 110	DW10ATED, DW10ATED4	03/00 → 10/06
JUMPY I 2.0 HDi 110 16V	DW10ATED4, DW10BTED	12/03 → 10/06
JUMPY I 2.0 HDi 95	DW10BTED, 8HS(DV4TED)	10/99 → 10/06
NEMO 1.4 HDi	8HS(DV4TED), RHX	02/08 →

FIAT

SCUDO I 2.0 JTD	RHX, RHM	12/02 → 12/06
SCUDO I 2.0 JTD 16V	RHM, RHM	05/99 → 12/06
ULYSSE II 2.0 JTD	RHM, F6JA	08/02 → 08/06
ULYSSE II 2.2 JTD	4HW(DW12ATED4)	08/02 → 08/06

FORD

FIESTA V 1.4 TDCi	F6JA, HHJA	11/01 → 12/10
FIESTA V 1.6 TDCi	HHJA, F6JB	11/04 → 06/08
FIESTA VI 1.4 TDCi	F6JB, F6JA	01/09 →
FUSION 1.4 TDCi	F6JA, RHM	08/02 → 12/12

LANCIA

PHEDRA 2.0 JTD	RHM, 4HP	07/03 → 11/10
PHEDRA 2.2 JTD	4HP, 8HX(DV4TD)	09/02 → 11/10

MAZDA

2 II 1.4 MZR-CD	Y404	01/08 → 06/15
-----------------	------	---------------

PEUGEOT

107 1.4 HDi	8HT(DV4TD), 8HX(DV4TD)	06/05 → 05/14
206 1.4 HDi	8HX(DV4TD), 8HX(DV4TD)	09/01 →
206 1.4 HDi eco 70	8HX(DV4TD), 8HX(DV4TD)	09/01 →
206+ 1.4 HDi eco 70	8HX(DV4TD), 8HZ(DV4TD)	01/09 →
207 1.4 HDi	8HZ(DV4TD), DW10ATED	02/06 →
406 2.0 HDi 110	DW10ATED, DW10ATED	08/01 → 10/04
406 2.2 HDi	DW12TED4	03/00 → 12/04
607 2.0 HDi	DW10ATED, 4HX(DW12TED4/FAP)	05/00 → 09/05
607 2.0 HDi 110 FAP	RHS(DW10ATED)	12/04 →
607 2.2 HDi	4HX(DW12TED4/FAP), DW10ATED4	02/00 → 02/06
807 2.0 HDi	DW10ATED4, 4HX(DW12TED4/FAP)	06/02 →
807 2.2 HDi	4HX(DW12TED4/FAP), 8HS(DV4TED)	06/02 →
1007 1.4 HDi	8HX(DV4TD), 8HT(DV4TD)	04/05 →
BIPPER 1.4 HDi	8HS(DV4TED), 8HS(DV4TED)	02/08 →
BIPPER TEEPEE 1.4 HDi	8HS(DV4TED), DW10ATED4	04/08 →

PEUGEOT		
EXPERT I 2.0 HDI	DW10ATED4, DW10ATED4	07/00 ⇒ 12/06
EXPERT I 2.0 HDI 16V	DW10ATED4, X20DTH	07/00 ⇒ 12/06
TOYOTA		
AYGO I 1.4 HDi	2WZ-TV	07/05 ⇒ 08/10

10.3114



ABSOLUTE PRESSURE SENSORS (MAP)

Adatt./Suitable:

- BOSCH**
0 281 002 438
- GENERAL MOTORS**
24 420 761
- OPEL**
24420761
8 51 365
- VAUXHALL**
24420761



kPa	mV	
12 - 308	250 - 4750	

OPEL		
ASTRA G 2.0 DTI	Y20DTH	09/00 ⇒ 04/05
ASTRA G 2.0 DTI 16V	X20DTH, X20DTH	08/99 ⇒ 01/05
VECTRA B 2.0 DTI 16V	X20DTH, Y22DTR	06/97 ⇒ 07/03
VECTRA B 2.2 DTI 16V	Y22DTR, X20DTH	09/00 ⇒ 07/03
ZAFIRA A 2.0 DTI 16V	Y20DTH	09/00 ⇒ 06/05
VAUXHALL		
ASTRA IV 2.0 DTI 16V	Y20DTH	02/98 ⇒ 05/05
ASTRAVAN II 2.0 DTI	Y20DTH	04/04 ⇒ 08/06
VECTRA B 2.0 DTI 16V	X20DTH, M47D20(204D4)	08/95 ⇒ 10/01
VECTRA B 2.2 DTI 16V	Y22DTR	08/95 ⇒ 10/01
ZAFIRA A 2.0 DTI 16V	Y20DTH	04/99 ⇒ 08/05

10.3115



ABSOLUTE PRESSURE SENSORS (MAP)

Adatt./Suitable:

- BMW**
13 32 7 785 354
- BOSCH**
0 261 230 046
- GENERAL MOTORS**
93 171 659
- LAND ROVER**
WKW000060
- OPEL**
62 38 222



kPa	mV	
24 - 400	250 - 4536	

BMW		
3 IV 330 d	M57D30(306D1)	10/99 ⇒ 02/05
3 IV 330 xd	M57D30(306D1)	01/00 ⇒ 03/03
X5 I 3.0 d	M57D30(306D1)	05/01 ⇒ 12/03
OPEL		
OMEGA B 2.5 DTI	Y25DT	09/01 ⇒ 07/03
VAUXHALL		
OMEGA B 2.5 DTI 24V	Y25DT	09/01 ⇒ 07/03

10.3116



ABSOLUTE PRESSURE SENSORS (MAP)

Adatt./Suitable:

- BMW**
13 61 7 787 142
7 787 142

MARKET DIFFUSION: MEDIUM



kPa	mV	
35 - 314	250 - 4750	

BMW		
1 I 118 d	M47D20(204D4), M47D20(204D4)	11/03 ⇒ 02/07
1 I 120 d	M47D20(204D4), M47D20(204D4)	03/03 ⇒ 12/11
3 IV 318 d	M47D20(204D4), M47D20(204D4)	03/03 ⇒ 02/05
3 IV 318 td	M47D20(204D4), M47D20(204D4)	03/03 ⇒ 02/05
3 IV 320 Cd	M47D20(204D4), M47D20(204D4)	11/03 ⇒ 12/07
3 IV 320 d	M47D20(204D4), M47D20(204D4)	09/01 ⇒ 02/05
3 IV 320 td	M47D20(204D4), M57D30(306D2)	09/01 ⇒ 02/05

BMW		
3 IV 330 Cd	M57D30(306D2), M57D30(306D2)	03/03 ⇒ 12/07
3 IV 330 d	M57D30(306D2), M57D30(306D2)	03/03 ⇒ 02/05
3 IV 330 xd	M57D30(306D2), M47D20(204D4)	08/02 ⇒ 05/05
3 V 318 d	M47D20(204D4), M47D20(204D4)	03/05 ⇒ 08/07
3 V 320 d	M47D20(204D4), M47D20(204D4)	12/04 ⇒ 06/12
5 V 520 d	M47D20(204D4), M57D30(306D2)	02/05 ⇒ 02/08
5 V 530 d	M57D30(306D2), M57D30(306D2)	09/02 ⇒ 12/09
7 IV 730 d	M57D30(306D2), M67D39(398D1)	06/02 ⇒ 07/08
7 IV 740 d	M67D39(398D1), M47D20(204D4)	10/02 ⇒ 02/05
X3 I 2.0 d	M47D20(204D4), M57D30(306D2)	11/03 ⇒ 08/07
X5 I 3.0 d	M57D30(306D2), M47D20(204D1)	09/03 ⇒ 12/06

10.3117



ABSOLUTE PRESSURE SENSORS (MAP)

Adatt./Suitable:

- BMW**
13 62 2 246 977
2 246 977
- GENERAL MOTORS**
93 171 579
- LAND ROVER**
MHK101060L
- MG**
MHK101060
- OPEL**
58 50 801
- ROVER**
MHK101060



kPa	mV	
26 - 250	270 - 4750	

BMW		
3 IV 318 d	M47D20(204D1), M47D20(204D1)	09/01 ⇒ 03/03
3 IV 320 d	M47D20(204D1), M57D30(306D1)	02/98 ⇒ 09/01
3 IV 330 d	M57D30(306D1), M57D30(306D1)	10/99 ⇒ 02/05
3 IV 330 xd	M57D30(306D1), M47D20(204D1)	01/00 ⇒ 03/03
5 IV 520 d	M47D20(204D1), M57D25(256D1)	02/00 ⇒ 09/03
5 IV 525 d	M57D25(256D1), M57D30(306D1)	02/00 ⇒ 05/04
5 IV 530 d	M57D30(306D1), M57D30(306D1)	08/98 ⇒ 05/04
5 V 525 d	M57D25(256D1)	12/04 ⇒ 03/10
7 III 730 d	M57D30(306D1), M57D30(306D1)	04/00 ⇒ 11/01
7 III 740 d	M67D39(398D1)	05/99 ⇒ 11/01
X5 I 3.0 d	M57D30(306D1), 204D3	05/01 ⇒ 12/03

LAND ROVER		
FREELANDER 2.0 Td4 4x4	204D3, 306D1	10/00 ⇒ 10/06
FREELANDER 2.5 V6 4x4	25K4F	11/00 ⇒ 10/06
RANGE ROVER III 3.0 D 4x4	306D1, 204D2	03/02 ⇒ 08/12
MG		
MG ZT 2.0 CDTi	204D2, 204D2	06/02 ⇒ 07/05
MG ZT-T 2.0 CDTi	204D2, 204D2	06/02 ⇒ 07/05
OPEL		
OMEGA B 2.5 DTI	Y25DT	09/01 ⇒ 07/03
ROVER		
75 2.0 CDT	204D2, G6DA	02/99 ⇒ 05/05
75 2.0 CDTi	204D2	02/03 ⇒ 05/05
VAUXHALL		
OMEGA B 2.5 DTI 24V	Y25DT	09/01 ⇒ 07/03

10.3118



3,5

ABSOLUTE PRESSURE SENSORS (MAP)

Adatt./Suitable:

HYUNDAI

39300-38100
39300-38200

KIA

39300-38100
39300-38200

kPa	mV	
10 - 120,8	362,9 - 4750	

HYUNDAI

AZERA 3.3 [ExtraEU]	G6DB	02/07 → 12/11
EQUUS / CENTENNIAL I 3.5	G6CU	10/99 → 03/09
EQUUS / CENTENNIAL II 3.8	G6DA	03/09 →
GENESIS 3.8 V6	G6DA, G6DB	01/08 → 12/14
GRANDEUR 2.7	G6BA	05/06 → 10/10
GRANDEUR 3.3	G6DB, G4CS	04/05 → 12/11
H-1 I 2.4	G4CS, G4CS	03/00 → 04/04
H-1 I 2.4 4WD	G4CS, G6DA	06/01 → 04/04
H1 2.4 [ExtraEU]	G4JS	11/01 → 08/07
H200 2.4	G4CS	09/00 → 10/06
IX55 3.8 V6	G6DA	01/11 →
IX55 3.8 V6 4WD	G6DA, G4JS	01/07 →
SANTA FE I 2.4 16V	G4JS, G4JS	02/01 → 03/06
SANTA FE I 2.4 16V 4x4	G4JS, G6BA	02/01 → 03/06
SANTA FE I 2.7	G6EA	10/05 → 03/06
SANTA FE I 2.7 4x4	G6EA	10/05 → 03/06
SANTA FE I 3.5	G6CU	09/03 → 02/06
SANTA FE I 3.5 4x4	G6CU	09/03 → 02/06
SANTA FE II 2.7	G6BA	03/06 → 12/12
SANTA FE II 2.7 4x4	G6BA, G6DB	03/06 → 12/12
SANTA FE II 2.7 V6 GLS	G6EA	03/06 → 12/09
SANTA FE II 2.7 V6 GLS 4x4	G6EA	03/06 → 12/09
SANTA FE II 3.3	G6DB	07/07 → 11/08
SANTA FE II 3.3 Dynamic 4x4	G6DB	03/06 → 12/12
SONATA IV 2.4 16V	G4BS	03/98 → 10/01
SONATA V 3.3	G6DB, G6CT	01/05 → 12/10
SONICA 3.3 CVT	G6DB	03/09 → 12/10
TERRACAN 3.5 i V6 4WD	G6CU	12/01 → 12/06
VERACRUZ 3.8 [ExtraEU]	G6DA	01/08 → 11/12
XG 3.0	G6CT	10/01 → 05/05
XG 30	G6CT, G6BA	12/98 → 12/05
XG 300	G6CT	09/00 → 12/01
XG 350	G6CU	10/02 → 12/05
XG-SERIES 3.0	G6CT	09/99 → 09/03

KIA

AMANTI 3.5 [CAN] [USA]	--	09/03 →
CARNIVAL II 2.7 V6	G6EA	06/06 →
MAGENTIS I 2.4 [USA]	--	01/01 → 12/04
MAGENTIS I 2.7 V6	G6BA	04/04 →
MAGENTIS II 2.7	G6BA, 312A1.000	11/05 →
MAGENTIS II 2.7 V6	G6EA	07/09 →
OPIRUS 3.0	--	05/04 → 08/06
OPIRUS 3.0 GH300	G6CT	09/03 →
OPIRUS 3.5	G6CU	09/03 →
OPIRUS 3.8 V6	G6DA	10/06 →
QUORIS 3.8	G6DK	01/13 →
QUORIS 3.8 [ExtraEU]	G6DK	03/17 →
SORENTO I 2.4	G4JS	08/02 →
SORENTO I 3.3 V6	--	12/06 →
SORENTO I 3.3 V6 4WD	G6DB	02/07 →
SORENTO I 3.5 V6 4WD	G6CU	08/02 →

10.3121



3

ABSOLUTE PRESSURE SENSORS (MAP)

Adatt./Suitable:

ABARTH

55209194
55219295

ALFA ROMEO

55209194
55219295

BOSCH

0 281 002 566
0 281 002 931
0 281 002 996
0 281 002 997

CHRYSLER

55219295

DACIA

22 36 500 01R
82 00 168 253

FIAT

55209194
55219295

GENERAL MOTORS

55 219 295
93 198 753
93 857 938

JEEP

55219295
K68137978AA

LANCIA

55209194
55219295

MERCEDES-BENZ

A 281 905 00 00

NISSAN

22365-0001R
22365-BC400
25085-00Q0A
25085-00Q0C
25085-AW300

OPEL

12 35 128
44 17 030
44 51 799
93198753
93857938

RENAULT

22 36 500 01R
82 00 168 253
H82 00 843 680

SMART

A 281 905 00 00

SUZUKI

18590-84A50
18590-84A50-000
18590-84A51
18590-84A51-000

VAUXHALL

93198753
93857938

MARKET DIFFUSION: HIGH



kPa	mV	
11 - 306	250 - 4750	

ABARTH

500 1.4	312A1.000, 312A1.000	08/08 →
500 MY12 1.4	--	01/12 →
500C / 595C 1.4	312A1.000, 199A8.000	05/08 →
GRANDE PUNTO 1.4	199A8.000, 199A8.000	12/07 → 12/12
PUNTO 1.4	199A8.000, 198A4.000	03/12 →
PUNTO EVO 1.4	955A8.000	10/09 → 02/12

ALFA ROMEO

159 1.8 MPI	939A4.000	06/05 → 11/11
159 1.8 Tbi	939B1.000	05/09 → 12/12
4C 1.8	960A1.000	10/14 →
GIULIETTA II 1.4 TB	198A4.000, 940A1.000	04/10 →
GIULIETTA II 1.8	940A1.000	04/11 → 02/16
GIULIETTA II 1.8 Tbi	940A1.000, H5F402	04/10 →
MITO 1.4 TB	955B1.000	12/13 →
SPIDER III 1.8 Tbi	939B1.000	05/09 → 03/11
STELVIO 2.9 Q4	670050436	11/17 →

CHRYSLER

DELTA 1.4	198A4.000	08/11 →
DELTA 1.4 16V	198A7.000	08/11 →
YPSILON 0.9 Twinair	312A2.000	05/11 →

DACIA

DOKKER 1.2 TCe	H5F402, --	11/12 →
DOKKER 1.2 TCe 115	--, K9K830	12/12 →

DACIA

DOKKER 1.5 dCi	K9K830, H5F404	11/12 →
DOKKER 1.5 dCi [ExtraEU]	K9K830	11/12 →
DUSTER 1.2 TCe 125	H5F404, K9K612	01/12 →
DUSTER 1.2 TCe 125 4x4	H5F404	10/13 →
DUSTER 1.5 dCi	K9K612, K9K658	04/10 →
DUSTER 1.5 dCi 4x4	K9K658, H5F402	06/10 →
LODGY 1.2 TCe	H5F402, --	03/12 →
LODGY 1.5 dCi	--, K9K830	03/12 →
LODGY 1.5 dCi [ExtraEU]	K9K830	11/12 →
LOGAN I 1.5 dCi	K9K892	05/10 →
LOGAN II 1.5 dCi	K9K830, H4B400	10/12 →
LOGAN II TCe 90	H4B400, K9K626	10/12 →
LOGAN II TCe 90 LPG	H4B410	09/15 →
LOGAN II MCV 1.5 dCi	K9K830	02/13 →
LOGAN II MCV TCe 90	H4B400, H4B405	02/13 →
LOGAN II MCV TCe 90 LPG	H4B405, H4B400	09/15 →
SANDERO I 1.5 dCi	K9K892	05/10 →
SANDERO II 1.5 dCi	K9K626, --	10/12 →
SANDERO II TCe 90	--, 199B6.000	10/12 →
SANDERO II TCe 90 LPG	H4B410	09/15 →

FIAT

500 0.9	199B6.000, 199B6.000	07/10 →
500 C 0.9	199B6.000, 199B6000CNG	09/09 →
500 MY12 0.9	--	01/12 →
500 MY15 0.9	--	01/15 →
500L 0.9 Natural Power	199B6000CNG, 843A1.000	03/13 →
500L 1.4	843A1.000, 198A4.000	09/12 →
500L 1.4 [CAN]	--	01/13 →
500L 1.4 LPG	940B7.000	02/14 →
500X 1.4 LPG	55277701	03/17 →
DOBLO II 1.4	198A4.000	10/11 →
DOBLO II 1.4 Natural Power	198A4.000, 312A2.000	02/10 →
DOBLO II 1.6 D Multijet	940C1.000	02/16 →
PANDA III 0.9	312A2.000, 312A2.000	02/12 →
PANDA III 0.9 4x4	312A2.000, 312A2.000	09/12 →
PANDA III 0.9 Natural Power	312A2.000, 312A2.000	07/12 →
PUNTO III EVO 1.4	350A1.000	03/09 →
PUNTO III EVO 1.4 16V	955A2.000	10/09 → 02/12
PUNTO III EVO 1.4 Natural Power	350A1.000	10/09 → 02/12
PUNTO III 0.9 Twinair Turbo	312A2.000	03/12 →
TIPO II 1.4	940B7.000	03/16 →
TIPO II 1.4 LPG	940B7.000	05/16 →

JEEP

COMPASS 1.4 MultiAir	EAQ(55263624)	03/17 →
COMPASS 1.4 MultiAir Trazione integrale	EAQ(55263623)	03/17 →

LANCIA

DELTA III 1.8	939B1.000	01/09 → 08/14
YPSILON II 0.9 CNG	312A2.000, 312A2.000	05/11 →
YPSILON II 0.9 TwinAir	312A2.000, K9K	05/11 →

MERCEDES-BENZ

CITAN 112	M200.711	06/13 →
-----------	----------	---------

NISSAN

CUBE 1.5 dCi	K9K, G9U650	03/10 →
INTERSTAR dCi 100	G9U650, G9U650	11/03 →
INTERSTAR dCi 120	G9U650, K9K410	04/02 →
INTERSTAR dCi 150	G9U632	08/06 →
JUKE 1.2 DIG-T	HRA2DDT	05/14 →
JUKE 1.5 dCi	K9K410, K9K276	06/10 →
MICRA III 1.5 dCi	K9K276, K9K276	06/05 → 06/10
MICRA V 0.9 IG-T	HR09DET	12/16 →
NOTE I 1.5 dCi	K9K276, K9K	03/06 → 06/12
NV200 / EVALIA 1.5 dci	K9K, K9K	07/10 →
NV200 1.5 dci	K9K, M9R630	02/10 →
PRIMASTAR 2.0 dCi 115	M9R630, M9R630	09/06 →
PRIMASTAR 2.0 dCi 90	M9R630, G9U630	09/06 →
PRIMASTAR 2.5 dCi 115	G9U630, G9U630	09/08 →
PRIMASTAR 2.5 dCi 140	G9U730	07/02 →
PRIMASTAR 2.5 dCi 150	G9U630, G9U630	04/06 →
PRIMASTAR dCi 115	G9U630, M9R630	09/08 →
PRIMASTAR dCi 120	M9R630, G9U630	09/06 →
PRIMASTAR dCi 140	G9U730	07/03 →
PRIMASTAR dCi 150	G9U630, M9R630	09/06 →
PRIMASTAR dCi 90	M9R630, F9Q	09/06 →
PRIMERA III 1.9 dCi	F9Q, K9K	08/02 →
PULSAR 1.2 DIG-T	HRA2DDT	10/14 →
QASHQAI 1.5 dCi	K9K, K9K	08/08 → 11/13
QASHQAI I 1.5 dCi	K9K, H5FT	02/07 → 12/13
QASHQAI II 1.2 DIG-T	H5FT, K9K	11/13 →
TIIDA 1.5 dCi	K9K, G9U632	01/07 → 06/13

OPEL

MOVANO A 2.5 CDTI	G9U632, M9R630	10/03 →
VIVARO A 2.0 CDTI	M9R630, G9M86	01/06 →
VIVARO A 2.5 CDTI	G9M86, H4B400	08/06 →

RENAULT

AVANTIME 2.2 dCi	G9T712	05/02 → 05/03
------------------	--------	---------------

RENAULT		
CAPTUR 0.9 TCe 90	H4B400, H5F403	06/13 →
CAPTUR 1.2 T	H5F403	06/13 →
CAPTUR 1.2 TCe 120	H5F403, K9K608	06/13 →
CAPTUR 1.5 dCi	K9K830	06/13 →
CAPTUR 1.5 dCi 90	K9K608, K9K764	06/13 →
CLIO 1.5 dCi	K9K830	11/12 →
CLIO III 1.2	D4F784	11/07 → 12/11
CLIO III 1.2 16V	D4F784	05/07 →
CLIO III 1.5 dCi	K9K764, H4B400	06/05 →
CLIO IV 0.9 TCe 75	H4B408	10/18 →
CLIO IV 0.9 TCe 90	H4B400, H5F403	11/12 →
CLIO IV 0.9 TCe 90 LPG	H4B410	08/15 →
CLIO IV 1.2 TCe 120	H5F403, K9K830	03/13 →
CLIO IV 1.5 dCi	K9K830, M5M400	11/12 →
CLIO IV 1.6 RS	M5M400, K9K612	03/13 →
DOKKER 1.5 dCi	K9K612, F9Q680	12/13 →
DUSTER 1.5 dCi [ExtraEU]	K9K898	09/13 →
DUSTER 1.5 dCi 4x4	K9K884	06/11 →
ESPACE IV 1.9 dCi	F9Q680, G9T645	11/02 →
ESPACE IV 2.2 dCi	G9T645, K9K656	11/02 →
FLUENCE 1.5 dCi	K9K656, F9Q803	02/10 →
GRAND SCÉNIC II 1.9 dCi	F9Q803, H5F400	04/04 →
GRAND SCÉNIC III 1.2 TCe	H5F400, K9K636	04/12 →
GRAND SCÉNIC III 1.4 16V	H4J700	02/09 →
GRAND SCÉNIC III 1.5 dCi	K9K636, H5F400	02/09 →
GRAND SCÉNIC IV 1.2 TCe 115	H5F408	09/16 →
GRAND SCÉNIC IV 1.2 TCe 130	H5F408	09/16 →
KADJAR 1.2 TCe 130	H5F408	06/15 →
KANGOO II 1.2 TCe 115	H5F400, K9K608	07/13 →
KANGOO II 1.5 dCi	K9K608, K9K636	02/08 →
KANGOO II 1.5 dCi 110	K9K636, K9K802	09/10 →
KANGOO II 1.5 dCi 75	K9K802, K9K800	09/10 →
KANGOO II 1.5 dCi 85	K9K800, K9K608	02/08 →
KANGOO II 1.5 dCi 90	K9K608, F9Q650	06/09 →
KANGOO 1.2 LPG	H5F400	07/13 →
LAGUNA II 1.9 dCi	F9Q650, G9T600	03/01 →
LAGUNA II 2.2 dCi	G9T600, K9K780	03/01 →
LAGUNA III 1.5 dCi	K9K780, K9K782	10/07 →
LATITUDE 1.5 dCi	K9K782, K9K830	07/10 →
LODGY 1.5 dCi [ExtraEU]	K9K830, K9K796	11/14 →
LOGAN 1.5 dCi	K9K796, G9U632	02/08 →
LOGAN/STEPWAY 1.5 dCi	K9K838	12/13 →
MASTER II 2.5 dCi	G9U632, K9K636	08/06 →
MEGANE II 1.5 dCi	K9K724, F9Q800	08/03 → 12/10
MEGANE II 1.9 dCi	F9Q800, H5F400	11/02 →
MEGANE III 1.2 TCe	H5F400, K9K636	03/12 →
MEGANE III 1.4 TCe	H4J700	04/09 →
MEGANE III 1.5 dCi	K9K636, F4R874	11/08 →
MEGANE III 2.0 R.S.	F4R874, F4R870	11/08 →
MEGANE III 2.0 TCe	F4R870, K9K834	11/08 →
MEGANE III 2.0 TCe 220	F4R874	11/13 →
MEGANE 1.5 dCi	K9K636, H5F400	01/09 → 08/15
MEGANE IV 1.2 TCe 100	H5F408	11/15 →
MEGANE IV 1.2 TCe 130	H5F408	11/15 →
MEGANE III HATCHBACK VAN 1.5 dCi	K9K834, K9K752	11/08 → 08/15
MEGANE CC 1.2 TCe	H5F400, K9K636	09/12 →
MEGANE CC 1.4 TCe	H4J700	06/10 →
MEGANE CC 1.5 dCi	K9K636, F4R870	06/10 →
MEGANE CC 2.0 TCe	F4R870, K9K724	06/10 →
MEGANE CC 2.0 Turbo	F4R874	10/11 →
MODUS / GRAND MODUS 1.5 dCi	K9K752, K9K612	12/04 →
MODUS / GRAND MODUS 1.5 dCi 75	K9K770	10/10 →
MODUS / GRAND MODUS 1.5 dCi 90	K9K770	10/10 →
SANDERO I 1.5 dCi	K9K892	05/10 →
SANDERO II 1.5 dCi	K9K612, K9K722	12/13 →
SCÉNIC II 1.5 dCi	K9K722, F9Q804	06/03 →
SCÉNIC II 1.9 D	F9Q812	06/06 →
SCÉNIC II 1.9 dCi	F9Q804, H5F400	06/03 →
SCÉNIC III 1.2 TCe	H5F400, K9K636	04/12 →
SCÉNIC III 1.4 16V	H4J700	02/09 →
SCÉNIC III 1.5 dCi	K9K636, M9R630	02/09 →
SCÉNIC IV 1.2 TCe 115	H5F408	09/16 →
SCÉNIC IV 1.2 TCe 130	H5F408	09/16 →
SCÉNIC 1.5 dCi	K9K734	06/07 → 11/08
THALIA II 0.9 TCe	H4B400	11/12 → 06/14
TRAFIC II 2.0 dCi 115	M9R630, M9R630	08/06 →
TRAFIC II 2.0 dCi 90	M9R630, G9T600	08/06 →
TRAFIC II 2.5 dCi	G9U630	08/07 →
TRAFIC II 2.5 dCi 115	G9U630	02/08 →
TRAFIC II 2.5 dCi 135	G9U730	03/01 →
TRAFIC II 2.5 dCi 145	G9U630	08/06 →
TRAFIC II 2.5 DTi	G9U730	03/03 → 07/03
TWINGO 1.5 dCi	K9K820	10/10 → 09/14
TWINGO II 1.5 dCi 75	K9K820	10/10 →

RENAULT		
TWINGO II 1.5 dCi 90	K9K820	10/10 →
TWINGO III 0.9 TCe 110	H4B401	11/16 →
TWINGO III 0.9 TCe 90	H4B401	09/14 →
VEL SATIS 2.2 dCi	G9T600, G9U632	06/02 →
SMART		
FORFOUR III 0.9	M281.910	11/14 →
FORFOUR III 0.9 Brabus	M281.910	07/16 →
FORTWO III 0.9	M281.910	09/14 →
FORTWO III 0.9 Brabus	M281.910	07/16 →
SUZUKI		
JIMNY III 1.5 DDIS 4x4	K9K266	08/05 →
VAUXHALL		
MOVANO A 2.5 CDTI	G9U632, M9R630	10/01 → 12/10
VIVARO 1.9 DI	F9Q762	04/03 → 07/14
VIVARO 2.0 CDTI	M9R630, G9U630	01/06 → 07/14
VIVARO 2.5 CDTI	G9U630, K9K790	04/03 → 07/14
VIVARO 2.5 DTI	G9U630	07/03 → 07/14

10.3122  **3,5**

ABSOLUTE PRESSURE SENSORS (MAP)

Adatt./Suitable:

- BOSCH**
0 281 002 593
- DACIA**
22 36 572 66R
82 00 225 971
- GENERAL MOTORS**
93 450 122
93 852 290
- NISSAN**
22630-00Q2G
22635-AY902
25085-00QAC
- OPEL**
44 06 441
44 12 919
- RENAULT**
22 36 572 66R
82 00 225 971
82 00 715 610 *W
- SUZUKI**
18590-84A00
18590-84A00-000
18590-84A01
18590-84A01-000

- *W Without connector parts nor air temperature sensor
- Senza pezzi di raccordo e senza sensore temperatura aria
- Sans raccords ni capteur de température d'air
- Ohne Anschlusssteile oder Lufttemperatursensor
- Sin piezas de conexión ni sensor de temperatura de aire

10.4005

MARKET DIFFUSION: **HIGH**



kPa	mV	
12,5 - 255,7	250 - 4750	

DACIA		
DUSTER 1.5 dCi	K9K796	04/10 →
LOGAN I 1.5 dCi	K9K790, K9K790	09/05 →
SANDERO I 1.5 dCi	K9K790, G9U720	06/08 →
NISSAN		
INTERSTAR dCi 100	G9U720, F9Q772	11/03 →
INTERSTAR dCi 80	F9Q772, K9K702	04/02 →
KUBISTAR 1.5 dCi	K9K702, K9K716	08/03 →
KUBISTAR 1.5 dCi 70	K9K700	09/05 → 10/09
KUBISTAR 1.5 dCi 85	K9K276	04/06 → 10/09
KUBISTAR dCi 85	K9K716, K9K276	04/06 → 10/09
MICRA III 1.5 dCi	K9K276, F9Q762	01/03 → 06/10
MICRA IV 1.5 dCi	K9K	05/10 →
PRIMASTAR 1.9 dCi 100	F9Q760	07/02 →
PRIMASTAR 1.9 dCi 80	F9Q762	07/02 →
PRIMASTAR dCi 100	F9Q760	03/01 →
PRIMASTAR dCi 80	F9Q762	03/01 →
OPEL		
MOVANO A 1.9 DTI	F9Q774	10/01 →
VIVARO A 1.9 DI	F9Q762, K9K700	08/01 →
VIVARO A 1.9 DTI	F9Q760	08/01 →
RENAULT		
CLIO II 1.5 dCi	K9K700, K9K752	06/01 →
CLIO III 1.5 dCi	K9K752, K9K700	05/05 →
DUSTER 1.5 dCi [ExtraEU]	K9K796	06/11 →
KANGOO I 1.5 dCi	K9K700, K9K790	12/01 →
LOGAN 1.5 dCi	K9K790, F9Q772	09/05 →
LOGAN EXPRESS 1.5 dCi	K9K792	04/07 →

RENAULT		
MASTER II 1.9 dCi 80	F9Q772, F9Q732	11/01 →
MEGANE I 1.9 dCi	F9Q732, F8Q784	10/00 → 08/03
MEGANE I 1.9 dT	F8Q784	01/96 → 08/03
MEGANE I 1.9 dTi	F8Q784, K9K752	02/01 → 08/03
MODUS / GRAND MODUS 1.5 dCi	K9K752, F9Q732	12/04 →
SANDERO I 1.5 dCi	K9K790	04/07 →
SCÉNIC I 1.9 dCi	F9Q732, F9Q738	09/99 → 08/03
SCÉNIC I 1.9 dCi RX4	F9Q740	11/00 → 08/03
SCÉNIC I 1.9 dTi	F9Q738, K9K700	02/01 → 08/03
THALIA I 1.5 dCi	K9K700, K9K700	01/01 →
THALIA II 1.5 dCi	K9K700, F9Q760	09/08 →
TRAFIC II 1.9 dCi	F9Q760, F9Q760	03/01 →
TRAFIC II 1.9 dCi 100	F9Q760	03/01 →
TRAFIC II 1.9 dCi 80	F9Q760, K9K718	03/01 →
TWINGO II 1.5 dCi	K9K718, K9K	03/07 →

SUZUKI		
JIMNY III 1.5 DDIS 4WD	K9K, K9K	12/03 →
JIMNY III 1.5 DDIS 4x4	K9K, W11B16A	08/05 →
VAUXHALL		
MOVANO A 1.9 DTI	F9Q774	10/01 → 05/10
VIVARO 1.9 DI	F9Q762	08/01 → 07/14
VIVARO 1.9 DTI	F9Q760	08/01 → 12/06

10.3125  **3,5**

ABSOLUTE PRESSURE SENSORS (MAP)

Adatt./Suitable:

- BMW**
0 872 679
- MINI**
12 14 0 872 679
- ROVER**
MHK101040



kPa	mV	
14 - 247	250 - 4750	

MINI		
MINI I Cooper S	W11B16A, --	03/02 → 11/07
MINI I John Cooper Works	W11B16A	07/04 → 11/07
MINI I S Works	W11B16A	11/03 → 06/05
MINI I Works	W11B16A	11/03 → 09/06
ROVER		
75 1.8 Turbo	--, CR12DE	05/03 → 05/05

10.3126



3,5

10.3131



3,5

10.3132



3,5

ABSOLUTE PRESSURE SENSORS (MAP)

Adatt./Suitable:

CONTINENTAL5WK9 6823
A2C90894300**NISSAN**22365-AX000
22365-AX00A**SIEMENS**

5WK9 6819

SSANGYONG

1730940048

MARKET DIFFUSION: MEDIUM



kPa	mV	O + NTC -
10 - 110	349 - 4750	

NISSAN

Model	Code	Year
MICRA III 1.0 16V	CG10DE	01/03 → 06/10
MICRA III 1.2	CR12DE, CG12DE	10/03 → 06/10
MICRA III 1.2 16V	CG12DE, CG12DELPG	01/03 → 06/10
MICRA III 1.2 LPG	CG12DELPG, D4BF	10/02 → 06/10
MICRA III 1.3	CGA3DE	08/04 →
MICRA III 1.4 16V	CR14DE	01/03 → 06/10
MICRA C+C 1.4 16V	CR14DE	08/05 →
NOTE I 1.4	CR14DE	03/06 → 06/12
NOTE I 1.4 LPG	CR14DE	01/06 → 08/13

SSANGYONG

Model	Code	Year
TIVOLI 1.6	G16DF	04/15 →
TIVOLI 1.6 CNG	G16DFCNG	07/18 →
TIVOLI 1.6 GPL	G16DF	04/15 →
TIVOLI 1.6 GPL Trazione integrale	G16DF	03/15 →
TIVOLI 1.6 Trazione integrale	G16DF	03/15 →
XLV 1.6 CNG	G16DFCNG	07/18 →
XLV 1.6 GPL	G16DF	05/16 →
XLV 1.6 GPL Trazione integrale	G16DF	05/16 →
XLV e-XGi 160	G16DF	04/16 →
XLV e-XGi 160 Trazione integrale	G16DF	04/16 →

ABSOLUTE PRESSURE SENSORS (MAP)

Adatt./Suitable:

HYUNDAI39200-27400
39200-42020
39200-42030**KIA**39200-27400
39200-42020
39200-42030

kPa	mV	O + NTC -
12,3 - 254,6	250 - 4750	

HYUNDAI

Model	Code	Year
GENESIS 2.0 CVT	G4KF	06/08 → 02/14
GENESIS 2.0 T	G4KF	01/08 → 12/12
H-1 I 2.5 D	D4BF, D4BH	10/97 → 10/06
H-1 I 2.5 Tci	D4BH, D4BF	05/04 → 12/07
H-1 I 2.5 TD	D4BF, D4BF	06/97 → 08/07
H-1 I 2.5 TD 4WD	D4BF, D4BB	03/01 → 04/04
H100 2.5 CRDi	D4CB	01/04 →
H100 2.5 D	D4BF	05/96 → 12/97
H100 2.5 TCI	--	01/04 →
H100 2.5 TD	4D56T	07/93 →
H100 2.5 TDCi	D4BH	08/03 → 10/06
H100 2.5 TDiC	D4BF	06/98 → 10/03
H100 2.6 TD [ExtraEU]	D4BB, D4BH	04/96 → 12/98
H200 2.5 TD	D4BF	10/97 → 07/01
H200 2.5 TDCi	D4BH, D4BH	06/00 → 10/05
IX35 Fuel Cell	--	09/14 →
LIBERO 2.5 TCI	D4BH	07/00 →
MATRIX 1.5 CRDi	D4FA	12/04 → 08/10
MATRIX 1.5 CRDi VGT	D4FA	08/05 → 08/10
PORTER I 2.5 TD	D4BH	07/94 → 04/04
PORTER II 2.5 CRDi	D4CB	05/04 →
PORTER II 2.5 TCI	D4BH	05/04 →
SATELLITE 2.5 TDCi	D4BH	03/01 → 10/05
TERRACAN 2.5 D	D4BH	06/01 → 10/03
TERRACAN 2.5 TD	D4BH, D4FA	12/01 → 12/06
TERRACAN 2.5 TDiC [ExtraEU]	D4BHG	06/01 → 10/03

KIA

Model	Code	Year
BONGO IV 2.4 TDCi	D4BH	10/03 →
CERATO I 1.5 CRDi	D4FA, D4BH	07/05 →
K-SERIES 2.5 TDCi	D4BH, 1KR	10/03 →
K2500 2.5 CRDi	D4CB	01/10 →
K2500 2.5 D	D4BH	01/03 →
K3000 2.5 TCI	--	10/01 →
PREGIO 2.5 D	D4BH	08/95 → 09/04
PREGIO 2.5 TCI D	D4BH	09/02 →

ABSOLUTE PRESSURE SENSORS (MAP)

Adatt./Suitable:

ASTON MARTIN

8942152010

CITROËN

1920 KN

DAIHATSU

89421-52010

LEXUS

89421-52010

PEUGEOT

1920 KN

SUBARU

89421-52010

TOYOTA

89421-52010

MARKET DIFFUSION: HIGH



kPa	mV	NTC + - 0
10 - 138	915 - 4750	

ASTON MARTIN

Model	Code	Year
CYGNET 1.3	1NR-FE	04/11 → 10/13

CITROËN

Model	Code	Year
C1 I 1.0	1KR, 2GR-FXE	06/05 →
C1 II 1.0 VTi 68	1KR	04/14 →
C1 II 1.0 VTi 72	1KR	06/18 →

DAIHATSU

Model	Code	Year
CUORE VII 1.0	1KR-FE	04/07 →
CUORE VII 1.0 LPG	1KR-FE	09/11 → 12/12
SIRION 1.0	1KR-FE	01/05 → 06/13
SIRION 1.0 LPG	1KR-FE	01/05 → 06/13

LEXUS

Model	Code	Year
GS 450h	2GR-FXE, 1KR	01/12 →
GX 460 4WD	1UR-FE	01/10 →
RX III 450h	2GR-FXE	12/08 → 10/15
RX III 450h AWD	2GR-FXE	12/08 → 10/15

PEUGEOT

Model	Code	Year
107 1.0	1KR, 1KR	06/05 →
108 1.0 VTi	1KR, 1NR-FE	05/14 →
108 1.0 VTi 72	1KR	05/18 →

SUBARU

Model	Code	Year
JUSTY IV 1.0	1KR-FE	01/07 →
JUSTY IV 1.0 BiFuel	1KR-FE	09/07 → 03/12

TOYOTA

Model	Code	Year
AYGO I 1.0	1KR-FE	07/05 → 05/14
AYGO I 1.0 GPL	1KR-FE	07/05 → 05/14
AYGO I 1.0 VVTi	1KR-FE	07/05 → 05/14
IQ 1.0	1KR-FE	01/09 → 12/15
IQ 1.33	1NR-FE, 192B2.000	01/09 →
PRIUS III 1.8 Hybrid	2ZR-FXE	06/08 →
PRIUS III 1.8 Hybrid [ExtraEU]	2ZR-FXE	06/08 →
VIOS / YARIS 1.0	1KR-FE	09/05 → 10/13
VITZ 1.0 VVTi [ExtraEU]	1KR-FE	11/05 → 11/10
YARIS II 1.0 GPL	1KR-FE	01/06 → 12/11
YARIS II 1.0 VVT-i	1KR-FE	01/05 → 12/11
YARIS III 1.0	1KR-FE	12/10 →

10.3133



3

ABSOLUTE PRESSURE SENSORS (MAP)

Adatt./Suitable:

- BOSCH**
0 261 230 052
- FIAT**
46769979
77363792
77364146
- LANCIA**
46769979
77363792



kPa	mV	
10 - 117	386 - 4750	

FIAT		
DOBLO I 1.4	350A1.000	10/05 ⇨
GRANDE PUNTO 1.4 LPG	350A1.000	03/09 ⇨ 12/12
GRANDE PUNTO 1.4 Natural Power	350A1000CNG	03/09 ⇨ 12/12
IDEA 1.4	192B2.000, 350A1.000	12/03 ⇨
IDEA 1.4 16V	--	08/10 ⇨
IDEA 1.4 LPG	350A1.000	03/09 ⇨
LINEA 1.4	350A1.000	06/07 ⇨
PALIO 1.4	350A1.000, 199A7.000	10/02 ⇨
PUNTO III / GRANDE PUNTO 1.2 Actual	--	09/09 ⇨
PUNTO III / GRANDE PUNTO 1.4	199A7.000, 350A1.000	06/05 ⇨ 12/15
PUNTO III / GRANDE PUNTO 1.4 16V	199A6.000	10/05 ⇨
PUNTO III / GRANDE PUNTO 1.4 Actual	--	09/09 ⇨
PUNTO III / GRANDE PUNTO 1.4 LPG	350A1.000	12/08 ⇨
PUNTO III / GRANDE PUNTO 1.4 Natural Power	350A1.000, 199A7.000	07/08 ⇨
PUNTO III EVO 1.4	199A7.000, --	03/09 ⇨
PUNTO III EVO 1.4 16V	955A2.000	10/09 ⇨ 02/12
PUNTO III EVO 1.4 Natural Power	350A1.000	10/09 ⇨ 02/12
PUNTO III 1.4	199A7.000, 199A7.000	04/08 ⇨
PUNTO III 1.4 LPG	350A1.000	03/09 ⇨
PUNTO III 1.4 Natural Power	350A1.000	03/09 ⇨
SIENA 1.4	--, 4HP(DW12BTED4)	01/02 ⇨
LANCIA		
MUSA 1.4	350A1.000	09/05 ⇨ 09/12
MUSA 1.4 LPG	350A1.000	11/10 ⇨ 09/12
THESIS 2.0 Turbo	841E.000	07/02 ⇨ 07/09
YPSILON I 1.4	350A1.000	02/06 ⇨ 12/11
YPSILON I 1.4 LPG	350A1.000	11/10 ⇨ 12/11

10.3134



3

ABSOLUTE PRESSURE SENSORS (MAP)

Adatt./Suitable:

- CITROËN**
1920 LH
96 519 312 80
- DENSO**
079800-7670
079800-7870
- FIAT**
9651931280
- FORD**
1 703 244
AV2Q-12T551-AA
- LANCIA**
9651931280
- PEUGEOT**
1920 LH

MARKET DIFFUSION: MEDIUM



kPa	mV	
26,7 - 326,7	250 - 4750	

CITROËN		
C3 II 1.4 HDi	DV4C	06/10 ⇨ 09/16
C3 II 1.4 HDi 70	8HR(DV4C)	11/09 ⇨
C5 I 2.2 HDi	4HP(DW12BTED4), 4HT(DW12BTED4)	04/06 ⇨
C5 II 2.2 HDi	4HT(DW12BTED4), 4HP(DW12BTED4)	02/08 ⇨
C5 II 2.2 HDi 165	4HP(DW12BTED4), 4HP(DW12BTED4)	02/08 ⇨
C6 2.2 HDi	4HP(DW12BTED4), 4HP(DW12BTED4)	06/06 ⇨ 12/12
C8 2.2 HDi	4HP(DW12BTED4), 4HN(DW12MTED4)	06/06 ⇨
C-CROSSER 2.2 HDi	4HN(DW12MTED4), 4HN(DW12MTED4)	02/07 ⇨
C-CROSSER ENTERPRISE 2.2 HDi	4HN(DW12MTED4), 8HR(DV4C)	01/09 ⇨
DS3 1.4 HDi 70	8HR(DV4C), 4H01	04/10 ⇨ 07/15
FIAT		
ULYSSE II 2.2 Multijet	4H01, UGJC	10/07 ⇨
FORD		
B-MAX 1.5 TDCi	UGJC, F6JD	10/12 ⇨
FIESTA VI 1.4 TDCi	F6JD, UGJC	07/10 ⇨
FIESTA VI 1.5 TDCi	UGJC, UGCA	09/12 ⇨
TOURNEO COURIER 1.5 TDCi	UGCA, UGCA	02/14 ⇨
TRANSIT COURIER 1.5 TDCi	UGCA, 4HS	02/14 ⇨
LANCIA		
PHEDRA 2.2 D Multijet	4HS, 8HR(DV4C)	03/08 ⇨ 11/10
PHEDRA 2.2 JTD	4H01	03/08 ⇨
PEUGEOT		
206+ 1.4 HDi	DV4C	06/10 ⇨
206+ 1.4 HDi eco 70	DV4C, 8HP(DV4C)	01/09 ⇨
207 1.4 HDi	8HR(DV4C)	02/06 ⇨
208 1.4 HDi	8HP(DV4C), 4HK(DW12MTED4)	03/12 ⇨
407 2.2 HDi	4HP(DW12BTED4), 4HR(DW12BTED4)	03/06 ⇨
407 2.2 HDi 170	4HR(DW12BTED4), 4HP(DW12BTED4)	05/06 ⇨
607 2.2 HDi	4HP(DW12BTED4), 4HT(DW12BTED4)	05/06 ⇨
807 2.2 HDi	4HT(DW12BTED4), Z28NET	06/06 ⇨
2008 1.4 HDi	8HR(DV4C), DV4C	06/13 ⇨
4007 2.2 HDi	4HK(DW12MTED4), 4HP(DW12BTED4)	02/07 ⇨

10.3135



3

ABSOLUTE PRESSURE SENSORS (MAP)

Adatt./Suitable:

- ALFA ROMEO**
71741115
- BOSCH**
0 261 230 101
- GENERAL MOTORS**
12 575 467
24 420 587
- OPEL**
12575467
24420587
62 35 707
62 35 728
- SAAB**
12 575 467
- VAUXHALL**
12575467
24420587

MARKET DIFFUSION: MEDIUM



kPa	mV	
10 - 117,5	391,5 - 4750	

ALFA ROMEO		
159 3.2 JTS	939A.000	01/08 ⇨ 11/11
159 3.2 JTS Q4	939A.000	12/05 ⇨ 11/11
159 MY2011 3.2 JTS	--	01/10 ⇨
BRERA 3.2 JTS	939A.000	03/08 ⇨ 06/10
BRERA 3.2 JTS Q4	939A.000	01/06 ⇨ 05/11
SPIDER III 3.2 JTS	939A.000	03/08 ⇨ 03/11
SPIDER III 3.2 JTS Q4	939A.000	03/06 ⇨ 03/11
CADILLAC		
BLS 2.8 T	Z28NET, Z12XEP	04/06 ⇨
BLS 2.8 T AWD	Z28NET	10/08 ⇨
OPEL		
CORSA D 1.0	Z10XEP	07/06 ⇨ 08/14
CORSA D 1.2	Z12XEP	07/06 ⇨ 08/14
CORSA D 1.2 LPG	Z12XEP, Z28NEL	08/06 ⇨ 08/14
CORSA D 1.4	Z14XEP	07/06 ⇨ 08/14
CORSA D 1.4 LPG	Z14XEP	08/06 ⇨ 12/11
SIGNUM 2.8	Z28NET	10/06 ⇨
VECTRA C 2.8 V6 Turbo	Z28NEL, B284	08/05 ⇨ 10/08
VECTRA C 2.8 V6 Turbo OPC	Z28NET	09/06 ⇨ 08/08
SAAB		
9-3 2.8 Turbo V6	B284, B284R	03/05 ⇨
9-3 2.8 Turbo V6 XWD	B284R	05/08 ⇨ 12/11
9-3 2.8 V6 T	B284R, Z28NEL	09/07 ⇨ 02/15
VAUXHALL		
CORSA D 1.0	Z10XEP	08/06 ⇨ 08/14
CORSA D 1.2	Z12XEP	08/06 ⇨ 08/14
CORSA D 1.2 LPG	Z12XEP	09/09 ⇨ 08/14
CORSA D 1.4	Z14XEP	08/06 ⇨ 08/14
CORSA D 1.4 LPG	Z14XEP	07/06 ⇨ 08/14
CORSAVAN III 1.2	Z12XEP	07/09 ⇨
SIGNUM 2.8 V6 Turbo	Z28NET	05/07 ⇨ 10/08
VECTRA C 2.8 V6 Turbo	Z28NEL, 4HP(DW12BTED4)	08/05 ⇨ 05/09

10.3136



3

ABSOLUTE PRESSURE SENSORS (MAP)

Adatt./Suitable:

CITROËN
1920 LG
96 493 965 80

DENSO
079800-7661

FIAT
9649396580

FORD
1 427 942
1 438 809
6G9Q-9F479-AB

JAGUAR
C2Z 14334

LANCIA
9649396580

LAND ROVER
LR001324

MINI
1865A122

PEUGEOT
1920 LG



kPa	mV	+ - 0
26,7 - 326,7	250 - 4750	

CITROËN

C5 I 2.2 HDi	4HP(DW12BTEd4), 4HT(DW12BTEd4)	04/06 ⇨
C5 II 2.2 HDi	4HT(DW12BTEd4), 4HP(DW12BTEd4)	02/08 ⇨
C5 II 2.2 HDi 165	4HP(DW12BTEd4), 4HL(DW12C)	02/08 ⇨
C5 II 2.2 HDi 200	4HL(DW12C), 4HP(DW12BTEd4)	07/10 ⇨
C6 2.2 HDi	4HP(DW12BTEd4), 4HP(DW12BTEd4)	06/06 ⇨ 12/12
C8 2.2 HDi	4HP(DW12BTEd4), 4HN(DW12MTEd4)	06/06 ⇨
C-CROSSER 2.2 HDi	4HN(DW12MTEd4), 4HN(DW12MTEd4)	02/07 ⇨
C-CROSSER ENTERPRISE 2.2 HDi	4HN(DW12MTEd4), 4H01	01/09 ⇨

FIAT

ULYSSE II 2.2 D Multijet	4H01, KNWA	10/07 ⇨
--------------------------	------------	---------

FORD

GALAXY II 2.2 TDCi	KNWA, KNBA	03/08 ⇨ 06/15
MONDEO III 2.2 TDCi	KNBA, KNWA	03/08 ⇨ 01/15
MONDEO 2.2 TDCi	KNBA	03/13 ⇨ 09/14
S-MAX I 2.2 TDCi	KNWA, 224DT	03/08 ⇨ 12/14

JAGUAR

XF 2.2 D	224DT, 4HS	04/11 ⇨ 04/15
----------	------------	---------------

LANCIA

PHEDRA 2.2 D Multijet	4HS, 224DT	03/08 ⇨ 11/10
PHEDRA 2.2 JTD	4H01	03/08 ⇨

LAND ROVER

DISCOVERY IV 2.0 D	204DTD	08/15 ⇨
DISCOVERY IV 2.2 D 4x4	224DT	09/14 ⇨
FREELANDER 2.2 eD4	224DT, 224DT	08/10 ⇨ 10/14
FREELANDER 2.2 SD4 4x4	224DT	08/10 ⇨ 10/14
FREELANDER 2.2 TD4 4x4	224DT, 4HK	10/06 ⇨ 10/14
RANGE ROVER EVOQUE 2.2 D	224DT	06/11 ⇨
RANGE ROVER EVOQUE 2.2 D 4x4	224DT	06/11 ⇨

MITSUBISHI

OUTLANDER II 2.2 DI-D 4WD	4HK, 4HK(DW12MTEd4)	08/07 ⇨ 11/12
---------------------------	---------------------	---------------

PEUGEOT

407 2.2 HDi	4HP(DW12BTEd4), 4HR(DW12BTEd4)	03/06 ⇨
407 2.2 HDi 170	4HR(DW12BTEd4), 4HL(DW12C)	05/06 ⇨
508 I 2.2 HDi	4HL(DW12C), 4HP(DW12BTEd4)	11/10 ⇨
607 2.2 HDi	4HP(DW12BTEd4), 4HT(DW12BTEd4)	05/06 ⇨
807 2.2 HDi	4HT(DW12BTEd4), 5FT(EP6DT)	06/06 ⇨
4007 2.2 HDi	4HK(DW12MTEd4), 4HP(DW12BTEd4)	02/07 ⇨

10.3137



3,5

ABSOLUTE PRESSURE SENSORS (MAP)

Adatt./Suitable:

BOSCH
0 261 230 134

CITROËN
1922 R6

DS
1922 R6

MINI
13 62 7 535 069
7 535 069

PEUGEOT
1922 R6



kPa	mV	0 + NTC -
10 - 264.9	314 - 4750	

CITROËN

C4 I 1.6 THP 140	5FT(EP6DT)	07/08 ⇨ 07/11
C4 I 1.6 THP 150	5FX(EP6DT)	07/08 ⇨ 07/11
C4 II 1.6 THP 155	5FV(EP6CDT)	11/09 ⇨
C4 GRAND PICASSO I 1.6 16V	5FT(EP6DT), 5FX(EP6DT)	07/08 ⇨ 08/13
C4 PICASSO I 1.6 16V	5FX(EP6DT), 5FT(EP6DT)	07/08 ⇨ 08/13
C4 PICASSO I 1.6 THP 140	5FT(EP6DT), 5FN(EP6CDT)	07/08 ⇨ 08/13
C5 II 1.6 THP 150	5FN(EP6CDT), 5FV(EP6CDT)	04/09 ⇨
C5 II 1.6 THP 155	5FV(EP6CDT), 5FD(EP6DTS)	04/09 ⇨

DS3 1.6	5FM(EP6DT)	01/12 ⇨ 07/15
DS3 1.6 Racing	5FD(EP6DTS), 5FX(EP6DT)	02/11 ⇨ 07/15
DS3 1.6 THP 150	5FX(EP6DT), 5FR(EP6DT)	01/10 ⇨ 07/15
DS3 1.6 THP 155	5FR(EP6DT), EP6CDTM	04/10 ⇨ 07/15
DS4 1.6 THP 150	EP6CDTMD	04/11 ⇨ 07/15
DS4 1.6 THP 155	5FV(EP6CDT)	04/11 ⇨ 07/15
DS4 1.6 THP 160	EP6CDTM	04/12 ⇨ 07/15
DS4 1.6 THP 165	EP6CDTM, N14B16A	01/12 ⇨ 07/15
DS5 1.6 THP 150	EP6CDTMD	11/11 ⇨ 07/15
DS5 1.6 THP 155	5FV(EP6CDT)	11/11 ⇨ 07/15
DS5 1.6 THP 165	EP6CDTMD	01/12 ⇨ 07/15

DS

DS4 / DS4 CROSSBACK 1.6 THP 150	EP6CDTMD	10/16 ⇨
---------------------------------	----------	---------

MINI

MINI II Cooper S	N14B16A, N14B16A	10/06 ⇨ 06/14
MINI II Cooper S John Cooper Works	N14B16A, 5FY(EP6DTS)	11/06 ⇨ 02/10

PEUGEOT

207 1.6 16V RC	5FY(EP6DTS), 5FR(EP6DT)	02/07 ⇨
207 1.6 16V Turbo	5FR(EP6DT), 5FR(EP6DT)	02/06 ⇨
207 CC 1.6 16V Turbo	5FR(EP6DT), 5FV(EP6CDT)	02/07 ⇨
308 I 1.6 16V	5FT(EP6DT), EP6CDTMD	09/07 ⇨
3008 1.6 THP	5FV(EP6CDT), 5FT(EP6DT)	06/09 ⇨
5008 1.6 16V	EP6CDT	09/09 ⇨
5008 1.6 THP 150	EP6CDTMD, KKDA	02/12 ⇨
5008 1.6 THP 163	EP6CDTM	02/12 ⇨
RCZ 1.6 16V	EP6CDT	03/10 ⇨ 12/15

10.3144



3,5

ABSOLUTE PRESSURE SENSORS (MAP)

Adatt./Suitable:

BOSCH
0 261 230 119
0 261 230 120

FORD
1 338 678
1 352 477 *7
4M51-9F479-AA
4M5Q-95428-AA *7

*7 without connector parts
• senza pezzi raccordo
• sans raccords
• ohne Anschlusssteile
• sin piezas de conexión

MARKET DIFFUSION: MEDIUM



kPa	mV	0 - +
10,9 - 309,5	250 - 4750	

FORD

C-MAX I 1.8 TDCi	KKDA, KKDA	02/07 ⇨ 09/10
FOCUS I 1.8 TDCi	KKDA, FFWA	07/04 ⇨ 09/12
FOCUS C-MAX 1.8 TDCi	KKDA	01/05 ⇨ 03/07
GALAXY II 1.8 TDCi	FFWA, FFBA	05/06 ⇨ 06/15
MONDEO III 1.8 TDCi	FFBA, FFWA	03/07 ⇨ 01/15
S-MAX I 1.8 TDCi	FFWA, HCPA	05/06 ⇨ 12/14
TOURNEO CONNECT I 1.8 TDCi	HCPA, BHPA	06/02 ⇨ 12/13
TOURNEO CONNECT I 1.8 TDCi /TDi /Di	BHPA, BHPA	06/02 ⇨ 12/13
TRANSIT CONNECT I 1.8 Di	HCPA, HCPA	06/02 ⇨ 12/13
TRANSIT CONNECT I 1.8 TDCi	HCPA, --	06/02 ⇨ 12/13

10.3151



3,5

ABSOLUTE PRESSURE SENSORS (MAP)

Adatt./Suitable:

BOSCH
0 261 230 122
0 261 230 123
0 261 230 180
0 261 230 181

FORD
1 319 285
1 439 251
1 446 702
4S4G-9F479-AA
4S4G-9F479-AB
4S4G-9F479-AC

MAZDA

L301-18-211
L301-18-211A
L301-18-211B
LF01-18-211
LF01-18-211A

MARKET DIFFUSION: MEDIUM



kPa	mV	0 + -
10 - 117,3	405 - 4750	

FORD

C-MAX II 2.0 Energi	--, GZ	01/15 ⇨
MAVERICK 2.3	--	05/06 ⇨
MAVERICK 2.3 16V	GZ, LF17	03/04 ⇨

MAZDA

312.0	LF17, LF17	09/03 ⇨ 12/09
-------	------------	---------------

MAZDA		
3 II 2.0 MZR	LF17, LF-5H	01/09 → 09/14
3 II 2.0 MZR DISI	LF-5H, LF-5H	12/08 → 05/13
3 II 2.5	L5-VE	03/09 → 09/14
5 I 1.8	L823	02/05 → 05/10
5 I 2.0	LF7	02/05 → 05/10
5 I 2.0 MZR	LF5	09/07 →
5 II 1.8 MZR	L850	09/10 →
5 II 2.0	LF-5H, L813	09/10 →
6 I 1.8	L813, LF17	08/02 → 08/07
6 I 2.0	LF17, L3C1	06/02 → 08/07
6 I 2.3	L3C1, L813	01/02 → 02/08
6 I 2.3 AWD	L3C1	11/02 → 08/07
6 I 2.3 MPS Turbo	L3KG	12/05 → 08/07
6 II 1.8 MZR	L813, LF17	08/07 → 07/13
6 II 2.0 MZR	LF17, L501	08/07 → 07/13
6 II 2.5 MZR	L501, L5-VE	08/07 → 07/13
CX-7 2.5 MZR	L5-VE, L828	07/09 → 03/13
MPV II 2.3	L3	07/02 → 02/06
MX-5 III 1.8	L828, --	03/05 → 12/14
MX-5 III 2.0	--, CAVG	03/05 →
TRIBUTE 2.3 GX	L3-VE	12/03 → 10/04

10.3157



ABSOLUTE PRESSURE SENSORS (MAP)

Adatt./Suitable:

AUDI
036 906 051 G

BENTLEY
036 906 051 G

BOSCH
0 261 230 081
0 261 230 082

PORSCHE
958 355 051 07

SEAT
036 906 051 G

1K0 612 041 BT *7

1K0 612 041 DH *7

1K0 612 041 GH *7

1K0 612 041 KA *7

5N0 612 041 AH *7

5N0 612 041 BA *7

6R1 612 041 H *7

6R1 612 041 M *7

6R2 612 041 AE *7

6R2 612 041 J *7

6R2 612 051 A *7

SKODA
036 906 051 G

1K0 612 041 FR *7

1K0 612 041 HJ *3

6R1 612 041 AL *7

6R1 612 041 M *7

6R1 612 041 P *7

VW
036 906 051 G

1K0 612 041 BT *7

1K0 612 041 DH *7

1K0 612 041 FE *7

1K0 612 041 FR *7

1K0 612 041 GH *7

1K0 612 041 HB *7

1K0 612 041 HJ *3

1K0 612 041 HL *3

1K0 612 041 JL *7

1K0 612 041 KA *7

1K0 612 041 KE *3

1K0 612 041 KP *7

1K0 612 041 LG *7

3AA 612 041 AC *7

3AA 612 041 AG *3

5N0 612 041 AF *7

5N0 612 041 AH *7

5N0 612 041 BA *7

6R1 612 041 H *7

6R2 612 041 AE *7

6R2 612 041 J *7

7N0 612 041 C *7

7N0 612 041 D *7

*3 without connecting pipe

- senza tubo raccordo
- sans tuyau de raccordement
- ohne Anschlussrohr
- sin tubo de conexión

*7 without connector parts

- senza pezzi raccordo
- sans raccords
- ohne Anschlusssteile
- sin piezas de conexión

MARKET DIFFUSION: HIGH



kPa	mV	
10 - 117	405 - 4750	

AUDI		
A1 1.2 TFSI	CBZA	05/10 → 04/15
A1 1.4 TFSI	CAVG, CAYB	05/10 → 04/15
A1 1.6 TDI	CAYB, CFHB	05/10 → 04/15
A1 2.0 TDI	CFHB, AUA	09/11 → 04/15
A1 2.0 TFSI quattro	CDLH	03/12 → 11/12
A2 1.4	AUA, CAXC	02/00 → 08/05
A2 1.6 FSI	BAD	05/02 → 08/05
A3 II 1.2 TFSI	CBZB	03/10 → 05/13
A3 II 1.2 TSI	CBZB	04/10 → 08/12
A3 II 1.4 TFSI	CAXC, BGU	09/07 → 05/13
A3 II 1.6	BGU, BAG	05/03 → 08/12
A3 II 1.6 E-Power	CCSA	01/11 → 08/12
A3 II 1.6 FSI	BAG, BYT	08/03 → 09/07
A3 II 1.8 TFSI	BYT, AXW	11/06 → 08/12
A3 II 2.0 FSI	AXW, AXX	05/03 → 06/08
A3 II 2.0 TDI 16V	CLJA	05/03 → 08/12
A3 II 2.0 TFSI	AXX, AXX	09/04 → 08/12
A3 II 2.0 TFSI quattro	AXX, BDB	09/04 → 08/12
A3 II 3.2 V6 quattro	BDB, CAXC	07/03 → 05/09
A3 II S3 quattro	CDLA	11/06 → 08/12
A3 II SPORTBACK 1.2 TSI	CBZB	04/10 → 03/13
A3 II SPORTBACK 1.4 TFSI	CAXC, BGU	09/07 → 03/13
A3 II SPORTBACK 1.6	BGU, BLF	09/04 → 03/13

AUDI		
A3 II SPORTBACK 1.6 E-Power	CCSA	01/11 → 03/13
A3 II SPORTBACK 1.6 FSI	BLF, BYT	09/04 → 09/07
A3 II SPORTBACK 1.8 TFSI	BYT, AXW	11/06 → 03/13
A3 II SPORTBACK 2.0 FSI	AXW, AXX	09/04 → 06/08
A3 II SPORTBACK 2.0 TDI 16V	CLJA	09/04 → 03/13
A3 II SPORTBACK 2.0 TFSI	AXX, AXX	09/04 → 03/13
A3 II SPORTBACK 2.0 TFSI quattro	AXX, BMJ	09/04 → 03/13
A3 II SPORTBACK 3.2 V6 quattro	BMJ, CDHA	09/04 → 05/09
A3 II SPORTBACK S3 quattro	CDLA	06/08 → 03/13
A4 IV 1.8 TFSI	CDHA, CGLC	01/08 → 12/15
A4 IV 1.8 TFSI quattro	CJEB	11/11 → 12/15
A4 IV 2.0 TDI	CGLC, CGLC	11/07 → 12/15
A4 IV 2.0 TDI quattro	CGLC, CAEA	04/08 → 12/15
A4 IV 2.0 TFSI	CAEA, CAEB	06/08 → 12/15
A4 IV 2.0 TFSI flexible fuel	CFKA	11/09 → 12/15
A4 IV 2.0 TFSI flexible fuel quattro	CFKA	11/09 → 12/15
A4 IV 2.0 TFSI quattro	CAEB, CDUC	06/08 → 12/15
A4 IV 3.0 TDI	CLAB	11/11 → 12/15
A4 IV 3.0 TDI quattro	CDUC, CMUA	11/11 → 12/15
A4 IV 3.0 TFSI quattro	CMUA, CGLC	02/12 → 12/15
A4 IV S4 quattro	CAKA, CJEB	11/08 → 12/15
A4 IV ALLROAD 2.0 TDI quattro	CGLC, CDNC	04/09 → 05/16
A4 IV ALLROAD 2.0 TFSI quattro	CDNC, CDUC	04/09 → 05/16
A4 IV ALLROAD 3.0 TDI quattro	CDUC, CAKA	01/12 → 05/16
A5 I 1.8 TFSI	CJEB, CGLC	10/07 → 01/17
A5 I 2.0 TDI	CGLC, CGLC	08/08 → 01/17
A5 I 2.0 TDI quattro	CGLC, CAEB	12/11 → 01/17
A5 I 2.0 TFSI	CAEB, CAEB	06/08 → 01/17
A5 I 2.0 TFSI quattro	CAEB, CDUC	06/08 →
A5 I 3.0 TDI	CLAB	10/11 → 01/17
A5 I 3.0 TDI quattro	CDUC, CHMB	10/11 → 01/17
A5 I 3.0 TFSI quattro	CHMB, CAKA	08/11 →
A5 I S5 quattro	CAKA, CGLC	06/09 → 01/17
A6 IV 2.0 TDI	CGLC, CAEB	03/11 → 09/18
A6 IV 2.0 TDI quattro	CNHA	04/15 → 09/18
A6 IV 2.0 TFSI	CAEB, CDUC	03/11 →
A6 IV 2.0 TFSI hybrid	CHJA	11/11 → 09/18
A6 IV 2.0 TFSI quattro	CAEB	05/12 → 05/13
A6 IV 2.8 FSI	CHVA	11/10 → 04/15
A6 IV 2.8 FSI quattro	CHVA	11/10 → 04/15
A6 IV 3.0 TDI	CLAB	11/10 → 09/18
A6 IV 3.0 TDI quattro	CDUC, CGWB	03/11 →
A6 IV 3.0 TFSI quattro	CGWB, CRDB	11/10 → 09/18
A6 IV RS6 performance quattro	CWUC	11/15 → 09/18
A6 IV RS6 quattro	CRDB, CHVA	01/13 → 09/18
A6 IV S6 quattro	CEUC	02/12 → 09/18
A7 SPORTBACK 2.5 FSI	CLXB	05/12 →
A7 SPORTBACK 2.8 FSI	CHVA	02/11 → 03/15
A7 SPORTBACK 2.8 FSI quattro	CHVA, CDUC	10/10 → 03/15
A7 SPORTBACK 3.0 TDI	CLAB	11/10 → 03/15
A7 SPORTBACK 3.0 TDI quattro	CDUC, CGWB	10/10 → 06/17
A7 SPORTBACK 3.0 TFSI quattro	CGWB, CRDB	10/10 → 03/15
A7 SPORTBACK RS7 performance quattro	CWUC	11/15 → 04/18
A7 SPORTBACK RS7 quattro	CRDB, CPAA	10/13 → 04/18
A7 SPORTBACK S7 quattro	CEUC	02/12 → 03/15
A8 III 2.0 TFSI hybrid	CHJA	02/12 → 11/15
A8 III 2.0 TFSI quattro	CYPA	09/16 → 01/18
A8 III 2.5 TFSI	CPAA, CDTA	07/12 → 06/16
A8 III 3.0 TDI	CLAB	09/11 → 09/13
A8 III 3.0 TDI quattro	CDTA, CGWA	07/10 →
A8 III 3.0 TFSI quattro	CGWA, CEUA	06/10 → 01/18
A8 III 4.0 TFSI	CTGF	11/15 →
A8 III 4.0 TFSI quattro	CEUA, CDSB	03/12 → 12/15
A8 III 4.2 FSI quattro	CDRA	11/09 → 12/12
A8 III 4.2 TDI quattro	CDSB, CEJA	11/09 → 01/18
A8 III 6.3 W12 quattro	CEJA, CGTA	01/11 → 01/18
A8 III S8 plus quattro	DDTA	11/15 → 01/18
A8 III S8 quattro	CGTA, CFFA	04/12 → 01/18
Q3 1.4 TSI	CHPB	10/13 → 10/18
Q3 2.0 TDI	CFFA, CFFB	06/11 → 10/18
Q3 2.0 TDI quattro	CFFB, CCZC	06/11 → 10/18
Q3 2.0 TFSI	CCTA	10/13 →
Q3 2.0 TFSI quattro	CCZC, CJCA	06/11 → 10/18
Q5 1.2 TDI	CJCA, CAGA	11/10 →
Q5 1.2 TDI quattro	CAGA, CAEB	11/08 →
Q5 1.2 TFSI	CDNA	11/08 →
Q5 1.2 TFSI hybrid quattro	CHJA	06/11 →
Q5 1.2 TFSI quattro	CAEB, CWVA	11/08 →

AUDI		
Q5 I 3.0 TDI	CTBC	06/12 →
Q5 I 3.0 TDI quattro	CCWA, CTUC	11/08 →
Q5 I 3.0 TFSI quattro	CTUC, CGQB	06/12 →
Q5 I 3.2 FSI quattro	CALB	11/08 →
Q5 I SQ5 TDI quattro	CGQB, CTUD	12/12 →
Q5 I SQ5 TFSI quattro	CTUD, CASA	05/13 →
Q7 I 3.0 TDI quattro	CASA, M05.9E	03/06 → 08/15
R8 5.2 FSI quattro	CSPA	05/17 →
R8 5.2 FSI RWS	DKAB	09/17 →

BENTLEY		
CONTINENTAL 6.0 AWD	DJLA	11/17 → 05/18
CONTINENTAL 6.0 Super-sports AWD	DJLA	09/17 → 05/18

PORSCHE		
CAYENNE II 3.0 Diesel	M05.9E, M06.EC	06/10 →
CAYENNE II 3.0 S E-Hybrid	M06.EC, M55.02	06/10 →
CAYENNE II 3.6	M55.02, MCU.DB	06/10 →
CAYENNE II 3.6 GTS	MCX.ZA	02/15 →
CAYENNE II 3.6 S	MCU.RA	10/14 →
CAYENNE II 4.2 S Diesel	MCU.DB, M48.52	10/12 →
CAYENNE II 4.8 GTS	M48.02	06/12 →
CAYENNE II 4.8 S	M48.02	06/10 →
CAYENNE II 4.8 Turbo	M48.52, M48.52	06/10 →
CAYENNE II 4.8 Turbo S	M48.52, MCR.CB	10/12 →
PANAMERA 3.0 D	MCR.CB, MCG.EA	08/11 → 10/16
PANAMERA 3.0 S E-Hybrid	MCG.EA, CAVA	03/11 → 10/16

SEAT		
ALHAMBRA III 1.4 TSI	CAVA, BSE	06/10 →
ALTEA 1.2 TSI	CBZB	04/10 →
ALTEA 1.4 16V	CGGB	05/06 →
ALTEA 1.4 TSI	CAXC	11/07 →
ALTEA 1.6	BSE, CAYB	03/04 →
ALTEA 1.6 LPG	CHGA	09/09 →
ALTEA 1.6 TDI	CAYB, BLS	10/09 →
ALTEA 1.8 TFSI	CDA	01/07 →
ALTEA 1.9 TDI	BLS, BLR	04/04 →
ALTEA 2.0 FSI	BLR, BMM	05/04 → 03/09
ALTEA 2.0 TDI	BMM, BKD	11/05 →
ALTEA 2.0 TDI 16V	BKD, BSE	03/04 →
ALTEA 2.0 TFSI	BWA	04/06 → 05/09
ALTEA XL 1.2 TSI	CBZB	04/10 →
ALTEA XL 1.4 16V	CGGB	10/06 →
ALTEA XL 1.4 TSI	CAXC	11/07 →
ALTEA XL 1.6	BSE, CAYB	10/06 →
ALTEA XL 1.6 LPG	CHGA	09/09 →
ALTEA XL 1.6 Multifuel	CCSA	10/06 →
ALTEA XL 1.6 TDI	CAYB, BLS	10/09 →
ALTEA XL 1.8 TFSI	CDA	01/07 →
ALTEA XL 1.9 TDI	BLS, BVY	10/06 →
ALTEA XL 1.9 TDI 4x4	BLS	06/09 → 12/10
ALTEA XL 2.0 FSI	BVY, BMM	10/06 → 03/09
ALTEA XL 2.0 TDI	BMM, BKD	10/06 →
ALTEA XL 2.0 TDI 16V	BKD, BMM	10/06 →
ALTEA XL 2.0 TDI 16V 4x4	CFHC	10/10 →
ALTEA XL 2.0 TDI 4x4	BMM, BWA	06/07 →
ALTEA XL 2.0 TFSI	BWA	10/06 → 05/09
ALTEA XL 2.0 TFSI 4x4	BWA, CGPA	06/07 →
IBIZA IV 1.2	CGPA, CAVF	03/08 →
IBIZA IV 1.2 TSI	CBZB	09/10 →
IBIZA IV 1.4 TSI	CAVE, CAVE	06/09 →
IBIZA IV 1.4 TSI Cupra	CAVE, BLR	06/09 →
LEON II 1.2 TSI	CBZB	02/10 → 12/12
LEON II 1.4 TSI	CAXC	11/07 → 12/12
LEON II 1.9 TDI	BXE	07/05 → 12/10
LEON II 2.0 FSI	BLR, CHYA	07/05 → 05/10
LEON II 2.0 TDI 16V	BKD	07/05 → 12/12
MII 1.0	CHYA, BLR	10/11 →
MII 1.0 EcoFuel	CPGA	11/12 →
TOLEDO III 2.0 FSI	BLR, CBZA	10/04 → 05/09
TOLEDO III 2.0 TFSI	BWA	11/05 → 05/09
TOLEDO IV 1.2 TSI	CBZA, CHYA	07/12 →
TOLEDO IV 1.4 TSI	CAXA	07/12 →
TOLEDO IV 1.6	CFNA	07/13 →

SKODA		
CITIGO 1.0	CHYA, CBZA	10/11 →
CITIGO 1.0 CNG	CPGA	11/12 →
FABIA II 1.2 TSI	CBZA, CAVE	03/10 → 12/14
FABIA II 1.4	CGGB	01/07 → 12/14
FABIA II 1.4 TSI RS	CAVE, BCA	05/10 → 12/14
OCTAVIA II 1.2 TSI	CBZB	02/10 → 06/13
OCTAVIA II 1.4	BCA, BGU	05/04 → 06/13
OCTAVIA II 1.4 TSI	CAXA	11/08 → 06/13
OCTAVIA II 1.6	BGU, BZB	06/04 → 06/13
OCTAVIA II 1.6 FSI	BLF	02/04 → 10/08
OCTAVIA II 1.6 LPG	CHGA	08/09 → 11/12
OCTAVIA II 1.6 MultiFuel	CCSA	01/08 → 06/13
OCTAVIA II 1.8 TSI	BZB, CDAA	06/07 → 06/13
OCTAVIA II 1.8 TSI 4x4	CDAA, BLR	11/08 → 02/13

SKODA		
OCTAVIA II 2.0 FSI	BLR, BLX	11/04 → 10/08
OCTAVIA II 2.0 FSI 4x4	BLX, CAVD	11/04 → 10/08
OCTAVIA II 2.0 RS	BWA	10/05 → 02/13
ROOMSTER 1.4	CGGB	09/06 → 05/15
YETI 1.2 TSI	CYVB	05/15 → 12/17
YETI 1.4 TSI	CZCA	05/15 → 12/17
YETI 1.4 TSI 4x4	CZDA	05/15 → 12/17

VW		
BEETLE 1.2 TSI	CBZB	07/11 →
BEETLE 1.4 TSI	CAVD, CBZA	10/11 →
CADDY III 1.2 TSI	CBZA, CTHD	09/10 → 05/15
CC 1.4 TSI	CTHD, BVY	11/11 → 12/16
EOS 1.4 TSI	CAXA	11/07 → 08/15
EOS 2.0 FSI	BVY, BCA	03/06 → 05/08
GOLF IV 1.4 16V	BCA	08/97 → 06/06
GOLF IV 1.6 FSI	BAG	10/03 → 07/04
GOLF V 1.4	BUD	06/07 → 07/09
GOLF V 1.4 16V	BCA, BLG	10/03 → 11/08
GOLF V 1.4 FSI	BKG	10/03 → 11/06
GOLF V 1.4 TSI	BLG, BGU	11/05 → 07/09
GOLF V 1.6	BGU, BAG	01/04 →
GOLF V 1.6 FSI	BAG, BLS	10/03 → 07/08
GOLF V 1.6 MultiFuel	CCSA	10/07 → 07/09
GOLF V 1.9 TDI	BLS, BLS	10/03 → 07/09
GOLF V 1.9 TDI 4motion	BLS, BHY	08/04 → 07/09
GOLF V 2.0	BHY, AXW	08/06 → 07/09
GOLF V 2.0 FSI	AXW, BLX	01/04 → 11/08
GOLF V 2.0 FSI 4motion	BLX, AXX	08/04 → 11/08
GOLF V 2.0 GTI	AXX, AZV	10/04 → 02/09
GOLF V 2.0 SDI	BKD	01/04 → 11/08
GOLF V 2.0 TDI	AZV, CBTA	10/03 →
GOLF V 2.0 TDI 16V	BKD	10/03 → 07/09
GOLF V 2.0 TDI 16V 4motion	BKD	08/04 → 11/08
GOLF V 2.0 TDI 4motion	AZV	08/04 → 07/09
GOLF V 2.5	CBTA, BGP	05/07 → 11/08
GOLF V 2.5 FSI	BGP, BUB	06/05 → 11/08
GOLF V 3.2	BUB, BUB	09/05 → 11/08
GOLF V 3.2 R32 4motion	BUB, CBZA	11/05 → 11/08
GOLF VI 1.2 TSI	CBZA, CJZA	11/08 →
GOLF VI 1.2 TSI 16V	CJZA, BUD	11/13 → 05/16
GOLF VI 1.4	BUD, CAVD	10/08 → 07/13
GOLF VI 1.4 TSI	CAVD, BSE	10/08 →
GOLF VI 1.6	BSE, CCSA	10/08 →
GOLF VI 1.6 BiFuel	CHGA	03/09 → 11/12
GOLF VI 1.6 MultiFuel	CCSA, CAYB	10/08 → 07/13
GOLF VI 1.6 TDI	CAYB, CBFA	02/09 → 07/13
GOLF VI 1.6 TDI 4motion	CAYC	07/09 → 07/13
GOLF VI 1.8 TSI	CDAA	06/09 → 01/11
GOLF VI 2.0 GTI	CBFA, CDLA	04/09 → 05/16
GOLF VI 2.0 R	CDLA	01/13 → 05/16
GOLF VI 2.0 R 4motion	CDLA, BMM	11/09 → 11/13
GOLF VI 2.0 TDI	BMM, CBAB	10/08 → 07/13
GOLF VI 2.0 TDI 4motion	CBAB, BLR	05/09 → 11/12
GOLF VI 2.0 TSI	CDLC	01/13 →
GOLF VI 2.5	CBUA	07/09 → 05/11
JETTA V 1.4 TSI	CAXA	05/07 → 10/10
JETTA V 1.6 FSI	BLF	09/05 → 10/10
JETTA V 2.0 FSI	BLR, BGQ	08/05 → 10/10
JETTA V 2.0 TDI	CLCA	01/10 → 10/10
JETTA V 2.0 TFSI	CCZA	10/05 → 10/10
JETTA V 2.5	BGQ, CBZB	01/05 →
JETTA VI 1.2 TSI	CBZB, CAVA	10/10 →
JETTA VI 1.4 TSI	CAVA, CNLA	04/11 →
JETTA VI 1.4 TSI Hybrid	CNLA, CAAB	04/11 →
UP 1.0	--, A17DTJ	08/11 →
UP 1.0 EcoFuel	CPGA	11/12 →
UP 1.0 GTI	DKRA	11/17 →
MULTIVAN 2.0 BitDI	CFCA	09/09 → 08/15
MULTIVAN 2.0 BitDI 4motion	CFCA	09/09 → 08/15
MULTIVAN 2.0 TDI	CAAB, CAAE	09/09 → 08/15
MULTIVAN 2.0 TDI 4motion	CAAE, BPR	05/10 → 08/15
NEW BEETLE 2.5	BPR, CAXA	07/05 → 09/10
PASSAT V 1.4 TSI	CAXA, BLR	08/10 → 12/14
PASSAT V 1.6 FSI	BLF	03/05 → 06/08
PASSAT V 2.0 FSI	BLR, BLX	03/05 → 11/10
PASSAT V 2.0 FSI 4motion	BLX, CGPA	09/05 → 11/10
PASSAT V 3.6 R36 4motion	BWS	04/07 → 11/10
POLO IV 1.4 FSI	AXU	02/02 → 07/06
POLO V 1.2	CGPA, CBZB	06/09 →
POLO V 1.2 TSI	CBZB, CAVE	11/09 →
POLO V 1.4 GTI	CAVE, CAVD	05/10 →
POLO V 1.4 TSI	CPTA	10/12 →
POLO V 1.4 TSI [RUS]	CZCA	05/14 →
POLO V 1.6	CWVA	07/14 →
SCIROCCO III 1.4 TSI	CAVD, CDLA	05/08 →
SCIROCCO III 2.0 R	CDLA, CBBB	11/09 → 11/17
SCIROCCO III 2.0 TDI	CBBB, CAWB	08/08 → 11/17
SCIROCCO III 2.0 TSI	CAWB, CAVA	05/08 → 11/17

VW		
SHARAN II 1.4 TSI	CAVA, CAVA	05/10 →
TIGUAN I 1.4 TSI	CAVA, CAVA	05/08 →
TIGUAN I 1.4 TSI 4motion	CAVA, CASA	09/07 →
TOUAREG II 3.0 TFSI	CYJA	01/15 →
TOUAREG II 3.0 V6 TDI	CASA, CGRA	01/10 → 03/18
TOUAREG II 3.0 V6 TSI	CJTA	08/10 → 03/18
TOUAREG II 3.6 V6 FSI	CGRA, CAVC	04/10 → 03/18
TOURAN I 1.2 TSI	CBZB	05/10 → 05/15
TOURAN I 1.4 FSI	BLG	11/06 → 05/10
TOURAN I 1.4 TSI	CAVC, BSE	02/06 → 05/15
TOURAN I 1.6	BSE, BAG	07/03 → 05/10
TOURAN I 1.6 FSI	BAG, BKC	02/03 → 01/07
TOURAN I 1.9 TDI	BKC, BLX	08/03 → 05/10
TOURAN I 2.0 EcoFuel	BSX	02/06 → 05/09
TOURAN I 2.0 FSI	BLX, AZV	10/03 → 01/07
TOURAN I 2.0 TDI	AZV, --	02/03 → 05/10

10.3158  **3,5**

ABSOLUTE PRESSURE SENSORS (MAP)

Adatt./Suitable:
GENERAL MOTORS
 97 381 191
OPEL
 62 38 678
 97381191
VAUXHALL
 97381191

MARKET DIFFUSION: MEDIUM

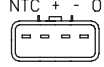

kPa	mV	NTC + - 0
30,8 - 369,2	250 - 4750	

OPEL		
ASTRA H 1.7 CDTI	A17DTJ, A17DTC	02/07 → 05/14
ASTRA J 1.7 CDTI	A17DTC, Z16SE	01/09 →
CORSA D 1.7 CDTI	Z17DTR	08/06 → 12/11
MERIVA A 1.3 CDTI	Z13DTP	09/03 → 05/10
MERIVA A 1.4 16V Twinport LPG	Z14XEP	07/04 → 05/10
MERIVA A 1.6	Z16SE, A17DTR	05/03 → 05/10
MERIVA A 1.6 16V	Z16XE	05/03 → 01/06
MERIVA A 1.7 CDTI	A17DTR, A17DT	09/06 → 05/10
MERIVA A 1.8	Y17DT	09/03 → 05/10
MERIVA A 1.7 DTI	Z18XE	05/03 → 05/10
MERIVA B 1.7 CDTI	A17DT, A17DTJ	06/10 → 01/17
ZAFIRA B 1.7 CDTI	A17DTJ, A17DTJ	01/08 → 04/15

VAUXHALL		
ASTRA V 1.7 CDTI	A17DTJ, A17DTC	01/04 → 10/12
ASTRA VI 1.7 CDTI	A17DTC, A17DTJ	12/09 →
ASTRAVAN III 1.7 CDTi	A17DTJ, A17DT	06/11 →
CORSA D 1.7 CDTI	Z17DTR	11/06 → 08/14
MERIVA I 1.3 CDTI	Z13DTP	01/03 → 10/09
MERIVA I 1.4 16V Twinport	Z14XEP	01/03 → 06/10
MERIVA I 1.7 CDTI	Z17DTR	08/06 → 06/10
MERIVA I 1.7 DTI	Y17DT	06/03 → 06/10
MERIVA II 1.7 CDTI	A17DT, A17DTJ	06/10 →
ZAFIRA B 1.7 CDTI	A17DTJ, 2KD-FTV	01/08 → 11/14

10.3163



3

ABSOLUTE PRESSURE SENSORS (MAP)

Adatt./Suitable:

DENSO

- 7470 1N20 *1
- 7470 2J08 *1

*1 without fastening damp

- senza staffa fissaggio
- sans bride de fixation
- ohne Befestigungsbügel
- sin estribo de sujeción

MINI

- 13 62 7 801 387

TOYOTA

- 89420-12210 *1
- 89420-12220 *1
- 89421-71020

MARKET DIFFUSION: MEDIUM



kPa	mV	
10 - 270,3	956,2 - 4750	

MINI			
MINI I One D	1ND-TV	06/03	⇒ 09/06
TOYOTA			
AURIS I 1.4 D-4D	1ND-TV	03/07	⇒ 04/13
COROLLA IX 1.4 D	1ND-TV	07/04	⇒ 02/07
COROLLA IX 1.4 D-4D	1ND-TV	06/04	⇒ 10/06
COROLLA IX 1.4 D4-D	1ND-TV	06/04	⇒ 10/07
COROLLA X 1.4 D-4D	1ND-TV	10/06	⇒ 07/14
DYNA 2.5 D4D	2KD-FTV, 2KD-FTV	07/01	⇒
HIACE IV 2.5 D-4D	2KD-FTV, 2KD-FTV	06/04	⇒
HIACE IV 2.5 D-4D 4WD	2KD-FTV	08/04	⇒ 09/07
HILUX 2.5 D4d	2KD-FTV	11/01	⇒ 07/05
HILUX VI 2.5 D-4D 4WD	2KD-FTV	11/01	⇒ 07/05
HILUX VII 2.5 D 4WD	2KD-FTV	08/05	⇒ 05/15
HILUX VII 2.5 D-4D	2KD-FTV, 2KD-FTV	08/05	⇒
HILUX VII 2.5 D-4D 4WD	2KD-FTV, 1KD-FTV	11/04	⇒
HILUX VII 3.0 D	1KD-FTV, 1KD-FTV	11/04	⇒
HILUX VII 3.0 D 4WD	1KD-FTV	02/05	⇒
HILUX VII 3.0 D-4D 4WD	1KD-FTV, 1KD-FTV	08/05	⇒ 05/15
LAND CRUISER 120 3.0 D-4D	1KD-FTV, 5FT(EP6DT)	09/02	⇒ 12/10
YARIS II 1.4 D-4D	1ND-TV	08/05	⇒ 12/12

10.3164



3

ABSOLUTE PRESSURE SENSORS (MAP)

Adatt./Suitable:

BOSCH

- 0 261 230 135

CITROËN

- 1920 KZ

DS

- 1920 KZ

MINI

- 13 62 7 540 508
- 7 540 508

PEUGEOT

- 1920 KZ



kPa	mV	
10 - 264,9	314 - 4750	

CITROËN			
C4 I 1.6 THP	EP6DT	06/08	⇒ 07/11
C4 I 1.6 THP 140	5FT(EP6DT), 5FX(EP6DT)	07/08	⇒ 07/11
C4 I 1.6 THP 150	5FX(EP6DT), 5FX(EP6DT)	07/08	⇒ 07/11
C4 I 1.6 Vti 120	EP6	07/08	⇒ 07/11
C4 II 1.6 THP 155	5FV(EP6CDT)	11/09	⇒
C4 GRAND PICASSO I 1.6 16V	5FT(EP6DT), 5FT(EP6DT)	07/08	⇒ 08/13
C4 GRAND PICASSO II 1.6 THP 150	5FX(EP6DT)	09/14	⇒
C4 PICASSO I 1.6 16V	5FX(EP6DT), 5FT(EP6DT)	07/08	⇒ 08/13
C4 PICASSO I 1.6 THP 140	5FT(EP6DT), 5FN(EP6CDT)	07/08	⇒ 08/13
C4 PICASSO II 1.6 THP 150	5FX(EP6DT)	09/14	⇒
CS II 1.6 THP 150	5FN(EP6CDT), 5FV(EP6CDT)	04/09	⇒
CS II 1.6 THP 155	5FV(EP6CDT), 5FM(EP6DT)	04/09	⇒
DS3 1.6	5FM(EP6DT), 5FD(EP6DTS)	01/12	⇒ 07/15
DS3 1.6 Racing	5FD(EP6DTS), 5FN(EP6CDT)	02/11	⇒ 07/15
DS3 1.6 THP 150	5FN(EP6CDT), 5FR(EP6DT)	01/10	⇒ 07/15
DS3 1.6 THP 155	5FR(EP6DT), 5GZ(EP6FDT)	04/10	⇒ 07/15
DS3 1.6 THP 165	5GZ(EP6FDT), EP6CDTM	10/14	⇒ 07/15
DS4 1.6 THP 150	EP6CDTMD	04/11	⇒ 07/15
DS4 1.6 THP 155	5FV(EP6CDT)	04/11	⇒ 07/15
DS4 1.6 THP 160	EP6CDTM	04/12	⇒ 07/15
DS4 1.6 THP 165	EP6CDTM, N14B16A	01/12	⇒ 07/15
DS5 1.6 THP 150	EP6CDTMD	11/11	⇒ 07/15
DS5 1.6 THP 155	5FV(EP6CDT)	11/11	⇒ 07/15
DS5 1.6 THP 165	EP6CDTMD	01/12	⇒ 07/15
DS			
DS3 1.6 THP	EP6FDTM	07/15	⇒
DS3 1.6 THP 165	5GZ(EP6FDT)	07/15	⇒
DS4 / DS4 CROSSBACK 1.6 THP 150	EP6CDTMD	10/16	⇒
MINI			
MINI II Cooper S	N14B16A, N14B16A	10/06	⇒ 06/14
MINI II Cooper S John Cooper Works	N14B16A, 5FY(EP6DTS)	11/06	⇒ 02/10
PEUGEOT			
207 1.6 16V RC	5FY(EP6DTS), 5FR(EP6DT)	02/07	⇒
207 1.6 16V Turbo	5FR(EP6DT), 5FR(EP6DT)	02/06	⇒
207 CC 1.6 16V Turbo	5FR(EP6DT), 5FV(EP6CDT)	02/07	⇒
308 I 1.6 16V	5FT(EP6DT), EP6CDTM	09/07	⇒
308 I 1.6 THP	EP6CDTM, EP6CDTMD	01/11	⇒
308 II 1.6	5GZ(EP6FDT)	01/12	⇒
308 II 1.6 THP 150	EP6FDTMD	03/14	⇒
508 I 1.6	5GZ(EP6FDT)	01/12	⇒
508 I 1.6 THP	EP6CDTM	05/11	⇒
3008 1.6 THP	5FV(EP6CDT), EP6CDTM	06/09	⇒
3008 1.6 Turbo	EP6CDTM, 5FT(EP6DT)	05/14	⇒ 08/16
5008 1.6 16V	EP6CDT	09/09	⇒
5008 1.6 THP 150	EP6CDTMD, EDJ	02/12	⇒
5008 1.6 THP 163	EP6CDTM	02/12	⇒
RCZ 1.6 16V	EP6CDT	03/10	⇒ 12/15
RCZ 1.6 THP	EP6CDTM	01/11	⇒
RCZ 1.6 THP 150	5FE(EP6CDTMD)	03/11	⇒ 12/15

10.3165



3

ABSOLUTE PRESSURE SENSORS (MAP)

Adatt./Suitable:

BOSCH

- 0 261 230 143
- 0 261 230 144
- 0 261 230 193
- 0 261 230 194

CHRYSLER

- 5117545AA
- 71775581
- K05117545AA
- K68066040AA

JEEP

- 5117545AA
- 71775581
- K05117545AA
- K68066040AA

MERCEDES-BENZ

- 0061531528
- 0061539928
- A 004 153 84 28
- A 006 153 15 28
- A 006 153 99 28

MITSUBISHI

- MN960275
- MN960418

SMART

- A 004 153 84 28
- A 006 153 15 28
- A 006 153 99 28

MARKET DIFFUSION: HIGH



kPa	mV	
34,4 - 315,6	399 - 4654	

CHRYSLER			
300C I 3.0 CRD	EXL	09/05	⇒ 11/12
300C I 3.0 V6 CRD	EXL	11/10	⇒ 11/12
300C II 3.0 CRD	EXL	09/05	⇒ 12/10
PT CRUISER 2.2 CRD	EDJ, EXL	03/02	⇒ 12/10
JEEP			
COMMANDER 3.0 CRD 4x4	EXL, EXL	09/05	⇒ 12/10
GRAND CHEROKEE 3.0 CRD	EXL	06/05	⇒ 12/10
GRAND CHEROKEE 3.0 CRD 4x4	EXL, OM611.962	06/05	⇒ 12/10
MERCEDES-BENZ			
CLASSE A II A 160 CDI	OM640.942	09/04	⇒ 06/12
CLASSE A II A 180 CDI	OM640.940	09/04	⇒ 06/12
CLASSE A II A 200 CDI	OM640.941	09/04	⇒ 06/12
CLASSE B I B 180 CDI	OM640.940	03/05	⇒ 11/11
CLASSE B I B 200 CDI	OM640.941	03/05	⇒ 11/11
CLASSE C II C 200 CDI	OM611.962, OM646.811	02/01	⇒
CLASSE C II C 220 CDI	OM646.963	02/03	⇒ 05/08
CLASSE C II C 320 CDI	OM642.910	01/05	⇒ 08/07
CLASSE C III C 200 CDI	OM646.811, OM642.830	01/07	⇒ 12/11
CLASSE C III C 220 CDI	OM646.811	01/07	⇒ 11/08
CLASSE C III C 300 CDI 4-matic	OM642.832	01/11	⇒ 01/14
CLASSE C III C 320 CDI	OM642.960	01/07	⇒ 08/14
CLASSE C III C 320 CDI 4-matic	OM642.961	08/07	⇒ 12/11
CLASSE C III C 350 CDI	OM642.830, OM642.832	08/07	⇒ 08/14
CLASSE C III C 350 CDI 4-matic	OM642.832, OM646.962	08/07	⇒ 08/14
CLASSE CLC CLC 200 CDI	OM646.962, OM642.852	05/08	⇒ 06/11
CLASSE CLC CLC 220 CDI	OM646.963	05/08	⇒ 06/11
CLASSE CLK II 220 CDI	OM646.966	01/05	⇒ 05/09
CLASSE CLK II 320 CDI	OM642.910	01/05	⇒ 05/09
CLASSE CLK II CLK 320 CDI	OM642.910	03/05	⇒ 03/10
CLASSE CLS I CLS 320 CDI	OM642.920	01/05	⇒ 12/10
CLASSE CLS I CLS 350 CDI	OM642.920	04/09	⇒ 12/10
CLASSE CLS II CLS 350 BlueTEC	OM642.852	05/14	⇒
CLASSE CLS II CLS 350 BlueTEC / d	OM642.852, OM642.854	11/12	⇒
CLASSE CLS II CLS 350 BlueTEC / d 4-matic	OM642.854, OM642.854	11/12	⇒

MERCEDES-BENZ		
CLASSE CLS II CLS 350 BlueTEC 4-matic	OM642.854	01/13 →
CLASSE CLS II CLS 350 CDI / d 4-matic	OM642.853	01/11 →
CLASSE CLS II CLS 350 CDI / d 4-matic	OM642.854	09/11 →
CLASSE CLS II CLS 350 d 4-matic	OM642.854, OM646.821	04/15 →
CLASSE E III E 200 CDI	OM646.820, OM646.821	07/02 → 07/09
CLASSE E III E 220 CDI	OM646.821, OM646.821	03/02 → 07/09
CLASSE E III E 220 T CDI	OM646.821, OM642.920	03/03 → 07/09
CLASSE E III E 270 CDI	OM647.961	03/02 → 12/08
CLASSE E III E 270 T CDI	OM647.961	03/03 → 07/09
CLASSE E III E 280 CDI	OM642.920, OM642.920	05/04 → 12/08
CLASSE E III E 280 CDI 4-matic	OM642.921	03/05 → 12/08
CLASSE E III E 280 T CDI	OM642.920, OM642.920	05/04 → 07/09
CLASSE E III E 280 T CDI 4-matic	OM642.921	03/05 → 07/09
CLASSE E III E 300 BlueTEC	OM642.920	09/07 → 12/08
CLASSE E III E 320 CDI	OM642.920, OM642.920	11/02 → 12/08
CLASSE E III E 320 CDI 4-matic	OM642.921	03/05 → 12/08
CLASSE E III E 320 T CDI	OM642.920, OM642.850	03/05 → 07/09
CLASSE E III E 320 T CDI 4-matic	OM642.921	03/05 → 07/09
CLASSE E III E 420 CDI	OM629.910	01/06 → 12/08
CLASSE E IV E 300 BlueTEC	OM642.852	03/11 →
CLASSE E IV E 300 CDI	OM642.850, OM642.850	12/09 →
CLASSE E IV E 300 CDI / BlueTEC	OM642.850, OM642.838	11/09 →
CLASSE E IV E 350 BlueTEC	OM642.838, OM642.852	01/09 →
CLASSE E IV E 350 BlueTEC / d 4-matic	OM642.838	05/14 →
CLASSE E IV E 350 BlueTEC 4-matic	OM642.852, OM642.836	11/12 →
CLASSE E IV E 350 BlueTEC / d 4-matic	OM642.838	05/14 →
CLASSE E IV E 350 CDI	OM642.836, OM642.856	01/09 →
CLASSE E IV E 350 CDI 4-matic	OM642.856, OM642.822	09/09 →
CLASSE E V E 350 d	OM642.855	01/16 →
CLASSE E V E 350 d 4-matic	OM642.873	06/17 →
CLASSE E E 220 CDI	OM646.821, OM647.961	10/03 → 07/09
CLASSE E E 270 CDI	OM647.961, OM646.820	03/03 → 07/09
CLASSE E E 280 CDI	OM642.920	08/05 → 07/09
CLASSE G II G 280 CDI	OM642.975	04/09 →
CLASSE G II G 300 CDI	OM642.884	01/10 →
CLASSE G II G 320 CDI	OM642.970	09/06 →
CLASSE G II G 350 BlueTEC	OM642.970	07/09 →
CLASSE G II G 350 CDI	OM642.886	07/11 →
CLASSE GL I GL 320 CDI / 350 BlueTEC 4-matic	OM642.820	12/09 →
CLASSE GL I GL 320 CDI 4-matic	OM642.940	09/06 → 05/09
CLASSE GL I GL 320 CDI BlueTEC 4-matic	OM642.820	12/09 →
CLASSE GL I GL 350 CDI 4-matic	OM642.822, OM642.824	05/09 →
CLASSE GL I GL 420 CDI 4-matic	OM629.912	09/06 → 05/09
CLASSE GL I GL 450 CDI 4-matic	OM629.912	05/09 →
CLASSE GL II GL 350 CDI / BlueTEC 4-matic	OM642.826	07/12 → 10/15
CLASSE GLC 350 d 4-matic	OM642.873	10/16 →
CLASSE GLE 350 d 4-matic	OM642.824, OM642.832	03/15 →
CLASSE GLK 320 CDI 4-matic	OM642.961	06/08 → 06/15
CLASSE GLK 350 CDI 4-matic	OM642.832, OM642.826	07/09 →
CLASSE GLS 350 d 4-matic	OM642.826, OM642.820	11/15 →
CLASSE M II ML 280 CDI 4-matic	OM642.940	07/05 → 07/09
CLASSE M II ML 300 CDI 4-matic	OM642.820, OM642.820	07/09 → 12/11
CLASSE M II ML 320 CDI 4-matic	OM642.820, OM642.820	07/05 →
CLASSE M II ML 350 CDI 4-matic	OM642.820, OM642.870	07/09 → 12/11
CLASSE M II ML 420 CDI 4-matic	OM629.912	02/06 → 09/09
CLASSE M II ML 450 CDI 4-matic	OM629.912	09/09 → 12/11
CLASSE M III ML 350 BlueTEC 4-matic	OM642.826	06/11 → 02/15
CLASSE M III ML 350 CDI BlueEfficiency 4-matic	OM642.826	02/12 →
CLASSE R R 280 CDI	OM642.870, OM642.870	05/06 →
CLASSE R R 280 CDI 4-matic	OM642.950	05/06 →
CLASSE R R 300 CDI	OM642.870, OM642.870	07/09 →
CLASSE R R 300 CDI 4-matic	OM642.950	07/09 →
CLASSE R R 320 CDI 4-matic	OM642.870, OM642.870	01/06 →
CLASSE R R 350 CDI 4-matic	OM642.870, OM642.932	01/06 →
CLASSE S IV S 320 CDI	OM648.960	09/02 → 08/05
CLASSE S V S 320 CDI	OM642.930	10/05 → 12/13

MERCEDES-BENZ		
CLASSE SV S 320 CDI 4-matic	OM642.932, OM642.932	10/05 → 12/13
CLASSE SV S 350 BlueTEC	OM642.862	04/11 → 12/13
CLASSE SV S 350 BlueTEC 4-matic	OM642.868	04/11 → 12/13
CLASSE SV S 350 CDI	OM642.930	06/09 → 12/13
CLASSE SV S 350 CDI 4-matic	OM642.932, OM642.824	01/09 → 07/13
CLASSE SV S 420 CDI	OM629.911	10/06 → 12/09
CLASSE SV S 450 CDI	OM629.911	01/09 → 12/13
CLASSE SV S350 CDI [ExtraEU]	OM642.930	06/09 → 12/13
CLASSE SVI S 350 BlueTEC / d 4-matic	OM642.861	05/13 →
CLASSE SVI S 350 BlueTEC / d 4-matic	OM642.867	02/14 →
CLASSE SVI S 350 BlueTEC 4-matic	OM642.867	02/14 →
CLASSE SVI S 350 CDI	OM642.861	05/13 →
CLASSE XX 350 d 4-matic	OM642.889	07/18 →
CLC-SERIES CLC220 CDI	OM646.963	05/08 → 06/11
CLS-SERIES CLS350 BlueTEC	OM642.852	05/14 → 12/17
C-SERIES C300 CDI/CDi BlueEFFICIENCY	OM642.832	01/11 → 01/14
GLE-SERIES GLE350	OM642.824, OM646.986	04/15 →
ML-SERIES ML350 -/BlueTec [ExtraEU]	OM642.826	06/11 → 02/15
SPRINTER II 209 CDI	OM646.984	06/06 → 12/09
SPRINTER II 211 CDI	OM646.985	06/06 → 12/09
SPRINTER II 213 CDI	OM646.986	06/06 → 12/09
SPRINTER II 215 CDI	OM646.986, OM642.896	06/06 → 12/09
SPRINTER II 218 CDI	OM642.896, OM642.896	06/06 → 12/09
SPRINTER II 219 CDI / BlueTEC	OM642.896, OM646.986	03/09 →
SPRINTER II 219 CDI	OM646.984	06/06 → 12/09
SPRINTER II 311 CDI	OM646.701	06/06 →
SPRINTER II 311 CDI 4x4	OM646.985	02/08 → 12/09
SPRINTER II 313 CDI	OM646.986	06/06 →
SPRINTER II 315 CDI	OM646.986, OM646.986	06/06 → 12/09
SPRINTER II 315 CDI 4x4	OM646.986, OM642.896	02/08 → 12/09
SPRINTER II 318 CDI	OM642.896, OM642.896	06/06 → 12/09
SPRINTER II 318 CDI 4x4	OM642.896, OM642.896	02/08 → 12/09
SPRINTER II 319 CDI / BlueTEC	OM642.896, OM642.896	03/09 →
SPRINTER II 319 CDI / BlueTEC 4x4	OM642.896, OM646.986	03/09 →
SPRINTER II 411 CDI	OM646.701	06/09 →
SPRINTER II 413 CDI	OM646.986, OM646.986	06/06 →
SPRINTER II 415 CDI	OM646.986, OM642.896	06/06 → 12/09
SPRINTER II 418 CDI	OM642.896, OM642.896	06/06 → 05/16
SPRINTER II 419 CDI	OM642.896, OM646.986	03/09 →
SPRINTER II 509 CDI	OM646.984	06/06 → 12/09
SPRINTER II 510 CDI	OM651.955	03/09 →
SPRINTER II 511 CDI	OM646.985	06/06 → 12/09
SPRINTER II 511 CDI 4x4	OM646.985	06/06 → 12/09
SPRINTER II 515 CDI	OM646.986, OM646.986	06/06 → 12/09
SPRINTER II 515 CDI 4x4	OM646.986, OM642.896	06/06 → 12/09
SPRINTER II 518 CDI	OM642.896, OM642.896	06/06 → 12/09
SPRINTER II 518 CDI 4x4	OM642.896, OM642.896	06/06 → 12/09
SPRINTER II 519 CDI / BlueTEC	OM642.896, OM642.896	03/09 →
SPRINTER II 519 CDI / BlueTEC 4x4	OM642.896, OM642.896	03/09 →
SPRINTER SERIES Sprinter 213D CDI	OM646.986	04/12 →
SPRINTER SERIES Sprinter 318D CDI	OM642.896, OM646.981	03/09 →
VIANO CDI 2.0	OM646.981, OM642.890	08/05 →
VIANO CDI 2.0 4-matic	OM646.982	03/06 →
VIANO CDI 3.0	OM642.890, OM646.980	03/06 →
VITO II 109 CDI	OM646.980, OM646.980	08/06 →
VITO II 109 CDI 4x4	OM646.981	09/07 →
VITO II 111 CDI	OM646.980, OM646.980	11/06 →
VITO II 115 CDI	OM646.980, 605960	09/03 →
VITO II 120 CDI	OM642.990	07/06 →
VITO II 122 CDI	OM642.890	09/10 →
MITSUBISHI		
COLT VI 1.5 DiD	605910	08/04 → 06/12
COLT VI 1.5 Di-D	605960, F9Q803	08/04 → 06/12
SMART		
FORFOUR 1.5 CDI	OM639.939	09/04 → 06/06
FORTWO II 0.8 CDI	OM660.951	08/09 →

10.3167

3,5

ABSOLUTE PRESSURE SENSORS (MAP)

Adatt./Suitable:

BOSCH
0 281 002 709**RENAULT**
22 36 507 54R
82 00 375 080
82 00 375 977**SUZUKI**
18590-67JAO
18590-67JAO-000

MARKET DIFFUSION: MEDIUM



kPa	mV	+	-
45 - 370	420 - 4740		

RENAULT

GRAND SCÉNIC II 1.9 dCi	F9Q803, F9Q758	04/04 →
LAGUNA II 1.9 dCi	F9Q758, F9Q800	01/05 → 12/07
MEGANE II 1.9 dCi	F9Q800, F9Q816	11/02 →
SCÉNIC II 1.9 dCi	F9Q803, F9Q8	06/03 →
SCÉNIC II 1.9 dCi 130	F9Q804	10/05 → 12/09
SCENIC 1.9 dCi	F9Q816, F9Q803	06/07 → 11/08

SUZUKI

GRAND VITARA II 1.9 DDiS	F9QB	03/06 → 08/08
GRAND VITARA II 1.9 DDiS Trazione integrale	F9QB, P4JA	10/05 → 02/15

10.3171

3,5

ABSOLUTE PRESSURE SENSORS (MAP)

Adatt./Suitable:

BOSCH
0 261 230 099
0 261 230 100
0 261 230 299
0 261 230 333
0 261 230 334**CITROËN**
16 075 787 80**FIAT**
77363801**FORD**
1 751 185
CV2A-9F479-AA**HONDA**
37830-PWE-G01**LADA**
21800-1413010-00
2180-1413010**MITSUBISHI**
1865A201**PEUGEOT**
16 075 787 80

MARKET DIFFUSION: MEDIUM



kPa	mV	O + NTC -
10 - 117,3	405 - 4750	

CITROËN

C4 AIRCROSS 1.6	4A92	04/12 →
-----------------	------	---------

FIAT			
STILO 1.6	192B3.000	04/05 → 08/08	
STILO 1.6 16V	192B3.000	03/05 → 12/07	
FORD			
FIESTA VI 1.0	P4JA, XPIA	10/12 →	
FIESTA VII 1.1	XPJA, R9DA	01/17 →	
FOCUS III 2.0 ST	R9DA, B2KA	07/12 →	
KA+ 1.2	B2KA, YSKD	06/16 →	
KA+ 1.2 Ti-VCT	YSKD, --	06/16 →	
KUGA II 1.6 EcoBoost	--, JQMA	01/13 →	
KUGA II 1.6 EcoBoost 4x4	JQMA, M1CA	10/12 →	
MONDEO IV 1.0 EcoBoost	M1CA, L12A1	02/15 →	
HONDA			
JAZZ I 1.2 i-DSI	L12A1, L13A1	03/02 → 07/08	
JAZZ I 1.3	L13A1, L13A1	03/02 → 07/08	
JAZZ I 1.4 iDSI	L13A1, 4A92	12/06 → 10/08	
JAZZ II 1.2	L12A4	01/06 →	
JAZZ II 1.4	L13A6	01/06 →	
LADA			
KALINA 1.6	21127	06/13 →	
MITSUBISHI			
ASX 1.6 LPG	4A92	06/10 →	
ASX 1.6 MIVEC	4A92, 4A90	05/10 →	
COLT VI 1.1	3A91	10/04 → 06/12	
COLT VI 1.1 LPG	3A91	10/04 → 06/12	
COLT VI 1.3	4A90, --	06/04 →	
COLT VI 1.3 4WD	4A90	08/04 →	
COLT VI 1.3 LPG	4A90	06/04 → 06/12	
LANCER IX 1.5	4A91	06/08 →	
LANCER IX 1.5 Bifuel	4A91	02/10 →	
LANCER IX 1.6 MIVEC	4A92	05/10 →	
PEUGEOT			
4008 1.6	--, D4F784	05/12 →	

10.3173  **3**

ABSOLUTE PRESSURE SENSORS (MAP)

Adatt./Suitable:

- BOSCH**
0 281 002 616
- RENAULT**
22 36 585 70R
82 00 233 831



kPa	mV	
11,6 - 254,9	250 - 4750	

RENAULT			
CLIO III 1.2	D4F784	11/07 → 12/11	
CLIO III 1.2 16V	D4F784, F4R794	05/07 →	
CLIO III 1.2 16V Hi-Flex	D4F740	07/08 →	
ESPACE IV 2.0	F4R794, F4R794	04/05 →	
ESPACE IV 2.0 Turbo	F4R794, F4R784	11/02 →	
GRAND SCÉNIC II 2.0	F4R776	04/04 →	
LAGUNA II 2.0 16V	F4R784, F4R764	01/05 → 09/07	
LAGUNA II 2.0 16V Turbo	F4R764, F4R811	01/03 → 08/05	
LAGUNA III 2.0	F4R813	02/08 →	
LAGUNA III 2.0 16V Turbo	F4R811, F4R800	10/07 → 12/15	
LAGUNA III 2.0 GT	F4R800, F4R774	03/08 → 12/15	
MEGANE II 2.0	F4R770	08/06 → 01/11	
MEGANE II 2.0 16V Turbo	F4R776	05/04 → 03/09	
MEGANE II 2.0 Renault Sport	F4R774, F4R770	05/04 → 10/09	
MODUS / GRAND MODUS 1.2	D4F786	04/11 →	
MODUS / GRAND MODUS 1.2 16V	D4F784	05/07 →	
SCÉNIC II 2.0	F4R770, D4F780	06/03 → 07/10	
SCÉNIC II 2.0 16V Turbo	F4R776	05/04 →	
TWINGO II 1.2 TcE 100	D4F780, D4F780	02/11 →	
TWINGO II 1.2 Turbo	D4F780, F4R766	03/07 →	
VEL SATIS 2.0 16V Turbo	F4R766, F4R762	04/04 →	
VEL SATIS 2.0 16V Turbo	F4R762, F4R767	06/02 →	
VEL SATIS 2.0 Turbo	F4R767, D4F780	04/05 →	
WIND 1.2	D4F780, ENE	07/10 →	
WIND 1.2 TcE 100	D4F780	02/11 →	

10.3175  **3**

ABSOLUTE PRESSURE SENSORS (MAP)

Adatt./Suitable:

- BOSCH**
0 261 230 153
0 261 230 154
0 261 230 195
0 261 230 196
0 261 230 439
0 261 230 440
- INFINITI**
22365-HG00A
22365-HG00C
- JEEP**
68089600AA
68089605AA
K68089600AA
K68089600AB
K68089605AA
- MERCEDES-BENZ**
0061531628
0071530028
0101537228
A 006 153 16 28
A 007 153 00 28
A 010 153 72 28
- MOPAR PARTS**
68089600AB

MARKET DIFFUSION: **HIGH**



kPa	mV	
28,9 - 400	250 - 4480	

INFINITI			
Q50 50 D	OM651	04/13 →	
Q70 2.2 D	OM651	10/14 →	
JEEP			
COMPASS 2.2 CRD	ENE	05/11 →	
COMPASS 2.2 CRD 4x4	ENE, OM651.901	12/10 →	
PATRIOT 2.2 CRD	ENE	01/11 →	
PATRIOT 2.2 CRD 4x4	ENE	01/11 →	
MERCEDES-BENZ			
CLASSE V V 200 CDI / d	OM651.950	03/14 →	
CLASSE V V 200 CDI / d 4-matic	OM651.950	04/15 →	
CLASSE V V 220 CDI / d	OM651.950	03/14 →	
CLASSE V V 220 CDI / d 4-matic	OM651.950	04/15 →	
CLASSE V V 250 BlueTEC / d	OM651.950	03/14 →	
CLASSE V V 250 BlueTEC / d 4-matic	OM651.950	12/14 →	
CLASSE A III A 180 CDI	OM651.901, OM651.901	06/12 →	
CLASSE A III A 200 CDI	OM651.901	06/12 →	
CLASSE A III A 220 CDI	OM651.930	09/12 →	
CLASSE A III A 220 d 4-matic	OM651.930	07/15 →	
CLASSE B II B 180 CDI	OM651.901, OM651.911	11/11 →	
CLASSE B II B 200 CDI	OM651.901	11/11 →	
CLASSE B II B 220 CDI / d	OM651.930	11/11 →	
CLASSE C III C 180 CDI	OM651.913	01/11 → 08/14	
CLASSE C III C 200 CDI	OM651.913	08/10 → 08/14	
CLASSE C III C 220 CDI	OM651.911, OM651.921	10/08 →	
CLASSE C III C 220 CDI 4-matic	OM651.912	02/13 → 08/14	
CLASSE C III C 250 CDI	OM651.911	08/08 →	
CLASSE C III C 250 CDI 4-matic	OM651.912	04/10 → 08/14	
CLASSE C IV C 200 d	OM651.921	10/15 →	
CLASSE C IV C 220 BlueTEC / d	OM651.921, OM651.913	12/13 →	
CLASSE C IV C 220 d	OM651.921	10/15 →	
CLASSE C IV C 220 d 4-matic	OM651.921	04/15 →	
CLASSE C IV C 250 BlueTEC / d	OM651.921	02/14 →	
CLASSE C IV C 250 BlueTEC / d 4-matic	OM651.921	02/14 →	
CLASSE C IV C 250 d	OM651.921	10/15 →	
CLASSE C IV C 250 d 4-matic	OM651.921	04/16 →	
CLASSE C IV C 300 BlueTEC Hybrid / h	OM651.921	05/14 →	

MERCEDES-BENZ			
CLASSE CLA CLA 220 CDI / d	OM651.930	01/13 →	
CLASSE CLS II CLS 220 BlueTEC / d	OM651.924	05/14 →	
CLASSE CLS II CLS 250 BlueTEC / d 4-matic	OM651.924	05/14 →	
CLASSE CLS II CLS 250 CDI / BlueTEC / d	OM651.924	04/11 →	
CLASSE E IV E 200 CDI / BlueTEC	OM651.925	01/09 →	
CLASSE E IV E 220 BlueTEC	OM651.911	05/14 →	
CLASSE E IV E 220 BlueTEC 4-matic	OM651.924	12/14 →	
CLASSE E IV E 220 CDI	OM651.911	01/09 →	
CLASSE E IV E 220 CDI / BlueTEC	OM651.924	01/09 →	
CLASSE E IV E 220 CDI / BlueTEC / d	OM651.911	01/10 →	
CLASSE E IV E 220 CDI / d	OM651.911	01/10 →	
CLASSE E IV E 250 BlueTEC	OM651.911	01/09 →	
CLASSE E IV E 250 CDI / BlueTEC	OM651.924	01/09 →	
CLASSE E IV E 250 CDI / BlueTEC / d	OM651.911	01/09 →	
CLASSE E IV E 250 CDI / BlueTEC 4-matic	OM651.924	01/09 →	
CLASSE E IV E 300 Hybrid / BlueTEC Hybrid	OM651.924	12/11 →	
CLASSE GLC 220 d 4-matic	OM651.921	06/15 →	
CLASSE GLC 250 d 4-matic	OM651.921	06/15 →	
CLASSE GLE 250 d	OM651.960	04/15 →	
CLASSE GLE 250 d 4-matic	OM651.960	04/15 →	
CLASSE GLK 200 CDI	OM651.913, OM651.950	07/10 → 06/15	
CLASSE GLK 220 CDI	OM651.916	12/08 → 06/15	
CLASSE GLK 220 CDI 4-matic	OM651.912	12/08 → 06/15	
CLASSE GLK 250 CDI 4-matic	OM651.912	09/09 → 06/15	
CLASSE M III ML 250 CDI / BlueTEC 4-matic	OM651.960	06/11 → 12/15	
CLASSE S V S 250 CDI	OM651.961	01/11 → 12/13	
CLASSE S VI S 300 BlueTEC Hybrid / h	OM651.921	02/14 →	
CLASSE SLC 250 d	OM651.980	01/16 → 10/17	
CLASSE SLK III 250 CDI / d	OM651.980	01/12 →	
C-SERIES C200 Cdi	OM651.913	01/10 → 01/14	
SPRINTER II 210 CDI	OM651.955	03/09 →	
SPRINTER II 211 CDI	OM651.955	04/16 →	
SPRINTER II 213 CDI	OM651.955, OM651.955	06/06 →	
SPRINTER II 214 CDI	OM651.955	04/16 →	
SPRINTER II 216 CDI	OM651.955, OM642.896	06/06 →	
SPRINTER II 219 CDI / BlueTEC	OM642.896, OM651.955	03/09 →	
SPRINTER II 310 CDI	OM651.955, OM651.955	03/09 →	
SPRINTER II 311 CDI	OM651.955	05/16 →	
SPRINTER II 313 CDI	OM651.955, OM651.955	06/06 →	
SPRINTER II 313 CDI 4x4	OM651.955, OM651.955	06/06 →	
SPRINTER II 314 CDI	OM651.955	05/16 →	
SPRINTER II 314 CDI 4x4	OM651.955	05/16 →	
SPRINTER II 316 CDI	OM651.955, OM651.955	03/09 →	
SPRINTER II 316 CDI 4x4	OM651.955, OM651.955	03/09 →	
SPRINTER II 413 CDI	OM651.955, OM646.986	06/06 → 05/16	
SPRINTER II 414 CDI	OM651.955	05/16 →	
SPRINTER II 416 CDI	OM651.957	03/09 →	
SPRINTER II 510 CDI	OM651.955	03/09 →	
SPRINTER II 511 CDI	OM651.955	05/16 →	
SPRINTER II 513 CDI	OM646.986, OM651.955	06/06 →	
SPRINTER II 513 CDI 4x4	OM651.955, OM651.955	06/06 →	
SPRINTER II 514 CDI	OM651.955	05/16 →	
SPRINTER II 514 CDI 4x4	OM651.955	05/16 →	
SPRINTER II 516 CDI	OM651.955, OM651.955	03/09 →	
SPRINTER II 516 CDI 4x4	OM651.955, M9T694	06/06 →	
SPRINTER 211 CDI	OM651.950, OM651.950	02/18 →	
SPRINTER 214 Cdi	OM651.950, OM651.950	02/18 →	
SPRINTER 311 CDI	OM651.950, OM651.950	02/18 →	
SPRINTER 314 CDI	OM651.950, OM651.950	02/18 →	
SPRINTER 316 CDI	OM651.958	02/18 →	
SPRINTER 411 CDI	OM651.950, OM651.950	02/18 →	
SPRINTER 414 CDI	OM651.950, OM651.955	02/18 →	
SPRINTER 416 CDI	OM651.958	02/18 →	
SPRINTER 511 CDI	OM651.958	02/18 →	
SPRINTER 514 CDI	OM651.958	02/18 →	
SPRINTER 516 CDI	OM651.958	02/18 →	
SPRINTER SERIES Sprinter 213D Cdi	OM646.986	04/12 →	
SPRINTER SERIES Sprinter 411D Cdi/Cdi BlueEFFICIENCY	OM651.955	04/16 →	
SPRINTER SERIES Sprinter 414D Cdi	OM651.955	04/16 →	
SPRINTER SERIES Sprinter 416D Cdi	OM651.957	11/13 →	

MERCEDES-BENZ		
SPRINTER SERIES Sprinter 519D CDI	OM651.957	03/09 →
VIANO CDI 2.0	OM651.940	07/10 →
VIANO CDI 2.0 4-matic	OM651.940	07/10 →
VIANO CDI 2.2	OM651.940	07/10 →
VIANO CDI 2.2 4-matic	OM651.940	07/10 →
VITO II 110 CDI	OM651.940	09/10 →
VITO II 113 CDI	OM651.940	09/10 →
VITO II 113 CDI 4x4	OM651.940	09/10 →
VITO II 116 CDI	OM651.940	09/10 →
VITO II 116 CDI 4x4	OM651.940	09/10 →
VITO III 114 CDI	OM651.950	10/14 →
VITO III 114 CDI 4x4	OM651.950	07/15 →
VITO III 116 CDI	OM651.950	10/14 →
VITO III 116 CDI / 116 BlueTEC	OM651.950	10/14 →
VITO III 116 CDI / 116 BlueTEC 4x4	OM651.950	07/15 →
VITO III 116 CDI 4x4	OM651.950	07/15 →
VITO III 119 BlueTEC	OM651.950	10/14 →
VITO III 119 BlueTEC 4x4	OM651.950	12/14 →
VITO III 119 CDI / 119 BlueTEC 4x4	OM651.950	12/14 →
VITO III 119 CDI / BlueTEC	OM651.950	10/14 →
VITO III 119 CDI / BlueTEC 4x4	OM651.950	07/15 →
VITO-SERIES Vito 114 BlueTEC	OM651.950	07/15 →
VITO-SERIES Vito 114 BlueTEC/CDi/CDi BlueEFFICIENCY	OM651.950	10/14 →
VITO-SERIES Vito 200 CDI BlueEFFICIENCY	OM651.950	03/15 →
VITO-SERIES Vito 200 CDI/CDi BlueEFFICIENCY	OM651.950	03/15 →

10.3176

3,5

ABSOLUTE PRESSURE SENSORS (MAP)

Adatt./Suitable:

00 Eliminated on 26-11-2018. Please verify the availability through our local distributors

- Eliminato il 26-11-2018. Verificare la disponibilità presso i nostri distributori
- Éliminé le 26-11-2018. Vérifier la disponibilité auprès de nos distributeurs sur place
- Am 26-11-2018 gestrichen. Evtl. Verfügbarkeit bitte bei unseren Händlern prüfen
- Eliminado en fecha 26-11-2018. Verificar la disponibilidad a través de nuestros distribuidores locales

1006 After depletion of stock this part is replaced by:

- Esaurite le scorte questo pezzo sarà sostituito da:
- Après épuisement du stock, cette pièce est remplacée par:
- Nach Vorraterschöpfung wird ersetzt durch:
- Despues agotamiento stock, sera sustituido por:

10.3092



kPa	mV	O + NTC -
20 - 253	390 - 4700	

10.3177

3

ABSOLUTE PRESSURE SENSORS (MAP)

Adatt./Suitable:

BOSCH

0 281 002 740
0 281 002 958
0 281 002 961

GENERAL MOTORS

93 168 455

INFINITI

22365-5X20A

NISSAN

01131-00Q0B
22365-5X20A
22630-00Q0E
23731-00Q0H
23731-00Q0L
82006-85363

OPEL

44 20 747
93168455

RENAULT

77 01 062 395
82 00 092 433
82 00 685 363

SUZUKI

18590-80KA0
18590-80KA0-000
18590-80KA1
18590-80KA1-000
18590-80KCO
18590-80KCO-000

VAUXHALL

93168455

MARKET DIFFUSION: MEDIUM



kPa	mV	O - +
31,1 - 372	250 - 4750	

INFINITI		
FX 30d AWD	V9X	04/10 →
NISSAN		
NAVARA II 3.0 dCi	V9X	03/10 →
NAVARA II 3.0 dCi 4WD	V9X	02/10 →
NV400 2.3 dCi 145 RWD	M9T694, M9T	11/11 → 02/14
NV400 2.3 dCi 150	M9T880	02/14 → 09/16
NV400 2.3 dCi 165	M9T, M9T670	06/14 → 09/16
NV400 dCi 100	M9T670, --	11/11 → 06/14
NV400 dCi 110	--, M9T670	06/14 →
NV400 dCi 125	M9T670, M9T686	11/11 → 09/16
NV400 dCi 125 RWD	M9T686, --	11/11 → 09/16
NV400 dCi 140	--, M9T696	06/14 → 09/16
NV400 dCi 140 RWD	M9T696, M9T678	06/14 → 09/16
NV400 dCi 145	M9T678, M9T694	11/11 → 06/16
NV400 dCi 145 RWD	M9T694, M9T	11/11 → 06/16
NV400 dCi 150	M9T880	02/14 → 09/16
NV400 dCi 150 RWD	M9T880	02/14 → 09/16
NV400 dCi 160	M9T, M9T	06/14 → 09/16
NV400 dCi 165	M9T, M9T	06/14 → 06/16
NV400 dCi 165 RWD	M9T, M9R630	06/14 →
NV400 dCi 170	M9T	07/15 →
PATHFINDER III 3.0 dCi	V9X	05/10 →
PRIMASTAR 2.0 dCi 115	M9R630, M9R630	09/06 →
PRIMASTAR 2.0 dCi 90	M9R630, M9R630	09/06 →
PRIMASTAR dCi 120	M9R630, M9R630	09/06 →
PRIMASTAR dCi 90	M9R630, M1D	09/06 →
QASHQAI I 2.0 dCi	M1D, M1D	02/07 → 12/13
QASHQAI I 2.0 dCi Trazione integrale	M1D, M9R	02/07 → 12/13
QASHQAI II 1.6 dCi	R9M	11/13 →
QASHQAI II 1.6 dCi ALL MODE 4x4-i	R9M	11/13 →
X-TRAIL 2.0 dCi [ExtraEU]	M9R760	10/09 → 02/14
X-TRAIL II 2.0 dCi	M9R760	06/07 → 11/13
X-TRAIL II 2.0 dCi 4x4	M9R, M9T670	06/07 → 11/13
X-TRAIL II 2.0 dCi FWD	M9R	06/07 → 11/13
OPEL		
MOVANO B 2.3 CDTI FWD	M9T670, M9T686	05/10 →
MOVANO B 2.3 CDTI RWD	M9T686, M9R630	05/10 →
VIVARO A 2.0 CDTI	M9R630, M9R740	01/06 →
RENAULT		
ESPACE IV 2.0 dCi	M9R740, M9R700	01/06 →

RENAULT		
GRAND SCÉNIC II 2.0 dCi	M9R700, F9Q870	09/05 →
GRAND SCÉNIC III 1.9 dCi	F9Q870, M9R610	02/09 →
GRAND SCÉNIC III 2.0 dCi	M9R610, R9M410	02/09 →
KADJAR 1.6 dCi 130	R9M410, R9M414	06/15 →
KADJAR 1.6 dCi 130 4x4	R9M414, M9R830	06/15 →
KOLEOS 2.0 dCi	M9R830, M9R830	09/08 →
KOLEOS 2.0 dCi [ExtraEU]	M9R830, M9R830	07/13 →
KOLEOS 2.0 dCi 4x4	M9R830, M9R740	09/08 →
LAGUNA 2.0 dCi	M9R740, M9R742	08/05 → 12/07
LAGUNA III 2.0 dCi	M9R742, M9R816	10/07 →
LAGUNA III 2.0 dCi GT	M9R816, V9X791	03/08 → 12/15
LAGUNA III 3.0 dCi	V9X791, M9R824	09/08 → 12/15
LATITUDE 2.0 dCi 130	M9R756	12/13 →
LATITUDE 2.0 dCi 150	M9R824, M9R804	02/11 →
LATITUDE 2.0 dCi 175	M9R804, M9T676	05/11 →
LATITUDE 3.0 dCi 240	V9X891	02/11 →
MASTER III 2.3 dCi 100 FWD	M9T670, M9T690	02/10 →
MASTER III 2.3 dCi 100 RWD	M9T690, M9T870	02/10 →
MASTER III 2.3 dCi 110 FWD	M9T870, M9T670	09/14 →
MASTER III 2.3 dCi 125 FWD	M9T670, M9T686	02/10 →
MASTER III 2.3 dCi 125 RWD	M9T686, M9T700	02/10 →
MASTER III 2.3 dCi 135 FWD	M9T700, M9T672	07/14 →
MASTER III 2.3 dCi 135 RWD	M9T702	07/14 →
MASTER III 2.3 dCi 145 FWD	M9T672, M9T694	02/10 →
MASTER III 2.3 dCi 145 RWD	M9T694, M9T880	02/10 →
MASTER III 2.3 dCi 150 FWD	M9T880, M9T694	10/12 →
MASTER III 2.3 dCi 150 RWD	M9T694, M9T700	03/13 →
MASTER III 2.3 dCi 165 FWD	M9T700, F9Q870	07/14 →
MASTER III 2.3 dCi 165 RWD	M9T702	07/14 →
MASTER III 2.3 dCi 170 FWD	M9T706	07/15 →
MASTER 2.3 dCi	M9T676, M9T670	02/10 →
MEGANE II 2.0 dCi	M9R700, F9Q870	09/05 →
MEGANE III 1.9 dCi	F9Q870, M9R610	11/08 →
MEGANE III 2.0 dCi	M9R610, R9M409	04/09 →
MEGANE IV 1.6 dCi 130	R9M409, M9R700	11/15 →
MEGANE CC 1.9 dCi	F9Q870, M9R700	06/10 →
MEGANE CC 2.0 dCi	M9R610	06/10 →
SCÉNIC II 2.0 dCi	M9R700, F9Q870	09/05 →
SCÉNIC III 1.9 dCi	F9Q870, M9R610	02/09 →
SCÉNIC III 2.0 dCi	M9R610, M9R630	02/09 →
TRAFIC 2.0 dCi	M9R630, M9R630	08/06 →
TRAFIC II 2.0 dCi 115	M9R630, M9R630	08/06 →
TRAFIC II 2.0 dCi 90	M9R630, M9R760	08/06 →
VEL SATIS 2.0 dCi	M9R760, M9T686	08/05 →

SUZUKI

GRAND VITARA II 1.9 DDIS	F9QB	03/06 → 08/08
--------------------------	------	---------------

VAUXHALL

MOVANO 2.3 CDTI	M9T880	05/10 →
MOVANO B 2.3 CDTI [RWD]	M9T686, M9T670	07/10 →
MOVANO B 2.3 CDTI FWD	M9T670, M9T670	05/10 →
MOVANO B 2.3 CDTI RWD	M9T670, M9R630	05/10 →
VIVARO 2.0 CDTI	M9R630, D4FA	01/06 → 07/14

10.3178



3,5

ABSOLUTE PRESSURE SENSORS (MAP)

Adatt./Suitable:

HYUNDAI

39300-2G000
39300-84400

KIA

39300-2G000
39300-84400

MARKET DIFFUSION: HIGH



kPa	mV	O + NTC -
18,2 - 300,2	250 - 4750	

HYUNDAI

ACCENT III 1.5 CRDi GLS	D4FA	11/05 → 11/10
ACCENT IV 1.6 CRDi	D4FB	11/10 → 12/15
ELANTRA IV 1.6 CRDi	D4FB	02/06 →
ELANTRA V 1.6 CRDi	D4FB	02/11 → 12/15
ELANTRA V 1.6 T-GDi [ExtraEU]	G4FJ	02/16 →
GENESIS 2.0	G4KF	01/13 →
GENESIS 2.0 CVVT	G4KF	02/13 → 02/14
GENESIS 2.0 T	G4KF	11/11 → 12/14
GENESIS 2.0 Tci	--	01/11 →
GETZ 1.5 CRDi	D4FA	08/05 → 06/09
GETZ 1.5 CRDi GLS	D4FA, D4EB	07/04 → 06/09
GRANDEUR 2.2 CRDi	D4EB, D4CB	06/06 → 12/11
GRAND SANTA FE 2.2 CRDi Trazione integrale	D4HB	06/13 →
H-1 1.2.5 CRDi	D4CB, D4CB	07/01 →
H-1 1.2.5 CRDi 4WD	D4CB	12/02 → 04/04
H-1 1.2.5 CRDi 4x4	D4CB	12/02 →
H-1 1.2.5 CRDi	D4CB, D4FC	02/08 →
H1 2.5 CRDi	D4CB	09/06 → 08/07
H100 2.5 CRDi	D4CB	01/04 →
H100 2.5 TCI	--	01/04 →
H100 2.5 TD	D4DF	01/10 →
I10 I 1.1 CRDi	D3FA	01/08 → 12/11
I20 I 1.1 CRDi	D3FA	03/12 → 12/15
I20 I 1.4 CRDi	D4FC, D4FB	08/08 → 12/15
I20 I 1.6 CRDi	D4FB, D4FB	09/08 → 12/12
I20 II 1.0 T-GDi	G3LC	09/15 →
I30 1.6 CRDi VGT	D4FB	10/07 → 11/11
I30 I 1.6 CRDi	D4FB, D4EA	10/07 → 06/12
I30 I 2.0 CRDi	D4EA, G4FG	10/07 → 06/12
I30 II 1.4 CRDi	D4FC	12/11 →
I30 II 1.6	G4FG, D4FB	12/11 →
I30 II 1.6 CRDi	D4FB, D4FC	11/11 →
I30 II 1.6 GDi	G4FD	06/12 →
I30 II 1.6 T-GDi	G4FJ	01/15 →
I30 III 1.0 T-GDi	G3LC	11/16 →
I30 III 1.4 T-GDi	G4LD	11/16 →
I30 III 2.0 N	G4KH	07/17 →
I40 1.7 CRDi	D4FD	07/11 →
IX20 1.4 CRDi	D4FC, D4HA	11/10 →
IX20 1.6 CRDi	D4FB	06/11 →
IX35 1.7 CRDi	D4FD	11/10 →
IX35 2.0 CRDi	D4HA, D6EA	01/10 →
IX35 2.0 CRDi 4WD	D4HA	01/10 →
IX55 3.0 V6 CRDi 4WD	D6EA, D4EB	09/08 → 12/12
KONA 1.0 T-GDi	G3LC	07/17 →
KONA 1.6 T-GDi	G4FJ	07/17 →
KONA 1.6 T-GDi 4WD	G4FJ	06/17 →
LAVITA 1.5 CRDi	--	01/07 →
MATRIX 1.5 CRDi	D4FA	12/04 → 08/10
MATRIX 1.5 CRDi VGT	D4FA	08/05 → 08/10
MATRIX 1.5 CRDi VGT [TUR]	D4FA	04/08 →
PORTER II 2.5 CRDi	D4CB	05/04 →
PORTER II 2.5 Tci	D4BH	05/04 →

HYUNDAI

SANTA FE II 2.0 CRDi	D4HA	12/10 → 12/12
SANTA FE II 2.0 CRDi 4x4	D4HA	12/10 → 12/12
SANTA FE II 2.2 CRDi	D4EB, D4EB	03/06 → 12/12
SANTA FE II 2.2 CRDi 4x4	D4EB, D4EA	10/05 → 12/12
SANTA FE II 2.2 CRDi GLS	D4EB	03/06 → 12/09
SANTA FE II 2.2 CRDi GLS 4x4	D4EB	03/06 → 12/09
SANTA FE III 2.0 CRDi	D4HA	09/12 →
SANTA FE III 2.0 CRDi 4WD	D4HA	09/12 →
SANTA FE III 2.2 CRDi 4WD	D4HB	09/12 → 12/15
SB 11 1.6 CRDi	--	01/11 →
SONATA V 2.0 CRDi	D4EA, G6DB	02/06 → 12/10
SONATA V 3.3	G6DB, D4EA	01/05 → 12/10
SONICA 3.3 CVVT	G6DB	03/09 → 12/10
STAREX 2.5 CRDi	D4CB	09/07 →
TUCSON 1.6 T-GDi	G4FJ	06/15 →
TUCSON 1.6 T-GDi Trazione integrale	G4FJ	06/15 →
TUCSON 2.0 CRDi	D4EA, D4EA	08/04 → 03/10
TUCSON 2.0 CRDi Trazione integrale	D4EA, D6EA	08/04 → 03/10
VELOSTER 1.6 GDi	G4FD	03/11 →
VELOSTER 1.6 T-GDi	G4FJ	10/12 →
VERNA II 1.5 CRDi GLS	--	11/05 →

KIA

BONGO IV 2.9 TDic	HJ3	10/03 →
BONGO IV 2.9 TDic 4WD	HJ3	10/03 →
BORREGO 3.0 CRDi 4WD	D6EA, D4EA	11/07 →
CARENS II 2.0 CRDi	D4EA, D4FB	07/02 →
CARENS III 1.6 CRDi 110	D4FB	10/10 →
CARENS III 1.6 CRDi 128	D4FB	10/10 →
CARENS III 2.0 CRDi 115	D4EA	05/07 →
CARENS III 2.0 CRDi 135	D4EA	08/09 →
CARENS III 2.0 CRDi 140	D4EA	09/06 →
CARENS IV 1.7 CRDi	D4FD	07/15 →
CEED I 1.6 CRDi 115	D4FB	12/06 → 12/12
CEED I 1.6 CRDi 128	D4FB	10/10 → 12/12
CEED I 1.6 CRDi 90	D4FB, D4EA	12/06 → 12/12
CEED I 2.0 CRDi	D4EA	06/07 → 12/12
CEED I 2.0 CRDi 140	D4EA, D4FD	07/07 → 12/12
CEED II 1.0 T-GDi	G3LC	04/15 →
CEED II 1.4 CRDi 90	D4FC	05/12 →
CEED II 1.6 CRDi	D4FB	07/12 →
CEED II 1.6 CRDi 110	D4FB	05/12 →
CEED II 1.6 CRDi 115	D4FB	05/12 →
CEED II 1.6 CRDi 128	D4FB	05/12 →
CEED II 1.6 CRDi 90	D4FB-L	05/12 →
CEED II 1.6 CVVT	G4FC	05/12 →
CEED II 1.6 GT	G4FJ	06/13 →
CEED III 1.0 T-GDi	G3LC	05/18 →
CEED III 1.0 T-GDi [ExtraEU]	G3LC	03/18 →
CEED III 1.4 T-GDi	G4LD	04/18 →
CEED III 1.4 T-GDi [ExtraEU]	G4LD	03/18 →
CEED III 1.6 T-GDi GT	G4FJ	10/18 →
CERATO I 1.6 CRDi	D4FB	06/05 →
CERATO III 1.6	--	07/12 →
CERATO 1.6 T-GDi [ExtraEU]	G4FJ	09/14 →
FORTE III 1.6	--	07/12 →
K-SERIES 2.9 CRDi	J3	08/07 →
K2900 2.9 D	J3	01/08 →
MAGENTIS II 2.0 CRDi	D4EA	11/05 → 12/08
MOHAVE 3.0 D	--	09/08 →
OPTIMA II 2.0 CRDi	D4EA	09/06 →
OPTIMA III 1.7 CRDi	D4FD, D4FB	03/12 →
OPTIMA III 2.0	G4KH	09/10 →
OPTIMA III 2.4	G4KJ	09/10 →
OPTIMA IV 1.6 T-GDi	G4FJ	01/18 →
OPTIMA IV 2.0 T-GDi	G4KH	09/15 →
OPTIMA IV 2.0 T-GDi GT	G4KH	01/18 →
PICANTO I 1.0 D	--	09/05 →
PICANTO I 1.1 CRDi	D3FA	11/05 →
PICANTO III 1.0 T-GDi	G3LC	03/17 →
PROCEED 1.0 T-GDi	G3LC	10/18 →
PROCEED 1.4 T-GDi	G4LD	10/18 →
PROCEED 1.6 T-GDi	G4FJ	10/18 →
PRO CEE'D I 1.6 CRDi 115	D4FB	02/08 → 09/12
PRO CEE'D I 1.6 CRDi 128	D4FB	10/10 → 09/12
PRO CEE'D I 1.6 CRDi 90	D4FB, D4EA	02/08 → 09/12
PRO CEE'D I 2.0 CRDi 140	D4EA, D4FA	02/08 → 09/12
PRO CEE'D II 1.0 T-GDi	G3LC	07/15 →
PRO CEE'D II 1.4 CRDi 90	D4FC	03/13 →
PRO CEE'D II 1.6 CRDi 110	D4FB	03/13 →
PRO CEE'D II 1.6 CRDi 128	D4FB	03/13 →
PRO CEE'D II 1.6 GT	G4FJ	06/13 →
PRO CEE'D 1.6 CRDi	D4FB	10/12 →
RIO II 1.5 CRDi	D4FA, D4CB	03/05 →
RIO III 1.1 CRDi	D3FA	09/11 →
RIO III 1.4 CRDi	D4FC	09/11 →
RIO 1.1 CRDi	D3FA	09/11 →

KIA

RIO IV 1.0 T-GDi 100	G3LC	01/17 →
RIO IV 1.0 T-GDi 120	G3LC	01/17 →
SORENTO 2.5 CRDi [ExtraEU]	D4CB	09/06 → 12/11
SORENTO 1 2.5 CRDi	D4CB, D4HA	08/02 →
SORENTO II 2.0 CRDi	D4HA, D4HA	11/09 →
SORENTO II 2.0 CRDi 4WD	D4HA, D4EA	11/09 →
SOUL I 1.6 CRDi 115	D4FB	02/09 →
SOUL I 1.6 CRDi 128	D4FB	02/09 →
SOUL II 1.6 CRDi 128	D4FB	02/14 →
SOUL II 1.6 CRDi 136	D4FB	04/15 →
SOUL II 1.6 TGDl	G4FJ	11/16 →
SPORTAGE 2.0 CRDi [ExtraEU]	D4HA	08/12 → 12/15
SPORTAGE II 2.0 16V 4WD	G4GC	09/04 →
SPORTAGE II 2.0 CRDi	D4EA, D4EA	02/05 →
SPORTAGE II 2.0 CRDi 4WD	D4EA, D4FD	09/04 →
SPORTAGE III 1.7 CRDi	D4FD, D4HA	12/10 →
SPORTAGE III 2.0 CRDi	D4HA, D4HA	07/10 →
SPORTAGE III 2.0 CRDi AWD	D4HA, G4KD	07/10 →
SPORTAGE III 2.0 CVVT	G4KD, G4KL	06/10 →
SPORTAGE III 2.0 CVVT AWD	G4NC	07/10 →
SPORTAGE III 2.4 14WD	G4KE	08/10 →
SPORTAGE IV 1.6 GDi	G4FJ	09/15 →
SPORTAGE IV 1.6 GDi AWD	G4FJ	09/15 →
STINGER 2.0 T-GDi	G4KL, G4KL	06/17 →
STINGER 2.0 T-GDi 4WD	G4KL, G3LC	06/17 →
STONIC 1.0 T-GDi	G3LC, D4EA	07/17 →
VENGA 1.4 CRDi 75	D4FC	02/10 →
VENGA 1.4 CRDi 90	D4FC	02/10 →
VENGA 1.6 CRDi 115	D4FB	02/10 →
VENGA 1.6 CRDi 128	D4FB	02/10 →
VENGA CRDi	D4FC	04/15 →

10.3179



3,5

ABSOLUTE PRESSURE SENSORS (MAP)

Adatt./Suitable:

HYUNDAI

39200-27000



kPa	mV	O + -
13 - 256,1	250 - 4750	

HYUNDAI

GENESIS 2.0 CVVT	G4KF	06/08 → 02/14
GENESIS 2.0 T	G4KF	01/08 → 12/12
SANTA FE I 2.0 CRDi	D4EA	08/01 → 03/06
SANTA FE I 2.0 CRDi 4x4	D4EA, D4EA	04/01 → 03/06
SANTA FE I 2.0 CRDi Trazione integrale	D4EA	11/03 → 02/06
TRAJET 2.0 CRDi	D4EA, G4FA	04/01 → 07/08

10.3180



3,5

ABSOLUTE PRESSURE SENSORS (MAP)

Adatt./Suitable:

HYUNDAI

39300-03000
39300-2B000
39300-2B100
39300-2E600

KIA

39300-2B000
39300-2B100
39300-2E600

MARKET DIFFUSION: HIGH



kPa	mV	O + NTC -
10 - 120	374,2 - 4750	

HYUNDAI

ACCENT IV 1.4	G4FA, G4FC	11/10 →
ACCENT IV 1.4 CVT	--	11/10 →
ACCENT IV 1.6	G4FC, G4FG	11/10 →
ACCENT 1.4	G4LC	07/18 →
AZERA [USA] 2.4	--	09/10 →
AZERA [USA] 3.0	--	09/10 →
AZERA 3.0 MPI [ExtraEU]	G6DE	03/11 →
CRETA 1.6	G4FG	01/16 →
CRETA 1.6 4WD	G4FG	08/16 →
CRETA 2.0	G4NA	01/16 →
CRETA 2.0 4WD	G4NA	01/16 →
ELANTRA 1.8 CVVT [ExtraEU]	G4NB	01/11 → 12/16
ELANTRA IV 1.6 CVVT	G4FC	06/06 → 06/11
ELANTRA V 1.6	G4FG, G4NA	06/11 →
ELANTRA V 1.8	G4NB-B	09/10 →
ELANTRA V 2.0	G4NA	10/15 →
ELANTRA V 2.0 MPI [ExtraEU]	G4NA, G4KC	02/16 →
EQUUS 5.0 GDi [ExtraEU]	G8BE	08/14 →
EQUUS / CENTENNIAL II 5.0 GDi	G8BE	03/09 →
GRANDEUR 2.4	G4KC, G6DE	07/11 →
GRANDEUR 2.4 16V	G4KC	01/11 →
GRANDEUR 3.0	G6DE, --	07/11 →
GRAND SANTA FE 3.0 GDi	G6DG	07/13 →
GRAND SANTA FE 3.3	G6DF	01/14 →
GRAND SANTA FE 3.3 Trazione integrale	G6DF	02/14 →
H-1 II 2.4	--, G4HG	02/08 →
H-1 II 2.4 i	G4KC	02/08 →
H1 2.4 CVVT	G4KC	01/10 →
I10 1.2 LPG	G4LA	01/10 → 12/13
I101 1.0	B3LA	01/11 → 12/17
I101 1.1	G4HG, G4LA	11/08 → 12/13
I101 1.1 LPG	G4HG	04/11 → 12/13
I101 1.2	G4LA, B3LA	11/08 → 12/13
I10 II 1,0 LPG	B3LA, G4LA	02/14 →
I10 II 1.2	G4LA	12/13 →
I20 1.2	G4AG	12/08 → 08/14
I20 1.2 CVVT	G4LA	05/15 →
I20 1.2 LPG	G4LA	01/09 → 08/14
I20 1.4 CVVT	G4LC	05/15 →
I20 1.4 CVVT LPG	G4FA	12/08 → 12/12
I201 1.2	G4LA, G4LA	09/08 → 12/15
I201 1.4	G4FA	09/08 → 12/15
I201 1.6	G4FC	09/08 → 12/12
I20 II 1.2	G4LA, G4FA	11/14 →
I20 II 1.2 LPGi	G4LA	11/14 →
I20 II 1.4	G4LC	05/15 →
I30 1.4 CVVT	G4LC	05/15 →
I30 1.4 CVVT LPG	G4FA, G4FD	01/09 → 06/12
I30 1.4 LPG	G4FA	01/13 →
I30 1.6 CVVT	G4FC	06/14 →
I30 1.6 GDi	G4FD, G4FA	07/14 →

HYUNDAI

I30 I 1.4	G4FA, G4FC	10/07 → 06/12
I30 I 1.6	G4FC, G4FA	10/07 → 06/12
I30 II 1.4	G4FA, G4FC	12/11 →
I30 II 1.6	G4FC, G4LC	12/11 →
I30 II 1.6 CVVT [ExtraEU]	G4FC	03/16 →
I30 II 1.6 GDi	G4FD	12/11 →
I30 III 1.6 MPI	G4FC	11/16 →
I30 III 1.4 MPI	G4LC, G4NA	11/16 →
I40 1.6 GDi	G4FD	07/11 →
I40 1.7 CRDi	D4FD	07/11 →
I40 2.0	G4NC	03/12 →
I40 2.0 CVVT	G4NA	10/12 →
I40 2.0 GDi	G4NA, G4KD	07/11 →
IONIQ 1.6 GDi Hybrid	G4LE	03/16 →
IX20 1.4	G4FA	11/10 →
IX20 1.4 CVVT [ExtraEU]	G4FA	11/10 →
IX20 1.4 LPG	G4FA	11/10 →
IX20 1.6	G4FC	11/10 →
IX20 1.6 LPG ECONEXT	G4FC	03/15 →
IX35 1.6	G4FD	11/10 →
IX35 2.0	G4KD, G4KD	01/10 →
IX35 2.0 4WD	G4KD, G4KD	01/10 →
IX35 2.0 AWD	G4NA	11/13 →
IX35 2.0 CVVT	G4KD, G4KD	08/09 →
IX35 2.0 CVVT [ExtraEU]	G4NA	11/13 →
IX35 2.0 CVVT 4WD	G4NA	08/13 → 12/15
IX35 2.0 CVVT AWD	G4KD, G4FC	08/09 →
IX35 2.0 GDi	G4NC	08/13 →
IX35 2.0 GDi 4WD	G4NC	08/13 →
IX35 2.4 4WD	G4KE	09/12 → 12/13
IX35 2.4 DCVVT-I 4WD	G4KE	07/10 → 12/13
IX35 2.4 GDi 4WD	G4KJ	01/13 →
NF 2.0 CVVT	G4BPE	05/05 → 12/10
SANTA FE 2.4 CVVT [ExtraEU]	G4KE	06/15 →
SANTA FE II 2.4	G4KE	11/10 → 12/12
SANTA FE II 2.4 4x4	G4KE	07/10 → 12/12
SANTA FE III 2.4	G4KJ	09/12 → 12/15
SANTA FE III 2.4 4WD	G4KJ	09/12 → 12/15
SANTA FE III 2.4 CCVT AWD	G4KE	09/12 →
SANTA FE III 2.4 GDi	G4KJ	05/15 →
SANTA FE III 2.4 GDi 4WD	G4KJ	05/15 →
SANTA FE IV 2.4 GDi AWD	G4KJ	07/18 →
SB 11 1.4	--	01/11 →
SB 11 1.6	--	01/11 →
SOLARIS 1.4	G4LC	01/17 →
SOLARIS 1.4 16V	--	01/11 →
SOLARIS 1.6	G4FC, G4KA	01/17 →
SOLARIS 1.6 16V	--	01/11 →
SONATA V 2.0 GLSi	G4KD	07/08 → 12/10
SONATA V 2.0 VVTi GLS	G4KA, G4KD	05/05 → 12/10
SONATA V 2.4	G4KE	06/08 → 12/10
SONATA VI 2.0	G4KD, G4KD	01/09 → 12/15
SONATA VI 2.0 i	G4KD, G4KC	01/11 → 06/14
SONATA VI 2.4	G4KC, G4FC	01/09 → 12/15
SONATA VI 2.4 GDi	--	03/14 →
TUCSON 1.6 GDi	G4FD	06/15 →
TUCSON 2.0	G4NA	06/15 →
VELOSTER 1.6	G4FG	06/11 →
VELOSTER 1.6 GDi	G4FD	03/11 →
VELOSTER 1.6 GDi [ExtraEU]	G4FD	01/11 →
VELOSTER 1.6 MPI	G4FC	04/11 →

KIA

CARENS III 1.6 CVVT	G4FC, G4FA	08/09 →
CARENS IV 1.6 GDi	G4FD	03/13 →
CARENS IV 2.0 GDi	G4NC	03/13 →
CEED I 1.4	G4FA, G4FA	12/06 → 12/12
CEED I 1.4 CVVT	G4FA, G4FA	07/09 → 12/12
CEED I 1.4 LPG	G4FA, G4FC	01/09 → 04/12
CEED I 1.6	G4FC, G4FC	12/06 → 12/12
CEED I 1.6 CVVT	G4FC	06/09 → 12/12
CEED I 1.6 GDi	G4FC, G4FA	06/07 → 09/12
CEED II 1.4 CVVT	G4FA, G4FC	05/12 →
CEED II 1.4 LPG	G4FA	05/12 →
CEED II 1.4 MPI	G4LC	04/15 →
CEED II 1.6 CVVT	G4FC, G4ED	05/12 →
CEED II 1.6 GDi	G4FD	05/12 →
CEED III 1.4	G4LC	04/18 →
CEED III 1.4 LPG	G4LC	12/18 →
CEED III 1.4 MPI [ExtraEU]	G4LC	03/18 →
CEED III 1.6	G4FG	03/18 →
CERATO 1.6 CVVT [ExtraEU]	G4FC	06/13 →
CERATO I 1.6	G4ED, G4FC	04/04 →
CERATO II 1.6	G4FC	01/10 →
CERATO II 1.6 CVVT	G4FC, G4KD	02/09 →
CERATO II 2.0	G4KD, G4JP	01/09 →
CERATO II 2.0 CVVT	G4KD	07/09 → 06/13
CERATO III 1.6	--	07/12 →
CERATO III 1.6 CVVT	G4FC	07/16 →

KIA

CERATO III 1.8	--	07/12 →
CERATO III 2.0	--	07/12 →
CERATO III 2.0 MPI	G4KD	06/13 →
FORTE III 1.6	--	07/12 →
FORTE III 1.8	--	07/12 →
FORTE III 2.0	--	07/12 →
MAGENTIS II 2.0	G4JP, G4KD	09/06 →
NIRO 1.6 GDi Hybrid	G4LE	09/16 →
OPTIMA III 2.0	--	03/10 →
OPTIMA III 2.0 CVVL	G4KD	03/12 →
OPTIMA III 2.0 CVVT	G4KD, --	01/11 → 12/15
OPTIMA III 2.0 CVVT Hybrid	--, --	12/12 →
OPTIMA III 2.4	--, G4NA	03/10 →
OPTIMA III 2.4 Hybrid	--	09/11 →
OPTIMA IV 2.0	G4ND	09/15 →
OPTIMA IV 2.0 CVVL	G4NA, G4FA	09/15 →
OPTIMA IV 2.0 GDi Hybrid	G4NG	09/16 →
OPTIMA IV 2.4 GDi	G4KJ	09/15 →
PICANTO II 1.0	G3LA	05/11 →
PICANTO II 1.0 Bi-Fuel	B3LA	05/11 →
PICANTO II 1.0 LPG	B3LA	08/13 →
PICANTO II 1.2	G4LA	09/11 →
PRO CEE'D I 1.4	G4FA	02/08 → 09/12
PRO CEE'D I 1.4 CVVT	G4FA, G4FC	06/10 → 09/12
PRO CEE'D I 1.6	G4FC	02/08 → 09/12
PRO CEE'D I 1.6 CVVT	G4FC, G4FA	02/08 → 02/13
PRO CEE'D II 1.4 CVVT	G4FA, G4LC	03/13 →
PRO CEE'D II 1.4 MPI	G4LC, G4FA	07/13 →
PRO CEE'D II 1.6 CVVT	G4FC	03/13 →
PRO CEE'D II 1.6 GDi	G4FD	03/13 →
PRO CEE'D 1.4 CVVT	G4FA	05/12 →
PRO CEE'D 1.6 GDi	G4FD	04/15 →
QUORIS 5.0 GDi	G8BE	05/15 →
RIO III 1.2	G4LA	09/11 →
RIO III 1.2 CVVT	G4LA	11/14 →
RIO III 1.25 CVVT	G4LA	09/11 →
RIO III 1.25 LPG	G4LA	09/11 →
RIO III 1.4 CVVT	G4FA, G4KE	06/11 →
RIO III 1.6 CVVT	G4FC	06/12 →
RIO 1.2 CVVT	G4LA	04/15 →
RIO 1.4 CVVT	G4FA	04/15 →
RIO IV 1.25	G4LA	01/17 →
RIO IV 1.4	G4LC	01/17 →
RIO IV 1.6	G4FG	07/17 →
SORENTO II 2.4 CVVT	G4KE, G4KE	11/09 →
SORENTO II 2.4 CVVT 4WD	G4KE, G4FC	11/09 →
SORENTO II 2.4 GDi	G4KJ	10/12 →
SORENTO II 2.4 GDi 4WD	G4KJ	10/12 →
SORENTO II 2.4 LPG	G4KE	04/10 → 12/15
SORENTO II 2.4 LPG 4WD	G4KE	04/10 → 12/15
SORENTO II 3.3 GDi	--	10/12 →
SORENTO III 2.4	G4KE	01/15 →
SORENTO III 2.4 4WD	G4KE	01/15 →
SORENTO III 2.4 GDi	G4KJ	01/15 →
SORENTO III 2.4 GDi 4WD	G4KJ	01/15 →
SORENTO III 3.3 4WD	G6DF	04/15 →
SORENTO III 3.5 D-CVVT	G6DC	12/18 →
SORENTO III 3.5 D-CVVT 4WD	G6DC	12/18 →
SOUL 1.6 LPG	G4FG	12/14 →
SOUL I 1.6	G4FC	09/09 → 12/14
SOUL I 1.6 CVVT	G4FC, G4FC	02/09 →
SOUL I 1.6 Flex	--	01/11 →
SOUL I 1.6 GDi	G4FD	06/11 →
SOUL I 1.6 LPG	G4FC, G4FC	02/09 → 12/14
SOUL I 2.0	G4KD	02/09 →
SOUL II 1.6 CVVT	G4FC, G4FC	02/14 →
SOUL II 1.6 GDi	G4FD	02/14 →
SOUL II 1.6 MPI [ExtraEU]	G4FC, G4NA	07/16 →
SOUL II 2.0 CVVT	G4NA, G4KD	02/14 →
SOUL II 2.0 MPI	--	02/14 →
SPORTAGE 2.4 GDi [ExtraEU]	G4KJ	01/16 →
SPORTAGE III 1.6 GDi	G4FD	02/11 →
SPORTAGE III 1.6 LPG	G4FD	01/14 → 12/15
SPORTAGE III 2.0 CVVT	G4KD, G4KD	06/10 →
SPORTAGE III 2.0 CVVT AWD	G4KD, G4FA	06/10 →
SPORTAGE III 2.0 flex	--	07/10 →
SPORTAGE III 2.0 GDi	G4NC	02/14 →
SPORTAGE III 2.0 GDi AWD	G4NC	02/14 →
SPORTAGE III 2.4 i 4WD	G4KE	08/10 →
SPORTAGE IV 1.6 GDi	G4FD	09/15 →
SPORTAGE IV 2.0	G4NA	12/15 →
SPORTAGE IV 2.0 AWD	G4NA	12/15 →
SPORTAGE IV 2.4 GDi [ExtraEU]	G4KJ	05/16 →
STONIC 1.2 CVVT	G4LA	07/17 →
STONIC 1.4 CVVT	G4LC	07/17 →
STONIC 1.4 LPG	G4LC	11/18 →
VENGA 1.4 CVVT	G4FA, G4FA	02/10 →

KIA			
VENGA 1.4 LPG	G4FA	02/10	⇒
VENGA 1.6 CVVT	G4FC	02/10	⇒
VENGA CVVT	G4FA, R9DA	02/15	⇒

10.3186



3,5

ABSOLUTE PRESSURE SENSORS (MAP)

Adatt./Suitable:

BOSCH
0 261 230 106
0 261 230 295
0 261 230 296

FORD
1 379 704
1 689 133
6G9N-12B676-AA
6G9N-12B676-AB

JAGUAR
AJ8 11668

LAND ROVER
LR008887
LR021587

VOLVO
30622083
31303975
31355463

MARKET DIFFUSION: MEDIUM



kPa	mV	O + NTC -
22 - 305	410 - 4735	

FORD

FOCUS II 2.5 RS	JZDA	01/09	⇒ 07/11
FOCUS II 2.5 RS 500	JZDA	05/10	⇒ 07/11
FOCUS III 2.0 ST	R9DA, TNWA	07/12	⇒
GALAXY II 2.0 EcoBoost	TNWA, HYDB	03/10	⇒
GALAXY II 2.5 ST	HUWA	05/06	⇒
KUGA I 2.5	HYDB, HYDB	03/09	⇒ 11/12
KUGA I 2.5 4x4	HYDB, TNBA	02/08	⇒ 11/12
MONDEO III 2.0 EcoBoost	TPBA	03/10	⇒ 01/15
MONDEO III 2.0 SCTi	TNBA	03/10	⇒ 01/15
MONDEO III 2.5	HUBA	03/07	⇒ 01/15
MONDEO 2.0 EcoBoost	TNBA, TNWA	03/10	⇒ 09/14
S-MAX I 2.0 EcoBoost	TNWA, 508PS	03/10	⇒ 12/14
S-MAX I 2.5 ST	HUWA	05/06	⇒ 12/14

JAGUAR

F-PACE 3.0 AWD	306PS	09/15	⇒
F-PACE 5.0 SVR AWD	508PS	08/18	⇒
F-TYPE 3.0	306PS	10/12	⇒
F-TYPE 3.0 S	306PS	10/12	⇒
F-TYPE 3.0 S AWD	306PS	12/14	⇒
F-TYPE 400	306PS	11/16	⇒
F-TYPE 400 AWD	306PS	11/16	⇒
F-TYPE 5.0 R	508PS	10/13	⇒
F-TYPE 5.0 R AWD	508PS	12/14	⇒
F-TYPE 5.0 S	508PS	10/12	⇒
F-TYPE 5.0 SVR	508PS, 306PS	05/15	⇒
XE 2.0	204PT	03/15	⇒
XE 3.0 S	306PS	02/17	⇒
XE 5.0 SVO PROJECT 8	508PS	03/18	⇒
XF 2.0	204PT	05/15	⇒
XF 3.0	306PS, 508PS	03/08	⇒
XF 3.0 AWD	306PS	10/12	⇒
XF 3.0 D	306DT	09/12	⇒ 04/14
XF 3.0 D AWD	AJV6D	03/12	⇒
XF 3.0 Supercharged [ExtraEU]	306PS	05/15	⇒
XF 5.0	508PN	03/09	⇒ 04/15
XF 5.0 Kompressor	508PS, 508PS	01/09	⇒ 04/15
XF 5.0 XFR-S	508PS	10/12	⇒ 04/15
XJ 3.0	306PS	03/12	⇒
XJ 3.0 AWD	306PS	10/12	⇒
XJ 5.0 R575	508PS	07/17	⇒

JAGUAR

XJ 5.0 V8	508PS, 508PS	10/09	⇒
XK 5.0 V8	508PN	01/09	⇒ 07/14
XK 5.0 XKR	508PS, 204PT	01/09	⇒ 07/14
XK 5.0 XKR-S	508PS	01/11	⇒ 07/14

LAND ROVER

DISCOVERY IV 2.0 4x4	204PT, 224DT	11/14	⇒
DISCOVERY IV 2.2 D 4x4	224DT	09/14	⇒
DISCOVERY IV 3.0 4x4	306PS	08/13	⇒
DISCOVERY V 3.0 4x4	306PS	09/16	⇒
FREELANDER 2 2.0 Si4 4x4	204PT	10/11	⇒ 10/14
FREELANDER 2 2.2 eD4	224DT, 224DT	08/10	⇒ 10/14
FREELANDER 2 2.2 SD4 4x4	224DT	08/10	⇒ 10/14
FREELANDER 2 2.2 TD4 4x4	224DT, 204PT	10/06	⇒ 10/14
RANGE ROVER III 5.0 4x4	508PN, 306PS	09/09	⇒ 08/12
RANGE ROVER IV 3.0 4x4	306PS, 508PS	10/13	⇒
RANGE ROVER IV 5.0 4x4	508PS, 508PN	08/12	⇒
RANGE ROVER EVOQUE 2.0 [ExtraEU]	204PT	09/11	⇒
RANGE ROVER EVOQUE 2.0 4x4	204PT, 508PN	06/11	⇒
RANGE ROVER EVOQUE 2.2 D	224DT	06/11	⇒
RANGE ROVER EVOQUE 2.2 D 4x4	224DT	06/11	⇒
RANGE ROVER SPORT I 5.0 4x4	508PN, 306PS	04/09	⇒ 03/13
RANGE ROVER SPORT II 3.0 4x4	306PS, 508PS	04/13	⇒
RANGE ROVER SPORT II 5.0 4x4	508PS, D5244T13	04/13	⇒
RANGE ROVER VELAR 3.0 P340 4x4	306PS	04/18	⇒
RANGE ROVER VELAR 3.0 P380 4x4	306PS	03/17	⇒

VOLVO

C30 2.5 T5 [ExtraEU]	B5254T7	03/12	⇒ 12/13
C30 D5	D5244T13, B5254T3	10/06	⇒ 12/12
C30 T5	B5254T3, D5244T13	10/06	⇒ 12/12
C70 II 2.4 D	D5244T9	03/07	⇒ 06/13
C70 II D5	D5244T13, B5254T3	03/06	⇒ 06/13
C70 II T5	B5254T3, D5244T13	03/06	⇒ 10/09
S40 II 2.4 CDI	D5244T9	03/07	⇒ 12/10
S40 II 2.4 D5	D5244T13, B5254T3	03/06	⇒ 12/10
S40 II T5	B5254T3, B5254T3	01/04	⇒ 12/12
S40 II T5 AWD	B5254T3, D5244T5	04/04	⇒ 12/10
S60 I 2.4	B5244T4	01/05	⇒ 10/06
S60 I 2.4 AWD	B5244T5	02/04	⇒ 04/10
S60 I 2.4 D	D5244T5, B4204T6	03/05	⇒ 04/10
S60 I 2.4 D5	D5244T4	03/05	⇒ 04/10
S60 I 2.4 T5	B5244T5	04/04	⇒ 04/10
S60 I 2.5 AWD	B5254T4	09/03	⇒ 04/10
S60 I R 2,5 T AWD	B5254T4	01/03	⇒ 04/10
S60 II 2.0 T	B4204T6, B5254T14	04/10	⇒ 12/15
S60 II 2.0 T5 DRIVE	B4204T7	09/14	⇒ 12/15
S60 II 2.5 T	B5254T14	01/13	⇒
S60 II 2.5 T5	B5254T5	09/11	⇒
S60 II 2.5 T5 AWD	B5254T14, B6304T3	09/12	⇒
S60 II 3.0 T AWD	B6304T5	04/14	⇒
S60 II T	B5204T9	04/14	⇒
S60 II T5	B4204T7	04/10	⇒ 12/14
S60 II T5 AWD	B5254T12	08/15	⇒
S60 II T6 AWD	B6304T3, D5244T19	04/10	⇒ 12/15
S80 I 2.4 LTP	B5244T4	06/04	⇒ 07/06
S80 II 2.0 T	B4204T6	01/10	⇒
S80 II 2.4 D	D5244T19, B5254T10	03/06	⇒
S80 II 2.5 T	B5254T10, B5254T11	03/06	⇒
S80 II 2.5 T AWD	B5254T6	10/06	⇒ 04/09
S80 II 2.5 T FlexFuel	B5254T11, B6304T2	05/08	⇒ 12/11
S80 II D5	D5244T4	03/06	⇒
S80 II D5 AWD	D5244T4	01/07	⇒
S80 II T5	B4204T7	10/10	⇒
S80 II T6 AWD	B6304T2, B6304T2	01/07	⇒ 12/16
S80L 2.0 T	B4204T6	01/10	⇒
S80L 2.5 T	B5254T6	01/08	⇒
S80L 2.5 T5	B5254T12	01/12	⇒
S80L T4	B5204T8	01/12	⇒
S80L T5	B4204T7	01/12	⇒
S80L T6 AWD	B6304T2, B5204T9	01/08	⇒
V40 II T4	B5204T8	07/13	⇒ 12/15
V40 II T4 AWD	B5204T8	07/13	⇒
V40 II T5	B5204T9, B5204T9	12/12	⇒
V40 II T5 AWD	B5204T9, D5244T13	01/13	⇒
V50 2.4 D5	D5244T13, B5254T3	03/06	⇒ 12/10
V50 2.4 Tdi	D5244T9	05/07	⇒ 12/10
V50 T5	B5254T3, B5254T3	04/04	⇒ 12/12
V50 T5 AWD	B5254T3, B4204T6	04/04	⇒ 12/10
V60 I 2.0 BiFuel	B5204T9	03/14	⇒ 12/15
V60 I 2.0 T	B4204T6, B4204T7	07/10	⇒
V60 I 3.0 T AWD	B6304T5	04/14	⇒
V60 I T5	B4204T7, B5254T12	09/10	⇒

VOLVO

V60 I T5 AWD	B5254T12, B6304T3	03/15	⇒
V60 I T6 AWD	B6304T3, D5244T4	07/10	⇒ 12/15
V70 II 2.4 CDI	D5244T6	07/05	⇒ 12/08
V70 II 2.4 D	D5244T7	04/05	⇒ 12/08
V70 II 2.4 D5	D5244T4, D5244T4	04/05	⇒ 12/08
V70 II 2.4 D5 AWD	D5244T4, B5204T9	07/02	⇒ 08/07
V70 II 2.4 T	B5244T4	01/05	⇒ 12/05
V70 II 2.4 T5	B5244T5	04/04	⇒ 08/07
V70 II 2.5 R Sport	B5254T4	12/02	⇒ 08/07
V70 II R 2,5 T AWD	B5254T4	03/03	⇒ 08/07
V70 III 2.0 BiFuel	B5204T9, D5244T14	03/13	⇒ 12/15
V70 III 2.0 GDI	B5204T9	04/12	⇒ 12/15
V70 III 2.0 T	B4204T6	09/09	⇒ 12/11
V70 III 2.4 D	D5244T14, B5254T10	04/07	⇒ 12/10
V70 III 2.5 T	B5254T10, B5254T11	08/07	⇒ 12/12
V70 III 2.5 T FlexiFuel	B5254T11, D5204T2	05/08	⇒ 12/11
V70 III 3.0 T6 AWD	B6304T4	11/13	⇒
V70 III D3 / D4	D5204T2, D5244T10	03/10	⇒ 12/15
V70 III D5	D5244T10, D5244T10	04/07	⇒ 12/11
V70 III D5 AWD	D5244T10, B6304T2	04/07	⇒ 12/11
V70 III T5	B4204T7	01/10	⇒ 12/14
V70 III T6 AWD	B6304T2, D5244T16	08/07	⇒ 12/15
XC60 I 2.0 T	B4204T6	12/09	⇒ 12/12
XC60 I 2.4 D / D3 / D4 AWD	D5244T16, B6304T2	05/08	⇒ 12/07
XC60 I D5 AWD	D5244T4	05/08	⇒ 12/09
XC60 I T5	B4204T7	09/10	⇒ 12/14
XC60 I T5 AWD	B5254T12	04/14	⇒ 02/17
XC60 I T6 AWD	B6304T2, D5244T16	05/08	⇒ 02/17
XC70 I 2.4 D5 AWD	D5244T4	12/05	⇒ 08/07
XC70 I 2.4 T XC AWD	B5244T4	01/05	⇒ 12/06
XC70 II 2.4 D	D5244T14	06/09	⇒ 12/10
XC70 II 2.4 D / D4 AWD	D5244T16, D5244T10	08/07	⇒
XC70 II D5 AWD	D5244T10, B5254T14	04/07	⇒ 12/11
XC70 II T5 AWD	B5254T12	08/15	⇒
XC70 II T6 AWD	B5254T14, D5244T18	01/08	⇒
XC90 I D3 / D5	D5244T5	04/09	⇒ 12/14
XC90 I D5 AWD	D5244T18, K10B	10/02	⇒ 12/14

10.3189



3

ABSOLUTE PRESSURE SENSORS (MAP)

Adatt./Suitable:

BOSCH
0 261 230 197

GENERAL MOTORS
93 194 419

OPEL
47 09 502
93194419

SUZUKI
18590-73KA0
18590-73KA0-000

VAUXHALL
93194419



kPa	mV	O - +
10 - 117,9	364,9 - 4750	

OPEL

AGILA B 1.0	K10B, K12B	04/08	⇒ 07/14
AGILA B 1.0 LPG	K10B	01/10	⇒ 06/11
AGILA B 1.2	K12B, K10B	04/08	⇒ 10/14
AGILA B 1.2 LPG	K12B	04/08	⇒ 10/10

SUZUKI

SPLASH 1.0	K10B, K12B	01/08	⇒
SPLASH 1.2	K12B	01/08	⇒
SPLASH 1.2 LPG	K12B	04/08	⇒ 12/14
SPLASH 1.2 VVT	K12B, A14XER	09/10	⇒

VAUXHALL

AGILA B 1.0 12V	K10B	01/08	⇒ 11/14
AGILA B 1.0 i	K10B	08/11	⇒ 11/14
AGILA B 1.2 i 16V	K12B	01/08	⇒ 11/14

10.3195



3

ABSOLUTE PRESSURE SENSORS (MAP)

Adatt./Suitable:

BOSCH

0 261 230 146
0 261 230 282
0 261 230 289

CHEVROLET

12591290
12594942
12644228
55573248
93192107

DAEWOO

55573248

GENERAL MOTORS

12 591 290
12 594 942
12 644 228
55 573 248
93 192 107

OPEL

12 35 040
12 35 060
12 38 395
12 38 894
48 19 481
55573248
93192107

SAAB

12 594 942
12 644 228

VAUXHALL

12591290
55573248
93192107

MARKET DIFFUSION: HIGH



kPa	mV	
10 - 121,6	394,3 - 4750	

CHEVROLET

Model	Part Number	Year Range
AVEO I 1.4	A14XER, LDC	04/08 →
AVEO II 1.2	LDC, A12XER	03/11 →
AVEO II 1.2 LPG	A12XER, L99(376CUV8)	11/12 → 12/15
AVEO II 1.4	LDD	03/11 →
AVEO II 1.6	F16D4	03/11 →
CAMARO 3.6	LFX	09/11 → 12/15
CAMARO 6.2	L99(376CUV8), LF1	09/09 →
CAMARO 6.2 [ExtraEU]	LT1(376CUV8)	09/15 →
CAMARO 6.2 ZL1	LSA	09/12 → 12/15
CAPTIVA 2.4	LAF	03/11 →
CAPTIVA 2.4 4WD	LE5	03/11 →
CAPTIVA 3.0 4WD	LF1, A14XER	01/10 →
CORVETTE 6.2	LT1(376CUV8)	04/14 →
CORVETTE 6.2 Z06	LT4(376CUV8)	09/14 →
CRUZE 1.4	A14XER, L61	09/10 →
CRUZE 1.6	LDE	12/12 →
HHR 2.2	L61, LE9	09/05 → 12/11
HHR 2.2 [ExtraEU]	L61	09/05 → 12/08
MALIBU 2.4	LE9, LMT	01/12 →
MALIBU 3.0	LFW	04/13 →
SPARK III 1.0	LMT	03/10 →
SPARK III 1.0 LPG	LMT, LMU	03/10 →
SPARK III 1.2	LMU, 2H0	03/10 →
SPARK III 1.2 LPG	LMU	03/10 →
TRAILBLAZER 3.6 [ExtraEU]	LY7	01/13 →
TRAX 1.8	2H0	03/13 →
TRAX 1.8 AWD	2H0, A12XEL	03/13 →
VOLT EV 150	LUU	11/11 →

DAEWOO

GENTRA 1.5	B15D2	06/13 →
------------	-------	---------

OPEL

Model	Part Number	Year Range
ADAM 1.2	A12XEL, A14XEL	10/12 →
ADAM 1.4	A14XEL, A14XEL	10/12 →
ADAM 1.4 LPG	A14XEL, A24XE	07/13 →
AMPERA EV 150	A14XFL	11/11 → 03/15
ANTARA 2.4	A24XE, A24XE	12/10 →
ANTARA 2.4 4x4	A24XE, A30XF	12/10 →
ANTARA 3.0	A30XF, Z16XE1	11/10 →
ASTRA H 1.6	Z16XE1, A14NEL	03/04 → 10/10
ASTRA H 1.6 EcoTec	Z16XEP	02/04 → 11/04

OPEL

Model	Part Number	Year Range
ASTRA H 1.8	A18XER	02/07 → 09/12
ASTRA J 1.4	A14NEL, A14NEL	12/09 →
ASTRA J 1.4 LPG	A14NET	12/11 →
ASTRA J 1.4 Turbo	A14NEL, A16LET	12/09 →
ASTRA J 1.6	A16LET, A10XEP	12/09 →
ASTRA J 1.6 LPG	A16XER	10/12 → 10/15
ASTRA J 1.6 Turbo	A16LET	12/09 →
ASTRA J 1.8	A18XER	10/11 → 10/15
CORSA D 1.0	A10XEP, A12XEL	08/06 → 08/14
CORSA D 1.2	A12XEL, A14XEL	12/09 → 08/14
CORSA D 1.2 LPG	A12XER	06/11 → 08/14
CORSA D 1.4	A14XEL, A16LEL	09/09 → 08/14
CORSA D 1.4 LPG	A14XEL	09/09 → 08/14
CORSA D 1.6	Z16LER	07/12 → 08/14
CORSA D 1.6 Turbo	A16LEL, B14XEJ	05/07 → 08/14
CORSA E 1.2	B12XEL	09/14 →
CORSA E 1.4	B14XEJ, B14XEL	09/14 →
CORSA E 1.4 LPG	B14XEL, A18XER	03/15 →
CORSA E 1.6 Turbo	B16LES	03/15 →
INSIGNIA 1.4	B18XER	04/11 →
INSIGNIA 1.6	A16XER	07/08 → 03/17
INSIGNIA 1.6 Turbo	A16LET	07/08 → 03/17
INSIGNIA 1.8	A18XER, A14NEL	07/08 → 03/17
INSIGNIA 2.0 Turbo 4x4	A20NFT	07/11 → 03/17
MERIVA B 1.4	A14NEL, A14NEL	06/10 → 03/17
MERIVA B 1.4 LPG	A14NEL, A16XER	06/11 → 03/17
MOKKA 1.6	A16XER, Z16XE1	06/12 →
MOKKA 1.8	A18XER	01/13 →
MOKKA 1.8 4x4	A18XER	01/13 →
ZAFIRA B 1.6	Z16XE1, A14NEL	07/05 → 09/12
ZAFIRA B 1.8	A18XEL	06/13 → 04/15
ZAFIRA C 1.4	A14NEL, A14NET	10/11 →
ZAFIRA C 1.4 LPG	A14NET, A18XEL	10/11 →
ZAFIRA C 1.8	A18XEL, A12XEL	10/11 →
ZAFIRA C 1.8 LPG	A18XER	10/11 →

SAAB

Model	Part Number	Year Range
9-3 2.0 t	A20NFT	01/11 → 02/15
9-3 2.0 t Bio Power	A20NFT	01/11 → 02/15
9-3 2.0 t BioPower	A20NFT	01/11 → 02/15
9-3 2.0 t BioPower XWD	A20NFT	01/08 → 02/15
9-3 2.0 t XWD	A20NFT	01/08 → 02/15
9-3 2.0 T16	A20NFT	01/11 → 02/15
9-5 2.0 t BioPower	A20NFT	05/10 → 01/12
9-5 2.0 t BioPower XWD	A20NFT	05/10 → 01/12
9-5 2.0 Turbo	A20NHT	05/10 → 01/12
9-5 2.0 Turbo XWD	A20NHT	05/10 → 01/12
9-3X 2.0 t BioPower XWD	A20NFT	01/11 → 12/12

VAUXHALL

Model	Part Number	Year Range
ADAM 1.2	A12XEL, A14XEL	10/12 →
ADAM 1.4	A14XEL, 4ET50	10/12 →
ADAM 1.4 LPG	A14XEL	07/13 →
AMPERA EV 150	4ET50, A24XE	03/12 →
ANTARA 2.4	A24XE, A24XE	11/10 → 04/15
ANTARA 2.4 4x4	A24XE, A16XER	11/10 → 04/15
ANTARA 3.0 4x4	A30XH	11/10 → 04/15
ASTRA V 1.6	A16XER, A14NEL	01/04 → 11/10
ASTRA V 1.8	A18XER	12/05 → 10/10
ASTRA V 1.8 i 16V	A18XER	03/07 → 11/10
ASTRA VI 1.4	A14NEL, A14NEL	12/09 →
ASTRA VI 1.4 Turbo	A14NEL, A16LET	12/09 →
ASTRA VI 1.6	A16LET, Z16XE1	12/09 →
ASTRA VI 1.6 Turbo	A16LET	12/09 →
ASTRAVAN III 1.6	Z16XE1, A12XER	03/05 →
CORSA D 1.0	A10XEP	08/06 → 08/14
CORSA D 1.0 i 12V	A10XEP	01/10 → 08/14
CORSA D 1.2	A12XEL	06/10 → 08/14
CORSA D 1.2 i 16V	A12XER	12/09 → 08/14
CORSA D 1.2 LPG	A12XER, A14XEL	06/11 → 08/14
CORSA D 1.4	A14XEL, A16LEL	09/09 → 08/14
CORSA D 1.4 LPG	A14XEL	09/09 → 08/14
CORSA D 1.6 SRI	A16LEL, A16LES	05/07 → 08/14
CORSA D 1.6 VXR	A16LES, B14XEJ	06/11 → 08/14
CORSA E 1.2	B12XEL	08/14 →
CORSA E 1.4	B14XEJ, A16XER	08/14 →
CORSA E 1.4 LPG	B14XEL	08/14 →
CORSA E 1.6 VXR	B16LES	04/15 →
CORSAVAN III 1.2	A12XEL	01/10 →
CORSAVAN IV 1.2	B12XEL	10/14 →
CORSAVAN IV 1.4	B14XEJ	10/14 →
INSIGNIA 1.6	A16XER, A18XER	07/08 → 05/17
INSIGNIA 1.6 Turbo	A16LET	01/09 → 05/17
INSIGNIA 1.8	A18XER, A14NEL	07/08 → 05/17
INSIGNIA 2.0 Turbo	A20NFT	04/14 → 05/17
INSIGNIA 2.0 Turbo 4x4	A20NFT	09/11 → 05/17
MERIVA II 1.4	A14NEL, A14NEL	06/10 →
MERIVA II 1.4 LPG	A14NEL, A16XER	06/11 →
MOKKA / MOKKA X 1.6	A16XER, Z16XE1	06/12 →
VXR8 6.2	LS3(376CUV8)	04/08 →

VAUXHALL

Model	Part Number	Year Range
VXR8 6.2 LS3 V8	LS3(376CUV8)	06/10 →
ZAFIRA B 1.6	Z16XE1, A14NEL	07/05 → 11/14
ZAFIRA B 1.8	A18XEL	04/13 → 11/14
ZAFIRA C 1.4	A14NEL, A18XEL	10/11 → 08/18
ZAFIRA C 1.4 LPG	A14NET	10/11 → 08/18
ZAFIRA C 1.8	A18XEL, F16D4	10/11 →

10.3196

3,5

ABSOLUTE PRESSURE SENSORS (MAP)

Adatt./Suitable:

CHEVROLET

55563375

GENERAL MOTORS

55 563 375

OPEL

12 38 394

55563375

SIEMENS

5WK9 6820

VAUXHALL

55563375

MARKET DIFFUSION: MEDIUM



kPa	mV	
10 - 121,7	390,5 - 4700	

CHEVROLET

Model	Part Number	Year Range
CRUZE 1.6	F16D4, 2H0	05/09 →
CRUZE 1.8	2H0, A16XER	05/09 →
CRUZE 1.8 LPG	2H0	06/11 →
ORLANDO 1.8	2H0	02/11 →
ORLANDO 1.8 LPG	2H0	06/11 →

OPEL

Model	Part Number	Year Range
ASTRA H 1.6	A16XER, A18XER	12/06 → 05/14
ASTRA H 1.6 EcoTec	Z16XER	10/06 → 12/10
ASTRA H 1.6 LPG	Z16XER	08/09 → 10/10
ASTRA H 1.8	A18XER, A16XER	08/05 → 05/14
ASTRA J 1.6	Z16XER	12/06 →
ASTRA J 1.8	Z18XER	02/07 →
ZAFIRA B 1.6	A16XER, A18XER	01/08 → 04/15
ZAFIRA B 1.6 FlexFuel	Z16XER	08/08 → 12/12
ZAFIRA B 1.8	A18XER, A16XER	07/05 → 04/15
ZAFIRA 1.8 ECOTEC	A18XER	01/11 →

VAUXHALL

Model	Part Number	Year Range
ASTRA V 1.6	A16XER, A16XER	01/04 → 05/09
ASTRA V 1.6 i 16V	A16XER, A18XER	10/06 → 08/11
ASTRA V 1.8	A18XER, A16XER	01/04 → 11/10
ASTRA V 1.8 i 16V	Z18XER	03/07 → 11/10
ZAFIRA B 1.6	A16XER, A18XER	12/07 → 11/14
ZAFIRA B 1.8	A18XER, R2AA	04/05 → 11/14

10.3198



3,5

ABSOLUTE PRESSURE SENSORS (MAP)

Adatt./Suitable:

MAZDA
RF7J-18-211

kPa	mV	
26,9 - 400	250 - 4509,9	

MAZDA

3 I 2.0 MZR-CD	RF7J	12/06 ⇨ 06/09
3 II 2.2 MZR CD	R2AA, R2AA	01/09 ⇨ 09/14
5 I 2.0 CD	RF7J	02/05 ⇨ 05/10
5 I 2.0 MZR-CD	RF	09/07 ⇨
6 II 2.0 MZR-CD	RF7J	08/07 ⇨ 12/10
6 II 2.2 D	R2AA, R2AA	01/10 ⇨ 07/13
6 II 2.2 MZR-CD	R2AA, --	08/08 ⇨ 07/13
CX-7 2.2 MZR-CD AWD	--, ZJ06	07/09 ⇨

10.3201



3,5

ABSOLUTE PRESSURE SENSORS (MAP)

Adatt./Suitable:

MAZDA
ZJ20-18-211

kPa	mV	
10 - 213,5	939,5 - 4750	

MAZDA

2 II 1.3	ZJ06, ZJ-46	07/07 ⇨ 06/15
2 II 1.3 BiFuel	ZJ-46	05/11 ⇨ 11/14
2 II 1.3 MZR	ZJ-46, ZY05	01/10 ⇨ 06/15
2 II 1.5	ZY05, ZY05	10/07 ⇨ 06/15
2 II 1.5 i	ZY-DE	05/10 ⇨ 06/15
2 II 1.5 MZR	ZY05, Z6	06/11 ⇨ 06/15
3 II 1.6 MZR	Z6, L3N9	12/08 ⇨ 09/14

10.3202



3,5

ABSOLUTE PRESSURE SENSORS (MAP)

Adatt./Suitable:

BOSCH
0 261 230 128
0 261 230 129

MAZDA
L3K9-18-211
L3K9-18-211A

- ITEM NOW AVAILABLE FROM PRODUCTION**
- ARTICOLO ORA DISPONIBILE PER LA VENDITA
 - ARTICLE DISPONIBLE EN PRODUCTION COURANTE
 - JETZT ZUM VERKAUF VERFÜGBARER ARTIKEL
 - ARTICULO AHORA DISPONIBLE EN PRODUCCION



kPa	mV	
11,4 - 254,6	250 - 4750	

MAZDA

3 I 2.3 DiSi Turbo MPS	L3YH	06/06 ⇨ 06/09
3 I 2.3 MPS Turbo	L3N9, L3KG	12/06 ⇨ 06/09
3 II 2.3 MPS Turbo	L3KG, L3K4	06/09 ⇨ 09/14
CX-7 2.3 AWD	L3Y6	06/06 ⇨ 12/12
CX-7 2.3 MZR DISI Turbo AWD	L3K4, 4HV(P22DTE)	06/06 ⇨ 12/14
CX7 2.3 DiSi [ExtraEU]	L3K7	06/06 ⇨ 06/09

10.3205



3,5

ABSOLUTE PRESSURE SENSORS (MAP)

Adatt./Suitable:

BOSCH
0 261 230 131
0 261 230 132
0 261 230 224
0 261 230 225

CITROËN
1920 LA

FIAT
9660603480

FORD
1 372 511
1 503 280
6C11-9F479-AA
6C11-9F479-AB

PEUGEOT
1920 LA

MARKET DIFFUSION: MEDIUM



kPa	mV	
11 - 307	250 - 4750	

CITROËN

JUMPER III 2.2 HDi 100	4HV(P22DTE), 4HU(P22DTE)	04/06 ⇨
JUMPER III 2.2 HDi 120	4HU(P22DTE), 4HH(P22DTE)	04/06 ⇨
JUMPER III 2.2 HDi 130	4HH(P22DTE), P8FA	04/06 ⇨

FIAT

DUCATO III 100 Multijet 2,2 D	4HV	07/06 ⇨
-------------------------------	-----	---------

FORD

TRANSIT III 2.2 TDCi	P8FA, CVRA	04/06 ⇨ 08/14
TRANSIT III 2.2 TDCi RWD	CVRA, GZFA	09/11 ⇨
TRANSIT III 2.3 16V RWD	GZFA, --	04/06 ⇨ 08/14
TRANSIT III 2.4 TDCi	--, H9FD	04/06 ⇨
TRANSIT III 2.4 TDCi 4x4	H9FB	11/06 ⇨ 08/14
TRANSIT III 2.4 TDCi HPCR	--	07/06 ⇨
TRANSIT III 2.4 TDCi RWD	H9FD, SAFA	04/06 ⇨ 08/14
TRANSIT III 3.2 TDCi	SAFA, SAFA	02/08 ⇨ 08/14
TRANSIT III 3.2 TDCi RWD	SAFA, QVFA	09/07 ⇨ 08/14
TRANSIT TOURNEO 2.2 TDCi	QVFA, 4HV(P22DTE)	07/06 ⇨ 08/14

PEUGEOT

BOXER II 2.2 HDi 100	4HV(P22DTE), 4HU(P22DTE)	04/06 ⇨
BOXER II 2.2 HDi 120	4HU(P22DTE), 55266388	04/06 ⇨
BOXER II 2.2 HDi 130	4HH(P22DTE)	03/11 ⇨

10.3206



3,5

ABSOLUTE PRESSURE SENSORS (MAP)

Adatt./Suitable:

ALFA ROMEO
55203389
55219299

BOSCH
0 261 230 426
0 281 002 576
0 281 006 051
0 281 006 052
0 281 006 102

CHEVROLET
55568176

CHRYSLER
55219299

DAF
1403945

FIAT
55203389
55219299

FORD
G4D3-12B676-AA

GENERAL MOTORS
55 568 176
93 191 643

IVECO
0000504073323
0000504372225
501073323
504073323
504372225
5043722250
5443722250

JAGUAR
AJ8 13215

JEEP
55203389
55219299
68275301AA
K68275301AA

LANCIA
55203389
55219299

OPEL
12 38 838
55219299
55568176

RENAULT TRUCKS
21385453
50 10 437 653

SAAB
55 219 299
55 568 176
93 191 643

SUZUKI
18590-55P00
18590-55P00-000

VAUXHALL
55568176

VOLVO
20524936
22320906

MARKET DIFFUSION: MEDIUM



kPa	mV	
28,9 - 400	250 - 4480	

ALFA ROMEO

GIULIA 2.2 D	55266388, 55268818	10/15 ⇨
--------------	--------------------	---------

ALFA ROMEO		
GIULIA 2.2 D Q4	55268818, 940A3.000	11/16 →
GIULIETTA II 1.6 JTDM	940A3.000, 940B5.000	04/10 →
GIULIETTA II 2.0 JTDM	940B5.000, 55268818	08/13 →
STELVIO 2.2 D	55268818, LNQ	12/16 →
STELVIO 2.2 D Q4	55271838	12/16 →
STELVIO 2.2 JTDM Q4	55268818	08/18 →

CADILLAC		
BLS 1.9 D	Z19DTR	12/07 →

CHEVROLET		
CAPTIVA 2.0 CDI	LNP	01/12 →
CAPTIVA 2.0 D	LNP	01/11 →
CAPTIVA 2.0 D 4WD	LNP	01/11 →
CAPTIVA 2.2 D	LNQ, A22DMH	03/11 →
CAPTIVA 2.2 D 4WD	A22DMH, LNP	03/11 →
CAPTIVA 2.2 L	LNQ	01/12 →
CRUZE 2.0 CDI	LNP, 198A3.000	05/09 →
CRUZE 2.0 TD	LNP	08/12 →
ORLANDO 2.0 D	LNP	02/11 →

FIAT		
500L 1.6 D Multijet	199B.5000	09/12 →
500X 1.6 D Multijet	55260384	09/14 →
DOBLO II 1.6 D Multijet	198A3.000, 55260384	02/10 →
TIPO II 1.6 D	55260384, F2CFE611B	10/15 →

IVECO		
CROSSWAY	F2CFE611B, F4AE0481A	01/16 →
EURO CARGO IV	F4AFE411A, F3AE0681E	09/15 →
EURO CARGO I-III	F4AE0481A, F4AFE411A	09/00 → 09/15
EUROSTAR	F3AE0681E, F2BCNG	01/93 →
STRALIS	F2BCNG, F4AE3681B	02/02 →
TECTOR	F4AE3681B, F2BE0681A	01/12 →
TRAKKER	F2BE0681A, F2CFE611A	10/04 →
URBANWAY	F2CFE611A, F4AE3481A	05/13 →
VERTIS	F4AE3481A, 204DTA	10/10 →

JAGUAR		
E-PACE 2.0 D	204DTD	09/17 →
E-PACE 2.0 D AWD	204DTA, 204DTA	09/17 →
F-PACE 2.0 D	204DTD	02/17 →
F-PACE 2.0 D AWD	204DTA	02/17 →
XE 2.0 D	204DTD	03/15 →
XE 2.0 D AWD	204DTA, 204DTA	10/15 →
XF 2.0 D	204DTA, 204DTA	05/15 →
XF 2.0 D AWD	204DTA, EBU	03/16 →

JEEP		
CHEROKEE V 2.2 CRD 4x4	EBU, EJJ(55260384)	08/15 →
COMPASS 1.6 CRD	EJJ(55260384)	03/17 →
RENEGADE 1.6 CRD	EJJ(55260384), A22DM	07/14 →
WRANGLER 2.2 Multijet II	EBH	11/17 →

KAMAZ		
6	740.51	05/03 →

LANCIA		
DELTA III 1.9 D Multijet	844A1.000	01/09 → 08/14

OPEL		
ANTARA 2.2 CDTi	A22DM, A22DM	12/10 →
ANTARA 2.2 CDTi 4x4	A22DM, A16FDH	12/10 → 12/15
ASTRA J 2.0 BiTurbo CDTi	A20DTR	09/12 → 10/15
CASCADA 2.0 CDTi	A20DTR	04/13 →
COMBO D 1.6 CDTi	A16FDH, A20DTR	02/12 →
INSIGNIA 2.0 Biturbo CDTi	A20DTR, A20DTR	07/08 → 03/17
INSIGNIA 2.0 Biturbo CDTi 4x4	A20DTR, dC111-270	07/08 → 03/17
INSIGNIA 2.0 CDTi 4x4	A20DTR	09/13 → 03/17
ZAFIRA C 2.0 Biturbo CDTi	A20DTR	01/13 →

RENAULT TRUCKS		
KERAX	dC111-270, MACKE. TECHA/46	01/01 →
MAGNUM	MACKE. TECHA/46, dC14B	05/00 →
MIDLUM	dC14B, dC111B/43	10/01 →
PREMIUM	dC111B/43, A19DTR	08/00 →

SAAB		
9-3 1.9 TTiD	A19DTR, A22DM	12/07 → 02/15
9-5 2.0 TTiD	A20DTR	05/10 → 01/12
9-5 2.0 TTiD XWD	A20DTR	05/10 → 01/12
9-3X 1.9 TTiD AWD	Z19DTR	02/09 → 12/12

SUZUKI		
VITARA IV 1.6 DDiS	D16AA	02/15 →
VITARA IV 1.6 DDiS AllGrip	D16AA	02/15 →

VAUXHALL		
ANTARA 2.2 CDTi 4x4	A22DM, D9B260	12/10 →
ANTARA 2.2 CDTi FWD	A22DM	12/10 →
ASTRA VI 2.0 Biturbo CDTi	A20DTR	12/12 →
CASCADA 2.0 CDTi	A20DTR	02/13 →
INSIGNIA 2.0 Biturbo CDTi	A20DTR	03/12 → 05/17
INSIGNIA 2.0 Biturbo CDTi 4x4	A20DTR	03/12 → 05/17
INSIGNIA 2.0 CDTi	A20DTR	10/08 → 05/17
INSIGNIA 2.0 CDTi 4x4	A20DTR	05/09 → 05/17
ZAFIRA C 2.0 BiTurbo CDTi	A20DTR	11/12 → 08/18

VOLVO		
7700	D9B260, D13C420	06/06 →
9700	D13C420, D13C420	01/09 →
9900	D13C420, D9B260	01/09 →
B 9	D9B260, D7E240	09/05 →
FE	D7E240, D7E240	05/06 →
FE II	D7E240, D13A400	05/12 →
FH	D13A400, D12A340	09/05 →
FH 12	D12A340, D16C550	09/01 →
FH 16	D16C550, D16G540	01/03 →
FH 16 II	D16G540, D7E240	05/12 →
FL II	D7E240, D7E240	05/06 →
FL III	D7E240, D11B390	05/13 →
FM	D11B390, D12C340	09/05 →
FM 9	D9A260, D11C330	12/01 → 09/05
FM 12	D12C340, D9A260	08/98 → 09/05
FMX	D11C330, R16A1	04/10 →

10.3209



3

ABSOLUTE PRESSURE SENSORS (MAP)

Adatt./Suitable:

ACURA

37830-RNA-A01

DENSO

079800-7590

HONDA

37830-RNA-A01

ITEM NOW AVAILABLE FROM PRODUCTION

• ARTICOLO ORA DISPONIBILE PER LA VENDITA

• ARTICLE DISPONIBLE EN PRODUCTION COURANTE

• JETZT ZUM VERKAUF VERFÜGBARER ARTIKEL

• ARTICULO AHORA DISPONIBLE EN PRODUCCION

MARKET DIFFUSION: MEDIUM



kPa	mV	
10 - 169,3	405 - 4750	

ACURA		
MDX 3.5 iVtec [ExtraEU]	J35Y5	11/13 →
MDX 3.5 iVtec AWD	J35Y5	01/14 →
RDX 3.5 iVtec [ExtraEU]	J35Z2	01/12 →
TLX 2.4 iVtec [ExtraEU]	K24W7	07/14 →
TLX 3.5 i-VTEC AWD	J35Y6	07/14 →

HONDA		
ACCORD VIII 2.0 i	R20A3	06/08 →
ACCORD VIII 2.4 i	K24Z3	07/08 →
ACCORD VIII 3.5 i	J35Z2	07/08 →
ACCORD VIII 3.5 V 6	J35Z2	09/07 → 09/12
ACCORD IX 2.4	K24W2	07/14 →
ACCORD IX 3.5	J35Y1	09/12 →
CITY 1.4 i-VTEC	L13Z1	09/08 →
CITY 1.5 i-VTEC	L15A7	02/09 →
CIVIC 1.8 iVtec [ExtraEU]	R18Z1	09/11 →
CIVIC VIII 1.4	L13Z1	10/08 →
CIVIC VIII 1.6	R16A1, R18A1	09/05 →
CIVIC VIII 1.8	R18A1, --	09/05 →
CIVIC VIII 1.8 EXS Flex	R18A1	11/06 →
CIVIC VIII 2.0	--, J35Y1	01/06 →
CIVIC VIII 2.0 i-VTEC Type R	K20Z4	03/10 → 12/10
CIVIC VIII Type R	K20Z4	09/06 →
CIVIC IX 1.4 i-VTEC	L13Z4	02/12 →
CIVIC IX 1.8	R18Z1	02/12 →
CIVIC IX 1.8 i-VTEC	R18Z4	02/12 →
CR-V 2.0	R20A9	10/12 →
CR-V 2.0 AWD	R20A9	10/12 →
CR-V 2.0 e-CVT Hybrid	LF81	12/18 →
CR-V 2.0 e-CVT Hybrid AWD	LF81	12/18 →
CR-V 2.0 iVtec [ExtraEU]	R20A9	10/12 →
CR-V 2.4 AWD	K24Z9	01/12 →
CR-V 2.4 iVtec [ExtraEU]	K24W9	09/15 →
CR-V II 2.0	R20A1	06/04 →
CR-V III 2.0 i	R20A2	01/07 →
CR-V III 2.0 i-VTEC	R20A2	01/07 → 06/12

HONDA		
CR-V III 2.0 i-VTEC 4WD	R20A2	10/06 → 06/12
CR-V III 2.4	K24Z1	04/07 →
CR-V III 2.4 4WD	K24Z1	09/06 →
CR-V III 2.4 iVtec [ExtraEU]	K24Z1	06/06 →
CR-V III 2.4 i-Vtec 4WD	K24Z1, LEA1	10/06 →
CROSSTOUR 2.4	K24Y2	09/12 →
CROSSTOUR 3.5 4WD	J35Y1, K24Z1	01/12 →
CR-Z 1.5 Hybrid	LEA1, L12B1	06/10 →
FR-V 1.8	R18A1	01/07 →
HR-V 1.5	L15B4	08/15 →
INSIGHT 1.3 Hybrid	LDA3	04/09 →
JAZZ III 1.2	L12B1, J35Z4	07/08 →
JAZZ III 1.3	L13B2	09/15 →
JAZZ III 1.3 HYBRID	LDA3	04/11 →
JAZZ III 1.4	L13Z1	11/08 →
JAZZ III 1.5 i-VTEC	L15A7	07/08 →
JAZZ III 1.5 iVtec [ExtraEU]	L15B3	01/15 →
LEGEND 3.7 Vtec [ExtraEU]	J37A3	08/08 → 12/12
LEGEND III 3.7 VTEC V6	J37A2	07/08 →
LEGEND IV 3.7 VTEC V6 4WD	J37A3	07/08 → 12/12
ODYSSEY 3.5	J35A6	01/05 →
PILOT 3.0 iVtec [ExtraEU]	J30A9	01/17 →
PILOT 3.5 4WD	J35Z4, N47D20A	09/08 →
S2000 2.0 i	F20C2	01/06 →

10.3210



3

ABSOLUTE PRESSURE SENSORS (MAP)

Adatt./Suitable:

BMW

13 62 7 804 742

13 62 8 570 118

13 62 8 637 896

7 804 742

8 637 896

MINI

13 62 7 804 742

13 62 8 570 118

13 62 8 637 896

TOYOTA

89420-WA010

MARKET DIFFUSION: HIGH



kPa	mV	
27,2 - 400	250 - 4508	

BMW		
1 116 d	N47D20A, N47D20A	11/08 → 09/12
1 118 d	N47D20A, N47D20A	09/06 → 12/13
1 120 d	N47D20A, N47D20B	03/03 → 12/13
1 123 d	N47D20B, B37D15A	03/07 → 12/13
1 114 d	B37D15A, B37D15A	07/12 →
1 116 d	B37D15A, B47D20A	12/10 →
1 118 d	B47D20A, B47D20A	12/10 →
1 118 d xDrive	B47D20A, B47D20A	05/13 →
1 1120 d	B47D20A, B47D20A	12/10 →
1 1120 d xDrive	B47D20A, B47D20B	01/11 →
1 1120 i	B48B20A	09/15 →
1 1125 d	B47D20B, B47C20A	08/11 →
1 1125 i	B48B20B	09/15 →
1 11 M 140 i	B58B30A	09/15 →
1 11 M 140 i xDrive	B58B30A	09/15 →
1 SERIES 120i [ExtraEU]	B48B20A	10/15 →
2 214 d	B37C15A	07/14 → 02/18
2 216 d	B37C15A	03/14 →
2 218 d	B47C20A, B47C20A	11/13 →
2 218 d xDrive	B47C20A, B47C20A	12/14 →
2 220 d	B47C20A, B47C20A	10/12 →
2 220 d xDrive	B47C20A, B47D20B	03/14 →
2 220 i	B48B20A	09/15 →
2 225 d	B47D20B, B46B20B	01/14 →
2 230 i	B46B20B, N47D20A	09/15 →
2 M 240 i	B58B30A	09/15 →
2 M 240 i xDrive	B58B30A	09/15 →

BMW		
3 V 316 d	N47D20C	07/09 → 06/12
3 V 318 d	N47D20A, M47D204D4	02/07 → 06/12
3 V 320 d	M47D204D4, N47D20C	12/04 → 12/13
3 V 320 d xDrive	N47D20C, --	02/08 → 06/13
3 V 320 xd	--, M57D306D3	03/07 →
3 V 325 d	N57D30A	09/09 → 12/13
3 V 330 d	M57D306D3, B47D20A	06/05 → 12/13
3 V 330 d xDrive	N57D30A	09/08 → 06/13
3 V 330 xd	N57D30A	03/08 → 02/10
3 VI 316 d	B47D20A, B47D20A	05/11 →
3 VI 318 d	B47D20A, B47D20A	05/11 →
3 VI 318 d xDrive	N47D20C	11/12 → 05/15
3 VI 320 d	B47D20A, B47D20A	03/11 →
3 VI 320 d xDrive	B47D20A, B47D20B	05/11 →
3 VI 320 i	B48B20A	09/14 →
3 VI 320 i xDrive	B48B20A	09/14 →
3 VI 325 d	B47D20B, B46B20B	07/12 →
3 VI 328 d [USA]	--	10/11 →
3 VI 328 d xDrive [USA]	--	10/11 →
3 VI 330 d	N57D30A	01/12 →
3 VI 330 d xDrive	N57D30A	06/12 →
3 VI 330 e	B48B20A	11/15 → 10/18
3 VI 330 i	B46B20B, B58B30A	09/14 →
3 VI 330 i xDrive	B46B20B	10/14 →
3 VI 335 d xDrive	N57D30B	04/13 →
3 VI 340 i	B58B30A, B58B30A	10/14 →
3 VI 340 i xDrive	B58B30A, B47D20A	10/14 →
3 VII 320 d	B47D20B	11/18 →
3 VII 320 d xDrive	B47D20B	11/18 →
4 418 d	B47D20A, B47D20A	03/14 →
4 420 d	B47D20A, B47D20A	07/13 →
4 420 d xDrive	B47D20A, B47D20B	11/13 →
4 420 i	B48B20A	02/16 →
4 420 i xDrive	B48B20A	02/16 →
4 425 d	B47D20B, N57D30A	01/14 →
4 430 d	N57D30A, N57D30A	10/13 →
4 430 d xDrive	N57D30A, B46B20B	11/13 →
4 430 i	B48B20B	03/16 →
4 430 i xDrive	B46B20B, N47D20A	03/16 →
4 435 d xDrive	N57D30B	11/13 →
4 440 i	B58B30A	03/16 →
4 440 i xDrive	B58B30A	03/16 →
5 VI GT 520 d	N47D20C, N57D30A	04/11 → 02/17
5 VI GT 530 d	N57D30A, N57D30A	08/09 → 02/17
5 VI GT 530 d xDrive	N57D30A, N57D30B	06/10 → 02/17
5 VI GT 535 d	N57D30B, N57D30B	03/10 → 02/17
5 VI GT 535 d xDrive	N57D30B, B48B16A	03/10 → 02/17
5 V 520 d	N47D20A, B47D20A	02/05 → 05/10
5 VI 518 d	B47D20A, B47D20A	07/13 → 02/17
5 VI 520 d	B47D20A, B47D20A	06/10 → 02/17
5 VI 520 d xDrive	B47D20A, N47D20D	01/13 → 02/17
5 VI 525 d	N47D20D, N57D30A	03/10 → 02/17
5 VI 525 d xDrive	N47D20D	09/11 → 02/17
5 VI 530 d	N57D30A, N57D30B	01/10 → 02/17
5 VI 530 d xDrive	N57D30A	03/11 → 02/17
5 VI 535 d	N57D30B, N47D20C	09/10 → 02/17
5 VI 535 d xDrive	N57D30B	09/11 → 02/17
5 VII 518d [ExtraEU]	B47D20B	07/18 →
5 VII 518d Touring [ExtraEU]	B47D20B	07/18 →
5 VII 520 d	B47D20A	09/16 →
5 VII 520 d xDrive	B47D20A	09/16 →
5 VII 520 i	B48B16A, N57D30A	07/17 →
5 VII 525 d	B47D20B	07/17 →
5 VII 530 d	B57D30A	09/16 →
5 VII 530 d xDrive	B57D30A	09/16 →
5 VII 530 e iPerformance	B48B20B	03/17 →
5 VII 530 i	B48B20B	03/17 →
5 VII 530 i xDrive	B48B20B	07/17 →
5 VII 540 d xDrive	B57D30B	07/17 →
5 VII 540 i	B58B30A	09/16 →
5 VII 540 i xDrive	B58B30A	09/16 →
6 III 640 d	N57D30B	11/10 →
6 III 640 d xDrive	N57D30B	09/11 →
6 IV GT 620 d	B47D20B	07/18 →
6 IV GT 620d Gran Turismo [ExtraEU]	B47D20B	07/18 →
6 IV GT 620d xDrive Gran Turismo [ExtraEU]	B47D20B	07/18 →
6 IV GT 630 d	B57D30A	06/17 →
6 IV GT 630 d xDrive	B57D30A	06/17 →
6 IV GT 630 i	B48B20B	06/17 →
6 IV GT 640 d xDrive	B57D30B	11/17 →
6 IV GT 640 i	B58B30A	06/17 →
6 IV GT 640 i xDrive	B58B30A	06/17 →
7 V 730 d	N57D30A, N57D30B	02/08 → 05/15
7 V 730 d LCI	N57D30A	01/11 →
7 V 730 d xDrive	N57D30A	11/11 → 05/15
7 V 730Ld	N57D30A	06/08 →

BMW		
7 V 740 d	N57D30B, N57D30B	09/09 → 12/15
7 V 740 d LCI [USA]	N57D30B	01/11 →
7 V 740 d LCI xDrive [USA]	N57D30B	01/11 →
7 V 740 d xDrive	N57D30B, B57D30A	09/09 → 12/15
7 V 740Ld xDrive [USA]	N57D30A	01/13 →
7 VI 725 d, Ld	B47D20B	07/16 → 02/19
7 VI 730 d	B57D30A, B47C20A	07/15 →
7 VI 730 d xDrive	B57D30A	09/15 →
7 VI 730 d, Ld xDrive	B57D30A	09/15 →
7 VI 730 i, Li	B48B20B	11/15 → 02/19
7 VI 740 d, Ld xDrive	B57D30B	11/15 →
7 VI 740 e, Le	B48B20B	07/16 → 02/19
7 VI 740 i, Li	B58B30A	07/15 → 02/19
7 VI 740 Le xDrive	B48B20B	07/16 → 02/19
7 VI 740 Li xDrive	B58B30A	03/16 → 02/19
8 840 d xDrive	B57D30B	07/18 →
X1 sDrive 16 d	B37C15A	04/12 →
X1 sDrive 18 d	B47C20A, B47C20A	03/09 →
X1 sDrive 20 d	B47C20A, B47C20A	10/09 →
X1 xDrive 18 d	B47C20A, B47C20A	03/09 →
X1 xDrive 20 d	B47C20A, N47D20C	10/09 →
X1 xDrive 23 d	N47D20C, B47C20A	10/09 → 06/15
X1 xDrive 25 d	B47C20B	10/09 →
X2 sDrive 16 d	B37C15A	11/18 →
X2 sDrive 18 d	B47C20A, B47C20A	03/18 →
X2 sDrive 20 d	B47C20A, B47C20A	11/18 →
X2 X2 sDrive 18d [ExtraEU]	B47C20A, N47D20A	03/18 →
X2 X2 sDrive 18d [ExtraEU]	B47C20B	03/18 →
X2 xDrive 18 d	B47C20B	03/18 →
X2 xDrive 20 d	B47C20A	11/17 →
X2 xDrive 25 d	B47C20B	11/17 →
X3 I 2.0 d	N47D20A, N47D20C	03/07 → 03/09
X3 I xDrive 18 d	N47D20C, B47D20A	09/08 → 12/11
X3 I xDrive 20 d	N47D20C	09/07 → 08/10
X3 II sDrive 18 d	B47D20A, B47D20A	10/12 → 08/17
X3 II xDrive 20 d	B47D20A, N57D30A	09/10 → 08/17
X3 II xDrive 28 d	N47D20C	09/14 →
X3 II xDrive 30 d	N57D30A, B58B30A	04/11 → 08/17
X3 II xDrive 35 d	N57D30B	10/11 → 08/17
X3 III sDrive 18 d	B47D20A	04/18 →
X3 III sDrive 20 i	B48B20A	12/17 →
X3 III sDrive 20 i 1.6	B48B16A	12/17 →
X3 III xDrive 20 d	B47D20A	10/17 →
X3 III xDrive 25 d	B47D20B	04/18 →
X3 III xDrive 30 i	B48B20B	12/17 →
X3 III xDrive 30d	B57D30A	07/17 →
X3 III xDrive M40 d	B57D30B	08/18 →
X3 III xDrive M40 i	B58B30A, B57D30A	10/17 →
X4 M40 d xDrive	B57D30B	04/18 →
X4 M40 i xDrive	B58B30A	04/18 →
X4 xDrive 20 d	B47D20A	04/14 →
X4 xDrive 20 i	B48B20A	04/18 →
X4 xDrive 25 d	B47D20B	04/18 →
X4 xDrive 30 d	B57D30A, N57D30A	04/14 →
X4 xDrive 35 d	N57D30B	04/14 → 03/18
X5 III sDrive 25 d	B47D20B, B47D20B	12/13 → 07/18
X5 III xDrive 25 d	B47D20B, N57D30A	12/13 → 07/18
X5 III xDrive 30 d	N57D30A, N57D30B	08/13 → 07/18
X5 III xDrive 35 d [USA]	N57D30A	01/13 →
X5 III xDrive 40 d	N57D30B, N57D30(306D3)	12/13 → 07/18
X5 II xDrive 30 d	N57D30A, B47D20B	10/08 → 07/13
X5 II xDrive 40 d	N57D30B	09/10 → 06/13
X5 IV xDrive 30 d	B57D30A	08/18 →
X5 IV xDrive 40 i	B58B30C	08/18 →
X6 I xDrive 30 d	M57D30(306D3), N57D30A	04/08 → 07/14
X6 I xDrive 40 d	N57D30B	07/09 → 06/14
X6 II xDrive 30 d	N57D30A, B46B20B	08/14 →
X6 II xDrive 40 d	N57D30B	12/14 →
X7 xDrive 30 d	B57D30A	03/19 →
X7 xDrive 40 i	B58B30C	03/19 →
Z4 M40 i	B58B30C	11/18 →
Z4 sDrive 20 i	B46B20B, N47C16A	11/18 →
Z4 sDrive 30 i	B48B20B	11/18 →

MINI		
MINI II Cooper D	N47C16A, N47C16A	05/09 → 10/16
MINI II Cooper D ALL4	N47C16A, N47C20A	01/10 → 10/16
MINI II Cooper SD	N47C20A, B37C15A	06/09 → 10/16
MINI II Cooper SD ALL4	N47C20A	01/10 → 09/16
MINI II One D	N47C16A	01/10 → 10/16
MINI III Cooper D	B37C15A, B47C20A	10/13 →
MINI III Cooper D ALL4	B47C20A	10/16 →
MINI III Cooper SD	B47C20A, B47C20A	09/13 →
MINI III Cooper SD ALL4	B47C20A, AJ8FR	04/15 →
MINI III One D	B37C15A	02/14 →

TOYOTA		
AVENSIS III 2.0 D-4D	2WW	04/15 →
VERSO 1.6 D4-D	1WW	11/13 →

10.3211  **3,5**

ABSOLUTE PRESSURE SENSORS (MAP)

Adatt./Suitable:
FORD 1N1A-9F479-AA
JAGUAR AJ8 2763
LAND ROVER PMMS00080

ITEM NOW AVAILABLE FROM PRODUCTION

- ARTICOLO ORA DISPONIBILE PER LA VENDITA
- ARTICLE DISPONIBLE EN PRODUCTION COURANTE
- JETZT ZUM VERKAUF VERFÜGBARER ARTIKEL
- ARTICULO AHORA DISPONIBLE EN PRODUCCION



kPa	mV	
10 - 204,1	400 - 4750	

JAGUAR		
S-TYPE 2.5 V6	AJ6	04/02 → 10/07
S-TYPE 3.0 V6	XR8	01/99 → 10/07
S-TYPE 4.0 V8	AJ8	01/99 → 04/02
S-TYPE 4.2 Supercharged	AJ8FT	11/01 → 12/08
S-TYPE 4.2 V8	AJ8FR, AJ-V6	04/02 → 10/07
S-TYPE R 4,2 V8	AJ8FT	04/02 → 10/07
XF 4.2 Kompressor	SV8TS	03/08 → 04/15
XJ 3.0	AJ-V6, AJ8FT	05/03 → 03/09
XJ D 2.7	AJD	10/05 → 03/09
XJ R 4.2	AJ8FT	03/03 → 03/09
XK 8 4.2	AJ8FT, AJ8FT	08/02 → 12/06
XK 8 R 4,2	AJ8FT, AJNYB	08/02 → 12/06
X-TYPE 2.1 V6	AJNYB, AJMxB	03/02 → 11/09
X-TYPE 2.5	AJMxB, AJMxB	02/04 → 12/09
X-TYPE 2.5 V6 Trazione integrale	AJMxB, AJLWB	06/01 → 11/09
X-TYPE 3.0	AJLWB, AJLWB	02/04 → 12/09
X-TYPE 3.0 Trazione integrale	AJ-V6	09/02 → 12/08
X-TYPE 3.0 V6 Trazione integrale	AJLWB, 428PS	06/01 → 12/08

LAND ROVER		
RANGE ROVER III 4.2 4x4	428PS, 428PS	05/05 → 08/12
RANGE ROVER SPORT I 4.2 4x4	428PS, AJ8FR	02/05 → 03/13

10.3212



3,5

ABSOLUTE PRESSURE SENSORS (MAP)

Adatt./Suitable:

FORD
2W93-9F479-AA**JAGUAR**
AJ8 4034
C2C 22616**LAND ROVER**
4628195

ITEM NOW AVAILABLE FROM

PRODUCTION

• ARTICOLO ORA DISPONIBILE PER LA VENDITA

• ARTICLE DISPONIBLE EN PRODUCTION COURANTE

• JETZT ZUM VERKAUF VERFÜGBARER ARTIKEL

• ARTICULO AHORA DISPONIBLE EN PRODUCCION



kPa	mV	
10 - 204,1	400 - 4750	

JAGUAR

S-TYPE 4.2 V8	AJ8FR, AJ6WG	04/02 → 10/07
XF 3.0	AJ6WG, SV82G	03/08 → 04/15
XF 3.0 D	306DT	09/12 → 04/14
XF 3.0 D AWD	AJV6D	03/12 →
XF 4.2	SV82G, AJ6WG	03/08 →
XJ 3.0	AJ6WG, AJ36NG	01/11 →
XJ 3.6	AJ36NG, AJ8FR	05/03 → 03/09
XJ 4.2	AJ8FR, AJ8NG	05/03 → 03/09
XK 8 4.2	AJ8FT, AJ8FT	08/02 → 12/06
XK 8 R 4.2	AJ8FT, AJNYB	08/02 → 12/06
XK 3.6	AJ8NG, AJ8FT	07/07 → 07/14
XK 4.2	AJ8T24C	09/07 → 12/09
XK 4.2 [ExtraEU]	AJ8N21B	02/08 → 07/14
XK 4.2 XK8	AJ8FT, AJ8FT	03/06 → 07/14
XK 4.2 XKR	AJ8FT, AJ8FT	03/06 → 07/14
XK 5.0 V8	508PN	01/09 → 07/14
X-TYPE 2.1 V6	AJNYB, 448PN	03/02 → 11/09

LAND ROVER

DISCOVERY III 4.4 4x4	448PN	07/04 → 09/09
RANGE ROVER III 4.4 4x4	448PN, JB-DET	08/04 → 08/12
RANGE ROVER SPORT I 4.4 4x4	448PN	02/05 → 03/13

10.3213



3

ABSOLUTE PRESSURE SENSORS (MAP)

Adatt./Suitable:

DAIHATSU89421-26030
89421-B101
89421-B1010
89421-B1010-000**DENSO**079800-9180
7760 10K15
7760 10K16 *1
7760 11K03 *1
7760 11K10
7760 4L24 *1
7760 5K30 *1**LEXUS**

89421-26030

SUBARU22012-AA200
22012-AA230
89421-26030**TOYOTA**89420-12230 *1
89420-12240 *1
89420-12250 *1
89420-12270 *1
89420-74010 *1
89421-26030
89421-37010
89421-37030

*1 without fastening clamp

• senza staffa fissaggio

• sans bride de fixation

• ohne Befestigungsbügel

• sin estribo de sujeción

MARKET DIFFUSION: MEDIUM



kPa	mV	
10 - 138,7	894,6 - 4637,5	

DAIHATSU

CHARADEVI 1.33 16V	1NR-FE	05/11 →
COPEN 0.7	JB-DET, K3-VE	09/03 → 09/12
MATERIA 1.3	K3-VE	10/06 →
MATERIA 1.5	3S2-VE	10/06 →
MATERIA 1.5 ECO 4WD	3S2-VE	10/06 →
MATERIA 1.5 LPG	3S2-VE	01/10 → 12/11
SIRION 1.3	K3-VE, K3-VE	01/05 →
SIRION 1.3 4WD	K3-VE, 3S2-VE	04/05 →
SIRION 1.5	3S2-VE	03/08 →
TERIOS II 1.3 VVT-i 4x4	K3-VE	11/05 →
TERIOS II 1.3 VVT-i LPG 4x4	K3-VE	01/09 → 12/09
TERIOS II 1.5 4x4	3S2-VE	05/06 →
TERIOS II 1.5 LPG 4x4	3S2-VE	06/09 →
TERIOS II 1.5 VVT-i 4x4	3S2-VE	09/10 →
TERIOS II 1.5 VVT-i RWD	3S2-VE, EZ30D	11/05 →

LEXUS

ES 200	6AR-FSE	08/15 →
NX 2.5 VVTi Hybrid [ExtraEU]	2AR-FXE	07/14 →
NX 200	3ZR-FAE	11/14 →
NX 200 AWD	3ZR-FAE	11/14 →
NX 300h	2AR-FXE	07/14 →
NX 300h AWD	2AR-FXE	07/14 →

SUBARU

LEGACY 3.6 [ExtraEU]	EZ36D	01/15 →
LEGACY IV 3.0	EZ30D	05/03 →
LEGACY IV 3.0 R AWD	EZ30	09/03 → 06/09
LEGACY V 3.6 AWD	EZ36D	09/09 → 12/14
OUTBACK 3.6 [ExtraEU]	EZ36D	01/15 →
OUTBACK III 3.0 AWD	EZ30	11/03 → 09/09
OUTBACK IV 3.6 AWD	EZ36D	06/11 → 12/14
OUTBACK IV 3.6 R AWD	EZ36D	09/09 →
TREZIA 1.3	1NR-FE	03/11 →
TRIBECA 3.0	EZ30D, 1NR-FE	01/05 →

TOYOTA

AURIS I 1.33 Dual-VVTi	1NR-FE, 1ZR-FAE	05/09 → 09/12
AURIS I 1.6	1ZR-FAE, 2ZR-FAE	03/07 → 09/12
AURIS I 1.8	2ZR-FAE, 3ZR-FAE	10/06 → 09/12
AURIS I 1.8 4WD	2ZR-FAE	02/09 → 09/12
AURIS II 1.3	1NR-FE	10/12 →
AURIS II 1.6	1ZR-FAE	10/12 →
AVENSIS III 1.6	1ZR-FAE	11/08 →
AVENSIS III 1.8	2ZR-FAE	11/08 →
AVENSIS III 2.0	3ZR-FAE, 6ARFSE	11/08 →

TOYOTA

CAMRY 2.0	6ARFSE, 2ZR-FXE	12/14 →
CAMRY 2.5 Hybrid	2AR-FXE	09/11 →
CAMRY 2.5 Hybrid [CHN]	4AR-FXE	05/12 →
C-HR 1.8 Hybrid	2ZR-FXE, 2ZR-FAE	10/16 →
C-HR 2.0	3ZR-FAE	11/16 →
COROLLA 1.8 Hybrid	2ZR-FXE	10/18 →
COROLLA IX 1.6	1ZR-FE	11/06 → 07/07
COROLLA X 1.33	1NR-FE	12/08 → 07/14
COROLLA X 1.6 Dual VVTi	1ZR-FE	01/07 → 07/14
COROLLA X 1.6 VVTi	1ZR-FE	03/07 → 12/10
COROLLA X 1.8	2ZR-FAE, 1ZR-FAE	09/06 →
COROLLA X 1.8 4WD	2ZR-FAE	09/06 →
COROLLA XI 1.3	1NR-FE	05/12 →
COROLLA XI 1.5	1NZ-FE	05/12 →
COROLLA XI 1.6	1ZR-FAE, N04C-TQ	06/13 →
COROLLA XI 1.8	2ZR-FAE	05/12 →
COROLLA XI 1.8 [USA] [CAN]	2ZR-FAE	08/13 →
DYNA 4.0 D4d	N04C-TQ, N04C-UL	08/01 →
DYNA 4.0 D4d 4WD	N04C-UL, 1NR-FE	10/06 →
DYNA 4.0 Hybrid	N04C-UL	05/11 →
DYNA 4.6 D4d	S05C	06/03 →
DYNA 5.3 D	J05C	10/01 →
DYNA 250 4.6 TDi	S05C-TB	06/03 → 12/03
DYNA 400 4.6 D	S05C	10/00 → 09/06
DYNA 400 4.6 TDi	S05C-TB	06/03 → 09/06
IQ 1.33	1NR-FE, 3ZR-FAE	01/09 →
PRIUS IV 1.8 Hybrid	2ZR-FXE	09/15 →
PRIUS IV 1.8 Plug-in Hybrid	2ZR-FXE	01/16 →
RACTIS 1.3 VVTi [ExtraEU]	1NR-FE	07/10 → 04/14
RACTIS 1.5 VVTi [ExtraEU]	1NZ-FE	07/11 →
RAV 4 IV 2.0	3ZR-FE	12/12 →
RAV 4 IV 2.0 4WD	3ZR-FAE, 2AR-FXE	12/12 →
RAV 4 IV 2.5 Hybrid	2AR-FXE, 2AR-FXE	10/15 →
RAV 4 IV 2.5 Hybrid 4WD	2AR-FXE, 1NR-FE	10/15 →
RAV 4 III 2.0	3ZR-FAE, 3ZR-FAE	12/08 → 06/13
RAV 4 III 2.0 4WD	3ZR-FAE, 3ZR-FAE	12/08 → 06/13
URBAN CRUISER 1.33	1NR-FE, 1NR-FE	01/09 → 03/16
VERSO 1.6	1ZR-FAE	04/09 →
VERSO 1.8	2ZR-FAE	04/09 →
VERSO S 1.33	1NR-FE	11/10 → 10/16
YARIS II 1.33 VVT-i	1NR-FE, 1AD-FTV	11/08 → 12/11
YARIS III 1.3	1NR-FE	09/11 →
YARIS III 1.3 4WD	1NR-FE	12/10 →
YARIS 1.3 VVTi	1NR-FE	10/12 →

10.3214



3,5

ABSOLUTE PRESSURE SENSORS (MAP)

Adatt./Suitable:

LEXUS

89421-20200

SUBARU

89421-20200

TOYOTA

89421-20200

89421-71030

MARKET DIFFUSION: HIGH



kPa	mV	
27,8 - 400	250 - 4498	

LEXUS

IS II 200d	2AD-FTV	07/10 → 07/12
IS II 220d	2AD-FHV	08/05 → 07/12
LX 450d	1VD-FTV	09/15 →

SUBARU

TREZIA 1.4 D	1ND-TV	03/11 →
--------------	--------	---------

TOYOTA

AURIS I 1.4 D-4D	1ND-TV	03/07 → 04/13
AURIS I 2.0 D-4D	1AD-FTV	03/07 → 09/12
AURIS I 2.2 D	2AD-FHV	11/06 → 09/12
AURIS II 1.4 D-4D	1ND-TV	10/12 →
AURIS II 2.0 D-4D	1AD-FTV	10/12 →

TOYOTA		
AVENSIS II 2.0 D-4D	1AD-FTV	03/06 ⇨ 11/08
AVENSIS II 2.2 D-4D	2AD-FTV	10/05 ⇨ 11/08
AVENSIS II 2.2 D-CAT	2AD-FHV	07/05 ⇨ 11/08
AVENSIS III 2.0 D-4D	1AD-FTV, 2AD-FHV	11/08 ⇨
AVENSIS III 2.2 D-4D	2AD-FHV, 2AD-FHV	11/08 ⇨
COROLLA X 1.4 D-4D	1ND-TV	10/06 ⇨ 07/14
COROLLA X 2.0 D-4D	1AD-FTV	11/06 ⇨ 07/14
COROLLA XI 1.4 D-4D	1ND-TV	06/13 ⇨
COROLLA VERSO II 2.2 D-4D	2AD-FHV, 1KD-FTV	10/05 ⇨ 03/09
DYNA 100 3.0 D4d	1KD-FTV, 1KD-FTV	10/09 ⇨
DYNA 3.0 D4d	1KD-FTV, 2KD-FTV	08/01 ⇨
DYNA 3.0 D4d 4WD	1KD-FTV	09/06 ⇨
FORTUNER 2.8 [ExtraEU]	1GD-FTV	05/15 ⇨
FORTUNER 2.8 D 4x4	1GD-FTV	05/15 ⇨
HIACE 3.0 [ExtraEU]	1KD-FTV	11/08 ⇨
HIACE IV 2.5 D-4D	2KD-FTV, 2KD-FTV	11/01 ⇨
HIACE IV 2.5 D-4D 4WD	2KD-FTV, 1KD-FTV	08/01 ⇨
HIACE IV 3.0 [ExtraEU]	1KD-FTV	05/10 ⇨
HIACE IV 3.0 D	1KD-FTV, 2KD-FTV	08/04 ⇨
HILUX VII 2.5 D 4WD	2KD-FTV	08/05 ⇨ 05/15
HILUX VII 2.5 D-4D	2KD-FTV, 2KD-FTV	08/05 ⇨
HILUX VII 2.5 D-4D 4WD	2KD-FTV, 1KD-FTV	12/07 ⇨
HILUX VII 3.0 D	1KD-FTV, 1KD-FTV	11/04 ⇨
HILUX VII 3.0 D 4WD	1KD-FTV, 1KD-FTV	02/05 ⇨
HILUX VII 3.0 D-4D 4WD	1KD-FTV, 2GD-FTV	08/05 ⇨ 05/15
HILUX VIII 2.4 D	2GD-FTV	05/15 ⇨
HILUX VIII 2.4 D 4WD	2GD-FTV, 1KD-FTV	05/15 ⇨
HILUX VIII 2.8 D	1GD-FTV	05/15 ⇨
HILUX VIII 2.8 D 4WD	1GD-FTV	05/15 ⇨
IQ 1.4 D-4D	1ND-TV	01/09 ⇨ 12/15
LAND CRUISER 2.8 D4d	1GD-FTV	10/18 ⇨
LAND CRUISER 120 3.0 D-4D	1KD-FTV, 1GD-FTV	09/02 ⇨ 12/10
LAND CRUISER 200 4.5 D V8	1VD-FTV	01/08 ⇨
LAND CRUISER 200 4.5 D-4D	1VD-FTV	01/08 ⇨
LAND CRUISER 200 4.5 D4-D	1VD-FTV, 2AD-FHV	08/07 ⇨
LAND CRUISER 150 2.8 D-4D	1GD-FTV, 1KD-FTV	06/15 ⇨
LAND CRUISER 150 3.0 D-4D	1KD-FTV, 1VD-FTV	08/09 ⇨
LAND CRUISER PRADO 120 3.0 D-4D	1KD-FTV	08/06 ⇨ 08/09
LAND CRUISER PRADO 150 3.0 D-4D	1KD-FTV	08/09 ⇨
LAND CRUISER VAN 3.0 D4d 4WD	1KD-FTV	01/11 ⇨
RAV 4 IV 2.0 D	1AD-FTV	12/12 ⇨
RAV 4 IV 2.0 D 4WD	1AD-FTV	01/13 ⇨
RAV 4 IV 2.2 D 4WD	2AD-FHV, 1AD-FTV	12/12 ⇨
RAV 4 III 2.2 D	2AD-FHV, 2AD-FHV	12/08 ⇨ 06/13
RAV 4 III 2.2 D 4WD	2AD-FHV, 2AD-FHV	11/05 ⇨ 06/13
URBAN CRUISER 1.4 D-4D	1ND-TV	01/09 ⇨ 04/14
URBAN CRUISER 1.4 D-4D 4WD	1ND-TV	01/09 ⇨ 04/14
VERSO 2.0 D-4D	1AD-FTV, CABA	04/09 ⇨
VERSO 2.2 D-4D	2AD-FHV	04/09 ⇨
VERSO 2.2 D-CAT	2AD-FHV	04/09 ⇨
VERSO S 1.4 D4-D	1ND-TV	11/10 ⇨ 10/16
YARIS II 1.4 D-4D	1ND-TV	08/05 ⇨ 12/12
YARIS III 1.4 D	1ND-TV	09/11 ⇨
YARIS 1.4 D4d	1ND-TV	07/14 ⇨

10.3217



3,5

ABSOLUTE PRESSURE SENSORS (MAP)

Adatt./Suitable:

00 Eliminated on 02-05-2018. Please verify the availability through our local distributors

• Eliminato il 02-05-2018. Verificare la disponibilità presso i nostri distributori

• Éliminé le 02-05-2018. Vérifier la disponibilité auprès de nos distributeurs sur place

• Am 02-05-2018 gestrichen. Evtl. Verfügbarkeit bitte bei unseren Händlern prüfen

• Eliminado en fecha 02-05-2018. Verificar la disponibilidad a través de nuestros distribuidores locales

1006 After depletion of stock this part is replaced by:

• Esaurite le scorte questo pezzo sarà sostituito da:

• Après épuisement du stock, cette pièce est remplacée par:

• Nach Vorraterschöpfung wird ersetzt durch:

• Después agotamiento stock, sera sustituido por:

10.3213



kPa	mV	
10 - 138,4	890,9 - 4750	

10.3226



3,5

ABSOLUTE PRESSURE SENSORS (MAP)

Adatt./Suitable:

AUDI

036 906 051 C

BOSCH

0 261 230 053

0 261 230 054

VW

036 906 051 C

MARKET DIFFUSION: MEDIUM



kPa	mV	
16,9 - 116,9	250 - 4750	

AUDI		
A4 II 1.8 T	BFB	07/02 ⇨ 03/09
A4 II 1.8 T quattro	BFB	05/03 ⇨ 03/09
A4 II RS4 quattro	BNS	06/06 ⇨ 03/09
A4 III RS4 quattro	BNS	09/05 ⇨ 06/08
A4 IV 1.8 TFSI	CABA, CAGA	11/07 ⇨ 12/15
A4 IV 1.8 TFSI quattro	CDHB	09/08 ⇨ 03/12
A4 IV 2.0 TDI	CAGA, CAGA	11/07 ⇨ 12/15
A4 IV 2.0 TDI quattro	CAGA, CAEA	01/08 ⇨ 12/15

AUDI		
A4 IV 2.0 TFSI	CAEA, CAEB	06/08 ⇨ 12/15
A4 IV 2.0 TFSI flexible fuel	CFKA	11/09 ⇨ 12/15
A4 IV 2.0 TFSI flexible fuel quattro	CFKA	11/09 ⇨ 12/15
A4 IV 2.0 TFSI quattro	CAEB, CAMA	06/08 ⇨ 12/15
A4 IV 2.7 TDI	CAMA, CAGA	11/07 ⇨ 03/12
A4 IV 3.0 TDI quattro	CAPA, CAGA	11/07 ⇨ 03/12
A4 IV 3.2 FSI	CALA	09/08 ⇨ 03/12
A4 IV 3.2 FSI quattro	CALA	11/07 ⇨ 03/12
A4 IV RS4 quattro	CFAA	05/12 ⇨ 08/15
A4 IV S4 quattro	CAKA, CABD	11/08 ⇨ 12/15
A4 IV ALLROAD 2.0 TDI quattro	CAGA, CCNC	04/09 ⇨ 05/16
A4 IV ALLROAD 2.0 TFSI quattro	CCNC, CCWA	04/09 ⇨ 05/16
A4 IV ALLROAD 3.0 TDI quattro	CCWA, CAGA	04/09 ⇨ 05/16
A5 I 1.8 TFSI	CABD, CAGA	10/07 ⇨ 01/17
A5 I 2.0 TDI	CAGA, CAEA	08/08 ⇨ 01/17
A5 I 2.0 TDI quattro	CAHA	08/08 ⇨ 03/12
A5 I 2.0 TFSI	CAEA, CAEB	06/08 ⇨ 06/14
A5 I 2.0 TFSI quattro	CAEB, CAMA	06/08 ⇨ 01/17
A5 I 2.7 TDI	CAMA, CAGA	06/07 ⇨ 01/17
A5 I 3.0 TDI quattro	CAPA, CAGA	06/07 ⇨ 03/12
A5 I 3.2 FSI	CALA	06/07 ⇨ 03/12
A5 I 3.2 FSI quattro	CALA	06/07 ⇨ 03/12
A5 I RS5 quattro	CFAA	03/10 ⇨ 08/15
A5 I S5 quattro	CAKA, AMM	06/07 ⇨ 01/17
A6 II 1.9 TDI	AVF	08/01 ⇨ 01/05
A6 II 2.4	AMM, AKE	08/01 ⇨ 01/05
A6 II 2.4 quattro	BBV	08/01 ⇨ 01/05
A6 II 2.5 TDI	AKE, AKE	02/00 ⇨ 01/05
A6 II 2.5 TDI quattro	AKE, ARE	02/00 ⇨ 01/05
A6 II 2.7 T quattro	ARE, ASN	08/01 ⇨ 01/05
A6 II 3.0	ASN	08/01 ⇨ 01/05
A6 II 3.0 quattro	ASN, ASN	06/01 ⇨ 01/05
A6 II 4.2 quattro	ASG	11/98 ⇨ 01/05
A6 II S6 quattro	ANK	09/99 ⇨ 01/05
A6 III 3.0	BBJ	03/05 ⇨ 05/06
A6 III 3.0 quattro	BBJ	03/05 ⇨ 05/06
A6 III 4.2 FSI quattro	BVJ	05/06 ⇨ 08/11
A6 III S6 quattro	BXA	03/06 ⇨ 08/11
A8 II 3.0	ASN, AKE	07/03 ⇨ 05/06
A8 II 4.2 FSI quattro	BVJ	06/06 ⇨ 07/10
A8 II S8 quattro	BSM	06/06 ⇨ 07/10
ALLROAD 2.5 TDI quattro	AKE, CTA	05/00 ⇨ 08/05
ALLROAD 2.7 T quattro	ARE	05/00 ⇨ 08/05
ALLROAD 4.2 V8 quattro	BAS	07/02 ⇨ 08/05
Q3 RS 2.5 quattro	CTSA, BYH	05/13 ⇨ 10/18
Q3 RS performance 2.5 quattro	CZGB	01/15 ⇨ 10/18
Q7 I 4.2 FSI quattro	BAR	03/06 ⇨ 05/10
R8 4.2 FSI quattro	BYH, BUJ	04/07 ⇨ 07/15
R8 5.2 FSI quattro	BUJ, M132.930	04/09 ⇨ 07/15

VW		
PASSAT IV 1.8 [CHN]	BGC	06/01 ⇨
PASSAT IV 2.0	BFF	11/00 ⇨ 05/05
PASSAT IV 2.0 [CHN]	BFF	06/03 ⇨
PASSAT IV 2.8 [CHN]	BGG	09/01 ⇨

10.3227



3,5

ABSOLUTE PRESSURE SENSORS (MAP)

Adatt./Suitable:

CONTINENTAL
5WK9698
MITSUBISHI
1865A049
SIEMENS
5WK9698
SMART
A 451 820 69 10



kPa	mV	O + NTC -
15 - 120	250 - 4750	

SMART

FORTWO II 1.0 | M132.910 | 01/07 ⇨

10.3230



3,5

ABSOLUTE PRESSURE SENSORS (MAP)

Adatt./Suitable:

MITSUBISHI
1865A050
SIEMENS
5WK9699
SMART
A 451 820 70 10



kPa	mV	O + NTC -
10 - 211,5	424 - 4750	

SMART

FORTWO II 1.0 Brabus	M132.930, M271.820	01/08 ⇨
FORTWO II 1.0 Turbo	M132.930	01/07 ⇨
FORTWO II 1.0 Turbo Brabus	M132.930	07/10 ⇨

10.3231



3,5

ABSOLUTE PRESSURE SENSORS (MAP)

Adatt./Suitable:

BOSCH
0 261 230 250
0 261 230 251
MERCEDES-BENZ
0081530228
A 008 153 02 28

ITEM NOW AVAILABLE FROM PRODUCTION

- ARTICOLO ORA DISPONIBILE PER LA VENDITA
- ARTICLE DISPONIBLE EN PRODUCTION COURANTE
- JETZ ZUM VERKAUF VERFÜGBARER ARTIKEL
- ARTICULO AHORA DISPONIBLE EN PRODUCCION



kPa	mV	+ O -
10 - 254,4	288 - 4750	

MERCEDES-BENZ

CLASSE C III C 180	M271.820	06/11 ⇨
CLASSE C III C 180 CGI	M271.820, M271.820	11/09 ⇨ 08/14
CLASSE C III C 180 Kompressor	M271.820, M271.820	08/07 ⇨ 08/14
CLASSE C III C 200	M271.820	05/11 ⇨ 01/14
CLASSE C III C 200 CGI	M271.820, M271.820	01/07 ⇨
CLASSE C III C 200 Kompressor	M271.820, M271.820	01/07 ⇨ 08/14
CLASSE C III C 250	M271.860	06/11 ⇨
CLASSE C III C 250 CGI	M271.860	07/09 ⇨ 08/14
CLASSE C III C 63 AMG	--	07/10 ⇨ 08/14
CLASSE C III C 63 AMG DR 520	--	07/10 ⇨ 01/14
CLASSE E IV E 200 CGI	M271.820, A14NET	08/09 ⇨
CLASSE E IV E 250 CGI	M271.860	01/09 ⇨
CLASSE G II G 65 AMG	M279.982	05/12 ⇨
CLASSE S VI S 600	M277.980	04/14 ⇨
CLASSE S VI S 65 AMG	M279.980	07/14 ⇨
CLASSE S VI S 650 Maybach	M279.980	08/17 ⇨
CLASSE SLK III 200	M271.861	02/11 ⇨
CLASSE SLK III 250	M271.861	02/11 ⇨

10.3234



3

ABSOLUTE PRESSURE SENSORS (MAP)

Adatt./Suitable:

BOSCH
0 261 230 262
0 261 230 263
CHEVROLET
55567257
GENERAL MOTORS
55 567 257
OPEL
12 38 269
55567257
VAUXHALL
55567257

MARKET DIFFUSION: MEDIUM



kPa	mV	O - +
10 - 286	332,1 - 4750	

CHEVROLET

AVEO II 1.4 Turbo	A14NET	08/13 ⇨
CRUZE 1.4	A14NET	06/12 ⇨
ORLANDO 1.4	LUJ	06/12 ⇨
TRAX 1.4	A14NET	12/12 ⇨
TRAX 1.4 AWD	A14NET, A14NEL	12/12 ⇨
TRAX 1.4 LPG	A14NET	04/13 ⇨

OPEL

ADAM 1.4 S	B14NEH	11/14 ⇨
ASTRA J 1.4	A14NEL, A14NEL	10/11 ⇨
ASTRA J 1.4 LPG	A14NET	12/11 ⇨
ASTRA J 1.4 Turbo	A14NEL, A14NEL	12/09 ⇨
ASTRA J 1.6	A16LET	10/11 ⇨
ASTRA J 1.6 Turbo	A16LET	12/09 ⇨
CASCADA 1.4	A14NEL, A14NET	03/13 ⇨
CASCADA 1.4 Turbo	A14NET, B14NEH	03/13 ⇨
CORSA D 1.4	A14NEL	07/12 ⇨ 08/14
CORSA E 1.4 Turbo	B14NEH, A14NET	09/14 ⇨
CORSA E 1.6 Turbo	B16LES	03/15 ⇨
INSIGNIA 1.4	A14NET, A14NET	04/11 ⇨ 03/17
INSIGNIA 1.4 LPG	A14NET, A14NEL	07/12 ⇨ 03/17
MERIVA B 1.4	A14NEL, A14NEL	06/10 ⇨ 03/17
MERIVA B 1.4 LPG	A14NEL, A14NET	06/11 ⇨ 03/17
MOKKA 1.4	A14NET, A14NET	04/13 ⇨
MOKKA 1.4 4x4	A14NET, A14NET	06/12 ⇨
MOKKA 1.4 LPG	A14NET, A14NEL	04/13 ⇨
ZAFIRA C 1.4	A14NEL, A14NET	10/11 ⇨
ZAFIRA C 1.4 LPG	A14NET, A14NEL	10/11 ⇨

VAUXHALL

ADAM 1.4 S	B14NEH	11/14 ⇨
ASTRA VI 1.4	A14NEL, A14NEL	10/11 ⇨
ASTRA VI 1.4 Turbo	A14NEL, A14NEL	12/09 ⇨
ASTRA VI 1.6	A16LET	10/11 ⇨
ASTRA VI 1.6 Turbo	A16LET	12/09 ⇨
CASCADA 1.4	A14NEL, B14NEH	02/13 ⇨
CORSA D 1.4	A14NEL	08/12 ⇨ 08/14
CORSA E 1.4	B14NEH, A14NET	08/14 ⇨
CORSA E 1.6 VXR	B16LES	04/15 ⇨
INSIGNIA 1.4	A14NET, A14NEL	04/11 ⇨ 05/17
INSIGNIA 1.4 LPG	A14NET	07/12 ⇨ 05/17
MERIVA II 1.4	A14NEL, A14NEL	06/10 ⇨
MERIVA II 1.4 LPG	A14NEL, A14NET	06/11 ⇨
MOKKA / MOKKA X 1.4	A14NET, A14NET	04/13 ⇨
MOKKA / MOKKA X 1.4 4x4	A14NET, A14NEL	06/12 ⇨
ZAFIRA C 1.4	A14NEL, CGQB	10/11 ⇨ 08/18
ZAFIRA C 1.4 LPG	A14NET	10/11 ⇨ 08/18

10.3235



3,5

ABSOLUTE PRESSURE SENSORS (MAP)

Adatt./Suitable:

- AUDI**
03K 906 051
- BOSCH**
0 281 006 059
0 281 006 060
- MAN**
03K 906 051
- PORSCHE**
03K 906 051
- SEAT**
03K 906 051
- SKODA**
03K 906 051
- VW**
03K 906 051

ITEM NOW AVAILABLE FROM PRODUCTION

- ARTICOLO ORA DISPONIBILE PER LA VENDITA
- ARTICLE DISPONIBLE EN PRODUCTION COURANTE
- JETZT ZUM VERKAUF VERFÜGBARER ARTIKEL
- ARTICULO AHORA DISPONIBLE EN PRODUCCION

MARKET DIFFUSION: MEDIUM



kPa	mV	O + NTC -
28,9 - 400	250 - 4480	

AUDI

Model	Code	Year
A1 1.4 TDI	CUSB	11/14 → 10/18
A6 IV 3.0 TDI quattro	CGQB, CGQB	11/11 → 09/18
A7 SPORTBACK 3.0 TDI quattro	CGQB, CGQB	11/11 → 05/18
Q5 1.505 TDI quattro	CGQB, DAUA	12/12 →

MAN

Model	Code	Year
TGE 2.0 TDI	DAUA, DAUA	11/16 →
TGE 2.0 TDI AWD	DAUA, DASA	02/17 →
TGE 2.0 TDI RWD	DASA, CUSA	05/17 →

PORSCHE

Model	Code	Year
PANAMERA 3.0 D	MCWJA	07/13 → 10/16

SEAT

Model	Code	Year
IBIZA IV 1.4 TDI	CUSA, CUSA	05/15 →
TOLEDO IV 1.4 TDI	CUSB	05/15 →

SKODA

Model	Code	Year
FABIA III 1.4 TDI	CUSA, CDCA	08/14 →
RAPID 1.4 TDI	CUSB	05/15 →

VW

Model	Code	Year
AMAROK 2.0 BiTDI	CDCA, CDCA	09/10 →
AMAROK 2.0 BiTDI 4motion	CDCA, CDBA	09/10 →
AMAROK 2.0 TDI	CDBA, CDBA	09/10 →
AMAROK 2.0 TDI 4motion	CDBA, CDBA	09/10 →
AMAROK 2.0 TDi/TDi BlueMotion	CDBA, CDBA	05/12 → 10/13
AMAROK 2.0 TDi/TDi BlueMotion [ExtraEU]	CDBA, CAAB	09/11 →
CAMPMOBILE 2.0 TDi BlueMotion	CAAB, CKTB	04/15 →
CRAFTER 2.0 TDI	CKTB, CSNA	05/11 →
CRAFTER 2.0 TDI 4motion	CSNA, DASA	11/11 →
CRAFTER 2.0 TDI RWD	DASA, CAAB	11/16 →
MULTIVAN 2.0 BiTDI	CFCA	09/09 → 08/15
MULTIVAN 2.0 BiTDI 4motion	CFCA	09/09 → 08/15
MULTIVAN 2.0 TDI	CAAB, CFCA	04/15 →
MULTIVAN 2.0 TDI 4motion	CFCA, CUSA	06/15 →
POLO V 1.4 TDI	CUSA, CAAA	02/14 →
TRANSPORTER 2.0 TDi BlueMotion	CXEC	08/18 →
TRANSPORTER V 2.0 BiTDI	CFCA	09/09 → 08/15
TRANSPORTER V 2.0 BiTDI 4motion	CFCA	09/09 → 08/15
TRANSPORTER VI 2.0 TDI	CAAA, CFCA	04/15 →
TRANSPORTER VI 2.0 TDI 4motion	CFCA, A2ONFT	06/15 →

10.3236



3,5

ABSOLUTE PRESSURE SENSORS (MAP)

Adatt./Suitable:

- CHEVROLET**
12612111
12644807
- GENERAL MOTORS**
12 612 111
12 644 807
- OPEL**
12 47 062
12 47 361
12612111
12644807
- SAAB**
12 644 807
- VAUXHALL**
12612111
12644807

ITEM NOW AVAILABLE FROM PRODUCTION

- ARTICOLO ORA DISPONIBILE PER LA VENDITA
- ARTICLE DISPONIBLE EN PRODUCTION COURANTE
- JETZT ZUM VERKAUF VERFÜGBARER ARTIKEL
- ARTICULO AHORA DISPONIBLE EN PRODUCCION



kPa	mV	O + NTC -
10 - 372,2	485 - 4750	

CHEVROLET

Model	Code	Year
CAMARO 2.0 Turbo	LTG	01/16 →
CORVETTE 6.2 Z06	LT4(376CUV8)	09/14 →

OPEL

Model	Code	Year
ASTRA J 2.0	A2ONFT, A2ONFT	04/12 →
INSIGNIA 2.0 4x4	B2ONFT	03/17 →
INSIGNIA 2.0 E85 Turbo	A2ONFT, A2ONHT	09/10 → 03/17
INSIGNIA 2.0 Turbo	A2ONHT, A2ONFT	07/08 → 03/17
INSIGNIA 2.0 Turbo 4x4	A2ONFT, A2ONFT	07/08 → 03/17
INSIGNIA 2.0 Turbo E85	A2ONFT	07/08 → 03/17

SAAB

Model	Code	Year
9-3 2.0 t	A2ONFT	01/11 → 02/15
9-3 2.0 t Bio Power	A2ONFT	01/11 → 02/15
9-3 2.0 t BioPower	A2ONFT	01/11 → 02/15
9-3 2.0 t BioPower XWD	A2ONFT	01/08 → 02/15
9-3 2.0 t XWD	A2ONFT	01/08 → 02/15
9-3 2.0 T16	A2ONFT	01/11 → 02/15
9-3X 2.0 t BioPower XWD	A2ONFT	01/11 → 12/12

VAUXHALL

Model	Code	Year
ASTRA VI 2.0 VXR	A2ONFT, A2ONFT	04/12 →
INSIGNIA 2.0 4x4	B2ONFT	03/17 →
INSIGNIA 2.0 E85 Turbo	A2ONHT	09/10 → 05/17
INSIGNIA 2.0 Turbo	A2ONFT, A2ONFT	07/08 → 05/17
INSIGNIA 2.0 Turbo 4x4	A2ONFT, 4HG(P22DTE)	07/08 → 05/17

10.3244



3

ABSOLUTE PRESSURE SENSORS (MAP)

Adatt./Suitable:

- BOSCH**
0 261 230 264
0 261 230 265
0 261 230 308
0 261 230 309
0 261 230 453
- CITROËN**
96 753 795 80
- FORD**
1 682 141
1 762 251
1 913 600
AG91-9F479-AA
AG91-9F479-AB
AG91-9F479-AC
- FORD USA**
1 682 141
1 762 251
1 913 600
AG91-9F479-AA
AG91-9F479-AB
AG91-9F479-AC
- JAGUAR**
C2G 2675
JDE 29140
T2H 21415
- LAND ROVER**
LR022157
LR038762
- MAZDA**
U202-18-211
- PEUGEOT**
96 753 795 80
- VOLVO**
31316349
31338107

MARKET DIFFUSION: MEDIUM



kPa	mV	O - +
10 - 307,5	250 - 4750	

CITROËN

Model	Code	Year
JUMPER III 2.2 HdI 110	4HG(P22DTE), 4HJ(P22DTE)	07/11 →
JUMPER III 2.2 HdI 130	P22DTE	07/11 →
JUMPER III 2.2 HdI 150	4HJ(P22DTE), M1JA	07/11 →

FORD

Model	Code	Year
B-MAX 1.0 EcoBoost	M1JA, --	10/12 →
C-MAX II 1.0 EcoBoost	--, 10FD0X	10/12 →
ECOSPORT 1.0 EcoBoost	10FD0X, M1JE	10/13 →
FIESTA VI 1.0 EcoBoost	M1JE, YYJA	09/12 →
FIESTA VI 1.0 Sport	YYJA, JTJA	05/14 →
FIESTA VI 1.6 EcoBoost	--	01/13 →
FIESTA VI 1.6 ST	JTJA, M1DA	03/13 →
FIESTA VI 1.6 ST200	JTJC	04/16 →
FOCUS III 1.0 EcoBoost	M1DA, JQDA	02/12 →
FOCUS III 1.0 GTDI	--	07/12 →
FOCUS III 1.6 EcoBoost	JQDA, R9DA	07/10 →
FOCUS III 1.6 Flexifuel	YUDA	07/13 →
FOCUS III 2.0 ST	R9DA, --	07/12 →
GALAXY II 1.6 EcoBoost	--, TNWA	11/10 →
GALAXY II 2.0 EcoBoost	TNWA, R9CD	03/10 →
GALAXY III 2.0 EcoBoost	R9CD, B7DA	01/15 →
GRAND C-MAX 1.0 EcoBoost	B7DA, --	10/12 →
KUGA II 1.6 EcoBoost	--, JQMA	01/13 →
KUGA II 1.6 EcoBoost 4x4	JQMA, TNBA	10/12 →
KUGA II 2.0 4x4	--	03/13 → 06/16
KUGA II 2.0 EcoBoost	--	03/13 →
MONDEO III 1.6 EcoBoost	JTBA, --	11/10 → 01/15
MONDEO III 2.0 EcoBoost	TPBA	03/10 → 01/15
MONDEO III 2.0 SCTi	TNBA	03/10 → 01/15
MONDEO IV 2.0 EcoBoost	--, --	09/12 →
MONDEO IV 2.0 EcoBoost 4x4	--	09/12 → 07/16
MONDEO 1.6 EcoBoost	JTBA	11/10 → 09/14
MONDEO 2.0 EcoBoost	TNBA, JTBA	03/10 → 09/14
RANGER VI 2.2 TDCi	--, --	04/11 →
RANGER VI 2.2 TDCi 4x4	--, SA2R	04/11 →
RANGER VI 3.2 TDCi 4x4	SA2R, --	04/11 →
S-MAX I 1.6 EcoBoost	--, TNWB	02/11 →
S-MAX I 2.0 EcoBoost	TNWB, R9CD	07/10 → 12/14

FORD		
S-MAX II 2.0 EcoBoost	R9CD, M2GA	01/15 →
TOURNEO CONNECT II 1.0 EcoBoost	M2GA, --	11/13 →
TOURNEO CONNECT II 1.6 EcoBoost	--, SFCA	09/13 →
TOURNEO COURIER 1.0 EcoBoost	SFCA, CVFF	02/14 →
TOURNEO CUSTOM 2.2 TDCi	CVFF, CVFA	04/12 →
TRANSIT III 2.2 TDCi	CYFA, CYRB	10/07 → 08/14
TRANSIT III 2.2 TDCi 4x4	CYRB, CVRA	10/11 → 08/14
TRANSIT III 2.2 TDCi RWD	CVRA, PHFA	10/11 →
TRANSIT III 2.4 TDCi	PHFA, --	04/06 → 08/14
TRANSIT IV 2.2 TDCi	--, CV24	08/13 →
TRANSIT IV 2.2 TDCi 4x4	CV24, CV24	08/13 →
TRANSIT IV 2.2 TDCi RWD	CV24, CYFA	08/13 →
TRANSIT 2.2 TDCi	CVFA, M2GA	10/11 → 08/14
TRANSIT CONNECT II 1.0 EcoBoost	M2GA, --	02/13 →
TRANSIT CONNECT II 1.6 EcoBoost	--, SFCA	02/13 →
TRANSIT COURIER 1.0 EcoBoost	SFCA, CVFF	02/14 →
TRANSIT CUSTOM 2.2 TDCi	CVFF, CYFA	04/12 →
TRANSIT TOURNEO 2.2	CYFA, PGFA	10/11 → 08/14
TRANSIT TOURNEO 2.2 TDCi	PGFA, C23HD0D	10/07 → 08/14

FORD USA

MUSTANG 2.3 EcoBoost	C23HD0D, 4HG(P22DTE)	01/15 →
----------------------	----------------------	---------

JAGUAR

XE 2.0	204PT	03/15 →
XF 2.0	204PT	06/12 →
XJ 2.0	204PT	05/12 →

MAZDA

BT-50 2.2 MZR-CD	U2	10/11 →
BT-50 3.2 MZR-CD	UH	10/11 →

PEUGEOT

BOXER II 2.2 HdI 110	4HG(P22DTE), 4HH(P22DTE)	03/11 →
BOXER II 2.2 HdI 130	4HH(P22DTE), 4HJ(P22DTE)	03/11 →
BOXER II 2.2 HdI 150	4HJ(P22DTE), B42047	03/11 →

VOLVO

S60 II 2.0 T	B4204T6	04/10 → 12/11
S60 II T3	B4164T3	04/10 → 12/15
S60 II T4	B4164T	04/10 → 12/15
S60 II T4F	B4164T2	04/11 → 12/15
S60 II T5	B4204T7	04/10 → 12/14
S80 II 2.0 T	B4204T6	01/10 →
S80 II T4	B4164T	10/10 →
S80 II T4F	B4164T2	05/11 →
S80 II T5	B4204T7	10/10 →
S80L 2.0 T	B4204T6	01/10 →
S80L T5	B4204T7	01/12 →
V40 II T2 GTDi	B4164T4	03/13 → 12/15
V40 II T3 GTDi	B4164T3	03/12 →
V40 II T4	B4164T	04/14 →
V40 II T4 GTDi	B4164T	03/12 →
V60 I 2.0 T	B4204T6	07/10 → 12/12
V60 I T3	B4164T3	09/10 → 12/15
V60 I T4	B4164T	09/10 → 12/15
V60 I T4F	B4164T2	04/11 → 12/15
V60 I T5	B4204T7, A20NFT	09/10 →
V70 III 1.6 T4F	B4164T2	01/11 → 12/15
V70 III 2.0 T	B4204T6	09/09 → 12/11
V70 III T4	B4164T	10/10 → 12/15
V70 III T5	B4204T7	01/10 → 12/14
XC60 I 2.0 T	B4204T6	12/09 → 12/12
XC60 I T5	B4204T7	09/10 → 12/14

10.3245



3,5

ABSOLUTE PRESSURE SENSORS (MAP)

Adatt./Suitable:

GENERAL MOTORS
 12 592 017

OPEL
 12592017
 48 03 140

SAAB
 12 592 017

VAUXHALL
 12592017

kPa	mV	O + NTC -
11,9 - 261,9	250 - 4750	

OPEL

GT 2.0	LNF	06/07 → 12/11
INSIGNIA 2.0 E85 Turbo	A20NFT, A20NFT	09/10 → 03/17
INSIGNIA 2.0 Turbo	A20NHT	07/08 → 03/17
INSIGNIA 2.0 Turbo 4x4	A20NFT, A20NFT	07/08 → 03/17
INSIGNIA 3.0 Turbo E85	A20NFT	07/08 → 03/17

SAAB

9-5 2.0 t BioPower	A20NFT	05/10 → 01/12
9-5 2.0 t BioPower XWD	A20NFT	05/10 → 01/12
9-5 2.0 Turbo	A20NHT	05/10 → 01/12
9-5 2.0 Turbo XWD	A20NHT	05/10 → 01/12

VAUXHALL

INSIGNIA 2.0 E85 Turbo	A20NHT	09/10 → 05/17
INSIGNIA 2.0 Turbo	A20NFT, A20NFT	07/08 → 05/17
INSIGNIA 2.0 Turbo 4x4	A20NFT, G9U650	07/08 → 05/17

10.3246



3

ABSOLUTE PRESSURE SENSORS (MAP)

Adatt./Suitable:

BOSCH
 0 281 002 573

GENERAL MOTORS
 9 109 787

NISSAN
 22630-00Q2F
 25085-00QAB

OPEL
 44 01 787
 91 09 787

RENAULT
 22 36 581 43R
 82 00 194 432
 H82 00 197 927

VAUXHALL
 9109787

MARKET DIFFUSION: MEDIUM



kPa	mV	O + NTC -
12,7 - 255,3	250 - 4750	

NISSAN

INTERSTAR dCi 100	G9U650, G9U650	11/03 →
INTERSTAR dCi 120	G9U650, G9T722	04/02 →
INTERSTAR dCi 150	G9U632	08/06 →
INTERSTAR dCi 90	G9T722, K9K276	07/02 →
MICRA III 1.5 dCi	K9K276, G9U750	09/03 → 06/10

OPEL

MOVANO A 2.2 DTI	G9T750	09/00 →
MOVANO A 2.5 CDTI	G9U754	10/03 → 12/06
MOVANO A 2.5 DTI	G9U750, K9K728	10/01 →

RENAULT

CLIO II 1.5 dCi	K9K712	01/04 →
CLIO III 1.5 dCi	K9K750	11/07 →
GRAND SCÉNIC II 1.5 dCi	K9K728, G9T720	04/04 →
MASTER II 2.2 dCi 90	G9T720, G9U632	09/00 →
MASTER II 2.5 dCi	G9U632, G9U720	01/04 →
MASTER II 2.5 dCi 100	G9U754	10/03 →
MASTER II 2.5 dCi 120	G9U720, K9K722	10/01 →
MEGANE II 1.5 dCi	K9K722, K9K722	09/02 → 12/10
MASTER 2.5 dCi	G9U724	11/02 → 05/10
MODUS / GRAND MODUS 1.5 dCi	K9K750	09/04 →
MODUS / GRAND MODUS 1.5 dCi 90	K9K750	10/10 →
SCÉNIC II 1.5 dCi	K9K722, G9U750	06/03 →
SCENIC 1.5 dCi	K9K728	06/07 → 11/08

VAUXHALL

MOVANO A 2.2 DTI	G9T750	09/00 → 05/10
MOVANO A 2.5 CDTI	G9U754	10/01 → 12/10
MOVANO A 2.5 DTI	G9U750, E400V1	01/01 → 05/10

10.3248



3,5

ABSOLUTE PRESSURE SENSORS (MAP)

Adatt./Suitable:

- BOSCH**
0 261 230 293
0 261 230 294
- FORD**
9G9N-12B676-AC
- VOLVO**
30777337
31303974
31355462

MARKET DIFFUSION: MEDIUM



kPa	mV	O + NTC -
31,1 - 372	250 - 4750	

VOLVO		
C30 D3	D5204T5	10/10 ⇨ 12/12
C30 D4	D5204T	10/10 ⇨ 12/12
C30 Electric	E400V1, D5244T13	12/10 ⇨ 12/12
C70 II D3	D5204T5	10/10 ⇨ 06/13
C70 II D4	D5204T	10/10 ⇨ 06/13
S40 II 2.4 CDI	D5244T9	03/07 ⇨ 12/10
S40 II 2.4 D5	D5244T13, D5204T2	03/06 ⇨ 12/10
S40 II D3	D5204T5	10/10 ⇨ 12/12
S40 II D4	D5204T	10/10 ⇨ 12/12
S60 II 2.4 D4 AWD	D5244T21	03/15 ⇨
S60 II D3	D5204T2, D5204T2	04/10 ⇨ 12/15
S60 II D4	D5204T2, D5244T10	04/10 ⇨ 12/14
S60 II D5	D5244T10, D5244T10	04/10 ⇨ 12/15
S60 II D5 AWD	D5244T10, D5244T14	04/10 ⇨ 12/15
S80 II 2.4 D	D5244T14, D5204T2	03/06 ⇨
S80 II D3	D5204T7	05/12 ⇨
S80 II D3 / D4	D5204T2, D5244T10	01/10 ⇨
S80 II D5	D5244T10, D5244T10	01/10 ⇨
S80 II D5 AWD	D5244T10, D5244T11	01/10 ⇨
V40 II 2.0 D3	D5204T6	09/13 ⇨ 12/15
V40 II 2.0 D4	D5204T4	09/13 ⇨ 12/14
V40 II D3	D5204T6	03/12 ⇨ 03/15
V40 II D4	D5204T4	03/12 ⇨
V40 2.0 D3	D5204T6	09/13 ⇨ 12/15
V40 2.0 D4	D5204T4	09/13 ⇨ 12/14
V50 D3	D5204T5	10/10 ⇨ 12/12
V50 D4	D5204T	10/10 ⇨ 12/12
V60 I 2.0 D3	D5204T7	09/13 ⇨ 12/15
V60 I 2.0 D4	D5204T3	09/13 ⇨ 12/15
V60 I 2.4 D4 AWD	D5244T12	09/13 ⇨ 12/15
V60 I 2.4 D5	D5244T11, D5244T11	04/11 ⇨ 12/15
V60 I 2.4 D5 AWD	D5244T11, D5244T15	04/11 ⇨ 12/15
V60 I 2.4 D5 Hybrid AWD	D87PHEV	03/15 ⇨
V60 I 2.4 Hybrid D6 AWD	D5244T15, D5204T2	06/12 ⇨ 12/15
V60 I D3	D5204T7	05/12 ⇨ 12/15
V60 I D3 / D4	D5204T2, D5244T12	07/10 ⇨ 12/14
V60 I D4 AWD	D5244T12, D5244T10	05/12 ⇨
V60 I D5	D5244T10, D5244T10	07/10 ⇨ 12/15
V60 I D5 AWD	D5244T10, D5244T11	07/10 ⇨ 12/15
V60 I D6 Hybrid AWD	D97PHEV	03/15 ⇨
V70 2.0 D4/D4 DRIVE	D5204T3	09/13 ⇨
V70 III 2.0 D3 DRIVE	D5204T7	09/13 ⇨
V70 III 2.4 D	D5244T14	04/09 ⇨ 12/10
V70 III 2.4 D4 AWD	D5244T17	09/13 ⇨
V70 III 2.4 D5	D5244T11, D5204T2	09/13 ⇨
V70 III D3	D5204T7	10/07 ⇨ 12/15
V70 III D3 / D4	D5204T2, D5244T12	03/10 ⇨ 12/15
V70 III D4 AWD	D5244T12, D5244T10	10/07 ⇨
V70 III D5	D5244T10, D5244T10	10/08 ⇨
V70 III D5 AWD	D5244T10, D5244T16	12/09 ⇨
XC60 I 2.4 D	D5244T14	04/09 ⇨ 12/10
XC60 I 2.4 D / D3 / D4 AWD	D5244T16, D5204T2	05/08 ⇨ 02/17

VOLVO		
XC60 I 2.4 D AWD	D5244T14	06/09 ⇨ 12/10
XC60 I D3	D5204T7	04/12 ⇨ 12/15
XC60 I D3 / D4	D5204T2, D5244T12	03/10 ⇨ 12/14
XC60 I D4 AWD	D5244T12, D5244T10	10/13 ⇨ 02/17
XC60 I D5	D5244T11	06/11 ⇨ 02/17
XC60 I D5 AWD	D5244T10, D5244T16	07/09 ⇨ 02/17
XC70 II 2.4 D	D5244T14	06/09 ⇨ 12/10
XC70 II 2.4 D / D4 AWD	D5244T16, D5204T2	08/07 ⇨
XC70 II D3	D5204T2, D5244T10	04/10 ⇨ 12/15
XC70 II D3 AWD	D5204T2	08/11 ⇨
XC70 II D4 AWD	D5244T12	10/13 ⇨
XC70 II D5 AWD	D5244T10, D4HB	04/09 ⇨

10.3249



3,5

ABSOLUTE PRESSURE SENSORS (MAP)

Adatt./Suitable:

- HYUNDAI**
39200-2F000
- KIA**
39200-2F000



kPa	mV	O + -
28,9 - 400	250 - 4480	

HYUNDAI		
GRAND SANTA FE 2.2 CRDi Trazione integrale	D4HB, D4CB	06/13 ⇨
H-1 II 2.5 CRDi	D4CB, D4HA	02/08 ⇨
H100 2.5 CRDi	D4CB	01/04 ⇨
H100 2.5 TCI	--	01/04 ⇨
H350 2.5 CRDi	D4CB	04/15 ⇨
IX35 2.0 CRDi	D4HA, D6EA	01/10 ⇨
IX35 2.0 CRDi 4WD	D4HA	01/10 ⇨
IX55 3.0 V6 CRDi 4WD	D6EA, D4HB	09/08 ⇨ 12/12
PORTER II 2.5 CRDi	D4CB	05/04 ⇨
PORTER II 2.5 TCI	D4HB	05/04 ⇨
SANTA FE II 2.2 CRDi	D4HB, D4HA	01/09 ⇨ 12/12
SANTA FE II 2.2 CRDi 4x4	D4HB	01/09 ⇨ 12/12
SANTA FE III 2.0 CRDi	D4HA, D4HB	09/12 ⇨
SANTA FE III 2.0 CRDi 4WD	D4HA	09/12 ⇨
SANTA FE III 2.2 CRDi	D4HB, D4HB	09/12 ⇨
SANTA FE III 2.2 CRDi 4WD	D4HB, D4HB	09/12 ⇨
SANTA FE IV 2.0 CRDi	D4HA	07/18 ⇨
SANTA FE IV 2.0 CRDi AWD	D4HA	07/18 ⇨
SANTA FE IV 2.0 D	D4HA	02/18 ⇨
SANTA FE IV 2.0 D AWD	D4HA	02/18 ⇨
SANTA FE IV 2.2 CRDi	D4HB	07/18 ⇨
SANTA FE IV 2.2 CRDi AWD	D4HB	07/18 ⇨
TUCSON 2.0 CRDi	D4EA	01/09 ⇨
TUCSON 2.0 CRDi hybrid 48V Trazione integrale	D4HA	10/18 ⇨
TUCSON 2.0 CRDi Trazione integrale	D4EA	01/09 ⇨
VERACRUZ 3.0 CRDi [ExtraEU]	D6EA	11/08 ⇨ 11/12

KIA		
BONGO IV 2.5 CRDi	D4CB	01/12 ⇨
BORREGO 3.0 CRDi 4WD	G6EN	11/07 ⇨
CARNIVAL II 2.2 CRDi	D4HB, D4HB	01/10 ⇨
K2500 2.5 CRDi	D4CB	01/10 ⇨
MOHAVE 3.0 D	--	09/08 ⇨
SORENTO 2.2 CRDi [ExtraEU]	D4HB	11/09 ⇨ 12/15
SORENTO II 2.2 CRDi	D4HB	11/09 ⇨
SORENTO II 2.2 CRDi 4WD	D4HB	11/09 ⇨
SORENTO III 2.0 CRDi 4WD	D4HA	07/15 ⇨
SORENTO III 2.2 CRDi	D4HB	01/15 ⇨
SORENTO III 2.2 CRDi 4WD	D4HB, D4HA	01/15 ⇨
SPORTAGE 2.0 CRDi [ExtraEU]	D4HA	08/12 ⇨ 12/15
SPORTAGE III 2.0 CRDi	D4HA, D4HA	07/10 ⇨
SPORTAGE III 2.0 CRDi AWD	D4HA, D5204T2	07/10 ⇨
SPORTAGE IV 2.0 CRDi	D4HA	09/15 ⇨

KIA		
SPORTAGE IV 2.0 CRDi AWD	D4HA	09/15 ⇨
SPORTAGE IV 2.0 CRDi Eco-Dynamics+ AWD	D4HA	06/18 ⇨
STINGER 2.2 CRDi VGT	D4HC	06/17 ⇨
STINGER 2.2 CRDi VGT 4WD	D4HC	06/17 ⇨

10.3250



3,5

ABSOLUTE PRESSURE SENSORS (MAP)

Adatt./Suitable:

- BOSCH**
0 261 230 218
0 261 230 219
- VOLVO**
31216308

MARKET DIFFUSION: MEDIUM



kPa	mV	O + -
31,1 - 372	250 - 4750	

VOLVO		
C30 D3	D5204T5	10/10 ⇨ 12/12
C30 D4	D5204T	10/10 ⇨ 12/12
C70 II D3	D5204T5	10/10 ⇨ 06/13
C70 II D4	D5204T	10/10 ⇨ 06/13
S40 II D3	D5204T5	10/10 ⇨ 12/12
S40 II D4	D5204T	10/10 ⇨ 12/12
S60 II 2.4 D4 AWD	D5244T21	03/15 ⇨
S60 II D3	D5204T2, D5204T2	04/10 ⇨ 12/15
S60 II D4	D5204T2, D5244T10	04/10 ⇨ 12/14
S60 II D5	D5244T10, D5244T10	04/10 ⇨ 12/15
S60 II D5 AWD	D5244T10, D5244T14	04/10 ⇨ 12/15
S80 II 2.4 D	D5244T14, D5204T2	03/06 ⇨
S80 II D3	D5204T7	05/12 ⇨
S80 II D3 / D4	D5204T2, D5244T10	01/10 ⇨
S80 II D5	D5244T10, D5244T10	01/10 ⇨
S80 II D5 AWD	D5244T10, D5244T11	01/10 ⇨
V40 II 2.0 D3	D5204T6	09/13 ⇨ 12/15
V40 II 2.0 D4	D5204T4	09/13 ⇨ 12/14
V40 II D3	D5204T6	03/12 ⇨ 03/15
V40 II D4	D5204T4	03/12 ⇨
V40 2.0 D3	D5204T6	09/13 ⇨ 12/15
V40 2.0 D4	D5204T4	09/13 ⇨ 12/14
V50 D3	D5204T5	10/10 ⇨ 12/12
V50 D4	D5204T	10/10 ⇨ 12/12
V60 I 2.0 D3	D5204T7	09/13 ⇨ 12/15
V60 I 2.0 D4	D5204T3	09/13 ⇨ 12/15
V60 I 2.4 D4 AWD	D5244T12	09/13 ⇨ 12/15
V60 I 2.4 D5	D5244T11, D5244T11	04/11 ⇨ 12/15
V60 I 2.4 D5 AWD	D5244T11, D5244T15	04/11 ⇨ 12/15
V60 I 2.4 Hybrid D6 AWD	D5244T15, D5204T2	06/12 ⇨ 12/15
V60 I D3	D5204T7	05/12 ⇨ 12/15
V60 I D3 / D4	D5204T2, D5244T12	07/10 ⇨ 12/14
V60 I D4 AWD	D5244T12, D5244T10	05/12 ⇨
V60 I D5	D5244T10, D5244T10	07/10 ⇨ 12/15
V60 I D5 AWD	D5244T10, D5244T11	07/10 ⇨ 12/15
V60 I D6 Hybrid AWD	D97PHEV	03/15 ⇨
V70 2.0 D4/D4 DRIVE	D5204T3	09/13 ⇨
V70 III 2.0 D3 DRIVE	D5204T7	09/13 ⇨
V70 III 2.4 D	D5244T14	04/09 ⇨ 12/10
V70 III 2.4 D4 AWD	D5244T17	09/13 ⇨
V70 III 2.4 D5	D5244T11, D5204T2	09/13 ⇨
V70 III D3	D5204T7	10/07 ⇨ 12/15
V70 III D3 / D4	D5204T2, D5244T12	03/10 ⇨ 12/15
V70 III D4 AWD	D5244T12, D5244T10	10/07 ⇨
V70 III D5	D5244T10, D5244T10	10/08 ⇨
V70 III D5 AWD	D5244T10, D5244T16	12/09 ⇨
XC60 I 2.4 D	D5244T14	04/09 ⇨ 12/10
XC60 I 2.4 D / D3 / D4 AWD	D5244T16, D5204T2	05/08 ⇨ 02/17
XC60 I 2.4 D AWD	D5244T14	06/09 ⇨ 12/10
XC60 I D3	D5204T7	04/12 ⇨ 12/15

VOLVO			
XC60 I D3 / D4	D5204T2, D5244T12	03/10 →	12/14
XC60 I D4 AWD	D5244T12, D5244T10	10/13 →	02/17
XC60 I D5	D5244T11	06/11 →	02/17
XC60 I D5 AWD	D5244T10, D5244T16	07/09 →	02/17
XC70 II 2.4 D	D5244T14	06/09 →	12/10
XC70 II 2.4 D / D4 AWD	D5244T16, D5204T2	08/07 →	
XC70 II D3	D5204T2, D5244T10	04/10 →	12/15
XC70 II D3 AWD	D5204T2	08/11 →	
XC70 II D4 AWD	D5244T12	10/13 →	
XC70 II D5 AWD	D5244T10, --	04/09 →	

10.3259



3,5

ABSOLUTE PRESSURE SENSORS (MAP)

Adatt./Suitable:

ALFA ROMEO
55240726

BOSCH
0 281 002 456
0 281 002 945
0 281 006 816
0 281 007 041

FIAT
55240726

HONDA
37830-RZ0-G01
37830-RZ0-G02
37830-RZ0-G11
37830-RZ0-G12

LANCIA
55240726

MERCEDES-BENZ
0041538228
A 004 153 82 28

NISSAN
22365-9X700

RENAULT
22 36 523 05R
H82 00 701 295

ITEM NOW AVAILABLE FROM PRODUCTION

- ARTICOLO ORA DISPONIBILE PER LA VENDITA
- ARTICLE DISPONIBLE EN PRODUCTION COURANTE
- JETZT ZUM VERKAUF VERFÜGBARER ARTIKEL
- ARTICULO AHORA DISPONIBLE EN PRODUCCION

LANCIA		
YPSILON II 1.2 Bi-fuel	169A4.000	05/11 →
MERCEDES-BENZ		
CLASSE C II C 30 CDI AMG	OM612.990	09/02 → 05/08
RENAULT		
ESPACE IV 2.0 dCi	M9R760, 9HN(DV6ETED)	01/06 →

10.3261



3,5

ABSOLUTE PRESSURE SENSORS (MAP)

Adatt./Suitable:

CITROËN
1920 QR
96 634 808 80
98 055 003 80

DENSO
079800-9200
079800-9940
079800-9941

DS
1920 QR

FIAT
9663480880

FORD
1 683 949
1 796 446
AV6Q-12B676-AA

MAZDA
Y650-18-845
Y655-18-845

MITSUBISHI
MN982572

PEUGEOT
1920 QR

TOYOTA
SU001-A0692

VOLVO
30725679
30725865
31319622

MARKET DIFFUSION: HIGH



kPa	mV	O + NTC -
32,3 - 370,7	250 - 4750	

kPa	mV	NTC + - 0
12,9 - 316,5	250 - 4750	

FIAT			
500 MY12 1.2	--	01/12 →	
BRAVO II 1.4 16V	--, 198A1.000	04/07 →	
BRAVO II 1.4 LPG	--	01/10 →	
BRAVO II 1.4 T-Jet	198A1.000, M9R760	09/07 →	12/14
PANDA II 1.2	169A4.000	09/10 →	
PANDA II 1.2 4x4	169A4.000	09/10 →	
PANDA II 1.2 Bi-Power / Natural Power	--	04/09 →	
PANDA II 1.2 Euro 4	--	04/09 →	
PANDA II 1.2 Euro 5	--	04/09 →	
PANDA II 1.2 LPG	169A4.000	09/10 →	
PANDA II 1.2 Natural Power	188A4.000	01/07 →	12/11
PUNTO III / GRANDE PUNTO 1.2 Actual	--	09/09 →	
PUNTO III / GRANDE PUNTO 1.4 16V	199A6.000	10/05 →	
PUNTO III / GRANDE PUNTO 1.4 Actual	--	09/09 →	
PUNTO III / GRANDE PUNTO 1.4 T-Jet	198A4.000	09/07 →	
PUNTO III EVO 1.4	350A1.000	03/09 →	
PUNTO III EVO 1.4 16V	955A2.000	10/09 →	02/12
PUNTO III 1.4	350A1.000	04/08 →	
PUNTO III 1.4 Bifuel	350A1.000	03/12 →	
PUNTO III 1.4 Turbo Multi Air	955A2.000	03/12 →	
HONDA			
CIVIC IX 1.6 i-DTEC	N16A1	02/13 →	
CR-V 1.6 i-DTEC	N16A2	10/13 →	
CR-V 1.6 i-DTEC 4WD	N16A4	02/15 →	
HR-V 1.6 i-DTEC	N16A3	08/15 →	
LANCIA			
MUSA 1.4 8V	--	01/11 →	12/12
YPSILON I 1.4 LPG	350A1.000	11/10 →	12/11

CITROËN		
BERLINGO II 1.6 HDi / BlueHDi 75	9HN(DV6ETED), 9HL(DV6C)	07/10 →
BERLINGO II 1.6 HDi 110	9HL(DV6C), 9HL(DV6C)	07/10 →
BERLINGO II 1.6 HDi 115	9HL(DV6C), 9HN(DV6ETED)	07/10 →
BERLINGO II 1.6 HDi 115 4x4	--	02/12 →
BERLINGO II 1.6 HDi 75 / BlueHDi 75	9HN(DV6ETED), 9HF(DV6DTE)	04/08 →
BERLINGO II 1.6 HDi 75 4x4	9HN(DV6ETED)	02/12 →
BERLINGO II 1.6 HDi 90	9HF(DV6DTE), 9HJ(DV6DTE)	07/10 →
BERLINGO II 1.6 HDi 90 4x4	9HF(DV6DTE)	02/12 →
BERLINGO II 1.6 HDi 92	9HJ(DV6DTE), 9HJ(DV6DTE)	07/10 →
C3 II 1.6 BlueHDi 75	DV6ETEDM, 9HJ(DV6DTE)	04/15 →
C3 II 1.6 HDi	9HJ(DV6DTE), 9HR(DV6C)	11/09 →
C3 II 1.6 HDi 110	9HR(DV6C), 9HD(DV6C)	11/09 →
C3 II 1.6 HDi 115	9HD(DV6C), 9HR(DV6C)	09/12 →
C3 AIRCROSS 1.6 HDi 92	DV6D	10/17 →
C3 PICASSO 1.6 HDi 110	9HR(DV6C), 9HD(DV6C)	05/10 →
C3 PICASSO 1.6 HDi 115	9HD(DV6C), 9HP(DV6DTE)	01/13 →
C3 PICASSO 1.6 HDi 90	9HP(DV6DTE), 9HL(DV6C)	07/10 →
C4 II 1.6 BlueHDi 115	DV6C, DV6C	08/14 →
C4 II 1.6 HDi	DV6C, 9HR(DV6C)	11/09 →
C4 II 1.6 HDi 110	9HR(DV6C), 9HD(DV6C)	11/09 →
C4 II 1.6 HDi 115	9HD(DV6C), 9HJ(DV6DTE)	07/12 →
C4 II 1.6 HDi 90	9HJ(DV6DTE), 9HJ(DV6DTE)	11/09 →
C4 II 1.6 HDi 92	9HJ(DV6DTE), 9HJ(DV6DTE)	07/10 →

CITROËN		
C4 II 2.0 HDi	DW10CFAPDTR, DW10CTED4	10/10 →
C4 II 2.0 HDi / BlueHDi 150	DW10CTED4, 9HL(DV6C)	11/09 →
C4 II 2.0 HDi / BlueHDi 160	DW10CTED4	10/10 →
C4 AIRCROSS 1.6 HDi 115	9HL(DV6C), 9HL(DV6C)	04/12 →
C4 AIRCROSS 1.6 HDi 115 AWC	9HL(DV6C), 9HP(DV6DTE)	05/12 →
C4 CACTUS 1.6 HDi 90	9HP(DV6DTE), 9HL(DV6C)	09/14 →
C4 GRAND PICASSO I 1.6 HDi 110	9HL(DV6C), DW10CTED4	09/10 →
C4 GRAND PICASSO I 2.0 HDi 150	DW10CTED4, DW10CTED4	07/09 → 08/13
C4 GRAND PICASSO II 2.0 HDi 165	DW10CTED4, 9HC(DV6C)	09/10 → 08/13
C4 GRAND PICASSO II 1.6 HDi / BlueHDi 115	9HC(DV6C), 9HP(DV6DTE)	09/13 →
C4 GRAND PICASSO II 1.6 HDi 90	9HP(DV6DTE), DV6C	09/13 →
C4 PICASSO I 1.6 HDi 110	9HL(DV6C), DW10CTED4	09/10 →
C4 PICASSO I 2.0 HDi 150	DW10CTED4, DW10CTED4	07/09 → 08/13
C4 PICASSO I 2.0 HDi 165	DW10CTED4, DV6C	09/10 →
C4 PICASSO II 1.6 HDi / BlueHDi 115	DV6C, 9HP(DV6DTE)	02/13 →
C4 PICASSO II 1.6 HDi 90	9HP(DV6DTE), 9HL(DV6C)	02/13 →
C5 II 1.6 HDi 110	9HL(DV6C), 9HL(DV6C)	07/10 →
C5 II 1.6 HDi 115	9HL(DV6C), DW10CTED4	01/12 →
C5 II 2.0 HDi 150 / BlueHDi 150	DW10CTED4, DW10CTED4	04/09 →
C5 II 2.0 HDi 165	DW10CTED4, DW10CTED4	04/09 →
C8 2.0 HDi 135	DW10BTED4, DW10CTED4	03/06 →
C8 2.0 HDi 165	DW10CTED4, 9HJ(DV6DTE)	03/06 →
C-ELYSEE 1.6 HDi 92	9HJ(DV6DTE), 9HR(DV6C)	11/12 →
DS3 1.6 HDi 110	9HR(DV6C), 9HD(DV6C)	11/09 → 07/15
DS3 1.6 HDi 115	9HD(DV6C), 9HP(DV6DTE)	08/12 → 07/15
DS3 1.6 HDi 90	9HP(DV6DTE), 9HR(DV6C)	11/09 → 07/15
DS4 1.6 HDi 110	9HR(DV6C), 9HD(DV6C)	04/11 → 07/15
DS4 1.6 HDi 115	9HD(DV6C), 9HP(DV6DTE)	08/12 → 07/15
DS4 1.6 HDi 90	9HP(DV6DTE), DW10CB	05/11 → 07/15
DS4 2.0 HDi / BlueHDi 135	DW10CB, DW10CTED4	09/11 → 07/15
DS4 2.0 HDi 165	DW10CTED4, 9HR(DV6C)	04/11 → 07/15
DS5 1.6 HDi 110	9HR(DV6C), DV6C	11/11 → 07/15
DS5 1.6 HDi 115	DV6C, DW10CBDTR	06/12 → 07/15
DS5 2.0 HDi 135	DW10CBDTR, DW10CTED4	11/11 → 07/15
DS5 2.0 HDi 165	DW10CTED4, DW10CTED4	11/11 → 07/15
DS5 2.0 HDi 165 Hybrid4 4x4	DW10CTED4, 9HH(DV6DUM)	12/11 → 07/15
DS5 2.0 HDi 200 Hybrid4 Trazione integrale	DW10CTED4	12/11 → 07/15
JUMPY 1.6 HDi	DV6DUM	06/07 → 03/16
JUMPY II 1.6 HDi 90	DV6DU	01/07 →
JUMPY II 1.6 HDi 90 8V	9HH(DV6DUM), AHZ(DW10CD)	01/07 →
JUMPY II 2.0 HDi 125	AHZ(DW10CD), DW10CTED4	07/11 →
JUMPY II 2.0 HDi 125 4x4	AHZ(DW10CD)	07/11 →
JUMPY II 2.0 HDi 165	DW10CTED4, AHY(DW10CE)	07/10 →
JUMPY II 2.0 HDi 95	AHY(DW10CE), DV6C	07/11 →
JUMPY III 1.6 HDi 90	DV6DU	04/16 →
DS		
DS 5 1.6 BlueHDi 115	DV6C, DW10CTED4	06/15 →
DS 5 2.0 HDi 165 Hybrid4 4x4	DW10CTED4, RH02	04/15 →
FIAT		
SCUDO II 2.0 D Multijet	RH02, T1DA	07/10 →
SCUDO II 2.0 D Multijet 4x4	RH02	04/11 →
FORD		
B-MAX 1.6 TDCi	T3JB	10/12 →
C-MAX II 1.6 TDCi	T1DA, TXDB	12/10 →
C-MAX II 2.0 TDCi	TXDB, UGJE	04/10 →
ECOSPORT 1.5 TDCi	UGJE, T3JA	10/13 →
FIESTA VI 1.6 TDCi	T3JA, NGDA	02/10 →
FIESTA VI 1.6 TDCi SOHC	--	02/10 →
FOCUS III 1.6 TDCi	NGDA, TXDB	07/10 →
FOCUS III 1.6 TDCi EConetic	NGDB	05/12 →
FOCUS III 2.0 TDCi	TXDB, T1WA	07/10 →
GALAXY II 1.6 TDCi	T1WA, --	02/11 → 06/15
GALAXY II 2.0 TDCi	--, T1DA	05/06 →
GALAXY II 2.0 TDCi CR TC	--	03/10 →
GALAXY II 2.0 TDCi DSL	--	03/10 →
GRAND C-MAX 1.6 TDCi	T1DA, T7DB	12/10 →
GRAND C-MAX 2.0 TDCi	T7DB, --	12/10 →
KUGA I 2.0 TDCi	--, TXDA	03/10 →
KUGA I 2.0 TDCi 4x4	TXDA, T7MA	03/10 → 11/12
KUGA I 2.0 TDCi CR TC	--	03/10 →
KUGA II 2.0 TDCi	T7MA, T7MA	03/13 →
KUGA II 2.0 TDCi 4x4	T7MA, T1BA	03/13 →

FORD		
MONDEO III 1.6 TDCi	T1BA, AZBC	12/10 → 01/15
MONDEO III 2.0 TDCi	AZBC, NGCA	03/07 → 01/15
MONDEO IV 1.6 TDCi	NGCA, T1WA	09/14 →
S-MAX I 1.6 TDCi	T1WA, AZWC	02/11 → 12/14
S-MAX I 2.0 TDCi	AZWC, T1GA	05/06 → 12/14
S-MAX I 2.0 TDCi CRT	--	03/10 →
S-MAX I 2.0 TDCi DSL	--	03/10 →
TOURNEO CONNECT II 1.6 TDCi	T1GA, T3CA	09/13 →
TOURNEO COURIER 1.6 TDCi	T3CA, T1GA	02/14 →
TRANSIT CONNECT II 1.6 TDCi	T1GA, T3CA	02/13 →
TRANSIT COURIER 1.6 TDCi	T3CA, Y655	02/14 →

MAZDA		
2 II 1.6 MZ-CD	Y655, Y601	06/11 → 06/15
3 II 1.6 MZR CD	Y601, Y650	12/08 → 05/13
5 II 1.6 CD	Y650, 9HP(DV6DTEd)	09/10 →

MITSUBISHI		
ASX 1.6 DI-D	9HD	07/15 →
ASX 1.6 DI-D 4WD	9HD	07/15 →

PEUGEOT		
207 1.6 HDi	9HP(DV6DTEd), 9HR(DV6C)	08/09 →
207 1.6 HDi 110	9HR(DV6C), 9HR(DV6C)	08/09 →
207 CC 1.6 HDi	9HR(DV6C), 9HP(DV6DTEd)	08/09 →
208 1.6 HDi	9HP(DV6DTEd), 9HK(DV6ETEDM)	03/12 →
208 1.6 HDi / BlueHDi 75	9HK(DV6ETEDM), 9HR(DV6C)	01/13 →
208 1.6 HDi 90	9HJ(DV6DTEdM)	03/12 →
301 1.6 HDi 90	9HF(DV6DTEd), 9HP(DV6DTEd)	11/12 →
308 I 1.6 HDi	9HP(DV6DTEd), DW10BTED4	06/09 →
308 I 2.0 HDi	DW10BTED4, 9HC(DV6C)	09/07 →
308 II 1.6 e-HDi 115	DV6C	03/15 →
308 II 1.6 HDi	DV6DTEd	09/13 →
308 II 1.6 HDi / BlueHDi 115	9HC(DV6C), 9HP(DV6DTEd)	09/13 →
308 II 1.6 HDi 92	9HP(DV6DTEd), 9HD(DV6C)	03/14 →
407 2.0 HDi	DW10CTED4, 9HD(DV6CTED)	06/09 →
508 I 1.6 HDi	9HD(DV6CTED), DW10BTED4	11/10 →
508 I 2.0 HDi	DW10BTED4, DW10CTED4	11/10 →
508 I 2.0 HDi Hybrid4 AWC	DW10CTED4, DW10CTED4	11/10 →
508 I 2.0 HDi RXH Hybrid4	DW10CTED4, DW10CBDTR/FAP	11/10 →
807 2.0 HDi	DW10CBDTR/FAP, 9HH(DV6DUM)	06/09 →
2008 1.6 HDi	9HP(DV6DTEd), 9HP(DV6DTEd)	03/13 →
3008 1.6 HDi	9HR(DV6C), DV6C	12/09 → 08/16
3008 1.6 HDi 115 / BlueHDi 115	DV6C, DW10CB	02/13 → 08/16
3008 2.0 HDi	DW10CB, DW10CTED4	06/09 →
3008 2.0 HDi 150 / BlueHDi 150	DW10CTED4, DW10CTED4	06/09 → 08/16
3008 2.0 HDi Hybrid4	DW10CTED4, 9HF(DV6DTEd)	02/11 → 08/16
4008 1.6 HDi	DV6C	05/12 →
4008 1.6 HDi AWC	9HD(DV6C), DW10CTED4	05/12 →
5008 1.6 HDi	9HD(DV6CTED), DW10CBFAPDTR	08/10 →
5008 2.0 HDi	DW10CBFAPDTR, DW10CB	09/09 →
5008 2.0 HDi 136 / BlueHDi 136	DW10CB, DW10CTED4	02/12 →
5008 2.0 HDi 150 / BlueHDi 150	DW10CTED4, 9HD(DV6CTED)	06/09 →
EXPERT II 1.6 HDi 90 8V	9HH(DV6DUM), AHZ(DW10CD)	01/07 →
EXPERT II 2.0 HDi 130	AHZ(DW10CD), DW10CTED4	03/11 →
EXPERT II 2.0 HDi 130 4x4	AHZ(DW10CD)	01/12 →
EXPERT II 2.0 HDi 165	DW10CTED4, 9HH(DV6DUM)	09/09 →
EXPERT II TEPEE 1.6 HDi 90 8V	9HH(DV6DUM), AHY(DW10CE)	01/07 →
EXPERT II TEPEE 2.0 HDi 100	AHY(DW10CE), AHZ(DW10CD)	03/11 →
EXPERT II TEPEE 2.0 HDi 130	AHZ(DW10CD), DW10CTED4	03/11 →
EXPERT II TEPEE 2.0 HDi 130 4x4	AHZ(DW10CD)	03/11 →
EXPERT II TEPEE 2.0 HDi 165	DW10CTED4, 9HF(DV6DTEd)	09/09 →
PARTNER 1.6 HDi	DV6DTEdM	08/05 → 07/08
PARTNER I 1.6 HDi 75	DV6ETEDM	08/05 → 07/08
PARTNER II 1.6 HDi	9HF(DV6DTEd), 9HN(DV6ETED)	12/11 →
PARTNER II 1.6 HDi / BlueHDi 75	9HN(DV6ETED), 9HP(DV6DTEd)	07/11 →
PARTNER II 1.6 HDi 90	9HP(DV6DTEd), 9HF(DV6DTEd)	04/10 →
PARTNER II TEPEE 1.6 HDi	9HF(DV6DTEd), DV6ETEDM	04/08 →

PEUGEOT		
PARTNER II TEPEE 1.6 HDi / BlueHDi 75	DV6ETEDM, 9HJ(DV6DTEdM)	01/15 →
PARTNER II TEPEE 1.6 HDi 90	9HJ(DV6DTEdM), DW10CTED4	04/10 →
RCZ 2.0 HDi	DW10CTED4, 4WZ-FHV	03/10 → 12/15
TOYOTA		
PROACE 1.6 D	3WZ-TV	06/13 → 03/16
PROACE 2.0 D	4WZ-FHV, M47D20(204D4)	06/13 → 03/16
PROACE 2.0 D 4WD	4WZ-FTV	06/13 → 03/16
VOLVO		
C30 1.6 D2	D4162T	10/10 → 12/12
S40 II 1.6 D2	D4162T	10/10 → 12/12
S60 II Drive / D2	D4162T	01/11 → 12/15
S80 II 1.6 D2	D4162T	01/14 →
S80 II 1.6 Drive	D4162T	06/11 →
V40 II 1.6 D2 / Drive	D4162T	09/13 → 12/15
V40 II D2	D4162T	03/12 →
V40 1.6 D2	D4162T	09/13 → 12/15
V50 1.6 D2	D4162T	01/10 → 12/12
V60 I 1.6 Drive	D4162T	02/11 → 12/15
V70 III 1.6 Drive / D2	D4162T	04/11 → 12/15

PEUGEOT		
207 1.6 HDi	9HP(DV6DTEd), 9HR(DV6C)	08/09 →
207 1.6 HDi 110	9HR(DV6C), 9HR(DV6C)	08/09 →
207 CC 1.6 HDi	9HR(DV6C), 9HP(DV6DTEd)	08/09 →
208 1.6 HDi	9HP(DV6DTEd), 9HK(DV6ETEDM)	03/12 →
208 1.6 HDi / BlueHDi 75	9HK(DV6ETEDM), 9HR(DV6C)	01/13 →
208 1.6 HDi 90	9HJ(DV6DTEdM)	03/12 →
301 1.6 HDi 90	9HF(DV6DTEd), 9HP(DV6DTEd)	11/12 →
308 I 1.6 HDi	9HP(DV6DTEd), DW10BTED4	06/09 →
308 I 2.0 HDi	DW10BTED4, 9HC(DV6C)	09/07 →
308 II 1.6 e-HDi 115	DV6C	03/15 →
308 II 1.6 HDi	DV6DTEd	09/13 →
308 II 1.6 HDi / BlueHDi 115	9HC(DV6C), 9HP(DV6DTEd)	09/13 →
308 II 1.6 HDi 92	9HP(DV6DTEd), 9HD(DV6C)	03/14 →
407 2.0 HDi	DW10CTED4, 9HD(DV6CTED)	06/09 →
508 I 1.6 HDi	9HD(DV6CTED), DW10BTED4	11/10 →
508 I 2.0 HDi	DW10BTED4, DW10CTED4	11/10 →
508 I 2.0 HDi Hybrid4 AWC	DW10CTED4, DW10CTED4	11/10 →
508 I 2.0 HDi RXH Hybrid4	DW10CTED4, DW10CBDTR/FAP	11/10 →
807 2.0 HDi	DW10CBDTR/FAP, 9HH(DV6DUM)	06/09 →
2008 1.6 HDi	9HP(DV6DTEd), 9HP(DV6DTEd)	03/13 →
3008 1.6 HDi	9HR(DV6C), DV6C	12/09 → 08/16
3008 1.6 HDi 115 / BlueHDi 115	DV6C, DW10CB	02/13 → 08/16
3008 2.0 HDi	DW10CB, DW10CTED4	06/09 →
3008 2.0 HDi 150 / BlueHDi 150	DW10CTED4, DW10CTED4	06/09 → 08/16
3008 2.0 HDi Hybrid4	DW10CTED4, 9HF(DV6DTEd)	02/11 → 08/16
4008 1.6 HDi	DV6C	05/12 →
4008 1.6 HDi AWC	9HD(DV6C), DW10CTED4	05/12 →
5008 1.6 HDi	9HD(DV6CTED), DW10CBFAPDTR	08/10 →
5008 2.0 HDi	DW10CBFAPDTR, DW10CB	09/09 →
5008 2.0 HDi 136 / BlueHDi 136	DW10CB, DW10CTED4	02/12 →
5008 2.0 HDi 150 / BlueHDi 150	DW10CTED4, 9HD(DV6CTED)	06/09 →
EXPERT II 1.6 HDi 90 8V	9HH(DV6DUM), AHZ(DW10CD)	01/07 →
EXPERT II 2.0 HDi 130	AHZ(DW10CD), DW10CTED4	03/11 →
EXPERT II 2.0 HDi 130 4x4	AHZ(DW10CD)	01/12 →
EXPERT II 2.0 HDi 165	DW10CTED4, 9HH(DV6DUM)	09/09 →
EXPERT II TEPEE 1.6 HDi 90 8V	9HH(DV6DUM), AHY(DW10CE)	01/07 →
EXPERT II TEPEE 2.0 HDi 100	AHY(DW10CE), AHZ(DW10CD)	03/11 →
EXPERT II TEPEE 2.0 HDi 130	AHZ(DW10CD), DW10CTED4	03/11 →
EXPERT II TEPEE 2.0 HDi 130 4x4	AHZ(DW10CD)	03/11 →
EXPERT II TEPEE 2.0 HDi 165	DW10CTED4, 9HF(DV6DTEd)	09/09 →
PARTNER 1.6 HDi	DV6DTEdM	08/05 → 07/08
PARTNER I 1.6 HDi 75	DV6ETEDM	08/05 → 07/08
PARTNER II 1.6 HDi	9HF(DV6DTEd), 9HN(DV6ETED)	12/11 →
PARTNER II 1.6 HDi / BlueHDi 75	9HN(DV6ETED), 9HP(DV6DTEd)	07/11 →
PARTNER II 1.6 HDi 90	9HP(DV6DTEd), 9HF(DV6DTEd)	04/10 →
PARTNER II TEPEE 1.6 HDi	9HF(DV6DTEd), DV6ETEDM	04/08 →

10.3312  **3,5**

ABSOLUTE PRESSURE SENSORS (MAP)

Adatt./Suitable:

- BMW**
13 62 7 789 219
- DENSO**
0011 2R06

MARKET DIFFUSION: **MEDIUM**



kPa	mV	+	0	-
10 - 212,7	930 - 475			

BMW		
11118 d	M47D20(204D4), M47D20(204D4)	11/03 → 02/07
11120 d	M47D20(204D4), M47D20(204D4)	03/03 → 06/11
3V 318 d	M47D20(204D4), M47D20(204D4)	03/05 → 08/07
3V 320 d	M47D20(204D4), M57D30(306D3)	12/04 → 06/12
3V 325 d	M57D30(306D3), M57D30(306D3)	09/06 → 06/12
3V 330 d	M57D30(306D3), M57D30(306D3)	12/04 → 12/13
3V 330 xd	M57D30(306D3), M47D20(204D4)	09/05 → 06/12
5V 520 d	M47D20(204D4), M57D25(256D2)	02/05 → 02/08
5V 525 d	M57D25(256D2), M57D30(306D2)	03/04 →
5V 525 d xDrive	M57D30(306D3)	09/07 → 05/10
5V 525 xd	M57D30(306D3)	11/06 → 09/08
5V 530 d	M57D30(306D2), M57D30(306D3)	09/02 → 05/10
5V 530 d xDrive	M57D30(306D3)	09/07 → 05/10
5V 530 xd	M57D30(306D3), M57D30(306D3)	02/05 → 08/07
5V 535 d	M57D30(306D4)	09/04 → 12/10
7 IV 730 d	M57D30(306D3)	10/02 → 07/08
7 IV 730 Ld	M57D30(306D3), M67D44(448D1)	07/05 → 08/08
7 IV 745 d	M67D44(448D1), M47D20(204D4)	03/05 → 07/08
X3 I 2.0 d	M47D20(204D4), M57D30(306D3)	11/03 → 08/07
X3 I 3.0 d	M57D30(306D3), M57D30(306D3)	09/05 → 08/08
X3 I xDrive 30 d	M57D30(306D3), M57D30(306D3)	09/08 → 08/10
X5 I 3.0 d	M57D306D2	09/03 → 12/06
X5 II 3.0 d	M57D30(306D3), EE20Z	02/07 → 09/08
X5 II xDrive 30 d	M57D306D3	10/08 → 03/10

10.3317  **3,5**

ABSOLUTE PRESSURE SENSORS (MAP)

Adatt./Suitable:

- DENSO**
079800-9150
- SUBARU**
22627-AA430



kPa	mV	NTC + - 0
50 - 349,8	250 - 4750	

SUBARU		
FORESTER III 2.0 D AWD	EE20Z	09/08 → 09/13
FORESTER IV 2.0 D	EJ20Z	08/12 →
FORESTER IV 2.0 D AWD	EE20Z	03/13 →
IMPREZA III 2.0 D AWD	EE20Z, EE20	01/09 →
LEGACY IV 2.0 D AWD	EE20Z	02/08 → 12/09
LEGACY V 2.0 D	EJ20Z	05/09 →
LEGACY V 2.0 D AWD	EE20, --	09/09 → 12/14
OUTBACK III 2.0 D	EJ20Z	09/08 → 09/09
OUTBACK III 2.0 D AWD	EE20Z	09/08 → 09/09
OUTBACK IV 2.0 D AWD	--, N47D20A	09/09 →
XV 2.0 D AWD	EE20Z	03/12 →

10.3319  **3,5**

ABSOLUTE PRESSURE SENSORS (MAP)

Adatt./Suitable:

- BMW**
13 62 7 808 013
7 808 013
- DENSO**
1600 11Q18
1600 1R29
1600 6K26

MARKET DIFFUSION: **MEDIUM**



kPa	mV	+ 0 -
13,6 - 400	250 - 3642,7	

BMW		
11116 d	N47D20A, N47D20A	11/08 → 09/12
11118 d	N47D20A, N47D20A	09/06 → 12/13
11120 d	N47D20A, N47D20A	03/03 → 12/13
11123 d	N47D20B, N47D20A	03/07 → 12/13
3V 316 d	N47D20C	07/09 → 06/12
3V 318 d	N47D20A, N47D204D4	02/07 → 06/12
3V 320 d	M47D204D4, N47D20C	12/04 → 12/13
3V 320 d xDrive	N47D20C, --	02/08 → 06/13
3V 320 xd	--, M57D306D3	03/07 →
3V 325 d	N57D30A	09/09 → 12/13
3V 330 d	M57D306D3, N47D20A	06/05 → 12/13
3V 330 d xDrive	N57D30A	09/08 → 06/13
3V 330 i	N52B30A	03/07 → 12/13

BMW			
3 V 330 xd	N57D30A	03/08	⇒ 02/10
3 V 335 d	M57D30(306D5)	03/06	⇒ 03/13
5 VI GT 530 d	N57D30A, N57D30A	08/09	⇒ 06/12
5 VI GT 530 d xDrive	N57D30A	06/10	⇒ 06/12
5 VI GT 535 d	N57D30B	03/10	⇒ 06/12
5 VI GT 535 d xDrive	N57D30B	03/10	⇒ 06/12
5 V 520 d	N47D20A, N57D30B	02/05	⇒ 05/10
5 VI 525 d	N57D30A	03/10	⇒ 08/11
5 VI 535 d	N57D30B, N57D30A	09/10	⇒ 08/11
7 V 730 d	N57D30A, N57D30B	02/08	⇒ 05/15
7 V 740 d	N57D30B, N57D30B	09/09	⇒ 12/15
7 V 740 d xDrive	N57D30B, N47D20C	09/09	⇒ 12/15
X1 sDrive 18 d	N47D20C, N47D20C	03/09	⇒ 06/15
X1 sDrive 20 d	N47D20C, N47D20C	10/09	⇒ 06/15
X1 sDrive 18 d	N47D20C, N47D20C	03/09	⇒ 06/15
X1 xDrive 20 d	N47D20C, N47D20C	10/09	⇒ 06/15
X1 xDrive 23 d	N47D20C, N47D20A	10/09	⇒ 06/15
X3 I 2.0 d	N47D20A, N47D20C	03/07	⇒ 03/09
X3 I xDrive 18 d	N47D20C, N57D30A	09/08	⇒ 12/11
X3 I xDrive 20 d	N47D20C	09/07	⇒ 08/10
X5 II xDrive 30 d	N57D30A, M57D30(306D3)	10/08	⇒ 07/13
X5 II xDrive 35 d	M57D30(306D5)	10/08	⇒ 06/13
X5 II xDrive 40 d	N57D30B	09/10	⇒ 06/13
X6 I xDrive 30 d	M57D30(306D3), 1UR-FE	04/08	⇒ 07/14
X6 I xDrive 40 d	N57D30B	07/09	⇒ 06/14

10.3328



3,5

ABSOLUTE PRESSURE SENSORS (MAP)

Adatt./Suitable:

CITROËN

96 755 419 80

DENSO

079800-9720

DS

96 755 419 80

FORD

1 867 675

FM5Q-12B676-AA

FORD USA

1 867 675

FM5Q-12B676-AA

GENERAL MOTORS

3 646 412

OPEL

3646412

PEUGEOT

96 755 419 80

TOYOTA

SU001-A3631

VAUXHALL

3646412

ITEM NOW AVAILABLE FROM PRODUCTION

• ARTICOLO ORA DISPONIBILE PER LA VENDITA

• ARTICLE DISPONIBLE EN PRODUCTION COURANTE

• JETZT ZUM VERKAUF VERFÜGBARER ARTIKEL

• ARTICULO AHORA DISPONIBLE EN PRODUCCION

MARKET DIFFUSION: MEDIUM



kPa	mV	NTC + - 0
25,6 - 369,5	250 - 4750	

CITROËN

BERLINGO II 1.6 BlueHdi 100	BHY(DV6FD), BHZ(DV6FC)	12/14	⇒
BERLINGO II 1.6 BlueHdi 100 4x4	BHY(DV6FD)	12/14	⇒
BERLINGO II 1.6 BlueHdi 120	BHZ(DV6FC), BHW(DV6FE)	12/14	⇒
BERLINGO II 1.6 Hdi / BlueHdi 75	BHW(DV6FE)	07/10	⇒
BERLINGO II 1.6 Hdi 75 / BlueHdi 75	BHW(DV6FE), EB2ADT	04/08	⇒
BERLINGO III 1.2 PureTech 110	EB2ADT	06/18	⇒
BERLINGO III BlueHdi 100	DV6FD	06/18	⇒
C3 II 1.6 BlueHdi	DV6FE	03/15	⇒ 09/16
C3 II 1.6 BlueHdi 100	BHY(DV6FD), BHW(DV6FE)	07/14	⇒
C3 II 1.6 BlueHdi 75	BHW(DV6FE), BHY(DV6FD)	04/15	⇒
C3 III 1.6 BlueHdi 100	DV6FD	07/16	⇒
C3 III 1.6 BlueHdi 75	DV6FE	07/16	⇒
C3 AIRCROSS 1.2 PureTech 110	EB2ADT, BHY(DV6FD)	06/17	⇒
C3 AIRCROSS 1.6 BlueHdi 100	DV6FD	07/17	⇒
C3 AIRCROSS 1.6 BlueHdi 115	DV6FC	06/17	⇒
C3 AIRCROSS 1.6 BlueHdi 120	DV6FC	07/17	⇒
C3 PICASSO 1.6 BlueHdi 100	BHY(DV6FD), BHY(DV6FD)	01/15	⇒
C4 II 1.6 BlueHdi	DV6FC, BHY(DV6FD)	07/14	⇒
C4 II 1.6 BlueHdi 100	BHY(DV6FD), BHZ(DV6FC)	07/14	⇒
C4 II 1.6 BlueHdi 115	BHX(DV6FC)	08/14	⇒
C4 II 1.6 BlueHdi 120	BHZ(DV6FC), DW10CTED4	02/15	⇒
C4 II 2.0 Hdi / BlueHdi 150	DW10CTED4, BHY(DV6FD)	11/09	⇒
C4 CACTUS 1.6 BlueHdi 100	BHY(DV6FD), BHY(DV6FD)	09/14	⇒
C4 GRAND PICASSO II 1.6 BlueHdi 100	BHY(DV6FD), BHZ(DV6FC)	01/15	⇒
C4 GRAND PICASSO II 1.6 BlueHdi 120	BHZ(DV6FC), AHX(DW10FD)	07/14	⇒
C4 GRAND PICASSO II 1.6 Hdi / BlueHdi 115	BHX(DV6FC)	09/13	⇒
C4 GRAND PICASSO II 2.0 BlueHdi 135	DW10FD	09/13	⇒
C4 GRAND PICASSO II 2.0 BlueHdi 135 Hybrid	AHS(DW10FD)	09/13	⇒
C4 GRAND PICASSO II 2.0 BlueHdi 150	AHX(DW10FD), DV6FC	09/13	⇒
C4 PICASSO II 1.2 THP 110	EB2ADT	04/16	⇒
C4 PICASSO II 1.6 BlueHdi 100	BHY(DV6FD), BHZ(DV6FC)	12/14	⇒

CITROËN

C4 PICASSO II 1.6 BlueHdi 120	BHZ(DV6FC), BHX(DV6FC)	07/14	⇒
C4 PICASSO II 1.6 Hdi / BlueHdi 115	BHX(DV6FC), AHR(DW10FD)	02/13	⇒
C4 PICASSO II 2.0 BlueHdi 135	DW10FD	09/13	⇒
C4 PICASSO II 2.0 BlueHdi 135 Hybrid	AHS(DW10FD)	09/13	⇒
C4 PICASSO II 2.0 BlueHdi 150	DW10FD	09/13	⇒
C4 SPACETOURER 1.6 BlueHdi 100	DV6FD	04/18	⇒
C4 SPACETOURER 1.6 BlueHdi 120	DV6FC	04/18	⇒
C4 SPACETOURER 2.0 BlueHdi 150	DW10FD	04/18	⇒
C5 II 2.0 Hdi 150 / BlueHdi 150	AHR(DW10FD), AHW(DW10FC)	04/09	⇒
C5 II 2.0 Hdi 180	AHW(DW10FC), BHY(DV6FD)	03/15	⇒
C5 AIRCROSS 1.2 PureTech 130	EB2ADTS	11/18	⇒
C-ELYSEE 1.6 BlueHdi 100	BHY(DV6FD), BHY(DV6FD)	11/14	⇒
DISPATCH 2.0 BlueHdi 120	DW10FE	06/16	⇒
DS3 1.6 BlueHdi 100	BHY(DV6FD), BHZ(DV6FC)	07/14	⇒ 07/15
DS3 1.6 BlueHdi 115	BHX(DV6FC), BHZ(DV6FC)	10/13	⇒ 07/15
DS3 1.6 BlueHdi 120	BHZ(DV6FC), BHW(DV6FE)	10/13	⇒ 07/15
DS3 1.6 BlueHdi 75	BHW(DV6FE), BHZ(DV6FC)	03/15	⇒ 07/15
DS3 1.6 Hdi 115	BHX(DV6FC), BHZ(DV6FC)	10/13	⇒ 07/15
DS4 1.6 BlueHdi 115	BHX(DV6FC), BHZ(DV6FC)	07/14	⇒ 07/15
DS4 1.6 BlueHdi 120	BHZ(DV6FC), AHX(DW10FD)	07/14	⇒ 07/15
DS4 2.0 BlueHdi 150	AHX(DW10FD), AHW(DW10FC)	07/14	⇒ 07/15
DS4 2.0 BlueHdi 150 Hybrid	AHR(DW10FD)	07/14	⇒ 07/15
DS4 2.0 BlueHdi 180	AHW(DW10FC), AHS(DW10FD)	07/14	⇒ 07/15
DS4 2.0 Hdi / BlueHdi 135	AHS(DW10FD), DV6C	09/11	⇒ 07/15
DS5 1.6 BlueHdi 120	DV6FC	07/14	⇒ 07/15
DS5 1.6 Hdi	DV6FC	11/13	⇒ 07/15
DS5 1.6 Hdi 115	DV6C, AHW(DW10FC)	06/12	⇒ 07/15
DS5 2.0 BlueHdi 135 Hybrid	AHS(DW10FD)	11/11	⇒ 07/15
DS5 2.0 BlueHdi 150	DW10FD	07/14	⇒ 07/15
DS5 2.0 BlueHdi 180	AHW(DW10FC), AHM(DW10FUE)	08/13	⇒ 07/15
DS5 2.0 Hdi 150 Hybrid	AHX(DW10FD)	11/11	⇒ 07/15
GRAND C4 SPACETOURER 1.6 BlueHdi 100	DV6FD	04/18	⇒
GRAND C4 SPACETOURER 1.6 BlueHdi 120	DV6FC	04/18	⇒
GRAND C4 SPACETOURER 2.0 BlueHdi 150	DW10FD	04/18	⇒
JUMPER III 2.0 BlueHdi 110	AHM(DW10FUE), AHN(DW10FUD)	07/15	⇒
JUMPER III 2.0 BlueHdi 130	AHN(DW10FUD), AHP(DW10FUC)	07/15	⇒
JUMPER III 2.0 BlueHdi 130 4x4	AHN(DW10FUD)	04/16	⇒
JUMPER III 2.0 BlueHdi 160	AHP(DW10FUC), BHZ(DV6FC)	07/15	⇒
JUMPER III 2.0 BlueHdi 160 4x4	AHP(DW10FUC)	04/16	⇒
JUMPY III 1.6 BlueHdi 115	BHX(DV6FC), BHW(DV6FD)	04/16	⇒
JUMPY III 1.6 BlueHdi 95	BHY(DV6FD), AHJ(DW10FE)	04/16	⇒
JUMPY III 2.0 BlueHdi 120	AHJ(DW10FE), AHR(DW10FD)	04/16	⇒
JUMPY III 2.0 BlueHdi 150	AHR(DW10FD), AHJ(DW10FE)	04/16	⇒
JUMPY III 2.0 BlueHdi 180	DW10FC	04/16	⇒
SPACETOURER 1.6 BlueHdi 115	DV6FC	04/16	⇒
SPACETOURER 1.6 BlueHdi 95	DV6FD	04/16	⇒
SPACETOURER 2.0 BlueHdi 120	AHJ(DW10FE), DV6C	04/16	⇒
SPACETOURER 2.0 BlueHdi 150	DW10FD	04/16	⇒
SPACETOURER 2.0 BlueHdi 180	DW10FC	04/16	⇒
DS			
DS 5 1.6 BlueHdi 115	DV6C, BHZ(DV6FC)	06/15	⇒
DS 5 1.6 BlueHdi 120	BHZ(DV6FC), AHR(DW10FD)	06/15	⇒
DS 5 2.0 BlueHdi 135	DW10FDD	06/15	⇒
DS 5 2.0 BlueHdi 150	AHR(DW10FD), AHW(DW10FC)	04/15	⇒
DS 5 2.0 BlueHdi 180	AHW(DW10FC), BHY(DV6FD)	04/15	⇒
DS 7 2.0 BlueHdi 180	DW10FC	09/17	⇒
DS 7 PureTech 130	EB2ADTS	10/18	⇒
DS3 1.6 BlueHdi 100	BHY(DV6FD), BHZ(DV6FC)	04/15	⇒
DS3 1.6 BlueHdi 116	DV6FC	07/15	⇒
DS3 1.6 BlueHdi 120	BHZ(DV6FC), BHW(DV6FE)	07/15	⇒

10.3320



3,5

ABSOLUTE PRESSURE SENSORS (MAP)

Adatt./Suitable:

TOYOTA

89421-47010



kPa	mV	+ - 0
10 - 138	915 - 4750	

LEXUS

GS 300h	2AR-FSE	10/13	⇒
GX 460 4WD	1UR-FE	01/10	⇒
LC 500h	8GR-FXS	11/16	⇒
LS V 500h	8GR-FXS	10/17	⇒
LS V 500h AWD	8GR-FXS	10/17	⇒
RC 300h	2AR-FSE	09/14	⇒
RX IV 3.5 VVTi Hybrid [ExtraEU]	2GR-FXS	10/15	⇒
RX IV 450h AWD	2GR-FXS	11/15	⇒

TOYOTA

AQUA 1.5 Hybrid	1NZ-FXE	12/11	⇒
AURIS I 1.8 Hybrid	2ZR-FXE	09/10	⇒ 09/12
AURIS II 1.8 Hybrid	2ZR-FXE	10/12	⇒
COROLLA XI 1.5 Hybrid	1NZ-FXE	10/14	⇒
PRIUS 1.8 Hybrid	2ZR-FXE	03/12	⇒
LAND CRUISER 200 4.6 V8	1UR-FE, 2ZR-FXE	09/10	⇒
PRIUS III 1.8 Hybrid	2ZR-FXE, 1NZ-FXE	06/08	⇒
PRIUS III 1.8 Hybrid [ExtraEU]	2ZR-FXE	06/08	⇒
PRIUS III 1.8 Plug-in Hybrid	2ZR-FXE	01/12	⇒
PRIUS C 1.5 Hybrid	1NZ-FXE	12/11	⇒
YARIS III 1.5	2NR-FKE	03/17	⇒
YARIS III 1.5 Hybrid	1NZ-FXE, BHY(DV6FD)	03/12	⇒

DS		
DS3 1.6 BlueHdi 75	BHW(DV6FE), BHZ(DV6FC)	07/15 →
DS4 / DS4 CROSSBACK 1.6 BlueHdi 100	DV6FD	04/16 →
DS4 / DS4 CROSSBACK 1.6 BlueHdi 115	DV6FC	07/15 →
DS4 / DS4 CROSSBACK 1.6 BlueHdi 120	BHZ(DV6FC), AHR(DW10FD)	07/15 →
DS4 / DS4 CROSSBACK 2.0 BlueHdi 150	AHR(DW10FD), AHW(DW10FC)	07/15 →
DS4 / DS4 CROSSBACK 2.0 BlueHdi 180	AHW(DW10FC), XVJA	07/15 →

FORD		
B-MAX 1.5 TDCi	XVJA, XWDA	04/15 →
C-MAX II 1.5 TDCi	XWDA, --	03/15 →
C-MAX II 1.5 TDCi ECONetic	AEDA	03/15 →
C-MAX II 2.0 TDCi	--, UGJE	03/15 →
ECOSPORT 1.5 TDCi	UGJE, XVJB	10/13 →
FIESTA VI 1.5 TDCi	XVJB, XUJC	05/15 →
FIESTA VII 1.5 TDCi	XUJC, XWDA	01/17 →
FOCUS III 1.5 TDCi	XWDA, AEDA	09/14 →
FOCUS III 1.5 TDCi ECONetic	AEDA, T7DA	09/14 →
FOCUS III 2.0 TDCi	T7DA, --	11/14 →
FOCUS III 2.0 TDCi ST	T8DA	11/14 →
GALAXY III 2.0 TDCi	--, T7CI	01/15 →
GALAXY III 2.0 TDCi 4x4	T7CI, T9CB	05/15 → 06/18
GALAXY III 2.0 TDCi Bi-Turbo	T9CB, AEDA	01/15 → 06/18
GRAND C-MAX 1.5 TDCi	AEDA, T7DB	03/15 →
GRAND C-MAX 2.0 TDCi	T7DB, --	03/15 →
KA+ 1.5 TDCi	15DSOX	02/18 →
KUGA II 1.5 TDCi	--, T7MA	07/16 →
KUGA II 2.0 TDCi	T7MA, T7MA	03/13 →
KUGA II 2.0 TDCi 4x4	T7MA, UGCC	03/13 →
MONDEO IV 1.5 TDCi	UGCC, T7CA	03/15 →
MONDEO IV 2.0 TDCi	T7CA, T7CA	09/14 →
MONDEO IV 2.0 TDCi 4x4	T7CA, --	09/14 →
MONDEO IV 2.0 TDCi Bi-Turbo	T9CA	03/15 →
S-MAX II 2.0 TDCi	--, T7CI	01/15 →
S-MAX II 2.0 TDCi 4x4	T7CI, T9CB	01/15 → 06/18
S-MAX II 2.0 TDCi Bi-Turbo	T9CB, --	01/15 → 06/18
TOURNEO CONNECT II 1.5 TDCi	--, UGCA	09/13 →
TOURNEO COURIER 1.5 TDCi	UGCA, --	02/14 →
TRANSIT CONNECT II 1.5 TDCi	--, UGCA	02/13 →
TRANSIT COURIER 1.5 TDCi	UGCA, B16DT(DV6FD)	02/14 →

FORD USA		
EDGE 2.0 TDCi AWD	T8CM	08/15 → 07/18
EDGE 2.0 TDCi Bi-Turbo AWD	T9CE	08/15 → 07/18

OPEL		
COMBO 1.2	D12XHL(EB2ADT)	06/18 →
CROSSLAND X 1.6 Turbo D	B16DT(DV6FD), B12XHT(EB2DTS)	03/17 →
GRANDLAND X 1.2	B12XHT(EB2DTS), BHX(DV6FC)	06/17 →
GRANDLAND X 1.6 Turbo D	B16DTH(DV6FC)	06/17 →
GRANDLAND X 2.0 D	D20DTH(DW10FC)	11/17 →

PEUGEOT		
208 1.6 BlueHdi 100	BHY(DV6FD), BHZ(DV6FC)	01/15 →
208 1.6 BlueHdi 120	BHZ(DV6FC), BHW(DV6FE)	11/13 →
208 1.6 BlueHdi 75	BHW(DV6FE), BHX(DV6FC)	04/15 →
208 1.6 Hdi	BHX(DV6FC), BHW(DV6FE)	03/12 →
208 1.6 Hdi / BlueHdi 75	BHW(DV6FE), BHZ(DV6FC)	01/13 →
301 1.6 BlueHdi 100	DV6FD	04/14 →
301 1.6 Hdi 100	BHY(DV6FD)	11/12 →
308 II 1.6 BlueHdi	DV6FD	04/14 →
308 II 1.6 BlueHdi 100	BHY(DV6FD), BHZ(DV6FC)	04/14 →
308 II 1.6 BlueHdi 120	BHZ(DV6FC), BHZ(DV6FC)	11/13 →
308 II 1.6 Hdi / BlueHdi 115	BHZ(DV6FC), BHY(DV6FD)	09/13 →
308 II 1.6 Hdi 100	BHY(DV6FD), AHX(DW10FD)	04/14 →
308 II 2.0 BlueHdi 150	AHX(DW10FD), AHW(DW10FC)	11/13 →
308 II 2.0 GT BlueHdi 180	DW10FC	06/17 →
308 II 2.0 GT Hdi 180 / BlueHdi 180	AHW(DW10FC), BHZ(DV6FC)	06/14 →
508 I 1.6 BlueHdi 120	BHZ(DV6FC), BHX(DV6FC)	03/14 →
508 I 1.6 Hdi	BHX(DV6FC), AHX(DW10FD)	09/14 →
508 I 2.0 BlueHdi 150	AHX(DW10FD), AHW(DW10FC)	04/14 →
508 I 2.0 BlueHdi 180	AHW(DW10FC), AHN(DW10FUD)	04/14 →
508 I 2.0 Hdi 180 RXH	DW10FC	10/14 →
508 II 2.0 BlueHdi 160	DW10FCC	09/18 →
508 II 2.0 BlueHdi 180	DW10FC	09/18 →
2008 1.6 BlueHdi	BHX(DV6FC), BHY(DV6FD)	07/14 →
2008 1.6 BlueHdi 100	BHY(DV6FD), BHZ(DV6FC)	01/15 →
2008 1.6 BlueHdi 120	BHZ(DV6FC), BHW(DV6FE)	07/14 →

PEUGEOT		
2008 1.6 BlueHdi 75	BHW(DV6FE), BHZ(DV6FC)	01/15 →
3008 1.6 BlueHdi 100	DV6FD	11/16 →
3008 1.6 BlueHdi 115	DV6FC	11/16 →
3008 1.6 BlueHdi 120	BHZ(DV6FC), BHX(DV6FC)	05/14 →
3008 1.6 Hdi 115 / BlueHdi 115	BHX(DV6FC), DW10FC	02/13 → 08/16
3008 2.0 BlueHdi 136	DW10FD	11/16 →
3008 2.0 BlueHdi 150	DW10FD	05/16 →
3008 2.0 BlueHdi 180	DW10FC, AHX(DW10FD)	05/16 →
3008 2.0 Hdi 150 / BlueHdi 150	AHX(DW10FD), BHY(DV6FD)	06/09 → 08/16
5008 1.6 BlueHdi 100	DV6FD	12/16 →
5008 1.6 BlueHdi 115	DV6FC	12/16 →
5008 1.6 BlueHdi 120	BHZ(DV6FC), DW10FC	05/14 →
5008 2.0 BlueHdi 136	DW10FD	12/16 →
5008 2.0 BlueHdi 150	DW10FD	12/16 →
5008 2.0 BlueHdi 180	DW10FC, AHR(DW10FD)	12/16 →
5008 2.0 Hdi 136 / BlueHdi 136	AHV(DW10FD)	02/12 →
5008 2.0 Hdi 150 / BlueHdi 150	AHR(DW10FD), BHZ(DV6FC)	06/09 →
BOXER II 2.0 BlueHdi 110	DW10FUE	07/15 →
BOXER II 2.0 BlueHdi 130	AHN(DW10FUD), AHP(DW10FUC)	07/15 →
BOXER II 2.0 BlueHdi 160	AHP(DW10FUC), BHY(DV6FD)	07/15 →
EXPERT III 1.6 BlueHdi 115	DV6FCU	04/16 →
EXPERT III 1.6 BlueHdi 95	DV6FDU	04/16 →
EXPERT III 2.0 BlueHdi 120	DW10FE	04/16 →
EXPERT III 2.0 BlueHdi 150	DW10FD	04/16 →
EXPERT III 2.0 BlueHdi 180	DW10FC	04/16 →
PARTNER 1.6 BlueHdi	DV6FD	04/15 →
PARTNER II 1.6 BlueHdi 100	BHY(DV6FD), BHZ(DV6FC)	04/15 →
PARTNER II 1.6 BlueHdi 120	BHZ(DV6FC), BHW(DV6FE)	04/15 →
PARTNER II 1.6 Hdi / BlueHdi 75	BHW(DV6FE), BHY(DV6FD)	07/11 →
PARTNER II TEPEE 1.6 BlueHdi 100	BHY(DV6FD), BHZ(DV6FC)	12/14 →
PARTNER II TEPEE 1.6 BlueHdi 120	BHZ(DV6FC), BHW(DV6FE)	12/14 →
PARTNER II TEPEE 1.6 Hdi / BlueHdi 75	BHW(DV6FE), 3WZ-HV	01/15 →
PARTNER III 1.6 BlueHdi 100	DV6FD	09/18 →
RIFTER 1.2 PureTech 110	EB2ADT	09/18 →
TRAVELLER 1.6 BlueHdi 115	DV6FCU	04/16 →
TRAVELLER 1.6 BlueHdi 95	DV6FDU	04/16 →
TRAVELLER 2.0 BlueHdi 150	DW10FD	04/16 →
TRAVELLER 2.0 BlueHdi 180	DW10FC	04/16 →

TOYOTA		
PROACE 1.6 D	3WZ-HV, 4WZ-FHV	02/16 →
PROACE 1.6 D4d	3WZ-TV	02/16 →
PROACE 2.0 D	4WZ-FHV, 3WZ-HV	02/16 →
PROACE 2.0 D4d	4WZ-FTV	02/16 →
PROACE VERSO 1.6 D	3WZ-HV, 4WZ-FHV	02/16 →
PROACE VERSO 2.0 D	4WZ-FHV, B16DT(DV6FD)	02/16 →

VAUXHALL		
CROSSLAND X 1.6 Turbo D	B16DT(DV6FD), B12XHT(EB2DTS)	03/17 →
GRANDLAND X 1.2 Turbo	B12XHT(EB2DTS), --	06/17 →
GRANDLAND X 1.6 Turbo D	B16DTH(DV6FC)	06/17 →
GRANDLAND X 2.0 D	D20DTH(DW10FC)	10/17 →

ABSOLUTE PRESSURE SENSORS (MAP)

Adatt./Suitable:

CITROËN

96 753 330 80

DENSO

079800-9830

DS

96 753 330 80

PEUGEOT

96 753 330 80

ITEM NOW AVAILABLE FROM PRODUCTION

• ARTICOLO ORA DISPONIBILE PER LA VENDITA

• ARTICLE DISPONIBLE EN PRODUCTION COURANTE

• JETZT ZUM VERKAUF VERFÜGBARER ARTIKEL

• ARTICULO AHORA DISPONIBLE EN PRODUCCION



kPa	mV	NTC + - 0
25,6 - 316,5	250 - 4750	

CITROËN		
BERLINGO II 1.2 PureTech 110	--, EB2ADT	02/16 →
C3 II 1.2 THP 110	EB2DT, EB2ADT	10/14 →
C3 III 1.2 THP 110	EB2ADT, EB2DT	07/16 →
C3 AIRCROSS 1.2 PureTech 110	EB2ADT, EB2DT	06/17 →
C3 AIRCROSS 1.2 PureTech 130	EB2DTS	07/17 →
C3 PICASSO 1.2 THP 110	EB2DT, EB2ADT	01/15 →
C4 II 1.2 THP 110	EB2DT, EB2DTS	02/15 →
C4 II 1.2 THP 130	EB2DTS, EB2DTS	04/14 →
C4 CACTUS 1.2 PureTech 130	EB2DTS	11/17 →
C4 CACTUS 1.2 THP 110	EB2ADT, EB2DTS	09/14 →
C4 GRAND PICASSO II 1.2 THP 130	EB2DTS, EB2DT	04/14 →
C4 PICASSO II 1.2 THP 110	EB2ADT	04/16 →
C4 PICASSO II 1.2 THP 130	EB2DTS, EB2ADTS	04/14 →
C4 SPACETOURER 1.2 PureTech 110	EB2DTS	04/18 →
C4 SPACETOURER 1.2 PureTech 130	EB2ADTS, EB2DT	04/18 →
DS3 1.2 THP 110	EB2DT, EB2DTS	10/14 → 07/15
DS4 1.2 THP 130	EB2DTS, EB2ADTS	07/14 → 07/15
GRAND C4 SPACETOURER 1.2 PureTech 130	EB2ADTS, EB2ADT	04/18 →

DS		
DS 7 PureTech 130	EB2ADTS	10/18 →
DS3 1.2 THP 110	EB2ADT, EB2DTS	04/15 →
DS3 1.2 THP 130	EB2DTS	09/15 →
DS4 / DS4 CROSSBACK 1.2 THP 130	EB2DTS, EB2DT	07/15 →

PEUGEOT		
208 1.2 THP	EB2ADT, EB2DTS	01/13 →
308 II 1.2 THP 110	EB2ADT, EB2DTS	11/13 →
308 II 1.2 THP 130	EB2DTS, EB2ADTS	11/13 →
2008 1.2 THP 110	EB2DT, EB2DTS	01/15 →
2008 1.2 THP 130	EB2DTS, EB2ADT	01/15 →
3008 1.2	EB2DTS, EB2ADT	01/15 → 08/16
3008 1.2 PureTech 130	EB2DTS	05/16 →
5008 1.2	EB2ADTS, EB2DT	01/15 →
PARTNER II TEPEE 1.2 THP	EB2DT, --	02/16 →

10.3337



3

ABSOLUTE PRESSURE SENSORS (MAP)

Adatt./Suitable:

CITROËN
96 753 204 80

DENSO
079800-9730

DS
96 753 204 80

GENERAL MOTORS
3 639 836

OPEL
3639836

PEUGEOT
96 753 204 80

VAUXHALL
3639836

ITEM NOW AVAILABLE FROM PRODUCTION

- ARTICOLO ORA DISPONIBILE PER LA VENDITA
- ARTICLE DISPONIBLE EN PRODUCTION COURANTE
- JETZT ZUM VERKAUF VERFÜGBARER ARTIKEL
- ARTICULO AHORA DISPONIBLE EN PRODUCCION



kPa	mV	
19 - 294	561 - 4423	

CITROËN

BERLINGO II 1.2 PureTech 110	--, EB2ADT	02/16 →
C3 II 1.2 THP 110	EB2DT, EB2ADT	10/14 →
C3 III 1.2 THP 110	EB2ADT, EB2DT	07/16 →
C3 AIRCROSS 1.2 PureTech 110	EB2ADT, EB2DT	06/17 →
C3 AIRCROSS 1.2 PureTech 130	EB2DTS	07/17 →
C3 PICASSO 1.2 THP 110	EB2DT, EB2ADT	01/15 →
C4 II 1.2 THP 110	EB2DT, EB2DTS	02/15 →
C4 II 1.2 THP 130	EB2DTS, EB2DTS	04/14 →
C4 CACTUS 1.2 PureTech 130	EB2DTS	11/17 →
C4 CACTUS 1.2 THP 110	EB2ADT, EB2DTS	09/14 →
C4 GRAND PICASSO II 1.2 THP 130	EB2DTS, EB2DT	04/14 →
C4 PICASSO II 1.2 THP 130	EB2DTS, EB2ADTS	04/14 →
C4 SPACETOUREUR 1.2 PureTech 110	EB2DTS	04/18 →
C4 SPACETOUREUR 1.2 PureTech 130	EB2ADTS, EB2DT	04/18 →
DS3 1.2 THP 110	EB2DT, EB2DTS	10/14 → 07/15
DS4 1.2 THP 130	EB2DTS, EB2ADTS	07/14 → 07/15
GRAND C4 SPACETOUREUR 1.2 PureTech 130	EB2ADTS, EB2ADT	04/18 →

DS

DS3 1.2 THP 110	EB2ADT, EB2DTS	04/15 →
DS3 1.2 THP 130	EB2DTS	09/15 →
DS4 / DS4 CROSSBACK 1.2 THP 130	EB2DTS, B12XHL(EB2DT)	07/15 →

OPEL

CROSSLAND X 1.2	B12XHL(EB2DT), B12XHT(EB2DTS)	03/17 →
GRANDLAND X 1.2	B12XHT(EB2DTS), EB2DT	06/17 →

PEUGEOT

208 1.2 THP	EB2ADT, EB2DTS	01/13 →
308 II 1.2 THP 110	EB2ADT, EB2DTS	11/13 →
308 II 1.2 THP 130	EB2DTS, EB2ADTS	11/13 →
2008 1.2 THP 110	EB2DT, EB2DTS	01/15 →
2008 1.2 THP 130	EB2DTS, EB2ADT	01/15 →
3008 1.2	EB2DTS, EB2ADT	01/15 → 08/16
3008 1.2 PureTech 130	EB2DTS	05/16 →
5008 1.2	EB2ADTS, EB2DT	01/15 →
PARTNER II TEPEE 1.2 THP	EB2DT, B12XHL(EB2DT)	02/16 →

VAUXHALL

CROSSLAND X 1.2	B12XHL(EB2DT), B12XHT(EB2DTS)	03/17 →
GRANDLAND X 1.2 Turbo	B12XHT(EB2DTS), 312A1.000	06/17 →

10.3341



3,5

ABSOLUTE PRESSURE SENSORS (MAP)

Adatt./Suitable:

ABARTH
77366837

ALFA ROMEO
77366837

BOSCH
0 261 230 313
0 261 230 421
0 261 230 422
0 261 230 429
0 261 230 430
0 261 230 448
0 261 230 449

FIAT
77366837

FORD
1 852 633
1 871 255
EL8A-9F479-AA
EL8A-9F479-CA

FORD USA
1 871 255
EL8A-9F479-CA

IVECO
73503657

VOLVO
31355973
31405340
31432308



kPa	mV	
11,2 - 307,2	250 - 4750	

ABARTH

500 1.4	312A1.000, 312A1.000	08/08 →
500 MY12 1.4	--	01/12 →
500C / 595C 1.4	312A1.000, 198A4.000	05/08 →

ALFA ROMEO

GIULIETTA II 1.4 TB	198A4.000, 843A1.000	04/10 →
MITO 1.4 TB	955B1.000	12/13 →

FIAT

500L 1.4	843A1.000, --	09/12 →
DOBLO II 1.4	198A4.000	10/11 →
DOBLO II 1.4 Natural Power	198A4000CNG	06/10 →
EGEA 1.4T-Jet	--	10/15 →
PUNTO III 1.4 Turbo Multi Air	955A2.000	03/12 →
TIPO II 1.4 LPG	940B7.000	05/16 →
TIPO II 1.4T-Jet	--	10/15 →

FORD

B-MAX 1.0 EcoBoost	YYJC	02/16 →
C-MAX II 1.0 EcoBoost	--, M8DB	10/12 →
C-MAX II 1.5 16V	--	03/15 →
C-MAX II 1.5 EcoBoost	M8DB, JQDA	03/15 →
C-MAX II 1.6 EcoBoost	JQDA, 10FD0X	12/10 →
ECOSPORT 1.0 EcoBoost	10FD0X, SFJA	10/13 →
FIESTA VI 1.0 EcoBoost	SFJA, M1JL	01/13 →
FIESTA VII 1.0 EcoBoost	M1JL, M1DA	01/17 →
FOCUS III 1.0 EcoBoost	M1DA, M8DA	02/12 →
FOCUS III 1.5 EcoBoost	M8DA, C15HDTX	09/14 →
FOCUS III 1.6 Flexifuel	YUDA	07/13 →
FOCUS III 2.3 RS AWD	YVDA	07/15 →
GALAXY III 1.5 EcoBoost	C15HDTX, M8DB	01/15 →
GRAND C-MAX 1.0 EcoBoost	B7DA	10/12 →
GRAND C-MAX 1.5 EcoBoost	M8DB, JQDA	03/15 →
GRAND C-MAX 1.6 EcoBoost	JQDA, BNMA	12/10 →
KUGA II 1.5 16V	--	03/13 →
KUGA II 1.5 EcoBoost	BNMA, C15HDTX	09/14 →
KUGA II 1.5 EcoBoost 4x4	C15HDTX, --	09/14 →
KUGA II 1.6 EcoBoost	--, JQMA	01/13 →
KUGA II 1.6 EcoBoost 4x4	JQMA, M1CA	10/12 →
KUGA II 2.0 4x4	--	03/13 → 06/16
KUGA II 2.0 EcoBoost	--	03/13 →
MONDEO IV 1.0 EcoBoost	M1CA, UNCA	02/15 →
MONDEO IV 1.5 EcoBoost	UNCA, --	09/14 →
MONDEO IV 1.5 GTDI	--	09/14 →
MONDEO IV 2.0 EcoBoost	--, C15HDTX	09/12 →
MONDEO IV 2.0 EcoBoost 4x4	--	09/12 → 07/16
S-MAX II 1.5 EcoBoost	C15HDTX, M2GA	01/15 →

FORD

TOURNEO CONNECT II 1.0 EcoBoost	M2GA, M2GA	11/13 →
TOURNEO CONNECT II 1.6 EcoBoost	JQGA	11/13 →
TRANSIT CONNECT II 1.0 EcoBoost	M2GA, C23HD0D	02/13 →
TRANSIT CONNECT II 1.6 EcoBoost	JQGA	11/13 →

FORD USA

MUSTANG 2.3 EcoBoost	C23HD0D, B4204T23	01/15 →
----------------------	-------------------	---------

VOLVO

S60 II 1.5 T2	B4154T5	10/15 →
S60 II 1.5 T3	B4154T4	03/15 →
S60 II 2.0 T3	B4204T37	03/15 →
S60 II 2.0 T4	B4204T19	03/15 →
S60 II T3	B4164T3	04/10 → 12/15
S60 II T4	B4164T	04/10 → 12/15
S60 II T4F	B4164T2	04/11 → 12/15
S60 II T5	B4204T11	09/13 →
S60 II T5 AWD	B4204T11	07/14 →
S60 II T6	B4204T9	09/13 →
S60 II T6 AWD	B4204T9	09/15 →
S80 II 2.0 Drive-E	B4204T11	12/14 →
S80 II 2.0 T5	B4204T15	01/14 →
S80 II T4	B4164T	10/10 →
S80 II T4F	B4164T2	05/11 →
S80 II T5	B4204T11	09/13 →
S90 2.0	B4204T20	03/16 →
S90 2.0 Hybrid AWD	B4204T35	10/17 →
S90 2.0 T4	B4204T31	10/17 →
S90 2.0 T5	B4204T23, B4154T3	03/16 →
S90 2.0 T8 Hybrid AWD	B4204T34	04/18 →
V40 II T2	B4154T3, B4154T2	02/15 →
V40 II T2 GTDi	B4164T4	03/13 → 12/15
V40 II T3	B4154T2, B4164T	02/15 →
V40 II T3 GTDi	B4164T3	03/12 →
V40 II T4	B4164T, B4154T4	04/14 →
V40 II T4 AWD	B4204T21	05/14 →
V40 II T4 GTDi	B4164T	03/12 →
V40 II T5	B4204T11	05/14 →
V40 II T5 AWD	B4204T11	05/14 →
V60 I 1.5 T2	B4154T5	10/15 →
V60 I 2.0 T4	B4204T19	03/15 →
V60 I 2.0 T5	B4204T15	01/14 →
V60 I T3	B4154T4, B4164T	09/10 →
V60 I T4	B4164T	09/10 → 12/15
V60 I T4F	B4164T2	04/11 → 12/15
V60 I T5	B4204T11	10/13 →
V60 I T6	B4204T9	10/13 →
V60 I T6 AWD	B4204T9	10/13 →
V60 II T5	B4204T26	02/18 →
V60 II T8 Plug-in Hybrid AWD	B4204T34	02/18 →
V70 III 1.6 T4F	B4164T2	01/11 → 12/15
V70 III T4	B4164T, B4204T23	10/10 →
V70 III T5	B4204T11	10/13 →
V90 2.0 Hybrid AWD	B4204T35	03/16 →
V90 2.0 T4	B4204T31	10/17 →
V90 2.0 T5	B4204T23, B4204T20	03/16 →
V90 2.0 T5 AWD	B4204T20, B4204T23	03/16 →
V90 2.0 T8 Hybrid AWD	B4204T34	04/18 →
XC40 2.0 T4	B4204T47	05/18 →
XC40 2.0 T4 AWD	B4204T47	05/18 →
XC40 T5 AWD	B4204T14	10/17 →
XC60 I T5	B4204T11	10/13 →
XC60 I T5 AWD	B4204T11	10/15 → 02/17
XC60 I T6	B4204T9	10/13 →
XC60 I T6 AWD	B4204T9	10/13 →
XC60 II 2.0 T4	B4204T31	09/18 →
XC60 II 2.0 T5	B4204T23, B4204T20	03/17 →
XC60 II 2.0 T5 AWD	B4204T20, B4204T27	03/17 →
XC60 II 2.0 T6 AWD	B4204T27, B4204T34	03/17 →
XC60 II 2.0 T8 Hybrid AWD	B4204T34, B4204T20	03/17 →
XC70 II T5	B4204T11	10/13 →
XC90 II 2.0	B4204T20	09/14 →
XC90 II 2.0 T5 AWD	B4204T20, D4FB	06/15 →
XC90 II 2.0 T6 AWD	B4204T29	10/17 →
XC90 II 2.0 T8 Hybrid AWD	B4204T34	04/18 →
XC90 II T5 AWD	B4204T23	06/15 →
XC90 II T6 AWD	B4204T27	09/14 →
XC90 II T8 Hybrid AWD	B4204T35	06/15 →

10.3344



3,5

ABSOLUTE PRESSURE SENSORS (MAP)

Adatt./Suitable:

HYUNDAI
39200-2A650

kPa	mV	O + NTC -
18,2 - 300,2	250 - 4750	

HYUNDAI

I20 1.1 CRDi	D3FA	05/15 ⇨
I20 II 1.1 CRDi	D3FA	11/14 ⇨

10.3345



3,5

ABSOLUTE PRESSURE SENSORS (MAP)

Adatt./Suitable:

HYUNDAI
39300-2A600
39300-2B050

KIA
39300-2A600
39300-2B050

MARKET DIFFUSION: MEDIUM



kPa	mV	O + -
18,2 - 300,2	250 - 4750	

HYUNDAI

ACCENT IV 1.6 CRDi	D4FB, G4FC	11/10 ⇨
ELANTRA V 1.6 CRDi	D4FB	10/15 ⇨
ELANTRA V 1.6 T-GDi [ExtraEU]	G4FJ	02/16 ⇨
I20 1.4 CRDi	D4FC	05/15 ⇨
I20 II 1.4 CRDi	D4FC	11/14 ⇨
I30 1.6 CRDi	D4FB	05/15 ⇨
I30 II 1.4 CRDi	D4FC	12/11 ⇨
I30 II 1.6	G4FC, D4FB	12/11 ⇨
I30 II 1.6 CRDi	D4FB, D4FB	11/11 ⇨
I30 II 1.6 GDi	G4FD	12/11 ⇨
I30 II 1.6 T-GDi	G4FJ	01/15 ⇨
I30 III 1.0 T-GDi	G3LC	11/16 ⇨
I30 III 1.6 CRDi	D4FB, D4FD	11/16 ⇨
I30 III 1.6 CRDi VGT [ExtraEU]	D4FE	08/18 ⇨
I40 1.6 CRDi	D4FE	07/18 ⇨
I40 1.7 CRDi	D4FD, D4FD	07/11 ⇨
KONA 1.0 T-GDi	G3LC	07/17 ⇨
KONA 1.6 CRDi	D4FE	08/18 ⇨
KONA 1.6 CRDi e-VGT	D4FE	08/18 ⇨
KONA 1.6 CRDi e-VGT AWD	D4FE	08/18 ⇨
KONA 1.6 T-GDi	G4FJ	07/17 ⇨
KONA 1.6 T-GDi 4WD	G4FJ	06/17 ⇨

HYUNDAI

TUCSON 1.6 CRDi	D4FE	08/18 ⇨
TUCSON 1.6 CRDi Trazione integrale	D4FE	08/18 ⇨
TUCSON 1.6 T-GDi	G4FJ	06/15 ⇨
TUCSON 1.6 T-GDi Trazione integrale	G4FJ	06/15 ⇨
TUCSON 1.7 CRDi	D4FD	06/15 ⇨

KIA

CEED II 1.0 T-GDi	G3LC	04/15 ⇨
CEED II 1.4 CRDi	D4FC	04/15 ⇨
CEED II 1.6 CRDi 136	D4FB	07/15 ⇨
CEED III 1.0 T-GDi	G3LC	05/18 ⇨
CEED III 1.0 T-GDi [ExtraEU]	G3LC	03/18 ⇨
CEED III 1.4 T-GDi	G4LD	04/18 ⇨
CEED III 1.4 T-GDi [ExtraEU]	G4LD	03/18 ⇨
CEED III 1.6 CRDi [ExtraEU]	D4FE	03/18 ⇨
CEED III 1.6 CRDi 115	D4FE	05/18 ⇨
CEED III 1.6 CRDi 136	D4FE	05/18 ⇨
CEED III 1.6 T-GDi GT	G4FJ	10/18 ⇨
OPTIMA IV 1.6 CRDi	D4FE	01/18 ⇨
OPTIMA IV 1.6 T-GDi	G4FJ	01/18 ⇨
OPTIMA IV 1.7 CRDi	D4FD	11/15 ⇨
PROCEED 1.0 T-GDi	G3LC	10/18 ⇨
PROCEED 1.4 T-GDi	G4LD	10/18 ⇨
PROCEED 1.6 CRDi 136	D4FE	10/18 ⇨
PROCEED 1.6 T-GDi	G4FJ	10/18 ⇨
PRO CEE'D II 1.6 CRDi 136	D4FB	07/15 ⇨
PRO CEE'D 1.4 CRDi	D4FC	05/15 ⇨
PRO CEE'D 1.6 CRDi	D4FB	10/12 ⇨
RIO 1.4 CRDi	D4FC	04/15 ⇨
RIO IV 1.0 T-GDi 100	G3LC	01/17 ⇨
RIO IV 1.0 T-GDi 120	G3LC	01/17 ⇨
RIO IV 1.4 CRDi 77	D4FC	01/17 ⇨
RIO IV 1.4 CRDi 90	D4FC	01/17 ⇨
SOUL II 1.6 TGD	G4FJ	11/16 ⇨
SPORTAGE IV 1.6 CRDi	D4FE	07/18 ⇨
SPORTAGE IV 1.6 CRDi AWD	D4FE	07/18 ⇨
SPORTAGE IV 1.6 GDi	G4FJ	09/15 ⇨
SPORTAGE IV 1.6 GDi AWD	G4FJ	09/15 ⇨
SPORTAGE IV 1.7 CRDi	D4FD, G3LC	09/15 ⇨
STONIC 1.0 T-GDi	G3LC, D4FB	07/17 ⇨
STONIC 1.6 CRDi	D4FB, --	07/17 ⇨
VENGA CRDi	D4FC	04/15 ⇨

10.3348



3,5

ABSOLUTE PRESSURE SENSORS (MAP)

Adatt./Suitable:

BOSCH
0 261 230 172

FORD
1 440 437
6X71-9F479-AA

MARKET DIFFUSION: MEDIUM



kPa	mV	O - +
10 - 307,1	252,5 - 4750,6	

FORD

TRANSIT III 2.4 TDCi	--, H9FD	04/06 ⇨
TRANSIT III 2.4 TDCi 4x4	H9FB	11/06 ⇨ 08/14
TRANSIT III 2.4 TDCi HPCR	--	07/06 ⇨
TRANSIT III 2.4 TDCi RWD	H9FD, RTJ	04/06 ⇨ 08/14

10.3355



3,5

ABSOLUTE PRESSURE SENSORS (MAP)

Adatt./Suitable:

FORD

 1 041 954 *1
 1 127 268 *1
 1 139 330 *1
 1 144 420 *1
 1M5F-9S428-AA *1
 1M5F-9S428-AB *1
 4 449 664 *1
 8X23-9S428-AA *1
 98AB-9S428-AB *1
 YC15-9S428-AA *1

*1 without fastening clamp

- senza staffa fissaggio
- sans bride de fixation
- ohne Befestigungsbügel
- sin estribo de sujeción

JAGUAR

 C2C 29212 *1
 C2P 5434 *1
 C2Z 4525 *1

MARKET DIFFUSION: MEDIUM



kPa	mV	+ O -
38,3 - 262,5	250 - 4750	

FORD

FIESTA IV 1.8 D	RTJ, RTN	08/95 ⇨ 04/00
FIESTA IV 1.8 Di	RTN, RTJ	04/00 ⇨ 08/03
FIESTA IV D 1.8	RTJ, RTN	05/98 ⇨ 04/02
FIESTA IV TD 1.8	RTN, BHDA	03/00 ⇨ 08/03
FOCUS I 1.8 Di / TDDi	BHDA, F9DA	08/99 ⇨ 11/04
FOCUS I 1.8 TDCi	F9DA, BHDA	03/01 ⇨ 03/05
FOCUS I 1.8 TDDi	BHDA, BHDA	08/98 ⇨ 03/05
FOCUS I 1.8 Turbo Di / TDDi	BHDA, HCPA	10/98 ⇨ 03/05
TOURNEO CONNECT I 1.8 TDCi	HCPA, BHPA	06/02 ⇨ 12/13
TOURNEO CONNECT I 1.8 TDCi / TDi / Di	BHPA, BHPA	06/02 ⇨ 12/13
TRANSIT III 2.4 Di	D2FA, D4FA	01/00 ⇨ 05/06
TRANSIT III 2.4 Di RWD	D4FA, D2FE	01/00 ⇨ 05/06
TRANSIT III 2.4 TD	F4FA	08/00 ⇨ 08/03
TRANSIT III 2.4 TD 4x4	F4FA	08/00 ⇨ 08/03
TRANSIT III 2.4 TDCi	H9FA	03/04 ⇨ 05/06
TRANSIT III 2.4 TDDi	D2FE, D0FA	08/00 ⇨ 03/06
TRANSIT III 2.4 TDE	DOFA, AJ-V6	07/01 ⇨ 05/06
TRANSIT CONNECT I 1.8 Di	BHPA, HCPA	06/02 ⇨ 12/13
TRANSIT CONNECT I 1.8 TDCi	HCPA, D2FA	06/02 ⇨ 12/13

JAGUAR

XF 3.0	FB	03/08 ⇨ 04/15
XF 3.0 D	306DT	09/12 ⇨ 04/14
XF 3.0 D AWD	AJV6D	03/12 ⇨
XF 4.2	SV8TS	07/09 ⇨
XJ 3.0	AJ-V6, D4204T20	05/03 ⇨
XJ 3.6	RG(AJ-V8)	05/03 ⇨ 03/09
XJ 4.2	AJ8FT	05/03 ⇨ 03/09
XJ D 2.7	AJD	10/05 ⇨ 03/09
XK 3.6	RG(AJ-V8)	07/07 ⇨ 07/14
XK 4.2 XK8	AJ8FT	03/06 ⇨ 07/14

10.3357



3,5

ABSOLUTE PRESSURE SENSORS (MAP)

Adatt./Suitable:

BOSCH0 261 230 423
0 261 230 424**VOLVO**

31405341



kPa	mV	O + NTC -
28,9 - 400	250 - 4480	

VOLVO

S60 II 2.0 D2	D4204T20, D4204T4	03/15 →
S60 II 2.0 D3	D4204T4, D4204T16	03/15 →
S60 II 2.0 D4	D4204T14	03/15 →
S60 II 2.0 D5	D4204T11	03/15 →
S60 II 2.0 Polestar AWD	B4204T43	06/15 →
S60 II D4	D4204T5	09/13 → 12/15
S80 II D4	D4204T5	09/13 →
S90 2.0 D3	D4204T16, D4204T13	03/16 →
S90 2.0 D4	D4204T14	03/16 →
S90 2.0 D4 AWD	D4204T14	03/16 →
S90 2.0 D5 AWD	D4204T23	03/16 →
V40 II D2	D4204T13, D4204T16	02/15 →
V40 II D3	D4204T16, D4204T20	04/15 →
V40 II D4	D4204T14	05/14 →
V60 I 2.0 D2	D4204T20, D4204T4	03/15 →
V60 I 2.0 D3	D4204T4, D4204T16	03/15 →
V60 I 2.0 D4	D4204T14	03/15 →
V60 I 2.0 Polestar AWD	B4204T43	06/15 →
V60 I D4	D4204T5	10/13 → 12/15
V60 I D5	D4204T11	03/15 →
V60 IT5 AWD	B4204T11	07/14 →
V60 II D3	D4204T16	02/18 →
V60 II D3 AWD	D4204T4	09/18 →
V60 II D4	D4204T14	02/18 →
V60 II D4 AWD	D4204T14	09/18 →
V60 II D4 Polestar	D4204T14	02/18 →
V60 2.0 D3	D4204T4	12/18 →
V60 2.0 D4	D4204T14	12/18 →
V70 III D2	D4204T20	03/15 →
V70 III D3	D4204T9	03/15 →
V70 III D4	D4204T5	10/13 →
V90 2.0 D3	D4204T16, D4204T14	03/16 →
V90 2.0 D3 AWD	D4204T4	03/16 →
V90 2.0 D4	D4204T14, D4204T14	03/16 →
V90 2.0 D4 AWD	D4204T14, D4204T14	03/16 →
V90 2.0 D5 AWD	D4204T23	03/16 →
V90 2.0 Polestar AWD	D4204T14, D4204T16	10/16 →
XC40 2.0 D3	D4204T16, D4204T16	10/17 →
XC40 2.0 D3 AWD	D4204T16, D4204T14	10/17 →
XC40 2.0 D4 AWD	D4204T12	10/17 →
XC60 I D3	D4204T4	03/15 → 02/17
XC60 I D4	D4204T14, D4204T14	10/13 → 02/17
XC60 II 2.0 D3	D4204T4	03/17 →
XC60 II 2.0 D4	D4204T14, D4204T11	03/17 →
XC60 II 2.0 D4 AWD	D4204T14	03/17 →
XC60 II 2.0 D5 AWD	D4204T23	03/17 →
XC70 II D4	D4204T5	10/13 →
XC90 II D4	D4204T14	06/15 →
XC90 II D4 AWD	D4204T6	06/15 →
XC90 II D5 AWD	D4204T11, F1CE3481C	09/14 →

10.3359



3,5

ABSOLUTE PRESSURE SENSORS (MAP)

Adatt./Suitable:

00 Eliminated on 26-05-2017. Please verify the availability through our local distributors

- Eliminato il 26-05-2017. Verificare la disponibilità presso i nostri distributori
- Éliminé le 26-05-2017. Vérifier la disponibilité auprès de nos distributeurs sur place
- Am 26-05-2017 gestrichen. Evtl. Verfügbarkeit bitte bei unseren Händlern prüfen
- Eliminado en fecha 26-05-2017. Verificar la disponibilidad a través de nuestros distribuidores locales

1006 After depletion of stock this part is replaced by:

- Esaurite le scorte questo pezzo sarà sostituito da:
- Après épuisement du stock, cette pièce est remplacée par:
- Nach Vorraterschöpfung wird ersetzt durch:
- Después agotamiento stock, será sustituido por:

10.3341



kPa	mV	O + NTC -
11,2 - 307,2	250 - 4750	

10.3377



3,5

ABSOLUTE PRESSURE SENSORS (MAP)

Adatt./Suitable:

BOSCH

0 281 006 049

IVECO

504307953

ITEM NOW AVAILABLE FROM PRODUCTION

- ARTICOLO ORA DISPONIBILE PER LA VENDITA
- ARTICLE DISPONIBLE EN PRODUCTION COURANTE
- JETZT ZUM VERKAUF VERFÜGBARER ARTIKEL
- ARTICULO AHORA DISPONIBLE EN PRODUCCION



kPa	mV	O + NTC -
10 - 400	297,5 - 4017	

IVECO

DAILY IV 35C14 K, 35C14 DK, 35S14 K, 35S14 DK	F1CE3481L	07/07 → 08/11
DAILY IV 35C14 V, 35C14 V/P, 35S14 V, 35S14 V/P	F1CE3481L	07/07 → 08/11
DAILY IV 35C14, 35C14 /P, 35S14, 35S14 /P, 35S14 D, 35S14 D/P	F1CE3481L	07/07 → 08/11

DAILY IV 35C17 K, 35C17 DK, 35S17 K, 35S17 DK	F1CE3481C	07/07 → 08/11
DAILY IV 35C17 V, 35C17 V/P, 35S17 V, 35S17 V/P	F1CE3481C	07/07 → 08/11
DAILY IV 35C17 V, 35S17 V, 40C17 V, 45C17 V, 50C17 V, 60C17 V	F1CE3481C	09/11 → 02/14
DAILY IV 35C17, 35C17 /P, 35S17, 35S17 /P, 35S17 D	F1CE3481C	07/07 → 08/11
DAILY IV 35C17, 35C17D, 35S17, 40C17, 45C17, 50C17, 60C17, 70C17	F1CE3481C	09/11 → 02/14
DAILY IV 35C17K, 35S17DKP, 50C17K, 65C17DK 70C17K	F1CE3481C, F1CF411G	09/11 → 02/14
DAILY IV 35C21 V, 35S21 V, 40C21 V, 45C21 V, 50C21 V	F1CE3481D	09/11 → 02/14
DAILY IV 35C21, 35S21, 40C21, 45C21, 50C21, 60C21, 70C21	F1CE3481D	09/11 → 02/14
DAILY IV 35S17 W, 35S17 WD	F1CE3481C	07/07 → 08/11
DAILY IV 40C14 K, 40C14 DK	F1CE3481L	07/07 → 08/11
DAILY IV 40C14 V, 40C14 V/P	F1CE3481L	07/07 → 08/11
DAILY IV 40C14, 40C14 /P	F1CE3481L	07/07 → 08/11
DAILY IV 40C17 K, 40C17 DK	F1CE3481C	07/07 → 08/11
DAILY IV 40C17 V, 40C17 V/P	F1CE3481C	07/07 → 08/11
DAILY IV 40C17, 40C17 /P	F1CE3481C	07/07 → 08/11
DAILY IV 45C14, 45C14 /P	F1CE3481L	07/07 → 08/11
DAILY IV 45C17 V, 45C17 V/P	F1CE3481C	07/07 → 08/11
DAILY IV 45C17, 45C17 /P	F1CE3481C	07/07 → 08/11
DAILY IV 50C14 K, 50C14 DK	F1CE3481L	07/07 → 08/11
DAILY IV 50C14 V, 50C14 V/P	F1CE3481L	07/07 → 08/11
DAILY IV 50C17 K, 50C17 DK	F1CE3481C	07/07 → 08/11
DAILY IV 50C17 V, 50C17 V/P	F1CE3481C	07/07 → 08/11
DAILY IV 50C17, 50C17 /P	F1CE3481C	07/07 → 08/11
DAILY IV 55C17	F1CE3481C	08/07 → 03/12
DAILY IV 55S17 W, 55S17 WD	F1CE3481C	07/07 → 08/11
DAILY IV 60C14 K, 60C14 DK	F1CE3481L	07/07 → 08/11
DAILY IV 60C14, 60C14 /P	F1CE3481L	07/07 → 08/11
DAILY IV 60C17 K, 60C17 DK	F1CE3481C	07/07 → 08/11
DAILY IV 60C17 V, 60C17 V/P	F1CE3481C	07/07 → 08/11
DAILY IV 60C17, 60C17 /P	F1CE3481C	07/07 → 08/11
DAILY IV 65C14 K, 65C14 DK	F1CE3481L	07/07 → 08/11
DAILY IV 65C14 V, 65C14 V/P	F1CE3481L	07/07 → 08/11
DAILY IV 65C14, 65C14 /P	F1CE3481L	07/07 → 08/11
DAILY IV 65C17 K, 65C17 DK, 65C17KK	F1CE3481C	07/07 → 08/11
DAILY IV 65C17 V, 65C17 V/P	F1CE3481C	07/07 → 08/11
DAILY IV 65C17, 65C17 /P	F1CE3481C	07/07 → 08/11
DAILY IV 70C14 K, 70C14 DK, 70C14 KK	F1CE3481L	07/07 → 08/11
DAILY IV 70C14 V, 70C14 V/P	F1CE3481L	07/07 → 08/11
DAILY IV 70C14, 70C14 /P	F1CE3481L	07/07 → 08/11
DAILY IV 70C17 K, 70C17 DK, 70C17 KK	F1CE3481C	07/07 → 08/11
DAILY IV 70C17, 70C17 /P	F1CE3481C	07/07 → 08/11
DAILY IV 70C17V, 70C17 V/P	F1CE3481C	07/07 → 08/11
DAILY V 35S21, 35C21, 40C21, 50C21, 65C21, 70C21	F1CF411G, EXF	03/14 →
DAILY 3.0	F1CE3481C, F1CE3481C	09/09 → 02/14



ABSOLUTE PRESSURE SENSORS (MAP)

Adatt./Suitable:

BOSCH
0 281 006 330**JEEP**
68211211AA
K68211211AA**MASERATI**
46330273
673001047**OPAR PARTS**
68211211AA**NEW - ITEM NOW AVAILABLE FROM PRODUCTION**

- NUOVO - ARTICOLO ORA DISPONIBILE PER LA VENDITA
- NOUVEAU - ARTICLE DISPONIBLE EN PRODUCTION COURANTE
- NEU - JETZ ZUM VERKAUF VERFÜGBARER ARTIKEL
- NUEVO - ARTICULO AHORA DISPONIBLE EN PRODUCCION



kPa	mV	
307	250 - 4750	

JEEP			
GRAND CHEROKEE 3.0 CRD	EXF	09/13	⇒
GRAND CHEROKEE 3.0 CRD V6 4x4	EXF, B5254T3	01/11	⇒
MASERATI			
GHIBLI 3.0 D	M15746D	08/13	⇒
LEVANTE 3.0 D Trazione integrale	B630WM	06/16	⇒
QUATTROPORTE 3.0 D	M15746D	09/13	⇒



ABSOLUTE PRESSURE SENSORS (MAP)

Adatt./Suitable:

VOLVO
31336111

- NEW - AVAILABLE FROM:**
- NUOVO - DISPONIBILE DA:
 - NOUVEAU - DISPONIBLE EN:
 - NEU - VERFUEGBAR AB:
 - NUEVO - DISPONIBLE EN:

20/Q1



kPa	mV	
10 - 271	958 - 4750	

VOLVO			
S40 II T5	B5254T3, B5254T3	01/04	⇒ 12/12
S40 II T5 AWD	B5254T3, B5254T14	04/04	⇒ 12/10
S60 II 2.0 T	B5204T8	05/12	⇒ 12/15
S60 II 2.0 T5 DRIVe	B4204T7	09/14	⇒ 12/15
S60 II 2.5 T	B5254T14	01/13	⇒
S60 II 2.5 T5	B5254T5	09/11	⇒
S60 II 2.5 T5 AWD	B5254T14, B5254T10	09/12	⇒
S60 II T	B5204T9	04/14	⇒
S60 II T5 AWD	B5254T12	08/15	⇒
S80 II 2.5 T	B5254T10, B5254T11	03/06	⇒
S80 II 2.5 T AWD	B5254T6	10/06	⇒ 04/09
S80 II 2.5 T FlexFuel	B5254T11, B5204T9	05/08	⇒ 12/11
S80L 2.5 T	B5254T6	01/08	⇒
S80L 2.5 T5	B5254T12	01/12	⇒
S80L T4	B5204T8	01/12	⇒
V40 II T4	B5204T8	07/13	⇒ 12/15

VOLVO			
V40 II T4 AWD	B5204T8	07/13	⇒
V40 II T5	B5204T9, B5204T9	12/12	⇒
V40 II T5 AWD	B5204T9, B5254T3	01/13	⇒
V50 T5	B5254T3, B5254T3	04/04	⇒ 12/12
V50 T5 AWD	B5254T3, B5254T12	04/04	⇒ 12/10
V60 I 2.0 T	B5204T8	01/14	⇒
V60 I T5	B5204T9	10/13	⇒
V60 I T5 AWD	B5254T12, B5254T10	03/15	⇒
V70 III 2.0 BiFuel	B5204T9	03/13	⇒ 12/15
V70 III 2.0 GDI	B5204T9	04/12	⇒ 12/15
V70 III 2.5 T	B5254T10, B5254T11	08/07	⇒ 12/12
V70 III 2.5 T FlexiFuel	B5254T11, LF17	05/08	⇒ 12/11
XC60 I T5 AWD	B5254T12	04/14	⇒ 02/17
XC70 II T5 AWD	B5254T12	08/15	⇒
XC70 II T6 AWD	B5254T14	03/15	⇒



ABSOLUTE PRESSURE SENSORS (MAP)

Adatt./Suitable:

MAZDA
BCM6-43-7V0
MITSUBISHI
1865A148

- NEW - AVAILABLE FROM:**
- NUOVO - DISPONIBILE DA:
 - NOUVEAU - DISPONIBLE EN:
 - NEU - VERFUEGBAR AB:
 - NUEVO - DISPONIBLE EN:

20/Q1



kPa	mV	
10 - 119,7	395 - 4750	

MAZDA			
3 II 2.0 MZR	LF17, LF-5H	01/09	⇒ 09/14
3 II 2.0 MZR DISI	LF-5H, LF-5H	12/08	⇒ 05/13
5 II 2.0	LF-5H, PE-VPS	09/10	⇒
CX-5 2.0	PE-VPS, PEY4	11/11	⇒
CX-5 2.0 [ExtraEU]	PEY4, PE-VPS	07/12	⇒ 02/17
CX-5 2.0 AWD	PE-VPS, SH-VPTS	11/11	⇒
CX-5 2.2 D	SH-VPTS, PY-VPS	04/12	⇒
CX-5 2.2 D 4WD	SH-VPTS	04/12	⇒
CX-5 2.2 D AWD	SHY1	04/12	⇒ 02/17
CX-5 2.5	PY-VPS, 6B31	02/13	⇒
CX-5 2.5 4WD	PY-VPS	07/14	⇒
CX-5 2.5 AWD	PYY1	02/15	⇒ 02/17
CX5 2.0 [ExtraEU]	PEY4, PEY4	11/11	⇒ 02/17

MITSUBISHI			
OUTLANDER 3.0 Mivec [ExtraEU]	6B31	08/12	⇒
OUTLANDER II 3.0 4WD	6B31, B4204T23	11/06	⇒ 11/12
OUTLANDER II 3.0 AWD	6B31	11/06	⇒ 12/10
OUTLANDER II 3.0 FWD	6B31	11/06	⇒ 11/12
OUTLANDER II 3.0 Mivec [ExtraEU]	6B31	09/10	⇒ 12/12
OUTLANDER III 3.0	6B31	08/12	⇒
OUTLANDER III 3.0 4WD	6B31	03/14	⇒
PAJERO 3.5	6G7450HC	09/08	⇒
PAJERO SPORT II 3.0	6B31	09/08	⇒
PAJERO SPORT II 3.0 4WD	6B31	09/08	⇒
PAJERO SPORT II 3.5	6G74(SOHC24V)	01/10	⇒
PAJERO SPORT II 3.5 V6 24V	6G74(SOHC24V)	09/08	⇒
PAJERO SPORT III 3.0 Mivec 4x4	6B31	08/15	⇒



ABSOLUTE PRESSURE SENSORS (MAP)

Adatt./Suitable:

VOLVO
31372487
31392382

- NEW - AVAILABLE FROM:**
- NUOVO - DISPONIBILE DA:
 - NOUVEAU - DISPONIBLE EN:
 - NEU - VERFUEGBAR AB:
 - NUEVO - DISPONIBLE EN:

20/Q1



kPa	mV	
10 - 312	983 - 4750	

VOLVO			
S60 II 1.5 T2	B4154T5	10/15	⇒
S60 II 2.0 Polestar AWD	B4204T43	06/15	⇒
S60 II 2.0 T3	B4204T37	03/15	⇒
S60 II 2.0 T4	B4204T19	03/15	⇒
S60 II T5	B4204T11	09/13	⇒
S60 II T5 AWD	B4204T11	07/14	⇒
S60 II T6	B4204T9	09/13	⇒
S60 II T6 AWD	B4204T9	09/15	⇒
S80 II 2.0 Drive- E	B4204T11	12/14	⇒
S80 II 2.0 T5	B4204T15	01/14	⇒
S80 II T5	B4204T11	09/13	⇒
S90 2.0	B4204T20	03/16	⇒
S90 2.0 Hybrid AWD	B4204T35	10/17	⇒
S90 2.0 T4	B4204T31	10/17	⇒
S90 2.0 T5	B4204T23, B4204T27	03/16	⇒
S90 2.0 T6 AWD	B4204T27, B4154T3	03/16	⇒
S90 2.0 T8 Hybrid AWD	B4204T34	04/18	⇒
V40 II T2	B4154T3, B4154T2	02/15	⇒
V40 II T3	B4154T2, B4204T23	02/15	⇒
V40 II T4	B4204T19	08/15	⇒
V40 II T4 AWD	B4204T21	05/14	⇒
V40 II T5	B4204T11	05/14	⇒
V40 II T5 AWD	B4204T11	05/14	⇒
V60 I 1.5 T2	B4154T5	10/15	⇒
V60 I 2.0 Polestar AWD	B4204T43	06/15	⇒
V60 I 2.0 T4	B4204T19	03/15	⇒
V60 I 2.0 T5	B4204T15	01/14	⇒
V60 I T5	B4204T11	10/13	⇒
V60 I T5 AWD	B4204T11	07/14	⇒
V60 I T6	B4204T9	10/13	⇒
V60 I T6 AWD	B4204T9	10/13	⇒
V60 II T5	B4204T26	02/18	⇒
V60 II T6 AWD	B4204T29	02/18	⇒
V60 II T8 Plug-in Hybrid AWD	B4204T34	02/18	⇒
V70 III T4	B4204T19	03/15	⇒
V70 III T5	B4204T11	10/13	⇒
V90 2.0 Hybrid AWD	B4204T35	03/16	⇒
V90 2.0 Polestar AWD	B4204T27	10/16	⇒
V90 2.0 T4	B4204T31	10/17	⇒
V90 2.0 T5	B4204T23, B4204T20	03/16	⇒
V90 2.0 T5 AWD	B4204T20, B4204T27	03/16	⇒
V90 2.0 T6 AWD	B4204T27, B4204T23	03/16	⇒
V90 2.0 T8 Hybrid AWD	B4204T34	04/18	⇒
XC40 T5 AWD	B4204T14	10/17	⇒
XC60 I T5	B4204T11	10/13	⇒
XC60 I T5 AWD	B4204T11	10/15	⇒ 02/17
XC60 I T6	B4204T9	10/13	⇒
XC60 I T6 AWD	B4204T9	10/13	⇒
XC60 II 2.0 T4	B4204T31	09/18	⇒
XC60 II 2.0 T5	B4204T23, B4204T20	03/17	⇒
XC60 II 2.0 T5 AWD	B4204T20, B4204T27	03/17	⇒
XC60 II 2.0 T6 AWD	B4204T27, B4204T34	03/17	⇒
XC60 II 2.0 T8 Hybrid AWD	B4204T34, B4204T20	03/17	⇒
XC70 II T5	B4204T11	10/13	⇒
XC90 II 2.0	B4204T20	09/14	⇒
XC90 II 2.0 T5 AWD	B4204T20, ECE	06/15	⇒
XC90 II 2.0 T6 AWD	B4204T29	10/17	⇒
XC90 II 2.0 T8 Hybrid AWD	B4204T34	04/18	⇒

VOLVO		
XC90 II T5 AWD	B4204T23	06/15 →
XC90 II T6 AWD	B4204T27	09/14 →
XC90 II T8 Hybrid AWD	B4204T35	06/15 →

10.3385



04

ABSOLUTE PRESSURE SENSORS (MAP)

Adatt./Suitable:

LEXUS
89421-78010

TOYOTA
89421-78010

NEW - AVAILABLE FROM:

- NUOVO - DISPONIBILE DA:
- NOUVEAU - DISPONIBLE EN:
- NEU - VERFUEGBAR AB:
- NUEVO - DISPONIBLE EN:

20/Q1



kPa	mV	NTC + - 0
9,7 - 320,2	975 - 4700	

LEXUS		
GS 2.0 VVTi [ExtraEU]	8AR-FTS	09/17 →
GS 200t	8AR-FTS	09/15 →
IS III 200t	8AR-FTS	08/15 →
IS III 300	8AR-FTS	10/17 →
LS V 500	V35A-FTS	10/17 →
LS V 500 AWD	V35A-FTS	12/17 →
NX 200t	8AR-FTS	07/14 →
NX 200t AWD	8AR-FTS	07/14 →
NX 300	8AR-FTS	09/17 →
NX 300 AWD	8AR-FTS	09/17 →
RC 200t	8AR-FTS	08/15 →
RC 300	8AR-FTS	11/17 →
RX IV 200t	8AR-FTS	10/15 → 12/17
RX IV 200t AWD	8AR-FTS	10/15 → 12/17
RX IV 300	8AR-FTS	12/17 →
RX IV 300 AWD	8AR-FTS	12/17 →
TOYOTA		
C-HR 1.2	8NR-FTS	10/16 →
C-HR 1.2 4WD	8NR-FTS	10/16 →
COROLLA 1.2	8NR-FTS	01/19 →

10.3387



3,5

ABSOLUTE PRESSURE SENSORS (MAP)

Adatt./Suitable:

BOSCH
0 281 002 847
0 281 002 848

DODGE
5149001AA
K05149001AA

JEEP
K05149001AA

MOPAR PARTS
05149001AA

NEW - AVAILABLE FROM:

- NUOVO - DISPONIBILE DA:
- NOUVEAU - DISPONIBLE EN:
- NEU - VERFUEGBAR AB:
- NUEVO - DISPONIBLE EN:

20/Q1



kPa	mV	O + NTC -
-29,8 - 234,4	311 - 3368	

DODGE		
JOURNEY 2.0 CRD	ECE, ECD	06/08 →
JEEP		
COMPASS 2.0 CRD	ECD, ECD	08/06 →
COMPASS 2.0 CRD 4x4	ECD, ECD	09/06 →
PATRIOT 2.0 CRD	ECD, ECD	02/07 →
PATRIOT 2.0 CRD 4x4	ECD, CHZB	02/07 →

10.3388



3,5

ABSOLUTE PRESSURE SENSORS (MAP)

Adatt./Suitable:

AUDI
04C 906 051

SEAT
04C 906 051

SKODA
04C 906 051

VW
04C 906 051

NEW - AVAILABLE FROM:

- NUOVO - DISPONIBILE DA:
- NOUVEAU - DISPONIBLE EN:
- NEU - VERFUEGBAR AB:
- NUEVO - DISPONIBLE EN:

20/Q1



kPa	mV	O + NTC -
11 - 307	250 - 4750	

AUDI		
A1 1.0 TFSI	CHZB, CHZL	03/15 → 10/18
A1 25 TFSI	CHZL, DKJA	11/18 →
A1 30 TFSI	DKJA, CHZD	07/18 →
A3 III 1.0 TFSI	CHZD, CUKB	07/16 →
A3 III 1.4 TFSI e-tron	CUKB, CHZD	05/14 →
A3 III 30 TFSI	CHZD, CHZJ	07/18 →
A4 V 1.4 TFSI	CVNA	08/15 →
A5 II 1.4 TFSI	CVNA	11/16 →
Q2 1.0 TFSI	CHZJ, CHZJ	10/16 →
Q2 30 TFSI	CHZJ, CHZJ	07/18 →
SEAT		
ARONA 1.0 TSI	CHZJ, CHZJ	07/17 →
ATECA 1.0 TSI	CHZJ, CHZB	05/16 →

SEAT		
IBIZA IV 1.0 TSI	CHZB, CHZJ	05/15 →
IBIZA V 1.0 TGI	DBYA	11/17 →
IBIZA V 1.0 TSI	CHZJ, CHZD	01/17 →
LEON III 1.0 TSI	CHZD, CHZB	05/15 →
LEON ST 1.0 TSI	CHZD	05/15 →
TOLEDO IV 1.0 TSI	CHZB, CHZB	05/17 →

SKODA		
FABIA III 1.0 TSI	CHZB, CHZD	08/14 →
KAROQ 1.0 TSI	CHZJ	07/17 →
OCTAVIA III 1.0 TSI	CHZD, CHZB	05/16 →
RAPID 1.0 TSI	CHZB, CHZG	07/12 →

VW		
CADDY III 1.0 TSI	CHZG, CHZC	11/15 →
GOLF VII 1.0 TSI	CHZC, CHZB	05/15 →
GOLF VII 1.4 GTE Hybrid	CUKB	05/14 →
UP 1.0 GTI	DKRA	11/17 →
UP 1.0 TSI	CHZA	05/16 →
UP 1.0 TSI BlueMotion	CHZA	05/16 →
PASSAT VI 1.4 GTE Hybrid	CUKC	06/15 →
POLO V 1.0 TSI	CHZB, CHZJ	11/14 →
POLO VI 1.0 TGI	DBYA	09/17 →
POLO VI 1.0 TSI	CHZJ, DKJA	06/17 →
T-ROC 1.0 TSI	CHZJ	07/17 →

ILLUSTRATED SECTION -Parte figurata -Partie illustrée -Bildteil -Parte ilustrada



DIFFERENTIAL PRESSURE SENSORS

·SENSORI DI PRESSIONE ARIA DIFFERENZIALE ·CAPTEURS DE PRESSION D'AIR DIFFERENTIEL
·DIFFERENZDRUCKSENSOREN ·SENSORES DE PRESIÓN DIFERENCIAL (DPS)

FA-SEN19Q2

(A) P/NRS. - NOTES

- CODICI - NOTE
- RÉFS. - NOTES
- ARTIKEL-NR. - ANMERKUNGEN
- CODIGOS - NOTAS

10.3316 **04**

DIFFERENTIAL PRESSURE SENSORS

Adatt./Suitabl **2**

CITROËN
16 231 373 80
1618 09
1618 ET
96 450 226 80

FIAT
504102810
55210304
9645022680

IVECO
504102810
55210304

LANCIA
9645022680

MITSUBISHI
1588A200

PEUGEOT
16 231 373 80
1618 09
1618 ET

NEW - AVAILABLE FROM:
·NUOVO - DISPONIBILE DA:
·NOUVEAU - DISPONIBLE EN:
·NEU - VERFUEGBAR AB:
·NUEVO - DISPONIBLE EN:
19/Q1

MARKET DIFFUSION: HIGH

(A)

1 # FACET

2 OEM P/NRS.

- CODICI ORIGINALI
- RÉFS. D'ORIGINE
- ORIGINALTEILE-NR.
- CODIGOS ORIGINALES

3 PACKAGING SIZE

- FORMATO CONFEZIONE
- FORMAT DU CONDITIONNEMENT
- ABPACKENSGROESSE
- TAMAÑO DEL ENVASE

4 PRODUCT AVAILABILITY DATE

- DATA DI DISPONIBILITÀ DEL PRODOTTO
- DISPONIBILITÉ DU PRODUIT
- PRODUKTVERFUEGBARKEITSDATUM
- DISPONIBILIDAD ARTICULO

5 NOTE

- NOTE
- NOTES
- BERMERKUNGEN
- NOTAS

(B) PICTURE + TECHNICAL INFO

- FOTO + INFORMAZIONE TECNICA
- ILLUSTRATION + INFORMATION TECHNIQUE
- BILD + TECHNISCHE INFO
- FOTO + INFORMACIÓN TÉCNICA

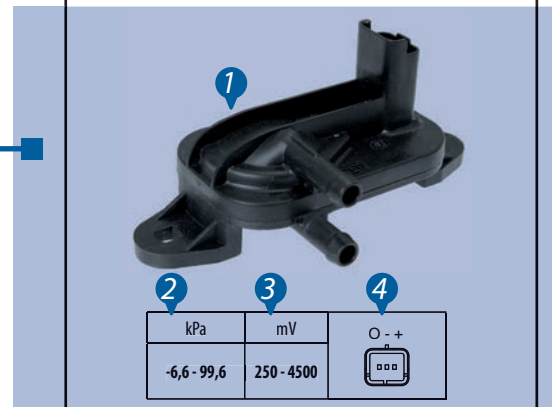

(C) APPLICATION LIST

- GUIDA APPLICAZIONI
- LISTE D'APPLICATIONS
- ANWENDUNGSTABELLE
- LISTA DE APLICACIONES

CITROËN		
C3 I 1.6 16V HDi	9HZ(DV6TED4)	09/05 ⇨
C4 I 1.6 HDi	9HZ(DV6TED4)	11/04 ⇨ 07/11
C4 I 2.0 HDi	RHR(DW10BTED4)	11/04 ⇨ 07/11
C4 GRAND PICASSO I 2.0 HDi 138	RHJ(DW10BTED4), RHJ(DW10BTED4)	10/06 ⇨
C4 PICASSO I 2.0 HDi 138	RHJ(DW10BTED4), 4HP(DW12BTED4)	10/06 ⇨ 08/13

1 PICTURE

- FOTO
- PHOTO
- BILD
- FOTO

2 AIR PRESSURE

- PRESSIONE DELL'ARIA
- PRESSION DE L'AIR
- LUFDRUCK
- PRESION DEL AIRE

3

OUTPUT VOLTAGE/FREQUENCY

- TENSIONE/FREQUENZA D'USCITA
- VOLTAGE/FREQUENCE EN SORTIE
- AUSGANGSSPANNUNG BZW. FREQUENZ
- VOLTAJE/FRECUENCIA DE SALIDA

4

TYPE OF CONNECTION

- TIPO DI CONNESSIONE
- TYPE DE CONNEXION
- ANSCHLUSSART
- TIPO DE ENCHUFE



10.3XXX

Differential air pressure sensors (DPS)

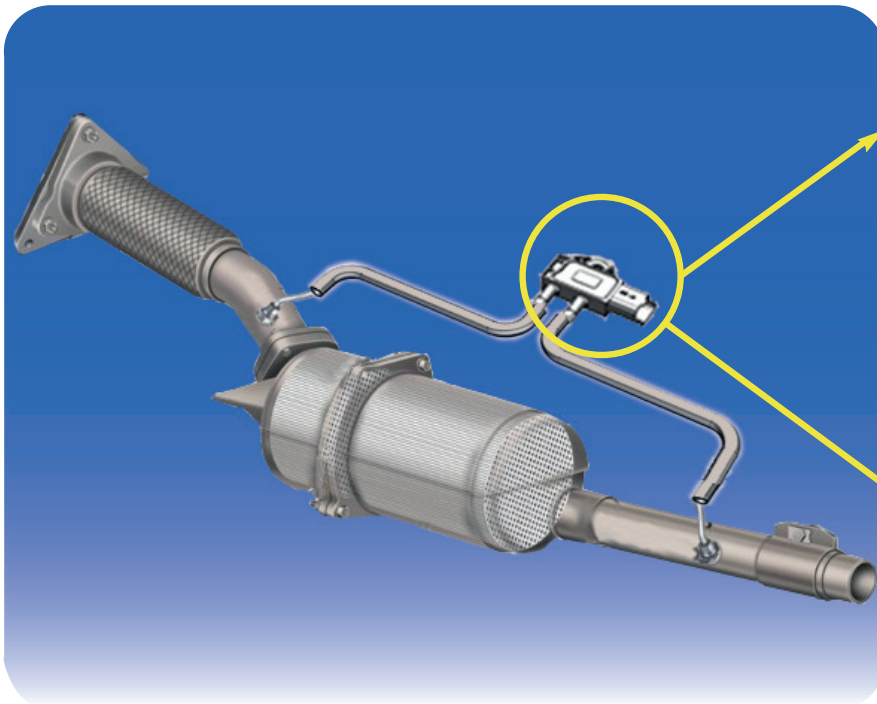

Rendering: by kind concession of FIAT POWERTRAIN TECHNOLOGIES

IDPS sensors (*Differential Pressure*) are used to monitor the efficiency of the DPF (Diesel Particulate Filter), the device that reduces emissions of particulate matter, by detecting when it is clogged.

The DPS detects a variation of pressure between the inlet and outlet of the DPF, so that the Engine Control Unit can command the start of the cycle of regeneration, in other words the cleaning, of the DPF.

DPS are also fitted to braking systems to check, for example, the value of depression of the power assistance compared to ambient pressure.

The Gauge typology, on the other hand, is fitted to the intake manifold, to detect the pressure of the intake air and compare it to outside atmospheric pressure, so that the Engine Control Unit can adjust the air intake on the basis of the variation of outside atmospheric pressure.

DPS sensors can be used with **gasoline, diesel and hybrid powered engines**.

The main **reasons for failures** in the product are:

- infiltration of humidity in the connection due to wiring
- presence of solid or oily substances in exhaust gas
- leaks in the exhaust system
- clogged particulate filter

Signs of malfunctions of the sensor are indicated by increased emissions, reduced performance, illumination of the particulate

filter warning lamp and by excessive frequency of filter cleaning. DPS sensors are designed and assembled to withstand the critical installation conditions inside the engine compartment.

In particular, the following **requirements** shall be met:

- *operating temperature*: $-40^{\circ}\text{C} \div +125^{\circ}\text{C}$
- *electromagnetic immunity*
- *resistance to hydrocarbons*

The DPS sensors undergo **qualification and endurance tests** to determine if the product is suitable for construction and sale:

- High and low pressure cyclic operation during high and low temperature conditions for a total of 400h
- Hermetic seal
- Susceptibility to electromagnetic radiofrequency interference induced on the cables
- Resistance to vibrations
- Resistance to impacts

When these tests have been passed and after the approval to manufacture has been given, the product, in the assembly process, is strictly checked through a series of cycles which include a **100% testing** of the sensor output at high and low pressure as well as of the absorbed current of the hermetic seal.

Structural elements and operation

The operating principle of relative pressure sensors is the same as that of absolute pressure sensors. The main difference lies in the fact that the cavity in the rear part of the chip is connected to the second air intake (atmospheric pressure or other working pressure).

- **The differential type of DPS** comprises a container fitted with *two pipettes* for connecting to the tubes in which the pressure is to be measured, and an electrical connector, for the connection to the input and output wires. The pressure sensor and, if fitted, an electronic circuit for conditioning the signal, are located inside the container. One of the two sides of the sensor membrane must be connected to the first air intake, while the other must be connected to the second air intake. The electronic circuit may be made from a printed circuit or on *aluminium* (hybrid circuit).

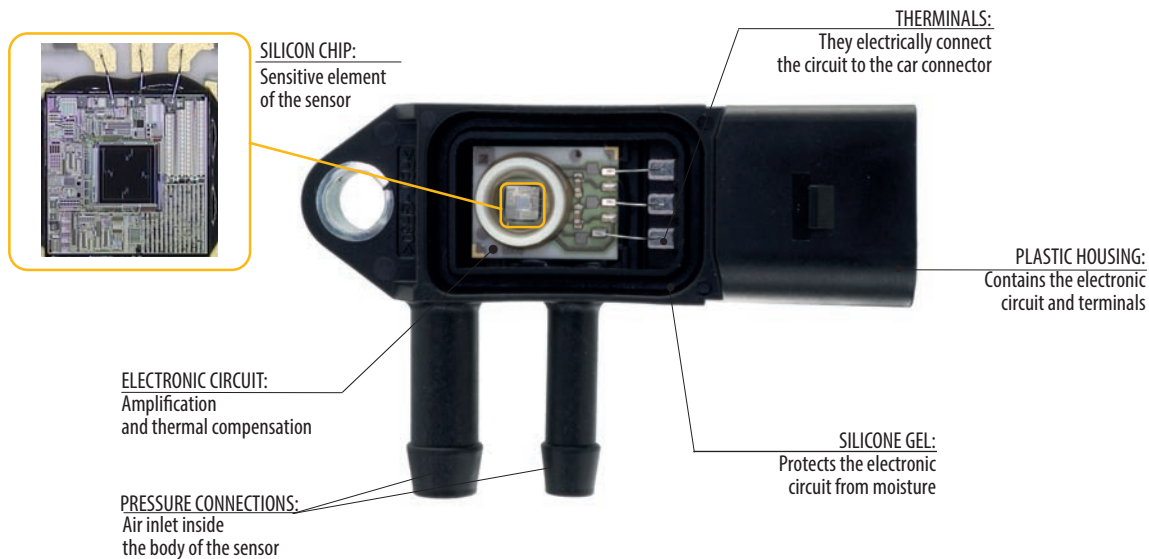

Reading of the transfer function of the relative pressure sensors is carried out by applying a variable pressure to one input, while the other is left to atmospheric pressure (or a given reference pressure). The output voltage then varies according to the air intake used and, consequently, the side of the membrane (top or bottom) which is deflected by the pressure.

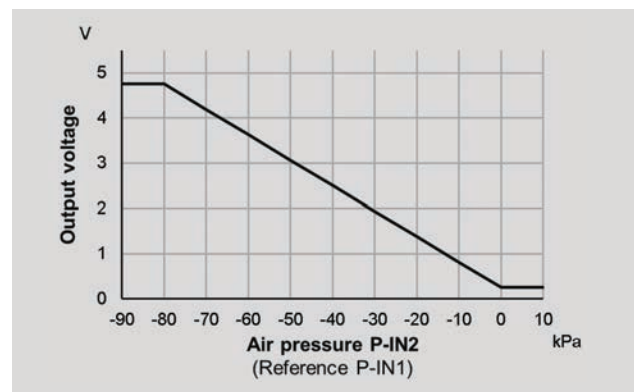
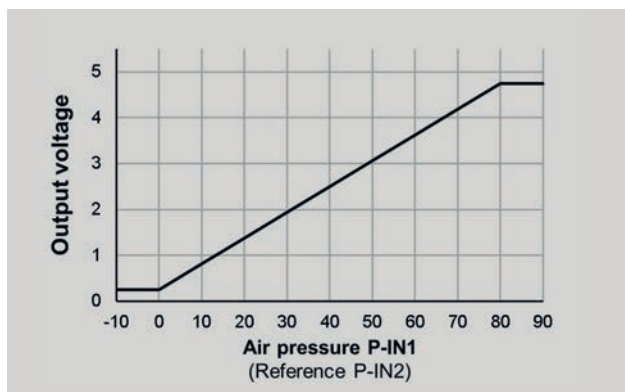

Transfer function of relative DPS in graphic form (per $V_a = 5V$) and relative equation valid in field included between $P_{fsi} = 500 \text{ mV}$ measured with P_{fsi} (lower pressure limit) and $U_{fss} = 4500 \text{ mV}$ measured with P_{fss} (upper pressure limit).

- **The Gauge type of DPS** comprises a container, generally fitted with a *pipette* for connecting to the tube in which the pressure is to be measured, and an *electrical connector*, for the connection to the input and output wires. A hole in the cover or in the container itself supplies the air input for the reference pressure (normally atmospheric pressure). The *pressure sensor* and, if fitted, an *electronic circuit* for conditioning the signal, are located inside the container. One of the two sides of the sensor membrane must be connected to the air intake. The other side may be left free, as long as it creates a chamber (sealed off from the air intake) within which the reference pressure can flow. The *electronic circuit* may be made from a printed circuit or on *aluminium* (hybrid circuit).



10.3XXX

Sensori di pressione aria differenziale (DPS)

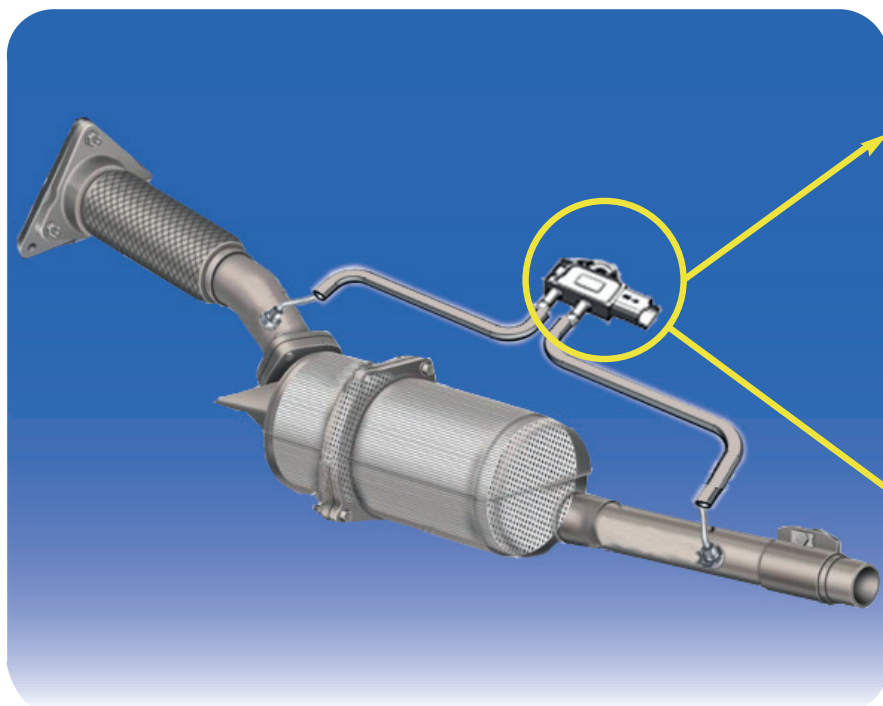

Rendering: per gentile concessione di FIAT POWERTRAIN TECHNOLOGIES

I sensori DPS (*Differential Pressure*) **consentono di monitorare l'efficienza del FAP** (Filtro Anti Particolato), dispositivo che abbate le emissioni di polveri sottili, rilevandone l'intasamento.

Il DPS rileva la variazione di pressione fra ingresso ed uscita del FAP, consentendo alla Engine Control Unit di determinare l'avvio del ciclo di rigenerazione, e dunque di pulizia, del FAP stesso.

I DPS sono anche montati sugli impianti frenanti per verificare, ad esempio, il valore di depressione del servofreno rispetto alla pressione ambientale.

Nella tipologia Gauge sono invece montati sul collettore di aspirazione, rilevano la pressione dell'aria aspirata e la rapportano alla pressione atmosferica esterna, consentendo alla Engine Control Unit di regolare l'apporto di aria in base alla variazione della pressione atmosferica esterna.

I sensori DPS si possono applicare a **veicoli con alimentazione a benzina, a gasolio e ibrida**.

Le principali **cause di guasto** del prodotto sono:

- infiltrazioni di umidità nella connessione dovuta al cablaggio
- presenza di parti solide e oleose nei gas di scarico
- perdite nell'impianto di scarico
- intasamento del filtro antiparticolato

I **segnali di malfunzionamento** del sensore sono ravvisabili nell'aumento delle emissioni, nella riduzione delle prestazioni,

nell'accensione della spia filtro anti-particolato e nel ciclo di pulizia del filtro troppo frequente.

I sensori DPS sono progettati e costruiti per sopportare le condizioni critiche di montaggio nel vano motore. In particolare devono soddisfare i seguenti **requisiti**:

- *temperatura di funzionamento*: $-40^{\circ}\text{C} \div +125^{\circ}\text{C}$
- *immunità elettromagnetica*
- *resistenza agli idrocarburi*

I sensori DPS sono sottoposti a rigorose **prove di qualificazione e di durata** per stabilire se il prodotto è idoneo per essere costruito e venduto:

- funzionamento ciclico ad alta e bassa pressione in condizioni di alta e bassa temperatura per un totale di 400h
- resistenza ai cicli rapidi di temperatura
- tenuta ermetica
- suscettibilità elettromagnetica ai disturbi a radiofrequenza indotti sui cavi
- resistenza alle vibrazioni
- resistenza agli urti

Superate tali prove e concesso il benessere a produrre, durante l'assemblaggio il prodotto viene sottoposto a severi cicli di controllo che prevedono il **collaudo al 100%** dell'uscita del sensore a bassa e alta pressione, della corrente assorbita e della tenuta ermetica.

Elementi costruttivi e principio di funzionamento

Il principio di funzionamento dei sensori di pressione relativa è analogo a quello dei sensori di pressione assoluta. La principale differenza sta nel fatto che la cavità presente nella parte posteriore del chip è collegata al secondo ingresso aria (pressione atmosferica o altra pressione di lavoro).

• **Il DPS di tipo differenziale** è costituito da un contenitore munito di *due pipette* per il collegamento ai condotti dei quali si vuole misurare la differenza di pressione, e di un connettore elettrico, per il collegamento ai cavi di alimentazione e di uscita. All'interno del contenitore sono alloggiati il sensore di pressione e il circuito elettronico di condizionamento del segnale. Uno dei due lati della membrana del sensore deve essere collegato alla prima presa dell'aria, l'altro deve essere collegato alla seconda presa dell'aria. Il circuito elettronico è realizzato su *allumina* (circuito ibrido).

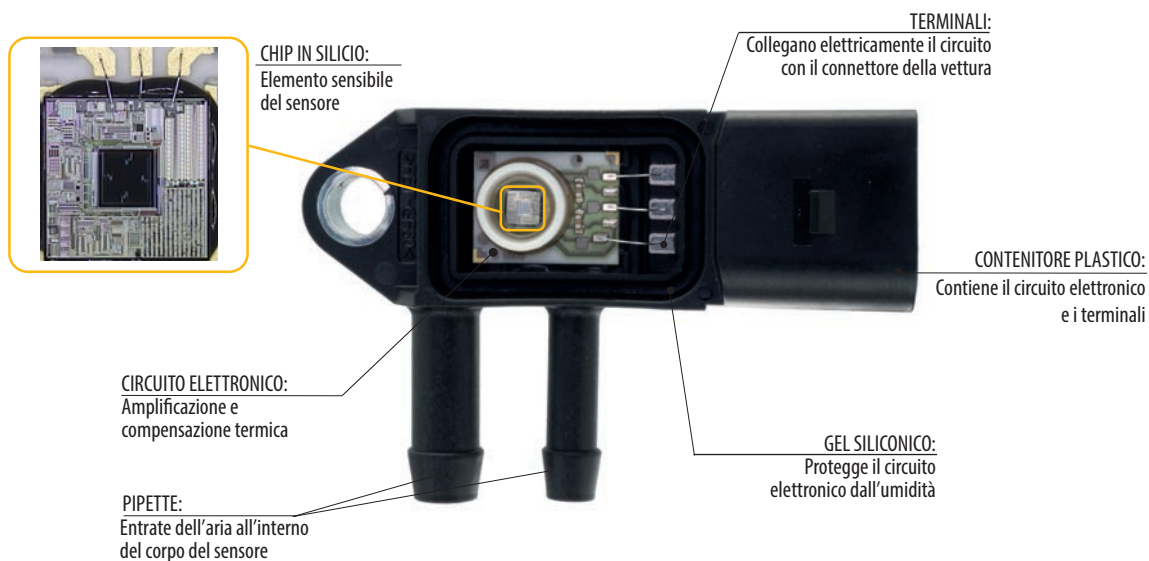

Il rilievo della funzione di trasferimento dei sensori di pressione relativa viene eseguito applicando una pressione variabile su un ingresso, mentre l'altro viene lasciato alla pressione atmosferica (o ad una pressione di riferimento). La tensione di uscita, quindi, varia in funzione dell'ingresso dell'aria utilizzato e, di conseguenza, del lato della membrana (top o bottom) deformato dalla pressione.

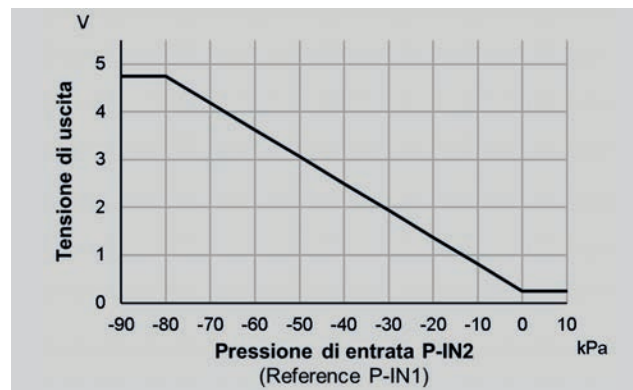
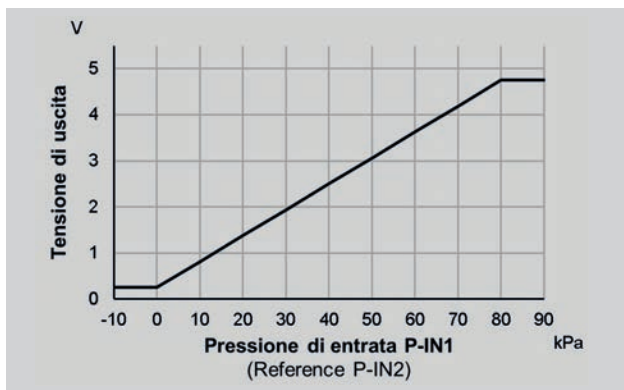

Funzione di trasferimento del DPS in forma grafica (per $V_a = 5V$) e relativa equazione valida nel campo compreso tra $U_{fsi} = 500\text{ mV}$ misurati con P_{fsi} (pressione limite inferiore) e $U_{fss} = 4500\text{ mV}$ misurati con P_{fss} (pressione limite superiore).

• **Il DPS di tipo Gauge** è costituito da un contenitore, generalmente munito di una *pipetta* per il collegamento al condotto del quale si vuole misurare la pressione, e di un *connettore elettrico*, per il collegamento ai cavi di alimentazione e di uscita. Un *foro* nel coperchio o nel contenitore stesso fornisce l'ingresso aria per la pressione di riferimento (generalmente la pressione atmosferica). All'interno del contenitore è alloggiato il *sensore di pressione* ed il *circuito elettronico* di condizionamento del segnale. Uno dei due lati della membrana del sensore deve essere collegato alla presa dell'aria. L'altro lato è lasciato libero, nella camera (a tenuta stagna rispetto alla presa dell'aria) all'interno della quale fluisce la pressione di riferimento. Il *circuito elettronico* è realizzato su *allumina* (circuito ibrido).



10.3XXX

Capteurs de pression d'air différentiel (DPS)

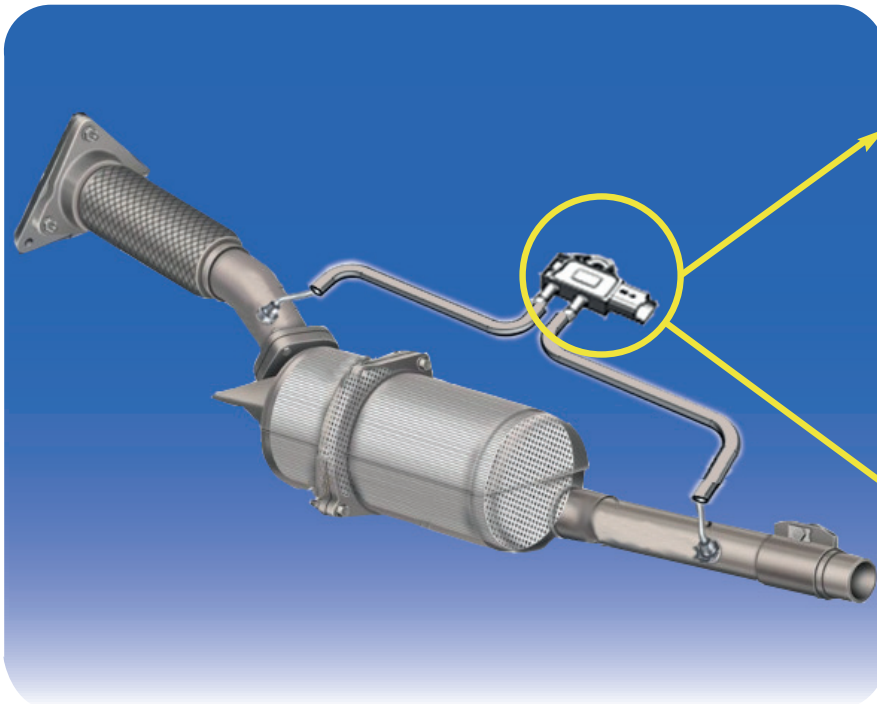

Rendering: per gentile concessione di FIAT POWERTRAIN TECHNOLOGIES

Les capteurs DPS (*Differential Pressure Sensor*) **permettent de surveiller l'efficacité du FAP** (filtre à particules), un dispositif qui réduit les émissions de particules fines, détectant le colmatage du filtre.

Le DPS détecte la variation de pression entre l'entrée et la sortie du FAP, permettant à l'unité de commande du moteur de déterminer le démarrage du cycle de régénération et donc de nettoyage du FAP.

Les DPS sont également montés sur les systèmes de freinage pour vérifier, par exemple, la valeur de dépression du servofrein par rapport à la pression ambiante.

En revanche, dans le type Gauge, ils sont montés sur le collecteur d'admission, détectent la pression d'air aspirée et la comparent à la pression atmosphérique extérieure, permettant à l'unité de contrôle du moteur de régler l'entrée d'air en fonction de la variation de la pression atmosphérique extérieure.

Les capteurs DPS trouvent leur application dans les **véhicules alimentés à essence, au gasoil et hybrides**.

Les principales causes de défaut du produit sont :

- infiltrations d'humidité dans la connexion due au câblage
- présence de parties solides et huileuses dans le système d'échappement
- fuites dans le système d'échappement
- colmatage du filtre à particules

Les signaux de dysfonctionnement du capteur sont reconnaissables par l'augmentation des émissions, la réduction des perfor-

mances, l'allumage du témoin du filtre à particules et la haute fréquence du cycle de nettoyage du filtre.

Les capteurs DPS sont conçus et construits pour résister aux conditions critiques de montage dans le compartiment moteur. En particulier, ils doivent répondre aux **caractéristiques** suivantes :

- *température de fonctionnement* : $-40^{\circ}\text{C} \div +125^{\circ}\text{C}$
- *immunité électromagnétique*
- *résistance aux hydrocarbures*

Les capteurs DPS sont soumis à des **tests rigoureux de qualification et de durée** pour déterminer si le produit est apte à la construction et à la vente :

- fonctionnement cyclique à haute et basse pression dans des conditions de haute et basse température pour un total de 400 h
- résistance aux cycles de température rapides
- étanchéité hermétique
- susceptibilité électromagnétique aux parasites en radio-fréquence induites sur les câbles
- résistance aux vibrations
- résistance aux coups

Une fois les tests réussis et l'autorisation à la production accordée, pendant l'assemblage le produit est soumis à des cycles de contrôle sévères qui prévoient l'**essai à 100%** de la sortie du capteur à basse et haute pression, du courant absorbé et de l'étanchéité hermétique.

Éléments constitutifs et principe de fonctionnement

Le principe de fonctionnement des capteurs de pression relative est identique à celui des capteurs de pression absolue. La principale différence réside dans le fait que la cavité présente à l'arrière de la puce est raccordée à la seconde entrée d'air (pression atmosphérique ou autre pression de travail).

• **Le DPS de type différentiel** est composé d'un boîtier muni de deux pipettes pour le raccordement aux conduits dont on veut mesurer la pression, et d'un connecteur électrique, pour le raccordement aux câbles d'alimentation et de sortie. Le capteur de pression et éventuellement le circuit électronique de conditionnement du signal sont logés dans le boîtier. L'un des deux côtés de la membrane du capteur doit être raccordé à la première prise d'air, l'autre côté doit être raccordé à la seconde prise d'air. Le circuit électronique peut être réalisé sur un circuit imprimé ou sur une *alumine* (circuit hybride).



Le relevé de la fonction de transfert des capteurs de pression relative s'effectue en appliquant une pression variable sur une entrée, tandis que l'autre est laissée à la pression atmosphérique (ou à une pression de référence). La tension de sortie varie donc en fonction de l'entrée d'air utilisée et, par conséquent, du côté de la membrane (top ou bottom) déformé par la pression.

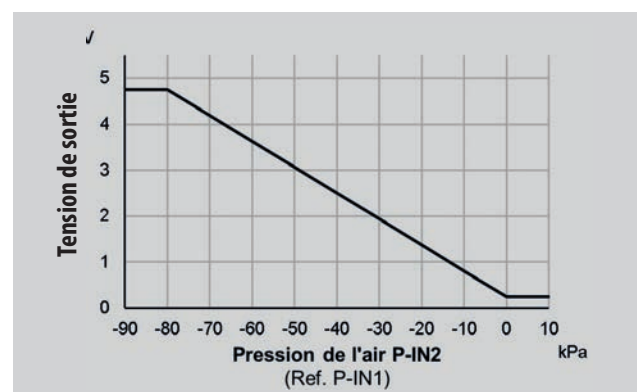
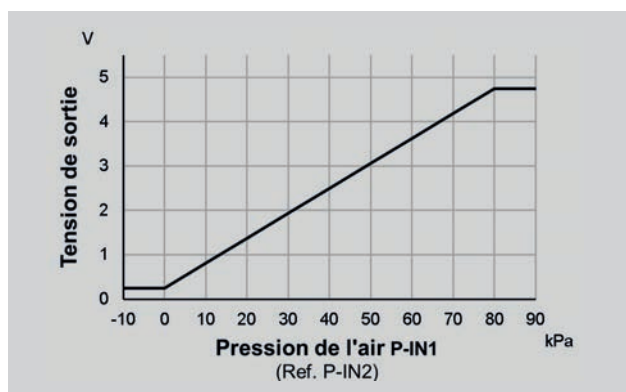

Fonction de transfert du DPS relatif sous forme graphique (pour $V_a = 5V$) et équation correspondante valable dans le champ compris entre $U_{fsi} = 500\text{ mV}$ mesurés par P_{fsi} (pression limite inférieure) et $U_{fss} = 4500\text{ mV}$ mesurés par P_{fss} (pression limite supérieure).

• **Le DPS de type Gauge** est composé d'un boîtier, généralement muni d'une pipette pour le raccordement au conduit dont on veut mesurer la pression, et d'un connecteur électrique, pour le raccordement aux câbles d'alimentation et de sortie. Un trou dans le couvercle ou dans le boîtier fournit l'entrée d'air pour la pression de référence (généralement la pression atmosphérique). Le capteur de pression et éventuellement le circuit électronique de conditionnement du signal sont logés dans le boîtier. L'un des deux côtés de la membrane du capteur doit être raccordé à la prise d'air. L'autre côté peut rester libre, à condition qu'il se crée une chambre (étanche par rapport à la prise d'air) à l'intérieur de laquelle passe la pression de référence. Le circuit électronique peut être réalisé sur un circuit imprimé ou sur une alumine (circuit hybride).



10.3XXX

Differenzdrucksensoren (DPS)

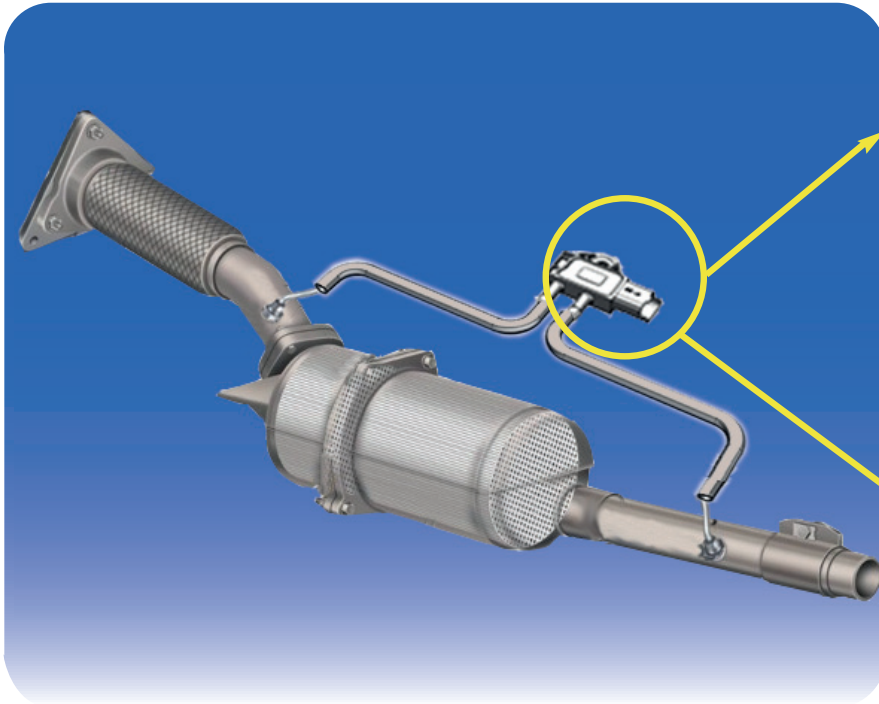

Rendering: bei freundlichem Zugeständnis von FIAT POWERTRAIN TECHNOLOGIES

Die DPS-Sensoren (Differenzdrucksensoren) **gestatten das Messen des Wirkungsgrads des FAP** (Partikelfilter), einer Vorrichtung, die die Feinstaubemissionen verringert, indem seine Verstopfung gemessen wird.

Der DPS misst die Druckänderung zwischen dem Eingang und dem Ausgang des FAP und gestattet es so der Engine Control Unit, den Regenerierungszyklus und damit den Reinigungszyklus des FAP zu bestimmen.

Die DPS sind auch auf den Bremsanlagen montiert, um zum Beispiel den Wert des Unterdrucks der Servobremse im Verhältnis zum Umgebungsdruck zu überprüfen.

Beim Typ Gauge sind sie dagegen auf der Ansaugleitung montiert, messen den Druck der angesaugten Luft und das Verhältnis des externen atmosphärischen Drucks und gestatten es so der Engine Control Unit, die Luftzufuhr basierend auf der Änderung des externen atmosphärischen Drucks zu regulieren.

Die DPS-Sensoren können bei **bezinbetriebenen, dieselbetriebenen und wasserstoffbetriebenen Fahrzeugen** eingesetzt werden.

Die **Hauptursachen für Defekte** des Produktes sind:

- Eindringen von Feuchtigkeit in den Anschluss aufgrund der Verkabelung
- Vorhandensein von Fest- oder Ölpartikeln in den Abgasen
- Verluste in der Auspuffanlage
- Verstopfung des Dieselrußpartikelfilters

Die **Anzeichen einer Funktionsstörung** des Sensors sind an der

Erhöhung der Emissionen, der Leistungsverringerung, dem Aufleuchten der Dieselrußpartikelfilteranzeige und einem zu häufigen Filterreinigungszyklus zu erkennen.

Die DPS-Sensoren wurden so entwickelt und gebaut, dass sie den kritischen Bedingungen der Montage im Motorraum standhalten. Insbesondere müssen sie die folgenden **Anforderungen** erfüllen:

- *betriebs*temperatur: $-40^{\circ}\text{C} \div +125^{\circ}\text{C}$
- *elektromagnetische Störfestigkeit*
- *beständigkeit gegen Kohlenwasserstoffe*

Die DPS-Sensoren werden strengen Prüfungen hinsichtlich **Qualifizierung und Beständigkeit unterzogen**, um festzustellen, ob das Produkt sich für die Herstellung und den Verkauf eignet:

- zyklischer Betrieb bei hohem und niedrigem Druck bei hohen und niedrigen Temperaturbedingungen insgesamt 400 Stunden lang
- Beständigkeit bei schnellen Temperaturwechseln
- hermetische Dichtigkeit
- elektromagnetische Suszeptibilität gegenüber die Kabel wirkende Funkfrequenzstörungen
- Schwingungsfestigkeit
- Stoßfestigkeit

Nach Bestehen dieser Prüfungen und Freigabe der Produktion wird das Produkt während der Montage strengen Kontrollzyklen unterzogen, die **Endabnahmen zu 100 %** des Sensors bei niedrigem und hohem Druck, der Stromaufnahme und der hermetischen Dichtigkeit vorsehen.

Bauteile und Funktionsprinzip

Das Funktionsprinzip der Sensoren des relativen Drucks ist dem der Sensoren des absoluten Drucks ähnlich. Der Hauptunterschied liegt darin, dass der Hohlraum im hinteren Teil des Chips mit dem zweiten Lufteinlass verbunden ist (Luftdruck oder anderer Betriebsdruck).

• **Der DPS des Differential-Typs** besteht aus einem im Allgemeinen mit zwei Pipetten für den Anschluss an die Leitungen, deren Druckunterschied gemessen werden soll, und einem elektrischen Verbinder für den Anschluss an die Versorgungs- und Ausgangskabel ausgestatteten Gehäuse. Im Inneren des Gehäuses sind der Drucksensor und der eventuelle elektronische Schaltkreis zur Signalverarbeitung untergebracht. Eine der beiden Seiten der Sensormembran muss an den ersten Lufteinlass angeschlossen sein und der anderen an den zweiten Lufteinlass. Der elektronische Schaltkreis kann auf einer Leiterplatte oder auf Aluminiumoxid realisiert werden (Hybridkreis).

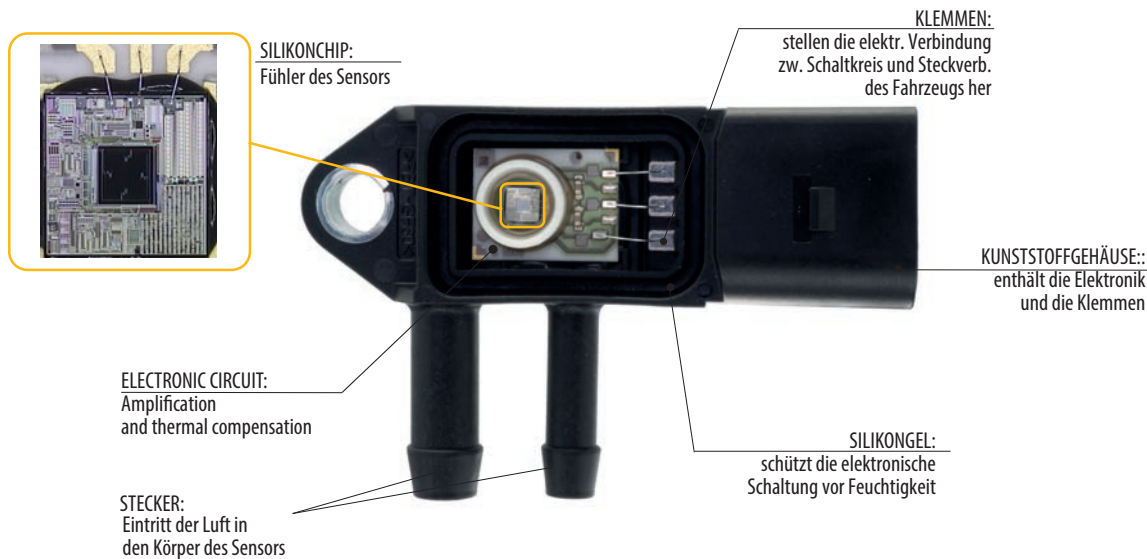

Die Feststellung der Übertragungsfunktion der Sensoren des relativen Drucks erfolgt durch Anwendung eines variablen Drucks auf einen Eingang, während der andere bei Luftdruck gelassen wird (oder bei einem Bezugsdruck). Die Ausgangsspannung variiert daher abhängig von dem verwendeten Lufteinlass und damit der Seite der durch den Druck verformten Membran (Top oder Bottom).

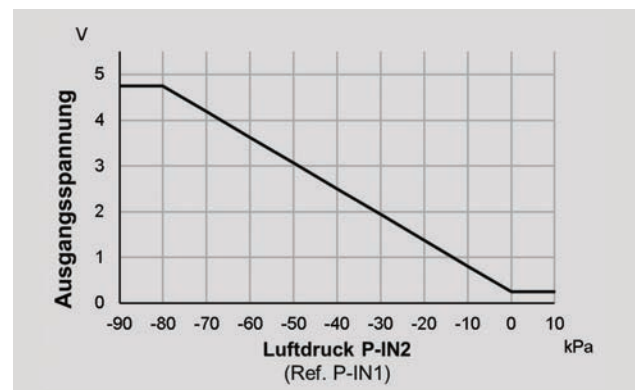
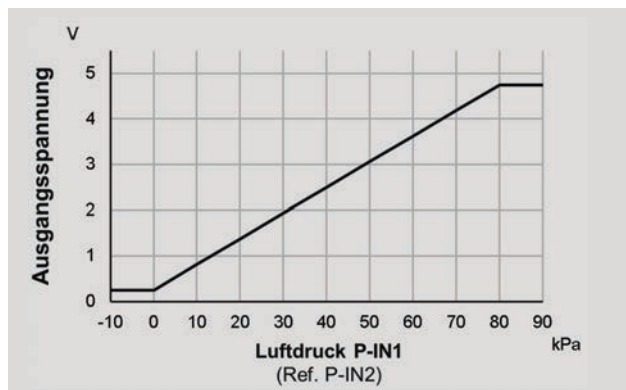

Funktion der Übertragung des entsprechenden DPS in grafischer Form (für $V_a = 5V$) und entsprechende Gleichung mit Gültigkeit im Feld zwischen $U_{fsi} = 500\text{ mV}$, gemessen bei P_{fsi} (unterer Grenzdruck), und $U_{fss} = 4500\text{ mV}$, gemessen bei P_{fss} (oberer Grenzdruck).

• **Der DPS des Gauge-Typs** besteht aus einem im Allgemeinen mit *Pipette* für den Anschluss an die Leitungen, deren Druck gemessen werden soll, und einem *elektrischen Verbinder* für den Anschluss an die Versorgungs- und Ausgangskabel ausgestatteten Gehäuse. Eine *Öffnung* in der Abdeckung oder im Gehäuse selbst dient dem Lufteinlass für den jeweiligen Druck (im Allgemeinen Luftdruck). Im Inneren des Gehäuses sind ein *Drucksensor* und eventuell der *elektronische Schaltkreis* zur Signalverarbeitung untergebracht. Eine der beiden Seiten der Sensormembran muss an den Lufteinlass angeschlossen sein. Die andere Seite kann frei bleiben, vorausgesetzt, es entsteht eine Kammer (die dem Lufteinlass gegenüber dicht ist), in deren Inneren der Bezugsdruck aufgebaut wird. Der *elektronische Schaltkreis* kann auf einer Leiterplatte oder auf Aluminiumoxid realisiert werden (Hybridkreis).



10.3XXX

Sensores de presión diferencial (DPS)

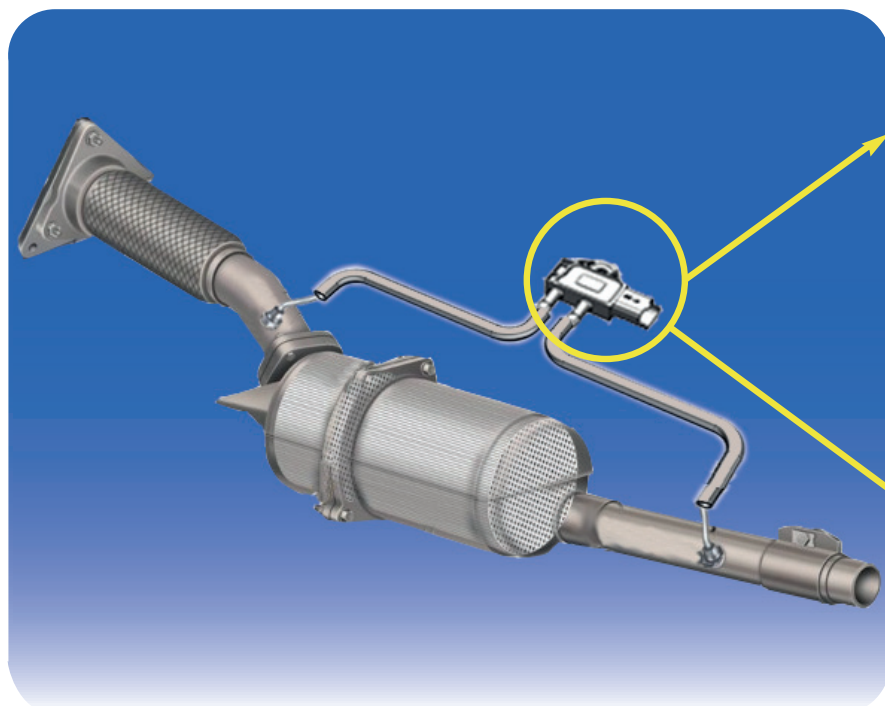

Rendering: por amable concesion de FIAT POWERTRAIN TECHNOLOGIES

Los sensores de presión diferencial DPS (*Differential Pressure*) **permiten controlar la eficiencia del FAP** (Filtro de partículas), dispositivo que reduce las emisiones de polvos finos, detectando su atascamiento.

El DPS detecta la variación de presión entre la entrada y la salida del FAP, permitiendo que la Engine Control Unit (Unidad de control del motor) determine el inicio del ciclo de regeneración y, por consiguiente, de limpieza del FAP.

Los DPS también están montados en los sistemas de frenado para controlar, por ejemplo, el valor de depresión del servofreno con respecto a la presión ambiental.

En cambio, los de tipo Gauge se montan en el colector de admisión y detectan la presión del aire aspirado y la comparan con la presión atmosférica exterior, permitiendo que la Engine Control Unit ajuste la relación de aire según la variación de la presión atmosférica exterior.

Los sensores DPS se pueden instalar en **vehículos con alimentación de gasolina, de gasoleo e híbrida**.

Las principales **causas de avería** del producto son:

- filtraciones de humedad en la conexión debido al cableado
- presencia de partículas sólidas y oleosas en los gases de escape
- fugas en el sistema de escape
- atascamiento del filtro de partículas

Las **señales de problemas de funcionamiento** del sensor se

pueden observar por el aumento de las emisiones, la reducción de las prestaciones, el encendido del testigo del filtro de partículas, y por un ciclo de limpieza del filtro demasiado frecuente.

Los sensores DPS están diseñados y fabricados para soportar las condiciones críticas de montaje en el espacio motor.

En especial, deben cumplir con los siguientes **requisitos**:

- *temperatura de funcionamiento*: $-40^{\circ}\text{C} \div +125^{\circ}\text{C}$
- *inmunidad electromagnética*
- *resistencia a los hidrocarburos*

Los sensores DPS son sometidos a rigurosos **ensayos de calificación y de duración**, para determinar si el producto es apropiado para ser fabricado y vendido:

- funcionamiento cíclico a alta y baja presión en condiciones de alta y baja temperatura por un total de 400 horas
- hermeticidad
- susceptibilidad electromagnética a los ruidos parásitos de radiofrecuencia inducidos en los cables
- resistencia a las vibraciones
- resistencia a los golpes

Después de haber superado estas pruebas y obtenido la aprobación para la producción, durante el ensamblaje el producto se somete a severos ciclos de control que prevén el **ensayo al 100%** de la salida del sensor a baja y alta presión, de la corriente absorbida y de la hermeticidad.

Elementos de construcción y principio de funcionamiento

El principio de funcionamiento de los sensores de presión relativa es similar al de los sensores de presión absoluta. La diferencia principal consiste en que la cavidad presente en la parte trasera del chip está conectada a la segunda entrada de aire (presión atmosférica u otra presión de trabajo).

• **El DPS de tipo diferencial** está formado por un cuerpo con *dos pipetas* para la conexión con los conductos de los que se quiere medir la diferencia de presión, y por un conector eléctrico, para la conexión con los cables de alimentación y de salida. Dentro del cuerpo se encuentran el sensor de presión y un posible circuito electrónico de acondicionamiento de la señal. Uno de los dos lados de la membrana del sensor debe estar conectado con la primera toma de aire, mientras que el otro debe estar conectado con la segunda toma de aire. El circuito electrónico se puede realizar en circuito impreso o en *alúmina* (circuito híbrido).

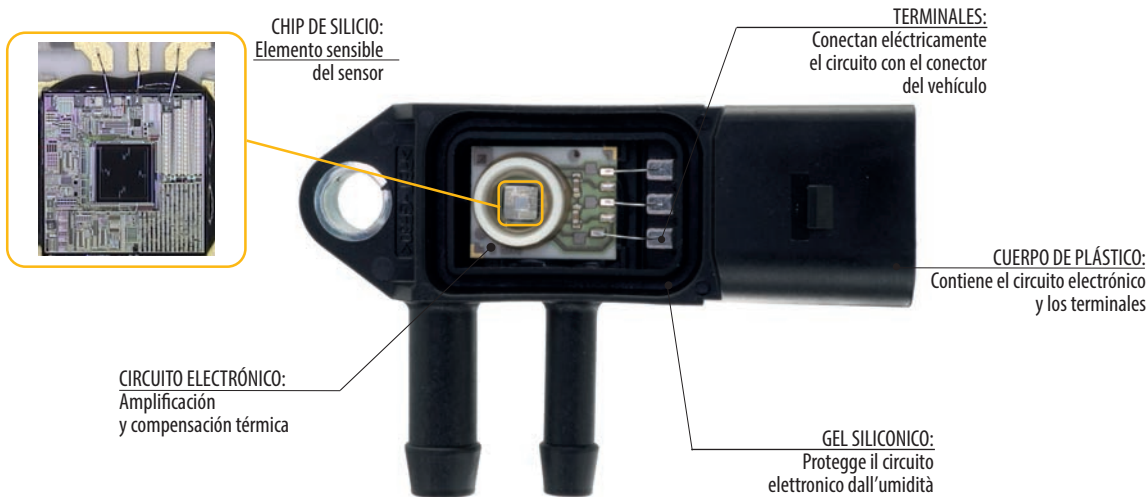

La detección de la función de transferencia de los sensores de presión relativa se lleva a cabo aplicando una presión variable en una de las entradas, mientras que la otra se deja a la presión atmosférica (o a una presión de referencia). Por lo tanto, la presión de salida varía según la entrada de aire utilizada y, por consiguiente, según el lado de la membrana (superior o inferior) deformado por la presión.

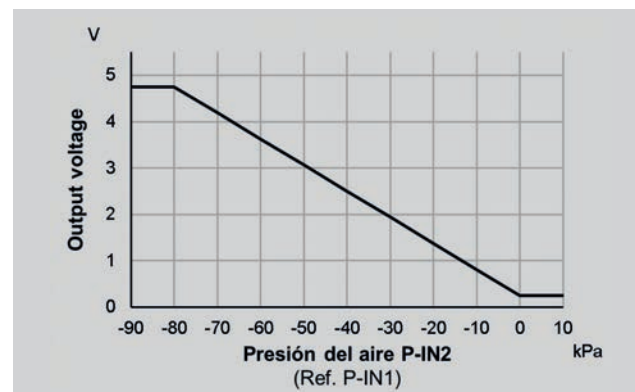
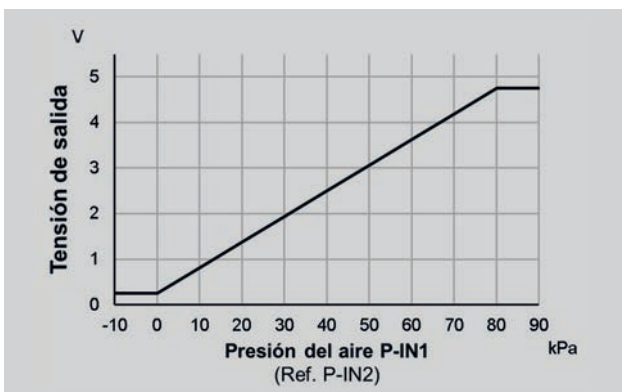

Función de transferencia del DPS relativo en forma de gráfico (para $V_a = 5V$) y ecuación correspondiente válida en un campo de $U_{fsi} = 500$ mV medidos con P_{fsi} (presión límite inferior) a $U_{fss} = 4500$ mV medidos con P_{fss} (presión límite superior).

• **El DPS de tipo Gauge** está formado por un cuerpo, que generalmente tiene una *pipeta* para la conexión con el conducto del que se quiere medir la presión, y por un *conector eléctrico*, para la conexión con los cables de alimentación y de salida. Un *orificio* en la cubierta o en el cuerpo proporciona la entrada de aire para la presión de referencia (generalmente, la presión atmosférica). Dentro del cuerpo se encuentran el *sensor de presión* y un posible *circuito electrónico* de acondicionamiento de la señal. Uno de los dos lados de la membrana del sensor se debe conectar a la toma de aire. El otro lado se puede dejar libre, siempre que se cree una cámara (hermética con respecto a la toma de aire) en cuyo interior fluya la presión de referencia. El *circuito electrónico* se puede realizar en circuito impreso o en *alúmina* (circuito híbrido).

10.3263



3

DIFFERENTIAL PRESSURE SENSORS

Adatt./Suitable:

AUDI

059 906 051 A
07Z 906 051 B

BOSCH

0 281 006 005
0 281 006 006

PORSCHE

955 606 151 00
958 606 151 10

SEAT

059 906 051 A
07Z 906 051 B

SKODA

059 906 051 A
07Z 906 051 B

VW

059 906 051 A
07Z 906 051 B
3D0 131 552 E *K
4F0 131 552 AM *K
4F0 131 552 AT *K
4F0 131 552 BA *K

*K No mounting bracket and no connecting pipes supplied

• Fornito senza staffa di fissaggio e senza tubi di raccordo

• Livré sans support de fixation et sans tuyaux de raccord

• Keine Halterung und Verbindungsrohre geliefert

• Soporte de montaje y conexión de tuberías no suministrados

MARKET DIFFUSION: HIGH



kPa	mV	O - +
-5,5 - 95,2	250 - 4750	

AUDI

A4 IV 2.0 TDI	CAGA, CAGA	11/07 ⇒ 12/15
A4 IV 2.0 TDI quattro	CAGA, CAMA	01/08 ⇒ 12/15
A4 IV 2.7 TDI	CAMA, CAPA	11/07 ⇒ 03/12
A4 IV 3.0 TDI	CLAB	11/11 ⇒ 12/15
A4 IV 3.0 TDI quattro	CAPA, CAGA	11/07 ⇒ 12/15
A4 IV ALLROAD 2.0 TDI quattro	CAGA, CCWA	04/09 ⇒ 05/16
A4 IV ALLROAD 3.0 TDI quattro	CCWA, CAGA	04/09 ⇒ 05/16
A5 I 2.0 TDI	CAGA, CAMA	08/08 ⇒ 01/17
A5 I 2.0 TDI quattro	CAHA	08/08 ⇒ 03/12
A5 I 2.7 TDI	CAMA, CAPA	06/07 ⇒ 01/17
A5 I 3.0 TDI	CLAB	10/11 ⇒ 01/17
A5 I 3.0 TDI quattro	CAPA, BNA	06/07 ⇒ 01/17
A6 III 2.0 TDI	BNA, BPP	07/04 ⇒ 08/11
A6 III 2.7 TDI	BPP, BPP	11/04 ⇒ 08/11
A6 III 2.7 TDI quattro	BPP, ASB	11/04 ⇒ 08/11
A6 III 3.0 TDI	ASB	06/06 ⇒ 08/11
A6 III 3.0 TDI quattro	ASB, CLAB	05/04 ⇒ 08/11
A6 IV 3.0 TDI	CLAB, CDUC	11/10 ⇒ 09/18
A6 IV 3.0 TDI quattro	CDUC, CLAB	03/11 ⇒
A7 SPORTBACK 3.0 TDI	CLAB, CDUC	11/10 ⇒ 05/18
A7 SPORTBACK 3.0 TDI quattro	CDUC, CPNA	10/10 ⇒ 05/18
A8 III 3.0 TDI	CLAB	09/11 ⇒ 09/13
A8 III 3.0 TDI quattro	CPNA, CAGA	11/12 ⇒
A8 III 4.2 TDI quattro	CDSB	11/09 ⇒ 04/14
Q5 I 2.0 TDI quattro	CAGA, CCWA	11/08 ⇒
Q5 I 3.0 TDI quattro	CCWA, CGQB	11/08 ⇒
Q5 I SQ5 TDI quattro	CGQB, BUG	12/12 ⇒
Q7 I 3.0 TDI quattro	BUG, BTR	03/06 ⇒ 08/15
Q7 I 4.2 TDI quattro	BTR, M05.9E	03/07 ⇒ 08/15
Q7 I 6.0 TDI quattro	CCGA	09/08 ⇒ 05/14

PORSCHE

CAYENNE I 3.0 TDI	M05.9D	02/09 ⇒ 09/10
CAYENNE II 3.0 Diesel	M05.9E, MCU.DB	06/10 ⇒
CAYENNE II 4.2 S Diesel	MCU.DB, MCR.C	10/12 ⇒
MACAN 3.0 S [ExtraEU]	MCD.UD	02/14 ⇒
MACAN 3.0 S Diesel	MCD.UD	02/14 ⇒
PANAMERA 3.0 D	MCR.C, BMM	08/11 ⇒ 10/16

SEAT

ALHAMBRA I / II 2.0 TDI	BRT	11/05 ⇒ 03/10
ALTEA 1.9 TDI	BLS	04/04 ⇒
ALTEA 2.0 TDI	BMM, BMM	11/05 ⇒
ALTEA XL 1.9 TDI	BLS	10/06 ⇒

SEAT

ALTEA XL 1.9 TDI 4x4	BLS	06/09 ⇒ 12/10
ALTEA XL 2.0 TDI	BMM, BMM	10/06 ⇒
ALTEA XL 2.0 TDI 4x4	BMM, CAGA	06/07 ⇒
EXEO 2.0 TDI	CAGA, BMM	12/08 ⇒
LEON II 1.9 TDI	BLS	07/05 ⇒ 12/10
LEON II 2.0 TDI	BMM, BMM	10/05 ⇒ 12/12
TOLEDO III 1.9 TDI	BLS	10/04 ⇒ 05/09
TOLEDO III 2.0 TDI	BMM, BMM	11/05 ⇒ 05/09

SKODA

OCTAVIA II 2.0 TDI	BMM	11/05 ⇒ 05/10
OCTAVIA II 2.0 TDI RS	BMN	04/06 ⇒ 02/13

VW

EOS 2.0 TDI	BMM	06/06 ⇒ 05/08
JETTA V 1.9 TDI	BLS	08/05 ⇒ 10/10
JETTA V 2.0 TDI	BMM, BRR	10/05 ⇒ 10/10
MULTIVAN 1.9 TDI	BRR, AXD	01/06 ⇒ 11/09
MULTIVAN 2.5 TDI	AXD, AXD	04/03 ⇒ 11/09
MULTIVAN 2.5 TDI 4motion	AXD, BMK	07/04 ⇒ 11/09
PHAETON 3.0 V6 TDI 4motion	BMK, BRT	09/04 ⇒ 03/16
SHARAN I 2.0 TDI	BRT, BPD	11/05 ⇒ 03/10
TOUAREG I 2.5 R5 TDI	BPD, BUN	01/03 ⇒ 05/10
TOUAREG I 3.0 TDI	BUN, CASA	04/06 ⇒ 05/10
TOUAREG I 3.0 V6 TDI	CASA, CASA	11/04 ⇒ 05/10
TOUAREG II 3.0 V6 TDI	CASA, AXB	01/10 ⇒ 03/18
TOUAREG II 4.2 V8 TDI	CKDA	01/10 ⇒ 03/18
TRANSPORTER V 1.9 TDI	AXB, AXD	04/03 ⇒ 11/09
TRANSPORTER V 2.5 TDI	AXD, AXD	04/03 ⇒ 11/09
TRANSPORTER V 2.5 TDI 4motion	AXD, BMM	04/04 ⇒ 11/09

10.3264



3

DIFFERENTIAL PRESSURE SENSORS

Adatt./Suitable:

AUDI

03G 906 051 A
03G 998 059
076 906 051 A

DODGE

5149175AA
K05149175AA
K05149175AB

JEEP

5149175AA
K05149175AA
K05149175AB

MITSUBISHI

1865A119

MOPAR PARTS

05149175AB

SEAT

076 906 051 A

SKODA

03G 906 051 A
03G 998 059
076 906 051 A
1K0 131 552 B *7
1K0 131 552 E *7
1K0 131 552 F *7

VW

03G 906 051 *1
03G 906 051 A *1
03G 998 059
076 906 051 A
076 906 051 C
2E0 131 552 F *1

*1 without fastening clamp

- senza staffa fissaggio
- sans bride de fixation
- ohne Befestigungsbügel
- sin estribo de sujeción

*7 without connector parts

- senza pezzi raccordo
- sans raccords
- ohne Anschlusssteile
- sin piezas de conexión

MARKET DIFFUSION: HIGH



kPa	mV	O - +
-5,5 - 95,5	250 - 4750	

AUDI

A3 II 1.9 TDI	BLS	05/03 ⇒ 05/10
A3 II 2.0 TDI	BMM, BKD	05/03 ⇒ 05/13
A3 II 2.0 TDI 16V	CBAB	05/03 ⇒ 08/12
A3 II 2.0 TDI 16V quattro	BKD, BMM	08/04 ⇒ 08/12
A3 II 2.0 TDI quattro	BMM, BKC	01/06 ⇒ 08/12
A3 II SPORTBACK 1.9 TDI	BKC, AZV	09/04 ⇒ 05/10

AUDI

A3 II SPORTBACK 2.0 TDI	AZV, BKD	09/04 ⇒ 03/13
A3 II SPORTBACK 2.0 TDI 16V	BKD, BKD	09/04 ⇒ 03/13
A3 II SPORTBACK 2.0 TDI 16V quattro	BKD, BMM	11/05 ⇒ 03/13
A3 II SPORTBACK 2.0 TDI quattro	BMM, BPW	01/06 ⇒ 03/13
A4 II 2.0 TDI	BPW, BKE	01/06 ⇒ 03/09
A4 III 1.9 TDI	BKE, BPW	11/04 ⇒ 06/08
A4 III 2.0 TDI	BPW, BLB	11/04 ⇒ 06/08
A4 III 2.0 TDI 16V	BLB, BPW	11/04 ⇒ 06/08
A4 III 2.0 TDI quattro	BPW, BLB	01/06 ⇒ 06/08
A6 III 2.0 TDI	BLB, CBBB	07/04 ⇒ 08/11
TT II 2.0 TDI quattro	CBBB, ECD	06/08 ⇒ 06/14

JEEP

COMPASS 2.0 CRD	ECD, ECD	08/06 ⇒
COMPASS 2.0 CRD 4x4	ECD, ECD	09/06 ⇒
PATRIOT 2.0 CRD	ECD, ECD	02/07 ⇒
PATRIOT 2.0 CRD 4x4	ECD, BSY	02/07 ⇒

MITSUBISHI

GRANDIS 2.0 DI-D	BSY, BKD	09/05 ⇒ 03/10
LANCER IX 2.0 DI-D	BKD, BMM	01/08 ⇒

SEAT

ALHAMBRA I / II 2.0 TDI	BRT	11/05 ⇒ 03/10
ALTEA 1.9 TDI	BLS	04/04 ⇒
ALTEA 2.0 TDI	BMM, BMM	11/05 ⇒
ALTEA XL 1.9 TDI	BLS	10/06 ⇒
ALTEA XL 1.9 TDI 4x4	BLS	06/09 ⇒ 12/10
ALTEA XL 2.0 TDI	BMM, BMM	10/06 ⇒
ALTEA XL 2.0 TDI 4x4	BMM, BLS	06/07 ⇒
CORDOBA II 1.4 TDI	BMS	06/05 ⇒ 11/09
CORDOBA II 1.9 TDI	BMT	09/02 ⇒ 11/09
IBIZA III 1.4 TDI	BMS	06/05 ⇒ 11/09
IBIZA III 1.9 TDI	BMT	02/02 ⇒ 11/09
IBIZA IV 1.4 TDI	BMS	07/08 ⇒ 06/10
IBIZA IV 1.9 TDI	BLS, BMM	03/08 ⇒ 06/10
LEON II 1.9 TDI	BLS	07/05 ⇒ 12/10
LEON II 2.0 TDI	BMM, BMM	10/05 ⇒ 12/12
TOLEDO III 1.9 TDI	BLS	10/04 ⇒ 05/09
TOLEDO III 2.0 TDI	BMM, BMN	11/05 ⇒ 05/09

SKODA

FABIA II 1.4 TDI	BMS	01/07 ⇒ 03/10
FABIA II 1.9 TDI	BLS	04/07 ⇒ 03/10
OCTAVIA II 2.0 TDI	BMM	11/05 ⇒ 05/10
OCTAVIA II 2.0 TDI 4x4	BMM	07/06 ⇒ 05/10
OCTAVIA II 2.0 TDI RS	BMN, BLS	04/06 ⇒ 02/13
ROOMSTER 1.4 TDI	BMS	09/06 ⇒ 03/10
ROOMSTER 1.9 TDI	BLS	09/06 ⇒ 03/10
SUPERB II 1.9 TDI	BLS, CBDB	03/08 ⇒ 11/10
SUPERB II 2.0 TDI	BMP	03/08 ⇒ 05/10
YETI 2.0 TDI 4x4	CBDB, BLS	05/09 ⇒ 12/17

VW

CADDY III 1.9 TDI	BLS, AXB	04/04 ⇒ 08/10
CADDY III 1.9 TDI 4motion	BLS	05/08 ⇒ 08/10
CADDY III 2.0 TDI	BMM	09/07 ⇒ 08/10
CAMPMOBILE 1.9 TDi	AXB, AXD	03/04 ⇒ 11/09
CAMPMOBILE 2.5 TDi	AXD, BJJ	03/04 ⇒ 11/09
CRAFTER 2.5 TDI	BJJ, BLS	04/06 ⇒
EOS 2.0 TDI	BMM	06/06 ⇒ 05/08
EOS 2.0 TDI 16V	CBAB	05/08 ⇒ 08/15
GOLF V 1.9 TDI	BLS, BMM	10/03 ⇒ 07/09
GOLF V 1.9 TDI 4motion	BLS	08/04 ⇒ 07/09
GOLF V 2.0 TDI	BMM, CBDB	12/04 ⇒
GOLF V 2.0 TDI 16V	CBDB	06/07 ⇒ 07/09
GOLF V 2.0 TDI 4motion	BMM	08/04 ⇒ 11/08
GOLF VI 2.0 TDI	BMM, CBAB	10/08 ⇒
GOLF VI 2.0 TDI 4motion	CBAB, BMM	05/09 ⇒ 11/12
GOLF VAN 2.0 TDI	CBDB, BMM	07/09 ⇒ 05/19
JETTA V 1.9 TDI	BLS	08/05 ⇒ 10/10
JETTA V 2.0 TDI	BMM, CBDB	10/05 ⇒ 10/10
JETTA V 2.0 TDI 16V	CBDB, AXB	08/05 ⇒ 10/10
MULTIVAN 1.9 TDI	AXB, AXD	04/03 ⇒ 11/09
MULTIVAN 2.5 TDI	AXD, AXD	04/03 ⇒ 11/09
MULTIVAN 2.5 TDI 4motion	AXD, CBAA	07/04 ⇒ 11/09
PASSAT V 1.9 TDI	BLS	03/05 ⇒ 11/10
PASSAT V 2.0 TDI	BMP, BMP	03/05 ⇒ 11/10
PASSAT V 2.0 TDI 16V	CBAB	03/05 ⇒ 11/10
PASSAT V 2.0 TDI 16V 4motion	CBAB	03/05 ⇒ 11/10
PASSAT V 2.0 TDI 4motion	BMP, CARA	03/05 ⇒ 11/10
PASSAT CC 2.0 BlueTDI	CBAC	05/09 ⇒ 11/10
PASSAT CC 2.0 TDI	CBAA, CBAB	05/08 ⇒ 01/12
PASSAT CC 2.0 TDI 4motion	CBAB, BMP	08/09 ⇒ 01/12
PHAETON 3.0 V6 TDI 4motion	CARA, BMS	06/07 ⇒ 03/16
POLO IV 1.4 TDI	BMS, CBDB	04/05 ⇒ 11/09
POLO IV 1.9 TDI	BMT	10/01 ⇒ 11/09
SCIROCCO III 2.0 TDI	CBDB, BRT	08/08 ⇒ 11/17
SCIROCCO 2.0 TDI	CBDB, CBDB	08/08 ⇒ 05/14
SHARAN I 2.0 TDI	BRT, CBAB	11/05 ⇒ 03/10

VW		
TIGUAN I 2.0 TDI	CBAB, CBAA	03/08 →
TIGUAN I 2.0 TDI 4motion	CBAA, BPD	09/07 →
TOUAREG I 2.5 R5 TDI	BPD, BKC	01/03 → 05/10
TOUAREG I 3.0 TDI	BUN	04/06 → 05/10
TOURAN I 1.9 TDI	BKC, AZV	08/03 → 05/10
TOURAN I 2.0 TDI	AZV, AXB	02/03 → 05/10
TOURAN I 2.0 TDI 16V	BKD	08/03 → 05/10
TRANSPORTER V 1.9 TDI	AXB, AXD	04/03 → 11/09
TRANSPORTER V 2.5 TDI	AXD, AXD	04/03 → 11/09
TRANSPORTER V 2.5 TDI 4motion	AXD, CAYB	04/04 → 11/09

SKODA		
ROOMSTER 1.2 TDI	CFWA	03/10 → 05/15
ROOMSTER 1.6 TDI	CAYA, CBBB	03/10 → 05/15
SUPERB II 2.0 TDI	CBBB, BKD	07/08 → 05/15
SUPERB II 2.0 TDI 16V	BKD, CBBB	01/09 → 05/15
SUPERB II 2.0 TDI 16V 4x4	CFFB	11/10 → 05/15
SUPERB II 2.0 TDI 4x4	CBBB, CFFB	09/08 → 05/15

SKODA		
SUPERB II 1.6 TDI	CAYC	09/10 → 05/15
YETI 1.6 TDI	CAYC	11/10 → 05/15
YETI 2.0 TDI	CFHA, CEGA	11/09 → 12/17
YETI 2.0 TDI 4x4	CEGA, CDCA	05/09 → 12/17

10.3265  **3**

DIFFERENTIAL PRESSURE SENSORS

Adatt./Suitable:

- AUDI**
059 906 051 C
- BOSCH**
0 281 006 082
0 281 006 083
- SEAT**
059 906 051 C
- SKODA**
059 906 051 C
- VW**
059 906 051 C

MARKET DIFFUSION: **HIGH**



kPa	mV	
-21,3 - 107,3	250 - 4750	

AUDI		
A1 1.6 TDI	CAYB, CFHB	05/10 → 04/15
A1 2.0 TDI	CFHB, CBAA	09/11 → 04/15
A3 II 2.0 TDI	CBAA, BKD	05/03 → 05/13
A3 II 2.0 TDI 16V	CFFB	05/03 → 08/12
A3 II 2.0 TDI 16V quattro	BKD, AZV	08/04 → 08/12
A3 II SPORTBACK 2.0 TDI	AZV, BKD	09/04 → 03/13
A3 II SPORTBACK 2.0 TDI 16V	BKD, BKD	09/04 → 03/13
A3 II SPORTBACK 2.0 TDI 16V quattro	BKD, CAGA	11/05 → 03/13
A4 IV 2.0 TDI	CAGA, CAGA	11/07 → 12/15
A4 IV 2.0 TDI quattro	CAGA, CAGA	04/08 → 12/15
A4 IV ALLROAD 2.0 TDI quattro	CAGA, CAGA	04/09 → 05/16
A5 I 2.0 TDI	CAGA, CGLC	08/08 → 01/17
A5 I 2.0 TDI quattro	CGLC	12/11 → 01/17
A6 IV 2.0 TDI	CGLC, CJCA	03/11 → 09/18
Q5 I 2.0 TDI	CJCA, CAGA	11/10 →
Q5 I 2.0 TDI quattro	CAGA, CAGA	11/08 →

SEAT		
ALTEA 2.0 TDI 16V	CFHC	03/04 →
ALTEA 2.0 TDI 16V 4WD	CFHC	10/10 →
ALTEA XL 2.0 TDI 16V	CFHC	10/06 →
ALTEA XL 2.0 TDI 16V 4x4	CFHC	10/10 →
ALTEA XL 2.0 TDI 4x4	CFJA	06/07 →
EXEO 2.0 TDI	CAGA, CAYB	12/08 →
IBIZA IV 1.2 TDI	CFWA	04/10 →
IBIZA IV 1.6 TDI	CAYB, CAYB	05/09 →
IBIZA IV 2.0 TDI	CFHD	01/10 →
IBIZA 1.6 TDi	CAYB	05/09 →
LEON II 2.0 TDI	CFJA	05/06 → 12/12
LEON II 2.0 TDI 16V	CFHC	07/05 → 12/12
TOLEDO IV 1.6 TDI	CAYB, CAYA	07/12 →

SKODA		
FABIA II 1.6 TDI	CAYA, CFHF	03/10 → 12/14
OCTAVIA II 2.0 TDI	CFHF, CAYB	03/10 → 06/13
OCTAVIA II 2.0 TDI 16V	CFHC	02/04 → 05/13
OCTAVIA II 2.0 TDI 16V 4x4	CFHC	05/10 → 02/13
OCTAVIA II 2.0 TDI 4x4	CFHF	05/11 → 02/13
RAPID 1.6 TDI	CAYB, CAYA	07/12 →

VW		
BEETLE 2.0 TDI	CFFB, CFHC	04/11 → 07/16
CADDY III 2.0 TDI	CFHC, CFHC	11/10 →
CADDY III 2.0 TDI 16V	CFHC, CFHC	11/10 → 05/15
CADDY III 2.0 TDI 16V 4motion	CFHC	11/10 → 05/15
CADDY III 2.0 TDI 4motion	CFHC, CFFB	08/10 →
EOS 2.0 TDI	CFFA	11/10 → 08/15
EOS 2.0 TDI 16V	CFFB	05/08 → 08/15
GOLF VI 2.0 TDI	CBAA, CBAB	10/08 →
GOLF VI 2.0 TDI 4motion	CBAB, CFFB	05/09 →
GOLF VI 2.0 TDI Gtd	CFGB	05/11 →
GOLF 2.0 TDi	CFFB, CBDB	09/09 → 11/12
GOLF VAN 2.0 TDi	CBDB, CBAA	07/09 → 05/19
JETTA V 2.0 TDI	CLCA	01/10 → 10/10
JETTA VI 2.0 TDI	CFFB, CAYA	10/10 →
POLO V 1.2 TDI	CFWA	10/09 →
POLO V 1.6 TDI	CAYA, CBBB	06/09 →
POLO V 1.6 TDi BlueMotion	CAYB	06/09 → 05/14
SCIROCCO III 2.0 TDI	CBBB, CFHC	08/08 → 11/17
SCIROCCO 2.0 TDi	CBBB, CBBB	08/08 → 05/14
TOURAN I 2.0 TDI	CFHC, CAYB	05/10 → 05/15

10.3266  **3**

DIFFERENTIAL PRESSURE SENSORS

Adatt./Suitable:

- AUDI**
076 906 051 B
 - SEAT**
076 906 051 B
 - SKODA**
076 906 051 B
1K0 131 552 L ⁷
1K0 131 552 M ⁷
 - VW**
076 906 051 B
- ⁷without connector parts
- senza pezzi raccordo
 - sans raccords
 - ohne Anschlusssteile
 - sin piezas de conexión

MARKET DIFFUSION: **HIGH**



kPa	mV	
-21,3 - 107,3	250 - 4750	

AUDI		
A3 II 1.6 TDI	CAYB, CAYB	05/09 → 05/13
A3 II SPORTBACK 1.6 TDI	CAYB, CFFA	05/09 → 03/13
Q3 2.0 TDI	CFFA, CFFB	06/11 → 10/18
Q3 2.0 TDI quattro	CFFB, CBBB	06/11 → 10/18
TT II 2.0 TDI quattro	CBBB, CFFA	06/08 → 06/14

SEAT		
ALHAMBRA III 2.0 TDI	CFFA, CAYB	06/10 →
ALHAMBRA III 2.0 TDI 4Drive	CFFB	05/11 →
ALTEA 1.6 TDI	CAYB, CAYB	10/09 →
ALTEA 2.0 TDI	CEGA	03/06 →
ALTEA XL 1.6 TDI	CAYB, CAYB	10/09 →
ALTEA XL 2.0 TDI	CEGA	06/07 →
ALTEA XL 2.0 TDI 4x4	CEGA	06/07 →
LEON II 1.6 TDI	CAYB, CFHA	02/10 → 12/12
LEON II 2.0 TDI	CEGA	05/06 → 12/12

SKODA		
FABIA II 1.4 TDI	BMS	01/07 → 03/10
FABIA II 1.9 TDI	BLS	04/07 → 03/10
OCTAVIA II 1.6 TDI	CAYC	06/09 → 04/13
OCTAVIA II 1.6 TDI 4x4	CAYC	06/09 → 02/13
OCTAVIA II 2.0 TDI RS	CEGA	04/06 → 02/13
ROOMSTER 1.4 TDI	BMS	09/06 → 03/10
ROOMSTER 1.9 TDI	BLS	09/06 → 03/10

VW		
AMAROK 2.0 BitDI	CDCA, CDCA	09/10 →
AMAROK 2.0 BitDI 4motion	CDCA, CDBA	09/10 →
AMAROK 2.0 TDI	CDBA, CDBA	09/10 →
AMAROK 2.0 TDI 4motion	CDBA, CDBA	09/10 →
AMAROK 2.0 TDi/TDi BlueMotion	CDBA, CDBA	05/12 → 10/13
AMAROK 2.0 TDi/TDi BlueMotion [ExtraEU]	CDBA, CFFB	09/11 →
BEETLE 1.6 TDI	CAYC	10/11 → 07/16
BEETLE 2.0 TDI	CFFB, CAYD	04/11 → 07/16
CADDY III 1.6 TDI	CAYD, CAAB	08/10 →
CAMPMOBILE 2.0 TDi	CCHB	05/10 → 08/15
CAMPMOBILE 2.0 TDi BlueMotion	CAAB, CFFA	04/15 →
CC 2.0 TDI	CFFA, CFFB	11/11 → 12/16
CC 2.0 TDI 4motion	CFFB, CKTB	11/11 → 12/16
CRAFTER 2.0 TDI	CKTB, CKUB	05/11 → 12/16
CRAFTER 2.0 TDI 4motion	CKUB, CFFB	11/11 → 12/16
GOLF VI 1.6 TDI	CAYB, CBAB	02/09 →
GOLF VI 1.6 TDI 4motion	CAYC	07/09 → 07/13
GOLF VI 2.0 TDI	CBAB, CAYB	10/08 →
GOLF 1.6 TDi	CAYB	02/09 → 11/12
GOLF 1.6 TDi BlueMotion	CAYC	05/09 → 11/12
GOLF 2.0 TDi	CFFB, CAYB	09/09 → 11/12
GOLF VAN 1.6 TDi	CAYB	12/09 → 10/12
GOLF VAN 1.6 TDi BlueMotion	CAYC	07/09 → 05/14
JETTA V 1.6 TDI	CAYB, CAAA	06/09 → 10/10
JETTA V 2.0 TDI	CBDA	09/05 → 10/10
JETTA VI 1.6 TDI	CAYC	04/10 → 07/14
JETTA VI 2.0 TDI	CJAA	02/11 →
MULTIVAN 2.0	AXA	11/03 → 08/15
MULTIVAN 2.0 BitDI	CFCA	09/09 → 08/15
MULTIVAN 2.0 BitDI 4motion	CFCA	09/09 → 08/15
MULTIVAN 2.0 TDI	CAAA, CAAC	09/09 →
MULTIVAN 2.0 TDI 4motion	CAAC, CBAA	09/09 →
PASSAT 2.0 Blue TDi/TDi/TDi BlueMotion [ExtraEU]	CFFB	08/10 → 12/14
PASSAT 2.0 TDi BlueMotion	CFFB	08/10 → 12/14
PASSAT V 1.6 TDI	CAYC	08/09 → 12/14
PASSAT V 2.0 BlueTDI	CBAC	01/09 → 11/10
PASSAT V 2.0 TDI	CBAA, CBBB	03/05 →
PASSAT V 2.0 TDI 16V	CBAB	03/05 → 11/10
PASSAT V 2.0 TDI 16V 4motion	CBAB	03/05 → 11/10
PASSAT V 2.0 TDI 4motion	CBBB, CBBB	05/09 → 12/14
PASSAT CC 2.0 BlueTDI	CBAC	05/09 → 11/10
PASSAT CC 2.0 TDI	CBAA, CBAB	05/08 → 01/12
PASSAT CC 2.0 TDI 4motion	CBAB, CBAA	08/09 → 01/12
SCIROCCO III 2.0 TDI	CBBB, CFFA	05/09 → 11/17
SCIROCCO 2.0 TDi	CBBB, CBBB	05/09 → 05/14
SHARAN II 2.0 TDI	CFFA, CFFA	05/10 →
SHARAN II 2.0 TDI 4motion	CFFA, CBAB	05/11 →
TIGUAN I 2.0 TDI	CBAB, CBAA	03/08 →
TIGUAN I 2.0 TDI 4motion	CBAA, CAYB	09/07 →
TOURAN I 1.6 TDI	CAYB, CAAA	05/10 → 05/15
TRANSPORTER V 2.0 BitDI	CFCA	09/09 → 08/15
TRANSPORTER V 2.0 BitDI 4motion	CFCA	09/09 → 08/15
TRANSPORTER V 2.0 TDI	CAAA, CAAC	09/09 → 08/15
TRANSPORTER V 2.0 TDI 4motion	CAAC, CAAA	09/09 → 08/15
TRANSPORTER VI 2.0 TDI	CAAA, CAAC	04/15 →
TRANSPORTER VI 2.0 TDI 4motion	CAAC, G8DA	06/15 →

10.3268



04

DIFFERENTIAL PRESSURE SENSORS

Adatt./Suitable:

FORD

1 315 684
1 381 208 *K
1 382 257 *3
1 415 606
1 416 652 *K
1 436 292 *K
1 496 208 *7
1 508 703 *7
1 534 268 *7
3M5A-5H209-BF *3
3M5A-5L200-AB
6S71-5H209-AC *K
8V41-5H209-AC *7

*3 without connecting pipe

- senza tubo raccordo
- sans tuyau de raccordement
- ohne Anschlussrohr
- sin tubo de conexión

*7 without connector parts

- senza pezzi raccordo
- sans raccords
- ohne Anschlusssteile
- sin piezas de conexión

JAGUAR

C2C 39730

LAND ROVER

LR007083 *7
LR008463

MAZDA

Y401-20-360 *3
Y642-18-215A *3
Y642-18-215B *3
Y650-18-215 *3
Y650-18-215A *3

VOLVO

30684336 *3
30750460
30757183 *3
30757189
31293629 *7
31319368 *7
869953-0

*K No mounting bracket and no connecting pipes supplied

- Fornito senza staffa di fissaggio e senza tubi di raccordo
- Livré sans support de fixation et sans tuyaux de raccord
- Keine Halterung und Verbindungsrohre geliefert
- Soporte de montaje y conexión de tuberías no suministrados

MARKET DIFFUSION: HIGH



kPa	mV	
5 - 70	690,9 - 4209,9	

FORD

C-MAX I 1.6 TDCi	G8DA, G6DA	02/07 ⇒ 09/10
C-MAX I 2.0 TDCi	G6DA, G8DA	02/07 ⇒ 09/10
FOCUS II 1.6 TDCi	G8DA, G6DA	07/04 ⇒ 09/12
FOCUS II 2.0 TDCi	G6DA, AZWA	07/04 ⇒ 09/12
FOCUS C-MAX 1.6 TDCi	G8DA, G6DA	10/03 ⇒ 03/07
FOCUS C-MAX 2.0 TDCi	G6DA, G8DA	10/03 ⇒ 03/07
GALAXY II 2.0 TDCi	AZWA, KNWA	05/06 ⇒ 06/15
GALAXY II 2.2 TDCi	KNWA, G6DG	03/08 ⇒ 06/15
KUGA I 2.0 TDCi	G6DG, G6DG	03/08 ⇒ 11/12
KUGA I 2.0 TDCi 4x4	G6DG, D5BA	03/08 ⇒ 11/12
KUGA I 2.0 TDCi CR TC	--	03/10 ⇒
MONDEO II 2.0 16V DI / TDDi / TDCi	D5BA, D6BA	10/00 ⇒ 03/07
MONDEO II 2.0 16V TDDi / TDCi	D6BA, --	10/00 ⇒ 03/07
MONDEO II 2.0 DI	PD20FMCR	10/00 ⇒ 03/07
MONDEO II 2.0 TDCi	--, QJBA	10/01 ⇒ 03/07
MONDEO II 2.2 TDCi	QJBA, AZBA	09/04 ⇒ 03/07
MONDEO III 2.0 TDCi	AZBA, AZWA	03/07 ⇒ 01/15
S-MAX I 2.0 TDCi	AZWA, 224DT	05/06 ⇒ 12/14

JAGUAR

XJ D 2.7	AJD	10/05 ⇒ 03/09
----------	-----	---------------

LAND ROVER

FREELANDER 2 2.2 eD4	224DT, 224DT	08/10 ⇒ 10/14
FREELANDER 2 2.2 SD4 4x4	224DT	08/10 ⇒ 10/14
FREELANDER 2 2.2 TD4 4x4	224DT, Y601	10/06 ⇒ 10/14

MAZDA

3 I 1.6 DI Turbo	Y601, Y601	06/04 ⇒ 06/09
3 I 1.6 MZ-CD	Y406	06/06 ⇒ 12/09
3 II 1.6 MZR CD	Y601, Y650	12/08 ⇒ 05/13
5 II 1.6 CD	Y650, D5244T5	09/10 ⇒

VOLVO

C30 1.6 D	D4164T	10/06 ⇒ 12/12
C30 2.0 D	D4204T	10/06 ⇒ 12/12
C70 II 2.0 D	D4204T	01/08 ⇒ 10/09
S40 II 1.6 D	D4164T	01/05 ⇒ 12/12
S40 II 2.0 CDI	D4204T2	07/05 ⇒ 12/06
S40 II 2.0 D	D4204T	01/04 ⇒ 12/10
S40 II 2.0 D4	D4204T2	07/05 ⇒ 12/12

VOLVO

S60 I 2.4 D	D5244T5, D4164T	03/05 ⇒ 04/10
S60 I 2.4 D5	D5244T4	03/05 ⇒ 04/10
S80 II 1.6 D DRIVE	D4164T	01/10 ⇒ 12/11
V50 1.6 D	D4164T, D5244T4	01/05 ⇒ 12/12
V50 2.0 CDI	D4204T2	12/03 ⇒ 12/06
V50 2.0 D	D4204T	04/04 ⇒ 12/10
V70 II 2.4 CDI	D5244T6	07/05 ⇒ 12/08
V70 II 2.4 D	D5244T7	04/05 ⇒ 12/08
V70 II 2.4 D5	D5244T4, D5244T	04/05 ⇒ 12/08
V70 II 2.4 D5 AWD	D5244T, D5244T18	07/02 ⇒ 08/07
V70 III 1.6 D	D4164T	07/09 ⇒ 12/11
XC70 I 2.4 D5 AWD	D5244T4	12/05 ⇒ 08/07
XC90 I D3 / D5	D5244T5	04/09 ⇒ 12/14
XC90 I D5 AWD	D5244T18, ENS	10/02 ⇒ 12/14

10.3269



3,5

DIFFERENTIAL PRESSURE SENSORS

Adatt./Suitable:

BOSCH

0 281 002 810
0 281 002 822
0 281 002 823
0 281 002 924
0 281 002 925
0 281 006 025
0 281 006 170
0 281 006 279

*1 without fastening clamp

- senza staffa fissaggio
- sans bride de fixation
- ohne Befestigungsbügel
- sin estribo de sujeción

CHRYSLER

5146187AD *7
56044587AA
56044587AB
K05146187AD *7
K56044587AA
K56044587AB

*3 without connecting pipe

- senza tubo raccordo
- sans tuyau de raccordement
- ohne Anschlussrohr
- sin tubo de conexión

DODGE

56044587AA
56044587AB
K56044587AA
K56044587AB

*7 without connector parts

- senza pezzi raccordo
- sans raccords
- ohne Anschlusssteile
- sin piezas de conexión

FIAT

K05146187AD *7
K05149278AB *7

INFINITI

22771-4GCOA
22771-HG00A

JEEP

5149278AB *7
56044587AA
56044587AB
68078181AA *3
K05149235AB *1
K05149277AB
K05149278AB *7
K56044587AA
K56044587AB
K68078181AA *3

LANCIA

K05146187AD *7
K05149278AB *7

MERCEDES-BENZ

0061534928
0061539528
0071536128
6429050100
A 004 153 95 28
A 005 153 74 28
A 005 153 77 28
A 006 153 49 28
A 006 153 95 28
A 007 153 61 28
A 642 905 01 00

MOPAR PARTS

05146187AD *7
05149235AB *1
05149278AB *7
56044587AB
68078181AA *3

SMART

A 004 153 95 28
A 005 153 74 28
A 005 153 77 28
A 006 153 49 28
A 006 153 95 28
A 007 153 61 28
A 642 905 01 00

MARKET DIFFUSION: HIGH



kPa	mV	
-1,1 - 108,5	500 - 4500	

CHRYSLER

300C I 3.0 CRD	EXL	09/05 ⇒ 11/12
300C I 3.0 V6 CRD	EXL	11/10 ⇒ 11/12
300C II 3.0 CRD	EXL	09/05 ⇒ 12/10
GRAND VOYAGER V 2.8 CRD	ENS, ENR	10/07 ⇒

DODGE

CALIBER 2.2 CRD	ENE	07/10 ⇒
NITRO 2.8 CRD	ENR, ENR	10/06 ⇒ 12/12
NITRO 2.8 CRD 4WD	ENR, ENS	06/07 ⇒ 12/12

INFINITI

Q50 50 D	OM651	04/13 ⇒
----------	-------	---------

INFINITI			
Q70 2.2 D	OM651	10/14	→
JEEP			
CHEROKEE IV 2.8 CRD 4x4	ENS, EXL	05/08	→
COMMANDER 3.0 CRD 4x4	EXL, ENE	09/05	→ 12/10
COMPASS 2.2 CRD	ENE	05/11	→
COMPASS 2.2 CRD 4x4	ENE, EXL	12/10	→
GRAND CHEROKEE 3.0 CRD	EXF	06/05	→
GRAND CHEROKEE 3.0 CRD 4x4	EXL, EXF	06/05	→ 12/10
GRAND CHEROKEE 3.0 CRD V6 4x4	EXF, ENS	01/11	→
PATRIOT 2.2 CRD	ENE	01/11	→
PATRIOT 2.2 CRD 4x4	ENE	01/11	→
WRANGLER 2.8 CRD	ENS, ENS	04/07	→
WRANGLER 2.8 CRD RWD	ENS	04/07	→ 02/10
LANCIA			
VOYAGER 2.8 CRD	ENS, OM611.962	09/11	→ 12/14
MERCEDES-BENZ			
CLASSE A II A 160 CDI	OM640.942	09/04	→ 06/12
CLASSE A II A 180 CDI	OM640.940	09/04	→ 06/12
CLASSE A II A 200 CDI	OM640.941	09/04	→ 06/12
CLASSE B I B 180 CDI	OM640.940	03/05	→ 11/11
CLASSE B I B 200 CDI	OM640.941	03/05	→ 11/11
CLASSE C II C 200 CDI	OM611.962, OM646.963	02/01	→
CLASSE C II C 220 CDI	OM646.963, OM646.811	02/03	→ 05/08
CLASSE C II C 320 CDI	OM642.910	01/05	→ 08/07
CLASSE C III C 180 CDI	OM651.913	01/11	→ 08/14
CLASSE C III C 200 CDI	OM646.811, OM646.811	01/07	→ 08/14
CLASSE C III C 220 CDI	OM646.811, OM642.830	01/07	→
CLASSE C III C 220 CDI 4-matic	OM651.912	02/13	→ 08/14
CLASSE C III C 250 CDI	OM651.911	08/08	→
CLASSE C III C 250 CDI 4-matic	OM651.912	04/10	→ 08/14
CLASSE C III C 300 CDI 4-matic	OM642.832	01/11	→ 01/14
CLASSE C III C 320 CDI	OM642.960	01/07	→ 08/14
CLASSE C III C 320 CDI 4-matic	OM642.961	07/07	→ 01/14
CLASSE C III C 350 CDI	OM642.830, OM642.832	08/07	→ 08/14
CLASSE C III C 350 CDI 4-matic	OM642.832, OM646.962	08/07	→ 08/14
CLASSE CLC CLC 200 CDI	OM646.962, OM646.821	05/08	→ 06/11
CLASSE CLC CLC 220 CDI	OM646.963	05/08	→ 06/11
CLASSE CLK II 220 CDI	OM646.966	01/05	→ 05/09
CLASSE CLK II 320 CDI	OM642.910	01/05	→ 05/09
CLASSE CLK II CLK 320 CDI	OM642.910	03/05	→ 03/10
CLASSE CLS I CLS 320 CDI	OM642.920	01/05	→ 12/10
CLASSE CLS I CLS 350 CDI	OM642.920	04/09	→ 12/10
CLASSE CLS II CLS 250 CDI / BlueTEC / d	OM651.924	04/11	→
CLASSE CLS II CLS 350 CDI / d	OM642.853	01/11	→
CLASSE CLS II CLS 350 CDI / d 4-matic	OM642.854	09/11	→
CLASSE E III E 200 CDI	OM646.820, OM646.821	07/02	→ 07/09
CLASSE E III E 220 CDI	OM646.821, OM646.821	03/02	→ 07/09
CLASSE E III E 220 T CDI	OM646.821, OM642.920	03/03	→ 07/09
CLASSE E III E 280 CDI	OM642.920, OM642.920	05/04	→ 12/08
CLASSE E III E 280 CDI 4-matic	OM642.921	03/05	→ 12/08
CLASSE E III E 280 T CDI	OM642.920, OM642.920	05/04	→ 07/09
CLASSE E III E 280 T CDI 4-matic	OM642.921	03/05	→ 07/09
CLASSE E III E 300 BlueTEC	OM642.920	09/07	→ 12/08
CLASSE E III E 320 CDI	OM642.920, OM642.920	11/02	→ 12/08
CLASSE E III E 320 CDI 4-matic	OM642.921	03/05	→ 12/08
CLASSE E III E 320 T CDI	OM642.920, OM642.850	03/03	→ 07/09
CLASSE E III E 320 T CDI 4-matic	OM642.921	03/05	→ 07/09
CLASSE E III E 420 CDI	OM629.910	01/06	→ 12/08
CLASSE E IV E 200 CDI / BlueTEC	OM651.925	01/09	→
CLASSE E IV E 220 CDI	OM651.911	01/09	→
CLASSE E IV E 220 CDI / BlueTEC	OM651.924	01/09	→
CLASSE E IV E 220 CDI / BlueTEC / d	OM651.911	01/10	→
CLASSE E IV E 220 CDI / d	OM651.911	01/10	→
CLASSE E IV E 250 CDI / BlueTEC	OM651.924	01/09	→
CLASSE E IV E 250 CDI / BlueTEC / d	OM651.911	01/09	→
CLASSE E IV E 250 CDI / BlueTEC 4-matic	OM651.924	01/09	→
CLASSE E IV E 300 BlueTEC	OM642.852	03/11	→
CLASSE E IV E 300 CDI	OM642.850, OM642.850	12/09	→
CLASSE E IV E 300 CDI / BlueTEC	OM642.850, OM642.836	11/09	→
CLASSE E IV E 350 CDI	OM642.836, OM642.856	01/09	→

MERCEDES-BENZ			
CLASSE E IV E 350 CDI 4-matic	OM642.856, OM642.822	09/09	→
CLASSE E E 220 CDI	OM646.821, OM646.820	10/03	→ 07/09
CLASSE G II G 280 CDI	OM642.975	04/09	→
CLASSE G II G 300 CDI	OM642.884	01/10	→
CLASSE G II G 320 CDI	OM642.970	09/06	→
CLASSE G II G 350 BlueTEC	OM642.970	07/09	→
CLASSE G II G 350 CDI	OM642.886	07/11	→
CLASSE GL I GL 320 CDI / 350 BlueTEC 4-matic	OM642.820	12/09	→
CLASSE GL I GL 320 CDI 4-matic	OM642.940	09/06	→ 05/09
CLASSE GL I GL 320 CDI BlueTEC 4-matic	OM642.820	12/09	→
CLASSE GL I GL 350 CDI 4-matic	OM642.822, OM651.913	05/09	→
CLASSE GL I GL 420 CDI 4-matic	OM629.912	09/06	→ 05/09
CLASSE GL I GL 450 CDI 4-matic	OM629.912	05/09	→
CLASSE GLK 200 CDI	OM651.913, OM642.832	07/10	→ 06/15
CLASSE GLK 220 CDI	OM651.916	12/08	→ 06/15
CLASSE GLK 220 CDI 4-matic	OM651.912	12/08	→ 06/15
CLASSE GLK 250 CDI 4-matic	OM651.912	09/09	→ 06/15
CLASSE GLK 320 CDI 4-matic	OM642.961	06/08	→ 06/15
CLASSE GLK 350 CDI 4-matic	OM642.832, OM642.820	07/09	→
CLASSE M II ML 280 CDI 4-matic	OM642.940	07/05	→ 07/09
CLASSE M II ML 300 CDI 4-matic	OM642.820, OM642.820	07/09	→ 12/11
CLASSE M II ML 320 CDI 4-matic	OM642.820, OM642.820	07/05	→
CLASSE M II ML 350 CDI 4-matic	OM642.820, OM642.870	07/09	→ 12/11
CLASSE M II ML 420 CDI 4-matic	OM629.912	02/06	→ 09/09
CLASSE M II ML 450 CDI 4-matic	OM629.912	09/09	→ 12/11
CLASSE M III ML 350 BlueTEC 4-matic	OM642.826	06/11	→ 02/15
CLASSE R R 280 CDI	OM642.870, OM642.870	05/06	→
CLASSE R R 280 CDI 4-matic	OM642.950	05/06	→
CLASSE R R 300 CDI	OM642.870, OM642.870	07/09	→
CLASSE R R 300 CDI 4-matic	OM642.950	07/09	→
CLASSE R R 320 CDI 4-matic	OM642.870, OM642.870	01/06	→
CLASSE R R 350 CDI 4-matic	OM642.870, OM642.930	01/06	→
CLASSE S IV S 320 CDI	OM648.960	09/02	→ 08/05
CLASSE S V S 250 CDI	OM651.961	01/11	→ 12/13
CLASSE S V S 320 CDI	OM642.930, OM642.932	10/05	→ 12/13
CLASSE S V S 320 CDI 4-matic	OM642.932, OM642.932	10/05	→ 12/13
CLASSE S V S 350 BlueTEC	OM642.862	04/11	→ 12/13
CLASSE S V S 350 BlueTEC 4-matic	OM642.868	04/11	→ 12/13
CLASSE S V S 350 CDI	OM642.930	06/09	→ 12/13
CLASSE S V S 350 CDI 4-matic	OM642.932, OM646.986	01/09	→ 07/13
CLASSE S V S 420 CDI	OM629.911	10/06	→ 12/09
CLASSE S V S 450 CDI	OM629.911	01/09	→ 12/13
CLASSE S V S 530 CDI [ExtraEU]	OM642.930	06/09	→ 12/13
CLASSE SLC 250 d	OM651.980	01/16	→ 10/17
CLASSE SLK III 250 CDI / d	OM651.980	01/12	→
CLC-SERIES CLC220 CDI	OM646.963	05/08	→ 06/11
C-SERIES C200 CDI	OM651.913	01/10	→ 01/14
C-SERIES C300 CDI/CDi BlueEFFICIENCY	OM642.832	01/11	→ 01/14
ML-SERIES ML350-/BlueTEC [ExtraEU]	OM642.826	06/11	→ 02/15
SPRINTER II 209 CDI	OM646.984	06/06	→ 12/09
SPRINTER II 210 CDI	OM651.955	03/09	→
SPRINTER II 211 CDI	OM646.985	06/06	→ 12/09
SPRINTER II 213 CDI	OM646.986, OM646.986	06/06	→
SPRINTER II 214 CDI	OM651.955	04/16	→
SPRINTER II 215 CDI	OM646.986, OM651.955	06/06	→ 12/09
SPRINTER II 216 CDI	OM651.955, OM642.896	06/06	→
SPRINTER II 218 CDI	OM642.896, OM642.896	06/06	→ 12/09
SPRINTER II 219 CDI / BlueTEC	OM642.896, OM651.955	03/09	→
SPRINTER II 309 CDI	OM646.984	06/06	→ 12/09
SPRINTER II 310 CDI	OM651.955, OM646.986	03/09	→
SPRINTER II 311 CDI	OM646.985	06/06	→ 12/09
SPRINTER II 311 CDI 4x4	OM646.985	02/08	→ 12/09
SPRINTER II 313 CDI	OM646.986, OM651.955	06/06	→
SPRINTER II 313 CDI 4x4	OM651.955, OM646.986	06/06	→
SPRINTER II 314 CDI	OM651.955	05/16	→
SPRINTER II 314 CDI 4x4	OM651.955	05/16	→
SPRINTER II 315 CDI	OM646.986, OM646.986	06/06	→ 12/09
SPRINTER II 315 CDI 4x4	OM646.986, OM651.955	02/08	→ 12/09
SPRINTER II 316 CDI	OM651.955, OM651.955	03/09	→
SPRINTER II 316 CDI 4x4	OM651.955, OM642.896	03/09	→
SPRINTER II 318 CDI	OM642.896, OM642.896	06/06	→ 12/09

MERCEDES-BENZ			
SPRINTER II 318 CDI 4x4	OM642.896, OM642.896	02/08	→ 12/09
SPRINTER II 319 CDI / BlueTEC	OM642.896, OM642.896	03/09	→
SPRINTER II 319 CDI / BlueTEC 4x4	OM642.896, OM646.986	03/09	→
SPRINTER II 411 CDI	OM646.985	06/09	→ 12/18
SPRINTER II 413 CDI	OM646.986, OM646.986	06/06	→ 05/16
SPRINTER II 415 CDI	OM646.986, OM642.896	06/06	→ 12/09
SPRINTER II 416 CDI	OM651.957	03/09	→
SPRINTER II 418 CDI	OM642.896, OM642.896	06/06	→ 05/16
SPRINTER II 419 CDI	OM642.896, OM646.986	03/09	→
SPRINTER II 509 CDI	OM646.984	06/06	→ 12/09
SPRINTER II 510 CDI	OM651.955	03/09	→
SPRINTER II 511 CDI	OM646.985	06/06	→ 12/09
SPRINTER II 511 CDI 4x4	OM646.985	06/06	→ 12/09
SPRINTER II 513 CDI	OM646.986, OM651.955	06/06	→
SPRINTER II 513 CDI 4x4	OM651.955, OM646.986	06/06	→
SPRINTER II 515 CDI	OM646.986, OM646.986	06/06	→ 12/09
SPRINTER II 515 CDI 4x4	OM646.986, OM651.955	06/06	→ 12/09
SPRINTER II 516 CDI	OM651.955, OM651.955	03/09	→
SPRINTER II 516 CDI 4x4	OM651.955, OM642.896	06/06	→
SPRINTER II 518 CDI	OM642.896, OM642.896	06/06	→ 12/09
SPRINTER II 518 CDI 4x4	OM642.896, OM642.896	06/06	→ 12/09
SPRINTER II 519 CDI / BlueTEC	OM642.896, OM642.896	03/09	→
SPRINTER II 519 CDI / BlueTEC 4x4	OM642.896, OM646.981	03/09	→
SPRINTER SERIES Sprinter 213D CDI	OM646.986	04/12	→
SPRINTER SERIES Sprinter 416D CDI	OM651.957	11/13	→
VIANO CDI 2.0	OM646.981, OM646.982	09/03	→
VIANO CDI 2.0 4-matic	OM646.982, OM646.982	07/05	→
VIANO CDI 2.2	OM651.940	07/10	→
VIANO CDI 2.2 4-matic	OM646.982, OM642.890	07/05	→
VIANO CDI 3.0	OM642.890, OM646.980	03/06	→
VITO II 109 CDI	OM646.980, OM646.980	09/03	→
VITO II 109 CDI 4x4	OM646.981	09/07	→
VITO II 110 CDI	OM651.940	09/10	→
VITO II 111 CDI	OM646.980, OM646.980	09/03	→
VITO II 111 CDI 4x4	OM646.982	09/07	→
VITO II 113 CDI	OM651.940	09/10	→
VITO II 113 CDI 4x4	OM651.940	09/10	→
VITO II 115 CDI	OM646.980, OM660.950	09/03	→
VITO II 115 CDI 4x4	OM646.982	07/06	→
VITO II 116 CDI	OM651.940	09/10	→
VITO II 116 CDI 4x4	OM651.940	09/10	→
VITO II 120 CDI	OM642.990	07/06	→
VITO II 122 CDI	OM642.890	09/10	→

SMART			
FORFOUR 1.5 CDI	OM639.939	09/04	→ 06/06
FORTWO II 0.8 Cdi	OM660.950, 9HL(DV6C)	01/07	→

10.3271



3,5

DIFFERENTIAL PRESSURE SENSORS

Adatt./Suitable:

CITROËN

1618 LP
1618 Z9
96 621 431 80

DS

1618 Z9

FIAT

9662143180

LANCIA

9662143180

MINI

13 62 7 805 472

MITSUBISHI

1865A176

PEUGEOT

1618 LP
1618 Z9

TOYOTA

SU001-A0596

MARKET DIFFUSION: HIGH



kPa	mV	
-6,1 - 106,3	250 - 4750	

CITROËN

BERLINGO II 1.6 HDi / BlueHdi 75	9HN(DV6ETED)	07/10 ⇨
BERLINGO II 1.6 HDi 110	9HL(DV6C), 9HL(DV6C)	04/08 ⇨
BERLINGO II 1.6 HDi 115	9HL(DV6C), 9HF(DV6DTEd)	07/10 ⇨
BERLINGO II 1.6 HDi 115 4x4	--	02/12 ⇨
BERLINGO II 1.6 HDi 75 / BlueHdi 75	9HN(DV6ETED)	04/08 ⇨
BERLINGO II 1.6 HDi 75 4x4	9HN(DV6ETED)	02/12 ⇨
BERLINGO II 1.6 HDi 90	9HF(DV6DTEd), DV6ATED4	04/08 ⇨
BERLINGO II 1.6 HDi 90 16V	DV6ATED4, 9HD(DV6C)	04/08 ⇨
BERLINGO II 1.6 HDi 90 4x4	9HF(DV6DTEd)	02/12 ⇨
BERLINGO II 1.6 HDi 92	DV6DTEd	07/10 ⇨
C2 1.6 HDi	9HZ(DV6TED4)	09/05 ⇨
C3 1.6 16V HDi	9HZ(DV6TED4)	09/05 ⇨
C3 II 1.4 HDi	DV4C	06/10 ⇨ 09/16
C3 II 1.4 HDi 70	8HR(DV4C)	11/09 ⇨
C3 II 1.6 HDi	9HP(DV6DTEd)	11/09 ⇨
C3 II 1.6 HDi 110	9HR(DV6C)	11/09 ⇨
C3 II 1.6 HDi 115	9HD(DV6C), 9HD(DV6C)	09/12 ⇨
C3 AIRCROSS 1.6 HDi 92	DV6D	10/17 ⇨
C3 PICASSO 1.6 HDi	9HZ(DV6TED4)	02/09 ⇨
C3 PICASSO 1.6 HDi 110	9HR(DV6C)	05/10 ⇨
C3 PICASSO 1.6 HDi 115	9HD(DV6C), 9HP(DV6DTEd)	01/13 ⇨
C3 PICASSO 1.6 HDi 90	9HP(DV6DTEd)	07/10 ⇨
C4 1.6 HDi	9HV(DV6TED4), DV6C	11/04 ⇨
C4 1.2 HDi	RHR(DW10BTEd4)	11/04 ⇨ 07/11
C4 1.6 BlueHdi 115	DV6C, DV6C	08/14 ⇨
C4 1.6 HDi	DV6C, 9HR(DV6C)	11/09 ⇨
C4 1.6 HDi 110	9HR(DV6C), 9HD(DV6C)	11/09 ⇨
C4 1.6 HDi 115	9HD(DV6C), 9HP(DV6DTEd)	07/12 ⇨
C4 1.6 HDi 90	9HP(DV6DTEd), DW10CFAPDTR	11/09 ⇨
C4 II 2.0 HDi	DW10CFAPDTR, DW10CTED4	10/10 ⇨
C4 II 2.0 HDi / BlueHdi 150	DW10CTED4, 9HY(DV6TED4)	11/09 ⇨
C4 II 2.0 HDi / BlueHdi 160	DW10CTED4	10/10 ⇨
C4 AIRCROSS 1.6 HDi 115	9HL(DV6C)	04/12 ⇨
C4 AIRCROSS 1.6 HDi 115 AWC	9HL(DV6C)	05/12 ⇨
C4 CACTUS 1.6 HDi 90	9HP(DV6DTEd), 9HY(DV6TED4)	09/14 ⇨
C4 GRAND PICASSO 1.6 HDi	9HY(DV6TED4), 9HL(DV6C)	10/06 ⇨ 06/11

CITROËN

C4 GRAND PICASSO I 1.6 HDi 110	9HL(DV6C), RHJ(DW10BTEd4)	09/10 ⇨
C4 GRAND PICASSO I 2.0 HDi 138	RHJ(DW10BTEd4), DW10CTED4	10/06 ⇨ 12/13
C4 GRAND PICASSO I 2.0 HDi 150	DW10CTED4, DW10CTED4	07/09 ⇨ 08/13
C4 GRAND PICASSO I 2.0 HDi 165	DW10CTED4, 9HC(DV6C)	09/10 ⇨ 08/13
C4 GRAND PICASSO II 1.6 HDi / BlueHdi 115	9HC(DV6C), 9HP(DV6DTEd)	09/13 ⇨
C4 GRAND PICASSO II 1.6 HDi 90	9HP(DV6DTEd), AHX(DW10FD)	09/13 ⇨
C4 GRAND PICASSO II 2.0 BlueHdi 135	DW10FD	09/13 ⇨
C4 GRAND PICASSO II 2.0 BlueHdi 135 Hybrid	AHS(DW10FD)	09/13 ⇨
C4 GRAND PICASSO II 2.0 BlueHdi 150	AHX(DW10FD), 9HV(DV6TED4)	09/13 ⇨
C4 PICASSO I 1.6 HDi	9HY(DV6TED4), 9HL(DV6C)	02/07 ⇨ 08/13
C4 PICASSO I 1.6 HDi 110	9HL(DV6C), RHJ(DW10BTEd4)	09/10 ⇨
C4 PICASSO I 2.0 HDi 138	RHJ(DW10BTEd4), DW10CTED4	10/06 ⇨ 08/13
C4 PICASSO I 2.0 HDi 150	DW10CTED4, DW10CTED4	07/09 ⇨ 08/13
C4 PICASSO I 2.0 HDi 165	DW10CTED4, DV6C	09/10 ⇨
C4 PICASSO II 1.6 HDi / BlueHdi 115	DV6C, 9HP(DV6DTEd)	02/13 ⇨
C4 PICASSO II 1.6 HDi 90	9HP(DV6DTEd), 9HL(DV6C)	02/13 ⇨
C4 PICASSO II 2.0 BlueHdi 135	DW10FD	09/13 ⇨
C4 PICASSO II 2.0 BlueHdi 135 Hybrid	AHS(DW10FD)	09/13 ⇨
C4 PICASSO II 2.0 BlueHdi 150	DW10FD	09/13 ⇨
C5 1.6 HDi	9HZ(DV6TED4)	09/04 ⇨
C5 1.2 HDi	RHR(DW10BTEd4)	09/04 ⇨
C5 II 1.6 HDi 110	9HL(DV6C), 9HL(DV6C)	02/08 ⇨
C5 II 1.6 HDi 115	9HL(DV6C), RHF(DW10BTEd4)	01/12 ⇨
C5 II 2.0 HDi	RHF(DW10BTEd4), AHR(DW10FD)	02/08 ⇨
C5 II 2.0 HDi 140	RHF(DW10BTEd4)	04/09 ⇨
C5 II 2.0 HDi 150 / BlueHdi 150	AHR(DW10FD), AHW(DW10FC)	04/09 ⇨
C5 II 2.0 HDi 165	RHH(DW10CTED4)	04/09 ⇨
C5 II 2.0 HDi 180	AHW(DW10FC), DT17ED4	03/15 ⇨
C5 II 2.2 HDi	4HT(DW12BTEd4)	02/08 ⇨
C5 II 2.2 HDi 165	4HP(DW12BTEd4)	02/08 ⇨
C5 II 2.2 HDi 200	4HL(DW12C)	07/10 ⇨
C5 II 2.7 HDi	DT17ED4, 4HP(DW12BTEd4)	02/08 ⇨
C5 II 3.0 HDi 240	DT20C	04/09 ⇨
C6 2.2 HDi	4HP(DW12BTEd4), DT17ED4	06/06 ⇨ 12/12
C6 2.7 HDi	DT17ED4, RHD(DW10CB)	09/05 ⇨ 12/11
C6 3.0 HDi	DT20C	04/09 ⇨ 12/12
C8 2.0 HDi 135	RHD(DW10CB), RHE(DW10CTED4)	03/06 ⇨
C8 2.0 HDi 165	RHE(DW10CTED4), 4HP(DW12BTEd4)	03/06 ⇨
C8 2.2 HDi	4HP(DW12BTEd4), 4HN(DW12MTEd4)	06/06 ⇨
C-CROSSER 2.2 HDi	4HN(DW12MTEd4), 9HP(DV6DTEd)	02/07 ⇨
C-CROSSER ENTERPRISE 2.2 HDi	4HN(DW12MTEd4)	01/09 ⇨
C-ELYSEE 1.6 HDi 92	9HP(DV6DTEd), 8HR(DV4C)	11/12 ⇨
DISPATCH 2.0 BlueHdi 120	DW10FE	06/16 ⇨
DS3 1.4 HDi 70	8HR(DV4C), 9HR(DV6C)	04/10 ⇨ 07/15
DS3 1.6 HDi 110	9HR(DV6C), 9HD(DV6C)	11/09 ⇨ 07/15
DS3 1.6 HDi 115	9HD(DV6C), 9HP(DV6DTEd)	08/12 ⇨ 07/15
DS3 1.6 HDi 90	9HP(DV6DTEd), 9HR(DV6C)	11/09 ⇨ 07/15
DS4 1.6 HDi 110	9HR(DV6C), 9HD(DV6C)	04/11 ⇨ 07/15
DS4 1.6 HDi 115	9HD(DV6C), 9HP(DV6DTEd)	08/12 ⇨ 07/15
DS4 1.6 HDi 90	9HP(DV6DTEd), AHX(DW10FD)	05/11 ⇨ 07/15
DS4 2.0 BlueHdi 150	AHX(DW10FD), AHW(DW10FC)	07/14 ⇨ 07/15
DS4 2.0 BlueHdi 150 Hybrid	AHR(DW10FD)	07/14 ⇨ 07/15
DS4 2.0 BlueHdi 180	AHW(DW10FC), AHS(DW10FD)	07/14 ⇨ 07/15
DS4 2.0 HDi / BlueHdi 135	AHS(DW10FD), DW10CTED4	09/11 ⇨ 07/15
DS4 2.0 HDi 165	DW10CTED4, DV6C	04/11 ⇨ 07/15
DS5 1.6 HDi 110	9HR(DV6C)	11/11 ⇨ 07/15
DS5 1.6 HDi 115	DV6C, AHW(DW10FC)	06/12 ⇨ 07/15
DS5 2.0 BlueHdi 135 Hybrid	AHS(DW10FD)	11/11 ⇨ 07/15
DS5 2.0 BlueHdi 150	DW10FD	07/14 ⇨ 07/15
DS5 2.0 BlueHdi 180	AHW(DW10FC), AHM(DW10FUE)	08/13 ⇨ 07/15
DS5 2.0 HDi 135	RHD(DW10CB)	11/11 ⇨ 07/15

CITROËN

DS5 2.0 HDi 150 Hybrid	AHX(DW10FD)	11/11 ⇨ 07/15
DS5 2.0 HDi 165	RHH(DW10CTED4)	11/11 ⇨ 07/15
DS5 2.0 HDi 165 Hybrid4 4x4	RHC(DW10CTED4)	12/11 ⇨ 07/15
JUMPER III 2.0 BlueHdi 110	AHM(DW10FUE), AHN(DW10FUD)	07/15 ⇨
JUMPER III 2.0 BlueHdi 130	AHN(DW10FUD), AHP(DW10FUC)	07/15 ⇨
JUMPER III 2.0 BlueHdi 130 4x4	AHN(DW10FUD)	04/16 ⇨
JUMPER III 2.0 BlueHdi 160	AHP(DW10FUC), 9HH(DV6DUM)	07/15 ⇨
JUMPER III 2.0 BlueHdi 160 4x4	AHP(DW10FUC)	04/16 ⇨
JUMPY II 1.6 HDi 90 8V	9HH(DV6DUM), AHZ(DW10CD)	01/07 ⇨
JUMPY II 2.0 HDi 120	RHG(DW10UTED4/FAP)	01/07 ⇨
JUMPY II 2.0 HDi 125	AHZ(DW10CD), AHY(DW10CE)	07/11 ⇨
JUMPY II 2.0 HDi 125 4x4	AHZ(DW10CD)	07/11 ⇨
JUMPY II 2.0 HDi 140	RHR(DW10BTEd4)	01/07 ⇨
JUMPY II 2.0 HDi 165	RHH(DW10CTED4)	07/10 ⇨
JUMPY II 2.0 HDi 95	AHY(DW10CE), AHJ(DW10FE)	07/11 ⇨
JUMPY III 1.6 HDi 90	DV6DU	04/16 ⇨
JUMPY III 2.0 BlueHdi 120	AHJ(DW10FE), AHR(DW10FD)	04/16 ⇨
JUMPY III 2.0 BlueHdi 150	AHR(DW10FD), AHJ(DW10FE)	04/16 ⇨
JUMPY III 2.0 BlueHdi 180	DW10FC	04/16 ⇨
SPACETOURER 2.0 BlueHdi 120	AHJ(DW10FE), DV6C	04/16 ⇨
SPACETOURER 2.0 BlueHdi 150	DW10FD	04/16 ⇨
SPACETOURER 2.0 BlueHdi 180	DW10FC	04/16 ⇨
XSARA PICASSO 1.6 HDi	9HZ(DV6TED4)	05/04 ⇨
DS 5 1.6 BlueHdi 115	DV6C, AHR(DW10FD)	06/15 ⇨
DS 5 2.0 BlueHdi 135	DW10FDD	06/15 ⇨
DS 5 2.0 BlueHdi 150	AHR(DW10FD), AHW(DW10FC)	04/15 ⇨
DS 5 2.0 BlueHdi 180	AHW(DW10FC), DW10CTED4	04/15 ⇨
DS 5 2.0 HDi 165 Hybrid4 4x4	DW10CTED4, AHR(DW10FD)	04/15 ⇨
DS4 / DS4 CROSSBACK 2.0 BlueHdi 150	AHR(DW10FD), AHW(DW10FC)	07/15 ⇨
DS4 / DS4 CROSSBACK 2.0 BlueHdi 180	AHW(DW10FC), 9H07	07/15 ⇨
FIAT		
SCUDO II 1.6 D Multijet	9H07, DW10BTEd4	01/07 ⇨
SCUDO II 2.0 D Multijet	DW10BTEd4, RH02	01/07 ⇨
SCUDO II 2.0 D Multijet 4x4	RHD, RHM	01/07 ⇨
ULYSSE II 2.0 D Multijet	RHR	05/06 ⇨ 06/11
ULYSSE II 2.0 JTD	RHM, 4H01	08/02 ⇨ 08/06
ULYSSE II 2.2 D Multijet	4H01, 4HP	10/07 ⇨
ULYSSE II 2.2 JTD	4HP, 4HS	08/02 ⇨ 06/11
LANCIA		
PHEDRA 2.0 D Multijet	RHR(DW10BTEd4)	07/06 ⇨ 11/10
PHEDRA 2.2 D Multijet	4HS, 9HZ	03/08 ⇨ 11/10
PHEDRA 2.2 JTD	4H01	03/08 ⇨
MINI		
MINI II Cooper D	9HZ, 9HZ	11/06 ⇨ 09/10
MINI II One D	9HZ, 4HK	06/09 ⇨ 07/10
MITSUBISHI		
ASX 1.6 Di	--	06/10 ⇨
ASX 1.6 Di-D	9HD	07/15 ⇨
ASX 1.6 Di-D 4WD	9HD	07/15 ⇨
OUTLANDER II 2.2 Di-D 4WD	4HK, 8HR(DV4C)	08/07 ⇨ 11/12
PEUGEOT		
206 1.6 HDi 110	9HZ(DV6TED4)	05/04 ⇨
206+ 1.4 HDi	DV4C	06/10 ⇨
206+ 1.4 HDi eco 70	DV4C, 9HP(DV6DTEd)	01/09 ⇨
207 1.4 HDi	8HR(DV4C)	02/06 ⇨
207 1.6 HDi	9HP(DV6DTEd), 9HR(DV6C)	02/06 ⇨
207 1.6 HDi 110	9HR(DV6C)	08/09 ⇨
207 CC 1.6 HDi	9HR(DV6C), 8HP(DV4C)	02/07 ⇨
208 1.4 HDi	8HP(DV4C), 9HP(DV6DTEd)	03/12 ⇨
208 1.6 HDi	9HP(DV6DTEd), 9HR(DV6C)	03/12 ⇨
301 1.6 HDi 90	9HF(DV6DTEd), 9HZ(DV6TED4)	11/12 ⇨
307 1.6 HDi	9HV(DV6ATED4)	04/05 ⇨ 03/09
307 1.6 HDi 110	9HZ(DV6TED4), DW10ATED	02/04 ⇨ 03/09
307 1.6 HDi 90	9HV(DV6ATED4)	12/06 ⇨ 04/08
307 2.0 HDi	DW10ATED, DW10ATED	01/03 ⇨ 12/09
307 2.0 HDi 110	DW10ATED, DW10BTEd4	08/00 ⇨ 12/09
307 2.0 HDi 135	DW10BTEd4, 9HP(DV6DTEd)	10/03 ⇨ 04/09
308 1.6 HDi	9HP(DV6DTEd), DW10BTEd4	09/07 ⇨
308 1.2 HDi	DW10BTEd4, 9HC(DV6C)	09/07 ⇨

PEUGEOT		
308 II 1.6 e-HDi 115	DV6C	03/15 →
308 II 1.6 HDi	DV6DTEd	09/13 →
308 II 1.6 HDi / BlueHdi 115	9HC(DV6C), 9HP(DV6DTEd)	09/13 →
308 II 1.6 HDi 92	9HP(DV6DTEd), AHX(DW10FD)	03/14 →
308 II 2.0 BlueHdi 150	AHX(DW10FD), AHW(DW10FC)	11/13 →
308 II 2.0 GT BlueHdi 180	DW10FC	06/17 →
308 II 2.0 GT HDi 180 / BlueHdi 180	AHW(DW10FC), 4HK(DW12MTEd4)	06/14 →
406 2.0 HDi 110	RHS(DW10ATED)	08/01 → 10/04
406 2.2 HDi	4HX(DW12TEd4/FAP)	03/00 → 12/04
407 2.0 HDi	DW10BTEd4, RHL(DW10BTEd4)	11/04 →
407 2.0 HDi [ExtraEU]	DW10BTEd4	11/04 → 10/07
407 2.0 HDi 135	RHL(DW10BTEd4), 4HP(DW12BTEd4)	05/04 →
407 2.2 HDi	4HP(DW12BTEd4), 4HR(DW12BTEd4)	03/06 →
407 2.2 HDi 170	4HR(DW12BTEd4), 9HD(DV6CTEd)	05/06 →
407 2.7 HDi	UHZ(DT17)	10/05 →
407 3.0 HDi	DT20C	06/09 →
508 I 1.6 HDi	9HD(DV6CTEd), AHX(DW10FD)	11/10 →
508 I 2.0 BlueHdi 150	AHX(DW10FD), AHW(DW10FC)	04/14 →
508 I 2.0 BlueHdi 180	AHW(DW10FC), DW10BTEd4	04/14 →
508 I 2.0 HDi	DW10BTEd4, RHC(DW10CTEd4)	11/10 →
508 I 2.0 HDi 180 RXH	DW10FC	10/14 →
508 I 2.0 HDi Hybrid4 AWC	RHC(DW10CTEd4), RHR(DW10BTEd4)	11/10 →
508 I 2.0 HDi RXH Hybrid4	RHC(DW10CTEd4)	11/10 →
508 I 2.2 HDi	4HL(DW12C)	11/10 →
607 2.0 HDi	RHR(DW10BTEd4), 4HP(DW12BTEd4)	03/01 → 07/11
607 2.0 HDi 135	RHL(DW10BTEd4)	09/05 →
607 2.2 HDi	4HP(DW12BTEd4), DW10CBDR/FAP	02/00 →
607 2.7 HDi 24V	DT17TEd4	12/04 → 07/11
807 2.0 HDi	DW10CBDR/FAP, 4HT(DW12BTEd4)	06/06 →
807 2.2 HDi	4HT(DW12BTEd4), AHN(DW10FUD)	06/02 →
1007 1.6 HDi	9HZ(DV6TEd4)	06/07 →
2008 1.4 HDi	8HR(DV4C), 9HP(DV6DTEd)	06/13 →
2008 1.6 HDi	9HP(DV6DTEd), DV4C	03/13 →
3008 1.6 HDi	9HR(DV6C), DV6C	06/09 → 08/16
3008 1.6 HDi 115 / BlueHdi 115	DV6C, DW10CBFAPDR	02/13 → 08/16
3008 2.0 HDi	DW10CBFAPDR, AHX(DW10FD)	06/09 →
3008 2.0 HDi 150 / BlueHdi 150	AHX(DW10FD), 9HF(DV6DTEd)	06/09 → 08/16
3008 2.0 HDi Hybrid4	RHC(DW10CTEd4)	02/11 → 08/16
4007 2.2 HDi	4HK(DW12MTEd4), 9HD(DV6C)	02/07 →
4008 1.6 HDi	DV6C	05/12 →
4008 1.6 HDi AWC	9HD(DV6C), DW10BTEd4	05/12 →
5008 1.6 HDi	9HD(DV6CTEd), DW10CBFAPDR	09/09 →
5008 2.0 HDi	DW10CBFAPDR, AHV(DW10FD)	09/09 →
5008 2.0 HDi 136 / BlueHdi 136	AHV(DW10FD), AHR(DW10FD)	02/12 →
5008 2.0 HDi 150 / BlueHdi 150	AHR(DW10FD), 9HD(DV6CTEd)	06/09 →
BOXER II 2.0 BlueHdi 110	DW10FUE	07/15 →
BOXER II 2.0 BlueHdi 130	AHN(DW10FUD), AHP(DW10FUC)	07/15 →
BOXER II 2.0 BlueHdi 160	AHP(DW10FUC), 9HM(DV6UC)	07/15 →
EXPERT II 1.6 HDi 90 8V	9HM(DV6UC), AHZ(DW10CD)	01/07 →
EXPERT II 2.0 HDi 120	RHG(DW10UTEd4/FAP)	01/07 →
EXPERT II 2.0 HDi 130	AHZ(DW10CD), 9HM(DV6UC)	03/11 →
EXPERT II 2.0 HDi 130 4x4	AHZ(DW10CD)	01/12 →
EXPERT II 2.0 HDi 140	RHR(DW10BTEd4)	01/07 →
EXPERT II 2.0 HDi 165	RHH(DW10CTEd4)	09/09 →
EXPERT II TEPEE 1.6 HDi 90 8V	9HM(DV6UC), AHZ(DW10CD)	01/07 →
EXPERT II TEPEE 2.0 HDi 100	AHY(DW10CE)	03/11 →
EXPERT II TEPEE 2.0 HDi 130	AHZ(DW10CD), 9HF(DV6DTEd)	03/11 →
EXPERT II TEPEE 2.0 HDi 130 4x4	AHZ(DW10CD)	03/11 →
EXPERT II TEPEE 2.0 HDi 140	RHR(DW10BTEd4)	01/07 →
EXPERT II TEPEE 2.0 HDi 165	RHH(DW10CTEd4)	09/09 →
EXPERT III 2.0 BlueHdi 120	DW10FE	04/16 →
EXPERT III 2.0 BlueHdi 150	DW10FD	04/16 →
EXPERT III 2.0 BlueHdi 180	DW10FC	04/16 →
PARTNER II 1.6 HDi	9HF(DV6DTEd), 9HN(DV6TEd)	04/08 →

PEUGEOT		
PARTNER II 1.6 HDi / BlueHdi 75	9HN(DV6TEd), DV6ATED4	07/11 →
PARTNER II 1.6 HDi 16V	DVGATED4, 9HP(DV6DTEd)	04/08 →
PARTNER II 1.6 HDi 90	9HP(DV6DTEd), 9HF(DV6DTEd)	04/10 →
PARTNER II TEPEE 1.6 HDi	9HF(DV6DTEd), 9HP(DV6DTEd)	04/08 →
PARTNER II TEPEE 1.6 HDi 16V	9HV(DV6TEd4)	04/08 →
PARTNER II TEPEE 1.6 HDi 90 RCZ 2.0 HDi	9HP(DV6DTEd), 4WZ-FHV RHH(DW10CTEd4)	04/10 → 03/10 → 12/15
TRAVELLER 2.0 BlueHdi 150	DW10FD	04/16 →
TRAVELLER 2.0 BlueHdi 180	DW10FC	04/16 →

TOYOTA		
PROACE 1.6 D	3WZ-TV	06/13 → 03/16
PROACE 2.0 D	4WZ-FHV, 4WZ-FHV	06/13 →
PROACE 2.0 D 4WD	4WZ-FTV	06/13 → 03/16
PROACE 2.0 D4d	4WZ-FTV	02/16 →
PROACE VERSO 2.0 D	4WZ-FHV, 937A8.000	02/16 →

10.3273  **3,5**

DIFFERENTIAL PRESSURE SENSORS

Adatt./Suitable:

- ALFA ROMEO**
51792301
- BOSCH**
0 281 002 770
0 281 002 771
- CHEVROLET**
55566186
- CHRYSLER**
5035213AA
K05035213AA
- FGP**
55204352
- FIAT**
51792301
55198717
71747292
- FORD**
1 557 672
1 563 425
95S1-5E260-AB
- GENERAL MOTORS**
55 566 186
93 187 247
- JEEP**
K05035213AA
- LANCIA**
51792301
55198717
71747292
- MOPAR PARTS**
05035213AA
- OPEL**
47 09 270
55566186
8 62 040
8 62 715
93187247
- SAAB**
93 187 247
- SUZUKI**
18590-79J50
18590-79J50-000
- VAUXHALL**
55566186
93187247

MARKET DIFFUSION: HIGH

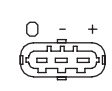

kPa	mV	
3,2 - 120,6	500 - 4500	

ALFA ROMEO

147 1.9 JTD 16V	192B1.000	10/04 → 03/10
147 1.9 JTDM	939A7.000	10/04 → 03/10
147 1.9 JTDM 16V	937A6.000	06/08 → 03/10
147 1.9 JTDM 8V	937A3.000	07/05 → 03/10
159 1.9 JTDM 16V	937A8.000, 937A7.000	09/05 → 11/11
159 1.9 JTDM 8V	937A7.000, 939A3.000	09/05 → 11/11

ALFA ROMEO		
159 1.9 JTS	939A6.000	09/05 → 11/11
159 2.4 JTDM	939A3.000, 939A3.000	09/05 → 12/12
159 2.4 JTDM Q4	939A9.000	05/07 → 11/11
159 MY2011 1.9 8V JTD	--	01/10 →
159 MY2011 2.4 JTD	--	01/10 →
BRERA 2.4 JTDM 20V	939A3.000, 199A3.000	01/06 → 06/10
GT 1.9 JTD	937A5.000	11/03 → 09/10
MITO 1.3 MultiJet	199A3.000, 939A3.000	08/08 →
SPIDER III 2.4 JTDM	939A3.000, Z19DTR	04/07 → 06/10

CADILLAC		
BLS 1.9 D	Z19DTR, LDV	04/06 →

CHEVROLET		
AVEO II 1.3 D	LDV, LKR	07/11 →
CRUZE 1.7 D	LUD	01/12 →
CRUZE 1.7 TD	LKR, --	08/12 →
MALIBU 2.0 D	LBS	04/12 →

CHRYSLER		
300C II 6.4	ESG	09/11 →

FIAT		
500 1.3 D Multijet	169A1.000	10/07 →
500 C 1.3 D Multijet	169A1.000	09/09 →
BRAVO II 1.4	192B2.000	04/07 → 12/14
BRAVO II 1.4 16V	--, 198A1.000	04/07 →
BRAVO II 1.4 T-Jet	198A1.000, 192A1.000	09/07 → 12/14
BRAVO II 1.9 D Multijet	192A1.000, 939A1.000	11/06 → 12/14
BRAVO II 1.9 D Multijet 8V	--	01/10 →
BRAVO II 1.9 D Multijet 16V	--	01/10 →
CROMA II 1.9 D Multijet	939A1.000, 199A2.000	06/05 →
CROMA II 1.9 MJTD	939A1.000	04/06 → 12/11
CROMA II 2.4 D Multijet	939A3.000	06/05 →
DOBLO I 1.3 D Multijet	199A2.000	10/05 →
DOBLO I 1.3 JTD 16V Multijet	223A9.000	08/06 →
DOBLO I 1.9 D Multijet	186A9.000	10/05 →
DOBLO I 1.9 JTD Multijet	186A9.000	12/06 →
FIORINO III 1.3 D Multijet	199A2.000, 199A2.000	11/07 →
GRANDE PUNTO 1.3 JTD Multijet	199A2.000, 188A9.000	02/06 → 06/13
IDEA 1.3 D Multijet	188A9.000, --	01/04 →
MULTIPLA 1.9 JTD	186A9.000	04/02 → 06/10
MULTIPLA 1.9 JTD 115	186A8.000	07/02 → 06/10
PANDA II 1.3 D Multijet	--, 199A2.000	01/06 →
PANDA II 1.3 D Multijet 4x4	169A1.000	01/06 →
PUNTO III / GRANDE PUNTO 1.3 D Multijet	199A2.000, 199A5.000	10/05 →
PUNTO III / GRANDE PUNTO 1.3 JTD	--	01/08 → 09/09
PUNTO III / GRANDE PUNTO 1.3 JTD Actual	--	09/09 →
PUNTO III / GRANDE PUNTO 1.9 D Multijet	199A5.000, 199A2.000	10/05 →
QUBO 1.3 D Multijet	199A2.000, 192A8.000	02/08 →
SEDICI 1.9 D Multijet	D19AA	06/06 → 10/11
SEDICI 1.9 D Multijet 4x4	D19AA	06/06 → 10/11
STILO 1.9 D	192B5.000	09/04 → 08/08
STILO 1.9 D Multijet	192A8.000, 192A1.000	09/05 → 08/08
STILO 1.9 JTD	192A1.000, BAAA	10/01 → 08/08

FORD		
KA II 1.3 TDCi	BAAA, A17DTJ	10/08 →

JEEP		
GRAND CHEROKEE 6.4 SRT8 4x4	ESG	03/11 →

LANCIA		
MUSA 1.3 D Multijet	199A3.000	09/06 → 09/12
THESIS 2.4 D Multijet	841P000	04/06 → 07/09

OPEL		
AGILA B 1.3 CDTi	D13A	04/08 → 04/10
ASTRA H 1.3 CDTi	Z13DTH	04/05 → 10/10
ASTRA H 1.7 CDTi	A17DTJ, Z19DT	02/07 → 05/14
ASTRA H 1.9 CDTi	Z19DT, A17DTC	06/04 → 10/10
ASTRA H 1.9 CDTi 16V	Z19DTJ	04/04 → 10/10
ASTRA J 1.3 CDTi	A13DTE	12/09 → 10/15
ASTRA J 1.7 CDTi	A17DTC, A20DTH	09/09 → 10/15
ASTRA J 2.0 Biturbo CDTi	A20DTR	09/12 → 10/15
ASTRA J 2.0 CDTi	A20DTH, A20DTH	09/09 →
CASCADA 2.0 CDTi	A20DTH, A13DTC	04/13 →
CORSA D 1.3 CDTi	A13DTC, A17DTS	07/06 → 08/14
CORSA D 1.7 CDTi	A17DTS, A20DTR	08/06 → 08/14
INSIGNIA 2.0 Biturbo CDTi	A20DTR, A20DTR	07/08 → 03/17
INSIGNIA 2.0 Biturbo CDTi 4x4	A20DTR, A20DT	07/08 → 03/17
INSIGNIA 2.0 CDTi	A20DT, A20DTH	07/08 → 03/17
INSIGNIA 2.0 CDTi 4x4	A20DTH, A17DTR	06/10 → 03/17
MERIVA A 1.3 CDTi	Z13DTJ	09/03 → 05/10
MERIVA A 1.7 CDTi	A17DTR, A13DTC	09/03 → 05/10
MERIVA B 1.3 CDTi	A13DTC, A17DT	06/10 → 11/14
MERIVA B 1.7 CDTi	A17DT, Z19DT	06/10 → 01/17
MOKKA 1.7 CDTi	A17DTS	06/12 →
MOKKA 1.7 CDTi 4x4	A17DTS	06/12 →
SIGNUM 1.9 CDTi	Z19DT, Z19DT	04/04 →

OPEL			
SIGNUM 3.0 V6 CDTI	Z30DT	09/05 → 12/08	
VECTRA C 1.9 CDTI	Z19DT, A17DTJ	04/04 → 01/09	
VECTRA C 3.0 CDTI	Z30DT	08/05 → 08/08	
VECTRA C 3.0 V6 CDTI	Z30DT	08/05 → 08/08	
ZAFIRA B 1.7 CDTI	A17DTJ, Z19DT	01/08 → 04/15	
ZAFIRA B 1.9 CDTI	Z19DT, A20DT	07/05 → 04/15	
ZAFIRA C 2.0 Biturbo CDTI	A20DTR	01/13 →	
ZAFIRA C 2.0 CDTI	A20DT, Z19DT	10/11 →	

SAAB			
9-3 1.9 TiD	Z19DT, A19DTR	09/04 → 02/15	
9-3 1.9 TiTD	A19DTR, D13A	12/07 → 02/15	
9-5 1.9 TiD	Z19DTH	01/06 → 12/09	
9-3X 1.9 TiTD AWD	Z19DTR	02/09 → 12/12	

VAUXHALL			
AGILA B 1.3 CDTI	D13A, A17DTJ	01/08 → 11/14	
ASTRA V 1.3 CDTI	Z13DTH	01/04 → 11/10	
ASTRA V 1.7 CDTi	A17DTJ, Z19DT	01/04 → 10/12	
ASTRA V 1.9 CDTI	Z19DT, A17DTC	01/04 → 11/10	
ASTRA V 1.9 CDTI 16V	Z19DTJ	01/04 → 05/09	
ASTRA VI 1.3 CDTI	A13DTE	12/09 →	
ASTRA VI 1.7 CDTI	A17DTC, A20DTH	12/09 →	
ASTRA VI 2.0 Biturbo CDTI	A20DTR	12/12 →	
ASTRA VI 2.0 CDTI	A20DTH, A17DTJ	12/09 →	
ASTRAVAN III 1.3 CDTi	Z13DTH	08/05 →	
ASTRAVAN III 1.7 CDTi	A17DTJ, Z19DT	06/11 →	
ASTRAVAN III 1.9 CDTi	Z19DT, A20DTH	03/05 → 11/11	
CASCADA 2.0 CDTI	A20DTH, A13DTC	02/13 →	
CORSA 1.3 CDTI	A13DTC, A17DTS	08/06 → 08/14	
CORSA D 1.7 CDTI	A17DTS, A13DTC	11/06 → 08/14	
CORSAVAN III 1.3 CDTI	A13DTC, A20DT	07/06 →	
INSIGNIA 2.0 Biturbo CDTI	A20DTR	03/12 → 05/17	
INSIGNIA 2.0 Biturbo CDTI 4x4	A20DTR	03/12 → 05/17	
INSIGNIA 2.0 CDTI	A20DT, A20DTH	07/08 → 05/17	
INSIGNIA 2.0 CDTI 4x4	A20DTH, A13DTC	07/08 → 05/17	
MERIVA I 1.3 CDTI	Z13DTJ	01/03 → 10/09	
MERIVA I 1.7 CDTi	Z17DTR	08/06 → 06/10	
MERIVA II 1.3 CDTI	A13DTC, A17DT	06/10 →	
MERIVA II 1.7 CDTI	A17DT, Z19DT	06/10 →	
MOKKA / MOKKA X 1.7 CDTI	A17DTS	06/12 →	
MOKKA / MOKKA X 1.7 CDTI 4x4	A17DTS	06/12 →	
SIGNUM 1.9 CDTI	Z19DT	04/04 → 03/08	
SIGNUM 1.9 CDTI 16V	Z19DTH	04/04 → 03/08	
SIGNUM 1.9 Turbo	Z19DTL	01/05 → 05/08	
SIGNUM 3.0 V6 CDTI	Z30DT	07/05 → 06/08	
VECTRA C 1.9 CDTI	Z19DT, A17DTJ	04/02 → 09/08	
VECTRA C 1.9 CDTI 16V	Z19DTH	04/04 → 05/09	
VECTRA C 3.0 CDTi	Z30DT	08/05 → 07/08	
ZAFIRA B 1.7 CDTI	A17DTJ, Z19DT	01/08 → 11/14	
ZAFIRA B 1.9 CDTI	Z19DT, A20DT	07/05 → 11/14	
ZAFIRA C 2.0 Biturbo CDTI	A20DTR	11/12 → 08/18	
ZAFIRA C 2.0 CDTI	A20DT, BPY	10/11 →	

10.3275



3,5

DIFFERENTIAL PRESSURE SENSORS

Adatt./Suitable:

ATE
10.0522-9803.1

AUDI
1KO 998 213

SEAT
1KO 998 213

VW
1KO 906 207
1KO 998 213

MARKET DIFFUSION: HIGH



kPa	mV	
-70 - 10 / -10 - -70	1521 - 4075 / 3453 - 895	

AUDI

TT II 2.0 TDI quattro	CBBB	06/08 → 06/14
TT II 2.0 TFSI	BPY, BWA	08/06 → 06/10
TT II 2.0 TFSI quattro	BWA, CDLA	06/08 → 06/10
TT II 2.0 TTS quattro	CDLA, BXW	05/08 → 06/14
TT II 3.2 V6 quattro	BUB	08/06 → 06/10

SEAT

ALTEA 1.2 TSI	CBZB	04/10 →
ALTEA 1.4 16V	BXW, BSE	05/06 →
ALTEA 1.4 TSI	CAXC	11/07 →
ALTEA 1.6	BSE, CAYB	03/04 →
ALTEA 1.6 LPG	CHGA	09/09 →
ALTEA 1.6 TDI	CAYB, BYT	10/09 →
ALTEA 1.8 TFSI	BYT, BLS	01/07 →
ALTEA 1.9 TDI	BLS, BVY	04/04 →
ALTEA 2.0 FSI	BVY, AZV	05/04 → 03/09
ALTEA 2.0 TDI	AZV, BXW	03/04 →
ALTEA 2.0 TDI 16V	BKD	03/04 →
ALTEA 2.0 TFSI	BWA	04/06 → 05/09
ALTEA XL 1.2 TSI	CBZB	04/10 →
ALTEA XL 1.4 16V	BXW, BSE	10/06 →
ALTEA XL 1.4 TSI	CAXC	11/07 →
ALTEA XL 1.6	BSE, CAYB	10/06 →
ALTEA XL 1.6 LPG	CHGA	09/09 →
ALTEA XL 1.6 Multifuel	CCSA	10/06 →
ALTEA XL 1.6 TDI	CAYB, BYT	10/09 →
ALTEA XL 1.8 TFSI	BYT, BLS	01/07 →
ALTEA XL 1.9 TDI	BLS, BVY	10/06 →
ALTEA XL 1.9 TDI 4x4	BLS	06/09 → 12/10
ALTEA XL 2.0 FSI	BVY, AZV	10/06 → 03/09
ALTEA XL 2.0 TDI	AZV, BMM	10/06 →
ALTEA XL 2.0 TDI 16V	BKD	10/06 →
ALTEA XL 2.0 TDI 4x4	BMM, BWA	06/07 →
ALTEA XL 2.0 TFSI	BWA	10/06 → 05/09
ALTEA XL 2.0 TFSI 4x4	BWA, BSE	06/07 →
LEON II 1.4 TSI	CAXC	11/07 → 12/12
LEON II 1.6	BSE, BLR	07/05 → 12/12
LEON II 1.6 LPG	CHGA	12/09 → 12/12
LEON II 1.6 MultiFuel	BSE	11/10 → 12/12
LEON II 1.9 TDI	BKC	07/05 → 12/10
LEON II 2.0 FSI	BLR, BLG	07/05 → 05/10
LEON II 2.0 TDI	AZV	07/05 → 05/10

VW

GOLF V 1.4	BUD	06/07 → 07/09
GOLF V 1.4 16V	BUD	05/06 → 11/08
GOLF V 1.4 TSI	BLG, BSE	11/05 → 07/09
GOLF V 1.6	BSE, BKC	01/04 → 07/09
GOLF V 1.6 MultiFuel	CCSA	10/07 → 07/09
GOLF V 1.9 TDI	BKC, BKC	10/03 → 07/09
GOLF V 1.9 TDI 4motion	BKC, BHY	08/04 → 07/09
GOLF V 2.0	BHY, BVX	08/06 → 07/09
GOLF V 2.0 FSI	BVX, BPY	01/04 → 11/08
GOLF V 2.0 FSI 4motion	BVX	08/04 → 11/08
GOLF V 2.0 GTI	BPY, AZV	10/04 → 02/09
GOLF V 2.0 SDI	BKD	01/04 → 11/08

GOLF V 2.0 TDI	AZV, BKD	10/03 →
GOLF V 2.0 TDI 16V	BKD, CBTA	10/03 → 07/09
GOLF V 2.0 TDI 16V 4motion	BKD	08/04 → 11/08
GOLF V 2.0 TDI 4motion	AZV	08/04 → 07/09
GOLF V 2.5	CBTA, CBZA	05/07 → 11/08
GOLF VI 1.2 TSI	CBZA, BUD	11/08 →
GOLF VI 1.4	BUD, BUD	10/08 → 07/13
GOLF VI 1.4 16V	BUD, CAVD	01/09 → 05/11
GOLF VI 1.4 TSI	CAVD, BSE	10/08 →
GOLF VI 1.6	BSE, CCSA	01/09 → 07/13
GOLF VI 1.6 BiFuel	CHGA	03/09 → 11/12
GOLF VI 1.6 MultiFuel	CCSA, CAYB	10/08 → 07/13
GOLF VI 1.6 TDI	CAYB, CBFA	02/09 → 07/13
GOLF VI 1.6 TDI 4motion	CAYC	07/09 → 07/13
GOLF VI 1.8 TSI	CDA	06/09 → 01/11
GOLF VI 2.0 GTi	CBFA, CDLA	04/09 → 11/13
GOLF VI 2.0 R 4motion	CDLA, BMM	11/09 → 11/12
GOLF VI 2.0 TDI	BMM, CBAB	10/08 → 07/13
GOLF VI 2.0 TDI 4motion	CBAB, CAVD	05/09 → 11/12
GOLF VI 2.0 TSI	CCZA	07/09 → 07/13
GOLF VI 2.5	CBUA	07/09 → 05/11
JETTA V 1.4 TSI	CAVD, BSE	05/07 → 10/10
JETTA V 1.6	BSE, CAYB	10/05 → 10/10
JETTA V 1.6 MultiFuel	CCSA	01/08 → 10/10
JETTA V 1.6 TDI	CAYB, BKC	06/09 → 10/10
JETTA V 1.9 TDI	BKC, AZV	08/05 → 10/10
JETTA V 2.0 TDI	AZV, CBDB	09/05 → 10/10
JETTA V 2.0 TDI 16V	CBDB, BPY	08/05 → 10/10
JETTA V 2.0 TFSI	BPY, BGP	10/05 → 10/10
JETTA V 2.5	BGP, BZB	01/06 → 10/10
PASSAT V 1.4 TSI	CAXA	05/07 → 11/10
PASSAT V 1.4 TSI EcoFuel	CDGA	01/09 → 11/10
PASSAT V 1.6	BSE, BZB	05/05 → 11/10
PASSAT V 1.6 FSI	BLF	03/05 → 06/08
PASSAT V 1.6 TDI	CAYC	08/09 → 11/10
PASSAT V 1.8 TSI	BZB, BLS	05/07 → 10/11
PASSAT V 1.9 TDI	BLS, BPY	03/05 → 11/10
PASSAT V 2.0 BlueTDI	CBAC	01/09 → 11/10
PASSAT V 2.0 FSI	BPY, BMA	03/05 → 11/10
PASSAT V 2.0 FSI 4motion	BVX	09/05 → 11/10
PASSAT V 2.0 TDI	BMA, BKP	03/05 → 11/10
PASSAT V 2.0 TDI 16V	BKP, BKP	03/05 → 11/10
PASSAT V 2.0 TDI 16V 4motion	BKP, BMP	03/05 → 11/10
PASSAT V 2.0 TDI 4motion	BMP, CAVD	03/05 → 11/10
PASSAT V 3.2 FSI 4motion	AZV	11/05 → 11/10
PASSAT V 3.6 FSI	BLV	06/05 → 11/10
PASSAT V 3.6 FSI 4motion	BLV	09/05 → 11/10
PASSAT V 3.6 R36 4motion	BWS	04/07 → 11/10
PASSAT CC 1.4 TSI MultiFuel	CKMA	01/11 → 01/12
PASSAT CC 1.8 TSI	BZB, CBAA	06/08 → 01/12
PASSAT CC 2.0 BlueTDI	CBAC	05/09 → 11/10
PASSAT CC 2.0 TDI	CBAA, CBAB	05/08 → 01/12
PASSAT CC 2.0 TDI 4motion	CBAB, CAWB	08/09 → 01/12
PASSAT CC 2.0 TSI	CAWB, BLV	06/08 → 01/12
PASSAT CC 3.6 FSI	BLV, BLV	06/08 →
PASSAT CC 3.6 FSI 4motion	BLV, BSE	02/08 → 01/12
SCIROCCO III 1.4 TSI	CAVD, CDLA	05/08 →
SCIROCCO III 2.0 R	CDLA, CBBB	11/09 → 11/17
SCIROCCO III 2.0 TDI	CBBB, CAWB	08/08 → 11/17
SCIROCCO III 2.0 TSI	CAWB, BSE	05/08 → 11/17
TOURAN I 1.4 FSI	BLG	11/06 → 05/10
TOURAN I 1.4 TSI	BMY	02/06 → 05/10
TOURAN I 1.6	BSE, BKC	07/03 → 05/10
TOURAN I 1.9 TDI	BKC, BLR	08/03 → 05/10
TOURAN I 2.0 EcoFuel	BSX	02/06 → 05/09
TOURAN I 2.0 FSI	BLR, AZV	10/03 → 01/07
TOURAN I 2.0 TDI	AZV, 4HG(P22DTE)	02/03 → 05/10
TOURAN I 2.0 TDI 16V	BKD	08/03 → 05/10

10.3277



3

DIFFERENTIAL PRESSURE SENSORS

Adatt./Suitable:

CITROËN

16 066 108 80

FORD

1 545 549 *1
1 546 997 *1
1 573 374 *K
1 600 077
1 693 102 *1
1 722 675 *1
1 722 679 *1
1 725 470 *3
6G9N-5L200-AB
8V21-5H209-CD *1
AB39-5L224-AA*3
AV21-5H209-AB *1

FORD USA

1 725 470 *3
AB39-5L224-AA*3

MAZDA

Y645-18-215A *K
Y645-18-215B *K
Y660-18-215A

PEUGEOT

16 066 108 80

VOLVO

30713750
30785486
30785486-AA

*1 without fastening damp

- senza staffa fissaggio
- sans bride de fixation
- ohne Befestigungsbügel
- sin estribo de sujeción

*3 without connecting pipe

- senza tubo raccordo
- sans tuyau de raccordement
- ohne Anschlussrohr
- sin tubo de conexión

*K No mounting bracket and no connecting pipes supplied

- Fornito senza staffa di fissaggio e senza tubi di raccordo
- Livré sans support de fixation et sans tuyaux de raccord
- Keine Halterung und Verbindungsrohre geliefert
- Soporte de montaje y conexión de tuberías no suministrados

MARKET DIFFUSION: HIGH



kPa	mV	
10 - 70	985,7 - 4201,6	

CITROËN

JUMPER III 2.2 HDi 110	4HG(P22DTE), 4HJ(P22DTE)	07/11 ⇨
JUMPER III 2.2 HDi 130	P22DTE	07/11 ⇨
JUMPER III 2.2 HDi 150	4HJ(P22DTE), F6JD	07/11 ⇨

FORD

FIESTA VI 1.4 TDCi	F6JD, HHJC	07/10 ⇨
FIESTA VI 1.6 TDCi	HHJC, --	06/08 ⇨
FIESTA VI 1.6 TDCi SOHC	--	02/10 ⇨
RANGER VI 2.2 TDCi	--, --	11/11 ⇨
RANGER VI 2.2 TDCi 4x4	--, HCPA	04/11 ⇨
RANGER VI 3.2 TDCi 4x4	SAFA	04/11 ⇨
TOURNEO CONNECT I 1.8 TDCi	HCPA, BHPA	06/02 ⇨ 12/13
TOURNEO CONNECT I 1.8 TDCi /TDDi /Di	BHPA, BHPA	06/02 ⇨ 12/13
TRANSIT III 2.2 TDCi	CYFA, CYRB	04/06 ⇨ 08/14
TRANSIT III 2.2 TDCi 4x4	CYRB, CVRA	10/11 ⇨ 08/14
TRANSIT III 2.2 TDCi RWD	CVRA, --	09/11 ⇨
TRANSIT III 2.4 TDCi	--, H9FD	04/06 ⇨
TRANSIT III 2.4 TDCi 4x4	H9FB	11/06 ⇨ 08/14
TRANSIT III 2.4 TDCi HPCR	--	07/06 ⇨
TRANSIT III 2.4 TDCi RWD	H9FD, SAFA	04/06 ⇨ 08/14
TRANSIT III 3.2 TDCi	SAFA, SAFA	02/08 ⇨ 08/14
TRANSIT III 3.2 TDCi RWD	SAFA, PGFA	09/07 ⇨ 08/14
TRANSIT CONNECT I 1.8 Di	BHPA, HCPA	06/02 ⇨ 12/13
TRANSIT CONNECT I 1.8 TDCi	HCPA, CYFA	06/02 ⇨ 12/13
TRANSIT TOURNEO 2.2 TDCi	PGFA, Y406	07/06 ⇨ 08/14

MAZDA

2 II 1.6 MZ-CD	Y406, 4HG(P22DTE)	10/08 ⇨ 06/15
----------------	-------------------	---------------

PEUGEOT

BOXER II 2.2 HDi 110	4HG(P22DTE), 4HH(P22DTE)	03/11 ⇨
BOXER II 2.2 HDi 130	4HH(P22DTE), 4HJ(P22DTE)	03/11 ⇨
BOXER II 2.2 HDi 150	4HJ(P22DTE), D5244T13	03/11 ⇨

VOLVO

C30 D3	D5204T5	10/10 ⇨ 12/12
C30 D4	D5204T	10/10 ⇨ 12/12
C30 D5	D5244T13, D5244T13	10/06 ⇨ 12/12
C70 II 2.4 D	D5244T9	03/07 ⇨ 06/13
C70 II D3	D5204T5	10/10 ⇨ 06/13
C70 II D4	D5204T	10/10 ⇨ 06/13

VOLVO

C70 II D5	D5244T13, D5244T13	03/06 ⇨ 06/13
S40 II 2.4 CDI	D5244T9	03/07 ⇨ 12/10
S40 II 2.4 D5	D5244T13, D5204T2	03/06 ⇨ 12/10
S40 II D3	D5204T5	10/10 ⇨ 12/12
S40 II D4	D5204T	10/10 ⇨ 12/12
S60 II 2.4 D4 AWD	D5244T21	03/15 ⇨
S60 II D3	D5204T2, D5244T10	04/10 ⇨ 12/15
S60 II D4	D5204T3	04/10 ⇨ 12/14
S60 II D5	D5244T10, D5244T10	04/10 ⇨ 12/15
S60 II D5 AWD	D5244T10, D5244T14	04/10 ⇨ 12/15
S80 II 2.0 TDi	D4204T	02/08 ⇨ 03/11
S80 II 2.4 D	D5244T14, D5204T2	03/06 ⇨
S80 II D3	D5204T7	05/12 ⇨
S80 II D3 / D4	D5204T2, D5244T10	01/10 ⇨
S80 II D5	D5244T10, D5244T10	03/06 ⇨
S80 II D5 AWD	D5244T10, D5244T13	01/07 ⇨
V50 2.4 D5	D5244T13, D5244T11	03/06 ⇨ 12/10
V50 2.4 Tdi	D5244T9	05/07 ⇨ 12/10
V50 D3	D5204T5	10/10 ⇨ 12/12
V50 D4	D5204T	10/10 ⇨ 12/12
V60 I 2.0 D3	D5204T7	09/13 ⇨ 12/15
V60 I 2.0 D4	D5204T3	09/13 ⇨ 12/15
V60 I 2.4 D4 AWD	D5244T12	09/13 ⇨ 12/15
V60 I 2.4 D5	D5244T11, D5244T11	04/11 ⇨ 12/15
V60 I 2.4 D5 AWD	D5244T11, D5244T15	04/11 ⇨ 12/15
V60 I 2.4 D5 Hybrid AWD	D87PHEV	03/15 ⇨
V60 I 2.4 Hybrid D6 AWD	D5244T15, D5204T2	06/12 ⇨ 12/15
V60 I D3	D5204T7	05/12 ⇨ 12/15
V60 I D3 / D4	D5204T2, D5244T12	07/10 ⇨ 12/14
V60 I D4 AWD	D5244T12, D5244T10	05/12 ⇨
V60 I D5	D5244T10, D5244T10	07/10 ⇨ 12/15
V60 I D5 AWD	D5244T10, D5244T14	07/10 ⇨ 12/15
V60 I D6 Hybrid AWD	D97PHEV	03/15 ⇨
V70 2.0 D4/D4 DRIVE	D5204T3	09/13 ⇨
V70 III 2.0 D	D4204T	10/07 ⇨ 12/15
V70 III 2.0 D3 DRIVE	D5204T7	09/13 ⇨
V70 III 2.4 D	D5244T14, D5244T11	04/07 ⇨ 12/10
V70 III 2.4 D4 AWD	D5244T17	09/13 ⇨
V70 III 2.4 D5	D5244T11, D5204T2	09/13 ⇨
V70 III D3	D5204T7	10/07 ⇨ 12/15
V70 III D3 / D4	D5204T2, D5244T12	03/10 ⇨ 12/15
V70 III D4 AWD	D5244T12, D5244T10	10/07 ⇨
V70 III D5	D5244T10, D5244T10	04/07 ⇨
V70 III D5 AWD	D5244T10, D5244T16	04/07 ⇨
XC60 I 2.4 D	D5244T14	04/09 ⇨ 12/10
XC60 I 2.4 D / D3 / D4 AWD	D5244T16, D5204T2	05/08 ⇨ 02/17
XC60 I 2.4 D AWD	D5244T14	06/09 ⇨ 12/10
XC60 I D3	D5204T7	04/12 ⇨ 12/15
XC60 I D3 / D4	D5204T2, D5244T12	03/10 ⇨ 12/14
XC60 I D4 AWD	D5244T12, D5244T10	10/13 ⇨ 02/17
XC60 I D5	D5244T11	06/11 ⇨ 02/17
XC60 I D5 AWD	D5244T10, D5244T16	05/08 ⇨ 02/17
XC70 II 2.4 D	D5244T14	06/09 ⇨ 12/10
XC70 II 2.4 D / D4 AWD	D5244T16, D5204T2	08/07 ⇨
XC70 II D3	D5204T2, D5244T10	04/10 ⇨ 12/15
XC70 II D3 AWD	D5204T2	08/11 ⇨
XC70 II D4 AWD	D5244T12	10/13 ⇨
XC70 II D5 AWD	D5244T10, CAXC	04/07 ⇨

10.3280



3,5

DIFFERENTIAL PRESSURE SENSORS

Adatt./Suitable:

AUDI

1K0 612 041 EN *7
1K0 612 041 JT *7
1K0 612 041 KG *7

BOSCH

0 261 230 169
0 261 230 170

PORSCHE

991 355 577 04 *3
991 355 577 05 *3
991 355 578 02 *3
991 355 578 03 *3

SEAT

1K0 612 041 EP *7
1K0 612 041 KG *7
7N0 612 041 *7
7N0 612 041 F *7

SKODA

1K0 612 041 EP *7
1K0 612 041 HK *3
1K0 612 041 KG *7
3T0 612 041 D *7
3T0 612 041 H *7
3T0 612 041 K *7

VW

1K0 612 041 EM *7
1K0 612 041 EN *7
1K0 612 041 EP *7
1K0 612 041 GD *7
1K0 612 041 HK *3
1K0 612 041 HT *7
1K0 612 041 JT *7
1K0 612 041 KG *7
1K0 612 041 KH *7
1K0 612 041 KJ *3
1K0 906 207 A
3AA 612 041 AH *3
3AA 612 041 D *7
5N0 612 041 BG *7
7N0 612 041 *7
7N0 612 041 F *7

NEW - ITEM NOW AVAILABLE FROM PRODUCTION

- NUOVO - ARTICOLO ORA DISPONIBILE PER LA VENDITA
- NOUVEAU - ARTICLE DISPONIBLE EN PRODUCTION COURANTE
- NEU - JETZ ZUM VERKAUF VERFÜGBARER ARTIKEL
- NUEVO - ARTICULO AHORA DISPONIBLE EN PRODUCCION

*3 without connecting pipe

- senza tubo raccordo
- sans tuyau de raccordement
- ohne Anschlussrohr
- sin tubo de conexión

*7 without connector parts

- senza pezzi raccordo
- sans raccords
- ohne Anschlusssteile
- sin piezas de conexión

MARKET DIFFUSION: MEDIUM



kPa	mV	
-3,8 - 104,2	500 - 4500	

AUDI

A3 II 1.2 TSI	CBZB	04/10 ⇨ 08/12
A3 II 1.4 TFSI	CAXC, CAXC	09/07 ⇨ 08/12
A3 II 1.6	BSE	05/03 ⇨ 08/12
A3 II SPORTBACK 1.2 TSI	CBZB	04/10 ⇨ 03/13
A3 II SPORTBACK 1.4 TFSI	CAXC, CAVA	09/07 ⇨ 03/13
A3 II SPORTBACK 1.6	BSE	09/04 ⇨ 03/13

PORSCHE

911 VI 3.0 Carrera	MDC.KA	11/15 ⇨
911 VI 3.0 Carrera 4	MDC.KA	11/15 ⇨
911 VI 3.0 Carrera 4S	MDC.HA	11/15 ⇨
911 VI 3.0 Carrera S	MDC.HA	11/15 ⇨
911 VI 3.4 Carrera	MA1.04	12/11 ⇨
911 VI 3.4 Carrera 4	MA1.04	11/12 ⇨
911 VI 3.8 Carrera 4S	MA1.03	11/12 ⇨
911 VI 3.8 Carrera 4S / 4 GTS	MA1.03	11/12 ⇨
911 VI 3.8 Carrera S	MA1.03	12/11 ⇨
911 VI 3.8 Carrera S / GTS	MA1.03	07/12 ⇨
911 VI 3.8 GT3	MA1.75	08/13 ⇨
911 VI 3.8 Turbo	MA1.71	09/13 ⇨
911 VI 3.8 Turbo S	MA1.71	09/13 ⇨
911 VI 4.0 GT3 RS / R	MA1.76	04/15 ⇨
BOXSTER III 2.7	MA1.22	04/12 ⇨
BOXSTER III 3.8	MDB.XA	07/15 ⇨
BOXSTER III GTS 3.4	--	02/14 ⇨
BOXSTER III S 3.4	MA1.23	04/12 ⇨
CAYMAN II 2.7	MA1.22	03/13 ⇨
CAYMAN II 3.8 GT4	MDB.XA	01/15 ⇨
CAYMAN II GTS 3.4	--	02/14 ⇨
CAYMAN II S 3.4	MA1.23	03/13 ⇨

SEAT

ALHAMBRA III 1.4 TSI	CAVA, CDA	06/10 ⇨
LEON II 1.4 TSI	CAXC	11/07 ⇨ 12/12
TOLEDO III 1.4 TSI	CAXC	11/07 ⇨ 05/09

SKODA		
SUPERB II 1.8 TSI 4x4	CDA, BLG	11/08 → 05/15
SUPERB II 2.0 TDI 4x4	CBBB	09/08 → 05/15
YETI 1.2 TSI	CYVB	05/15 → 12/17
YETI 1.4 TSI	CZCA	05/15 → 12/17
YETI 1.4 TSI 4x4	CZDA	05/15 → 12/17
VW		
CC 1.4 TSI	CZDA	05/15 → 12/16
CC 1.4 TSI MultiFuel	CKMA	11/11 → 12/16
GOLF V 1.4 TSI	BLG, CBZA	11/05 → 12/13
GOLF V 1.6	BSE	01/04 → 07/09
GOLF VI 1.2 TSI	CBZA, CAVD	11/09 →
GOLF VI 1.4	CNWA	04/11 → 05/12
GOLF VI 1.4 TSI	CAVD, BSE	10/08 →
GOLF VI 1.6	BSE, CAVD	01/09 →
GOLF VI 2.0 TSI	CULC	11/13 → 05/16
JETTA V 1.4 TSI	CAVD, CJZD	05/07 → 10/10
JETTA VI 1.4 TSI	CJZD, CAXA	02/11 →
JETTA VI 1.4 TSI	CAXA, CAVD	04/11 →
PASSAT V 1.4 TSI	CTHD	11/12 → 12/14
PASSAT V 1.4 TSI MultiFuel	CKMA	11/10 → 12/14
PASSAT CC 1.4 TSI MultiFuel	CKMA	01/11 → 01/12
SCIROCCO III 1.4 TSI	CAVD, CAVA	05/08 →
SHARAN II 1.4 TSI	CAVA, CAWA	05/10 →
TIGUAN I 2.0 TFSI	CCTB	05/08 →
TIGUAN I 2.0 TFSI 4motion	CAWA, CCZB	09/07 →
TIGUAN I 2.0 TSI 4motion	CCZB, CAVB	05/11 →
TOURAN I 1.2 TSI	CBZB	05/10 → 05/15
TOURAN I 1.4 FSI	CAVB	11/06 → 05/10
TOURAN I 1.4 TSI	CAVB, D4HB	02/06 → 05/15
TOURAN I 1.4 TSI EcoFuel	CDGA	05/09 → 05/15

10.3284



3,5

DIFFERENTIAL PRESSURE SENSORS

Adatt./Suitable:

DENSO

1220 12Q16
1220 4M12
499000-1330

FIAT

6000608599

HYUNDAI

39210-2A800

KIA

39210-2A800

MAZDA

R2BF-18-2B2
R2Y1-18-2B5 *1

MITSUBISHI

1865A292

NISSAN

22771-1AT0A
22771-1AT0B

RENAULT TRUCKS

74 85 133 040

MARKET DIFFUSION: MEDIUM



kPa	mV	
-14,1 - 100	500 - 4500	

FIAT		
FULLBACK 2.4 D	4N15	01/16 →
FULLBACK 2.4 D 4x4	4N15	01/16 →
HYUNDAI		
ACCENT IV 1.6 CRDi	D4FB	11/10 → 12/15
ELANTRA V 1.6 CRDi	D4FB	02/11 → 12/15
GRAND SANTA FE 2.2 CRDi Trazione integrale	D4HB, D4CB	06/13 →
H-1 II 2.5 CRDi	D4CB, D4FC	02/08 →
H100 2.5 CRDi	D4CB	01/04 →
H100 2.5 TCI	--	01/04 →
I20 I 1.1 CRDi	D3FA	03/12 → 12/15
I20 I 1.4 CRDi	D4FC, D4FB	08/08 → 12/15
I20 I 1.6 CRDi	D4FB, D4FB	09/08 → 12/12

HYUNDAI		
I30 II 1.4 CRDi	D4FC	12/11 →
I30 II 1.6 CRDi	D4FB, D4FC	11/11 →
I40 1.7 CRDi	D4FD	07/11 →
IX20 1.4 CRDi	D4FC, D4HA	11/10 →
IX20 1.6 CRDi	D4FB	06/11 →
IX35 1.7 CRDi	D4FD	11/10 →
IX35 2.0 CRDi	D4HA, D6EA	01/10 →
IX35 2.0 CRDi 4WD	D4HA	01/10 →
IX35 3.0 V6 CRDi 4WD	D6EA, D4HB	09/08 → 12/12
PORTER II 2.5 CRDi	D4CB	05/04 →
PORTER II 2.5 TCI	D4BH	05/04 →
SANTA FE II 2.0 CRDi	D4HA	12/10 → 12/12
SANTA FE II 2.0 CRDi 4x4	D4HA	12/10 → 12/12
SANTA FE II 2.2 CRDi	D4HB	01/09 → 12/12
SANTA FE II 2.2 CRDi 4x4	D4HB	01/09 → 12/12
SANTA FE III 2.0 CRDi	D4HA	09/12 →
SANTA FE III 2.0 CRDi 4WD	D4HA	09/12 →
SANTA FE III 2.2 CRDi	D4HB, D4HB	09/12 →
SANTA FE III 2.2 CRDi 4WD	D4HB, D4HB	09/12 →
VERACRUZ 3.0 CRDi [ExtraEU]	D6EA	11/08 → 11/12

KIA		
BONGO IV 2.5 CRDi	D4CB	01/12 →
BORREGO 3.0 CRDi 4WD	G6EN	11/07 →
CARENS III 1.6 CRDi 128	D4FB	10/10 →
CARNIVAL II 2.2 CRDi	D4HB, D4FD	01/10 →
CEED I 1.6 CRDi 128	D4FB	10/10 → 12/12
CEED II 1.4 CRDi 90	D4FC	05/12 →
CEED II 1.6 CRDi	D4FB	07/12 →
CEED II 1.6 CRDi 110	D4FB	05/12 →
CEED II 1.6 CRDi 115	D4FB	05/12 →
CEED II 1.6 CRDi 128	D4FB	05/12 →
CEED II 1.6 CRDi 90	D4FB-L	05/12 →
K2500 2.5 CRDi	D4CB	01/10 →
OPTIMA III 1.7 CRDi	D4FD, D4HA	03/12 →
PRO CEE'D I 1.6 CRDi 128	D4FB	10/10 → 09/12
PRO CEE'D II 1.4 CRDi 90	D4FC	03/13 →
PRO CEE'D II 1.6 CRDi 110	D4FB	03/13 →
PRO CEE'D II 1.6 CRDi 128	D4FB	03/13 →
RIO III 1.1 CRDi	D3FA	09/11 →
RIO III 1.4 CRDi	D4FC	09/11 →
SORENTO 2.2 CRDi [ExtraEU]	D4HB	11/09 → 12/15
SORENTO II 2.0 CRDi	D4HA, D4HA	11/09 →
SORENTO II 2.0 CRDi 4WD	D4HA, D4HA	11/09 →
SORENTO II 2.2 CRDi	D4HB	11/09 →
SORENTO II 2.2 CRDi 4WD	D4HB	11/09 →
SOUL I 1.6 CRDi 115	D4FB	02/09 →
SOUL I 1.6 CRDi 128	D4FB	02/09 →
SOUL II 1.6 CRDi 128	D4FB	02/14 →
SPORTAGE 2.0 CRDi [ExtraEU]	D4HA	08/12 → 12/15
SPORTAGE III 1.7 CRDi	D4FD-L	12/10 →
SPORTAGE III 2.0 CRDi	D4HA, D4HA	07/10 →
SPORTAGE III 2.0 CRDi AWD	D4HA, R2AA	07/10 →
VENGA 1.4 CRDi 75	D4FC	02/10 →
VENGA 1.4 CRDi 90	D4FC	02/10 →
VENGA 1.6 CRDi 115	D4FB	02/10 →
VENGA 1.6 CRDi 128	D4FB	02/10 →

MAZDA		
6 II 2.2 D	R2AA, R2AA	01/10 → 07/13
6 II 2.2 MZR-CD	R2AA, 4N15	08/08 → 07/13

MITSUBISHI		
L200 / TRITON 2.4 DI-D	4N15	09/15 →
L200 / TRITON 2.4 DI-D 4WD	4N15, YD25DDTi	11/14 →
PAJERO SPORT III 2.4 DI-D 4x4	4N15	08/15 →

NISSAN		
CABSTAR 3.0 TDi	ZD30DDTi	09/06 → 12/13
CABSTAR III 2.5 D	YD25DDTi	09/06 →
CABSTAR III 3.0 D	ZD30DDTi	09/06 →
CABSTAR III 35.14 DCI 3.0	ZD30DDTi	09/06 → 12/13
CABSTAR III 35.15 DCI, 45.15 DCI 3.0	ZD30DDTi	09/06 → 12/13
JUKE 1.6 DIG-T	MR16DDT	06/10 →
JUKE 1.6 DIG-T 4x4	MR16DDT	06/10 →
JUKE 1.6 DIG-T NISMO	MR16DDT	03/13 → 07/14
JUKE 1.6 DIG-T NISMO 4x4	MR16DDT	02/13 → 07/14
JUKE 1.6 DIG-T NISMO RS	MR16DDT	08/14 →
JUKE 1.6 DIG-T NISMO RS 4x4	MR16DDT	08/14 →
MURANO II 2.5 dCi 4x4	YD25DDTi	01/10 → 09/14
NAVARA II 2.5 dCi	YD25DDTi, YD25DDTi	07/05 →
NAVARA II 2.5 dCi 4WD	YD25DDTi, T1GA	07/05 →
NT400 CABSTAR 35.13	ZD30DDTi	09/16 →
NT400 CABSTAR 35.15, 45.15	ZD30DDTi	09/16 →
PATHFINDER III 2.5 dCi 4WD	YD25DDTi	10/06 →
PULSAR 1.6 DIG-T	MR16DDT	02/15 →
QASHQAI II 1.6 DIG-T	MR16DDT	10/14 →
X-TRAIL III 1.6 DIG-T	MR16DDT	06/15 →

RENAULT TRUCKS		
MAXITY 2.5 dCi	YD25DDTi	12/11 →

RENAULT TRUCKS		
MAXITY 3.0 TDi	ZD30DTI	12/06 → 12/14

10.3291



3

DIFFERENTIAL PRESSURE SENSORS

Adatt./Suitable:

BOSCH

0 261 006 207
0 261 230 562
0 281 002 772
0 281 006 079
0 281 006 080
0 281 006 207
0 281 006 208
0 281 006 252
0 281 006 286
0 281 006 328
0 281 006 329

*3 without connecting pipe

- senza tubo raccordo
- sans tuyau de raccordement
- ohne Anschlusrohr
- sin tubo de conexión

*7 without connector parts

- senza pezzi raccordo
- sans raccords
- ohne Anschlusssteile
- sin piezas de conexión

FIAT

6000616923

FORD

1 837 949 *7

CV61-5L200-AA

DV61-5H209-AC *7

GENERAL MOTORS

93 455 603

93 868 338 *7

95 519 600 *7

95 521 513 *7

MERCEDES-BENZ

671 1590058

A 607 905 05 00

A 671 159 00 58

NISSAN

20827-00Q0B *7

20827-00Q0G *7

20827-00Q0K *7

20827-00Q0M *7

22771-JG70A

OPEL

44 07 955

44 22 694 *7

45 02 771 *7

45 02 876 *7

93455603

93868338 *7

95519600 *7

95521513 *7

RENAULT

20 81 556 42R *3

22 77 021 84R

22 77 1JG 70A

82 00 198 965

82 00 469 905

H82 01 238 402

SSANGYONG

6711590058

6711590058

SUZUKI

18215-53SA0

18215-53SA0-000

18590-67J80

18590-67J80-000

VAUXHALL

93455603

93868338 *7

95521513 *7

VOLVO

31293659

31370160

MARKET DIFFUSION: HIGH



kPa	mV	
0,2 - 100	500 - 4500	

FIAT

TALENTO 1.6 D R9M408 06/16 →

FORD

TOURNEO CONNECT II 1.6 TDi T1GA, F9Q772 09/13 →

MERCEDES-BENZ

CITAN 111 CDI 0M607.951 06/13 →

CLASSE A III A 160 CDI / d 0M607.951 06/13 →

CLASSE B II B 160 CDI / d 0M607.951 05/13 →

CLASSE B II B 180 CDI / d 0M607.951 02/13 →

CLASSE CLA CLA 180 CDI / d 0M607.951 10/13 →

CLASSE CLA CLA 180 d 0M607.951 07/15 →

MERCEDES-BENZ

CLASSE GLA GLA 180 CDI / d	OM607.951	07/14 →
VITO III 109 CDI	OM622.951	10/14 →
VITO III 109 CDI / 109 BlueTEC	OM622.951	10/14 →
VITO III 111 CDI	OM622.951	10/14 →
VITO III 111 CDI / 111 BlueTEC	OM622.951	10/14 →

NISSAN

FRONTIER 2.3 dCi	M9T	11/14 →
INTERSTAR dCi 80	F9Q772, K9K410	04/02 → 08/06
INTERSTAR dCi 90	G9T722	07/02 →
JUKE 1.5 dCi	K9K410, M9T	06/10 →
NAVARA III 2.3 dCi	M9T, YS23DDT	10/14 →
NAVARA III 2.3 dCi 4x4	YS23DDT, K9K608	01/15 →
NOTE II 1.5 dCi	K9K608, K9K400	06/13 →
NP300 2.3 dCi	M9T	06/14 →
NV200 / EVALIA 1.5 dci	K9K400, K9K400	07/10 →
NV200 1.5 dci	K9K400, M9T670	02/10 →
NV400 2.3 dCi 150	M9T880	02/14 → 09/16
NV400 2.3 dCi 165	M9T702	06/14 → 09/16
NV400 dCi 100	M9T670, M9T670	11/11 → 06/14
NV400 dCi 110	M9T870	06/14 →
NV400 dCi 125	M9T670, M9T678	11/11 → 09/16
NV400 dCi 130	M9T704	06/16 →
NV400 dCi 130 RWD	M9T710	06/16 →
NV400 dCi 140	M9T702	06/14 → 09/16
NV400 dCi 145	M9T678, M1D	11/11 → 06/16
NV400 dCi 150	M9T880	02/14 → 09/16
NV400 dCi 150 RWD	M9T880	02/14 → 09/16
NV400 dCi 160	M9T702	06/14 → 09/16
NV400 dCi 165	M9T702	06/14 → 06/16
NV400 dCi 170	M9T706	06/16 →
PULSAR 1.5 dCi	K9K	10/14 →
QASHQAI 1.6 dCi	R9M	07/11 → 11/13
QASHQAI 2.0 dCi	M9R	08/08 → 11/13
QASHQAI I 1.6 dCi	R9M	10/11 → 12/13
QASHQAI I 1.6 dCi Trazione integrale	R9M	10/11 → 12/13
QASHQAI I 2.0 dCi	M1D, M1D	02/07 → 12/13
QASHQAI I 2.0 dCi Trazione integrale	M1D, K9K636	02/07 → 12/13
QASHQAI II 1.5 dCi	K9K636, M9R	11/13 →
QASHQAI II 1.6 dCi	R9M	11/13 →
QASHQAI II 1.6 dCi ALL MODE 4x4-i	R9M	11/13 →
X-TRAIL 2.0 dCi [ExtraEU]	M9R760	10/09 → 02/14
X-TRAIL II 2.0 dCi	M9R760	06/07 → 11/13
X-TRAIL II 2.0 dCi 4x4	M9R, M9T702	06/07 → 11/13
X-TRAIL II 2.0 dCi FWD	M9R	06/07 → 11/13
X-TRAIL III 1.6 dCi	R9M	04/14 →
X-TRAIL III 1.6 dCi ALL MODE 4x4-i	R9M	04/14 →

OPEL

MOVANO B 2.3 CDTI FWD	M9T702, M9T700	05/14 →
MOVANO B 2.3 CDTI RWD	M9T700, R9M408	05/14 →
VIVARO B 1.6 CDTI	R9M408, K9K608	06/14 →

RENAULT

CAPTUR 1.5 dCi 90	K9K608, K9K608	06/13 →
CLIO IV 1.5 dCi 90	K9K608, R9M402	11/12 →
FLUENCE 1.6 dCi	R9M402	07/14 →
GRAND SCÉNIC III 1.6 dCi	R9M402, R9M410	04/11 →
KADJAR 1.6 dCi 130	R9M410, R9M414	06/15 →
KADJAR 1.6 dCi 130 4x4	R9M414, K9K608	06/15 →
KANGOO II 1.5 dCi	K9K608, K9K636	06/08 →
KANGOO II 1.5 dCi 110	K9K636, K9K608	09/10 →
KANGOO II 1.5 dCi 75	K9K608, K9K608	09/10 →
KANGOO II 1.5 dCi 90	K9K608, R9M402	06/09 →
MEGANE III 1.6 dCi	R9M402, R9M409	04/11 →
MEGANE IV 1.6 dCi 130	R9M409, R9M402	11/15 →
MEGANE CC 1.6 dCi	R9M402	04/11 →
SCÉNIC III 1.5 dCi	K9K636	04/09 →
SCÉNIC III 1.6 dCi	R9M402, R9M413	04/11 →
TRAFIC III 1.6 dCi 115	R9M408	05/14 →
TRAFIC III 1.6 dCi 120	R9M413, D20DTR	05/14 →
TRAFIC III 1.6 dCi 140	R9M450	05/14 →
TRAFIC III 1.6 dCi 90	R9M408	05/14 →
TRAFIC III 1.6 dCi 95	R9M413	07/15 →

SSANGYONG

ACTYON I 2.0 Xdi	D20DTR	09/11 →
ACTYON I 2.0 Xdi 4WD	D20DTR	09/11 →
ACTYON II 2.0 Xdi	D20DTR	10/12 →
ACTYON II 2.0 Xdi 4WD	D20DTR, D20DTR	10/12 →
ACTYON II 2.2 Xdi	D22DTR	07/15 →
ACTYON II 2.2 Xdi 4WD	D22DTR	07/15 →
KORANDO 2.0 e-XDi	D20DTF	11/10 →
KORANDO 2.2 Xdi	D22DTF	07/15 →
KORANDO 2.2 Xdi 4WD	D22DTF	07/15 →
REXTON I 2.0 Xdi	D20DTR, D20DTR	07/12 →
REXTON I 2.0 Xdi Trazione integrale	D20DTR, D20DTR	07/12 →

SSANGYONG

REXTON I 2.2 Xdi	D22DTR	07/15 →
REXTON I 2.2 Xdi Trazione integrale	D22DTR	07/15 →
REXTON II 2.2 e-XDi	D22DTR	01/18 →
REXTON II 2.2 e-XDi 4WD	D22DTR	01/18 →
REXTON II 2.2 Xdi	D22DTR	07/17 →
REXTON II 2.2 Xdi Trazione integrale	D22DTR	07/17 →
RODIUS 2.0 XDi	D20DTR, M9T700	06/13 →
RODIUS 2.0 Xdi 4WD	D20DTR	07/13 →
RODIUS 2.2 Xdi	D22DTR	07/15 →
RODIUS 2.2 Xdi 4WD	D22DTR	07/15 →
STAVIC 2.0 200 XDi	D20DTR	06/13 →
TIVOLI 1.6 e-XDi [ExtraEU]	D16DTF	04/15 →
TIVOLI 1.6 Xdi 160	D16DTF	04/15 →
TIVOLI 1.6 Xdi 160 Trazione integrale	D16DTF	04/15 →
XLV e-XDi 160	D16DTF	04/16 →
XLV e-XDi 160 Trazione integrale	D16DTF	04/16 →

SUZUKI

GRAND VITARA II 1.9 DDiS Trazione integrale	F9QB	10/05 → 02/15
VITARA IV 1.0	K10C	10/18 →
VITARA IV 1.0 AllGrip	K10C	10/18 →

VAUXHALL

MOVANO B 2.3 CDTI FWD	M9T700	05/14 →
MOVANO B 2.3 CDTI RWD	M9T700, R9M408	05/14 →
VIVARO 1.6 CDTi	R9M408, D5244T13	05/14 →

VOLVO

C30 D3	D5204T5	10/10 → 12/12
C30 D4	D5204T	10/10 → 12/12
C30 D5	D5244T13, D5244T13	10/06 → 12/12
C70 II 2.4 D	D5244T9	03/07 → 06/13
C70 II D3	D5204T5	10/10 → 06/13
C70 II D4	D5204T	10/10 → 06/13
C70 II D5	D5244T13, D5244T13	03/06 → 06/13
S40 II 2.4 CDI	D5244T9	03/07 → 12/10
S40 II 2.4 D5	D5244T13, D4204T20	03/06 → 12/10
S40 II D3	D5204T5	10/10 → 12/12
S40 II D4	D5204T	10/10 → 12/12
S60 II 2.0 D2	D4204T20, D4204T4	03/15 →
S60 II 2.0 D3	D4204T4, D5204T2	03/15 →
S60 II 2.0 D4	D4204T14	03/15 →
S60 II 2.0 D5	D4204T11	03/15 →
S60 II 2.4 D4 AWD	D5244T21	03/15 →
S60 II D3	D5204T2, D4204T5	04/10 → 12/15
S60 II D4	D4204T5, D5244T10	04/10 → 12/15
S60 II D5	D5244T10, D5244T10	04/10 → 12/15
S60 II D5 AWD	D5244T10, D5244T14	04/10 → 12/15
S80 II 2.0 Tdi	D4204T	02/08 → 03/11
S80 II 2.4 D	D5244T14, D5204T2	03/06 →
S80 II D3	D5204T7	05/12 →
S80 II D3 / D4	D5204T2, D5244T10	01/10 →
S80 II D4	D4204T5	09/13 →
S80 II D5	D5244T10, D5244T10	03/06 →
S80 II D5 AWD	D5244T10, D4204T16	01/07 →
S90 2.0 D3	D4204T16, D4204T13	03/16 →
S90 2.0 D4	D4204T14	03/16 →
S90 2.0 D4 AWD	D4204T14	03/16 →
S90 2.0 D5 AWD	D4204T23	03/16 →
S90 2.0 T4	B4204T31	10/17 →
S90 2.0 T5	B4204T26	10/17 →
S90 2.0 T6 AWD	B4204T29	10/17 →
V40 II 2.0 D3	D5204T6	09/13 → 12/15
V40 II 2.0 D4	D5204T4	09/13 → 12/14
V40 II D2	D4204T13, D4204T16	02/15 →
V40 II D3	D4204T16, D4204T14	03/12 →
V40 II D4	D4204T14, D5244T13	03/12 →
V40 2.0 D3	D5204T6	09/13 → 12/15
V40 2.0 D4	D5204T4	09/13 → 12/14
V50 2.4 D5	D5244T13, D4204T20	03/06 → 12/10
V50 2.4 Tdi	D5244T9	05/07 → 12/10
V50 D3	D5204T5	10/10 → 12/12
V50 D4	D5204T	10/10 → 12/12
V60 I 2.0 D2	D4204T20, D4204T4	03/15 →
V60 I 2.0 D3	D4204T4, D5244T11	09/13 →
V60 I 2.0 D4	D4204T14	09/13 →
V60 I 2.4 D4 AWD	D5244T12	09/13 → 12/15
V60 I 2.4 D5	D5244T11, D5244T11	04/11 → 12/15
V60 I 2.4 D5 AWD	D5244T11, D5244T15	04/11 → 12/15
V60 I 2.4 D5 Hybrid AWD	D87PHEV	03/15 →
V60 I 2.4 Hybrid D6 AWD	D5244T15, D5244T12	06/12 → 12/15
V60 I D3	D5204T7	05/12 → 12/15
V60 I D4	D4204T5	10/13 → 12/15
V60 I D4 AWD	D5244T12, D4204T11	05/12 →
V60 I D5	D4204T11, D5244T10	07/10 →
V60 I D5 AWD	D5244T10, D5244T14	07/10 → 12/15

VOLVO

V60 I D6 Hybrid AWD	D97PHEV	03/15 →
V70 2.0 D4/D4 DRIVE	D5204T3	09/13 →
V70 III 2.0 D	D4204T	10/07 → 12/15
V70 III 2.0 D3 DRIVE	D5204T7	09/13 →
V70 III 2.4 D	D5244T14, D5244T11	04/07 → 12/10
V70 III 2.4 D4 AWD	D5244T17	09/13 →
V70 III 2.4 D5	D5244T11, D4204T9	09/13 →
V70 III D3	D4204T9, D5204T2	10/07 →
V70 III D3 / D4	D5204T2, D5244T12	03/10 → 12/15
V70 III D4 AWD	D5244T12, D5244T10	10/07 →
V70 III D5	D5244T10, D5244T10	04/07 →
V70 III D5 AWD	D5244T10, D4204T16	04/07 →
V90 2.0 D3	D4204T14, D4204T14	03/16 →
V90 2.0 D3 AWD	D4204T4	03/16 →
V90 2.0 D4	D4204T14	03/16 →
V90 2.0 D4 AWD	D4204T14	03/16 →
V90 2.0 D5 AWD	D4204T23	03/16 →
V90 2.0 Polestar AWD	D4204T14, D5244T16	10/16 →
V90 2.0 T4	B4204T31	10/17 →
V90 2.0 T5	B4204T26	10/17 →
V90 2.0 T5 AWD	B4204T26	10/17 →
V90 2.0 T6 AWD	B4204T29	10/17 →
XC40 2.0 D4 AWD	D4204T12	10/17 →
XC60 I 2.4 D	D5244T14	04/09 → 12/10
XC60 I 2.4 D / D3 / D4 AWD	D5244T16, D4204T4	05/08 → 02/17
XC60 I 2.4 D AWD	D5244T14	06/09 → 12/10
XC60 I D3	D4204T4, D5204T2	04/12 → 02/17
XC60 I D3 / D4	D5204T2, D4204T14	03/10 → 12/14
XC60 I D4	D4204T14, D5244T12	10/13 → 02/17
XC60 I D4 AWD	D5244T12, D5244T10	10/13 → 02/17
XC60 I D5	D5244T11	06/11 → 02/17
XC60 I D5 AWD	D5244T11, D5244T16	05/08 → 02/17
XC70 II 2.4 D	D5244T14	06/09 → 12/10
XC70 II 2.4 D / D4 AWD	D5244T16, D5204T2	08/07 →
XC70 II D3	D5204T2, D5244T10	04/10 → 12/15
XC70 II D3 AWD	D5204T2	08/11 →
XC70 II D4	D4204T5	10/13 →
XC70 II D4 AWD	D5244T12	10/13 →
XC70 II D5 AWD	D5244T10, D4204T11	04/07 →
XC90 II 2.0 T5 AWD	B4204T26	10/17 →
XC90 II 2.0 T6 AWD	B4204T29	10/17 →
XC90 II D4	D4204T14	06/15 →
XC90 II D4 AWD	D4204T6	06/15 →
XC90 II D5 AWD	D4204T11, 937A8.000	09/14 →

10.3292



04

DIFFERENTIAL PRESSURE SENSORS

Adatt./Suitable:

ALFA ROMEO

51855119
51908411
55200301
55227306

BOSCH
0 281 002 783
0 281 002 784
0 281 006 122
0 281 006 287

CHRYSLER

51908411

CITROËN
16 105 313 80
1618 SV

FGP

55200301

FIAT

51855119
51908411
55194788
55200301
55227306
71750558
71768359
K05146181AA *K
K05149270AC *K

FORD

1 729 036
1 769 289
B551-5E260-AA
B551-5E260-AB

GENERAL MOTORS

93 185 556
95 510 744
95 516 902

IVECO

504372730
504375822
55241075
5801356473
5801600484

JEEP

5146842AD *3
51908411
55227306
68228804AA *3
K05146842AD *3
K68228804AA *3

LANCIA

51855119

51908411

MASERATI

675000335

MOPAR PARTS

05146842AD *3
05149270AC *K
68228804AA *3

OPEL

12 47 419
8 62 023
8 62 107
95510744
95516902

PEUGEOT

16 105 313 80
1618 SV

SAAB

93 185 556

SUZUKI

18590-62M00
18590-62M00-000
18590-68L50
18590-68L50-000
18590-79J80
18590-79J80-000

VAUXHALL

93185556
95510744
95516902

*3 without connecting pipe

- senza tubo raccordo
- sans tuyau de raccordement
- ohne Anschlussrohr
- sin tubo de conexión

*K No mounting bracket and no connecting pipes supplied

- Fornito senza staffa di fissaggio e senza tubi di raccordo
- Livré sans support de fixation et sans tuyaux de raccord
- Keine Halterung und Verbindungsrohre geliefert
- Soporte de montaje y conexión de tuberías no suministrados

MARKET DIFFUSION: HIGH



kPa	mV	
0,1 - 92,6	500 - 4500	

ALFA ROMEO

159 1.9 JTDM 16V	937A8.000, 937A7.000	09/05 ⇒ 11/11
159 1.9 JTDM 8V	937A7.000, 844A2.000	09/05 ⇒ 11/11
159 2.0 JTDM	844A2.000, 939A3.000	05/09 ⇒ 11/11

ALFA ROMEO

159 2.4 JTDM	939A3.000, 939A3.000	09/05 ⇒ 12/12
159 2.4 JTDM Q4	939A9.000	05/07 ⇒ 11/11
159 MY2011 2.0 JTD	--	01/10 ⇒
BRERA 2.4 JTDM 20V	939A3.000, 55266388	01/06 ⇒ 06/10
GIULIA 2.2 D	55266388, 55268818	10/15 ⇒
GIULIA 2.2 D Q4	55268818, 940A2.000	11/16 ⇒
GIULIETTA II 1.4 TB	940A2.000, 940A3.000	09/14 ⇒
GIULIETTA II 1.6 JTDM	940A3.000, 940A4.000	04/10 ⇒
GIULIETTA II 2.0 JTDM	940A4.000, 199A3.000	04/10 ⇒
MITO 1.3 MultiJet	199A3.000, 198A2.000	08/08 ⇒
MITO 1.6 JTDM	198A2.000, 844A2.000	08/08 ⇒
SPIDER III 2.0 JTDM	844A2.000, 55268818	04/09 ⇒ 06/10
STELVIO 2.2 D	55268818, Z19DTR	12/16 ⇒
STELVIO 2.2 D Q4	55271838	12/16 ⇒
STELVIO 2.2 JTDM Q4	55268818	08/18 ⇒

CADILLAC

BLS 1.9 D	Z19DTR, F13DTE6	04/06 ⇒
-----------	-----------------	---------

CHRYSLER

DELTA 1.6 D Multijet	844A3000	08/11 ⇒
DELTA 2.0 D Multijet	198A5.000	08/11 ⇒
YPSILON 1.3 Multijet	199B1.000	05/11 ⇒

CITROËN

JUMPER III 3.0 HDi 145	F30DT	07/10 ⇒
JUMPER III 3.0 HDi 155	F30DT	07/10 ⇒
JUMPER III 3.0 HDi 160	F30DT	09/06 ⇒
JUMPER III 3.0 HDi 180	F30DT	07/11 ⇒
NEMO 1.3 BlueHDi 80	F13DTE6, F13DTE5	02/16 ⇒
NEMO 1.3 HDi 75	F13DTE5, F13DTE6	10/10 ⇒
NEMO 1.3 HDi 80	F13DTE6, 199B1.000	10/15 ⇒

FIAT

500 1.3 D Multijet	199B1.000, 199B1.000	12/09 ⇒
500 C 1.6 D Multijet	199B1.000, 199B4.000	09/09 ⇒
500 MY12 1.3 JTD	--	01/12 ⇒
500 MY15 1.3 JTD	--	01/15 ⇒
500L 1.3 D Multijet	199B4.000, 199B5.000	09/12 ⇒
500L 1.6 D Multijet	199B5.000, 55263087	09/12 ⇒
500X 1.3 D Multijet	55266963	11/14 ⇒
500X 1.6 D Multijet	55260384	09/14 ⇒
500X 2.0 D Multijet 4x4	55263087, --	09/14 ⇒
BRAVO II 1.6 D Multijet	--	09/07 ⇒
BRAVO II 1.6 JTD	198A3.000	03/08 ⇒ 12/14
BRAVO II 2.0 D Multijet	--, 939A1.000	09/08 ⇒
CROMA II 1.9 D Multijet	939A1.000, 199A3.000	06/05 ⇒ 12/11
CROMA II 1.9 MJTD	939A1.000	04/06 ⇒ 12/11
CROMA II 2.4 D Multijet	939A3.000	06/05 ⇒
DOBLO II 1.3 D Multijet	199A3.000, 198A3.000	02/10 ⇒
DOBLO II 1.6 D Multijet	198A3.000, 250A1.000	02/10 ⇒
DOBLO II 2.0 D Multijet	263A1.000	01/10 ⇒
DUCATO III 110 Multijet 2,3 D	F1AE3481G	08/06 ⇒
DUCATO III 115 Multijet 2,0 D	250A1.000, F1AE0481N	06/11 ⇒
DUCATO III 120 Multijet 2,3 D	FPT	07/06 ⇒
DUCATO III 120 Multijet 2,3 D 4x4	F1AE0481D	03/10 ⇒
DUCATO III 130 Multijet 2,3 D	F1AE0481N, F1AE3481E	07/06 ⇒
DUCATO III 150 Multijet 2,3 D	F1AE3481E, F1CE0481D	06/11 ⇒
DUCATO III 150 Multijet 3,0 D	F1CE3481N	04/10 ⇒
DUCATO III 160 Multijet 3,0 D	F1CE0481D, 199A2.000	07/06 ⇒
DUCATO III 180 Multijet 2,3 D	F1AGL411B	12/15 ⇒
DUCATO III 180 Multijet 3,0 D	F1CE3481E	06/11 ⇒
DUCATO III 2.0	--	01/14 ⇒
DUCATO III 2.3	--	01/14 ⇒
DUCATO III 3.0	--	01/14 ⇒
DUCATO 2.3 Multijet	F1AE0481N	12/09 ⇒ 07/14
FIORINO III 1.3 D Multijet	199A2.000, 939B5.000	11/07 ⇒
FREEMONT 2.0 JTD	939B5.000, 199A2.000	08/11 ⇒
FREEMONT 2.0 JTD 4x4	939B5.000	08/11 ⇒
GRANDE PUNTO 1.3 JTD Multijet	199A2.000, 188A9.000	02/06 ⇒ 06/13
IDEA 1.3 D Multijet	188A9.000, 199A3.000	01/04 ⇒
IDEA 1.6 D Multijet	350A2.000	05/08 ⇒
LINEA 1.3 D Multijet	199A3.000, --	06/07 ⇒
LINEA 1.6 D Multijet	198A3.000	06/09 ⇒
PANDA II 1.3 D Multijet	--, 169A1.000	09/03 ⇒
PANDA II 1.3 D Multijet 4x4	169A1.000, 169A1.000	10/04 ⇒
PANDA II 1.3 JTD Multijet 4x4	169A1.000, 199A1.000	09/10 ⇒ 08/13
PANDA III 1.3 D Multijet	199A1.000, 199A1.000	02/12 ⇒
PANDA III 1.3 D Multijet 4x4	199A1.000, 199A2.000	06/12 ⇒
PUNTO III EVO 1.3 D Multijet	199A2.000, 199A2.000	07/08 ⇒
PUNTO III EVO 1.6 D Multijet	955A3.000	10/09 ⇒ 02/12
PUNTO III / GRANDE PUNTO 1.3 D Multijet	199A2.000, 199A2.000	10/05 ⇒
PUNTO III / GRANDE PUNTO 1.3 JTD Actual	--	09/09 ⇒
PUNTO III / GRANDE PUNTO 1.6 D Multijet	955A3.000	07/08 ⇒
PUNTO III 1.3 D Multijet	199A2.000, 199A2.000	04/08 ⇒
PUNTO III 1.3 JTD Multijet	955B2.000	05/18 ⇒
QUBO 1.3 D Multijet	199A2.000, 199B1.000	02/08 ⇒

FIAT

SEDCI 2.0 D Multijet	D20AA	06/06 ⇒ 10/14
SEDCI 2.0 D Multijet 4x4	D20AA	06/06 ⇒ 10/14
SEDCI MY12 2.0 D	--	01/12 ⇒
STRADA 1.3 D	--	01/11 ⇒
STRADA 1.3 D Multijet	199B1.000	05/06 ⇒
TIPO II 1.3 D	199B1.000, 55260384	10/15 ⇒
TIPO II 1.6 D	55260384, BAAA	10/15 ⇒

FORD		
KA II 1.3 TDCi	BAAA, F1CE3481B	10/08 ⇒

IVECO		
DAILY IV 26L11, 26L11D, 35C11D, 35S11, 40C11	F1AE3481A	09/11 ⇒ 02/14
DAILY IV 29L11 V, 35C11 V, 35S11 V, 40C11 V	F1AE3481A	09/11 ⇒ 02/14
DAILY IV 29L13 V, 35C13 V, 35S13 V, 40C13 V, 40S13 V	F1AE3481B	09/11 ⇒ 02/14
DAILY IV 29L13D, 29L13D, 35C13D, 40C13	F1AE3481B	09/11 ⇒ 02/14
DAILY IV 29L15 V, 35C15 V, 40C15 V, 50C15 V	F1AE3481C	09/11 ⇒ 02/14
DAILY IV 29L15 V, 35S15 V, 35C15 V, 40C15 V, 50C15 V	F1AE3481C	09/11 ⇒ 02/14
DAILY IV 35C11K, 35S11DKP	F1AE3481A	09/11 ⇒ 02/14
DAILY IV 35C13K, 35C13DKP	F1AE3481B	09/11 ⇒ 02/14
DAILY IV 35C15 V, 40C15 V, 50C15 V, 60C15 V	F1CE3481B, F1CE3481B	09/11 ⇒ 02/14
DAILY IV 35C15, 35C15D, 35S15, 40C15, 45C15, 50C15, 60C15, 70C15	F1CE3481B	09/11 ⇒ 02/14
DAILY IV 35C15K, 35S15DKP, 50C15K, 60C15K, 65C15DK, 70C15K	F1CE3481B	09/11 ⇒ 02/14
DAILY IV 35C17 V, 35S17 V, 40C17 V, 45C17 V, 50C17 V, 60C17 V	F1CE3481C	09/11 ⇒ 02/14
DAILY IV 35C17D, 35C17D, 35S17, 40C17, 45C17, 50C17, 60C17, 70C17	F1CE3481C	09/11 ⇒ 02/14
DAILY IV 35C17K, 35S17DKP, 50C17K, 65C17DK 70C17K	F1CE3481C, F1CE3481J	09/11 ⇒ 02/14
DAILY IV 35C21 V, 35S21 V, 40C21 V, 45C21 V, 50C21 V	F1CE3481D	09/11 ⇒ 02/14
DAILY IV 35C21, 35S21, 40C21, 45C21, 50C21, 60C21, 70C21	F1CE3481D	09/11 ⇒ 02/14
DAILY V 33S11, 35S11, 35C11	F1AF4111A	03/14 ⇒ 04/16
DAILY V 33S12, 35S12	F1AGL411H	04/16 ⇒
DAILY V 33S12, 35S12, 35C12	F1AGL411H	04/16 ⇒
DAILY V 33S13, 35S13, 35C13	F1AF411B	03/14 ⇒ 04/16
DAILY V 33S14, 35S14	F1AGL411J	04/16 ⇒
DAILY V 33S14, 35S14, 35C14	F1AGL411J	04/16 ⇒
DAILY V 33S15, 35S15, 35C15	F1AF411C	03/14 ⇒ 04/16
DAILY V 33S16, 35S16	F1AGL411G	04/16 ⇒
DAILY V 33S16, 35S16, 35C16	F1AGL411G	04/16 ⇒
DAILY V 35S14, 35S15, 35C15, 40S14, 40C15, 50C15, 65C15, 70C15	F1CE3481J	03/14 ⇒ 04/16
DAILY V 35S15, 35C15, 40C15, 50C15	F1CGL411A	04/16 ⇒
DAILY V 35S15, 35C15, 40C15, 50C15, 65C15, 70C15	F1CE3481I, F1CFL411F	03/14 ⇒
DAILY V 35S15, 35C15, 40C15, 50C15, 65C15, 70C15, 72C15	F1CGL411A	04/16 ⇒
DAILY V 35S17, 35C17, 40C17, 45S17, 45C17, 50C17, 55C17, 65C17, ...	F1CFL411F	03/14 ⇒ 04/16
DAILY V 35S17, 35C17, 40C17, 50C17, 55C17, 65C17, 70C17	F1CFL411F, F1CFL411W	03/14 ⇒ 04/16
DAILY V 35S17, 55S17 4x4	F1CFL411F	08/15 ⇒ 04/16
DAILY V 35S18, 35C18, 40C18, 50C18	F1CGL411B	04/16 ⇒
DAILY V 35S18, 35C18, 40C18, 50C18, 65C18, 70C18	F1CGL411B	04/16 ⇒
DAILY V 35S18, 35C18, 40C18, 50C18, 65C18, 70C18, 72C18	F1CFL411W, F1CFL411W	04/16 ⇒
DAILY V 35S18, 55S18 4x4	F1CFL411W, F1CFL411G	09/16 ⇒
DAILY V 35S21, 35C21, 40C21, 50C21, 65C21, 70C21	F1CFL411G, F1CE3481J	03/14 ⇒
DAILY V 40C15, 50C15, 60C15	F1CFL411E	06/14 ⇒ 10/16
DAILY V 40C15, 50C15, 65C15	F1CE3481J, F1CFL411F	03/14 ⇒ 04/16
DAILY V 40C17, 50C17, 60C17	F1CFL411F	06/14 ⇒ 10/16
DAILY V 40C17, 50C17, 65C17	F1CFL411F, EBS	03/14 ⇒ 04/16
DAILY V 50C15	F1CFL411E	06/14 ⇒ 10/16
DAILY V 50C17	F1CFL411F	06/14 ⇒ 10/16
DAILY V 50C17, 65C17	F1CFL411F	06/14 ⇒ 10/16

IVECO			
DAILY 2.3	F1AE3481C	09/11 → 02/14	
DAILY 3.0	F1CE3481B, F1CE3481B	09/11 →	

JEEP			
CHEROKEE V 2.0 CRD	EBS, EBS	04/14 →	
CHEROKEE V 2.0 CRD [ExtraEU]	EBS, EBS	04/14 →	
CHEROKEE V 2.0 CRD 4x4	EBS, EJJ(55260384)	04/14 →	
CHEROKEE V 2.2 CRD 4x4	LAU61	08/15 →	
RENEGADE 1.6 CRD	EJJ(55260384), 55263088	07/14 →	
RENEGADE 2.0 CRD 4x4	55263088, 198A2.000	07/14 →	
RENEGADE 2.4	ED6	09/15 →	
RENEGADE 2.4 4x4	ED6	09/15 →	

LANCIA			
DELTA III 1.6 D Multijet	198A2.000, 198A5.000	08/08 → 08/14	
DELTA III 1.9 D Multijet	844A1.000	01/09 → 08/14	
DELTA III 2.0 D Multijet	198A5.000, --	09/08 → 08/14	
MUSA 1.3 D Multijet	--	03/09 → 12/12	
MUSA 1.6 D Multijet	--, 199A2.000	07/08 → 12/12	
YPSILON I 1.3 D Multijet	199A2.000, 199B1.000	09/06 → 12/11	
YPSILON II 1.3 D Multijet	199B1.000, Z19DT	05/11 →	

MASERATI			
Ghibli 3.0 D	M15746D	08/13 →	
LEVANTE 3.0 D Trazione integrale	B630WM	06/16 →	
QUATTROPORTE 3.0 D	M15746D	09/13 →	

OPEL			
ASTRA H 1.9 CDTi	Z19DT, A13FD	06/04 → 10/10	
ASTRA H 1.9 CDTi 16V	Z19DTJ	04/04 → 10/10	
COMBO D 1.3 CDTi	A13FD, A16FDH	02/12 →	
COMBO D 1.6 CDTi	A16FDH, Z19DT	02/12 →	
COMBO D 2.0 CDTi	A20FD	02/12 →	
SIGNUM 1.9 CDTi	Z19DT, Z19DT	04/04 →	
VECTRA C 1.9 CDTi	Z19DT, Z19DT	04/04 → 01/09	
ZAFIRA B 1.9 CDTi	Z19DT, 199A9.000	07/05 → 04/15	

PEUGEOT			
BIPPER 1.3 BlueHDi 80	F13DTE6	12/15 →	
BIPPER 1.3 HDi 75	199A9.000, 199A9.000	10/10 →	
BIPPER TEPEE 1.3 HDi 75	199A9.000, F13DTE6	10/10 →	
BIPPER TEPEE 1.3 HDi 80	F13DTE6, D13A	12/15 →	
BOXER II 3.0 D	F30DT	09/08 → 12/09	
BOXER II 3.0 HDi	F30DT	07/06 →	
BOXER II 3.0 HDi 145	F30DT	04/10 →	
BOXER II 3.0 HDi 160	F30DT	04/06 →	
BOXER II 3.0 HDi 175	F30DT	03/11 →	

SUZUKI			
SWIFT V 1.3 DDiS	D13A, M16A	10/10 →	
SX4 1.2.0 DDiS	D20AA	07/09 →	
SX4 1.2.0 DDiS 4x4	D20AA	07/09 →	
SX4 II 1.6 DDiS	D16AA	08/13 →	
SX4 II 1.6 DDiS AllGrip	D16AA	08/13 →	
SX4 2.0 DDiS	D20AA	09/13 → 12/15	
VITARA IV 1.6	M16A, M16A	02/15 →	
VITARA IV 1.6 AllGrip	M16A, Z19DT	02/15 →	
VITARA IV 1.6 DDiS	D16AA	02/15 →	
VITARA IV 1.6 DDiS AllGrip	D16AA	02/15 →	

VAUXHALL			
ASTRA V 1.9 CDTi	Z19DT, Z19DT	01/04 → 11/10	
ASTRA V 1.9 CDTi 16V	Z19DTJ	01/04 → 05/09	
ASTRAVAN III 1.9 CDTi	Z19DT, A13FD	03/05 → 11/11	
COMBO D 1.3 CDTi	A13FD, A16FDH	11/11 →	
COMBO D 1.6 CDTi	A16FDH, Z19DT	11/11 →	
COMBO D 2.0 CDTi	A20FD	11/11 →	
SIGNUM 1.9 CDTi	Z19DT	04/04 → 03/08	
SIGNUM 1.9 CDTi 16V	Z19DTH	04/04 → 03/08	
SIGNUM 1.9 Turbo	Z19DTL	01/05 → 05/08	
VECTRA C 1.9 CDTi	Z19DT, Z19DT	04/02 → 09/08	
VECTRA C 1.9 CDTi 16V	Z19DTH	04/04 → 05/09	
ZAFIRA B 1.9 CDTi	Z19DT, OM651.901	07/05 → 11/14	

10.3294



3,5

DIFFERENTIAL PRESSURE SENSORS

Adatt./Suitable:

BOSCH0 281 006 213
0 281 006 214**INFINITI**22771-5DB0A
22771-HG00C**MERCEDES-BENZ**6429050200
A 642 905 02 00

MARKET DIFFUSION: MEDIUM



kPa	mV	OUT - +
-1,9 - 108,1	500 - 4500	

INFINITI

Q30 2.2 D	651930	11/15 →
Q30 2.2 D AWD	651930	11/15 →
Q70 2.2 D	OM651	10/14 →
QX30 2.2 D AWD	651930	04/16 →

MERCEDES-BENZ

B-SERIES B180 CDI [ExtraEU]	OM651.930	07/14 →
CLASSE A III A 180 CDI	OM651.901, OM651.901	06/12 →
CLASSE A III A 200 CDI	OM651.901	06/12 →
CLASSE A III A 200 CDI / d	OM651.930	02/14 →
CLASSE A III A 200 CDI / d 4-matic	OM651.930	02/14 →
CLASSE A III A 220 CDI	OM651.930	09/12 →
CLASSE A III A 220 CDI 4-matic	OM651.930	09/12 →
CLASSE A III A 220 d	OM651.930	07/15 →
CLASSE A III A 220 d 4-matic	OM651.930	07/15 →
CLASSE B II B 180 CDI	OM651.901, OM651.930	11/11 →
CLASSE B II B 200 CDI	OM651.901	11/11 →
CLASSE B II B 200 CDI / d	OM651.930	08/14 →
CLASSE B II B 200 CDI / d 4-matic	OM651.930	08/14 →
CLASSE B II B 220 CDI / d	OM651.930, OM651.930	11/11 →
CLASSE B II B 220 CDI / d 4-matic	OM651.930	09/14 →
CLASSE B II B 220 d 4-matic	OM651.930	06/18 →
CLASSE CLA CLA 200 CDI	OM651.901	06/13 →
CLASSE CLA CLA 200 CDI / d	OM651.930	07/14 →
CLASSE CLA CLA 200 CDI / d 4-matic	OM651.930	07/14 →
CLASSE CLA CLA 220 CDI / d	OM651.930, OM651.930	01/13 →
CLASSE CLA CLA 220 CDI / d 4-matic	OM651.930, OM642.852	08/14 →
CLASSE CLA CLA 220 CDI 4-matic	OM651.930	07/14 →
CLASSE CLA CLA 220 d	OM651.930	07/18 →
CLASSE CLA CLA 220 d 4-matic	OM651.930	07/18 →
CLASSE CLS II CLS 220 BlueTEC / d	OM651.924	05/14 →
CLASSE CLS II CLS 250 BlueTEC / d 4-matic	OM651.924	05/14 →
CLASSE CLS II CLS 250 CDI / BlueTEC / d	OM651.924	04/11 →
CLASSE CLS II CLS 350 BlueTEC	OM642.852	05/14 →
CLASSE CLS II CLS 350 BlueTEC / d	OM642.852, OM642.854	11/12 →
CLASSE CLS II CLS 350 BlueTEC / d 4-matic	OM642.854, OM642.854	11/12 →
CLASSE CLS II CLS 350 BlueTEC 4-matic	OM642.854	01/13 →

MERCEDES-BENZ			
CLASSE CLS II CLS 350 d 4-matic	OM642.854, OM642.850	04/15 →	
CLASSE E IV E 200 CDI / BlueTEC	OM651.925	01/09 →	
CLASSE E IV E 220 BlueTEC	OM651.911	05/14 →	
CLASSE E IV E 220 BlueTEC 4-matic	OM651.924	12/14 →	
CLASSE E IV E 220 CDI	OM651.924	01/09 →	
CLASSE E IV E 220 CDI / BlueTEC	OM651.924	01/09 →	
CLASSE E IV E 220 CDI / BlueTEC / d	OM651.911	01/10 →	
CLASSE E IV E 220 CDI / d	OM651.911	01/10 →	
CLASSE E IV E 250 BlueTEC	OM651.911	01/09 →	
CLASSE E IV E 250 CDI / BlueTEC	OM651.924	01/09 →	
CLASSE E IV E 250 CDI / BlueTEC / d	OM651.911	01/09 →	
CLASSE E IV E 250 CDI / BlueTEC 4-matic	OM651.924	01/09 →	
CLASSE E IV E 300 BlueTEC	OM642.852	03/11 →	
CLASSE E IV E 300 CDI	OM642.852	03/11 →	
CLASSE E IV E 300 CDI / BlueTEC	OM642.850, OM642.838	11/09 →	
CLASSE E IV E 300 Hybrid / BlueTEC Hybrid	OM651.924	12/11 →	
CLASSE E IV E 350 BlueTEC	OM642.838, OM642.852	01/09 →	
CLASSE E IV E 350 BlueTEC / d	OM642.838	05/14 →	
CLASSE E IV E 350 BlueTEC 4-matic	OM642.852, OM642.824	11/12 →	
CLASSE E IV E 350 BlueTEC / d 4-matic	OM642.838	05/14 →	
CLASSE E IV E 350 CDI	OM642.852	09/14 →	
CLASSE G II G 300 CDI	OM642.884	01/10 →	
CLASSE G II G 350 CDI	OM642.886	07/11 →	
CLASSE GLI II GL 350 CDI / BlueTEC 4-matic	OM642.826	07/12 → 10/15	
CLASSE GLA GLA 200 CDI / d	OM651.930	12/13 →	
CLASSE GLA GLA 200 CDI 4-matic	OM651.930	12/13 →	
CLASSE GLA GLA 220 CDI	OM651.930	12/13 →	
CLASSE GLA GLA 220 CDI / d	OM651.930	12/13 →	
CLASSE GLA GLA 220 CDI / d 4-matic	OM651.930	12/13 →	
CLASSE GLA GLA 220 CDI 4-matic	OM651.930	12/13 →	
CLASSE GLA GLA 220 d	OM651.930	07/15 →	
CLASSE GLA GLA 220 d 4-matic	OM651.930	07/15 →	
CLASSE GLK 350 d 4-matic	OM642.824, OM651.955	03/15 →	
CLASSE GLK 220 CDI	OM651.916	12/08 → 06/15	
CLASSE GLK 220 CDI 4-matic	OM651.912	12/08 → 06/15	
CLASSE GLK 250 CDI 4-matic	OM651.912	09/09 → 06/15	
CLASSE GLS 350 d 4-matic	OM642.826	11/15 →	
CLASSE M III ML 350 BlueTEC 4-matic	OM642.826	06/11 → 02/15	
CLASSE M III ML 350 CDI BlueEfficiency 4-matic	OM642.826	02/12 →	
CLASSE R R 280 CDI	OM642.872	05/06 →	
CLASSE R R 350 CDI 4-matic	OM642.870	01/06 →	
CLASSE S VI S 300 BlueTEC Hybrid / h	OM651.921	02/14 →	
CLASSE S VI S 350 BlueTEC / d	OM642.861	05/13 →	
CLASSE S VI S 350 BlueTEC / d 4-matic	OM642.867	02/14 →	
CLASSE S VI S 350 BlueTEC 4-matic	OM642.867	02/14 →	
CLASSE S VI S 350 CDI	OM642.861	05/13 →	
CLS-SERIES CLS350 BlueTec	OM642.852	05/14 → 12/17	
GLE-SERIES GLE350	OM642.826	04/15 →	
ML-SERIES ML350 -/BlueTec [ExtraEU]	OM642.826	06/11 → 02/15	
SPRINTER II 210 CDI	OM651.955	03/09 →	
SPRINTER II 211 CDI	OM651.955	04/16 →	
SPRINTER II 213 CDI	OM651.955, OM651.955	06/06 →	
SPRINTER II 214 CDI	OM651.955	04/16 →	
SPRINTER II 216 CDI	OM651.955, OM651.955	06/06 →	
SPRINTER II 310 CDI	OM651.955, OM651.955	03/09 →	
SPRINTER II 311 CDI	OM646.701	09/13 →	
SPRINTER II 313 CDI	OM651.955, OM651.955	05/09 →	
SPRINTER II 313 CDI 4x4	OM651.955, OM651.955	05/09 →	
SPRINTER II 314 CDI	OM651.955	05/16 →	
SPRINTER II 314 CDI 4x4	OM651.955	05/16 →	
SPRINTER II 316 CDI	OM651.955, OM651.955	03/09 →	
SPRINTER II 316 CDI 4x4	OM651.955, OM651.955	03/09 →	
SPRINTER II 411 CDI	OM646.701	09/13 →	
SPRINTER II 413 CDI	OM651.955, OM651.955	06/06 → 05/16	
SPRINTER II 414 CDI	OM651.955	05/16 →	
SPRINTER II 416 CDI	OM651.957	03/09 →	
SPRINTER II 510 CDI	OM651.955	03/09 →	
SPRINTER II 511 CDI	OM651.955	05/16 →	
SPRINTER II 513 CDI	OM651.955, OM651.955	06/06 →	

MERCEDES-BENZ		
SPRINTER II 513 CDI 4x4	OM651.955, OM651.955	06/06 →
SPRINTER II 514 CDI	OM651.955	05/16 →
SPRINTER II 514 CDI 4x4	OM651.955	05/16 →
SPRINTER II 516 CDI	OM651.955, OM651.955	03/09 →
SPRINTER II 516 CDI 4x4	OM651.955, BPW	06/06 →
SPRINTER SERIES Sprinter 411D CDI/CDi BlueEFFICIENCY	OM651.955	04/16 →
SPRINTER SERIES Sprinter 416D CDI	OM651.957	11/13 →
VITO III 114 CDI	OM651.950	10/14 →
VITO III 114 CDI 4x4	OM651.950	07/15 →
VITO III 116 CDI	OM651.950	10/14 →
VITO III 116 CDI / 116 BlueTEC	OM651.950	10/14 →
VITO III 116 CDI / 116 BlueTEC 4x4	OM651.950	07/15 →
VITO III 116 CDI 4x4	OM651.950	07/15 →
VITO III 119 BlueTEC	OM651.950	10/14 →
VITO III 119 BlueTEC 4x4	OM651.950	12/14 →
VITO III 119 CDI / 119 BlueTEC 4x4	OM651.950	12/14 →
VITO III 119 CDI / BlueTEC	OM651.950	10/14 →
VITO III 119 CDI / BlueTEC 4x4	OM651.950	07/15 →
VITO-SERIES Vito 114 BlueTec	OM651.950	07/15 →
VITO-SERIES Vito 114 Blue-Tec/CDi/CDi BlueEFFICIENCY	OM651.950	10/14 →

10.3297

3,5

DIFFERENTIAL PRESSURE SENSORS

Adatt./Suitable:

AUDI

07Z 906 051
07Z 906 051 A
4F0 131 552 AK *K

BOSCH

0 281 002 710
0 281 002 711

SEAT

07Z 906 051 A

SKODA

07Z 906 051
07Z 906 051 A

VW

07Z 906 051
07Z 906 051 A
4F0 131 552 AK *K

*K No mounting bracket and no connecting pipes supplied

- Fornito senza staffa di fissaggio e senza tubi di raccordo
- Livré sans support de fixation et sans tuyaux de raccord
- Keine Halterung und Verbindungsrohre geliefert
- Soporte de montaje y conexión de tuberías no suministrados



kPa	mV	+	0	-
-5,5 - 95,2	250 - 4750			

AUDI		
A4 II 2.0 TDI	BPW, ASB	01/06 → 03/09
A4 II 2.7 TDI	BPP	06/06 → 03/09
A4 II 3.0 TDI quattro	ASB, BKE	01/06 → 03/09
A4 III 1.9 TDI	BKE, BPW	11/04 → 06/08
A4 III 2.0 TDI	BPW, BPW	11/04 → 06/08
A4 III 2.0 TDI quattro	BPW, BPP	01/06 → 06/08
A4 III 2.7 TDI	BPP, ASB	11/05 → 06/08
A4 III 3.0 TDI quattro	ASB, BLB	11/04 → 06/08
A6 III 2.0 TDI	BLB, ASB	07/04 → 08/11
A8 II 3.0 TDI quattro	ASB, BMC	08/03 → 07/10
A8 II 4.0 TDI quattro	ASE	05/03 → 07/05
A8 II 4.2 TDI quattro	BMC, BUG	01/05 → 07/10
Q7 I 3.0 TDI quattro	BUG, BLE	03/06 → 05/10
Q7 I 6.0 TDI quattro	CCGA	09/08 → 05/14
SKODA		
SUPERB I 2.0 TDI	BSS	10/05 → 03/08
VW		
PASSAT IV 2.0 TDI	BGW	12/03 → 05/05
PHAETON 5.0 V10 TDI 4motion	AJS	11/02 → 10/06
TOUAREG I 5.0 R50 TDI	CBWA	08/07 → 05/10

VW		
TOUAREG I 5.0 V10 TDI	BLE, 1KD-FTV	10/02 → 05/10

10.3308

3

DIFFERENTIAL PRESSURE SENSORS

Adatt./Suitable:

DENSO

1200 12K16 *1
1200 8M 6 *1
1290 11K12 *1
1290 4L24

*1 without fastening clamp

- senza staffa fissaggio
- sans bride de fixation
- ohne Befestigungsbügel
- sin estribo de sujeción

LEXUS

89480-53020 *1

TOYOTA

89480-42020 *1
89480-53020 *1
89480-74010 *1
89481-12050
89481-52010

MARKET DIFFUSION: MEDIUM



kPa	mV	+	0	-
-6,7 - 95,6	500 - 4500			

LEXUS		
IS II 200d	2AD-FTV	07/10 → 07/12
TOYOTA		
AURIS I 1.4 D-4D	1ND-TV	03/07 → 04/13
AURIS II 1.4 D-4D	1ND-TV	10/12 →
COROLLA X 1.4 D-4D	1ND-TV	10/06 → 07/14
COROLLA XI 1.4 D-4D	1ND-TV	06/13 →
HIACE 3.0 [ExtraEU]	1KD-FTV	11/08 →
HIACE IV 3.0 D	1KD-FTV, 2KD-FTV	08/04 →
HILUX VII 2.5 D 4WD	2KD-FTV	08/05 → 05/15
HILUX VII 2.5 D-4D	2KD-FTV, 2KD-FTV	08/05 →
HILUX VII 2.5 D-4D 4WD	2KD-FTV, 1KD-FTV	12/07 →
HILUX VII 3.0 D	1KD-FTV	02/05 →
HILUX VII 3.0 D 4WD	1KD-FTV, 1KD-FTV	02/05 →
HILUX VII 3.0 D-4D 4WD	1KD-FTV, 1KD-FTV	08/05 → 05/15
IQ 1.4 D-4D	1ND-TV	01/09 → 12/15
LAND CRUISER 150 3.0 D-4D	1KD-FTV, 2AD-FHV	08/09 →
LAND CRUISER PRADO 150 3.0 D-4D	1KD-FTV	08/09 →
LAND CRUISER VAN 3.0 D4d 4WD	1KD-FTV	01/11 →
RAV 4 IV 2.0 D	1AD-FTV	12/12 →
RAV 4 IV 2.0 D 4WD	1AD-FTV	01/13 →
RAV 4 IV 2.2 D 4WD	2AD-FHV, RHH(DW10BTED4)	12/12 →
RAV 4 III 2.2 D	2AD-FHV, 2AD-FHV	12/08 → 06/13
RAV 4 III 2.2 D 4WD	2AD-FHV, 2AD-FHV	02/06 → 06/13
URBAN CRUISER 1.4 D-4D	1ND-TV	01/09 → 04/14
URBAN CRUISER 1.4 D-4D 4WD	1ND-TV	01/09 → 04/14
VERSO S 1.4 D4-D	1ND-TV	11/10 → 10/16
YARIS II 1.4 D-4D	1ND-TV	08/05 → 12/12
YARIS III 1.4 D	1ND-TV	09/11 →
YARIS 1.4 D4d	1ND-TV	07/14 →

10.3316



04

DIFFERENTIAL PRESSURE SENSORS

Adatt./Suitable:

CITROËN

16 231 373 80
1618 09
1618 ET
96 450 226 80

FIAT

504102810
55210304
9645022680

FUSO (MITSUBISHI)

ME556179

IVECO

504102810
55210304

LANCIA

9645022680

MITSUBISHI

1588A200

PEUGEOT

16 231 373 80
1618 09
1618 ET

AVAILABLE FROM:

- DISPONIBILE DA:
- DISPONIBLE EN:
- VERFUEGBAR AB:
- DISPONIBLE EN:

19/03

MARKET DIFFUSION: HIGH



kPa	mV	+	0	-
-6,6 - 99,6	250 - 4500			

CITROËN		
C3 I 1.6 16V HDi	9HZ(DV6TED4)	09/05 →
C4 I 1.6 HDi	9HZ(DV6TED4)	11/04 → 07/11
C4 I 2.0 HDi	RHR(DW10BTED4)	11/04 → 07/11
C4 GRAND PICASSO I 2.0 HDi 138	RHJ(DW10BTED4), RHJ(DW10BTED4)	10/06 → 12/13
C4 PICASSO I 2.0 HDi 138	RHJ(DW10BTED4), 4HP(DW12BTED4)	10/06 → 08/13
C5 I 1.6 HDi	9HZ(DV6TED4)	09/04 →
C5 I 2.0 HDi	RHR(DW10BTED4)	03/01 →
C5 I 2.2 HDi	4HP(DW12BTED4), 4HP(DW12BTED4)	03/01 →
C6 2.2 HDi	4HP(DW12BTED4), DT17ED4	06/06 → 12/12
C6 2.7 HDi	DT17ED4, RHM(DW10ATED4)	09/05 → 12/11
C8 2.0 HDi	RHM(DW10ATED4), F300FAP	07/02 →
C8 2.0 HDi 135	RHR(DW10BTED4)	03/06 →
C8 2.2 HDi	4HW(DW12TED4)	07/02 →
C-CROSSER 2.2 HDi	4HN(DW12MTED4)	02/07 →
C-CROSSER ENTERPRISE 2.2 HDi	4HN(DW12MTED4)	01/09 →
JUMPER III 3.0 HDi 145	F300FAP, F30DTFAP	07/10 →
JUMPER III 3.0 HDi 155	F30DTFAP, F30DTFAP	07/10 →
JUMPER III 3.0 HDi 160	F30DTFAP, F1AE0481D	09/06 →
JUMPER III 3.0 HDi 180	F30DT	07/11 →
JUMPY II 2.0 HDi 140	RHR(DW10BTED4)	01/07 →
XSARA PICASSO 1.6 HDi	9HZ(DV6TED4)	05/04 →

FIAT		
DUCATO III 100 Multijet 2,2 D	4HV	07/06 →
DUCATO III 110 Multijet 2,3 D	F1AE0481D, F1AE0481D	08/06 →
DUCATO III 120 Multijet 2,3 D	F1AE0481D, F1AE0481N	07/06 →
DUCATO III 120 Multijet 2,3 D 4x4	F1AE0481D	03/10 →
DUCATO III 130 Multijet 2,3 D	F1AE0481N, F1AE3481E	07/06 →
DUCATO III 150 Multijet 2,3 D	F1AE3481E, F1CE0481D	06/11 →
DUCATO III 150 Multijet 3,0 D	F1CE3481N	04/10 →
DUCATO III 160 Multijet 3,0 D	F1CE0481D, 4P10T2	07/06 →
DUCATO III 180 Multijet 2,3 D	F1AGL411B	12/15 →
DUCATO III 180 Multijet 3,0 D	F1CE3481E	06/11 →
DUCATO 2.3 Multijet	F1AE0481N	01/07 → 07/14
ULYSSE II 2.0 JTD	RHM(DW10ATED4)	05/03 → 08/06
ULYSSE II 2.2 JTD	4HW(DW12ATED4)	08/02 → 08/06

FUSO (MITSUBISHI)			
CANTER 3.0 DiTD	4P10T2, F1CE0481H	04/06	⇒
IVECO			
DAILY IV 26L11, 26L11D, 35C11D, 35S11, 40C11	F1AE3481A	09/11	⇒ 02/14
DAILY IV 29L11 V, 35C11 V, 35S11 V, 40C11 V	F1AE3481A	09/11	⇒ 02/14
DAILY IV 29L13 V, 35C13 V, 35S13 V, 40C13 V, 40S13 V	F1AE3481B	09/11	⇒ 02/14
DAILY IV 29L13D, 29L13D, 35C13D, 40C13	F1AE3481B	09/11	⇒ 02/14
DAILY IV 29L15 V, 35C15L V, 40C15L V, 50C15L V	F1AE3481C	09/11	⇒ 02/14
DAILY IV 35C11K, 35S11DKP	F1AE3481A	09/11	⇒ 02/14
DAILY IV 35C13K, 35C13DKP	F1AE3481B	09/11	⇒ 02/14
DAILY IV 35C14 K, 35C14 DK, 35S14 K, 35S14 DK	F1CE3481L	07/07	⇒ 08/11
DAILY IV 35C14 V, 35C14 V/P, 35S14 V, 35S14 V/P	F1CE3481L	07/07	⇒ 08/11
DAILY IV 35C14 /P, 35S14 /P, 35S14 D, 35S14 D/P	F1CE3481L	07/07	⇒ 08/11
DAILY IV 35C15 V, 40C15 V, 50C15 V, 60C15 V	F1CE3481B, F1CE3481B	09/11	⇒ 02/14
DAILY IV 35C15, 35C15D, 35S15, 40C15, 45C15, 50C15, 60C15, 70C15	F1CE3481B	09/11	⇒ 02/14
DAILY IV 35C15K, 35S15DKP, 50C15K, 60C15K, 65C15DK, 70C15K	F1CE3481B	09/11	⇒ 02/14
DAILY IV 35C17 K, 35C17 DK, 35S17 K, 35S17 DK	F1CE3481C	07/07	⇒ 08/11
DAILY IV 35C17 V, 35C17 V/P, 35S17 V, 35S17 V/P	F1CE3481C	07/07	⇒ 08/11
DAILY IV 35C17 V, 35S17 V, 40C17 V, 45C17 V, 50C17 V, 60C17 V	F1CE3481C	09/11	⇒ 02/14
DAILY IV 35C17 /P, 35S17 /P, 35S17 D	F1CE3481C	07/07	⇒ 08/11
DAILY IV 35C17D, 35S17, 40C17, 45C17, 50C17, 60C17, 70C17	F1CE3481C	09/11	⇒ 02/14
DAILY IV 35C17K, 35S17DKP, 50C17K, 65C17DK 70C17K	F1CE3481C, 4HS	09/11	⇒ 02/14
DAILY IV 35C21 V, 35S21 V, 40C21 V, 45C21 V, 50C21 V	F1CE3481D	09/11	⇒ 02/14
DAILY IV 35C21, 35S21, 40C21, 45C21, 50C21, 60C21, 70C21	F1CE3481D	09/11	⇒ 02/14
DAILY IV 35S17 W, 35S17 WD	F1CE3481C	07/07	⇒ 08/11
DAILY IV 40C14 K, 40C14 DK	F1CE3481L	07/07	⇒ 08/11
DAILY IV 40C14 V, 40C14 V/P	F1CE3481L	07/07	⇒ 08/11
DAILY IV 40C14 /P	F1CE3481L	07/07	⇒ 08/11
DAILY IV 40C17 K, 40C17 DK	F1CE3481C	07/07	⇒ 08/11
DAILY IV 40C17 V, 40C17 V/P	F1CE3481C	07/07	⇒ 08/11
DAILY IV 40C17 /P	F1CE3481C	07/07	⇒ 08/11
DAILY IV 45C14, 45C14 /P	F1CE3481L	07/07	⇒ 08/11
DAILY IV 45C17 V, 45C17 V/P	F1CE3481C	07/07	⇒ 08/11
DAILY IV 45C17 /P	F1CE3481C	07/07	⇒ 08/11
DAILY IV 50C14 K, 50C14 DK	F1CE3481L	07/07	⇒ 08/11
DAILY IV 50C14 V, 50C14 V/P	F1CE3481L	07/07	⇒ 08/11
DAILY IV 50C14 /P	F1CE3481L	07/07	⇒ 08/11
DAILY IV 50C17 K, 50C17 DK	F1CE3481C	07/07	⇒ 08/11
DAILY IV 50C17 V, 50C17 V/P	F1CE3481C	07/07	⇒ 08/11
DAILY IV 50C17 /P	F1CE3481C	07/07	⇒ 08/11
DAILY IV 55C17	F1CE3481C	08/07	⇒ 03/12
DAILY IV 55S17 W, 55S17 WD	F1CE3481C	07/07	⇒ 08/11
DAILY IV 55S18W	F1CE0481H	06/06	⇒ 08/11
DAILY IV 60C14 K, 60C14 DK	F1CE3481L	07/07	⇒ 08/11
DAILY IV 60C14 /P	F1CE3481L	07/07	⇒ 08/11
DAILY IV 60C17 K, 60C17 DK	F1CE3481C	07/07	⇒ 08/11
DAILY IV 60C17 V, 60C17 V/P	F1CE3481C	07/07	⇒ 08/11
DAILY IV 60C17 /P	F1CE3481C	07/07	⇒ 08/11
DAILY IV 65C14 K, 65C14 DK	F1CE3481L	07/07	⇒ 08/11
DAILY IV 65C14 V, 65C14 V/P	F1CE3481L	07/07	⇒ 08/11
DAILY IV 65C14 /P	F1CE3481L	07/07	⇒ 08/11
DAILY IV 65C17 K, 65C17 DK, 65C17KK	F1CE3481C	07/07	⇒ 08/11
DAILY IV 65C17 V, 65C17 V/P	F1CE3481C	07/07	⇒ 08/11
DAILY IV 65C17 /P	F1CE3481C	07/07	⇒ 08/11
DAILY IV 70C14 K, 70C14 DK, 70C14 KK	F1CE3481L	07/07	⇒ 08/11
DAILY IV 70C14 V, 70C14 V/P	F1CE3481L	07/07	⇒ 08/11
DAILY IV 70C14 /P	F1CE3481L	07/07	⇒ 08/11
DAILY IV 70C15	F1CE0481L	07/08	⇒ 08/11
DAILY IV 70C17 K, 70C17 DK, 70C17 KK	F1CE3481C	07/07	⇒ 08/11
DAILY IV 70C17 /P	F1CE3481C	07/07	⇒ 08/11
DAILY IV 70C17V, 70C17 V/P	F1CE3481C	07/07	⇒ 08/11
DAILY V 35S17, 55S17 4x4	F1CFL411F	08/15	⇒ 04/16
DAILY V 40C15, 50C15, 60C15	F1CFL411E	06/14	⇒ 10/16
DAILY V 40C17, 50C17, 60C17	F1CFL411F	06/14	⇒ 10/16

IVECO			
DAILY V 50C15	F1CFL411E	06/14	⇒ 10/16
DAILY V 50C17	F1CFL411F	06/14	⇒ 10/16
DAILY V 50C17, 65C17	F1CFL411F	06/14	⇒ 10/16
DAILY 3.0	F1CE0481H, F1CE3481B	06/06	⇒
LANCIA			
PHEDRA 2.0 D Multijet	RHR(DW10BTEd4)	07/06	⇒ 11/10
PHEDRA 2.0 JTD	RHM(DW10ATED4)	07/03	⇒ 11/10
PHEDRA 2.2 D Multijet	4HS, 4H01	03/08	⇒ 11/10
PHEDRA 2.2 JTD	4H01, 4HK	09/02	⇒
MITSUBISHI			
OUTLANDER II 2.2 DI-D 4WD	4HK, 9HY(DV6TED4)	08/07	⇒ 11/12
PEUGEOT			
207 1.6 HDi	9HY(DV6TED4), 9HZ(DV6TED4)	02/06	⇒
207 CC 1.6 HDi	9HZ(DV6TED4)	02/07	⇒
307 1.6 HDi	9HY(DV6ATED4)	04/05	⇒ 03/09
307 1.6 HDi 110	9HZ(DV6ATED4), 4HK(DW12MTED4)	02/04	⇒ 03/09
307 1.6 HDi 90	9HY(DV6ATED4)	12/06	⇒ 04/08
307 2.0 HDi 135	RHR(DW10BTEd4)	10/03	⇒ 04/09
407 2.0 HDi	DW10BTEd4	11/04	⇒
407 2.0 HDi [ExtraEU]	DW10BTEd4	11/04	⇒ 10/07
407 2.0 HDi 135	RHL(DW10BTEd4), 4HR(DW12BTEd4)	05/04	⇒
407 2.2 HDi	DW12BTEd4	03/06	⇒ 12/10
407 2.2 HDi 170	4HR(DW12BTEd4), 4HP(DW12BTEd4)	05/06	⇒
407 2.7 HDi	UH2(DT17)	10/05	⇒
607 2.0 HDi	RHR(DW10BTEd4)	09/05	⇒ 07/11
607 2.0 HDi 110 FAP	RHS(DW10ATED)	12/04	⇒
607 2.0 HDi 135	RHL(DW10BTEd4)	09/05	⇒
607 2.2 HDi	4HP(DW12BTEd4), RHM(DW10ATED4)	02/00	⇒
607 2.7 HDi 24V	DT17TED4	12/04	⇒ 07/11
807 2.0 HDi	RHM(DW10ATED4), F1CE0481D(F30DT)	06/02	⇒
807 2.2 HDi	DW12TED4	04/04	⇒
1007 1.6 HDi	9HZ(DV6TED4)	06/07	⇒
4007 2.2 HDi	4HK(DW12MTED4), RHL(DW10BTEd4)	02/07	⇒
BOXER II 3.0 D	F30DT	09/08	⇒ 12/09
BOXER II 3.0 HDi	F1CE0481D(F30DT), F1CE3481N(F30DTE)	07/06	⇒
BOXER II 3.0 HDi 145	F1CE3481N(F30DTE), F1CE0481D(F30DT)	04/10	⇒
BOXER II 3.0 HDi 160	F1CE0481D(F30DT), F1CE0481D(F30DT)	04/06	⇒
BOXER II 3.0 HDi 175	F1CE0481D(F30DT), 1AD-FTV	03/11	⇒
EXPERT II 2.0 HDi 140	RHR(DW10BTEd4)	01/07	⇒
EXPERT II TEPEE 2.0 HDi 140	RHR(DW10BTEd4)	01/07	⇒

10.3332

DIFFERENTIAL PRESSURE SENSORS

Adatt./Suitable:

- FORD**
6G9N-5L200-AA
8H42-5H209-AD *K
- JAGUAR**
C2Z 6459 *K
- LAND ROVER**
LR023134
MHK501130 *K
MHK501160 *K

- * No mounting bracket and no connecting pipes supplied**
- Fornito senza staffa di fissaggio e senza tubi di raccordo
- Livré sans support de fixation et sans tuyaux de raccord
- Keine Halterung und Verbindungsrohre geliefert
- Soporte de montaje y conexión de tuberías no suministrados



kPa	mV	
-18 - 100	250 - 3230	

JAGUAR		
XF 3.0 D	AJV6D	09/12 ⇒ 04/14
LAND ROVER		
RANGE ROVER III 3.6 D 4x4	368DT	04/06 ⇒ 08/12

LAND ROVER		
RANGE ROVER III 4.4 D 4x4	448DT	07/10 ⇒ 08/12

10.3333

3,5

DIFFERENTIAL PRESSURE SENSORS

Adatt./Suitable:

DENSO

- 1210 01L07
- 1210 01L27 *1
- 1210 11K25 *1
- 1210 2L10 *1
- 1211 9P 6 *1

- *1 without fastening clamp**
- senza staffa fissaggio
- sans bride de fixation
- ohne Befestigungsbügel
- sin estribo de sujeción

LEXUS

89481-20030

TOYOTA

- 89480-12040 *1
- 89480-12050 *1
- 89480-12060 *1
- 89480-20040 *1
- 89480-64020 *1
- 89481-20030

MARKET DIFFUSION: MEDIUM

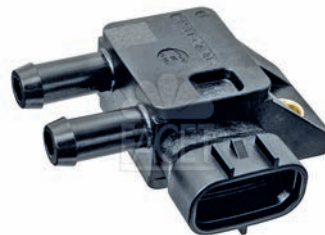

kPa	mV	
-5,7 - 96,6	496,4 - 4500	

LEXUS		
LX 450d	1VD-FTV	09/15 ⇒
TOYOTA		
AURIS I 2.0 D-4D	1AD-FTV	03/07 ⇒ 09/12
AURIS I 2.2 D	2AD-FHV	11/06 ⇒ 09/12
AURIS II 2.0 D-4D	1AD-FTV	10/12 ⇒
AVENSIS III 2.0 D-4D	1AD-FTV, 2AD-FHV	11/08 ⇒
AVENSIS III 2.2 D-4D	2AD-FHV, 1VD-FTV	11/08 ⇒
COROLLA X 2.0 D-4D	1AD-FTV	11/06 ⇒ 07/14
LAND CRUISER 200 4.5 D V8	1VD-FTV	01/08 ⇒
LAND CRUISER 200 4.5 D-4D	1VD-FTV	01/08 ⇒
LAND CRUISER 200 4.5 D4-D	1VD-FTV, 1AD-FTV	08/07 ⇒
VERSO 2.0 D-4D	1AD-FTV, M273.961	04/09 ⇒
VERSO 2.2 D-4D	2AD-FHV	04/09 ⇒
VERSO 2.2 D-CAT	2AD-FHV	04/09 ⇒

10.3340



3,5

DIFFERENTIAL PRESSURE SENSORS

Adatt./Suitable:

ATE

10.0522-9976.1
10.0522-9996.1

BMW

34 33 6 788 808

MERCEDES-BENZ

A 000 905 45 00
A 006 542 38 18

NEW - ITEM NOW AVAILABLE FROM PRODUCTION

• NUOVO - ARTICOLO ORA DISPONIBILE PER LA VENDITA

• NOUVEAU - ARTICLE DISPONIBLE EN PRODUCTION COURANTE

• NEU - JETZT ZUM VERKAUF VERFÜGBARER ARTIKEL

• NUEVO - ARTICULO AHORA DISPONIBLE EN PRODUCCION



kPa	mV	O ₂ + - O ₁
-80 - 6,8	1279 - 4500	

BMW

X6 I ActiveHybrid	N63B44A	01/09 → 10/11
X6 I ActiveHybrid xDrive	N63B44A	01/09 → 10/11

MERCEDES-BENZ

CLASSE B I B 150	M266.920	03/05 → 11/11
CLASSE B I B 160	M266.920	04/09 → 11/11
CLASSE B I B 170	M266.940	03/05 → 11/11
CLASSE B I B 170 NGT	M266.960	04/08 → 11/11
CLASSE B I B 180	M266.940	04/09 → 11/11
CLASSE B I B 180 CDI	OM640.940	03/05 → 11/11
CLASSE B I B 180 NGT	M266.960	04/08 → 11/11
CLASSE B I B 200	M266.960	03/05 → 11/11
CLASSE B I B 200 CDI	OM640.941	03/05 → 11/11
CLASSE B I B 200 TURBO	M266.980	03/05 → 11/11
CLASSE S V CL 500	M273.961, M273.968	06/06 → 12/13
CLASSE S V CL 500 4-matic	M273.968, M156.984	02/08 → 12/13
CLASSE S V CL 550 [JPN]	M273.961	06/06 →
CLASSE S V CL 550 [USA]	M273.961	06/06 →
CLASSE S V CL 550 4-matic [JPN]	M273.968	02/08 →
CLASSE S V CL 550 4-matic [USA]	M273.968	02/08 →
CLASSE S V CL 600	M275.953	05/06 → 12/13
CLASSE S V CL 63 AMG	M156.984, M275.982	10/06 → 12/13
CLASSE S V CL 65 AMG	M275.982, OM642.930	10/06 → 12/13
CLASSE S V S 250 CDI	OM651.961	01/11 → 12/13
CLASSE S V S 280	M272.946	08/06 → 12/13
CLASSE S V S 300	M272.946	08/06 → 12/13
CLASSE S V S 320 CDI	OM642.930, OM642.932	10/05 → 12/13
CLASSE S V S 320 CDI 4-matic	OM642.932, M156.984	10/05 → 12/13
CLASSE S V S 350	M272.965	10/05 → 12/13
CLASSE S V S 350 4-matic	M272.975	02/08 → 12/13
CLASSE S V S 350 BlueTec	OM642.862	04/11 → 12/13
CLASSE S V S 350 BlueTEC 4-matic	OM642.868	04/11 → 12/13
CLASSE S V S 350 CDI	OM642.930	06/09 → 12/13
CLASSE S V S 350 CDI 4-matic	OM642.932	01/09 → 12/10
CLASSE S V S 350 CGI	M276.950	04/11 → 12/13
CLASSE S V S 350 CGI 4-matic	M276.950	04/11 → 12/13
CLASSE S V S 400 Hybrid	M272.974	01/09 → 12/13
CLASSE S V S 420 CDI	OM629.911	10/06 → 12/09
CLASSE S V S 450	M273.922	12/05 → 12/13
CLASSE S V S 450 4-matic	M273.924	12/05 → 12/13
CLASSE S V S 500	M273.961	10/05 → 12/13
CLASSE S V S 500 4-matic	M273.968	10/05 → 12/13
CLASSE S V S 500 CGI	M278.932	04/11 → 12/13
CLASSE S V S 500 CGI 4-matic	M278.932	03/11 → 12/13
CLASSE S V S 550 [JPN]	M273.961	10/05 →
CLASSE S V S 550 [USA]	M273.961	10/05 →
CLASSE S V S 550 4-matic [JPN]	M273.968	10/05 →
CLASSE S V S 550 4-matic [USA]	M273.968	10/05 →
CLASSE S V S 600	M275.953	12/05 → 12/13

MERCEDES-BENZ

CLASSE S V S 63 AMG	M156.984, M275.982	10/06 → 12/13
CLASSE S V S 65 AMG	M275.982, D4FB	12/05 → 12/13

10.3342



3

DIFFERENTIAL PRESSURE SENSORS

Adatt./Suitable:

FIAT

6000611746

HYUNDAI

39210-2F600 *3
39251-2A600 *3
39251-2A610 *3

KIA

39210-2F600 *3
39251-2A600 *3
39251-2A610 *3
39360-03HCO *K

MITSUBISHI

1865A364

NEW - ITEM NOW AVAILABLE FROM PRODUCTION

• NUOVO - ARTICOLO ORA DISPONIBILE PER LA VENDITA

• NOUVEAU - ARTICLE DISPONIBLE EN PRODUCTION COURANTE

• NEU - JETZT ZUM VERKAUF VERFÜGBARER ARTIKEL

• NUEVO - ARTICULO AHORA DISPONIBLE EN PRODUCCION

*3 without connecting pipe

- senza tubo raccordo
- sans tuyau de raccordement
- ohne Anschlussrohr
- sin tubo de conexión

MARKET DIFFUSION: MEDIUM



kPa	mV	+ O ₂ -
-14,1 - 100	500 - 4500	

FIAT

FULLBACK 2.4 D	4N15	01/16 →
FULLBACK 2.4 D 4x4	4N15	01/16 →

HYUNDAI

ACCENT IV 1.6 CRDi	D4FB, D4FB	11/10 →
ELANTRA V 1.6 CRDi	D4FB, D4CB	02/11 →
GRAND SANTA FE 2.2 CRDi Trazione integrale	D4HB	10/15 →
H-1 II 2.5 CRDi	D4CB, D4FC	01/09 →
H350 2.5 CRDi	D4CB	04/15 →
I20 1.1 CRDi	D3FA	05/15 →
I20 1.4 CRDi	D4FC	05/15 →
I20 I 1.4 CRDi	D4FC, D4FB	08/08 → 12/15
I20 II 1.1 CRDi	D3FA	11/14 →
I20 II 1.4 CRDi	D4FC	11/14 →
I30 1.6 CRDi	D4FB	05/15 →
I30 II 1.4 CRDi	D4FC	12/11 →
I30 II 1.6 CRDi	D4FB, D4FB	11/11 →
I30 III 1.6 CRDi	D4FB, D4HA	11/16 →
I30 III 1.6 CRDi VGT [ExtraEU]	D4FE	08/18 →
I40 1.6 CRDi	D4FE	07/18 →
I40 1.7 CRDi	D4FD	07/11 →
IX35 1.7 CRDi	D4FD	11/10 →
IX35 2.0 CRDi	D4HA, D4HA	01/10 →
IX35 2.0 CRDi 4WD	D4HA	01/10 →
KONA 1.6 CRDi	D4FE	08/18 →
KONA 1.6 CRDi e-VGT	D4FE	08/18 →
KONA 1.6 CRDi e-VGT AWD	D4FE	08/18 →
SANTA FE III 2.0 CRDi	D4HA, D4HB	09/12 →
SANTA FE III 2.0 CRDi 4WD	D4HA	09/12 →
SANTA FE III 2.2 CRDi	D4HB, D4HB	09/12 →
SANTA FE III 2.2 CRDi 4WD	D4HB, D4FD	09/12 →
SANTA FE IV 2.0 CRDi	D4HA	07/18 →
SANTA FE IV 2.0 CRDi AWD	D4HA	07/18 →
SANTA FE IV 2.0 D	D4HA	02/18 →
SANTA FE IV 2.0 AWD	D4HA	02/18 →
SANTA FE IV 2.2 CRDi	D4HB	07/18 →
SANTA FE IV 2.2 CRDi AWD	D4HB	07/18 →
TUCSON 1.6 CRDi	D4FE	08/18 →
TUCSON 1.6 CRDi Trazione integrale	D4FE	08/18 →
TUCSON 1.7 CRDi	D4FD	06/15 →

HYUNDAI

TUCSON 2.0 CRDi	D4HA	06/15 →
TUCSON 2.0 CRDi hybrid 48V Trazione integrale	D4HA	10/18 →
TUCSON 2.0 CRDi Trazione integrale	D4HA	06/15 →

KIA

BONGO IV 2.5 CRDi	D4CB	01/12 →
CEED II 1.4 CRDi	D4FC	04/15 →
CEED II 1.4 CRDi 90	D4FC	05/12 →
CEED II 1.6 CRDi	D4FB	07/12 →
CEED II 1.6 CRDi 110	D4FB	05/12 →
CEED II 1.6 CRDi 128	D4FB	05/12 →
CEED II 1.6 CRDi 136	D4FB	07/15 →
CEED III 1.6 CRDi [ExtraEU]	D4FE	03/18 →
CEED III 1.6 CRDi 115	D4FE	05/18 →
CEED III 1.6 CRDi 136	D4FE	05/18 →
NIRO 1.6 GDI Hybrid	G4LE	09/16 →
OPTIMA III 1.7 CRDi	D4FD-L	03/12 →
OPTIMA IV 1.6 CRDi	D4FE	01/18 →
OPTIMA IV 1.7 CRDi	D4FD, D4HB	11/15 →
PROCEED 1.6 CRDi 136	D4FE	10/18 →
PRO CEE'D II 1.4 CRDi 90	D4FC	03/13 →
PRO CEE'D II 1.6 CRDi 110	D4FB	03/13 →
PRO CEE'D II 1.6 CRDi 128	D4FB	03/13 →
PRO CEE'D II 1.6 CRDi 136	D4FB	07/15 →
PRO CEE'D 1.4 CRDi	D4FC	05/15 →
PRO CEE'D 1.6 CRDi	D4FB	10/12 →
RIO III 1.1 CRDi	D3FA	09/11 →
RIO III 1.4 CRDi	D4FC	09/11 →
RIO IV 1.4 CRDi 77	D4FC	01/17 →
RIO IV 1.4 CRDi 90	D4FC	01/17 →
SORENTO 2.2 CRDi [ExtraEU]	D4HB	11/09 → 12/15
SORENTO III 2.0 CRDi 4WD	D4HA	07/15 →
SORENTO III 2.2 CRDi	D4HB	01/15 →
SORENTO III 2.2 CRDi 4WD	D4HB, D4HA	01/15 →
SOUL II 1.6 CRDi 128	D4FB	02/14 →
SOUL II 1.6 CRDi 136	D4FB	04/15 →
SPORTAGE 2.0 CRDi [ExtraEU]	D4HA	08/12 → 12/15
SPORTAGE III 1.7 CRDi	D4FD-L	12/10 →
SPORTAGE III 2.0 CRDi	D4HA, D4HA	07/10 →
SPORTAGE III 2.0 CRDi AWD	D4HA, D4FD	07/10 →
SPORTAGE IV 1.6 CRDi	D4FE	07/18 →
SPORTAGE IV 1.6 CRDi AWD	D4FE	07/18 →
SPORTAGE IV 1.7 CRDi	D4FD, D4FB	09/15 →
SPORTAGE IV 2.0 CRDi	D4HA	09/15 →
SPORTAGE IV 2.0 CRDi AWD	D4HA	09/15 →
SPORTAGE IV 2.0 CRDi Eco-Dynamics+ AWD	D4HA	06/18 →
STINGER 2.2 CRDi VGT	D4HC	06/17 →
STINGER 2.2 CRDi VGT 4WD	D4HC	06/17 →
STONIC 1.6 CRDi	D4FB, 2UR-GSE	07/17 →
VENGA 1.4 CRDi 75	D4FC	02/10 →
VENGA 1.4 CRDi 90	D4FC	02/10 →
VENGA 1.6 CRDi 115	D4FB	02/10 →
VENGA 1.6 CRDi 128	D4FB	02/10 →
VENGA CRDi	D4FC	04/15 →

MITSUBISHI

PAJERO SPORT III 2.4 DI-D 4x4	4N15	08/15 →
-------------------------------	------	---------

10.3386



3

DIFFERENTIAL PRESSURE SENSORS

Adatt./Suitable:

LEXUS

89481-71010

TOYOTA

89481-71010

NEW - AVAILABLE FROM:

- NUOVO - DISPONIBILE DA:
- NOUVEAU - DISPONIBLE EN:
- NEU - VERFUEGBAR AB:
- NUEVO - DISPONIBLE EN:

20/Q1



kPa	mV	
-6,7 - 95,6	500 - 4500	

LEXUS

LC 500	2UR-GSE, 2GD-FTV	11/16 ⇨
LS V 500 AWD	V35A-FTS	12/17 ⇨
RC F	2UR-GSE	03/18 ⇨
UX 200	M20A-FKS	10/18 ⇨
UX 250h	M20A-FXS	10/18 ⇨
UX 250h E-Four	M20A-FXS	10/18 ⇨

TOYOTA

C-HR 1.2 4WD	8NR-FTS	10/16 ⇨
COROLLA 1.2	8NR-FTS	01/19 ⇨
FORTUNER 2.8 [ExtraEU]	1GD-FTV	05/15 ⇨
FORTUNER 2.8 D 4x4	1GD-FTV	05/15 ⇨
HILUX VIII 2.4 D	2GD-FTV	05/15 ⇨
HILUX VIII 2.4 D 4WD	2GD-FTV, 1GD-FTV	05/15 ⇨
HILUX VIII 2.8 D	1GD-FTV	05/15 ⇨
HILUX VIII 2.8 D 4WD	1GD-FTV	05/15 ⇨
LAND CRUISER 2.8 D4d	1GD-FTV	10/18 ⇨
LAND CRUISER 150 2.8 D-4D	1GD-FTV, 1GD-FTV	06/15 ⇨
RAV 4 V 2.0	M20A-FKS	12/18 ⇨
RAV 4 V 2.0 AWD	M20A-FKS	12/18 ⇨
RAV 4 V 2.5 Hybrid	A25A-FXS	12/18 ⇨
RAV 4 V 2.5 Hybrid AWD	A25A-FXS	12/18 ⇨



AIR TEMPERATURE SENSORS

·SENSORI DI TEMPERATURA DELL'ARIA ·CAPTEURS DE TEMPERATURE D'AIR ·LUFTEMPERATUR-SENSOREN
·TERMORESISTENCIAS PARA TEMPERATURA DE AIRE

(A) P/NRS. - NOTES

- CODICI - NOTE
- RÉFS. - NOTES
- ARTIKEL-NR. - ANMERKUNGEN
- CODIGOS - NOTAS

10.4035

1

AIR TEMPERATURE SENSORS

Adatt./Suitabl

DACIA

60 01 543 611

82 00 061 780

82 00 833 248

RENAULT

60 01 543 611

82 00 061 780

82 00 833 248

NEW - ITEM NOW AVAILABLE FROM PRODUCTION

·NUOVO - ARTICOLO ORA DISPONIBILE PER LA VENDITA

·NOUVEAU - ARTICLE DISPONIBLE EN PRODUCTION COURANTE

·NEU - JETZT ZUM VERKAUF VERFÜGBARER ARTIKEL

·NUEVO - ARTICULO AHORA DISPONIBLE EN PRODUCCION

MARKET DIFFUSION: **HIGH**

(B) PICTURE + TECHNICAL INFO

- FOTO + INFORMAZIONE TECNICA
- ILLUSTRATION + INFORMATION TECHNIQUE
- BILD + TECHNISCHE INFO
- FOTO + INFORMACIÓN TÉCNICA

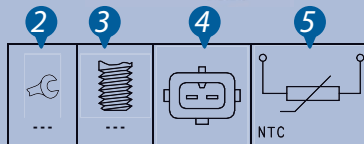

(C) APPLICATION LIST

- GUIDA APPLICAZIONI
- LISTE D'APPLICATIONS
- ANWENDUNGSTABELLE
- LISTA DE APLICACIONES

DACIA		
DOKKER 1.5 dCi	K9K830, K7M812	11/12 =>
DOKKER 1.5 dCi [ExtraEU]	K9K830	11/12 =>
DOKKER 1.6	K7M812, K7M812	11/12 =>
DOKKER 1.6 LPG	K7M812, K9K796	11/13 =>
DUSTER 1.5 dCi	K9K796, K4M490	04/10 =>
DUSTER 1.6 16V	K4M490, K4M490	04/10 =>

(A)

1 # FACET

2 OEM P/NRS.

- CODICI ORIGINALI
- RÉFS. D'ORIGINE
- ORIGINALTEILE-NR.
- CODIGOS ORIGINALES

3 PACKAGING SIZE

- FORMATO CONFEZIONE
- FORMAT DU CONDITIONNEMENT
- ABPACKENSGROSSE
- TAMAÑO DEL ENVASE

4 PRODUCT AVAILABILITY DATE

- DATA DI DISPONIBILITÀ DEL PRODOTTO
- DISPONIBILITÉ DU PRODUIT
- PRODUKTVERFUEGBARKEITSDATUM
- DISPONIBILIDAD ARTÍCULO

5 NOTE

- NOTE
- NOTES
- BERMERKUNGEN
- NOTAS

(B)

1 PICTURE

- FOTO
- PHOTO
- BILD
- FOTO

2 WRENCH

- CHIAVE
- CLÉ
- SCHLÜSSELWEITE
- LLAVE

3 THREAD

- FILETTATURA
- FILET
- GEWINDE
- ROSCA

	Cylindrical ·Cilindrica ·Cylindrique ·Zylindrisch ·Cilindrico
	Conical ·Conica ·Conique ·Konisch ·Conico

4 CIRCUIT

- CIRCUITO
- CIRCUIT
- STROHMKREIS
- CIRCUITO

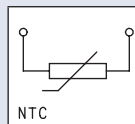
**NTC Variable resistance between terminals (insulated ground)**

- Resistenza NTC variabile tra i terminali (massa isolata)
- Résistance NTC variable entre les connexions (masse isolée)
- NTC Variabler Widerstand zwischen beiden Anschlüssen (Masse isoliert)
- Resistencia NTC variable entre los enchufes (masa aislada)

NTC**NEGATIVE TEMPERATURE COEFFICIENT**

- COEFFICIENTE NEGATIVO DI TEMPERATURA
- COEFFICIENT NEGATIF DE TEMPERATURE
- NEGATIVER TEMPERATURKOEFFIZIENT
- COEFICIENTE NEGATIVO DE TEMPERATURA

5 TYPE OF CONNECTION

- TIPO DI CONNESSIONE
- TYPE DE CONNEXION
- ANSCHLUSSART
- TIPO DE ENCHUFE

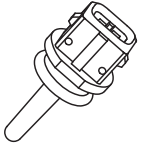

10.4XXX

Air temperature sensors

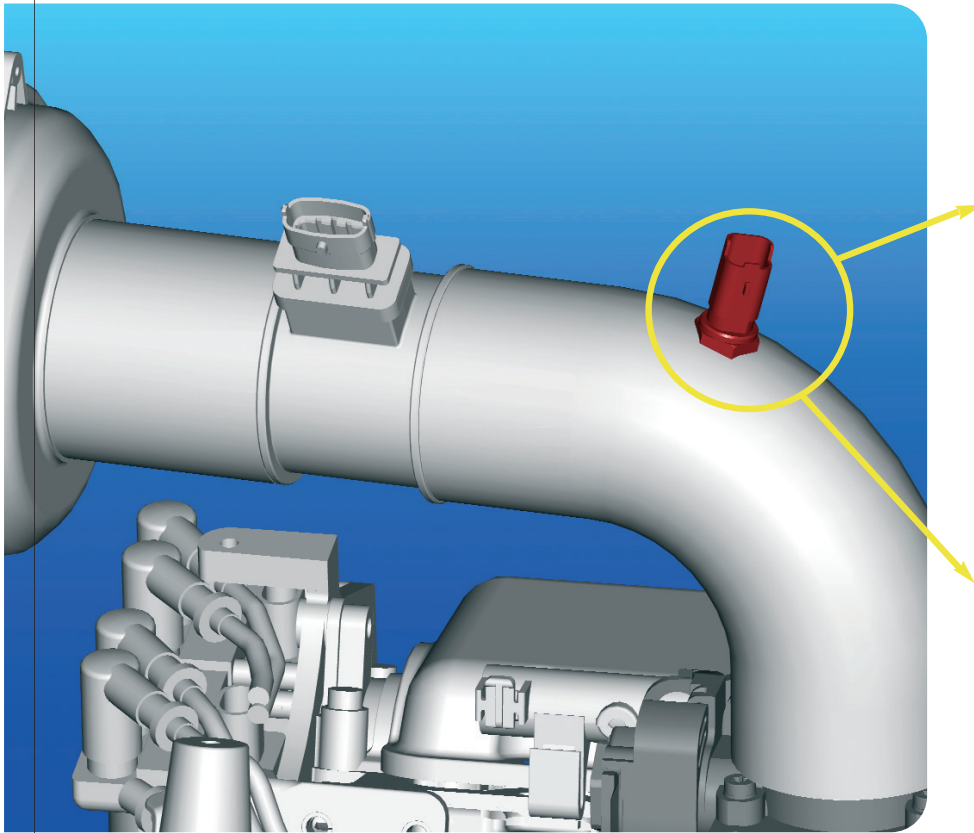

Rendering: per gentile concessione di FIAT POWERTRAIN TECHNOLOGIES

Air temperature transmitters **measure the temperature of the air drawn in by the intake manifold of the engine** by means of a *thermistor* (a resistor whose resistance depends on the temperature). The signal indicating the temperature is sent to the engine control unit to *indirectly* calculate the amount of air sucked in (starting from measurements of the pressure and air temperature, RPM and engine timing), in order to determine the correct fuel quantity. Air temperature sensors can thus guarantee optimum thermal efficiency as well as keep exhaust gases within the percentages established by the anti-pollution standards.

Air temperature sensors can be used with gasoline, diesel and hybrid powered engines.

Furthermore, depending on the type of engine and control unit, air temperature sensors may be integrated in:

- air flow sensors*1
- absolute pressure sensors*2

*1 (Facet P/NRS 10.1XXX); *2 (Facet P/NRS 10.3XXX).

The main **reasons for failures** in the product are:

- jets of water at high pressure (e.g. during washing of the engine) may cause deterioration of the electrical insulation
- defects in seals on the intake tube cover, defects in the exhaust gas

recirculation valves, penetration of dust and oil particles into the intake manifold

Signs of malfunctions of the sensor are indicated by illumination of the engine warning lamp, loss of engine power, difficulty in starting the engine, increased fuel consumption.

Air temperature sensors are designed and assembled to withstand the critical installation conditions inside the engine compartment. In particular, the following **requirement** shall be met:

- *operating temperature*: $-40^{\circ}\text{C} \div +125^{\circ}\text{C}$

The air temperature sensors undergo **qualification and endurance tests** to determine if the product is suitable for construction and sale:

- resistance to high temperatures
- resistance to thermal shocks
- resistance to impacts
- resistance to vibrations
- resistance to water immersion

When these tests have been passed and after the approval to manufacture has been given, the product, in the assembly process, is strictly checked through a series of cycles which include a **100% sensor resistance test**.

Structural elements and operation

The sensitive element of the sensors, the *thermistor*, is surface-mounted or fit into a protective *plastic body*. The end containing the sensitive element is in contact with the air, hence its temperature, to be measured; the other end has a *connector*, generally made of plastic, which contains the terminals for the electrical contact. The leads of the thermistor are welded directly onto the contacts of the *connector*. The metal body is usually provided with a *threaded portion* or with *toothed elements* so that it can be screwed on or snaplocked onto the car. A rubber *O-ring recess* ensures a hermetic seal between the sensor and the intake manifold.

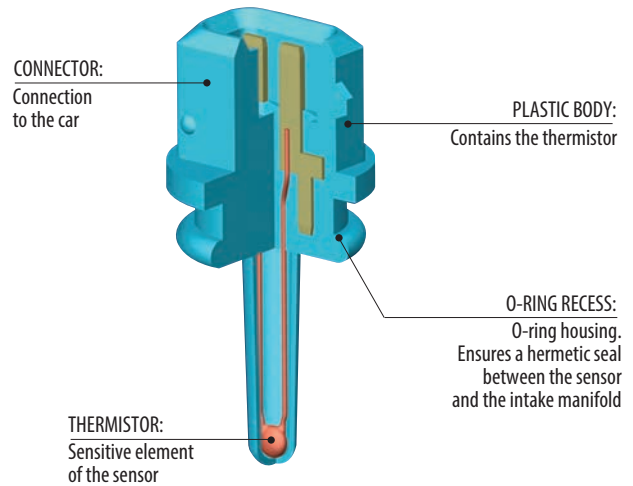

There are 2 types of sensors, depending on the sensitive element:

• **NTC Thermistor (Negative Temperature Coefficient):** the resistance of the sensitive element (thermistor) will decrease as the temperature rises, thereby causing a decrease in the tension transmitted to the unit. The resistance, expressed according to the temperature, is approximated by an **exponential** curve:

$$R_T = R_{25} \exp \left\{ B \left(\frac{1}{T} - \frac{1}{298,15} \right) \right\} [\Omega]$$

T: temperature [°C]
 R_T : resistance at temperature T [Ω]
 R_{25} : resistance at temperature 25°C [Ω]
 B: material constant [°C]

The NTC thermistors consist of a mixture of metal oxides and oxidized crystals which are produced through pressing with the addition of bonding agents and through further sintering.

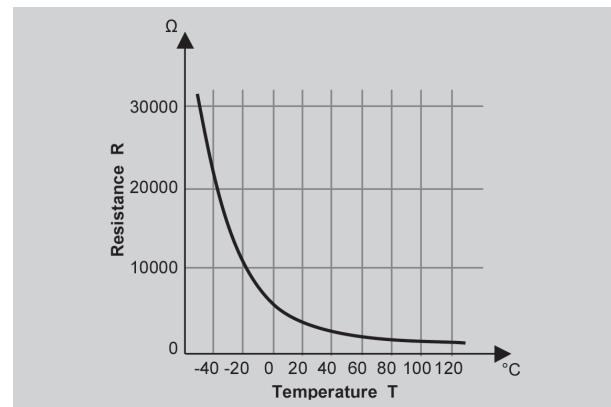

Loren

• **Linear PTC Thermistor (Positive Temperature Coefficient):** the resistance of the sensitive element (thermistor) will increase as the temperature rises, thereby causing an increase in the tension transmitted to the unit. The resistance, expressed according to the temperature, is approximated by a **linear** curve.

Linear PTC thermistors are made of silicon chips which make use of the conductive features of the crystal structure. They are achieved through photolithography, deposition of metals from the vapor phase as well as other common processes used in semiconductor technology.

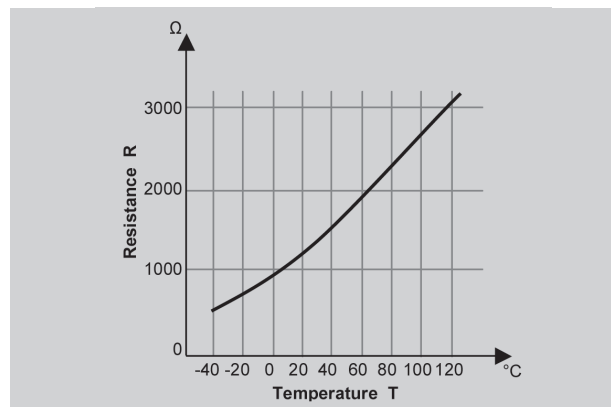

Installation instructions

Tightening torque for air temperature sensors: **30÷50 Nm.**

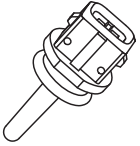

10.4XXX

Sensori di temperatura dell'aria

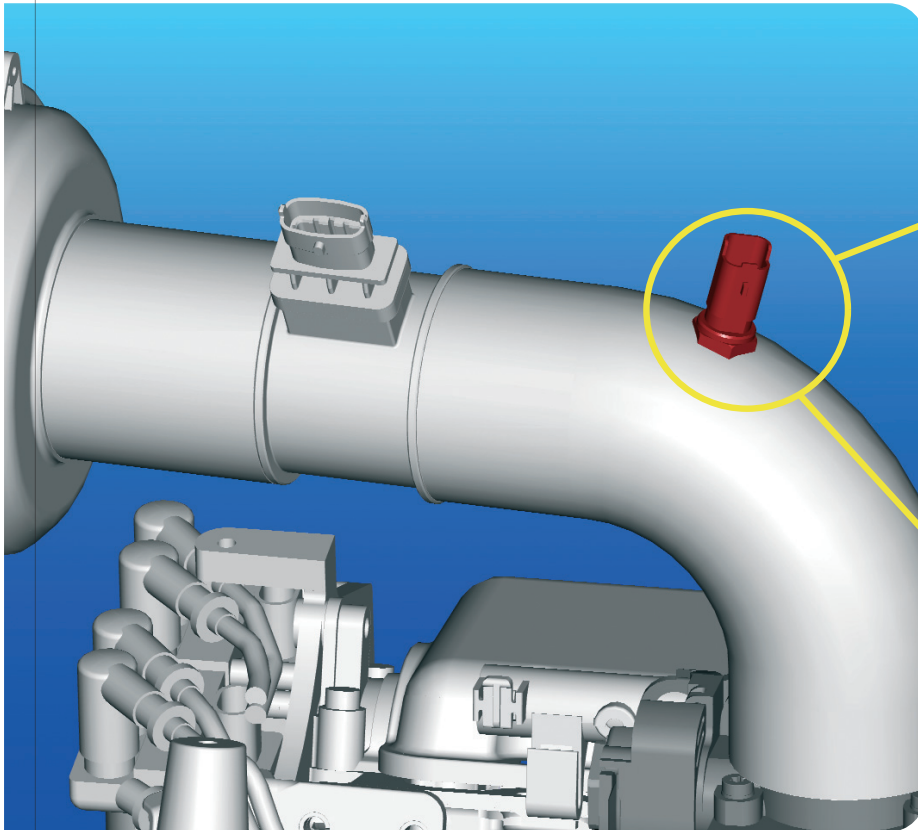

Rendering: per gentile concessione di FIAT POWERTRAIN TECHNOLOGIES

I sensori temperatura aria **misurano la temperatura dell'aria aspirata dal collettore d'aspirazione del motore** per mezzo di un *termistore*. Il segnale indicante la temperatura è inviato alla centralina di controllo motore per calcolare in modo *indiretto* la quantità di aria aspirata e stabilire il corretto dosaggio di carburante. I sensori temperatura aria garantiscono un buon rendimento termico e permettono di mantenere i gas tossici esausti di combustione entro le percentuali stabilite dalle norme anti-inquinamento.

I sensori temperatura aria si possono applicare a **veicoli con alimentazione a benzina, a gasolio e ibrida**. Inoltre, in funzione della tipologia di motore e della centralina di controllo, i sensori temperatura aria possono essere integrati:

- nei sensori di portata aria*1
- nei sensori di pressione assoluta*2

*1 (articolo Facet 10.1XXX); *2 (articolo Facet 10.3XXX).

Le principali **cause di guasto** del prodotto sono:

- spruzzi di acqua ad alta pressione (es. durante il lavaggio del motore) possono causare la riduzione dell'isolamento elettrico
- difetti nella tenuta ermetica nella canalizzazione del condotto di aspirazione, difetti delle valvole di ricircolo gas di scarico, passaggio di particelle di polvere ed olio all'interno del condotto di aspirazione

I **segnali di malfunzionamento** del sensore sono ravvisabili nell'accensione della spia motore, nella perdita di potenza del motore, difficoltà di avviamento del veicolo, elevato consumo di carburante.

I sensori temperatura aria sono progettati e costruiti per sopportare le condizioni critiche di montaggio nel vano motore. In particolare devono soddisfare il seguente **requisito**:

- *temperatura di funzionamento*: $-40^{\circ}\text{C} \div +125^{\circ}\text{C}$

I sensori temperatura aria sono sottoposti a rigorose **prove di qualificazione e di durata** per stabilire se il prodotto è idoneo per essere costruito e venduto:

- resistenza all'alta temperatura
- resistenza agli shock termici
- resistenza agli urti
- resistenza alle vibrazioni
- resistenza all'immersione in acqua

Superate tali prove e concesso il benessere a produrre, durante l'assemblaggio il prodotto viene sottoposto a severi cicli di controllo che prevedono il **collaudo al 100%** della resistenza dei sensori.

Elementi costruttivi e principio di funzionamento

L'elemento sensibile dei sensori, il *termistore*, è montato a vista o in serito in un *corpo plastico* protettivo. L'estremità contenente l'elemento sensibile è a contatto con l'aria di cui deve misurare la temperatura, l'altra estremità presenta un *connettore*, generalmente di materiale plastico, contenente i terminali per il contatto elettrico. I reofori del termistore sono saldati direttamente sui contatti del *connettore*. Il corpo plastico può essere provvisto, solitamente, di una porzione *filettata* o di *elementi a dente* per consentire il montaggio su vettura tramite avvvitamento o scatto. Una sede per *guarnizione ad anello* in gomma garantisce la tenuta ermetica tra sensore e collettore di aspirazione.

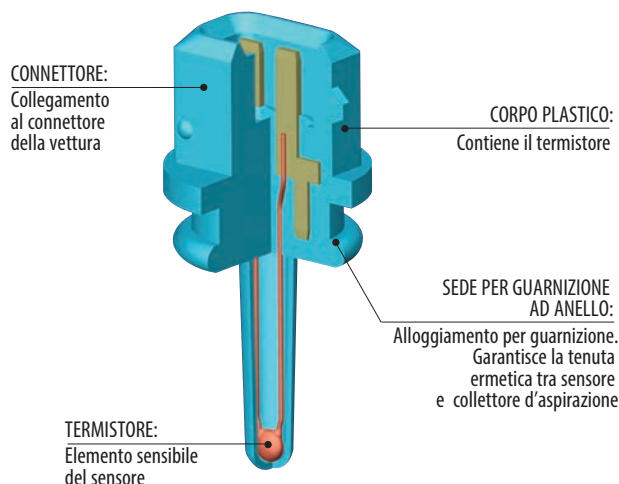

Esistono 2 tipologie di sensori in funzione dell'elemento sensibile:

• **Termistore NTC** (a *coefficiente di temperatura negativo*): la resistenza dell'elemento sensibile (termistore) diminuisce all'aumentare della temperatura causando una diminuzione della tensione trasmessa alla centralina. La resistenza, espressa in funzione della temperatura, è approssimata da una curva **esponenziale**:

$$R_T = R_{25} \exp \left\{ B \left(\frac{1}{T} - \frac{1}{298,15} \right) \right\} [\Omega]$$

T:	temperatura	[°C]
R_T :	resistenza alla temperatura T	[Ω]
R_{25} :	resistenza alla temperatura 25°C	[Ω]
B:	costante del materiale	[°C]

I termistori NTC sono formati da una miscela di ossidi di metallo e cristalli ossidati e sono prodotti mediante una pressatura con aggiunta di agenti leganti e una successiva sinterizzazione.

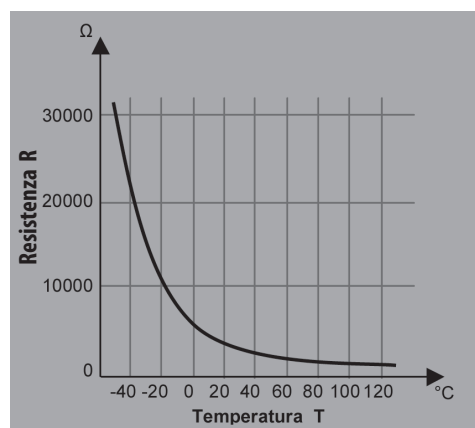

• **Termistore PTC lineare** (a *coefficiente di temperatura positivo*): la resistenza dell'elemento sensibile (termistore) aumenta all'aumentare della temperatura causando un aumento della tensione trasmessa alla centralina. La resistenza, espressa in funzione della temperatura, è approssimata da una curva **lineare**.

I termistori di tipo PTC lineare sono realizzati in chip di silicio e ne sfruttano le caratteristiche conduttive della struttura a cristallo. Sono realizzati mediante fotolitografia, deposito di metalli in fase vapore e altri processi usuali della tecnologia dei semiconduttori.

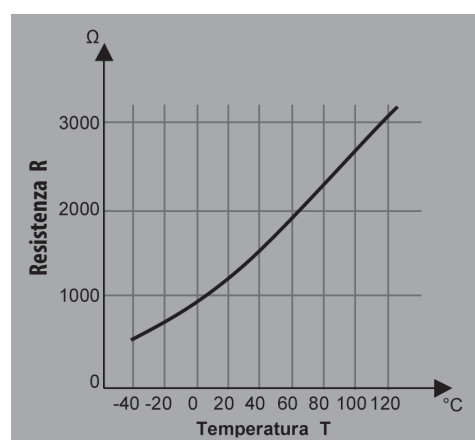

Istruzioni di montaggio

Coppia di serraggio dei sensori temperatura aria: **30÷50 Nm**.

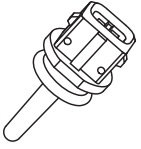

10.4XXX

Capteurs de température d'air

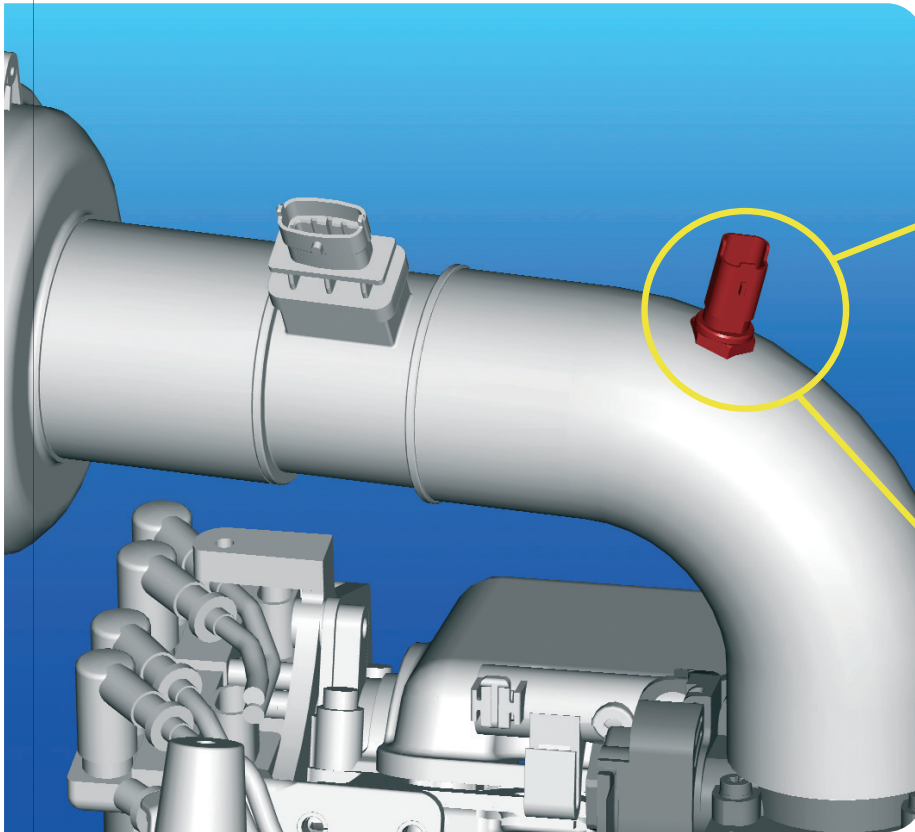

Rendering: par aimable concession de FIAT POWERTRAIN TECHNOLOGIES

Les capteurs de température d'air **mesurent la température de l'air qui est aspiré par le collecteur d'admission du moteur**, au moyen d'un *thermiste* (résisteur dont la résistance dépend de la température). Le signal indiquant la température est envoyé à l'unité de contrôle du moteur pour calculer, de façon *indirecte*, la quantité d'air aspiré (à partir de mesures de la pression et de la température de l'air, du nombre de tours et phase du moteur) pour établir le bon dosage du carburant. Les capteurs de température d'air garantissent donc un bon rendement thermique et permettent de maintenir les gaz toxiques produits par la combustion dans les pourcentages définis par les normes antipollution.

Les capteurs de température d'air peuvent être appliqués dans les **véhicules alimentés à essence, au gasoil et hybrides**.

De plus, en fonction de la typologie des moteurs et des unités de contrôle, les capteurs de température d'air peuvent être intégrés aux:

- capteurs de débit d'air*1
- capteurs de pression absolue*2.

*1 (article Facet 10.1XXX); *2 (article Facet 10.3XXX).

Les principales **causes de défaut** du produit sont:

- des jets d'eau à haute pression (ex. pendant le lavage du moteur) qui peuvent causer une réduction de l'isolation électrique
- défauts d'étanchéité hermétique dans la canalisation du conduit

d'admission, défauts des soupapes de recyclage des gaz d'échappement, passage de particules de poussière et d'huile dans le conduit d'admission

Les **signaux de dysfonctionnement** du capteur sont reconnaissables par l'allumage du témoin du moteur, la perte de puissance du moteur, la difficulté de démarrage du véhicule, la consommation élevée de carburant.

Les capteurs de température d'air sont conçus et fabriqués pour supporter les conditions de montage critiques dans le compartiment moteur. En particulier, ils doivent répondre à la **caractéristique** suivante :

- *température de fonctionnement*: $-40^{\circ}\text{C} \div +125^{\circ}\text{C}$

Les capteurs de température d'air sont soumis à des **essais de qualification et de durée rigoureux** pour établir si le produit est adéquat à la fabrication et à la vente :

- résistance aux hautes températures
- résistance aux chocs thermiques
- résistance aux coups
- résistance aux vibrations
- résistance à l'immersion dans l'eau

À l'issue positive de ces essais et une fois l'autorisation de production accordée, le produit est soumis tout au long de son assemblage à de sévères cycles de contrôle envisageant le **test à 100%** de la résistance des capteurs.

Éléments constitutifs et principe de fonctionnement

L'élément sensible des capteurs, le *thermisteur*, peut être monté à vue ou inséré dans un *corps plastique* de protection. L'extrémité comportant l'élément sensible est en contact avec l'air dont la température doit être mesurée, tandis que l'autre extrémité dispose d'un connecteur, généralement en matériau plastique, renfermant les bornes pour le contact électrique. Les conducteurs électriques du thermisteur sont soudés directement sur les contacts du *connecteur*. Le corps plastique possède habituellement une portion *filetée* ou des *éléments à dent* pour en permettre le montage sur la voiture par vissage ou encliquetage. Un *logement pour joint torique* en caoutchouc assure l'étanchéité hermétique entre le capteur et le collecteur d'admission.

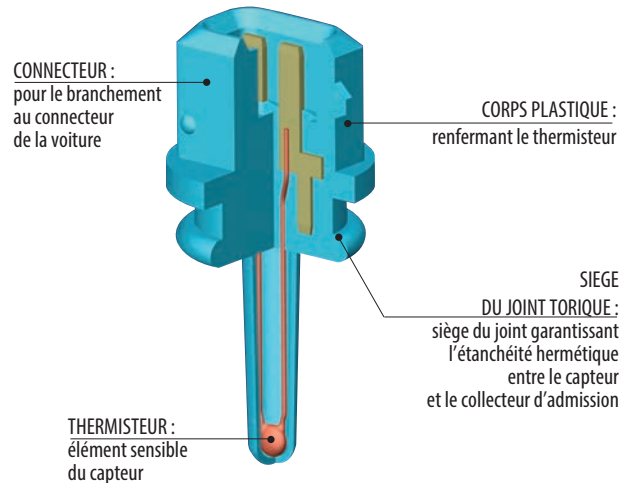

Il existe 2 typologies de capteurs, en fonction de l'élément sensible:

• **Thermisteur NTC** (à coefficient de température négatif): la résistance de l'élément sensible (thermisteur) diminue alors que la température augmente et cela comporte une diminution de la tension qui est transmise à l'unité de contrôle. La résistance, exprimée en fonction de la température, est approchée par une courbe **exponentielle**:

$$R_T = R_{25} \exp \left\{ B \left(\frac{1}{T} - \frac{1}{298,15} \right) \right\} [\Omega]$$

T: température [°C]
 R_T : résistance à la température T [Ω]
 R_{25} : résistance à la température 25°C [Ω]
 B: constante du matériel [°C]

Les thermisteurs NTC, composées d'un mélange d'oxydes de métal et de cristaux oxydés, sont produites par pressage avec ajout d'agents liants et frittage successif.

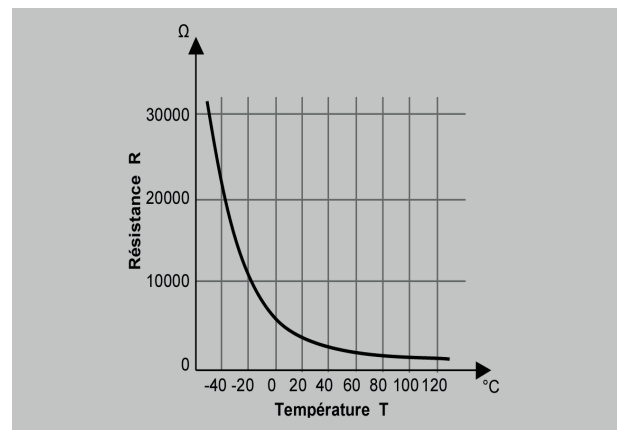

• **Thermisteur PTC linéaire** (à coefficient de température positif): la résistance de l'élément sensible (thermisteur) augmente alors que la température augmente et cela comporte une augmentation de la tension qui est transmise à l'unité de contrôle. La résistance, exprimée en fonction de la température, est approchée par une courbe **linéaire**.

Les thermisteurs de type PTC linéaire sont réalisées à l'aide de puces en silicium et en exploitent les caractéristiques conductrices de la structure à cristal. Elles sont produites moyennant photolithographie, dépôt de métaux en phase vapeur et autres processus propres de la technologie des semi-conducteurs.

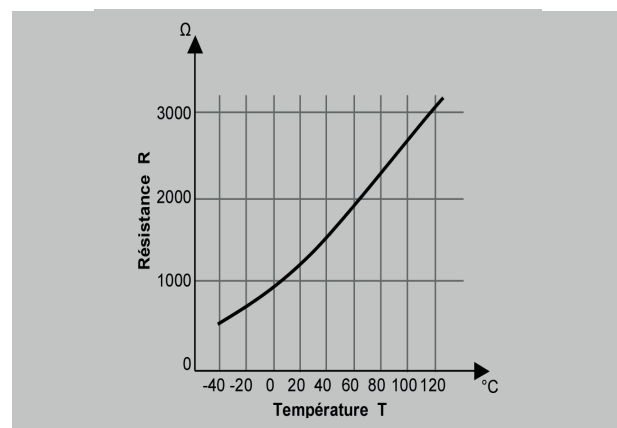

Instructions de montage

Couple de serrage des capteurs de température d'air: 30÷50 Nm.

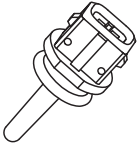

10.4XXX Lufttemperatursensoren

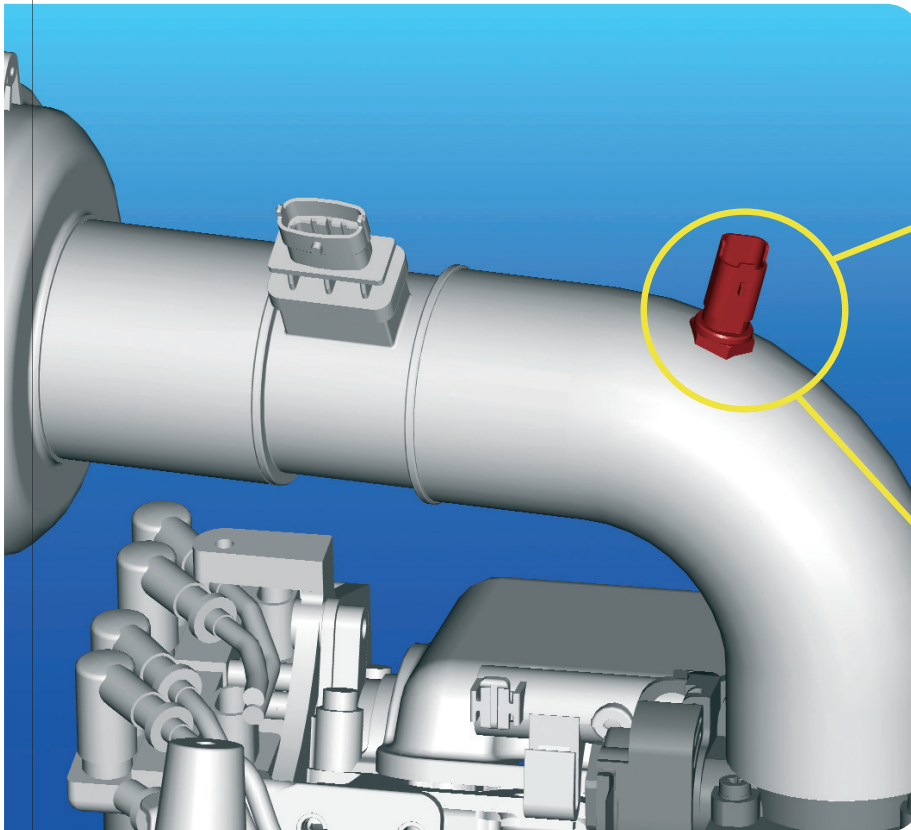

Rendering: bei freundlichem Zugeständnis von FIAT POWERTRAIN TECHNOLOGIES

Die Lufttemperatursensoren **messen die Temperatur der vom Ansaugkrümmer des Motors angesaugten Luft** mit Hilfe eines Thermistors (Widerstand, dessen Leistung von der Temperatur abhängt). Das Signal mit der Anzeige der Temperatur wird dem Steuergerät des Motors gesendet, um *indirekt* die Menge der angesaugten Luft zu berechnen (ausgehend von Messungen des Drucks und der Lufttemperatur, der Drehzahl und der Phase des Motors), damit die korrekte Kraftstoffdosierung ermittelt wird. Die Temperaturfühler gewährleisten daher eine gute thermische Leistung und ermöglichen die Beibehaltung der Werte der giftigen Abgase innerhalb der von den Umweltschutzbestimmungen festgelegten Anteile.

Die Lufttemperatursensoren können bei **bezinbetriebenen, dieselbetriebenen und wasserstoffbetriebenen Fahrzeugen** eingesetzt werden.

Je nach Art des Motors und des Steuergeräts können die Lufttemperatursensoren folgendermaßen integriert werden:

- in die Luftmassenmesser^{*1}
- in die Drucksensoren^{*2}

^{*1} (Artikel Facet 10.1XXX); ^{*2} (Artikel Facet 10.3XXX)

Die **Hauptursachen für Defekte** des Produktes sind:

- Wasserspritzer unter hohem Druck (z. B. während des Reinigen des Motors) können zur Verringerung der Elektroisolierung führen

- Defekte der hermetischen Dichtheit auf dem Verlauf der Ansaugleitung, Defekte der Abgasrückführungsventile, Eindringen von Staub- und Ölparkeln in das Innere der Ansaugleitung
- Die Anzeichen einer Funktionsstörung** des Sensors sind am Aufleuchten der Motoranzeige, der Leistungsverringerung des Motors, an Startschwierigkeiten des Fahrzeugs und an hohem Kraftstoffverbrauch zu erkennen.

Die Lufttemperatursensoren werden im Hinblick auf Planung und Bau so ausgelegt, dass sie den kritischen Montagebedingungen im Motorraum standhalten. Insbesondere müssen sie folgende **Anforderungen** erfüllen:

- **Betriebstemperatur:** -40°C ÷ +125°C

Die Lufttemperatursensoren werden **Qualitäts- und Haltbarkeitstests** unterzogen, um festzustellen, ob das Produkt für Bau und Verkauf geeignet ist:

- Temperaturbeständigkeit (hohe und niedrige Temperaturen)
- Beständigkeit gegen starke Temperaturschwankungen
- Stoßfestigkeit
- Schwingungsfestigkeit
- Beständigkeit gegen das Eintauchen in Wasser

Bei positiven Prüfergebnissen und nach Erteilung der Produktionsgenehmigung erfolgen während der Montage strenge Kontrollzyklen auf dem Produkt, mit der **100% - Abnahmeprüfung** des Widerstands der Sensoren.

Bauteile und Funktionsprinzip

Der Fühler der Sensoren, d.h. der *Thermistor*, ist sichtbar montiert oder in einem *Schutzgehäuse aus Kunststoff* enthalten. Das Ende mit dem Fühler steht in Berührung mit der Luft, deren Temperatur gemessen werden soll. Das andere Ende ist mit einem Anschluss ausgerüstet, der in der Regel aus Kunststoffmaterial besteht und die Klemmen für den elektrischen Kontakt enthält. Die Leiter des Thermistors sind direkt auf den Kontakten des *Anschlusses* verschweißt. Das Kunststoffgehäuse kann in der Regel mit einem *Gewindeteil* oder mit *Federelementen* ausgerüstet sein, damit es auf das Fahrzeug aufgeschraubt oder durch eine Klick - Verbindung montiert werden kann. Eine *Aufnahme für Ringdichtung* aus Gummi gewährleistet die hermetische Abdichtung zwischen Sensor und Ansaugkrümmer.

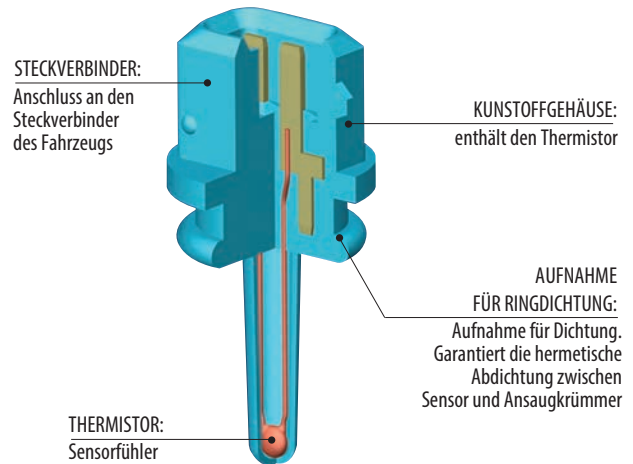

Je nach Fühler gibt es 2 verschiedene Arten von Sensoren:

- **NTC-Thermistor** (mit negativem Temperaturkoeffizienten): der Widerstand des Fühlers (Thermistor) verringert sich mit ansteigender Temperatur, wodurch die dem Steuergerät übertragene Spannung gesenkt wird. Der Widerstand wird je nach Temperatur von einer **Exponentialkurve** approximiert:

$$R_T = R_{25} \exp \left\{ B \left(\frac{1}{T} - \frac{1}{298,15} \right) \right\} [\Omega]$$

T:	temperatur	[°C]
R_T :	Widerstand bei Temperatur T	[Ω]
R_{25} :	Widerstand bei Temperatur 25°C	[Ω]
B:	Materialkonstante	[°C]

Die NTC-Thermistoren sind aus einer Mischung aus Metalloxiden und oxidierten Kristallen gebildet und durch eine Pressung mit dem Zusatz von Bindungsmitteln und einer nachfolgenden Sinterung geschützt.

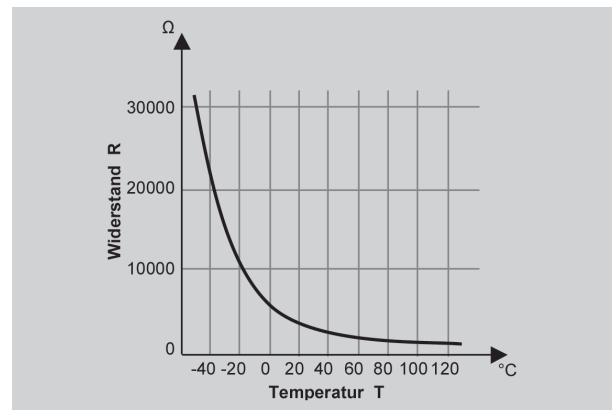

- **PTC-Thermistor linear** (mit positivem Temperaturkoeffizienten): Der Widerstand des Fühlers (Thermistor) erhöht sich mit ansteigender Temperatur, wodurch die dem Steuergerät übertragene Spannung erhöht wird. Der Widerstand wird je nach Temperatur von einer **linearen** Kurve approximiert:

Die PTC-Thermistoren sind als Silizium-Chips ausgelegt und nutzen die leitenden Eigenschaften der Kristallstruktur. Sie werden mit Fotolithographie, Abscheidung von Metallen aus der Dampfphase sowie anderen der Technologie der Halbleiter entsprechenden Verfahren hergestellt.

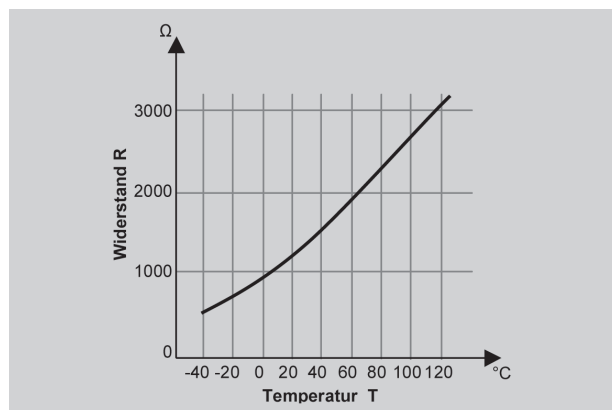

Montageanweisungen

Anzugsmoment der Lufttemperatursensoren: **30 ÷ 50 Nm.**

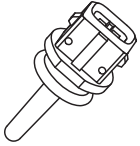

10.4XXX

Sensores de temperatura del aire

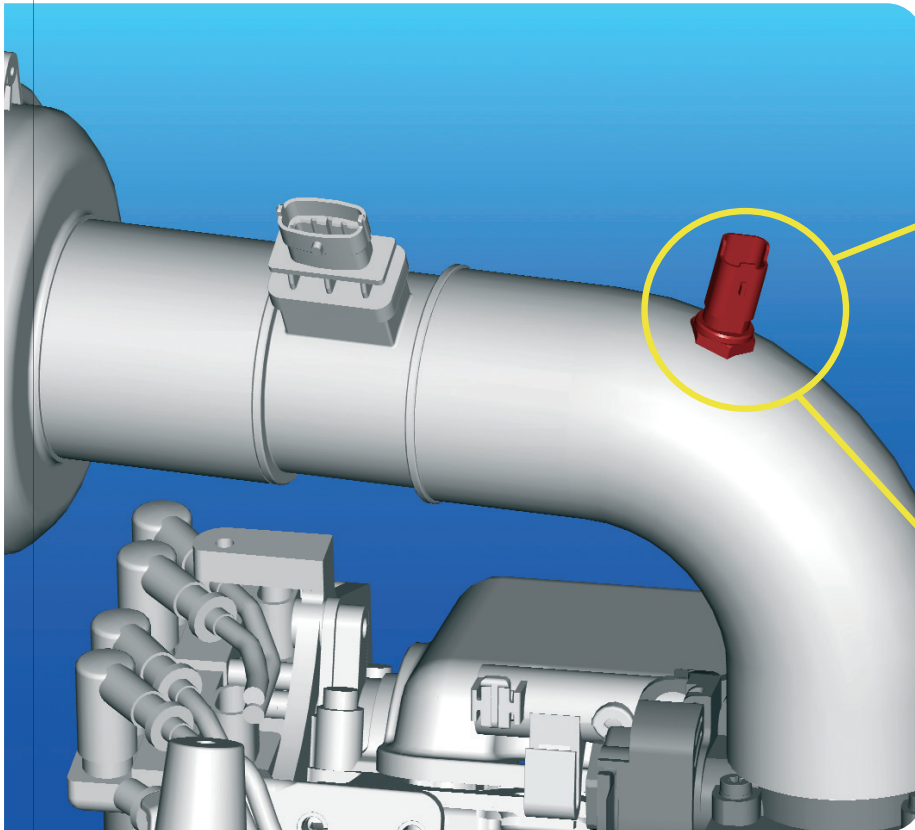

Rendering: por amable concesion de FIAT POWERTRAIN TECHNOLOGIES

Las termoresistencias para temperatura de aire **miden la temperatura del aire aspirado por el colector de aspiración del motor** a través de un *termistor* (con una capacidad de resistencia que depende de la temperatura). La señal que indica la temperatura se envía a la centralita de control del motor para calcular de manera *indirecta* la cantidad de aire aspirado (a partir de mediciones de la presión y de la temperatura del aire, el número de revoluciones y la fase del motor) para determinar la correcta dosificación de combustible. Por lo tanto, las termoresistencias para temperatura del aire garantizan un buen rendimiento térmico y permiten mantener los gases tóxicos de combustión dentro de los porcentajes establecidos por las normas de control de la contaminación.

Las termoresistencias para temperatura del aire se pueden instalar en **vehículos con alimentación de gasolina, gasóleo e híbrida**. De acuerdo con el tipo de motor y de centralita de control, las termoresistencias para temperatura del aire pueden estar incorporadas:

- en las sondas de masa de aire*1
- en los sensores de presión*2

*1 (artículo Facet 10.1XXX); *2 (artículo Facet 10.3XXX).

Las principales **causas de avería** del producto son:

- las salpicaduras de agua a alta presión (por ejemplo, durante el lavado del motor) pueden provocar la disminución del aislamiento eléctrico

- defectos de hermeticidad en el canal del conducto de admisión, defectos de las válvulas de recirculación de gases de escape, paso de partículas de polvo y aceite dentro del conducto de admisión
- Las **señales de problemas de funcionamiento** del sensor se notan por el encendido del testigo del motor, la pérdida de potencia del motor, la dificultad de arranque del vehículo y el elevado consumo de combustible.

Las termoresistencias para temperatura de aire están diseñadas y fabricadas para soportar las condiciones críticas de montaje en el espacio motor. En especial, deben cumplir con el siguiente **requisito**:

- *temperatura de funcionamiento*: $-40^{\circ}\text{C} \div +125^{\circ}\text{C}$

Las termoresistencias para temperatura de aire son sometidos a rigurosos **ensayos de calificación y de duración**, para determinar si el producto es apropiado para ser fabricado y vendido:

- resistencia a las altas temperaturas
- resistencia a los choques térmicos
- resistencia a los golpes
- resistencia a las vibraciones
- resistencia a la inmersión en agua

Después que ha superado estas pruebas y obtenido la aprobación para la producción, durante el ensamblaje el producto se somete a severos ciclos de control que prevén el **ensayo al 100%** de la resistencia de las termoresistencias.

Elementos de construcción y principio de funcionamiento

El elemento sensible de las termoresistencias, el *termistor*, está montado a la vista o introducido en un *cuerpo de plástico* de protección. El extremo que contiene el elemento sensible está en contacto con el aire del que debe medir la temperatura; el otro extremo tiene un *conector*, generalmente de material plástico, que contiene los terminales para el contacto eléctrico. Los filamentos eléctricos del termistor están soldados directamente en los contactos del conector. El cuerpo de plástico puede tener, normalmente, una parte *roscada* o *elementos dentados* para permitir el montaje en el vehículo mediante roscado o a presión. Un *asiento para junta anular* de caucho garantiza la hermeticidad entre el sensor y el colector de aspiración.

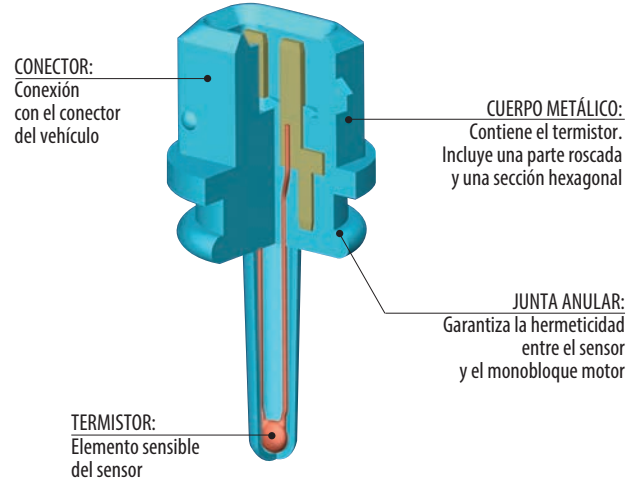

Existen dos tipos de termoresistencias, según el elemento sensible:

• **Termistor NTC** (de *coeficiente de temperatura negativo*): la resistencia del elemento sensible (termistor) disminuye a medida que aumenta la temperatura, generando una reducción de la tensión transmitida a la centralita. La resistencia, expresada según la temperatura, está aproximada por una curva **exponencial**:

$$R_T = R_{25} \exp \left\{ B \left(\frac{1}{T} - \frac{1}{298,15} \right) \right\} [\Omega]$$

T:	temperatura	[°C]
R_T :	resistencia a la temperatura T	[Ω]
R_{25} :	resistencia a la temperatura 25°C	[Ω]
B:	constante del material	[°C]

Los termistores NTC están formados por una mezcla de óxidos de metal y cristales oxidados y se fabrican mediante prensado con el agregado de agentes aglutinantes y una posterior sinterización.

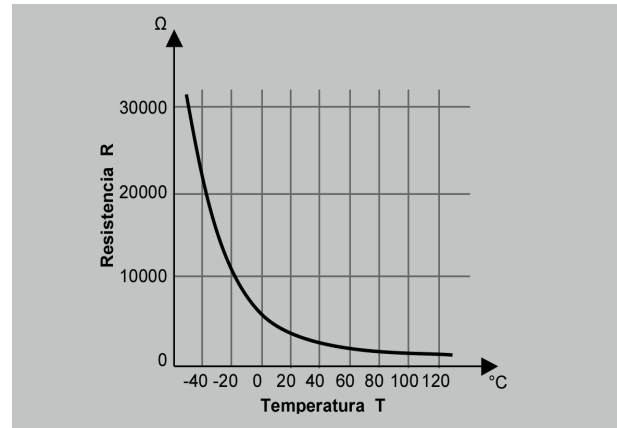

• **Termistor PTC lineal** (de *coeficiente de temperatura positivo*): la resistencia del elemento sensible (termistor) aumenta a medida que aumenta la temperatura, generando un aumento de la tensión transmitida a la centralita. La resistencia, expresada según la temperatura, está aproximada por una curva **lineal**.

Los termistores de tipo PTC lineal están realizados en chips de silicio y aprovechan las características de conducción de la estructura de cristal. Están fabricados mediante fotolitografía, depósito de metales en fase vapor y otros procedimientos usuales de la tecnología de los semiconductores.

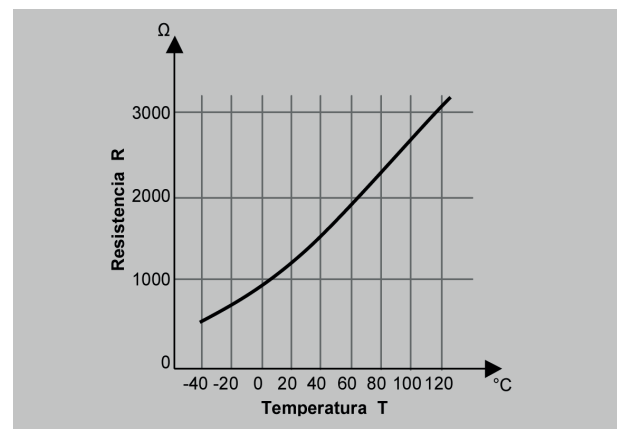

Instrucciones de montaje

Par de torsión de las termoresistencias para temperatura de aire: **30÷50 Nm**.



AIR TEMPERATURE SENSORS

Adatt./Suitable:

AUDI

058 905 379

BOSCH

0 280 130 085

PORSCHE

993 606 114 00

SEAT

058 905 379

SKODA

058 905 379

VW

058 905 379

MARKET DIFFUSION: MEDIUM

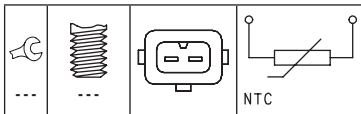
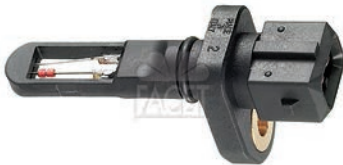

AUDI

A3 I 1.6	AEH, AGN	09/96 ⇒ 05/03
A3 I 1.8	AGN, AGU	09/96 ⇒ 05/03
A3 I 1.8 T	AGU, AGU	12/96 ⇒ 05/03
A3 I 1.8 T quattro	AGU, AMK	12/96 ⇒ 05/03
A3 I S3 quattro	AMK, ADP	10/01 ⇒ 05/03
A4 I 1.8 T	AMB, AMB	11/00 ⇒ 03/09
A4 I 1.8 T quattro	AMB, AGE	11/00 ⇒ 03/09
A4 I 1.6	ADP, ADR	11/94 ⇒ 09/01
A4 I 1.8	ADR, ADR	11/94 ⇒ 09/01
A4 I 1.8 quattro	ADR, AEB	01/95 ⇒ 09/01
A4 I 1.8 T	AEB, AEB	01/95 ⇒ 09/01
A4 I 1.8 T quattro	AEB, AGA	01/95 ⇒ 09/01
A4 I 2.4	AGA, AGA	03/97 ⇒ 09/01
A4 I 2.4 quattro	AGA, ACK	03/97 ⇒ 09/01
A4 I 2.6 quattro	ABC	01/95 ⇒ 09/01
A4 I 2.8	ACK, ACK	10/96 ⇒ 09/01
A4 I 2.8 quattro	ACK, ASJ	10/96 ⇒ 09/01
A4 I RS4 quattro	ASJ, AGB	05/00 ⇒ 09/01
A4 I S4 quattro	AGB, AMB	09/97 ⇒ 09/01
A6 I 1.8	ADR	12/95 ⇒ 12/97
A6 I 1.8 quattro	ADR	12/95 ⇒ 12/97
A6 II 1.8	AFY, AEB	05/97 ⇒ 01/05
A6 II 1.8 T	AEB, AEB	01/97 ⇒ 01/05
A6 II 1.8 T quattro	AEB, AGA	02/97 ⇒ 01/05
A6 II 2.4	AGA, AGA	08/01 ⇒ 01/05
A6 II 2.4 quattro	AGA, AJK	08/01 ⇒ 01/05
A6 II 2.7 T	AJK	02/99 ⇒ 01/05
A6 II 2.7 T quattro	AJK, ACK	08/01 ⇒ 01/05
A6 II 2.8	ACK, ACK	02/97 ⇒ 01/05
A6 II 2.8 quattro	ACK, ACK	02/97 ⇒ 01/05
A6 2.8	AGE, AFY	04/98 ⇒ 05/01
A8 I 2.8	ACK, ACK	04/96 ⇒ 09/02
A8 I 2.8 quattro	ACK, ARE	04/96 ⇒ 09/02
ALLROAD 2.7 T quattro	ARE, AJQ	05/00 ⇒ 08/05
CABRIOLET 1.8	ADR	01/97 ⇒ 08/00
TT I 1.8 T	AJQ, AJQ	01/01 ⇒ 06/06
TT I 1.8 T quattro	AJQ, M64.60R	02/00 ⇒ 06/06

PORSCHE

911 III 3.6 Turbo 4	M64.60	03/95 ⇒ 09/97
911 III 3.6 Turbo GT2	M64.60R	03/95 ⇒ 09/97
911 III 3.6 Turbo GT2 4	M64.60R, AJH	08/95 ⇒ 09/97

SEAT

ALHAMBRA I / II 1.8 T 20V	AJH, AQX	10/97 ⇒ 03/10
CORDOBA I 1.8 T 20V Cupra	AQX	07/00 ⇒ 10/02
IBIZA II 1.8 T 20V Cupra	AQX, APP	07/00 ⇒ 02/02
LEON I 1.8 20VT	APP, AJQ	11/99 ⇒ 06/06
LEON I 1.8 20VT 4	AJQ, AMK	11/99 ⇒ 06/06
LEON I 1.8 T Cupra R	AMK, AEH	02/02 ⇒ 06/06
LEON I 1.8 Turbo 4x4	AMK	05/02 ⇒ 05/03
LEON I 2.3 V5	AGZ	10/98 ⇒ 11/00
TOLEDO II 1.8 20VT	AUQ	09/00 ⇒ 07/04
TOLEDO II 2.3 V5	AGZ	10/98 ⇒ 11/00

SKODA

OCTAVIA I 1.6	AEH, AGU	02/97 ⇒ 12/07
---------------	----------	---------------

SKODA

OCTAVIA I 1.8	AGN	09/96 ⇒ 07/00
OCTAVIA I 1.8 20V	AGN	07/98 ⇒ 07/00
OCTAVIA I 1.8 T	AGU, AGU	08/97 ⇒ 12/10
OCTAVIA I 1.8 T 4x4	ARX	05/01 ⇒ 05/06
OCTAVIA I RS 1.8 T	AUQ	05/01 ⇒ 01/06
SUPERB I 1.8 T	AWT	12/01 ⇒ 03/08
SUPERB I 2.8 V6	AMX	12/01 ⇒ 03/08

VOLKSWAGEN (BR)

GOL 1.0i 16v Turbo	512	06/00 ⇒
GOLF A4 1.8i Turbo 20v	AGU	10/99 ⇒
PARATI 1.0i 16v Turbo	512	06/00 ⇒

VW

BORA 1.8 T	AGU, AGU	05/00 ⇒ 05/05
BORA 2.3 V5	AGZ	10/98 ⇒ 10/00
BORA 2.3 V5 4motion	AGZ	12/98 ⇒ 10/00
GOLF IV 1.8 T	AGU, AGU	08/97 ⇒ 06/06
GOLF IV 1.8 T GTI	AUQ	08/01 ⇒ 06/05
GOLF IV 2.3 V5	AGZ	08/97 ⇒ 06/06
GOLF IV 2.3 V5 4motion	AGZ	12/98 ⇒ 06/06
NEW BEETLE 1.8 T	AGU, ADP	11/01 ⇒ 09/10
PASSAT IV 1.6	ADP, ADR	10/96 ⇒ 11/00
PASSAT IV 1.8	ADR, ANQ	10/96 ⇒ 03/05
PASSAT IV 1.8 [CHN]	ANQ, ADR	03/00 ⇒
PASSAT IV 1.8 4motion	AWM	03/01 ⇒ 05/05
PASSAT IV 1.8 Syncro/4motion	ADR, AWL	10/96 ⇒ 11/00
PASSAT IV 1.8 T	AWM	02/01 ⇒ 08/05
PASSAT IV 1.8 T 20V	AWL, AMX	11/00 ⇒ 05/05
PASSAT IV 1.8 T 4motion	AWM	03/01 ⇒ 05/05
PASSAT IV 1.9 TDI	AWX	11/00 ⇒ 05/05
PASSAT IV 2.3 VR5	AGZ	10/96 ⇒ 11/00
PASSAT IV 2.3 VR5 Syncro/4motion	AGZ	10/97 ⇒ 11/00
PASSAT IV 2.8	AMX, AMX	10/00 ⇒
PASSAT IV 2.8 [CHN]	BBG	09/01 ⇒
PASSAT IV 2.8 4motion	AMX, ACK	10/00 ⇒
PASSAT IV 2.8 Syncro	AGE	05/97 ⇒ 09/99
PASSAT IV 2.8 V6	ACK, ACK	08/96 ⇒ 09/99
PASSAT IV 2.8 V6 4motion	ATX	09/99 ⇒ 11/00
PASSAT IV 2.8 V6 Syncro/4motion	ACK, AJH	10/96 ⇒ 11/00
PASSAT 2.8 [ExtraEU]	BBG	10/00 ⇒ 05/05
SHARAN I 1.8 T 20V	AJH, AR32102	09/97 ⇒ 03/10



AIR TEMPERATURE SENSORS

Adatt./Suitable:

Eliminated on 02-08-2018. Please verify the availability through our local distributors

- Eliminato il 02-08-2018. Verificare la disponibilità presso i nostri distributori
- Éliminé le 02-08-2018. Vérifier la disponibilité auprès de nos distributeurs sur place
- Am 02-08-2018 gestrichen. Evtl. Verfügbarkeit bitte bei unseren Händlern prüfen
- Eliminado en fecha 02-08-2018. Verificar la disponibilidad a través de nuestros distribuidores locales

1006 After depletion of stock this part is replaced by:

- Esaurite le scorte questo pezzo sarà sostituito da:
- Après épuisement du stock, cette pièce est remplacée par:
- Nach Vorraterschöpfung wird ersetzt durch:
- Despues agotamiento stock, sera sustituido por:

10.4005

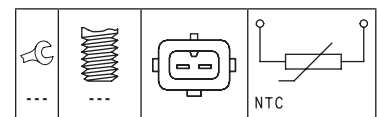

10.4003



1

AIR TEMPERATURE SENSORS

Adatt./Suitable:

ALFA ROMEO

60591909
60813345
7763719

BOSCH

0 280 130 073

FIAT

7763719

GENERAL MOTORS

90 442 182

HOLDEN

90442182

HONDA

37880-PDF-E01

IVECO

8024226

LANCIA

7763719

OPEL

8 36 401

90442182

PORSCHE

993 606 113 00

SAAB

42 39 067

SCANIA

4239067

SEAT

6W0 906 081

VAUXHALL

90442182

VW

6W0 906 081

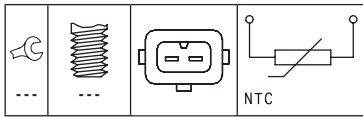

ALFA ROMEO

145 1.4 i.e.	AR33501	07/94 ⇒ 12/96
145 1.4 i.e. 16V T.S.	AR33503	12/96 ⇒ 01/01
145 1.6 i.e.	AR33201	10/94 ⇒ 12/96
145 1.6 i.e. 16V T.S.	AR32102, AR32102	12/96 ⇒ 01/01
145 1.6 LPG	AR32102	01/98 ⇒ 01/01
145 1.7 i.e. 16V	AR33401	10/94 ⇒ 12/96
145 1.8 i.e. 16V T.S.	AR67106	12/96 ⇒ 12/98
145 1.8 i.e. 16V T.S. [BRA]	AR67199	10/96 ⇒ 02/99
145 2.0 16V T.S.	AR67204	10/95 ⇒ 01/01
145 2.0 16V T.SPARK [BRA]	AR67299	10/96 ⇒ 02/99
145 2.0 16V T.SPARK Q.V. [BRA]	AR67299	10/95 ⇒ 09/96
146 1.4 i.e. 16V T.S.	AR33503	11/96 ⇒ 01/01
146 1.6 i.e. 16V T.S.	AR32102, AR67204	11/96 ⇒ 10/01
146 1.7 i.e. 16V	AR33401	12/94 ⇒ 12/96
146 1.8 i.e. 16V T.S.	AR67106	11/96 ⇒ 01/01
146 1.9 TD	AR33601	12/94 ⇒ 02/99
146 2.0 16V T.S.	AR67204	10/95 ⇒ 01/01
155 1.6 16V T.S.	AR67601	05/96 ⇒ 12/97
155 1.7 T.S. 16V	AR67106	05/96 ⇒ 12/97
155 2.0 T.S. 16V	AR67204, AR32102	03/95 ⇒ 12/97
156 1.6 16V T.SPARK	AR32102, AR32103	09/97 ⇒ 09/05
156 1.6 16V T.SPARK.	AR32103, AR32201	05/00 ⇒ 05/06
156 1.8 16V T.SPARK	AR32201, AR32301	05/00 ⇒ 05/06
156 2.0 16V T.SPARK	AR32301, 932A2.000	05/00 ⇒ 06/02
156 2.0 JTS	932A2.000, 841C000	01/02 ⇒ 05/06
156 2.4 JTD	841C000, AR32401	03/02 ⇒ 05/06
156 2.5 V6 24V	AR32401, AR64307	02/97 ⇒ 05/06
156 2.5 V6 24V [BRA]	AR32402	10/97 ⇒ 12/01
164 3.0 24V Q4	AR64307, AR16201	09/92 ⇒ 10/98
164 3.0 24V QV Trazione integrale	AR64307	11/92 ⇒ 10/97
164 3.0 i 24V Super Q4	AR66304	03/95 ⇒ 12/98
GTV 2.0 T.SPARK 16V	AR16201, AR16102	06/95 ⇒ 10/05
GTV 3.0 V6 24V	AR16102, AR16101	10/00 ⇒ 10/05
GTV 3.2 V6 24V	936A6.000	04/03 ⇒ 10/05
SPIDER 3.0 [ExtraEU]	AR16101, AR16201	04/95 ⇒ 04/05
SPIDER II 2.0 T.SPARK 16V	AR16201, AR16199	06/95 ⇒ 04/05
SPIDER II 3.0 12V [BRA]	AR16199, AR16101	09/95 ⇒

ALFA ROMEO

SPIDER II 3.0 V6	AR16101, 182A7.000	09/94 ⇒ 04/05
FIAT		
BRAVA 1.9 JTD	182A7.000, 182A7.000	09/00 ⇒ 10/01
BRAVA 1.9 TD 100 S	182A7.000, 182A7.000	03/96 ⇒ 10/01
BRAVA 1.9 TD 75 S	182A8.000	03/96 ⇒ 10/01
BRAVO I 1.9 JTD	182A7.000, 182A7.000	09/00 ⇒ 10/01
BRAVO I 1.9 TD 100 S	182A7.000, 182A1.000	03/96 ⇒ 10/01
BRAVO I 1.9 TD 75 S	182A8.000	03/96 ⇒ 10/01
BRAVO I 2.0 HGT 20V	182A1.000	10/95 ⇒ 07/98
COUPE 2.0 20V	182A1.000, 182A7.000	08/96 ⇒ 09/98
MAREA 1.9 TD	182A7.000	08/96 ⇒ 02/99
MAREA 1.9 TD 100	182A7.000, 182A1.000	05/96 ⇒ 06/03
MAREA 2.0 150 20V	182A1.000, 838A1.000	01/01 ⇒ 04/99
MAREA 2.0 155 20V	182B7.000	04/99 ⇒ 02/03
MAREA 2.0i 20v [BRA]	182A1.011	10/96 ⇒ 04/99
MAREA 2.4 JTD 130	185A6.000	04/99 ⇒ 05/02
MAREA 2.4 TD 125	185A2.000	09/96 ⇒ 04/99
MARENGO 1.9 TD	182A7.000	07/96 ⇒ 02/99
FIAT (BR)		
MAREA 2.0i 20v	2.0Mpi	01/99 ⇒ 12/00
HOLDEN		
CALIBRA_YE 2.5i 24v	C25XE	08/95 ⇒ 10/97
FRONTERA_UT 2.0i	X20SE	10/95 ⇒ 03/99
HONDA		
ACCORD 1.6	D16B7	10/98 ⇒ 12/01
ACCORD VI 1.6	D16B6	12/99 ⇒ 12/02
ACCORD VI 1.6 i	D16B6	10/98 ⇒ 12/02
ACCORD VI 1.6 LS	D16B7	10/98 ⇒ 12/02
LANCIA		
KAPPA 2.0 20V	838A1.000, 838A2.000	10/94 ⇒ 10/01
KAPPA 2.4 20V	838A2.000, 838A3.000	08/94 ⇒ 10/01
KAPPA 2.4 T.DS	838A3.000, M64.05	08/94 ⇒ 10/01
KAPPA 3.0 24V	838B.000	08/94 ⇒ 10/01
OPEL		
ASTRA F 1.8 i 16V	18SE	09/95 ⇒ 09/96
ASTRA F 2.0 GSi 16V	C20XE	09/91 ⇒ 01/98
ASTRA F 2.0 i	C20NE	09/91 ⇒ 09/98
ASTRA F 2.0 i 16V	C20XE	03/93 ⇒ 01/98
CALIBRA A 2.0 i 16V	C20XE	06/90 ⇒ 02/94
CALIBRA A 2.0 i 16V 4x4	C20XE	06/90 ⇒ 02/94
CALIBRA A 2.5 i V6	C25XE	04/93 ⇒ 07/97
FRONTERA A 2.0 i	X20SE	03/92 ⇒ 10/98
FRONTERA A 2.2 i	X22XE	03/95 ⇒ 10/98
OMEGA B 2.0	X20SE	03/94 ⇒ 09/99
OMEGA B 2.5 V6	X25XE	03/94 ⇒ 09/00
OMEGA B 3.0 V6	X30XE	04/94 ⇒ 02/01
SINTRA 2.2 i 16V	X22XE	11/96 ⇒ 04/99
SINTRA 3.0 i 24V	X30XE	11/96 ⇒ 04/99
VECTRA A 2.0 i 16V	20XEJ	02/89 ⇒ 10/90
VECTRA A 2.0 i 16V 4x4	C20XE	08/89 ⇒ 08/95
VECTRA A 2.0 i 16V Cat	C20XE	02/90 ⇒ 11/95
VECTRA A 2.5 CD 4x4	C25XE	08/92 ⇒ 08/95
VECTRA A 2.5 V6	C25XE	02/93 ⇒ 11/95
VECTRA A 2000 16V 4x4	20XEJ	01/89 ⇒ 10/90
VECTRA A 2000/GT 16V	20XEJ	01/89 ⇒ 06/94
VECTRA A 2000/GT 16V Cat	C20XE	02/90 ⇒ 11/95
VECTRA A 2000/GT 16V Cat 4x4	C20XE	02/90 ⇒ 11/95
VECTRA B 2.0 DI 16V	X20DTL	11/96 ⇒ 04/02
VECTRA B 2.0 i	20NEJ	10/95 ⇒ 04/02
VECTRA B 2.5	X25XE	10/99 ⇒ 06/00
VECTRA B 2.5 i V6	X25XE	10/95 ⇒ 09/00
VECTRA Bi 500 2.5	X25XE	05/98 ⇒ 09/00
PORSCHE		
911 III 3.6 Carrera	M64.05, M64.05	10/93 ⇒ 09/97
911 III 3.6 Carrera 4	M64.05, M64.055	07/94 ⇒ 09/97
911 III 3.8 Carrera	M64.055, M64.055	06/95 ⇒ 09/97
911 III 3.8 Carrera 4	M64.055, C25XE	06/95 ⇒ 09/97
911 III 3.8 Carrera RS	M64.20	06/95 ⇒ 09/97
SAAB		
9000 3.0 -24 V6 CD/CDE	B3081	07/94 ⇒ 12/98
9000 3.0 -24 V6 CS/CSE	B3081	07/94 ⇒ 12/98
SEAT		
ALHAMBRA I / II 2.0 i	ADY	04/96 ⇒ 03/10
VAUXHALL		
ASTRA III 1.8 i 16V	18SE	09/95 ⇒ 02/98
ASTRA III 2.0 i	C20NE	09/91 ⇒ 09/98
ASTRA III 2.0 i 16V	C20XE	09/91 ⇒ 02/98
CALIBRA 2.0 i 16V	C20XE	06/90 ⇒ 02/94
CALIBRA 2.0 i 16V 4x4	C20XE	06/90 ⇒ 02/94
CALIBRA 2.5 i V6	C25XE, AM11	04/93 ⇒ 07/97
FRONTERA A 2.0	X20SE	04/95 ⇒ 08/98
FRONTERA A 2.0 i	X20SE	03/92 ⇒ 10/98
FRONTERA A 2.2 i	X22XE	03/95 ⇒ 10/98
OMEGA B 2.0	X20SE	03/94 ⇒ 09/99
OMEGA B 2.5 V6	X25XE	03/94 ⇒ 09/00
OMEGA B 3.0 V6	X30XE	04/94 ⇒ 07/00
SINTRA 2.2 i 16V	X22XE	11/96 ⇒ 04/99

VAUXHALL

SINTRA 3.0 i 24V	X30XE	11/96 ⇒ 04/99
VECTRA B 2.0 DI 16V	X20DTL	08/95 ⇒ 10/01
VECTRA B 2.0 i	20NEJ	10/95 ⇒ 03/02
VECTRA B 2.5 i GSi	X25XE	03/98 ⇒ 07/00
VECTRA B 2.5 i V6	X25XE	09/95 ⇒ 08/00
VW		
SHARAN I 2.0	ADY	09/95 ⇒ 03/10

10.4004



3

AIR TEMPERATURE SENSORS

Adatt./Suitable:

ASTON MARTIN

6G43-08-10064
EG33-08-10726

FORD

1 090 457
1 682 035
3 906 827
4 046 339
7 256 454
9C11-12A697-BA
F62F-12A697-AA
F65F-12A697-AA
F65F-12A697-AB
F7RF-12A697-AA
YC1F-12A697-AB

MAZDA

FSB9-18-845

MARKET DIFFUSION: MEDIUM

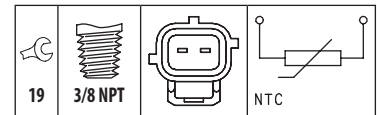

ASTON MARTIN

DB9 6.0	AM11, AM11	04/04 ⇒ 10/16
DB9 6.0 V12	AM11, AM07	01/04 ⇒ 10/16
RAPIDE 6.0	AM16	03/10 ⇒ 09/13
RAPIDE 6.0 S	AM11	02/13 ⇒ 02/14
VANQUISH 6.0	AM11	10/12 ⇒
VANTAGE 4.7	AM07, RTN	10/08 ⇒
VANTAGE 4.7 GT8	AM15	07/13 ⇒
VANTAGE 4.7 S	AM15	01/11 ⇒
VANTAGE 6.0 V12S	AM28	01/13 ⇒

FORD

ESCORT IV 1.6 16V	L1E	10/98 ⇒ 07/00
ESCORT VI 1.6 16V	L1E	02/99 ⇒ 07/00
ESCORT VI 1.8 16V	RKC	01/95 ⇒ 02/99
ESCORT VI 1.8 16V XR3i	RKC	10/95 ⇒ 08/98
FIESTA IV 1.8 DI	RTN, RTN	04/00 ⇒ 08/03
FIESTA IV TD 1.8	RTN, BHDA	03/00 ⇒ 08/03
FOCUS I 1.8 DI / TDDi	BHDA, F9DA	08/99 ⇒ 11/04
FOCUS I 1.8 TDCi	F9DA, BHDA	03/01 ⇒ 03/05
FOCUS I 1.8 TDDi	BHDA, BHDA	08/98 ⇒ 03/05
FOCUS I 1.8 Turbo DI / TDDi	BHDA, MHA	10/98 ⇒ 03/05
PUMA 1.7 16V	MHA, RWPA	03/97 ⇒ 06/02
PUMA Racing ST 160	MHA	06/99 ⇒ 06/02
TOURNEO CONNECT I 1.8 TDCi	RWPA, 4HA	08/06 ⇒ 12/13
TRANSIT II 2.5 DI	--, 4EB	06/94 ⇒ 03/00
TRANSIT II 2.5 TD	4EB, 4EB	06/94 ⇒ 06/00
TRANSIT II 2.5 TDI	4EB, D2FA	06/94 ⇒ 03/00
TRANSIT III 2.4 DI	D2FA, D4FA	01/00 ⇒ 05/06
TRANSIT III 2.4 DI RWD	D4FA, D2FE	01/00 ⇒ 05/06
TRANSIT III 2.4 TD	F4FA	08/00 ⇒ 08/03
TRANSIT III 2.4 TD 4x4	F4FA	08/00 ⇒ 08/03
TRANSIT III 2.4 TDDi	D2FE, 4FA	08/00 ⇒ 03/06
TRANSIT III 2.4 TDE	DOFA	07/01 ⇒ 05/06
TRANSIT 2.5 TD	4HA, BHPA	08/94 ⇒ 12/00
TRANSIT 2.5 TDDi	4ED	12/98 ⇒ 06/00
TRANSIT CONNECT I 1.8 Di	BHPA, RWPA	06/02 ⇒ 12/13
TRANSIT CONNECT I 1.8 TDCi	RWPA, --	08/06 ⇒ 12/13
TRANSIT TOURNEO 2.4 D	4HA	08/94 ⇒ 06/00
TRANSIT TOURNEO 2.5 DI	4FA, 4EB	11/94 ⇒ 12/00
TRANSIT TOURNEO 2.5 TD	4EB, FP63	11/94 ⇒ 12/00

MAZDA

626 1.8 BiFuel	FP63, FS4B	11/97 ⇒ 04/02
626 2.0 BiFuel	FS4B, FP	11/97 ⇒ 04/02
626 VI 1.8	FP, FS	05/97 ⇒ 10/02
626 VI 2.0	FS, FS2C	05/97 ⇒ 10/02

MAZDA	626 VI 2.0 H.P.	FS2C, TU32	02/98 ⇒ 10/02
--------------	-----------------	------------	---------------

10.4005

AIR TEMPERATURE SENSORS

Adatt./Suitable:

CITROËN		
1920 1J		17 without connector parts
1920 4G		• senza pezzi raccordo
1920 8Y		• sans raccords
DACIA		• ohne Anschlusssteile
16 58 027 99R		• sin piezas de conexión
60 01 543 611		
82 00 061 780		
82 00 164 249		
82 00 415 409		
82 00 415 410		
82 00 454 482		
82 00 833 248		

FIAT		
9463327680		1076 Has the same colour as the original part : Brown
9627389680		• corrisponde al pezzo originale colorato : marrone
GENERAL MOTORS		• Correspond à la pièce originale dans sa couleur : marron
91 159 932		• Entspricht dem Originalteil in Farbe : braun
93 161 007		• corresponde al color de la pieza original : marrón

LADA		
77001-01451		
LANCIA		1083 Has the same colour as the original part : Green
9463327680		• corrisponde al pezzo originale colorato : verde
9627389680		• Correspond à la pièce originale dans sa couleur : vert
MAGNETI MARELLI		• Entspricht dem Originalteil in Farbe : grün
230016073047		• corresponde al color de la pieza original : verde
230016073067		
IATS 04		
IATS 04/01		

NISSAN		
22630-0001H		
22630-0003D		
22630-0003E		
22630-000AA		
22630-000AC		
22630-BN701		
77001-01451		

OPEL		
44 08 308		
44 12 325		
PEUGEOT		
1920 1J		
1920 4G		
1920 8Y		
1920 9F		

RENAULT		
16 58 027 99R		
60 01 543 611		
77 00 101 451		
77 01 042 145		
82 00 061 780		
82 00 164 249		
82 00 415 409		
82 00 415 410		
82 00 454 482		
82 00 833 248		

SMART		
A 281 905 09 00		
VAUXHALL		
91 159 932		

MARKET DIFFUSION: HIGH

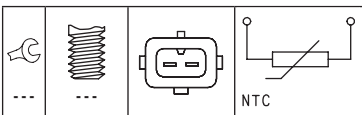

CITROËN

BERLINGO I 1.4 bivalent	TU3JPCNG	11/02 ⇒ 12/11
BERLINGO I 1.4 i	KFW(TU3JP), EW10J4	07/96 ⇒ 12/11
BERLINGO I 1.4 i bivalent	KFW(TU3JP)	04/03 ⇒ 10/05
BERLINGO 1.4	TU32, KFW(TU3JP)	07/96 ⇒ 12/11
C4 I 2.0 16V	EW10J4, 6FZ(EW7J4)	11/04 ⇒ 12/10
C5 I 1.8	EW7J4	09/04 ⇒ 08/05
C5 I 1.8 16V	6FZ(EW7J4), EW10J4	03/01 ⇒
C5 I 2.0 16V	EW10J4, EW10D	03/01 ⇒ 08/04
C5 I 2.0 16V HPI	EW10D, ES9J45HP	03/01 ⇒ 08/04
C5 I 3.0 Carlsson	ES9J45HP, ES9J45	09/03 ⇒ 08/04
C5 I 3.0 V6	ES9J45, ES9A	03/01 ⇒
C5 II 3.0 V6	ES9A, ES9A	02/08 ⇒

CITROËN		
C6 3.0 V6	ES9A, 3FZ(EW12J4)	09/05 ⇒ 12/12
C8 2.0	RFN(EW10J4)	07/02 ⇒
C8 2.2	3FZ(EW12J4), ES9J45	07/02 ⇒
C8 3.0 V6	ES9J45, EW10J4	07/02 ⇒
EVASION 2.0 16V	EW10J4, EW10J4	05/00 ⇒ 07/02
JUMPY I 2.0	EW10J4, EW10J4	04/00 ⇒ 12/06
JUMPY I 2.0 i 16V	EW10J4, KFW(TU3JP)	03/00 ⇒ 10/06
SAXO 1.4 VTS	KFW(TU3JP), NFX(TU5JP4)	05/96 ⇒ 06/03
SAXO 1.6	NFX(TU5JP4), NFX(TU5JP4)	02/96 ⇒ 04/04
SAXO 1.6 VTR	NFX(TU5JP4)	05/96 ⇒ 07/99
SAXO 1.6 VTS	NFX(TU5JP4), EW10J4	06/96 ⇒ 09/03
XANTIA I 3.0 i 24V	XFZ(ES9J4)	01/97 ⇒ 04/03
XANTIA I 3.0 V6	XFZ(ES9J4)	01/98 ⇒ 04/03
XANTIA II 3.0 V6	XFZ(ES9J4)	01/98 ⇒ 04/03
XM II 3.0 V6	XFZ(ES9J4)	04/97 ⇒ 10/00
XSARA 1.4 i	KFX(TU3JP)	04/97 ⇒ 08/05
XSARA 2.0 [ExtraEU]	EW10J4	02/04 ⇒ 10/04
XSARA 2.0 16V	EW10J4, RFS(XU10J4RS)	09/00 ⇒ 08/05
XSARA 2.0 i 16V	RFS(XU10J4RS), 6FZ(EW7J4)	02/98 ⇒ 03/05
XSARA PICASSO 1.8 16V	6FZ(EW7J4), EW10J4	02/00 ⇒
XSARA PICASSO 2.0 16V	EW10J4, K9K612	01/03 ⇒
ZX 1.4 i	KFX(TU3JP)	03/91 ⇒ 10/97
ZX 2.0	RFS(XU10J4RS)	09/96 ⇒ 10/97
ZX 2.0 i 16V	RFS(XU10J4RS)	05/96 ⇒ 06/97

DACIA

DOKKER 1.5	K9K872	12/18 ⇒
DOKKER 1.5 dCi	K9K612, H4M738	11/12 ⇒
DOKKER 1.5 dCi [ExtraEU]	K9K830	11/12 ⇒
DOKKER 1.6	H4M738, H4M740	11/12 ⇒
DOKKER 1.6 LPG	H4M740, K9K796	11/13 ⇒
DUSTER 1.2 TCe 125	H5F408	10/17 ⇒
DUSTER 1.2 TCe 125 4x4	H5F410	06/15 ⇒
DUSTER 1.5 dCi	K9K796, K9K656	04/10 ⇒
DUSTER 1.5 dCi 110	K9K656, K4M642	10/17 ⇒
DUSTER 1.6	K4M642, K4M490	04/10 ⇒
DUSTER 1.6 16V	K4M490, K4M490	04/10 ⇒
DUSTER 1.6 16V 4x4	K4M490, K4M616	06/10 ⇒
DUSTER 1.6 16V Hi-Flex	K4M696	08/10 ⇒
DUSTER 1.6 16V LPG	K4M616, H4M438	04/11 ⇒
DUSTER 1.6 SGe 115	H4M438, H4M430	06/15 ⇒
DUSTER 1.6 SGe 115 4x4	H4M430, F4R400	06/15 ⇒
DUSTER 1.6 SGe 115 LPG	H4M740	06/15 ⇒
DUSTER 2.0	F4R400, H5F402	04/10 ⇒
LOGGY 1.2 TCe	H5F402, K9K612	03/12 ⇒
LOGGY 1.5 dCi	K9K612, H4M738	03/12 ⇒
LOGGY 1.5 dCi [ExtraEU]	K9K830	11/12 ⇒
LOGGY 1.6	H4M738, H4M740	03/12 ⇒
LOGGY 1.6 LPG	H4M740, H4M738	11/13 ⇒
LOGGY 1.6 SGe 115	H4M738, K7J710	06/15 ⇒
LOGAN 1.6	K7M812	06/13 ⇒ 08/16
LOGAN 1.6 Hi-Flex	K7M714	01/11 ⇒ 10/12
LOGAN I 1.0	D4D760	12/05 ⇒
LOGAN I 1.0 Hi-Flex	D4D760	01/11 ⇒ 10/12
LOGAN I 1.2 16V	D4F732	02/06 ⇒
LOGAN I 1.2 16V LPG	D4F734	02/06 ⇒
LOGAN I 1.4	K7J710	09/04 ⇒
LOGAN I 1.4 MPI LPG	K7J710, K9K790	02/06 ⇒
LOGAN I 1.5 dCi	K9K790, K7M710	09/05 ⇒
LOGAN I 1.6	K7M710, K4M690	09/04 ⇒
LOGAN I 1.6 16V	K4M690, K4M690	12/05 ⇒
LOGAN I 1.6 16V Flexifuel	K4M696	07/10 ⇒
LOGAN I 1.6 16V Hi-Flex	K4M690, K7M710	11/09 ⇒
LOGAN I 1.6 Bifuel	K7M710, D4F732	11/08 ⇒
LOGAN I 1.6 LPG	K7M718	08/04 ⇒ 12/12
LOGAN I 1.6 MPI 85	K7M800	05/10 ⇒
LOGAN II 1.0	D4D754	10/12 ⇒
LOGAN II 1.2	D4F732, D4F732	10/12 ⇒
LOGAN II 1.2 LPG	D4F732, K9K612	10/12 ⇒
LOGAN II 1.5 dCi	K9K612, K4M842	10/12 ⇒
LOGAN II 1.6 16V	K4M842, F4R412	10/12 ⇒
LOGAN II 2.0	F4R412, D4F732	10/12 ⇒
LOGAN II MCV 1.2	D4F732, D4F732	02/13 ⇒
LOGAN II MCV 1.2 LPG	D4F732, K9K612	02/13 ⇒
LOGAN II MCV 1.5 dCi	K9K612, D4F732	02/13 ⇒
LOGAN II MCV 1.6	K7M812	06/13 ⇒
SANDERO I 1.0 Hi-Flex	D4D760	01/11 ⇒ 12/12
SANDERO I 1.2 16V	D4F732	11/08 ⇒
SANDERO I 1.2 16V LPG	D4F732, K9K790	11/08 ⇒
SANDERO I 1.4	K7J710	06/08 ⇒
SANDERO I 1.4 MPI LPG	K7J714	01/09 ⇒
SANDERO I 1.5 dCi	K9K790, K7M710	06/08 ⇒
SANDERO I 1.6	K7M710, K4M690	06/08 ⇒
SANDERO I 1.6 16V	K4M690, K4M690	07/11 ⇒
SANDERO I 1.6 16V Bifuel	K4M690, K7M718	01/11 ⇒
SANDERO I 1.6 Hi-Flex	K7M732	06/08 ⇒ 12/12
SANDERO I 1.6 LPG	K7M718, D4F732	06/08 ⇒ 12/12

DACIA		
SANDERO I 1.6 MPI 85	K7M800	05/10 ⇒
SANDERO II 1.0	D4D754	10/12 ⇒
SANDERO II 1.2	D4F732, D4F732	10/12 ⇒
SANDERO II 1.2 LPG	D4F732, K9K612	10/12 ⇒
SANDERO II 1.5 dCi	K9K612, K4M842	10/12 ⇒
SANDERO II 1.6	K7M812	11/12 ⇒
SANDERO II 1.6 16V	K4M842, 11189	01/13 ⇒
SANDERO II 1.6 i	K7M764	10/12 ⇒
SANDERO II 2.0	F4R416	10/12 ⇒
SANDERO II 2.0 LPG	F4R412	10/12 ⇒
SOLENZA 1.4	E7J262	02/03 ⇒
SOLENZA 1.9 D	F8Q636	02/03 ⇒

FIAT		
SCUDO I 2.0	RFN(EW10J4)	05/00 ⇒ 12/06
SCUDO I 2.0 16V	RFN(EW10J4)	06/00 ⇒ 12/06
ULYSSE I 2.0 16V	RFN(EW10J4)	09/00 ⇒ 08/02
ULYSSE II 2.0	RFN(EW10J4)	08/02 ⇒ 06/11
ULYSSE II 3.0	XFW	08/02 ⇒ 06/11

LADA

LARGUS 1.6	11189, ES9J45	03/12 ⇒
------------	---------------	---------

LANCIA		
PHEDRA 2.0	RFN(EW10J4)	09/02 ⇒ 11/10
PHEDRA 3.0 V6	ES9J45, K4M490	09/02 ⇒
ZETA 2.0 16V	RFN	07/00 ⇒ 09/02

NISSAN

ALMERA II 1.5 dCi	K9K722	01/03 ⇒ 09/06
ALMERA III 1.6	K4M	11/12 ⇒
BLUEBIRD SYLPHY 1.6	K4M490, D4F712	12/12 ⇒
FRONTIER 2.3 dCi	M9T	11/14 ⇒
KUBISTAR 1.2 16V	D4F712, K9K702	04/06 ⇒
KUBISTAR 1.4	K7J700	08/03 ⇒ 10/09
KUBISTAR 1.5 dCi	K9K702, K4M750	08/03 ⇒
KUBISTAR 1.5 dCi 70	K9K700	04/06 ⇒ 10/09
KUBISTAR 1.5 dCi 85	K9K276	04/06 ⇒ 10/09
KUBISTAR 1.6 16V	K4M750, K9K276	08/03 ⇒
MICRA III 1.5 dCi	K9K276, M9T	01/03 ⇒ 06/10
MICRA IV 1.5 dCi	K9K	05/10 ⇒
NAVARA III 2.3 dCi	M9T, YS23DDT	10/14 ⇒
NAVARA III 2.3 dCi 4x4	YS23DDT, K9K276	01/15 ⇒
NOTE 1.5 dCi	K9K276, F4R720	03/06 ⇒ 06/12
NP300 2.3 dCi	M9T	06/14 ⇒
NV400 2.3 dCi 150	M9T880	02/14 ⇒ 09/16
NV400 dCi 110	M9T870	06/14 ⇒
NV400 dCi 130	M9T704	06/16 ⇒
NV400 dCi 130 RWD	M9T710	06/16 ⇒
NV400 dCi 140	M9T702	06/14 ⇒ 09/16
NV400 dCi 150	M9T880	02/14 ⇒ 09/16
NV400 dCi 150 RWD	M9T880	02/14 ⇒ 09/16
NV400 dCi 170	M9T706	07/15 ⇒
PRIMASTAR 2.0	F4R720, H4M	03/01 ⇒
TERRANO III 1.6	H4M, H4M	09/13 ⇒
TERRANO III 1.6 4x4	H4M, F4R	03/14 ⇒
TERRANO III 2.0	F4R	09/13 ⇒
TERRANO III 2.0 4x4	F4R, KFW(TU3JP)	03/14 ⇒

OPEL

VIVARO A 2.0 16V	F4R720	08/01 ⇒
VIVARO A 2.0 ECOTEC	F4R820	08/06 ⇒

PEUGEOT

106 II 1.4 i	KFW(TU3JP), NFX(TU5J4)	05/96 ⇒ 07/04
106 II 1.6 S16	NFX(TU5J4), HFY(TU1JP)	05/96 ⇒ 07/04
206 1.1	HFY(TU1JP), K6C(TU3JP)	08/98 ⇒ 07/00
206 1.1 i	HFZ(TU1JP)	09/98 ⇒
206 1.4 i	K6C(TU3JP), NFX(TU5JP)	09/98 ⇒
206 1.6 8V	TU5JP	05/99 ⇒ 10/03
206 1.6 i	NFX(TU5JP), RFX(EW10J4)	09/98 ⇒ 12/00
206 2.0 16V	RFN(EW10J4)	07/02 ⇒ 02/07
206 2.0 S16	RFN(EW10J4), KFW(TU3JP)	04/99 ⇒
306 1.4	KFW(TU3JP), KFW(TU3JP)	04/93 ⇒ 04/02
306 1.4 SL	KFW(TU3JP), EW10J4	06/94 ⇒ 05/01
306 2.0 S16	RFS(XU10J4RS)	06/96 ⇒ 05/01
307 2.0	EW10J4, EW10J4	03/02 ⇒ 06/05
307 2.0 16V	EW10J4, 6FZ(EW7J4)	08/00 ⇒ 04/08
406 1.8 16V	6FZ(EW7J4), EW10J4	10/00 ⇒ 10/04
406 1.8 BiFuel	EW7J4	09/00 ⇒ 05/04
406 2.0 16V	EW10J4, EW10D	08/00 ⇒ 12/04
406 2.0 16V HPI	EW10D, 3FZ(EW12J4)	05/01 ⇒ 10/04
406 2.2	3FZ(EW12J4), ES9J4	07/00 ⇒ 12/04
406 3.0 24V	ES9J4, ES9J45	10/96 ⇒ 10/04
406 3.0 V6	ES9J45, ES9J4	03/00 ⇒ 12/04

PEUGEOT		
607 2.0	EW10J4, 3FY(EW12J4)	02/00 → 08/05
607 2.2 16V	3FY(EW12J4), ES9A	02/00 → 06/10
607 3.0 V6 24V	ES9A, EW10J4	02/00 → 07/11
806 2.0 16V	EW10J4, EW10J4	09/00 → 08/02
807 2.0	EW10J4, 3FZ(EW12J4)	06/02 →
807 2.2	3FZ(EW12J4), ES9J4S	06/02 →
807 3.0 V6	ES9J4S, EW10J4	06/02 →
EXPERT I 2.0	EW10J4, KFX(TU3JP)	07/00 → 12/06
PARTNER 1.4	TU3JP	09/99 → 10/02
PARTNER I 1.4	KFX(TU3JP), K6C(TU3JP)	06/96 → 12/15
RANCH 1.4	K6C(TU3JP), F4R760	06/96 →
RENAULT		
ALASKAN 2.3 dCi 163 4x4	M9T260	09/17 →
ALASKAN 2.3 dCi 190 4x4	M9T260	09/17 →
AVANTIME 2.0 16V Turbo	F4R760, K9K608	11/01 → 05/03
CAPTUR 1.5 dCi	K9K830	06/13 →
CAPTUR 1.5 dCi 110	K9K646	01/15 →
CAPTUR 1.5 dCi 90	K9K608, D4F728	06/13 →
CLIO 1.2	D4F728, K9K830	08/98 →
CLIO 1.2 BiFuel	D7F722	03/98 → 10/01
CLIO 1.2 Hi-Flex	D4F742	11/07 → 12/09
CLIO 1.4	K7J700	08/00 → 02/09
CLIO 1.5 dCi	K9K830, K4M734	11/12 →
CLIO 1.6	K4M734, M4R700	07/00 → 02/10
CLIO 1.6 [ExtraEU]	K4M708	03/99 → 12/08
CLIO 2.0	M4R700, D7F710	11/07 → 12/12
CLIO II 1.2	D7F730	01/96 → 09/98
CLIO II 1.0	D7D760	02/00 → 05/01
CLIO II 1.2	D7F710, D4F706	09/98 →
CLIO II 1.2 16V	D4F706, D7F722	06/01 →
CLIO II 1.2 LPG	D7F722, E7J634	09/98 → 06/09
CLIO II 1.4	E7J634, K4J700	09/98 →
CLIO II 1.4 16V	K4J700, K9K700	02/00 →
CLIO II 1.5 dCi	K9K700, K4M746	06/01 →
CLIO II 1.6	K4M746, K4M708	09/98 →
CLIO II 1.6 16V	K4M708, F8Q630	09/98 →
CLIO II 1.6 Hi-Flex	K4M748	01/05 → 02/10
CLIO II 1.6i	K4M736	11/04 →
CLIO II 1.9 D	F8Q630, F9Q780	02/00 →
CLIO II 1.9 dTi	F9Q780, F4R730	12/99 → 05/05
CLIO II 2.0 16V	F4R732	06/01 →
CLIO II 2.0 16V Sport	F4R730, D4F740	02/00 →
CLIO III 1.2	D4F740, D4F740	10/05 →
CLIO III 1.2 16V	D4F740, D4F740	06/05 →
CLIO III 1.2 16V Hi-Flex	D4F740, K9K750	07/08 →
CLIO III 1.2 Ethanol	D4F742	07/08 →
CLIO III 1.4 16V	K4J780	06/05 →
CLIO III 1.5 dCi	K9K750, K4M800	05/05 →
CLIO III 1.6 16V	K4M800, M4R700	06/05 →
CLIO III 1.6 16V GT	K4M862	06/09 →
CLIO III 2.0 16V	M4R700, --	09/06 →
CLIO III 2.0 16V Sport	--, D4F740	02/06 →
CLIO IV 1.2 16V	D4F740, K9K830	11/12 →
CLIO IV 1.2 16V LPG	D4F744	01/14 →
CLIO IV 1.2 LPG	D4F744	01/14 →
CLIO IV 1.2 LPG 16V	D4F744	11/12 → 06/15
CLIO IV 1.5 dCi	K9K830, K9K612	11/12 →
DOKKER 1.5 dCi	K9K612, H4M438	12/13 →
DOKKER 1.6	K7M812	12/13 →
DUSTER 1.6 16V	H4M438, H4M430	02/12 →
DUSTER 1.6 16V 4x4	H4M430, F4R403	06/11 →
DUSTER 2.0	F4R403, F4R410	02/12 →
DUSTER 2.0 [ExtraEU]	F4R410, F4R400	10/11 →
DUSTER 2.0 4x4	F4R400, F4R700	02/12 →
ESPACE III 2.0	F4R700, F4R700	09/01 → 10/02
ESPACE III 2.0 16V	F4R700, F4R790	10/98 → 10/02
ESPACE III 2.2 dCi	G9T710	10/00 → 10/02
ESPACE IV 2.0	F4R790, F4R794	11/02 →
ESPACE IV 2.0 Turbo	F4R794, K9K830	11/02 →
FLUENCE 1.5 dCi	K9K830, H4M729	02/10 →
FLUENCE 1.6	H4M729, K4M838	01/13 →
FLUENCE 1.6 16V	K4M838, M4R714	02/10 →
FLUENCE 1.6 LPG 16V	K4M839	01/12 →
FLUENCE 2.0 [ExtraEU]	M4R714, M4R714	01/10 →
FLUENCE 2.0 16V	M4R714, M4R714	02/10 →
FLUENCE 2.0 Hi-Flex [ExtraEU]	M4R714, K4M761	02/10 → 11/18
GRAND SCÉNIC II 1.6	K4M761, F4R770	04/04 →
GRAND SCÉNIC III 1.6 Flex	K4M766	06/06 → 11/08
GRAND SCÉNIC II 2.0	F4R770, K4M866	04/04 →
GRAND SCÉNIC III 1.2 TcE	H5F408	07/14 →
GRAND SCÉNIC III 1.5 dCi	K9K830	04/09 →
GRAND SCÉNIC III 1.6 16V	K4M858	02/09 →
GRAND SCÉNIC III 1.6 16V Bifuel	K4M866, M4R711	02/09 →
GRAND SCÉNIC III 1.6 E85	K4M866	02/09 →
GRAND SCÉNIC III 2.0 16V	M4R711, D4D700	02/09 →
KANGOO 1.0 [ExtraEU]	D4D700, D4F712	01/02 → 01/07

RENAULT		
KANGOO 1.2	D4F712, D7F710	07/01 → 10/03
KANGOO 1.2 BiFuel	D7F710, K4M708	06/97 → 06/03
KANGOO 1.6	K4M836	02/12 →
KANGOO 1.6 [ExtraEU]	K4M708, D4D700	06/01 → 03/09
KANGOO 1.6 BiFuel	K4M750	06/05 → 06/08
KANGOO 1.6 CNG	K4M830CNG	11/07 → 01/12
KANGOO 1.6 Hi-Flex [ExtraEU]	K4M850	03/07 →
KANGOO I 1.0	D4D700, D7F710	09/98 →
KANGOO I 1.2	D7F710, D4F712	08/97 →
KANGOO I 1.2 16V	D4F712, D7F710	06/01 →
KANGOO I 1.2 BiFuel	D7F710, E7J634	07/98 → 07/01
KANGOO I 1.4	E7J634, K9K700	08/97 →
KANGOO I 1.5 dCi	K9K700, K4M730	02/01 →
KANGOO I 1.6	K4M730, K4M708	09/01 →
KANGOO I 1.6 16V	K4M708, K4M708	06/01 →
KANGOO I 1.6 16V 4x4	K4M708, F8Q630	02/01 →
KANGOO I 1.6 16V bivalent	K4M850CNG	06/05 →
KANGOO I 1.9 D	F8Q632	09/99 → 06/03
KANGOO I 1.9 RXED	F8Q632	09/99 → 06/01
KANGOO I D 55 1.9	F8Q662	08/97 →
KANGOO I D 65 1.9	F8Q630, H5F400	08/97 →
KANGOO II 1.2 TcE 115	H5F400, K4M830	07/13 →
KANGOO II 1.6	K4M830, K4M830	02/08 →
KANGOO II 1.6 16V	K4M830, H4M429	02/08 →
KANGOO II 1.6 16V Flex	K4M834	02/08 →
KANGOO II 1.6 16V Hi-Flex	K4M834	02/08 →
KAPTUR 1.6	H4M429, K4M720	03/16 →
KAPTUR 2.0 4WD	F4R410	03/16 →
LAGUNA 1.1 16V	K4M720, K4M710	11/97 → 03/01
LAGUNA 1.1 8V	F4P760	04/98 → 03/01
LAGUNA 1.2.0	F4R780	09/99 → 02/01
LAGUNA 1.2 16V	F4R780	09/99 → 03/01
LAGUNA II 1.6	K4M710	03/01 → 10/05
LAGUNA II 1.6 16V	K4M710, F4P770	03/01 → 12/07
LAGUNA II 1.6 Bifuel	K4M714	06/05 → 12/07
LAGUNA II 1.6 LPG	K4M714	03/01 → 05/05
LAGUNA II 1.8 16V	F4P770, F4R712	03/01 →
LAGUNA II 2.0 16V	F4R712, F5R700	08/02 → 12/07
LAGUNA II 2.0 16V IDE	F5R700, F4R764	04/01 → 09/07
LAGUNA II 2.0 16V Turbo	F4R764, F4R811	01/03 → 08/05
LAGUNA III 1.6 16V	K4M824	10/07 → 12/15
LAGUNA III 2.0	F4R813	02/08 →
LAGUNA III 2.0 16V Hi-Flex	M4R726	10/07 → 12/15
LAGUNA III 2.0 16V Turbo	F4R811, F4R800	10/07 → 12/15
LAGUNA III 2.0 GT	F4R800, M4R735	03/08 → 12/15
LATITUDE 2.0 16V	M4R735, K9K830	02/11 →
LODGY 1.5 dCi [ExtraEU]	K9K830, K7M812	11/14 →
LODGY 1.6	K7M812, D4F732	07/13 →
LOGAN 1.0	D4D760	12/05 →
LOGAN 1.2 16V	D4F732, D4F732	02/06 →
LOGAN 1.2 16V LPG	D4F732, K9K790	12/13 →
LOGAN 1.4	K7J710	09/04 →
LOGAN 1.4 LPG	K7J714	02/08 → 10/13
LOGAN 1.5 dCi	K9K790, K4M690	09/05 →
LOGAN 1.6	K4M690, D4F732	09/04 →
LOGAN 1.6 16V	K4M694	12/05 →
LOGAN 1.6 MPI 85	K7M800	05/10 →
LOGAN EXPRESS 1.5 dCi	K9K792	04/07 →
LOGAN EXPRESS 1.6	K7M710	04/07 →
LOGAN/STEPWAY 1.2	D4F732, D4F732	11/13 →
LOGAN/STEPWAY 1.2 16V LPG	D4F732, H4M429	11/13 →
LOGAN/STEPWAY 1.5 dCi	K9K838	12/13 →
LOGAN/STEPWAY 1.6	H4M429, M9T696	11/13 →
MASTER III 2.3 dCi 110 FWD	M9T870, M9T700	09/14 →
MASTER III 2.3 dCi 130 RWD	M9T710	03/12 →
MASTER III 2.3 dCi 135 FWD	M9T700, M9T700	07/14 →
MASTER III 2.3 dCi 135 RWD	M9T700, M9T700	07/14 →
MASTER III 2.3 dCi 150 FWD	M9T880	10/12 →
MASTER III 2.3 dCi 165 FWD	M9T700, M9T700	07/14 →
MASTER III 2.3 dCi 165 RWD	M9T700, K4J714	07/14 →
MASTER III 2.3 dCi 170 FWD	M9T706	07/15 →
MEGANE II 1.4	K4J730, K4J730	08/03 →
MEGANE II 1.4 16V	K4J730, K4M760	11/02 → 02/08
MEGANE II 1.5 dCi	K9K724	04/05 → 12/10
MEGANE II 1.6	K4M760, K4M760	08/03 →
MEGANE II 1.6 16V	K4M760, F4R770	11/02 →
MEGANE II 1.6 16V Hi-Flex	K4M856	02/08 → 07/09
MEGANE II 1.6 Bifuel	K4M788	06/05 → 02/08
MEGANE II 1.6 Flex-Fuel	K4M856	01/07 → 02/08
MEGANE II 1.6 LPG 16V	K4M760	01/06 → 08/09
MEGANE II 2.0	F4R770, F4R770	08/03 →
MEGANE II 2.0 16V	F4R770, F4R774	11/02 → 02/08
MEGANE II 2.0 16V Turbo	F4R776	05/04 → 03/09
MEGANE II 2.0 Renault Sport	F4R774, K4M848	05/04 → 10/09
MASTER 2.3 dCi	M9T696, M9T870	07/14 →
MEGANE 1.4	K4J714, K4M704	04/01 → 07/03

RENAULT		
MEGANE 1.6 BiFuel	K4M704, F4R740	04/01 → 08/15
MEGANE 1.6 VVT	K4M858	01/13 → 08/15
MEGANE 1.8	F4P722	04/01 → 07/03
MEGANE 1.9	F8Q622	02/00 → 09/00
MEGANE 2.0	F4R740, M4R711	08/95 → 02/99
MEGANE I 1.4	E7J626, K4J700	09/96 → 08/03
MEGANE I 1.4 16V	K4J700, E7J626	03/99 → 08/03
MEGANE I 1.4 e	E7J626, K4M700	01/96 → 08/03
MEGANE I 1.6	K7M704	02/00 → 09/00
MEGANE I 1.6 16V	K4M700, K4M704	05/00 →
MEGANE I 1.6 Bifuel	K4M712	03/99 → 09/00
MEGANE I 1.6 LPG	K4M704, F4P260	10/00 → 08/02
MEGANE I 1.8 16V	F4P260, F8Q620	07/00 → 08/03
MEGANE I 1.9	F8Q790	06/99 → 09/00
MEGANE I 1.9 D	F8Q620, F8Q784	09/96 → 08/03
MEGANE I 1.9 dT	F8Q784	01/96 → 08/03
MEGANE I 1.9 dTi	F8Q784, F4R276	03/97 → 08/03
MEGANE I 2.0 16V	F4R276, F4R746	05/00 →
MEGANE I 2.0 16V IDE	F4R746, F3R791	11/99 → 08/03
MEGANE I 2.0 i	F3R791, F4R740	03/99 → 08/03
MEGANE I 2.0 RT	F4R740, K4J730	03/01 → 08/03
MEGANE III 1.5 dCi	K9K830	11/08 →
MEGANE III 1.6 16V	K4M848, M4R710	11/08 →
MEGANE III 1.6 Bifuel	K4M866	11/08 →
MEGANE III 1.6 BiFuel	K4M866	11/08 →
MEGANE III 2.0	M4R710, M4R711	01/11 →
MEGANE III 2.0 CVT	M4R711, F4R874	02/09 →
MEGANE III 2.0 R.S.	F4R874, F4R870	11/08 →
MEGANE III 2.0 TcE	F4R870, H4M738	11/08 →
MEGANE III 2.0 TcE 220	F4R874	11/13 →
MEGANE IV 1.2 TcE 100	H5F408	11/15 →
MEGANE IV 1.2 TcE 130	H5F408	11/15 →
MEGANE IV 1.6 16V	H4M738, H4M738	11/15 →
MEGANE IV 1.6 S cE	H4M738, K4M700	10/16 →
MEGANE CC 1.6 16V	K4M858	06/10 →
MEGANE CC 1.6 16V Hi-Flex	K4M866	06/10 →
MEGANE CC 2.0 CVT	M4R711, E7J626	06/10 →
MEGANE CC 2.0 TcE	F4R872	06/10 →
MEGANE CC 2.0 Turbo	F4R874	10/11 →
MEGANE SCÉNIC I 1.4 i	E7J764	01/97 → 09/99
MEGANE SCÉNIC I 1.6 16V	K4M700, D4F740	04/98 → 10/99
MEGANE SCÉNIC I 1.9 D	F8Q790	03/97 → 09/99
MEGANE SCÉNIC I 1.9 dTi	F9Q734	04/97 → 09/99
MODUS 1.4	K4J770, N7Q710	04/06 → 12/13
MODUS / GRAND MODUS 1.2 16V	D4F740, D4F740	12/04 →
MODUS / GRAND MODUS 1.2 16V Hi-Flex	D4F784	05/07 →
MODUS / GRAND MODUS 1.2 16V	D4F740, K4J770	10/08 →
MODUS / GRAND MODUS 1.2 GPL	D4F744	05/08 → 12/12
MODUS / GRAND MODUS 1.4	K4J770, K9K750	12/04 →
MODUS / GRAND MODUS 1.5 dCi	K9K750, K4M790	09/04 →
MODUS / GRAND MODUS 1.6	K4M790, K4J770	12/04 →
SAFRANE II 2.0 16V	N7Q710, K4M697	07/96 → 12/00
SAFRANE II 2.2 dT	G8T740	07/96 → 12/00
SANDERO I 1.2 16V	D4F732	11/08 →
SANDERO I 1.4	K7J710	02/09 →
SANDERO I 1.4 LPG	K7J714	02/09 →
SANDERO I 1.5 dCi	K9K790	04/07 →
SANDERO I 1.6	K4M697, D4F732	12/07 →
SANDERO I 1.6 MPI 85	K7M800	05/10 →
SANDERO II 1.2 16V	D4F732, K9K612	12/13 →
SANDERO II 1.2 16V LPG	D4F734	12/13 →
SANDERO II 1.5 dCi	K9K612, H4M438	12/13 →
SANDERO II 1.6	H4M438, K4M842	11/13 →
SANDERO II 1.6 16V	K4M842, K4M812	04/14 →
SCÉNIC I 1.4 16V	K4J714, K4M700	09/99 → 08/03
SCÉNIC I 1.6	K4M700, K4M704	03/01 → 09/03
SCÉNIC I 1.6 16V	K4M712	05/00 → 08/03
SCÉNIC I 1.6 BiFuel	K4M704, F4P720	03/01 → 08/03
SCÉNIC I 1.8 16V	F4P720, F8Q788	01/01 → 08/03
SCÉNIC I 1.8 4x4	F4P722	07/00 → 04/01
SCÉNIC I 1.9 D	F8Q788, F9Q731	09/99 → 03/01
SCÉNIC I 1.9 dTi	F9Q731, F4R740	09/99 → 08/03
SCÉNIC I 2.0 16V	F4R740, F4R744	07/00 → 08/03
SCÉNIC I 2.0 16V RX4	F4R744, K4J730	06/00 → 08/03
SCÉNIC II 1.4	K4J730, K4M761	06/03 →
SCÉNIC II 1.5 dCi	K9K724	05/05 →
SCÉNIC II 1.6	K4M761, K4M764	06/03 →
SCÉNIC II 1.6 16V	K4M764, F4R770	05/03 →
SCÉNIC II 1.6 BiFuel	K4M764	08/03 → 05/06
SCÉNIC II 1.6 Hi-Flex	K4M766	03/05 → 07/10
SCÉNIC II 2.0	F4R770, K4M866	06/03 →
SCÉNIC II 2.0 16V Turbo	F4R776	05/04 →
SCÉNIC III 1.2 TcE		

RENAULT		
SCÉNIC III 1.6 16V	K4M858	02/09 →
SCÉNIC III 1.6 16V Bifuel	K4M866, M4R711	02/09 →
SCÉNIC III 1.6 E85	K4M866	02/09 →
SCÉNIC III 2.0 16V	M4R711, K4M744	12/08 →
SCÉNIC IV 1.2 TCe 130	HSF408	09/16 →
SCENIC 1.5 dCi	K9K734	06/07 → 11/08
SCENIC 1.6	K4M812, K4J714	07/07 → 05/09
SYMBOL 1.2 LPG [ExtraEU]	D4F734	12/13 →
SYMBOL 1.6 [ExtraEU]	K4M744, K7J700	01/09 → 06/14
THALIA I 1.2 16V	D4F728	04/02 →
THALIA I 1.2i 16V	D4F728	04/04 →
THALIA I 1.4	K7J700, K4J712	05/00 →
THALIA I 1.4 16V	K4J712, K9K700	08/00 →
THALIA I 1.5 dCi	K9K700, K4M670	01/01 →
THALIA I 1.6	K4M670, K4M742	01/01 →
THALIA I 1.6 16V	K7M734	04/02 →
THALIA I 1.6 Authentique Hi-Flex	K4M742, D4F728	11/04 → 02/09
THALIA I 1.9 D	F8Q630	02/98 → 05/01
THALIA II 1.2 16V	D4F728, K4J712	09/08 →
THALIA II 1.2 LPG	D4F728	01/10 → 12/13
THALIA II 1.4	K4J712, K9K700	09/08 → 06/14
THALIA II 1.5 dCi	K9K700, K4M670	09/08 →
THALIA II 1.6 16V	K4M670, F4R720	09/08 →
THALIA III 1.2 16V	D4F732	12/13 →
TRAFIC II 2.0	F4R720, D7F700	03/01 →
TRAFIC II 2.0 16V	F4R820	08/06 →
TWINGO 1.2	D4F770	09/10 → 09/14
TWINGO I 1.0	D7D740	01/00 →
TWINGO I 1.2	D7F700, D4F702	05/96 →
TWINGO I 1.2 16V	D4F702, D4F764	01/01 → 06/07
TWINGO II 1.2	D7F800	03/07 →
TWINGO II 1.2 16V	D4F764, D4F780	03/07 →
TWINGO II 1.2 TCe 100	D4F780, D4F780	02/11 →
TWINGO II 1.2 Turbo	D4F780, K9K718	03/07 →
TWINGO II 1.5 dCi	K9K718, F4R766	03/07 →
TWINGO II 1.6 RS	K4M854	05/08 →
TWINGO III 1.0 S5e 70	H4D400	09/14 →
VEL SATIS 2.0 16 V Turbo	F4R766, F4R762	04/04 →
VEL SATIS 2.0 16V Turbo	F4R762, F4R767	06/02 →
VEL SATIS 2.0 Turbo	F4R767, M281.920	04/05 →
WIND 1.6	K4M854	07/10 →

SMART		
FORFOUR III 1.0	M281.920, M281.920	07/14 →
FORTWO III 1.0	M281.920, BGU	07/14 →

VAUXHALL		
VIVARO 2.0 16V	F4R720	08/01 → 07/14
VIVARO 2.0 ECOTEC	F4R820	08/06 → 07/14

10.4006



AIR TEMPERATURE SENSORS

Adatt./Suitable:

- AUDI**
 - 06B 905 379
 - 06B 905 379 A
 - 06B 905 379 D
 - 06B 998 124
- BENTLEY**
 - 06B 905 379 B
 - 06B 905 379 D
- PORSCHE**
 - 9A7 905 379 00
- SEAT**
 - 06B 905 379 A
 - 06B 905 379 C
 - 06B 905 379 D
 - 06B 906 379 C
 - 06B 998 124
- SKODA**
 - 06B 905 379 A
 - 06B 905 379 C
 - 06B 905 379 D
 - 06B 906 379 C
 - 06B 998 124
- VW**
 - 06B 905 379
 - 06B 905 379 A
 - 06B 905 379 C
 - 06B 905 379 D
 - 06B 906 379 C
 - 06B 998 124

MARKET DIFFUSION: HIGH

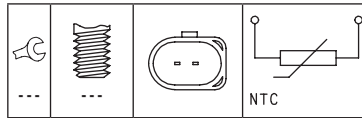

AUDI		
A1 2.0 TFSI quattro	CDLH	03/12 → 11/12
A3 II 1.6	BGU, CCSA	05/03 → 08/12
A3 II 1.6 E-Power	CCSA, BAG	01/11 → 08/12
A3 II 1.6 FSI	BAG, BYT	08/03 → 09/07
A3 II 1.8 TFSI	BYT, BKC	11/06 → 05/13
A3 II 1.8 TFSI quattro	CDA	07/08 → 08/12
A3 II 1.9 TDI	BKC, AXW	05/03 → 05/10
A3 II 2.0 FSI	AXW, AZV	05/03 → 06/08
A3 II 2.0 TDI	AZV, BKD	05/03 → 08/12
A3 II 2.0 TDI 16V	BKD, BKD	05/03 → 08/12
A3 II 2.0 TDI 16V quattro	BKD, BMM	08/04 → 08/12
A3 II 2.0 TDI quattro	BMM, AXX	01/06 → 08/12
A3 II 2.0 TFSI	AXX, AXX	09/04 → 05/13
A3 II 2.0 TFSI quattro	AXX, BDB	09/04 → 08/12
A3 II 3.2 V6 quattro	BDB, BHZ	07/03 → 05/09
A3 II S3 quattro	BHZ, BGU	11/06 → 08/12
A3 II SPORTBACK 1.6	BGU, CCSA	09/04 → 03/13
A3 II SPORTBACK 1.6 E-Power	CCSA, BLF	01/11 → 03/13
A3 II SPORTBACK 1.6 FSI	BLF, BYT	09/04 → 09/07
A3 II SPORTBACK 1.8 TFSI	BYT, BKC	11/06 → 03/13
A3 II SPORTBACK 1.8 TFSI quattro	CDA	07/08 → 03/13
A3 II SPORTBACK 1.9 TDI	BKC, AXW	09/04 → 05/10
A3 II SPORTBACK 2.0 FSI	AXW, AZV	09/04 → 06/08
A3 II SPORTBACK 2.0 TDI	AZV, BKD	09/04 → 03/13
A3 II SPORTBACK 2.0 TDI 16V	BKD, BKD	09/04 → 03/13
A3 II SPORTBACK 2.0 TDI 16V quattro	BKD, BMM	11/05 → 03/13
A3 II SPORTBACK 2.0 TDI quattro	BMM, AXX	01/06 → 03/13
A3 II SPORTBACK 2.0 TFSI	AXX, AXX	09/04 → 03/13
A3 II SPORTBACK 2.0 TFSI quattro	AXX, BDB	09/04 → 03/13
A3 II SPORTBACK 3.2 V6 quattro	BDB, BHZ	09/04 → 05/09
A3 II SPORTBACK S3 quattro	BHZ, AMB	06/08 → 03/13
A4 II 1.8 T	AMB, AMB	11/00 → 03/09
A4 II 1.8 T quattro	AMB, BWE	11/00 → 03/09
A4 II 2.0	ALT	11/00 → 12/05
A4 II 2.0 TFSI 16V	BWE, AMM	01/06 → 03/09
A4 II 2.0 TFSI quattro	BWT	11/05 → 03/09
A4 II 2.4	AMM, BGB	09/01 → 12/05
A4 III 1.8 T	BFB	11/04 → 06/08
A4 III 1.8 T quattro	BFB	11/04 → 06/08

AUDI		
A4 III 2.0	ALT	11/04 → 06/08
A4 III 2.0 TFSI	BGB, BGB	11/04 → 06/08
A4 III 2.0 TFSI quattro	BGB, CABA	11/04 → 06/08
A4 IV 1.8 TFSI	CABA, CAEA	11/07 → 12/15
A4 IV 1.8 TFSI quattro	CDHB	09/08 → 03/12
A4 IV 2.0 TFSI	CAEA, CAEB	06/08 → 12/15
A4 IV 2.0 TFSI quattro	CAEB, CDNC	06/08 → 12/15
A4 IV ALLROAD 2.0 TFSI quattro	CDNC, CVKB	04/09 → 05/16
A4 V 2.0 TFSI	CVKB, CYMC	05/15 →
A4 V 2.0 TFSI quattro	CYMC, CRTC	05/15 →
A4 V 3.0 TDI	CSWB	09/15 →
A4 V 3.0 TDI quattro	CRTC, CYMC	05/15 →
A4 V ALLROAD 2.0 TFSI quattro	CYMC, CRTC	01/16 →
A4 V ALLROAD 3.0 TDI quattro	CRTC, CABD	01/16 →
A5 I 1.8 TFSI	CABD, CAEA	10/07 → 01/17
A5 I 2.0 TFSI	CAEA, CAEB	06/08 → 12/14
A5 I 2.0 TFSI quattro	CAEB, CVKB	06/08 → 01/17
A5 II 2.0 TFSI	CVKB, DKYA	09/16 →
A5 II 2.0 TFSI g-tron	CVLA	02/17 →
A5 II 2.0 TFSI Mild Hybrid	DKYA, CYMC	07/18 →
A5 II 2.0 TFSI quattro	CYMC, CRTC	06/16 →
A5 II 3.0 TDI	CSWB	11/16 →
A5 II 3.0 TDI quattro	CRTC, AEB	07/16 →
A6 II 1.8 T	AEB, AEB	01/97 → 01/05
A6 II 1.8 T quattro	AEB, AJG	02/97 → 01/05
A6 II 2.0	ALT	08/01 → 01/05
A6 II 2.4	AJG, ARE	08/01 → 01/05
A6 II 2.4 quattro	BDV	08/01 → 01/05
A6 II 2.7 T quattro	ARE, BPJ	08/01 → 01/05
A6 III 2.0 TFSI	BPJ, CAEB	06/05 → 08/11
A6 IV 2.0 TFSI	CAEB, CRTD	03/11 →
A6 IV 2.0 TFSI hybrid	CHJA	11/11 → 09/18
A6 IV 2.0 TFSI quattro	CAEB	05/12 → 05/13
A6 IV 3.0 TDI quattro	CRTD, DDVE	09/14 → 09/18
A7 SPORTBACK 3.0 TDI	CTCC, CRTD	07/14 →
A7 SPORTBACK 3.0 TDI quattro	CRTD, ARE	05/14 → 05/18
A7 45 TDI Mild Hybrid quattro	DDVE, CTCC	04/18 →
A7 50 TDI Mild Hybrid quattro	DDVB	10/17 →
A8 III 2.0 TFSI hybrid	CHJA	02/12 → 11/15
ALLROAD 2.7 T quattro	ARE, CCZC	05/00 → 08/05
Q3 2.0 TFSI	CCTA	10/13 →
Q3 2.0 TFSI [ExtraEU]	CCTA	09/14 → 10/18
Q3 2.0 TFSI quattro	CCZC, CAEB	06/11 → 10/18
Q5 1.2 TFSI hybrid quattro	CHJA	06/11 →
Q5 1.2 TFSI quattro	CAEB, CADA	11/08 →
Q5 1.2 TFSI quattro [CHN]	CADA, CRTC	09/09 →
Q5 1.3 TDI quattro	DCPC	07/17 →
Q7 II 3.0 TDI e-tron quattro	CVZA	08/15 →
Q7 II 3.0 TDI quattro	CRTC, BPY	05/15 →
Q7 II SQ7 TDI quattro	CZAC	04/16 →
Q8 3.0 45 TDI Mild Hybrid quattro	DHXC	07/18 →
Q8 3.0 50 TDI Mild Hybrid quattro	DHXA	07/18 →
Q8 3.0 TDI quattro	CVMD	02/18 →
TT II 1.8 TFSI	CDA	06/08 → 06/14
TT II 2.0 TFSI	BPY, BWA	08/06 → 06/14
TT II 2.0 TFSI quattro	BWA, CDLA	06/08 → 06/14
TT II 2.0 TTS quattro	CDLA, BEB	05/08 → 06/14

BENTLEY		
BENTAYGA 4.0 D	CZAC	01/17 →
BENTAYGA 4.0 TDI	CZAA	11/16 →
CONTINENTAL 6.0	BEB, BEB	06/03 →
CONTINENTAL 6.0 AWD	BEB, CKHB	06/06 →
CONTINENTAL 6.0 FLEX	CKHB, CKHA	11/10 →
CONTINENTAL 6.0 FLEX AWD	CKHA, BWRB	03/10 →
CONTINENTAL 6.0 FlexFuel	CKHC	01/10 → 07/10
CONTINENTAL 6.0 Flexfuel [ExtraEU]	BWRB, BWRA	02/08 →
CONTINENTAL 6.0 ISR/ISR Flexfuel	CKHE	03/11 → 06/14
CONTINENTAL 6.0 Speed [ExtraEU]	DBDD	11/17 → 07/18
CONTINENTAL 6.0 Super-sports AWD	DJLA	09/17 → 05/18
CONTINENTAL 6.0 Trazione integrale	BWRA, BWR	08/07 → 04/11
CONTINENTAL FLYING SPUR 6.0	BWR, BEB	03/05 →
CONTINENTAL FLYING SPUR 6.0 FLEX	BEB, CVAA	03/05 →
FLYING SPUR 6.0	CVAA, BYT	03/13 →

PORSCHE		
PANAMERA 4.0 4S Diesel	MDB.UC	11/16 →

SEAT		
ALHAMBRA III 1.8 TSI	CDA	11/12 →
ALHAMBRA III 2.0 TSI	CCZA	11/10 →
ALTEA 1.8 TFSI	BYT, BLR	01/07 →
ALTEA 2.0 FSI	BLR, BYT	05/04 → 03/09
ALTEA 2.0 TFSI	BWA	04/06 → 05/09
ALTEA XL 1.8 TFSI	BYT, BVY	01/07 →
ALTEA XL 2.0 FSI	BVY, BWA	10/06 → 03/09
ALTEA XL 2.0 TFSI	BWA	10/06 → 05/09
ALTEA XL 2.0 TFSI 4x4	BWA, CDHA	06/07 →
EXEO 1.8 T	CFMA	12/08 → 05/10
EXEO 1.8 TSI	CDHA, BWE	05/10 →
EXEO 2.0 TFSI	BWE, BBU	03/09 →
IBIZA III 1.8 T Cupra R	BBU, BJX	01/04 → 02/08
IBIZA III 1.8 T FR	BJX, BZB	12/03 → 05/08
LEON II 1.8 TSI	BZB, BLR	06/07 → 12/12
LEON II 2.0 Cupra R	CDLA	09/09 → 12/12
LEON II 2.0 FSI	BLR, BWA	07/05 → 05/10
LEON II 2.0 TFSI	BWA, BYT	05/05 → 12/12
TOLEDO III 1.8 TFSI	BYT, BLR	01/07 → 05/09
TOLEDO III 2.0 FSI	BLR, AGU	10/04 → 05/09
TOLEDO III 2.0 TFSI	BWA	11/05 → 05/09

SKODA		
OCTAVIA I 1.8 T	AGU, BYJ	08/97 → 12/10
OCTAVIA I 1.8 T 4x4	ARX	05/01 → 05/06
OCTAVIA I RS 1.8 T	AUQ	05/01 → 01/06
OCTAVIA II 1.6 FSI	BLF	02/04 → 10/08
OCTAVIA II 1.8 [CHN]	BYJ, BZB	04/07 →
OCTAVIA II 1.8 TSI	BZB, CDA	06/07 → 06/13
OCTAVIA II 1.8 TSI 4x4	CDA, BLR	11/08 → 02/13
OCTAVIA II 2.0 [CHN]	CGMA	07/10 →
OCTAVIA II 2.0 4x4	CCZA	11/08 →
OCTAVIA II 2.0 FSI	BLR, BLX	11/04 → 10/08
OCTAVIA II 2.0 FSI 4x4	BLX, BWA	11/04 → 10/08
OCTAVIA II 2.0 RS	BWA, CFHF	10/05 → 02/13
OCTAVIA II 2.0 TDI	CFHF, AMX	03/10 → 06/13
SUPERB I 1.8 T	AWT	12/01 → 03/08
SUPERB I 2.8 V6	AMX, BZB	12/01 → 03/08
SUPERB II 1.8 [CHN]	CEAA	04/09 →
SUPERB II 1.8 TSI	BZB, CDA	03/08 → 05/15
SUPERB II 1.8 TSI 4x4	CDA, CDA	11/08 → 05/15
SUPERB II 2.0 [CHN]	CGMA	04/09 →
SUPERB II 2.0 TSI	CCZA	05/10 → 05/15
YETI 1.8	CDAB	02/11 →
YETI 1.8 TSI 4x4	CDA, DDXA	05/09 → 12/17

VW		
AMAROK 2.0 TSI	CFPA	12/10 →
AMAROK 3.0 TDI	DDXA	06/16 →
AMAROK 3.0 TDI 4motion	DDXA, CBFA	06/16 →
AMAROK 3.0 TDi BlueMotion	DDXB	06/16 →
BEETLE 2.0 TSI	CBFA, AGU	04/11 → 07/16
BORA 1.8 T	AGU, CJK	05/00 → 05/05
CAMPMOBILE 2.0 TSi BlueMotion	CJK, CDA	04/15 →
CC 1.8 TSI	CDA, CBFA	11/11 → 12/16
CC 2.0 TSI	CBFA, BVY	11/11 →
EOS 1.6 FSI	BLF	06/06 → 05/08
EOS 2.0 FSI	BVY, BPY	03/06 → 05/08
EOS 2.0 TDI	BMM	06/06 → 05/08
EOS 2.0 TFSI	BPY, BUB	03/06 → 08/15
EOS 2.0 TSI	CCZB	11/09 → 08/15
EOS 3.2 V6	BUB, BKG	06/06 → 05/09
GOLF IV 1.6 FSI	BAG	10/03 → 07/04
GOLF V 1.4 FSI	BKG, BAG	10/03 → 11/06
GOLF V 1.6 FSI	BAG, BWA	10/03 → 07/08
GOLF V 2.0	BWA, AXW	06/07 → 07/09
GOLF V 2.0 FSI	AXW, BLX	01/04 → 11/08
GOLF V 2.0 FSI 4motion	BLX, AXX	08/04 → 11/08
GOLF V 2.0 GTI	AXX, CBFA	10/04 → 02/09
GOLF VI 1.8 TSI	CDA	06/09 → 01/11
GOLF VI 2.0	CDLF	05/11 →
GOLF VI 2.0 GTi	CBFA, CDLA	04/09 → 05/16
GOLF VI 2.0 R	CDLA	01/13 → 05/16
GOLF VI 2.0 R 4motion	CDLA, CBFA	11/09 → 11/13
GOLF VI 2.0 TFSi	CRZA	11/11 →
GOLF VI 2.0 TFSi Gti	CBFA, BLR	05/11 →
GOLF VI 2.0 TSI	CCZA	07/09 →
GOLF 2.0 GTi	CCZB	02/09 → 11/12
GOLF 2.0 TSi R 4motion	CDLF	11/09 → 11/12
JETTA V 1.6 FSI	BLF	09/05 → 10/10
JETTA V 2.0 FSI	BLR, BPY	08/05 → 10/10
JETTA V 2.0 TFSI	BPY, CBFA	10/05 → 10/10
JETTA VI 2.0 TSI	CBFA, CJK	12/10 →
MULTIVAN 2.0 TSI	CJK, AGU	05/11 →
MULTIVAN 2.0 TSI 4motion	CJK	07/11 →
NEW BEETLE 1.8 T	AGU, BZB	11/01 → 09/10
PASSAT IV 1.8 [CHN]	ANQ, BZB	03/00 →
PASSAT IV 1.8 4motion	AWM	03/01 → 05/05
PASSAT IV 1.8 T	AWM	02/01 → 08/05

VW		
PASSAT IV 1.8 T 20V	AWT	11/00 → 05/05
PASSAT IV 1.8 T 4motion	AWM	03/01 → 05/05
PASSAT IV 2.0	ALT	11/01 → 05/05
PASSAT V 1.6 FSI	BLF	03/05 → 06/08
PASSAT V 1.8 TSI	BZB, AXX	05/07 → 12/14
PASSAT V 2.0 FSI	AXX, BLX	03/05 → 11/10
PASSAT V 2.0 FSI 4motion	BLX, CDLA	09/05 → 11/10
PASSAT V 2.0 TSI	CCZB	11/10 → 12/15
PASSAT V 2.0 TSI 4motion	CCZB	01/12 → 12/14
PASSAT CC 1.8 TSI	BZB, CAWB	06/08 → 01/12
PASSAT CC 2.0 TSI	CAWB, ANQ	06/08 → 01/12
PASSAT 1.8 TFSI	CDA	08/10 → 12/14
PASSAT 2.0 TFSI	CCZB	11/10 → 12/14
POLO IV 1.4 FSI	AXU	02/02 → 07/06
POLO IV 1.8 GTI	BJX	09/05 → 11/09
POLO IV 1.8 GTi Cup Edition	BBU	05/06 → 11/09
POLO V 2.0 WRC	CDJ	08/13 →
SCIROCCO III 2.0 R	CDLA, CAWB	11/09 → 11/17
SCIROCCO III 2.0 TSI	CAWB, CAVA	05/08 → 11/17
SCIROCCO 2.0 TFSI	CCZB	11/09 → 05/14
SHARAN II 1.8 TSI	CDA	11/11 →
SHARAN II 2.0 TSI	CCZA	12/10 →
TIGUAN I 1.8 [CHN]	CEAA	12/09 →
TIGUAN I 2.0 [CHN]	CGMA	12/09 →
TIGUAN I 2.0 TFSI	CCTB	05/08 →
TIGUAN I 2.0 TFSI 4motion	CAWA, CCZB	09/07 →
TIGUAN I 2.0 TSI 4motion	CCZB, CVMD	05/11 →
TOUAREG II 3.0 TDI	DENA	11/17 →
TOUAREG II 3.0 TDI 4motion	CVMD, BAG	01/18 →
TOURAN I 1.6 FSI	BAG, BPL	02/03 → 01/07
TOURAN I 1.8 [CHN]	BPL., AXW	02/08 →
TOURAN I 2.0 FSI	AXW, CJK	10/03 → 01/07
TRANSPORTER V 2.0 TSI	CJK, CJK	05/11 → 08/15
TRANSPORTER V 2.0 TSI 4motion	CJK	07/11 → 08/15
TRANSPORTER VI 2.0 TSI	CJK, F14S3	04/15 →
TRANSPORTER VI 2.0 TSI 4motion	CJK	06/15 →

10.4008

1

AIR TEMPERATURE SENSORS

Adatt./Suitable:

CHEVROLET

96183228
96417820

DAEWOO

96183228
96417820

GENERAL MOTORS

90 499 898
96 183 228
96 417 820

HOLDEN

90499898

HYUNDAI

39340-24750
39340-24755

KIA

0K951-18831

OPEL

48 18 912
62 38 331
90499898
96417820

RENAULT

77 00 271 119

SIEMENS

5WK 96061

VAUXHALL

90499898
96417820

VOLVO

138955-6
344788-1
346781-3

MARKET DIFFUSION: MEDIUM

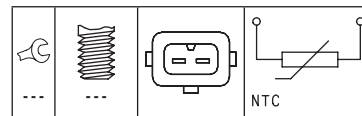

CHEVROLET

AVEO I 1.4	F14S3, A16DMS	03/05 →
AVEO I 1.4 16V	F14D3	05/03 → 05/08
AVEO I 1.5	F15S3	01/05 →
AVEO I 1.6	A16DMS, LDA	09/03 →
CAPTIVA 2.4	Z24SED	06/06 →
CAPTIVA 2.4 4WD	Z24SED	06/06 →
CAPTIVA 2.4 LPG	Z24SED	01/07 →
CAPTIVA 2.4 LPG 4WD	Z24SED	01/07 →
CRUZE 1.6	LXT	05/09 →
EPICA 2.0	L88	01/05 → 12/06
EVANDA 2.0	X20SED	03/05 →
KALOS 1.4 16V	F14D3	03/05 →
LACETTI 1.8	LDA	03/05 →
LACETTI 2.0	U20SED	03/05 →
LANOS 1.3	--	01/97 →
LANOS 1.5	A15SMS	11/05 →
LANOS 1.6 16V	A16DMS	11/05 →
LEGANZA 2.0	--	01/98 →
LEGANZA 2.2	--	01/98 →
NUBIRA 1.8	LDA, F18D3	03/05 → 12/11
OPTRA 1.8	F18D3, L88	08/03 →
OPTRA 1.8 SRV	T18SED	06/06 →
OPTRA 2.0	U20SED	06/99 →
REZZO 2.0	L88, L88	03/05 →
TACUMA 2.0	X20SED	02/05 →
VIVANT 2.0	X20SED	08/00 →
VIVANT 2.0 CX	T20SED	01/05 →

DAEWOO

ASSOL 1.3	C14L	04/97 → 06/99
ASSOL 1.5	Y15L	04/97 → 06/99
ASSOL 1.6	616L	02/98 → 06/99
EVANDA 2.0	L88, F14D3	08/02 →
KALOS 1.4	F14D3, A13SM	09/02 →
KALOS 1.4 16V	F14D3	04/03 →
KALOS 1.6	F16S4	02/03 →
LACETTI 1.8	T18SED	02/04 →
LANOS 1.3	A13SM, A15DMS	05/97 →
LANOS 1.5	A15DMS, 616L	05/97 →
LANOS 1.6	A16DMS	10/97 → 12/02

DAEWOO		
LANOS 1.6 16V	616L, T20SED	02/97 →
LEGANZA 2.0	T20SED, T20SED	01/01 → 12/02
LEGANZA 2.0 16V	T20SED, 616L	07/00 → 04/04
LEGANZA 2.2 16V	T22SED	04/99 → 12/02
MAGNUS 2.0	X20SED	07/99 → 01/06
NUBIRA I 1.6	A16DMS	08/02 → 07/03
NUBIRA I 1.6 [ExtraEU]	A16DMS	08/02 → 07/03
NUBIRA I 1.6 16V	616L, T20SED	05/97 →
NUBIRA I 2.0 16V	T20SED, T20SED	06/99 →
NUBIRA I 2.0 CDX	T20SED	08/02 → 07/03
NUBIRA II 1.8	T18SED	07/03 →
ORION 1.6	616L	04/99 → 08/00
REZZO 2.0	T20SED, Z24XE	09/00 →
TACUMA 2.0	X20SED	09/00 → 01/05

HOLDEN		
ASTRA_TR 1.8i 16v Hatchback	C18SEL	09/96 → 09/98
ASTRA_TR 1.8i 16v Sedan	C18SEL	09/96 → 09/98
ASTRA_TR 2.0i 16V Hatchback	X20XE	09/96 → 09/98
CALIBRA_YE 2.0i 16V	X20XE	08/95 → 10/97

HYUNDAI		
ELANTRA I 1.5 i GL	G4DJ	12/90 → 08/94
LANTRA I 1.5 i.e.	G4DJ	10/90 → 11/95

OPEL		
ANTARA 2.4	Z24XE, C18SEL	07/06 → 12/11
ANTARA 2.4 4x4	Z24XE	08/06 → 12/11
ANTARA 2.4 LPG	Z24XE	10/08 →
ANTARA 2.4 LPG 4x4	Z24XE	08/06 → 12/10
ASTRA F 1.8 i 16V	C18SEL, C20SEL	07/94 → 03/01
ASTRA F 2.0 i 16V	X20XE	02/95 → 08/00
CALIBRA A 2.0 i 16V	X20XE	02/94 → 07/97
CALIBRA A 2.0 i 16V 4x4	X20XE	02/94 → 07/97
OMEGA B 2.0 16V	X20XE	03/94 → 09/99
VECTRA 2.0	C20SEL	10/95 → 04/02
VECTRA A 2.0 i 16V	X20XE	08/92 → 08/95
VECTRA A 2.0 i 16V 4x4	X20XE	06/94 → 11/95
VECTRA B 1.8 FlexFuel	X18XE	01/99 → 09/00
VECTRA B 1.8 i 16V	X18XE	10/95 → 09/00
VECTRA B 2.0 i 16V	C20SEL, F3N743	10/95 → 07/03
VECTRA B 2.2 i 16V	C22SEL	07/00 → 07/02

RENAULT		
19 I 1.7	F3N746	08/88 → 12/92
19 II 1.7	F3N743, X18XE	04/92 → 12/95

VAUXHALL		
ANTARA 2.4	Z24XE	08/06 → 04/15
ANTARA 2.4 LPG 4x4	Z24XE	08/06 →
ASTRA III 1.8 16V	X18XE	11/94 → 03/01
ASTRA III 1.8 i 16V	X18XE	09/94 → 02/98
ASTRA III 2.0 i 16V	X20XE	01/94 → 09/98
CALIBRA 2.0 i 16V	X20XE	06/90 → 07/97
CALIBRA 2.0 i 16V 4x4	X20XE	02/94 → 07/97
OMEGA B 2.0 16V	X20XE	03/94 → 07/01
VECTRA B 1.8 i 16V	X18XE, B18E	09/95 → 09/00
VECTRA B 2.0 Dualfuel	X20XE	05/98 → 01/01
VECTRA B 2.0 i 16V	X20XE	10/95 → 01/01

VOLVO		
440 1.6	B16F	09/88 → 12/96
440 1.7	B18E, B18U	08/88 → 12/96
440 1.8	B18U, B20F	08/91 → 12/96
440 2.0	B20F, B18EP	08/92 → 07/96
460 1.6	B16F	07/92 → 07/96
460 1.7	B18EP, B20F	08/89 → 07/95
460 1.8	B18U	08/91 → 07/96
460 2.0	B20F, B18E	08/92 → 07/96
480 1.7	B18E, B5252	04/86 → 07/96
480 2.0	B20F	08/92 → 09/95
850 2.0	B5202S	08/94 → 12/96
850 2.0 10V	B5202FS	08/94 → 12/97
850 2.4	B5252, B5252FS	06/91 → 12/96
850 2.5 10V	B5252FS, B5202FS	06/91 → 12/97
S70 2.0	B5202FS, B5202FS	01/97 → 11/00
S70 2.4	B5252FS	01/97 → 11/00
S70 2.4 AWD	B5252FS	11/96 → 05/99
S70 2.4 Bifuel	GB5252S	10/98 → 11/00
S70 2.5 Bifuel	GB5252S2	01/99 → 12/99
V70 I 2.0	B5202FS, F8Q600	12/95 → 03/00
V70 I 2.4	B5252FS	12/95 → 03/00
V70 I 2.4 Bifuel	GB5252S	05/98 → 12/99
V70 I 2.5	B5252FS	01/97 → 03/00
V70 I 2.5 Bifuel	GB5252S2	01/99 → 12/99

10.4009



AIR TEMPERATURE SENSORS

Adatt./Suitable:

GENERAL MOTORS

9 109 683

90 411 958

MITSUBISHI

MD313486

OPEL

44 01 683

8 36 402

91 09 683

RENAULT

77 00 744 583

SIEMENS

5WK 90581

VAUXHALL

9109683

VOLVO

30804940

30871112

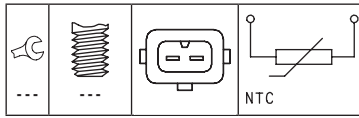

OPEL

ARENA 1.9 D	F8Q600, C18XE	01/97 → 12/01
-------------	---------------	---------------

ASTRA F 1.8 i 16V	C18XE, F3N742	06/93 → 03/01
-------------------	---------------	---------------

RENAULT

19 I 1.7	F3N742, F3N742	07/88 → 04/92
----------	----------------	---------------

19 II 1.7	F3N742, F3P682	04/92 → 12/95
-----------	----------------	---------------

19 II 1.8	F3P682, F2N722	04/92 → 06/96
-----------	----------------	---------------

21 1.7	F2N722, J7R746	03/86 → 06/94
--------	----------------	---------------

21 2.0	J7R746, J7R746	03/86 → 12/93
--------	----------------	---------------

21 2.0 4x4	J7R746, J7T754	03/89 → 12/93
------------	----------------	---------------

21 2.2	J7T754, J7T754	04/86 → 12/95
--------	----------------	---------------

21 2.2 4x4	J7T754, F3P754	06/86 → 06/94
------------	----------------	---------------

CLIO I 1.8	F3P754, F3P712	08/90 → 09/98
------------	----------------	---------------

CLIO I 1.8 Rsi	F3P712, F3R728	01/93 → 09/98
----------------	----------------	---------------

CLIO II 1.9 D	F8Q630	02/00 → 05/01
---------------	--------	---------------

ESPACE III 1.9 dTi	F9Q722	02/99 → 10/02
--------------------	--------	---------------

ESPACE III 2.0	F3R728, G8T714	11/96 → 10/00
----------------	----------------	---------------

ESPACE III 2.2 12V TD	G8T714, G8T714	11/96 → 10/00
-----------------------	----------------	---------------

ESPACE III 2.2 D	G8T714, F8Q630	11/97 → 01/00
------------------	----------------	---------------

KANGOO I D 65 1.9	F8Q630, F3P670	08/97 →
-------------------	----------------	---------

LAGUNA I 1.8	F3P670, --	06/95 → 03/01
--------------	------------	---------------

LAGUNA I 1.9 dTi	F9Q716	10/97 → 03/01
------------------	--------	---------------

LAGUNA I 2.0	--, N7Q700	11/93 → 03/01
--------------	------------	---------------

LAGUNA I 2.0 16V	N7Q700, F8Q784	06/95 → 03/01
------------------	----------------	---------------

LAGUNA I 2.2 D	G8T792	11/93 → 03/01
----------------	--------	---------------

LAGUNA I 2.2 dT	G8T760	03/96 → 03/01
-----------------	--------	---------------

MEGANE 1.9 DT/DTi	F8Q784, F8Q784	09/96 → 09/00
-------------------	----------------	---------------

MEGANE I 1.9	F8Q788	01/96 → 02/99
--------------	--------	---------------

MEGANE I 1.9 D	F8Q784	04/96 → 02/01
----------------	--------	---------------

MEGANE I 1.9 dT	F8Q784, F8Q784	01/96 → 08/03
-----------------	----------------	---------------

MEGANE I 1.9 dTi	F8Q784, F8Q784	03/97 →
------------------	----------------	---------

MEGANE I 1.9 TDI	F8Q784, F3R750	09/96 → 08/03
------------------	----------------	---------------

MEGANE I 2.0	F3R750, F7R710	04/97 → 08/03
--------------	----------------	---------------

MEGANE I 2.0 16V	F7R710, F3R750	03/96 → 08/03
------------------	----------------	---------------

MEGANE I 2.0 i	F3R750, F3R750	01/96 → 08/03
----------------	----------------	---------------

MEGANE I 2.0 RT	F3R750, F8Q784	10/96 → 02/99
-----------------	----------------	---------------

MEGANE SCÉNIC I 1.9 dT	F8Q784, F3R750	01/97 → 09/99
------------------------	----------------	---------------

MEGANE SCÉNIC I 1.9 dTi	F9Q730	04/97 → 09/99
-------------------------	--------	---------------

MEGANE SCÉNIC I 2.0 i	F3R750, F3R791	01/97 → 09/99
-----------------------	----------------	---------------

MEGANE SCÉNIC I 2.0 RXE 4x4	F3R750	05/97 → 10/99
-----------------------------	--------	---------------

SCÉNIC I 1.9 D	F8Q788	05/97 → 06/99
----------------	--------	---------------

SCÉNIC I 2.0	F3R791, F7R712	09/99 → 08/03
--------------	----------------	---------------

SPORT SPIDER 2.0	F7R710	12/95 → 08/96
------------------	--------	---------------

SPORT SPIDER 2.0 16V	F7R712, F8Q600	03/95 → 10/99
----------------------	----------------	---------------

SUPER 5 1.7 i	F3N702	10/86 → 08/91
---------------	--------	---------------

TRAFIC I 1.9 D	F8Q600, F8Q600	06/97 → 05/01
----------------	----------------	---------------

VAUXHALL

ARENA 1.9 D	F8Q600, C18XE	03/98 → 08/01
-------------	---------------	---------------

ASTRA III 1.8	C18XE	09/94 → 08/96
---------------	-------	---------------

ASTRA III 1.8 16V	C18XEL	11/94 → 03/01
-------------------	--------	---------------

ASTRA III 1.8 i 16V	C18XE, B4184S	06/93 → 02/98
---------------------	---------------	---------------

VOLVO		
S40 I 1.6	B4164S	09/95 → 08/99
S40 I 1.8	B4184S, B4204S	07/95 → 08/99
S40 I 1.9 DI	D4192T2	03/99 → 07/00
S40 I 1.9 TD	D4192T	07/95 → 08/99
S40 I 2.0	B4204S, B4184S	07/95 → 08/99
V40 I 1.6	B4164S	12/95 → 08/99
V40 I 1.8	B4184S, B4204S	07/95 → 08/99
V40 I 1.9 DI	D4192T2	03/99 → 07/00
V40 I 1.9 TD	D4192T	07/95 → 08/99
V40 I 2.0	B4204S, HEE	07/95 → 08/99

10.4010



AIR TEMPERATURE SENSORS

Adatt./Suitable:

DAIHATSU

89424-8770

89424-87703

89424-87703-000

DENSO

170400-4330

170400-6010

170400-6020

GENERAL MOTORS

95 514 355

HOLDEN

8942412010

LEXUS

89424-12010

MAZDA

BP4W-18-845

KL47-18-845

R2AX-18-2B5

R2Y1-18-2B5

RF8B-18-2B5

RF8G-18-2B5

MITSUBISHI

1865A095

NISSAN

22630-4A0A0

OPEL

47 00 661

95514355

SUBARU

13650-60G00

22634-KA070

22634-KA071

SUZUKI

13650-52G00

13650-52G00-000

13650-60G00

13650-60G00-000

13650-84M00

13650-84M00-000

TOYOTA

89424-06010

89424-12010

89424-12020

89424-33010

89429-17020

DAIHATSU			
MATERIA 1.5 LPG	3SZ-VE	01/10 ⇒ 12/11	
SIRION 1.3	K3-VE, K3-VE	01/05 ⇒	
SIRION 1.3 4WD	K3-VE, K3-VE	04/05 ⇒	
SIRION 1.3 Rally	K3-VE	06/02 ⇒ 03/05	
SIRION 1.3 Rally 4WD	K3-VE	06/02 ⇒ 03/05	
SIRION 1.3 Sport	K3-VE, 3SZ-VE	08/00 ⇒ 01/05	
SIRION 1.3 Sport 4WD	K3-VE2	08/00 ⇒ 03/05	
SIRION 1.5	3SZ-VE	03/08 ⇒	
TERIOS 1.3	K3-VE	09/01 ⇒ 10/05	
TERIOS 1.3 4WD	K3-VE	10/00 ⇒ 10/05	
TERIOS 1.3 VVT-i Turbo 4WD	K3-VE	10/02 ⇒ 10/05	
TERIOS II 1.3 VVT-i 4x4	K3-VE	11/05 ⇒	
TERIOS II 1.3 VVT-i LPG 4x4	K3-VE	01/09 ⇒ 12/09	
TERIOS II 1.5 4x4	3SZ-VE	05/06 ⇒	
TERIOS II 1.5 LPG 4x4	3SZ-VE	06/09 ⇒	
TERIOS II 1.5 VVT-i 4x4	3SZ-VE	09/10 ⇒	
TERIOS II 1.5 VVT-i RWD	3SZ-VE, HEE	11/05 ⇒	
TREVIS 1.0	EJ-VE	06/06 ⇒	
VALERA 1.5i 16v	HEE, RF7J	03/93 ⇒	
YRV 1.3	K3-VE	02/01 ⇒	
YRV 1.3 4WD	K3-VE	02/01 ⇒	

HOLDEN			
APOLLO 2.2 i	5S-FE	03/93 ⇒ 05/97	
NOVA_LF 1.8i Hatchback	7AFE	08/91 ⇒ 03/93	
NOVA_LF 1.8i Sedan	7AFE	08/91 ⇒ 03/93	
NOVA_LG 1.6i Hatchback	4AFE	09/94 ⇒ 09/96	
NOVA_LG 1.6i Sedan	4AFE	09/94 ⇒ 09/96	
NOVA_LG 1.8i Hatchback	7AFE	09/94 ⇒ 09/96	
NOVA_LG 1.8i Sedan	7AFE	09/94 ⇒ 09/96	

LEXUS			
GS 300	2JZ-GE	01/93 ⇒ 08/97	
IS 1200	1G-FE	04/99 ⇒ 10/05	

MAZDA			
3 I 2.0 MZR-CD	RF7J, FS	12/06 ⇒ 06/09	
5 I 2.0 CD	RF7J	02/05 ⇒ 05/10	
5 I 2.0 MZR-CD	RF7	09/07 ⇒	
6 II 2.0 MZR-CD	RF7J	08/07 ⇒ 12/10	
6 II 2.2 D	R2AA, R2AA	01/10 ⇒ 07/13	
6 II 2.2 MZR-CD	R2AA, B32L	08/08 ⇒ 07/13	
323 1.8 [ExtraEU]	FP55	05/98 ⇒ 05/04	
323 VII C 1.3 16V	B3(16V)	08/94 ⇒ 09/98	
323 VII C 1.5 16V	Z5-DE	08/94 ⇒ 09/98	
323 VII 1.5 16V	Z5-DE	07/94 ⇒ 09/98	
323 VII P 1.3 16V	B3(16V)	10/96 ⇒ 09/98	
323 VII P 1.5 16V	Z5-DE	10/96 ⇒ 09/98	
323 VII P 2.0 D	RF1G	10/96 ⇒ 09/98	
323 VIII F 1.8 Astina	BP(DOHC)	09/98 ⇒ 05/04	
323 VIII F 1.9 16V	FP	09/98 ⇒ 01/01	
323 VIII F 2.0	FS	02/00 ⇒ 09/04	
323 VIII F 2.0 TD	--	09/98 ⇒ 12/01	
323 VIII S 1.3 16V	B3(16V)	08/94 ⇒ 09/98	
323 VIII S 1.5 16V	Z5-DE	08/94 ⇒ 09/98	
323 VIII S 1.8 Protege	BP(DOHC)	05/98 ⇒ 05/04	
323 VIII S 1.9 16V	FP	09/98 ⇒ 05/04	
323 VIII S 2.0	FS, R2AA	02/00 ⇒ 05/04	
323 VIII S 2.0 D	RF1G	10/96 ⇒ 05/04	
323 VIII S 2.0 TD	RF3F	09/98 ⇒ 05/04	
626 VI 2.0 DITD	RF3F	09/99 ⇒ 10/02	
626 VI 2.0 Turbo DI	RF4F	04/98 ⇒ 10/02	
CX-7 2.2 MZR-CD AWD	--	09/09 ⇒	
DEMIO 1.3 16V	B3ME	08/98 ⇒ 07/03	
DEMIO 1.3 i 16V	B32L, BP6J	08/98 ⇒ 04/00	
DEMIO 1.5 16V	B5E	04/00 ⇒ 07/03	
MILLENNIA 2.3i [USA]	--	05/99 ⇒	
MILLENNIA 2.5i [USA]	--	05/99 ⇒	
MPV II 2.0	FS-DS	09/99 ⇒ 08/00	
MX-5 II 1.6 16V	B6D	05/98 ⇒ 10/05	
MX-5 II 1.8	BP6J, BPD	08/02 ⇒ 10/05	
MX-5 II 1.8 16V	BPD, 4M41R	11/00 ⇒ 10/05	
PREMACY 1.9	FP	07/99 ⇒ 03/05	
PROTEGE 1.8i [USA]	--	06/98 ⇒	
XEDOS 9 2.0	KF	08/98 ⇒ 08/00	
XEDOS 9 2.0 24V	KF	08/93 ⇒ 01/00	
XEDOS 9 2.3 24V	KJ-ZEM	02/95 ⇒ 01/00	
XEDOS 9 2.5 24V	KL	07/93 ⇒ 07/00	
XEDOS 9 2.5 V6	KL	07/00 ⇒ 09/02	

MITSUBISHI			
PAJERO IV 3.2 DI-D 4WD	4M41, K10B	02/07 ⇒	
PAJERO 3.2 DiD	4M41R, 4M41	02/07 ⇒	

NISSAN			
PIXO 1.0	K10B	06/09 ⇒	

OPEL			
AGILA B 1.0	K10B, EJ202	04/08 ⇒ 07/14	
AGILA B 1.0 LPG	K10B	01/10 ⇒ 06/11	

SUBARU			
FORESTER I 2.0	EJ20J	08/97 ⇒ 09/02	
FORESTER I 2.0 AWD	EJ202, EJ20	08/97 ⇒ 09/02	
FORESTER II 2.0 AWD	EJ20, EJ201	06/02 ⇒ 05/05	

SUBARU			
FORESTER II 2.0 S Turbo AWD	EJ205	09/02 ⇒ 05/05	
FORESTER II 2.0 X AWD	EJ201, EJ251	06/05 ⇒ 05/08	
FORESTER II 2.5	EJ251	02/02 ⇒	
FORESTER II 2.5 RX Nato AWD	EJ251, EJ18	11/02 ⇒ 12/08	
FORESTER II 2.5 XT AWD	EJ255	06/05 ⇒ 05/08	
IMPREZA I 1.6	EJ16E	01/93 ⇒ 12/00	
IMPREZA I 1.6 i	EJ16	08/92 ⇒ 12/00	
IMPREZA I 1.6 i AWD	EJ16	08/92 ⇒ 12/00	
IMPREZA I 1.8 AWD	EJ18	01/93 ⇒ 10/95	
IMPREZA I 1.8 i	EJ18E	11/95 ⇒ 06/96	
IMPREZA I 1.8 i AWD	EJ18, EJ22E	08/92 ⇒ 12/00	
IMPREZA I 1.8 i AWD	EJ18, EJ22E	08/92 ⇒ 12/00	
IMPREZA I 2.2 i	EJ22E, EJ16	11/93 ⇒ 08/98	
IMPREZA II 1.6	EJ161	10/00 ⇒ 09/06	
IMPREZA II 1.6 AWD	EJ16, EJ20	12/00 ⇒ 06/09	
IMPREZA II 2.0 AWD	EJ20, EJ207	12/00 ⇒ 12/07	
IMPREZA II 2.0 i AWD	EJ201	12/00 ⇒ 06/09	
IMPREZA II 2.0 WRX STi AWD	EJ207, EJ25	11/01 ⇒ 07/05	
IMPREZA II 2.5 [ExtraEU]	EJ251	12/02 ⇒ 09/05	
IMPREZA II 2.5 AWD	EJ251	03/01 ⇒ 09/05	
JUSTY II 1.3i	G13BA	05/96 ⇒ 09/00	
LEGACY II 1.8 AWD	EJ18E	05/96 ⇒ 09/98	
LEGACY III 2.0	EJ201	12/98 ⇒ 08/03	
LEGACY III 2.0 AWD	EJ201	12/98 ⇒ 08/03	
LEGACY III 2.5	EJ251	10/98 ⇒ 08/03	
LEGACY III 2.5 AWD	EJ25, EJ202	10/98 ⇒ 08/03	
LEGACY IV 2.0 AWD	EJ202, EJ25	09/03 ⇒ 04/09	
LEGACY IV 2.0 D AWD	EE20Z	02/08 ⇒ 12/09	
LEGACY IV 2.0 R AWD	EJ204	09/07 ⇒ 12/09	
LEGACY IV 2.5 AWD	EJ25, EJ252	09/03 ⇒ 04/09	
LEGACY IV 2.5 i	EJ252, EJ25	05/03 ⇒	
LEGACY IV 2.5 i AWD	EJ25, EJ25	09/07 ⇒ 12/09	
LEGACY IV 3.0 R AWD	30D	09/03 ⇒ 06/09	
OUTBACK II 2.5 AWD	EJ25, EJ252	10/00 ⇒ 08/03	
OUTBACK III 2.0	EJ202	09/03 ⇒ 10/05	
OUTBACK III 2.0 AWD	EJ202	09/03 ⇒ 10/05	
OUTBACK III 2.0 D AWD	EE20Z	09/08 ⇒ 09/09	
OUTBACK III 2.5	EJ252, EJ252	09/08 ⇒ 09/09	
OUTBACK III 2.5 AWD	EJ252, F10D	11/03 ⇒ 09/09	
OUTBACK III 3.0 AWD	30D	11/03 ⇒ 09/09	

SUZUKI			
ALTO IV 1.0	G10BB	09/94 ⇒ 09/98	
ALTO V 1.0	G10BB	01/00 ⇒ 06/02	
ALTO VI 1.1	F10D, K10B	09/04 ⇒ 12/08	
ALTO VIII 1.0	K10B	01/09 ⇒	
BALENO 1.3	G13BA	09/96 ⇒ 05/02	
BALENO 1.3 16V	G13BB	03/97 ⇒ 05/02	
BALENO 1.3 i 16V	G13BB	07/95 ⇒ 05/02	
BALENO 1.6	G16B	07/96 ⇒ 01/99	
BALENO 1.6 i 16V	G16B	07/95 ⇒ 05/02	
BALENO 1.6 i 16V 4x4	G16B	07/95 ⇒ 05/02	
BALENO 1.8	J18A	02/99 ⇒ 10/01	
BALENO 1.8 GTX	J18A	03/96 ⇒ 05/02	
BALENO 1.8 i 16V	J18A	08/96 ⇒ 05/02	
BALENO 1.8 i 16V 4x4	J18A	08/96 ⇒ 05/02	
BALENO 1.8 i 4x4	J18A	03/96 ⇒ 05/02	
CARRY 1.3	G13BB	02/99 ⇒ 12/06	
CARRY 1.3 16V	G13BB	03/00 ⇒	
CELERIO 1.0	K10B, G16B	03/14 ⇒	
ESTEEM 1.6i [USA]	G16B	09/98 ⇒	
ESTEEM 1.8i [USA]	J18A	09/98 ⇒	
GRAND VITARA I 1.6 4x4	G16B, J20A	03/98 ⇒ 09/05	
GRAND VITARA I 2.0	J20A	08/98 ⇒ 12/00	
GRAND VITARA I 2.0 4x4	J20A, RF	03/98 ⇒ 08/05	
GRAND VITARA I 2.0 TD 4x4	RF, H25A	03/98 ⇒ 07/03	
GRAND VITARA I 2.5 V6 24V 4x4	H25A, H27A	04/01 ⇒ 07/03	
GRAND VITARA I 2.7	H27A, H27A	06/01 ⇒ 08/06	
GRAND VITARA I 2.7 4x4	H27A, G13BB	09/01 ⇒ 07/03	
GRAND VITARA II 1.6	M16A	01/15 ⇒ 02/15	
GRAND VITARA II 1.6 4x4	M16A	01/15 ⇒ 02/15	
GRAND VITARA II 1.6 Trazione integrale	M16A	04/05 ⇒	
GRAND VITARA II 2.0 Trazione integrale	J20A	10/05 ⇒ 02/15	
IGNIS I 1.3	M13A	10/00 ⇒ 09/03	
IGNIS I 1.3 4WD	M13A	10/00 ⇒ 09/03	
IGNIS II 1.5 Sport	M15A	12/03 ⇒	
JIMNY III 1.3	M13A	08/04 ⇒	
JIMNY III 1.3 16V	G13BB, G13BB	02/01 ⇒	
JIMNY III 1.3 16V 4WD	G13BB, M16A	09/98 ⇒	
JIMNY III 1.3 16V 4x4	M13A	08/05 ⇒	
JIMNY III 1.3 4WD	M13A	05/14 ⇒	
JIMNY III 1.3 4x4	G13BB	09/98 ⇒ 08/00	
JIMNY 1.5 AllGrip	K15B	07/18 ⇒	
LIANA 1.3	M13A	07/01 ⇒	
LIANA 1.4 DDIS	8HY	04/04 ⇒	
LIANA 1.6	M16A, M16A	07/01 ⇒	
LIANA 1.6 4WD	M16A, M16A	07/01 ⇒	

SUZUKI			
LIANA 1.6 i	M16A	04/02 ⇒	
LIANA 1.8 i	M18A	10/01 ⇒	
SIDEKICK 1.8 J1X Sport 4x4 [USA]	--	05/96 ⇒ 07/98	
SIDEKICK 1.8 JX Sport 4x4 [USA]	--	05/96 ⇒ 07/98	
SWIFT III 1.3 [USA]	--	06/95 ⇒ 05/01	
SWIFT III 1.3 i	G13BA	06/96 ⇒ 03/01	
SWIFT I / II / III 1.0 i	G10A	01/95 ⇒ 12/05	
SX4 II 1.6	M16A, M16A	08/13 ⇒	
SX4 II 1.6 AllGrip	M16A, M16A	08/13 ⇒	
VITARA I 2.0 16V	J20A	12/96 ⇒ 03/99	
VITARA I 2.0 16V Trazione integrale	J20A	12/96 ⇒ 03/98	
VITARA I 2.0 TD Intercooler Trazione integrale	RF	12/95 ⇒ 03/98	
VITARA I 2.0 TD Trazione integrale	RF	12/94 ⇒ 03/98	
VITARA I 2.0 V6 24V Trazione integrale	H20A	12/94 ⇒ 03/98	
VITARA II 1.6i [USA]	--	08/99 ⇒ 12/06	
VITARA II 2.0i [USA]	--	08/99 ⇒	
VITARA IV 1.6	M16A, M16A	02/15 ⇒	
VITARA IV 1.6 AllGrip	M16A, G10A	02/15 ⇒	
VITARA IV 1.6 DDIS	D16AA	02/15 ⇒	
VITARA IV 1.6 DDIS AllGrip	D16AA	02/15 ⇒	
WAGON R+ II 1.0	K10A	08/00 ⇒ 07/03	
WAGON R+ II 1.0 XT Plus	--	08/00 ⇒ 07/01	
WAGON R+ II 1.3	G13BB, G13BB	05/00 ⇒	
WAGON R+ II 1.3 4WD	G13BB, 4A-FE	10/01 ⇒	
WAGON R III 1.0	G10A, G13BB	07/03 ⇒ 08/05	
WAGON R III 1.3	M13A	09/03 ⇒ 12/10	
WAGON R 1.3 [ExtraEU]	G13BB	04/99 ⇒ 08/03	

TOYOTA			
4 RUNNER 2.7 4WD	3RZ-FE	11/95 ⇒ 08/02	
AVENSIS I 1.6	4A-FE, 1AZ-FSE	09/97 ⇒ 10/00	
AVENSIS I 1.8	7A-FE	09/97 ⇒ 10/00	
AVENSIS I 2.0	1AZ-FSE, 5S-FE	09/97 ⇒ 02/03	
AVENSIS I 2.0 VVT-i	1AZ-FSE	10/00 ⇒ 02/03	
CAMRY 2.2	5S-FE, 4A-FE	06/91 ⇒	
CAMRY SOLARA I 2.2	5S-FE	06/98 ⇒ 11/02	
CARINA E 1.6	4A-FE, 3S-GE	04/92 ⇒ 09/97	
CARINA E 1.6 16V	4A-FE	12/94 ⇒ 09/97	
CARINA E 1.6 GLI	4A-FE	04/92 ⇒ 09/97	
CARINA E 1.6 i	4A-FE	02/95 ⇒ 09/97	
CARINA E 1.8	7A-FE	04/92 ⇒ 09/97	
CARINA E 1.8 i	7A-FE	02/95 ⇒ 09/97	
CARINA E 1.8 i 16V	7A-FE	01/95 ⇒ 09/97	
CARINA E 2.0	3S-FE	01/93 ⇒ 09/97	
CARINA E 2.0 GLI	3S-FE	04/92 ⇒ 09/97	
CARINA E 2.0 GTi			

TOYOTA		
FUNCRUISER 2.0 i 16V 4WD	3SFE	04/94 →
HIACE 2.4 LPG	2RZ-E	08/95 → 06/99
HIACE IV 2.0	1RZ-E	11/96 → 10/00
HIACE IV 2.4	2RZ-E, 2KD-FTV	08/89 → 08/04
HIACE IV 2.4 4WD	2RZ-E	08/89 → 04/98
HIACE IV 2.4 i	2RZ-E	08/95 → 08/04
HIACE IV 2.5 D-4D	2KD-FTV, 3RZ-FE	06/04 →
HIACE IV 2.5 D-4D 4WD	2KD-FTV	08/04 → 09/07
HIACE IV 2.7	3RZ-FE, 3RZ-FE	04/98 → 12/06
HIACE IV 2.7 4WD	3RZ-FE, 2KD-FTV	04/98 →
HIACE IV 3.0 D	5L-E	01/05 →
HILUX VII 2.5 D-4D 4WD	2KD-FTV, 1KZ-TE	11/04 →
HILUX VII 3.0 D	5L-E	07/05 →
HILUX VII 3.0 D 4WD	5L-E	07/05 →
LAND CRUISER 90 2.7	3RZ-FE	06/95 → 08/02
LAND CRUISER 90 3.0 TD	1KZ-TE, 3S-GE	04/95 → 12/02
LAND CRUISER 120 3.0 D	5L-E	09/02 → 07/09
LAND CRUISER PRADO 120 2.7	3RZ-FE	09/02 → 08/04
LAND CRUISER PRADO 120 3.0 D	5L-E	09/02 → 08/09
LAND CRUISER PRADO 150 3.0 D	5L-E	08/09 →
MARK 2.2	5S-FE	01/97 → 12/02
MR 2 II 2.0	3S-FE	12/89 → 08/92
MR 2 II 2.0 16V	3S-GE, 3S-FE	12/89 → 09/99
MR 2 II 2.0 Turbo	3S-GTE	12/89 → 07/99
MR 2 II 2.2 16V	5S-FE	01/90 → 06/95
PASEO 1.5	5E-FE	08/95 → 06/99
PASEO 1.5 Efi	5E-FE	01/97 → 07/99
PICNIC I 2.0	3S-FE, 3S-FE	01/01 → 12/01
PICNIC I 2.0 16V	3S-FE	08/96 → 09/00
PREVIA I 2.4	2TZ-FE	05/90 → 08/00
PREVIA I 2.4 4WD	2TZ-FE	01/90 → 08/00
RAV 4 I 2.0	3S-FE	06/97 → 09/99
RAV 4 I 2.0 4WD	3S-FE, 2E	01/94 → 06/00
STARLET 1.3	2E, 2E	01/96 → 10/99
STARLET 1.3 12V	2E, 2JZ-GTE	12/89 → 12/92
STARLET 1.3 12V Cat	2E-E	12/89 → 03/96
STARLET 1.3 XL	2E	12/89 → 12/91
SUPRA 3.0 i	2JZ-GE	05/93 → 07/02
SUPRA 3.0 i Bi-Turbo	2JZ-GTE, 5E-FE	05/93 → 07/02
T100 2.7 i [USA]	3RZFE	10/93 → 07/98
TACOMA 2.4 i [USA]	2RZFE	01/95 →
TERCEL 1.5	5E-FE, NFZ(TU5JP)	09/94 → 09/99
TERCEL 1.5 4WD	5E-FE	09/94 → 09/99
VAUXHALL		
AGILA B 1.0 12V	K10B	01/08 → 11/14
AGILA B 1.0 i	K10B	08/11 → 11/14

DACIA		
LOGAN I 1.0 Hi-Flex	D4D760	01/11 → 10/12
SANDERO I 1.0 Hi-Flex	D4D760	01/11 → 12/12
NISSAN		
KUBISTAR 1.2 16V	D4F712, NFZ(TU5JP)	04/06 →
PEUGEOT		
206 1.6 8V	TU5JP	05/99 → 10/03
206 1.6 i	NFZ(TU5JP), D7F720	09/98 → 12/00
306 1.6	NFZ(TU5JP)	05/93 → 10/00
306 1.6 SR	NFZ(TU5JP)	06/94 → 10/00
RENAULT		
CLIO II 1.0 16V	D4D700	01/01 →
CLIO II 1.2	D7F720, D4F706	09/98 →
CLIO II 1.2 16V	D4F706, D4F706	06/01 →
CLIO III 1.2 16V	D4F706, D4D700	06/05 →
KANGOO 1.0 [ExtraEU]	D4D700, D4F712	01/02 → 01/07
KANGOO 1.2	D4F712, D4D700	07/01 → 10/03
KANGOO I 1.0 16V	D4D700, D7F710	03/98 →
KANGOO I 1.2	D7F710, D4F712	08/97 →
KANGOO I 1.2 16V	D4F712, D7F710	06/01 →
KANGOO I 1.2 BiFuel	D7F710, D4F742	07/98 → 07/01
LOGAN 1.0	D4D760	12/05 →
MODUS / GRAND MODUS 1.2	D4F742, D4F702	12/04 →
TWINGO I 1.0 16V	D4D712	01/01 →
TWINGO I 1.2 16V	D4F702, 1Z	01/01 → 06/07

VW		
BORA 1.9 SDi	AGP, 1Y	10/98 → 05/05
CADDY II 1.9 D	1Y, 1Y	11/95 → 01/04
CADDY II 1.9 SDI	1Y, 1Z	11/95 → 01/04
CADDY II 1.9 TDI	1Z, 1Z	09/96 → 01/04
CORRADO 2.0 i	ADY	04/93 → 12/95
FOX 1.9 D	ASY	12/07 →
GOLF III 1.9 TDI	1Z, 1Z	09/93 → 04/99
GOLF III 1.9 TDI Syncro	1Z, ADY	07/95 → 04/99
GOLF III 2.0	ADY, AGP	11/91 → 04/99
GOLF III 2.0 GL	AEP	08/95 → 09/97
GOLF III 2.0 GTI 16V	ABF	08/92 → 08/97
GOLF III 2.0 Syncro	AGG	08/95 → 04/99
GOLF IV 1.9 SDI	AGP, AFN	08/97 → 06/06
GOLF IV 1.9 TDI	AFN, AGG	06/98 → 06/02
GOLF IV 2.0	AGG, ADY	06/98 → 06/02
GOLF 1.9 SDi	AQM	11/98 → 05/04
JETTA V 1.9 SDI [CHN]	AQM	02/02 →
LT II 2.5 SDI	AGX	07/96 → 07/06
LUPU 1.7 SDI	AKU	09/98 → 07/05
PASSAT IV 1.9 TDI	AFN, AEF	10/96 → 11/00
PASSAT IV 1.9 TDI Syncro/4motion	AFN	10/96 → 11/00
PASSAT III 2.0	ADY, ADY	02/90 → 05/97
PASSAT III 2.0 16V	ABF	01/94 → 05/97
PASSAT III 2.0 Syncro	ADY, AFN	10/90 → 05/97
POLO III 1.7 SDI	AKU	08/97 → 09/01
POLO III 1.9 D	AEF, AEF	10/99 → 09/01
POLO III 1.9 SDI	AEF, AFN	05/96 → 09/01
POLO III 1.9 TDI	AFN, AEF	05/97 → 09/01
POLO III 57 1.7 SDI	AKW	07/97 → 09/01
POLO III 60 1.7 SDI	AKU	08/97 → 10/99
POLO III 64 1.9 D	AEF, AEF	10/94 → 10/99
POLO III 64 1.9 SDI	AEF, AGP	12/95 → 10/99
POLO III 68 1.9 SDI	AGP, AGR	08/99 → 01/02
POLO III 90 1.9 TDI	AGR, 1Z	09/96 → 09/01
POLO IV 1.9 SDI	ASY	10/01 →
SHARAN I 1.9 TDI	1Z, ACU	09/95 → 03/10
SPACEFOX / SPACE CROSS 1.9 SDI	ASY	09/07 →
TRANSPORTER IV 2.0	AAC	07/90 → 04/03
TRANSPORTER IV 2.5	ACU, ACU	11/90 → 06/03
TRANSPORTER IV 2.5 Syncro	ACU, ACV	10/92 → 04/03
TRANSPORTER IV 2.5 TDI	ACV, E23	09/95 → 04/03
TRANSPORTER IV 2.5 TDI Syncro	ACV	09/95 → 04/03
VENTO 1.9 TDI	AHU	09/93 → 09/98

10.4013



AIR TEMPERATURE SENSORS

Adatt./Suitable:

- AUDI 028 906 081
- FORD 1 003 742
- SEAT 028 906 081
- SKODA 028 906 081
- VW 028 906 081

MARKET DIFFUSION: MEDIUM

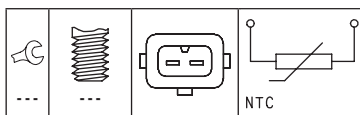

AUDI		
CABRIOLET 1.9 TDI	1Z, 1Z	06/95 → 08/00
FORD		
GALAXY I 1.9 TDI	1Z, 1Z	03/95 → 05/06
SEAT		
ALHAMBRA I / II 1.9 TDI	1Z, AEY	04/96 → 03/10
AROSA 1.7 SDI	AKU	08/97 → 06/04
CORDOBA I 1.8 i 16V	ADL	10/93 → 08/96
CORDOBA I 1.9 SDI	AEY, 1Z	08/96 → 06/99
CORDOBA I 1.9 TDI	1Z, 1Z	08/96 → 12/02
CORDOBA I 2.0 i	AGG	02/93 → 06/99
CORDOBA II 1.9 SDI	ASY	09/02 → 11/09
IBIZA II 1.8 i 16V	ADL	11/93 → 08/96
IBIZA II 1.9 SDI	AEY	08/96 → 08/99
IBIZA II 1.9 TDI	1Z, 1Y	08/96 → 12/97
IBIZA II 2.0 i	AGG	03/93 → 08/99
IBIZA III 1.9 SDI	ASY	02/02 → 12/05
INCA 1.9 D	1Y, 1Y	11/95 → 06/03
INCA 1.9 SDI	1Y, AFN	11/95 → 06/03
LEON I 1.9 SDI	AQM	11/99 → 06/06
TOLEDO I 1.6 i	AFT	11/96 → 03/99
TOLEDO I 1.9 TDI	AFN, AGP	08/95 → 03/99
TOLEDO I 2.0 i	AGG	05/91 → 03/99
SKODA		
FABIA I 1.9 SDI	ASY	11/99 → 03/08
OCTAVIA I 1.9 D	AQM	08/00 → 12/03
OCTAVIA I 1.9 SDI	AGP, AGP	06/97 → 12/03
VOLKSWAGEN (BR)		
POLO 1.9 SDI	ASY	05/02 →

10.4012



AIR TEMPERATURE SENSORS

Adatt./Suitable:

- CITROËN 1920 6C
- DACIA 77 01 055 723
- NISSAN 22693-00QAA
- PEUGEOT 1920 6C
- RENAULT 77 01 055 723

MARKET DIFFUSION: MEDIUM

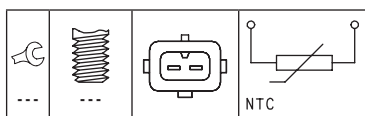

CITROËN		
SAXO 1.6	NFZ(TU5JP), NFZ(TU5JP)	02/96 → 06/03
SAXO 1.6 VTL,VTR	NFZ(TU5JP), NFZ(TU5JP)	05/96 → 06/03
XSARA 1.6 i	NFZ(TU5JP)	04/97 → 09/00
XSARA PICASSO 1.6	NFZ(TU5JP), D4F712	06/02 →
DACIA		
LOGAN I 1.0	D4D760	12/05 →

10.4014



1

AIR TEMPERATURE SENSORS

Adatt./Suitable:

BOSCH

1 287 213 607

DAEWOO

0005422818

INFINITI

22630-HG00C

JEEP

K05149209AA

MERCEDES-BENZ

A 000 542 28 18

A 006 153 20 28

A 006 153 80 28

A 651 153 00 28

MITSUBISHI

MN960276

MOPAR PARTS

05149209AA

SIEMENS

809/19/8

SMART

A 000 542 28 18

A 006 153 20 28

A 006 153 80 28

A 651 153 00 28

Q 0003119V002000000

SSANGYONG

0005422818

VW

2D0 905 379 A

MARKET DIFFUSION: HIGH

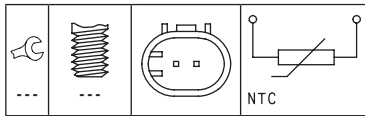

DAEWOO		
KORANDO 2.3	E23, E32	01/99 ⇨
KORANDO 3.2 4x4	E32, M104.992	01/99 ⇨
MUSSO 2.3	M111.970	01/99 ⇨
MUSSO 3.2 4x4	M104.992, ENE	01/99 ⇨
INFINITI		
Q30 2.2 D	651930	11/15 ⇨
Q30 2.2 D AWD	651930	11/15 ⇨
Q50 50 D	OM651	04/13 ⇨
Q70 2.2 D	OM651	10/14 ⇨
QX30 2.2 D AWD	651930	04/16 ⇨
JEEP		
COMPASS 2.2 CRD	ENE	05/11 ⇨
COMPASS 2.2 CRD 4x4	ENE, M166.940	12/10 ⇨
MAYBACH		
57 5.5	285950	09/02 ⇨ 12/12
57 6.0	285980	01/11 ⇨ 12/12
57 5 6.0	285980	09/05 ⇨ 12/12
62 5.5	285950	09/02 ⇨ 12/12
62 6.0	285980	01/11 ⇨ 12/12
62 S 6.0	285980	09/05 ⇨ 12/12
MERCEDES-BENZ		
100 LI 2.3	M161.971	11/96 ⇨
B-SERIES B150 BlueEFFICIENCY	M266.920	01/09 ⇨ 11/11
B-SERIES B180 CDI [ExtraEU]	OM651.930	07/14 ⇨
CLASSE V V 200 CDI	OM611.980	03/99 ⇨ 07/03
CLASSE V V 200 CDI / d	OM651.950	03/14 ⇨
CLASSE V V 200 CDI / d 4-matic	OM651.950	04/15 ⇨
CLASSE V V 220 CDI	OM611.980	03/99 ⇨ 07/03
CLASSE V V 220 CDI / d	OM651.950	03/14 ⇨
CLASSE V V 220 CDI / d 4-matic	OM651.950	04/15 ⇨
CLASSE V V 230	M111.978, OM642.824	10/96 ⇨ 07/03
CLASSE V V 250 BlueTEC / d	OM651.950	03/14 ⇨
CLASSE V V 250 BlueTEC / d 4-matic	OM651.950	12/14 ⇨
CLASSE A I A 140	M166.940, OM668.940	01/01 ⇨ 08/04
CLASSE A I A 160	M166.960	07/97 ⇨ 08/04
CLASSE A I A 160 CDI	OM668.940, OM668.940	02/01 ⇨ 08/04

MERCEDES-BENZ		
CLASSE A I A 170 CDI	OM668.940, 266960NGT	02/01 ⇨ 08/04
CLASSE A I A 190	M166.990	03/99 ⇨ 08/04
CLASSE A I A 210	M166.995	12/01 ⇨ 08/04
CLASSE A II A 150	M266.920	09/04 ⇨ 06/12
CLASSE A II A 160	M266.920	04/09 ⇨ 06/12
CLASSE A II A 160 CDI	OM640.942	09/04 ⇨ 06/12
CLASSE A II A 170	M266.940	09/04 ⇨ 06/12
CLASSE A II A 180	M266.940	04/09 ⇨ 06/12
CLASSE A II A 180 CDI	OM640.940	09/04 ⇨ 06/12
CLASSE A II A 200	M266.960	09/04 ⇨ 06/12
CLASSE A II A 200 CDI	OM640.941	09/04 ⇨ 06/12
CLASSE A II A 200 TURBO	M266.980	09/05 ⇨ 06/12
CLASSE A III A 200 CDI / d	OM651.930	02/14 ⇨
CLASSE A III A 220 CDI 4-matic	OM651.930	09/12 ⇨
CLASSE A III A 220 d	OM651.930	07/15 ⇨
CLASSE A III A 220 d 4-matic	OM651.930	07/15 ⇨
CLASSE A 200 d	OM654.920	11/18 ⇨
CLASSE A 220 d	OM654.920	11/18 ⇨
CLASSE B B 200 d	OM654.920	12/18 ⇨
CLASSE B B 220 d	OM654.920	12/18 ⇨
CLASSE B I B 150	M266.920	03/05 ⇨ 11/11
CLASSE B I B 160	M266.920	04/09 ⇨ 11/11
CLASSE B I B 170	M266.940	03/05 ⇨ 11/11
CLASSE B I B 170 NGT	266960NGT, 266960NGT	04/08 ⇨ 11/11
CLASSE B I B 180	M266.940	04/09 ⇨ 11/11
CLASSE B I B 180 CDI	OM640.940	03/05 ⇨ 11/11
CLASSE B I B 180 NGT	266960NGT, OM651.930	04/08 ⇨ 11/11
CLASSE B I B 200	M266.960	03/05 ⇨ 11/11
CLASSE B I B 200 CDI	OM640.941	03/05 ⇨ 11/11
CLASSE B I B 200 TURBO	M266.980	03/05 ⇨ 11/11
CLASSE B I B 200 CDI	OM651.901	11/11 ⇨
CLASSE B I B 200 CDI	OM651.901	11/11 ⇨
CLASSE B I B 200 CDI / d	OM651.930	08/14 ⇨
CLASSE B I B 200 CDI / d 4-matic	OM651.930	08/14 ⇨
CLASSE B I B 220 CDI / d	OM651.930, M111.944	11/11 ⇨
CLASSE B I B 220 CDI / d 4-matic	OM651.930	09/14 ⇨
CLASSE B I B 220 d 4-matic	OM651.930	06/18 ⇨
CLASSE C I C 180	M111.920	03/93 ⇨ 05/00
CLASSE C I C 180 T	M111.920	06/96 ⇨ 09/00
CLASSE C I C 200	M111.941	01/94 ⇨ 05/00
CLASSE C I C 200 CDI	OM611.960	03/98 ⇨ 05/00
CLASSE C I C 200 D	OM604.915	10/96 ⇨ 05/00
CLASSE C I C 200 Kompressor	M111.944, OM604.910	10/95 ⇨ 05/00
CLASSE C I C 200 T	M111.941	06/96 ⇨ 03/01
CLASSE C I C 200 T CDI	OM611.960	03/98 ⇨ 03/01
CLASSE C I C 200 T D	OM604.915	10/96 ⇨ 03/01
CLASSE C I C 200 T Kompressor	M111.944	11/96 ⇨ 03/01
CLASSE C I C 220	M111.961	03/93 ⇨ 05/00
CLASSE C I C 220 CDI	OM611.960	09/97 ⇨ 05/00
CLASSE C I C 220 D	OM604.910, OM604.910	08/93 ⇨ 05/00
CLASSE C I C 220 T CDI	OM611.960	09/97 ⇨ 03/01
CLASSE C I C 220 T D	OM604.910, OM611.962	06/96 ⇨ 09/98
CLASSE C I C 230 Kompressor	M111.975	10/95 ⇨ 05/00
CLASSE C I C 230 T Kompressor	M111.975	06/97 ⇨ 09/00
CLASSE C I C 250 D	OM605.910	05/93 ⇨ 05/00
CLASSE C I C 250 T Turbo-D	OM605.960	06/96 ⇨ 03/01
CLASSE C I C 250 Turbo-D	OM605.960	10/95 ⇨ 05/00
CLASSE C I C 280	M104.941	05/93 ⇨ 05/00
CLASSE C I C 36 AMG	M104.941(AMG3.6)	05/94 ⇨ 05/00
CLASSE C II C 160 Kompressor	M271.921	05/02 ⇨ 05/08
CLASSE C II C 180 Kompressor	M271.946	05/02 ⇨ 05/08
CLASSE C II C 200 CDI	OM611.962, OM611.962	09/00 ⇨
CLASSE C II C 200 CGI Kompressor	M271.942	03/03 ⇨ 05/08
CLASSE C II C 200 Kompressor	M271.940	05/02 ⇨ 05/08
CLASSE C II C 220	M271.948	05/02 ⇨ 05/08
CLASSE C II C 220 CDI	OM611.962, M271.820	05/00 ⇨ 05/08
CLASSE C II C 230 Kompressor	M271.948	05/02 ⇨ 05/08
CLASSE C II C 270 CDI	OM612.962	12/00 ⇨ 08/07
CLASSE C II C 30 CDI AMG	OM612.990	09/02 ⇨ 05/08
CLASSE C II C 32 AMG Kompressor	M112.961	02/01 ⇨ 08/07
CLASSE C II C 320 CDI	OM642.910	01/05 ⇨ 08/07
CLASSE C III C 180	M271.820	06/11 ⇨
CLASSE C III C 180 CDI	OM651.913	01/11 ⇨ 08/14
CLASSE C III C 180 CGI	M271.820, M271.820	01/07 ⇨ 08/14
CLASSE C III C 180 Kompressor	M271.820, OM646.811	01/07 ⇨ 08/14
CLASSE C III C 200	M271.820	05/11 ⇨ 01/14
CLASSE C III C 200 CDI	OM646.811, M271.820	01/07 ⇨ 08/14
CLASSE C III C 200 CGI	M271.820, M271.820	01/07 ⇨
CLASSE C III C 200 Kompressor	M271.820, OM646.811	01/07 ⇨ 08/14
CLASSE C III C 220 CDI	OM646.811, OM642.830	01/07 ⇨

MERCEDES-BENZ		
CLASSE C III C 220 CDI 4-matic	OM651.912	02/13 ⇨ 08/14
CLASSE C III C 250	M271.860	06/11 ⇨
CLASSE C III C 250 CDI	OM651.911	08/08 ⇨
CLASSE C III C 250 CDI 4-matic	OM651.912	04/10 ⇨ 08/14
CLASSE C III C 250 CGI	M271.860	07/09 ⇨ 08/14
CLASSE C III C 300 CDI 4-matic	OM642.832	01/11 ⇨ 01/14
CLASSE C III C 320 CDI	OM642.960	01/07 ⇨ 08/14
CLASSE C III C 320 CDI 4-matic	OM642.961	07/07 ⇨ 01/14
CLASSE C III C 350 CDI	OM642.830, OM642.832	08/07 ⇨ 08/14
CLASSE C III C 350 CDI 4-matic	OM642.832, --	08/07 ⇨ 08/14
CLASSE C III C 63 AMG	--, --	02/08 ⇨
CLASSE C III C 63 AMG DR 520	--, OM651.921	07/10 ⇨ 01/14
CLASSE C IV C 180 d	OM654.916	05/18 ⇨
CLASSE C IV C 200 d	OM651.921, OM651.921	10/15 ⇨
CLASSE C IV C 220 BlueTEC / d	OM651.921, OM651.921	12/13 ⇨
CLASSE C IV C 220 d	OM651.921, OM651.921	10/15 ⇨
CLASSE C IV C 220 d 4-matic	OM651.921, OM651.930	04/15 ⇨
CLASSE C IV C 250 BlueTEC / d	OM651.921	02/14 ⇨
CLASSE C IV C 250 BlueTEC / d 4-matic	OM651.921	02/14 ⇨
CLASSE C IV C 250 d	OM651.921	10/15 ⇨
CLASSE C IV C 250 d 4-matic	OM651.921	04/16 ⇨
CLASSE C IV C 300 BlueTEC Hybrid / h	OM651.921	05/14 ⇨
CLASSE C IV C 300 d	OM654.920	06/18 ⇨
CLASSE C IV C 300 d 4-matic	OM654.920	06/18 ⇨
CLASSE C IV C300 D [ExtraEU]	OM654.920	06/18 ⇨
CLASSE CLA CLA 200 CDI	OM651.901	06/13 ⇨
CLASSE CLA CLA 200 CDI / d	OM651.930	07/14 ⇨
CLASSE CLA CLA 200 CDI / d 4-matic	OM651.930	07/14 ⇨
CLASSE CLA CLA 220 CDI / d	OM651.930, OM651.930	01/13 ⇨
CLASSE CLA CLA 220 CDI / d 4-matic	OM651.930, M271.911	08/14 ⇨
CLASSE CLA CLA 220 CDI 4-matic	OM651.930	07/14 ⇨
CLASSE CLA CLA 220 d	OM651.930	07/18 ⇨
CLASSE CLA CLA 220 d 4-matic	OM651.930	07/18 ⇨
CLASSE CLC CLC 160	M271.911, M271.940	02/09 ⇨ 06/11
CLASSE CLC CLC 180 Kompressor	M271.940, OM646.962	05/08 ⇨ 06/11
CLASSE CLC CLC 200 CDI	OM646.962, M271.940	05/08 ⇨ 06/11
CLASSE CLC CLC 200 Kompressor	M271.957	05/08 ⇨ 06/11
CLASSE CLC CLC 220 CDI	OM646.963	05/08 ⇨ 06/11
CLASSE CLK I 200 Kompressor	M111.944	06/97 ⇨ 06/00
CLASSE CLK I 230 Kompressor	M111.975	06/97 ⇨ 06/00
CLASSE CLK II 200 CGI	M271.942	07/03 ⇨ 05/09
CLASSE CLK II 200 Kompressor	M271.940, OM612.962	09/02 ⇨ 05/09
CLASSE CLK II 220 CDI	OM646.966	01/05 ⇨ 05/09
CLASSE CLK II 270 CDI	OM612.962, M156.982	10/02 ⇨ 05/09
CLASSE CLK II 320 CDI	OM642.910	01/05 ⇨ 05/09
CLASSE CLK II 63 AMG	M156.982, M271.940	04/06 ⇨ 05/09
CLASSE CLK II CLK 200 CGI	M271.942	07/03 ⇨ 03/10
CLASSE CLK II CLK 200 Kompressor	M271.940, OM642.852	02/03 ⇨ 03/10
CLASSE CLK II CLK 320 CDI	OM642.910	03/05 ⇨ 03/10
CLASSE CLK II CLK 63 AMG	M156.982	04/06 ⇨ 03/10
CLASSE CLS I CLS 320 CDI	OM642.920	01/05 ⇨ 12/10
CLASSE CLS I CLS 350 CDI	OM642.920	04/09 ⇨ 12/10
CLASSE CLS I CLS 55 AMG	M113.990	01/05 ⇨ 12/10
CLASSE CLS I CLS 63 AMG	M156.983	04/06 ⇨ 12/10
CLASSE CLS II CLS 220 BlueTEC / d	OM651.924	05/14 ⇨
CLASSE CLS II CLS 250 BlueTEC / d 4-matic	OM651.924	05/14 ⇨
CLASSE CLS II CLS 250 CDI / BlueTEC / d	OM651.924	04/11 ⇨
CLASSE CLS II CLS 300 d	OM654.920	04/18 ⇨
CLASSE CLS II CLS 350 BlueTEC	OM642.852	05/14 ⇨
CLASSE CLS II CLS 350 BlueTEC / d	OM642.852, OM642.854	11/12 ⇨
CLASSE CLS II CLS 350 BlueTEC / d 4-matic	OM642.854, OM642.854	11/12 ⇨
CLASSE CLS II CLS 350 BlueTEC 4-matic	OM642.854	01/13 ⇨
CLASSE CLS II CLS 350 CDI / d 4-matic	OM642.853	01/11 ⇨
CLASSE CLS II CLS 350 CDI / d 4-matic	OM642.854	09/11 ⇨
CLASSE CLS II CLS 350 d	OM656.929	08/18 ⇨
CLASSE CLS II CLS 350 d 4-matic	OM642.854, OM611.961	04/15 ⇨

MERCEDES-BENZ			MERCEDES-BENZ			MERCEDES-BENZ		
CLASSE CLS II CLS 400 d 4-matic	OM656.929	12/17 →	CLASSE E IV E 250 CDI / BlueTEC / d	OM651.911	01/09 →	CLASSE M II ML 450 CDI 4-matic	OM629.912	09/09 → 12/11
CLASSE E I E 200	M111.940	06/93 → 03/98	CLASSE E IV E 250 CDI / BlueTEC 4-matic	OM651.924	01/09 →	CLASSE M II ML 63 AMG 4-matic	M156.980	01/06 → 12/11
CLASSE E I E 200 T	M111.940	06/93 → 06/96	CLASSE E IV E 250 CGI	M271.860	01/09 →	CLASSE M III ML 250 CDI / BlueTEC 4-matic	OM651.960	06/11 → 12/15
CLASSE E I E 220	M111.960	06/93 → 03/98	CLASSE E IV E 300 BlueTEC	OM642.852	03/11 →	CLASSE M III ML 350 BlueTEC 4-matic	OM642.826	06/11 → 02/15
CLASSE E I E 220 T	M111.960	06/93 → 06/96	CLASSE E IV E 300 CDI	OM642.850, OM642.850	12/09 →	CLASSE M III ML 350 CDI BlueEfficiency 4-matic	OM642.826	02/12 →
CLASSE E I E 280	M104.942	06/93 → 06/95	CLASSE E IV E 300 CDI / BlueTEC	OM642.850, OM642.838	11/09 →	CLASSE R R 280 CDI	OM642.870, OM642.870	05/06 →
CLASSE E I E 280 T	M104.942	06/93 → 06/96	CLASSE E IV E 300 Hybrid / BlueTEC Hybrid	OM651.924	12/11 →	CLASSE R R 280 CDI 4-matic	OM642.950	05/06 →
CLASSE E I E 320	M104.992	06/93 → 03/98	CLASSE E IV E 350 BlueTEC	OM642.838, OM642.852	01/09 →	CLASSE R R 300 CDI	OM642.870, OM642.870	07/09 →
CLASSE E I E 320 T	M104.992	06/93 → 06/96	CLASSE E IV E 350 BlueTEC / d	OM642.838	05/14 →	CLASSE R R 300 CDI 4-matic	OM642.950	07/09 →
CLASSE E I E 36 AMG	M104.992(AMG3.6), OM611.961	06/93 → 03/98	CLASSE E IV E 350 BlueTEC 4-matic	OM642.852, OM642.836	11/12 →	CLASSE R R 320 CDI 4-matic	OM642.870, OM642.870	01/06 →
CLASSE E I E 36 T AMG	M104.992(AMG3.6)	05/94 → 06/96	CLASSE E IV E 350 BlueTEC / d	OM642.838	05/14 →	CLASSE R R 350 CDI 4-matic	OM642.870, OM613.960	01/06 →
CLASSE E II E 200	M111.942	06/95 → 08/00	CLASSE E IV E 350 CDI	OM642.836, OM642.856	01/09 →	CLASSE R R 63 AMG 4-matic	M156.980	02/06 →
CLASSE E II E 200 CDI	OM611.961, M111.947	06/98 → 03/02	CLASSE E IV E 350 CDI 4-matic	OM642.856, OM654.916	09/09 →	CLASSE S III 300 SE 2.8	M104.944	01/93 → 10/98
CLASSE E II E 200 D	OM604.917	01/96 → 03/02	CLASSE E IV E 63 AMG	M156.985	08/09 →	CLASSE S III 300 SE, SEL/S320	M104.994	03/91 → 10/98
CLASSE E II E 200 Kompressor	M111.957	08/00 → 03/02	CLASSE E V E 200 d	OM654.916, OM642.855	07/16 →	CLASSE S III 400 SE, SEL/S420	M119.981	01/93 → 09/98
CLASSE E II E 200 T	M111.942	06/96 → 08/00	CLASSE E V E 220 d	OM654.920	01/16 →	CLASSE S III 600 SE, SEL	M120.982	04/91 → 12/92
CLASSE E II E 200 T Kompressor	M111.947, OM611.961	08/00 → 03/03	CLASSE E V E 220 d 4-matic	OM654.920	10/16 →	CLASSE S III S 280	M104.944	02/93 → 10/98
CLASSE E II E 220 CDI	OM611.961, OM604.912	06/98 → 07/99	CLASSE E V E 220 d 4-matic	OM654.920	10/16 →	CLASSE S III S 300 Turbo-D	OM606.961	05/96 → 10/98
CLASSE E II E 220 D	OM604.912, OM611.961	06/95 → 07/99	CLASSE E V E 300 d	OM654.920	12/17 →	CLASSE S III S 500	M119.980	01/93 → 10/98
CLASSE E II E 220 T	OM611.961, OM612.961	06/98 → 07/99	CLASSE E V E 300 de	OM654.920	10/18 →	CLASSE S III S 600	M120.982	01/93 → 09/99
CLASSE E II E 230	M111.970	06/95 → 06/97	CLASSE E V E 350 d	OM642.855, OM612.963	01/16 →	CLASSE S III SEC/CL 420	M119.981	10/94 → 02/99
CLASSE E II E 230 T	M111.970	06/96 → 06/97	CLASSE E V E 350 d 4-matic	OM642.873	06/17 →	CLASSE S III SEC/CL 600	M120.982	09/92 → 02/99
CLASSE E II E 250 D	OM605.912	06/95 → 07/99	CLASSE E V E 400 d	OM656.929	12/18 →	CLASSE S IV CL 55 AMG Kompressor	M113.991	06/02 → 03/06
CLASSE E II E 250 D	OM605.912	06/96 → 07/99	CLASSE E V E 400 d 4-matic	OM656.929	04/18 →	CLASSE S IV S 320 CDI	M275.950	09/02 → 03/06
CLASSE E II E 250 Turbo-D	OM605.962	06/97 → 07/99	CLASSE E V E 420 CDI	OM611.961, OM612.961	07/99 → 07/09	CLASSE S IV S 400 CDI	OM613.960, OM628.960	09/02 → 08/05
CLASSE E II E 250 Turbo-D	OM605.962	06/97 → 07/99	CLASSE E E 250 d	OM605.912	06/96 → 06/98	CLASSE S IV S 400 CDI	OM628.960, M275.982	06/00 → 08/05
CLASSE E II E 270 CDI	OM612.961	07/99 → 03/02	CLASSE E E 270 CDI	OM612.961, M104.992(AMG3.6)	07/99 → 07/09	CLASSE S IV S 55 AMG Kompressor	M113.991	06/02 → 08/05
CLASSE E II E 270 T CDI	OM612.961, M119.980	02/00 → 03/03	CLASSE E E 280 CDI	OM642.920	08/05 → 07/09	CLASSE S IV S 600	M275.950	09/02 → 08/05
CLASSE E II E 280	M104.945	01/96 → 06/97	CLASSE G II 320 GE	M104.996	09/94 → 11/97	CLASSE S IV S 65 AMG	M275.980	03/04 → 08/05
CLASSE E II E 290 Turbo-D	OM602.982	06/96 → 07/99	CLASSE G II G 270 CDI	OM612.963, M113.993	01/01 →	CLASSE S V CL 600	M275.953	05/06 → 12/13
CLASSE E II E 290 Turbo-D	OM602.982	03/96 → 07/99	CLASSE G II G 280 CDI	OM642.975	04/09 →	CLASSE S V CL 63 AMG	M156.984	10/06 → 12/13
CLASSE E II E 300 D	OM606.912	06/95 → 06/97	CLASSE G II G 290 TD	OM602.983	07/97 →	CLASSE S V CL 65 AMG	M275.982, OM642.930	10/06 → 12/13
CLASSE E II E 300 Turbo-D	OM606.962	12/96 → 07/99	CLASSE G II G 300 CDI	OM642.884	01/10 →	CLASSE S V S 250 CDI	OM651.961	01/11 → 12/13
CLASSE E II E 300 Turbo-D	OM606.962	12/96 → 07/99	CLASSE G II G 300 TD	OM606.964	08/96 → 07/00	CLASSE S V S 320 CDI	OM642.930, OM642.932	10/05 → 12/13
CLASSE E II E 320	M104.995	06/95 → 06/97	CLASSE G II G 320	M104.996	09/94 → 12/97	CLASSE S V S 320 CDI 4-matic	OM642.932, OM642.932	10/05 → 12/13
CLASSE E II E 320 CDI	OM613.961	07/99 → 03/02	CLASSE G II G 320 CDI	OM642.970	09/06 →	CLASSE S V S 350 BlueTec	OM642.862	04/11 → 12/13
CLASSE E II E 320 T CDI	OM613.961	07/99 → 03/03	CLASSE G II G 350 BlueTEC	OM642.970	07/09 →	CLASSE S V S 350 BlueTEC 4-matic	OM642.868	04/11 → 12/13
CLASSE E II E 36 AMG	M104995AMG	04/96 → 01/98	CLASSE G II G 350 CDI	OM642.886	07/11 →	CLASSE S V S 350 CDI	OM642.930	06/09 → 12/13
CLASSE E II E 420	M119.980, M119.980	01/96 → 06/97	CLASSE G II G 360 CDI	M104.996(AMG3.6)	01/95 → 07/98	CLASSE S V S 350 CDI 4-matic	OM642.932, M275.982	01/09 → 07/13
CLASSE E II E 420 T	M119.985	06/96 → 06/97	CLASSE G II G 350 AMG	M104.996(AMG3.6)	01/95 → 07/98	CLASSE S V S 420 CDI	OM629.911	10/06 → 12/09
CLASSE E II E 50 AMG	M119.980, OM646.820	02/96 → 08/97	CLASSE G II G 400 CDI	OM628.962	12/00 →	CLASSE S V S 450 CDI	OM629.911	01/09 → 12/13
CLASSE E III E 200 CDI	OM646.820, M271.941	07/02 → 07/09	CLASSE G II G 55 AMG	M113.993, OM642.822	06/04 →	CLASSE S V S 600	M275.953	12/05 → 12/13
CLASSE E III E 200 Kompressor	M271.941, 271941NGT	11/02 → 07/09	CLASSE G II G 65 AMG	M279.982	05/12 →	CLASSE S V S 63 AMG	M156.984	10/06 → 12/13
CLASSE E III E 200 NGT	271941NGT, OM646.821	03/04 → 12/08	CLASSE GL I GL 320 CDI / 350 BlueTEC 4-matic	OM642.820	12/09 →	CLASSE S V S 65 AMG	M275.982, OM656.929	12/05 → 12/13
CLASSE E III E 200 T Kompressor	M271.941	03/03 → 07/09	CLASSE GL I GL 320 CDI 4-matic	OM642.940	09/06 → 05/09	CLASSE S V S350 Cdi [ExtraEU]	OM642.930	06/09 → 12/13
CLASSE E III E 220 CDI	OM646.821, OM646.821	03/02 → 07/09	CLASSE GL I GL 320 CDI BlueTEC 4-matic	OM642.820	12/09 →	CLASSE S VI AMG S 65	M279.980	04/16 →
CLASSE E III E 220 T CDI	OM646.821, OM642.920	03/03 → 07/09	CLASSE GL I GL 350 CDI 4-matic	OM642.822, OM642.824	05/09 →	CLASSE S VI S 300 BlueTEC Hybrid / h	OM651.921	02/14 →
CLASSE E III E 270 CDI	OM647.961	03/02 → 12/08	CLASSE GL I GL 420 CDI 4-matic	OM629.912	09/06 → 05/09	CLASSE S VI S 350 BlueTEC / d	OM642.861	05/13 →
CLASSE E III E 270 T CDI	OM647.961	03/03 → 07/09	CLASSE GL I GL 450 CDI 4-matic	OM629.912	05/09 →	CLASSE S VI S 350 BlueTEC / d 4-matic	OM642.867	02/14 →
CLASSE E III E 280 CDI	OM642.920, OM642.920	05/04 → 12/08	CLASSE GL II GL 350 CDI / BlueTEC 4-matic	OM642.826	07/12 → 10/15	CLASSE S VI S 350 CDI	OM642.861	05/13 →
CLASSE E III E 280 CDI 4-matic	OM642.921	03/05 → 12/08	CLASSE GLA GLA 220 d	OM651.930	07/15 →	CLASSE S VI S 350 d	OM656.929	07/17 →
CLASSE E III E 280 T CDI	OM642.920, OM642.920	05/04 → 07/09	CLASSE GLA GLA 220 d 4-matic	OM651.930	07/15 →	CLASSE S VI S 350 d 4-matic	OM656.929, M113.992	05/17 →
CLASSE E III E 280 T CDI 4-matic	OM642.921	03/05 → 07/09	CLASSE GLC 220 d 4-matic	OM651.921	06/15 →	CLASSE S VI S 400 d	OM656.929	07/17 →
CLASSE E III E 300 BlueTEC	OM642.920	09/07 → 12/08	CLASSE GLC 250 d 4-matic	OM651.921	06/15 →	CLASSE S VI S 400 d 4-matic	OM656.929	05/17 →
CLASSE E III E 320 CDI	OM642.920, OM642.920	11/02 → 12/08	CLASSE GLC 350 d 4-matic	OM642.873	10/16 →	CLASSE S VI S 600	M277.980	02/14 →
CLASSE E III E 320 CDI 4-matic	OM642.921	03/05 → 12/08	CLASSE GLE 250 d	OM651.960	04/15 →	CLASSE S VI S 600 Maybach	M277.980	12/14 →
CLASSE E III E 320 T CDI	OM642.920, M271.820	03/03 → 07/09	CLASSE GLE 250 d 4-matic	OM651.960	04/15 →	CLASSE S VI S 65 AMG	M279.980	02/14 →
CLASSE E III E 320 T CDI 4-matic	OM642.921	03/05 → 07/09	CLASSE GLE 350 d 4-matic	OM642.824, OM651.913	03/15 →	CLASSE S VI S 650 Maybach	M279.980	07/17 →
CLASSE E III E 400 CDI	OM628.961	02/03 → 12/08	CLASSE GLK 200 CDI	OM651.913, OM642.832	07/10 → 06/15	CLASSE SL IV 280	M104.943	08/93 → 10/01
CLASSE E III E 420 CDI	OM629.910	01/06 → 12/08	CLASSE GLK 220 CDI	OM651.916	12/08 → 06/15	CLASSE SL IV 320	M104.991	09/93 → 10/01
CLASSE E III E 55 AMG Kompressor	M113.990	10/02 → 12/08	CLASSE GLK 220 CDI 4-matic	OM651.912	12/08 → 06/15	CLASSE SL IV 500	M119.982	09/92 → 10/01
CLASSE E III E 55 T AMG Kompressor	M113.990	07/03 → 07/09	CLASSE GLK 250 CDI 4-matic	OM651.912	09/09 → 06/15	CLASSE SL IV 600	M120.983	07/92 → 10/01
CLASSE E III E 63 AMG	M156.983	03/06 → 07/09	CLASSE GLK 320 CDI 4-matic	OM642.961	06/08 → 06/15	CLASSE SL IV 600 SL	M120.983	02/92 → 08/94
CLASSE E IV E 200 CDI / BlueTEC	OM651.925	01/09 →	CLASSE GLK 350 CDI 4-matic	OM642.832, OM642.826	07/09 →	CLASSE SL V 55 AMG	M113.992, M275.951	10/01 → 01/12
CLASSE E IV E 200 CGI	M271.820, 271958NGT	08/09 →	CLASSE GLS 350 d 4-matic	OM642.826, OM642.820	11/15 →	CLASSE SL V 55 AMG Kompressor	M113.992	06/02 → 01/12
CLASSE E IV E 200 NGT	271958NGT, OM642.850	03/11 →	CLASSE M I ML 270 CDI	OM612.963	12/99 → 06/05	CLASSE SL V 600	M275.951, M271.944	04/03 → 01/12
CLASSE E IV E 220 BlueTEC	OM651.911	05/14 →	CLASSE M I ML 400 CDI	OM628.963	09/01 → 06/05	CLASSE SL V 63 AMG	M156.981	03/08 → 01/12
CLASSE E IV E 220 BlueTEC 4-matic	OM651.924	12/14 →	CLASSE M II ML 280 CDI 4-matic	OM642.940	07/05 → 07/09	CLASSE SL V 65 AMG	M275.981	03/04 → 01/12
CLASSE E IV E 220 CDI	OM651.911	01/09 →	CLASSE M II ML 300 CDI 4-matic	OM642.820, OM642.820	07/09 → 12/11	CLASSE SL V 65 AMG Black Series	M275.983	07/08 → 01/12
CLASSE E IV E 220 CDI / BlueTEC	OM651.924	01/09 →	CLASSE M II ML 320 CDI 4-matic	OM642.820, OM642.820	07/05 →	CLASSE SL VI 65 AMG	M279.981	05/12 →
CLASSE E IV E 220 CDI / BlueTEC / d	OM651.911	01/10 →	CLASSE M II ML 350 CDI 4-matic	OM642.820, OM642.870	07/09 → 12/11	CLASSE SLC 250 d	OM651.980	01/16 → 10/17
CLASSE E IV E 220 CDI / d	OM651.911	01/10 →	CLASSE M II ML 420 CDI 4-matic	OM629.912	02/06 → 09/09	CLASSE SLK I 32 AMG Kompressor	M112.960	03/01 → 04/04
CLASSE E IV E 250 BlueTEC	OM651.911	01/09 →				CLASSE SLK II 200 Kompressor	M271.944, M111.978	03/04 → 02/11
CLASSE E IV E 250 CDI / BlueTEC	OM651.924	01/09 →						

MERCEDES-BENZ		
CLASSE SLK III 200	M271.861	02/11 →
CLASSE SLK III 250	M271.861	02/11 →
CLASSE SLK III 250 CDI / d	OM651.980	01/12 →
CLASSE X X 350 d 4-matic	OM642.889	07/18 →
CLK-SERIES CLK363 AMG Black Series	M156.982	05/07 → 05/09
CLS-SERIES CLS350 BlueTEC	OM642.852	05/14 → 12/17
COUPE 220 CE	M111.960	10/92 → 05/93
COUPE 320 CE	M104.992	10/92 → 05/93
C-SERIES C160 Kompressor	M271.921	06/02 → 07/06
C-SERIES C200 CDI	OM651.913	01/10 → 01/14
C-SERIES C300 CDI/CDi BlueEFFICIENCY	OM642.832	01/11 → 01/14
GLE GLE 300 d 4-matic	OM654.920	10/18 →
GLE GLE 350 d 4-matic	OM656.929	12/18 →
GLE GLE 400 d 4-matic	OM656.929	12/18 →
GLE-SERIES GLE350	OM642.824, M155.980	04/15 →
KOMBI II 200 TE	M111.940	05/86 → 06/93
KOMBI II 220 TE	M111.960	10/92 → 05/93
KOMBI II 280 TE	M104.942	10/92 → 06/93
KOMBI II 320 TE	M104.992	10/92 → 06/93
ML-SERIES ML350 -/BlueTEC [ExtraEU]	OM642.826	06/11 → 02/15
SLR McLAREN 5.4	M155.980, M159.980	04/04 →
SLR McLAREN 5.4 722 Edition	M155.980	10/06 →
SLR-SERIES SLR McLaren Kompressor Stirling Moss	M155.980	06/09 → 12/11
SLS AMG 6.2	M159.980, OM651.950	03/10 →
SLS AMG 6.2 GT	M159.980	06/13 →
SPRINTER I 208 CDI	OM611.987	04/00 → 05/06
SPRINTER I 208 D	OM601.943, OM601.943	01/95 → 04/00
SPRINTER I 210 D	OM602.980	01/97 → 04/00
SPRINTER I 211 CDI	OM611.981	04/00 → 05/06
SPRINTER I 212 D	OM602.980	02/95 → 04/00
SPRINTER I 213 CDI	OM611.981	04/00 → 05/06
SPRINTER I 216 CDI	OM612.981	04/00 → 05/06
SPRINTER I 308 CDI	OM611.987	04/00 → 05/06
SPRINTER I 308 D	OM601.943, OM601.943	02/95 → 04/00
SPRINTER I 308 D 4x4	OM601.943	06/97 → 12/99
SPRINTER I 308 D 2.3	OM601.943, OM646.985	02/95 → 04/00
SPRINTER I 310 D	OM602.980	01/97 → 12/99
SPRINTER I 311 CDI	OM611.981	04/00 → 05/06
SPRINTER I 311 CDI 4x4	OM611.981	08/02 → 05/06
SPRINTER I 312 D 2.9	OM602.980	12/98 → 09/01
SPRINTER I 313 CDI	OM611.981	04/00 → 05/06
SPRINTER I 313 CDI 4x4	OM611.981	08/02 → 05/06
SPRINTER I 316 CDI	OM612.981	04/00 → 05/06
SPRINTER I 316 CDI 4x4	OM612.981	08/02 → 05/06
SPRINTER I 408 CDI	OM611.987	04/00 → 05/06
SPRINTER I 408 D	OM601.943	02/96 → 05/06
SPRINTER I 408 D 4x4	OM601.943	06/97 → 12/99
SPRINTER I 410 D	OM602.980	02/96 → 05/06
SPRINTER I 410 D 4x4	OM602.980	05/97 → 05/06
SPRINTER I 411 CDI	OM611.981	04/00 → 05/06
SPRINTER I 411 CDI 4x4	OM611.981	04/00 → 05/06
SPRINTER I 412 D	OM602.980	02/96 → 05/06
SPRINTER I 412 D 4x4	OM602.980	05/97 → 05/06
SPRINTER I 413 CDI	OM611.981	04/00 → 05/06
SPRINTER I 413 CDI 4x4	OM611.981	04/00 → 05/06
SPRINTER I 416 CDI	OM612.981	04/00 → 05/06
SPRINTER I 416 CDI 4x4	OM612.981	04/00 → 05/06
SPRINTER I 616 CDI	OM612.981	04/01 →
SPRINTER II 209 CDI	OM646.984	06/06 → 12/09
SPRINTER II 210 CDI	OM651.955	03/09 →
SPRINTER II 211 CDI	OM646.985, OM646.986	06/06 →
SPRINTER II 213 CDI	OM646.986, OM646.986	06/06 →
SPRINTER II 214 CDI	OM651.955	04/16 →
SPRINTER II 215 CDI	OM646.986, OM651.955	06/06 → 12/09
SPRINTER II 216	M271.951	09/08 →
SPRINTER II 216 CDI	OM651.955, OM642.896	06/06 →
SPRINTER II 218 CDI	OM642.896, OM642.896	06/06 → 12/09
SPRINTER II 219 CDI / BlueTEC	OM642.896, OM651.955	03/09 →
SPRINTER II 309 CDI	OM646.984	06/06 → 12/09
SPRINTER II 310 CDI	OM651.955, OM646.701	03/09 →
SPRINTER II 311 CDI	OM646.701, OM646.986	06/06 →
SPRINTER II 311 CDI 4x4	OM646.985	02/08 → 12/09
SPRINTER II 313 CDI	OM646.986, OM651.955	06/06 →
SPRINTER II 313 CDI 4x4	OM651.955, OM646.986	06/06 →
SPRINTER II 314 CDI	OM651.955	05/16 →
SPRINTER II 314 CDI 4x4	OM651.955	05/16 →
SPRINTER II 315 CDI	OM646.986, OM646.986	06/06 → 12/09
SPRINTER II 315 CDI 4x4	OM646.986, OM651.955	02/08 → 12/09
SPRINTER II 316	M271.951	09/08 →
SPRINTER II 316 CDI	OM651.955, OM651.955	03/09 →
SPRINTER II 316 CDI 4x4	OM651.955, 271951NGT	03/09 →
SPRINTER II 316 LGT	M271.951	09/08 →
SPRINTER II 316 NGT	271951NGT, OM642.896	09/08 →

MERCEDES-BENZ		
SPRINTER II 318 CDI	OM642.896, OM642.896	06/06 → 12/09
SPRINTER II 318 CDI 4x4	OM642.896, OM642.896	02/08 → 12/09
SPRINTER II 319 CDI / BlueTEC	OM642.896, OM642.896	03/09 →
SPRINTER II 319 CDI / BlueTEC 4x4	OM642.896, OM646.986	03/09 →
SPRINTER II 411 CDI	OM646.701	06/09 →
SPRINTER II 413 CDI	OM646.986, OM646.986	06/06 →
SPRINTER II 414 CDI	OM651.955	05/16 →
SPRINTER II 415 CDI	OM646.986, OM642.896	06/06 → 12/09
SPRINTER II 416 CDI	OM651.957	03/09 →
SPRINTER II 418 CDI	OM642.896, OM642.896	06/06 → 05/16
SPRINTER II 419 CDI	OM642.896, OM646.985	03/09 →
SPRINTER II 509 CDI	OM646.984	06/06 → 12/09
SPRINTER II 510 CDI	OM651.955	03/09 →
SPRINTER II 511 CDI	OM642.896, OM646.986	06/06 →
SPRINTER II 511 CDI 4x4	OM646.985	06/06 → 12/09
SPRINTER II 513 CDI	OM646.986, OM651.955	06/06 →
SPRINTER II 513 CDI 4x4	OM651.955, OM646.986	06/06 →
SPRINTER II 514 CDI	OM651.955	05/16 →
SPRINTER II 514 CDI 4x4	OM651.955	05/16 →
SPRINTER II 515 CDI	OM646.986, OM646.986	06/06 → 12/09
SPRINTER II 515 CDI 4x4	OM646.986, OM651.955	06/06 → 12/09
SPRINTER II 516	M271.951	09/08 →
SPRINTER II 516 CDI	OM651.955, OM651.955	03/09 →
SPRINTER II 516 CDI 4x4	OM651.955, 271951NGT	06/06 →
SPRINTER II 516 NGT	271951NGT, OM642.896	09/08 →
SPRINTER II 518 CDI	OM642.896, OM642.896	06/06 → 12/09
SPRINTER II 518 CDI 4x4	OM642.896, OM642.896	06/06 → 12/09
SPRINTER II 519 CDI / BlueTEC	OM642.896, OM642.896	03/09 →
SPRINTER II 519 CDI / BlueTEC 4x4	OM642.896, OM646.981	03/09 →
SPRINTER 211 CDI	OM651.950, OM651.950	02/18 →
SPRINTER 214 CdI	OM651.950, OM651.950	02/18 →
SPRINTER 311 CDI	OM651.950, OM651.950	02/18 →
SPRINTER 314 CDI	OM651.950, OM651.950	02/18 →
SPRINTER 316 CDI	OM651.958	02/18 →
SPRINTER 319 CDI	OM642.899	02/18 →
SPRINTER 411 CDI	OM651.950, OM651.950	02/18 →
SPRINTER 414 CDI	OM651.950, OM601.943	02/18 →
SPRINTER 416 CDI	OM651.958	02/18 →
SPRINTER 419 CDI	OM642.899	02/18 →
SPRINTER 511 CDI	OM651.958	02/18 →
SPRINTER 514 CDI	OM651.958	02/18 →
SPRINTER 516 CDI	OM651.958	02/18 →
SPRINTER 519 CDI	OM642.899	02/18 →
SPRINTER SERIES Sprinter 213D CdI	OM646.986	04/12 →
SPRINTER SERIES Sprinter 411D CdI/CDi BlueEFFICIENCY	OM651.955	04/16 →
SPRINTER SERIES Sprinter 414D CdI	OM651.955	04/16 →
SPRINTER SERIES Sprinter 416D CdI	OM651.957	11/13 →
SPRINTER SERIES Sprinter 516 NGT Supercharged	271951NGT	03/09 →
SPRINTER SERIES Sprinter 516 Supercharged	M271.951	03/09 →
SPRINTER SERIES Sprinter 519D CdI	OM651.957	03/09 →
TRE VOLUMI II 200 E	M111.940	10/92 → 06/93
TRE VOLUMI II 220 E	M111.960	10/92 → 06/93
TRE VOLUMI II 280 E	M104.942	10/92 → 06/93
TRE VOLUMI II 320 E	M104.992	10/92 → 06/93
VANEO 1.6	M166.961	02/02 → 07/05
VANEO 1.7 CDI	OM668.914	02/02 → 07/05
VANEO 1.9	M166.991	02/02 → 07/05
VIANO CDI 2.0	OM646.981, OM646.982	09/03 →
VIANO CDI 2.0 4-matic	OM646.982, OM646.980	07/05 →
VIANO CDI 2.2	OM646.980, OM646.982	09/03 →
VIANO CDI 2.2 4-matic	OM646.982, OM642.890	07/05 →
VIANO CDI 3.0	OM642.890, OM611.980	03/06 →
VITO I 108 CDI 2.2	OM611.980, OM611.980	03/99 → 07/03
VITO I 110 CDI 2.2	OM611.980, OM646.980	03/99 → 07/03
VITO I 112 CDI 2.2	OM611.980	03/99 → 07/03
VITO II 109 CDI	OM646.980, OM646.980	09/03 →
VITO II 109 CDI 4x4	OM646.981	09/07 →
VITO II 110 CDI	OM651.940	09/10 →
VITO II 111 CDI	OM646.980, OM646.980	09/03 →
VITO II 111 CDI 4x4	OM646.982	09/07 →
VITO II 113 CDI	OM651.940	09/10 →
VITO II 113 CDI 4x4	OM651.940	09/10 →
VITO II 115 CDI	OM646.980, M160E-6ALB03	09/03 →
VITO II 115 CDI 4x4	OM646.982	07/06 →
VITO II 116 CDI	OM651.940	09/10 →
VITO II 116 CDI 4x4	OM651.940	09/10 →
VITO II 120 CDI	OM642.990	07/06 →

MERCEDES-BENZ		
VITO II 122 CDI	OM642.890	09/10 →
VITO III 114 CDI	OM651.950	10/14 →
VITO III 114 CDI 4x4	OM651.950	07/15 →
VITO III 116 CDI	OM651.950	10/14 →
VITO III 116 CDI / 116 BlueTEC	OM651.950	10/14 →
VITO III 116 CDI / 116 BlueTEC 4x4	OM651.950	07/15 →
VITO III 116 CDI 4x4	OM651.950	07/15 →
VITO III 119 BlueTEC	OM651.950	10/14 →
VITO III 119 BlueTEC 4x4	OM651.950	12/14 →
VITO III 119 CDI / 119 BlueTEC 4x4	OM651.950	12/14 →
VITO III 119 CDI / BlueTEC	OM651.950	10/14 →
VITO III 119 CDI / BlueTEC 4x4	OM651.950	07/15 →
VITO-SERIES Vito 114 BlueTEC/CDi/CDi BlueEFFICIENCY	OM651.950	10/14 →
VITO-SERIES Vito 200 CdI BlueEFFICIENCY	OM651.950	03/15 →
VITO-SERIES Vito 200 CdI/CDi BlueEFFICIENCY	OM651.950	03/15 →
MITSUBISHI		
COLT VI 1.5 Di-D	OM639.939	08/04 → 06/12
PUCH		
G-MODELL 290 GD Turbo-diesel	OM602.983	04/97 → 12/01
G-MODELL G 300 Turbodiesel	OM606.964	01/96 → 11/00
G-MODELL G 320	M104.996	02/94 → 12/97
G-MODELL G 36 AMG	M104.952(AMG3, 6)	01/95 → 04/98
SMART		
CABRIO 0.6	M160E6ALB03, M160.910	03/00 → 01/04
CABRIO 0.7	M160.910, OM660DE8LA	01/03 → 01/04
CABRIO 0.8 CDI	OM660DE8LA, M160E-6ALB03	03/01 → 01/04
CITY-COUPE 0.6	M160E6ALB03, M160.910	01/01 → 01/04
CITY-COUPE 0.7	M160.910, OM660DE8LA	01/03 → 01/04
CITY-COUPE 0.8 CDI	OM660DE8LA, M160.910	11/99 → 01/04
CITY COUPE 0.6	M160.910	12/99 → 04/03
CROSSBLADE 0.6	M160.910, M160.910	06/02 → 12/03
FORFOUR 1.5 CDI	OM639.939	09/04 → 06/06
FORTWO I 0.6	M160.910	01/04 → 02/07
FORTWO I 0.7	M160.910, OM660DE8LA	01/04 → 01/07
FORTWO I 0.8 CDI	OM660DE8LA, OM660.950	01/04 → 01/07
FORTWO II 0.8 CdI	OM660.950, M160.921	01/07 →
FORTWO 0.6 [ExtraEU]	M160.910	01/04 → 12/06
ROADSTER 0.7	M160.921, E32	04/03 → 11/05
ROADSTER 0.7 Brabus	M160.923	12/03 → 11/05
SSANGYONG		
ACTYON II 2.0	G20DF	08/12 →
ACTYON II 2.0 4x4	G20DF	08/12 →
KORANDO 2.0	G20D	02/12 →
KORANDO 2.0 4WD	G20D	02/12 →
KORANDO 2.0 e-XGi	G20D	02/12 →
KORANDO 2.0 e-XGi [ExtraEU]	G20D	02/12 →
KORANDO 3.2	E32, B12S1	12/96 → 11/02
VW		
LT II 2.3	AGL	05/96 → 07/06

10.4015



1

AIR TEMPERATURE SENSORS

Adatt./Suitable:

CHEVROLET

96253552
96279856

DAEWOO

96253552
96279856

GENERAL MOTORS

96 279 856

RENAULT

77 00 737 572

VOLVO

30865366

MARKET DIFFUSION: MEDIUM

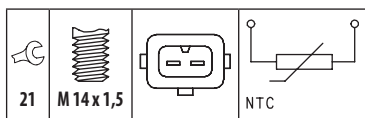

CHEVROLET

AVEO I 1.2	B12S1, LDA	01/04 ⇨
KALOS 1.2 LPG	LY4	01/05 ⇨ 05/08
LACETTI 1.4	F14D3	03/05 ⇨
LACETTI 1.4 16V	L14(85CUL4)	03/05 ⇨
LACETTI 1.4 LPG	L14(85CUL4)	01/05 ⇨ 12/12
LACETTI 1.6	LXT	03/05 ⇨
LACETTI 1.6 LPG	LXT	06/09 ⇨ 12/11
LACETTI 1.8	LDA, LBF(49CUL3)	05/03 ⇨
MATIZ 0.8	LBF(49CUL3), B10S	03/05 ⇨ 12/13
MATIZ 1.0	B10S, LA2	03/05 ⇨
MATIZ 1.0 LPG	LA2, L14(85CUL4)	03/05 ⇨ 03/11
NUBIRA 1.4	L14(85CUL4), L44(96CUL4)	01/05 ⇨ 12/08
NUBIRA 1.6	L44(96CUL4), L44(96CUL4)	03/05 ⇨
NUBIRA 1.6 LPG	L44(96CUL4), F16D3	03/05 ⇨ 12/10
OPTRA 1.4 16V	F14D3	03/05 ⇨
OPTRA 1.6	F16D3, L44(96CUL4)	08/03 ⇨ 12/08
OPTRA 1.6 SRV	F16D3	06/06 ⇨
REZZO 1.6	L44(96CUL4), LBF(49CUL3)	03/05 ⇨
SPARK I 0.8	F8CV	09/00 ⇨ 12/04
SPARK I 1.0	G10CV	11/02 ⇨ 12/04
SPARK II 0.8	LBF(49CUL3), B10S	05/05 ⇨ 02/10
SPARK II 1.0 LPG	B10S	05/05 ⇨
SPARK II 1.0 SX	B10S, B12S1	05/05 ⇨
TACUMA 1.6	A16DMS	02/05 ⇨
VIVANT 1.6	A16DMS	08/01 ⇨
VIVANT 1.8	F18S2	05/00 ⇨

DAEWOO

KALOS 1.2	B12S1, F14D3	04/03 ⇨
LACETTI 1.4	F14D3, F8CV	06/02 ⇨
LACETTI 1.6	A16DMS	06/99 ⇨
MATIZ 0.8	F8CV, B10S	08/98 ⇨
MATIZ 1.0	B10S, A16DMS	01/03 ⇨
NUBIRA I 1.6	A16DMS	08/02 ⇨ 07/03
NUBIRA I 1.6 [ExtraEU]	A16DMS	08/02 ⇨ 07/03
NUBIRA I 1.6 16V	A16DMS	06/99 ⇨
NUBIRA II 1.4	F14D3	10/03 ⇨ 12/04
NUBIRA II 1.6	F16D3	07/03 ⇨
REZZO 1.6	A16DMS, A16SMS	09/00 ⇨
REZZO 1.6 SX	A16SMS, --	08/01 ⇨ 12/04
REZZO 1.8	--, F7P700	09/00 ⇨
TACUMA 1.6	A16DMS	09/00 ⇨ 01/05
TACUMA 1.8	F18S2	09/00 ⇨

RENAULT

19 I 1.8 16V	F7P700, F7P704	06/89 ⇨ 09/92
19 II 1.4	E7J706	01/92 ⇨ 12/95
19 II 1.8 16V	F7P704, J7R740	04/92 ⇨ 06/96
21 2.0	J7R740	02/90 ⇨ 06/94
21 2.0 4x4	J7R740	12/89 ⇨ 02/94
21 2.0 Turbo	J7R752	04/87 ⇨ 03/90
21 2.0 Turbo 4x4	J7R752	08/89 ⇨ 10/93
21 2.0 TXi	J7R740, J7R720	07/89 ⇨ 05/93
25 2.0 12V	J7R720, Z7W700	06/88 ⇨ 12/93
25 2.8 V6	Z7W700, Z7W706	06/87 ⇨ 02/90

RENAULT

25 2.8 V6 Injection	Z7W706, Z7W712	06/87 ⇨ 12/92
CLIO I 1.4	E7J716	01/90 ⇨ 05/94
ESPACE II 2.8 V6	Z7W712, Z7X760	01/91 ⇨ 10/96
ESPACE III 3.0	Z7X775	11/96 ⇨ 10/98
LAGUNA I 1.0	Z7X760, K7M702	11/93 ⇨ 03/01
MASTER I 2.2	J7T788	08/93 ⇨ 02/98
MASTER I 30 2,2	J7T788	08/80 ⇨ 07/98
MEGANE I 1.6 e	K7M702, K7M702	01/96 ⇨ 08/03
MEGANE I 1.6 i	K7M720	01/96 ⇨ 03/99
MEGANE I 1.6 LPG	K7M702	08/95 ⇨ 03/99
MEGANE SCÉNIC I 1.6 e	K7M702, E7J726	10/96 ⇨ 10/99
MEGANE SCÉNIC I 1.6 i	K7M720	01/97 ⇨ 09/99
MEGANE 1.6 BiFuel	K7M702	10/96 ⇨ 10/99
RAPID 1.4	E7J726, J7R732	09/91 ⇨ 03/98
SAFRANE I 2.0	J7R732, J7R734	08/92 ⇨ 09/96
SAFRANE I 2.0 12V	J7R734, J7T760	04/92 ⇨ 07/96
SAFRANE I 2.2	J7T760, Z7X721	04/92 ⇨ 07/96
SAFRANE I 3.0	Z7X723	02/93 ⇨ 06/96
SAFRANE I 3.0 Biturbo 4x4	Z7X726	02/93 ⇨ 07/96
SAFRANE I 3.0 V6	Z7X721, Z7X721	12/92 ⇨ 07/96
SAFRANE I 3.0 V6 4x4	Z7T760, Z7X755	12/92 ⇨ 07/96
SAFRANE II 2.9 24V	L7X713	03/99 ⇨ 12/00
SAFRANE II 3.0 V6	Z7X755, B4194T	07/96 ⇨ 12/00
TRAFIC I 2.2	J7T600	06/94 ⇨ 04/98
TRAFIC I 2.2 4x4	J7T600	06/94 ⇨ 04/98

VOLVO

S40 I 1.9T4	B4194T, B4204T	05/97 ⇨ 07/00
S40 I 2.0T	B4204T, B4194T	06/01 ⇨ 12/03
S40 I 2.0T4	B4204T5	07/00 ⇨ 12/03
V40 I 1.9T4	B4194T, B4204T	05/97 ⇨ 07/00
V40 I 2.0T	B4204T, AR67203	06/01 ⇨ 06/04
V40 I 2.0T4	B4204T5	07/00 ⇨ 06/04

10.4016



1

AIR TEMPERATURE SENSORS

Adatt./Suitable:

ALFA ROMEO

60806471

FIAT

500309797
60806471
7547976

FORD

1 639 284
V86HF-12A697-AA

IVECO

500309797

LANCIA

7547976

MAGNETI MARELLI

215810020901
ATS04
ATS-04/01

VV

048 906 161 1

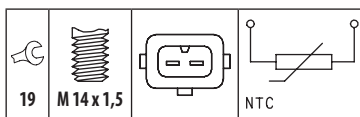

ALFA ROMEO

155 2.0 16V Turbo Q4	AR67203, 182A4.000	01/92 ⇨ 12/97
BRAVA 1.6 16V	182A4.000, 182A4.000	10/95 ⇨ 12/02
BRAVO I 1.6 16V	182A4.000, 178B3.000	10/95 ⇨ 10/01
COUPE 2.0 16V	836A3.000	11/93 ⇨ 08/96
COUPE 2.0 16V [BRA]	836A3.011	11/93 ⇨ 08/96
COUPE 2.0 16V Turbo	175A1.000	11/93 ⇨ 08/96
MAREA 1.6	185A3.000	03/99 ⇨ 08/00
MAREA 1.6 100 16V	182A4.000	09/96 ⇨ 05/02
MAREA 1.6 100 16V Bipower	185A3.000	04/99 ⇨ 05/02
MAREA 1.6 16V	185A3.000	04/97 ⇨ 02/99
MAREA 1.6 SX	182B5.098	09/00 ⇨ 08/02
PALIO 1.6	178D2.011	06/99 ⇨
PALIO 1.6 16V	178B3.000, 159A4.000	04/96 ⇨ 10/03
SIENA 1.6 16V	178B3.000	09/98 ⇨ 12/09
TEMPRA 1.8 4x4	159A4.000	07/92 ⇨ 06/93
TEMPRA 1.8 i.e.	159A4.000, 835C2.000	03/90 ⇨ 08/96

FIAT

TEMPRA 2.0	159A6.046	04/90 ⇨ 06/93
TEMPRA 2.0 i.e.	159A6.046	10/90 ⇨ 08/96
TEMPRA 2.0 i.e. [BRA]	159A6.011	04/93 ⇨ 12/96
TEMPRA 2.0 i.e. 4x4	159A6.046	03/92 ⇨ 03/95
TIPO I 1.8 i.e.	836A5.000	03/93 ⇨ 04/95
TIPO I 1.8 i.e.	835C2.000, 159A6.046	03/93 ⇨ 10/95
TIPO I 1.8 i.e. 16V Sport	160A5.000	11/89 ⇨ 06/92
TIPO I 2.0	159A6.046, 835A2.000	10/90 ⇨ 04/95
TIPO I 2.0 16V	160A8.046	07/91 ⇨ 04/95
TIPO I 2.0 i.e.	159A6.046	03/90 ⇨ 04/95
TIPO I 2.0 i.e. [BRA]	159A6.011	03/93 ⇨ 10/95
TIPO I 2.0 i.e. 16V Sport	836A3.000	03/93 ⇨ 04/95

FIAT (BR)

BRAVA 1.6i 16v	1.6Mpi	01/00 ⇨ 12/01
COUPÉ 2.0i 16V	2.0Mpi	01/95 ⇨ 12/97
PALIO 1.0i	1.0Mpi	01/96 ⇨
PALIO 1.5i	1.5Mpi	01/96 ⇨ 12/00
PALIO 1.6i	1.6Mpi	01/99 ⇨ 12/00
PALIO 1.6i 16v	1.6Mpi16v	01/96 ⇨ 12/00
SIENA 1.0i	1.0Mpi	01/99 ⇨ 12/00
SIENA 1.5i	1.5Mpi	01/99 ⇨ 12/00
SIENA 1.6i 16v	1.6Mpi	01/98 ⇨ 12/99
STRADA 1.5i	1.5Mpi	01/99 ⇨ 12/01
STRADA 1.6i 16v	1.6Mpi	01/99 ⇨
TIPO 2.0i 16V	2.0Mpi	01/94 ⇨ 12/95
TIPO 2.0i 8v	2.0Mpi	01/94 ⇨ 12/95
UNO 1.5i Furgoneta	1.5Mpi	01/97 ⇨
UNO MILLE 1.0i	1.0Mpi	01/99 ⇨

FORD

ESCORT V RS Cosworth 4x4	NSF	09/92 ⇨ 01/95
--------------------------	-----	---------------

IVECO

DAILY II 2.8 CNG	814903CNG	05/99 ⇨ 07/07
DAILY II 50 C 11 Natural Power	814903CNG	05/99 ⇨ 04/06
DAILY III 50 C 11 Natural Power	814903CNG	05/02 ⇨ 05/06
DAILY 2.8 CNG	814903CNG	07/99 ⇨ 12/06

LANCIA

DEDRA 1.8 i.e.	835A2.000, 835A5.000	09/89 ⇨ 07/99
DEDRA 2.0 16V	836A3.000	07/94 ⇨ 07/99
DEDRA 2.0 HF Integrale	835A7.046	11/90 ⇨ 07/94
DEDRA 2.0 i.e.	835A5.000, 149C2.000	09/89 ⇨ 07/99
DEDRA 2.0 i.e. Turbo	835A8.046	04/91 ⇨ 07/99
DEDRA 2.0 i.e. Turbo Integrale	835A7.000	05/90 ⇨ 07/94
DEDRA 2.0 Integrale	836A3.000	07/94 ⇨ 07/99
DEDRA 2.0 Turbo	835A8.000	11/90 ⇨ 06/94
DELTA I 1.6 GT i.e.	149C2.000, 831B3.000	08/86 ⇨ 08/92
DELTA I 1.6 HF Turbo	831B3.000, 831E5.000	08/86 ⇨ 03/89
DELTA I 2.0 16V HF Evo Integrale	831E5.000, 831B5.000	06/93 ⇨ 01/94
DELTA I 2.0 16V HF Integrale	831D5.000	03/89 ⇨ 09/91
DELTA I 2.0 HF Integrale	831B5.000, 835C2.000	11/86 ⇨ 12/92
DELTA II 1.6 i.e.	182A6.000	03/96 ⇨ 08/99
DELTA II 1.6 i.e. 16V	182A4.000	01/96 ⇨ 08/99
DELTA II 1.8 i.e.	835C2.000, 175A4.000	06/93 ⇨ 08/99
DELTA II 2.0 16V	836A3.000	06/93 ⇨ 08/99
DELTA II 2.0 16V Turbo	175A4.000, 1P25LCBD	06/93 ⇨ 08/99

VOLKSWAGEN (BR)

GOL 2.0i 16V	112	10/95 ⇨
PARATI 2.0i 16V	112	02/96 ⇨

10.4017



1

AIR TEMPERATURE SENSORS

Adatt./Suitable:

FORD
3 477 940
F5AF-12A697-AA

FORD USA
3 477 940
F5AF-12A697-AA

MAZDA
1E03-18-845

MARKET DIFFUSION: MEDIUM

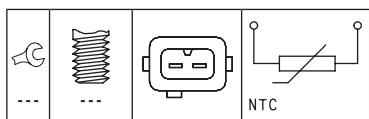

FORD		
COUGAR 2.5 ST 200	SGA	01/00 → 12/01
COUGAR 2.5 V6 24V	JP25LCBD, DHA	06/00 → 12/01
FIESTA IV 1.0 i	ZH10JRB	02/97 → 09/99
FIESTA IV 1.25 i 16V	DHA, J4C	08/95 → 01/02
FIESTA IV 1.3	J4C, J4C	02/96 → 08/03
FIESTA IV 1.3 i	J4C, FHA	08/95 → 01/02
FIESTA IV 1.4 i 16V	FHA, L1T	04/96 → 01/02
FIESTA IV 1.6 16V Sport	L1T, BHDA	02/00 → 01/02
FOCUS I 1.8 DI / TDDi	BHDA, F9DA	08/99 → 11/04
FOCUS I 1.8 TDCi	F9DA, BHDA	03/01 → 03/05
FOCUS I 1.8 TDDi	BHDA, BHDA	08/98 → 03/05
FOCUS I 1.8 Turbo DI / TDDi	BHDA, BAA	10/98 → 03/05
IKON 1.3 EFI	--	01/00 →
KA I 1.3 i	BAA, SEA	09/96 → 11/08
MONDEO I 2.5 24V	SEA, HCPA	08/96 → 09/00
MONDEO I 2.5 i 24V	SEA	07/94 → 08/96
TOURNEO CONNECT I 1.8 TDCi	HCPA, BHPA	06/02 → 12/13
TOURNEO CONNECT I 1.8 TDCi / TDDi / DI	BHPA, BHPA	06/02 → 12/13
TRANSIT CONNECT I 1.8 Di	BHPA, HCPA	06/02 → 12/13
TRANSIT CONNECT I 1.8 TDCi	HCPA, --	06/02 → 12/13
WINDSTAR 3.0 i 12V	99U	04/95 → 07/97
WINDSTAR 3.0 i 12V S	99U	08/97 →
FORD USA		
WINDSTAR 3.0 V6	--, DHF	01/95 → 02/99
MAZDA		
121 III 1.25	DHF, J4R	03/96 → 04/03
121 III 1.3	J4R, G6BA	03/96 → 04/03

10.4019



1

AIR TEMPERATURE SENSORS

Adatt./Suitable:

CHEVROLET
96508200

DAEWOO
96351837
96508200

HYUNDAI
39230-2F000
39340-24760
39340-24765
39340-26010
39340-2F000
39340-37100

KIA
0K2AB-18831
0K9BV-18831
39230-2F000
39340-24765
39340-26010
39340-2F000
39340-37100
KK371-18831

SSANGYONG
1610943248
1610943648

*1b

MARKET DIFFUSION: MEDIUM

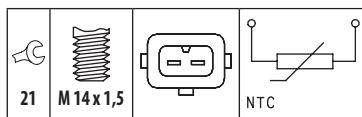

CHEVROLET		
SPARK I 0.8	F8CV	09/00 → 12/04
DAEWOO		
MATIZ 0.8	F8CV	08/98 →
HYUNDAI		
ACCENT I 1.3	G4EH	10/94 → 01/00
ACCENT I 1.3 i 12V	G4EH	10/94 → 01/00
ACCENT I 1.5	G4EK	10/94 → 07/99
ACCENT I 1.5 i 12V	G4EK	10/94 → 01/00
ACCENT I 1.5 i 16V	G4ER	10/95 → 01/00
COUPE II 2.7 V6	G6BA, D4HB	01/01 → 08/09
EXCEL 1.3 i 12V	G4EH	09/94 → 08/99
EXCEL 1.5 i 12V	G4EK	09/94 → 08/99
EXCEL 1.5 i 16V GT	G4ER	10/96 → 08/99
GRAND SANTA FE 2.2 CRDi Trazione integrale	D4HB, D4CB	06/13 →
H-1 II 2.5 CRDi	D4CB, D4BB	02/08 →
H100 2.5 CRDi	D4CB	01/04 →
H100 2.5 D	D4BF	05/96 → 12/97
H100 2.5 TCI	--	01/04 →
H100 2.5 TD	D4BF	07/93 → 03/00
H100 2.5 TDCi	D4BH	08/03 → 10/06
H100 2.5 TDiC	D4BF	06/98 → 10/03
H100 2.6 TD [ExtraEU]	D4BB, D4HA	04/96 → 12/98
H350 2.5 CRDi	D4CB	04/15 →
HIGHWAY VAN 2.7 V6 24V	G6BA	03/00 → 03/04
IX35 2.0 CRDi	D4HA, D6EA	01/10 →
IX35 2.0 CRDi 4WD	D4HA	01/10 →
IX35 3.0 V6 CRDi 4WD	D6EA, G15B	09/08 → 12/12
LANTRA II 1.5 12V	G4EK	12/96 → 10/00
PONY 1.5 i	G15B, G6BA	10/89 → 01/95
PONY / EXCEL 1.5 i	G15B, G15B	01/90 → 01/95
PORTER II 2.5 CRDi	D4CB	05/04 →
PORTER II 2.5 TCI	D4BH	05/04 →
SANTA FE I 2.7 4x4	G6BA	09/02 → 12/04
SANTA FE I 2.7 V6 4x4	G6BA, D4HB	02/01 → 03/06
SANTA FE II 2.2 CRDi	D4HB, D4HA	01/09 → 12/12
SANTA FE II 2.2 CRDi 4x4	D4HB	01/09 → 12/12
SANTA FE III 2.0 CRDi	D4HA, D4HB	09/12 →
SANTA FE III 2.0 CRDi 4WD	D4HA	09/12 →
SANTA FE III 2.2 CRDi	D4HB, D4HB	09/12 →
SANTA FE III 2.2 CRDi 4WD	D4HB, G6BV	09/12 →
SANTA FE IV 2.0 CRDi	D4HA	07/18 →
SANTA FE IV 2.0 CRDi AWD	D4HA	07/18 →
SANTA FE IV 2.0 D	D4HA	02/18 →
SANTA FE IV 2.0 D AWD	D4HA	02/18 →
SANTA FE IV 2.2 CRDi	D4HB	07/18 →
SANTA FE IV 2.2 CRDi AWD	D4HB	07/18 →

HYUNDAI		
SONATA IV 2.5 V6 24V	G6BV, G6BA	06/98 → 10/01
SONATA IV 2.7 V6	G6BA, G6BA	10/01 → 11/04
SONATA V 2.7 V6 [RUS]	--	01/05 → 12/10
TIBURON 2.7 CVT [ExtraEU]	G6BA	02/02 → 12/08
TRAJET 2.7 V6	G6BA, G6BA	09/00 → 07/08
TUCSON 2.0 CRDi	D4EA	01/09 →
TUCSON 2.0 CRDi hybrid 48V Trazione integrale	D4HA	10/18 →
TUCSON 2.0 CRDi Trazione integrale	D4EA	01/09 →
TUCSON 2.7 Trazione integrale	G6BA, T8	08/04 →
VERACRUZ 3.0 CRDi [ExtraEU]	D6EA	11/08 → 11/12
XG 250	G6AV	12/98 → 12/05

KIA		
AVELLA 1.3	B3	11/95 → 12/01
AVELLA 1.5	--	02/97 → 12/01
BONGO IV 2.5 CRDi	D4CB	01/12 →
BORREGO 3.0 CRDi 4WD	G6EN	11/07 →
CARENS I 1.8 i	T8, D4HB	11/00 → 07/02
CARENS I 1.8 i 16V	T8D	03/00 → 05/02
CARNIVAL I 2.5 V6	K5	08/99 → 06/06
CARNIVAL II 2.2 CRDi	D4HB, G4CP	01/10 →
CERATO I 1.8	T8	10/01 → 07/04
JOICE 2.0	G4CP, B3	02/00 →
K2500 2.5 CRDi	D4CB	01/10 →
MAGENTIS I 2.5 V6	G6BV	05/01 →
MOHAVE 3.0 D	--	09/08 →
PRIDE 1.3	B3A5	08/98 → 05/01
PRIDE 1.3 16V	B3, --	01/90 → 09/01
RETONA 2.0 TD	RF	06/99 →
SEDONA 2.5	--	06/98 →
SEDONA 2.5 V6	--	07/01 →
SEPHIA I 1.5 i	B5	02/96 → 10/97
SEPHIA I 1.8 i 16V	--, BFD	01/95 → 10/97
SEPHIA II 1.5 i 16V	--	09/97 →
SEPHIA II 1.8 i 16V	--	09/97 →
SHUMA I 1.5	OK280	03/96 → 12/98
SHUMA I 1.5 i 16V	BFD, T8	10/97 → 10/01
SHUMA I 1.8 i 16V	T8, T8	10/97 → 03/01
SHUMA II 1.8	T8, D4HB	05/01 → 08/04
SORENTO 2.2 CRDi [ExtraEU]	D4HB	11/09 → 12/15
SORENTO II 2.2 CRDi	D4HB	11/09 →
SORENTO II 2.2 CRDi 4WD	D4HB	11/09 →
SORENTO III 2.0 CRDi 4WD	D4HA	07/15 →
SORENTO III 2.2 CRDi	D4HB	01/15 →
SORENTO III 2.2 CRDi 4WD	D4HB, FERF	01/15 →
SPECTRA 1.5 i	--	09/97 →
SPECTRA 1.5 i 16V	--	09/97 →
SPECTRA 1.8 i 16V	--	09/97 →
SPORTAGE 2.0 CRDi [ExtraEU]	D4HA	08/12 → 12/15
SPORTAGE I 2.0	FE(16V)	10/00 → 08/03
SPORTAGE I 2.0 4WD	FE(16V)	10/00 → 08/03
SPORTAGE I 2.0 i 16V	FE(16V)	10/99 → 08/03
SPORTAGE I 2.0 TD 4WD	FERF, D4HA	10/97 → 08/03
SPORTAGE II 2.7 V6 4WD	G6BA	09/04 →
SPORTAGE III 2.0 CRDi	D4HA, D4HA	07/10 →
SPORTAGE III 2.0 CRDi AWD	D4HA, G23D	07/10 →
SPORTAGE IV 2.0 CRDi	D4HA	09/15 →
SPORTAGE IV 2.0 CRDi AWD	D4HA	09/15 →
SPORTAGE IV 2.0 CRDi Eco-Dynamics+ AWD	D4HA	06/18 →
STINGER 2.2 CRDi VGT	D4HC	06/17 →
STINGER 2.2 CRDi VGT 4WD	D4HC	06/17 →

SSANGYONG		
ACTYON I 2.3	G23D, G23D	11/06 →
ACTYON I 2.3 4WD	G23D	09/11 →
ACTYON I 2.3 4x4	G23D, DV6B	11/06 →
KYRON 2.3	E23	01/10 →
REXTON I 2.3 RX230 4x4	G23D	05/02 →

10.4021



3

AIR TEMPERATURE SENSORS

Adatt./Suitable:

CITROËN

- 1920 GF
- 1920 JL
- 1920 PJ
- 96 554 327
- 96 749 432 80

1083 Has the same colour as the original part : Green

- corrisponde al pezzo originale colorato : verde
- correspond à la pièce originale dans sa couleur : vert
- Entspricht dem Originalteil in Farbe : grün
- corresponde al color de la pieza original : verde

FIAT

9664612580

FORD

- 1 251 249
- 1 331 461
- 1 333 818
- 1 348 613
- 1 359 930
- 1 423 736
- 1 530 145
- 1 719 362
- 2 006 019
- 256Q-12A697-AC
- 3M5A-12A697-AB
- 3M5A-12A697-AC
- 3M5A-12A697-AD
- 9C11-12A697
- 9C11-12A697-AB
- 9C11-12A697-AC

FORD USA

- 1 719 362
- 9C11-12A697-AB

JAGUAR

C2Z 14371

LANCIA

9664612580

LAND ROVER

- LR003575
- LR008852
- LR032216

MAZDA

- Y404-18-845
- Y404-18-845A
- Y603-18-845A
- Y603-18-845B
- Y603-18-845C

MINI

13 62 7 794 982

MITSUBISHI

- 1525A018
- 1525A023

PEUGEOT

- 1920 GF
- 1920 JL
- 1920 PJ
- 96 749 432 80

SUZUKI

- 13650-69K01
- 13650-69K01-000

TOYOTA

- SU001-00647
- SU001-00792
- SU001-00839

VOLVO

- 30777255
- 31216702

MARKET DIFFUSION: HIGH

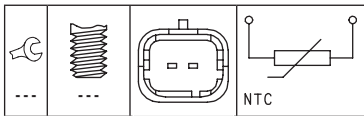

CITROËN

BERLINGO I 1.6 HDi 75	DV6B, 9HX(DV6ATED4)	07/05 ⇨ 12/11
BERLINGO I 1.6 HDi 90	9HX(DV6ATED4), 9HZ(DV6ATED4)	07/05 ⇨ 12/11
BERLINGO II 1.6 HDi 110	9HZ(DV6ATED4), 9HT(DV6ATED4)	04/08 ⇨
BERLINGO II 1.6 HDi 75	9HT(DV6ATED4), 9HT(DV6ATED4)	04/08 ⇨
BERLINGO II 1.6 HDi 75 16V	9HT(DV6ATED4), 9HX(DV6ATED4)	04/08 ⇨
BERLINGO II 1.6 HDi 90	9HX(DV6ATED4), 9HS(DV6ATED4BU)	04/08 ⇨
BERLINGO II 1.6 HDi 90 16V	9HS(DV6ATED4BU), 8HT(DV4TD)	04/08 ⇨
BERLINGO 1.6 HDi	DV6ATED4	06/08 ⇨ 12/11
C1 I 1.4 HDi	8HT(DV4TD), 8HX(DV4TD)	06/05 ⇨ 09/14
C2 1.4 HDi	8HX(DV4TD), 9HZ(DV6ATED4)	09/03 ⇨
C2 1.6 HDi	9HZ(DV6ATED4), 8HX(DV4TD)	09/05 ⇨

CITROËN

C3 I 1.4 HDi	8HX(DV4TD), 9HX(DV6ATED4)	02/02 ⇨
C3 I 1.6 16V HDi	9HX(DV6ATED4), 8HX(DV4TD)	09/05 ⇨
C3 I PLURIEL 1.4 HDi	8HX(DV4TD), 8HR(DV4C)	04/04 ⇨
C3 II 1.4 HDi	DV4C	06/10 ⇨ 09/16
C3 II 1.4 HDi 70	8HR(DV4C), DV6DTE	11/09 ⇨
C3 II 1.6 HDi	DV6DTE, 9HX(DV6ATED4)	11/09 ⇨
C3 II 1.6 HDi 90	9HX(DV6ATED4), HNV(EV2DTM)	11/09 ⇨
C3 III 1.2 THP 110	HNV(EV2DTM), 9HX(DV6ATED4)	07/16 ⇨
C3 III 1.2 VTi 82	HMZ(EV2F)	07/16 ⇨
C3 PICASSO 1.6 HDi	9HX(DV6ATED4), 9HY(DV6ATED4)	02/09 ⇨
C4 I 1.6 HDi	9HV(DV6ATED4), DW10BTE4	11/04 ⇨
C4 I 2.0 HDi	DW10BTE4, 9HY(DV6ATED4)	11/04 ⇨ 07/11
C4 GRAND PICASSO I 1.6 HDi	9HY(DV6ATED4), DW10BTE4	10/06 ⇨ 06/11
C4 GRAND PICASSO I 2.0 HDi 138	DW10BTE4, 9HY(DV6ATED4)	10/06 ⇨ 12/13
C4 PICASSO I 1.6 HDi	9HY(DV6ATED4), DW10BTE4	02/07 ⇨ 08/13
C4 PICASSO I 2.0 HDi 138	DW10BTE4, 9HY(DV6ATED4)	10/06 ⇨ 08/13
C5 I 1.6 HDi	9HY(DV6ATED4), DW10BTE4	09/04 ⇨
C5 I 2.0 HDi	DW10BTE4, 4HP(DW12BTE4)	09/04 ⇨
C5 I 2.2 HDi	4HP(DW12BTE4), 9HZ(DV6ATED4)	04/06 ⇨
C5 II 1.6 HDi 110	9HZ(DV6ATED4), DW10BTE4	02/08 ⇨
C5 II 2.0 HDi	DW10BTE4, DW10BTE4	02/08 ⇨
C5 II 2.0 HDi 140	DW10BTE4, 4HT(DW12BTE4)	04/09 ⇨
C5 II 2.2 HDi	4HT(DW12BTE4), 4HP(DW12BTE4)	02/08 ⇨
C5 II 2.2 HDi 165	4HP(DW12BTE4), 4HL(DW12C)	02/08 ⇨
C5 II 2.2 HDi 200	4HL(DW12C), 4HP(DW12BTE4)	07/10 ⇨
C6 2.2 HDi	4HP(DW12BTE4), DW10BTE4	06/06 ⇨ 12/12
C8 2.0 HDi	DW10BTE4, DW10BTE4	07/02 ⇨
C8 2.0 HDi 135	DW10BTE4, 4HP(DW12BTE4)	03/06 ⇨
C8 2.2 HDi	4HP(DW12BTE4), 4HN(DW12MTE4)	06/06 ⇨
C-CROSSER 2.2 HDi	4HN(DW12MTE4), 4HN(DW12MTE4)	02/07 ⇨
C-CROSSER ENTERPRISE 2.2 HDi	4HN(DW12MTE4), 8HR(DV4C)	01/09 ⇨
DISPATCH 1.6 HDi	DV6GTE4	06/07 ⇨ 03/16
DISPATCH 2.0 HDi	DW10BTE4	06/07 ⇨ 03/16
DS3 1.4 HDi 70	8HR(DV4C), 4HG(P22DTE)	04/10 ⇨ 07/15
JUMPER III 2.2 HDi 110	4HG(P22DTE), 4HJ(P22DTE)	07/11 ⇨
JUMPER III 2.2 HDi 130	P22DTE	07/11 ⇨
JUMPER III 2.2 HDi 150	4HJ(P22DTE), 9HU(DV6ATED4)	07/11 ⇨
JUMPY 1.6 HDi	DV6GTE4	06/07 ⇨ 03/16
JUMPY 2.0 HDi	DW10BTE4	06/07 ⇨ 03/16
JUMPY II 1.6 HDi 90 16V	9HU(DV6ATED4), DW10BTE4	01/07 ⇨
JUMPY II 2.0 HDi 120	DW10BTE4, DW10BTE4	01/07 ⇨
JUMPY II 2.0 HDi 120 4x4	RHK(DW10BTE4)	01/10 ⇨
JUMPY II 2.0 HDi 140	DW10BTE4, 8HS(DV4TED)	01/07 ⇨
JUMPY II 2.0 i	EW10A	01/07 ⇨
NEMO 1.4 HDi	8HS(DV4TED), 9HX(DV6ATED4)	02/08 ⇨
XSARA PICASSO 1.6 HDi	9HX(DV6ATED4), 9H07	05/04 ⇨

FIAT

SCUDO II 1.6 D Multijet	9H07, DW10BTE4	01/07 ⇨
SCUDO II 2.0 D Multijet	DW10BTE4, RHK	01/07 ⇨
ULYSSE II 2.0 D Multijet	RHK, 4H01	05/06 ⇨ 06/11
ULYSSE II 2.2 D Multijet	4H01, UGJC	10/07 ⇨

FORD

B-MAX 1.5 TDCi	UGJC, G8DA	10/12 ⇨
C-MAX I 1.6 TDCi	G8DA, KKDA	02/07 ⇨ 09/10
C-MAX I 1.8 TDCi	KKDA, G6DA	02/07 ⇨ 09/10
C-MAX I 2.0 TDCi	G6DA, F6JA	02/07 ⇨ 09/10
FIESTA V 1.4 TDCi	F6JA, HHJA	11/01 ⇨ 12/10
FIESTA V 1.6 TDCi	HHJA, F6JB	11/04 ⇨ 09/09
FIESTA VI 1.4 TDCi	F6JB, UGJC	01/09 ⇨
FIESTA VI 1.5 TDCi	UGJC, HHJC	09/12 ⇨
FIESTA VI 1.6 TDCi	HHJC, G8DA	06/08 ⇨
FOCUS II 1.6 TDCi	G8DA, KKDA	07/04 ⇨ 09/12
FOCUS II 1.8 TDCi	KKDA, G6DA	07/04 ⇨ 09/12
FOCUS II 2.0 TDCi	G6DA, G8DA	07/04 ⇨ 09/12
FOCUS II CASSONE / FURGONATO / PROMISCUO 1.6 TDCi	G8DA, G6DB	07/04 ⇨ 07/11

FORD

FOCUS II CASSONE / FURGONATO / PROMISCUO 2.0 TDCi	G6DB, F6JA	09/05 ⇨ 07/11
FOCUS C-MAX 1.6 TDCi	G8DA, G6DA	10/03 ⇨ 03/07
FOCUS C-MAX 1.8 TDCi	KKDA	01/05 ⇨ 03/07
FOCUS C-MAX 2.0 TDCi	G6DA, G8DA	10/03 ⇨ 03/07
FUSION 1.4 TDCi	F6JA, HHJA	08/02 ⇨ 12/12
FUSION 1.6 TDCi	HHJA, FFWA	11/04 ⇨ 12/12
GALAXY II 1.8 TDCi	FFWA, AZWA	05/06 ⇨ 06/15
GALAXY II 2.0 TDCi	AZWA, KNWA	05/06 ⇨ 06/15
GALAXY II 2.2 TDCi	KNWA, G6DG	03/08 ⇨ 06/15
KUGA I 2.0 TDCi	G6DG, G6DG	03/08 ⇨ 11/12
KUGA I 2.0 TDCi 4x4	G6DG, FFWA	03/08 ⇨ 11/12
MONDEO III 1.8 TDCi	FFBA, AZBC	03/07 ⇨ 01/15
MONDEO III 2.0 TDCi	AZBC, KNBA	11/07 ⇨ 01/15
MONDEO III 2.2 TDCi	KNBA, --	03/08 ⇨ 01/15
MONDEO 2.0 TDCi	KLBA	11/07 ⇨ 09/14
MONDEO 2.2 TDCi	KNBA	03/13 ⇨ 09/14
RANGER VI 2.2 TDCi	--, --	04/11 ⇨
RANGER VI 2.2 TDCi 4x4	--, SA2R	04/11 ⇨
RANGER VI 3.2 TDCi 4x4	SA2R, FFWA	04/11 ⇨
S-MAX I 1.8 TDCi	FFWA, AZWA	05/06 ⇨ 12/14
S-MAX I 2.0 TDCi	AZWA, KNWA	05/06 ⇨ 12/14
S-MAX I 2.2 TDCi	KNWA, UGCA	03/08 ⇨ 12/14
TOURNEO COURIER 1.5 TDCi	UGCA, CVFF	02/14 ⇨
TOURNEO CUSTOM 2.2 TDCi	CVFF, CVFA	04/12 ⇨
TRANSIT III 2.2 TDCi	CYFA, CYRB	10/07 ⇨ 08/14
TRANSIT III 2.2 TDCi 4x4	CYRB, CVRA	10/11 ⇨ 08/14
TRANSIT III 2.2 TDCi RWD	CVRA, PHFA	09/11 ⇨
TRANSIT III 2.4 TDCi	PHFA, PHFA	04/06 ⇨ 08/14
TRANSIT III 2.4 TDCi RWD	PHFA, --	04/06 ⇨ 08/14
TRANSIT IV 2.2 TDCi	--, CV24	08/13 ⇨
TRANSIT IV 2.2 TDCi 4x4	CV24, CV24	08/13 ⇨
TRANSIT IV 2.2 TDCi RWD	CV24, CYFA	08/13 ⇨
TRANSIT 2.2 TDCi	CVFA, UGCA	10/11 ⇨ 08/14
TRANSIT COURIER 1.5 TDCi	UGCA, CVFF	02/14 ⇨
TRANSIT CUSTOM 2.2 TDCi	CVFF, CVFA	04/12 ⇨
TRANSIT TOURNEO 2.2	CVFA, PGFA	10/11 ⇨ 08/14
TRANSIT TOURNEO 2.2 TDCi	PGFA, 224DT	10/07 ⇨ 08/14

JAGUAR

XF 2.2 D	224DT, 4HS	04/11 ⇨ 04/15
----------	------------	---------------

LANCIA

PHEDRA 2.0 D Multijet	RHR(DW10BTE4)	07/06 ⇨ 11/10
PHEDRA 2.0 JTD	RHK(DW10BTE4)	06/06 ⇨ 11/10
PHEDRA 2.2 D Multijet	4HS, DT224	03/08 ⇨ 11/10
PHEDRA 2.2 JTD	4H01	03/08 ⇨

LAND ROVER

DEFENDER 2.2 Td4 4x4	DT224, DT244	08/11 ⇨ 02/16
DEFENDER 2.4 TD4 [ExtraEU]	DT244	05/07 ⇨
DEFENDER 2.4 Td4 4x4	DT244, 224DT	05/07 ⇨ 02/16
FREELANDER 2.2.2 eD4	224DT, 224DT	08/10 ⇨ 10/14
FREELANDER 2.2.2 SD4 4x4	224DT	08/10 ⇨ 10/14
FREELANDER 2.2.2 TD4 4x4	224DT, Y406	10/06 ⇨ 10/14

MAZDA

2 II 1.4 MZR-CD	Y404	01/08 ⇨ 06/15
2 II 1.6 MZ-CD	Y406, Y601	10/08 ⇨ 06/15
3 I 1.6 DI Turbo	Y601, Y601	06/04 ⇨ 06/09
3 I 1.6 MZ-CD	Y406	06/06 ⇨ 12/09
3 II 1.6 MZR CD	Y601, 9HZ	12/08 ⇨ 05/13

MINI

MINI II Cooper D	9HZ, 9HZ	11/06 ⇨ 09/10
MINI II One D	9HZ, 4HK	06/09 ⇨ 07/10

MITSUBISHI

OUTLANDER II 2.2 DI-D 4WD	4HK, 8HX(DV4TD)	08/07 ⇨ 11/12
---------------------------	-----------------	---------------

PEUGEOT

107 1.4 HDi	8HT(DV4TD), 8HR(DV4C)	06/05 ⇨ 05/14
206 1.4 HDi	8HX(DV4TD), 8HX(DV4TD)	09/01 ⇨
206 1.4 HDi eco 70	8HX(DV4TD), 9HY(DV6ATED4)	09/01 ⇨
206 1.6 HDi 110	9HY(DV6ATED4), 8HX(DV4TD)	05/04 ⇨
206+ 1.4 HDi	DV4C	06/10 ⇨
206+ 1.4 HDi eco 70	8HX(DV4TD), 8HR(DV4C)	01/09 ⇨
207 1.4 HDi	8HR(DV4C), 9HV(DV6ATED4)	02/06 ⇨
207 1.6 HDi	9HV(DV6ATED4), 9HZ(DV6ATED4)	02/06 ⇨
207 CC 1.6 HDi	9HZ(DV6ATED4), 8HP(DV4C)	02/07 ⇨
208 1.4 HDi	8HP(DV4C), 9HZ(DV6ATED4)	03/12 ⇨
307 1.6 HDi	9HV(DV6ATED4), 9HY(DV6ATED4)	04/05 ⇨ 03/09
307 1.6 HDi 110	9HY(DV6ATED4), 9HV(DV6ATED4)	02/04 ⇨ 03/09
307 1.6 HDi 90	9HV(DV6ATED4), DW10BTE4	12/06 ⇨ 04/08
307 2.0 HDi	DW10BTE4	04/04 ⇨ 11/07
307 2.0 HDi 135	DW10BTE4, 9HV(DV6ATED4)	10/03 ⇨ 04/09
308 I 1.6 HDi	9HV(DV6ATED4), DW10BTE4	09/07 ⇨

PEUGEOT		
308 I 2.0 HDi	DW10BTEd4, 4HK(DW12MTEd4)	09/07 →
407 1.6 HDi	DV6TEd4	08/04 → 12/10
407 1.6 HDi 110	9HZ(DV6TEd4), DW10BTEd4	05/04 →
407 2.0 HDi	DW10BTEd4, DW10BTEd4	11/04 →
407 2.0 HDi [ExtraEU]	DW10BTEd4	11/04 → 10/07
407 2.0 HDi 135	DW10BTEd4, 4HP(DW12BTEd4)	05/04 →
407 2.2 HDi	4HP(DW12BTEd4), 4HR(DW12BTEd4)	03/06 →
407 2.2 HDi 170	4HR(DW12BTEd4), 9HZ(DV6TEd4)	05/06 →
508 I 2.0 HDi	DW10BTEd4, 4HL(DW12C)	11/10 →
508 I 2.2 HDi	4HL(DW12C), DW10BTEd4	11/10 →
607 2.0 HDi	DW10BTEd4, 4HP(DW12BTEd4)	09/05 → 07/11
607 2.0 HDi 135	RHL(DW10BTEd4)	09/05 →
607 2.2 HDi	4HP(DW12BTEd4), DW10UTEd4	05/06 →
807 2.0 HDi	DW10UTEd4, 4HT(DW12BTEd4)	02/06 →
807 2.2 HDi	4HT(DW12BTEd4), 8HS(DV4TEd)	06/06 →
1007 1.4 HDi	8HX(DV4TD), 9HZ(DV6TEd4)	04/05 →
1007 1.6 HDi	9HZ(DV6TEd4), 8HT(DV4TD)	06/07 →
2008 1.4 HDi	8HR(DV4C), 8HX(DV4TD)	06/13 →
3008 1.6 HDi	9HZ(DV6TEd4), 9HV(DV6ATEd4)	06/09 → 08/16
4007 2.2 HDi	4HK(DW12MTEd4), 9HZ(DV6TEd4)	02/07 →
5008 1.6 HDi	9HZ(DV6TEd4), DW10BTEd4	09/09 →
BIPPER 1.4 HDi	8HS(DV4TEd)	02/08 →
BIPPER TEPEE 1.4 HDi	8HS(DV4TEd), 4HG(P22DTE)	04/08 →
BOXER II 2.2 HDi 110	4HG(P22DTE), 4HH(P22DTE)	03/11 →
BOXER II 2.2 HDi 130	4HH(P22DTE), 4HJ(P22DTE)	03/11 →
BOXER II 2.2 HDi 150	4HJ(P22DTE), 9HU(DV6UTEd4)	03/11 →
EXPERT II 1.6 HDi 90 16V	9HU(DV6UTEd4), DW10UTEd4	01/07 →
EXPERT II 2.0 HDi 120	DW10UTEd4, DW10BTEd4	01/07 →
EXPERT II 2.0 HDi 120 4x4	RHK(DW10UTEd4)	01/10 →
EXPERT II 2.0 HDi 140	DW10BTEd4, 9HU(DV6UTEd4)	01/07 →
EXPERT II TEPEE 1.6 HDi 90 16V	9HU(DV6UTEd4), DW10UTEd4	01/07 →
EXPERT II TEPEE 2.0 HDi 120	DW10UTEd4, DW10BTEd4	01/07 →
EXPERT II TEPEE 2.0 HDi 120 4x4	RHK(DW10UTEd4)	01/07 →
EXPERT II TEPEE 2.0 HDi 140	DW10BTEd4, DV6AUTEd4	01/07 →
PARTNER 1.6 HDi	DV6AUTEd4, 9HW(DV6BTEd4)	08/05 →
PARTNER I 1.6 HDi 75	9HW(DV6BTEd4), 9HX(DV6ATEd4)	02/06 →
PARTNER I 1.6 HDi 90	9HX(DV6ATEd4), 9HT(DV6BTEd4)	10/05 → 12/15
PARTNER II 1.6 HDi	9HT(DV6BTEd4), 9HS(DV6TEd4BU)	04/08 →
PARTNER II 1.6 HDi 16V	9HS(DV6TEd4BU), 9HS(DV6TEd4BU)	04/08 →
PARTNER II 1.6 HDi 16V 4x4	9HS(DV6TEd4BU), 9HT(DV6BTEd4)	04/12 →
PARTNER II TEPEE 1.6 HDi	9HT(DV6BTEd4), 9HV(DV6TEd4)	04/08 →
PARTNER II TEPEE 1.6 HDi 16V	9HV(DV6TEd4), D4164T	04/08 →
RANCH 1.6 HDi 75	DV6B	02/06 →
RANCH 1.6 HDi 90	9HX(DV6ATEd4)	02/06 →

SUZUKI		
SX4 I 1.6 DDIS	9HX	04/07 →

TOYOTA		
AYGO I 1.4 HDi	2WZ-TV	07/05 → 08/10

VOLVO		
C30 1.6 D	D4164T	10/06 → 12/12
C30 1.6 D2	D4162T	10/10 → 12/12
C30 2.0 D	D4204T	10/06 → 12/12
C70 II 2.0 D	D4204T	01/08 → 10/09
S40 II 1.6 D	D4164T	01/05 → 12/12
S40 II 2.0 CDI	D4204T2	07/05 → 12/06
S40 II 2.0 D	D4204T	01/04 → 12/10
S40 II 2.0 D4	D4204T2	07/05 → 12/12
S80 II 1.6 D DRIVe	D4164T	01/10 → 12/11
S80 II 2.0 TDi	D4204T	02/08 → 03/11
V50 1.6 D	D4164T, 1CD-FTV	01/05 → 12/12
V50 2.0 CDI	D4204T2	12/03 → 12/06
V50 2.0 D	D4204T	04/04 → 12/10
V50 2.0 D4	D4204T2	07/05 → 12/06
V70 III 1.6 D	D4164T	07/09 → 12/11
V70 III 2.0 D	D4204T	10/07 → 12/15

10.4024



1

AIR TEMPERATURE SENSORS

Adatt./Suitable:

LEXUS
89424-60010
SUBARU
89424-60010
TOYOTA
89424-28020
89424-60010

MARKET DIFFUSION: HIGH

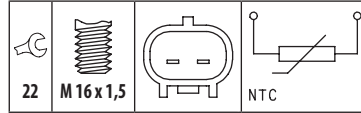
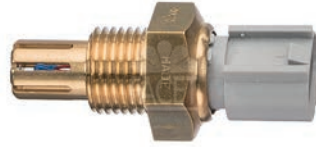

LEXUS		
IS II 200d	2AD-FTV	07/10 → 07/12
IS II 220d	2AD-FHV	08/05 → 07/12
LX 450d	1VD-FTV	09/15 →

SUBARU		
TREZIA 1.4 D	1ND-TV	03/11 →

TOYOTA		
AURIS I 1.4 D-4D	1ND-TV	03/07 → 04/13
AURIS I 2.0 D-4D	1AD-FTV	03/07 → 09/12
AURIS I 2.2 D	2AD-FHV	11/06 → 09/12
AURIS II 1.4 D-4D	1ND-TV	10/12 →
AURIS II 2.0 D-4D	1AD-FTV	10/12 →
AVENSIS 2.0 TD [ExtraEU]	2C-T	10/97 → 05/98
AVENSIS I 2.0 D	1CD-FTV, 1CD-FTV	10/97 → 02/03
AVENSIS I 2.0 D-4D	1CD-FTV, 1AD-FTV	10/99 → 02/03
AVENSIS I 2.0 TD	2C-TE	09/97 → 02/03
AVENSIS II 2.0 D	1CD-FTV	08/01 → 08/05
AVENSIS II 2.0 D-4D	1AD-FTV, 1AD-FTV	04/03 → 11/08
AVENSIS II 2.2 D-4D	2AD-FTV	10/05 → 11/08
AVENSIS II 2.2 D-CAT	2AD-FHV	07/05 → 11/08
AVENSIS III 1.8	2ZR-FAE	02/09 →
AVENSIS III 2.0 D-4D	1AD-FTV, 2AD-FHV	11/08 →
AVENSIS III 2.2 D-4D	2AD-FHV, 1CD-FTV	11/08 →
COROLLA VIII 2.0 D-4D	1CD-FTV, 1KD-FTV	08/00 → 01/02
COROLLA IX 2.0 D4d	1CD-FTV	09/00 → 10/01
COROLLA IX 2.0 D-4D	1CD-FTV, 1CD-FTV	01/02 → 07/07
COROLLA X 1.4 D-4D	1ND-TV	10/06 → 07/14
COROLLA X 2.0 D-4D	1AD-FTV	11/06 → 07/14
COROLLA XI 1.4 D-4D	1ND-TV	06/13 →
COROLLA VERSO I 2.0 D-4D	1CD-FTV, 2AD-FHV	09/01 → 07/04
COROLLA VERSO II 2.0 D-4D	1CD-FTV	04/04 → 03/09
COROLLA VERSO II 2.2 D-4D	2AD-FHV, 1CD-FTV	10/05 → 03/09
DYNA 100 3.0 D4d	1KD-FTV, 2KD-FTV	10/09 →
DYNA 2.5 D4d	2KD-FTV, 1KD-FTV	07/01 →
DYNA 3.0 D4d	1KD-FTV, N04C-TQ	08/01 →
DYNA 3.0 D4d 4WD	1KD-FTV	09/06 →
DYNA 4.0 D4d	N04C-TQ, N04C-UL	08/01 →
DYNA 4.0 D4d 4WD	N04C-UL, 2KD-FTV	10/06 →
DYNA 4.0 Hybrid	N04C-UL	05/11 →
DYNA 4.1 TDi [ExtraEU]	15B-FTE	10/04 → 01/07
DYNA 400 4.1 TDi	15B-FTE	11/02 → 12/06
FORTUNER 2.8 [ExtraEU]	1GD-FTV	05/15 →
FORTUNER 2.8 D 4x4	1GD-FTV	05/15 →
HIACE 3.0 [ExtraEU]	1KD-FTV	11/08 →
HIACE IV 2.5 D-4D	2KD-FTV, 2KD-FTV	11/01 →
HIACE IV 2.5 D-4D 4WD	2KD-FTV, 1KD-FTV	08/01 →
HIACE IV 3.0 [ExtraEU]	1KD-FTV	05/10 →
HIACE IV 3.0 D	1KD-FTV, 2KD-FTV	08/04 →
HILUX 2.5 D4d	2KD-FTV	11/01 → 07/05
HILUX VI 2.5 D-4D 4WD	2KD-FTV	11/01 → 07/05
HILUX VII 2.5 D 4WD	2KD-FTV	08/05 → 05/15
HILUX VII 2.5 D-4D	2KD-FTV, 2KD-FTV	08/05 →
HILUX VII 2.5 D-4D 4WD	2KD-FTV, 1KD-FTV	12/07 →
HILUX VII 3.0 D	1KD-FTV, 1KD-FTV	11/04 →
HILUX VII 3.0 D 4WD	1KD-FTV, 1KD-FTV	02/05 →
HILUX VII 3.0 D-4D 4WD	1KD-FTV, 2GD-FTV	08/05 → 05/15
HILUX VIII 2.4 D	2GD-FTV	05/15 →
HILUX VIII 2.4 D 4WD	2GD-FTV, 1KD-FTV	05/15 →
HILUX VIII 2.8 D	1GD-FTV	05/15 →
HILUX VIII 2.8 D 4WD	1GD-FTV	05/15 →

TOYOTA		
IPSUM 2.2 TD	3C-TE	01/97 → 05/01
IQ 1.4 D-4D	1ND-TV	01/09 → 12/15
LAND CRUISER 90 3.0 D-4D 4WD	1KD-FTV	08/00 → 08/02
LAND CRUISER 90 3.0 TD	1KZ-TE	04/96 → 12/02
LAND CRUISER 120 3.0 D-4D	1KD-FTV, 1KD-FTV	09/02 → 12/10
LAND CRUISER 200 4.5 D V8	1VD-FTV	01/08 →
LAND CRUISER 200 4.5 D-4D	1VD-FTV	01/08 →
LAND CRUISER 200 4.5 D4-D	1VD-FTV, 1KD-FTV	08/07 →
LAND CRUISER 150 2.8 D-4D	1GD-FTV	06/15 →
LAND CRUISER 150 3.0 D-4D	1KD-FTV, 1VD-FTV	08/09 →
LAND CRUISER PRADO 120 3.0 D-4D	1KD-FTV, 2AD-FHV	09/02 → 08/09
LAND CRUISER PRADO 150 3.0 D-4D	1KD-FTV	08/09 →
LAND CRUISER VAN 3.0 D4d 4WD	1KD-FTV	01/11 →
PICNIC I 2.2 D	3C-TE	08/97 → 12/01
PREVIA II 2.0 D-4D	1CD-FTV	03/01 → 01/06
RAV 4 II 2.0 D 4WD	1CD-FTV	05/01 → 11/05
RAV 4 IV 2.0 D	1AD-FTV	12/12 →
RAV 4 IV 2.0 D 4WD	1AD-FTV	01/13 →
RAV 4 IV 2.2 D 4WD	2AD-FHV, 1AD-FTV	12/12 →
RAV 4 III 2.2 D	2AD-FHV, 2AD-FHV	12/08 → 06/13
RAV 4 III 2.2 D 4WD	2AD-FHV, 2AD-FHV	11/05 → 06/13
TARAGO MPV / SPACE 2.0 TDi	1CD-FTV	10/03 → 12/05
URBAN CRUISER 1.4 D-4D	1ND-TV	01/09 → 04/14
URBAN CRUISER 1.4 D-4D 4WD	1ND-TV	01/09 → 04/14
VERSO 2.0 D-4D	1AD-FTV, M50B20(206S1)	04/09 →
VERSO 2.2 D-4D	2AD-FHV	04/09 →
VERSO 2.2 D-CAT	2AD-FHV	04/09 →
VERSO S 1.4 D4-D	1ND-TV	11/10 → 10/16
YARIS II 1.4 D-4D	1ND-TV	08/05 → 12/12
YARIS III 1.4 D	1ND-TV	09/11 →
YARIS 1.4 D4d	1ND-TV	07/14 →

10.4027



3

AIR TEMPERATURE SENSORS

Adatt./Suitable:

BMW
13 62 1 739 510
LAND ROVER
1739510
NNK000020

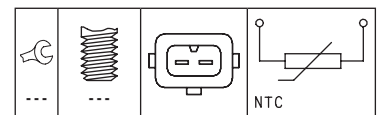

BMW		
3 III 318 is	M44B19(19451)	09/95 → 04/99
3 III 318 tds	M41D17(174T1)	03/94 → 05/01
3 III 318 ti	M44B19(19451)	07/95 → 08/00
3 III 320 i	M50B20(206S1), M52B25(256S3)	09/90 → 10/99
3 III 323 i	M52B25(256S3)	03/95 → 10/99
3 III 323 i 2.5	M52B25(256S3)	03/95 → 02/98
3 III 323 ti	M52B25(256S3), M52B20(206S4)	06/97 → 09/00
3 III 328 i	M52B28(286S1)	08/94 → 12/99
3 IV 320 Ci	M52B20(206S4), M52B20(206S4)	01/00 → 12/07
3 IV 320 i	M52B20(206S4), M52B25(256S4)	09/00 → 02/05
3 IV 323 Ci	M52B25(256S4), -246S3)	04/99 → 09/00
3 IV 323 i	-246S3), M54B25(256S5)	03/98 → 12/03
3 IV 325 Ci	M54B25(256S5), -246S4)	09/00 → 12/07
3 IV 325 i	-246S4), M54B25(256S5)	09/00 →
3 IV 325 ti	M54B25(256S5), M54B25(256S5)	06/01 → 02/05
3 IV 325 xi	M54B25(256S5), M52B28(286S2)	09/00 → 02/05
3 IV 328 Ci	M52B28(286S2), M52B28(286S2)	04/99 → 06/00
3 IV 328 i	M52B28(286S2), M54B30(306S3)	02/98 → 06/00

BMW		
3 IV 330 Ci	M54830(30653), M54830(30653)	06/00 → 12/07
3 IV 330 i	M54830(30653), M54830(30653)	06/00 → 04/05
3 IV 330 xi	M54830(30653), M54832(32654)	06/00 → 07/06
3 IV M3	M54832(32654), M52820(20653)	06/03 → 07/06
5 IV 520 i	M52820(20653), M52825(25653)	09/00 → 05/04
5 IV 523 i	M52825(25653), M54825(25655)	11/95 → 09/00
5 IV 525 i	M54825(25655), M52828(28651)	09/00 → 05/04
5 IV 528 i	M52828(28651), M54830(30653)	11/95 → 09/00
5 IV 530 i	M54830(30653), M62B35(35851)	09/00 → 05/04
5 IV 535 i	M62B35(35851), M62B44(44851)	04/96 → 03/99
5 IV 540 i	M62B44(44851), M52828(28651)	04/96 → 05/04
7 III 728 i, iL	M52828(28651), M62B44(44851)	08/95 → 11/01
7 III 728i X	M52828(28651)	11/95 → 09/01
7 III 735 i, iL	M62B35(35851)	01/96 → 12/98
7 III 740 i, iL	M62B44(44851), M54825(25655)	01/96 → 11/01
8 850 Ci	M73B54(54121)	09/94 → 12/99
X3 I 2.5 i	M54825(25655), M54830(30653)	01/04 → 08/06
X3 I 3.0 i xDrive	M54830(30653), M54830(30653)	01/04 → 08/06
X5 I 3.0 i	M54830(30653), M44819(19451)	05/00 → 12/06
Z3 I 1.9 i	M44819(19451), M52820(20654)	10/95 → 03/99
Z3 2.0 i	M52820(20654), M54822(22651)	04/99 → 01/03
Z3 2.2 i	M54822(22651), M52828(28651)	08/00 → 01/03
Z3 2.8 i	M52828(28651), M54830(30653)	01/96 → 07/00
Z3 3.0 i	M54830(30653), B37D15A	06/00 → 06/03

LAND ROVER		
DEFENDER 2.8 90, 110	--	09/00 →
FREELANDER 2.5 V6 4x4	25KV6	11/00 → 10/06

BMW		
2 216 d	B37C15A	03/14 →
2 218 d	B47C20A, B47C20A	11/13 →
2 218 d xDrive	B47C20A, B47C20A	12/14 →
2 220 d	B47C20A, B47C20A	10/12 →
2 220 d xDrive	B47C20A, N47D20A	03/14 →
2 225 d	N47D20D	01/14 →
3 V 316 d	N47D20C	09/09 → 06/12
3 V 320 d	N47D20A, N47D20C	09/06 → 12/13
3 V 320 d xDrive	N47D20C, --	09/08 → 06/13
3 V 320 xd	--, M57D30(306D5)	03/07 →
3 V 335 d	M57D30(306D5), B47D20A	03/06 → 03/13
3 VI 316 d	B47D20A, B47D20A	05/11 →
3 VI 318 d	B47D20A, B47D20A	05/11 →
3 VI 318 d xDrive	N47D20C	11/12 → 05/15
3 VI 320 d	B47D20A, B47D20A	03/11 →
3 VI 320 d xDrive	B47D20A, B47D20B	05/11 →
3 VI 325 d	B47D20B, B47D20A	07/12 →
3 VI 328 d [USA]	--	10/11 →
3 VI 328 d xDrive [USA]	--	10/11 →
3 VI 330 d	N57D30A	01/12 →
3 VI 330 d xDrive	N57D30A	06/12 →
3 VI 335 d xDrive	N57D30B	04/13 →
3 VII 320 d	B47D20B	11/18 →
3 VII 320 d xDrive	B47D20B	11/18 →
4 418 d	B47D20A, B47D20A	03/14 →
4 420 d	B47D20A, B47D20A	07/13 →
4 420 d xDrive	B47D20A, N57D30A	11/13 →
4 425 d	B47D20B	01/14 →
4 430 d	N57D30A, N57D30A	10/13 →
4 430 d xDrive	N57D30A, B47D20A	11/13 →
4 435 d xDrive	N57D30B	11/13 →
5 VI GT 520 d	N47D20C, B57D30A	04/11 → 02/17
5 VI GT 530 d	N57D30A	07/12 → 02/17
5 VI GT 530 d xDrive	N57D30A	07/12 → 02/17
5 VI GT 535 d	N57D30B	07/12 → 02/17
5 VI GT 535 d xDrive	N57D30B	07/12 → 02/17
5 VI 518 d	B47D20A, B47D20A	07/13 → 02/17
5 VI 520 d	B47D20A, B47D20A	06/10 → 02/17
5 VI 520 d xDrive	B47D20A, N47D20D	01/13 → 02/17
5 VI 525 d	N47D20D, N57D30A	09/11 → 02/17
5 VI 525 d xDrive	N47D20D	09/11 → 02/17
5 VI 530 d	N57D30A, N57D30B	09/10 → 02/17
5 VI 530 d xDrive	N57D30A	03/11 → 02/17
5 VI 535 d	N57D30B, N47D20C	09/10 → 02/17
5 VI 535 d xDrive	N57D30B	09/11 → 02/17
5 VI M 550 d xDrive	N57D30C	03/12 → 10/16
5 VII 518d [ExtraEU]	B47D20B	07/18 →
5 VII 518d Touring [ExtraEU]	B47D20B	07/18 →
5 VII 520 d	B47D20A	09/16 →
5 VII 520 d xDrive	B47D20A	09/16 →
5 VII 525 d	B47D20B	07/17 →
5 VII 530 d	B57D30A	09/16 →
5 VII 530 d xDrive	B57D30A	09/16 →
5 VII 540 d xDrive	B57D30B	07/17 →
5 VII M 550 d xDrive	B57D30C	06/17 →
6 III 640 d	N57D30B	11/10 →
6 III 640 d xDrive	N57D30B	09/11 →
6 IV GT 620 d	B47D20B	07/18 →
6 IV GT 620d Gran Turismo [ExtraEU]	B47D20B	07/18 →
6 IV GT 620d xDrive Gran Turismo [ExtraEU]	B47D20B	07/18 →
6 IV GT 630 d	B57D30A	06/17 →
6 IV GT 630 d xDrive	B57D30A	06/17 →
6 IV GT 640 d xDrive	N57D30B	11/17 →
7 V 730 d	N57D30A	07/12 → 05/15
7 V 730 d LCI	N57D30A	01/11 →
7 V 730 d xDrive	N57D30A	11/11 → 05/15
7 V 730Ld	N57D30A	06/08 →
7 V 740 d	N57D30B	07/12 → 12/15
7 V 740 d LCI [USA]	N57D30B	01/11 →
7 V 740 d LCI xDrive [USA]	N57D30B	01/11 →
7 V 740 d xDrive	N57D30B	07/12 → 12/15
7 V 740Ld xDrive [USA]	N57D30A	01/13 →
7 V 750 d xDrive	N57D30C	07/12 → 12/15
7 VI 730 d	B57D30A, IB1P25B	07/15 →
7 VI 730 d xDrive	B57D30A	09/15 →
7 VI 730 d, Ld xDrive	B57D30A	09/15 →
7 VI 740 d, Ld xDrive	B57D30B	11/15 →
7 VI 750 d, Ld xDrive	B57D30C	07/16 →
8 840 d xDrive	B57D30B	07/18 →
I3 Range Extender	IB1P25B, B47C20A	08/13 →
X1 sDrive 16 d	B37C15A	04/12 →
X1 sDrive 18 d	B47C20A, B47C20A	10/09 →
X1 sDrive 20 d	B47C20A, B47C20A	07/12 →
X1 xDrive 18 d	B47C20A, B47C20A	10/09 →
X1 xDrive 20 d	B47C20A, B47C20A	07/12 →

BMW		
X1 xDrive 25 d	B47C20B	10/09 →
X2 sDrive 16 d	B37C15A	11/18 →
X2 sDrive 18 d	B47C20A, B47C20A	03/18 →
X2 sDrive 20 d	B47C20A, B47C20A	11/18 →
X2 X2 sDrive 18d [ExtraEU]	B47C20A, B47D20A	03/18 →
X2 X2 xDrive 18d [ExtraEU]	B47C20B	03/18 →
X2 xDrive 18 d	B47C20B	03/18 →
X2 xDrive 20 d	B47C20A	11/17 →
X2 xDrive 25 d	B47C20B	11/17 →
X3 II sDrive 18 d	B47D20A, B47D20A	10/12 → 08/17
X3 II xDrive 20 d	B47D20A, N57D30A	09/10 → 08/17
X3 II xDrive 28 d	N47D20C	09/14 →
X3 II xDrive 30 d	N57D30A, B57D30A	04/11 → 08/17
X3 II xDrive 35 d	N57D30B	10/11 → 08/17
X3 III sDrive 18 d	B47D20A	04/18 →
X3 III xDrive 20 d	B47D20A	10/17 →
X3 III xDrive 25 d	B47D20B	04/18 →
X3 III xDrive 30d	B57D30A	07/17 →
X3 III xDrive M40 d	B57D30B	08/18 →
X4 M40 d xDrive	B57D30B	04/18 →
X4 xDrive 20 d	B47D20A	04/18 →
X4 xDrive 25 d	B47D20B	04/18 →
X4 xDrive 30 d	B57D30A, N57D30A	04/14 →
X4 xDrive 35 d	N57D30B	04/14 → 03/18
X5 III M 50 d	N57D30C	12/13 → 07/18
X5 III sDrive 25 d	B47D20B, B47D20B	12/13 → 07/18
X5 III xDrive 25 d	B47D20B, N57D30A	12/13 → 07/18
X5 III xDrive 30 d	N57D30A, N57D30B	08/13 → 07/18
X5 III xDrive 35 d [USA]	N57D30A	01/13 →
X5 III xDrive 40 d	N57D30B, M57D30(306D3)	12/13 → 07/18
X5 II M 50 d	N57D30C	08/11 → 06/13
X5 II xDrive 30 d	N57D30A, B47D20B	10/08 → 07/13
X5 II xDrive 35 d	M57D30(306D5)	10/08 → 06/13
X5 II xDrive 40 d	N57D30B	09/10 → 06/13
X5 IV xDrive 30 d	B57D30A	08/18 →
X5 IV xDrive M 50 d	B57D30C	08/18 →
X6 I M 50 d	N57D30C	08/11 → 06/14
X6 I xDrive 30 d	M57D30(306D3), N57D30A	04/08 → 07/14
X6 I xDrive 40 d	N57D30B	07/09 → 06/14
X6 II M 50 d	N57D30C	08/14 →
X6 II xDrive 30 d	N57D30A, N47C16A	08/14 →
X6 II xDrive 40 d	N57D30B	12/14 →
X7 xDrive 30 d	B57D30A	03/19 →
X7 xDrive M 50 d	B57D30C	03/19 →

MINI		
MINI II Cooper D	N47C16A, N47C16A	05/09 → 10/16
MINI II Cooper D ALL4	N47C16A, N47C20A	01/10 → 10/16
MINI II Cooper SD	N47C20A, B37C15A	06/09 → 10/16
MINI II Cooper SD ALL4	N47C20A	01/10 → 09/16
MINI II One D	N47C16A	01/10 → 10/16
MINI III Cooper D	B37C15A, B47C20A	10/13 →
MINI III Cooper D ALL4	B47C20A	10/16 →
MINI III Cooper SD	B47C20A, B47C20A	09/13 →
MINI III Cooper SD ALL4	B47C20A, F16D4	04/15 →
MINI III One D	B37C15A	02/14 →

10.4032



AIR TEMPERATURE SENSORS

Adatt./Suitable:

BMW
13 62 7 812 741
13 62 8 519 445
7 812 741

MINI
13 62 7 812 741
13 62 8 519 445

MARKET DIFFUSION: HIGH

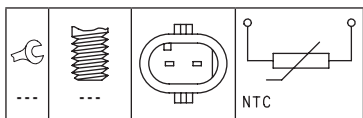

BMW		
1 II 114 d	B37D15A, B37D15A	07/12 →
1 II 116 d	B37D15A, B47D20A	12/10 →
1 II 118 d	B47D20A, B47D20A	12/10 →
1 II 118 d xDrive	N47D20C	05/13 →
1 II 120 d	B47D20A, N47D20C	12/10 →
1 II 120 d xDrive	N47D20C, B47D20B	01/11 →
1 II 125 d	B47D20B, B47C20A	08/11 →
2 214 d	B37C15A	07/15 → 02/18

10.4033



AIR TEMPERATURE SENSORS

Adatt./Suitable:

ALFA ROMEO
60606033**CHEVROLET**
12129596**GENERAL MOTORS**
12 129 596**OPEL**
12 38 079
12129596**VAUXHALL**
12129596

MARKET DIFFUSION: HIGH

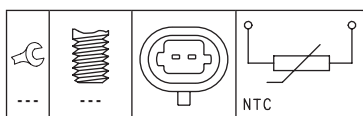

ALFA ROMEO

145 1.6 i.e.	AR33201	10/94 ⇒ 12/96
145 1.6 LPG	AR32102	01/98 ⇒ 01/01
146 1.4 i.e.	AR33501	12/94 ⇒ 12/96
146 1.6 i.e.	AR33201	12/94 ⇒ 12/96

CHEVROLET

CRUZE 1.6	F16D4, 2H0	05/09 ⇒
CRUZE 1.8	2H0, X14XE	05/09 ⇒
CRUZE 1.8 LPG	2H0	06/11 ⇒
ORLANDO 1.8	2H0	02/11 ⇒
ORLANDO 1.8 LPG	2H0	06/11 ⇒

OPEL

ASTRA F 1.4 i 16V	X14XE	01/96 ⇒ 03/01
ASTRA F 1.6 i	X16SZ	02/93 ⇒ 08/96
ASTRA F 1.6 i 16V	X16XEL	08/94 ⇒ 01/05
ASTRA G 1.4	X14XE, X14XE	09/98 ⇒ 04/05
ASTRA G 1.4 16V	X14XE, X14XE	02/98 ⇒ 01/05
ASTRA G 1.4 LPG	X14XE, C16SEL	02/98 ⇒ 01/05
ASTRA G 1.6	C16SEL, X16XEL	09/98 ⇒ 07/09
ASTRA G 1.6 16V	X16XEL, X16XEL	02/98 ⇒ 10/05
ASTRA G 1.6 CNG	Z16YNG	03/03 ⇒ 07/04
ASTRA G 1.6 LPG	X16XEL, A16XER	03/98 ⇒ 01/05
ASTRA H 1.4 16V	Z14XE	05/04 ⇒ 07/09
ASTRA H 1.6	A16XER, Z16XEP	03/04 ⇒ 05/14
ASTRA H 1.6 16V	Z16XE	03/04 ⇒ 01/08
ASTRA H 1.6 EcoTec	Z16XEP, A18XER	02/04 ⇒ 12/10
ASTRA H 1.6 LPG	Z16XER	08/09 ⇒ 10/10
ASTRA H 1.8	A18XER, C14NZ	08/05 ⇒ 05/14
ASTRA J 1.6	Z16XER	12/06 ⇒
ASTRA J 1.8	Z18XER	02/07 ⇒
COMBO B 1.2	X12SZ	07/94 ⇒ 10/01
COMBO B 1.4	C14NZ, Y16YNG	07/94 ⇒ 10/01
COMBO B 1.4 16V	X14XE	08/99 ⇒ 10/01
COMBO C 1.4	Z14XEP	10/04 ⇒ 12/11
COMBO C 1.4 16V	Z14XEP	08/05 ⇒
COMBO C 1.6	Z16SE	10/01 ⇒
COMBO C 1.6 CNG	Y16YNG, Y16YNG	04/05 ⇒ 12/11
COMBO C 1.6 CNG 16V	Y16YNG, C14NZ	04/05 ⇒
CORSA B 1.2 i	X12SZ	03/93 ⇒ 09/00
CORSA B 1.4	C14SE	04/93 ⇒ 08/94
CORSA B 1.4 i	C14NZ, C14SEL	03/93 ⇒ 09/00
CORSA B 1.4 i 16V	C14SEL, C16SEL	09/94 ⇒ 12/02
CORSA B 1.4 Si	C14SE	03/93 ⇒ 09/00
CORSA B 1.6 GSI 16V	C16XE	03/93 ⇒ 09/00
CORSA B 1.6 i 16V	C16SEL, A10XEP	09/94 ⇒ 09/00
CORSA C 1.4	Z14XE	07/00 ⇒
CORSA C 1.4 Twinport	Z14XEP	06/03 ⇒ 12/09
CORSA C 1.6	Z16SE	09/00 ⇒
CORSA C 1.6 CNG	Y16YNG	05/03 ⇒ 12/09
CORSA C 1.6 X	Z16YNG	08/05 ⇒
CORSA D 1.0	A10XEP, Z12XEP	07/06 ⇒ 08/14
CORSA D 1.2	Z12XEP	07/06 ⇒ 08/14
CORSA D 1.2 LPG	Z12XEP, Z16SE	08/06 ⇒ 08/14
CORSA D 1.4	Z14XEP	07/06 ⇒ 08/14
CORSA D 1.4 LPG	Z14XEP	08/06 ⇒ 12/11
MERIVA A 1.6	Z16SE, X14XE	05/03 ⇒ 05/10
MERIVA A 1.6 16V	Z16XE	05/03 ⇒ 01/06
TIGRA A 1.4 16V	X14XE, C16SEL	07/94 ⇒ 12/00

OPEL

TIGRA A 1.6 16V	C16SEL, X16XEL	07/94 ⇒ 08/98
VECTRA B 1.6 i 16V	X16XEL, Z16XE	10/95 ⇒ 07/02
VECTRA C 1.6	Z16XE, X16XEL	08/05 ⇒ 08/08
VECTRA C 1.6 16V	Z16XE	06/04 ⇒ 09/08
ZAFIRA A 1.6 16V	X16XEL, X16XEL	09/02 ⇒ 06/05
ZAFIRA A 1.6 CNG	Z16YNG	09/01 ⇒ 06/05
ZAFIRA A 1.6 LPG	X16XEL, A16XER	04/99 ⇒ 06/05
ZAFIRA B 1.6	A16XER, A18XER	07/05 ⇒ 04/15
ZAFIRA B 1.6 CNG	Z16YNG	07/05 ⇒ 04/15
ZAFIRA B 1.6 FlexFuel	Z16XER	08/08 ⇒ 12/12
ZAFIRA B 1.8	A18XER, X14XE	07/05 ⇒ 04/15
ZAFIRA B 1.8 LPG	Z18XER	07/09 ⇒ 04/15

VAUXHALL

ASTRA III 1.4 i 16V	X14XE	01/96 ⇒ 03/01
ASTRA III 1.6 i	X16SZ	02/93 ⇒ 02/98
ASTRA III 1.6 i 16V	X16XEL	01/94 ⇒ 09/98
ASTRA IV 1.4 16V	X14XE, X14XE	02/98 ⇒ 05/05
ASTRA IV 1.4 16V Dualfuel	X14XE, X16XEL	09/99 ⇒ 06/03
ASTRA IV 1.6	Z16XEP	12/02 ⇒ 05/05
ASTRA IV 1.6 16V	X16XEL, X16XEL	02/98 ⇒ 10/05
ASTRA IV 1.6 Dualfuel	X16XEL, A16XER	03/98 ⇒ 05/05
ASTRA V 1.6	A16XER, A16XER	01/04 ⇒ 05/09
ASTRA V 1.6 i 16V	A16XER, A18XER	10/06 ⇒ 08/11
ASTRA V 1.8	A18XER, Z16XE1	01/04 ⇒ 11/10
ASTRA V 1.8 i 16V	Z18XER	03/07 ⇒ 11/10
ASTRAVAN I 1.6 i	X16SZ	09/94 ⇒ 08/96
ASTRAVAN II 1.4 16V	Z14XE	09/00 ⇒ 05/05
ASTRAVAN II 1.6 Dualfuel	Z16XE	07/00 ⇒ 08/05
ASTRAVAN III 1.6	Z16XE1, C14NZ	03/05 ⇒
COMBO B 1.2	X12SZ	07/94 ⇒ 10/01
COMBO B 1.4	C14NZ, Z16SE	07/94 ⇒ 10/01
COMBO B 1.4 16V	X14XE	08/99 ⇒ 10/01
COMBO C 1.4	Z14XEP	10/04 ⇒ 09/10
COMBO C 1.4 16V	Z14XE	10/01 ⇒ 05/07
COMBO C 1.4 i 16V	Z14XEP	01/04 ⇒ 11/11
COMBO C 1.6	Z16SE, Z16YNG	09/01 ⇒ 11/11
COMBO C 1.6 CNG	Z16YNG, Y16YNG	04/05 ⇒ 02/12
COMBO C 1.6 CNG 16V	Y16YNG, C14NZ	04/05 ⇒ 02/12
CORSA B 1.2 i	X12SZ	03/93 ⇒ 09/00
CORSA B 1.4 i	C14NZ, X16XEL	03/93 ⇒ 09/00
CORSA B 1.4 i 16V	X14XE	09/94 ⇒ 09/00
CORSA B 1.4 i S	C14SE	03/93 ⇒ 09/00
CORSA B 1.6 GSI 16V	C16XE	03/93 ⇒ 09/00
CORSA B 1.6 i 16V	X16XE	09/94 ⇒ 09/00
CORSA C 1.4 16V	Z14XE	09/00 ⇒ 10/06
CORSA C 1.4 Twinport	Z14XEP	06/03 ⇒ 10/06
CORSA D 1.0	Z10XEP	08/06 ⇒ 08/14
CORSA D 1.2	Z12XEP	08/06 ⇒ 08/14
CORSA D 1.2 LPG	Z12XEP	09/09 ⇒ 08/14
CORSA D 1.4	Z14XEP	08/06 ⇒ 08/14
CORSA D 1.4 LPG	Z14XEP	07/06 ⇒ 08/14
CORSAVAN I 1.4 i	C14NZ	01/94 ⇒ 09/00
CORSAVAN II 1.4	Z14XEP	11/03 ⇒ 06/06
CORSAVAN III 1.2	Z12XEP	07/09 ⇒
MERIVA I 1.6 i	Z16SE	01/03 ⇒ 06/10
MERIVA I 1.6 i 16V	Z16XE	01/03 ⇒ 09/05
MERIVA I 1.6 i 16V Twinport	Z16XEP	05/03 ⇒ 06/10
TIGRA A 1.4 16V	X14XE	07/94 ⇒ 12/00
TIGRA A 1.6 16V	X16XE	07/94 ⇒ 12/00
VECTRA B 1.6 i 16V	X16XEL, Z16XE	08/95 ⇒ 03/02
VECTRA C 1.6 16V	Z16XE, X16XEL	06/04 ⇒ 07/08
ZAFIRA A 1.6 16V	X16XEL, A16XER	04/99 ⇒ 08/05
ZAFIRA A 1.6 CNG	Z16YNG	09/01 ⇒ 06/05
ZAFIRA A 1.6 Dualfuel	X16XEL	11/98 ⇒ 08/05
ZAFIRA B 1.6	A16XER, A18XER	07/05 ⇒ 11/14
ZAFIRA B 1.6 CNG	Z16YNG	07/05 ⇒ 11/14
ZAFIRA B 1.8	A18XER, LMT	04/05 ⇒ 11/14

10.4034



AIR TEMPERATURE SENSORS

Adatt./Suitable:

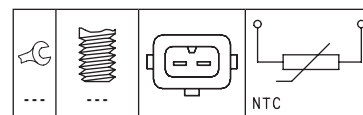
CHEVROLET
96806010**DAEWOO**
96806010**GENERAL MOTORS**
96 806 010

CHEVROLET

AVEO I 1.4	LDT	04/08 ⇒
SPARK III 1.0	LMT	03/10 ⇒
SPARK III 1.0 LPG	LMT, LMU	03/10 ⇒
SPARK III 1.2	LMU, N47D20A	03/10 ⇒
SPARK III 1.2 LPG	LMU	03/10 ⇒

DAEWOO

GENTRA 1.5	B15D2	06/13 ⇒
------------	-------	---------

10.4035



AIR TEMPERATURE SENSORS

Adatt./Suitable:

00 Eliminated on 11-05-2018. Please verify the availability through our local distributors

- Eliminato il 11-05-2018. Verificare la disponibilità presso i nostri distributori
- Éliminé le 11-05-2018. Vérifier la disponibilité auprès de nos distributeurs sur place
- Am 11-05-2018 gestrichen. Evtl. Verfügbarkeit bitte bei unseren Händlern prüfen
- Eliminado en fecha 11-05-2018. Verificar la disponibilidad a través de nuestros distribuidores locales

1006 After depletion of stock this part is replaced by:

- Esaurite le scorte questo pezzo sarà sostituito da:
- Après épuisement du stock, cette pièce est remplacée par:
- Nach Vorraterschöpfung wird ersetzt durch:
- Después agotamiento stock, sera sustituido por:

10.4005

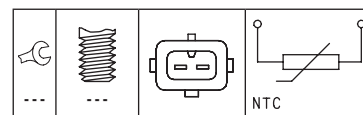



AIR TEMPERATURE SENSORS

Adatt./Suitable:

BMW

13 62 7 792 203
7 792 203

MARKET DIFFUSION: MEDIUM

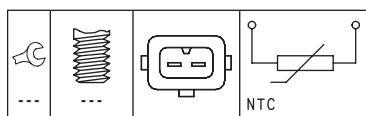

BMW		
1 I 116 d	N47D20A, M47D20(204D4)	11/08 ⇨ 09/12
1 I 118 d	M47D20(204D4), M47D20(204D4)	11/03 ⇨ 12/13
1 I 120 d	M47D20(204D4), N47D20B	03/03 ⇨ 12/13
1 I 123 d	N47D20B, M57D30(306D2)	03/07 ⇨ 12/13
3 IV 330 Cd	M57D30(306D2), M57D30(306D2)	03/03 ⇨ 12/07
3 IV 330 d	M57D30(306D2), M47D20(204D4)	03/03 ⇨ 02/05
3 V 316 d	N47D20C	07/09 ⇨ 12/11
3 V 318 d	M47D20(204D4), M47D20(204D4)	03/05 ⇨ 06/12
3 V 320 d	M47D20(204D4), N47D20C	12/04 ⇨ 12/13
3 V 320 d xDrive	N47D20C, --	02/08 ⇨ 06/13
3 V 320 xd	--, M57D30(306D3)	03/07 ⇨
3 V 325 d	M57D30(306D3), M57D30(306D3)	09/06 ⇨ 12/13
3 V 330 d	M57D30(306D3), M57D30(306D3)	12/04 ⇨ 12/13
3 V 330 d xDrive	N57D30A	09/08 ⇨ 06/13
3 V 330 i	N52B30A	09/07 ⇨ 12/11
3 V 330 xd	M57D30(306D3), M57D30(306D5)	09/05 ⇨ 06/12
3 V 335 d	M57D30(306D5), M47D20(204D4)	03/06 ⇨ 03/13
3 V M	S65B40A	03/07 ⇨ 06/13
3 V M3	S65B40A	03/07 ⇨ 10/13
5 VI GT 530 d	N57D30A, M57D30(306D5)	08/09 ⇨ 06/12
5 VI GT 530 d xDrive	N57D30A	06/10 ⇨ 06/12
5 VI GT 535 d	N57D30B	03/10 ⇨ 06/12
5 VI GT 535 d xDrive	N57D30B	03/10 ⇨ 06/12
5 V 520 d	M47D20(204D4), M57D25(256D2)	02/05 ⇨ 05/10
5 V 525 d	M57D25(256D2), M57D30(306D3)	03/04 ⇨
5 V 525 d xDrive	M57D30(306D3), M57D30(306D3)	09/07 ⇨ 05/10
5 V 525 xd	M57D30(306D3), M57D30(306D2)	11/06 ⇨ 09/08
5 V 530 d	M57D30(306D2), M57D30(306D3)	09/02 ⇨ 05/10
5 V 530 d xDrive	M57D30(306D3), M57D30(306D3)	09/07 ⇨ 05/10
5 V 530 xd	M57D30(306D3), M57D30(306D4)	02/05 ⇨ 08/07
5 V 535 d	M57D30(306D4), N57D30B	09/04 ⇨ 12/10
5 VI 525 d	N57D30A	03/10 ⇨ 08/11
5 VI 530 d	N57D30A	01/10 ⇨ 08/11
5 VI 535 d	N57D30B, N57D30A	09/10 ⇨ 08/11
6 II 635 d	M57D30(306D5), M57D30(306D3)	07/07 ⇨ 07/10
7 IV 730 d	M57D30(306D3), M57D30(306D3)	10/02 ⇨ 07/08
7 IV 730 Ld	M57D30(306D3), M67D44(448D1)	07/05 ⇨ 08/08



AIR TEMPERATURE SENSORS

Adatt./Suitable:

RENAULT

16 58 024 65R

SMART

A 281 905 08 00

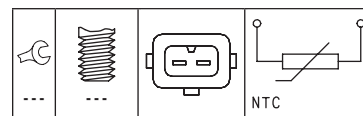

AIR TEMPERATURE SENSORS

Adatt./Suitable:

BOSCH

0 281 006 152
0 281 006 153¹⁰² without pressure sensor

- senza sensore pressione
- sans sensor de pression
- ohne Drucksensor
- sin sensor de presión

SEAT

03P 906 081

SKODA

03P 906 081

VW

03P 906 081

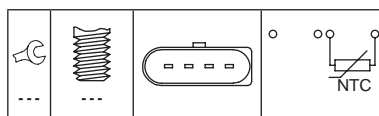

SEAT

IBIZA IV 1.2 TDI CFWA 04/10 ⇨

IBIZA 1.2 TDi CFWA 05/10 ⇨

SKODA

FABIA II 1.2 TDI CFWA 05/10 ⇨ 12/14

FABIA II 1.6 TDI CAYB, CAYC 03/10 ⇨ 12/14

ROOMSTER 1.2 TDI CFWA 03/10 ⇨ 05/15

VW

POLO V 1.2 TDI CFWA 10/09 ⇨

POLO V 1.2 TDI BlueMotion CFWA 10/09 ⇨ 05/14



THROTTLE POSITION SENSORS

·SENSORI DI POSIZIONE FARFALLA ·SONDES DE POSITION DU PAPILLON
·DROSSELKLAPPEN-POSITIONS-SENSOREN ·SENSORES DE POSICION DE LA MARIPOSA

(A) P/NRS. - NOTES

- CODICI - NOTE
- RÉFS. - NOTES
- ARTIKEL-NR. - ANMERKUNGEN
- CODIGOS - NOTAS

10.5096

1

THROTTLE POSITION SENSORS

Adatt./Suite:

FIAT

71719387

71752610 *G

LANCIA

71752610 *G

*G without gasket / seal

- senza guarnizione
- sans joint d'étanchéité
- ohne Dichtung
- sin junta

MARKET DIFFUSION: MEDIUM

(B) PICTURE + TECHNICAL INFO

- FOTO + INFORMAZIONE TECNICA
- ILLUSTRATION + INFORMATION TECHNIQUE
- BILD + TECHNISCHE INFO
- FOTO + INFORMACIÓN TÉCNICA

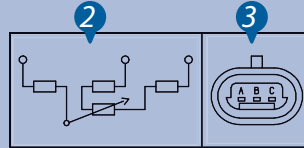

(C) APPLICATION LIST

- GUIDA APPLICAZIONI
- LISTE D'APPLICATIONS
- ANWENDUNGSTABELLE
- LISTA DE APLICACIONES

FIAT

500 0.9	199B6.000, 199B6.000	07/10 ⇨
500 1.2	169A4.000	10/07 ⇨
500 1.4	169A3.000	10/07 ⇨
500 C 0.9	199B6.000, 169A3.000	09/09 ⇨
500 C 1.2	169A4.000	09/09 ⇨
500 C 1.4	169A3.000, --	09/09 ⇨
500 MY12 0.9	--	01/12 ⇨
500 MY12 1.2	--	01/12 ⇨
500 MY12 1.4	--	01/12 ⇨
IDEA 1.4	192B2.000	12/03 ⇨
IDEA 1.4 16V	--, 312A2.000	01/04 ⇨
PANDA II 1.2	188A4.000	09/03 ⇨
PANDA II 1.2 4x4	188A4.000	09/04 ⇨
PANDA II 1.2 Euro 4	--	04/09 ⇨
PANDA III 0.9	312A2.000, 312A2.000	02/12 ⇨

1 # FACET

2 **OEM P/NRS.**
· CODICI ORIGINALI
· RÉFS. D'ORIGINE
· ORIGINALTEILE-NR.
· CODIGOS ORIGINALES

3 **PACKAGING SIZE**
· FORMATO CONFEZIONE
· FORMAT DU CONDITIONNEMENT
· ABPACKENSGROESSE
· TAMAÑO DEL ENVASE

4 **PRODUCT AVAILABILITY DATE**
· DATA DI DISPONIBILITÀ DEL PRODOTTO
· DISPONIBILITÉ DU PRODUIT
· PRODUKTVERFUEGBARKEITSDATUM
· DISPONIBILIDAD ARTÍCULO

5 **NOTE**
· NOTE
· NOTES
· BERMERKUNGEN
· NOTAS

(B)

1 **PICTURE**
· FOTO
· PHOTO
· BILD
· FOTO

2 **CIRCUIT**
· CIRCUITO
· CIRCUIT
· STROHMKREIS
· CIRCUITO

3 **TYPE OF CONNECTION**
· TIPO DI CONNESSIONE
· TYPE DE CONNEXION
· ANSCHLUSSART
· TIPO DE ENCHUFE

Combined circuits · Circuiti combinati · Circuits combinés · Kombinierte Kreise · Circuitos combinados

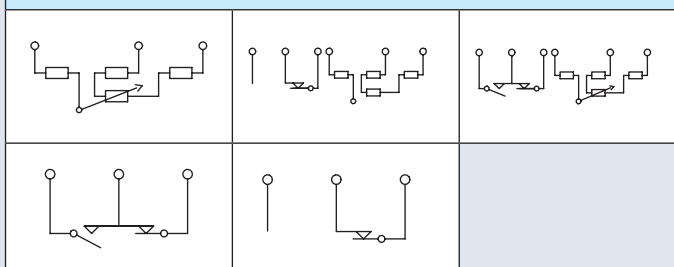

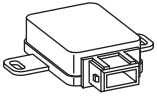

10.5XXX

Throttle position sensors

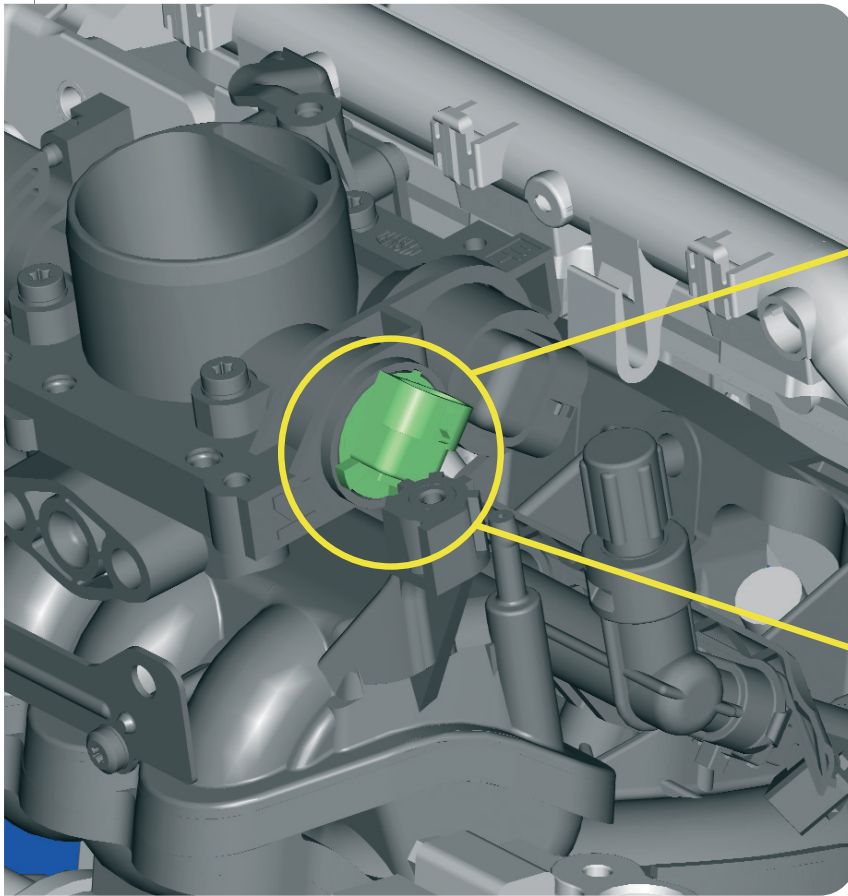

Rendering: by kind concession of FIAT POWERTRAIN TECHNOLOGIES

Throttle position sensors are installed **on the throttle body of cars; they measure the opening angle of the throttle valve**, which is controlled by the accelerator pedal, and adjust the amount of air drawn in by the engine. The electric signal is sent to the engine control unit in order to:

- Recognize the minimum/full engine load
- Cut the fuel off when releasing the accelerator
- Enrich the air/fuel mixture during acceleration
- Correct the injection timing
- Control boosting

Throttle position sensors can be used with **gasoline, hybrid and alcohol-powered engines**.

The main **reasons for failures** are:

- jets of water at high pressure (e.g. during washing of the engine) may cause deterioration of the electrical insulation
- wear in the resistance paths of the circuit

Signs of malfunctions of the sensor are indicated by illumination of the engine warning lamp, irregular response under acceleration, lack of power output from the engine at maximum revs.

Throttle position sensors are designed and assembled to withstand

the critical installation conditions inside the engine compartment. In particular, the following **requirements** shall be met:

- Operating temperature: $-40^{\circ}\text{C} \div +130^{\circ}\text{C}$

The throttle position sensors undergo **qualification and endurance tests** to determine if the product is suitable for construction and sale:

- long duration test includes 5,000,000 maneuvers
- Resistance to vibrations
- Resistance to low and high temperatures
- Resistance to salt spray fog
- Resistance to thermal shocks
- Resistance to impacts
- Airtight sealing

When these tests have been passed and after the approval to manufacture has been given, the product, in the assembly process, is strictly checked through a series of cycles which include a **100% testing** of the sensor output (potentiometer sensors) or of the exchange angle (switch sensors) at minimum and maximum throttle opening.

Structural elements and operation

There are 3 types of throttle position sensors:

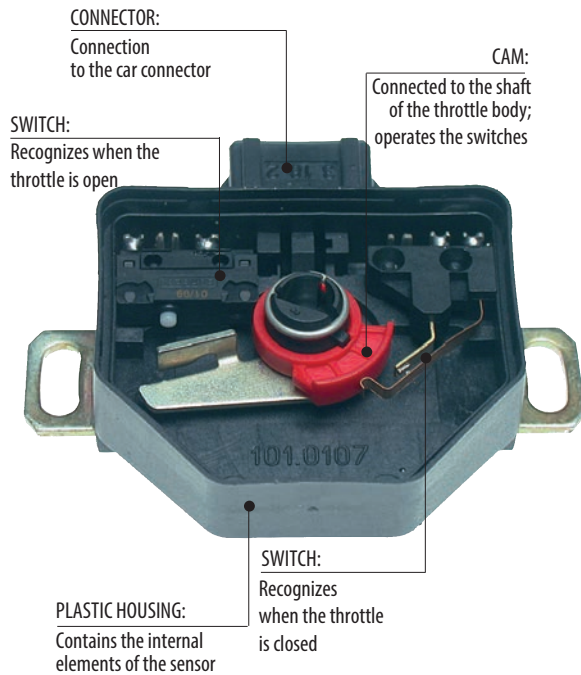

- **Switch sensors:** these sensors consist of *two switches* mechanically operated by a *cam* connected to the shaft of the throttle body:
 - *The minimum load switch* of the engine recognizes the closed throttle state ($\alpha < 1,5^\circ$): the signal is high (open circuit) when the throttle is closed, whereas it is low (closed circuit) when the throttle is open.
 - *The full load switch* of the engine recognizes the opened throttle state ($\alpha < 70^\circ$): the signal is high (open circuit) when the throttle is open, whereas it is low (closed circuit) when the throttle is closed.

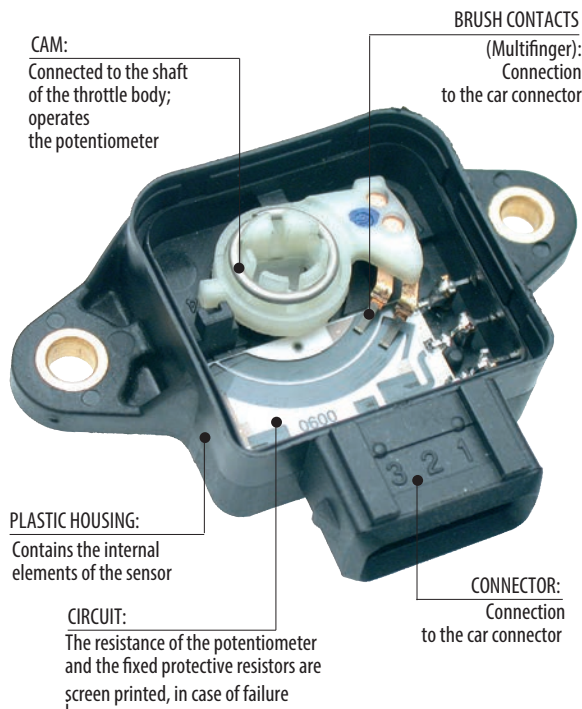
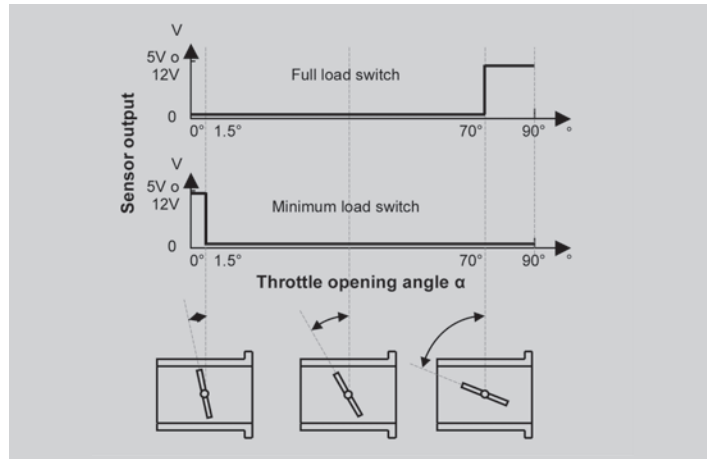

- **Potentiometer sensors:** these sensors consist of a *cam*, operated by the throttle body, provided with *brush contacts* (Multifinger) which move over a *screen printed resistor* on a *circuit*. As the opening angle of the throttle increases, the contacts move over the resistor, thereby making the resistance of the potentiometer increase **linearly**: from resistance 0 (engine idle), it linearly increases to the maximum value (full load engine). Therefore, the unit can distinguish each opening angle of the throttle and adjust the air/gasoline ratio correctly.

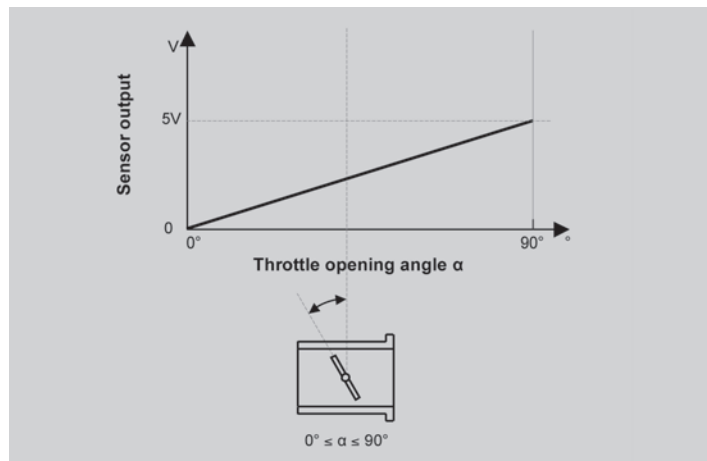

- **Switch / potentiometer sensors:** one cam simultaneously operates a switch and a potentiometer housed in *one housing*.

Installation instructions

When installing the **FACET** sensor, use the screws supplied in the box, where necessary, having the thread a **sealant paste** on it (Drylock) to prevent unscrewing.

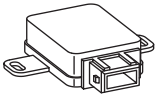

10.5XXX

Sensori di posizione farfalla

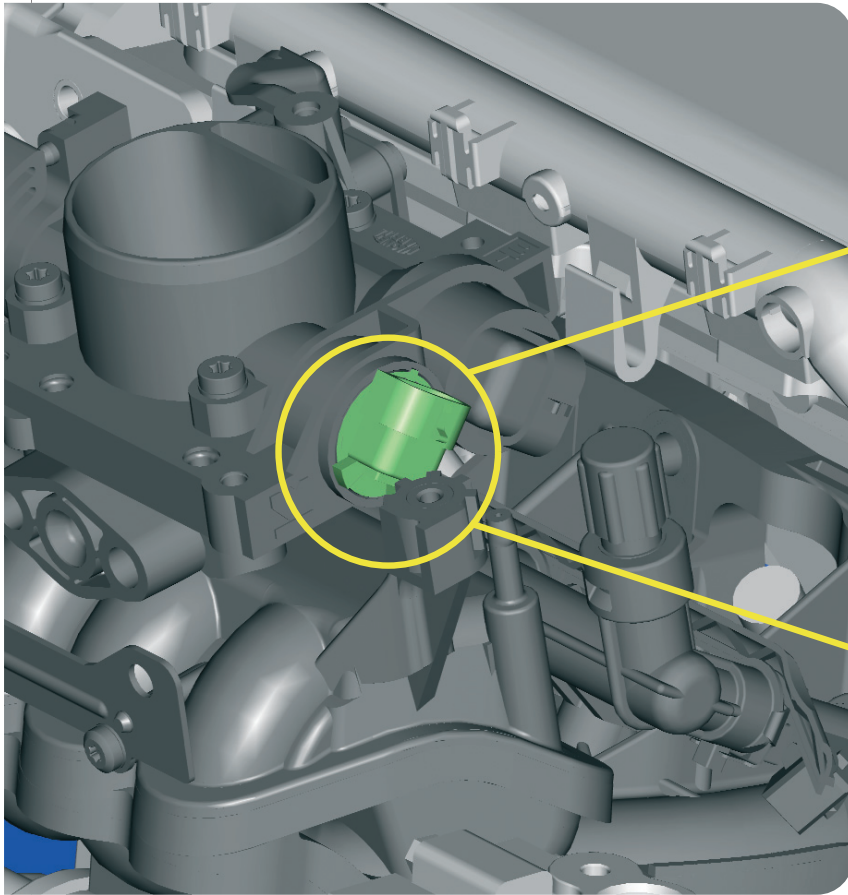

Rendering: per gentile concessione di FIAT POWERTRAIN TECHNOLOGIES

I sensori di posizione farfalla sono montati **sul corpo farfallato degli autoveicoli e misurano l'angolo di apertura della valvola a farfalla** la quale, comandata dal pedale dell'acceleratore, regola la quantità d'aria aspirata dal motore. Il segnale elettrico è inviato alla centralina di controllo motore al fine di:

- riconoscere il regime di minimo/pieno carico del motore
- tagliare l'iniezione carburante in rilascio (cut-off)
- arricchire la miscela aria/benzina in accelerazione
- correggere l'anticipo dell'iniezione
- gestire la sovralimentazione

I sensori di posizione farfalla sono applicati a **motori con alimentazione a benzina, ibrida o alcol**.

Le principali **cause di guasto** del prodotto sono:

- spruzzi di acqua ad alta pressione (es. durante il lavaggio del motore) possono causare la riduzione dell'isolamento elettrico
- usura delle piste resistive del circuito

I **segnali di malfunzionamento** del sensore sono ravvisabili nell'accensione della spia motore, nella risposta irregolare alla richiesta di accelerazione, nella mancanza di resa del motore alla potenza massima.

I sensori di posizione farfalla sono progettati e costruiti per sopportare le condizioni critiche di montaggio nel vano motore. In particolare devono soddisfare i seguenti **requisiti**:

- **temperatura di funzionamento:** $-40^{\circ}\text{C} \div +130^{\circ}\text{C}$

I sensori di posizione farfalla sono sottoposti a rigorose **prove di qualificazione e di durata** per stabilire se il prodotto è idoneo per essere costruito e venduto:

- prova di durata comprendente 5.000.000 manovre
- resistenza alle vibrazioni
- resistenza alla bassa e alta temperatura
- resistenza alla nebbia salina
- resistenza shock termici
- resistenza agli urti
- ermeticità

Superate tali prove e concesso il benestare a produrre, durante la produzione il prodotto viene sottoposto a severi cicli di controllo che prevedono il **collaudo al 100%** del segnale di uscita (sensori a potenziometro) o dell'angolo di scambio (sensori ad interruttore) al minimo e al massimo dell'apertura della farfalla.

Elementi costruttivi e principio di funzionamento

Esistono 3 tipologie di sensori farfalla:

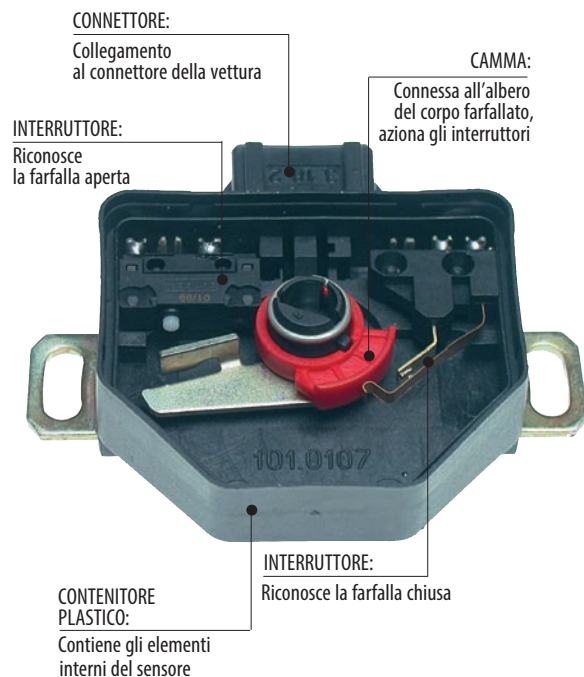

• **A interruttore:** sono composti da *due interruttori* azionati meccanicamente da una *camma* connessa all'albero del corpo farfallato:

- *L'interruttore regime di minimo* del motore riconosce la condizione di farfalla chiusa ($\alpha < 1,5^\circ$): il segnale è alto (circuitto aperto) a farfalla chiusa mentre è basso (circuitto chiuso) a farfalla aperta.

- *L'interruttore pieno carico* del motore riconosce la condizione di farfalla aperta ($\alpha > 70^\circ$): il segnale è alto (circuitto aperto) a farfalla aperta mentre è basso (circuitto chiuso) a farfalla chiusa.

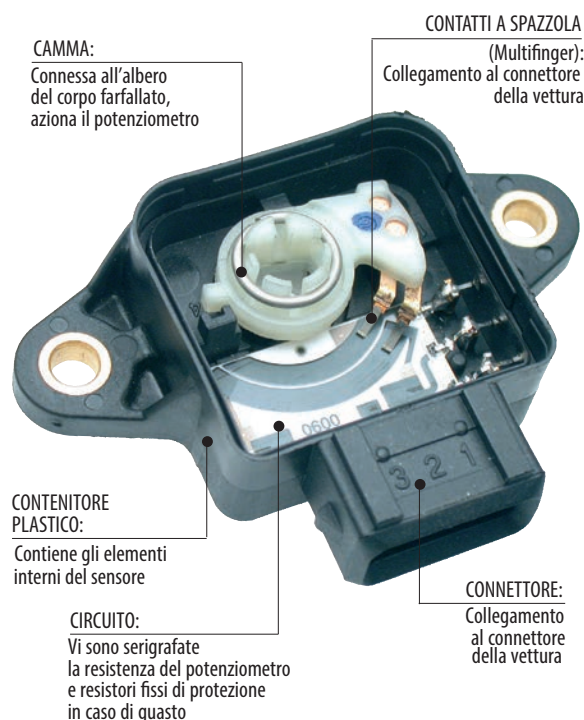
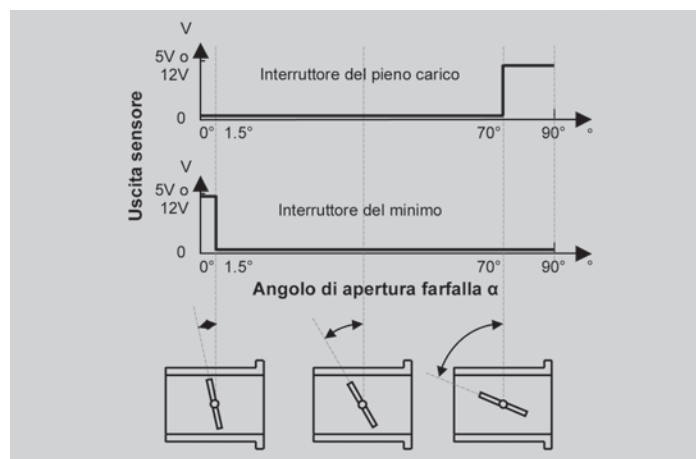

• **A potenziometro:** sono composti da una camma, azionata dall'albero del corpo farfallato, provvista di *contatti a spazzola* (Multifinger) che scorrono su un *resistore serigrafato* su un *circuitto*. All'aumentare dell'angolo di apertura della farfalla, i contatti scorrono sul resistore facendo aumentare **linearmente** la resistenza del potenziometro: da resistenza 0 (minimo del motore) aumenta linearmente fino al valore massimo (motore a pieno carico). La centralina può quindi discriminare ogni angolo di apertura della farfalla e regolare correttamente il rapporto aria/benzina.

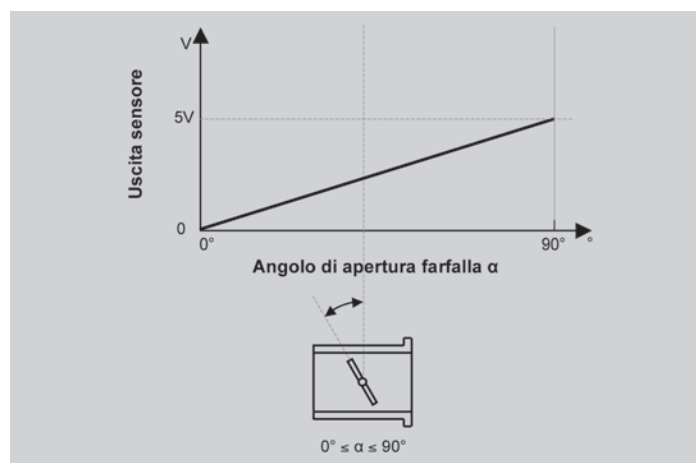

• **A interruttore e potenziometro:** un'unica camma aziona contemporaneamente un interruttore e un potenziometro alloggiati in un *unico contenitore*.

Istruzioni di montaggio

Nel montaggio del sensore **FACTET** utilizzare le viti di fissaggio fornite nella scatola, ove previste, in quanto la filettatura è dotata di **pasta bloccante** (DryLock) anti svitamento.

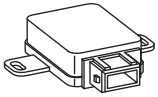

10.5XXX

Sondes de position du papillon

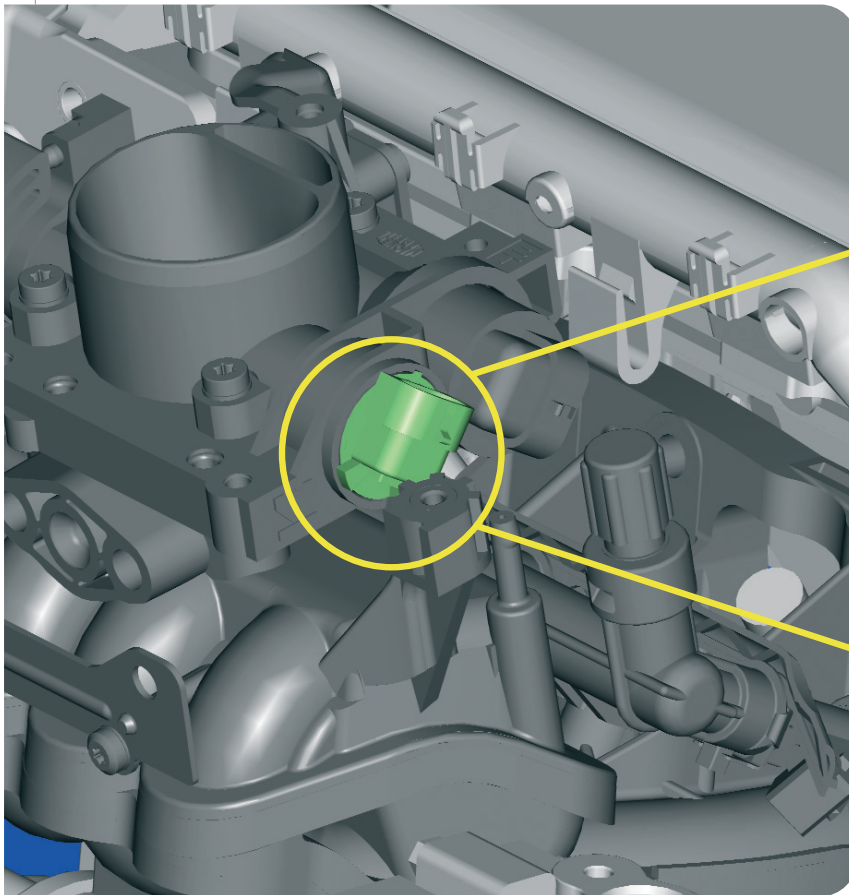

Rendering: par aimable concession de FIAT POWERTRAIN TECHNOLOGIES

Les sondes de position du papillon sont appliqués **sur le boîtier-papillon des véhicules automobiles et se chargent de mesurer l'angle d'ouverture du papillon** qui, commandé par la pédale de l'accélérateur, règle la quantité d'air aspiré par le moteur. Le signal électrique est délivré à l'unité de contrôle du moteur pour:

- reconnaître le régime de ralenti/pleine charge du moteur
- couper l'injection de carburant au relâchement (cut-off)
- enrichir le mélange air/essence en accélération
- corriger l'avance d'injection
- gérer la suralimentation

Les sondes de position du papillon trouvent leur application dans les véhicules **alimentés à essence, hybrides et à alcool**.

Les principales causes de défaut sont :

- des jets d'eau à haute pression (ex. pendant le lavage du moteur) peuvent causer une réduction de l'isolation électrique
- l'usure des pistes résistives du circuit

Les signaux de dysfonctionnement du capteur sont reconnaissables par l'allumage du témoin du moteur, une réponse irrégulière à la demande d'accélération, une absence de rendement du moteur à la puissance maximale.

Les capteurs de position du papillon sont conçus et fabriqués pour supporter les conditions de montage critiques dans le compartiment moteur. En particulier, ils doivent répondre à la **caractéristique** suivante :

- *température de fonctionnement*: -40°C ÷ +130°C

Les capteurs de position du papillon sont soumis à des **essais de qualification et de durée rigoureux** pour établir si le produit est adéquat à la fabrication et à la vente:

- essai de durée de vie comprenant 5.000.000 de manoeuvres
- résistance aux vibrations
- résistance aux basses et hautes températures
- résistance au brouillard salin
- résistance aux chocs thermiques
- résistance aux coups
- herméticité

A l'issue positive de ces essais et une fois l'autorisation de production accordée, le produit est soumis tout au long de son assemblage à de sévères cycles de contrôle envisageant le **test à 100%** du signal de sortie (capteurs à potentiomètre) ou de l'angle de commutation (capteurs à interrupteur) avec ouverture mini et maxi du papillon.

Éléments constitutifs et principe de fonctionnement

Ils existent 3 typologies de sondes de position du papillon:

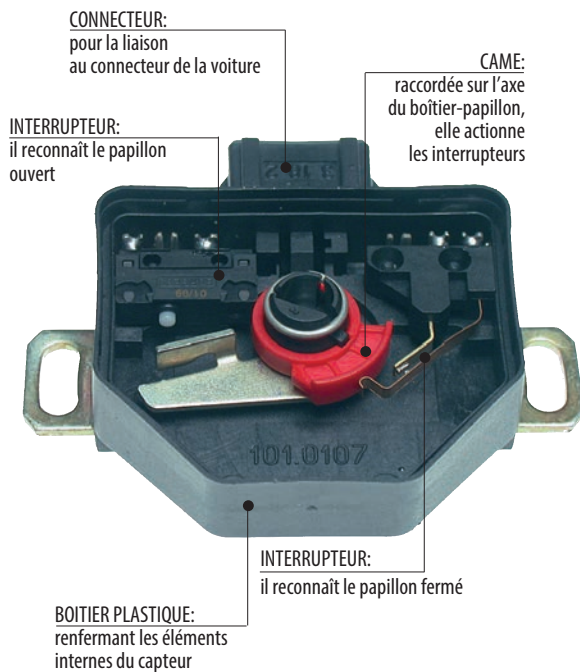

- **A interrupteur:** ils sont constitués de *deux interrupteurs*, actionnés mécaniquement par une came raccordée sur l'axe du boîtier-papillon:
- *l'interrupteur de régime de ralenti* du moteur reconnaît la condition de papillon fermé ($\alpha < 1,5^\circ$): le signal est à l'état haut (circuit ouvert) lorsque le papillon est fermé, tandis qu'il est à l'état bas (circuit fermé) lorsque le papillon est ouvert.
- *l'interrupteur de pleine charge* du moteur reconnaît la condition de papillon ouvert ($\alpha > 70^\circ$): le signal est à l'état haut (circuit ouvert) lorsque le papillon est ouvert, tandis qu'il est à l'état bas (circuit fermé) lorsque le papillon est fermé.

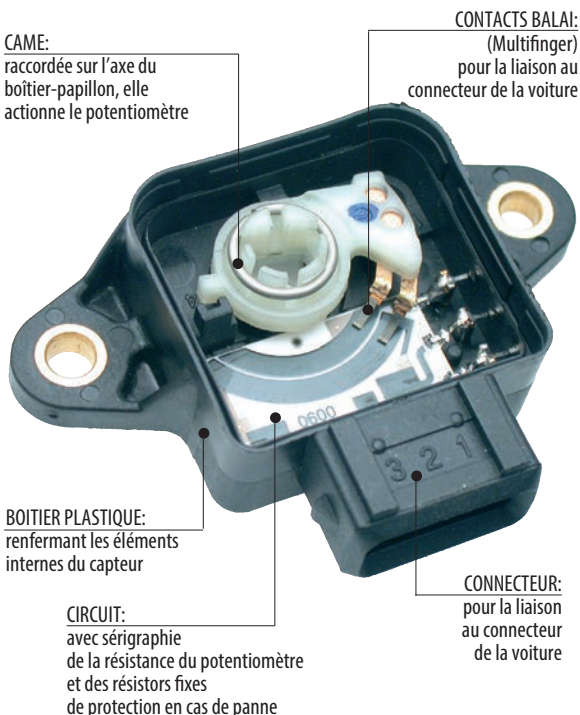
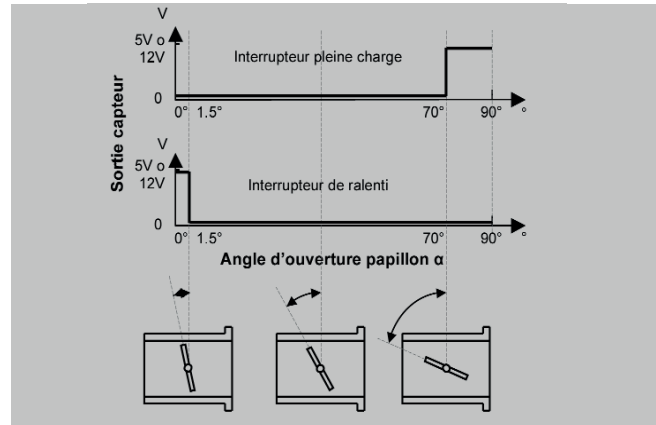

- **A potentiomètre:** ils sont constitués d'une came qui est actionnée par l'axe du boîtier-papillon et est dotée de *contacts balai* (Multifinger), glissants sur un *résistor sérigraphié* dans un *circuit*. Lorsque l'angle d'ouverture du papillon augmente, les contacts glissent sur le résistor et déterminent une augmentation **linéaire** de la résistance du potentiomètre: à partir de la résistance 0 (moteur au ralenti) elle augmente linéairement jusqu'à la valeur maximale (moteur à pleine charge). L'unité de contrôle peut ainsi discriminer tous les angles d'ouverture du papillon et procéder au réglage correct du rapport air/essence.

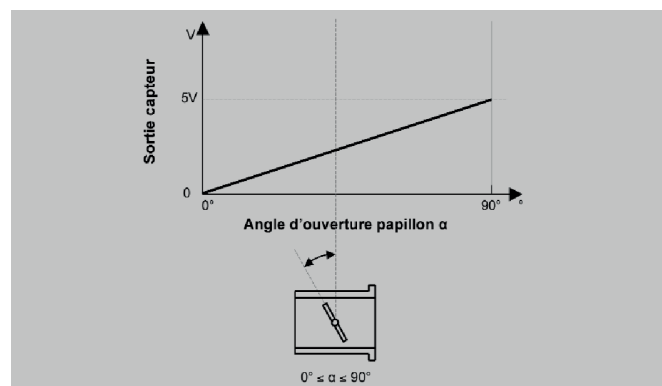

- **A interrupteur et potentiomètre:** une seule came actionne simultanément un interrupteur et un potentiomètre logés dans un *boîtier unique*.

Instructions de montage

Lors du montage du capteur FACET utiliser, si prévues, les vis de fixation fournies dans la boîte, le filetage de celles-ci étant muni de **pâte bloquante** (DryLock) anti-desserrage.

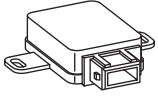

10.5XXX

Drosselklappenpositionssensoren

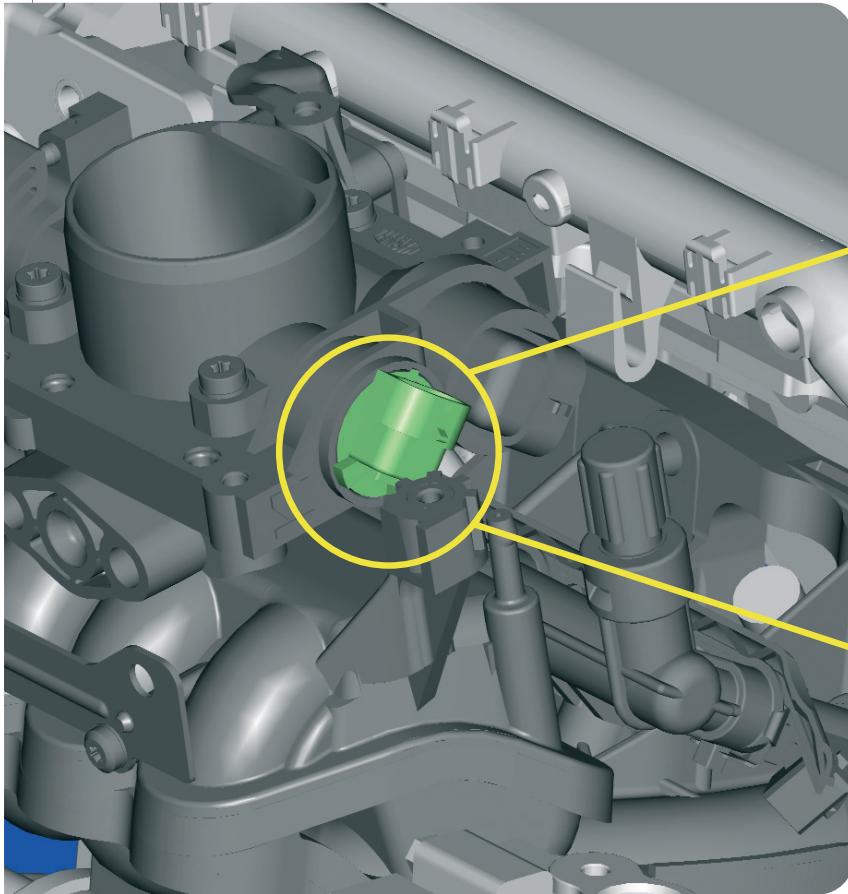

Rendering: bei freundlichem Zugeständnis von FIAT POWERTRAIN TECHNOLOGIES

Die Drosselklappenpositionssensoren sind an der **Drosselklappenachse der Fahrzeuge befestigt und messen den Öffnungswinkel der Drosselklappe**, die durch das Gaspedal betätigt wird und die vom Motor angesaugte Luftmenge reguliert. Das elektrische Signal wird dem Steuergerät des Motors gesendet, um:

- den Betrieb bei Mindestdrehzahl/voller Drehzahl zu erkennen
- die Brennstoffeinspritzung bei Freigabe abzutrennen (cut-off)
- die Mischung Luft/Benzin bei der Beschleunigung anzureichern
- die Einspritzverstellung zu korrigieren
- die Überversorgung zu steuern

Die Drosselklappenpositionssensoren werden bei benzin, **wasserstoffoder alkoholbetriebenen Motoren** angewendet.

Die Hauptursachen für Defekte sind:

- Wasserspritzer unter hohem Druck (z. B. während des Reinigens des Motors) können zur Verringerung der Elektroisolierung führen
- Verschleiß der Widerstandsbahnen

Die Anzeichen für Funktionsstörungen des Sensors sind durch Einschalten der Motoranzeige, unregelmäßige Reaktion auf die Beschleunigungsanfrage und das Fehlen der Motorleistung bei Nennleistung zu erkennen.

Die Drosselklappenpositionssensoren wurden im Hinblick auf Planung und Bau so ausgelegt, dass sie den kritischen Montagebedingungen im Motorraum standhalten. Insbesondere müssen sie folgende **Anforderungen** erfüllen:

- **Betriebstemperatur:** -40°C ÷ +130°C

Die Drosselklappenpositionssensoren werden **Qualität und Haltbarkeitstests unterzogen**, um festzulegen, ob das Produkt für Bau und Verkauf geeignet ist:

- Haltbarkeitsprüfung mit 5.000.000 Betätigungen
- Schwingungsfestigkeit
- Temperaturbeständigkeit (hohe und niedrige Temperaturen)
- Salznebelbeständigkeit
- Beständigkeit gegen starke Temperaturschwankungen
- Stoßfestigkeit
- hermetische Abdichtung

Bei positiven Prüfergebnissen und nach Erteilen der Produktionsgenehmigung erfolgen während der Herstellung strenge Kontrollzyklen auf dem Produkt mit der **100%-Abnahmeprüfung** des Ausgangssignals (Potentiometersensoren) oder des Austauschwinkels (Schaltsensoren) bei Mindest- oder Höchstöffnung der Drosselklappe.

Bauteile und Funktionsprinzip

Es gibt drei verschiedene Arten von Drosselklappenpositionssensoren:

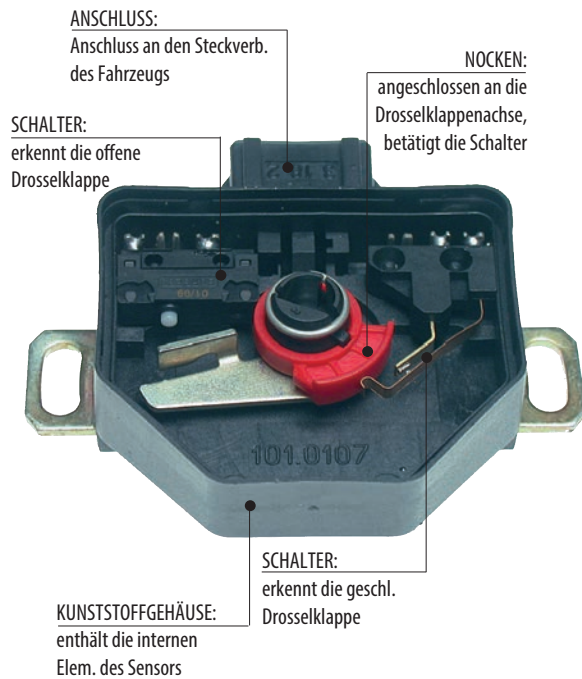

- **Schaltensensoren:** Schaltsensoren bestehen aus zwei *Schaltern*, die mechanisch von einem *Nocken* betätigt werden, der an die Drosselklappenwelle angeschlossen ist.
- *Der Schalter für die Mindestdrehzahl* des Motors erkennt, wenn die Drosselklappe geschlossen ist ($\alpha < 1,5^\circ$): Das Signal ist hoch (Schaltung offen), wenn die Drosselklappe geschlossen ist, und niedrig (Schaltung geschlossen), wenn die Drosselklappe offen ist.
- *Der Schalter für die volle Drehzahl* des Motors erkennt, wenn die Drosselklappe offen ist ($\alpha > 70^\circ$): Das Signal ist hoch (Schaltung offen), wenn die Drosselklappe offen ist, und niedrig (Schaltung geschlossen), wenn die Drosselklappe geschlossen ist.

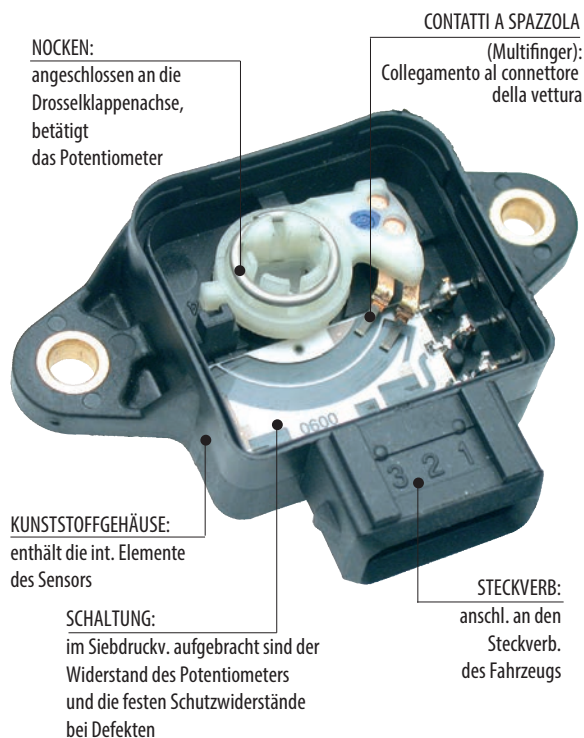
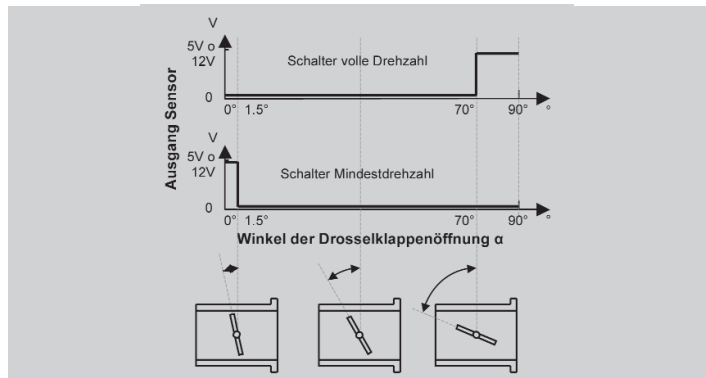

- **Potentiometersensoren:** Potentiometersensoren bestehen aus einem *Nocken*, der von der Drosselklappenwelle betätigt wird. Dieser Nocken ist mit *Bürstenkontakten* (Multifinger) ausgerüstet, die auf einem auf einer *Schaltung* im Siebdruckverfahren aufgetragenen *Widerstand* laufen. Wenn der Öffnungswinkel der Drosselklappe erhöht wird, laufen die Kontakte auf dem Widerstand, wodurch der Widerstand des Potentiometers **linear** erhöht wird: von Widerstand 0 (Minstdrehzahl des Motors) erhöht sich dieser Wert linear bis zum Höchstwert (Motor bei voller Last). Das Steuergerät kann somit jeden Öffnungswinkel unterscheiden und das Verhältnis Luft/Benzin korrekt regeln.

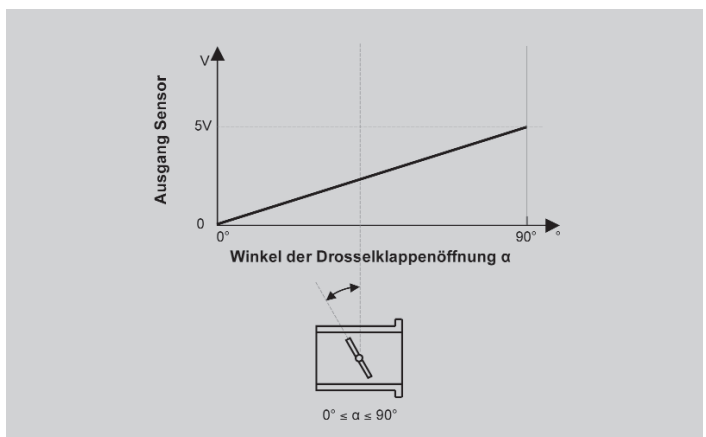

Schalt- und Potentiometersensor: Ein einziger Nocken betätigt gleichzeitig einen Schalter und ein Potentiometer, die sich in einem einzigen Gehäuse befinden.

Montageanweisungen

Bei der Montage des **FACET**-Sensors sind die in der Verpackung enthaltenen Befestigungsschrauben - wenn vorgesehen - zu verwenden, da das Gewinde mit einem **Sicherungsmittel** (DryLock) ausgerüstet ist.

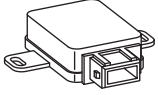

10.5XXX

Sensores de posición de la mariposa

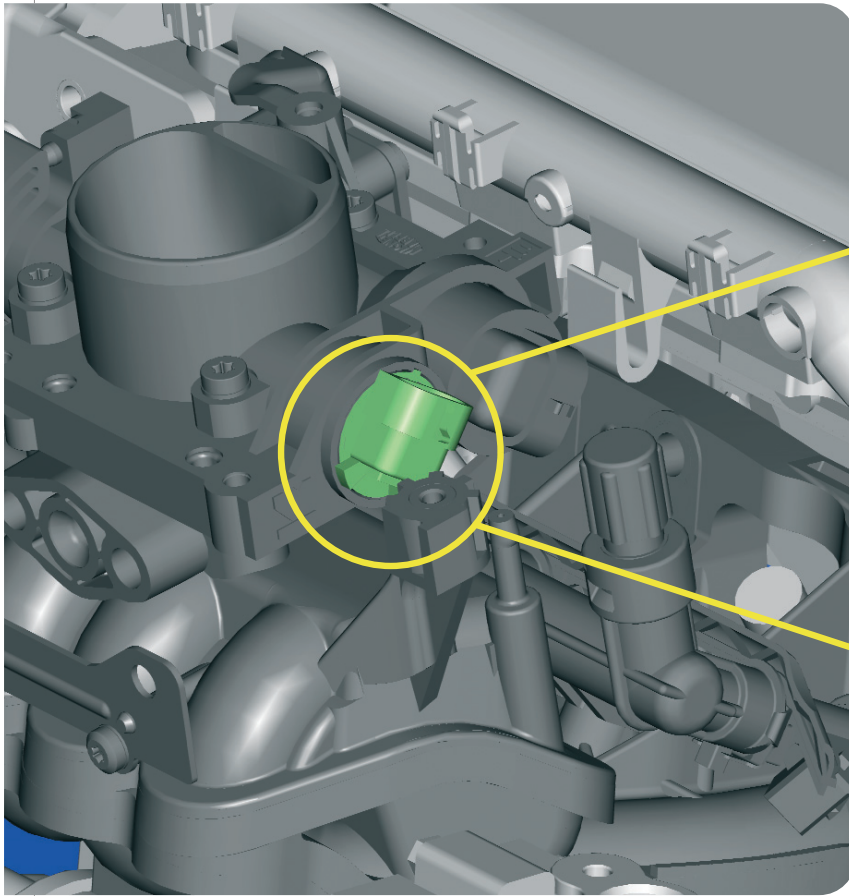

Rendering: por amable concesion de FIAT POWERTRAIN TECHNOLOGIES

Los sensores de posición de la mariposa están montados **en el cuerpo de mariposa de los automóviles y miden el ángulo de apertura de la válvula de mariposa** que, controlada por el pedal del acelerador, regula la cantidad de aire aspirado por el motor. La señal eléctrica se envía a la centralita de control del motor para:

- reconocer el régimen de ralentí/plena carga del motor
- cortar la inyección de combustible en liberación (cut-off)
- enriquecer la mezcla de aire/gasolina en aceleración
- corregir la anticipación de la inyección
- controlar la sobrealimentación.

Los sensores de posición de la mariposa están instalados en **motores con alimentación de gasolina, híbrida o de alcohol**.

Las principales **causas de avería** del producto son:

- las salpicaduras de agua a alta presión (por ejemplo, durante el lavado del motor), que pueden provocar la disminución del aislamiento eléctrico
- el desgaste de las pistas resistivas del circuito

Las **señales de problemas de funcionamiento** del sensor se pueden observar por el encendido del testigo del motor, por una respuesta irregular cuando se solicita una aceleración, por la falta de

rendimiento del motor a potencia máxima.

Los sensores de posición de la mariposa están diseñados y fabricados para soportar las condiciones críticas de montaje en el espacio motor. En especial, deben cumplir con los siguientes **requisitos**:

- *temperatura de funcionamiento*: $-40^{\circ}\text{C} \div +130^{\circ}\text{C}$

Los sensores de posición de la mariposa son sometidos a rigurosos **ensayos de calificación y de duración**, para determinar si el producto es apropiado para ser fabricado y vendido:

- prueba de duración que incluye 5.000.000 maniobras
- resistencia a las vibraciones
- resistencia a la baja y alta temperatura
- resistencia a la niebla salina
- resistencia a los choques térmicos
- resistencia a los golpes
- hermeticidad

Después de haber superado estas pruebas y obtenido la aprobación para la producción, durante el ensamblaje el producto se somete a severos ciclos de control que prevén el **ensayo al 100%** de la señal de salida (sensores de potenciómetro) o del ángulo de intercambio (sensores de interruptor) al mínimo y al máximo de la apertura de la mariposa.

Elementos de construcción y principio de funcionamiento

Existen tres tipos de sensores de posición de la mariposa:

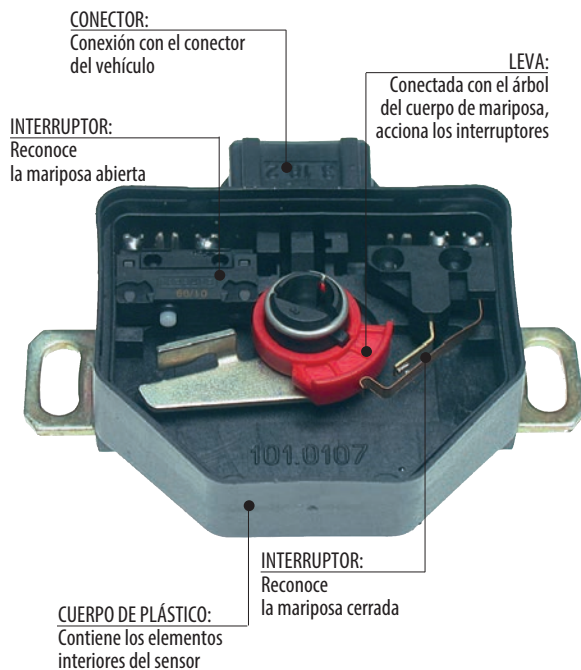

• **De interruptor:** están formados por dos interruptores accionados mecánicamente por una leva conectada con el árbol del cuerpo de mariposa:

• *El interruptor de régimen de ralentí* del motor reconoce el estado de la mariposa cerrada ($\alpha < 1,5^\circ$): la señal es alta (circuito abierto) con la mariposa cerrada, mientras que es baja (circuito cerrado) con la mariposa abierta.

• *El interruptor de plena carga* del motor reconoce el estado de la mariposa abierta ($\alpha > 70^\circ$): la señal es alta (circuito abierto) con la mariposa abierta, mientras que es baja (circuito cerrado) con la mariposa cerrada.

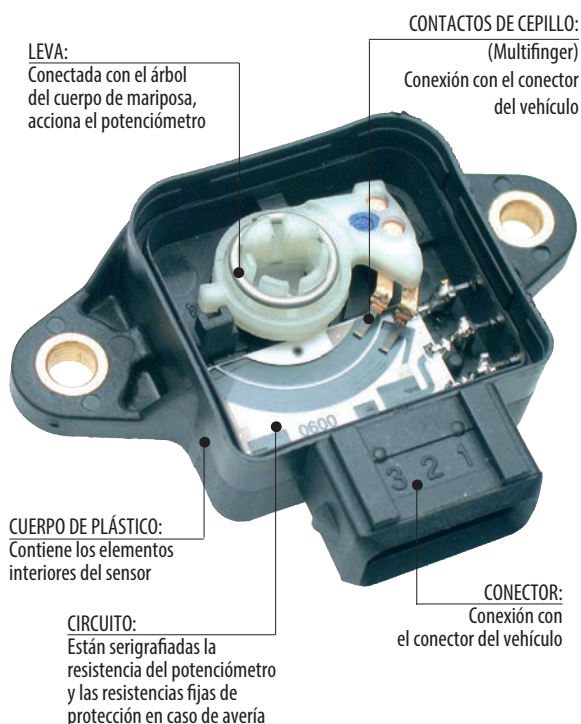
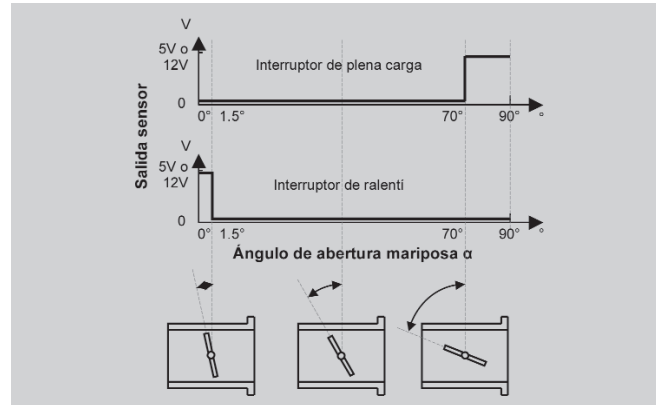

• **De potenciómetro:** están formados por una *leva*, accionada por el árbol del cuerpo de mariposa, dotada de *contactos de cepillo* (Multifinger) que se desplazan sobre una *resistencia serigrafiada* sobre un *circuito*. A medida que aumenta el ángulo de apertura de la mariposa, los contactos se desplazan sobre la resistencia haciendo aumentar **linealmente** la resistencia del potenciómetro: de resistencia 0 (mínimo del motor) aumenta linealmente hasta el valor máximo (motor a plena carga). La centralita puede pues discriminar cada ángulo de apertura de la mariposa y regular correctamente la relación aire/gasolina.

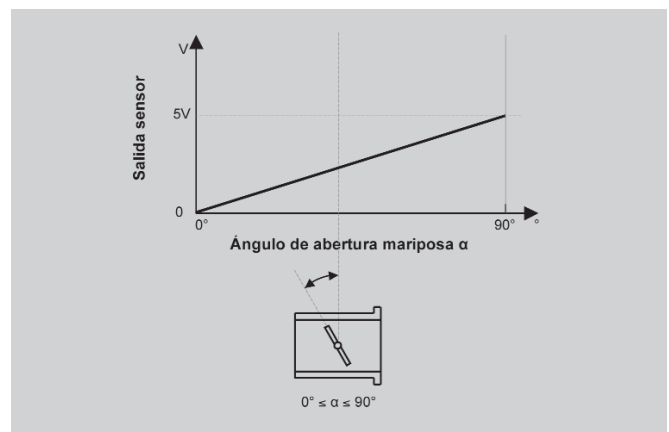

• **De interruptor y potenciómetro:** una leva única acciona simultáneamente un interruptor y un potenciómetro ubicados en un *solo cuerpo*.

Istrucciones de montaje

Para el montaje del sensor **FACET**, utilizar los tornillos de fijación entregados en la caja, cuando estén previstos, puesto que el roscado tiene **pasta de bloqueo** (DryLock) para evitar que se desenrosquen.

10.5001



1

THROTTLE POSITION SENSORS

Adatt./Suitable:

BOSCH

F 000 99S 001

CITROËN

1920 1H

FIAT

7076359

7079246

71737620

71752638 *G

7745679

9944468

INNOCENTI

7076359

LANCIA

71737620

71752638 *G

9944468

MAGNETI MARELLI

219244240500

KIT PF2C

PF 7C/00 *G

PEUGEOT

1920 1H

RENAULT

77 01 204 055

VOLVO

914631-5

91463158

*G without gasket / seal

- senza guarnizione
- sans joint d'étanchéité
- ohne Dichtung
- sin junta

MARKET DIFFUSION: MEDIUM

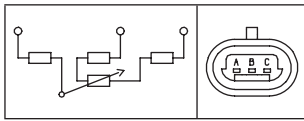
**CITROËN**

AX 11	HDZ(TU1M)	09/86 ⇒ 12/97
BERLINGO I 1.4 i	KFW(TU3JP), KFW(TU3JP)	07/96 ⇒ 12/11
BERLINGO I 1.4 i bivalent	KFW(TU3JP)	04/03 ⇒ 10/05
BERLINGO I 1.8 i	LFX(XU7JB)	05/97 ⇒ 10/02
BERLINGO I 1.8 i 4WD	LFX(XU7JB)	04/97 ⇒ 10/01
SAXO 1.4 VTS	KFW(TU3JP), NFX(TU5JP4)	05/96 ⇒ 06/03
SAXO 1.6	NFX(TU5JP4), NFZ(TU5JP)	02/96 ⇒ 04/04
SAXO 1.6 VTL,VTR	NFX(TU5JP)	05/96 ⇒ 06/03
SAXO 1.6 VTR	NFX(TU5JP4)	05/96 ⇒ 07/99
SAXO 1.6 VTS	NFX(TU5JP4)	06/96 ⇒ 09/03
XANTIA I 1.8 i	LFX(XU7JB)	04/97 ⇒ 04/03
XANTIA II 1.8 i	LFX(XU7JB)	01/98 ⇒ 04/03
XSARA 1.4 i	KFX(TU3JP)	04/97 ⇒ 08/05
XSARA 1.6 i	NFX(TU5JP)	04/97 ⇒ 09/00
XSARA 1.8 i	LFX(XU7JB)	04/97 ⇒ 09/00
XSARA PICASSO 1.6	NFX(TU5JP), KDX(TU3M/Z)	06/02 ⇒
ZX 1.4	KDZ(TU3M/Z)	03/91 ⇒ 06/97
ZX 1.4 i	KDX(TU3M/Z), 198A3.000	03/91 ⇒ 10/97

FIAT

CINQUECENTO 0.9 i.e.	170A1.046	07/91 ⇒ 09/94
CINQUECENTO 0.9 i.e. S	1170A1.046	07/91 ⇒ 07/99
CINQUECENTO 1.1 Sporting	176B2.000	10/94 ⇒ 01/98
DOBLO II 1.6 D Multijet	198A3.000, 199A2.000	02/10 ⇒
FIORINO III 1.3 D Multijet	199A2.000, 188A9.000	11/07 ⇒
IDEA 1.2 D	--	01/08 ⇒
IDEA 1.3 D Multijet	188A9.000, 176A8.000	01/04 ⇒
PALIO 1.2	176A8.000, 141C2.000	07/97 ⇒
PALIO 1.2 75	178B7.045	03/98 ⇒
PALIO 1.2 MPI	178C4.066	01/02 ⇒
PALIO 1.6 16V 100	178C8.098	01/98 ⇒
PANDA I 1.1	156C.046	05/91 ⇒ 03/95
PANDA I 1000 4x4	141C2.000	05/86 ⇒ 12/94
PANDA I 1000 i.e	156A2.246	08/92 ⇒ 02/04
PANDA I 1000 i.e. Cat	141C2.000, 156C.046	10/87 ⇒ 08/98
PANDA I 1100	156C.046, 176A6.000	05/91 ⇒ 12/99
PANDA I 1100 4x4	176B2.000	02/95 ⇒ 07/04
PANDA I 1100 Trekking 4x4	156C.046	10/91 ⇒ 07/04
PANDA I 900	1170A1.046	04/92 ⇒ 12/96
PANDA I 900 i.e.	1170A1.046	01/98 ⇒

FIAT

PUNTO I 1.1	176B2.000	04/96 ⇒ 02/00
PUNTO I 55 1.1	176A6.000, 176A7.000	09/93 ⇒ 09/99
PUNTO I 60 1.2	176A7.000, 199A2.000	09/93 ⇒ 06/00
PUNTO I 75 1.2	176A8.000	10/93 ⇒ 09/99
PUNTO II 1.3 D Multijet	188A9.000	02/05 ⇒ 10/09
PUNTO II 1.3 JTD	188A9.000	06/03 ⇒ 10/05
PUNTO II 1.3 JTD 16V	188A9.000	06/03 ⇒ 03/12
QUBO 1.3 D Multijet	199A2.000, 178B5.000	02/08 ⇒
SIENA 1.2	178B5.000, --	01/98 ⇒
STRADA 1.2	178B5.000	06/99 ⇒ 12/06
UNO 1.0	156A2.000	06/89 ⇒ 02/92
UNO 1.0 i.e.	146C7.000	09/89 ⇒ 03/94

FIAT (BR)

PALIO 1.0i	1.0Mpi	01/96 ⇒
PALIO 1.5i	1.5Mpi	01/96 ⇒ 12/00
PALIO 1.6i	1.6Spi	01/99 ⇒ 12/99
SIENA 1.0i	1.0Mpi	01/99 ⇒ 12/00
SIENA 1.6i	1.6Mpi	01/98 ⇒ 12/00
STRADA 1.5i	1.5Mpi	01/99 ⇒ 12/01
UNO 1.5i	1.5Spi	01/92 ⇒ 12/96
UNO 1.5i Furgoneta	1.5Mpi	01/92 ⇒
UNO CS 1.5i	1.5Spi	01/92 ⇒ 12/96
UNO MILLE 1.0i	1.0Mpi	01/96 ⇒

INNOCENTI

MILLE 1.0	146C7.000	07/95 ⇒ 05/97
MILLE 1.0i	146C7.000	02/93 ⇒ 02/98

LANCIA

MUSA 1.3 D Multijet	--, 199A2.000	10/04 ⇒ 12/12
Y 1.1	176B2.000	11/95 ⇒ 09/03
Y 1.2	840A3.000	03/96 ⇒ 09/03
YPSILON I 1.3 D Multijet	199A2.000, KFW(TU3JP)	09/06 ⇒ 12/11
YPSILON I 1.3 JTD	188A9.000	10/03 ⇒ 12/11

PEUGEOT

106 I 1.1	HDZ(TU1M)	09/91 ⇒ 04/96
106 II 1.4 i	KFW(TU3JP), K6C(TU3JP)	05/96 ⇒ 07/04
106 II 1.6 S16	NFX(TU5J4)	05/96 ⇒ 07/04
206 1.1	HFY(TU1JP)	08/98 ⇒ 07/00
206 1.1 i	HFZ(TU1JP)	09/98 ⇒
206 1.4 i	K6C(TU3JP), KFW(TU3JP)	09/98 ⇒
206 1.6 i	NFX(TU5JP)	09/98 ⇒ 12/00
306 1.4	KFW(TU3JP), KFW(TU3JP)	04/93 ⇒ 04/02
306 1.4 SL	KFW(TU3JP), KFX(TU3JP)	06/94 ⇒ 05/01
306 1.6	NFX(TU5JP)	05/93 ⇒ 10/00
306 1.6 SR	NFX(TU5JP)	06/94 ⇒ 10/00
406 1.8	LFX(XU7JB)	05/97 ⇒ 10/04
PARTNER I 1.4	KFX(TU3JP), K6C(TU3JP)	06/96 ⇒ 12/15
PARTNER I 1.8	LFX(XU7JB)	03/97 ⇒ 12/03
RANCH 1.4	K6C(TU3JP), D7F710	06/96 ⇒
RANCH 1.8	LFX(XU7JB)	05/97 ⇒

RENAULT

CLIO I 1.2	D7F730	01/96 ⇒ 09/98
CLIO II 1.2	D7F710, D7F722	09/98 ⇒
CLIO II 1.2 LPG	D7F722, D7F720	09/98 ⇒ 06/09
CLIO III 1.5 dCi	K9K766	06/05 ⇒
KANGOO I 1.2	D7F720, N7Q700	08/97 ⇒
LAGUNA 1.2.0	N7Q700, N7Q700	06/95 ⇒ 02/01
LAGUNA 1.2.0 16V	N7Q700, N7Q710	06/95 ⇒ 03/01
SAFRANE II 2.0 16V	N7Q710, D7F700	07/96 ⇒ 12/00
TWINGO I 1.2	D7F700, B41645	05/96 ⇒

VOLVO

S40 I 1.6	B41645, B41845	09/95 ⇒ 08/99
S40 I 1.8	B41845, B4194T	06/01 ⇒ 08/99
S40 I 1.8 16V	B4184510	08/00 ⇒
S40 I 1.9 T4	B4194T, B42045	05/97 ⇒ 07/00
S40 I 2.0	B42045, B4204T	07/95 ⇒ 08/99
S40 I 2.0 T	B4204T, B41645	06/01 ⇒ 12/03
S40 I 2.0 T4	B4204T5	07/00 ⇒ 12/03
V40 I 1.6	B41645, B41845	12/95 ⇒ 08/99
V40 I 1.8	B41845, B4194T	07/95 ⇒ 08/99
V40 I 1.8 16V	B4184510	08/00 ⇒
V40 I 1.9 T4	B4194T, B42045	05/97 ⇒ 07/00
V40 I 2.0	B42045, B4204T	07/95 ⇒ 08/99
V40 I 2.0 T	B4204T, AR67103	06/01 ⇒ 06/04
V40 I 2.0 T4	B4204T5	07/00 ⇒ 06/04

10.5002



3,5

THROTTLE POSITION SENSORS

Adatt./Suitable:

ALFA ROMEO

60549359

60811198

7637025

9946862

BOSCH

0 280 122 001

0 280 122 003

0 280 122 004

0 280 122 008

0 280 122 013

CITROËN

1628 1E

1628 L1

1920 Z4

96 038 938

DAF

1292636

FIAT

60808043

7637025

9603893880

9617220680

9625299980

9946862

9947132

GENERAL MOTORS

90 323 839

HOLDEN

90323839

HYUNDAI

OK9A5-18911

35170-22001

35170-22010

35170-23000

IVECO

0000008029510

8029510

KIA

OK011-18911

OK247-18911

OK30A-18911

OK9A5-18911

35170-22001

LANCIA

7637025

9603893880

9625299980

9947132

OPEL

8 26 924

PEUGEOT

1628 1E

1628 L1

1920 Z4

PORSCHE

944 606 116 00

944 606 116 01

RENAULT

77 01 034 407

77 01 047 921

SAAB

46 61 062

88 57 195

SCANIA

4661062

TOYOTA

89452-05010

VOLVO

133638-5

1336385S

345003-0

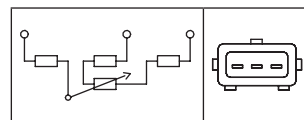
**ALFA ROMEO**

33 II 1.4 4x4	AR30755	07/90 ⇒ 12/92
33 II 1.4 i.e.	AR30755	06/91 ⇒ 09/94
33 II 1.4 i.e. 4x4	AR30755	07/90 ⇒ 09/94
33 II 1.5 i.e.	AR30751	01/90 ⇒ 09/94
33 II 1.5 i.e.	AR30738, AR30736	07/90 ⇒ 12/95
33 II 1.7 i.e.	AR30736, AR30736	01/90 ⇒ 12/95
33 II 1.7 i.e. 4x4	AR30736, AR16199	01/90 ⇒ 09/94
145 1.4 i.e. 16V T.S.	AR33503	12/96 ⇒ 01/01
145 1.7 i.e. 16V	AR33401	10/94 ⇒ 12/96

ALFA ROMEO		
145 1.8 i.e. 16V.T.S.	AR67106	12/96 ⇒ 12/98
145 1.8 i.e. 16V.T.S. [BRA]	AR67199	10/96 ⇒ 02/99
145 2.0 16V.T.S.	AR67204	10/95 ⇒ 01/01
145 2.0 16V.T.SPARK [BRA]	AR67299	10/96 ⇒ 02/99
145 2.0 16V.T.SPARK Q.V. [BRA]	AR67299	10/95 ⇒ 09/96
146 1.4 i.e. 16V.T.S.	AR33503	11/96 ⇒ 01/01
146 1.6 i.e. 16V.T.S.	AR67601	11/96 ⇒ 10/01
146 1.7 i.e. 16V	AR33401	12/94 ⇒ 12/96
146 1.8 i.e. 16V.T.S.	AR67106	11/96 ⇒ 01/01
146 2.0 16V.T.S.	AR67204	10/95 ⇒ 01/01
155 1.6 16V.T.S.	AR67601	05/96 ⇒ 12/97
155 1.7.T.S.	AR67103, AR67101	04/93 ⇒ 04/96
155 1.7.T.S. 16V	AR67106	05/96 ⇒ 12/97
155 1.8.T.S.	AR67101	02/92 ⇒ 05/94
155 1.8.T.S. Sport	AR67101, AR67201	03/92 ⇒ 12/96
155 2.0.T.S.	AR67201, AR67204	02/92 ⇒ 05/95
155 2.0.T.S. 16V	AR67204, AR67301	03/95 ⇒ 12/97
155 2.5 V6	AR67301, AR66301	03/92 ⇒ 12/97
156 1.6 16V.T.SPARK	AR67601	09/97 ⇒ 09/05
156 1.6 16V.T.SPARK.	AR67601	05/00 ⇒ 05/06
164 2.0.T.S.	AR64103	09/92 ⇒ 09/98
164 3.0	AR64304	04/93 ⇒ 02/95
164 3.0i 24V	AR66301, AR64307	09/92 ⇒ 09/98
164 3.0i 24V Q4	AR64307, AR64305	09/92 ⇒ 10/98
164 3.0i 24V QV	AR64304	09/92 ⇒ 09/98
164 3.0i 24V QV [USA]	AR64308	04/93 ⇒ 02/95
164 3.0i 24V QV Trazione integrale	AR64307	11/92 ⇒ 10/97
164 3.0i V6	AR64305, AR30738	09/92 ⇒ 09/98
164 3.0i 24V Super [BRA]	64306	09/92 ⇒ 10/98
164 3.0i 24V Super Q4	AR66304	03/95 ⇒ 12/98
GTV 2.0.T.SPARK 16V	AR16201	06/95 ⇒ 10/05
GTV 3.0 V6 24V	AR16102	10/96 ⇒ 10/00
SPIDER II 2.0.T.SPARK 16V	AR16201	06/95 ⇒ 04/05
SPIDER II 3.0 12V [BRA]	AR16199, KFY(TU3FJ2)	09/95 ⇒
SPIDER II 3.0 V6	AR16101	06/95 ⇒ 04/05

CITROËN		
AX 1.4 GTi	KFY(TU3FJ2), K6B(TU3FJ2)	06/91 ⇒ 12/96
AX 14	K6B(TU3FJ2), KD4	04/87 ⇒ 04/97
AX 14 4x4	KD4, 159C	06/91 ⇒ 12/96
BX 1.9	159C, D6D	09/85 ⇒ 12/94
BX 1.9 GTi	D6D, D6A(XU9J2)	01/87 ⇒ 01/92
BX 19	D6A(XU9J2), D6A(XU9J2)	07/86 ⇒ 12/94
BX 19 Cat	DFZ(XU9J1)	07/86 ⇒ 12/94
BX 19 GTi	D6A(XU9J2), RFT(XU10J4/Z)	07/86 ⇒ 02/93
BX 19 GTi 4x4	DKZ(XU9JA)	06/88 ⇒ 02/93
EVASION 2.0 16V	RFV(XU10J4R)	05/98 ⇒ 04/00
EVASION 2.0 Turbo C.T.	RGX(XU10J2TE)	06/94 ⇒ 07/02
SAXO 1.6	NFZ(TU5JP)	02/96 ⇒ 06/03
SAXO 1.6 VTL,VTR	NFZ(TU5JP)	05/96 ⇒ 06/03
XANTIA I 1.8 i 16V	LFY(XU7JP4)	06/95 ⇒ 04/03
XANTIA I 2.0 i 16V	RFT(XU10J4/Z), SFZ(ZPJ/Z)	03/93 ⇒ 04/03
XANTIA I 2.0 i SX 16V	XU10J4D	04/94 ⇒ 05/95
XANTIA I 2.0 i VSX 16V	XU10J4D	03/93 ⇒ 05/95
XANTIA I 2.0 Turbo	RGX(XU10J2TE)	06/95 ⇒ 04/03
XANTIA II 1.8 i 16V	LFY(XU7JP4)	01/98 ⇒ 04/03
XANTIA II 2.0 i 16V	RFV(XU10J4R)	01/98 ⇒ 04/03
XANTIA II 2.0 Turbo	RGX(XU10J2TE)	01/98 ⇒ 04/03
XM I 2.0 i	RFZ(XU10J2)	05/89 ⇒ 06/94
XM I 2.0 i Turbo	RGY(XU10J2TE/Z)	09/92 ⇒ 06/94
XM I 2.0 Turbo	RGY(XU10J2TE/Z)	09/92 ⇒ 04/94
XM I 3.0	UFZ(ZPJ/Z)	05/89 ⇒ 05/94
XM I 3.0 V6	SKZ(ZPJ/Z), SKZ(ZPJ4/Z)	05/89 ⇒ 06/94
XM I 3.0 V6 24V	SFZ(ZPJ4/Z), RGX(XU10J2TE)	07/90 ⇒ 06/94
XM II 2.0 i 16V	RFV(XU10J4R)	05/94 ⇒ 10/00
XM II 2.0 Turbo	RGX(XU10J2TE), SFZ(ZPJ/Z)	05/94 ⇒ 10/00
XM II 3.0 V6	SFZ(ZPJ/Z), SKZ(ZPJ4/Z)	05/94 ⇒ 10/00
XM II 3.0 V6 24V	SKZ(ZPJ4/Z), RFT(XU10J4/Z)	05/94 ⇒ 10/00
XSARA 1.6 i	NFZ(TU5JP)	04/97 ⇒ 09/00
XSARA 1.8 i 16V	LFY(XU7JP4)	04/97 ⇒ 09/00
XSARA 2.0 16V	RFV(XU10J4R)	07/98 ⇒ 09/00
ZX 1.8	LFY(XU7JP4)	04/96 ⇒ 10/97
ZX 1.8 i 16V	LFY(XU7JP4)	01/96 ⇒ 02/98
ZX 2.0 i 16V	RFT(XU10J4/Z), 176A4.000	07/92 ⇒ 10/97

FIAT		
BRAVO I 2.0 HGT 20V	182A1.000	10/95 ⇒ 07/98
COUPE 2.0 20V	182A1.000	08/96 ⇒ 09/98
COUPE 2.0 20V Turbo	175A3.000	08/96 ⇒ 08/00
CROMA I 2000 16V	154E1.000	08/92 ⇒ 08/96
CROMA I 2000 i.e. 16V	154E1.027	03/95 ⇒ 12/96
CROMA I 2500 V6	834G.000	06/93 ⇒ 08/96
MAREA 2.0 150 20V	182A1.000	09/96 ⇒ 04/99

FIAT		
MAREA 2.0i 20v [BRA]	182A1.011	10/96 ⇒ 04/99
PUNTO I 1.4 GT Turbo	176A4.000, G4JS	10/93 ⇒ 07/99
ULYSSE I 2.0 Turbo	RGX(XU10J2CTE)	06/94 ⇒ 08/02

FIAT (BR)		
MAREA 2.0i 20v	2.0Mpi	01/99 ⇒ 12/00
MAREA 2.0i 20v Turbo	2.0MpiTurbo	01/99 ⇒
TIPO 1.6i	1.6Mpi	01/96 ⇒ 12/97
UNO 1.6i	1.6Mpi	01/95 ⇒ 12/96

HOLDEN		
ASTRA_TR 1.8i 16v Hatchback	C18SEL	09/96 ⇒ 09/98
ASTRA_TR 1.8i 16v Sedan	C18SEL	09/96 ⇒ 09/98
ASTRA_TR 2.0i 16V Hatchback	X20XE	09/96 ⇒ 09/98
CALIBRA_YE 2.0i	C20NE	09/91 ⇒ 07/95
CALIBRA_YE 2.0i 16V	X20XE	08/95 ⇒ 10/97
FRONTERA_UT 2.0i	X20SE	10/95 ⇒ 03/99

HYUNDAI		
ACCENT I 1.3	G4EH	10/94 ⇒ 01/00
ACCENT I 1.3 i 12V	G4EH	10/94 ⇒ 01/00
ACCENT I 1.5	G4EK	10/94 ⇒ 07/99
ACCENT I 1.5 i 12V	G4EK	10/94 ⇒ 01/00
ACCENT I 1.5 i 16V	G4ER	10/95 ⇒ 01/00
COUPE 1.6 16V	G4GR	03/98 ⇒ 04/02
COUPE I 1.6 i 16V	4G61	12/96 ⇒ 04/02
COUPE I 2.0 16V	G4GF	08/96 ⇒ 04/02
COUPE II 2.7 V6	G6BA-G	03/02 ⇒ 08/09
ELANTRA II 1.6 i 16V	G4GR	06/95 ⇒ 05/00
ELANTRA II 1.8 i 16V	G4GM	05/95 ⇒ 05/00
ELANTRA II 2.0 i 16V	G4DF	06/97 ⇒ 05/00
EXCEL 1.3 i 12V	G4EH	09/94 ⇒ 08/99
EXCEL 1.5 i 12V	G4EK	09/94 ⇒ 08/99
EXCEL 1.5 i 16V GT	G4ER	10/96 ⇒ 08/99
H-1 I 2.4	G4JS, G4GL	11/01 ⇒ 04/04
LANTRA II 1.5 12V	G4EK	12/96 ⇒ 10/00
LANTRA II 1.6 i	G4GR	11/95 ⇒ 10/00
LANTRA II 1.8 16V	G4GM	11/95 ⇒ 10/00
LANTRA II 2.0 16V	G4GF	11/95 ⇒ 10/00
S COUPE 1.5 i	G4EK	04/92 ⇒ 05/96
S COUPE 1.5 i Turbo	G4EK-TC	04/91 ⇒ 05/96
TIBURON 1.6 i 16V	G4GL, B3	08/00 ⇒
TIBURON 2.0 i 16V	G4DF	08/99 ⇒
TRAJET 2.7 V6	G6BA-G	09/00 ⇒ 07/08
TUCSON 2.7 Trazione integrale	G6BA-G	08/04 ⇒

KIA		
AVELLA 1.3	B3	11/95 ⇒ 12/01
CARENS I 1.8 i	T8	11/00 ⇒ 07/02
CARENS II 1.6	GA6D	07/02 ⇒
CARENS II 1.8	T8	07/02 ⇒
CARNIVAL I 2.5 V6	K5	08/99 ⇒ 06/06
CLARUS 1.8 i 16V	T8	07/96 ⇒
CLARUS 2.0 i 16V	FE(16V)	07/96 ⇒
CREDOS 2.0 [AUS]	--	06/95 ⇒ 10/00
PRIDE 1.3	B3A5	08/99 ⇒ 05/01
PRIDE 1.3 16V	B3, A3E	01/90 ⇒ 09/01
RETONA 2.0 16V	FE(16V)	05/00 ⇒
RIO I 1.3	A3E, A5D	08/00 ⇒ 02/05
RIO I 1.5 16V	A5D, --	08/00 ⇒ 02/05
RIO I 1.6 [CAN] [USA]	--	06/00 ⇒ 02/05
SEDONA 2.5	--	06/98 ⇒
SEDONA 2.5 V6	--	07/01 ⇒
SEPHIA I 1.5 i	B5	02/96 ⇒ 10/97
SEPHIA I 1.8 i 16V	--, BFD	01/95 ⇒ 10/97
SEPHIA II 1.5 i 16V	--	09/97 ⇒
SEPHIA II 1.6 i 16V	--	07/00 ⇒
SEPHIA II 1.8 i 16V	--	09/97 ⇒
SHUMA I 1.5	OK280	03/96 ⇒ 12/98
SHUMA I 1.5 i 16V	BFD, T8	10/97 ⇒ 10/01
SHUMA I 1.6	GA6D	01/01 ⇒ 12/01
SHUMA I 1.8 i 16V	T8	10/97 ⇒ 03/01
SHUMA II 1.6	GA6D	05/01 ⇒ 08/04
SHUMA II 1.8	T8, 838A1.000	05/01 ⇒ 08/04
SPECTRA 1.5 i	--	09/97 ⇒
SPECTRA 1.5 i 16V	--	09/97 ⇒
SPECTRA 1.6 i 16V	--	07/00 ⇒
SPECTRA 1.8 i 16V	--	09/97 ⇒
SPORTAGE I 2.0	FE(16V)	10/00 ⇒ 08/03
SPORTAGE I 2.0 4WD	FE(16V)	10/00 ⇒ 08/03
SPORTAGE I 2.0 i 16V	FE(16V)	10/99 ⇒ 08/03
SPORTAGE I 2.0 i 16V 4WD	FE(16V)	04/94 ⇒ 08/03
SPORTAGE I 2.2 D 4WD	--	08/94 ⇒ 04/99
TOWNER 0.8i MPI	--	10/97 ⇒

LANCIA		
KAPPA 2.0 16V Turbo	834A4.000	02/95 ⇒ 10/01
KAPPA 2.0 20V	838A1.000, 838A2.000	10/94 ⇒ 10/01
KAPPA 2.0 20V Turbo	175A3.000	06/98 ⇒ 10/01
KAPPA 2.4 20V	838A2.000, 185E	08/94 ⇒ 10/01

LANCIA		
KAPPA 3.0 24V	838B.000	08/94 ⇒ 10/01
THEMA 2000 16V	834F1.000	05/92 ⇒ 07/94
THEMA 2000 16V Turbo	834F2.000	10/92 ⇒ 07/94
THEMA 2000 Turbo 16V	834F2.000	11/92 ⇒ 07/94
THEMA 3000 V6	834F.000	08/92 ⇒ 07/94
ZETA 2.0 16V	RFV(XU10J4R)	05/98 ⇒ 07/00
ZETA 2.0 Turbo	RGX(XU10J2TE)	05/95 ⇒ 09/02

OPEL		
ASTRA F 1.8 i 16V	185E, C20NE	06/93 ⇒ 03/01
ASTRA F 2.0 i	C20NE	09/91 ⇒ 09/98
ASTRA F 2.0 i 16V	X20XE	02/95 ⇒ 08/00
FRONTERA A 2.0 i	C20NE, C20SEL	03/92 ⇒ 10/98
OMEGA B 2.0	X20SE	03/94 ⇒ 09/99
OMEGA B 2.0 16V	X20XE	03/94 ⇒ 09/99
OMEGA B 2.5 V6	X25XE	03/94 ⇒ 09/00
OMEGA B 2.6	--	05/94 ⇒ 05/99
OMEGA B 2.6 V6	Y26SE	09/00 ⇒ 07/03
OMEGA B 3.0 V6	X30XE	04/94 ⇒ 02/01
OMEGA B 3.2 V6	Y32SE	02/01 ⇒ 07/03
SINTRA 2.2 i 16V	X22XE	11/96 ⇒ 04/99
SINTRA 3.0 i 24V	X30XE	11/96 ⇒ 04/99
VECTRA A 2.0 i	Z0NE	09/88 ⇒ 10/90
VECTRA A 2.0 i 4x4	Z0NE	01/89 ⇒ 10/90
VECTRA A 2.0 i Cat	C20NE	09/88 ⇒ 11/95
VECTRA A 2.0 i Cat 4x4	C20NE	01/89 ⇒ 11/95
VECTRA B 1.8 i 16V	X18XE	10/95 ⇒ 09/00
VECTRA B 2.0 i	Z0NEJ	10/95 ⇒ 04/02
VECTRA B 2.0 i 16V	C20SEL, NFY(TU5J2)	10/95 ⇒ 09/00
VECTRA B 2.5 i V6	X25XE	10/95 ⇒ 09/00

PEUGEOT		
106 I 1.4	KFZ(TU3J2/Z)	09/91 ⇒ 04/96
106 I 1.4 i	TU3FJ	01/91 ⇒ 12/96
106 I 1.4 i XSI	TU3J	09/91 ⇒ 03/96
106 I 1.6	NFY(TU5J2), NFW(TU5J2)	06/93 ⇒ 04/96
106 II 1.6 i	NFW(TU5J2), LFY(XU7JP4)	05/96 ⇒ 10/99
306 1.6	NFZ(TU5JP)	05/93 ⇒ 10/00
306 1.6 SR	NFZ(TU5JP)	06/94 ⇒ 10/00
306 1.8 16V	LFY(XU7JP4), RFV(XU10J4R)	03/97 ⇒ 10/03
306 2.0	RFV(XU10J4R), RFV(XU10J4R)	03/97 ⇒ 04/02
306 2.0 16V	RFV(XU10J4R), RFT(XU10J4)	03/97 ⇒ 04/02
306 2.0 S16	RFT(XU10J4), RFV(XU10J4R)	05/93 ⇒ 05/01
405 II 2.0 16V	RFT(XU10J4)	06/94 ⇒ 10/95
406 1.8 16V	LFY(XU7JP4)	11/95 ⇒ 10/00
406 2.0 16V	RFV(XU10J4R), RGX(XU10J2TE)	11/95 ⇒ 12/04
406 2.0 Turbo	RGX(XU10J2TE)	04/96 ⇒ 10/04
605 2.0 16V	RFV(XU10J4R)	07/94 ⇒ 09/99
605 2.0 Turbo	RGX(XU10J2TE), UFZ(ZPJ)	07/91 ⇒ 09/99
605 3.0	UFZ(ZPJ), M64.05	08/89 ⇒ 09/99
806 2.0 16V	RFV(XU10J4R)	05/98 ⇒ 09/00
806 2.0 Turbo	RGX(XU10J2TE)	06/94 ⇒ 08/02

PORSCHE		
911 III 3.6 Carrera	M64.05, M64.05	10/93 ⇒ 09/97
911 III 3.6 Carrera 4	M64.05, M64.60R	07/94 ⇒ 09/97
911 III 3.6 Turbo 4	M64.60	03/95 ⇒ 09/97
911 III 3.6 Turbo GT2	M64.60R	03/95 ⇒ 09/97
911 III 3.6 Turbo GT2 4	M64.60R, M64.055	08/95 ⇒ 09/97
911 III 3.8 Carrera	M64.055, M64.055	06/95 ⇒ 09/97
911 III 3.8 Carrera 4	M64.055, M44.43	06/95 ⇒ 09/97
911 III 3.8 Carrera RS	M64.20	06/95 ⇒ 09/97
968 3.0	M44.43, F3N743	06/91 ⇒ 11/95

RENAULT		
19 I 1.7	F3N746	08/88 ⇒ 12/92
19 II 1.7	F3N743, N7U700	04/92 ⇒ 12/95
SAFRANE II 2.5 20V	N7U700, B204I	07/96 ⇒ 12/00

SAAB		
900 I 2.1 -16	B212I	08/90 ⇒ 06/94
900 II 2.0 -16 Turbo	B204L	07/93 ⇒ 02/98
900 II 2.0 i	B204I, B204E	07/93 ⇒ 02/98
900 II 2.3 -16	B234I	07/93 ⇒ 02/98
9000 2.0 -16 CD	B204E, B202	09/93 ⇒ 12/98
9000 2.0 -16 CS	B204I	09/93 ⇒ 12/98
9000 2.0 -16 ND Turbo	B204E	09/93 ⇒ 12/98
9000 2.0 -16 Turbo	B202, B202XL	09/84 ⇒ 08/93
9000 2.0 -16 Turbo CD	B202XL, 4A-FE	09/88 ⇒ 12/98
9000 2.3 -16 Turbo CS	B234R	02/93 ⇒ 12/98
9000 2.3 -16 CD	B234I	08/89 ⇒ 12/98
9000 2.3 -16 CD Turbo	B234L	07/90 ⇒ 12/98

TOYOTA			
AVENSIS I 1.6	4A-FE, 4A-FE	09/97 ⇒	10/00
CARINA E 1.6	4A-FE, 18SE	04/92 ⇒	09/97
CARINA E 1.6 16V	4A-FE	12/94 ⇒	09/97
CARINA E 1.6 GLI	4A-FE	04/92 ⇒	09/97
CARINA E 1.6 i	4A-FE	02/95 ⇒	09/97
COROLLA VIII 1.4	4ZZ-FE	10/99 ⇒	01/02
COROLLA VIII 1.4 16V	4ZZ-FE	02/00 ⇒	11/01

VAUXHALL			
ASTRA III 1.8	C18XE	09/94 ⇒	08/96
ASTRA III 1.8 16V	C18XEL	11/94 ⇒	03/01
ASTRA III 1.8 i 16V	18SE, C20NE	06/93 ⇒	02/98
ASTRA III 2.0 i	C20NE	09/91 ⇒	09/98
ASTRA III 2.0 i 16V	X20XEV	01/94 ⇒	09/98
FRONTERA A 2.0	C20NE, C20NE	04/95 ⇒	08/98
FRONTERA A 2.0 i	C20NE, B18EP	03/92 ⇒	10/98
OMEGA B 2.0	X20SE	03/94 ⇒	09/99
OMEGA B 2.0 16V	X20XEV	03/94 ⇒	07/01
OMEGA B 2.5 V6	X25XE	03/94 ⇒	09/00
OMEGA B 2.6 V6	Y26SE	08/00 ⇒	07/03
OMEGA B 3.0 V6	X30XE	04/94 ⇒	07/00
OMEGA B 3.2 V6	Y32SE	02/01 ⇒	07/03
SINTRA 2.2 i 16V	X22XE	11/96 ⇒	04/99
SINTRA 3.0 i 24V	X30XE	11/96 ⇒	04/99
VECTRA B 1.8 i 16V	X18XE	10/95 ⇒	09/00
VECTRA B 2.0 i	Z0NEJ	10/95 ⇒	03/02
VECTRA B 2.0 i 16V	X20XEV	10/95 ⇒	01/01
VECTRA B 2.5 i V6	X25XE	09/95 ⇒	08/00

VOLVO			
440 1.6	B16F	09/88 ⇒	12/96
440 1.7	B18EP, B18U	09/88 ⇒	12/96
440 1.8	B18U, B20F	08/91 ⇒	12/96
440 2.0	B20F, B18EP	08/92 ⇒	07/96
460 1.6	B16F	07/92 ⇒	07/96
460 1.7	B18EP, B20F	08/89 ⇒	07/95
460 1.8	B18U	08/91 ⇒	07/96
460 2.0	B20F, B18EP	08/92 ⇒	07/96
480 1.7	B18EP, B5202S	08/89 ⇒	07/96
480 2.0	B20F	08/92 ⇒	09/95
850 2.0	B5202S, B5204FT	06/91 ⇒	12/96
850 2.0 10V	B5202FS	08/94 ⇒	12/97
850 2.0 Turbo	B5204FT, B5252	02/93 ⇒	10/97
850 2.3	B5234FS	01/96 ⇒	10/96
850 2.3 T5	B5234FT	02/93 ⇒	12/96
850 2.3 T5-R	B5234T4	08/95 ⇒	12/96
850 2.3 Turbo R	B5234T5	06/95 ⇒	10/97
850 2.4	B5252, B5252FS	06/91 ⇒	12/96
850 2.4 AWD	B5254T	04/96 ⇒	12/96
850 2.4 GLE	B5254T	09/93 ⇒	10/97
850 2.5 10V	B5252FS, B6304F	06/91 ⇒	12/97
850 2.5 20V	B5254FS	08/91 ⇒	12/97
960 I 2.9	B6304F, B6254FS	08/90 ⇒	07/94
960 II 2.4	B6244FS	01/95 ⇒	08/97
960 II 2.5	B6254S	07/94 ⇒	12/96
960 II 2.5 24V	B6254FS, B6304FS	01/95 ⇒	08/97
960 II 2.9	B6304FS, B5234T3	07/94 ⇒	08/97
C70 I 2.0	B5204T2	03/97 ⇒	10/05
C70 I 2.0 T	B5204T3	03/97 ⇒	10/05
C70 I 2.3 T5	B5234T3, B5244T7	07/02 ⇒	10/05
C70 I 2.3 T-5	B5234T3	03/97 ⇒	09/02
C70 I 2.4 T	B5244T7, B5202FS	03/97 ⇒	10/05
S70 2.0	B5202FS, B5234FS	01/97 ⇒	11/00
S70 2.0 Turbo	B5204T3	01/97 ⇒	11/00
S70 2.3	B5234FS, B6244FS	01/97 ⇒	07/99
S70 2.3 AWD	B5234T7	04/99 ⇒	09/00
S70 2.3 T-5	B5234T3	01/97 ⇒	11/00
S70 2.3 T5 AWD	B5234T4	07/97 ⇒	09/00
S70 2.3 T5-R AWD	B5234T2	11/96 ⇒	09/98
S70 2.3 Turbo	B5234FT+	01/97 ⇒	11/00
S70 2.4	B5254S	06/98 ⇒	11/00
S70 2.4 AWD	B5252FS	11/96 ⇒	05/99
S70 2.4 Bifuel	GB5252S	10/98 ⇒	11/00
S70 2.4 T5 AWD	B5254T	11/96 ⇒	04/99
S70 2.4 Turbo	B5254T	01/97 ⇒	11/00
S70 2.5 20V	B5254FS	01/97 ⇒	12/98
S70 2.5 Bifuel	GB5252S2	01/99 ⇒	12/99
S90 2.5	B6244FS, B6254FS	11/96 ⇒	10/98
S90 2.5 24V	B6254FS, B6304G	01/97 ⇒	05/98
S90 2.9	B6304G, B6304FS	01/97 ⇒	05/98
S90 2.9 24V	B6304FS, B5202FS	01/97 ⇒	05/98
V70 I 2.0	B5202FS, B5234T3	12/95 ⇒	03/00
V70 I 2.0 Turbo	B5204T3	11/96 ⇒	12/00
V70 I 2.0 Turbo AWD	B5204T3	11/96 ⇒	12/00
V70 I 2.3	B5234FS	01/97 ⇒	07/99
V70 I 2.3 AWD	B5234T3, B5234FT+	04/97 ⇒	09/98
V70 I 2.3 T AWD	B5234FT+, B5234FT+	04/97 ⇒	12/98
V70 I 2.3 T-5	B5234T3	11/96 ⇒	12/00
V70 I 2.3 T-5 AWD	B5234T3	01/97 ⇒	12/00
V70 I 2.3 Turbo	B5234FT+, B6304G	12/95 ⇒	12/98

VOLVO			
V70 I 2.4	B5254S	06/98 ⇒	12/99
V70 I 2.4 Bifuel	GB5252S	05/98 ⇒	12/99
V70 I 2.4 Turbo AWD	B5254T	04/96 ⇒	12/00
V70 I 2.5	B5252FS	01/97 ⇒	03/00
V70 I 2.5 20V	B5254FS	01/97 ⇒	12/99
V70 I 2.5 Bifuel	GB5252S2	01/99 ⇒	12/99
V90 2.5	B6254FS	11/96 ⇒	10/98
V90 2.5 24V	B6254GS	01/97 ⇒	12/97
V90 2.9	B6304G, B6304FS	01/97 ⇒	12/98
V90 2.9 24V	B6304FS, M20B20	01/97 ⇒	12/98

10.505  3,5

THROTTLE POSITION SENSORS

Adatt./Suitable:

INFINITI
22620-12G10

NISSAN
16260-12G00
16260-12G05
22620-12G00
22620-12G10
22620-12G11
22620-12G12
22620-V5011
22620-V5012
22620-V7000

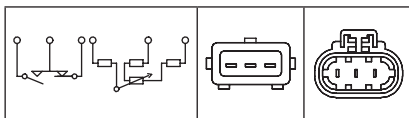

INFINITI		
M30 3.0	VG30E	01/89 ⇒ 12/93

NISSAN		
MAXIMA III 3.0 i [USA]	VE30DE	01/91 ⇒

10.508  3,5

THROTTLE POSITION SENSORS

Adatt./Suitable:

INFINITI
22620-45V02

NISSAN
22620-45V00
22620-45V01
22620-45V02

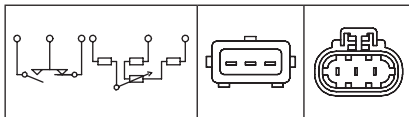

INFINITI		
J30 3.0	VG30DE	01/92 ⇒ 12/97

NISSAN		
200 SX 1.8 Turbo	CA18DET	07/88 ⇒ 11/93

10.511  3,5

THROTTLE POSITION SENSORS

Adatt./Suitable:

NISSAN
22620-71L01
22620-71L03

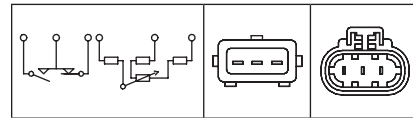

NISSAN		
PATHFINDER I 3.0 4WD	VG30E	07/86 ⇒ 08/95
PATROL GR I 4.2 Cat	TB42E	11/88 ⇒ 02/98
TERRANO I 3.0 i 4WD	VG30E	01/90 ⇒ 12/95

10.517  04

THROTTLE POSITION SENSORS

Adatt./Suitable:

NISSAN
22620-53F01

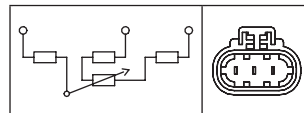

NISSAN		
ALTIMA 2.4	KA24DE	06/93 ⇒ 09/01
STANZA 2.4i [USA]	KA24DE	01/92 ⇒

10.5019



3,5

THROTTLE POSITION SENSORS

Adatt./Suitable:

NISSAN

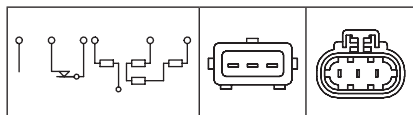
22620-71L00
22620-71L02

NISSAN

PATHFINDER I 3.0 4WD	VG30E	07/86 ⇒ 08/95
PATROL GR I 4.2 Cat	TB42E	11/88 ⇒ 02/98
TERRANO I 3.0 i 4WD	VG30E	01/90 ⇒ 12/95

10.5021



3,5

THROTTLE POSITION SENSORS

Adatt./Suitable:

NISSAN

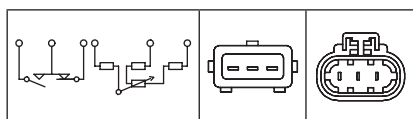
22620-53F10
22620-53F11

NISSAN

ALTIMA 2.4	KA24DE	06/93 ⇒ 09/01
STANZA 2.4i [USA]	KA24DE	01/92 ⇒

10.5032



3,5

THROTTLE POSITION SENSORS

Adatt./Suitable:

BMW

13 63 1 710 559

BOSCH

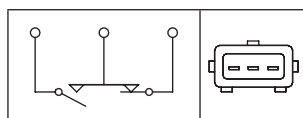
0 280 120 310
0 280 120 321

BMW

3 II 320 i	M20B20, M20B23(236EC)	09/82 ⇒ 10/93
3 II 323 i	M20B23(236EC), M20B27(276KA)	09/82 ⇒ 08/86
3 II 325 e 2.7	M20B27(276KA), M20B25(256E1)	10/83 ⇒ 12/88
3 II 325 i	M20B25(256E1), M20B25(256E1)	09/83 ⇒ 10/93
3 II 325 i X	M20B25(256E1), M20B20(206EA)	03/86 ⇒ 10/93
5 II 520 i	M20B20(206EA), M20B27(276EA)	06/81 ⇒ 12/87
5 II 525 e	M20B27(276EA), G13A	09/81 ⇒ 12/87
5 III 520 i	M20B20(206KA)	01/88 ⇒ 08/91
5 III 525 i	M20B25(256K1)	01/88 ⇒ 08/91
Z1 2.5	M20B25(256K1)	06/88 ⇒ 06/91

10.5044



3,5

THROTTLE POSITION SENSORS

Adatt./Suitable:

DENSO

179950-0056
179950-0311

SUBARU

22633-KA040

TOYOTA

89452-22010

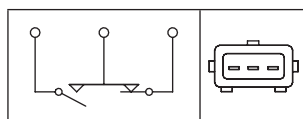

SUBARU

J-SERIES 1.2	--	01/87 ⇒ 12/91
J-SERIES 1.2 SDX	--	01/89 ⇒ 12/91
JUSTY I 1.2i EMPI [USA]	--	01/91 ⇒
TRENDY 1.2 12v	EF12	06/86 ⇒ 08/95

TOYOTA

CELICA III 2.4	22REC	10/84 ⇒ 12/85
MR 2 II 2.2 16V	5S-FE	01/90 ⇒ 06/95

10.5046



3,5

THROTTLE POSITION SENSORS

Adatt./Suitable:

DENSO

179950-0088
179950-0261

HOLDEN

8945214020

SUZUKI

13420-60B00
13420-60B00-000

TOYOTA

89452-14020

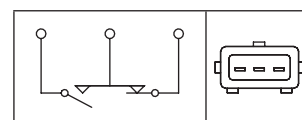

HOLDEN

NOVA_LF 1.6i Hatchback	4AFE	08/91 ⇒ 03/93
NOVA_LF 1.6i Sedan	4AFE	08/91 ⇒ 03/93

SUZUKI

SWIFT I / II 1.3	G13A	10/84 ⇒ 03/89
SWIFT I / II / III 1.3	G13A, G13A	03/89 ⇒ 12/95
SWIFT I / II / III 1.3 4WD	G13A, F4B	03/89 ⇒ 12/91
SWIFT I / II / III 1.3 GTi SOHC	G13B	10/89 ⇒ 12/95
SWIFT I / II / III 1.3i SOHC [USA]	--	01/89 ⇒ 12/91

TOYOTA

CELICA III 2.4	22REC	10/84 ⇒ 12/85
CELICA III 2.8 Supra	5M-GE	08/81 ⇒ 12/85
CELICA V 1.6	4A-FE	09/89 ⇒ 12/93
CRESSIDA 2.2 D	L	09/80 ⇒ 04/85
HIACE IV 2.4	2RZ-E	08/89 ⇒ 08/03
HIACE IV 2.4 4WD	2RZ-E	08/89 ⇒ 08/95
MODELL F 2.2	4Y-EC	08/85 ⇒ 01/90

10.5058



3,5

THROTTLE POSITION SENSORS

Adatt./Suitable:

NISSAN

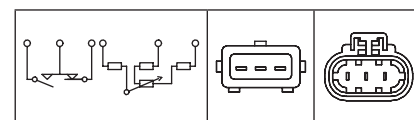
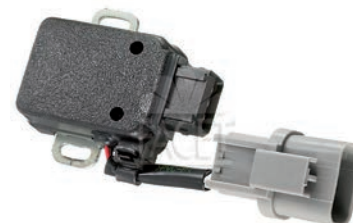
22620-07F01
22620-07F11
22620-84S00

10.5060



THROTTLE POSITION SENSORS

Adatt./Suitable:

NISSAN

16260-03G15
22620-41G00
22620-41G01
22620-89W01

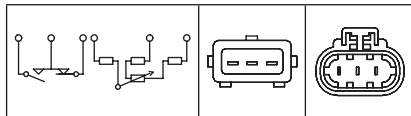
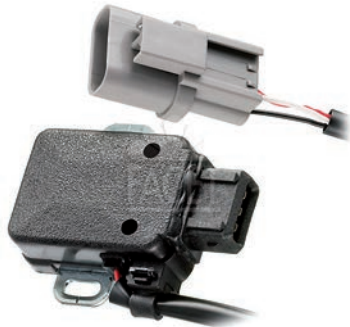

NISSAN

URVAN III 2.4 i | Z24i | 05/89 ⇒ 09/93

10.5062



THROTTLE POSITION SENSORS

Adatt./Suitable:

HOLDEN

22620V5002

NISSAN

22620-V5001
22620-V5002

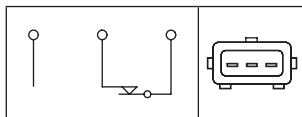

HOLDEN

CALAIS 3.0 Executive	--	10/88 ⇒ 09/90
CALAIS_VL 2.0i	2.0PFI	01/86 ⇒ 07/88
CALAIS_VL 3.0i Turbo	3.0EFITURBO	01/86 ⇒ 07/88
COMMODORE 3.0 Efi	RB30E	03/86 ⇒ 09/88
COMMODORE 3.0 Efi Turbo	RB30ET	01/86 ⇒ 08/88
COMMODORE_VL 2.0i	2.0PFI	01/86 ⇒ 07/88
COMMODORE_VL 2.0i Wagon	2.0PFI	01/86 ⇒ 07/88

NISSAN

300 ZX 3.0	VG30E	01/84 ⇒ 12/87
BLUEBIRD 1.8 Turbo	CA18T	04/84 ⇒ 11/92
MAXIMA III 3.0 i [USA]	--	01/81 ⇒ 12/87

10.5064



THROTTLE POSITION SENSORS

Adatt./Suitable:

FORD

6 667 704
6 854 782
7 173 046
928F-9B989-CA
95BF-9B989-JB

MAZDA

1E03-18-911

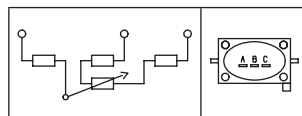

FORD

ESCORT IV 1.4	F4B	01/95 ⇒ 08/00
ESCORT IV 1.6 16V	L1E	10/98 ⇒ 07/00
ESCORT V 1.4	F4B, L1E	08/93 ⇒ 01/95
ESCORT V 1.4 i	F4B	07/93 ⇒ 01/95
ESCORT V 1.6 16V XR3i	L1E	12/92 ⇒ 01/95
ESCORT V 1.6 i 16V	L1E, RDA	09/92 ⇒ 01/95
ESCORT V 1.8 16V	RDA	02/92 ⇒ 12/92
ESCORT V 1.8 16V XR3i	RDA, RDA	02/92 ⇒ 01/95
ESCORT V 1.8 i 16V	RDA, RDA	09/92 ⇒ 01/95
ESCORT V 1.8 XR3i 16V 4x4	RDA, F4B	08/93 ⇒ 01/95
ESCORT VI 1.3	J4B	01/95 ⇒ 02/99
ESCORT VI 1.4	F4B, L1E	01/95 ⇒ 12/99
ESCORT VI 1.6 16V	L1E	01/95 ⇒ 07/00
ESCORT VI 1.6 16V 4x4	L1E	01/95 ⇒ 10/98
ESCORT VI 1.6 16V XR3i	L1E, L1E	02/95 ⇒ 09/99
ESCORT VI 1.6 i 16V	L1E, RDA	01/95 ⇒ 02/99
ESCORT VI 1.8 16V	RDA, RDA	01/95 ⇒ 02/99
ESCORT VI 1.8 XR3i XR3i	RDA, DHA	02/95 ⇒ 08/98
FIESTA III 1.4 Cat	F4A	03/89 ⇒ 12/95
FIESTA III 1.6 i 16V	L1G	01/94 ⇒ 12/95
FIESTA III 1.8 16V	RDB	02/92 ⇒ 12/95
FIESTA III 1.8 XR2i 16V	RQC	02/92 ⇒ 12/95
FIESTA IV 1.0 i	ZH10JRB	02/97 ⇒ 09/99
FIESTA IV 1.25 i 16V	DHA, J4C	08/95 ⇒ 01/02
FIESTA IV 1.3	J4C	02/96 ⇒ 08/03
FIESTA IV 1.3 i	J4C, FHA	08/95 ⇒ 01/02
FIESTA IV 1.4 i 16V	FHA, J4D	04/96 ⇒ 01/02
IKON 1.3 Rocam	--	10/00 ⇒
IKON 1.6 Efi Rocam	--	11/99 ⇒
KA I 1.3 i	J4D, L1E	09/96 ⇒ 11/08
ORION II 1.6 i 16V	L1E, RDA	07/92 ⇒ 12/93
ORION II 1.8 i 16V	RDA, FHD	01/92 ⇒ 12/93
PUMA 1.4 16V	FHD, MHA	11/97 ⇒ 10/00
PUMA 1.7 16V	MHA, DHF	03/97 ⇒ 06/02

FORD (BR)

FIESTA 1.0i	ZL10	07/99 ⇒
FIESTA 1.6i	ZL16	07/99 ⇒

MAZDA

121 III 1.25	DHF, J4R	03/96 ⇒ 04/03
121 III 1.3	J4R, B6(SOHC)	03/96 ⇒ 04/03

10.5066



THROTTLE POSITION SENSORS

Adatt./Suitable:

DENSO

179950-0123
179950-0161

HOLDEN

8945232020

KIA

0B630-18911

MAZDA

B630-18-911

TOYOTA

89452-32020

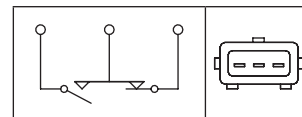

HOLDEN

APOLLO 2.0 i	3S-FE	08/89 ⇒ 02/93
--------------	-------	---------------

KIA

SEPHIA 1.6 i	B6	09/93 ⇒ 10/97
--------------	----	---------------

MAZDA

323 IV 1.3	E3	09/81 ⇒ 10/85
323 V 1.3	B333	08/85 ⇒ 05/89
323 V 1.3 i	B335	08/87 ⇒ 05/89
323 V 1.6	B6(SOHC), B6(SOHC)	09/86 ⇒ 10/95
323 V 1.6 GT	B6(SOHC), B681	01/86 ⇒ 10/89
323 V 1.6i	B681, B3383	06/86 ⇒ 07/87
323 V 1.6i 16v 4x4	B595	06/86 ⇒ 07/87
323 V 1.6i 16v Formula 4	B6F2	08/87 ⇒ 05/89
323 VI 1.8i 16v 4x4	BP51	06/89 ⇒ 03/91
323 VI 1.8i 16v GRSi	BP22	06/89 ⇒ 03/91
323 VI 1.8i 16v GT Formula 4	BP55	04/91 ⇒ 04/94
323 VI 1.8i 16v GT-R Formula 4	BP5J	04/91 ⇒ 04/94
323 VI C 1.6	B6E	09/89 ⇒ 06/91
323 VI C 1.6 16V	B6	03/91 ⇒ 10/94
323 VI F 1.6	B6E	09/89 ⇒ 06/91
323 VI F 1.6 16V	B6	03/91 ⇒ 10/94
323 VI F 1.8 16V	BP	08/89 ⇒ 07/94
323 VI F 1.8 16V GT	BP(DOHC)	08/89 ⇒ 07/94
323 VI F 1.8i 16v GRsi	BP31	06/89 ⇒ 03/91
323 VIs 1.3	B383, 8AN1	09/89 ⇒ 06/91
323 VIs 1.3 16V	B3(16V)	04/91 ⇒ 07/94
323 VIs 1.6	B6E	09/89 ⇒ 06/91
323 VIs 1.6 16V	B6	08/89 ⇒ 10/96
323 VIs 1.8 16V	BP52	08/89 ⇒ 07/94
323 VIs 1.8 16V 4WD	BP52	09/91 ⇒ 07/94
MIATA 1.6i 16v	CE16i	03/90 ⇒ 08/93
MIATA 1.6i 16v GT	CE16T	11/90 ⇒ 08/93
MX-3 1.6 i	B69	07/91 ⇒ 10/97
MX-5 I 1.6	8AN1, 3S-FE	05/90 ⇒ 04/98
PROTEGE 1.8i DOHC [USA]	--	01/90 ⇒
PROTEGE 1.8i OHC [USA]	--	01/90 ⇒

TOYOTA

CAMRY 2.0	3S-FE, 3S-FE	03/83 ⇒ 02/93
CAMRY 2.0 4WD	3S-FE, 4A-F	03/83 ⇒ 06/91
CARINA II 1.6	4A-F, 4ZE1	12/87 ⇒ 03/92
CARINA II 1.6 4WD	4A-FE	06/88 ⇒ 03/92
CELICA IV 2.0i [USA]	25SEL	01/85 ⇒ 12/86
COROLLA VI 1.3 i	2E-E	08/87 ⇒ 06/92
COROLLA VI 1.6	4A-FE	08/89 ⇒ 04/92
COROLLA VI 1.6 i	4A-FE	05/87 ⇒ 05/92
COROLLA VI 1.6 i 4WD	4A-FE	10/87 ⇒ 08/90
COROLLA VI 1.6 XLI	4A-FE	11/89 ⇒ 06/92
MR 2 II 2.0	3S-FE	12/89 ⇒ 08/92
STARLET 1.3 12V Cat	2E-E	12/89 ⇒ 03/96

10.5069



3,5

THROTTLE POSITION SENSORS

Adatt./Suitable:
GENERAL MOTORS
94 240 818

HOLDEN
8942408180

ISUZU
8-94240818-0

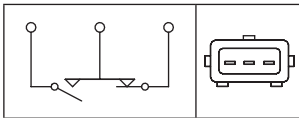
**HOLDEN**

JACKAROO_UBS 2.6i 4x4	4ZE1	11/88 ⇨ 12/91
RODEO_TF 2.6i	4ZE1, 4ZE1	08/88 ⇨ 03/96
RODEO_TF 2.6i 4x4	4ZE1	08/88 ⇨ 09/92

ISUZU

PICK-UP 2.6i [USA]	RLJ	01/88 ⇨
--------------------	-----	---------

10.5074



3,5

THROTTLE POSITION SENSORS

Adatt./Suitable:
GENERAL MOTORS
97 043 162

ISUZU
8-97043162-0

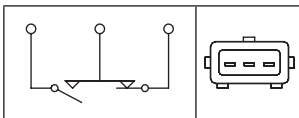
**ISUZU**

AMIGO 2.6i [USA]	RLJ	01/88 ⇨
------------------	-----	---------

10.5075



3,5

THROTTLE POSITION SENSORS

Adatt./Suitable:
GENERAL MOTORS
97 038 799

HOLDEN
8970387990

ISUZU
8-97038799-0

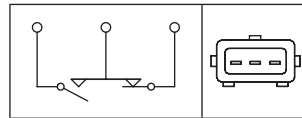
**HOLDEN**

RODEO_TF 2.6i 4x4	4ZE1	10/90 ⇨ 03/96
-------------------	------	---------------

ISUZU

PICK-UP 2.6i [USA]	RLJ	01/88 ⇨
--------------------	-----	---------

10.5076



04

THROTTLE POSITION SENSORS

Adatt./Suitable:
GENERAL MOTORS
94 341 862

HOLDEN
8943418620

ISUZU
8-94341862-0

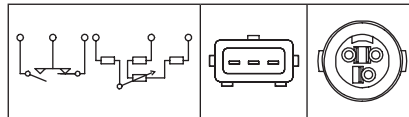
**HOLDEN**

JACKAROO_UBS 2.6i 4x4	4ZE1	11/88 ⇨ 12/91
RODEO_TF 2.6i	4ZE1, AR06416	08/88 ⇨ 03/96
RODEO_TF 2.6i 4x4	4ZE1	08/88 ⇨ 09/92

ISUZU

PICK-UP 2.6i [USA]	RLJ	01/88 ⇨
--------------------	-----	---------

10.5078



3,5

THROTTLE POSITION SENSORS

Adatt./Suitable:

ALFA ROMEO

116 46 11 022 00
116 85 11 022 00
195 36 11 022 00
60513337
60522875

BMW

13 63 1 273 265

BOSCH

0 280 120 302
0 280 120 304
0 280 120 311
0 280 120 315
0 280 120 320
0 280 120 328

FIAT

46137823
7636642
7706577

FORD

1 626 474
V85SF-12B527-AA

IVECO

5991955
7706585

LANCIA

46137823
7706577

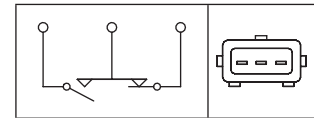
**ALFA ROMEO**

33 II 1.4 4x4	AR30755	07/90 ⇨ 12/92
33 II 1.4 i.e.	AR30755	06/91 ⇨ 09/94
33 II 1.4 i.e. 4x4	AR30755	07/90 ⇨ 09/94
33 II 1.5 i.e.	AR30751	01/90 ⇨ 09/94
33 II 1.5 i.e.	AR30738, AR30746	07/90 ⇨ 12/95
33 II 1.7 16V	AR30746, AR30746	01/90 ⇨ 09/94
33 II 1.7 16V 4x4	AR30746, AR30736	01/90 ⇨ 09/94
33 II 1.7 i.e.	AR30736, AR30736	01/90 ⇨ 12/95
33 II 1.7 i.e. 4x4	AR30736, AR06166	01/90 ⇨ 09/94
75 2.0 T.S. Cat	AR06224	05/85 ⇨ 02/92
75 2.0 T.S.	AR06166, AR01646	01/87 ⇨ 02/92
75 2.5 V6	AR01646, M10B18(184EA)	05/85 ⇨ 08/86
75 3.0 V6	AR06120	01/87 ⇨ 12/90
75 3.0 V6 Cat	AR06124	01/87 ⇨ 02/92
164 2.0 T.S.	AR06416, AR30738	06/87 ⇨ 09/92
164 2.0 Twin Spark	AR06420	06/87 ⇨ 09/92

BMW

3 II 318 i	M10B18(184EA), M30B34(346KA)	09/82 ⇨ 08/88
5 II 518 i	M10B18(184EB)	05/81 ⇨ 12/87
5 II 525 i	M30B25(256EA)	06/81 ⇨ 12/87
5 II 528 i	M30B28(286EA)	06/81 ⇨ 12/87
5 II 535 i	M30B34(346EC)	01/85 ⇨ 12/87
5 II 535 i, M 535 i	M30B34(346KA), M30B30(306EA)	01/85 ⇨ 12/87
5 III 530 i	M30B30(306KA)	01/88 ⇨ 08/91
5 III 535 i	M30B34(346KB)	01/88 ⇨ 09/95
7 II 730 i, iL	M30B30(306EA), F105L	12/86 ⇨ 09/94

LANCIA

THEMA 8.32	F105L, 146A5.046	09/87 ⇨ 05/92
Y10 1.3 i.e.	146A5.046, M20B23(236EC)	11/87 ⇨ 12/95

10.5079



3,5

THROTTLE POSITION SENSORS

Adatt./Suitable:

- BMW**
13 62 1 273 277
- BOSCH**
0 280 120 301
0 280 120 319
0 280 120 325
0 280 120 327

- CITROËN**
1628 50
1628 G4
91 519 925
95 567 200
96 015 940
96 081 740

- GENERAL MOTORS**
90 141 745

- OPEL**
8 26 285

- PEUGEOT**
1628 50
1628 A3
1628 G4

- RENAULT**
77 00 680 341

- VOLVO**
130693-8
334241-2
334302-9
351706-8
35170687

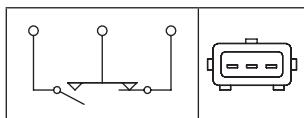

BMW		
3 II 323 i	M20B23(236EC), M20B27(276KA)	09/82 ⇨ 08/86
3 II 325 e 2.7	M20B27(276KA), M20B27(276EA)	10/83 ⇨ 12/88
5 II 520 i	M20B20(206EA)	06/81 ⇨ 12/87
5 II 525 e	M20B27(276EA), 182A	09/81 ⇨ 12/87
5 II M5	S38B35(356ED)	08/85 ⇨ 12/87
5 III M5	S38B36(366S1)	10/88 ⇨ 05/92
5 III M5 Cat	S38B36(366S1)	10/88 ⇨ 05/92
CITROËN		
BX 1.6	182A, 159C	01/87 ⇨ 12/94
BX 1.9	159C, D6D	09/85 ⇨ 12/94
BX 1.9 GTi	D6D, 159K	01/87 ⇨ 01/92
BX 1.9 GTi 16V	159K, D6A(XU9J2)	01/87 ⇨ 12/94
BX 16	180Z	03/86 ⇨ 12/94
BX 19	D6A(XU9J2), D6A(XU9J2)	07/86 ⇨ 12/94
BX 19 Cat	DFZ(XU9J1)	07/86 ⇨ 12/94
BX 19 GTi	D6A(XU9J2), D6C(XU9J4)	07/86 ⇨ 02/93
BX 19 GTi 16V	D6C(XU9J4), D6E(XU9JA)	09/87 ⇨ 02/93
BX 19 GTi 4x4	DKZ(XU9JA)	06/88 ⇨ 02/93
ZX 1.9	D6E(XU9JA), DKZ(XU9JA)	03/91 ⇨ 06/97
ZX 1.9 i	DKZ(XU9JA), F2N722	03/91 ⇨ 06/97
RENAULT		
19 I 1.7	F3N742	07/88 ⇨ 04/92
19 II 1.7	F3N742	04/92 ⇨ 12/95
21 1.7	F2N722, J7R740	03/86 ⇨ 06/94
21 2.0	J7R740, J7R740	03/86 ⇨ 06/94
21 2.0 4x4	J7R740, J7R740	03/89 ⇨ 02/94
21 2.0 TXi	J7R740, J7T754	07/89 ⇨ 05/93
21 2.2	J7T754, J7T754	04/86 ⇨ 12/95
21 2.2 4x4	J7T754, J7R722	06/86 ⇨ 06/94
25 2.0	J7R722, J7R720	03/87 ⇨ 12/93
25 2.0 12V	J7R720, J7T706	06/88 ⇨ 12/93
25 2.2	J7T706, J7T772	04/84 ⇨ 12/92
ESPACE I 2.0 i	J7R760	01/89 ⇨ 12/90
ESPACE I 2.0 i Quadra	J7R760	03/88 ⇨ 12/92
ESPACE I 2.2	J7T770	07/86 ⇨ 12/90
ESPACE I 2.2 Quadra	J7T770	01/88 ⇨ 12/90
ESPACE II 2.0	J7R768	01/91 ⇨ 10/96

RENAULT		
ESPACE II 2.2	J7T772, B230F	01/91 ⇨ 10/96
ESPACE II 2.2 4x4	J7T772	03/91 ⇨ 12/96
MASTER I 30 2,2	J7T782	08/80 ⇨ 07/98
SUPER 5 1.7 i	F3N702	10/86 ⇨ 08/91
TRAFIC I 2.2	J7T780	05/89 ⇨ 06/94
TRAFIC I 2.2 4x4	J7T780	05/89 ⇨ 06/94
VOLVO		
240 2.0	B200F	09/88 ⇨ 12/93
240 2.3	B230F, B200E	08/86 ⇨ 08/93
240 2.3 Cat	B230F	08/91 ⇨ 07/92
240 2.3 i Cat	B230F	08/86 ⇨ 07/93
340-360 2.0	B200E, B18E	08/84 ⇨ 07/89
440 1.7	B18E, B18E	08/88 ⇨ 07/89
480 1.7	B18E, B200ET	04/86 ⇨ 07/89
740 2.0	B200ET, B200ET	01/85 ⇨ 08/90
740 2.0 16V	B204E	09/87 ⇨ 08/90
740 2.0 GLE	B204E	09/87 ⇨ 08/90
740 2.0 Turbo	B200ET, B230F	09/87 ⇨ 08/91
740 2.3	B230F, B230ET	08/84 ⇨ 12/92
740 2.3 Turbo	B230ET, B230ET	08/85 ⇨ 08/91
760 2.3	B230ET, B23ET	08/84 ⇨ 07/92
760 2.3 Turbo	B23ET, B280E	08/82 ⇨ 08/90
760 2.8	B280E, B200F	08/81 ⇨ 08/91
940 I 2.0	B200F, B230F	09/90 ⇨ 07/94
940 I 2.0 GL	B204E	09/90 ⇨ 04/92
940 I 2.0 Turbo	B200FT	08/90 ⇨ 07/95
940 I 2.3	B230F, B230FT	08/90 ⇨ 07/95
940 I 2.3 16V	B234G	08/90 ⇨ 07/92
940 I 2.3 Turbo	B230FT, B230FD	08/90 ⇨ 07/94
940 II 2.0 GLT	B200GT	10/94 ⇨ 05/97
940 II 2.0 Turbo	B200FT	04/96 ⇨ 10/98
940 II 2.3	B230FD, B230FT	08/94 ⇨ 05/97
940 II 2.3 ti	B230FK	01/95 ⇨ 10/98
940 II 2.3 Turbo	B230FT, B280E	08/94 ⇨ 12/98
960 I 2.3	B230GT	08/90 ⇨ 07/94
960 I 2.3 Turbo	B230FT	09/90 ⇨ 08/93
960 I 2.8 GL	B280E, XFZ(ES9J4)	09/90 ⇨ 05/92

10.5082



3,5

THROTTLE POSITION SENSORS

Adatt./Suitable:

- BOSCH**
0 280 122 009
- CITROËN**
1628 8V
- PEUGEOT**
1628 8V
- RENAULT**
77 01 044 753

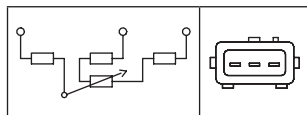

CITROËN		
XANTIA I 3.0 i 24V	XFZ(ES9J4)	01/97 ⇨ 04/03
XANTIA I 3.0 V6	XFZ(ES9J4)	01/98 ⇨ 04/03
XANTIA II 3.0 V6	XFZ(ES9J4)	01/98 ⇨ 04/03
XM II 3.0 V6	XFZ(ES9J4)	04/97 ⇨ 10/00
XSARA 2.0 16V	RFS(XU10J4RS)	04/97 ⇨ 09/00
XSARA 2.0 i 16V	RFS(XU10J4RS)	02/98 ⇨ 03/05
ZX 2.0	RFS(XU10J4RS)	09/96 ⇨ 10/97
ZX 2.0 i 16V	RFS(XU10J4RS)	05/96 ⇨ 06/97
PEUGEOT		
306 2.0 S16	RFS(XU10J4RS)	06/96 ⇨ 05/01
406 3.0 24V	XFZ(ES9J4), L7X700	10/96 ⇨ 10/04
406 3.0 V6 24V	XFZ(ES9J4)	03/97 ⇨ 12/04
RENAULT		
ESPACE III 3.0 V6 24V	L7X727	10/98 ⇨ 10/02
LAGUNA I 3.0 24V	L7X700, 182A4.000	03/97 ⇨ 03/01

10.5083



1

THROTTLE POSITION SENSORS

Adatt./Suitable:

- ALFA ROMEO**
9950634
- BOSCH**
F 000 995 002
- DACIA**
77 01 044 743
- FIAT**
7714824
9945634
9950634
- LANCIA**
9945634
- MAGNETI MARELLI**
219244300500
KIT PF1C
PF 1C/00
- RENAULT**
77 01 044 743

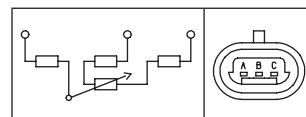

ALFA ROMEO		
145 1.4 i.e.	AR33501	07/94 ⇨ 12/96
145 1.6 i.e.	AR33201	10/94 ⇨ 12/96
146 1.4 i.e.	AR33501	12/94 ⇨ 12/96
146 1.6 i.e.	AR33201	12/94 ⇨ 12/96
DACIA		
LOGAN I 1.6 16V	K4M690	02/06 ⇨
LOGAN I 1.6 16V Hi-Flex	K4M690	11/09 ⇨
SANDERO I 1.6 16V	K4M690	07/11 ⇨
SANDERO I 1.6 16V Bifuel	K4M690	01/11 ⇨
FIAT		
BRAVA 1.6 16V	182A4.000, 182A4.000	10/95 ⇨ 10/01
BRAVO I 1.6 16V	182A4.000, 835C2.000	10/95 ⇨ 10/01
MAREA 1.6	185A3.000	03/99 ⇨ 08/00
MAREA 1.6 100 16V Bipower	185A3.000	04/99 ⇨ 05/02
MAREA 1.6 16V	185A3.000	04/97 ⇨ 02/99
PALIO 1.6 16V	178B3.000	04/96 ⇨ 10/02
SIENA 1.6 16V	178B3.000	09/98 ⇨ 12/09
TEMPRA 1.8 i.e.	835C2.000, 835C2.000	09/93 ⇨ 08/96
TIPO I 1.8 i.e.	835C2.000	04/93 ⇨ 04/95
FIAT (BR)		
BRAVA 1.6i 16v	1.6Mpi	01/00 ⇨ 12/01
BRAVA 1.8i 16v	1.8Mpi	01/00 ⇨
PALIO 1.6i	1.6Mpi	01/99 ⇨ 12/00
PALIO 1.6i 16v	1.6Mpi16v	01/96 ⇨ 12/00
SIENA 1.6i 16v	1.6Mpi	01/98 ⇨ 12/99
STRADA 1.6i 16v	1.6Mpi	01/99 ⇨
LANCIA		
DEDRA 1.8 i.e.	836A5.000	07/94 ⇨ 07/99
DELTA II 1.6 i.e.	182A6.000	03/96 ⇨ 08/99
DELTA II 1.6 i.e. 16V	182A4.000	01/96 ⇨ 08/99
DELTA II 1.8 i.e.	835C2.000, K4J712	06/93 ⇨ 08/99
RENAULT		
CLIO II 1.4 16V	K4J712, K4M734	02/00 ⇨ 07/08
CLIO II 1.6 16V	K4M734, F4R700	09/98 ⇨
ESPACE III 2.0	F4R700, F4R700	09/01 ⇨ 10/02
ESPACE III 2.0 16V	F4R700, K4M720	10/98 ⇨ 10/02
LAGUNA I 1.6 16V	K4M720, K4J712	11/97 ⇨ 03/01
LAGUNA I 1.8 16V	F4P760	04/98 ⇨ 03/01
LAGUNA I 2.0	F4R780	09/99 ⇨ 02/01
LAGUNA I 2.0 16V	F4R780	09/99 ⇨ 03/01
LOGAN 1.6	K4M690	04/07 ⇨
MEGANE I 1.4 16V	K4J712, K4M700	03/99 ⇨ 08/03
MEGANE I 1.6 16V	K4M700, F4P722	03/99 ⇨
MEGANE I 1.6 LPG	K4M704	10/00 ⇨ 08/02
MEGANE I 1.8 16V	F4P722, F4R700	07/00 ⇨ 08/03
MEGANE I 2.0 16V	F4R700, K4M700	05/00 ⇨
MEGANE I 2.0 16V IDE	F5R740	11/99 ⇨ 08/03
MEGANE SCËNIC I 1.6 16V	K4M700, F4R740	04/98 ⇨ 10/99
SCËNIC I 1.4 16V	K4J750	09/99 ⇨ 08/03

RENAULT			
SCÉNIC I 1.6	K4M706	09/99 ⇒	09/03
SCÉNIC I 1.8 16V	F4P722	01/01 ⇒	08/03
SCÉNIC I 1.8 4x4	F4P722	07/00 ⇒	04/01
SCÉNIC I 2.0 16V	F4R740, K4J712	07/00 ⇒	08/03
SCÉNIC I 2.0 16V RX4	F4R744	06/00 ⇒	08/03
THALIA I 1.4 16V	K4J712, AR06410	08/00 ⇒	
THALIA I 1.6	K4M670	01/01 ⇒	

SAAB			
9000 2.0 -16 Turbo CD	B202XL	09/88 ⇒	08/93
9000 2.3 -16 CD	B234I	08/89 ⇒	12/98
9000 2.3 -16 CD Turbo	B234L	07/90 ⇒	12/98
9000 2.3 -16 CS	B234I	09/89 ⇒	12/98
9000 2.3 -16 Turbo	B234L	09/90 ⇒	12/98

HYUNDAI		
VERNA I 1.5	G4EB, 35D	09/99 ⇒
VERNA I 1.6	G4ED-G	12/02 ⇒

10.5084  **3,5**

THROTTLE POSITION SENSORS

Adatt./Suitable:

ALFA ROMEO
195 00 11 022 00
60512672

BOSCH
0 280 120 300
0 280 120 326

FIAT
4430294
7706580

GENERAL MOTORS
90 299 240

HOLDEN
VS19462

IVECO
7706580

LANCIA
7706580

OPEL
8 26 290

ROLLS-ROYCE
UE45749

SAAB
75 01 612

10.5086  **3,5**

THROTTLE POSITION SENSORS

Adatt./Suitable:

BOSCH
0 280 122 014
0 280 122 016

GENERAL MOTORS
90 541 502

HONDA
37890-PDF-E01

HYUNDAI
35170-22600
35170-23500

KIA
35170-22600
35170-23500

LAND ROVER
ERR7322

NISSAN
22620-1F700

OPEL
58 26 473

PORSCHE
996 606 116 00

SAAB
91 81 538

MARKET DIFFUSION: MEDIUM

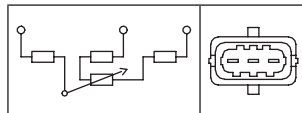
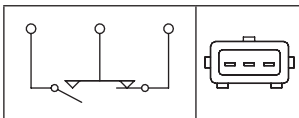

ALFA ROMEO

33 I 1.7 i.e.	AR30558	09/88 ⇒	12/89
33 I 1.7 i.e. 4x4	AR30558	09/88 ⇒	12/89
75 1.6 Cat	AR61101	05/89 ⇒	02/92
75 1.8	AR06168, AR01588	09/88 ⇒	02/92
75 1.8 i.e.	61202	08/89 ⇒	02/92
75 3.0 V6	AR61503	02/90 ⇒	02/92
164 3.0	AR06410	11/87 ⇒	09/91
164 3.0 i.e. QV	AR64301	09/90 ⇒	09/92
164 3.0 Lusso [USA] [CAN]	AR06412	10/91 ⇒	03/93
164 3.0 Sport [CAN] [USA]	AR64301	11/90 ⇒	03/92
164 3.0 Super	64303	06/87 ⇒	09/92
164 3.0 V6	AR06410, AR06168	06/87 ⇒	09/92
SPIDER I 2.0i [CAN]	AR01588	09/90 ⇒	10/93
SPIDER I 2.0i [USA]	AR01588	09/90 ⇒	10/93
SPIDER I 2.0i Veloce [CAN]	AR01588	09/90 ⇒	10/93
SPIDER I 2.0i Veloce [USA]	AR01588	09/90 ⇒	10/93
SPIDER I 2000	AR01588, B202I	01/77 ⇒	12/93

FIAT (BR)

UNO 1.6iR	1.6Mpi	01/93 ⇒	12/94
-----------	--------	---------	-------

HOLDEN

CALIBRA_YE 2.0i 16V	C20XE	09/91 ⇒	07/95
---------------------	-------	---------	-------

LANCIA

THEMA 2000 i.e. 16V	834B2.000	05/88 ⇒	08/92
---------------------	-----------	---------	-------

SAAB

900 I 2.0 -16	B202I, B201	01/86 ⇒	06/94
900 I 2.0 i	B201, B202S	11/80 ⇒	08/90
900 I 2.0 S Turbo-16	B202S, B202L	07/91 ⇒	06/94
900 I 2.0 Turbo-16	B202L, B202I	11/85 ⇒	06/94
900 I 2.0 Turbo-16 S	B202XL	01/84 ⇒	06/94
900 I 2.0 Turbo-16 S Cat	B202XL	01/89 ⇒	12/93
9000 2.0 -16	B202I, B202	12/85 ⇒	01/93
9000 2.0 -16 CS	B202I	01/89 ⇒	12/98
9000 2.0 -16 Turbo	B202, G4EA	09/84 ⇒	08/93

HONDA

ACCORD VI 1.6	D16B6	12/99 ⇒	12/02
ACCORD VI 1.6 16V	D16B7	10/01 ⇒	
ACCORD VI 1.6 i	D16B6	10/98 ⇒	12/02
ACCORD VI 1.6 iS	D16B7	10/98 ⇒	12/02

HYUNDAI

ACCENT II 1.3	G4EA, G4EB	01/00 ⇒	11/05
ACCENT II 1.5	G4EB, G4GC-G	01/00 ⇒	11/05
ACCENT II 1.6	G4ED-G	12/02 ⇒	11/05
COUPE I 1.6 16V	G4GR	03/98 ⇒	04/02
COUPE I 1.6 i 16V	4G6I	12/96 ⇒	04/02
COUPE II 1.6 16V	G4ED-G	03/02 ⇒	08/09
COUPE II 2.0	G4GC-G, G4ED-G	08/01 ⇒	08/09
COUPE II 2.0 GLS	G4GC-G	02/03 ⇒	08/09
ELANTRA III 1.6	G4ED-G, G4BB	06/00 ⇒	07/06
ELANTRA III 1.8	G4BB, G4GC	06/00 ⇒	07/06
ELANTRA III 2.0	G4GC, G4EA	06/00 ⇒	07/06
GETZ 1.1	G4HD	09/02 ⇒	09/05
GETZ 1.3	G4EA, G4ED-G	09/03 ⇒	06/09
GETZ 1.3 i	G4EA	09/02 ⇒	03/04
GETZ 1.6	G4ED-G	09/02 ⇒	09/05
LANTRA II 1.8	G4GB	06/00 ⇒	
LANTRA II 2.0	G4GC-G	06/00 ⇒	
LAVITA 1.8	--	01/07 ⇒	
MATRIX 1.6	G4ED-G, G4GC	06/01 ⇒	08/10
MATRIX 1.6 [TUR]	G4ED	04/08 ⇒	
MATRIX 1.8	G4GB-G	06/01 ⇒	08/10
MATRIX 1.8 [TUR]	G4GB	04/08 ⇒	
SONATA V 2.0 i [RUS]	--	04/06 ⇒	12/10
SONATA V 2.0 VVTi GLS	G4KA	05/05 ⇒	12/10
TRAJET 2.0	G4GC, G4GC	03/00 ⇒	07/08
TRAJET 2.0 CRDi	D4EA	08/05 ⇒	07/08
TUCSON 2.0	G4GC, G4GC	08/04 ⇒	
TUCSON 2.0 Trazione integrale	G4GC, G4EB	08/04 ⇒	11/10
VERNA I 1.3	G4EA	09/99 ⇒	

KIA		
CERATO I 1.6	G4ED	04/04 ⇒
CERATO II 2.0 CVT	--	01/09 ⇒
MAGENTIS II 2.0	G4KA	11/05 ⇒
OPTIMA II 2.0	G4KA	05/08 ⇒
SPORTAGE II 2.0 16V 4WD	G4GC	09/04 ⇒
SPORTAGE II 2.0 i 16V	G4GC	09/04 ⇒

LAND ROVER

DISCOVERY II 4.0 V8 4x4	35D, 46D	11/98 ⇒	06/04
DISCOVERY II 4.6 V8 [USA]	--	01/03 ⇒	06/04
RANGE ROVER II 3.9 4x4	42D	07/94 ⇒	03/02
RANGE ROVER II 4.0 4x4	42D	01/95 ⇒	03/02
RANGE ROVER II 4.6 4x4	46D, CG10DE	07/94 ⇒	03/02

NISSAN

MICRA II 1.0 i 16V	CG10DE, M96.01	09/00 ⇒	02/03
MICRA II 1.4 i 16V	CGA3DE	09/00 ⇒	02/03

OPEL

ASTRA F 1.8	Z18XEL	02/03 ⇒	07/04
ASTRA F 2.0 i 16V	X20XER	10/99 ⇒	08/00
ASTRA G 1.2 16V	X12XE	02/98 ⇒	09/00
ASTRA G 2.0 16V	X20XEV	02/98 ⇒	01/05
ASTRA G 2.0 16V OPC	X20XER	11/99 ⇒	09/02
CORSA B 1.0 i 12V	X10XE	11/96 ⇒	09/00
CORSA B 1.2 i 16V	X12XE	03/98 ⇒	09/00
OMEGA B 2.5 V6	X25XE	03/94 ⇒	09/00
OMEGA B 2.6	--	05/94 ⇒	05/99
OMEGA B 2.6 V6	Y26SE	09/00 ⇒	07/03
OMEGA B 3.0 V6	X30XE	04/94 ⇒	02/01
OMEGA B 3.2 V6	Y32SE	02/01 ⇒	07/03
VECTRA B 2.5 i V6	X25XE	10/95 ⇒	09/00

PORSCHE

911 IV 3.4 Carrera	M96.01, M96.01	09/97 ⇒	09/01
911 IV 3.4 Carrera 4	M96.01, M96.76	09/97 ⇒	09/01
911 IV 3.6	M96.03	12/01 ⇒	08/05
911 IV 3.6 Carrera	M96.03	10/01 ⇒	08/05
911 IV 3.6 Carrera 4	M96.03	10/01 ⇒	08/05
911 IV 3.6 Carrera 4S	M96.03	06/02 ⇒	08/05
911 IV 3.6 Carrera S	M96.03	06/02 ⇒	08/05
911 IV 3.6 GT3	M96.76, M96.22	03/03 ⇒	08/05
BOXSTER I 2.5	M96.20	09/96 ⇒	08/99
BOXSTER I 2.7	M96.22, M96.21	07/02 ⇒	12/04
BOXSTER I S 3.2	M96.24	07/02 ⇒	12/04
BOXSTER I S 3.2	M96.21, B204E	01/04 ⇒	12/04

SAAB

9-3 2.0 i	B204I	02/98 ⇒	08/03
9-3 2.0 SE Turbo	B204R	02/98 ⇒	08/03
9-3 2.0 Turbo	B204E, M40B16(164E1)	02/98 ⇒	08/03
9-3 2.3	B235R	09/99 ⇒	01/02
9-3 2.3 i	B234I	02/98 ⇒	08/03
9-3 2.3 Turbo	B235R	10/98 ⇒	08/03
900 II 2.0 -16 Turbo	B204L	07/93 ⇒	02/98
900 II 2.0 i	B204I	12/93 ⇒	02/98
900 II 2.3 -16	B234I	07/93 ⇒	02/98
9000 2.0 -16 CD	B204E, B204E	09/93 ⇒	12/98
9000 2.0 -16 CS	B204I	09/93 ⇒	12/98
9000 2.0 -16 ND Turbo	B204E	09/93 ⇒	12/98
9000 2.0 -16 Turbo CD	B204E, B204E	09/92 ⇒	12/98
9000 2.3 -16 Aero CS	B234R	02/93 ⇒	12/98
9000 2.3 -16 CD	B234I	08/89 ⇒	12/98
9000 2.3 -16 CD Turbo	B234L	07/90 ⇒	12/98
9000 2.3 -16 CDE	B234I	09/93 ⇒	12/98
9000 2.3 -16 CDE Eco-Power	B234E	09/93 ⇒	12/98
9000 2.3 -16 CS	B234I	09/89 ⇒	12/98
9000 2.3 -16 CSE	B234I	09/93 ⇒	12/98
9000 2.3 -16 CSE Eco Power	B234E	09/93 ⇒	12/98
9000 2.3 -16 Turbo	B234L	09/90 ⇒	12/98
9000 2.3 -16 Turbo CSE	B234L	09/93 ⇒	12/98

VAUXHALL

ASTRA IV 1.2 16V	X12XE	02/98 ⇒	09/00
ASTRA IV 2.0	X20XER	10/99 ⇒	08/00
ASTRA IV 2.0 16V	X20XEV	02/98 ⇒	05/05
CORSA B 1.0 i 12V	X10XE	11/96 ⇒	09/00
CORSA B 1.2 i 16V	X12XE	03/98 ⇒	09/00
OMEGA B 2.5 V6	X25XE	03/94 ⇒	09/00
OMEGA B 2.6 V6	Y26SE	08/00 ⇒	07/03
OMEGA B 3.0 V6	X30XE	04/94 ⇒	07/00
OMEGA B 3.2 V6	Y32SE	02/01 ⇒	07/03
VECTRA B 2.5 i V6	X25XE	09/95 ⇒	08/00

10.5091



3,5

THROTTLE POSITION SENSORS

Adatt./Suitable:

- BMW**
13 54 1 717 603
- BOSCH**
0 280 120 316
- GENERAL MOTORS**
90 281 520
- OPEL**
8 26 288

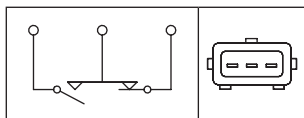

BMW		
3 II 316 i	M40B16(164E1), M40B18(184E1)	09/87 ⇨ 06/94
3 II 318 i	M40B18(184E1), M40B18(184E1)	09/87 ⇨ 06/94
5 III 518 i	M40B18(184E1), E7J634	08/89 ⇨ 01/97
OPEL		
VECTRA A 2.0 i	20NE	09/88 ⇨ 10/90
VECTRA A 2.0 i 4x4	20NE	01/89 ⇨ 10/90
VECTRA A 2.0 i Cat	C20NE	09/88 ⇨ 11/95
VECTRA A 2.0 i Cat 4x4	C20NE	01/89 ⇨ 11/95

10.5093



1

THROTTLE POSITION SENSORS

Adatt./Suitable:

- DACIA**
77 00 273 699
- RENAULT**
77 00 273 699 *2
77 01 206 371

- *2 Supplied the TPS sensor only, not the complete assembly
- Fornito sens. posiz. farfalla, no corpo farfallato completo
- Fourni seulement le senseur, pas le group complet
- Nur Sensor, ohne komplette Drosselklappengruppe
- Entegrado solamente el sensor, no el grupo completo

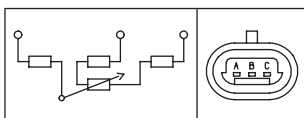

DACIA		
LOGAN I 1.4	K7J710	09/04 ⇨
LOGAN I 1.4 MPI LPG	K7J710	02/06 ⇨
LOGAN I 1.6	K7M710	09/04 ⇨
LOGAN I 1.6 Bifuel	K7M710	11/08 ⇨
SANDERO I 1.4	K7J710	06/08 ⇨
SANDERO I 1.6	K7M710	06/08 ⇨

RENAULT		
CLIO II 1.4	E7J634, E7J634	09/98 ⇨
CLIO II 1.6	K7M746	10/99 ⇨
KANGOO I 1.4	E7J634, E7J626	08/97 ⇨
KANGOO I 1.6	K7M746	09/99 ⇨
LOGAN 1.4	K7J710	09/04 ⇨
LOGAN 1.6	K7M710	09/04 ⇨
MEGANE I 1.4	E7J626, E7J626	09/96 ⇨ 08/03
MEGANE I 1.4 e	E7J626, K7M710	01/96 ⇨ 08/03
MEGANE I 1.6	K7M704	02/00 ⇨ 09/00
MEGANE SCÉNIC I 1.4 i	E7J764	01/97 ⇨ 09/99
SANDERO I 1.4	K7J710	02/09 ⇨
SANDERO I 1.6	K7M710, 540	12/07 ⇨

10.5094



1

THROTTLE POSITION SENSORS

Adatt./Suitable:

- BOSCH**
F 000 995 002
- MAGNETI MARELLI**
PF 5C/00
- VW**
027 998 385 1

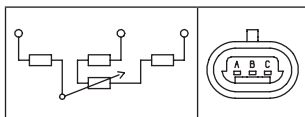

VOLKSWAGEN (BR)		
CADDY 1.6i	MY4	11/98 ⇨
GOL 1.6i	540, 542	10/96 ⇨
GOL 1.8i	542, 546	10/96 ⇨
GOL 2.0i	546, 540	10/96 ⇨
PARATI 1.6i	540, 546	10/96 ⇨
PARATI 1.8i	542	10/96 ⇨
PARATI 2.0i	546, MJ3	10/96 ⇨
POLO 1.6	MJ3, MJ2	07/00 ⇨
POLO 1.8	MJ2, 540	12/96 ⇨
SAVEIRO 1.6i	540, 542	10/96 ⇨
SAVEIRO 1.8i	542, 546	10/96 ⇨
SAVEIRO 2.0i	546, 199B6.000	10/96 ⇨
VW		
CADDY III 1.6 [ARG]	UVC	10/05 ⇨
CADDY III 1.8 [ARG]	BUR	10/05 ⇨

10.5096



1

THROTTLE POSITION SENSORS

Adatt./Suitable:

- FIAT**
71719387
71752610 *G
 - LANCIA**
71752610 *G
- *G without gasket / seal
- senza guarnizione
 - sans joint d'étanchéité
 - ohne Dichtung
 - sin junta

MARKET DIFFUSION: MEDIUM

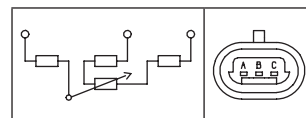

FIAT		
500 0.9	199B6.000, 199B6.000	07/10 ⇨
500 1.2	169A4.000	10/07 ⇨
500 1.4	169A3.000	10/07 ⇨
500 C 0.9	199B6.000, 169A3.000	09/09 ⇨
500 C 1.2	169A4.000	09/09 ⇨
500 C 1.4	169A3.000, --	09/09 ⇨
500 MY12 0.9	--	01/12 ⇨
500 MY12 1.2	--	01/12 ⇨
500 MY12 1.4	--	01/12 ⇨
IDEA 1.4	192B2.000	12/03 ⇨
IDEA 1.4 16V	--, 312A2.000	01/04 ⇨
PANDA II 1.2	188A4.000	09/03 ⇨
PANDA II 1.2 4x4	188A4.000	09/04 ⇨
PANDA II 1.2 Euro 4	--	04/09 ⇨
PANDA III 0.9	312A2.000, 312A2.000	02/12 ⇨
PANDA III 0.9 4x4	312A2.000, 312A2.000	09/12 ⇨
PANDA III 0.9 Natural Power	312A2.000, 199A7.000	07/12 ⇨
PUNTO II 1.2	188A4.000	06/03 ⇨
PUNTO III / GRANDE PUNTO 1.2 Actual	--	09/09 ⇨
PUNTO III / GRANDE PUNTO 1.3 JTD Actual	--	09/09 ⇨
PUNTO III / GRANDE PUNTO 1.4 Actual	--	09/09 ⇨
PUNTO III / GRANDE PUNTO 1.4 LPG	350A1.000	12/08 ⇨
PUNTO III EVO 1.4	350A1.000	03/09 ⇨
PUNTO III EVO 1.4 LPG	350A1.000	06/09 ⇨ 02/12
PUNTO III EVO 1.4 Natural Power	350A1.000	10/09 ⇨ 02/12
PUNTO III 1.4	199A7.000, 192B2.000	03/12 ⇨
PUNTO III 1.4 Bifuel	350A1.000	03/12 ⇨
PUNTO III 1.4 Multi Air	955A6.000	03/12 ⇨
PUNTO III 1.4 Natural Power	350A1.000	03/12 ⇨
PUNTO III 1.4 Turbo Multi Air	955A2.000	03/12 ⇨
STILO 2.4 20V	192A2.000	10/01 ⇨ 04/07
LANCIA		
MUSA 1.4	192B2.000, 312A2.000	10/04 ⇨ 09/12
MUSA 1.4 16V	--	01/11 ⇨ 12/12
YPSILON I 1.4 16V	843A1.000	10/03 ⇨ 12/11
YPSILON II 0.9 CNG	312A2.000	05/11 ⇨
YPSILON II 0.9 TwinAir	312A2.000, 312A5.000	05/11 ⇨



WHEEL SPEED SENSORS

·SENSORI DI NUMERO DI GIRI RUOTA ·CAPTEURS ABS ·RADDREHZAHLSSENSOR ·SENSORES DE REVOLUCIONES DE RUEDA

(A) P/NRS. - NOTES

- CODICI - NOTE
- RÉFS. - NOTES
- ARTIKEL-NR. - ANMERKUNGEN
- CODIGOS - NOTAS

21.0088

04,5

WHEEL SPEED SENSORS

Adatt./Suitable:

ABARTH

55703974

BOSCH

0 265 007 896

0 265 009 323

FIAT

55703974

GENERAL MOTORS

13 381 328

OPEL

12 29 098

13381328

62 35 747

93189276

VAUXHALL

13381328

93189276

NEW - ITEM NOW AVAILABLE FROM PRODUCTION

- NUOVO - ARTICOLO ORA DISPONIBILE PER LA VENDITA
- NOUVEAU - ARTICLE DISPONIBLE EN PRODUCTION COURANTE
- NEU - JETZT ZUM VERKAUF VERFÜGBARER ARTIKEL
- NUEVO - ARTICULO AHORA DISPONIBLE EN PRODUCCION

MARKET DIFFUSION: HIGH

(B) PICTURE + TECHNICAL INFO

- FOTO + INFORMAZIONE TECNICA
- ILLUSTRATION + INFORMATION TECHNIQUE
- BILD + TECHNISCHE INFO
- FOTO + INFORMACIÓN TÉCNICA



L	L1	Hall Effect	OUT +
648	27,9		

ABARTH

GRANDE PUNTO 1.4	199A8.000, 955A8.000	12/07 ⇔ 12/12
PUNTO 1.4	955A8.000	03/12 ⇔

(C) APPLICATION LIST

- GUIDA APPLICAZIONI
- LISTE D'APPLICATIONS
- ANWENDUNGSTABELLE
- LISTA DE APLICACIONES

(B)

- 1 **PICTURE**
- FOTO
 - PHOTO
 - BILD
 - FOTO

- 3 **RESISTANCE BETWEEN THE TERMINALS**
- RESISTENZA TRA I TERMINALI
 - RESISTANCE ENTRE LES CONNEXION
 - WIDERSTAND ZWISCHEN DEN ANSCHLÜSSEN
 - RESISTENCIA ENTRE LOS ENCHUFES

- 2 **LENGTH OF CABLE & OF SENSORS IN MM MEASURED AS SHOWN:**
- LUNGHEZZA IN MM DEL CAVO E DEL SENSORE COSÌ MISURATO:
 - LONGUEUR EN MM DU CABLE ET DU CAPTEUR MESURÉ COMME SUIT:
 - LÄNGE DES KABELS UND DES SENSORS IN MM GEMESSEN WIE GEZEIGT:
 - LARGO EN MM DEL CABLE Y DEL SENSOR MEDIDO DE LA FORMA ILUSTRADA:

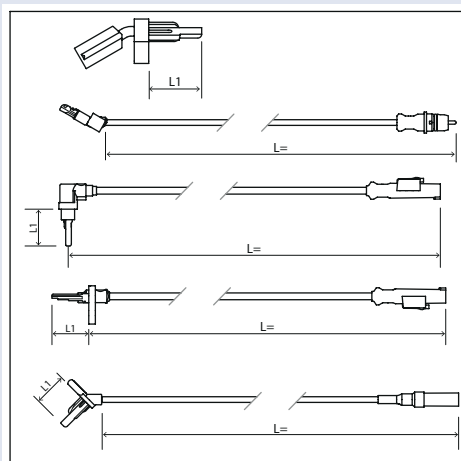

- 4 **TYPE OF CONNECTION**
- TIPO DI CONNESSIONE
 - TYPE DE CONNEXIONS
 - ANSCHLUSSART
 - TIPO DE ENCHUFE



21.XXXX

Wheel speed sensors

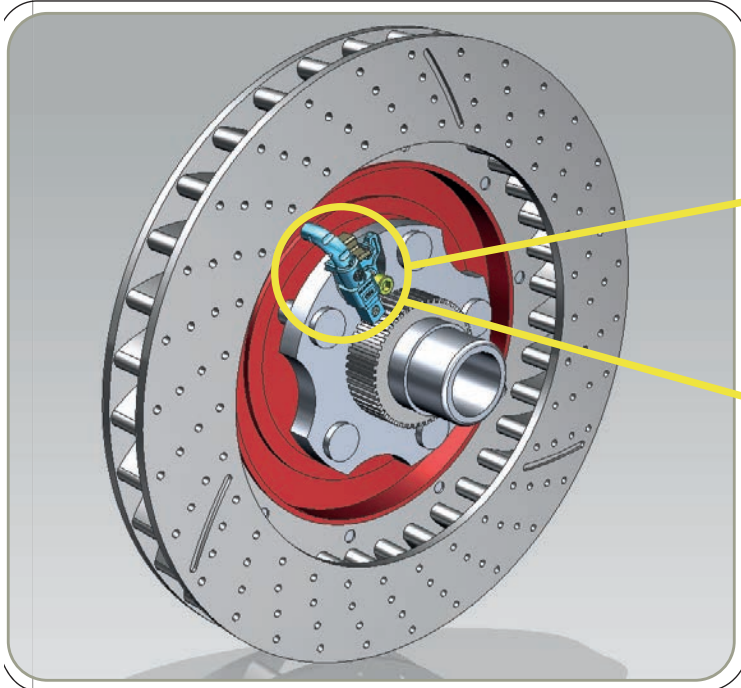

Wheel speed sensors (WSS) are used to detect the speed of the vehicle's wheels. This information is transmitted to the *Electronic Control Unit* (ECU) which forwards it to various **systems**:

- ABS (Antilock Braking System)
- ESC (Electronic Stability Control)
- TCS (Traction Control System)
- GPS (navigation)
- Hill-Hold
- Hill-Descent Control
- Cruise Control

WSS Sensors can be used with **gasoline, diesel and hybrid powered engines**. Typically **installed** in close proximity to a *cogwheel* or a *tonewheel*, which is magnetically coupled with the hub or the wheel's axle shaft. Sensors with a cable include accessories (rubber pads and clips) to enable the correct mounting path on the vehicle.

The main **causes of failure** of the product include:

- fissures and strains due to mechanical stress
- distortions and dents
- sensor over-heating
- Lack of signal, rupture of the cable due to friction or excessive vibration, short circuits, internal breakdown of the sensor due to mechanical or thermal stress

Malfunction signals of the sensor can be identified in case the ABS indicator is turned on and the wheels are locked.

Wheel speed sensors undergo strict **quality and endurance controls**, designed to ascertain their suitability for release on the market:

- audit of the dielectric rigidity on the coating of the cable and the coating of the sensors
- endurance testing
- fast temperature cycling test
- detection of electrical attributes at extreme temperatures
- O-RING hermetic seal testing
- resistance to vibrations / mechanical shocks testing
- resistance to torsion / traction of the connection cable
- resistance to the tear of the sensor of WSS featuring clips
- endurance to the dynamic wear of the cable
- sealing effectiveness against moisture and dust
- salt water immersion testing
- testing for corrosion in an industrial environment (Kersternich test)
- effectiveness in steady state damp heat

Upon successful completion of the tests and after granting production clearance, the product undergoes strict quality control cycles during assembly which include **tests on 100%** of the product to verify the endurance and inductance of the sensor, the intensity and the polarity of the signal, resistance to the current pulse, the absence of interruptions or short circuits.

Structural components and operating principles

Several types of wheel speed sensors exist:

• Active with hall effect

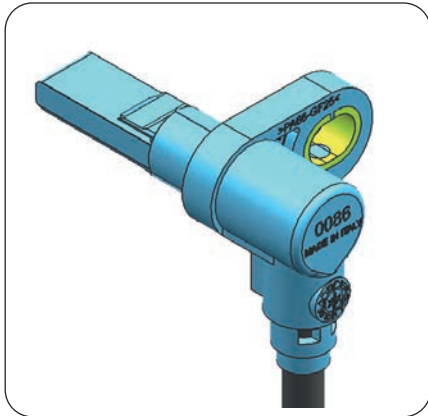

Generally comprised of a *semiconductor chip* which is responsive to a magnetic field. Furthermore, a *permanent magnet* can be situated behind it.

The component which is responsive to the magnetic field is found inside the chip and can be composed by one or more *Hall cells*, or by a bridge of *magnetoresistors*, all of which are integrated upon silicon.

Active WSS sensors are composed by a **chip with 2 wires**, with an output current signal, thus providing a **double benefit: one is diagnostic**, since the control unit can detect both the absence and also the excessive surge of current (open circuit or short circuit) in such a way to signal a failure to the sensor, while **the other is practical**, since the wiring which reaches the wheels is reduced. The images below shows the functioning of active WSS' and the typical output current signal.

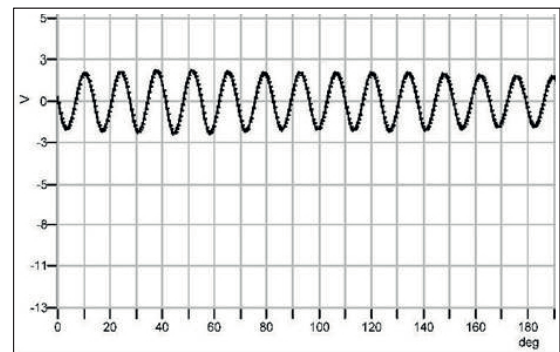
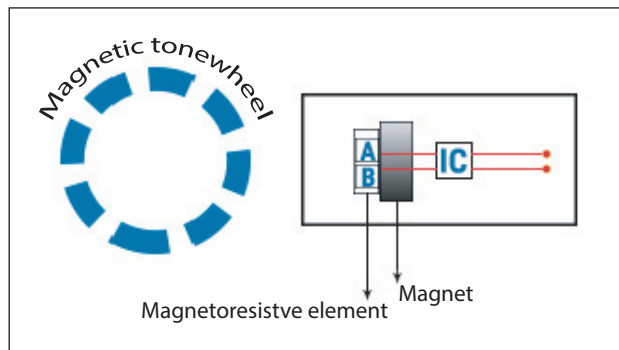

• Passive with variable-reluctance

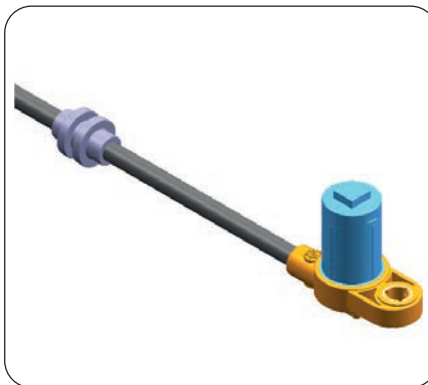

These are defined as **passive** since **they do not require an external power source**.

They are generally comprised by a **solenoid** enveloped by a permanent magnet above a *polarised cylindrical ferromagnetic nucleus*. VR WSS' are typically mounted in close proximity to a *clogwheel*, and their rotation creates pulses of alternating voltage out from the WSS. The variation in distance between the tip of the sensor and the rotating *ferromagnetic device* produces a variation in the *magnetic flux* which passes through the *solenoid*. The electrical control unit calculates the rotation speed from the frequency of the signal.

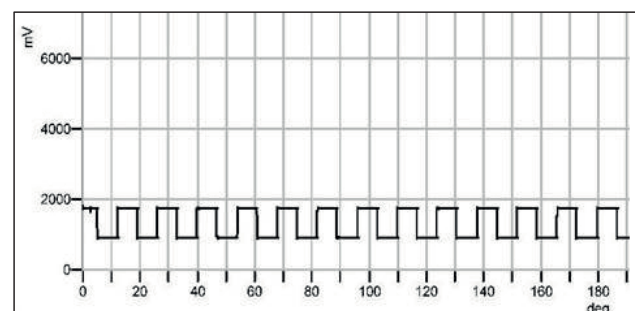
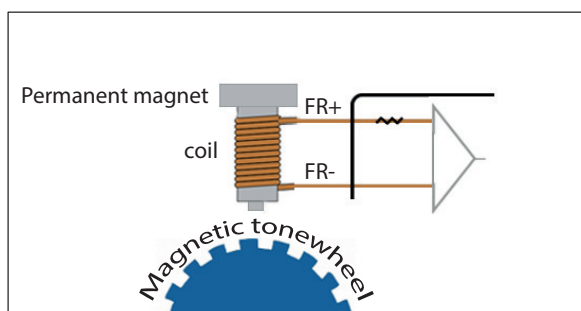



21.XXXX

Sensori di numero di giri ruota

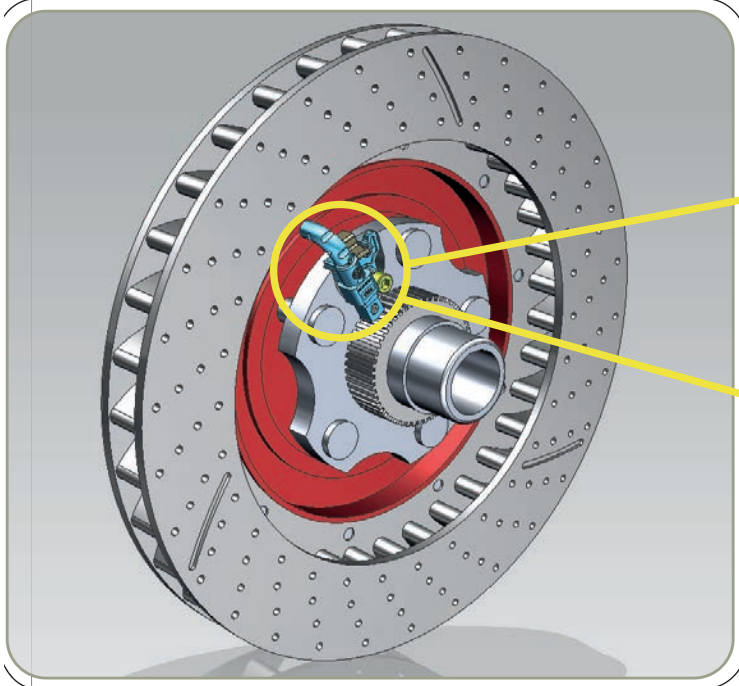

I sensori di numero di giri ruota (WSS – *Wheel Speed Sensors*) sono impiegati per rilevare la velocità delle ruote del veicolo. Tale informazione è trasmessa alla centralina ECU che ne dispone per diverse **applicazioni**:

- ABS (Antilock Braking System)
- ESC (Electronic Stability Control)
- TCS (Traction Control System)
- GPS (navigation)
- Hill-Hold
- Hill-Descent Control
- Cruise Control

I sensori di numero di giri ruota si possono applicare a **veicoli con alimentazione a benzina, a gasolio e ibrida**. Sono normalmente **montati** in prossimità di una *ruota dentata* o *ruota fonica magnetica* solidale con il mozzo o con il semiassi della ruota. I sensori con cavo sono dotati di accessori (gommini e clip) per avere un corretto percorso di fissaggio sul veicolo.

Le principali **cause di guasto** del prodotto sono:

- crepe e tensioni causate da stress meccanico
- deformazioni e ammaccature
- surriscaldamento del sensore
- mancanza di segnale, rottura del cavo per attrito o vibrazione eccessiva, corto circuiti, rottura interna del sensore per stress meccanico o termico.

I **segnali di malfunzionamento** del sensore sono ravvisabili nell' accensione della spia ABS e nel bloccaggio delle ruote.

I sensori di numero giri ruota sono sottoposti a rigorose **prove di qualificazione e di durata** volte a comprovarne l' idoneità all' immissione sul mercato:

- verifica della rigidità dielettrica su copertura cavo e su copertura sensori
- prova di durata
- prova cicli rapidi di temperatura
- rilevamento caratteristiche elettriche alle temperature estreme
- prova della tenuta ermetica dell'O-RING
- prova di resistenza alle vibrazioni/ a shock meccanico
- resistenza alla torsione/trazione del cavo di collegamento
- resistenza allo strappo del sensore per WSS dotati di clip
- resistenza affaticamento dinamico del cavo
- resistenza all'acqua e alla polvere
- prova di immersione in acqua salina
- prova di corrosione in atmosfera industriale (Kesternich)
- resistenza a caldo umido permanente

Superate tali prove e concesso il benessere a produrre, durante l'assemblaggio il prodotto viene sottoposto a severi cicli di controllo che prevedono il **collaudo al 100%** per verificare (la resistenza e l'induttanza, del sensore, l'intensità e la polarità del segnale, la resistenza all'impulso di corrente, l'assenza di interruzioni o di corto).

Elementi costruttivi e principio di funzionamento

Esistono diverse tipologie di sensore di numero di giri ruota:

• Attivi ad effetto hall

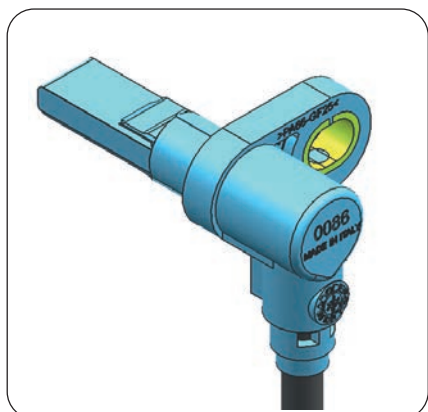

Sono generalmente costituiti da un *chip semiconduttore* sensibile al campo magnetico; inoltre, può essere presente una *magnete permanente* posto dietro di esso.

L'elemento sensibile al campo magnetico si trova all'interno del chip, e può essere costituito da una o più *celle di Hall*, o da un ponte di *magnetoresistori*, il tutto integrato su silicio.

I sensori WSS **attivi** sono costituiti da un **chip a 2 fili**, con segnale di uscita in corrente, ottenendo così un **duplice vantaggio: di tipo diagnostico**, poiché la centralina può rilevare sia l'assenza che l'aumento eccessivo di corrente (circuito aperto o cortocircuito) per segnalare un guasto al sensore, ed un **altro di natura pratica** in quanto viene ridotto il cablaggio che raggiunge le ruote. Nelle figure riportate sotto viene mostrato il funzionamento dei wss attivi, ed il **tipico segnale di uscita in corrente**.

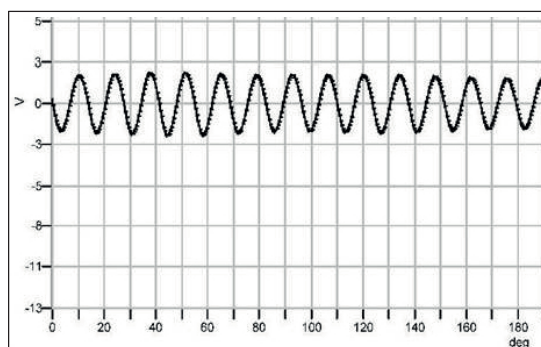
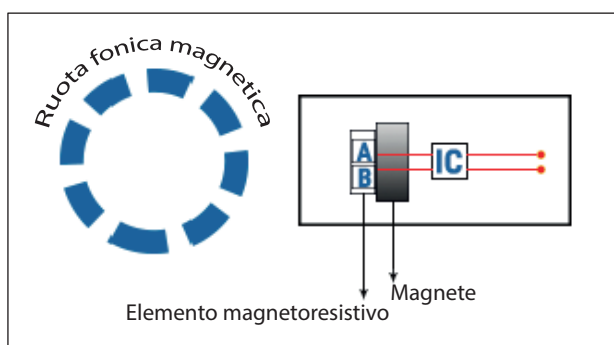

• Passivi a riluttanza variabile

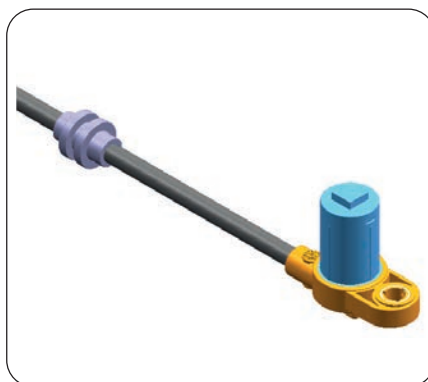

Vengono definiti **passivi** in quanto **non necessitano di un'alimentazione esterna**.

Essi sono generalmente costituiti da un **solenoide** avvolto sopra ad un *nucleo ferromagnetico cilindrico polarizzato* da un *magnete permanente*. I WSS RV sono normalmente montati in prossimità di una *ruota dentata*, la cui rotazione produce degli impulsi di tensione alternata in uscita dai WSS. La variazione della distanza tra il puntalino del sensore e il dispositivo *ferromagnetico* rotante causa una variazione del *flusso magnetico* che attraversa il *solenoide*. La centralina elettronica desume la velocità di rotazione dalla frequenza del segnale.

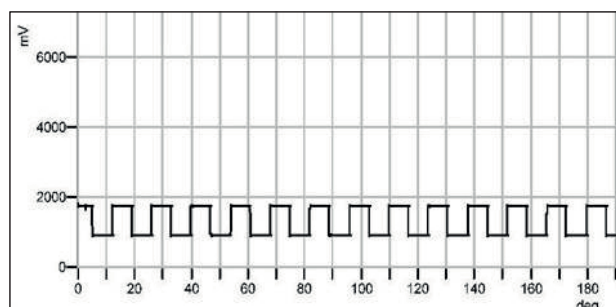
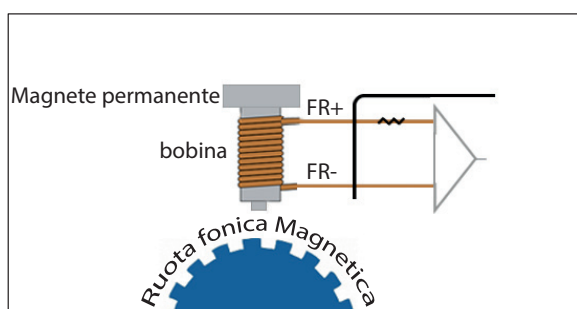



21.XXXX

Capteurs de vitesse de roue

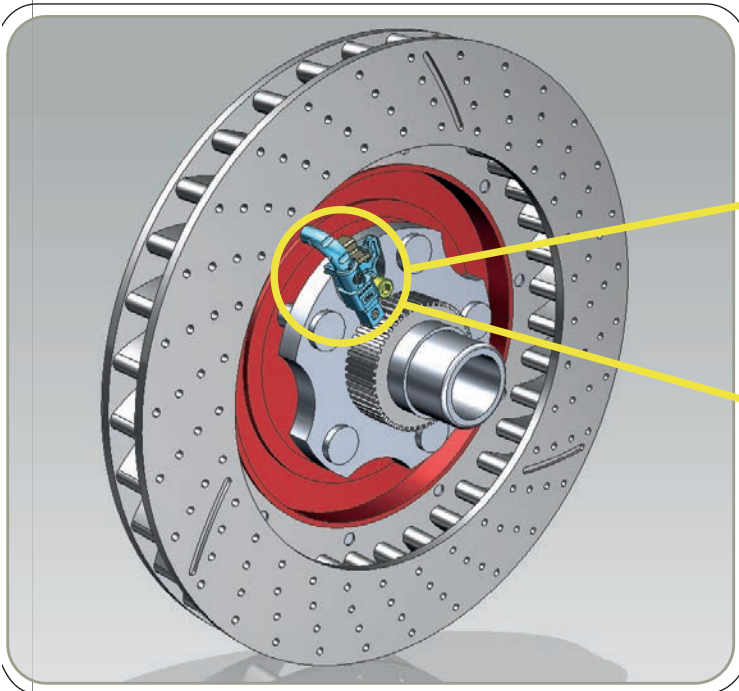

Les capteurs de vitesse de roue (*WSS – Wheel Speed Sensor*) sont utilisés pour détecter la vitesse des roues du véhicule. Cette information est transmise à l'unité de commande ECU qui en dispose pour **différentes applications** :

- ABS (Antilock Braking System)
- ESC (Electronic Stability Control)
- TCS (Traction Control System)
- GPS (navigation)
- Hill-Hold
- Hill-Descent Control
- Cruise Control

Les capteurs **WSS** trouvent leur application dans les **véhicules alimentés à essence, au gasoil et hybrides**. Ils sont normalement **montés** près d'une *roue dentée* ou d'une *roue phonique magnétique* solidaire avec le moyeu ou avec le demi-arbre de la roue. Les capteurs à câble sont équipés d'accessoires (caoutchoucs et clips) afin d'assurer un parcours de fixation correct sur le véhicule.

Les **principales causes de défaut** du produit sont :

- Fissures et tensions dues à des contraintes mécaniques
- Déformations et bosses
- Surchauffe du capteur
- Absence de signal, rupture du câble pour cause de frottement ou de vibration, excessive, courts-circuits, rupture interne du capteur due à une contrainte mécanique ou thermique.

Les **signaux de dysfonctionnement** du capteur sont signalés par l'allumage du témoin ABS et par le blocage des roues.

Les capteurs de vitesse de roue sont soumis à des **essais rigoureux de qualification et de durée** visant à prouver leur aptitude à la mise sur le marché :

Vérification de la rigidité diélectrique sur couverture câble et sur couverture capteurs

- Essai de durée
- Essai des cycles rapides de température
- Relevé des caractéristiques électriques à des températures extrêmes
- Essai d'étanchéité du joint torique
- Essai de résistance aux vibrations / chocs mécaniques
- Résistance à la torsion / traction du câble de raccordement
- Résistance à l'arrachement du capteur pour les WSS munis de clips
- Résistance à la fatigue dynamique du câble
- Résistance à l'eau et à la poussière
- Essai d'immersion dans l'eau saline
- Essai de corrosion en atmosphère industrielle (Kesternich)
- Résistance à la chaleur humide constante

Une fois que ces tests ont été effectués et que l'autorisation à la production a été accordée, pendant l'assemblage, le produit est soumis à des cycles sévères de contrôle qui prévoient des **essais à 100%** pour vérifier (la résistance et l'inductance, du capteur, l'intensité et la polarité du signal, la résistance à l'impulsion de courant, l'absence de coupures ou de courts-circuits).

Éléments constitutifs et principe de fonctionnement

Il existe différents types de capteurs de vitesse de rotation de roue :

• Actifs à effet hall

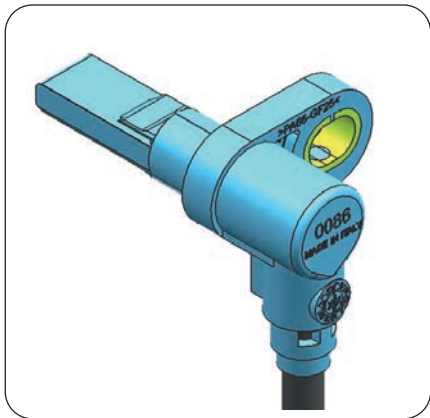

Ils sont généralement composés d'une *puce semi-conductrice* sensible au champ magnétique ; en outre, un *aimant permanent* situé derrière celle-ci peut être présent. L'élément sensible au champ magnétique se trouve à l'intérieur de la puce et il peut être composé d'une ou de plusieurs *cellules de Hall*, ou d'un pont de *magnétorésistances*, le tout intégré sur du silicium. Les capteurs WSS **actifs** sont composés d'une **puce à 2 fils**, avec le signal de sortie de courant, obtenant ainsi un **double avantage : de type diagnostic**, étant donné que l'unité de commande peut détecter aussi bien l'absence que l'augmentation excessive de courant (circuit ouvert ou court-circuit) pour signaler un défaut du capteur, et un autre **de nature pratique**, car il réduit le câblage qui atteint les roues. Les figures ci-dessous illustrent le fonctionnement des wss actifs et le signal **typique de sortie de courant**.

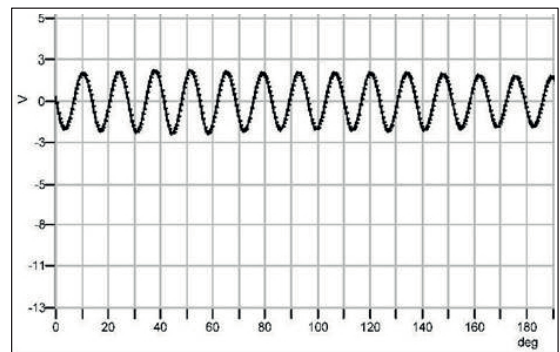
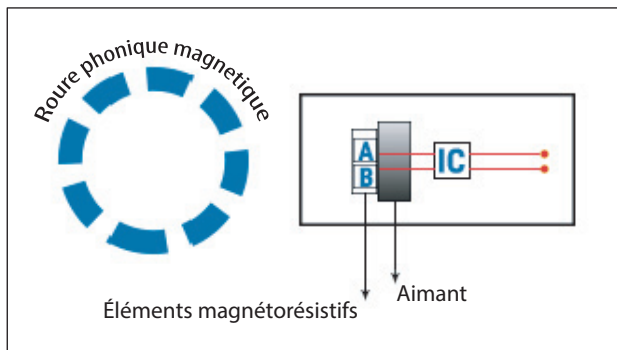

• Passifs à réluctance variable

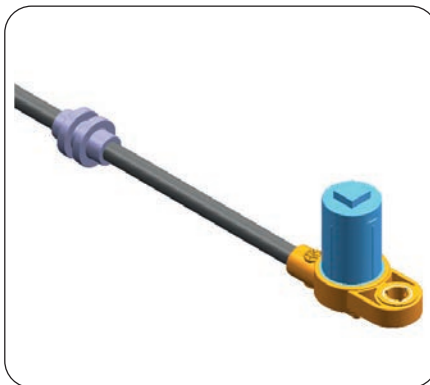

Ils sont dits **passifs**, car **ils ne nécessitent pas d'alimentation externe**. Ils sont généralement composés d'un **solénoïde** enroulé autour d'un **noyau ferromagnétique cylindrique polarisé** par un aimant permanent. Les WSS RV sont normalement montés près d'une *roue dentée*, dont la rotation produit des impulsions de tension alternative en sortie des WSS. La variation de la distance entre l'embout du capteur et le dispositif *ferromagnétique* rotatif provoque une variation du flux magnétique qui traverse le *solénoïde*. L'unité de commande électronique calcule la vitesse de rotation à partir de la fréquence du signal.

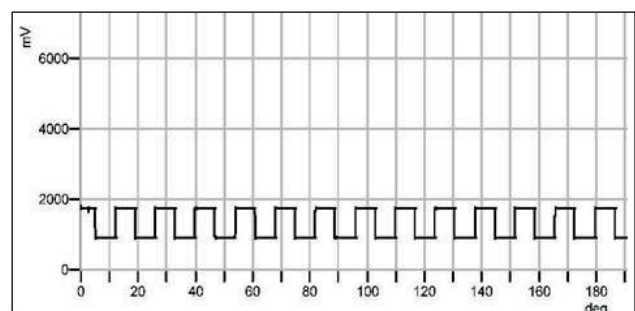
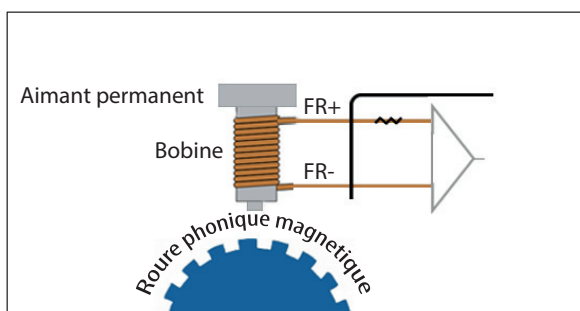



21.XXXX Raddrehzahlsensoren

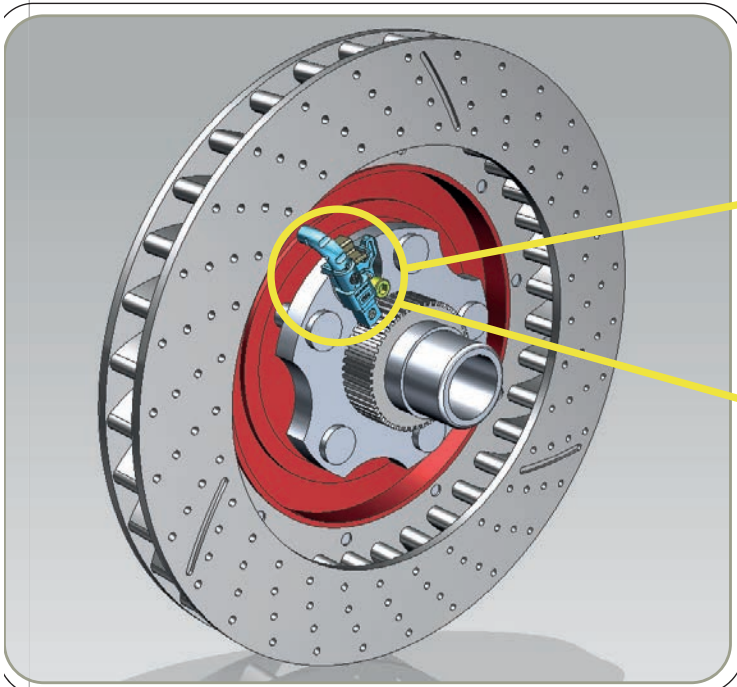

Die Raddrehzahlgeber (WSS – Wheel Speed Sensor) werden eingesetzt, um die Drehzahl der Räder des Fahrzeugs zu messen. Diese Information wird an das Steuergerät ECU übertragen, das sie für unterschiedliche **Anwendungen** nutzt:

- ABS (Antilock Braking System)
- ESC (Electronic Stability Control)
- TCS (Traction Control System)
- GPS (navigation)
- Hill-Hold
- Hill-Descent Control
- Cruise Control

Die **WSS**-Sensoren können bei **bezinbetriebenen, dieselbetriebenen und wasserstoffbetriebenen Fahrzeugen** eingesetzt werden. Sie werden normalerweise in der Nähe eines mit der Nabe oder der Halbachse des **Rads** verbundenen Zahnrads oder magnetischen **phonischen Rads montiert**.

Die Sensoren mit Kabel sind mit Zubehör (Gummitteile und Clips) ausgestattet, um dieses korrekt auf dem Fahrzeug **anzubringen**.

Die Hauptursachen für **Defekte des Produkts** sind:

- Risse und Spannungen durch mechanische Belastung
- Verformungen und Beulen
- Überhitzung des Sensors
- Fehlen des Signals, Kabelbruch durch Reibung oder übermäßige Erschütterung, Kurzschluss, innerer Bruch des Sensors durch mechanische Belastung oder Wärme.

Die Anzeichen für Funktionsstörungen des Sensors sind durch das Aufleuchten der ABS-Kontrollleuchte und das Blockieren der Räder festzustellen.

Die Raddrehzahlgeber werden strengen Prüfungen hinsichtlich **Qualifizierung und Beständigkeit unterzogen**, die darauf abzielen, die Eignung zur Markteinführung nachzuweisen:

- Überprüfung der Durchschlagsfestigkeit auf der Kabel- und Sensorabdeckung
- Dauertests
- Prüfung mit schnellen Temperaturwechseln
- Messung der elektrischen Eigenschaften bei Extremtemperaturen
- Prüfung der hermetischen Dichtheit des O-RINGS
- Prüfung der Festigkeit gegen Schwingungen / mechanische Stöße
- Torsions-/Zugfestigkeit des Anschlusskabels
- Reißfestigkeit des Sensors für WSS mit Clip
- Dynamische Ermüdungsfestigkeit des Kabels
- Wasser- und Staubfestigkeit
- Salzwasser-Tauchtest
- Korrosionsprüfung in industrieller Atmosphäre (Kesternich-Test)
- Festigkeit gegen ständige feuchte Wärme

Nach Bestehen dieser Prüfungen und Freigabe der Produktion wird das Produkt während der Montage strengen Kontrollzyklen unterzogen, die Endabnahmen zu **100 % vorsehen** (zur Prüfung des Widerstands und der Induktanz des Sensors, der Intensität und der Polarität des Signals, des Widerstands gegen den Stromimpuls, der Abwesenheit von Unterbrechungen oder Kurzschlüssen).

Bauliche Elemente und Funktionsprinzip

Es gibt verschiedene Raddrehzahlgeberarten:

• Aktiv mit hall-effekt

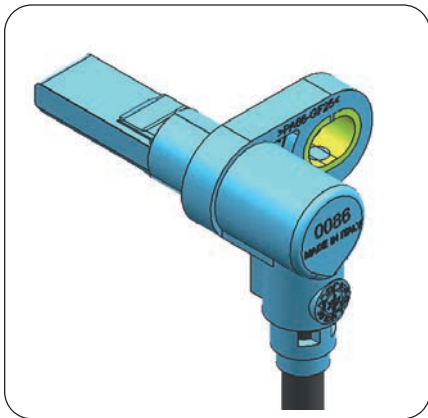

Diese bestehen im Allgemeinen aus einem gegenüber dem Magnetfeld empfindlichen *Halbleiter-Chip*. Außerdem kann ein hinter diesem positionierter *Dauermagnet* vorhanden sein. Das gegenüber dem Magnetfeld empfindliche Element befindet sich im Inneren des Chips und kann aus einer oder mehreren *Hall-Zellen* oder einer *Magnetwiderstandbrücke* bestehen, das Ganze auf Silizium integriert. Die **aktiven** WSS-Sensoren bestehen aus **einem Chip mit zwei Drähten** mit unter Strom stehendem Ausgangssignal, so dass ein **doppelter Vorteil** erzielt wird: **diagnostischer Art**, da das Steuergerät sowohl die Abwesenheit als auch den übermäßigen Anstieg des Stroms erfassen kann (geöffneter Stromkreis oder Kurzschluss), um dem Sensor einen Defekt zu melden, **ein weiterer praktischer Art**, da die zu den Rädern führende Verkabelung begrenzt wird. In den Abbildungen unten wird die Funktionsweise der aktiven WSS mit dem typischen unter Strom stehenden Ausgangssignal dargestellt.

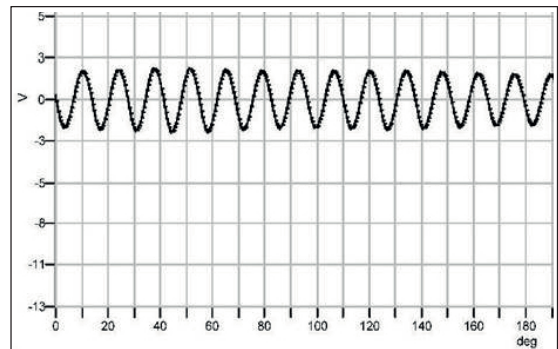
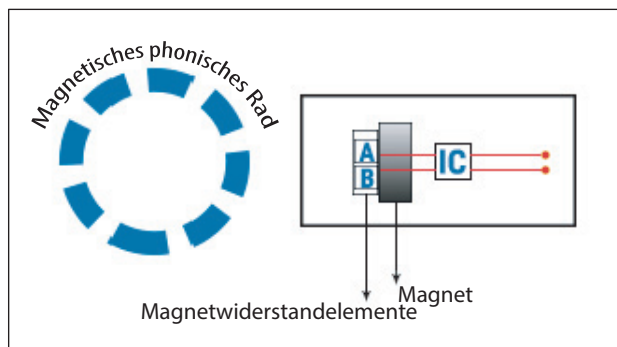

• Passiv mit variabler Reluktanz

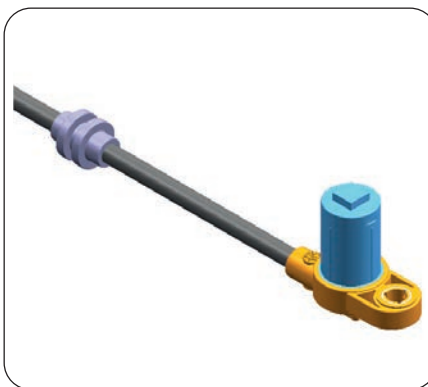

Sie werden als **passiv** definiert, da sie **keine Versorgung von außen benötigen**. Sie bestehen normalerweise aus einem um einen von einem Dauermagneten *polarisierten* *zylindrischen ferromagnetischen Kern* gewickelten **Spulenkörper**. Die WSS RV sind normalerweise in der Nähe eines *Zahnrad*s montiert, dessen Drehung Wechselfeldspannungsimpulse im Ausgang aus den WSS erzeugt. Die Änderung des Abstands zwischen der Spitze des Sensors und der drehenden *ferromagnetischen* Vorrichtung verursacht eine Änderung des den *Spulenkörper* durchfließenden *Magnetflusses*. Das elektronische Steuergerät leitet die Drehgeschwindigkeit aus der Signalfrequenz ab.

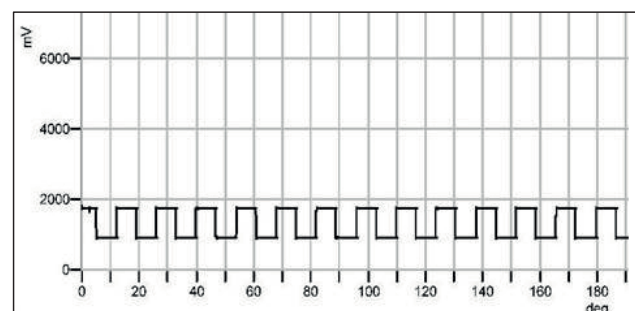
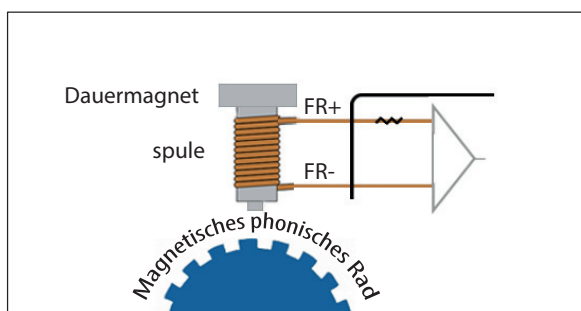



21.XXXX

Sensores de revoluciones de ruedas

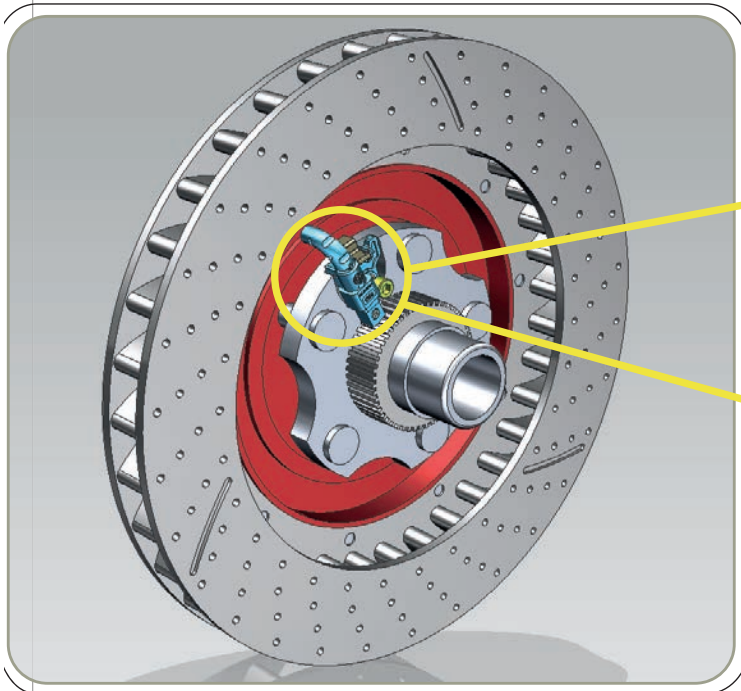

Los sensores de velocidad de la rueda (*WSS – Wheel Speed Sensor*) se utilizan para detectar la velocidad de las ruedas del vehículo. La información se transmite a la centralita ECU que la utiliza para distintas **aplicaciones**:

- ABS (Antilock Braking System)
- ESC (Electronic Stability Control)
- TCS (Traction Control System)
- GPS (navigation)
- Hill-Hold
- Hill-Descent Control
- Cruise Control

Los sensores **WSS** se pueden instalar en **vehículos con alimentación de gasolina, de gasoleo e híbrida**. Por lo general están **montados** cerca de una *rueda dentada* o *rueda fónica* magnética integrada en el cubo o en el semieje de la rueda. Los sensores con cable cuentan con accesorios (piezas de caucho y clips) para lograr un correcto recorrido de fijación en el vehículo.

Las **principales causas de avería** del producto son:

- rajaduras y tensiones provocadas por el estrés mecánico
- deformaciones y magulladuras
- recalentamiento del sensor
- ausencia de señal, rotura del cable por rozamiento o vibración excesiva, cortocircuitos, rotura interna del sensor por estrés mecánico o térmico.

Las **señales de problemas de funcionamiento** del sensor se

pueden observar por el encendido del testigo ABS y por el bloqueo de las ruedas.

Los sensores de velocidad de la rueda se someten a **rigurosas pruebas de calificación y de duración** para comprobar su aptitud para la introducción en el mercado:

- Comprobación de la rigidez dieléctrica en la cubierta del cable y en la cubierta de los sensores
- Prueba de duración
- Prueba de ciclos rápidos de temperatura
- Detección de características eléctricas con temperaturas extremas
- Prueba de hermeticidad de la junta tórica
- Prueba de resistencia a las vibraciones/a choques mecánicos
- Resistencia a la torsión/tracción del cable de conexión
- Resistencia al arrancamiento del sensor de los WSS con clip
- Resistencia a la fatiga dinámica del cable
- Resistencia al agua y al polvo
- Prueba de inmersión en agua salina
- Prueba de corrosión en atmósfera industrial (Kesternich)
- Resistencia al calor húmedo permanente

Tras superar esas pruebas y con la autorización para pasar a la producción, durante el ensamblaje el producto se somete a rigurosos ciclos de control que incluyen **ensayos al 100%**, para comprobar la resistencia y la inductancia del sensor, la intensidad y la polaridad de la señal, la resistencia al impulso de corriente y la ausencia de interrupciones o de cortocircuitos.

Elementos de construcción y principio de funcionamiento

Existen distintos tipos de sensores de velocidad de la rueda:

• Activos de efecto hall

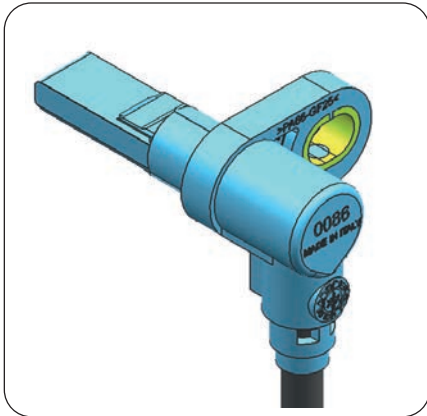

Generalmente constan de un *chip semiconductor* sensible al campo magnético; además, puede haber un *imán permanente* colocado detrás del mismo.

El elemento sensible al campo magnético se encuentra en el interior del chip, y puede estar formado por una o más *celdas de Hall*, o por un puente de *magnetorresistencias*, todo ello integrado en silicio.

Los sensores WSS **activos** están formados por un **chip de 2 cables**, con señal de salida en corriente, obteniendo así una **doble ventaja: de diagnóstico**, ya que la centralita puede detectar, tanto la ausencia como el aumento excesivo de corriente (circuito abierto o cortocircuito), para indicar una avería al sensor, y **otra ventaja de tipo práctico**, ya que se reduce el cableado que llega a las ruedas. En las figuras de abajo se muestra el funcionamiento de los WSS activos, y la típica señal de salida en corriente.

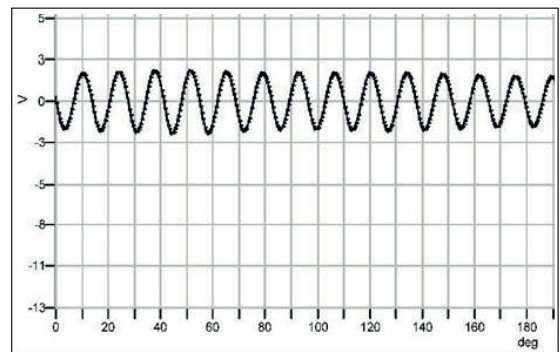
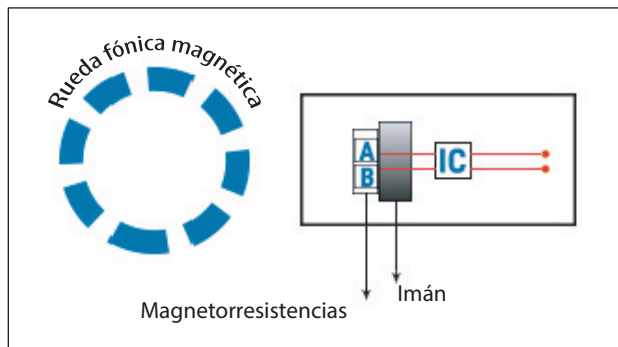

• Pasivos de reluctancia variable

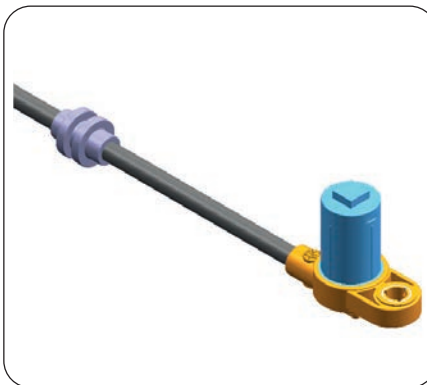

Se definen **pasivos** porque **no necesitan una alimentación externa**. Generalmente constan de un **solenoide** envuelto sobre un *núcleo ferromagnético cilíndrico polarizado* por un imán permanente. Los WSS RV normalmente están montados cerca de una *rueda dentada*, cuyo giro genera impulsos de tensión alterna en salida de los WSS. La variación de la distancia entre la virola del sensor y el dispositivo ferromagnético giratorio provoca una variación del *flujo magnético* que atraviesa el *solenoide*. A partir de la frecuencia de la señal, la centralita electrónica deduce la velocidad de giro.

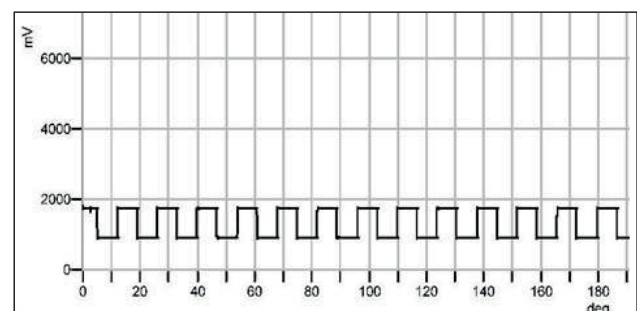
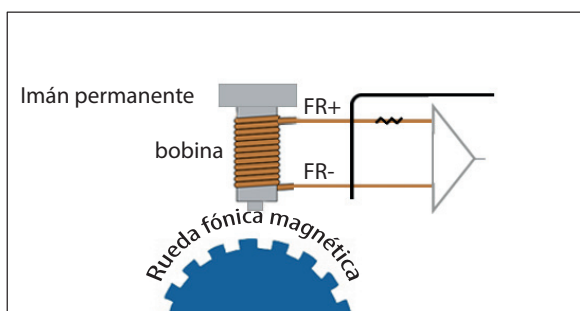

21.0001



1

WHEEL SPEED SENSORS

Adatt./Suitable:

ASTON MARTIN

3M5T-2B-372AB
4G43-90-10039

ATE

06.2107-5351.4
10.0711-5123.3
10.0711-5357.3
10.0711-5515.3

BOSCH

0 265 007 087
0 265 007 879
0 986 594 555
0 986 594 607

FORD

1 115 018
1 146 400
1 223 620
1 386 268
1 690 865
1 847 581
157T-2B372-AB
157T-2B372-AC
157T-2B372-AD
3M5T-2B372-AB
8M5T-2B372-AA
BV6T-2C204-FA
BV6T-2C204-FB

JAGUAR

C2S 17482
C2S 2340
C2S 43216

MAZDA

BP4K-43-701A

VOLVO

31274611

MARKET DIFFUSION: HIGH



L	L1		
---	24,9	Hall Effect	

ASTON MARTIN

DB9 6.0	AM11, AM11	04/04 → 10/16
DB9 6.0V12	AM11, AM6U5	01/04 → 10/16
DBS 6.0V12	AM4R9	09/07 →
ONE-77 7.3	AM21	06/10 → 06/12
RAPIDE 6.0	AM16	03/10 → 09/13
RAPIDE 6.0S	AM11	02/13 → 02/14
VANQUISH 6.0	AM11	10/12 →
VANQUISH 6.0 S	AM06	11/04 → 08/07
VANTAGE 4.3	AM6U5, AM07	10/05 → 12/10
VANTAGE 4.3 N400	AM6U5	01/08 → 12/10
VANTAGE 4.7	AM07, HWDA	10/08 →
VANTAGE 4.7 GT8	AM15	07/13 →
VANTAGE 4.7 S	AM15	01/11 →
VANTAGE 6.0	AM10	01/12 →
VANTAGE 6.0V12	AM3	09/09 → 12/13
VIRAGE 6.0	AM25	06/11 → 08/12
ZAGATO 6.0V12	AM4R9	05/12 →

FORD

C-MAX I 1.6	HWDA, G8DA	02/07 → 09/10
C-MAX I 1.6 TDCi	G8DA, --	02/07 → 09/10
C-MAX I 1.6 Ti-VCT	--, QQDA	03/07 →
C-MAX I 1.8	QQDA, KKDA	02/07 → 09/10
C-MAX I 1.8 Flexifuel	Q7DA	02/07 → 09/10
C-MAX I 1.8 TDCi	KKDA, AODA	02/07 → 09/10
C-MAX I 2.0	AODA, SYDA	02/07 → 09/10
C-MAX I 2.0 CNG	SYDA, G6DA	04/09 → 09/10
C-MAX I 2.0 LPG	SYDA	06/08 → 09/10
C-MAX I 2.0 TDCi	G6DA, --	02/07 → 09/10
C-MAX II 1.0 EcoBoost	--, M8DB	10/12 →
C-MAX II 1.5 16V	--	03/15 →
C-MAX II 1.5 EcoBoost	M8DB, XWDA	03/15 →
C-MAX II 1.5 TDCi	XWDA, IQDA	03/15 →
C-MAX II 1.5 TDCi ECOnetic	AEDA	03/15 →
C-MAX II 1.6	--	12/10 →

FORD

C-MAX II 1.6 CNG	MUDACNG	01/13 →
C-MAX II 1.6 EcoBoost	JQDA, MUDA	12/10 →
C-MAX II 1.6 Flexifuel	MUDA, MUDA	02/11 →
C-MAX II 1.6 LPG	MUDA, T1DA	02/12 →
C-MAX II 1.6 TDCi	T1DA, IQDA	12/10 →
C-MAX II 1.6 Ti	IQDA, --	12/10 →
C-MAX II 2.0 Energi	--, --	01/15 →
C-MAX II 2.0 TDCi	--, HWDA	04/10 →
FOCUS II 1.4	ASDA, HWDA	07/04 → 09/12
FOCUS II 1.6	HWDA, G8DA	07/04 → 09/12
FOCUS II 1.6 LPG	SIDA	10/09 → 09/12
FOCUS II 1.6 TDCi	G8DA, HXDA	07/04 → 09/12
FOCUS II 1.6 Ti	HXDA, Q7DA	07/04 → 09/12
FOCUS II 1.6 Ti-VCT	--	12/07 →
FOCUS II 1.8	Q7DA, --	03/06 → 09/12
FOCUS II 1.8 Flexifuel	--, KKDA	12/05 → 09/12
FOCUS II 1.8 TDCi	KKDA, AODA	07/04 → 09/12
FOCUS II 2.0	AODA, SYDA	07/04 → 09/12
FOCUS II 2.0 CNG	SYDA, G6DA	04/09 → 07/11
FOCUS II 2.0 Flex	SYDA	10/08 → 03/10
FOCUS II 2.0 LPG	SYDA	06/08 → 07/11
FOCUS II 2.0 TDCi	G6DA, ASDA	07/04 → 09/12
FOCUS II 2.5 RS	JZDA	01/09 → 07/11
FOCUS II 2.5 RS 500	JZDA	05/10 → 07/11
FOCUS II 2.5 ST	HYDA	10/05 → 09/12
FOCUS II CASSONE / FURGO-NATO / PROMISCUO 1.4	ASDA, G8DA	09/05 → 07/11
FOCUS II CASSONE / FURGO-NATO / PROMISCUO 1.6	HWDA	09/05 → 07/11
FOCUS II CASSONE / FURGO-NATO / PROMISCUO 1.6 TDCi	G8DA, HXDA	07/04 → 07/11
FOCUS II CASSONE / FURGO-NATO / PROMISCUO 1.6 Ti-VCT	HXDA, Q7DA	09/05 → 07/11
FOCUS II CASSONE / FURGO-NATO / PROMISCUO 1.8 Flexifuel	Q7DA, G6DB	06/09 → 07/11
FOCUS II CASSONE / FURGO-NATO / PROMISCUO 2.0 TDCi	G6DB, M1DA	09/05 → 07/11
FOCUS III 1.0 EcoBoost	M1DA, M8DA	02/12 →
FOCUS III 1.0 GTDI	--	07/12 →
FOCUS III 1.5 DiTc SIGMA A	--	09/14 →
FOCUS III 1.5 EcoBoost	M8DA, XWDA	09/14 →
FOCUS III 1.5 TDCi	XWDA, AEDA	09/14 →
FOCUS III 1.5 TDCi ECOnetic	AEDA, JQDA	09/14 →
FOCUS III 1.6 EcoBoost	JQDA, MUDA	07/10 →
FOCUS III 1.6 Flexifuel	MUDA, MUDA	07/10 →
FOCUS III 1.6 LPG	MUDA, NGDA	02/12 →
FOCUS III 1.6 TDCi	NGDA, NGDA	07/10 →
FOCUS III 1.6 TDCi ECOnetic	NGDA, IQDA	05/12 → 09/14
FOCUS III 1.6 Ti	IQDA, R9DA	07/10 →
FOCUS III 1.6 Ti-VCT	--	07/10 →
FOCUS III 2.0	XQDA	10/13 →
FOCUS III 2.0 DiTIVCT	--	04/11 →
FOCUS III 2.0 GDi	MGDA	08/11 →
FOCUS III 2.0 ST	R9DA, T7DA	07/12 →
FOCUS III 2.0 TDCi	T7DA, --	07/10 →
FOCUS III 2.0 TDCi ST	T8DA	11/14 →
FOCUS III 2.0 Ti-GDi	MGDA	07/10 →
FOCUS III 2.3 RS AWD	YVDA	07/15 →
FOCUS III Electric	KDDA	07/13 →
FOCUS C-MAX 1.6	HWDA, G8DA	10/03 → 03/07
FOCUS C-MAX 1.6 TDCi	G8DA, HXDA	10/03 → 03/07
FOCUS C-MAX 1.6 Ti	HXDA, CSDA	08/04 → 03/07
FOCUS C-MAX 1.8	CSDA, KKDA	10/03 → 03/07
FOCUS C-MAX 1.8 Flexifuel	Q7DA	01/06 → 03/07
FOCUS C-MAX 1.8 TDCi	KKDA, AODA	01/05 → 03/07
FOCUS C-MAX 2.0	AODA, G6DA	03/04 → 03/07
FOCUS C-MAX 2.0 TDCi	G6DA, ASDA	10/03 → 03/07
GALAXY II 1.6 EcoBoost	--, T1WA	11/10 →
GALAXY II 1.6 TDCi	T1WA, FFWA	02/11 → 06/15
GALAXY II 1.8 TDCi	FFWA, AOWA	05/06 → 06/15
GALAXY II 2.0	AOWA, TNWA	05/06 → 06/15
GALAXY II 2.0 EcoBoost	TNWA, TBWA	03/10 →
GALAXY II 2.0 Flexifuel	TBWA, --	05/06 → 06/15
GALAXY II 2.0 TDCi	--, KNWA	05/06 →
GALAXY II 2.0 TDCi CR TC	--	03/10 →
GALAXY II 2.0 TDCi DSL	--	03/10 →
GALAXY II 2.2 TDCi	KNWA, M1DA	03/08 → 06/15
GALAXY II 2.3	SEWA	09/07 → 06/15
GALAXY II 2.5 ST	HUWA	05/06 →
GRAND C-MAX 1.0 EcoBoost	M1DA, M8DB	10/12 →
GRAND C-MAX 1.5 EcoBoost	M8DB, AEDA	03/15 →
GRAND C-MAX 1.5 TDCi	AEDA, JQDA	03/15 →
GRAND C-MAX 1.6 EcoBoost	JQDA, T1DA	12/10 →
GRAND C-MAX 1.6 TDCi	T1DA, IQDA	12/10 →
GRAND C-MAX 1.6 Ti	IQDA, T7DB	12/10 →

FORD

GRAND C-MAX 2.0 TDCi	T7DB, --	12/10 →
KUGA I 2.0 TDCi	--, G6DG	03/08 →
KUGA I 2.0 TDCi 4x4	G6DG, HYDB	03/08 → 11/12
KUGA I 2.0 TDCi CR TC	--	03/10 →
KUGA I 2.5	HYDB, HYDB	03/09 → 11/12
KUGA I 2.5 4x4	HYDB, BNMA	02/08 → 11/12
KUGA II 1.5 16V	--	03/13 →
KUGA II 1.5 EcoBoost	BNMA, C15HDTX	09/14 →
KUGA II 1.5 EcoBoost 4x4	C15HDTX, --	09/14 →
KUGA II 1.5 TDCi	--, --	07/16 →
KUGA II 1.6 EcoBoost	--, JQMA	01/13 →
KUGA II 1.6 EcoBoost 4x4	JQMA, T7MA	10/12 →
KUGA II 2.0 4x4	--	03/13 → 06/16
KUGA II 2.0 EcoBoost	--	03/13 →
KUGA II 2.0 EcoBoost 4x4	R9MA	08/17 →
KUGA II 2.0 TDCi	T7MA, T7MA	03/13 →
KUGA II 2.0 TDCi 4x4	T7MA, --	03/13 →
KUGA II 2.5	--, T1BA	09/13 →
KUGA II 2.5 PFI	--	03/13 →
MONDEO II 1.8 16V	CGBA, CIBA	10/00 → 03/07
MONDEO II 1.8 SCi	CFBA	06/03 → 03/07
MONDEO II 2.0 16V	CJBA, D5BA	10/00 → 03/07
MONDEO II 2.0 16V DI / TDDi / TDCi	D5BA, D6BA	10/00 → 03/07
MONDEO II 2.0 16V TDDi / TDCi	D6BA, --	10/00 → 03/07
MONDEO II 2.0 DI	PD20FMCR	10/00 → 03/07
MONDEO II 2.0 TDCi	--, QJBA	10/01 → 03/07
MONDEO II 2.2 TDCi	QJBA, MP30MHBA	09/04 → 03/07
MONDEO II 2.5 V6	LCBD	10/00 → 03/07
MONDEO II 2.5 V6 24V	LCBD	10/00 → 03/07
MONDEO II 3.0 V6 24V	MP30MHBA, JTBA	09/04 → 03/07
MONDEO II ST220	MEBA	04/02 → 03/07
MONDEO III 1.6 EcoBoost	JTBA, T1BA	11/10 → 01/15
MONDEO III 1.6 TDCi	T1BA, KGBA	12/10 → 01/15
MONDEO III 1.6 Ti	KGBA, FFBA	03/07 → 01/15
MONDEO III 1.8 TDCi	FFBA, A0BA	03/07 → 01/15
MONDEO III 2.0	A0BA, TBBA	03/07 → 01/15
MONDEO III 2.0 EcoBoost	TPBA	03/10 → 01/15
MONDEO III 2.0 Flexifuel	TBBA, AZBA	03/09 → 01/15
MONDEO III 2.0 LPG	TBBA	07/09 → 01/15
MONDEO III 2.0 SCTi	TNBA	03/10 → 01/15
MONDEO III 2.0 TDCi	AZBA, KNBA	03/07 → 01/15
MONDEO III 2.2 TDCi	KNBA, --	03/08 → 01/15
MONDEO III 2.3	SEBA	07/07 → 01/15
MONDEO III 2.5	HUBA	03/07 → 01/15
MONDEO III 2.0 EcoBoost	JTBA	11/10 → 09/14
MONDEO 1.6 TDCi	T1BA, TNBA	03/13 → 09/14
MONDEO 2.0	A0BC	03/07 → 09/14
MONDEO 2.0 EcoBoost	TNBA, KLBA	03/10 → 09/14
MONDEO 2.0 TDCi	KLBA, CGBA	03/07 → 09/14
MONDEO 2.2 TDCi	KNBA	03/13 → 09/14
S-MAX I 1.6 EcoBoost	--, T1WA	02/11 →
S-MAX I 1.6 TDCi	T1WA, FFWA	02/11 → 12/14
S-MAX I 1.8 TDCi	FFWA, AODA	05/06 → 12/14
S-MAX I 2.0	AODA, TNWA	05/06 → 12/14
S-MAX I 2.0 EcoBoost	TNWA, TBWA	03/10 → 12/14
S-MAX I 2.0 Flexifuel	TBWA, AZWA	05/06 → 12/14
S-MAX I 2.0 TDCi	AZWA, KNWA	05/06 → 12/14
S-MAX I 2.0 TDCi CR TC	--	03/10 →
S-MAX I 2.0 TDCi DSL	--	03/10 →
S-MAX I 2.2 TDCi	KNWA, M2GA	03/08 → 12/14
S-MAX I 2.3	SEWA	07/07 → 12/14
S-MAX I 2.5 ST	HUWA	05/06 → 12/14
TOURNEO CONNECT II 1.0 EcoBoost	M2GA, --	11/13 →
TOURNEO CONNECT II 1.5 TDCi	--, --	09/13 →
TOURNEO CONNECT II 1.6 EcoBoost	--, T1GA	09/13 →
TOURNEO CONNECT II 1.6 TDCi	T1GA, M2GA	09/13 →
TOURNEO CONNECT II 2.5	--	09/13 →
TRANSIT CONNECT II 1.0 EcoBoost	M2GA, --	02/13 →
TRANSIT CONNECT II 1.5 TDCi	--, --	02/13 →
TRANSIT CONNECT II 1.6 EcoBoost	--, T1GA	02/13 →
TRANSIT CONNECT II 1.6 TDCi	T1GA, LJ46G	02/13 →
TRANSIT CONNECT II 2.5	--	02/13 →

JAGUAR

X-TYPE 2.0 D	LJ46B	07/03 → 12/09
X-TYPE 2.1 V6	AJNYB	03/02 → 11/09
X-TYPE 2.2 D	LJ46G, FXJA	10/05 → 12/09
X-TYPE 2.5	AJMXB	02/04 → 12/09
X-TYPE 2.5 V6 Trazione integrale	AJMXB	06/01 → 11/09
X-TYPE 3.0	AJLWB	02/04 → 12/09

JAGUAR		
X-TYPE 3.0 V6 Trazione integrale	AJLWB	06/01 → 12/08

MAZDA		
3 I 1.4	FXJA, B6ZE	10/03 → 06/09
3 I 1.6	B6ZE, Y601	10/03 → 06/09
3 I 1.6 DI Turbo	Y601, LF17	06/04 → 06/09
3 I 1.6 MZ-CD	Y406	06/06 → 12/09
3 I 2.0	LF17, RF7J	09/03 → 12/09
3 I 2.0 MZR-CD	RF7J, L3N9	12/06 → 06/09
3 I 2.3 DiSi Turbo MPS	L3YH	06/06 → 06/09
3 I 2.3 MPS Turbo	L3N9, Z6	12/06 → 06/09
3 II 1.6 MZR	Z6, Y601	12/08 → 09/14
3 II 1.6 MZR CD	Y601, LF17	12/08 → 05/13
3 II 2.0 MZR	LF17, LF-5H	01/09 → 09/14
3 II 2.0 MZR DISI	LF-5H, R2AA	12/08 → 05/13
3 II 2.2 MZR CD	R2AA, L3KG	01/09 → 09/14
3 II 2.3 MPS Turbo	L3KG, LFD7	06/09 → 09/14
3 II 2.5	L5-VE	03/09 → 09/14
5 I 1.8	L823	02/05 → 05/10
5 I 2.0	LF7D, Y650	12/08 → 05/10
5 I 2.0 CD	RF7J	02/05 → 05/10
5 I 2.0 MZR	LF5	09/07 →
5 I 2.0 MZR-CD	RF	09/07 →
5 II 1.6 CD	Y650, LF-5H	09/10 →
5 II 1.8 MZR	L850	09/10 →
5 II 2.0	LF-5H, B6304T2	09/10 →

VOLVO		
S80L 2.0 T	B4204T6	01/10 →
S80L 2.5 T	B5254T6	01/08 →
S80L 2.5 T5	B5254T12	01/12 →
S80L T4	B5204T8	01/12 →
S80L T5	B4204T7	01/12 →
S80L T6 AWD	B6304T2, D5244T20	01/08 →
XC60 I D3	D4204T4	03/15 → 02/17
XC60 I D4	D4204T14	03/15 → 02/17
XC60 I D4 AWD	D5244T21	03/15 → 02/17
XC60 I D5	D5244T11	06/11 → 02/17
XC60 I D5 AWD	D5244T20, HWDA	04/14 → 02/17
XC60 I T5 AWD	B4204T11	10/15 → 02/17
XC60 I T6 AWD	B4204T9	10/13 →

21.0002



WHEEL SPEED SENSORS

Adatt./Suitable:

ATE
10.0711-5133.3

BOSCH
0 986 594 556

FORD
1 356 184
3M5T-2B372-DA

MARKET DIFFUSION: **HIGH**



L	L1		
---	24,9	Hall Effect	

FORD		
C-MAX I 1.6	HWDA, G8DA	02/07 → 09/10
C-MAX I 1.6 TDCi	G8DA, --	02/07 → 09/10
C-MAX I 1.6 Ti-VCT	--, QQDA	03/07 →
C-MAX I 1.8	QQDA, KKDA	02/07 → 09/10
C-MAX I 1.8 Flexifuel	Q7DA	02/07 → 09/10
C-MAX I 1.8 TDCi	KKDA, AODA	02/07 → 09/10
C-MAX I 2.0	AODA, SYDA	02/07 → 09/10
C-MAX I 2.0 CNG	SYDA, G6DA	04/09 → 09/10
C-MAX I 2.0 LPG	SYDA	06/08 → 09/10
C-MAX I 2.0 TDCi	G6DA, HWDA	02/07 → 09/10
FOCUS II 1.4	ASDA, HWDA	07/04 → 09/12

FORD		
FOCUS II 1.6	HWDA, G8DA	07/04 → 09/12
FOCUS II 1.6 TDCi	G8DA, HXDA	07/04 → 09/12
FOCUS II 1.6 Ti	HXDA, Q7DA	07/04 → 09/12
FOCUS II 1.6 Ti-VCT	--	12/07 →
FOCUS II 1.8	Q7DA, --	03/06 → 09/12
FOCUS II 1.8 Flexifuel	--, KKDA	12/05 → 09/12
FOCUS II 1.8 TDCi	KKDA, AODA	07/04 → 09/12
FOCUS II 2.0	AODA, G6DA	07/04 → 09/12
FOCUS II 2.0 CNG	SYDA	04/09 → 07/11
FOCUS II 2.0 Flex	SYDA	10/08 → 03/10
FOCUS II 2.0 LPG	SYDA	06/08 → 07/11
FOCUS II 2.0 TDCi	G6DA, ASDA	07/04 → 09/12
FOCUS II 2.5 RS 500	JZDA	05/10 → 07/11
FOCUS II 2.5 ST	HYDA	10/05 → 09/12
FOCUS II CASSONE / FURGONATO / PROMISCUO 1.4	ASDA, G8DA	09/05 → 07/11
FOCUS II CASSONE / FURGONATO / PROMISCUO 1.6	HWDA	09/05 → 07/11
FOCUS II CASSONE / FURGONATO / PROMISCUO 1.6 TDCi	G8DA, HXDA	07/04 → 07/11
FOCUS II CASSONE / FURGONATO / PROMISCUO 1.6 Ti-VCT	HXDA, KLBA	09/05 → 07/11
FOCUS C-MAX 1.6	HWDA, G8DA	10/03 → 03/07
FOCUS C-MAX 1.6 TDCi	G8DA, HXDA	10/03 → 03/07
FOCUS C-MAX 1.6 Ti	HXDA, CSDA	08/04 → 03/07
FOCUS C-MAX 1.8	CSDA, KKDA	10/03 → 03/07
FOCUS C-MAX 1.8 Flexifuel	Q7DA	01/06 → 03/07
FOCUS C-MAX 1.8 TDCi	KKDA, AODA	01/05 → 03/07
FOCUS C-MAX 2.0	AODA, G6DA	03/04 → 03/07
FOCUS C-MAX 2.0 TDCi	G6DA, ASDA	10/03 → 03/07
MONDEO III 1.6 Ti	PNBA, FFBA	03/07 → 01/15
MONDEO III 1.8 TDCi	FFBA, AOBA	03/07 → 01/15
MONDEO III 2.0	AOBA, AZBA	03/07 → 01/15
MONDEO III 2.0 Flexifuel	TBBA	03/09 → 01/15
MONDEO III 2.0 TDCi	AZBA, D5244T13	03/07 → 01/15
MONDEO III 2.3	SEBA	07/07 → 01/15
MONDEO III 2.5	HUBA	03/07 → 01/15
MONDEO 2.0	AOBC	03/07 → 09/14
MONDEO 2.0 TDCi	KLBA, PNBA	03/07 → 09/14

21.0005



WHEEL SPEED SENSORS

Adatt./Suitable:

ATE
10.0711-5198.3

FORD
6G9N-2B372-CB

VOLVO
30748149
947555-7

MARKET DIFFUSION: **HIGH**



L	L1		
---	24,9	Hall Effect	

VOLVO		
C30 1.6	B416453	10/06 → 12/12
C30 1.6 D	D4164T	10/06 → 12/12
C30 1.6 D2	D4162T	10/10 → 12/12
C30 1.8	B4184511	10/06 → 12/12
C30 1.8 FlexFuel	B418458	01/07 → 12/12
C30 2.0	B420453	10/06 → 12/12
C30 2.0 D	D4204T	10/06 → 12/12
C30 2.0 FlexFuel	B420454	01/10 → 12/12
C30 2.4 i	B524454	10/06 → 12/12
C30 2.5 T5 [ExtraEU]	B525477	03/12 → 12/13
C30 D3	D5204T5	10/10 → 12/12

VOLVO		
C30 D4	D5204T	10/10 → 12/12
C30 D5	D5244T13, B5254T3	10/06 → 12/12
C30 Electric	E400V1	12/10 → 12/12
C30 T5	B5254T3, D5244T13	10/06 → 12/12
C70 II 2.0 D	D4204T	01/08 → 10/09
C70 II 2.4	B524455	03/06 → 10/09
C70 II 2.4 D	D5244T9	03/07 → 06/13
C70 II 2.4 i	B524454	03/06 → 10/09
C70 II D3	D5204T5	10/10 → 06/13
C70 II D4	D5204T	10/10 → 06/13
C70 II D5	D5244T13, B5254T3	03/06 → 06/13
C70 II T5	B5254T3, B524454	03/06 → 10/09
S40 II 1.6	B416453	01/05 → 12/12
S40 II 1.6 D	D4164T	01/05 → 12/12
S40 II 1.6 D2	D4162T	10/10 → 12/12
S40 II 1.8	B4184511	04/04 → 12/10
S40 II 1.8 FlexFuel	B418458	01/06 → 12/10
S40 II 2.0	B420453	10/06 → 12/12
S40 II 2.0 CDI	D4204T2	07/05 → 12/06
S40 II 2.0 D	D4204T	01/04 → 12/10
S40 II 2.0 D4	D4204T2	07/05 → 12/12
S40 II 2.0 F	B420454	10/09 → 12/12
S40 II 2.4	B524454, D5244T13	01/04 → 12/12
S40 II 2.4 AWD	B524454	08/06 → 12/12
S40 II 2.4 CDI	D5244T9	03/07 → 12/10
S40 II 2.4 D5	D5244T13, B5254T3	03/06 → 12/10
S40 II D3	D5204T5	10/10 → 12/12
S40 II D4	D5204T	10/10 → 12/12
S40 II T5	B5254T3, B5254T3	01/04 → 12/12
S40 II T5 AWD	B5254T3, D4204T20	04/04 → 12/10
S60 II 1.5 T2	B4154T5	10/15 →
S60 II 1.5 T3	B4154T4	03/15 →
S60 II 2.0 D2	D4204T20, D4204T4	03/15 →
S60 II 2.0 D3	D4204T4, B4204T6	03/15 →
S60 II 2.0 D4	D4204T14	03/15 →
S60 II 2.0 D5	D4204T11	03/15 →
S60 II 2.0 Polestar AWD	B4204T43	06/15 →
S60 II 2.0 T	B4204T6, B5254T14	04/10 → 12/15
S60 II 2.0 T3	B4204T37	03/15 →
S60 II 2.0 T4	B4204T19	03/15 →
S60 II 2.0 T5 DRIVE	B4204T7	09/14 → 12/15
S60 II 2.4 D4 AWD	D5244T21	03/15 →
S60 II 2.5 T	B5254T14	01/13 →
S60 II 2.5 T5	B5254T5	09/11 →
S60 II 2.5 T5 AWD	B5254T14, D5204T2	09/12 →
S60 II 3.0 T AWD	B6304T5	04/14 →
S60 II D3	D5204T2, D4204T5	04/10 → 12/15
S60 II D4	D4204T5, D5244T10	04/10 → 12/15
S60 II D5	D5244T10, D5244T10	04/10 → 12/15
S60 II D5 AWD	D5244T10, B4204T11	04/10 → 12/15
S60 II DRIVE / D2	D4162T	01/11 → 12/15
S60 II T	B5204T9	04/14 →
S60 II T3	B4164T3	04/10 → 12/15
S60 II T4	B4164T	04/10 → 12/15
S60 II T4F	B4164T2	04/11 → 12/15
S60 II T5	B4204T11, B4204T11	04/10 →
S60 II T5 AWD	B4204T11, B4204T9	07/14 →
S60 II T6	B4204T9	09/13 →
S60 II T6 AWD	B4204T9, D5244T14	04/10 →
S80 II 1.6 D DRIVE	D4164T	01/10 → 12/11
S80 II 1.6 D2	D4162T	01/14 →
S80 II 1.6 DRIVE	D4162T	06/11 →
S80 II 2.0	B420453	01/08 → 09/12
S80 II 2.0 Drive - E	B4204T11	12/14 →
S80 II 2.0 FlexFuel	B420454	01/08 → 12/11
S80 II 2.0 T	B4204T6	01/10 →
S80 II 2.0 T5	B4204T15	01/14 →
S80 II 2.0 TDi	D4204T	02/08 → 03/11
S80 II 2.4 D	D5244T14, B5254T10	03/06 →
S80 II 2.5 T	B5254T10, B5254T11	03/06 →
S80 II 2.5 T AWD	B5254T6	10/06 → 04/09
S80 II 2.5 T FlexFuel	B5254T11, B63245	05/08 → 12/11
S80 II 3.2	B63245, B63245	03/06 →
S80 II 3.2 AWD	B63245, D5204T2	01/07 → 12/12
S80 II 3.2 FlexFuel AWD	B63245	01/09 → 03/10
S80 II 4.4 V8 AWD	B84445	03/06 → 03/12
S80 II D3	D5204T7	05/12 →
S80 II D3 / D4	D5204T2, D5244T10	01/10 →
S80 II D4	D4204T5	09/13 →
S80 II D5	D5244T10, D5244T10	03/06 →
S80 II D5 AWD	D5244T10, B4204T11	01/07 →
S80 II T4	B4164T	10/10 →
S80 II T4F	B4164T2	05/11 →
S80 II T5	B4204T11, B6304T2	10/10 →
S80 II T6 AWD	B6304T2, B6304T2	01/07 → 12/16
S80L 2.0 T	B4204T6	01/10 →
S80L 2.5 T	B5254T6	01/08 →
S80L 2.5 T5	B5254T12	01/12 →

VOLVO		
S80L T4	B5204T8	01/12 →
S80L T5	B4204T7	01/12 →
S80L T6 AWD	B6304T2, D4162T	01/08 →
V40 II 1.6 D2 / DRIVE	D4162T	09/13 → 12/15
V40 II 2.0 D3	D5204T6	09/13 → 12/15
V40 II 2.0 D4	D5204T4	09/13 → 12/14
V40 II D2	D4162T, D4204T16	03/12 →
V40 II D3	D4204T16, D4204T14	03/12 →
V40 II D4	D4204T14, B4154T3	03/12 →
V40 II T2	B4154T3, B4154T2	02/15 →
V40 II T2 GTDi	B4164T4	03/13 → 12/15
V40 II T3	B4154T2, B4164T	02/15 →
V40 II T3 GTDi	B4164T3	03/12 →
V40 II T4	B4164T, B4204T21	07/13 →
V40 II T4 AWD	B4204T21, B4204T11	07/13 →
V40 II T4 GTDi	B4164T	03/12 →
V40 II T5	B4204T11, B4204T11	12/12 →
V40 II T5 AWD	B4204T11, B5244S4	01/13 →
V40 1.6 D2	D4162T	09/13 → 12/15
V40 2.0 D3	D5204T6	09/13 → 12/15
V40 2.0 D4	D5204T4	09/13 → 12/14
V50 1.6	B4164S3	01/05 → 12/12
V50 1.6 D	D4164T	01/05 → 12/11
V50 1.6 D2	D4162T	01/10 → 12/12
V50 1.8	B4184S11	04/04 → 12/10
V50 1.8 BiFuel	B4184S8	01/09 → 09/10
V50 1.8 FlexFuel	B4184S8	01/05 → 12/10
V50 2.0	B4204S3	10/06 → 12/12
V50 2.0 CDI	D4204T2	12/03 → 12/06
V50 2.0 D	D4204T	04/04 → 12/10
V50 2.0 D4	D4204T2	07/05 → 12/06
V50 2.0 FlexFuel	B4204S4	01/10 → 12/12
V50 2.4	B5244S4, D5244T13	04/04 → 12/10
V50 2.4 AWD	B5244S4	08/06 → 12/09
V50 2.4 D5	D5244T13, B5254T3	03/06 → 12/10
V50 2.4 Tdi	D5244T9	05/07 → 12/10
V50 D3	D5204T5	10/10 → 12/12
V50 D4	D5204T	10/10 → 12/12
V50 T5	B5254T3, B5254T3	04/04 → 12/12
V50 T5 AWD	B5254T3, D4204T20	04/04 → 12/10
V60 I 1.5 T2	B4154T5	10/15 →
V60 I 1.6 DRIVE	D4162T	02/11 → 12/15
V60 I 2.0 BiFuel	B5204T9	03/14 → 12/15
V60 I 2.0 D2	D4204T20, D4204T4	03/15 →
V60 I 2.0 D3	D4204T4, B4204T6	09/13 →
V60 I 2.0 D4	D4204T14	09/13 →
V60 I 2.0 Polestar AWD	B4204T43	06/15 →
V60 I 2.0 T	B4204T6, D5244T11	07/10 →
V60 I 2.0 T4	B4204T19	03/15 →
V60 I 2.0 T5	B4204T15	01/14 →
V60 I 2.4 D4 AWD	D5244T12	09/13 → 12/15
V60 I 2.4 D5	D5244T11, D5244T11	04/11 → 12/15
V60 I 2.4 D5 AWD	D5244T11, D5244T15	04/11 → 12/15
V60 I 2.4 D5 Hybrid AWD	D87PHEV	03/15 →
V60 I 2.4 Hybrid D6 AWD	D5244T15, D5204T2	06/12 → 12/15
V60 I 3.0 T AWD	B6304T5	04/14 →
V60 I D3	D5204T7	05/12 → 12/15
V60 I D3 / D4	D5204T2, D5244T12	07/10 → 12/14
V60 I D4	D4204T5	10/13 → 12/15
V60 I D4 AWD	D5244T12, D4204T11	05/12 →
V60 I D5	D4204T11, D5244T10	07/10 →
V60 I D5 AWD	D5244T10, B4154T4	07/10 → 12/15
V60 I D6 Hybrid AWD	D97PHEV	03/15 →
V60 IT3	B4154T4, B4204T11	09/10 →
V60 IT4	B4164T	09/10 → 12/15
V60 IT4F	B4164T2	04/11 → 12/15
V60 IT5	B4204T11, B4204T11	09/10 →
V60 IT5 AWD	B4204T11, B4204T9	07/14 →
V60 IT6	B4204T9	10/13 →
V60 IT6 AWD	B4204T9, B5204T9	07/10 →
V70 2.0 D4/D4 DRIVE	D5204T3	09/13 →
V70 III 1.6 D	D4164T	07/09 → 12/11
V70 III 1.6 D2	D4162T	04/11 → 12/15
V70 III 1.6 T4F	B4164T2	01/11 → 12/15
V70 III 2.0	B4204S3	10/07 → 12/11
V70 III 2.0 BiFuel	B5204T9, D5244T14	03/13 → 12/15
V70 III 2.0 D	D4204T	10/07 → 12/15
V70 III 2.0 D3 DRIVE	D5204T7	09/13 →
V70 III 2.0 FlexiFuel	B4204S4	01/08 → 12/11
V70 III 2.0 GDI	B5204T9	04/12 → 12/15
V70 III 2.0 T	B4204T6	09/09 → 12/11
V70 III 2.4 D	D5244T14, D5244T11	04/07 → 12/10
V70 III 2.4 D4 AWD	D5244T17	09/13 →
V70 III 2.4 D5	D5244T11, B5254T10	09/13 →
V70 III 2.5 T	B5254T10, B5254T11	08/07 → 12/12
V70 III 2.5 T FlexiFuel	B5254T11, B6324S	05/08 → 12/11
V70 III 3.0 T6 AWD	B6304T4	11/13 →
V70 III 3.2	B6324S, B6324S	08/07 → 12/14

VOLVO		
V70 III 3.2 AWD	B6324S, D4204T9	04/07 → 12/15
V70 III D2	D4204T20	03/15 →
V70 III D3	D4204T9, D5204T2	10/07 →
V70 III D3 / D4	D5204T2, D5244T12	03/10 → 12/15
V70 III D4	D4204T5	10/13 →
V70 III D4 AWD	D5244T12, D5244T10	10/07 →
V70 III D5	D5244T10, D5244T10	04/07 →
V70 III D5 AWD	D5244T10, B4164T	04/07 →
V70 III T4	B4164T, B4204T11	10/10 →
V70 III T5	B4204T11, B6304T2	01/10 →
V70 III T6 AWD	B6304T2, D5244T16	08/07 → 12/15
XC60 I 2.0 T	B4204T6	12/09 → 12/12
XC60 I 2.4 D	D5244T14	04/09 → 12/10
XC60 I 2.4 D / D3 / D4 AWD	D5244T16, B6324S	05/08 → 02/17
XC60 I 3.2 AWD	B6324S, D4204T4	07/09 → 12/15
XC60 I D3	D4204T4, D5204T2	04/12 → 02/17
XC60 I D3 / D4	D5204T2, D4204T14	03/10 → 12/14
XC60 I D4	D4204T14, D5244T12	10/13 → 02/17
XC60 I D4 AWD	D5244T12, D5244T10	10/13 → 02/17
XC60 I D5	D5244T11	06/11 → 02/17
XC60 I D5 AWD	D5244T10, B4204T11	05/08 → 02/17
XC60 I T5	B4204T11, B4204T11	09/10 →
XC60 I T5 AWD	B4204T11, B4204T9	04/14 → 02/17
XC60 I T6	B4204T9	10/13 →
XC60 I T6 AWD	B4204T9, D5244T16	05/08 →
XC70 II 2.4 D	D5244T14	06/09 → 12/10
XC70 II 2.4 D / D4 AWD	D5244T16, B6324S	08/07 →
XC70 II 3.2	B6324S	08/07 →
XC70 II 3.2 AWD	B6324S, D5204T2	08/07 →
XC70 II D3	D5204T2, D5244T10	04/10 → 12/15
XC70 II D3 AWD	D5204T2	08/11 →
XC70 II D4	D4204T5	10/13 →
XC70 II D4 AWD	D5244T12	10/13 →
XC70 II D5 AWD	D5244T10, B5254T14	04/07 →
XC70 II T5	B4204T11	10/13 →
XC70 II T5 AWD	B5254T12	08/15 →
XC70 II T6 AWD	B5254T14, CHZB	01/08 →

21.0006  **1**

WHEEL SPEED SENSORS

Adatt./Suitable:

ATE
10.0711-5272.3

AUDI
7H0 927 804
WHT 003 856

BOSCH
0 986 594 505

MAN
7H0 927 804
WHT 003 856

PORSCHE
7H0 927 804

SEAT
7H0 927 804
WHT 003 856

SKODA
1KD 927 804
7H0 927 804
WHT 003 856

VW
1KD 927 804
7H0 927 804
WHT 003 856

MARKET DIFFUSION: HIGH



L	L1		
---	27,5	Hall Effect	

AUDI		
A1 1.0 TFSI	CHZB, CZCA	03/15 → 10/18
A1 1.4 TDI	CUSB	11/14 → 10/18
A1 1.4 TFSI	CZCA, CAXC	11/14 → 10/18
A1 1.4 TSI	CZEA	11/14 → 10/18
A1 1.6 TDI	CMXA	11/14 → 10/18
A1 1.8 TFSI	DAJB	02/15 → 10/18

AUDI		
A1 S1 quattro	CWZA	03/14 → 10/18
A3 I [USA] 2.0	CBEA	08/09 →
A3 I [USA] 2.0 16V	--	01/06 → 12/10
A3 I [USA] 3.2 24V	CBRA	07/08 → 05/09
A3 I [USA] 3.2 24V AWD	--	01/06 → 12/09
A3 II 1.2 TFSI	CBZB	03/10 → 05/13
A3 II 1.2 TSI	CBZB	04/10 → 08/12
A3 II 1.4 TFSI	CAXC, BGU	09/07 → 05/13
A3 II 1.6	BGU, CCSA	05/03 → 08/12
A3 II 1.6 E-Power	CCSA, BAG	01/11 → 08/12
A3 II 1.6 FSI	BAG, CAYB	08/03 → 09/07
A3 II 1.6 TDI	CAYB, BYT	05/09 → 05/13
A3 II 1.8 TFSI	BYT, BKC	11/06 → 05/13
A3 II 1.8 TFSI quattro	CDAA	07/08 → 08/12
A3 II 1.9 TDI	BKC, AXW	05/03 → 05/10
A3 II 2.0 FSI	AXW, AZV	05/03 → 06/08
A3 II 2.0 TDI	AZV, BKD	05/03 → 05/13
A3 II 2.0 TDI 16V	BKD, BKD	05/03 → 08/12
A3 II 2.0 TDI 16V quattro	BKD, AZV	08/04 → 08/12
A3 II 2.0 TDI quattro	AZV, AXX	05/03 → 08/12
A3 II 2.0 TFSI	AXX, AXX	09/04 → 05/13
A3 II 2.0 TFSI quattro	AXX, BDB	09/04 → 08/12
A3 II 3.2 V6 quattro	BDB, BHZ	07/03 → 05/09
A3 II S3 quattro	BHZ, CAXC	11/06 → 08/12
A3 II SPORTBACK 1.2 TSI	CBZB	04/10 → 03/13
A3 II SPORTBACK 1.4 TFSI	CAXC, BGU	09/07 → 03/13
A3 II SPORTBACK 1.6	BGU, CCSA	09/04 → 03/13
A3 II SPORTBACK 1.6 E-Power	CCSA, BLF	01/11 → 03/13
A3 II SPORTBACK 1.6 FSI	BLF, CAYB	09/04 → 09/07
A3 II SPORTBACK 1.6 TDI	CAYB, BYT	05/09 → 03/13
A3 II SPORTBACK 1.8 TFSI	BYT, BKC	11/06 → 03/13
A3 II SPORTBACK 1.8 TFSI quattro	CDAA	07/08 → 03/13
A3 II SPORTBACK 1.9 TDI	BKC, AXW	09/04 → 05/10
A3 II SPORTBACK 2.0 FSI	AXW, AZV	09/04 → 06/08
A3 II SPORTBACK 2.0 TDI	AZV, BKD	09/04 → 03/13
A3 II SPORTBACK 2.0 TDI 16V	BKD, BKD	09/04 → 03/13
A3 II SPORTBACK 2.0 TDI 16V quattro	BKD, BMM	11/05 → 03/13
A3 II SPORTBACK 2.0 TDI quattro	BMM, AXX	01/06 → 03/13
A3 II SPORTBACK 2.0 TFSI	AXX, AXX	09/04 → 03/13
A3 II SPORTBACK 2.0 TFSI quattro	AXX, BDB	09/04 → 03/13
A3 II SPORTBACK 3.2 V6 quattro	BDB, BHZ	09/04 → 05/09
A3 II SPORTBACK RS3 quattro	CEPA	01/11 → 12/12
A3 II SPORTBACK S3 quattro	BHZ, CRBC	06/08 → 03/13
A3 III 1.6 TDI quattro	CXXB	05/15 →
A3 III 1.8 TFSI quattro	CJSB	08/12 →
A3 III 2.0 quattro	CNTC	11/13 →
A3 III 2.0 TDI quattro	CRBC, CNTC	10/12 →
A3 III 2.0 TFSI [ExtraEU]	CYFB	05/14 →
A3 III 2.0 TFSI quattro	CNTC, CJXB	05/14 →
A3 III RS3 quattro	CZGB	03/15 →
A3 III S3 quattro	CJXB, CHPB	11/12 →
Q3 1.4 TFSI	CZDB	07/16 → 10/18
Q3 1.4 TSI	CHPB, CFFA	10/13 → 10/18
Q3 2.0 TDI	CFFA, CFFB	06/11 →
Q3 2.0 TDI quattro	CFFB, CCTA	06/11 → 10/18
Q3 2.0 TFSI	CCTA, CCZC	10/13 →
Q3 2.0 TFSI [ExtraEU]	CCTA	09/14 → 10/18
Q3 2.0 TFSI quattro	CCZC, CTSA	06/11 → 10/18
Q3 RS 2.5 quattro	CTSA, CBBB	05/13 → 10/18
Q3 RS performance 2.5 quattro	CZGB	01/15 → 10/18
TT II 1.8 TFSI	CDAA	06/08 → 06/14
TT II 2.0 TDI quattro	CBBB, BPY	06/08 → 06/14
TT II 2.0 TFSI	BPY, BWA	08/06 → 06/14
TT II 2.0 TFSI quattro	BWA, CDLA	06/08 → 06/14
TT II 2.0 TTS quattro	CDLA, CEPA	05/08 → 06/14
TT II 2.5 RS quattro	CEPA, DAUA	07/09 → 06/14
TT II 3.2 V6 quattro	BUB	08/06 → 06/10

MAN		
TGE-SERIES 0.0	EBHA	07/18 →
TGE 2.0 TDI	DAUA, DAUA	11/16 →
TGE 2.0 TDI AWD	DAUA, DASA	02/17 →
TGE 2.0 TDI RWD	DASA, CAVA	05/17 →

PORSCHE		
CARRERA GT 5.7	M80.01	07/03 → 12/06

SEAT		
ALHAMBRA III 1.4 TSI	CAVA, CFFA	06/10 →
ALHAMBRA III 1.8 TSI	CDAA	11/12 →
ALHAMBRA III 2.0 TDI	CFFA, CFFB	06/10 →
ALHAMBRA III 2.0 TDI 4Drive	CFFB, CCZA	05/11 →
ALHAMBRA III 2.0 TSI	CCZA, BXW	11/10 →
ALTEA 1.2 TSI	CBZB	04/10 →
ALTEA 1.4 16V	BXW, BGU	05/06 →
ALTEA 1.4 TFSI	CAXC	05/10 → 04/11

SEAT		
ALTEA 1.4 TSI	CAXC	11/07 →
ALTEA 1.6	BGU, CAYB	03/04 →
ALTEA 1.6 LPG	CHGA	09/09 →
ALTEA 1.6 Multifuel	CMXA	11/10 → 05/11
ALTEA 1.6 TDI	CAYB, BYT	10/09 →
ALTEA 1.8 TFSI	BYT, BJB	01/07 →
ALTEA 1.9 TDI	BJB, BLR	04/04 →
ALTEA 2.0 FSI	BLR, AZV	05/04 → 03/09
ALTEA 2.0 TDI	AZV, BKD	03/04 →
ALTEA 2.0 TDI 16V	BKD, BXW	03/04 →
ALTEA 2.0 TDI 16V 4WD	CFHC	10/10 →
ALTEA 2.0 TFSI	BWA	04/06 → 05/09
ALTEA 2.0 TFSI [ExtraEU]	CCZB	05/09 →
ALTEA XL 1.2 TSI	CBZB	04/10 →
ALTEA XL 1.4 16V	BXW, BGU	10/06 →
ALTEA XL 1.4 TSI	CAXC	11/07 →
ALTEA XL 1.6	BGU, BSE	10/06 →
ALTEA XL 1.6 LPG	CHGA	09/09 →
ALTEA XL 1.6 Multifuel	BSE, CAYB	10/06 →
ALTEA XL 1.6 TDI	CAYB, BYT	10/09 →
ALTEA XL 1.8 TFSI	BYT, BKC	01/07 →
ALTEA XL 1.9 TDI	BKC, BVY	10/06 →
ALTEA XL 1.9 TDI 4x4	BLS	06/09 → 12/10
ALTEA XL 2.0 FSI	BVY, AZV	10/06 → 03/09
ALTEA XL 2.0 TDI	AVZ, BKD	10/06 →
ALTEA XL 2.0 TDI 16V	BKD, BMM	10/06 →
ALTEA XL 2.0 TDI 16V 4x4	CFHC	10/10 →
ALTEA XL 2.0 TDI 4x4	BMM, BWA	06/07 →
ALTEA XL 2.0 TFSI	BWA	10/06 → 05/09
ALTEA XL 2.0 TFSI 4x4	BWA, BXW	06/07 →
LEON II 1.2 TSI	CBZB	02/10 → 12/12
LEON II 1.4 16V	BXW, BSE	06/06 → 12/12
LEON II 1.4 TSI	CAXC	11/07 → 12/12
LEON II 1.6	BSE, BSE	07/05 → 12/12
LEON II 1.6 LPG	CHGA	12/09 → 12/12
LEON II 1.6 MultiFuel	BSE, CAYB	11/10 → 12/12
LEON II 1.6 TDI	CAYB, BZB	02/10 → 12/12
LEON II 1.8 TSI	BZB, BKC	06/07 → 12/12
LEON II 1.9 TDI	BKC, BLR	07/05 → 12/10
LEON II 2.0 Cupra R	CDLA	09/09 → 12/12
LEON II 2.0 FSI	BLR, AZV	07/05 → 05/10
LEON II 2.0 TDI	AZV, BKD	07/05 → 12/12
LEON II 2.0 TDI 16V	BKD, BWA	07/05 → 12/12
LEON II 2.0 TFSI	BWA, CLHA	05/05 → 12/12
LEON III 1.6 TDI 4Drive	CLHA, CRBC	04/14 →
LEON III 2.0 TDI 4Drive	CRBC, CRBC	04/14 →
LEON ST 2.0 TDI 4Drive	CRBC, BGU	09/14 →
TOLEDO III 1.4 16V	BXW	05/06 → 05/09
TOLEDO III 1.4 TSI	CAXC	11/07 → 05/09
TOLEDO III 1.6	BGU, BYT	10/04 → 05/09
TOLEDO III 1.8 TFSI	BYT, BJB	01/07 → 05/09
TOLEDO III 1.9 TDI	BJB, BLR	10/04 → 05/09
TOLEDO III 2.0 FSI	BLR, AZV	10/04 → 05/09
TOLEDO III 2.0 TDI	AZV, BCA	09/04 → 05/09
TOLEDO III 2.0 TDI 16V	BKD	04/04 → 05/09
TOLEDO III 2.0 TFSI	BWA	11/05 → 05/09

SKODA		
OCTAVIA II 1.2 TSI	CBZB	02/10 → 06/13
OCTAVIA II 1.4	BCA, BGU	05/04 → 06/13
OCTAVIA II 1.4 [CHN]	CFBA	03/10 →
OCTAVIA II 1.4 TSI	CAXA	11/08 → 06/13
OCTAVIA II 1.6	BGU, CDFA	06/04 → 06/13
OCTAVIA II 1.6 [CHN]	CDFA, BSE	09/07 →
OCTAVIA II 1.6 FSI	BLF	02/04 → 10/08
OCTAVIA II 1.6 LPG	BSE, CCSA	08/09 → 11/12
OCTAVIA II 1.6 Multifuel	CCSA, BYJ	01/08 → 06/13
OCTAVIA II 1.6 TDI	CAYC	06/09 → 04/13
OCTAVIA II 1.6 TDI 4x4	CAYC	06/09 → 02/13
OCTAVIA II 1.8 [CHN]	BYJ, BZB	04/07 →
OCTAVIA II 1.8 TSI	BZB, CDAA	06/07 → 06/13
OCTAVIA II 1.8 TSI 4x4	CDAA, BJB	11/08 → 02/13
OCTAVIA II 1.9 TDI	BJB, BKC	06/04 → 12/10
OCTAVIA II 1.9 TDI 4x4	BKC, BXX	11/04 → 12/10
OCTAVIA II 2.0 [CHN]	BXX, BLR	04/07 →
OCTAVIA II 2.0 4x4	CCZA	11/08 →
OCTAVIA II 2.0 FSI	BLR, BLX	11/04 → 10/08
OCTAVIA II 2.0 FSI 4x4	BLX, BWA	11/04 → 10/08
OCTAVIA II 2.0 RS	BWA, AZV	10/05 → 02/13
OCTAVIA II 2.0 TDI	AZV, AZV	02/04 → 06/13
OCTAVIA II 2.0 TDI 16V	AZV, BKD	02/04 → 05/13
OCTAVIA II 2.0 TDI 16V 4x4	BKD, BMM	05/10 → 02/13
OCTAVIA II 2.0 TDI 4x4	BMM, BMN	07/06 → 02/13
OCTAVIA II 2.0 TDI RS	BMN, CLHA	04/06 → 02/13
OCTAVIA III 1.6 TDI	CXXA	05/15 →
OCTAVIA III 1.6 TDI 4x4	CLHA, CISA	11/12 →
OCTAVIA III 1.8 TSI 4x4	CISA, CUNA	11/12 →
OCTAVIA III 2.0 TDI / TDI RS 4x4	CUNA, CKFC	09/14 →

SKODA		
OCTAVIA III 2.0 TDI 4x4	CKFC, BZB	11/12 →
SUPERB II 1.4 [CHN]	CFBA	03/10 →
SUPERB II 1.4 TSI	CAXC	07/08 → 05/15
SUPERB II 1.6 TDI	CAYC	09/10 → 05/15
SUPERB II 1.8 [CHN]	CEAA	04/09 →
SUPERB II 1.8 TSI	BZB, CDAA	03/08 → 05/15
SUPERB II 1.8 TSI 4x4	CDAA, BLS	11/08 → 05/15
SUPERB II 1.9 TDI	BLS, BMP	03/08 → 11/10
SUPERB II 2.0 [CHN]	CGMA	04/09 →
SUPERB II 2.0 TDI	BMP, BKD	03/08 → 05/15
SUPERB II 2.0 TDI 16V	BKD, CBBB	01/09 → 05/15
SUPERB II 2.0 TDI 16V 4x4	CFBB	11/10 → 05/15
SUPERB II 2.0 TDI 4x4	CBBB, --	09/08 → 05/15
SUPERB II 2.0 TSI	CCZA	05/10 → 05/15
SUPERB II 3.6 FSI 4x4	--, CZDA	11/08 → 05/15
SUPERB II 3.6 V6 4x4	CDVA	10/09 → 05/15
SUPERB III 1.4 TSI 4x4	CZDA, CRLB	03/15 →
SUPERB III 2.0 TDI 4x4	CRLB, CBZB	03/15 →
SUPERB III 2.0 TSI 4x4	CJXA	03/15 →
YETI 1.2 TSI	CBZB, CAXA	09/09 → 12/17
YETI 1.4 TSI	CAXA, CDAA	06/10 → 12/17
YETI 1.4 TSI 4x4	CZDA	05/15 → 12/17
YETI 1.6	CWVA	04/14 → 12/17
YETI 1.6 TDI	CAYC	11/10 → 05/15
YETI 1.8	CDAB	02/11 →
YETI 1.8 TSI 4x4	CDAA, CFHA	05/09 → 12/17
YETI 2.0 TDI	CFHA, CBDB	11/09 →
YETI 2.0 TDI 4x4	CBDB, CDCA	05/09 → 12/17

VW		
AMAROK 2.0 BiTDI	CDCA, CDCA	09/10 →
AMAROK 2.0 BiTDI 4motion	CDCA, CDCA	09/10 →
AMAROK 2.0 TDI	CDCA, CDCA	09/10 →
AMAROK 2.0 TDI 4motion	CDCA, CDCA	09/10 →
AMAROK 2.0 TDI/TDI BlueMotion	CDCA, CDCA	05/12 → 10/13
AMAROK 2.0 TDI/TDI BlueMotion [ExtraEU]	CDCA, DDXA	09/11 →
AMAROK 2.0 TSI	CFPA	12/10 →
AMAROK 3.0 TDI	DDXA	06/16 →
AMAROK 3.0 TDI 4motion	DDXA, CAVD	06/16 →
AMAROK 3.0 TDI BlueMotion	DDXB	06/16 →
BEETLE 1.2 TSI	CBZB	07/11 →
BEETLE 1.2 TSI 16V	CYVD	12/14 →
BEETLE 1.4 TSI	CAVD, CPKA	10/11 →
BEETLE 1.6 TDI	CAYC	10/11 → 07/16
BEETLE 1.8 TSI	CPKA, CFFB	12/13 →
BEETLE 2.0 TDI	CFFB, CBFA	04/11 →
BEETLE 2.0 TSI	CBFA, CBTA	04/11 →
BEETLE 2.5	CBTA, CHZG	04/11 →
CADDY III 1.0 TSI	CHZG, CBZA	11/15 →
CADDY III 1.2 TSI	CBZA, BCA	09/10 →
CADDY III 1.4	BCA, CZCB	03/04 → 08/10
CADDY III 1.4 TGI CNG	CPWA	06/15 →
CADDY III 1.4 TSI	CZCB, BGU	05/15 →
CADDY III 1.6	BGU, BSF	04/04 →
CADDY III 1.6 BiFuel	BSF, CAYD	05/11 → 05/15
CADDY III 1.6 TDI	CAYD, BJB	08/10 →
CADDY III 1.9 TDI	BJB, BDJ	04/04 → 08/10
CADDY III 1.9 TDI 4motion	BLS	05/08 → 08/10
CADDY III 2.0 EcoFuel	BSX	04/06 → 05/15
CADDY III 2.0 SDI	BDJ, BMM	03/04 → 08/10
CADDY III 2.0 TDI	BMM, CFHC	09/07 →
CADDY III 2.0 TDI 16V	CFHC, CFHC	11/10 → 05/15
CADDY III 2.0 TDI 16V 4motion	CFHC	11/10 → 05/15
CADDY III 2.0 TDI 4motion	CFHC, AXB	08/10 →
CAMPMOBILE 1.9 TDI	AXB, CAAB	03/04 → 11/09
CAMPMOBILE 2.0	AXA	03/04 → 11/09
CAMPMOBILE 2.0 TDI	CCHB	05/10 → 08/15
CAMPMOBILE 2.0 TDI BlueMotion	CAAB, CJKA	04/15 →
CAMPMOBILE 2.0 TSI BlueMotion	CJKA, AXD	04/15 →
CAMPMOBILE 2.5 TDI	AXD, CKMA	03/04 → 11/09
CARAVELLE 2.0 EcoFuel	AXACNG	01/06 → 03/14
CARAVELLE 2.0 TDI	CSDA	05/11 → 08/15
CARAVELLE 3.2	BDL	11/03 → 11/09
CC 1.4 TSI	CKMA, CDAA	11/11 → 12/16
CC 1.4 TSI MultiFuel	CKMA	11/11 → 12/16
CC 1.8 TSI	CDAA, CFFA	11/11 → 12/16
CC 2.0 TDI	CFFA, CFFB	11/11 → 12/16
CC 2.0 TDI 4motion	CFFB, CBFA	11/11 → 12/16
CC 2.0 TSI	CBFA, DASB	11/11 →
CC 3.6 FSI	CNNA	11/11 →
CC 3.6 FSI 4motion	BWS	11/11 → 12/16
CRAFTER 2.0 TDI	DASB, DAUA	09/16 →
CRAFTER 2.0 TDI 4motion	DAUA, DASA	03/17 →
CRAFTER 2.0 TDI RWD	DASA, CAVD	11/16 →

VW		
CRAFTER e-Crafter	EBHA	07/18 →
EOS 1.4 TSI	CAVD, BVY	11/07 → 08/15
EOS 1.6 FSI	BLF	06/06 → 05/08
EOS 2.0 FSI	BVY, BMM	03/06 → 05/08
EOS 2.0 TDI	BMM, CBAB	06/06 → 08/15
EOS 2.0 TDI 16V	CBAB, BPY	05/08 → 08/15
EOS 2.0 TFSI	BPY, BUB	03/06 → 08/15
EOS 2.0 TSI	CCZB	11/09 → 08/15
EOS 3.2 V6	BUB, CAVD	06/06 → 05/09
EOS 3.6 V6	CDVA	05/09 → 11/10
GOLF V 1.2 TSI	CBZA, BCA	11/09 → 12/13
GOLF V 1.4	BUD	06/07 → 07/09
GOLF V 1.4 16V	BCA, BKG	10/03 → 12/13
GOLF V 1.4 FSI	BKG, BLG	10/03 → 11/06
GOLF V 1.4 TSI	BLG, BGU	11/05 → 12/13
GOLF V 1.6	BGU, BAG	01/04 → 12/13
GOLF V 1.6 BiFuel	CHGA	05/09 → 12/13
GOLF V 1.6 FSI	BAG, CCSA	10/03 → 07/08
GOLF V 1.6 MultiFuel	CCSA, CAYB	10/07 → 12/13
GOLF V 1.6 TDI	CAYB, BKC	02/09 → 12/13
GOLF V 1.9 TDI	BKC, BKC	10/03 → 07/09
GOLF V 1.9 TDI 4motion	BKC, BHY	08/04 → 07/09
GOLF V 2.0	BHY, AXW	08/06 → 07/09
GOLF V 2.0 FSI	AXW, BLX	01/04 → 11/08
GOLF V 2.0 FSI 4motion	BLX, AXX	08/04 → 11/08
GOLF V 2.0 GTI	AXX, AZV	10/04 → 02/09
GOLF V 2.0 SDI	BDK	01/04 → 11/08
GOLF V 2.0 TDI	AZV, BKD	10/03 →
GOLF V 2.0 TDI 16V	BKD, CBTA	10/03 → 12/13
GOLF V 2.0 TDI 16V 4motion	BKD	08/04 → 11/08
GOLF V 2.0 TDI 4motion	AZV	08/04 → 07/09
GOLF V 2.5	CBTA, BUB	05/07 → 11/08
GOLF V 3.2	BUB, BUB	09/05 → 11/08
GOLF V 3.2 R32 4motion	BUB, CAVD	11/05 → 11/08
GOLF VI 1.2 TSI	CBZA, CJZA	11/08 →
GOLF VI 1.2 TSI 16V	CJZA, BUD	11/13 → 05/16
GOLF VI 1.4	BUD, BUD	10/08 →
GOLF VI 1.4 16V	BUD, CAVD	01/09 → 05/11
GOLF VI 1.4 TSI	CAVD, BSE	10/08 →
GOLF VI 1.6	BSE, CCSA	10/08 →
GOLF VI 1.6 BiFuel	BSF	03/09 →
GOLF VI 1.6 MultiFuel	CCSA, CAYB	10/08 →
GOLF VI 1.6 TDI	CAYB, CBFA	02/09 →
GOLF VI 1.6 TDI 4motion	CAYC	07/09 → 07/13
GOLF VI 1.8 TSI	CDAA	06/09 → 01/11
GOLF VI 2.0	CDLF	05/11 →
GOLF VI 2.0 GTi	CBFA, CDLA	04/09 → 05/16
GOLF VI 2.0 R	CDLA	01/13 → 05/16
GOLF VI 2.0 R 4motion	CDLA, BMM	11/09 → 11/13
GOLF VI 2.0 TDI	BMM, CBAB	10/08 →
GOLF VI 2.0 TDI 4motion	CBAB, CBFA	05/09 →
GOLF VI 2.0 TDI Gtd	CFGB	05/11 →
GOLF VI 2.0 TFSI	CRZA	11/11 →
GOLF VI 2.0 TFSI Gti	CBFA, CCZA	05/11 →
GOLF VI 2.0 TSI	CCZA, CBTA	07/09 →
GOLF VI 2.5	CBTA, CLHA	07/09 →
GOLF 1.2 TSI	CBZA	11/09 → 08/14
GOLF 1.2 TSI BlueMotion	CBZB	05/09 → 11/12
GOLF 1.4 TSI	CAVD, CAYB	10/08 → 08/14
GOLF 1.6 TDI	CAYB, CFFB	02/09 → 08/14
GOLF 1.6 TDI BlueMotion	CAYC	05/09 → 11/12
GOLF 2.0 GTI	CCZB	02/09 → 11/12
GOLF 2.0 TDI	CFFB, CBZA	09/09 → 08/14
GOLF 2.0 TDI BlueMotion 4motion	CRBC	05/13 →
GOLF 2.0 TSI R 4motion	CDLF	11/09 → 11/12
GOLF TSi	CAXA	10/08 → 11/12
GOLF VII 1.6 TDI 4motion	CLHA, CJXB	11/12 →
GOLF VII 1.8 TSI 4motion	CJSB	12/14 →
GOLF VII 2.0 R 4motion	CJXB, CKFC	11/13 →
GOLF VII 2.0 TDI 4motion	CKFC, BLG	11/12 →
GOLF VII 2.0 TFSI	CYFB	11/13 →
GOLF VAN 1.2 TSI	CBZB	09/09 → 05/14
GOLF VAN 1.4 TSI	CAVD, CBDB	07/09 → 05/14
GOLF VAN 1.6 TDI	CAYB	12/09 → 10/12
GOLF VAN 1.6 TDI BlueMotion	CAYC	07/09 → 05/14
GOLF VAN 1.6 TDI BlueMotion 4motion	CLHA	05/13 → 03/17
GOLF VAN 2.0 TDI	CBDB, CRBC	07/09 → 05/19
GOLF VAN 2.0 TDI BlueMotion	CRBC, CRBC	04/13 → 03/17
GOLF VAN 2.0 TDI BlueMotion 4motion	CRBC, CBZA	04/13 → 03/17
JETTA V 1.4 TSI	BLG, BSE	07/06 → 10/10
JETTA V 1.6	BSE, CAYB	10/05 → 10/10
JETTA V 1.6 FSI	BLF	09/05 → 10/10
JETTA V 1.6 MultiFuel	CCSA	01/08 → 10/10
JETTA V 1.6 TDI	CAYB, BKC	06/09 → 10/10
JETTA V 1.9 TDI	BKC, BLR	01/05 →



VW			
JETTA V 2.0 FSI	BLR, AZV	08/05	⇒ 10/10
JETTA V 2.0 TDI	AZV, BKD	09/05	⇒ 10/10
JETTA V 2.0 TDI 16V	BKD, BPY	08/05	⇒ 10/10
JETTA V 2.0 TFSI	BPY, BGP	10/05	⇒ 10/10
JETTA V 2.5	BGP, CBZB	01/05	⇒
JETTA VI 1.2 TSI	CBZB, CAVA	10/10	⇒
JETTA VI 1.2 TSI 16V	CYVD	08/14	⇒
JETTA VI 1.4 TSI	CAVA, CNLA	04/11	⇒
JETTA VI 1.4 TSI Hybrid	CNLA, CFNA	04/11	⇒
JETTA VI 1.6	CFNA, CWVA	12/11	⇒
JETTA VI 1.6 [RUS]	CWVA, CPKA	01/15	⇒
JETTA VI 1.6 MPi	CWVB	09/15	⇒ 04/18
JETTA VI 1.6 TDI	CWVP, CBZB	04/10	⇒ 07/14
JETTA VI 1.8 TSI	CPKA, CBPA	07/14	⇒
JETTA VI 2.0	CBPA, CFFB	06/10	⇒ 12/17
JETTA VI 2.0 TDI	CFFB, CBFA	10/10	⇒
JETTA VI 2.0 TSI	CBTA, CBTA	12/10	⇒
JETTA VI 2.5	CBTA, AXB	04/10	⇒
MULTIVAN 1.9 TDI	AXB, CAAA	04/03	⇒ 11/09
MULTIVAN 2.0	AXA	11/03	⇒ 08/15
MULTIVAN 2.0 BitDI	CFCFA	09/09	⇒ 08/15
MULTIVAN 2.0 BitDI 4motion	CFCFA	09/09	⇒ 08/15
MULTIVAN 2.0 TDI	CAAA, CAAC	09/09	⇒
MULTIVAN 2.0 TDI 4motion	CAAC, CJKA	09/09	⇒
MULTIVAN 2.0 TSI	CJKA, AXD	05/11	⇒
MULTIVAN 2.0 TSI 4motion	CJKA	07/11	⇒
MULTIVAN 2.5 TDI	AXD, AXD	04/03	⇒ 11/09
MULTIVAN 2.5 TDI 4motion	AXD, BDL	07/04	⇒ 11/09
MULTIVAN 3.2 V6	BDL, BKK	02/04	⇒ 11/09
MULTIVAN 3.2 V6 4motion	BKK, CFFB	07/04	⇒ 11/09
PASSAT 1.4 TSi BlueMotion	CAXA	08/10	⇒ 12/14
PASSAT 1.6 TDi BlueMotion	CAYC	08/10	⇒ 12/14
PASSAT 1.8 TFSI	CDAA	08/10	⇒ 12/14
PASSAT 2.0 Blue TDi/TDi/TDi BlueMotion [ExtraEU]	CFFB	08/10	⇒ 12/14
PASSAT 2.0 TDi BlueMotion	CFFB, BZB	08/10	⇒ 12/14
PASSAT 2.0 TFSI	CCZB	11/10	⇒ 12/14
PASSAT 3.6 FSi 4motion	BWS	01/11	⇒ 12/14
PASSAT V 1.4 TSI	CAXA, BSE	05/07	⇒ 12/14
PASSAT V 1.4 TSI EcoFuel	CDGA	01/09	⇒ 12/14
PASSAT V 1.4 TSI MultiFuel	CKMA	11/10	⇒ 12/14
PASSAT V 1.6	BSE, BZB	05/05	⇒ 11/10
PASSAT V 1.6 FSI	BLF	03/05	⇒ 06/08
PASSAT V 1.6 TDI	CAYC	08/09	⇒ 12/14
PASSAT V 1.8 TSI	BZB, BKC	05/07	⇒
PASSAT V 1.9 TDI	BKC, AXX	03/05	⇒ 11/10
PASSAT V 2.0 BlueTDI	CBAC	01/09	⇒ 11/10
PASSAT V 2.0 FSI	AXX, BLX	03/05	⇒ 11/10
PASSAT V 2.0 FSI 4motion	BLX, BMA	09/05	⇒ 11/10
PASSAT V 2.0 TDI	BMA, BKP	03/05	⇒
PASSAT V 2.0 TDI 16V	BKP, BKP	03/05	⇒ 11/10
PASSAT V 2.0 TDI 16V 4motion	BKP, BMP	03/05	⇒ 11/10
PASSAT V 2.0 TDI 4motion	BMP, CBTA	03/05	⇒ 12/14
PASSAT V 2.0 TSI	CCZB	11/10	⇒ 12/15
PASSAT V 2.0 TSI 4motion	CCZB	01/12	⇒ 12/14
PASSAT V 2.5 SRE	CBTA, CAVD	01/11	⇒
PASSAT V 3.2 FSi 4motion	AXZ	11/05	⇒ 11/10
PASSAT V 3.6 FSi	BLV	06/05	⇒
PASSAT V 3.6 FSi 4motion	BLV	09/05	⇒ 12/14
PASSAT V 3.6 R36 4motion	BWS	04/07	⇒ 11/10
PASSAT CC 1.4 TSi MultiFuel	CKMA	01/11	⇒ 01/12
PASSAT CC 1.8 TSI	BZB, CBAA	06/08	⇒ 01/12
PASSAT CC 2.0 BlueTDI	CBAC	05/09	⇒ 11/10
PASSAT CC 2.0 TDI	CBAA, CBAB	05/08	⇒ 01/12
PASSAT CC 2.0 TDI 4motion	CBAB, CAWB	08/09	⇒ 01/12
PASSAT CC 2.0 TSI	CAWB, BLV	06/08	⇒ 01/12
PASSAT CC 3.6 FSi	BLV, BLV	06/08	⇒
PASSAT CC 3.6 FSi 4motion	BLV, CAXA	02/08	⇒ 01/12
SCIROCCO III 1.4 TSI	CAVD, CDLA	05/08	⇒
SCIROCCO III 2.0 R	CDLA, CBBB	11/09	⇒ 11/17
SCIROCCO III 2.0 TDI	CBBB, CAWB	08/08	⇒ 11/17
SCIROCCO III 2.0 TSI	CAWB, CAVA	05/08	⇒ 11/17
SCIROCCO 1.4 TSi	CAVD, CBBB	06/08	⇒ 05/14
SCIROCCO 2.0 TDi	CBBB, CAVD	08/08	⇒ 05/14
SCIROCCO 2.0 TFSI	CCZB	11/09	⇒ 05/14
SHARAN II 1.4 TSI	CAVA, CFFA	05/10	⇒
SHARAN II 1.8 TSI	CDAA	11/11	⇒
SHARAN II 2.0 TDI	CFFA, CFFA	05/10	⇒
SHARAN II 2.0 TDI 4motion	CFFA, CCZA	05/11	⇒
SHARAN II 2.0 TSI	CCZA, BWK	12/10	⇒
TIGUAN I 1.4 [CHN]	CFBA.	11/11	⇒
TIGUAN I 1.4 TSI	BWK, BWK	05/08	⇒
TIGUAN I 1.4 TSI 4motion	BWK, CBAB	09/07	⇒
TIGUAN I 1.8 [CHN]	CEAA	12/09	⇒
TIGUAN I 2.0 [CHN]	CGMA	12/09	⇒
TIGUAN I 2.0 TDI	CBAB, CBAA	03/08	⇒
TIGUAN I 2.0 TDI 4motion	CBAA, CAWA	09/07	⇒

VW			
TIGUAN I 2.0 TFSI	CCTB	05/08	⇒
TIGUAN I 2.0 TFSI 4motion	CAWA, CCZB	09/07	⇒
TIGUAN I 2.0 TSI 4motion	CCZB, BLG	05/11	⇒
TIGUAN II 2.0 TDI	CUVE	05/15	⇒
TOURAN 1.2 TSI	CBZB	05/10	⇒ 05/15
TOURAN I 1.4 [CHN]	CFBA.	04/09	⇒
TOURAN I 1.4 FSI	BLG, BMY	11/06	⇒ 05/10
TOURAN I 1.4 TSI	BMY, BGU	02/06	⇒ 05/15
TOURAN I 1.4 TSI EcoFuel	CDGA	05/09	⇒ 05/15
TOURAN I 1.6	BGU, BAG	07/03	⇒ 05/10
TOURAN I 1.6 BiFuel	BSF	11/06	⇒ 05/10
TOURAN I 1.6 FSI	BAG, CAYB	02/03	⇒ 01/07
TOURAN I 1.6 TDI	CAYB, BPL	05/10	⇒ 05/15
TOURAN I 1.8 [CHN]	BPL., AVQ	02/08	⇒
TOURAN I 1.9 TDI	AVQ, AXW	02/03	⇒ 05/10
TOURAN I 2.0 EcoFuel	BSX	02/06	⇒ 05/09
TOURAN I 2.0 FSI	AXW, AZV	10/03	⇒ 05/10
TOURAN I 2.0 TDI	AZV, AXACNG	02/03	⇒ 05/15
TOURAN I 2.0 TDI [CHN]	CGZA	04/09	⇒
TOURAN I 2.0 TDI 16V	BKD	08/03	⇒ 05/10
TRANSPORTER 2.0 EcoFuel	AXACNG, AXB	11/03	⇒ 08/15
TRANSPORTER 2.0 TDi	CSDA	05/11	⇒ 08/15
TRANSPORTER 3.2	BDL	03/04	⇒ 06/05
TRANSPORTER V 1.9 TDI	AXB, AXA	04/03	⇒ 11/09
TRANSPORTER V 2.0	AXA, CAAA	11/03	⇒
TRANSPORTER V 2.0 BiFuel	AXACNG	05/11	⇒ 08/15
TRANSPORTER V 2.0 BitDI	CFCFA	09/09	⇒ 08/15
TRANSPORTER V 2.0 BitDI 4motion	CFCFA	09/09	⇒ 08/15
TRANSPORTER V 2.0 TDI	CAAA, CAAC	09/09	⇒ 08/15
TRANSPORTER V 2.0 TDI 4motion	CAAC, CJKA	09/09	⇒ 08/15
TRANSPORTER V 2.0 TSI	CJKA, AXD	05/11	⇒ 08/15
TRANSPORTER V 2.0 TSI 4motion	CJKA	07/11	⇒ 08/15
TRANSPORTER V 2.5 TDI	AXD, AXD	04/03	⇒ 11/09
TRANSPORTER V 2.5 TDI 4motion	AXD, BDL	04/04	⇒ 11/09
TRANSPORTER V 3.2 4motion	BDL, BDL	11/03	⇒ 11/09
TRANSPORTER V 3.2 V6	BDL, BKK	04/03	⇒ 11/09
TRANSPORTER V 3.2 V6 4motion	BKK, CAAA	11/03	⇒ 11/09
TRANSPORTER VI 2.0 TDI	CAAA, CAAC	04/15	⇒
TRANSPORTER VI 2.0 TDI 4motion	CAAC, CJKA	06/15	⇒
TRANSPORTER VI 2.0 TSI	CJKA, CHZB	04/15	⇒
TRANSPORTER VI 2.0 TSI 4motion	CJKA	06/15	⇒

21.0007

WHEEL SPEED SENSORS

Adatt./Suitable:

- ATE**
10.0711-5271.3
- AUDI**
7H0 927 803
WHT 003 857
- BOSCH**
0 986 594 504
- MAN**
7H0 927 803
WHT 003 857
- PORSCHE**
7H0 927 803
- SEAT**
7H0 927 803
WHT 003 857
- SKODA**
1KD 927 803
7H0 927 803
WHT 003 857
- VW**
1KD 927 803
7H0 927 803
WHT 003 857

MARKET DIFFUSION: HIGH



L	L1	Hall Effect	
---	27,5		

AUDI		
A1 1.0 TFSI	CHZB, CZCA	03/15 ⇒ 10/18
A1 1.4 TDI	CUSB	11/14 ⇒ 10/18
A1 1.4 TFSI	CZCA, CAXC	11/14 ⇒ 10/18
A1 1.4 TSI	CZEA	11/14 ⇒ 10/18
A1 1.6 TDI	CXMA	11/14 ⇒ 10/18
A1 1.8 TFSI	DAJB	02/15 ⇒ 10/18
A1 S1 quattro	CWZA	03/14 ⇒ 10/18
A3 I [USA] 2.0	CBEA	08/09 ⇒
A3 I [USA] 2.0 16V	--	01/06 ⇒ 12/10
A3 I [USA] 3.2 24V	CBRA	07/08 ⇒ 05/09
A3 I [USA] 3.2 24V AWD	--	01/06 ⇒ 12/09
A3 II 1.2 TFSI	CBZB	03/10 ⇒ 05/13
A3 II 1.2 TSI	CBZB	04/10 ⇒ 08/12
A3 II 1.4 TFSI	CAXC, BGU	09/07 ⇒ 05/13
A3 II 1.6	BGU, CCSA	05/03 ⇒ 08/12
A3 II 1.6 E-Power	CCSA, BAG	01/11 ⇒ 08/12
A3 II 1.6 FSI	BAG, CAYB	08/03 ⇒ 09/07
A3 II 1.6 TDI	CAYB, BYT	05/09 ⇒ 05/13
A3 II 1.8 TFSI	BYT, BKC	11/06 ⇒ 05/13
A3 II 1.8 TFSI quattro	CDAA	07/08 ⇒ 08/12
A3 II 1.9 TDI	BKC, AXW	05/03 ⇒ 05/10
A3 II 2.0 FSI	AXW, AZV	05/03 ⇒ 06/08
A3 II 2.0 TDI	AZV, BKD	05/03 ⇒ 05/13
A3 II 2.0 TDI 16V	BKD, BKD	05/03 ⇒ 08/12
A3 II 2.0 TDI 16V quattro	BKD, AZV	08/04 ⇒ 08/12
A3 II 2.0 TDI quattro	AZV, AXX	05/03 ⇒ 08/12
A3 II 2.0 TFSI	AXX, AXX	09/04 ⇒ 05/13
A3 II 2.0 TFSI quattro	AXX, BDB	09/04 ⇒ 08/12
A3 II 3.2 V6 quattro	BDB, BHZ	07/03 ⇒ 05/09
A3 II S3 quattro	BHZ, CAXC	11/06 ⇒ 08/12
A3 II SPORTBACK 1.2 TSI	CBZB	04/10 ⇒ 03/13
A3 II SPORTBACK 1.4 TFSI	CAXC, BGU	09/07 ⇒ 03/13
A3 II SPORTBACK 1.6	BGU, CCSA	09/04 ⇒ 03/13
A3 II SPORTBACK 1.6 E-Power	CCSA, BLF	01/11 ⇒ 03/13
A3 II SPORTBACK 1.6 FSI	BLF, CAYB	09/04 ⇒ 09/07
A3 II SPORTBACK 1.6 TDI	CAYB, BYT	05/09 ⇒ 03/13
A3 II SPORTBACK 1.8 TFSI	BYT, BKC	11/06 ⇒ 03/13
A3 II SPORTBACK 1.8 TFSI quattro	CDAA	07/08 ⇒ 03/13
A3 II SPORTBACK 1.9 TDI	BKC, AXW	09/04 ⇒ 05/10
A3 II SPORTBACK 2.0 FSI	AXW, AZV	09/04 ⇒ 06/08
A3 II SPORTBACK 2.0 TDI	AZV, BKD	09/04 ⇒ 03/13
A3 II SPORTBACK 2.0 TDI 16V	BKD, BKD	09/04 ⇒ 03/13
A3 II SPORTBACK 2.0 TDI 16V quattro	BKD, BMM	11/05 ⇒ 03/13
A3 II SPORTBACK 2.0 TDI quattro	BMM, AXX	01/06 ⇒ 03/13

AUDI			
A3 II SPORTBACK 2.0 TFSI	AXX, AXX	09/04 →	03/13
A3 II SPORTBACK 2.0 TFSI quattro	AXX, BDB	09/04 →	03/13
A3 II SPORTBACK 3.2 V6 quattro	BDB, BHZ	09/04 →	05/09
A3 II SPORTBACK RS3 quattro	CEPA	01/11 →	12/12
A3 II SPORTBACK S3 quattro	BHZ, CRBC	06/08 →	03/13
A3 III 1.6 TDI quattro	CXXB	05/15 →	
A3 III 1.8 TFSI quattro	CJSB	08/12 →	
A3 III 2.0 quattro	CNTC	11/13 →	
A3 III 2.0 TDI quattro	CRBC, CNTC	10/12 →	
A3 III 2.0 TFSI [ExtraEU]	CYFB	05/14 →	
A3 III 2.0 TFSI quattro	CNTC, CJB	05/14 →	
A3 III RS3 quattro	CZGB	03/15 →	
A3 III S3 quattro	CJXB, CHPB	11/12 →	
Q3 1.4 TFSI	CZDB	07/16 →	10/18
Q3 1.4 TSI	CHPB, CFFA	10/13 →	10/18
Q3 2.0 TDI	CFFA, CFFB	06/11 →	
Q3 2.0 TDI quattro	CFFB, CCTA	06/11 →	10/18
Q3 2.0 TFSI	CCTA, CCZC	10/13 →	
Q3 2.0 TFSI [ExtraEU]	CCTA	09/14 →	10/18
Q3 2.0 TFSI quattro	CCZC, CTSA	06/11 →	10/18
Q3 RS 2.5 quattro	CTSA, CBBB	05/13 →	10/18
Q3 RS performance 2.5 quattro	CZGB	01/15 →	10/18
TT II 1.8 TFSI	CDA	06/08 →	06/14
TT II 2.0 TDI quattro	CBBB, BPY	06/08 →	06/14
TT II 2.0 TFSI	BPY, BWA	08/06 →	06/14
TT II 2.0 TFSI quattro	BWA, CDLA	06/08 →	06/14
TT II 2.0 TTS quattro	CDLA, CEPA	05/08 →	06/14
TT II 2.5 RS quattro	CEPA, DAUA	07/09 →	06/14
TT II 3.2 V6 quattro	BUB	08/06 →	06/10

MAN

TGE-SERIES 0.0	EBHA	07/18 →	
TGE 2.0 TDI	DAUA, DAUA	11/16 →	
TGE 2.0 TDI AWD	DAUA, DASA	02/17 →	
TGE 2.0 TDI RWD	DASA, CAVA	05/17 →	

PORSCHE

CARRERA GT 5.7	M80.01	07/03 →	12/06
----------------	--------	---------	-------

SEAT

ALHAMBRA III 1.4 TSI	CAVA, CFFA	06/10 →	
ALHAMBRA III 1.8 TSI	CDA	11/12 →	
ALHAMBRA III 2.0 TDI	CFDA, CFFB	06/10 →	
ALHAMBRA III 2.0 TDI 4Drive	CFFB, CCZA	05/11 →	
ALHAMBRA III 2.0 TSI	CCZA, BXW	11/10 →	
ALTEA 1.2 TSI	CBZB	04/10 →	
ALTEA 1.4 16V	BXW, BGU	05/06 →	
ALTEA 1.4 TFSI	CAXC	05/10 →	04/11
ALTEA 1.4 TSI	CAXC	11/07 →	
ALTEA 1.6	BGU, CAYB	03/04 →	
ALTEA 1.6 LPG	CHGA	09/09 →	
ALTEA 1.6 Multifuel	CMXA	11/10 →	05/11
ALTEA 1.6 TDI	CAYB, BYT	10/09 →	
ALTEA 1.8 TFSI	BYT, BJB	01/07 →	
ALTEA 1.9 TDI	BJB, BLR	04/04 →	
ALTEA 2.0 FSI	BLR, AZV	05/04 →	03/09
ALTEA 2.0 TDI	AZV, BKD	03/04 →	
ALTEA 2.0 TDI 16V	BKD, BXW	03/04 →	
ALTEA 2.0 TDI 16V 4WD	CFHC	10/10 →	
ALTEA 2.0 TFSI	BWA	04/06 →	05/09
ALTEA 2.0 TFSI [ExtraEU]	CCZB	05/09 →	
ALTEA XL 1.2 TSI	CBZB	04/10 →	
ALTEA XL 1.4 16V	BXW, BGU	10/06 →	
ALTEA XL 1.4 TSI	CAXC	11/07 →	
ALTEA XL 1.6	BGU, BSE	10/06 →	
ALTEA XL 1.6 LPG	CHGA	09/09 →	
ALTEA XL 1.6 Multifuel	BSE, CAYB	10/06 →	
ALTEA XL 1.6 TDI	CAYB, BYT	10/09 →	
ALTEA XL 1.8 TFSI	BYT, BKC	01/07 →	
ALTEA XL 1.9 TDI	BKC, BVI	10/06 →	
ALTEA XL 1.9 TDI 4x4	BLS	06/09 →	12/10
ALTEA XL 2.0 FSI	BVI, AZV	10/06 →	03/09
ALTEA XL 2.0 TDI	AZV, BKD	10/06 →	
ALTEA XL 2.0 TDI 16V	BKD, BMM	10/06 →	
ALTEA XL 2.0 TDI 16V 4x4	CFHC	10/10 →	
ALTEA XL 2.0 TDI 4x4	BMM, BWA	06/07 →	
ALTEA XL 2.0 TFSI	BWA	10/06 →	05/09
ALTEA XL 2.0 TFSI 4x4	BWA, BXW	06/07 →	
LEON II 1.2 TSI	CBZB	02/10 →	12/12
LEON II 1.4 16V	BXW, BSE	06/06 →	12/12
LEON II 1.4 TSI	CAXC	11/07 →	12/12
LEON II 1.6	BSE, BSE	07/05 →	12/12
LEON II 1.6 LPG	CHGA	12/09 →	12/12
LEON II 1.6 Multifuel	BSE, CAYB	11/10 →	12/12
LEON II 1.6 TDI	CAYB, BZB	02/10 →	12/12
LEON II 1.8 TSI	BZB, BKC	06/07 →	12/12
LEON II 1.9 TDI	BKC, BLR	07/05 →	12/10
LEON II 2.0 Cupra R	CDLA	09/09 →	12/12

SEAT

LEON II 2.0 FSI	BLR, AZV	07/05 →	05/10
LEON II 2.0 TDI	AZV, BKD	07/05 →	12/12
LEON II 2.0 TDI 16V	BKD, BWA	07/05 →	12/12
LEON II 2.0 TFSI	BWA, CLHA	05/05 →	12/12
LEON III 1.6 TDI 4Drive	CLHA, CRBC	04/14 →	
LEON III 2.0 TDI 4Drive	CRBC, CRBC	04/14 →	
LEON ST 2.0 TDI 4Drive	CRBC, BGU	09/14 →	
TOLEDO III 1.4 16V	BXW	05/06 →	05/09
TOLEDO III 1.4 TSI	CAXC	11/07 →	05/09
TOLEDO III 1.6	BGU, BYT	10/04 →	05/09
TOLEDO III 1.8 TFSI	BYT, BJB	01/07 →	05/09
TOLEDO III 1.9 TDI	BJB, BLR	10/04 →	05/09
TOLEDO III 2.0 FSI	BLR, AZV	10/04 →	05/09
TOLEDO III 2.0 TDI	AZV, BCA	09/04 →	05/09
TOLEDO III 2.0 TDI 16V	BKD	04/04 →	05/09
TOLEDO III 2.0 TFSI	BWA	11/05 →	05/09

SKODA

OCTAVIA II 1.2 TSI	CBZB	02/10 →	06/13
OCTAVIA II 1.4	BCA, BGU	05/04 →	06/13
OCTAVIA II 1.4 [CHN]	CFBA	03/10 →	
OCTAVIA II 1.4 TSI	CAXA	11/08 →	06/13
OCTAVIA II 1.6	BGU, CDFA	06/04 →	06/13
OCTAVIA II 1.6 [CHN]	CDFA, BSE	09/07 →	
OCTAVIA II 1.6 TSI	BLF	02/04 →	10/08
OCTAVIA II 1.6 LPG	BSE, CCSA	08/09 →	11/12
OCTAVIA II 1.6 MultiFuel	CCSA, BYJ	01/08 →	06/13
OCTAVIA II 1.6 TDI	CAYC	06/09 →	04/13
OCTAVIA II 1.6 TDI 4x4	CAYC	06/09 →	02/13
OCTAVIA II 1.8 [CHN]	BYJ, BZB	04/07 →	
OCTAVIA II 1.8 TSI	BZB, CDA	06/07 →	06/13
OCTAVIA II 1.8 TSI 4x4	CDA, BJB	11/08 →	02/13
OCTAVIA II 1.9 TDI	BJB, BKC	06/04 →	12/10
OCTAVIA II 1.9 TDI 4x4	BKC, BXX.	11/04 →	12/10
OCTAVIA II 2.0 [CHN]	BXX., BLR	04/07 →	
OCTAVIA II 2.0 4x4	CCZA	11/08 →	
OCTAVIA II 2.0 FSI	BLR, BLX	11/04 →	10/08
OCTAVIA II 2.0 FSI 4x4	BLX, BWA	11/04 →	10/08
OCTAVIA II 2.0 RS	BWA, AZV	10/05 →	02/13
OCTAVIA II 2.0 TDI	AZV, AZV	02/04 →	06/13
OCTAVIA II 2.0 TDI 16V	AZV, BKD	02/04 →	05/13
OCTAVIA II 2.0 TDI 16V 4x4	BKD, BMM	05/10 →	02/13
OCTAVIA II 2.0 TDI 4x4	BMM, BMN	07/06 →	02/13
OCTAVIA II 2.0 TDI RS	BMN, CLHA	04/06 →	02/13
OCTAVIA III 1.6 TDI	CXXA	05/15 →	
OCTAVIA III 1.6 TDI 4x4	CLHA, CISA	11/12 →	
OCTAVIA III 1.8 TSI 4x4	CISA, CUNA	11/12 →	
OCTAVIA III 2.0 TDI / TDI RS 4x4	CUNA, CKFC	09/14 →	
OCTAVIA III 2.0 TDI 4x4	CKFC, BZB	11/12 →	
SUPERB II 1.4 [CHN]	CFBA.	03/10 →	
SUPERB II 1.4 TSI	CAXC	07/08 →	05/15
SUPERB II 1.6 TDI	CAYC	09/10 →	05/15
SUPERB II 1.8 [CHN]	CEAA	04/09 →	
SUPERB II 1.8 TSI	BZB, CDA	03/08 →	05/15
SUPERB II 1.8 TSI 4x4	CDA, BLS	11/08 →	05/15
SUPERB II 1.9 TDI	BLS, BMP	03/08 →	11/10
SUPERB II 2.0 [CHN]	CGMA	04/09 →	
SUPERB II 2.0 TDI	BMP, BKD	03/08 →	05/15
SUPERB II 2.0 TDI 16V	BKD, CBBB	01/09 →	05/15
SUPERB II 2.0 TDI 16V 4x4	CFFB	11/10 →	05/15
SUPERB II 2.0 TDI 4x4	CBBB, --	09/08 →	05/15
SUPERB II 2.0 TSI	CCZA	05/10 →	05/15
SUPERB II 3.6 FSI 4x4	--, CZDA	11/08 →	05/15
SUPERB II 3.6 V6 4x4	CDVA	10/09 →	05/15
SUPERB III 1.4 TSI 4x4	CZDA, CRLB	03/15 →	
SUPERB III 2.0 TDI 4x4	CRLB, CBZB	03/15 →	
SUPERB III 2.0 TSI 4x4	CJXA	03/15 →	
YETI 1.2 TSI	CBZB, CAXA	09/09 →	12/17
YETI 1.4 TSI	CAXA, CDA	06/10 →	12/17
YETI 1.4 TSI 4x4	CZDA	05/15 →	12/17
YETI 1.6	CVWA	04/14 →	12/17
YETI 1.6 TDI	CAYC	11/10 →	05/15
YETI 1.8	CDAB	02/11 →	
YETI 1.8 TSI 4x4	CDA, CFHA	05/09 →	12/17
YETI 2.0 TDI	CFHA, CBDDB	11/09 →	
YETI 2.0 TDI 4x4	CBDDB, CDCA	05/09 →	12/17

VW

AMAROK 2.0 BiTDI	CDCA, CDCA	09/10 →	
AMAROK 2.0 BiTDI 4motion	CDCA, CDCA	09/10 →	
AMAROK 2.0 TDI	CDCA, CDCA	09/10 →	
AMAROK 2.0 TDI 4motion	CDCA, CDCA	09/10 →	
AMAROK 2.0 TDI/TDi BlueMotion	CDCA, CDCA	05/12 →	10/13
AMAROK 2.0 TDI/TDi BlueMotion [ExtraEU]	CDCA, DDXA	09/11 →	
AMAROK 2.0 TSI	CFPA	12/10 →	
AMAROK 3.0 TDI	DDXA	06/16 →	
AMAROK 3.0 TDI 4motion	DDXA, CAVD	06/16 →	

VW

AMAROK 3.0 TDi BlueMotion	DDXB	06/16 →	
BEETLE 1.2 TSI	CBZB	07/11 →	
BEETLE 1.2 TSI 16V	CVVD	12/14 →	
BEETLE 1.4 TSI	CAVD, CPKA	10/11 →	
BEETLE 1.6 TDI	CAYC	10/11 →	07/16
BEETLE 1.8 TSI	CPKA, CFFB	12/13 →	
BEETLE 2.0 TDI	CFFB, CBFA	04/11 →	
BEETLE 2.0 TSI	CBFA, CBTA	04/11 →	
BEETLE 2.5	CBTA, CHZG	04/11 →	
CADDY III 1.0 TSI	CHZG, CBZA	11/15 →	
CADDY III 1.2 TSI	CBZA, BCA	09/10 →	
CADDY III 1.4	BCA, CZCB	03/04 →	08/10
CADDY III 1.4 TGI CNG	CPWA	06/15 →	
CADDY III 1.4 TSI	CZCB, BGU	05/15 →	
CADDY III 1.6	BGU, BSF	04/04 →	
CADDY III 1.6 BiFuel	BSF, CAYD	05/11 →	05/15
CADDY III 1.6 TDI	CAYD, BJB	08/10 →	
CADDY III 1.9 TDI	BJB, BDJ	04/04 →	08/10
CADDY III 1.9 TDI 4motion	BLS	05/08 →	08/10
CADDY III 2.0 EcoFuel	BSX	04/06 →	05/15
CADDY III 2.0 SDI	BDJ, BMM	03/04 →	08/10
CADDY III 2.0 TDI	BMM, CFHC	09/07 →	
CADDY III 2.0 TDI 16V	CFHC, CFHC	11/10 →	05/15
CADDY III 2.0 TDI 16V 4motion	CFHC	11/10 →	05/15
CADDY III 2.0 TDI 4motion	CFHC, AXB	08/10 →	
CAMPMOBILE 1.9 TDi	AXB, CAAB	03/04 →	11/09
CAMPMOBILE 2.0	AXA	03/04 →	11/09
CAMPMOBILE 2.0 TDi	CCHB	05/10 →	08/15
CAMPMOBILE 2.0 TDi BlueMotion	CAAB, CJKA	04/15 →	
CAMPMOBILE 2.0 TSi BlueMotion	CJKA, AXD	04/15 →	
CAMPMOBILE 2.5 TDi	AXD, CKMA	03/04 →	11/09
CARAVELLE 2.0 EcoFuel	AXACNG	01/06 →	03/14
CARAVELLE 2.0 TDi	CSDA	05/11 →	08/15
CARAVELLE 3.2	BDL	11/03 →	11/09
CC 1.4 TSI	CKMA, CDA	11/11 →	12/16
CC 1.4 TSI MultiFuel	CKMA	11/11 →	12/16
CC 1.8 TSI	CDA, CFFA	11/11 →	12/16
CC 2.0 TDI	CFFA, CFFB	11/11 →	12/16
CC 2.0 TDI 4motion	CFFB, CBFA	11/11 →	12/16
CC 2.0 TSI	CBFA, DASB	11/11 →	
CC 3.6 FSI	CNNA	11/11 →	
CC 3.6 FSI 4motion	BWS	11/11 →	12/16
CRAFTER 2.0 TDI	DASB, DAUA	09/16 →	
CRAFTER 2.0 TDI 4motion	DAUA, DASA	03/17 →	
CRAFTER 2.0 TDI RWD	DASA, CAVD	11/16 →	
CRAFTER e-Crafter	EBHA	07/18 →	
EOS 1.4 TSI	CAVD, BVI	11/07 →	08/15
EOS 1.6 FSI	BLF	06/06 →	05/08
EOS 2.0 FSI	BVI, BMM	03/06 →	05/08
EOS 2.0 TDI	BMM, CBAB	06/06 →	08/15
EOS 2.0 TDI 16V	CBAB, BPI	05/08 →	08/15
EOS 2.0 TFSI	BPY, BUB	03/06 →	08/15
EOS 2.0 TSI	CBZB	11/09 →	08/15
EOS 3.2 V6	BUB, CAVD	06/06 →	05/09
EOS 3.6 V6			

VW		
GOLF VI 1.6 BiFuel	BSF	03/09 →
GOLF VI 1.6 MultiFuel	CCSA, CAYB	10/08 →
GOLF VI 1.6 TDI	CAYB, CBFA	02/09 →
GOLF VI 1.6 TDI 4motion	CAYC	07/09 → 07/13
GOLF VI 1.8 TSI	CDA	06/09 → 01/11
GOLF VI 2.0	CDLF	05/11 →
GOLF VI 2.0 GTi	CBFA, CDLA	04/09 → 05/16
GOLF VI 2.0 R	CDLA	01/13 → 05/16
GOLF VI 2.0 R 4motion	CDLA, BMM	11/09 → 11/13
GOLF VI 2.0 TDI	BMM, CBAB	10/08 →
GOLF VI 2.0 TDI 4Motion	CBAB, CBFA	05/09 →
GOLF VI 2.0 TDI Gtd	CFGB	05/11 →
GOLF VI 2.0 TFSi	CRZA	11/11 →
GOLF VI 2.0 TFSi Gti	CBFA, CCZA	05/11 →
GOLF VI 2.0 TSi	CCZA, CBTA	07/09 →
GOLF VI 2.5	CBTA, CLHA	07/09 →
GOLF 1.2 TSi	CBZA	11/09 → 08/14
GOLF 1.2 TSi BlueMotion	CBZB	05/09 → 11/12
GOLF 1.4 TSi	CAVD, CAYB	10/08 → 08/14
GOLF 1.6 TDi	CAYB, CFFB	02/09 → 08/14
GOLF 1.6 TDi BlueMotion	CAYC	05/09 → 11/12
GOLF 2.0 GTi	CCZB	02/09 → 11/12
GOLF 2.0 TDi	CFFB, CBZA	09/09 → 08/14
GOLF 2.0 TDi BlueMotion 4motion	CRBC	05/13 →
GOLF 2.0 TSi R 4motion	CDLF	11/09 → 11/12
GOLF TSi	CAXA	10/08 → 11/12
GOLF VII 1.6 TDI 4motion	CLHA, CAXB	11/12 →
GOLF VII 1.8 TSI 4motion	CJSB	12/14 →
GOLF VII 2.0 R 4motion	CAXB, CKFC	11/13 →
GOLF VII 2.0 TDI 4motion	CKFC, BLG	11/12 →
GOLF VII 2.0 TFSi	CYFB	11/13 →
GOLF VAN 1.2 TSi	CBZB	09/09 → 05/14
GOLF VAN 1.4 TSi	CAVD, CBDB	07/09 → 05/14
GOLF VAN 1.6 TDi	CAYB	12/09 → 10/12
GOLF VAN 1.6 TDi BlueMotion	CAYC	07/09 → 05/14
GOLF VAN 1.6 TDi BlueMotion 4motion	CLHA	05/13 → 03/17
GOLF VAN 2.0 TDi	CBDB, CRBC	07/09 → 05/19
GOLF VAN 2.0 TDi BlueMotion	CRBC, CRBC	04/13 → 03/17
GOLF VAN 2.0 TDi BlueMotion 4motion	CRBC, CBZA	04/13 → 03/17
JETTA V 1.4 TSi	BLG, BSE	07/06 → 10/10
JETTA V 1.6	BSE, CAYB	10/05 → 10/10
JETTA V 1.6 FSI	BLF	09/05 → 10/10
JETTA V 1.6 MultiFuel	CCSA	01/08 → 10/10
JETTA V 1.6 TDI	CAYB, BKC	06/09 → 10/10
JETTA V 1.9 TDI	BKC, BLR	01/05 →
JETTA V 2.0 FSI	BLR, AZV	08/05 → 10/10
JETTA V 2.0 TDI	AZV, BKD	09/05 → 10/10
JETTA V 2.0 TDI 16V	BKD, BPY	08/05 → 10/10
JETTA V 2.0 TFSi	BPY, BGP	10/05 → 10/10
JETTA V 2.5	BGP, CBZB	01/05 →
JETTA VI 1.2 TSi	CBZB, CAVA	10/10 →
JETTA VI 1.2 TSi 16V	CYVD	08/14 →
JETTA VI 1.4 TSi	CAVA, CNLA	04/11 →
JETTA VI 1.4 TSi Hybrid	CNLA, CFNA	04/11 →
JETTA VI 1.6	CFNA, CWVA	12/11 →
JETTA VI 1.6 [RUS]	CWVA, CPKA	01/15 →
JETTA VI 1.6 MPi	CWVB	09/15 → 04/18
JETTA VI 1.6 TDI	CAYC	04/10 → 07/14
JETTA VI 1.8 TSi	CPKA, CBPA	07/14 →
JETTA VI 2.0	CBPA, CFFB	06/10 → 12/17
JETTA VI 2.0 TDI	CFFB, CBFA	10/10 →
JETTA VI 2.0 TSi	CBFA, CBTA	12/10 →
JETTA VI 2.5	CBTA, AXB	04/10 →
MULTIVAN 1.9 TDI	AXB, CAAA	04/03 → 11/09
MULTIVAN 2.0	AXA	11/03 → 08/15
MULTIVAN 2.0 BitDI	CFC	09/09 → 08/15
MULTIVAN 2.0 BitDI 4motion	CFC	09/09 → 08/15
MULTIVAN 2.0 TDI	CAAA, CAAC	09/09 →
MULTIVAN 2.0 TDI 4motion	CAAC, CJK	09/09 →
MULTIVAN 2.0 TSi	CJK, AXD	05/11 →
MULTIVAN 2.0 TSi 4motion	CJK	07/11 →
MULTIVAN 2.5 TDI	AXD, AXD	04/03 → 11/09
MULTIVAN 2.5 TDI 4motion	AXD, BDL	07/04 → 11/09
MULTIVAN 3.2 V6	BDL, BKK	02/04 → 11/09
MULTIVAN 3.2 V6 4motion	BKK, CFFB	07/04 → 11/09
PASSAT 1.4 TSi BlueMotion	CAXA	08/10 → 12/14
PASSAT 1.6 TDi BlueMotion	CAYC	08/10 → 12/14
PASSAT 1.8 TFSi	CDA	08/10 → 12/14
PASSAT 2.0 Blue TDi/TDi/BlueMotion [ExtraEU]	CFFB	08/10 → 12/14
PASSAT 2.0 TDi BlueMotion	CFFB, BZB	08/10 → 12/14
PASSAT 2.0 TFSi	CCZB	11/10 → 12/14
PASSAT 3.6 FSi 4motion	BWS	01/11 → 12/14
PASSAT V 1.4 TSi	CAXA, BSE	05/07 → 12/14
PASSAT V 1.4 TSi EcoFuel	CDGA	01/09 → 12/14

VW		
PASSAT V 1.4 TSi MultiFuel	CKMA	11/10 → 12/14
PASSAT V 1.6	BSE, BZB	05/05 → 11/10
PASSAT V 1.6 FSi	BLF	03/05 → 06/08
PASSAT V 1.6 TDI	CAYC	08/09 → 12/14
PASSAT V 1.8 TSi	BZB, BKC	05/07 →
PASSAT V 1.9 TDI	BKC, AXX	03/05 → 11/10
PASSAT V 2.0 BlueTDI	CBAC	01/09 → 11/10
PASSAT V 2.0 FSi	AXX, BLX	03/05 → 11/10
PASSAT V 2.0 FSi 4motion	BLX, BMA	09/05 → 11/10
PASSAT V 2.0 TDI	BMA, BKP	03/05 →
PASSAT V 2.0 TDI 16V	BKP, BKP	03/05 → 11/10
PASSAT V 2.0 TDI 16V 4motion	BKP, BMP	03/05 → 11/10
PASSAT V 2.0 TDI 4motion	BMP, CBTA	03/05 → 12/14
PASSAT V 2.0 TSi	CCZB	11/10 → 12/15
PASSAT V 2.0 TSi 4motion	CCZB	01/12 → 12/14
PASSAT V 2.5 SRE	CBTA, CAVD	01/11 →
PASSAT V 3.2 FSi 4motion	AXZ	11/05 → 11/10
PASSAT V 3.6 FSi	BLV	06/05 →
PASSAT V 3.6 FSi 4motion	BLV	09/05 → 12/14
PASSAT V 3.6 R36 4motion	BWS	04/07 → 11/10
PASSAT CC 1.4 TSi MultiFuel	CKMA	01/11 → 01/12
PASSAT CC 1.8 TSi	BZB, CBAA	06/08 → 01/12
PASSAT CC 2.0 BlueTDI	CBAC	05/09 → 11/10
PASSAT CC 2.0 TDI	CBAA, CBAB	05/08 → 01/12
PASSAT CC 2.0 TDI 4motion	CBAB, CAWB	08/09 → 01/12
PASSAT CC 2.0 TSi	CAWB, BLV	06/08 → 01/12
PASSAT CC 3.6 FSi	BLV, BLV	06/08 →
PASSAT CC 3.6 FSi 4motion	BLV, CAXA	02/08 → 01/12
SCIROCCO III 1.4 TSi	CAVD, CDLA	05/08 →
SCIROCCO III 2.0 R	CDLA, CBBB	11/09 → 11/17
SCIROCCO III 2.0 TDI	CBBB, CAWB	08/08 → 11/17
SCIROCCO III 2.0 TSi	CAWB, CAVA	05/08 → 11/17
SCIROCCO 1.4 TSi	CAVD, CBBB	06/08 → 05/14
SCIROCCO 2.0 TDi	CBBB, CAVD	08/08 → 05/14
SCIROCCO 2.0 TFSi	CCZB	11/09 → 05/14
SHARAN II 1.4 TSi	CAVA, CFFA	05/10 →
SHARAN II 1.8 TSi	CDA	11/11 →
SHARAN II 2.0 TDI	CFFA, CFFA	05/10 →
SHARAN II 2.0 TDI 4motion	CFFA, CCZA	05/11 →
SHARAN II 2.0 TSi	CCZA, BWK	12/10 →
TIGUAN I 1.4 [CHN]	CFBA	11/11 →
TIGUAN I 1.4 TSi	BWK, BWK	05/08 →
TIGUAN I 1.4 TSi 4motion	BWK, CBAB	09/07 →
TIGUAN I 1.8 [CHN]	CEAA	12/09 →
TIGUAN I 2.0 [CHN]	CGMA	12/09 →
TIGUAN I 2.0 TDI	CBAB, CBAA	03/08 →
TIGUAN I 2.0 TDI 4motion	CBAA, CAWA	09/07 →
TIGUAN I 2.0 TFSi	CCTB	05/08 →
TIGUAN I 2.0 TFSi 4motion	CAWA, CCZB	09/07 →
TIGUAN I 2.0 TSi 4motion	CCZB, BLG	05/11 →
TIGUAN II 2.0 TDI	CUVE	05/15 →
TOURAN I 1.2 TSi	CBZB	05/10 → 05/15
TOURAN I 1.4 [CHN]	CFBA	04/09 →
TOURAN I 1.4 FSi	BLG, BMY	11/06 → 05/10
TOURAN I 1.4 TSi	BMY, BGY	02/06 → 05/15
TOURAN I 1.4 TSi EcoFuel	CDGA	05/09 → 05/15
TOURAN I 1.6	BGY, BAG	07/03 → 05/10
TOURAN I 1.6 BiFuel	BGF	11/06 → 05/10
TOURAN I 1.6 FSi	CAYB, CAYB	02/03 → 01/07
TOURAN I 1.6 TDI	CAYB, BPL	05/10 → 05/15
TOURAN I 1.8 [CHN]	BPL, AVQ	02/08 →
TOURAN I 1.9 TDI	AVQ, AXW	02/03 → 05/10
TOURAN I 2.0 EcoFuel	BSX	02/06 → 05/09
TOURAN I 2.0 FSi	AXW, AZV	10/03 → 05/10
TOURAN I 2.0 TDI	AZV, AXACNG	02/03 → 05/15
TOURAN I 2.0 TDI [CHN]	CGZA	04/09 →
TOURAN I 2.0 TDI 16V	BKD	08/03 → 05/10
TRANSPORTER 2.0 EcoFuel	AXACNG, AXB	11/03 → 08/15
TRANSPORTER 2.0 TDi	CDSD	05/11 → 08/15
TRANSPORTER 3.2	BDL	03/04 → 06/05
TRANSPORTER V 1.9 TDI	AXB, AXA	04/03 → 11/09
TRANSPORTER V 2.0	AXA, CAAA	11/03 →
TRANSPORTER V 2.0 BiFuel	AXACNG	05/11 → 08/15
TRANSPORTER V 2.0 BitDI	CFC	09/09 → 08/15
TRANSPORTER V 2.0 BitDI 4motion	CFC	09/09 → 08/15
TRANSPORTER V 2.0 TDI	CAAA, CAAC	09/09 → 08/15
TRANSPORTER V 2.0 TDI 4motion	CAAC, CJK	09/09 → 08/15
TRANSPORTER V 2.0 TSi	CJK, AXD	05/11 → 08/15
TRANSPORTER V 2.0 TSi 4motion	CJK	07/11 → 08/15
TRANSPORTER V 2.5 TDI	AXD, AXD	04/03 → 11/09
TRANSPORTER V 2.5 TDI 4motion	AXD, BDL	04/04 → 11/09
TRANSPORTER V 3.2 4motion	BDL, BDL	11/03 → 11/09
TRANSPORTER V 3.2 V6	BDL, BKK	04/03 → 11/09

VW		
TRANSPORTER V 3.2 V6 4motion	BKK, CAAA	11/03 → 11/09
TRANSPORTER VI 2.0 TDI	CAAA, CAAC	04/15 →
TRANSPORTER VI 2.0 TDI 4motion	CAAC, CJK	06/15 →
TRANSPORTER VI 2.0 TSi	CJK, CAXC	04/15 →
TRANSPORTER VI 2.0 TSi 4motion	CJK	06/15 →

21.0008

3

WHEEL SPEED SENSORS

Adatt./Suitable:

ATE 10.0711-6232.3

AUDI 1KO 927 808

WHT 003 858

BOSCH 0 986 594 507

SEAT 1KO 927 808

WHT 003 858

SKODA 1KO 927 808

1KD 927 808

WHT 003 858

VW 1KO 927 808

1KD 927 808

WHT 003 858

MARKET DIFFUSION: HIGH



L	L1		
---	39,6	Hall Effect	

AUDI		
A1 1.4 TDI	CUSB	11/14 → 10/18
A3 I [USA] 2.0	CBEA	08/09 →
A3 I [USA] 2.0 16V	--	01/06 → 12/10
A3 I [USA] 3.2 24V	CBRA	07/08 → 05/09
A3 I [USA] 3.2 24V AWD	--	01/06 → 12/09
A3 II 1.2 TFSi	CBZB	03/10 → 05/13
A3 II 1.2 TSi	CBZB	04/10 → 08/12
A3 II 1.4 TFSi	CAXC, BGY	09/07 → 05/13
A3 II 1.4 TSi	BGY, CCSA	05/03 → 08/12
A3 II 1.6 E-Power	CCSA, BAG	01/11 → 08/12
A3 II 1.6 FSi	BAG, CAYB	08/03 → 09/07
A3 II 1.6 TDI	CAYB, BYT	05/09 → 05/13
A3 II 1.8 TFSi	BYT, BKC	11/06 → 05/13
A3 II 1.9 TDI	BKC, AXW	05/03 → 05/10
A3 II 2.0 FSi	AXW, AZV	05/03 → 06/08
A3 II 2.0 TDI	AZV, BKD	05/03 → 05/13
A3 II 2.0 TDI 16V	BKD, AXX	05/03 → 08/12
A3 II 2.0 TDI quattro	AZV	05/03 → 06/08
A3 II 2.0 TFSi	AXX, CAXC	09/04 → 05/13
A3 II SPORTBACK 1.2 TSi	CBZB	04/10 → 03/13
A3 II SPORTBACK 1.4 TFSi	CAXC, BGY	09/07 → 03/13
A3 II SPORTBACK 1.6	BGY, CCSA	09/04 → 03/13
A3 II SPORTBACK 1.6 E-Power	CCSA, BLF	01/11 → 03/13
A3 II SPORTBACK 1.6 FSi	BLF, CAYB	09/04 → 09/07
A3 II SPORTBACK 1.6 TDI	CAYB, BYT	05/09 → 03/13
A3 II SPORTBACK 1.8 TFSi	BYT, BKC	11/06 → 03/13
A3 II SPORTBACK 1.9 TDI	BKC, AXW	09/04 → 05/10
A3 II SPORTBACK 2.0 FSi	AXW, AZV	09/04 → 06/08
A3 II SPORTBACK 2.0 TDI	AZV, BKD	09/04 → 03/13
A3 II SPORTBACK 2.0 TDI 16V	BKD, AXX	09/04 → 03/13
A3 II SPORTBACK 2.0 TFSi	AXX, CHPB	09/04 → 03/13
Q3 1.4 TSi	CHPB, CFFA	10/13 → 10/18
Q3 2.0 TDI	CFFA, CCTA	06/11 →
Q3 2.0 TFSi	CCTA, BPY	10/13 →
TT II 1.8 TFSi	CDA	06/08 → 06/14
TT II 2.0 TFSi	BPY, CAVA	08/06 → 06/14
TT II 2.0 TFSi quattro	BWA	06/08 → 06/10
SEAT		
ALHAMBRA III 1.4 TSi	CAVA, CFFA	06/10 →
ALHAMBRA III 1.8 TSi	CDA	11/12 →
ALHAMBRA III 2.0 TDI	CFFA, CCZA	06/10 →

SEAT			VW			VW		
ALHAMBRA III 2.0 TSI	CCZA, BXW	11/10 →	BEETLE 1.2 TSI	CBZB	07/11 →	JETTA VI 2.0 TSI	CBFA, CBTA	12/10 →
ALTEA 1.2 TSI	CBZB	04/10 →	BEETLE 1.2 TSI 16V	CYVD	12/14 →	JETTA VI 2.5	CBTA, BZB	04/10 →
ALTEA 1.4 16V	BXW, BGU	05/06 →	BEETLE 1.4 TSI	CAVD, CPKA	10/11 →	PASSAT V 1.4 TSI	CAXA	05/07 → 11/10
ALTEA 1.4 TFSi	CAXC	05/10 → 04/11	BEETLE 1.6 TDI	CAYC	10/11 → 07/16	PASSAT V 1.4 TSI EcoFuel	CDGA	01/09 → 11/10
ALTEA 1.4 TSI	CAXC	11/07 →	BEETLE 1.8 TSI	CPKA, CFFB	12/13 →	PASSAT V 1.6 TSI	BSE, BZB	05/05 → 11/10
ALTEA 1.6	BGU, CAYB	03/04 →	BEETLE 2.0 TDI	CFFB, CBFA	04/11 →	PASSAT V 1.6 FSI	BLF	03/05 → 06/08
ALTEA 1.6 LPG	CHGA	09/09 →	BEETLE 2.0 TSI	CBFA, CBTA	04/11 →	PASSAT V 1.6 TDI	CAYC	08/09 → 11/10
ALTEA 1.6 Multifuel	CMXA	11/10 → 05/11	BEETLE 2.5	CBTA, CAVD	04/11 →	PASSAT V 1.8 TSI	BZB, BKC	05/07 →
ALTEA 1.6 TDI	CAYB, BYT	10/09 →	EOS 1.4 TSI	CAVD, BVY	11/07 → 08/15	PASSAT V 1.9 TDI	BKC, AXX	03/05 → 11/10
ALTEA 1.8 TFSi	BYT, BJB	01/07 →	EOS 1.6 FSI	BLF	06/06 → 05/08	PASSAT V 2.0 BlueTDI	CBAC	01/09 → 11/10
ALTEA 1.9 TDI	BJB, BLR	04/04 →	EOS 2.0 FSI	BVY, BMM	03/06 → 05/08	PASSAT V 2.0 TSI	AXX, BMA	03/05 → 11/10
ALTEA 2.0 FSI	BLR, AZV	05/04 → 03/09	EOS 2.0 TDI	BMM, CBAB	06/06 → 08/15	PASSAT V 2.0 TDI	BMA, BKP	03/05 →
ALTEA 2.0 TDI	AZV, BKD	03/04 →	EOS 2.0 TDI 16V	CBAB, BPY	05/08 → 08/15	PASSAT V 2.0 TDI 16V	BKP, CBTA	03/05 → 11/10
ALTEA 2.0 TDI 16V	BKD, BXW	03/04 →	EOS 2.0 TFSi	BPY, BUB	03/06 → 08/15	PASSAT V 2.5 SRE	CBTA, CAVD	01/11 →
ALTEA 2.0 TFSi	BWA	04/06 → 05/09	EOS 2.0 TSI	CCZB	11/09 → 08/15	PASSAT V 3.6 FSI	BLV	06/05 →
ALTEA 2.0 TFSi [ExtraEU]	CCZB	05/09 →	EOS 3.2 V6	BUB, CAVD	06/06 → 05/09	PASSAT CC 1.8 TSI	BZB, CBAA	06/08 → 01/12
ALTEA XL 1.2 TSI	CBZB	04/10 →	EOS 3.6 V6	CDVA	05/09 → 11/10	PASSAT CC 2.0 BlueTDI	CBAC	05/09 → 11/10
ALTEA XL 1.4 16V	BXW, BGU	10/06 →	GOLF V 1.2 TSI	CBZA, BCA	11/09 → 12/13	PASSAT CC 2.0 TDI	CBAA, CAWB	05/08 → 01/12
ALTEA XL 1.4 TSI	CAXC	11/07 →	GOLF V 1.4	BUD	06/07 → 07/09	PASSAT CC 2.0 TSI	CAWB, BLV	06/08 → 01/12
ALTEA XL 1.6	BGU, BSE	10/06 →	GOLF V 1.4 16V	BCA, BKG	10/03 → 12/13	PASSAT CC 3.6 FSI	BLV, BSE	06/08 →
ALTEA XL 1.6 LPG	CHGA	09/09 →	GOLF V 1.4 FSI	BKG, BLG	10/03 → 11/06	SCIROCCO III 1.4 TSI	CAVD, CDLA	05/08 →
ALTEA XL 1.6 Multifuel	BSE, CAYB	10/06 →	GOLF V 1.4 TSI	BLG, BGU	11/05 → 12/13	SCIROCCO III 2.0 R	CDLA, CBBB	11/09 → 11/17
ALTEA XL 1.6 TDI	CAYB, BYT	10/09 →	GOLF V 1.6	BGU, BAG	01/04 → 12/13	SCIROCCO III 2.0 TDI	CBBB, CAWB	08/08 → 11/17
ALTEA XL 1.8 TFSi	BYT, BKC	01/07 →	GOLF V 1.6 BiFuel	CHGA	05/09 → 12/13	SCIROCCO III 2.0 TSI	CAWB, CAVA	05/08 → 11/17
ALTEA XL 1.9 TDI	BKC, BVY	10/06 →	GOLF V 1.6 MultiFuel	BAG, CCSA	10/03 → 07/08	SCIROCCO 1.4 TSI	CAVD, CBBB	06/08 → 05/14
ALTEA XL 2.0 FSI	BVY, AZV	10/06 → 03/09	GOLF V 1.6 TDI	CCSA, CAYB	10/07 → 12/13	SCIROCCO 2.0 TDI	CBBB, CAVD	08/08 → 05/14
ALTEA XL 2.0 TDI	AZV, BKD	10/06 →	GOLF V 1.6 TDI	CAYB, BKC	02/09 → 12/13	SCIROCCO 2.0 TFSi	CCZB	11/09 → 05/14
ALTEA XL 2.0 TDI 16V	BKD, BXW	10/06 →	GOLF V 1.9 TDI	BKC, BHY	10/03 → 07/09	SHARAN II 1.4 TSI	CAVA, CFFA	05/10 →
ALTEA XL 2.0 TFSi	BWA	10/06 → 05/09	GOLF V 1.9 TDI 4motion	BLS	01/08 → 07/09	SHARAN II 1.8 TSI	CDAA	11/11 →
LEON II 1.2 TSI	CBZB	02/10 → 12/12	GOLF V 2.0	BHY, AXW	08/06 → 07/09	SHARAN II 2.0 TDI	CFFA, CFFA	05/10 →
LEON II 1.4 16V	BXW, BSE	06/06 → 12/12	GOLF V 2.0 FSI	AXW, AXX	01/04 → 11/08	SHARAN II 2.0 TDI 4motion	CFFA, CCZA	05/11 →
LEON II 1.4 TSI	CAXC	11/07 → 12/12	GOLF V 2.0 GTI	AXX, AZV	10/04 → 02/09	SHARAN II 2.0 TSI	CCZA, BWK	12/10 →
LEON II 1.6	BSE, BSE	07/05 → 12/12	GOLF V 2.0 SDI	BKD	01/04 → 11/08	TIGUAN I 1.4 [CHN]	CFBA.	11/11 →
LEON II 1.6 LPG	CHGA	12/09 → 12/12	GOLF V 2.0 TDI	AZV, BKD	10/03 →	TIGUAN I 1.4 TSI	BWK, CBAB	05/08 →
LEON II 1.6 MultiFuel	BSE, CAYB	11/10 → 12/12	GOLF V 2.0 TDI 16V	BKD, CBTA	10/03 → 12/13	TIGUAN I 1.8 [CHN]	CEAA	12/09 →
LEON II 1.6 TDI	CAYB, BZB	02/10 → 12/12	GOLF V 2.5	CBTA, CAVD	05/07 → 11/08	TIGUAN I 2.0 [CHN]	CGMA	12/09 →
LEON II 1.8 TSI	BZB, BKC	06/07 → 12/12	GOLF VI 1.2 TSI	CBZA, BUD	11/08 →	TIGUAN I 2.0 TDI	CBAB, BLG	03/08 →
LEON II 1.9 TDI	BKC, BLR	07/05 → 12/10	GOLF VI 1.4	BUD, BUD	10/08 →	TIGUAN I 2.0 TFSi	CCTB	05/08 →
LEON II 2.0 Cupra R	CDLA	09/09 → 12/12	GOLF VI 1.4 16V	BUD, CAVD	01/09 → 05/11	TIGUAN II 2.0 TDI	CUVE	05/15 →
LEON II 2.0 FSI	BLR, AZV	07/05 → 05/10	GOLF VI 1.4 TSI	CAVD, BSE	10/08 →	TOURAN I 1.2 TSI	CBZB	05/10 → 05/15
LEON II 2.0 TDI	AZV, BKD	07/05 → 12/12	GOLF VI 1.6	BSE, CCSA	10/08 →	TOURAN I 1.4 [CHN]	CFBA.	04/09 →
LEON II 2.0 TDI 16V	BKD, BWA	07/05 → 12/12	GOLF VI 1.6 BiFuel	BSF	03/09 →	TOURAN I 1.4 FSI	BLG, BMY	11/06 → 05/10
LEON II 2.0 TFSi	BWA, BGU	05/05 → 12/12	GOLF VI 1.6 MultiFuel	CCSA, CAYB	10/08 →	TOURAN I 1.4 TSI	BMY, BGU	02/06 → 05/15
TOLEDO III 1.4 16V	BXW	05/06 → 05/09	GOLF VI 1.6 TDI	CAYB, CBFA	02/09 →	TOURAN I 1.4 TSI EcoFuel	CDGA	05/09 → 05/15
TOLEDO III 1.4 TSI	CAXC	11/07 → 05/09	GOLF VI 1.8 TSI	CDAA	06/09 → 01/11	TOURAN I 1.6	BGU, BAG	07/03 → 05/10
TOLEDO III 1.6	BGU, BYT	10/04 → 05/09	GOLF VI 2.0	CDLF	05/11 →	TOURAN I 1.6 BiFuel	BSF	11/06 → 05/10
TOLEDO III 1.8 TFSi	BYT, BJT	01/07 → 05/09	GOLF VI 2.0 GTi	CBFA, BMM	04/09 → 11/13	TOURAN I 1.6 FSI	BAG, CAYB	02/03 → 01/07
TOLEDO III 1.9 TDI	BJB, BLR	10/04 → 05/09	GOLF VI 2.0 TDI	BMM, CBFA	10/08 →	TOURAN I 1.6 TDI	CAYB, BPL	05/10 → 05/15
TOLEDO III 2.0 FSI	BLR, AZV	10/04 → 05/09	GOLF VI 2.0 TDI Gtd	CFGB	05/11 →	TOURAN I 1.8 [CHN]	BPL., AVQ	02/08 →
TOLEDO III 2.0 TDI	AZV, BCA	09/04 → 05/09	GOLF VI 2.0 TFSi	CRZA	11/11 →	TOURAN I 1.9 TDI	AVQ, AXW	02/03 → 05/10
TOLEDO III 2.0 TDI 16V	BKD	04/04 → 05/09	GOLF VI 2.0 TFSi Gti	CBFA, CBTA	05/11 →	TOURAN I 2.0 EcoFuel	BSX	02/06 → 05/09
TOLEDO III 2.0 TFSi	BWA	11/05 → 05/09	GOLF VI 2.0 TSI	CCZA	07/09 →	TOURAN I 2.0 FSI	AXW, AZV	10/03 → 05/10
SKODA			GOLF VI 2.5	CBTA, BLG	07/09 →	TOURAN I 2.0 TDI	AZV, CAXC	02/03 → 05/15
OCTAVIA II 1.2 TSI	CBZB	02/10 → 06/13	GOLF 1.2 TSi	CBZA	11/09 → 08/14	TOURAN I 2.0 TDI [CHN]	CGZA	04/09 →
OCTAVIA II 1.4	BCA, BGU	05/04 → 06/13	GOLF 1.2 TSi BlueMotion	CBZB	05/09 → 11/12	TOURAN I 2.0 TDI 16V	BKD	08/03 → 05/10
OCTAVIA II 1.4 [CHN]	CFBA.	03/10 →	GOLF 1.4 TSI	CAVD, CAYB	10/08 → 08/14			
OCTAVIA II 1.4 TSI	CAXA	11/08 → 06/13	GOLF 1.6 TDi	CAYB, CFFB	02/09 → 08/14			
OCTAVIA II 1.6	BGU, CDFA	06/04 → 06/13	GOLF 1.6 TDi BlueMotion	CAYC	05/09 → 11/12			
OCTAVIA II 1.6 [CHN]	CDFA, BSE	09/07 →	GOLF 2.0 GTi	CCZB	02/09 → 11/12			
OCTAVIA II 1.6 FSI	BLF	02/04 → 10/08	GOLF 2.0 TDi	CFFB, CBZA	09/09 → 08/14			
OCTAVIA II 1.6 LPG	BSE, CCSA	08/09 → 11/12	GOLF TSi	CAXA	10/08 → 11/12			
OCTAVIA II 1.6 MultiFuel	CCSA, BYJ	01/08 → 06/13	GOLF VAN 1.2 TSi	CBZB	09/09 → 05/14			
OCTAVIA II 1.6 TDI	CAYC	06/09 → 04/13	GOLF VAN 1.4 TSi	CAVD, CBDB	07/09 → 05/14			
OCTAVIA II 1.8 [CHN]	BYJ, BZB	04/07 →	GOLF VAN 1.6 TDi	CAYB	12/09 → 10/12			
OCTAVIA II 1.8 TSI	BZB, BJB	06/07 → 06/13	GOLF VAN 1.6 TDi BlueMotion	CAYC	07/09 → 05/14			
OCTAVIA II 1.9 TDI	BJB, BXX.	06/04 → 12/10	GOLF VAN 2.0 TDi	CBDB, CBZA	07/09 → 05/19			
OCTAVIA II 2.0 [CHN]	BXX., BLR	04/07 →	JETTA V 1.4 TSI	BLG, BSE	07/06 → 10/10			
OCTAVIA II 2.0 FSI	BLR, BWA	11/04 → 10/08	JETTA V 1.6	BSE, CAYB	10/05 → 10/10			
OCTAVIA II 2.0 RS	BWA, AZV	10/05 → 02/13	JETTA V 1.6 FSI	BLF	09/05 → 10/10			
OCTAVIA II 2.0 TDI	AZV, AZV	02/04 → 06/13	JETTA V 1.6 MultiFuel	CCSA	01/08 → 10/10			
OCTAVIA II 2.0 TDI 16V	AZV, BMN	02/04 → 05/13	JETTA V 1.6 TDI	CAYB, BKC	06/09 → 10/10			
OCTAVIA II 2.0 TDI RS	BMN, BZB	04/06 → 02/13	JETTA V 1.9 TDI	BKC, BLR	01/05 →			
SUPERB II 1.4 [CHN]	CFBA.	03/10 →	JETTA V 2.0 FSI	BLR, AZV	08/05 → 10/10			
SUPERB II 1.4 TSI	CAXC	07/08 → 05/15	JETTA V 2.0 TDI	AZV, BKD	09/05 → 10/10			
SUPERB II 1.6 TDI	CAYC	09/10 → 05/15	JETTA V 2.0 TDI 16V	BKD, BPY	08/05 → 10/10			
SUPERB II 1.8 [CHN]	CEAA	04/09 →	JETTA V 2.0 TFSi	BPY, BGP	10/05 → 10/10			
SUPERB II 1.8 TSI	BZB, BLS	03/08 → 05/15	JETTA V 2.5	BGP, CBZB	01/05 →			
SUPERB II 1.9 TDI	BLS, BMP	03/08 → 11/10	JETTA VI 1.2 TSI	CBZB, CAVA	10/10 →			
SUPERB II 2.0 [CHN]	CGMA	04/09 →	JETTA VI 1.2 TSI 16V	CYVD	08/14 →			
SUPERB II 2.0 TDI	BMP, BKD	03/08 → 05/15	JETTA VI 1.4 TSI	CAVA, CNLA	04/11 →			
SUPERB II 2.0 TDI 16V	BKD, CBZB	01/09 → 05/15	JETTA VI 1.4 TSI Hybrid	CNLA, CFNA	04/11 →			
SUPERB II 2.0 TSI	CCZA	05/10 → 05/15	JETTA VI 1.6	CFNA, CWVA	12/11 →			
YETI 1.2 TSI	CBZB, CAXA	09/09 → 12/17	JETTA VI 1.6 [RUS]	CWVA, CPKA	01/15 →			
YETI 1.4 TSI	CAXA, CFHA	06/10 → 12/17	JETTA VI 1.6 MPi	CWVB	09/15 → 04/18			
YETI 1.6	CWVA	04/14 → 12/17	JETTA VI 1.6 TDI	CAYC	04/10 → 07/14			
YETI 1.6 TDI	CAYC	11/10 → 05/15	JETTA VI 1.8 TSI	CPKA, CBPA	07/14 →			
YETI 1.8	CDAB	02/11 →	JETTA VI 2.0	CBPA, CFFB	06/10 → 12/17			
YETI 2.0 TDI	CFHA, CAVD	11/09 →	JETTA VI 2.0 TDI	CFFB, CBFA	10/10 →			

21.0009



3

WHEEL SPEED SENSORS

Adatt./Suitable:

ATE
10.0711-6231.3

AUDI
1K0 927 807
WHT 003 859

BOSCH
0 986 594 506

SEAT
1K0 927 807
WHT 003 859

SKODA
1K0 927 807
1KD 927 807
WHT 003 859

VW
1K0 927 807
1KD 927 807
WHT 003 859

MARKET DIFFUSION: **HIGH**



L	L1	Hall Effect	
---	39,6		

AUDI			
A3 I [USA] 2.0	CBEA	08/09 →	
A3 I [USA] 2.0 16V	--	01/06 → 12/10	
A3 I [USA] 3.2 24V	CBRA	07/08 → 05/09	
A3 I [USA] 3.2 24V AWD	--	01/06 → 12/09	
A3 II 1.2 TFSI	CBZB	03/10 → 05/13	
A3 II 1.2 TSI	CBZB	04/10 → 08/12	
A3 II 1.4 TFSI	CAXC, BGU	09/07 → 05/13	
A3 II 1.6	BGU, CCSA	05/03 → 08/12	
A3 II 1.6 E-Power	CCSA, BAG	01/11 → 08/12	
A3 II 1.6 FSI	BAG, CAYB	08/03 → 09/07	
A3 II 1.6 TDI	CAYB, BYT	05/09 → 05/13	
A3 II 1.8 TFSI	BYT, BKC	11/06 → 05/13	
A3 II 1.9 TDI	BKC, AXW	05/03 → 05/10	
A3 II 2.0 FSI	AXW, AZV	05/03 → 06/08	
A3 II 2.0 TDI	AZV, BKD	05/03 → 05/13	
A3 II 2.0 TDI 16V	BKD, AXX	05/03 → 08/12	
A3 II 2.0 TDI quattro	AZV	05/03 → 06/08	
A3 II 2.0 TFSI	AXX, CAXC	09/04 → 05/13	
A3 II SPORTBACK 1.2 TSI	CBZB	04/10 → 03/13	
A3 II SPORTBACK 1.4 TFSI	CAXC, BGU	09/07 → 03/13	
A3 II SPORTBACK 1.6	BGU, CCSA	09/04 → 03/13	
A3 II SPORTBACK 1.6 E-Power	CCSA, BLF	01/11 → 03/13	
A3 II SPORTBACK 1.6 FSI	BLF, CAYB	09/04 → 09/07	
A3 II SPORTBACK 1.6 TDI	CAYB, BYT	05/09 → 03/13	
A3 II SPORTBACK 1.8 TFSI	BYT, BKC	11/06 → 03/13	
A3 II SPORTBACK 1.9 TDI	BKC, AXW	09/04 → 05/10	
A3 II SPORTBACK 2.0 FSI	AXW, AZV	09/04 → 06/08	
A3 II SPORTBACK 2.0 TDI	AZV, BKD	09/04 → 03/13	
A3 II SPORTBACK 2.0 TDI 16V	BKD, AXX	09/04 → 03/13	
A3 II SPORTBACK 2.0 TFSI	AXX, CHPB	09/04 → 03/13	
Q3 1.4 TSI	CHPB, CFFA	10/13 → 10/18	
Q3 2.0 TDI	CFFA, CTA	06/11 →	
Q3 2.0 TFSI	CCTA, BPY	10/13 →	
TT II 1.8 TFSI	CDAA	06/08 → 06/14	
TT II 2.0 TFSI	BPY, CAVA	08/06 → 06/14	
TT II 2.0 TFSI quattro	BWA	06/08 → 06/10	

SEAT			
ALHAMBRA III 1.4 TSI	CAVA, CFFA	06/10 →	
ALHAMBRA III 1.8 TSI	CDAA	11/12 →	
ALHAMBRA III 2.0 TDI	CFFA, CCZA	06/10 →	
ALHAMBRA III 2.0 TSI	CCZA, BXW	11/10 →	
ALTEA 1.2 TSI	CBZB	04/10 →	
ALTEA 1.4 16V	BXW, BGU	05/06 →	
ALTEA 1.4 TFSI	CAXC	05/10 → 04/11	
ALTEA 1.4 TSI	CAXC	11/07 →	
ALTEA 1.6	BGU, CAYB	03/04 →	
ALTEA 1.6 LPG	CHGA	09/09 →	
ALTEA 1.6 Multifuel	CMXA	11/10 → 05/11	
ALTEA 1.6 TDI	CAYB, BYT	10/09 →	

SEAT			
ALTEA 1.8 TFSI	BYT, BJB	01/07 →	
ALTEA 1.9 TDI	BJB, BLR	04/04 →	
ALTEA 2.0 FSI	BLR, AZV	05/04 → 03/09	
ALTEA 2.0 TDI	AZV, BKD	03/04 →	
ALTEA 2.0 TDI 16V	BKD, BXW	03/04 →	
ALTEA 2.0 TFSI	BWA	04/06 → 05/09	
ALTEA 2.0 TFSI [ExtraEU]	CCZB	05/09 →	
ALTEA XL 1.2 TSI	CBZB	04/10 →	
ALTEA XL 1.4 16V	BXW, BGU	10/06 →	
ALTEA XL 1.4 TSI	CAXC	11/07 →	
ALTEA XL 1.6	BGU, BSE	10/06 →	
ALTEA XL 1.6 LPG	CHGA	09/09 →	
ALTEA XL 1.6 Multifuel	BSE, CAYB	10/06 →	
ALTEA XL 1.6 TDI	CAYB, BYT	10/09 →	
ALTEA XL 1.8 TFSI	BYT, BKC	01/07 →	
ALTEA XL 1.9 TDI	BKC, BVY	10/06 →	
ALTEA XL 2.0 FSI	BVY, AZV	10/06 → 03/09	
ALTEA XL 2.0 TDI	AZV, BKD	10/06 →	
ALTEA XL 2.0 TDI 16V	BKD, BXW	10/06 →	
ALTEA XL 2.0 TFSI	BWA	10/06 → 05/09	
LEON II 1.2 TSI	CBZB	02/10 → 12/12	
LEON II 1.4 16V	BXW, BSE	06/06 → 12/12	
LEON II 1.4 TSI	CAXC	11/07 → 12/12	
LEON II 1.6	BSE, BSE	07/05 → 12/12	
LEON II 1.6 LPG	CHGA	12/09 → 12/12	
LEON II 1.6 Multifuel	BSE, CAYB	11/10 → 12/12	
LEON II 1.6 TDI	CAYB, BZB	02/10 → 12/12	
LEON II 1.8 TSI	BZB, BKC	06/07 → 12/12	
LEON II 1.9 TDI	BKC, BLR	07/05 → 12/10	
LEON II 2.0 Cupra R	CDLA	09/09 → 12/12	
LEON II 2.0 FSI	BLR, AZV	07/05 → 05/10	
LEON II 2.0 TDI	AZV, BKD	07/05 → 12/12	
LEON II 2.0 TDI 16V	BKD, BWA	07/05 → 12/12	
LEON II 2.0 TFSI	BWA, BGU	05/05 → 12/12	
TOLEDO III 1.4 16V	BXW	05/06 → 05/09	
TOLEDO III 1.4 TSI	CAXC	11/07 → 05/09	
TOLEDO III 1.6	BGU, BYT	10/04 → 05/09	
TOLEDO III 1.8 TFSI	BYT, BJB	01/07 → 05/09	
TOLEDO III 1.9 TDI	BLR, BJR	10/04 → 05/09	
TOLEDO III 2.0 FSI	BLR, AZV	10/04 → 05/09	
TOLEDO III 2.0 TDI	AZV, BCA	09/04 → 05/09	
TOLEDO III 2.0 TDI 16V	BKD	04/04 → 05/09	
TOLEDO III 2.0 TFSI	BWA	11/05 → 05/09	

SKODA			
OCTAVIA II 1.2 TSI	CBZB	02/10 → 06/13	
OCTAVIA II 1.4	BCA, BGU	05/04 → 06/13	
OCTAVIA II 1.4 [CHN]	CFBA	03/10 →	
OCTAVIA II 1.4 TSI	CAXA	11/08 → 06/13	
OCTAVIA II 1.6	BGU, CDFA	06/04 → 06/13	
OCTAVIA II 1.6 [CHN]	CDFA, BSE	09/07 →	
OCTAVIA II 1.6 FSI	BLF	02/04 → 10/08	
OCTAVIA II 1.6 LPG	BSE, CCSA	08/09 → 11/12	
OCTAVIA II 1.6 Multifuel	CCSA, BYJ	01/08 → 06/13	
OCTAVIA II 1.6 TDI	CAYC	06/09 → 04/13	
OCTAVIA II 1.8 [CHN]	BYJ, BZB	04/07 →	
OCTAVIA II 1.8 TSI	BZB, BJB	06/07 → 06/13	
OCTAVIA II 1.9 TDI	BJB, BXX	06/04 → 12/10	
OCTAVIA II 2.0 [CHN]	BXX., BLR	04/07 →	
OCTAVIA II 2.0 FSI	BLR, BWA	11/04 → 10/08	
OCTAVIA II 2.0 RS	BWA, AZV	10/05 → 02/13	
OCTAVIA II 2.0 TDI	AZV, AZV	02/04 → 06/13	
OCTAVIA II 2.0 TDI 16V	AZV, BMN	02/04 → 05/13	
OCTAVIA II 2.0 TDI RS	BMN, BZB	04/06 → 02/13	
SUPERB II 1.4 [CHN]	CFBA	03/10 →	
SUPERB II 1.4 TSI	CAXC	07/08 → 05/15	
SUPERB II 1.6 TDI	CAYC	09/10 → 05/15	
SUPERB II 1.8 [CHN]	CEAA	04/09 →	
SUPERB II 1.8 TSI	BZB, BLS	03/08 → 05/15	
SUPERB II 1.9 TDI	BLS, BMP	03/08 → 11/10	
SUPERB II 2.0 [CHN]	CGMA	04/09 →	
SUPERB II 2.0 TDI	BMP, BKD	03/08 → 05/15	
SUPERB II 2.0 TDI 16V	BKD, CBZB	01/09 → 05/15	
SUPERB II 2.0 TSI	CCZA	05/10 → 05/15	
YETI 1.2 TSI	CBZB, CAXA	09/09 → 12/17	
YETI 1.4 TSI	CAXA, CFHA	06/10 → 12/17	
YETI 1.6	CWVA	04/14 → 12/17	
YETI 1.6 TDI	CAYC	11/10 → 05/15	
YETI 1.8	CDAB	02/11 →	
YETI 2.0 TDI	CFHA, CAVD	11/09 →	

VW			
BEETLE 1.2 TSI	CBZB	07/11 →	
BEETLE 1.2 TSI 16V	CYVD	12/14 →	
BEETLE 1.4 TSI	CAVD, CPKA	10/11 →	
BEETLE 1.6 TDI	CAYC	10/11 → 07/16	
BEETLE 1.8 TSI	CPKA, CFFB	12/13 →	
BEETLE 2.0 TDI	CFFB, CBFA	04/11 →	
BEETLE 2.0 TSI	CBFA, CBTA	04/11 →	
BEETLE 2.5	CBTA, CKMA	04/11 →	

VW			
CC 1.4 TSI	CKMA, CDAA	11/11 → 12/16	
CC 1.4 TSI MultiFuel	CKMA	11/11 → 12/16	
CC 1.8 TSI	CDAA, CFFA	11/11 → 12/16	
CC 2.0 TDI	CFFA, CAVD	11/11 → 12/16	
CC 2.0 TSI	CCZB	11/11 → 12/16	
EOS 1.4 TSI	CAVD, BVY	11/07 → 08/15	
EOS 1.6 FSI	BLF	06/06 → 05/08	
EOS 2.0 FSI	BVY, BMM	03/06 → 05/08	
EOS 2.0 TDI	BMM, CBAB	06/06 → 08/15	
EOS 2.0 TDI 16V	CBAB, BPY	05/08 → 08/15	
EOS 2.0 TFSI	BPY, BUB	03/06 → 08/15	
EOS 2.0 TSI	CCZB	11/09 → 08/15	
EOS 3.2 V6	BUB, CAVD	06/06 → 05/09	
EOS 3.6 V6	CDVA	05/09 → 11/10	
GOLF V 1.2 TSI	CBZA, BCA	11/09 → 12/13	
GOLF V 1.4	BUD	06/07 → 07/09	
GOLF V 1.4 16V	BCA, BKG	10/03 → 12/13	
GOLF V 1.4 FSI	BKG, BLG	10/03 → 11/06	
GOLF V 1.4 TSI	BLG, BGU	11/05 → 12/13	
GOLF V 1.6	BGU, BAG	01/04 → 12/13	
GOLF V 1.6 BiFuel	CHGA	05/09 → 12/13	
GOLF V 1.6 FSI	BAG, CCSA	10/03 → 07/08	
GOLF V 1.6 MultiFuel	CCSA, CAYB	10/07 → 12/13	
GOLF V 1.6 TDI	CAYB, BKC	02/09 → 12/13	
GOLF V 1.9 TDI	BKC, BHY	10/03 → 07/09	
GOLF V 1.9 TDI 4motion	BLS	01/08 → 07/09	
GOLF V 2.0	BHY, AXW	08/06 → 07/09	
GOLF V 2.0 FSI	AXW, AXX	01/04 → 11/08	
GOLF V 2.0 GTI	AXX, AZV	10/04 → 02/09	
GOLF V 2.0 SDI	BOK	01/04 → 11/08	
GOLF V 2.0 TDI	AZV, BKD	10/03 →	
GOLF V 2.0 TDI 16V	BKD, CBTA	10/03 → 12/13	
GOLF V 2.5	CBTA, CAVD	05/07 → 11/08	
GOLF VI 1.2 TSI	CBZA, BUD	11/08 →	
GOLF VI 1.4	BUD, BUD	10/08 →	
GOLF VI 1.4 16V	BUD, CAVD	01/09 → 05/11	
GOLF VI 1.4 TSI	CAVD, BSE	10/08 →	
GOLF VI 1.6	BSE, CCSA	10/08 →	
GOLF VI 1.6 BiFuel	BSF	03/09 →	
GOLF VI 1.6 MultiFuel	CCSA, CAYB	10/08 →	
GOLF VI 1.6 TDI	CAYB, CBFA	02/09 →	
GOLF VI 1.8 TSI	CDAA	06/09 → 01/11	
GOLF VI 2.0	CDLF	05/11 →	
GOLF VI 2.0 GTi	CBFA, BMM	04/09 → 11/13	
GOLF VI 2.0 TDI	BMM, CBFA	10/08 →	
GOLF VI 2.0 TDI Gtd	CFGB	05/11 →	
GOLF VI 2.0 TFSI	CRZA	11/11 →	
GOLF VI 2.0 TFSI GTi	CBFA, CBTA	05/11 →	
GOLF VI 2.0 TSI	CCZA	07/09 →	
GOLF VI 2.5	CBTA, BLG	07/09 →	
GOLF 1.2 TSI	CBZA	11/09 → 08/14	
GOLF 1.2 TSI BlueMotion	CBZB	05/09 → 11/12	
GOLF 1.4 TSI	CAVD, CAYB	10/08 → 08/14	
GOLF 1.6 TDI	CAYB, CFFB	02/09 → 08/14	
GOLF 1.6 TDI BlueMotion	CAYC	05/09 → 11/12	
GOLF 2.0 GTI	CCZB	02/09 → 11/12	
GOLF 2.0 TDI	CFFB, CBZA	09/09 → 08/14	
GOLF TSi	CAXA	10/08 → 11/12	
GOLF VAN 1.2 TSI	CBZB	09/09 → 05/14	
GOLF VAN 1.4 TSI	CAVD, CBDB	07/09 → 05/14	
GOLF VAN 1.6 TDI	CAYB	12/09 → 10/12	
GOLF VAN 1.6 TDI BlueMotion	CAYC	07/09 → 05/14	
GOLF VAN 2.0 TDI	CBDB, CBZA	07/09 → 05/19	
JETTA V 1.4 TSI	BLG, BSE	07/06 → 10/10	
JETTA V 1.6	BSE, CAYB	10/05 → 10/10	
JETTA V 1.6 FSI	BLF	09/05 → 10/10	
JETTA V 1.6 MultiFuel	CCSA	01/08 → 10/10	
JETTA V 1.6 TDI	CAYB, BKC	06/09 → 10/10	
JETTA V 1.9 TDI	BKC, BLR	01/05 →	
JETTA V 2.0 FSI	BLR, AZV	08/05 → 10/10	
JETTA V 2.0 TDI	AZV, BKD	09/05 → 10/10	
JETTA V 2.0 TDI 16V	BKD, BPY	08/05 → 10/10	
JETTA V 2.0 TFSI	BPY, BGP	10/05 → 10/10	
JETTA V 2.5	BGP, CBZB	01/05 →	
JETTA VI 1.2 TSI	CBZB, CAVA	10/10 →	
JETTA VI 1.2 TSI 16V	CYVD	08/14 →	
JETTA VI 1.4 TSI	CAVA, CNLA	04/11 →	
JETTA VI 1.4 TSI Hybrid	CNLA, CFNA	04/11 →	
JETTA VI 1.6	CFNA, CWVA	12/11 →	
JETTA VI 1.6 [RUS]	CWVA, CPKA	01/15 →	
JETTA VI 1.6 MPI	CWVB	09/15 → 04/18	
JETTA VI 1.6 TDI	CAYC	04/10 → 07/14	
JETTA VI 1.8 TSI	CPKA, CBPA	07/14 →	
JETTA VI 2.0	CBPA, CFFB	06/10 → 12/17	
JETTA VI 2.0 TDI	CFFB, CBFA	10/10 →	
JETTA VI 2.0 TSI	CBFA, CBTA	12/10 →	
JETTA VI 2.5	CBTA, BZB	04/10 →	
PASSAT V 1.4 TSI	CAXA	05/07 → 11/10	

VW			
PASSAT V 1.4 TSI EcoFuel	CDGA	01/09	⇒ 11/10
PASSAT V 1.6	BSE, BZB	05/05	⇒ 11/10
PASSAT V 1.6 FSI	BLF	03/05	⇒ 06/08
PASSAT V 1.6 TDI	CAYC	08/09	⇒ 11/10
PASSAT V 1.8 TSI	BZB, BKC	05/07	⇒
PASSAT V 1.9 TDI	BKC, AXX	03/05	⇒ 11/10
PASSAT V 2.0 BlueTDI	CBAC	01/09	⇒ 11/10
PASSAT V 2.0 FSI	AXX, BMA	03/05	⇒ 11/10
PASSAT V 2.0 TDI	BMA, BKP	03/05	⇒
PASSAT V 2.0 TDI 16V	BKP, CBTA	03/05	⇒ 11/10
PASSAT V 2.5 SRE	CBTA, CAVD	01/11	⇒
PASSAT V 3.6 FSI	BLV	06/05	⇒
PASSAT CC 1.8 TSI	BZB, CBAA	06/08	⇒ 01/12
PASSAT CC 2.0 BlueTDI	CBAC	05/09	⇒ 11/10
PASSAT CC 2.0 TDI	CBAA, CAWB	05/08	⇒ 01/12
PASSAT CC 2.0 TSI	CAWB, BLV	06/08	⇒ 01/12
PASSAT CC 3.6 FSI	BLV, BSE	06/08	⇒
SCIROCCO III 1.4 TSI	CAVD, CDLA	05/08	⇒
SCIROCCO III 2.0 R	CDLA, CBBB	11/09	⇒ 11/17
SCIROCCO III 2.0 TDI	CBBB, CAWB	08/08	⇒ 11/17
SCIROCCO III 2.0 TSI	CAWB, CAVA	05/08	⇒ 11/17
SCIROCCO 1.4 TSi	CAVD, CBBB	06/08	⇒ 05/14
SCIROCCO 2.0 TDi	CBBB, CAVD	08/08	⇒ 05/14
SCIROCCO 2.0 TFSi	CCZB	11/09	⇒ 05/14
SHARAN II 1.4 TSI	CAVA, CFFA	05/10	⇒
SHARAN II 1.8 TSI	CDAA	11/11	⇒
SHARAN II 2.0 TDI	CFFA, CFFA	05/10	⇒
SHARAN II 2.0 TDI 4motion	CFFA, CZCA	05/11	⇒
SHARAN II 2.0 TSI	CCZA, BWK	12/10	⇒
TIGUAN I 1.4 [CHN]	CFBA	11/11	⇒
TIGUAN I 1.4 TSI	BWK, CBAB	05/08	⇒
TIGUAN I 1.8 [CHN]	CEAA	12/09	⇒
TIGUAN I 2.0 [CHN]	CGMA	12/09	⇒
TIGUAN I 2.0 TDI	CBAB, BLG	03/08	⇒
TIGUAN I 2.0 TFSi	CCTB	05/08	⇒
TIGUAN II 2.0 TDI	CUVE	05/15	⇒
TOURAN I 1.2 TSI	CBZB	05/10	⇒ 05/15
TOURAN I 1.4 [CHN]	CFBA	04/09	⇒
TOURAN I 1.4 FSI	BLG, BMY	11/06	⇒ 05/10
TOURAN I 1.4 TSI	BMY, BGU	02/06	⇒ 05/15
TOURAN I 1.4 TSI EcoFuel	CDGA	05/09	⇒ 05/15
TOURAN I 1.6	BGU, BAG	07/03	⇒ 05/10
TOURAN I 1.6 BiFuel	BSF	11/06	⇒ 05/10
TOURAN I 1.6 FSI	BAG, CAYB	02/03	⇒ 01/07
TOURAN I 1.6 TDI	CAYB, BPL	05/10	⇒ 05/15
TOURAN I 1.8 [CHN]	BPL, AVQ	02/08	⇒
TOURAN I 1.9 TDI	AVQ, AXW	02/03	⇒ 05/10
TOURAN I 2.0 EcoFuel	BSX	02/06	⇒ 05/09
TOURAN I 2.0 FSI	AXW, AZV	10/03	⇒ 05/10
TOURAN I 2.0 TDI	AZV, CHZB	02/03	⇒ 05/15
TOURAN I 2.0 TDI [CHN]	CGZA	04/09	⇒
TOURAN I 2.0 TDI 16V	BKD	08/03	⇒ 05/10

21.0010



WHEEL SPEED SENSORS

Adatt./Suitable:

ATE
10.0711-5274.3

AUDI
6Q0 927 804 A
6Q0 927 804 B
WHT 003 860

BOSCH
0 986 594 501

SEAT
6Q0 927 804 B
WHT 003 860

SKODA
6Q0 927 804 A
6Q0 927 804 B
WHT 003 860

VW
6Q0 927 804 A
6Q0 927 804 B
WHT 003 860

MARKET DIFFUSION: HIGH



L	L1	Hall Effect	
---	21		

AUDI

A1 1.0 TFSi	CHZB, CAVG	03/15	⇒ 10/18
A1 1.2 TFSi	CBZA	05/10	⇒ 04/15
A1 1.4 TDI	CJUSB	11/14	⇒ 10/18
A1 1.4 TFSi	CAVG, CAYB	05/10	⇒ 10/18
A1 1.4 TSI	CZEA	11/14	⇒ 10/18
A1 1.6 TDI	CAYB, CFHB	05/10	⇒ 10/18
A1 1.8 TFSi	DAJB	02/15	⇒ 10/18
A1 2.0 TDI	CFHB, CHZL	09/11	⇒ 04/15
A1 2.0 TFSi quattro	CDLH	03/12	⇒ 11/12
A1 25 TFSi	CHZL, DKJA	11/18	⇒
A1 30 TFSi	DKJA, CZPC	07/18	⇒
A1 35 TFSi	DADA	09/18	⇒
A1 40 TFSi	CZPC, AUA	09/18	⇒
A1 S1 quattro	CWZA	03/14	⇒ 10/18
A2 1.4	AUA, AMF	02/00	⇒ 08/05
A2 1.4 TDI	AMF, CHZD	02/00	⇒ 08/05
A2 1.6 FSI	BAD	05/02	⇒ 08/05
A3 III 1.0 TFSi	CHZD, CJZA	07/16	⇒
A3 III 1.2 TFSi	CJZA, CMBA	02/13	⇒
A3 III 1.4 TFSi	CMBA, CUKB	04/12	⇒
A3 III 1.4 TFSi e-tron	CUKB, CLHA	05/14	⇒
A3 III 1.4 TFSi g-tron	CPWA	11/13	⇒
A3 III 1.4 TSI	CZEA	05/14	⇒
A3 III 1.5 TFSi	DADA	05/17	⇒
A3 III 1.6 TDI	CLHA, CJSA	10/12	⇒
A3 III 1.6 TDI quattro	CXXB	05/15	⇒
A3 III 1.8 TFSi	CJSA, CRBC	04/12	⇒
A3 III 1.8 TFSi quattro	CJSB	08/12	⇒
A3 III 2.0 quattro	CNTC	11/13	⇒
A3 III 2.0 TDI	CRBC, CRBC	04/12	⇒
A3 III 2.0 TDI quattro	CRBC, CHHB	10/12	⇒
A3 III 2.0 TFSi	CHHB, CHHB	01/13	⇒
A3 III 2.0 TFSi [ExtraEU]	CHHB, CNTC	05/14	⇒
A3 III 2.0 TFSi quattro	CNTC, DDYA	05/14	⇒
A3 III 30 TDI	DDYA, CHZD	07/18	⇒
A3 III 30 TFSi	CHZD, CZGB	07/18	⇒
A3 III 35 TFSi	DADA	10/18	⇒
A3 III RS3 quattro	CZGB, CJXB	03/15	⇒
A3 III S3 quattro	CJXB, CHZJ	11/12	⇒
Q2 1.0 TFSi	CHZJ, DDYA	10/16	⇒
Q2 1.4 TFSi	CZEA	06/16	⇒
Q2 1.6 TDI	DDYA, DFGA	06/16	⇒ 10/18
Q2 2.0 TDI	DCYA	09/16	⇒
Q2 2.0 TDI quattro	DFGA, CZPB	07/16	⇒
Q2 2.0 TFSi quattro	CZPB, DDYA	05/17	⇒
Q2 30 TDi	DDYA, CHZJ	07/18	⇒
Q2 30 TFSi	CHZJ, CZPB	07/18	⇒

AUDI

Q2 35 TFSi	DADA	07/18	⇒
Q2 40 TFSi quattro	CZPB, CJSA	09/18	⇒
Q2 SQ2 TFSi quattro	DNUC	08/18	⇒
Q3 35 TDI	DFGA	09/18	⇒
Q3 35 TDI quattro	DFGA	09/18	⇒
Q3 35 TFSi	DADA	08/18	⇒
Q3 40 TDI quattro	DFHA	10/18	⇒
Q3 40 TFSi quattro	DKTC	07/18	⇒
Q3 45 TFSi quattro	DKTA	07/18	⇒
TT III 1.8 TFSi	CJSA, CHHC	08/15	⇒
TT III 2.0 TDI	CUNA	07/14	⇒
TT III 2.0 TDI quattro	CUNA	01/17	⇒
TT III 2.0 TFSi	CHHC	07/14	⇒
TT III 2.0 TFSi quattro	CHHC, CJXF	07/14	⇒
TT III 2.0 TFSi quattro	CJXF, DAZA	11/14	⇒
TT III 2.5 RS quattro	DAZA, CHZJ	10/16	⇒
TT 2.0 TFSi [ExtraEU]	CYFB	07/15	⇒

SEAT

ARONA 1.0 TGI	DBYA	11/18	⇒
ARONA 1.0 TSI	CHZJ, DGTA	07/17	⇒
ARONA 1.5 TSI	DADA	07/17	⇒
ARONA 1.6 SRE	CWVA	07/17	⇒
ARONA 1.6 TDI	DGTA, CHZJ	07/17	⇒
ATECA 1.0 TSI	CHZJ, DDYA	05/16	⇒
ATECA 1.4 TSI	CZEA	06/16	⇒
ATECA 1.4 TSI 4Drive	CZEA	06/16	⇒
ATECA 1.5 TSI	DADA	07/18	⇒
ATECA 1.5 TSI 4Drive	DADA	07/18	⇒
ATECA 1.6 TDI	DDYA, CRVA	04/16	⇒
ATECA 2.0 TDI	CRVA, DFFA	04/16	⇒
ATECA 2.0 TDI 4Drive	DFFA, CZPB	04/16	⇒
ATECA 2.0 TSI 4Drive	CZPB, AZQ	05/17	⇒
CORDOBA II 1.2	AZQ, BBY	10/02	⇒ 06/06
CORDOBA II 1.2 12V	BXV	05/06	⇒ 11/09
CORDOBA II 1.4 16V	BBY, AMF	09/02	⇒
CORDOBA II 1.4 TDI	AMF, ASZ	10/02	⇒ 11/09
CORDOBA II 1.6	BAH	04/03	⇒ 11/09
CORDOBA II 1.6 16V	BTS	11/06	⇒ 11/09
CORDOBA II 1.9 SDI	ASY	09/02	⇒ 11/09
CORDOBA II 1.9 TDI	ASZ, AZL	09/02	⇒ 11/09
CORDOBA II 2.0	AZL, AZQ	09/02	⇒ 11/09
IBIZA 1.2	CGPA	04/08	⇒
IBIZA 1.2 TDi	CFWA	05/10	⇒
IBIZA 1.6 SRE [ExtraEU]	CWVA	05/17	⇒
IBIZA 1.6 TDi	CAYB	05/09	⇒
IBIZA III 1.2	AZQ, AUB	02/02	⇒ 05/08
IBIZA III 1.2 12V	BXV	05/06	⇒ 11/09
IBIZA III 1.4 16V	AUB, AMF	02/02	⇒ 11/09
IBIZA III 1.4 TDI	AMF, BBU	05/02	⇒ 11/09
IBIZA III 1.6	BAH	02/03	⇒ 11/09
IBIZA III 1.6 16V	BTS	11/06	⇒ 11/09
IBIZA III 1.8 T Cupra R	BBU, BJX	01/04	⇒ 02/08
IBIZA III 1.8 T FR	BJX, ASZ	12/03	⇒ 05/08
IBIZA III 1.9 SDI	ASY	02/02	⇒ 12/05
IBIZA III 1.9 TDI	ASZ, BPX	02/02	⇒ 11/09
IBIZA III 1.9 TDI Cupra R	BPX, AZL	03/04	⇒ 02/08
IBIZA III 2.0	AZL, CHZB	04/02	⇒ 11/09
IBIZA IV 1.0	CHYB	05/15	⇒
IBIZA IV 1.0 TSI	CHZB, BZG	05/15	⇒
IBIZA IV 1.2	BZG, CBZA	03/08	⇒
IBIZA IV 1.2 LPG	BZG	03/08	⇒
IBIZA IV 1.2 TDI	CFWA	04/10	⇒
IBIZA IV 1.2 TSI	CBZA, BXW	09/10	⇒
IBIZA IV 1.4	BXW, BMS	03/08	⇒
IBIZA IV 1.4 LPG	BXW	03/08	⇒ 05/11
IBIZA IV 1.4 TDI	BMS, CAVF	07/08	⇒
IBIZA IV 1.4 TSI	CAVF, CAVE	06/09	⇒
IBIZA IV 1.4 TSI Cupra	CAVE, CWVA	06/09	⇒
IBIZA IV 1.6	BTS	05/08	⇒
IBIZA IV 1.6 LPG	CNKA	05/11	⇒
IBIZA IV 1.6 SRE	CWVA, CAYA	07/15	⇒
IBIZA IV 1.6 TDI	CAYA, BLS	05/09	⇒
IBIZA IV 1.8 TSI Cupra	DAJA	11/15	⇒
IBIZA IV 1.9 TDI	BLS, CHYB	03/08	⇒
IBIZA IV 2.0	CEKA	10/08	⇒
IBIZA IV 2.0 TDI	CFHD	01/10	⇒
IBIZA V 1.0	CHYB, CHZJ	01/17	⇒
IBIZA V 1.0 MPi	DFNA	07/18	⇒
IBIZA V 1.0 TGI	DBYA	11/17	⇒
IBIZA V 1.0 TSI	CHZJ, DGTA	01/17	⇒
IBIZA V 1.5 TSI	DADA	07/17	⇒
IBIZA V 1.6 TDI	DGTA, CHZD	09/17	⇒
LEON III 1.0 TSI	CHZD, CJZA	05/15	⇒
LEON III 1.2 TSI	CJZA, CHPA	12/12	⇒
LEON III 1.4 TGI	CPWA	02/13	⇒
LEON III 1.4 TSI	CHPA, DACA	09/12	⇒
LEON III 1.5 TGI	DHFA	10/18	⇒
LEON III 1.5 TSI	DACA, CLHA	09/18	⇒

SEAT			
LEON III 1.6 TDI	CLHA, CLHA	09/12 →	
LEON III 1.6 TDI 4Drive	CLHA, CJSA	04/14 →	
LEON III 1.6 TSI	CWVA	05/15 →	
LEON III 1.8 TFSI	CJSA	02/13 →	
LEON III 1.8 TSI	CJSA	02/13 →	
LEON III 1.8 TSI 4Drive	CJSA, CJXA	11/14 →	
LEON III 2.0 Cupra	CJXA, CJXC	10/13 →	
LEON III 2.0 Cupra 4Drive	CJXC, CKFC	11/16 →	
LEON III 2.0 Cupra R	CJXG	11/17 →	
LEON III 2.0 TDI	CKFC, CRBC	09/12 →	
LEON III 2.0 TDI 4Drive	CRBC, CJZB	04/14 →	
LEON III 2.0 TSI	DKZA	09/18 →	
LEON ST 1.0 TSI	CHZD	05/15 →	
LEON ST 1.2 TSI	CJZB, CZDA	01/13 →	
LEON ST 1.4 TSI	CZDA, CRKB	05/14 →	
LEON ST 1.6 TDI	CRKB, CJXA	09/13 →	
LEON ST 1.8 TFSI	CJSA	10/13 →	
LEON ST 2.0 Cupra	CJXA, CKFC	10/13 →	
LEON ST 2.0 Cupra 4Drive	CJXC	11/16 →	
LEON ST 2.0 TDI	CKFC, CRBC	04/13 →	
LEON ST 2.0 TDI 4Drive	CRBC, CHYA	09/14 →	
MII 1.0	CHYA, CHZB	10/11 →	
MII 1.0 EcoFuel	CPGA	11/12 →	
TOLEDO IV 1.0 TSI	CHZB, CJZC	05/17 →	
TOLEDO IV 1.2 TSI	CJZC, CFNA	05/15 →	
TOLEDO IV 1.4 TDI	CUSB	05/15 →	
TOLEDO IV 1.4 TSI	CZCA	05/15 →	
TOLEDO IV 1.6	CFNA, CAYB	07/13 →	
TOLEDO IV 1.6 TDI	CAYB, CHYA	06/13 →	

SKODA			
CITIGO 1.0	CHYA, AQV	10/11 →	
CITIGO 1.0 CNG	CPGA	11/12 →	
FABIA I 1.0	AQV, AWY	12/99 →	08/02
FABIA I 1.2	AWY, AME	07/01 →	03/08
FABIA I 1.4	AME, AUA	04/00 →	12/07
FABIA I 1.4 16V	AUA, AMF	12/99 →	03/08
FABIA I 1.4 TDI	AMF, ATD	04/03 →	03/08
FABIA I 1.9 SDI	ASY	11/99 →	03/08
FABIA I 1.9 TDI	ATD, ASZ	01/00 →	03/08
FABIA I 1.9 TDI RS	ASZ, BBM	06/03 →	03/08
FABIA I 2.0	AZL	12/99 →	03/08
FABIA II 1.2	BBM, CGPA	12/06 →	
FABIA II 1.2 [IND]	CJLA	09/10 →	
FABIA II 1.2 12V	CGPB	11/11 →	12/14
FABIA II 1.2 LPG	CGPA, CBZA	07/07 →	11/14
FABIA II 1.2 TDI	CFWA	05/10 →	12/14
FABIA II 1.2 TSI	CBZA, BXW	03/10 →	12/14
FABIA II 1.4	BXW, BXW	01/07 →	12/14
FABIA II 1.4 [CHN]	CDDA	12/08 →	
FABIA II 1.4 LPG	BXW, BMS	01/07 →	11/14
FABIA II 1.4 TDI	BMS, CAVE	01/07 →	03/10
FABIA II 1.4 TSI RS	CAVE, BTS	05/10 →	12/14
FABIA II 1.6	BTS, CDEA	04/07 →	12/14
FABIA II 1.6 [CHN]	CDEA, CAYA	12/08 →	
FABIA II 1.6 TDI	CAYA, BLS	03/10 →	12/14
FABIA II 1.9 TDI	BLS, CHYA	04/07 →	03/10
FABIA III 1.0	CHYA, CHZB	08/14 →	
FABIA III 1.0 TSI	CHZB, CJZC	08/14 →	
FABIA III 1.2 TSI	CJZC, CUSA	08/14 →	
FABIA III 1.4 TDI	CJSA, CWVA	08/14 →	
FABIA III 1.4 TSI RS	CZCA	02/18 →	
FABIA III 1.6	CWVA, DFFA	01/15 →	
KAROQ 1.0 TSI	CHZJ	07/17 →	
KAROQ 1.5 TSI	DADA	07/17 →	
KAROQ 1.5 TSI 4x4	DADA	07/17 →	
KAROQ 1.6 TDI	DDYA	07/17 →	
KAROQ 2.0 TDI 4x4	DFFA, CZCA	07/17 →	
KODIAQ 1.4 TSI	CZCA, CZDA	10/16 →	
KODIAQ 1.4 TSI 4x4	CZDA, DBGA	10/16 →	
KODIAQ 1.5 TSI	DADA	07/18 →	
KODIAQ 1.5 TSI 4x4	DADA	07/18 →	
KODIAQ 2.0 TDI	DBGC	10/16 →	
KODIAQ 2.0 TDI 4x4	DBGA, CHZD	10/16 →	
KODIAQ 2.0 TSI 4x4	CZPA	10/16 →	
OCTAVIA III 1.0 TSI	CHZD, CJZA	05/16 →	
OCTAVIA III 1.2 TSI	CJZA, CHPA	11/12 →	
OCTAVIA III 1.4 [CHN]	CSSA	02/14 →	
OCTAVIA III 1.4 TSI	CHPA, CLHA	11/12 →	
OCTAVIA III 1.4 TSI G-TEC	CPWA	11/13 →	
OCTAVIA III 1.5 TSI	DADA	02/17 →	
OCTAVIA III 1.6	CWVA	01/14 →	
OCTAVIA III 1.6 [CHN]	CSRA	02/14 →	
OCTAVIA III 1.6 TDI	CLHA, CLHA	11/12 →	
OCTAVIA III 1.6 TDI 4x4	CLHA, CJSA	11/12 →	
OCTAVIA III 1.8 TSI	CJSA, CJSA	11/12 →	
OCTAVIA III 1.8 TSI 4x4	CJSA, CKFB	11/12 →	
OCTAVIA III 2.0 TDI	CKFB, CUNA	11/12 →	

SKODA			
OCTAVIA III 2.0 TDI / TDI RS 4x4	CUNA, CKFC	09/14 →	
OCTAVIA III 2.0 TDI 4x4	CKFC, CUNA	11/12 →	
OCTAVIA III 2.0 TDI RS	CUNA, CHHA	05/13 →	
OCTAVIA III 2.0 TSI RS	CHHA, CHZB	11/12 →	
RAPID 1.0 TSI	CHZB, CBZA	07/12 →	
RAPID 1.2	CGPC	07/12 →	
RAPID 1.2 LPG	CGPA, CBZA	07/12 →	
RAPID 1.2 TSI	CBZA, CAXA	07/12 →	
RAPID 1.4 TDI	CUSB	05/15 →	
RAPID 1.4 TSI	CAXA, CFNA	07/12 →	
RAPID 1.6	CFNA, CAYB	07/12 →	
RAPID 1.6 SRE	CWVA	05/15 →	
RAPID 1.6 TDI	CAYB, BME	07/12 →	
ROOMSTER 1.2	BME, CBZA	05/06 →	05/15
ROOMSTER 1.2 LPG	CGPA	03/09 →	05/15
ROOMSTER 1.2 TDI	CFWA	03/10 →	05/15
ROOMSTER 1.2 TSI	CBZA, BXW	03/10 →	05/15
ROOMSTER 1.4	BXW, BXW	09/06 →	05/15
ROOMSTER 1.4 LPG	BXW, BMS	03/10 →	05/15
ROOMSTER 1.4 TDI	BMS, BTS	07/06 →	03/10
ROOMSTER 1.6	BTS, CAYA	09/06 →	05/15
ROOMSTER 1.6 LPG	BTS	06/06 →	07/10
ROOMSTER 1.6 TDI	CAYA, AXR	03/10 →	05/15
ROOMSTER 1.9 TDI	AXR, CZCA	03/06 →	03/10
SUPERB III 1.4 TSI	CZCA, CZDA	03/15 →	
SUPERB III 1.4 TSI 4x4	CZDA, CVRA.	03/15 →	
SUPERB III 1.6 TDI	CVRA., CJSA	03/15 →	
SUPERB III 1.8 TSI	CJSA, CRGA	03/15 →	
SUPERB III 2.0 TDI	CRGA, CRLB	03/15 →	
SUPERB III 2.0 TDI 4x4	CRLB, BAH	03/15 →	
SUPERB III 2.0 TSI	CHRB	03/15 →	
SUPERB III 2.0 TSI 4x4	CJXA	03/15 →	

VOLKSWAGEN (BR)			
POLO 1.0	ARA	07/02 →	01/04
POLO 1.4	BKY	07/06 →	
POLO 1.6	BAH, DBGA	02/02 →	
POLO 1.9 SDI	ASY	05/02 →	
POLO 2.0	BBX	05/02 →	

VW			
ARTEON 1.5 TSi	DADA	11/17 →	
ARTEON 2.0 TDI	DBGA, CUA	04/17 →	
ARTEON 2.0 TDI 4motion	CUAA, CZPB	04/17 →	
ARTEON 2.0 TSI	CZPB, DJHC	05/17 →	
ARTEON 2.0 TSI 4motion	DJHC, AQZ	04/17 →	
ATLAS 2.0 TSI 4motion	CXDA	12/17 →	
ATLAS 3.6 FSI 4motion	CDVC	12/16 →	
FOX 1.0	AQZ, BJE	10/03 →	
FOX 1.0 Alcohol	BJE, BMD	10/03 →	
FOX 1.0 Total Flex	CCNA	03/08 →	
FOX 1.2	BMD, BAH	04/05 →	12/11
FOX 1.4	BKR	04/05 →	12/09
FOX 1.4 TDI	BNM	04/05 →	12/09
FOX 1.6	BAH, BJA	10/03 →	08/14
FOX 1.6 Total Flex	BJA, CJZA	10/03 →	08/14
FOX 1.9 D	ASY	12/07 →	
GOLF VII 1.0 TSI	CHZC, CJZA	05/15 →	
GOLF VII 1.2 TSI	CJZA, CPWA	08/12 →	
GOLF VII 1.4 GTE Hybrid	CUKB	05/14 →	
GOLF VII 1.4 TGI CNG	CPWA, CHPA	06/13 →	
GOLF VII 1.4 TSI	CHPA, CPVA	08/12 →	
GOLF VII 1.4 TSI MultiFuel	CPVA, DACA	04/13 →	
GOLF VII 1.5 TGI	DACA	07/17 →	
GOLF VII 1.5 TSI	DACA, CLHA	04/17 →	
GOLF VII 1.6	CWVA	05/14 →	
GOLF VII 1.6 TDI	CLHA, CLHA	08/12 →	
GOLF VII 1.6 TDI 4motion	CLHA, CUNA	11/12 →	
GOLF VII 1.8 TSI 4motion	CJSB	12/14 →	
GOLF VII 2.0 GTD	CUNA, CHHA	04/13 →	
GOLF VII 2.0 GTI	CHHA, CJXD	04/13 →	
GOLF VII 2.0 GTI Clubsport	CJXE	02/16 →	
GOLF VII 2.0 GTI Clubsport S	CJXG	09/16 →	
GOLF VII 2.0 R 4motion	CJXD, CKFC	12/16 →	
GOLF VII 2.0 TDI	CKFC, CKFC	08/12 →	
GOLF VII 2.0 TDI 4motion	CKFC, EAGA	11/12 →	
GOLF VII 2.0 TFSI	CYFB	11/13 →	
GOLF VII e-Golf	EAGA, CZCA	03/14 →	
GOLF 1.2 TSi BlueMotion	CJZA, CHPA	08/12 →	
GOLF 1.4 TSi BlueMotion	CHPA, CLHA	08/12 →	
GOLF 1.6 TDi BlueMotion	CLHA, CHHA	08/12 →	
GOLF 2.0 GTD	CUNA	04/13 →	
GOLF 2.0 GTi	CHHA, CJZA	04/13 →	
GOLF 2.0 TDi BlueMotion 4motion	CRBC	05/13 →	
GOLF VAN 1.2 TSi BlueMotion	CJZA, CHPA	04/13 →	03/17
GOLF VAN 1.4 TSi BlueMotion	CHPA, CLHA	05/13 →	03/17
GOLF VAN 1.6 TDi BlueMotion	CLHA, CRBC	05/13 →	03/17

VW			
GOLF VAN 1.6 TDi BlueMotion 4motion	CLHA	05/13 →	03/17
GOLF VAN 2.0 TDi BlueMotion	CRBC, CRBC	04/13 →	03/17
GOLF VAN 2.0 TDi BlueMotion 4motion	CRBC, CHZC	04/13 →	03/17
UP 1.0	--, CHZB	08/11 →	
UP 1.0 BlueMotion	CHYB	05/16 →	
UP 1.0 EcoFuel	CPGA	11/12 →	
UP 1.0 GTI	DKRA	11/17 →	
UP 1.0 TSI	CHZA	05/16 →	
UP 1.0 TSi BlueMotion	CHZA	05/16 →	
UP e-Load Up	EABA	12/14 →	
UP e-Up	EABA	07/13 →	
PASSAT VI 1.4 GTE Hybrid	CUKC	06/15 →	
PASSAT VI 1.4 TSI	CZCA, DCXA	11/14 →	
PASSAT VI 1.4 TSI 4motion	CZCA	02/15 →	
PASSAT VI 1.5 TSI	DADA	08/18 →	
PASSAT VI 1.6 TDI	DCXA, CJSA	08/14 →	
PASSAT VI 1.8 TSI	CJSA, CRGA	02/15 →	
PASSAT VI 2.0 TDI	CRGA, CRLB	11/14 →	
PASSAT VI 2.0 TDI 4motion	CRLB, CHHB	08/14 →	
PASSAT VI 2.0 TSI	CHHB, CHHB	02/15 →	
PASSAT VI 2.0 TSI 4motion	CHHB, AWY	05/15 →	
POLO 1.6 [ExtraEU]	BAH	11/02 →	07/06
POLO 1.9 TDi [ExtraEU]	ATD	07/03 →	06/05
POLO IV 1.0	ARA	02/03 →	10/03
POLO IV 1.2	AWY, AZQ	01/02 →	11/09
POLO IV 1.2 12V	AZQ, BBY	10/01 →	11/09
POLO IV 1.4	BBY, AUA	08/02 →	
POLO IV 1.4 16V	AUA, AMF	10/01 →	11/09
POLO IV 1.4 BiFuel	BUD	05/06 →	11/09
POLO IV 1.4 TSI	AXU	02/02 →	07/06
POLO IV 1.4 TDI	AMF, BAH	10/01 →	
POLO IV 1.6	BAH, ASZ	08/02 →	
POLO IV 1.6 [ExtraEU]	BAH	09/02 →	
POLO IV 1.6 16V	BTS	05/06 →	11/09
POLO IV 1.8 GTI	BJX	09/05 →	11/09
POLO IV 1.8 GTI Cup Edition	BBU	05/06 →	11/09
POLO IV 1.9 SDI	ASY	10/01 →	
POLO IV 1.9 TDI	ASZ, CHYA	10/01 →	11/09
POLO IV 2.0	BBX	09/02 →	
POLO V 1.0	CHYA, CHZB	01/14 →	
POLO V 1.0 TSI	CHZB, CGPA	11/14 →	
POLO V 1.2	CGPA, CBZB	03/09 →	
POLO V 1.2 [IND]	CJLA	08/11 →	
POLO V 1.2 BlueMotion	CGPA	03/09 →	05/14
POLO V 1.2 TDI	CFWA	10/09 →	
POLO V 1.2 TDi BlueMotion	CFWA	10/09 →	05/14
POLO V 1.2 TSI	CBZB, CDDA	11/09 →	
POLO V 1.2 TSI 16V	CJZC	02/14 →	
POLO V 1.2 TSi BlueMotion	CBZB	11/09 →	05/14
POLO V 1.4	CDDA, CAVE	03/09 →	05/14
POLO V 1.4 BiFuel	CMAA	03/10 →	01/11
POLO V 1.4 GTI	CAVE, CUSA	05/10 →	
POLO V 1.4 TDI	CUSA, CPTA	02/14 →	
POLO V 1.4 TSI	CPTA, CWXA	10/12 →	
POLO V 1.4 TSI [RUS]	CZCA	05/14 →	
POLO V 1.5 TDI [IND]	CWXA, CFNA	05/14 →	
POLO V 1.6	CFNA, CAYA	01/10 →	
POLO V 1.6 BiFuel	CNKA	01/11 →	
POLO V 1.6 TDI	CAYA, CWYA	06/09 →	
POLO V 1.6 TDi BlueMotion	CAYB	06/09 →	05/14
POLO V 1.8 GTI	CWYA, CHYB	11/14 →	
POLO V 2.0 R WRC	CDLJ	08/13 →	
POLO VI 1.0	CHYB, CHZJ	06/17 →	
POLO VI 1.0 TGI	DBYA	09/17 →	
POLO VI 1.0 TSI	CHZI, DGTC	06/17 →	
POLO VI 1.6 TDI	DGTC, CZPC	11/17 →	
POLO VI 2.0 GTI	CZPC, CCRA	11/17 →	
T-ROC 1.0 TSI	CHZJ	07/17 →	
T-ROC 1.6 TDI	DGTE	03/18 →	
T-ROC 2.0 TDI	DFFA	03/18 →	
T-ROC 2.0 TDI 4motion	DFFA	09/17 →	
T-ROC 2.0 TSI 4motion	CZPB	07/17 →	
SPACEFOX / SPACE CROSS 1.6 FSI	CCRA, CCRA	03/06 →	
SPACEFOX / SPACE CROSS 1.6 Total Flex	CCRA, CZCA	03/06 →	
TIGUAN I 1.5	DADA	11/18 →	
TIGUAN II 1.4 TSI	CZCA, CZDA	01/16 →	
TIGUAN II 1.4 TSI 4motion	CZDA, CRFD	05/16 →	
TIGUAN II 1.5	DADA	11/18 →	
TIGUAN II 1.6 TDI	DGDB	05/16 →	
TIGUAN II 2.0 TDI	CRFD, CUAA	01/16 →	
TIGUAN II 2.0 TDI 4motion	CUAA, CHHB	01/16 →	
TIGUAN II 2.0 TSI 4motion	CHHB, CRKB	01/16 →	
TOURAN II 1.2 TSI	CVVB	05/15 →	
TOURAN II 1.4 TSI	CZDA	05/15 →	

VW			
TOURAN II 1.6 TDI	CRKB, CRVA	05/15	→
TOURAN II 1.8 TSI	CJSA	11/15	→
TOURAN II 2.0 TDI	CRVA, --	05/15	→
TOURAN II TSI	DADA	11/18	→

21.0011



1

WHEEL SPEED SENSORS

Adatt./Suitable:

ATE
10.0711-5273.3

AUDI
6QQ 927 803 B
WHT 003 861

BOSCH
0 986 594 500

SEAT
6QQ 927 803 B
WHT 003 861

SKODA
6QQ 927 803 B
WHT 003 861

VW
6QQ 927 803 B
WHT 003 861

MARKET DIFFUSION: HIGH



L	L1		
---	21	Hall Effect	

AUDI			
A1 1.0 TFSI	CHZB, CAVG	03/15	→ 10/18
A1 1.2 TFSI	CBZA	05/10	→ 04/15
A1 1.4 TDI	CUSB	11/14	→ 10/18
A1 1.4 TFSI	CAVG, CAYB	05/10	→ 10/18
A1 1.4 TSI	CZEA	11/14	→ 10/18
A1 1.6 TDI	CAYB, CFHB	05/10	→ 10/18
A1 1.8 TFSI	DAJB	02/15	→ 10/18
A1 2.0 TDI	CFHB, CHZL	09/11	→ 04/15
A1 2.0 TFSI quattro	CDLH	03/12	→ 11/12
A1 25 TFSI	CHZL, DKJA	11/18	→
A1 30 TFSI	DAKA, CZPC	07/18	→
A1 35 TFSI	DADA	09/18	→
A1 40 TFSI	CZPC, AUA	09/18	→
A1 S1 quattro	CWZA	03/14	→ 10/18
A2 1.4	AUA, AMF	02/00	→ 08/05
A2 1.4 TDI	AMF, CHZD	02/00	→ 08/05
A2 1.6 FSI	BAD	05/02	→ 08/05
A3 III 1.0 TFSI	CHZD, CJZA	07/16	→
A3 III 1.2 TFSI	CJZA, CMBA	02/13	→
A3 III 1.4 TFSI	CMBA, CUKB	04/12	→
A3 III 1.4 TFSI e-tron	CUKB, CLHA	05/14	→
A3 III 1.4 TFSI g-tron	CPWA	11/13	→
A3 III 1.4 TSI	CZEA	05/14	→
A3 III 1.5 TFSI	DADA	05/17	→
A3 III 1.6 TDI	CLHA, CUSA	10/12	→
A3 III 1.6 TDI quattro	CXXB	05/15	→
A3 III 1.8 TFSI	CJSA, CRBC	04/12	→
A3 III 1.8 TFSI quattro	CJSB	08/12	→
A3 III 2.0 quattro	CNTC	11/13	→
A3 III 2.0 TDI	CRBC, CRBC	04/12	→
A3 III 2.0 TDI quattro	CRBC, CHHB	10/12	→
A3 III 2.0 TFSI	CHHB, CHHB	01/13	→
A3 III 2.0 TFSI [ExtraEU]	CHHB, CNTC	05/14	→
A3 III 2.0 TFSI quattro	CNTC, DDYA	05/14	→
A3 III 30 TDI	DDYA, CHZD	07/18	→
A3 III 30 TFSI	CHZD, CZGB	07/18	→
A3 III 35 TFSI	DADA	10/18	→
A3 III RS3 quattro	CZGB, CXB	03/15	→
A3 III S3 quattro	CJXB, CHZJ	11/12	→
Q2 1.0 TFSI	CHZJ, DDYA	10/16	→
Q2 1.4 TFSI	CZEA	06/16	→
Q2 1.6 TDI	DDYA, DFGA	06/16	→ 10/18

AUDI			
Q2 2.0 TDI	DCYA	09/16	→
Q2 2.0 TDI quattro	DFGA, CZPB	07/16	→
Q2 2.0 TFSI quattro	CZPB, DDYA	05/17	→
Q2 30 TDi	DDYA, CHZJ	07/18	→
Q2 30 TFSI	CHZJ, CZPB	07/18	→
Q2 35 TFSI	DADA	07/18	→
Q2 40 TFSI quattro	CZPB, CJSA	09/18	→
Q2 SQ2 TFSI quattro	DNUE	08/18	→
Q3 35 TDI	DFGA	09/18	→
Q3 35 TDI quattro	DFGA	09/18	→
Q3 35 TFSI	DADA	08/18	→
Q3 40 TDI quattro	DFHA	10/18	→
Q3 40 TFSI quattro	DKTC	07/18	→
Q3 45 TFSI quattro	DKTA	07/18	→
TT III 1.8 TFSI	CJSA, CHHC	08/15	→
TT III 2.0 TDI	CUNA	07/14	→
TT III 2.0 TDI quattro	CUNA	01/17	→
TT III 2.0 TFSI	CHHC	07/14	→
TT III 2.0 TFSI quattro	CHHC, CJXF	07/14	→
TT III 2.0 TTS quattro	CJXF, DAZA	11/14	→
TT III 2.5 RS quattro	DAZA, CHZJ	10/16	→
TT 2.0 TFSI [ExtraEU]	CYFB	07/15	→

SEAT			
ARONA 1.0 TGI	DBYA	11/18	→
ARONA 1.0 TSI	CHZJ, DGTA	07/17	→
ARONA 1.5 TSI	DADA	07/17	→
ARONA 1.6 SRE	CWVA	07/17	→
ARONA 1.6 TDI	DGTA, CHZJ	07/17	→
ATECA 1.0 TSI	CHZJ, DDYA	05/16	→
ATECA 1.4 TSI	CZEA	06/16	→
ATECA 1.4 TSI 4Drive	CZEA	06/16	→
ATECA 1.5 TSI	DADA	07/18	→
ATECA 1.5 TSI 4Drive	DADA	07/18	→
ATECA 1.6 TDI	DDYA, CRVA	04/16	→
ATECA 2.0 TDI	CRVA, DFFA	04/16	→
ATECA 2.0 TDI 4Drive	DFFA, CZPB	04/16	→
ATECA 2.0 TSI 4Drive	CZPB, AZQ	05/17	→
CORDOBA II 1.2	AZQ, BBY	10/02	→ 06/06
CORDOBA II 1.2 12V	BXV	05/06	→ 11/09
CORDOBA II 1.4 16V	BBY, AMF	09/02	→
CORDOBA II 1.4 TDI	AMF, ASZ	10/02	→ 11/09
CORDOBA II 1.6	BAH	04/03	→ 11/09
CORDOBA II 1.6 16V	BTS	11/06	→ 11/09
CORDOBA II 1.9 SDI	ASY	09/02	→ 11/09
CORDOBA II 1.9 TDI	ASZ, AZL	09/02	→ 11/09
CORDOBA II 2.0	AZL, AZQ	09/02	→ 11/09
IBIZA 1.2	CGPA	04/08	→
IBIZA 1.2 TDi	CFWA	05/10	→
IBIZA 1.6 SRE [ExtraEU]	CWVA	05/17	→
IBIZA 1.6 TDi	CAYB	05/09	→
IBIZA III 1.2	AZQ, AUB	02/02	→ 05/08
IBIZA III 1.2 12V	BXV	05/06	→ 11/09
IBIZA III 1.4 16V	AUB, AMF	02/02	→ 11/09
IBIZA III 1.4 TDI	AMF, BBU	05/02	→ 11/09
IBIZA III 1.6	BAH	02/03	→ 11/09
IBIZA III 1.6 16V	BTS	11/06	→ 11/09
IBIZA III 1.8 T Cupra R	BBU, BJX	01/04	→ 02/08
IBIZA III 1.8 T FR	BJX, ASZ	12/03	→ 05/08
IBIZA III 1.9 SDI	ASY	02/02	→ 12/05
IBIZA III 1.9 TDI	ASZ, BPX	02/02	→ 11/09
IBIZA III 1.9 TDI Cupra R	BPX, AZL	03/04	→ 02/08
IBIZA III 2.0	AZL, CHZB	04/02	→ 11/09
IBIZA IV 1.0	CHYB	05/15	→
IBIZA IV 1.0 TSI	CHZB, BZG	05/15	→
IBIZA IV 1.2	BZG, CBZA	03/08	→
IBIZA IV 1.2 LPG	BZG	03/08	→
IBIZA IV 1.2 TDI	CFWA	04/10	→
IBIZA IV 1.2 TSI	CBZA, BXW	09/10	→
IBIZA IV 1.4	BXW, BMS	03/08	→
IBIZA IV 1.4 LPG	BXW	03/08	→ 05/11
IBIZA IV 1.4 TDI	BMS, CAVF	07/08	→
IBIZA IV 1.4 TSI	CAVF, CAVE	06/09	→
IBIZA IV 1.4 TSI Cupra	CAVE, CWVA	06/09	→
IBIZA IV 1.6	BTS	05/08	→
IBIZA IV 1.6 LPG	CNKA	05/11	→
IBIZA IV 1.6 SRE	CWVA, CAYA	07/15	→
IBIZA IV 1.6 TDI	CAYA, BLS	05/09	→
IBIZA IV 1.8 TSI Cupra	DAJA	11/15	→
IBIZA IV 1.9 TDI	BLS, CHYB	03/08	→
IBIZA IV 2.0	CEKA	10/08	→
IBIZA IV 2.0 TDI	CFHD	01/10	→
IBIZA V 1.0	CHYB, CHZJ	01/17	→
IBIZA V 1.0 MPi	DFNA	07/18	→
IBIZA V 1.0 TGI	DBYA	11/17	→
IBIZA V 1.0 TSI	CHZJ, DGTA	01/17	→
IBIZA V 1.5 TSI	DADA	07/17	→
IBIZA V 1.6 TDI	DGTA, CHZD	09/17	→
LEON III 1.0 TSI	CHZD, CJZA	05/15	→

SEAT			
LEON III 1.2 TSI	CJZA, CHPA	12/12	→
LEON III 1.4 TGI	CPWA	02/13	→
LEON III 1.4 TSI	CHPA, DACA	09/12	→
LEON III 1.5 TGI	DHFA	10/18	→
LEON III 1.5 TSI	DACA, CLHA	09/18	→
LEON III 1.6 TDI	CLHA, CLHA	09/12	→
LEON III 1.6 TDI 4Drive	CLHA, CJSA	04/14	→
LEON III 1.6 TSI	CWVA	05/15	→
LEON III 1.8 TFSI	CJSA	02/13	→
LEON III 1.8 TSI	CJSA	02/13	→
LEON III 1.8 TSI 4Drive	CJSA, CJXA	11/14	→
LEON III 2.0 Cupra	CJXA, CJXC	10/13	→
LEON III 2.0 Cupra 4Drive	CJXC, CKFC	11/16	→
LEON III 2.0 Cupra R	CJXG	11/17	→
LEON III 2.0 TDI	CKFC, CRBC	09/12	→
LEON III 2.0 TDI 4Drive	CRBC, CJZB	04/14	→
LEON III 2.0 TSI	DKZA	09/18	→
LEON ST 1.0 TSI	CHZD	05/15	→
LEON ST 1.2 TSI	CJZB, CZDA	01/13	→
LEON ST 1.4 TSI	CRKB, CRKB	05/14	→
LEON ST 1.6 TDI	CRKB, CJXA	09/13	→
LEON ST 1.8 TFSI	CJSA	10/13	→
LEON ST 2.0 Cupra	CJXA, CKFC	10/13	→
LEON ST 2.0 Cupra 4Drive	CJXC	11/16	→
LEON ST 2.0 TDI	CKFC, CRBC	04/13	→
LEON ST 2.0 TDI 4Drive	CRBC, CHYA	09/14	→
MII 1.0	CHYA, CHZB	10/11	→
MII 1.0 EcoFuel	CPGA	11/12	→
TOLEDO IV 1.0 TSI	CHZB, CJZC	05/17	→
TOLEDO IV 1.2 TSI	CJZC, CFNA	05/15	→
TOLEDO IV 1.4 TDI	CUSB	05/15	→
TOLEDO IV 1.4 TSI	CZCA	05/15	→
TOLEDO IV 1.6	CFNA, CAYB	07/13	→
TOLEDO IV 1.6 TDI	CAYB, CHYA	06/13	→

SKODA			
CITIGO 1.0	CHYA, AOV	10/11	→
CITIGO 1.0 CNG	CPGA	11/12	→
FABIA I 1.0	AOV, AWY	12/99	→ 08/02
FABIA I 1.2	AWY, AME	07/01	→ 03/08
FABIA I 1.4	AME, AUA	04/00	→ 12/07
FABIA I 1.4 16V	AUA, AMF	12/99	→ 03/08
FABIA I 1.4 TDI	AMF, ATD	04/03	→ 03/08
FABIA I 1.9 SDI	ASY	11/99	→ 03/08
FABIA I 1.9 TDI	ATD, ASZ	01/00	→ 03/08
FABIA I 1.9 TDI RS	ASZ, BBM	06/03	→ 03/08
FABIA I 2.0	AZL	12/99	→ 03/08
FABIA II 1.2	BBM, CGPA	12/06	→
FABIA II 1.2 [IND]	CLJA	09/10	→
FABIA II 1.2 12V	CGPB	11/11	→ 12/14
FABIA II 1.2 LPG	CGPA, CBZA	07/07	→ 11/14
FABIA II 1.2 TDI	CFWA	05/10	→ 12/14
FABIA II 1.2 TSI	CBZA, BXW	03/10	→ 12/14
FABIA II 1.4	BXW, BXW	01/07	→ 12/14
FABIA II 1.4 [CHN]	CDDA	12/08	→
FABIA II 1.4 LPG	BXW, BMS	01/07	→ 11/14
FABIA II 1.4 TDI	BMS, CAVE	01/07	→ 03/10
FABIA II 1.4 TSI RS	CAVE, BTS	05/10	→ 12/14
FABIA II 1.6	BTS, CDEA	04/07	→ 12/14
FABIA II 1.6 [CHN]	CDEA, CAYA	12/08	→
FABIA II 1.6 TDI	CAYA, BLS	03/10	→ 12/14
FABIA II 1.9 TDI	BLS, CHYA	04/07	→ 03/10
FABIA III 1.0	CHYA, CHZB	08/14	→
FABIA III 1.0 TSI	CHZB, CJZC	08/14	→
FABIA III 1.2 TSI	CJZC, CUSA	08/14	→
FABIA III 1.4 TDI	CUSA, CWVA	08/14	→
FABIA III 1.4 TSI RS	CZCA	02/18	→
FABIA III 1.6	CWVA, DFFA	01/15	→
KAROQ 1.0 TSI	CHZJ	07/17	→
KAROQ 1.5 TSI	DADA	07/17	→
KAROQ 1.5 TSI 4x4	DADA	07/17	→
KAROQ 1.6 TDI	DDYA	07/17	→
KAROQ 2.0 TDI 4x4	DFFA, CZCA	07/17	→
KODIAQ 1.4 TSI	CZCA, CZDA	10/16	→
KODIAQ 1.4 TSI 4x4	CZDA, DBGA	10/16	→
KODIAQ 1.5 TSI	DADA	07/18	→
KODIAQ 1.5 TSI 4x4	DADA	07/18	→
KODIAQ 2.0 TDI	DBGC	10/16	→
KODIAQ 2.0 TDI 4x4	DBGA, CHZD	10/16	→
KODIAQ 2.0 TSI 4x4	CZPA	10/16	→
OCTAVIA III 1.0 TSI	CHZD, CJZA	05/16	→
OCTAVIA III 1.2 TSI	CJZA, CHPA	11/12	→
OCTAVIA III 1.4 [CHN]	CSSA	02/14	→
OCTAVIA III 1.4 TSI	CHPA, CLHA	11/12	→
OCTAVIA III 1.4 TSI G-TEC	CPWA	11/13	→
OCTAVIA III 1.5 TSI	DADA	02/17	→
OCTAVIA III 1.6	CWVA	01/14	→
OCTAVIA III 1.6 [CHN]	CSRA	02/14	→
OCTAVIA III 1.6 TDI	CLHA, CLHA	11/12	→

SKODA		
OCTAVIA III 1.6 TDI 4x4	CLHA, CJSА	11/12 →
OCTAVIA III 1.8 TSI	CJSА, CJSА	11/12 →
OCTAVIA III 1.8 TSI 4x4	CJSА, CKFB	11/12 →
OCTAVIA III 2.0 TDI	CKFB, CUNA	11/12 →
OCTAVIA III 2.0 TDI / TDI RS 4x4	CUNA, CKFC	09/14 →
OCTAVIA III 2.0 TDI 4x4	CKFC, CUNA	11/12 →
OCTAVIA III 2.0 TDI RS	CUNA, CHHA	05/13 →
OCTAVIA III 2.0 TSI RS	CHHA, CHZB	11/12 →
RAPID 1.0 TSI	CHZB, CBZA	07/12 →
RAPID 1.2	CGPC	07/12 →
RAPID 1.2 LPG	CGPA, CBZA	07/12 →
RAPID 1.2 TSI	CBZA, CAXA	07/12 →
RAPID 1.4 TDI	CUSB	05/15 →
RAPID 1.4 TSI	CAXA, CFNA	07/12 →
RAPID 1.6	CFNA, CAYB	07/12 →
RAPID 1.6 SRE	CWVA	05/15 →
RAPID 1.6 TDI	CAYB, BME	07/12 →
ROOMSTER 1.2	BME, CBZA	05/06 → 05/15
ROOMSTER 1.2 LPG	CGPA	03/09 → 05/15
ROOMSTER 1.2 TDI	CFWA	03/10 → 05/15
ROOMSTER 1.2 TSI	CBZA, BXW	03/10 → 05/15
ROOMSTER 1.4	BXW, BXW	09/06 → 05/15
ROOMSTER 1.4 LPG	BXW, BMS	03/10 → 05/15
ROOMSTER 1.4 TDI	BMS, BTS	07/06 → 03/10
ROOMSTER 1.6	BTS, CAVA	09/06 → 05/15
ROOMSTER 1.6 LPG	BTS	06/06 → 07/10
ROOMSTER 1.6 TDI	CAYA, AXR	03/10 → 05/15
ROOMSTER 1.9 TDI	AXR, CZCA	03/06 → 03/10
SUPERB III 1.4 TSI	CZCA, CZDA	03/15 →
SUPERB III 1.4 TSI 4x4	CZDA, CVRA.	03/15 →
SUPERB III 1.6 TDI	CVRA., CJSА	03/15 →
SUPERB III 1.8 TSI	CJSА, CRGA	03/15 →
SUPERB III 2.0 TDI	CRGA, CRLB	03/15 →
SUPERB III 2.0 TDI 4x4	CRLB, BAH	03/15 →
SUPERB III 2.0 TSI	CHHB	03/15 →
SUPERB III 2.0 TSI 4x4	CJXA	03/15 →

VOLKSWAGEN (BR)		
POLO 1.0	ARA	07/02 → 01/04
POLO 1.4	BKY	07/06 →
POLO 1.6	BAH, DBGA	02/02 →
POLO 1.9 SDI	ASY	05/02 →
POLO 2.0	BBX	05/02 →

VW		
ARTEON 1.5 TSI	DADA	11/17 →
ARTEON 2.0 TDI	DBGA, CUAA	04/17 →
ARTEON 2.0 TDI 4motion	CUAA, CZPB	04/17 →
ARTEON 2.0 TSI	CZPB, DJHC	05/17 →
ARTEON 2.0 TSI 4motion	DJHC, AOZ	04/17 →
ATLAS 2.0 TSI 4motion	CXDA	12/17 →
ATLAS 3.6 FSI 4motion	CDVC	12/16 →
FOX 1.0	AOZ, BJE	10/03 →
FOX 1.0 Alcohol	BJE, BMD	10/03 →
FOX 1.0 Total Flex	CCNA	03/08 →
FOX 1.2	BMD, BAH	04/05 → 12/11
FOX 1.4	BKR	04/05 → 12/09
FOX 1.4 TDI	BNM	04/05 → 12/09
FOX 1.6	BAH, BJA	10/03 → 08/14
FOX 1.6 Total Flex	BJA, CJZA	10/03 → 08/14
FOX 1.9 D	ASY	12/07 →
GOLF VII 1.0 TSI	CHZC, CJZA	05/15 →
GOLF VII 1.2 TSI	CJZA, CPWA	08/12 →
GOLF VII 1.4 GTE Hybrid	CUKB	05/14 →
GOLF VII 1.4 TGI CNG	CPWA, CHPA	06/13 →
GOLF VII 1.4 TSI	CHPA, CPVA	08/12 →
GOLF VII 1.4 TSI MultiFuel	CPVA, DACA	04/13 →
GOLF VII 1.5 TGI	DACA	07/17 →
GOLF VII 1.5 TSI	DACA, CLHA	04/17 →
GOLF VII 1.6	CWVA	05/14 →
GOLF VII 1.6 TDI	CLHA, CLHA	08/12 →
GOLF VII 1.6 TDI 4motion	CLHA, CUNA	11/12 →
GOLF VII 1.8 TSI 4motion	CJSB	12/14 →
GOLF VII 2.0 GTD	CUNA, CHHA	04/13 →
GOLF VII 2.0 GTI	CHHA, CJXD	04/13 →
GOLF VII 2.0 GTI Clubsport	CJXE	02/16 →
GOLF VII 2.0 GTI Clubsport S	CJXG	09/16 →
GOLF VII 2.0 R 4motion	CJXD, CKFC	12/16 →
GOLF VII 2.0 TDI	CKFC, CKFC	08/12 →
GOLF VII 2.0 TDI 4motion	CKFC, EAGA	11/12 →
GOLF VII 2.0 TFSI	CYFB	11/13 →
GOLF VII e-Golf	EAGA, CZCA	03/14 →
GOLF 1.2 TSI BlueMotion	CJZA, CHPA	08/12 →
GOLF 1.4 TSI BlueMotion	CHPA, CLHA	08/12 →
GOLF 1.6 TDi BlueMotion	CLHA, CHHA	08/12 →
GOLF 2.0 GTD	CUNA	04/13 →
GOLF 2.0 GTi	CHHA, CJZA	04/13 →
GOLF 2.0 TDi BlueMotion 4motion	CRBC	05/13 →

VW		
GOLF VAN 1.2 TSI BlueMotion	CJZA, CHPA	04/13 → 03/17
GOLF VAN 1.4 TSI BlueMotion	CHPA, CLHA	05/13 → 03/17
GOLF VAN 1.6 TDi BlueMotion	CLHA, CRBC	05/13 → 03/17
GOLF VAN 1.6 TDi BlueMotion 4motion	CLHA	05/13 → 03/17
GOLF VAN 2.0 TDi BlueMotion	CRBC, CRBC	04/13 → 03/17
GOLF VAN 2.0 TDi BlueMotion 4motion	CRBC, CHZC	04/13 → 03/17
UP 1.0	--, CHZB	08/11 →
UP 1.0 BlueMotion	CHYB	05/16 →
UP 1.0 EcoFuel	CPGA	11/12 →
UP 1.0 GTI	DKRA	11/17 →
UP 1.0 TSI	CHZA	05/16 →
UP 1.0 TSI BlueMotion	CHZA	05/16 →
UP e-Load Up	EABA	12/14 →
UP e-Up	EABA	07/13 →
PASSAT VI 1.4 GTE Hybrid	CUKC	06/15 →
PASSAT VI 1.4 TSI	CZCA, DCXA	11/14 →
PASSAT VI 1.4 TSI 4motion	CZEA	02/15 →
PASSAT VI 1.5 TSI	DADA	08/18 →
PASSAT VI 1.6 TDI	DCXA, CJSА	08/14 →
PASSAT VI 1.8 TSI	CJSА, CRGA	02/15 →
PASSAT VI 2.0 TDI	CRGA, CRLB	11/14 →
PASSAT VI 2.0 TDI 4motion	CRLB, CHHB	08/14 →
PASSAT VI 2.0 TSI	CHHB, CHHB	02/15 →
PASSAT VI 2.0 TSI 4motion	CHHB, AWY	05/15 →
POLO 1.6 [ExtraEU]	BAH	11/02 → 07/06
POLO 1.9 TDI [ExtraEU]	ATD	07/03 → 06/05
POLO IV 1.0	ARA	02/03 → 10/03
POLO IV 1.2	AWY, AZQ	01/02 → 11/09
POLO IV 1.2 12V	AZQ, BBY	10/01 → 11/09
POLO IV 1.4	BBY, AUA	08/02 →
POLO IV 1.4 16V	AUA, AMF	10/01 → 11/09
POLO IV 1.4 BiFuel	BUD	05/06 → 11/09
POLO IV 1.4 FSI	AXU	02/02 → 07/06
POLO IV 1.4 TDI	AMF, BAH	10/01 →
POLO IV 1.6	BAH, ASZ	08/02 →
POLO IV 1.6 [ExtraEU]	BAH	09/02 →
POLO IV 1.6 16V	BTS	05/06 → 11/09
POLO IV 1.8 GTI	BJX	09/05 → 11/09
POLO IV 1.8 GTi Cup Edition	BBU	05/06 → 11/09
POLO IV 1.9 SDI	ASY	10/01 →
POLO IV 1.9 TDI	ASZ, CHYA	10/01 → 11/09
POLO IV 2.0	BBX	09/02 →
POLO V 1.0	CHYA, CHZB	01/14 →
POLO V 1.0 TSI	CHZB, CGPA	11/14 →
POLO V 1.2	CGPA, CBZB	03/09 →
POLO V 1.2 [IND]	CJLA	08/11 →
POLO V 1.2 BlueMotion	CGPA	03/09 → 05/14
POLO V 1.2 TDI	CFWA	10/09 →
POLO V 1.2 TDi BlueMotion	CFWA	10/09 → 05/14
POLO V 1.2 TSI	CBZB, CDDA	11/09 →
POLO V 1.2 TSI 16V	CJZC	02/14 →
POLO V 1.2 TSI BlueMotion	CBZB	11/09 → 05/14
POLO V 1.4	CDDA, CAVE	03/09 → 05/14
POLO V 1.4 BiFuel	CMAA	03/10 → 01/11
POLO V 1.4 GTi	CAVE, CUSA	05/10 →
POLO V 1.4 TDI	CUSA, CPTA	02/14 →
POLO V 1.4 TSI	CPTA, CWXA	10/12 →
POLO V 1.4 TSI [RUS]	CZCA	05/14 →
POLO V 1.5 TDI [IND]	CWXA, CFNA	05/14 →
POLO V 1.6	CFNA, CAYA	01/10 →
POLO V 1.6 BiFuel	CNKA	01/11 →
POLO V 1.6 TDI	CAYA, CWYA	06/09 →
POLO V 1.6 TDi BlueMotion	CAYB	06/09 → 05/14
POLO V 1.8 GTI	CWYA, CHYB	11/14 →
POLO V 2.0 R WRC	CDLJ	08/13 →
POLO VI 1.0	CHYB, CHZJ	06/17 →
POLO VI 1.0 TGI	DBYA	09/17 →
POLO VI 1.0 TSI	CHZJ, DGTC	06/17 →
POLO VI 1.6 TDI	DGTC, CZPC	11/17 →
POLO VI 2.0 GTI	CZPC, CCRA	11/17 →
T-ROC 1.0 TSI	CHZJ	07/17 →
T-ROC 1.6 TDI	DGTE	03/18 →
T-ROC 2.0 TDI	DFFA	03/18 →
T-ROC 2.0 TDI 4motion	DFFA	09/17 →
T-ROC 2.0 TSI 4motion	CZPB	07/17 →
SPACEFOX / SPACE CROSS 1.6 FSI	CCRA, CCRA	03/06 →
SPACEFOX / SPACE CROSS 1.6 Total Flex	CCRA, CZCA	03/06 →
TIGUAN I 1.5	DADA	11/18 →
TIGUAN II 1.4 TSI	CZCA, CZDA	01/16 →
TIGUAN II 1.4 TSI 4motion	CZDA, CRFD	05/16 →
TIGUAN II 1.5	DADA	11/18 →
TIGUAN II 1.6 TDI	DGDB	05/16 →
TIGUAN II 2.0 TDI	CRFD, CUAA	01/16 →
TIGUAN II 2.0 TDI 4motion	CUAA, CHHB	01/16 →

VW		
TIGUAN II 2.0 TSI 4motion	CHHB, CRKB	01/16 →
TOURAN II 1.2 TSI	CYVB	05/15 →
TOURAN II 1.4 TSI	CZDA	05/15 →
TOURAN II 1.6 TDI	CRKB, CRVA	05/15 →
TOURAN II 1.8 TSI	CJSА	11/15 →
TOURAN II 2.0 TDI	CRVA, --	05/15 →
TOURAN II TSI	DADA	11/18 →

21.0012



1

WHEEL SPEED SENSORS

Adatt./Suitable:

- ATE**
10.0711-6049.3
10.0711-6233.3
- AUDI**
6EO 927 807 B
6QO 927 807 B
WHT 003 863
- BOSCH**
0 986 594 502
- SEAT**
6QO 927 807 B
WHT 003 863
- SKODA**
6QO 927 807 B
WHT 003 863
- VW**
6EO 927 807 B
6QO 927 807 B
WHT 003 863

MARKET DIFFUSION: HIGH



L	L1		
---	23,6	Hall Effect	+ OUT

AUDI		
A1 1.0 TFSI	CHZB, CAVG	03/15 → 10/18
A1 1.2 TFSI	CBZA	05/10 → 04/15
A1 1.4 TDI	CUSB	11/14 → 10/18
A1 1.4 TFSI	CAVG, CAYB	05/10 → 10/18
A1 1.4 TSI	CZEA	11/14 → 10/18
A1 1.6 TDI	CAYB, CFHB	05/10 → 10/18
A1 1.8 TFSI	DAJB	02/15 → 10/18
A1 2.0 TDI	CFHB, AUA	09/11 → 04/15
A1 2.0 TFSI quattro	CDLH	03/12 → 11/12
A1 S1 quattro	CWZA	03/14 → 10/18
A2 1.2 TDI	ANY	03/01 → 08/05
A2 1.4	AUA, AMF	02/00 → 08/05
A2 1.4 TDI	AMF, AZQ	02/00 → 08/05
A2 1.6 FSI	BAD	05/02 → 08/05

SEAT		
CORDOBA II 1.2	AZQ, BBY	10/02 → 06/06
CORDOBA II 1.2 12V	BXV	05/06 → 11/09
CORDOBA II 1.4 16V	BBY, AMF	09/02 →
CORDOBA II 1.4 TDI	AMF, ASZ	10/02 → 11/09
CORDOBA II 1.6	BAH	04/03 → 11/09
CORDOBA II 1.6 16V	BTS	11/06 → 11/09
CORDOBA II 1.9 SDI	ASY	09/02 → 11/09
CORDOBA II 1.9 TDI	ASZ, AZL	09/02 → 11/09
CORDOBA II 2.0	AZL, AZQ	09/02 → 11/09
IBIZA III 1.2	AZQ, AUB	02/02 → 05/08
IBIZA III 1.2 12V	BXV	05/06 → 11/09
IBIZA III 1.4 16V	AUB, AMF	02/02 → 11/09
IBIZA III 1.4 TDI	AMF, BBU	05/02 → 11/09
IBIZA III 1.6	BAH	02/03 → 11/09
IBIZA III 1.6 16V	BTS	11/06 → 11/09
IBIZA III 1.8 T Cupra R	BBU, BJX	01/04 → 02/08
IBIZA III 1.8 FR	BJX, ASZ	12/03 → 05/08
IBIZA III 1.9 SDI	ASY	02/02 → 12/05
IBIZA III 1.9 TDI	ASZ, BPX	02/02 → 11/09
IBIZA III 1.9 TDI Cupra R	BPX, AZL	03/04 → 02/08
IBIZA III 2.0	AZL, CHZB	04/02 → 11/09
IBIZA IV 1.0	CHYB	05/15 →



SEAT		
IBIZA IV 1.0 TSI	CHZB, BZG	05/15 →
IBIZA IV 1.2	BZG, CBZA	03/08 →
IBIZA IV 1.2 LPG	BZG	03/08 →
IBIZA IV 1.2 TDI	CFWA	04/10 →
IBIZA IV 1.4 TSI	CBZA, BXW	09/10 →
IBIZA IV 1.4	BXW, BMS	03/08 →
IBIZA IV 1.4 LPG	BXW	03/08 → 05/11
IBIZA IV 1.4 TDI	BMS, CAVF	07/08 →
IBIZA IV 1.4 TSI	CAVF, CAVE	06/09 →
IBIZA IV 1.4 TSI Cupra	CAVE, CWVA	06/09 →
IBIZA IV 1.6	BTS	05/08 →
IBIZA IV 1.6 LPG	CNKA	05/11 →
IBIZA IV 1.6 SRE	CWVA, CAYA	07/15 →
IBIZA IV 1.6 TDI	CAYA, BLS	05/09 →
IBIZA IV 1.8 TSI Cupra	DAJA	11/15 →
IBIZA IV 1.9 TDI	BLS, CHYA	03/08 →
IBIZA IV 2.0	CEKA	10/08 →
IBIZA IV 2.0 TDI	CFHD	01/10 →
IBIZA 1.2	CGPA	04/08 →
IBIZA 1.2 TDi	CFWA	05/10 →
IBIZA 1.6 TDi	CAYB	05/09 →
MII 1.0	CHYA, CHZB	10/11 →
MII 1.0 EcoFuel	CPGA	11/12 →
TOLEDO IV 1.0 TSI	CHZB, CBZA	05/17 →
TOLEDO IV 1.2	CGPC	07/12 →
TOLEDO IV 1.2 TSI	CBZA, CAXA	07/12 →
TOLEDO IV 1.4 TDI	CUSB	05/15 →
TOLEDO IV 1.4 TSI	CAXA, CFNA	07/12 →
TOLEDO IV 1.6	CFNA, CAYB	07/13 →
TOLEDO IV 1.6 TDI	CAYB, CHYA	07/12 →

SKODA		
CITIGO 1.0	CHYA, AQV	10/11 →
CITIGO 1.0 CNG	CPGA	11/12 →
FABIA I 1.0	AQV, AWY	12/99 → 08/02
FABIA I 1.2	AWY, AME	07/01 → 03/08
FABIA I 1.4	AME, AUA	04/00 → 12/07
FABIA I 1.4 16V	AUA, AMF	12/99 → 03/08
FABIA I 1.4 TDI	AMF, ATD	04/03 → 03/08
FABIA I 1.9 SDI	ASY	11/99 → 03/08
FABIA I 1.9 TDI	ATD, ASZ	01/00 → 03/08
FABIA I 1.9 TDI RS	ASZ, BBM	06/03 → 03/08
FABIA I 2.0	AZL	12/99 → 03/08
FABIA II 1.2	BBM, CGPA	12/06 →
FABIA II 1.2 [IND]	CJLA	09/10 →
FABIA II 1.2 LPG	CGPA, CBZA	07/07 → 11/14
FABIA II 1.2 TDI	CFWA	05/10 → 12/14
FABIA II 1.2 TSI	CBZA, BXW	03/10 → 12/14
FABIA II 1.4	BXW, BXW	01/07 → 12/14
FABIA II 1.4 [CHN]	CDDA	12/08 →
FABIA II 1.4 LPG	BXW, BMS	01/07 → 11/14
FABIA II 1.4 TDI	BMS, CAVE	01/07 → 03/10
FABIA II 1.4 TSI RS	CAVE, BTS	05/10 → 12/14
FABIA II 1.6	BTS, CDEA	04/07 → 12/14
FABIA II 1.6 [CHN]	CDEA, CAYA	12/08 →
FABIA II 1.6 TDI	CAYA, BLS	03/10 → 12/14
FABIA II 1.9 TDI	BLS, CHYA	04/07 → 03/10
FABIA III 1.0	CHYA, CHZB	08/14 →
FABIA III 1.0 TSI	CHZB, CJZC	08/14 →
FABIA III 1.2 TSI	CJZC, CUSA	08/14 →
FABIA III 1.4 TDI	CUSA, CWVA	08/14 →
FABIA III 1.4 TSI R5	CZCA	02/18 →
FABIA III 1.6	CWVA, CHZB	01/15 →
RAPID 1.0 TSI	CHZB, CBZA	07/12 →
RAPID 1.2	CGPC	07/12 →
RAPID 1.2 LPG	CBZA, CBZA	07/12 →
RAPID 1.2 TSI	CBZA, CAXA	07/12 →
RAPID 1.4 TDI	CUSB	05/15 →
RAPID 1.4 TSI	CAXA, CFNA	07/12 →
RAPID 1.6	CFNA, CAYB	07/12 →
RAPID 1.6 SRE	CWVA	05/15 →
RAPID 1.6 TDI	CAYB, CAYA	07/12 →
ROOMSTER 1.2 TDI	CFWA	03/10 → 05/15
ROOMSTER 1.6 TDI	CAYA, BAH	03/10 → 05/15

VOLKSWAGEN (BR)		
POLO 1.0	ARA	07/02 → 01/04
POLO 1.4	BKY	07/06 →
POLO 1.6	BAH, AQZ	02/02 →
POLO 1.9 SDI	ASY	05/02 →
POLO 2.0	BBX	05/02 →

VW		
FOX 1.0	AQZ, BJE	10/03 →
FOX 1.0 Alcohol	BJE, BMD	10/03 →
FOX 1.0 Total Flex	CCNA	03/08 →
FOX 1.2	BMD, BAH	04/05 → 12/11
FOX 1.4	BKR	04/05 → 12/09
FOX 1.4 TDI	BNM	04/05 → 12/09
FOX 1.6	BAH, BJA	10/03 → 08/14
FOX 1.6 Total Flex	BJA, ANY	10/03 → 08/14

VW		
FOX 1.9 D	ASY	12/07 →
UP 1.0	--, CHZB	08/11 →
UP 1.0 BlueMotion	CHYB	05/16 →
UP 1.0 EcoFuel	CPGA	11/12 →
UP 1.0 GTI	DKRA	11/17 →
UP 1.0 TSI	CHZA	05/16 →
UP 1.0 TSI BlueMotion	CHZA	05/16 →
UP e-Load Up	EABA	12/14 →
UP e-Up	EABA	07/13 →
LUPO 1.2 TDI 3L	ANY, AWY	07/99 → 07/05
POLO 1.6 [ExtraEU]	BAH	11/02 → 07/06
POLO 1.9 TDi [ExtraEU]	ATD	07/03 → 06/05
POLO IV 1.0	ARA	02/03 → 10/03
POLO IV 1.2	AWY, AZQ	01/02 → 11/09
POLO IV 1.2 12V	AZQ, BBY	10/01 → 11/09
POLO IV 1.4	BBY, AUA	08/02 →
POLO IV 1.4 16V	AUA, AMF	10/01 → 11/09
POLO IV 1.4 BiFuel	BUD	05/06 → 11/09
POLO IV 1.4 FSI	AXU	02/02 → 07/06
POLO IV 1.4 TDI	AMF, BAH	10/01 →
POLO IV 1.6	BAH, ASZ	08/02 →
POLO IV 1.6 [ExtraEU]	BAH	09/02 →
POLO IV 1.6 16V	BTS	05/06 → 11/09
POLO IV 1.8 GTI	BJX	09/05 → 11/09
POLO IV 1.8 GTI Cup Edition	BBU	05/06 → 11/09
POLO IV 1.9 SDI	ASY	10/01 →
POLO IV 1.9 TDI	ASZ, CHYA	10/01 → 11/09
POLO IV 2.0	BBX	09/02 →
POLO V 1.0	CHYA, CHZB	01/14 →
POLO V 1.0 TSI	CHZB, CGPA	11/14 →
POLO V 1.2	CGPA, CBZB	03/09 →
POLO V 1.2 [IND]	CJLA	08/11 →
POLO V 1.2 BlueMotion	CGPA	03/09 → 05/14
POLO V 1.2 TDI	CFWA	10/09 →
POLO V 1.2 TDi BlueMotion	CFWA	10/09 → 05/14
POLO V 1.2 TSI	CBZB, CDDA	11/09 →
POLO V 1.2 TSI 16V	CJZC	02/14 →
POLO V 1.2 TSI BlueMotion	CBZB	11/09 → 05/14
POLO V 1.4	CDDA, CAVE	03/09 → 05/14
POLO V 1.4 BiFuel	CMAA	03/10 → 01/11
POLO V 1.4 GTI	CAVE, CUSA	05/10 →
POLO V 1.4 TDI	CUSA, CPTA	02/14 →
POLO V 1.4 TSI	CPTA, CWXA	10/12 →
POLO V 1.4 TSI [RUS]	CZCA	05/14 →
POLO V 1.5 TDI [IND]	CWXA, CFNA	05/14 →
POLO V 1.6	CFNA, CAYA	01/10 →
POLO V 1.6 BiFuel	CNKA	01/11 →
POLO V 1.6 TDI	CAYA, CWYA	06/09 →
POLO V 1.6 TDi BlueMotion	CAYB	06/09 → 05/14
POLO V 1.8 GTI	CWYA, CCRA	11/14 →
POLO V 2.0 R WRC	CDLJ	08/13 →
SPACEFOX / SPACE CROSS 1.6 FSI	CCRA, CCRA	03/06 →
SPACEFOX / SPACE CROSS 1.6 Total Flex	CCRA, --	03/06 →

21.0013

WHEEL SPEED SENSORS

Adatt./Suitable:

ATE

10.0711-6050.3
10.0711-6234.3

AUDI

6E0 927 808 B
6Q0 927 808 B
WHT 003 862

BOSCH

0 986 594 503

SEAT

6Q0 927 808 B
WHT 003 862

SKODA

6Q0 927 808 B
WHT 003 862

VW

6E0 927 808 B
6Q0 927 808 B
WHT 003 862

MARKET DIFFUSION: HIGH



L	L1	Hall Effect	+ OUT
---	23,6		

AUDI			
A1 1.0 TFSI	CHZB, CAVG	03/15 →	10/18
A1 1.2 TFSI	CBZA	05/10 →	04/15
A1 1.4 TDI	CUSB	11/14 →	10/18
A1 1.4 TFSI	CAVG, CAYB	05/10 →	10/18
A1 1.4 TSI	CZEA	11/14 →	10/18
A1 1.6 TDI	CAYB, CFHB	05/10 →	10/18
A1 1.8 TFSI	DAJB	02/15 →	10/18
A1 2.0 TDI	CFHB, AUA	09/11 →	04/15
A1 2.0 TFSI quattro	CDLH	03/12 →	11/12
A1 S1 quattro	CWZA	03/14 →	10/18
A2 1.2 TDI	ANY	03/01 →	08/05
A2 1.4	AUA, AMF	02/00 →	08/05
A2 1.4 TDI	AMF, AZQ	02/00 →	08/05
A2 1.6 FSI	BAD	05/02 →	08/05

SEAT			
CORDOBA II 1.2	AZQ, BBY	10/02 →	06/06
CORDOBA II 1.2 12V	BXV	05/06 →	11/09
CORDOBA II 1.4 16V	BBY, AMF	09/02 →	
CORDOBA II 1.4 TDI	AMF, ASZ	10/02 →	11/09
CORDOBA II 1.6	BAH	04/03 →	11/09
CORDOBA II 1.6 16V	BTS	11/06 →	11/09
CORDOBA II 1.9 SDI	ASY	09/02 →	11/09
CORDOBA II 1.9 TDI	ASZ, AZL	09/02 →	11/09
CORDOBA II 2.0	AZL, AZQ	09/02 →	11/09
IBIZA III 1.2	AZQ, AUB	02/02 →	05/08
IBIZA III 1.2 12V	BXV	05/06 →	11/09
IBIZA III 1.4 16V	AUB, AMF	02/02 →	11/09
IBIZA III 1.4 TDI	AMF, BBU	05/02 →	11/09
IBIZA III 1.6	BAH	02/03 →	11/09
IBIZA III 1.6 16V	BTS	11/06 →	11/09
IBIZA III 1.8 T Cupra R	BBU, BJX	01/04 →	02/08
IBIZA III 1.8 T FR	BJX, ASZ	12/03 →	05/08
IBIZA III 1.9 SDI	ASY	02/02 →	12/05
IBIZA III 1.9 TDI	ASZ, BPX	02/02 →	11/09
IBIZA III 1.9 TDI Cupra R	BPX, AZL	03/04 →	02/08
IBIZA III 2.0	AZL, CHZB	04/02 →	11/09
IBIZA IV 1.0	CHYB	05/15 →	
IBIZA IV 1.0 TSI	CHZB, BZG	05/15 →	
IBIZA IV 1.2	BZG, CBZA	03/08 →	
IBIZA IV 1.2 LPG	BZG	03/08 →	
IBIZA IV 1.2 TDI	CFWA	04/10 →	
IBIZA IV 1.2 TSI	CBZA, BXW	09/10 →	
IBIZA IV 1.4	BXW, BMS	03/08 →	
IBIZA IV 1.4 LPG	BXW	03/08 →	05/11
IBIZA IV 1.4 TDI	BMS, CAVF	07/08 →	
IBIZA IV 1.4 TSI	CAVF, CAVE	06/09 →	
IBIZA IV 1.4 TSI Cupra	CAVE, CWVA	06/09 →	



SEAT		
IBIZA IV 1.6	BTS	05/08 →
IBIZA IV 1.6 LPG	CNKA	05/11 →
IBIZA IV 1.6 SRE	CWVA, CAYA	07/15 →
IBIZA IV 1.6 TDI	CAYA, BLS	05/09 →
IBIZA IV 1.8 TSI Cupra	DAJA	11/15 →
IBIZA IV 1.9 TDI	BLS, CHYA	03/08 →
IBIZA IV 2.0	CEKA	10/08 →
IBIZA IV 2.0 TDI	CFHD	01/10 →
IBIZA 1.2	CGPA	04/08 →
IBIZA 1.2 TDi	CFWA	05/10 →
IBIZA 1.6 TDi	CAYB	05/09 →
MII 1.0	CHYA, CHZB	10/11 →
MII 1.0 EcoFuel	CPGA	11/12 →
TOLEDO IV 1.0 TSI	CHZB, CBZA	05/17 →
TOLEDO IV 1.2	CGPC	07/12 →
TOLEDO IV 1.2 TSI	CBZA, CAXA	07/12 →
TOLEDO IV 1.4 TDI	CUSB	05/15 →
TOLEDO IV 1.4 TSI	CAXA, CFNA	07/12 →
TOLEDO IV 1.6	CFNA, CAYB	07/13 →
TOLEDO IV 1.6 TDI	CAYB, CHYA	07/12 →

SKODA		
CITIGO 1.0	CHYA, AOV	10/11 →
CITIGO 1.0 CNG	CPGA	11/12 →
FABIA I 1.0	AWY, AWY	12/99 → 08/02
FABIA I 1.2	AWY, AME	07/01 → 03/08
FABIA I 1.4	AME, AUA	04/00 → 12/07
FABIA I 1.4 16V	AUA, AMF	12/99 → 03/08
FABIA I 1.4 TDI	AMF, ATD	04/03 → 03/08
FABIA I 1.9 SDI	ASY	11/99 → 03/08
FABIA I 1.9 TDI	ATD, ASZ	01/00 → 03/08
FABIA I 1.9 TDI RS	ASZ, BBM	06/03 → 03/08
FABIA I 2.0	AZL	12/99 → 03/08
FABIA II 1.2	BBM, CGPA	12/06 →
FABIA II 1.2 [IND]	CJLA	09/10 →
FABIA II 1.2 LPG	CGPA, CBZA	07/07 → 11/14
FABIA II 1.2 TDI	CFWA	05/10 → 12/14
FABIA II 1.2 TSI	CBZA, BXW	03/10 → 12/14
FABIA II 1.4	BXW, BXW	01/07 → 12/14
FABIA II 1.4 [CHN]	CDDA	12/08 →
FABIA II 1.4 LPG	BXW, BMS	01/07 → 11/14
FABIA II 1.4 TDI	BMS, CAVE	01/07 → 03/10
FABIA II 1.4 TSI RS	CAVE, BTS	05/10 → 12/14
FABIA II 1.6	BTS, CDEA	04/07 → 12/14
FABIA II 1.6 [CHN]	CDEA, CAYA	12/08 →
FABIA II 1.6 TDI	CAYA, BLS	03/10 → 12/14
FABIA II 1.9 TDI	BLS, CHYA	04/07 → 03/10
FABIA III 1.0	CHYA, CHZB	08/14 →
FABIA III 1.0 TSI	CHZB, CJZC	08/14 →
FABIA III 1.2 TSI	CJZC, CUSA	08/14 →
FABIA III 1.4 TDI	CUSA, CWVA	08/14 →
FABIA III 1.4 TSI R5	CZCA	02/18 →
FABIA III 1.6	CWVA, CHZB	01/15 →
RAPID 1.0 TSI	CHZB, CBZA	07/12 →
RAPID 1.2	CGPC	07/12 →
RAPID 1.2 LPG	CBZA, CBZA	07/12 →
RAPID 1.2 TSI	CBZA, CAXA	07/12 →
RAPID 1.4 TDI	CUSB	05/15 →
RAPID 1.4 TSI	CAXA, CFNA	07/12 →
RAPID 1.6	CFNA, CAYB	07/12 →
RAPID 1.6 SRE	CWVA	05/15 →
RAPID 1.6 TDI	CAYB, CAYA	07/12 →
ROOMSTER 1.2 TDI	CFWA	03/10 → 05/15
ROOMSTER 1.6 TDI	CAYA, BAH	03/10 → 05/15

VOLKSWAGEN (BR)		
POLO 1.0	ARA	07/02 → 01/04
POLO 1.4	BKY	07/06 →
POLO 1.6	BAH, AQZ	02/02 →
POLO 1.9 SDI	ASY	05/02 →
POLO 2.0	BBX	05/02 →

VW		
FOX 1.0	AQZ, BJE	10/03 →
FOX 1.0 Alcohol	BJE, BMD	10/03 →
FOX 1.0 Total Flex	CCNA	03/08 →
FOX 1.2	BMD, BAH	04/05 → 12/11
FOX 1.4	BKR	04/05 → 12/09
FOX 1.4 TDI	BNM	04/05 → 12/09
FOX 1.6	BAH, BJA	10/03 → 08/14
FOX 1.6 Total Flex	BJA, ANY	10/03 → 08/14
FOX 1.9 D	ASY	12/07 →
UP 1.0	--, CABA	08/11 →
UP 1.0 BlueMotion	CHYB	05/16 →
UP 1.0 EcoFuel	CPGA	11/12 →
UP 1.0 GTI	DKRA	11/17 →
UP 1.0 TSI	CHZA	05/16 →
UP 1.0 TSi BlueMotion	CHZA	05/16 →
UP e-Load Up	EABA	12/14 →
UP e-Up	EABA	07/13 →
LUPPO 1.2 TDI 3L	ANY, AWY	07/99 → 07/05

VW			
POLO 1.6 [ExtraEU]	BAH	11/02 → 07/06	
POLO 1.9 TDi [ExtraEU]	ATD	07/03 → 06/05	
POLO IV 1.0	ARA	02/03 → 10/03	
POLO IV 1.2	AWY, AZQ	01/02 → 11/09	
POLO IV 1.2 12V	AZQ, BBY	10/01 → 11/09	
POLO IV 1.4	BBY, AUA	08/02 →	
POLO IV 1.4 16V	AUA, AMF	10/01 → 11/09	
POLO IV 1.4 BiFuel	BUD	05/06 → 11/09	
POLO IV 1.4 FSI	AXU	02/02 → 07/06	
POLO IV 1.4 TDI	AMF, BAH	10/01 →	
POLO IV 1.6	BAH, ASZ	08/02 →	
POLO IV 1.6 [ExtraEU]	BAH	09/02 →	
POLO IV 1.6 16V	BTS	05/06 → 11/09	
POLO IV 1.8 GTI	BJX	09/05 → 11/09	
POLO IV 1.8 GTi Cup Edition	BBU	05/06 → 11/09	
POLO IV 1.9 SDI	ASY	10/01 →	
POLO IV 1.9 TDI	ASY, CHYA	10/01 → 11/09	
POLO IV 2.0	BBX	09/02 →	
POLO V 1.0	CHYA, CHZB	01/14 →	
POLO V 1.0 TSI	CHZB, CGPA	11/14 →	
POLO V 1.2	CGPA, CBZB	03/09 →	
POLO V 1.2 [IND]	CJLA	08/11 →	
POLO V 1.2 BlueMotion	CGPA	03/09 → 05/14	
POLO V 1.2 TDI	CFWA	10/09 →	
POLO V 1.2 TDi BlueMotion	CFWA	10/09 → 05/14	
POLO V 1.2 TSi	CBZB, CDDA	11/09 →	
POLO V 1.2 TSi 16V	CJZC	02/14 →	
POLO V 1.2 TSi BlueMotion	CBZB	11/09 → 05/14	
POLO V 1.4	CDDA, CAVE	03/09 → 05/14	
POLO V 1.4 BiFuel	CMAA	03/10 → 01/11	
POLO V 1.4 GTI	CAVE, CUSA	05/10 →	
POLO V 1.4 TDI	CUSA, CPTA	02/14 →	
POLO V 1.4 TSI	CPTA, CWXA	10/12 →	
POLO V 1.4 TSi [RUS]	CZCA	05/14 →	
POLO V 1.5 TDI [IND]	CFWA, CFNA	05/14 →	
POLO V 1.6	CFNA, CAYA	01/10 →	
POLO V 1.6 BiFuel	CNKA	01/11 →	
POLO V 1.6 TDI	CAYA, CWYA	06/09 →	
POLO V 1.6 TDi BlueMotion	CAYB	06/09 → 05/14	
POLO V 1.8 GTI	CWYA, CCRA	11/14 →	
POLO V 2.0 R WRC	CDLJ	08/13 →	
SPACEFOX / SPACE CROSS 1.6 FSI	CCRA, CCRA	03/06 →	
SPACEFOX / SPACE CROSS 1.6 Total Flex	CCRA, --	03/06 →	

21.0014

WHEEL SPEED SENSORS

Adatt./Suitable:

AUDI

4E0 927 803
4E0 927 803 A
4E0 927 803 D
4E0 927 803 F

BENTLEY

4E0 927 803
4E0 927 803 A
4E0 927 803 D
4E0 927 803 F

BOSCH

0 265 007 929
0 265 007 930

PORSCHE

4E0 927 803 F

ROLLS-ROYCE

4E09278

VW

4E0 927 803
4E0 927 803 A
4E0 927 803 D
4E0 927 803 F

MARKET DIFFUSION: HIGH



L	L1	Hall Effect	OUT +
---	37		

AUDI			
A4 IV 1.8 TFSI	CABA, CDHB	11/07 → 12/15	
A4 IV 1.8 TFSI quattro	CDHB, CAGA	09/08 → 12/15	
A4 IV 2.0 TDI	CAGA, CAGA	11/07 → 12/15	
A4 IV 2.0 TDI quattro	CAGA, CAEA	01/08 → 12/15	
A4 IV 2.0 TFSI	CAEA, CAEB	06/08 → 12/15	
A4 IV 2.0 TFSI flexible fuel	CFKA	11/09 → 12/15	
A4 IV 2.0 TFSI flexible fuel quattro	CFKA	11/09 → 12/15	
A4 IV 2.0 TFSI quattro	CAEB, CAMA	06/08 → 12/15	
A4 IV 2.7 TDI	CAMA, CAPA	11/07 → 03/12	
A4 IV 3.0 TDI	CLAB	11/11 → 12/15	
A4 IV 3.0 TDI quattro	CAPA, CMUA	11/07 → 12/15	
A4 IV 3.0 TFSI quattro	CMUA, CAGA	02/12 → 12/15	
A4 IV 3.2 FSI	CALA	09/08 → 03/12	
A4 IV 3.2 FSI quattro	CALA	11/07 → 03/12	
A4 IV RS4 quattro	CFSA	05/12 → 08/15	
A4 IV S4 quattro	CAKA, CABD	11/08 → 12/15	
A4 IV ALLROAD 2.0 TDI quattro	CAGA, CDNC	04/09 → 05/16	
A4 IV ALLROAD 2.0 TFSI quattro	CDNC, CCWA	04/09 → 05/16	
A4 IV ALLROAD 3.0 TDI quattro	CCWA, CAKA	04/09 → 05/16	
A4 2.0 TFSI [ExtraEU]	CFKA	11/09 → 03/13	
A5 I 1.8 TFSI	CABD, CAGA	10/07 → 01/17	
A5 I 2.0 TDI	CAGA, CAHA	08/08 → 01/17	
A5 I 2.0 TDI quattro	CAHA, CAEA	08/08 → 01/17	
A5 I 2.0 TFSI	CAEA, CAEB	06/08 → 01/17	
A5 I 2.0 TFSI quattro	CAEB, CAMA	06/08 →	
A5 I 2.7 TDI	CAMA, CAPA	06/07 → 01/17	
A5 I 3.0 TDI	CLAB	10/11 → 01/17	
A5 I 3.0 TDI quattro	CAPA, CHMB	06/07 → 01/17	
A5 I 3.0 TFSI quattro	CHMB, CAKA	08/11 →	
A5 I 3.2 FSI	CALA	06/07 → 03/12	
A5 I 3.2 FSI quattro	CALA	06/07 → 03/12	
A5 I RS5 quattro	CFSA	03/10 → 08/15	
A5 I S5 quattro	CAKA, BLB	06/07 → 01/17	
A6 III 2.0 TDI	BLB, BPJ	07/04 → 08/11	
A6 III 2.0 TFSI	BPJ, BPP	06/05 → 08/11	
A6 III 2.4	BDW	05/04 → 10/08	
A6 III 2.4 [CHN]	BDW	04/05 →	
A6 III 2.4 quattro	BDW	01/05 → 10/08	
A6 III 2.7 TDI	BPP, BPP	11/04 → 08/11	
A6 III 2.7 TDI quattro	BPP, BDX	11/04 → 08/11	

AUDI		
A6 III 2.8 FSI	BDX, BDX	11/06 → 08/11
A6 III 2.8 FSI quattro	BDX, ASB	06/07 → 08/11
A6 III 3.0	BBJ	08/04 → 05/06
A6 III 3.0 [CHN]	BBJ	04/05 →
A6 III 3.0 quattro	BBJ	05/04 → 05/06
A6 III 3.0 TDi	ASB	06/06 → 08/11
A6 III 3.0 TDi quattro	ASB, CAJA	05/04 → 08/11
A6 III 3.0 TFSI quattro	CAJA, AUK	10/08 → 08/11
A6 III 3.2 FSI	AUK, AUK	05/04 → 03/11
A6 III 3.2 FSI quattro	AUK, CGLC	05/04 → 10/08
A6 III 4.2 FSI quattro	BVJ	05/06 → 08/11
A6 III 4.2 quattro	BAT	05/04 → 05/06
A6 III RS6 quattro	BUH	04/08 → 08/10
A6 III S6 quattro	BXA	03/06 → 08/11
A6 IV 1.8 TFSI	CYGA	09/14 → 09/18
A6 IV 2.0 TDi	CGLC, CAEB	03/11 →
A6 IV 2.0 TDi quattro	CNHA	04/15 → 09/18
A6 IV 2.0 TFSI	CAEB, CAEB	03/11 →
A6 IV 2.0 TFSI hybrid	CHJA	11/11 → 09/18
A6 IV 2.0 TFSI quattro	CAEB, CHVA	05/12 → 09/18
A6 IV 2.8 FSI	CHVA	11/10 → 04/15
A6 IV 2.8 FSI quattro	CHVA, CLAB	11/10 → 09/18
A6 IV 3.0 TDi	CLAB, CDUC	11/10 → 09/18
A6 IV 3.0 TDi quattro	CDUC, CGWB	03/11 →
A6 IV 3.0 TFSI	CREH	09/14 →
A6 IV 3.0 TFSI quattro	CGWB, CRDB	11/10 → 09/18
A6 IV RS6 performance quattro	CWUC	11/15 → 09/18
A6 IV RS6 quattro	CRDB, CEUC	01/13 → 09/18
A6 IV S6 quattro	CEUC, CYNB	02/12 → 09/18
A7 SPORTBACK 1.8 TFSI	CYGA	04/15 → 05/18
A7 SPORTBACK 2.0 TFSI	CYPA	09/14 → 05/18
A7 SPORTBACK 2.0 TFSI quattro	CYNB, CHVA	05/15 → 05/18
A7 SPORTBACK 2.5 FSI	CLXB	05/12 →
A7 SPORTBACK 2.8 FSI	CHVA	02/11 → 03/15
A7 SPORTBACK 2.8 FSI quattro	CHVA, CLAB	10/10 → 05/18
A7 SPORTBACK 2.8 TFSI	CVPA	09/14 →
A7 SPORTBACK 3.0 TDi	CLAB, CDUC	11/10 →
A7 SPORTBACK 3.0 TDi quattro	CDUC, CGWB	10/10 → 05/18
A7 SPORTBACK 3.0 TFSI	CREH	05/14 →
A7 SPORTBACK 3.0 TFSI quattro	CGWB, CRDB	10/10 → 05/18
A7 SPORTBACK RS7 performance quattro	CWUC	11/15 → 04/18
A7 SPORTBACK RS7 quattro	CRDB, CEUC	10/13 → 04/18
A7 SPORTBACK S7 quattro	CEUC, BDX	02/12 → 05/18
A8 II 2.8 FSI	BDX, ASN	08/07 → 07/10
A8 II 3.0	ASN, ASN	07/03 → 05/06
A8 II 3.0 quattro	ASN, ASB	07/03 → 05/05
A8 II 3.0 TDi quattro	ASB, BMC	08/03 → 07/10
A8 II 3.2 FSI	BPK	06/05 → 07/10
A8 II 3.2 FSI quattro	BPK	06/05 → 07/10
A8 II 3.7 quattro	BFL	10/02 → 05/06
A8 II 4.0 TDi quattro	ASE	05/03 → 07/05
A8 II 4.2 FSI quattro	BVJ	06/06 → 07/10
A8 II 4.2 quattro	BFM	10/02 → 07/10
A8 II 4.2 TDi quattro	BMC, BHT	01/05 → 07/10
A8 II 6.0 W12 quattro	BHT, BSM	12/03 → 07/10
A8 II S8 quattro	BSM, CPAA	06/06 → 07/10
A8 III 2.0 TFSI hybrid	CHJA	02/12 → 11/15
A8 III 2.0 TFSI quattro	CYPA	09/16 → 01/18
A8 III 2.5 TFSI	CPAA, CDTA	07/12 → 06/16
A8 III 3.0 TDi	CLAB	09/11 → 09/13
A8 III 3.0 TDi quattro	CDTA, CGWA	07/10 →
A8 III 3.0 TFSI quattro	CGWA, CEUA	06/10 → 01/18
A8 III 4.0 TFSI	CTGF	11/15 →
A8 III 4.0 TFSI quattro	CEUA, CDSB	03/12 → 12/15
A8 III 4.2 FSI quattro	CDRA	11/09 → 12/12
A8 III 4.2 TDi quattro	CDSB, CEJA	11/09 → 01/18
A8 III 6.3 W12 quattro	CEJA, CGTA	01/11 → 01/18
A8 III S8 plus quattro	DDTA	11/15 → 01/18
A8 III S8 quattro	CGTA, CJCA	04/12 → 01/18
Q5 I 2.0 TDi	CJCA, CAGA	11/10 →
Q5 I 2.0 TDi quattro	CAGA, CAEB	11/08 →
Q5 I 2.0 TFSI	CDNA	11/08 →
Q5 I 2.0 TFSI hybrid quattro	CHJA	06/11 →
Q5 I 2.0 TFSI quattro	CAEB, CADA	11/08 →
Q5 I 2.0 TFSI quattro [CHN]	CADA, CCWA	09/09 →
Q5 I 3.0 TDi	CTBC	06/12 →
Q5 I 3.0 TDi quattro	CCWA, CTUC	11/08 →
Q5 I 3.0 TFSI quattro	CTUC, CGQB	06/12 →
Q5 I 3.2 FSI quattro	CALB	11/08 →
Q5 I SQ5 TDi quattro	CGQB, CTUD	12/12 →
Q5 I SQ5 TFSI quattro	CTUD, BYH	05/13 →
R8 4.2 FSI quattro	BYH, BUJ	04/07 → 07/15
R8 5.2 FSI quattro	BUJ, CMMC	04/09 →

AUDI		
R8 5.2 FSI RWS	DKAB	09/17 →
BENTLEY		
CONTINENTAL 4.0	CMMC, CMMD	09/11 →
CONTINENTAL 4.0 FLEX	CMMD, CMMC	12/13 →
CONTINENTAL 4.0 FLEX AWD	CMMC, CMMC	04/12 →
CONTINENTAL 4.0 FlexFuel [ExtraEU]	CMMC	09/11 →
CONTINENTAL 4.0 GT	CMMC, BEB	04/12 →
CONTINENTAL 6.0	BEB, BEB	06/03 →
CONTINENTAL 6.0 AWD	BEB, CKHB	06/06 →
CONTINENTAL 6.0 FLEX	CKHB, CKHA	11/10 →
CONTINENTAL 6.0 FLEX AWD	CKHA, BWRB	03/10 →
CONTINENTAL 6.0 FlexFuel	CKHC	01/10 → 07/10
CONTINENTAL 6.0 Flexfuel [ExtraEU]	BWRB, BWRA	02/08 →
CONTINENTAL 6.0 ISR/ISR Flexfuel	CKHE	03/11 → 06/14
CONTINENTAL 6.0 Speed [ExtraEU]	DBDD	11/17 → 07/18
CONTINENTAL 6.0 Super-sports AWD	DJLA	09/17 → 05/18
CONTINENTAL 6.0 Trazione integrale	BWRA, BWR	08/07 → 04/11
CONTINENTAL FLYING SPUR 6.0	BWR, BEB	03/05 →
CONTINENTAL FLYING SPUR 6.0 FLEX	BEB, CMMC	03/05 →
FLYING SPUR 4.0	CYCB	03/13 →
FLYING SPUR 4.0 FLEX	CMMC, CVAA	03/13 →
FLYING SPUR 6.0	CVAA, CKBB	03/13 →
FLYING SPUR V8 S 4.0	CYCA	05/16 →
FLYING SPUR W12 S 6.0	DBDE	11/16 →
MULSANNE 6.8	CKBB, BMK	09/09 →
PORSCHE		
918 4.6	M18.00	11/13 →
918 4.6 Hybrid	M18.00	11/13 →
VW		
PHAETON 3.0 V6 FSI 4motion	CPFA	11/11 →
PHAETON 3.0 V6 TDi 4motion	BMK, AYT	09/04 → 03/16
PHAETON 3.2 V6	AYT, BKL	04/02 → 05/05
PHAETON 3.2 V6 4motion	BKL, CHNA	02/04 → 11/08
PHAETON 3.6 V6 4motion	CHNA, BGH	11/08 → 03/16
PHAETON 4.2 V8 4motion	BGH, BAN	05/03 → 03/16
PHAETON 5.0 V10 TDi 4motion	AJS	11/02 → 10/06
PHAETON 6.0 W12 4motion	BAN, CABA	04/02 → 03/16

21.0015

WHEEL SPEED SENSORS

Adatt./Suitable:

AUDI

4E0 927 804
4E0 927 804 A
4E0 927 804 D
4E0 927 804 F

BENTLEY

4E0 927 804
4E0 927 804 A
4E0 927 804 D
4E0 927 804 F

BOSCH

0 265 007 406
0 265 007 927
0 265 007 928

ROLLS-ROYCE

4E09278

VW

4E0 927 804
4E0 927 804 A
4E0 927 804 D
4E0 927 804 F

MARKET DIFFUSION: HIGH

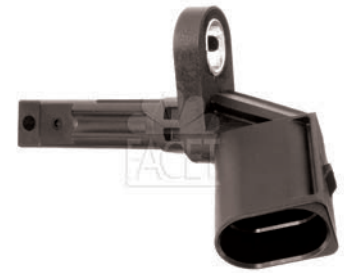

L	L1		
---	37	Hall Effect	

AUDI		
A4 IV 1.8 TFSI	CABA, CDHB	11/07 → 12/15
A4 IV 1.8 TFSI quattro	CDHB, CAGA	09/08 → 12/15
A4 IV 2.0 TDi	CAGA, CAGA	11/07 → 12/15
A4 IV 2.0 TDi quattro	CAGA, CAEA	01/08 → 12/15
A4 IV 2.0 TFSI	CAEA, CAEB	06/08 → 12/15
A4 IV 2.0 TFSI flexible fuel	CFKA	11/09 → 12/15
A4 IV 2.0 TFSI flexible fuel quattro	CFKA	11/09 → 12/15
A4 IV 2.0 TFSI quattro	CAEB, CAMA	06/08 → 12/15
A4 IV 2.7 TDi	CAMA, CAPA	11/07 → 03/12
A4 IV 3.0 TDi	CLAB	11/11 → 12/15
A4 IV 3.0 TDi quattro	CAPA, CMUA	11/07 → 12/15
A4 IV 3.0 TFSI quattro	CMUA, CAGA	02/12 → 12/15
A4 IV 3.2 FSI	CALA	09/08 → 03/12
A4 IV 3.2 FSI quattro	CALA	11/07 → 03/12
A4 IV RS4 quattro	CFSA	05/12 → 08/15
A4 IV S4 quattro	CAKA, CABD	11/08 → 12/15
A4 IV ALLROAD 2.0 TDi quattro	CAGA, CDNC	04/09 → 05/16
A4 IV ALLROAD 2.0 TFSI quattro	CDNC, CCWA	04/09 → 05/16
A4 IV ALLROAD 3.0 TDi quattro	CCWA, CAKA	04/09 → 05/16
A4 2.0 TFSI [ExtraEU]	CFKA	11/09 → 03/13
A5 I 1.8 TFSI	CABD, CAGA	10/07 → 01/17
A5 I 2.0 TDi	CAGA, CAHA	08/08 → 01/17
A5 I 2.0 TDi quattro	CAHA, CAEA	08/08 → 01/17
A5 I 2.0 TFSI	CAEA, CAEB	06/08 → 01/17
A5 I 2.0 TFSI quattro	CAEB, CAMA	06/08 →
A5 I 2.7 TDi	CAMA, CAPA	06/07 → 01/17
A5 I 3.0 TDi	CLAB	10/11 → 01/17
A5 I 3.0 TDi quattro	CAPA, CHMB	06/07 → 01/17
A5 I 3.0 TFSI quattro	CHMB, CAKA	08/11 →
A5 I 3.2 FSI	CALA	06/07 → 03/12
A5 I 3.2 FSI quattro	CALA	06/07 → 03/12
A5 I RS5 quattro	CFSA	03/10 → 08/15
A5 I S5 quattro	CAKA, BLB	06/07 → 01/17
A6 III 2.0 TDi	BLB, BPJ	07/04 → 08/11
A6 III 2.0 TFSI	BPJ, BPP	06/05 → 08/11
A6 III 2.4	BDW	05/04 → 10/08
A6 III 2.4 [CHN]	BDW	04/05 →
A6 III 2.4 quattro	BDW	01/05 → 10/08
A6 III 2.7 TDi	BPP, BPP	11/04 → 08/11
A6 III 2.7 TDi quattro	BPP, BDX	11/04 → 08/11
A6 III 2.8 FSI	BDX, BDX	11/06 → 08/11

AUDI			
A6 III 2.8 FSI quattro	BDX, ASB	06/07 → 08/11	
A6 III 3.0	BBJ	08/04 → 05/06	
A6 III 3.0 [CHN]	BBJ	04/05 →	
A6 III 3.0 quattro	BBJ	05/04 → 05/06	
A6 III 3.0 TDi	ASB	06/06 → 08/11	
A6 III 3.0 TDi quattro	ASB, CAJA	05/04 → 08/11	
A6 III 3.0 TFSI quattro	CAJA, AUK	10/08 → 08/11	
A6 III 3.2 FSI	AUK, AUK	05/04 → 03/11	
A6 III 3.2 FSI quattro	AUK, CGLC	05/04 → 10/08	
A6 III 4.2 FSI quattro	BVJ	05/06 → 08/11	
A6 III 4.2 quattro	BAT	05/04 → 05/06	
A6 III RS6 quattro	BUH	04/08 → 08/10	
A6 III S6 quattro	BXA	03/06 → 08/11	
A6 IV 1.8 TFSI	CYGA	09/14 → 09/18	
A6 IV 2.0 TDi	CGLC, CAEB	03/11 →	
A6 IV 2.0 TDi quattro	CNHA	04/15 → 09/18	
A6 IV 2.0 TFSI	CAEB, CAEB	03/11 →	
A6 IV 2.0 TFSI hybrid	CHJA	11/11 → 09/18	
A6 IV 2.0 TFSI quattro	CAEB, CHVA	05/12 → 09/18	
A6 IV 2.8 FSI	CHVA	11/10 → 04/15	
A6 IV 2.8 FSI quattro	CHVA, CLAB	11/10 → 09/18	
A6 IV 3.0 TDi	CLAB, CDUC	11/10 → 09/18	
A6 IV 3.0 TDi quattro	CDUC, CGWB	03/11 →	
A6 IV 3.0 TFSI	CREH	09/14 →	
A6 IV 3.0 TFSI quattro	CGWB, CRDB	11/10 → 09/18	
A6 IV RS6 performance quattro	CWUC	11/15 → 09/18	
A6 IV RS6 quattro	CRDB, CEUC	01/13 → 09/18	
A6 IV S6 quattro	CEUC, CYNB	02/12 → 09/18	
A7 SPORTBACK 1.8 TFSI	CYGA	04/15 → 05/18	
A7 SPORTBACK 2.0 TFSI	CYPA	09/14 → 05/18	
A7 SPORTBACK 2.0 TFSI quattro	CYNB, CHVA	05/15 → 05/18	
A7 SPORTBACK 2.5 FSI	CLXB	05/12 →	
A7 SPORTBACK 2.8 FSI	CHVA	02/11 → 03/15	
A7 SPORTBACK 2.8 FSI quattro	CHVA, CLAB	10/10 → 05/18	
A7 SPORTBACK 2.8 TFSI	CVPA	09/14 →	
A7 SPORTBACK 3.0 TDi	CLAB, CDUC	11/10 →	
A7 SPORTBACK 3.0 TDi quattro	CDUC, CGWB	10/10 → 05/18	
A7 SPORTBACK 3.0 TFSI	CREH	05/14 →	
A7 SPORTBACK 3.0 TFSI quattro	CGWB, CRDB	10/10 → 05/18	
A7 SPORTBACK RS7 performance quattro	CWUC	11/15 → 04/18	
A7 SPORTBACK RS7 quattro	CRDB, CEUC	10/13 → 04/18	
A7 SPORTBACK S7 quattro	CEUC, BDX	02/12 → 05/18	
A8 II 2.8 FSI	BDX, ASN	08/07 → 07/10	
A8 II 3.0	ASN, ASN	07/03 → 05/06	
A8 II 3.0 quattro	ASN, ASB	07/03 → 05/05	
A8 II 3.0 TDi quattro	ASB, BMC	08/03 → 07/10	
A8 II 3.2 FSI	BPK	06/05 → 07/10	
A8 II 3.2 FSI quattro	BPK	06/05 → 07/10	
A8 II 3.7 quattro	BFL	10/02 → 05/06	
A8 II 4.0 TDi quattro	ASE	05/03 → 07/05	
A8 II 4.2 FSI quattro	BVJ	06/06 → 07/10	
A8 II 4.2 quattro	BFM	10/02 → 07/10	
A8 II 4.2 TDi quattro	BMC, BHT	01/05 → 07/10	
A8 II 6.0 W12 quattro	BHT, BSM	12/03 → 07/10	
A8 II S8 quattro	BSM, CPAA	06/06 → 07/10	
A8 III 2.0 TFSI hybrid	CHJA	02/12 → 11/15	
A8 III 2.0 TFSI quattro	CYPA	09/16 → 01/18	
A8 III 2.5 TFSI	CPAA, CDTA	07/12 → 06/16	
A8 III 3.0 TDi	CLAB	09/11 → 09/13	
A8 III 3.0 TDi quattro	CDTA, CGWA	07/10 →	
A8 III 3.0 TFSI quattro	CGWA, CEUA	06/10 → 01/18	
A8 III 4.0 TFSI	CTGF	11/15 →	
A8 III 4.0 TFSI quattro	CEUA, CDSB	03/12 → 12/15	
A8 III 4.2 FSI quattro	CDRA	11/09 → 12/12	
A8 III 4.2 TDi quattro	CDSB, CEJA	11/09 → 01/18	
A8 III 6.3 W12 quattro	CEJA, CGTA	01/11 → 01/18	
A8 III S8 plus quattro	DDTA	11/15 → 01/18	
A8 III S8 quattro	CGTA, CICA	04/12 → 01/18	
Q5 I 2.0 TDi	CICA, CAGA	11/10 →	
Q5 I 2.0 TDi quattro	CAGA, CAEB	11/08 →	
Q5 I 2.0 TFSI	CDNA	11/08 →	
Q5 I 2.0 TFSI hybrid quattro	CHJA	06/11 →	
Q5 I 2.0 TFSI quattro	CAEB, CADA	11/08 →	
Q5 I 2.0 TFSI quattro [CHN]	CADA, CCWA	09/09 →	
Q5 I 3.0 TDi	CTBC	06/12 →	
Q5 I 3.0 TDi quattro	CCWA, CTUC	11/08 →	
Q5 I 3.0 TFSI quattro	CTUC, CGQB	06/12 →	
Q5 I 3.2 FSI quattro	CALB	11/08 →	
Q5 I SQ5 TDi quattro	CGQB, CTUD	12/12 →	
Q5 I SQ5 TFSI quattro	CTUD, BYH	05/13 →	
R8 4.2 FSI quattro	BYH, BUJ	04/07 → 07/15	
R8 5.2 FSI quattro	BUJ, CMMC	04/09 →	
R8 5.2 FSI RWS	DKAB	09/17 →	

BENTLEY			
CONTINENTAL 4.0	CMMC, CMMD	09/11 →	
CONTINENTAL 4.0 FLEX	CMMD, CMMC	12/13 →	
CONTINENTAL 4.0 FLEX AWD	CMMC, CMMC	04/12 →	
CONTINENTAL 4.0 FlexFuel [ExtraEU]	CMMC	09/11 →	
CONTINENTAL 4.0 GT	CMMC, BEB	04/12 →	
CONTINENTAL 6.0	BEB, BEB	06/03 →	
CONTINENTAL 6.0 AWD	BEB, CKHB	06/06 →	
CONTINENTAL 6.0 FLEX	CKHB, CKHA	11/10 →	
CONTINENTAL 6.0 FLEX AWD	CKHA, BWRB	03/10 →	
CONTINENTAL 6.0 FlexFuel [ExtraEU]	CKHC	01/10 → 07/10	
CONTINENTAL 6.0 FlexFuel [ExtraEU]	BWRB, BWRA	02/08 →	
CONTINENTAL 6.0 ISR/ISR Flexfuel	CKHE	03/11 → 06/14	
CONTINENTAL 6.0 Speed [ExtraEU]	DBDD	11/17 → 07/18	
CONTINENTAL 6.0 Super-sports AWD	DJLA	09/17 → 05/18	
CONTINENTAL 6.0 Trazione integrale	BWRA, BWR	08/07 → 04/11	
CONTINENTAL FLYING SPUR 6.0	BWR, BEB	03/05 →	
CONTINENTAL FLYING SPUR 6.0 FLEX	BEB, CMMC	03/05 →	
FLYING SPUR 4.0	CYCB	03/13 →	
FLYING SPUR 4.0 FLEX	CMMC, CVAA	03/13 →	
FLYING SPUR 6.0	CVAA, CKBB	03/13 →	
FLYING SPUR V8 S 4.0	CYCA	05/16 →	
FLYING SPUR W12 S 6.0	DBDE	11/16 →	
MULSANNE 6.8	CKBB, BMK	09/09 →	

VW			
PHAETON 3.0 V6 FSI 4motion	CPFA	11/11 →	
PHAETON 3.0 V6 TDi 4motion	BMK, AYT	09/04 → 03/16	
PHAETON 3.2 V6	AYT, BKL	04/02 → 05/05	
PHAETON 3.2 V6 4motion	BKL, CHNA	02/04 → 11/08	
PHAETON 3.6 V6 4motion	CHNA, BGH	11/08 → 03/16	
PHAETON 4.2 V8 4motion	BGH, BAN	05/03 → 03/16	
PHAETON 5.0 V10 TDi 4motion	AJS	11/02 → 10/06	
PHAETON 6.0 W12 4motion	BAN, CHZD	04/02 → 03/16	

21.0017



3

WHEEL SPEED SENSORS

Adatt./Suitable:

ATE
10.0711-6230.3

AUDI
WHT 003 864

BOSCH
0 986 594 526

MAN
2K0 927 807
WHT 003 864

SEAT
WHT 003 864

SKODA
WHT 003 864

VW
2K0 927 807
WHT 003 864

MARKET DIFFUSION: **HIGH**



L	L1	Hall Effect	+ OUT
---	37,8		

AUDI			
A3 III 1.0 TFSI	CHZD, CJZA	07/16 →	
A3 III 1.2 TFSI	CJZA, CMBA	02/13 →	
A3 III 1.4 TFSI	CMBA, CUKB	04/12 →	
A3 III 1.4 TFSI e-tron	CUKB, CLHA	05/14 →	
A3 III 1.4 TFSI g-tron	CPWA	11/13 →	
A3 III 1.4 TSI	CZEA	05/14 →	
A3 III 1.6 TDi	CLHA, CJSA	10/12 →	
A3 III 1.8 TFSI	CJSA, CRBC	04/12 →	
A3 III 2.0 TDi	CRBC, CHHB	04/12 →	
A3 III 2.0 TFSI	CHHB, CHZD	01/13 →	

AUDI			
A3 III 2.0 TFSI [ExtraEU]	CHHB	11/15 →	
A3 III 30 TFSI	CHZD, DAUA	07/18 →	
MAN			
TGE-SERIES 0.0	EBHA	07/18 →	
TGE 2.0 TDi	DAUA, CHZD	11/16 →	
SEAT			
LEON III 1.0 TSI	CHZD, CJZA	05/15 →	
LEON III 1.2 TSI	CJZA, CHPA	12/12 →	
LEON III 1.4 TGI	CPWA	02/13 →	
LEON III 1.4 TSI	CHPA, CLHA	09/12 →	
LEON III 1.6 TDi	CLHA, CJSA	09/12 →	
LEON III 1.6 TSI	CWVA	05/15 →	
LEON III 1.8 TFSI	CJSA	02/13 →	
LEON III 1.8 TSI	CJSA	02/13 →	
LEON III 1.8 TSI 4Drive	CJSA, CJXA	11/14 →	
LEON III 2.0 Cupra	CJXA, CKFC	10/13 →	
LEON III 2.0 TDi	CKFC, CJZB	09/12 →	
LEON III 2.0 TDi 4Drive	CUNA	11/14 →	
LEON ST 1.0 TSI	CHZD	05/15 →	
LEON ST 1.2 TSI	CJZB, CZDA	01/13 →	
LEON ST 1.4 TSI	CZDA, CRKB	05/14 →	
LEON ST 1.6 TDi	CRKB, CJXA	09/13 →	
LEON ST 1.8 TFSI	CJSA	10/13 →	
LEON ST 2.0 Cupra	CJXA, CKFC	10/13 →	
LEON ST 2.0 TDi	CKFC, CHZD	04/13 →	
LEON ST 2.0 TDi 4Drive	CUNA	10/14 →	
SKODA			
OCTAVIA III 1.0 TSI	CHZD, CJZA	05/16 →	
OCTAVIA III 1.2 TSI	CJZA, CHPA	11/12 →	
OCTAVIA III 1.4 [CHN]	CSSA	02/14 →	
OCTAVIA III 1.4 TSI	CHPA, CLHA	11/12 →	
OCTAVIA III 1.4 TSI G-TEC	CPWA	11/13 →	
OCTAVIA III 1.5 TSI	DADA	02/17 →	
OCTAVIA III 1.6	CWVA	01/14 →	
OCTAVIA III 1.6 [CHN]	CSRA	02/14 →	
OCTAVIA III 1.6 TDi	CLHA, CJSA	11/12 →	
OCTAVIA III 1.8 TSI	CJSA, CKFB	11/12 →	
OCTAVIA III 2.0 TDi	CKFB, CUNA	11/12 →	
OCTAVIA III 2.0 TDi RS	CUNA, CHHA	05/13 →	
OCTAVIA III 2.0 TSi RS	CHHA, CZCA	11/12 →	
SUPERB III 1.4 TSI	CZCA, CVRA.	03/15 →	
SUPERB III 1.6 TDi	CVRA., CJSA	03/15 →	
SUPERB III 1.8 TSI	CJSA, CRGA	03/15 →	
SUPERB III 2.0 TDi	CRGA, CHZG	03/15 →	
SUPERB III 2.0 TSI	CHHB	03/15 →	

VW			
CADDY III 1.0 TSI	CHZG, CBZA	11/15 →	
CADDY III 1.2 TSI	CBZA, BCA	09/10 →	
CADDY III 1.4	BCA, CZCB	03/04 → 08/10	
CADDY III 1.4 TGI CNG	CPWA	06/15 →	
CADDY III 1.4 TSI	CZCB, BGU	05/15 →	
CADDY III 1.6	BGU, BSF	04/04 →	
CADDY III 1.6 BiFuel	BSF, CAYD	05/11 → 05/15	
CADDY III 1.6 TDi	CAYD, BJB	08/10 →	
CADDY III 1.9 TDi	BJB, BDJ	04/04 → 08/10	
CADDY III 2.0 EcoFuel	BSX	04/06 → 05/15	
CADDY III 2.0 SDI	BDJ, BMM	03/04 → 08/10	
CADDY III 2.0 TDi	BMM, CFHC	09/07 →	
CADDY III 2.0 TDi 16V	CFHC, DAUA	11/10 → 05/15	
CRAFTER 2.0 TDi	DAUA, CJZA	09/16 →	
CRAFTER e-Crafter	EBHA	07/18 →	
GOLF VII 1.0 TSI	CHZC, CJZA	05/15 →	
GOLF VII 1.2 TSI	CJZA, CPWA	08/12 →	
GOLF VII 1.4 GTE Hybrid	CUKB	05/14 →	
GOLF VII 1.4 TGI CNG	CPWA, CHPA	06/13 →	
GOLF VII 1.4 TSI	CHPA, CPWA	08/12 →	
GOLF VII 1.4 TSI MultiFuel	CPWA, DACA	04/13 →	
GOLF VII 1.5 TSI	DACA, CLHA	05/17 →	
GOLF VII 1.6	CWVA	05/14 →	
GOLF VII 1.6 TDi	CLHA, CUNA	08/12 →	
GOLF VII 2.0 GTD	CUNA, CHHA	04/13 →	
GOLF VII 2.0 GTI	CHHA, CKFC	04/13 →	
GOLF VII 2.0 GTI Clubsport	CJXE	02/16 →	
GOLF VII 2.0 GTI Clubsport S	CJXG	09/16 →	
GOLF VII 2.0 TDi	CKFC, HWDA	08/12 →	
GOLF VII e-Golf	EAGA	03/14 → 02/17	
GOLF 1.2 TSI BlueMotion	CJZA, CHPA	08/12 →	
GOLF 1.4 TSI BlueMotion	CHPA, CLHA	08/12 →	
GOLF 1.6 TDi BlueMotion	CLHA, CHHA	08/12 →	
GOLF 2.0 GTD	CUNA	04/13 →	
GOLF 2.0 GTI	CHHA, CJZA	04/13 →	
GOLF VAN 1.2 TSI BlueMotion	CJZA, CHPA	04/13 → 03/17	
GOLF VAN 1.4 TSI BlueMotion	CHPA, CLHA	05/13 → 03/17	
GOLF VAN 1.6 TDi BlueMotion	CLHA, CHZC	05/13 → 03/17	

21.0018



1

WHEEL SPEED SENSORS

Adatt./Suitable:

ATE

10.0711-6220.3
10.0711-6296.3
10.0711-6385.3

BOSCH

0 986 594 554

FORD

1 223 622
1 225 843
1 481 190
1 695 086
1 847 905
3M5T-2B372-BD
BV6T-2C190-GA
BV6T-2C190-GB

MAZDA

BP4K-43-711A
BP4K-43-711B

VOLVO

30648986
30793635
31274612

MARKET DIFFUSION: HIGH



L	L1		OUT +
---	14	Hall Effect	

FORD

C-MAX I 1.6	HWDA, G8DA	02/07 → 09/10
C-MAX I 1.6 TDCi	G8DA, --	02/07 → 09/10
C-MAX I 1.6 Ti-VCT	--, QQDA	03/07 →
C-MAX I 1.8	QQDA, KKDA	02/07 → 09/10
C-MAX I 1.8 Flexifuel	Q7DA	02/07 → 09/10
C-MAX I 1.8 TDCi	KKDA, AODA	02/07 → 09/10
C-MAX 1.2.0	AODA, SYDA	02/07 → 09/10
C-MAX 1.2.0 CNG	SYDA, G6DA	04/09 → 09/10
C-MAX 1.2.0 LPG	SYDA	06/08 → 09/10
C-MAX 1.2.0 TDCi	G6DA, --	02/07 → 09/10
C-MAX II 1.0 EcoBoost	--, M8DB	10/12 →
C-MAX II 1.5 16V	--	03/15 →
C-MAX II 1.5 EcoBoost	M8DB, XWDA	03/15 →
C-MAX II 1.5 TDCi	XWDA, JQDA	03/15 →
C-MAX II 1.5 TDCi ECOnetic	AEDA	03/15 →
C-MAX II 1.6	--	12/10 →
C-MAX II 1.6 CNG	MUDACNG	01/13 →
C-MAX II 1.6 EcoBoost	JQDA, MUDA	12/10 →
C-MAX II 1.6 Flexifuel	MUDA, MUDA	02/11 →
C-MAX II 1.6 LPG	MUDA, T1DA	02/12 →
C-MAX II 1.6 TDCi	T1DA, IQDA	12/10 →
C-MAX II 1.6 Ti	IQDA, --	12/10 →
C-MAX II 2.0 Energi	--, --	01/15 →
C-MAX II 2.0 TDCi	--, HWDA	04/10 →
FOCUS II 1.4	ASDA, HWDA	07/04 → 09/12
FOCUS II 1.6	HWDA, G8DA	07/04 → 09/12
FOCUS II 1.6 LPG	SIDA	10/09 → 09/12
FOCUS II 1.6 TDCi	G8DA, HXDA	07/04 → 09/12
FOCUS II 1.6 Ti	HXDA, Q7DA	07/04 → 09/12
FOCUS II 1.6 Ti-VCT	--	12/07 →
FOCUS II 1.8	Q7DA, --	03/06 → 09/12
FOCUS II 1.8 Flexifuel	--, KKDA	12/05 → 09/12
FOCUS II 1.8 TDCi	KKDA, AODA	07/04 → 09/12
FOCUS II 2.0	AODA, SYDA	07/04 → 09/12
FOCUS II 2.0 CNG	SYDA, G6DA	04/09 → 07/11
FOCUS II 2.0 Flex	SYDA	10/08 → 03/10
FOCUS II 2.0 LPG	SYDA	06/08 → 07/11
FOCUS II 2.0 TDCi	G6DA, ASDA	07/04 → 09/12
FOCUS II 2.5 RS	JZDA	01/09 → 07/11
FOCUS II 2.5 RS 500	JZDA	05/10 → 07/11
FOCUS II 2.5 ST	HYDA	10/05 → 09/12
FOCUS II CASSONE / FURGO-NATO / PROMISCUO 1.4	ASDA, G8DA	09/05 → 07/11
FOCUS II CASSONE / FURGO-NATO / PROMISCUO 1.6	HWDA	09/05 → 07/11

FORD		
FOCUS II CASSONE / FURGO-NATO / PROMISCUO 1.6 TDCi	G8DA, HXDA	07/04 → 07/11
FOCUS II CASSONE / FURGO-NATO / PROMISCUO 1.6 Ti-VCT	HXDA, Q7DA	09/05 → 07/11
FOCUS II CASSONE / FURGO-NATO / PROMISCUO 1.8 Flexifuel	Q7DA, G6DB	06/09 → 07/11
FOCUS II CASSONE / FURGO-NATO / PROMISCUO 2.0 TDCi	G6DB, M1DA	09/05 → 07/11
FOCUS III 1.0 EcoBoost	M1DA, M8DA	02/12 →
FOCUS III 1.0 GTDI	--	07/12 →
FOCUS III 1.5 Di TCI SIGMA A	--	09/14 →
FOCUS III 1.5 EcoBoost	M8DA, XWDA	09/14 →
FOCUS III 1.5 TDCi	XWDA, AEDA	09/14 →
FOCUS III 1.5 TDCi ECOnetic	AEDA, JQDA	09/14 →
FOCUS III 1.6 EcoBoost	JQDA, MUDA	07/10 →
FOCUS III 1.6 Flexifuel	MUDA, MUDA	07/10 →
FOCUS III 1.6 LPG	MUDA, NGDA	02/12 →
FOCUS III 1.6 TDCi	NGDA, NGDA	07/10 →
FOCUS III 1.6 TDCi ECOnetic	NGDA, IQDA	05/12 →
FOCUS III 1.6 Ti	IQDA, R9DA	07/10 →
FOCUS III 1.6 Ti-VCT	--	07/10 →
FOCUS III 2.0	XQDA	10/13 →
FOCUS III 2.0 Di TIVCT	--	04/11 →
FOCUS III 2.0 GDi	MGDA	08/11 →
FOCUS III 2.0 ST	R9DA, T7DA	07/12 →
FOCUS III 2.0 TDCi	T7DA, --	07/10 →
FOCUS III 2.0 TDCi ST	T8DA	11/14 →
FOCUS III 2.0 Ti-GDi	MGDA	07/10 →
FOCUS III Electric	KDDA	07/13 →
FOCUS C-MAX 1.6	HWDA, G8DA	10/03 → 03/07
FOCUS C-MAX 1.6 TDCi	G8DA, HXDA	10/03 → 03/07
FOCUS C-MAX 1.6 Ti	HXDA, CSDA	08/04 → 03/07
FOCUS C-MAX 1.8	CSDA, KKDA	10/03 → 03/07
FOCUS C-MAX 1.8 Flexifuel	Q7DA	01/06 → 03/07
FOCUS C-MAX 1.8 TDCi	KKDA, AODA	01/05 → 03/07
FOCUS C-MAX 2.0	AODA, G6DA	03/04 → 03/07
FOCUS C-MAX 2.0 TDCi	G6DA, ASDA	10/03 → 03/07
GALAXY II 1.6 EcoBoost	--, T1WA	11/10 →
GALAXY II 1.6 TDCi	T1WA, FFWA	02/11 → 06/15
GALAXY II 1.8 TDCi	FFWA, AOWA	05/06 → 06/15
GALAXY II 2.0	AOWA, TNWA	05/06 → 06/15
GALAXY II 2.0 EcoBoost	TNWA, TBWA	03/10 →
GALAXY II 2.0 Flexifuel	TBWA, --	05/06 → 06/15
GALAXY II 2.0 TDCi	--, KNWA	05/06 →
GALAXY II 2.0 TDCi CR TC	--	03/10 →
GALAXY II 2.0 TDCi DSL	--	03/10 →
GALAXY II 2.2 TDCi	KNWA, M1DA	03/08 → 06/15
GALAXY II 2.3	SEWA	09/07 → 06/15
GALAXY II 2.5 ST	HUWA	05/06 →
GRAND C-MAX 1.0 EcoBoost	M1DA, M8DB	10/12 →
GRAND C-MAX 1.5 EcoBoost	M8DB, AEDA	03/15 →
GRAND C-MAX 1.5 TDCi	AEDA, JQDA	03/15 →
GRAND C-MAX 1.6 EcoBoost	JQDA, T1DA	12/10 →
GRAND C-MAX 1.6 TDCi	T1DA, IQDA	12/10 →
GRAND C-MAX 1.6 Ti	IQDA, T7DB	12/10 →
GRAND C-MAX 2.0 TDCi	T7DB, --	12/10 →
KUGA 1.2.0 TDCi	--, BNMA	03/08 →
KUGA 1.2.0 TDCi CR TC	--	03/10 →
KUGA 1.2.5	HYDC	03/09 → 11/12
KUGA II 1.5 16V	--	03/13 →
KUGA II 1.5 EcoBoost	BNMA, --	09/14 →
KUGA II 1.5 TDCi	--, JQMA	07/16 →
KUGA II 1.6 EcoBoost	JQMA, T7MA	03/13 →
KUGA II 2.0 EcoBoost	--	03/13 →
KUGA II 2.0 TDCi	T7MA, --	03/13 →
KUGA II 2.0 TDCi 4x4	TXDA	03/13 →
KUGA II 2.5	--, T1BA	09/13 →
KUGA II 2.5 PFI	--	03/13 →
MONDEO III 1.6 EcoBoost	JTBA, T1BA	11/10 → 01/15
MONDEO III 1.6 TDCi	T1BA, KGBA	12/10 → 01/15
MONDEO III 1.6 Ti	KGBA, FFBA	03/07 → 01/15
MONDEO III 1.8 TDCi	FFBA, A0BA	03/07 → 01/15
MONDEO III 2.0	A0BA, TBBA	03/07 → 01/15
MONDEO III 2.0 EcoBoost	TPBA	03/10 → 01/15
MONDEO III 2.0 Flexifuel	TBBA, AZBA	03/09 → 01/15
MONDEO III 2.0 LPG	TBBA	07/09 → 01/15
MONDEO III 2.0 SCTi	TNBA	03/10 → 01/15
MONDEO III 2.0 TDCi	AZBA, KNBA	03/07 → 01/15
MONDEO III 2.2 TDCi	KNBA, --	03/08 → 01/15
MONDEO III 2.3	SEBA	07/07 → 01/15
MONDEO III 2.5	HUBA	03/07 → 01/15
MONDEO 1.6 EcoBoost	JTBA	11/10 → 09/14
MONDEO 1.6 TDCi	T1BA, TNBA	03/13 → 09/14
MONDEO 2.0	A0BC	03/07 → 09/14
MONDEO 2.0 EcoBoost	TNBA, KLBA	03/10 → 09/14

FORD		
MONDEO 2.0 TDCi	KLBA, JTBA	03/07 → 09/14
MONDEO 2.2 TDCi	KNBA	03/13 → 09/14
S-MAX I 1.6 EcoBoost	--, T1WA	02/11 →
S-MAX I 1.6 TDCi	T1WA, FFWA	02/11 → 12/14
S-MAX I 1.8 TDCi	FFWA, AODA	05/06 → 12/14
S-MAX I 2.0	AODA, TNWA	05/06 → 12/14
S-MAX I 2.0 EcoBoost	TNWA, TBWA	03/10 → 12/14
S-MAX I 2.0 Flexifuel	TBWA, AZWA	05/06 → 12/14
S-MAX I 2.0 TDCi	AZWA, KNWA	05/06 → 12/14
S-MAX I 2.0 TDCi CR TC	--	03/10 →
S-MAX I 2.0 TDCi DSL	--	03/10 →
S-MAX I 2.2 TDCi	KNWA, M2GA	03/08 → 12/14
S-MAX I 2.3	SEWA	07/07 → 12/14
S-MAX I 2.5 ST	HUWA	05/06 → 12/14
TOURNEO CONNECT II 1.0 EcoBoost	M2GA, --	11/13 →
TOURNEO CONNECT II 1.5 TDCi	--, --	09/13 →
TOURNEO CONNECT II 1.6 EcoBoost	--, T1GA	09/13 →
TOURNEO CONNECT II 1.6 TDCi	T1GA, BHPA	09/13 →
TOURNEO CONNECT II 2.5	--	09/13 →
TRANSIT CONNECT I 1.8 Di	BHPA, M2GA	06/02 → 12/13
TRANSIT CONNECT II 1.0 EcoBoost	M2GA, --	02/13 →
TRANSIT CONNECT II 1.5 TDCi	--, --	02/13 →
TRANSIT CONNECT II 1.6 EcoBoost	--, T1GA	02/13 →
TRANSIT CONNECT II 1.6 TDCi	T1GA, FXJA	02/13 →
TRANSIT CONNECT II 2.5	--	02/13 →

MAZDA

3 I 1.4	FXJA, B6ZE	10/03 → 06/09
3 I 1.6	B6ZE, Y601	10/03 → 06/09
3 I 1.6 Di Turbo	Y601, LF17	06/04 → 06/09
3 I 1.6 MZ-CD	Y406	06/06 → 12/09
3 I 2.0	LF17, RF7J	09/03 → 12/09
3 I 2.0 MZR-CD	RF7J, L3N9	12/06 → 06/09
3 I 2.3 DiSi Turbo MPS	L3YH	06/06 → 06/09
3 I 2.3 MPS Turbo	L3N9, Z6	12/06 → 06/09
3 II 1.6 MZR	Z6, Y601	12/08 → 09/14
3 II 1.6 MZR CD	Y601, LF17	12/08 → 05/13
3 II 2.0 MZR	LF17, LF-5H	01/09 → 09/14
3 II 2.0 MZR DISI	LF-5H, R2AA	12/08 → 05/13
3 II 2.2 MZR CD	R2AA, L3KG	01/09 → 09/14
3 II 2.3 MPS Turbo	L3KG, LFD7	06/09 → 09/14
3 II 2.5	L5-VE	03/09 → 09/14
5 I 1.8	L823	02/05 → 05/10
5 I 2.0	LFD7, Y650	02/05 → 05/10
5 I 2.0 CD	RF7J	02/05 → 05/10
5 I 2.0 MZR	LF5	09/07 →
5 I 2.0 MZR-CD	RF	09/07 →
5 II 1.6 CD	Y650, LF-5H	09/10 →
5 II 1.8 MZR	L850	09/10 →
5 II 2.0	LF-5H, D5244T13	09/10 →

VOLVO

C30 1.6	B416453	10/06 → 12/12
C30 1.6 D	D4164T	10/06 → 12/12
C30 1.6 D2	D4162T	10/10 → 12/12
C30 1.8	B4184S11	10/06 → 12/12
C30 1.8 FlexFuel	B4184S8	01/07 → 12/12
C30 2.0	B420453	10/06 → 12/12
C30 2.0 D	D4204T	10/06 → 12/12
C30 2.0 FlexFuel	B420454	01/10 → 12/12
C30 2.4 i	B524454	10/06 → 12/12
C30 2.5 T5 [ExtraEU]	B525477	03/12 → 12/13
C30 D3	D520475	10/10 → 12/12
C30 D4	D5204T	10/10 → 12/12
C30 D5	D5244T13, B5254T3	10/06 → 12/12
C30 Electric	E400V1	12/10 → 12/12
C30 T5	B5254T3, D5244T13	10/06 → 12/12
C70 II 2.0 D	D4204T	01/08 → 10/09
C70 II 2.4	B524455	03/06 → 10/09
C70 II 2.4 D	D524479	03/07 → 06/13
C70 II 2.4 i	B524454	03/06 → 10/09
C70 II D3	D520475	10/10 → 06/13
C70 II D4	D5204T	10/10 → 06/13
C70 II D5	D5244T13, B5254T3	03/06 → 06/13
C70 II T5	B5254T3, B524454	03/06 → 10/09
S40 II 1.6	B416453	01/05 → 12/12
S40 II 1.6 D	D4164T	01/05 → 12/12
S40 II 1.8	B4184S11	04/04 → 12/10
S40 II 1.8 FlexFuel	B4184S8	01/06 → 12/10
S40 II 2.0	B420453	10/06 → 12/12
S40 II 2.0 CDI	D420472	07/05 → 12/06
S40 II 2.0 D	D4204T	01/04 → 12/10
S40 II 2.0 D4	D420472	07/05 → 12/12
S40 II 2.0 F	B420454	10/09 → 12/12
S40 II 2.4	B524454, D5244T13	01/04 → 12/12

VOLVO		
S40 II 2.4 AWD	B5244S4	08/06 ⇨ 12/12
S40 II 2.4 CDI	D5244T9	03/07 ⇨ 12/10
S40 II 2.4 D5	D5244T13, B5254T3	03/06 ⇨ 12/10
S40 II D3	D5204T5	10/10 ⇨ 12/12
S40 II D4	D5204T	10/10 ⇨ 12/12
S40 II T5	B5254T3, B5244S4	01/04 ⇨ 12/12
S80L 2.0 T	B4204T6	01/10 ⇨
S80L 2.5 T	B5254T6	01/08 ⇨
S80L 2.5 T5	B5254T12	01/12 ⇨
S80L T4	B5204T8	01/12 ⇨
S80L T5	B4204T7	01/12 ⇨
V50 1.6	B4164S3	01/05 ⇨ 12/12
V50 1.6 D	D4164T	01/05 ⇨ 12/11
V50 1.8	B4184S11	04/04 ⇨ 12/10
V50 1.8 BiFuel	B4184S8	01/09 ⇨ 09/10
V50 1.8 FlexFuel	B4184S8	01/05 ⇨ 12/10
V50 2.0	B4204S3	10/06 ⇨ 12/12
V50 2.0 CDI	D4204T2	12/03 ⇨ 12/06
V50 2.0 D	D4204T	04/04 ⇨ 12/10
V50 2.0 D4	D4204T2	07/05 ⇨ 12/06
V50 2.0 FlexFuel	B4204S4	01/10 ⇨ 12/12
V50 2.4	B5244S4, D5244T13	04/04 ⇨ 12/10
V50 2.4 D5	D5244T13, B5254T3	03/06 ⇨ 12/10
V50 2.4 Tdi	D5244T9	05/07 ⇨ 12/10
V50 D3	D5204T5	10/10 ⇨ 12/12
V50 D4	D5204T	10/10 ⇨ 12/12
V50 T5	B5254T3, 169A4.000	04/04 ⇨ 12/12

21.0020  **04,5**

WHEEL SPEED SENSORS

Adatt./Suitable:
BOSCH
 0 265 007 448
FIAT
 51718056

MARKET DIFFUSION: HIGH



L	L1	Hall Effect	OUT +
1000	27,9	Hall Effect	

FIAT		
PANDA I 1.1	187A1.000	09/00 ⇨ 02/04
PANDA I 1.1 AWD	187A1.000	09/00 ⇨ 02/04
PANDA II 1.1	--	09/03 ⇨
PANDA II 1.2	169A4.000, 169A4.000	09/03 ⇨
PANDA II 1.2 4x4	169A4.000, 169A4.000	09/04 ⇨
PANDA II 1.2 Bipower	188A4.000	09/04 ⇨ 12/11
PANDA II 1.2 Bi-Power / Natural Power	--	04/09 ⇨
PANDA II 1.2 Euro 4	--	04/09 ⇨
PANDA II 1.2 Euro 5	--	04/09 ⇨
PANDA II 1.2 LPG	169A4.000, --	04/09 ⇨
PANDA II 1.2 Natural Power	188A4.000	01/07 ⇨ 12/11
PANDA II 1.3 D Multijet	--, 169A1.000	09/03 ⇨
PANDA II 1.3 D Multijet 4x4	169A1.000, 350A1.000	10/04 ⇨
PANDA II 1.4	--	10/06 ⇨
PANDA II 1.4 16V	--	01/10 ⇨
PANDA II 1.4 Natural Power	350A1.000, 169A4.000	10/09 ⇨



WHEEL SPEED SENSORS

Adatt./Suitable:
BOSCH
 0 265 007 639
FIAT
 51745715



L	L1	Hall Effect	OUT +
1020	27,9	Hall Effect	

FIAT		
PANDA II 1.2 4x4	169A4.000, 188A8.000	10/04 ⇨
PANDA II 1.2 LPG	169A4.000	11/10 ⇨ 08/13
PANDA II 1.2 Natural Power	188A4000CNG	01/07 ⇨ 12/11
PANDA II 1.3 D Multijet 4x4	188A8.000, 169A1.000	10/04 ⇨
PANDA II 1.3 JTD Multijet 4x4	169A1.000, FXDA	09/10 ⇨ 08/13
PANDA II 1.4 Natural Power	350A1000CNG	10/09 ⇨



WHEEL SPEED SENSORS

Adatt./Suitable:
ATE
 10.0711-5049.3
BOSCH
 0 986 594 518
FORD
 1 064 227
 1 093 743
 98AG-2B32-AF

MARKET DIFFUSION: MEDIUM



L	L1	Hall Effect	OUT +
580	24,8	Hall Effect	

FORD		
FOCUS I 1.4	FXDA, FXDA	04/99 ⇨ 03/05
FOCUS I 1.4 16V	FXDA, FYDA	10/98 ⇨ 11/04
FOCUS I 1.6	FYDA, --	04/99 ⇨ 03/05
FOCUS I 1.6 16V	--, EYDB	02/99 ⇨ 11/04
FOCUS I 1.6 16V Flexifuel	FYDH	01/02 ⇨ 11/04
FOCUS I 1.8	EYDB, EYDB	04/99 ⇨ 03/05
FOCUS I 1.8 16V	EYDB, EYDD	10/98 ⇨ 11/04
FOCUS I 1.8 16V BiFuel	EYDD, BHDA	09/02 ⇨ 07/04
FOCUS I 1.8 BiFuel	EYDL	02/03 ⇨ 01/05
FOCUS I 1.8 DI / TDDi	BHDA, F9DA	08/99 ⇨ 11/04
FOCUS I 1.8 TDCi	F9DA, BHDA	03/01 ⇨ 03/05
FOCUS I 1.8 TDDi	BHDA, BHDA	08/98 ⇨ 03/05
FOCUS I 1.8 Turbo DI / TDDi	BHDA, EDDB	10/98 ⇨ 03/05
FOCUS I 2.0 16V	EDDB, FUJA	10/98 ⇨ 11/04
FOCUS I RS	HMDA	10/02 ⇨ 11/04
FOCUS I ST170	ALDA	03/02 ⇨ 11/04

21.0024



04,5

WHEEL SPEED SENSORS

Adatt./Suitable:

ATE
10.0711-5138.1BOSCH
0 986 594 516FORD
1 151 951
2561-2B372-ADMAZDA
DD32-43-70X

MARKET DIFFUSION: HIGH



L	L1		OUT +
782	24,8	Hall Effect	

FORD			
FIESTA V 1.25 16V	FUJA, A9JA	05/02 → 06/08	
FIESTA V 1.3	A9JA, FXJA	11/01 → 08/08	
FIESTA V 1.4	FXJA	05/02 → 09/05	
FIESTA V 1.4 16V	FXJA, F6JA	11/01 → 06/08	
FIESTA V 1.4 TDCi	F6JA, FYJA	11/01 → 12/10	
FIESTA V 1.6 16V	FYJA, HHJA	11/01 → 06/08	
FIESTA V 1.6 TDCi	HHJA, --	11/04 → 09/09	
FIESTA V ST150	N4JB	03/05 → 06/08	
FUSION 1.25	--	10/02 →	
FUSION 1.3	--, FXJA	08/02 →	
FUSION 1.4	--	08/02 →	
FUSION 2.0	--	11/04 →	

MAZDA			
211.2	FUJA	02/03 → 06/07	
211.25	FUJA	04/03 → 06/07	
211.3 L	ZJ-04	04/03 → 06/07	
211.4	FXJA, F6JA	02/03 → 06/07	
211.4 CD	F6JA, FYJA	04/03 → 06/07	
211.5	ZY-VE	04/03 → 06/07	
211.6	FYJA, EB2ADT	02/03 → 06/07	

21.0025



04,5

WHEEL SPEED SENSORS

Adatt./Suitable:

ATE
10.0711-5256.3BOSCH
0 986 594 597CITROËN
4545 E4
4545 J9
96 654 555 80DS
4545 J9
96 654 555 80PEUGEOT
4545 E4
4545 J9

MARKET DIFFUSION: HIGH



L	L1		OUT +
1052	34,3	Hall Effect	

CITROËN			
C3 II 1.0 VTi 68	EBO, HFX(TU1JP)	08/12 →	
C3 II 1.1	HFX(TU1JP), EB2DT	11/09 →	
C3 II 1.1 BiFuel	TU1A	11/10 →	
C3 II 1.2 THP 110	EB2DT, EB2	10/14 →	
C3 II 1.2 VTi 82	EB2, TU3A	06/12 →	
C3 II 1.4	TU3A, 8HR(DV4C)	11/09 →	
C3 II 1.4 16V	EP3C	11/09 →	
C3 II 1.4 HDi	DV4C	06/10 → 09/16	
C3 II 1.4 HDi 70	8HR(DV4C), 8FN(EP3)	11/09 →	
C3 II 1.4 LPG	8FN(EP3), 8FR(EP3)	07/10 →	
C3 II 1.4 VTi	8FR(EP3), 8FP(EP3)	11/09 →	
C3 II 1.4 VTi 95	8FP(EP3), BHY(DV6FD)	11/09 →	
C3 II 1.6 BlueHdi	DV6FE	03/15 → 09/16	
C3 II 1.6 BlueHdi 100	BHY(DV6FD), BHW(DV6FE)	07/14 →	
C3 II 1.6 BlueHdi 75	BHW(DV6FE), 9HJ(DV6TDEM)	04/15 →	
C3 II 1.6 HDi	9HJ(DV6TDEM), 9HR(DV6C)	11/09 →	
C3 II 1.6 HDi 110	9HR(DV6C), 9HD(DV6C)	11/09 →	
C3 II 1.6 HDi 115	9HD(DV6C), 5FS(EP6C)	09/12 →	
C3 II 1.6 HDi 90	DV6ATED4	11/09 →	
C3 II 1.6 VTi 120	5FS(EP6C), EB2ADT	11/09 →	
C3 III 1.2 PureTech 82	EB2FA	05/18 →	
C3 III 1.2 THP 110	EB2ADT, EB2DT	07/16 →	
C3 III 1.2 VTi 68	EB2FB	07/16 →	
C3 III 1.2 VTi 82	EB2F	07/16 →	
C3 III 1.5 BlueHdi 100	DV5RD	05/18 →	
C3 III 1.6 BlueHdi 100	DV6FD	07/16 →	
C3 III 1.6 BlueHdi 75	DV6FE	07/16 →	
C3 III 1.6 VTi	EC5F	02/17 →	
C3 AIRCROSS 1.2 PureTech 110	EB2ADT, EB2F	06/17 →	
C3 AIRCROSS 1.2 PureTech 130	EB2DTS	07/17 →	
C3 AIRCROSS 1.2 PureTech 82	EB2F, EBO	06/17 →	
C3 AIRCROSS 1.5 BlueHdi 100	DV5RD	08/18 →	
C3 AIRCROSS 1.5 BlueHdi 120	DV5SRC	08/18 →	
C3 AIRCROSS 1.6 BlueHdi 100	DV6FD	07/17 →	
C3 AIRCROSS 1.6 BlueHdi 115	DV6FC	06/17 →	
C3 AIRCROSS 1.6 BlueHdi 120	DV6FC	07/17 →	
C3 AIRCROSS 1.6 HDi 92	DV6D	10/17 →	
C3 PICASSO 1.2 THP 110	EB2DT, 8FN(EP3)	01/15 →	
C3 PICASSO 1.4	EP3C	02/09 →	
C3 PICASSO 1.4 VTi 95	8FN(EP3), 8FN(EP3)	02/09 →	
C3 PICASSO 1.4 VTi 95 LPG	8FN(EP3), BHY(DV6FD)	01/12 →	
C3 PICASSO 1.6 BlueHdi 100	BHY(DV6FD), 9HX(DV6ATED4)	01/15 →	
C3 PICASSO 1.6 HDi	9HX(DV6ATED4), 9HR(DV6C)	02/09 →	
C3 PICASSO 1.6 HDi 110	9HR(DV6C), 9HD(DV6C)	05/10 →	

CITROËN			
C3 PICASSO 1.6 HDi 115	9HD(DV6C), 9HP(DV6DTEd)	01/13 →	
C3 PICASSO 1.6 HDi 90	9HP(DV6DTEd), 5FS(EP6C)	07/10 →	
C3 PICASSO 1.6 VTi	EP6	07/09 →	
C3 PICASSO 1.6 VTi 120	5FS(EP6C), EB2ADT	02/09 →	
C4 CACTUS 1.2 PureTech 130	EB2DTS	11/17 →	
C4 CACTUS 1.2 THP 110	EB2ADT, EB2D	09/14 →	
C4 CACTUS 1.2 VTi 75	EB2D, EB2	09/14 →	
C4 CACTUS 1.2 VTi 82	EB2, BHY(DV6FD)	09/14 →	
C4 CACTUS 1.5 BlueHdi 100	DV5RD	06/18 →	
C4 CACTUS 1.5 BlueHdi 120	DV5RC	09/18 →	
C4 CACTUS 1.6 BlueHdi 100	BHY(DV6FD), 9HP(DV6DTEd)	09/14 →	
C4 CACTUS 1.6 HDi 90	9HP(DV6DTEd), EB2M	09/14 →	
C-ELYSEE 1.2 VTi 72	EB2M, BHY(DV6FD)	11/12 →	
C-ELYSEE 1.2 VTi 82	EB2F	12/14 →	
C-ELYSEE 1.5 BlueHdi 100 [ExtraEU]	DV5RD	05/18 →	
C-ELYSEE 1.6 BlueHdi 100	BHY(DV6FD), 9HJ(DV6DTEdM)	11/14 →	
C-ELYSEE 1.6 HDi 92	9HJ(DV6DTEdM), ECS	11/12 →	
C-ELYSEE 1.6 VTi 115	ECS, EB2DT	11/12 →	
DS3 1.2 THP 110	EB2DT, EB2	10/14 → 07/15	
DS3 1.2 VTi 82	EB2, 8HR(DV4C)	01/13 → 07/15	
DS3 1.4 HDi 70	8HR(DV4C), 8FP(EP3)	04/10 → 07/15	
DS3 1.4 VTi 95	8FP(EP3), 8FN(EP3)	04/10 → 07/15	
DS3 1.4 VTi 95 LPG	8FN(EP3), 8FR(EP3)	08/12 → 07/15	
DS3 1.4 VTi 98	8FR(EP3), 5FM(EP6DT)	11/09 → 07/15	
DS3 1.6	5FM(EP6DT), BHY(DV6FD)	02/11 → 07/15	
DS3 1.6 BlueHdi 100	BHY(DV6FD), BHX(DV6FC)	07/14 → 07/15	
DS3 1.6 BlueHdi 115	BHX(DV6FC), BHZ(DV6FC)	10/13 → 07/15	
DS3 1.6 BlueHdi 120	BHZ(DV6FC), BHW(DV6FE)	10/13 → 07/15	
DS3 1.6 BlueHdi 75	BHW(DV6FE), 9HR(DV6C)	03/15 → 07/15	
DS3 1.6 HDi 110	9HR(DV6C), 9HD(DV6C)	11/09 → 07/15	
DS3 1.6 HDi 115	9HD(DV6C), 9HP(DV6DTEd)	08/12 → 07/15	
DS3 1.6 HDi 90	9HP(DV6DTEd), 5FD(EP6DTS)	11/09 → 07/15	
DS3 1.6 Racing	5FD(EP6DTS), 5FN(EP6CDT)	02/11 → 07/15	
DS3 1.6 THP 150	5FN(EP6CDT), 5FR(EP6DT)	01/10 → 07/15	
DS3 1.6 THP 155	5FR(EP6DT), 5GZ(EP6FDT)	04/10 → 07/15	
DS3 1.6 THP 165	5GZ(EP6FDT), 5FS(EP6C)	10/14 → 07/15	
DS3 1.6 VTi 120	5FS(EP6C), EB2ADT	04/10 → 07/15	
DS			
DS3 1.2 THP 110	EB2ADT, EB2	04/15 →	
DS3 1.2 THP 130	EB2DTS	09/15 →	
DS3 1.2 VTi 82	EB2, BHY(DV6FD)	04/15 →	
DS3 1.6 BlueHdi 100	BHY(DV6FD), BHZ(DV6FC)	04/15 →	
DS3 1.6 BlueHdi 116	DV6FC	07/15 →	
DS3 1.6 BlueHdi 120	BHZ(DV6FC), BHW(DV6FE)	07/15 →	
DS3 1.6 BlueHdi 75	BHW(DV6FE), EP6FDT	07/15 →	
DS3 1.6 THP	EP6FDT, 5GZ(EP6FDT)	07/15 →	
DS3 1.6 THP 165	5GZ(EP6FDT), 5GR(EP6FDTX)	07/15 →	
DS3 1.6 THP 208	5GR(EP6FDTX), EB2DT	09/15 →	
PEUGEOT			
207 1.4	KFT(TU3A), 8FR(EP3)	02/06 →	
207 1.4 16V	8FR(EP3), 8HR(DV4C)	02/06 →	
207 1.4 BiFuel	TU3A	08/07 → 12/13	
207 1.4 Flex	KFW(TU3A)	11/08 →	
207 1.4 HDi	8HR(DV4C), 5FS(EP6C)	02/06 →	
207 1.4 LPG	TU3A	08/07 → 12/12	
207 1.6	N6A(TU5JP4)	08/08 →	
207 1.6 16V	5FS(EP6C), 5FY(EP6DTS)	02/06 →	
207 1.6 16V RC	5FY(EP6DTS), 5FR(EP6DT)	02/07 →	
207 1.6 16V Turbo	5FR(EP6DT), 5FS(EP6C)	02/06 →	
207 1.6 16V VTi	5FS(EP6C), 9HP(DV6DTEd)	02/07 →	
207 1.6 Bioflex	N6A(TU5JP4)	01/08 →	
207 1.6 HDi	9HP(DV6DTEd), 9HR(DV6C)	02/06 →	
207 1.6 HDi 110	9HR(DV6C), 5FS(EP6C)	08/09 →	
207 1.6 VTi	EP6	03/07 → 12/12	
207 1.6 VTi [ExtraEU]	EP6	09/08 → 12/12	
207 CC 1.6 16V	5FS(EP6C), 5FR(EP6DT)	02/07 →	
207 CC 1.6 16V Turbo	5FR(EP6DT), 9HR(DV6C)	02/07 →	
207 CC 1.6 HDi	9HR(DV6C), EBO	02/07 →	
208 1.0	EBO, EB2	03/12 →	
208 1.2	EB2, EB2F	03/12 →	
208 1.2 GPL	EB2F, EB2ADT	06/15 →	
208 1.2 THP	EB2ADT, 8HP(DV4C)	01/13 →	
208 1.2 VTi	HMZ(EB2)	09/13 →	
208 1.4 GPL	EP3C	10/13 →	
208 1.4 HDi	8HP(DV4C), 8FS(EP3)	03/12 →	
208 1.4 VTi	8FS(EP3), 5FS(EP6C)	03/12 →	
208 1.5 BlueHdi 100	DV5RD	05/18 →	
208 1.6	5FS(EP6C), BHY(DV6FD)	02/12 →	
208 1.6 BlueHdi 100	BHY(DV6FD), BHZ(DV6FC)	01/15 →	

PEUGEOT		
208 1.6 BlueHdi 120	BHZ(DV6FC), BHW(DV6FE)	11/13 →
208 1.6 BlueHdi 75	BHW(DV6FE), 5FU(EP6CDTX)	04/15 →
208 1.6 GTi	5FU(EP6CDTX), 9HP(DV6DTEd)	08/12 →
208 1.6 HDi	9HP(DV6DTEd), 9HK(DV6ETEDM)	03/12 →
208 1.6 HDi / BlueHdi 75	9HK(DV6ETEDM), EB2M	01/13 →
208 1.6 HDi 90	9HU(DV6DTEdM)	03/12 →
208 1.6 THP 165	EP6FDT	03/15 →
208 1.6 THP 210	5GM(EP6FDTX)	04/15 →
301 1.2	HMZ(EB2F)	11/12 →
301 1.2 Vti 72	EB2M, 9HF(DV6DTEd)	11/12 →
301 1.2 Vti 82	EB2F	12/14 →
301 1.5 [ExtraEU]	DV5RD	05/18 →
301 1.6 BlueHdi 100	DV6FD	04/14 →
301 1.6 HDi 100	BHY(DV6FD)	11/12 →
301 1.6 HDi 90	9HF(DV6DTEd), EC5	11/12 →
301 1.6 LPG	EC5	07/14 →
301 1.6 Vti 115	EC5, ET3J4	11/12 →
2008 1.2 PureTech 82	EB2FA	03/18 →
2008 1.2 THP 110	EB2DT, EB2DTS	01/15 →
2008 1.2 THP 130	EB2DTS, EB2	01/15 →
2008 1.2 Vti	EB2, 8HR(DV4C)	03/13 →
2008 1.4 HDi	8HR(DV4C), BHX(DV6FC)	06/13 →
2008 1.5 BlueHdi 100	DV5RD	05/18 →
2008 1.5 BlueHdi 120	DV5RC	05/18 →
2008 1.6 BlueHdi	BHX(DV6FC), BHY(DV6FD)	07/14 →
2008 1.6 BlueHdi 100	BHY(DV6FD), BHZ(DV6FC)	01/15 →
2008 1.6 BlueHdi 120	BHZ(DV6FC), BHW(DV6FE)	07/14 →
2008 1.6 BlueHdi 75	BHW(DV6FE), 9HP(DV6DTEd)	01/15 →
2008 1.6 HDi	9HP(DV6DTEd), 5FS(EP6C)	03/13 →
2008 1.6 Vti	5FS(EP6C), KFT(TU3A)	03/13 →

21.0027

04,5

WHEEL SPEED SENSORS

Adatt./Suitable:

- BOSCH**
0 265 007 664
- CITROËN**
4545 C2
96 526 967
96 526 967 80
- PEUGEOT**
4545 C2
96 526 967

MARKET DIFFUSION: HIGH



L	L1		+	OUT
815	---	Hall Effect		

CITROËN		
C41 1.4 16V	ET3J4, NFU(TU5JP4)	11/04 → 07/11
C41 1.6 16V	NFU(TU5JP4), N6A(TU5JP4)	11/04 → 07/11
C41 1.6 16V Bio-Flex	N6A(TU5JP4), 9HV(DV6TED4)	09/07 →

CITROËN		
C41 1.6 16V Flex Fuel	N6A(TU5JP4)	02/09 →
C41 1.6 Flex	--	02/09 → 07/11
C41 1.6 HDi	9HV(DV6TED4), EW10A	11/04 →
C41 1.6 THP 140	5FT(EP6DT)	07/08 → 07/11
C41 1.6 THP 150	5FX(EP6DT)	07/08 → 07/11
C41 1.6 Vti 120	5FW(EP6)	07/08 → 07/11
C41 2.0 16V	EW10A, DW10ATED	11/04 → 07/11
C41 2.0 HDi	DW10ATED, K6D(TU3JP)	11/04 → 07/11
C41 2.0 VTR	EW10A	10/06 → 12/07

PEUGEOT		
307 1.4	K6D(TU3JP), ET3J4	08/00 →
307 1.4 16V	ET3J4, 8HX(DV4TD)	11/03 → 07/07
307 1.4 HDi	8HX(DV4TD), N6A(TU5JP4)	10/01 → 06/05
307 1.4 HDi 70	8HZ(DV4TD)	03/02 → 06/05
307 1.6 16V	N6A(TU5JP4), 9HY(DV6TED4)	08/00 →
307 1.6 BioFlex	N6A(TU5JP4)	07/06 →
307 1.6 HDi	9HV(DV6ATED4)	04/05 → 03/09
307 1.6 HDi 110	9HY(DV6ATED4), EW10J4	02/04 → 03/09
307 1.6 HDi 90	9HV(DV6ATED4)	12/06 → 04/08
307 2.0	EW10J4, EW10J4	03/02 → 06/05
307 2.0 16V	EW10J4, DW10ATED	08/00 → 04/09
307 2.0 HDi	DW10ATED, DW10ATED	01/03 →
307 2.0 HDi 110	DW10ATED, DW10ATED4	08/00 → 12/09
307 2.0 HDi 135	DW10ATED4, DW10TD	10/03 → 04/09
307 2.0 HDi 90	DW10TD, ET3J4	08/00 → 04/08

21.0028

04,5

WHEEL SPEED SENSORS

Adatt./Suitable:

- BOSCH**
0 265 007 424
0 265 008 018
- CITROËN**
4545 H7
96 449 668 80
96 619 750 80
- PEUGEOT**
4545 89
4545 H7
96 449 668
96 449 668 80

MARKET DIFFUSION: HIGH



L	L1		+	OUT
815	---	Hall Effect		

CITROËN		
C41 1.4 16V	ET3J4, NFU(TU5JP4)	11/04 → 07/11
C41 1.6 16V	NFU(TU5JP4), N6A(TU5JP4)	11/04 → 07/11
C41 1.6 16V Bio-Flex	N6A(TU5JP4), 9HV(DV6TED4)	09/07 →
C41 1.6 16V Flex Fuel	N6A(TU5JP4)	02/09 →
C41 1.6 Flex	--	02/09 → 07/11
C41 1.6 HDi	9HV(DV6TED4), 5FT(EP6DT)	11/04 →
C41 1.6 THP	EP6DT	06/08 → 07/11
C41 1.6 THP 140	5FT(EP6DT), 5FX(EP6DT)	07/08 → 07/11

CITROËN		
C41 1.6 THP 150	5FX(EP6DT), 5FW(EP6)	07/08 → 07/11
C41 1.6 Vti 120	5FW(EP6), EW10A	07/08 → 07/11
C41 2.0 16V	EW10A, DW10ATED	11/04 → 07/11
C41 2.0 HDi	DW10ATED, K6D(TU3JP)	11/04 → 07/11
C41 2.0 VTR	EW10A	10/06 → 12/07

PEUGEOT		
307 1.4	K6D(TU3JP), ET3J4	08/00 →
307 1.4 16V	ET3J4, 8HX(DV4TD)	11/03 → 07/07
307 1.4 HDi	8HX(DV4TD), N6A(TU5JP4)	10/01 → 06/05
307 1.4 HDi 70	8HZ(DV4TD)	03/02 → 06/05
307 1.6	TU5JP4	07/06 → 04/12
307 1.6 16V	N6A(TU5JP4), --	08/00 →
307 1.6 BioFlex	--, 9HV(DV6ATED4)	07/06 →
307 1.6 HDi	9HV(DV6ATED4), 9HY(DV6TED4)	04/05 → 03/09
307 1.6 HDi 110	9HY(DV6TED4), 9HV(DV6ATED4)	02/04 → 03/09
307 1.6 HDi 90	9HV(DV6ATED4), EW10J4	12/06 → 04/08
307 2.0	EW10J4, EW10A	03/02 → 06/05
307 2.0 16V	EW10A, DW10ATED	08/00 → 04/09
307 2.0 HDi	RHZ(DW10ATED)	06/05 →
307 2.0 HDi 110	DW10ATED, DW10ATED4	08/00 → 12/09
307 2.0 HDi 135	DW10ATED4, DW10TD	10/03 → 04/09
307 2.0 HDi 90	DW10TD, ET3J4	08/00 → 04/08

21.0031

04,5

WHEEL SPEED SENSORS

Adatt./Suitable:

- BOSCH**
0 265 007 779
- CITROËN**
4545 C4
96 584 207 80
- PEUGEOT**
4545 C4

MARKET DIFFUSION: HIGH



L	L1		+	OUT
785	---	Hall Effect		

CITROËN		
C41 1.4 16V	ET3J4, NFU(TU5JP4)	11/04 → 07/11
C41 1.6 16V	NFU(TU5JP4), N6A(TU5JP4)	11/04 → 07/11
C41 1.6 16V Bio-Flex	N6A(TU5JP4), 9HV(DV6TED4)	09/07 →
C41 1.6 16V Flex Fuel	N6A(TU5JP4)	02/09 →
C41 1.6 Flex	--	02/09 → 07/11
C41 1.6 HDi	9HV(DV6TED4), EW10A	11/04 →
C41 1.6 THP 140	5FT(EP6DT)	07/08 → 07/11
C41 1.6 THP 150	5FX(EP6DT)	07/08 → 07/11
C41 1.6 Vti 120	5FW(EP6)	07/08 → 07/11
C41 2.0 16V	EW10A, DW10ATED4	11/04 → 07/11
C41 2.0 HDi	DW10ATED4, K6D(TU3JP)	11/04 → 07/11
C41 2.0 VTR	EW10A	10/06 → 12/07

PEUGEOT		
307 1.4	K6D(TU3JP), ET3J4	08/00 →
307 1.4 16V	ET3J4, 8HX(DV4TD)	11/03 → 07/07
307 1.4 HDi	8HX(DV4TD), N6A(TU5JP4)	10/01 → 06/05

PEUGEOT			
307 1.4 HDi 70	8HZ(DV4TD)	03/02 ⇒ 06/05	
307 1.6	TU5JP4	07/06 ⇒ 04/12	
307 1.6 16V	N6A(TU5JP4), --	08/00 ⇒	
307 1.6 BioFlex	--, 9HV(DV6ATED4)	07/06 ⇒	
307 1.6 HDi	9HV(DV6ATED4), 9HY(DV6TED4)	04/05 ⇒ 03/09	
307 1.6 HDi 110	9HY(DV6TED4), 9HV(DV6ATED4)	02/04 ⇒ 03/09	
307 1.6 HDi 90	9HV(DV6ATED4), EW10J4	12/06 ⇒ 04/08	
307 2.0	EW10J4, EW10A	03/02 ⇒ 06/05	
307 2.0 16V	EW10A, DW10ATED	08/00 ⇒ 04/09	
307 2.0 HDi	DW10ATED, DW10ATED	01/03 ⇒	
307 2.0 HDi 110	DW10ATED, DW10ATED	08/00 ⇒ 12/09	
307 2.0 HDi 135	DW10ATED, DW10ATED	10/03 ⇒ 04/09	
307 2.0 HDi 90	DW10ATED, ET3J4	08/00 ⇒ 04/08	

21.0032  **04,5**

WHEEL SPEED SENSORS

Adatt./Suitable:

BOSCH
0 265 007 663
0 265 008 017

CITROËN
4545 F6
96 526 969 80
96 619 749 80

PEUGEOT
4545 C3
4545 F6

MARKET DIFFUSION: **HIGH**



L	L1		
780	---	Hall Effect	

CITROËN			
C4 I 1.4 16V	ET3J4, NFU(TU5JP4)	11/04 ⇒ 07/11	
C4 I 1.6 16V	NFU(TU5JP4), N6A(TU5JP4)	11/04 ⇒ 07/11	
C4 I 1.6 16V Bio-Flex	N6A(TU5JP4), 9HV(DV6ATED4)	09/07 ⇒	
C4 I 1.6 16V Flex Fuel	N6A(TU5JP4)	02/09 ⇒	
C4 I 1.6 Flex	--	02/09 ⇒ 07/11	
C4 I 1.6 HDi	9HV(DV6ATED4), EW10A	11/04 ⇒	
C4 I 1.6 THP 140	5FT(EP6DT)	07/08 ⇒ 07/11	
C4 I 1.6 THP 150	5FX(EP6DT)	07/08 ⇒ 07/11	
C4 I 1.6 VTI 120	5FW(EP6)	07/08 ⇒ 07/11	
C4 I 2.0 16V	EW10A, DW10ATED	11/04 ⇒ 07/11	
C4 I 2.0 HDi	DW10ATED, K6D(TU3JP)	11/04 ⇒ 07/11	
C4 I 2.0 VTR	EW10A	10/06 ⇒ 12/07	

PEUGEOT			
307 1.4	K6D(TU3JP), ET3J4	08/00 ⇒	
307 1.4 16V	ET3J4, 8HX(DV4TD)	11/03 ⇒ 07/07	
307 1.4 HDi	8HX(DV4TD), N6A(TU5JP4)	10/01 ⇒ 06/05	
307 1.4 HDi 70	8HZ(DV4TD)	03/02 ⇒ 06/05	
307 1.6	TU5JP4	07/06 ⇒ 04/12	
307 1.6 16V	N6A(TU5JP4), --	08/00 ⇒	
307 1.6 BioFlex	--, 9HV(DV6ATED4)	07/06 ⇒	
307 1.6 HDi	9HV(DV6ATED4), 9HY(DV6TED4)	04/05 ⇒ 03/09	
307 1.6 HDi 110	9HY(DV6TED4), 9HV(DV6ATED4)	02/04 ⇒ 03/09	
307 1.6 HDi 90	9HV(DV6ATED4), EW10J4	12/06 ⇒ 04/08	

PEUGEOT			
307 2.0	EW10J4, EW10A	03/02 ⇒ 06/05	
307 2.0 16V	EW10A, DW10ATED	08/00 ⇒ 04/09	
307 2.0 HDi	DW10ATED, DW10ATED	01/03 ⇒	
307 2.0 HDi 110	DW10ATED, DW10ATED	08/00 ⇒ 12/09	
307 2.0 HDi 135	DW10ATED, DW10ATED	10/03 ⇒ 04/09	
307 2.0 HDi 90	DW10ATED, ET3J4	08/00 ⇒ 04/08	

21.0035  **04,5**

WHEEL SPEED SENSORS

Adatt./Suitable:

ATE
10.0711-5325.3

BOSCH
0 265 007 423
0 986 594 559

CITROËN
4545 C1
4545 F5
4545 K3
96 449 667 80
96 523 105 80
96 590 582 80
96 653 867 80

DS
4545 K3
4545 F5

PEUGEOT
4545 88
4545 C1
4545 F5
4545 K3

MARKET DIFFUSION: **HIGH**



L	L1		
685	---	Hall Effect	

CITROËN			
C4 I 1.4 16V	ET3J4, NFU(TU5JP4)	11/04 ⇒ 07/11	
C4 I 1.6 16V	NFU(TU5JP4), N6A(TU5JP4)	11/04 ⇒ 07/11	
C4 I 1.6 16V Bio-Flex	N6A(TU5JP4), 9HV(DV6ATED4)	09/07 ⇒	
C4 I 1.6 16V Flex Fuel	N6A(TU5JP4)	02/09 ⇒	
C4 I 1.6 Flex	--	02/09 ⇒ 07/11	
C4 I 1.6 HDi	9HV(DV6ATED4), 5FT(EP6DT)	11/04 ⇒	
C4 I 1.6 THP	EP6DT	06/08 ⇒ 07/11	
C4 I 1.6 THP 140	5FT(EP6DT), 5FX(EP6DT)	07/08 ⇒ 07/11	
C4 I 1.6 THP 150	5FX(EP6DT), 5FW(EP6)	07/08 ⇒ 07/11	
C4 I 1.6 VTI 120	5FW(EP6), EW10A	07/08 ⇒ 07/11	
C4 I 2.0 16V	EW10A, DW10ATED	11/04 ⇒ 07/11	
C4 I 2.0 HDi	DW10ATED, EB2DT	11/04 ⇒ 07/11	
C4 I 2.0 VTR	EW10A	10/06 ⇒ 12/07	
C4 II 1.2 THP 110	EB2DT, EB2DTS	02/15 ⇒	
C4 II 1.2 THP 130	EB2DTS, 8FP(EP3)	04/14 ⇒	
C4 II 1.4 16V	EP3C	11/09 ⇒	
C4 II 1.4 VTI 95	8FP(EP3), DV6FC	11/09 ⇒	
C4 II 1.6	EP6C	01/13 ⇒	
C4 II 1.6 16V	EP6FDTX	10/10 ⇒	
C4 II 1.6 BlueHdi	DV6FC, BHY(DV6FD)	07/14 ⇒	
C4 II 1.6 BlueHdi 100	BHY(DV6FD), BHZ(DV6FC)	07/14 ⇒	
C4 II 1.6 BlueHdi 115	BHZ(DV6FC), BHZ(DV6FC)	08/14 ⇒	
C4 II 1.6 BlueHdi 120	BHZ(DV6FC), DV6C	02/15 ⇒	
C4 II 1.6 Flex	NFX(TU5JP4)	11/09 ⇒	
C4 II 1.6 HDi	DV6C, 9HR(DV6C)	11/09 ⇒	
C4 II 1.6 HDi 110	9HR(DV6C), 9HD(DV6C)	11/09 ⇒	
C4 II 1.6 HDi 115	9HD(DV6C), 9HJ(DV6TEDM)	07/12 ⇒	
C4 II 1.6 HDi 90	9HJ(DV6TEDM), 5FV(EP6CDT)	11/09 ⇒	
C4 II 1.6 HDi 92	9HJ(DV6TEDM)	07/10 ⇒	

CITROËN			
C4 II 1.6 THP 155	5FV(EP6CDT), 5F5(EP6C)	11/09 ⇒	
C4 II 1.6 VTI 120	5F5(EP6C), 5F5(EP6C)	11/09 ⇒	
C4 II 1.6 VTI 120 LPG	5F5(EP6C), DW10CFADPTR	09/11 ⇒	
C4 II 2.0 Flex	RFJ(EW10A)	11/09 ⇒	
C4 II 2.0 HDi	DW10CFADPTR, DW10CTED4	10/10 ⇒	
C4 II 2.0 HDi / BlueHdi 150	DW10CTED4, EB2DTS	11/09 ⇒	
C4 II 2.0 HDi / BlueHdi 160	DW10CTED4	10/10 ⇒	
DS4 1.2 THP 130	EB2DTS, BHZ(DV6FC)	07/14 ⇒ 07/15	
DS4 1.6 BlueHdi 115	BHX(DV6FC), BHZ(DV6FC)	07/14 ⇒ 07/15	
DS4 1.6 BlueHdi 120	BHZ(DV6FC), 9HR(DV6C)	07/14 ⇒ 07/15	
DS4 1.6 HDi 110	9HR(DV6C), 9HD(DV6C)	04/11 ⇒ 07/15	
DS4 1.6 HDi 115	9HD(DV6C), 9HP(DV6DTE)	08/12 ⇒ 07/15	
DS4 1.6 HDi 90	9HP(DV6DTE), 5FV(EP6CDT)	05/11 ⇒ 07/15	
DS4 1.6 THP 150	EP6CDTMD	04/11 ⇒ 07/15	
DS4 1.6 THP 155	5FV(EP6CDT), 5FM(EP6DT)	04/11 ⇒ 07/15	
DS4 1.6 THP 160	5FM(EP6DT), 5FM(EP6DT)	04/12 ⇒ 07/15	
DS4 1.6 THP 165	5FM(EP6DT), 5FU(EP6DTX)	01/12 ⇒ 07/15	
DS4 1.6 THP 200	5FU(EP6DTX), 5F5(EP6C)	04/11 ⇒ 07/15	
DS4 1.6 THP 210	5GM(EP6FDTX)	07/15 ⇒ 07/15	
DS4 1.6 VTI 120	5F5(EP6C), AHX(DW10FD)	04/11 ⇒ 07/15	
DS4 2.0 BlueHdi 150	AHX(DW10FD), AHW(DW10FC)	07/14 ⇒ 07/15	
DS4 2.0 BlueHdi 150 Hybrid	AHR(DW10FD)	07/14 ⇒ 07/15	
DS4 2.0 BlueHdi 180	AHW(DW10FC), AHS(DW10FD)	07/14 ⇒ 07/15	
DS4 2.0 HDi / BlueHdi 135	AHS(DW10FD), DW10CTED4	09/11 ⇒ 07/15	
DS4 2.0 HDi 165	DW10CTED4, 9HR(DV6C)	04/11 ⇒ 07/15	
DS5 1.6 BlueHdi 120	DV6FC	07/14 ⇒ 07/15	
DS5 1.6 HDi	DV6FC	11/13 ⇒ 07/15	
DS5 1.6 HDi 110	9HR(DV6C), DV6C	11/11 ⇒ 07/15	
DS5 1.6 HDi 115	DV6C, 5FV(EP6CDT)	06/12 ⇒ 07/15	
DS5 1.6 THP 150	EP6CDTMD	11/11 ⇒ 07/15	
DS5 1.6 THP 155	5FV(EP6CDT), 5FM(EP6DT)	11/11 ⇒ 07/15	
DS5 1.6 THP 165	5FM(EP6DT), 5GZ(EP6FDT)	01/12 ⇒ 07/15	
DS5 1.6 THP 165 Hybrid	5GZ(EP6FDT), 5FU(EP6DTX)	06/12 ⇒ 07/15	
DS5 1.6 THP 200	5FU(EP6DTX), AHW(DW10FC)	11/11 ⇒ 07/15	
DS5 1.6 THP 210	5GM(EP6FDTX)	11/14 ⇒ 07/15	
DS5 2.0 BlueHdi 135 Hybrid	AHS(DW10FD)	11/11 ⇒ 07/15	
DS5 2.0 BlueHdi 150	DW10FD	07/14 ⇒ 07/15	
DS5 2.0 BlueHdi 180	AHW(DW10FC), DW10CBDTR	08/13 ⇒ 07/15	
DS5 2.0 HDi 135	DW10CBDTR, DW10CTED4	11/11 ⇒ 07/15	
DS5 2.0 HDi 150 Hybrid	AHX(DW10FD)	11/11 ⇒ 07/15	
DS5 2.0 HDi 165	DW10CTED4, DW10CTED4	11/11 ⇒ 07/15	
DS5 2.0 HDi 165 Hybrid4 4x4	DW10CTED4, DV6C	12/11 ⇒ 07/15	
DS5 2.0 HDi 200 Hybrid4 Trazione integrale	DW10CTED4	12/11 ⇒ 07/15	

DS			
DS 5 1.6 BlueHdi 115	DV6C, BHZ(DV6FC)	06/15 ⇒	
DS 5 1.6 BlueHdi 120	BHZ(DV6FC), 5GZ(EP6FDT)	06/15 ⇒	
DS 5 1.6 THP 165	5GZ(EP6FDT), 5GM(EP6FDTX)	07/15 ⇒	
DS 5 1.6 THP 210	5GM(EP6FDTX), AHR(DW10FD)	04/15 ⇒	
DS 5 2.0 BlueHdi 135	DW10FDD	06/15 ⇒	
DS 5 2.0 BlueHdi 150	AHR(DW10FD), AHW(DW10FC)	04/15 ⇒	
DS 5 2.0 BlueHdi 180	AHW(DW10FC), DW10CTED4	04/15 ⇒	
DS 5 2.0 HDi 165 Hybrid4 4x4	DW10CTED4, EB2DTS	04/15 ⇒	
DS4 / DS4 CROSSBACK 1.2 THP 130	EB2DTS, BHZ(DV6FC)	07/15 ⇒	
DS4 / DS4 CROSSBACK 1.6 BlueHdi 100	DV6FD	04/16 ⇒	
DS4 / DS4 CROSSBACK 1.6 BlueHdi 115	DV6FC	07/15 ⇒	
DS4 / DS4 CROSSBACK 1.6 BlueHdi 120	BHZ(DV6FC), 5GZ(EP6FDT)	07/15 ⇒	
DS4 / DS4 CROSSBACK 1.6 THP 150	EP6CDTMD	10/16 ⇒	
DS4 / DS4 CROSSBACK 1.6 THP 165	5GZ(EP6FDT), 5GM(EP6FDTX)	07/15 ⇒	
DS4 / DS4 CROSSBACK 1.6 THP 210	5GM(EP6FDTX), AHR(DW10FD)	07/15 ⇒	
DS4 / DS4 CROSSBACK 2.0 BlueHdi 150	AHR(DW10FD), AHW(DW10FC)	07/15 ⇒	
DS4 / DS4 CROSSBACK 2.0 BlueHdi 180	AHW(DW10FC), EB2DTS	07/15 ⇒	

PEUGEOT			
307 1.4	K6D(TU3JP), ET3J4	08/00 ⇒	
307 1.4 16V	ET3J4, 8HX(DV4TD)	11/03 ⇒ 07/07	
307 1.4 HDi	8HX(DV4TD), N6A(TU5JP4)	10/01 ⇒ 06/05	
307 1.4 HDi 70	8HZ(DV4TD)	03/02 ⇒ 06/05	

PEUGEOT		
307 1.6	TU5JP4	07/06 → 04/12
307 1.6 16V	N6A(TU5JP4), --	08/00 →
307 1.6 BioFlex	--, 9HV(DV6ATED4)	07/06 →
307 1.6 HDi	9HV(DV6ATED4), 9HY(DV6TED4)	04/05 → 03/09
307 1.6 HDi 110	9HY(DV6TED4), 9HV(DV6ATED4)	02/04 → 03/09
307 1.6 HDi 90	9HV(DV6ATED4), EW10J4	12/06 → 04/08
307 2.0	EW10J4, EW10A	03/02 → 06/05
307 2.0 16V	EW10A, DW10ATED	08/00 → 04/09
307 2.0 HDi	DW10ATED, DW10ATED	01/03 →
307 2.0 HDi 110	DW10ATED, DW10BTED4	08/00 → 12/09
307 2.0 HDi 135	DW10BTED4, DW10TD	10/03 → 04/09
307 2.0 HDi 90	DW10TD, 8FS(EP3)	08/00 → 04/08
308 I 1.4 16V	8FS(EP3), 5FT(EP6DT)	09/07 →
308 I 1.6 16V	5FT(EP6DT), N6A(TU5JP4)	09/07 →
308 I 1.6 Bioflex	N6A(TU5JP4), 9HP(DV6DTED)	04/08 →
308 I 1.6 GTi	EP6CDTX	07/10 →
308 I 1.6 HDi	9HP(DV6DTED), EP6CDTM	09/07 →
308 I 1.6 THP	EP6CDTM, EW10A	10/10 →
308 I 2.0 Bioflex	EW10A, EW10A	01/08 →
308 I 2.0 CVVT	EW10A, DW10BTED4	07/09 → 11/14
308 I 2.0 HDi	DW10BTED4, EB2DTS	09/07 →
3008 1.2	EB2DTS, BHZ(DV6FC)	01/15 → 08/16
3008 1.6 BlueHdi 120	BHZ(DV6FC), 9HR(DV6C)	05/14 → 08/16
3008 1.6 HDi	9HR(DV6C), BHX(DV6FC)	06/09 → 08/16
3008 1.6 HDi 115 / BlueHdi 115	BHX(DV6FC), 5FV(EP6CDT)	02/13 → 08/16
3008 1.6 THP	5FV(EP6CDT), 5GZ(EP6FDT)	06/09 →
3008 1.6 THP [ExtraEU]	EP6CDTM	09/10 → 08/16
3008 1.6 Turbo	5GZ(EP6FDT), 5FS(EP6C)	05/14 → 08/16
3008 1.6 VTi	5FS(EP6C), DW10CB	06/09 → 08/16
3008 2.0 HDi	DW10CB, AHX(DW10FD)	06/09 →
3008 2.0 HDi 150 / BlueHdi 150	AHX(DW10FD), DW10CTED4	06/09 → 08/16
3008 2.0 HDi Hybrid4	DW10CTED4, K6D(TU3JP)	02/11 → 08/16
5008 1.2	EB2DTS, 5FS(EP6C)	01/15 →
5008 1.6 16V	5FS(EP6C), BHZ(DV6FC)	09/09 →
5008 1.6 BlueHdi 120	BHZ(DV6FC), 9HD(DV6CTED)	05/14 → 03/17
5008 1.6 HDi	9HD(DV6CTED), EP6CDTMD	09/09 →
5008 1.6 THP 150	EP6CDTMD, 5GZ(EP6FDT)	02/12 →
5008 1.6 THP 163	5GZ(EP6FDT), 5GZ(EP6FDT)	02/12 →
5008 1.6 THP 165	5GZ(EP6FDT), DW10CBFAPDTR	02/12 →
5008 2.0 HDi	DW10CBFAPDTR, AHV(DW10FD)	09/09 →
5008 2.0 HDi 136 / BlueHdi 136	AHV(DW10FD), AHR(DW10FD)	02/12 →
5008 2.0 HDi 150 / BlueHdi 150	AHR(DW10FD), EP6CDT	06/09 →
RCZ 1.6 16V	EP6CDT, 5FE(EP6CDTMD)	03/10 →
RCZ 1.6 THP	EP6CDTM	01/11 →
RCZ 1.6 THP 150	5FE(EP6CDTMD), 5FG(EP6CDTR)	03/11 → 12/15
RCZ 1.6 THP 270	5FG(EP6CDTR), DW10CTED4	06/13 → 12/15
RCZ 2.0 HDi	DW10CTED4, K9K728	03/10 → 12/15

21.0052



WHEEL SPEED SENSORS

Adatt./Suitable:

- ATE 10.0711-5152.3
- BOSCH 0 265 007 468 0 986 594 600
- RENAULT 82 00 043 136 82 00 296 571

MARKET DIFFUSION: HIGH



L	L1		OUT
850	---	Hall Effect	

RENAULT

GRAND SCÉNIC II 1.5 dCi	K9K728, K4M761	04/04 →
GRAND SCÉNIC II 1.6	K4M761, F9Q803	04/04 →
GRAND SCÉNIC II 1.9 dCi	F9Q803, F4R770	04/04 →
GRAND SCÉNIC II 2.0	F4R770, M9R700	04/04 →
GRAND SCÉNIC II 2.0 dCi	M9R700, K4J730	09/05 →
MEGANE II 1.4	K4J730, K4J730	08/03 →
MEGANE II 1.4 16V	K4J730, K9K722	11/02 → 02/08
MEGANE II 1.5 dCi	K9K722, K4M760	09/02 → 12/10
MEGANE II 1.6	K4M760, K4M760	08/03 →
MEGANE II 1.6 16V	K4M760, F9Q800	11/02 →
MEGANE II 1.6 Bifuel	K4M788	06/05 → 02/08
MEGANE II 1.9 dCi	F9Q800, F4R770	11/02 →
MEGANE II 2.0	F4R770, F4R770	08/03 →
MEGANE II 2.0 16V	F4R770, M9R700	11/02 → 02/08
MEGANE II 2.0 16V Turbo	F4R776	05/04 → 03/09
MEGANE II 2.0 dCi	M9R700, F4R774	09/05 →
MEGANE II 2.0 Renault Sport	F4R774, K4J730	05/04 → 10/09
MEGANE I 2.0 16V	F4R770	01/02 → 08/03
SCÉNIC II 1.4	K4J730, K9K722	06/03 →
SCÉNIC II 1.5 dCi	K9K722, K4M761	06/03 →
SCÉNIC II 1.6	K4M761, K4M764	06/03 →
SCÉNIC II 1.6 16V	K4M764, F9Q803	05/03 →
SCÉNIC II 1.6 BiFuel	K4M764	08/03 → 05/06
SCÉNIC II 1.6 Hi-Flex	K4M766	03/05 → 07/10
SCÉNIC II 1.9 dCi	F9Q803, F4R770	06/03 →
SCÉNIC II 1.9 dCi 130	F9Q804	10/05 → 12/09
SCÉNIC II 2.0	F4R770, M9R700	06/03 →
SCÉNIC II 2.0 16V Turbo	F4R776	05/04 →
SCÉNIC II 2.0 dCi	M9R700, K4M761	09/05 →
SCENIC 1.5 dCi	K9K728, K4M812	06/07 → 11/08
SCENIC 1.6	K4M812, F9Q816	07/07 → 05/09
SCENIC 1.9 dCi	F9Q816, K4J730	06/07 → 11/08

21.0053



WHEEL SPEED SENSORS

Adatt./Suitable:

- ATE 10.0711-5181.3
- BOSCH 0 986 594 604
- RENAULT 82 00 416 683

MARKET DIFFUSION: HIGH



L	L1		OUT
867	---	Hall Effect	

RENAULT

GRAND SCÉNIC II 1.5 dCi	K9K728, K4M761	04/04 →
GRAND SCÉNIC II 1.6	K4M761, F9Q803	04/04 →
GRAND SCÉNIC II 1.6 Flex	K4M766	06/06 → 11/08
GRAND SCÉNIC II 1.9 dCi	F9Q803, F4R770	04/04 →
GRAND SCÉNIC II 2.0	F4R770, M9R700	04/04 →
GRAND SCÉNIC II 2.0 dCi	M9R700, K4J730	09/05 →
MEGANE II 1.4	K4J730, K4J730	08/03 →
MEGANE II 1.4 16V	K4J730, K9K722	11/02 → 02/08
MEGANE II 1.5 dCi	K9K722, K4M760	09/02 → 12/10
MEGANE II 1.6	K4M760, K4M760	08/03 →
MEGANE II 1.6 16V	K4M760, F9Q800	11/02 →
MEGANE II 1.6 16V Hi-Flex	K4M856	02/08 → 07/09
MEGANE II 1.6 Bifuel	K4M788	06/05 → 02/08
MEGANE II 1.6 Flex-Fuel	K4M856	01/07 → 02/08
MEGANE II 1.6 LPG 16V	K4M760	01/06 → 08/09
MEGANE II 1.9 dCi	F9Q800, F4R770	11/02 →
MEGANE II 2.0	F4R770, F4R770	08/03 →
MEGANE II 2.0 16V	F4R770, M9R700	11/02 → 02/08
MEGANE II 2.0 16V Turbo	F4R776	05/04 → 03/09
MEGANE II 2.0 dCi	M9R700, F4R774	09/05 →
MEGANE II 2.0 Renault Sport	F4R774, K9K728	05/04 → 10/09
MEGANE I 2.0 16V	F4R770	01/02 → 08/03
SCÉNIC II 1.4	K4J730, K9K722	06/03 →
SCÉNIC II 1.5 dCi	K9K722, K4M761	06/03 →
SCÉNIC II 1.6	K4M761, K4M764	06/03 →
SCÉNIC II 1.6 16V	K4M764, F9Q803	05/03 →
SCÉNIC II 1.6 BiFuel	K4M764	08/03 → 05/06
SCÉNIC II 1.6 Hi-Flex	K4M766	03/05 → 07/10
SCÉNIC II 1.9 D	F9Q812	06/06 →
SCÉNIC II 1.9 dCi	F9Q803, F4R770	06/03 →
SCÉNIC II 1.9 dCi 130	F9Q804	10/05 → 12/09
SCÉNIC II 2.0	F4R770, M9R700	06/03 →
SCÉNIC II 2.0 16V Turbo	F4R776	05/04 →
SCÉNIC II 2.0 dCi	M9R700, K4M761	09/05 →
SCENIC 1.5 dCi	K9K728, K4M812	06/07 → 11/08
SCENIC 1.6	K4M812, F9Q816	07/07 → 05/09
SCENIC 1.9 dCi	F9Q816, K4J730	06/07 → 11/08

21.0054



04,5

21.0055



04,5

21.0056



04,5

WHEEL SPEED SENSORS

Adatt./Suitable:

ATE
10.0711-5151.3**BOSCH**
0 265 007 467**MERCEDES-BENZ**
2405400517
A 240 540 05 17**RENAULT**
82 00 043 135
82 00 296 570
82 00 346 992

MARKET DIFFUSION: HIGH



L	L1		OUT
539	---	Hall Effect	

WHEEL SPEED SENSORS

Adatt./Suitable:

ATE
10.0711-5180.3**BOSCH**
0 986 594 603**RENAULT**
82 00 404 460

MARKET DIFFUSION: HIGH



L	L1		OUT
775	---	Hall Effect	

WHEEL SPEED SENSORS

Adatt./Suitable:

BOSCH
0 265 008 922**DACIA**
47 91 012 92R
82 00 195 825
82 00 419 177**NISSAN**
47911-00Q0C**RENAULT**
47 91 012 92R
82 00 195 825
82 00 419 177

MARKET DIFFUSION: HIGH



L	L1		OUT
634	-	Hall Effect	

RENAULT

GRAND SCÉNIC II 1.5 dCi	K9K728	04/04 →
GRAND SCÉNIC II 1.6	K4M761, F9Q803	04/04 →
GRAND SCÉNIC II 1.9 dCi	F9Q803, F4R770	04/04 →
GRAND SCÉNIC II 2.0	F4R770, K4J730	04/04 →
MEGANE II 1.4	K4J730, K4J730	08/03 →
MEGANE II 1.4 16V	K4J730, K9K722	11/02 → 02/08
MEGANE II 1.5 dCi	K9K722, K4M760	09/02 → 12/10
MEGANE II 1.6	K4M760, K4M760	08/03 →
MEGANE II 1.6 16V	K4M760, F9Q800	11/02 →
MEGANE II 1.9 dCi	F9Q800, F4R770	11/02 →
MEGANE II 2.0	F4R770, F4R770	08/03 →
MEGANE II 2.0 16V	F4R770, K4J730	11/02 → 02/08
MEGANE II 2.0 16V Turbo	F4R776	05/04 → 03/09
MEGANE II 2.0 dCi	M9R722	09/05 →
MEGANE II 2.0 16V	F4R770	01/02 → 08/03
SCÉNIC II 1.4	K4J730, K9K722	06/03 →
SCÉNIC II 1.5 dCi	K9K722, K4M761	06/03 →
SCÉNIC II 1.6	K4M761, K4M764	06/03 →
SCÉNIC II 1.6 16V	K4M764, F9Q803	05/03 →
SCÉNIC II 1.6 BiFuel	K4M764	08/03 → 05/06
SCÉNIC II 1.9 dCi	F9Q803, F4R770	06/03 →
SCÉNIC II 2.0	F4R770, K9K728	06/03 →
SCÉNIC II 2.0 16V Turbo	F4R776	05/04 →

RENAULT

GRAND SCÉNIC II 1.5 dCi	K9K728, K4M761	04/04 →
GRAND SCÉNIC II 1.6	K4M761, F9Q803	04/04 →
GRAND SCÉNIC II 1.6 Flex	K4M766	06/06 → 11/08
GRAND SCÉNIC II 1.9 dCi	F9Q803, F4R770	04/04 →
GRAND SCÉNIC II 2.0	F4R770, M9R700	04/04 →
GRAND SCÉNIC II 2.0 dCi	M9R700, K4J730	09/05 →
MEGANE II 1.4	K4J730, K4J730	08/03 →
MEGANE II 1.4 16V	K4J730, K9K722	11/02 → 02/08
MEGANE II 1.5 dCi	K9K722, K4M760	09/02 → 12/10
MEGANE II 1.6	K4M760, K4M760	08/03 →
MEGANE II 1.6 16V	K4M760, F9Q800	11/02 →
MEGANE II 1.6 16V Hi-Flex	K4M856	02/08 → 07/09
MEGANE II 1.6 BiFuel	K4M788	06/05 → 02/08
MEGANE II 1.6 Flex-Fuel	K4M856	01/07 → 02/08
MEGANE II 1.6 LPG 16V	K4M760	01/06 → 08/09
MEGANE II 1.9 dCi	F9Q800, F4R770	11/02 →
MEGANE II 2.0	F4R770, F4R770	08/03 →
MEGANE II 2.0 16V	F4R770, M9R700	11/02 → 02/08
MEGANE II 2.0 16V Turbo	F4R776	05/04 → 03/09
MEGANE II 2.0 dCi	M9R700, K9K728	09/05 →
MEGANE II 2.0 16V	F4R770	01/02 → 08/03
SCÉNIC II 1.4	K4J730, K9K722	06/03 →
SCÉNIC II 1.5 dCi	K9K722, K4M761	06/03 →
SCÉNIC II 1.6	K4M761, K4M764	06/03 →
SCÉNIC II 1.6 16V	K4M764, F9Q803	05/03 →
SCÉNIC II 1.6 BiFuel	K4M764	08/03 → 05/06
SCÉNIC II 1.6 Hi-Flex	K4M766	03/05 → 07/10
SCÉNIC II 1.9 D	F9Q812	06/06 →
SCÉNIC II 1.9 dCi	F9Q803, F4R770	06/03 →
SCÉNIC II 1.9 dCi 130	F9Q804	10/05 → 12/09
SCÉNIC II 2.0	F4R770, M9R700	06/03 →
SCÉNIC II 2.0 16V Turbo	F4R776	05/04 →
SCÉNIC II 2.0 dCi	M9R700, K7J710	09/05 →
SCENIC 1.5 dCi	K9K728, K4M812	06/07 → 11/08
SCENIC 1.6	K4M812, F9Q816	07/07 → 05/09
SCENIC 1.9 dCi	F9Q816, K4J730	06/07 → 11/08

DACIA

LOGAN 1.6 Hi-Flex	K7M714	01/11 → 10/12
LOGAN I 1.0	D4D760	12/05 →
LOGAN I 1.0 Hi-Flex	D4D760	01/11 → 10/12
LOGAN I 1.2 16V	D4F732	02/06 →
LOGAN I 1.2 16V LPG	D4F734	02/06 →
LOGAN I 1.4	K7J710	09/04 →
LOGAN I 1.4 MPI LPG	K7J710, K9K790	02/06 →
LOGAN I 1.5 dCi	K9K790, K7M710	09/05 →
LOGAN I 1.6	K7M710, K4M690	09/04 →
LOGAN I 1.6 16V	K4M690, K4M690	12/05 →
LOGAN I 1.6 16V Flexifuel	K4M696	07/10 →
LOGAN I 1.6 16V Hi-Flex	K4M690, K7M710	11/09 →
LOGAN I 1.6 BiFuel	K7M710, D4F732	11/08 →
LOGAN I 1.6 LPG	K7M718	08/04 → 12/12
LOGAN I 1.6 MPI 85	K7M800	05/10 →
SANDERO I 1.0 Hi-Flex	D4D760	01/11 → 12/12
SANDERO I 1.2 16V	D4F732	11/08 →
SANDERO I 1.2 16V LPG	D4F732, K9K790	11/08 →
SANDERO I 1.4	K7J710	06/08 →
SANDERO I 1.4 MPI LPG	K7J714	01/09 →
SANDERO I 1.5 dCi	K9K790, K7M710	06/08 →
SANDERO I 1.6	K7M710, K4M690	06/08 →
SANDERO I 1.6 16V	K4M690, K4M690	07/11 →
SANDERO I 1.6 16V BiFuel	K4M690, K7M718	01/11 →
SANDERO I 1.6 Hi-Flex	K7M732	06/08 → 12/12
SANDERO I 1.6 LPG	K7M718, K4M490	06/08 → 12/12
SANDERO I 1.6 MPI 85	K7M800	05/10 →

NISSAN

ALMERA III 1.6	K4M	11/12 →
BLUEBIRD SYLPHY 1.6	K4M490, M4R700	12/12 →

RENAULT

CLIO 1.2 Hi-Flex	D4F742	11/07 → 12/09
CLIO 2.0	M4R700, D4F740	11/07 → 12/12
CLIO III 1.2	D4F740, D4F740	10/05 →
CLIO III 1.2 16V	D4F740, D4F740	06/05 →
CLIO III 1.2 16V Hi-Flex	D4F740, K9K750	07/08 →
CLIO III 1.2 Ethanol	D4F742	07/08 →
CLIO III 1.4 16V	K4J780	06/05 →
CLIO III 1.5 dCi	K9K750, K4M800	05/05 →
CLIO III 1.6 16V	K4M800, M4R700	06/05 →
CLIO III 1.6 16V GT	K4M862	06/09 →
CLIO III 2.0 16V	M4R700, K9K790	09/06 →
LOGAN 1.0	D4D760	12/05 →
LOGAN 1.2 16V	D4F732	02/06 →
LOGAN 1.4	K7J710	09/04 →
LOGAN 1.4 LPG	K7J714	02/08 → 10/13
LOGAN 1.5 dCi	K9K790, K4M690	09/05 →

RENAULT		
LOGAN 1.6	K4M690, D4F740	09/04 →
LOGAN 1.6 16V	K4M694	12/05 →
LOGAN 1.6 MPI 85	K7M800	05/10 →
LOGAN EXPRESS 1.5 dCi	K9K792	04/07 →
LOGAN EXPRESS 1.6	K7M710	04/07 →
MODUS 1.4	K4J770, K4M697	04/06 → 12/13
MODUS / GRAND MODUS 1.2	D4F740, D4F740	12/04 →
MODUS / GRAND MODUS 1.2 16V	D4F784	05/07 →
MODUS / GRAND MODUS 1.2 16V Hi-Flex	D4F740, K4J770	10/08 →
MODUS / GRAND MODUS 1.2 GPL	D4F744	05/08 → 12/12
MODUS / GRAND MODUS 1.4	K4J770, K9K750	12/04 →
MODUS / GRAND MODUS 1.5 dCi	K9K750, K9K750	09/04 →
MODUS / GRAND MODUS 1.5 dCi 75	K9K770	10/10 →
MODUS / GRAND MODUS 1.5 dCi 90	K9K750, K4M790	10/10 →
MODUS / GRAND MODUS 1.6	K4M790, K4J770	12/04 →
SANDERO 1.2 16V	D4F732	11/08 →
SANDERO 1.4	K7J710	02/09 →
SANDERO 1.4 LPG	K7J714	02/09 →
SANDERO 1.5 dCi	K9K790	04/07 →
SANDERO 1.6	K4M697, 8FN(EP3)	12/07 →
SANDERO 1.6 MPI 85	K7M800	05/10 →

PEUGEOT		
207 1.4	KFT(TU3A), 8FR(EP3)	02/06 →
207 1.4 16V	8FR(EP3), 8HR(DV4C)	02/06 →
207 1.4 BiFuel	TU3A	08/07 → 12/13
207 1.4 Flex	KFW(TU3A)	11/08 →
207 1.4 HDi	8HR(DV4C), 5FS(EP6C)	02/06 →
207 1.4 LPG	TU3A	08/07 → 12/12
207 1.6	N6A(TU5JP4)	08/08 →
207 1.6 16V	5FS(EP6C), 5FY(EP6DTS)	02/06 →
207 1.6 16V RC	5FY(EP6DTS), 5FR(EP6DT)	02/07 →
207 1.6 16V Turbo	5FR(EP6DT), 5FS(EP6C)	02/06 →
207 1.6 16V VTi	5FS(EP6C), 9HP(DV6DTEd)	02/07 →
207 1.6 Bioflex	N6A(TU5JP4)	01/08 →
207 1.6 HDi	9HP(DV6DTEd), 9HR(DV6C)	02/06 →
207 1.6 HDi 110	9HR(DV6C), 5FS(EP6C)	08/09 →
207 1.6 VTi	EP6	03/07 → 12/12
207 1.6 VTi [ExtraEU]	EP6	09/08 → 12/12
207 CC 1.6 16V	5FS(EP6C), 5FR(EP6DT)	02/07 →
207 CC 1.6 16V Turbo	5FR(EP6DT), 9HR(DV6C)	02/07 →
207 CC 1.6 HDi	9HR(DV6C), E80	02/07 →
208 1.0	E80, EB2	03/12 →
208 1.2	EB2, EB2ADT	03/12 →
208 1.2 GPL	HMZ(EB2F)	06/15 →
208 1.2 THP	EB2ADT, 8HP(DV4C)	01/13 →
208 1.2 VTi	HMZ(EB2)	09/13 →
208 1.4 HDi	8HP(DV4C), 8FS(EP3)	03/12 →
208 1.4 VTi	8FS(EP3), 5FS(EP6C)	03/12 →
208 1.6	5FS(EP6C), 9HP(DV6DTEd)	02/12 →
208 1.6 BlueHdi 100	BHY(DV6FD)	01/15 →
208 1.6 BlueHdi 120	BHZ(DV6FC)	11/13 →
208 1.6 BlueHdi 75	BHW(DV6FE)	04/15 →
208 1.6 GTi	5FU(EP6CDTX)	08/12 →
208 1.6 HDi	9HP(DV6DTEd), 9HK(DV6ETEDM)	03/12 →
208 1.6 HDi / BlueHdi 75	9HK(DV6ETEDM), EB2M	01/13 →
208 1.6 HDi 90	9HJ(DV6DTEdM)	03/12 →
208 1.6 THP 210	5GM(EP6FTX)	04/15 →
301 1.2	HMZ(EB2F)	11/12 →
301 1.2 VTi 72	EB2M, 9HF(DV6DTEd)	11/12 →
301 1.6 HDi 100	BHY(DV6FD)	11/12 →
301 1.6 HDi 90	9HF(DV6DTEd), ECS	11/12 →
301 1.6 VTi 115	ECS, HFX(TU1A)	11/12 →

21.0061

04,5

WHEEL SPEED SENSORS

Adatt./Suitable:

- ATE 10.0711-5093.3
- BOSCH 0 986 594 552
- CITROËN 4545 98 96 385 307 80
- PEUGEOT 4545 98

MARKET DIFFUSION: HIGH



21.0060

04,5

WHEEL SPEED SENSORS

Adatt./Suitable:

- BOSCH 0 265 008 485
- CITROËN 4545 E5 4545 J8 96 655 923 80
- PEUGEOT 4545 E5 4545 J8

MARKET DIFFUSION: HIGH



L	L1	Hall Effect	OUT
763	27	Hall Effect	

L	L1	Hall Effect	OUT
782	30,8	Hall Effect	

CITROËN		
C3 PICASSO 1.2 THP 110	HNZ(EB2DT)	01/15 →
C3 PICASSO 1.4	EP3C	02/09 →
C3 PICASSO 1.4 VTi 95	8FN(EP3), 8FN(EP3)	02/09 →
C3 PICASSO 1.4 VTi 95 LPG	8FN(EP3), 9HX(DV6ATED4)	01/12 →
C3 PICASSO 1.6 BlueHdi 100	BHY(DV6FD)	01/15 →
C3 PICASSO 1.6 HDi	9HX(DV6ATED4), 9HR(DV6C)	02/09 →
C3 PICASSO 1.6 HDi 110	9HR(DV6C), 9HD(DV6C)	05/10 →
C3 PICASSO 1.6 HDi 115	9HD(DV6C), 9HP(DV6DTEd)	01/13 →
C3 PICASSO 1.6 HDi 90	9HP(DV6DTEd), 5FS(EP6C)	07/10 →
C3 PICASSO 1.6 VTi	EP6	07/09 →
C3 PICASSO 1.6 VTi 120	5FS(EP6C), EB2M	02/09 →
C-ELYSEE 1.2 VTi 72	EB2M, 9HJ(DV6DTEdM)	11/12 →
C-ELYSEE 1.2 VTi 82	EB2F	12/14 →
C-ELYSEE 1.6 BlueHdi 100	BHY(DV6FD)	11/14 →
C-ELYSEE 1.6 HDi 92	9HJ(DV6DTEdM), ECS	11/12 →
C-ELYSEE 1.6 VTi 115	ECS, KFT(TU3A)	11/12 →

CITROËN		
C2 1.1	HFX(TU1A), KFU(TU3JP)	09/03 →
C2 1.4	KFU(TU3JP), ET3J4	09/03 →
C2 1.4 16V	ET3J4, 8HX(DV4TD)	06/06 →
C2 1.4 HDi	8HX(DV4TD), NFU(TU5JP4)	09/03 →
C2 1.6	NFU(TU5JP4), 9HZ(DV6TED4)	09/03 →
C2 1.6 HDi	9HZ(DV6TED4), NFS(TU5JP4S)	09/05 →
C2 1.6 VTS	NFS(TU5JP4S), HFX(TU1A)	01/05 →
C3 I 1.1 i	HFX(TU1A), ET3J4	02/02 →
C3 I 1.1 LPG	TU1A	06/06 → 12/09
C3 I 1.4 16V	ET3J4, 8HY(DV4TED4)	12/03 →
C3 I 1.4 16V HDi	8HY(DV4TED4), 8HX(DV4TD)	02/02 →
C3 I 1.4 BiFuel	TU3JP	09/08 → 12/09
C3 I 1.4 HDi	8HX(DV4TD), KFU(TU3A)	02/02 →
C3 I 1.4 i	KFU(TU3A), KFU(TU3JP)	02/02 →
C3 I 1.4 i Bivalent	KFU(TU3JP), N6A(TU5JP4)	02/02 →
C3 I 1.6 16V	N6A(TU5JP4), 9HX(DV6ATED4)	02/02 →
C3 I 1.6 16V HDi	9HX(DV6ATED4), KFU(TU3A)	09/05 →
C3 I PLURIEL 1.4	KFU(TU3A), 8HX(DV4TD)	05/03 →
C3 I PLURIEL 1.4 HDi	8HX(DV4TD), NFU(TU5JP4)	04/04 →
C3 I PLURIEL 1.4 Hybrid	KFU(TU3JP)	05/05 →
C3 I PLURIEL 1.6	NFU(TU5JP4), K6E(TU3A)	05/03 →
C3 II 1.1 BiFuel	HFX(TU1A)	11/10 →
C3 II 1.4	K6E(TU3A), HNV(EB2DTM)	11/09 →
C3 II 1.4 HDi 70	8HZ(DV4TD)	11/09 →
C3 II 1.4 LPG	KFT(TU3A)	07/10 →
C3 II 1.6 Flex	NFX(TU5JP4)	11/09 →
C3 II 1.6 HDi 90	9HX(DV6ATED4)	11/09 →
C3 III 1.2 THP 110	HNV(EB2DTM), KFU(TU3A)	07/16 →
C3 III 1.2 VTi 82	HMZ(EB2F)	07/16 →

PEUGEOT		
1007 1.4	KFU(TU3A), ET3J4	04/05 →
1007 1.4 16V	ET3J4, 8HX(DV4TD)	10/05 →
1007 1.4 HDi	8HX(DV4TD), NFU(TU5JP4)	04/05 →
1007 1.6 16V	NFU(TU5JP4), 9HZ(DV6TED4)	04/05 →
1007 1.6 HDi	9HZ(DV6TED4), HFX(TU1A)	06/07 →

21.0062



04,5

21.0063



04,5

WHEEL SPEED SENSORS

Adatt./Suitable:

ATE

10.0711-5124.3

BOSCH

0 986 594 551

CITROËN

4545 97

96 387 201 80

PEUGEOT

4545 97

MARKET DIFFUSION: HIGH



L	L1		
1145	34,3	Hall Effect	

CITROËN

C2 1.1	HFX(TU1A), KFU(TU3JP)	09/03 ⇨
C2 1.4	KFU(TU3JP), ET3J4	09/03 ⇨
C2 1.4 16V	ET3J4, 8HX(DV4TD)	06/06 ⇨
C2 1.4 HDi	8HX(DV4TD), NFU(TU5JP4)	09/03 ⇨
C2 1.6	NFU(TU5JP4), 9HZ(DV6TED4)	09/03 ⇨
C2 1.6 HDi	9HZ(DV6TED4), NFS(TU5JP4S)	09/05 ⇨
C2 1.6 VTS	NFS(TU5JP4S), HFX(TU1A)	01/05 ⇨
C3 1.1 i	HFX(TU1A), ET3J4	02/02 ⇨
C3 1.1 LPG	TU1A	06/06 ⇨ 12/09
C3 1.4 16V	ET3J4, 8HY(DV4TED4)	12/03 ⇨
C3 1.4 16V HDi	8HY(DV4TED4), 8HX(DV4TD)	02/02 ⇨
C3 1.4 BiFuel	TU3JP	09/08 ⇨ 12/09
C3 1.4 HDi	8HX(DV4TD), KFU(TU3A)	02/02 ⇨
C3 1.4 i	KFU(TU3A), KFU(TU3JP)	02/02 ⇨
C3 1.4 i Bivalent	KFU(TU3JP), N6A(TU5JP4)	02/02 ⇨
C3 1.6 16V	N6A(TU5JP4), 9HX(DV6ATED4)	02/02 ⇨
C3 1.6 16V HDi	9HX(DV6ATED4), KFU(TU3A)	09/05 ⇨
C3 1 PLURIEL 1.4	KFU(TU3A), 8HX(DV4TD)	05/03 ⇨
C3 1 PLURIEL 1.4 HDi	8HX(DV4TD), NFU(TU5JP4)	04/04 ⇨
C3 1 PLURIEL 1.4 Hybrid	KFU(TU3JP)	05/05 ⇨
C3 1 PLURIEL 1.6	NFU(TU5JP4), K6E(TU3A)	05/03 ⇨
C3 II 1.1 BiFuel	HFX(TU1A)	11/10 ⇨
C3 II 1.4	K6E(TU3A), HNV(EB2DTM)	11/09 ⇨
C3 II 1.4 HDi 70	8HZ(DV4TD)	11/09 ⇨
C3 II 1.4 LPG	KFT(TU3A)	07/10 ⇨
C3 II 1.6 Flex	NFX(TU5JP4)	11/09 ⇨
C3 II 1.6 HDi 90	9HX(DV6ATED4)	11/09 ⇨
C3 III 1.2 THP 110	HNV(EB2DTM), KFU(TU3A)	07/16 ⇨
C3 III 1.2 VTi 82	HMZ(EB2F)	07/16 ⇨

PEUGEOT

1007 1.4	KFU(TU3A), ET3J4	04/05 ⇨
1007 1.4 16V	ET3J4, 8HX(DV4TD)	10/05 ⇨
1007 1.4 HDi	8HX(DV4TD), NFU(TU5JP4)	04/05 ⇨
1007 1.6 16V	NFU(TU5JP4), 9HZ(DV6TED4)	04/05 ⇨
1007 1.6 HDi	9HZ(DV6TED4), ET3J4	06/07 ⇨

WHEEL SPEED SENSORS

Adatt./Suitable:

CITROËN

4545 08

4545 L0

96 653 868 80

DS

4545 L0

PEUGEOT

4545 08

4545 L0

MARKET DIFFUSION: HIGH



L	L1		
815	---	Hall Effect	

CITROËN

C4 I 1.4 16V	ET3J4, NFU(TU5JP4)	11/04 ⇨ 07/11
C4 I 1.6 16V	NFU(TU5JP4), N6A(TU5JP4)	11/04 ⇨ 07/11
C4 I 1.6 16V Bio-Flex	N6A(TU5JP4), 9HV(DV6TED4)	09/07 ⇨
C4 I 1.6 16V Flex Fuel	N6A(TU5JP4)	02/09 ⇨
C4 I 1.6 Flex	--	02/09 ⇨ 07/11
C4 I 1.6 HDi	9HV(DV6TED4), EW10A	11/04 ⇨
C4 I 1.6 THP 140	5FT(EP6DT)	07/08 ⇨ 07/11
C4 I 1.6 THP 150	5FX(EP6DT)	07/08 ⇨ 07/11
C4 I 1.6 VTi 120	5FW(EP6)	07/08 ⇨ 07/11
C4 I 2.0 16V	EW10A, DW10ATED	11/04 ⇨ 07/11
C4 I 2.0 HDi	DW10ATED, EB2DT	11/04 ⇨ 07/11
C4 I 2.0 VTR	EW10A	10/06 ⇨ 12/07
C4 II 1.2 THP 110	EB2DT, EB2DTS	02/15 ⇨
C4 II 1.2 THP 130	EB2DTS, 8FP(EP3)	04/14 ⇨
C4 II 1.4 16V	EP3C	11/09 ⇨
C4 II 1.4 VTi 95	8FP(EP3), DV6FC	11/09 ⇨
C4 II 1.6	EP6C	01/13 ⇨
C4 II 1.6 16V	EP6FDTX	10/10 ⇨
C4 II 1.6 BlueHdi	DV6FC, BHV(DV6FD)	07/14 ⇨
C4 II 1.6 BlueHdi 100	BHY(DV6FD), BHX(DV6FC)	07/14 ⇨
C4 II 1.6 BlueHdi 115	BHX(DV6FC), BHZ(DV6FC)	08/14 ⇨
C4 II 1.6 BlueHdi 120	BHZ(DV6FC), DV6C	02/15 ⇨
C4 II 1.6 Flex	NFX(TU5JP4)	11/09 ⇨
C4 II 1.6 HDi	DV6C, 9HR(DV6C)	11/09 ⇨
C4 II 1.6 HDi 110	9HR(DV6C), 9HD(DV6C)	11/09 ⇨
C4 II 1.6 HDi 115	9HD(DV6C), 9HP(DV6TEDM)	07/12 ⇨
C4 II 1.6 HDi 90	9HJ(DV6TEDM), 5FV(EP6CDT)	11/09 ⇨
C4 II 1.6 HDi 92	9HJ(DV6TEDM)	07/10 ⇨
C4 II 1.6 THP 155	5FV(EP6CDT), 5FS(EP6C)	11/09 ⇨
C4 II 1.6 VTi 120	5FS(EP6C), 5FS(EP6C)	11/09 ⇨
C4 II 1.6 VTi 120 LPG	5FS(EP6C), DW10CFAPDTR	09/11 ⇨
C4 II 2.0 Flex	RFJ(EW10A)	11/09 ⇨
C4 II 2.0 HDi	DW10CFAPDTR, DW10CTED4	10/10 ⇨
C4 II 2.0 HDi / BlueHdi 150	DW10CTED4, EB2DTS	11/09 ⇨
C4 II 2.0 HDi / BlueHdi 160	DW10CTED4	10/10 ⇨
DS4 1.2 THP 130	EB2DTS, BHX(DV6FC)	07/14 ⇨ 07/15
DS4 1.6 BlueHdi 115	BHX(DV6FC), BHZ(DV6FC)	07/14 ⇨ 07/15
DS4 1.6 BlueHdi 120	BHZ(DV6FC), 9HR(DV6C)	07/14 ⇨ 07/15
DS4 1.6 HDi 110	9HR(DV6C), 9HD(DV6C)	04/11 ⇨ 07/15
DS4 1.6 HDi 115	9HD(DV6C), 9HP(DV6TED)	08/12 ⇨ 07/15
DS4 1.6 HDi 90	9HP(DV6TED), 5FV(EP6CDT)	05/11 ⇨ 07/15
DS4 1.6 THP 150	EP6CDTMD	04/11 ⇨ 07/15
DS4 1.6 THP 155	5FV(EP6CDT), 5FM(EP6DT)	04/11 ⇨ 07/15

CITROËN

DS4 1.6 THP 160	5FM(EP6DT), 5FM(EP6DT)	04/12 ⇨ 07/15
DS4 1.6 THP 165	5FM(EP6DT), 5FU(EP6DTX)	01/12 ⇨ 07/15
DS4 1.6 THP 200	5FU(EP6DTX), 5FS(EP6C)	04/11 ⇨ 07/15
DS4 1.6 THP 210	5GM(EP6FDTX)	07/15 ⇨ 07/15
DS4 1.6 VTi 120	5FS(EP6C), AHX(DW10FD)	04/11 ⇨ 07/15
DS4 2.0 BlueHdi 150	AHX(DW10FD), AHW(DW10FC)	07/14 ⇨ 07/15
DS4 2.0 BlueHdi 150 Hybrid	AHR(DW10FD)	07/14 ⇨ 07/15
DS4 2.0 BlueHdi 180	AHW(DW10FC), AHS(DW10FD)	07/14 ⇨ 07/15
DS4 2.0 HDi / BlueHdi 135	AHS(DW10FD), DW10CTED4	09/11 ⇨ 07/15
DS4 2.0 HDi 165	DW10CTED4, EB2DTS	04/11 ⇨ 07/15

DS

DS4 / DS4 CROSSBACK 1.2 THP 130	EB2DTS, BHZ(DV6FC)	07/15 ⇨
DS4 / DS4 CROSSBACK 1.6 BlueHdi 100	DV6FD	04/16 ⇨
DS4 / DS4 CROSSBACK 1.6 BlueHdi 115	DV6FC	07/15 ⇨
DS4 / DS4 CROSSBACK 1.6 BlueHdi 120	BHZ(DV6FC), 5GZ(EP6FDT)	07/15 ⇨
DS4 / DS4 CROSSBACK 1.6 THP 150	EP6CDTMD	10/16 ⇨
DS4 / DS4 CROSSBACK 1.6 THP 165	5GZ(EP6FDT), 5GM(EP6FDTX)	07/15 ⇨
DS4 / DS4 CROSSBACK 1.6 THP 210	5GM(EP6FDTX), AHR(DW10FD)	07/15 ⇨
DS4 / DS4 CROSSBACK 2.0 BlueHdi 150	AHR(DW10FD), AHW(DW10FC)	07/15 ⇨
DS4 / DS4 CROSSBACK 2.0 BlueHdi 180	AHW(DW10FC), --	07/15 ⇨

PEUGEOT

307 1.6	TU5JP4	07/06 ⇨ 04/12
307 1.6 16V	NFU(TU5JP4)	03/03 ⇨ 04/09
307 1.6 BioFlex	--, 9HV(DV6ATED4)	07/06 ⇨
307 1.6 HDi	9HV(DV6ATED4), 9HV(DV6ATED4)	04/05 ⇨ 03/09
307 1.6 HDi 110	DV6TED4	02/04 ⇨ 04/08
307 1.6 HDi 90	9HV(DV6ATED4), EW10A	12/06 ⇨ 04/08
307 2.0 16V	EW10A, 8FS(EP3)	12/04 ⇨ 04/09
307 2.0 HDi	RHZ(DW10ATED)	06/05 ⇨
307 2.0 HDi 110	RHS(DW10ATED)	03/02 ⇨ 12/09
307 2.0 HDi 135	RHR(DW10ATED)	06/05 ⇨ 04/09
308 1.4 16V	8FS(EP3), 5FT(EP6DT)	09/07 ⇨
308 1.6 16V	5FT(EP6DT), N6A(TU5JP4)	09/07 ⇨
308 1.6 Bioflex	N6A(TU5JP4), 9HP(DV6ATED)	04/08 ⇨
308 1.6 GTi	EP6CDT	07/10 ⇨
308 1.6 HDi	9HP(DV6ATED), EP6CDT	09/07 ⇨
308 1.6 THP	EP6CDT, EW10A	10/10 ⇨
308 1.2.0 Bioflex	EW10A, EW10A	01/08 ⇨
308 1.2.0 CVT	EW10A, DW10ATED4	07/09 ⇨ 11/14
308 1.2.0 HDi	DW10ATED4, F9Q680	09/07 ⇨

21.0069



04,5

WHEEL SPEED SENSORS

Adatt./Suitable:

ATE

10.0711-5094.1

BOSCH

0 986 594 602

RENAULT

82 00 001 595

82 00 084 125

MARKET DIFFUSION: MEDIUM



L	L1		OUT 
607	---	Hall Effect	

RENAULT

ESPACE IV 1.9 dCi	F9Q680, F4R790	11/02 →
ESPACE IV 2.0	F4R790, M9R740	11/02 →
ESPACE IV 2.0 dCi	M9R740, F4R794	01/06 →
ESPACE IV 2.0 Turbo	F4R794, G9T645	11/02 →
ESPACE IV 2.2 dCi	G9T645, P9X701	11/02 →
ESPACE IV 3.0 dCi	P9X701, V4Y711	11/02 →
ESPACE IV 3.5 V6	V4Y711, K4M710	11/02 →
LAGUNA II 1.6	K4M710	03/01 → 10/05
LAGUNA II 1.6 16V	K4M710, F4P770	03/01 →
LAGUNA II 1.6 Bifuel	K4M714	06/05 → 12/07
LAGUNA II 1.6 LPG	K4M714	03/01 → 05/05
LAGUNA II 1.8 16V	F4P770, F9Q650	03/01 →
LAGUNA II 1.9 dCi	F9Q650, F4R712	03/01 →
LAGUNA II 2.0 16V	F4R712, F5R700	08/02 → 12/07
LAGUNA II 2.0 16V IDE	F5R700, F4R764	04/01 → 09/07
LAGUNA II 2.0 16V Turbo	F4R764, M9R740	01/03 → 08/05
LAGUNA II 2.0 dCi	M9R740, G9T600	08/05 → 12/07
LAGUNA II 2.2 dCi	G9T600, L7X731	03/01 →
LAGUNA II 2.9 V6 24V	L7X731, L7X731	03/01 → 12/07
LAGUNA II 3.0 V6 24V	L7X731, F4R766	03/01 →
VEL SATIS 2.0 16 V Turbo	F4R766, F4R762	04/04 →
VEL SATIS 2.0 16V Turbo	F4R762, M9R760	06/02 →
VEL SATIS 2.0 dCi	M9R760, F4R767	08/05 →
VEL SATIS 2.0 Turbo	F4R767, G9T600	04/05 →
VEL SATIS 2.2 dCi	G9T600, P9X701	06/02 →
VEL SATIS 3.0 dCi	P9X701, V4Y701	06/02 →
VEL SATIS 3.5	V4Y715	10/04 →
VEL SATIS 3.5 V6	V4Y701, M4R700	06/02 →

21.0070



04,5

WHEEL SPEED SENSORS

Adatt./Suitable:

BOSCH

0 265 008 923

RENAULT

47 90 041 90R

82 00 195 832

MARKET DIFFUSION: HIGH



L	L1		OUT 
661	---	Hall Effect	

RENAULT

CLIO 1.2 Hi-Flex	D4F742	11/07 → 12/09
CLIO 2.0	M4R700, D4F740	11/07 → 12/12
CLIO III 1.2	D4F740, D4F740	10/05 →
CLIO III 1.2 16V	D4F740, D4F740	06/05 →
CLIO III 1.2 16V Hi-Flex	D4F740, K9K750	07/08 →
CLIO III 1.2 Ethanol	D4F742	07/08 →
CLIO III 1.4 16V	K4J780	06/05 →
CLIO III 1.5 dCi	K9K750, K4M800	05/05 →
CLIO III 1.6 16V	K4M800, M4R700	06/05 →
CLIO III 1.6 16V GT	K4M862	06/09 →
CLIO III 2.0 16V	M4R700, D4F740	09/06 →
MODUS 1.4	K4J770, CR12DE	04/06 → 12/13
MODUS / GRAND MODUS 1.2	D4F740, D4F740	12/04 →
MODUS / GRAND MODUS 1.2 16V	D4F784	05/07 →
MODUS / GRAND MODUS 1.2 16V Hi-Flex	D4F740, K4J770	10/08 →
MODUS / GRAND MODUS 1.2 GPL	D4F744	05/08 → 12/12
MODUS / GRAND MODUS 1.4	K4J770, K9K750	12/04 →
MODUS / GRAND MODUS 1.5 dCi	K9K750, K9K750	09/04 →
MODUS / GRAND MODUS 1.5 dCi 75	K9K770	10/10 →
MODUS / GRAND MODUS 1.5 dCi 90	K9K750, K4M790	10/10 →
MODUS / GRAND MODUS 1.6	K4M790, K4J770	12/04 →

21.0071



04,5

WHEEL SPEED SENSORS

Adatt./Suitable:

BOSCH

0 265 007 537

NISSAN

47910-AX600

47910-AX610

MARKET DIFFUSION: MEDIUM



L	L1		OUT 
1175	---	Hall Effect	

NISSAN

MICRA III 1.0 16V	CG10DE	01/03 → 06/10
MICRA III 1.2	CR12DE, CG12DE	10/03 → 06/10
MICRA III 1.2 16V	CG12DE, CG12DELPG	01/03 → 06/10
MICRA III 1.2 LPG	CG12DELPG, K9K276	10/02 → 06/10
MICRA III 1.3	CGA3DE	08/04 →
MICRA III 1.4 16V	CR14DE	01/03 → 06/10
MICRA III 1.5 dCi	K9K276, K9K276	01/03 → 06/10
MICRA III 160 SR	HR16DE	05/05 → 06/10
MICRA C+C 1.4 16V	CR14DE	08/05 →
MICRA C+C 1.6 160 SR	HR16DE	08/05 →
NOTE I 1.4	CR14DE	03/06 → 06/12
NOTE I 1.4 LPG	CR14DE	01/06 → 08/13
NOTE I 1.5 dCi	K9K276, 169A4.000	03/06 → 06/12
NOTE I 1.6	HR16DE	03/06 → 06/12

21.0074



04,5

WHEEL SPEED SENSORS

Adatt./Suitable:

BOSCH
0 265 008 005**FIAT**
51713211
51791153MARKET DIFFUSION: **HIGH**

L	L1	Hall Effect	OUT +
765	27,9	Hall Effect	

FIAT			
PANDA I 1.1	187A1.000	09/00 ⇨ 02/04	
PANDA I 1.1 AWD	187A1.000	09/00 ⇨ 02/04	
PANDA II 1.1	--	09/03 ⇨	
PANDA II 1.2	169A4.000, 169A4.000	09/03 ⇨	
PANDA II 1.2 Bipower	188A4.000	09/04 ⇨ 12/11	
PANDA II 1.2 Bi-Power / Natural Power	--	04/09 ⇨	
PANDA II 1.2 Euro 4	--	04/09 ⇨	
PANDA II 1.2 Euro 5	--	04/09 ⇨	
PANDA II 1.2 LPG	169A4.000, --	04/09 ⇨	
PANDA II 1.2 Natural Power	188A4.000	01/07 ⇨ 12/11	
PANDA II 1.3 D Multijet	--, N47D20A	09/03 ⇨	
PANDA II 1.4	169A3.000	10/06 ⇨	

21.0076



04,5

WHEEL SPEED SENSORS

Adatt./Suitable:

ATE
10.0711-6198.3**BMW**
34 52 6 762 465
6 762 465**BOSCH**
0 986 594 519**ITEM NOW AVAILABLE FROM PRODUCTION**

- ARTICOLO ORA DISPONIBILE PER LA VENDITA
- ARTICLE DISPONIBLE EN PRODUCTION COURANTE
- JETZT ZUM VERKAUF VERFÜGBARER ARTIKEL
- ARTICULO AHORA DISPONIBLE EN PRODUCCION

MARKET DIFFUSION: **HIGH**

L	L1	Hall Effect	+ OUT
667	31	Hall Effect	

BMW			
1 I 116 d	N47D20A, N43B16A	11/08 ⇨ 09/12	
1 I 116 i	N43B16A, M47D20(204D4)	11/03 ⇨ 12/11	
1 I 118 d	M47D20(204D4), N43B20A	11/03 ⇨ 12/13	
1 I 118 i	N43B20A, M47D20(204D4)	07/04 ⇨ 12/13	
1 I 120 d	M47D20(204D4), N43B20A	03/03 ⇨ 12/13	
1 I 120 i	N43B20A, N47D20B	11/03 ⇨ 12/13	
1 I 123 d	N47D20B, N43B16A	03/07 ⇨ 12/13	
1 SERIES 118i [ExtraEU]	N46B20B	09/04 ⇨ 02/08	
3 V 316 d	N47D20C	07/09 ⇨ 06/12	
3 V 316 i	N43B16A, M47D20(204D4)	09/05 ⇨ 12/13	
3 V 318 d	M47D20(204D4), N43B20A	03/05 ⇨ 06/12	
3 V 318 i	N43B20A, M47D20(204D4)	03/05 ⇨ 12/13	
3 V 320 d	M47D20(204D4), N43B20A	12/04 ⇨ 12/13	
3 V 320 i	N43B20A, N47D20A	03/05 ⇨ 12/13	
3 V 320 si	N45B20A	09/05 ⇨ 08/06	
3 V 320 xd	--	03/07 ⇨	
3 SERIES 320i Touring [ExtraEU]	N43B20A	06/07 ⇨ 10/12	

21.0077



04,5

WHEEL SPEED SENSORS

Adatt./Suitable:

ATE
10.0711-6158.3**BMW**
34 52 6 762 466
6 762 466**BOSCH**
0 986 594 514**ITEM NOW AVAILABLE FROM PRODUCTION**

- ARTICOLO ORA DISPONIBILE PER LA VENDITA
- ARTICLE DISPONIBLE EN PRODUCTION COURANTE
- JETZT ZUM VERKAUF VERFÜGBARER ARTIKEL
- ARTICULO AHORA DISPONIBLE EN PRODUCCION

MARKET DIFFUSION: **HIGH**

L	L1	Hall Effect	+ OUT
962	31	Hall Effect	

BMW			
1 I 116 d	N47D20A, N43B16A	11/08 ⇨ 09/12	
1 I 116 i	N43B16A, M47D20(204D4)	11/03 ⇨ 12/11	
1 I 118 d	M47D20(204D4), N43B20A	11/03 ⇨ 12/13	
1 I 118 i	N43B20A, M47D20(204D4)	07/04 ⇨ 12/13	
1 I 120 d	M47D20(204D4), N43B20A	03/03 ⇨ 12/13	
1 I 120 i	N43B20A, N43B16A	11/03 ⇨ 12/13	
1 SERIES 118i [ExtraEU]	N46B20B	09/04 ⇨ 02/08	
3 V 316 d	N47D20C	07/09 ⇨ 06/12	
3 V 316 i	N43B16A, M47D20(204D4)	09/05 ⇨ 12/13	
3 V 318 d	M47D20(204D4), N43B20A	03/05 ⇨ 06/12	
3 V 318 i	N43B20A, M47D20(204D4)	03/05 ⇨ 12/13	
3 V 320 d	M47D20(204D4), N43B20A	12/04 ⇨ 06/13	
3 V 320 i	N43B20A, 199A8.000	03/05 ⇨ 12/13	
3 V 320 xd	--	03/07 ⇨	
3 SERIES 320i Touring [ExtraEU]	N43B20A	06/07 ⇨ 10/12	

21.0086



04,5

WHEEL SPEED SENSORS

Adatt./Suitable:

ABARTH
52012826
52070363
55700426

ALFA ROMEO
52012826
52070363
55700426

BOSCH
0 265 004 137
0 265 004 157
0 265 004 814
0 265 004 815
0 265 007 769
0 265 009 324

FIAT
52012826
52070363
55700426

GENERAL MOTORS
13 381 329
93 189 277

OPEL
12 29 099
13381329
62 35 748
93189277

VAUXHALL
13381329
93189277

MARKET DIFFUSION: MEDIUM



L	L1	Hall Effect	OUT +
645	27,9		

ABARTH

GRANDE PUNTO 1.4	199A8.000, 199A8.000	12/07 ⇨ 12/12
PUNTO 1.4	199A8.000, 955A8.000	03/12 ⇨
PUNTO EVO 1.4	955A8.000, 844A2.000	07/08 ⇨ 02/12

ALFA ROMEO

BRERA 2.0 JTDM	844A2.000, 199B6.000	03/08 ⇨ 06/10
MITO 0.9	199B6.000	12/13 ⇨
MITO 0.9 TwinAir	199B6.000, 199A3.000	07/11 ⇨
MITO 1.3 Multijet	199A3.000, 199A6.000	08/08 ⇨
MITO 1.4	199A6.000, 198A4.000	08/08 ⇨
MITO 1.4 Bifuel	198A4.000, 940A2.000	01/09 ⇨
MITO 1.4 MultiAir	940A2.000, 198A1.000	09/09 ⇨
MITO 1.4 TB	955B1.000	12/13 ⇨
MITO 1.4 TJet	198A1.000, 955A2.000	08/08 ⇨
MITO 1.4 Turbo MultiAir	955A2.000, 198A2.000	10/09 ⇨
MITO 1.6 JTDM	198A2.000, 199A5.000	08/08 ⇨

FIAT

PUNTO III / GRANDE PUNTO 1.3 D Multijet	199A2.000	06/09 ⇨
PUNTO III / GRANDE PUNTO 1.3 JTD	--	01/08 ⇨ 09/09
PUNTO III / GRANDE PUNTO 1.4 Natural Power	350A1.000	07/08 ⇨
PUNTO III / GRANDE PUNTO 1.6 D Multijet	955A3.000	07/08 ⇨
PUNTO III / GRANDE PUNTO 1.9 D Multijet	199A5.000, 199A2.000	10/05 ⇨
PUNTO III EVO 1.3 D Multijet	199A2.000, A16LEL	03/09 ⇨
PUNTO III EVO 1.4	350A1.000	03/09 ⇨
PUNTO III EVO 1.4 16V	955A2.000	10/09 ⇨ 02/12
PUNTO III EVO 1.4 LPG	350A1.000	06/09 ⇨ 02/12
PUNTO III EVO 1.4 Natural Power	350A1.000	10/09 ⇨ 02/12
PUNTO III EVO 1.6 D Multijet	955A3.000	10/09 ⇨ 02/12
PUNTO III 0.9	199B6.000	12/13 ⇨
PUNTO III 1.3 D Multijet	199A2.000, 199A7.000	04/08 ⇨
PUNTO III 1.3 JTD Multijet	955B2.000	05/18 ⇨

FIAT

PUNTO III 1.4	199A7.000, 350A1.000	03/12 ⇨
PUNTO III 1.4 Bifuel	350A1.000	03/12 ⇨
PUNTO III 1.4 LPG	350A1.000	03/09 ⇨
PUNTO III 1.4 Multi Air	955A6.000	03/12 ⇨
PUNTO III 1.4 Natural Power	350A1.000, 199A2.000	03/09 ⇨
PUNTO III 1.4 Turbo Multi Air	955A2.000	03/12 ⇨
PUNTO 1.4	350A1.000	03/12 ⇨

OPEL

CORSA D 1.0	A10XEP	08/06 ⇨ 08/14
CORSA D 1.4	A14NEL	07/12 ⇨ 08/14
CORSA D 1.6 Turbo	A16LEL, A17DTS	11/06 ⇨ 08/14
CORSA D 1.7 CDTI	A17DTS, A14NEL	08/06 ⇨ 08/14

VAUXHALL

CORSA D 1.0	A10XEP	08/06 ⇨ 08/14
CORSA D 1.2 LPG	A12XER	06/11 ⇨ 08/14
CORSA D 1.4	A14NEL, A16LEL	09/09 ⇨ 08/14
CORSA D 1.4 LPG	A14XEL	09/09 ⇨ 08/14
CORSA D 1.6 SRi	A16LEL, A16LER	05/07 ⇨ 08/14
CORSA D 1.6 VXR	A16LER, A17DTS	11/06 ⇨ 08/14
CORSA D 1.7 CDTI	A17DTS, 10FDOX	11/06 ⇨ 08/14
CORSAVAN III 1.3 CDTI	B13DTR	07/06 ⇨

21.0087



04,5

WHEEL SPEED SENSORS

Adatt./Suitable:

BOSCH
0 265 004 116
0 265 004 314
0 265 008 287
0 265 008 986
0 265 009 271

FORD
1 514 205
1 525 681
1 761 113
1 894 135
2 094 988
8V51-2B372-AB
8V51-2B372-AC
8V51-2C190-A1A
8V51-2C190-AA
8V51-2C190-AB

MARKET DIFFUSION: HIGH



L	L1	Hall Effect	OUT +
673	9,5		

FORD

ECOSPORT 1.0 EcoBoost	10FDOX, UGJE	10/13 ⇨
ECOSPORT 1.5 TDCi	UGJE, UEJB	10/13 ⇨
ECOSPORT 1.5 Ti	UEJB, UEJB	10/13 ⇨
ECOSPORT 1.5 Ti-VCT [ExtraEU]	UEJB, HXJB	10/13 ⇨
FIESTA 1.6 Ti-VCT [ExtraEU]	HXJB, P4JA	03/15 ⇨
FIESTA VI 1.0	P4JA, M1JE	10/12 ⇨
FIESTA VI 1.0 EcoBoost	M1JE, YYJA	09/12 ⇨
FIESTA VI 1.0 Sport	YYJA, SNJA	05/14 ⇨
FIESTA VI 1.25	SNJA, --	06/08 ⇨
FIESTA VI 1.4	--, RTJA	06/08 ⇨
FIESTA VI 1.4 LPG	RTJA, F6JB	01/09 ⇨
FIESTA VI 1.4 TDCi	F6JB, UGJC	01/09 ⇨
FIESTA VI 1.5 TDCi	UGJC, HHJC	09/12 ⇨
FIESTA VI 1.6	XTJA	03/15 ⇨
FIESTA VI 1.6 EcoBoost	--	01/13 ⇨
FIESTA VI 1.6 TDCi	HHJC, --	06/08 ⇨

FORD

FIESTA VI 1.6 TDCi SOHC	--	02/10 ⇨
FIESTA VI 1.6 Ti	--, HXJA	06/08 ⇨
FIESTA VI 1.6 Ti-VCT	HXJA, B2KA	10/08 ⇨ 12/12
KA+ 1.2	B2KA, YSKA	06/16 ⇨
KA+ 1.2 Ti-VCT	YSKA, --	06/16 ⇨
KA+ 1.5 TDCi	--, 199A2.000	01/16 ⇨

21.0088



04,5

WHEEL SPEED SENSORS

Adatt./Suitable:

ABARTH
55703974

BOSCH
0 265 007 896
0 265 009 323

FIAT
55701387
55703974

GENERAL MOTORS
13 381 328

OPEL
12 29 098
13381328
62 35 747
93189276

VAUXHALL
13381328
93189276

MARKET DIFFUSION: HIGH



L	L1	Hall Effect	OUT +
648	27,9		

FIAT

GRANDE PUNTO 1.3 JTD Multijet	199A2.000, 169A4.000	02/06 ⇨ 06/13
GRANDE PUNTO 1.4	350A1.000	02/06 ⇨ 06/13
GRANDE PUNTO 1.4 LPG	350A1.000	03/09 ⇨ 12/12
GRANDE PUNTO 1.4 Natural Power	350A1000CNG	03/09 ⇨ 12/12
PUNTO III / GRANDE PUNTO 1.2	169A4.000, 199A2.000	10/05 ⇨
PUNTO III / GRANDE PUNTO 1.2 Actual	--	09/09 ⇨
PUNTO III / GRANDE PUNTO 1.2 LPG	199A4.000	07/08 ⇨
PUNTO III / GRANDE PUNTO 1.3 D Multijet	199A2.000, 199A7.000	10/05 ⇨
PUNTO III / GRANDE PUNTO 1.3 JTD	--	01/08 ⇨ 09/09
PUNTO III / GRANDE PUNTO 1.3 JTD Actual	--	09/09 ⇨
PUNTO III / GRANDE PUNTO 1.4	199A7.000, 350A1.000	06/05 ⇨ 12/15
PUNTO III / GRANDE PUNTO 1.4 16V	199A6.000	10/05 ⇨
PUNTO III / GRANDE PUNTO 1.4 Actual	--	09/09 ⇨
PUNTO III / GRANDE PUNTO 1.4 LPG	350A1.000	12/08 ⇨
PUNTO III / GRANDE PUNTO 1.4 Natural Power	350A1.000, 199B6.000	07/08 ⇨
PUNTO III EVO 1.2	169A4.000, 199A2.000	10/09 ⇨ 02/12
PUNTO III EVO 1.3 D Multijet	199A2.000, 199A7.000	07/08 ⇨
PUNTO III EVO 1.4	199A7.000, 350A1.000	03/09 ⇨
PUNTO III EVO 1.4 16V	955A6.000	10/09 ⇨ 02/12
PUNTO III EVO 1.4 LPG	350A1.000	06/09 ⇨ 02/12
PUNTO III EVO 1.4 Natural Power	350A1.000, B10XFL	10/09 ⇨ 02/12
PUNTO III 0.9	199B6.000, 169A4.000	07/13 ⇨
PUNTO III 0.9 Bifuel	312A2.000	03/12 ⇨

FIAT		
PUNTO III 0.9 Twinair Turbo	312A2.000	03/12 ⇨
PUNTO III 1.2	169A4.000, 199A2.000	03/12 ⇨
PUNTO III 1.3 D Multijet	199A2.000, 199A7.000	04/08 ⇨
PUNTO III 1.3 JTD Multijet	955B2.000	05/18 ⇨
PUNTO III 1.4	199A7.000, 350A1.000	04/08 ⇨
PUNTO III 1.4 Bifuel	350A1.000	03/12 ⇨
PUNTO III 1.4 LPG	350A1.000	03/09 ⇨
PUNTO III 1.4 Natural Power	350A1.000, 169A4.000	03/09 ⇨
PUNTO 1.4	350A1.000	03/12 ⇨
PUNTO 1.4 LPG	350A1.000	03/09 ⇨ 02/12
PUNTO 1.4 Natural Power	350A1000CNG	03/09 ⇨ 02/12

OPEL		
ADAM 1.0	B10XFL, A12XEL	07/14 ⇨
ADAM 1.2	A12XEL, A14XEL	10/12 ⇨
ADAM 1.4	A14XEL, A14XEL	10/12 ⇨
ADAM 1.4 LPG	A14XEL, A10XEP	07/13 ⇨
CORSA D 1.0	A10XEP, A12XEL	07/06 ⇨ 08/14
CORSA D 1.2	A12XEL, A12XER	07/06 ⇨ 08/14
CORSA D 1.2 LPG	A12XER, A13DTC	08/06 ⇨ 08/14
CORSA D 1.3 CDTi	A13DTC, A14XEL	07/06 ⇨ 08/14
CORSA D 1.4	A14XEL, A14XEL	07/06 ⇨ 08/14
CORSA D 1.4 LPG	A14XEL, B10XFL	08/06 ⇨ 08/14
CORSA E 1.0	B10XFL, B13DTC	09/14 ⇨
CORSA E 1.2	B12XEL	09/14 ⇨
CORSA E 1.3 CDTi	B13DTC, B14XEJ	09/14 ⇨
CORSA E 1.4	B14XEJ, B14XEL	09/14 ⇨
CORSA E 1.4 LPG	B14XEL, B14NEH	03/15 ⇨
CORSA E 1.4 Turbo	B14NEH, B10XFL	09/14 ⇨

VAUXHALL		
ADAM 1.0	B10XFL, A12XEL	07/14 ⇨
ADAM 1.2	A12XEL, A14XEL	10/12 ⇨
ADAM 1.4	A14XEL, A10XEP	10/12 ⇨
ADAM 1.4 LPG	A14XEL	07/13 ⇨
CORSA D 1.0	A10XEP, A12XEL	08/06 ⇨ 08/14
CORSA D 1.0 i 12V	A10XEP	01/10 ⇨ 08/14
CORSA D 1.2	A12XEL, A12XER	08/06 ⇨ 08/14
CORSA D 1.2 i 16V	A12XER	12/09 ⇨ 08/14
CORSA D 1.2 LPG	A12XER, A13DTC	09/09 ⇨ 08/14
CORSA D 1.3 CDTi	A13DTC, A14XEL	08/06 ⇨ 08/14
CORSA D 1.4	A14XEL, A14XEL	08/06 ⇨ 08/14
CORSA D 1.4 LPG	A14XEL, B10XFL	07/06 ⇨ 08/14
CORSA D 1.6 VXR	Z16LER	06/11 ⇨ 08/14
CORSA E 1.0	B10XFL, B13DTC	08/14 ⇨
CORSA E 1.2	B12XEL	08/14 ⇨
CORSA E 1.3 CDTi	B13DTC, B14NEH	08/14 ⇨
CORSA E 1.4	B14NEH, A12XEL	08/14 ⇨
CORSA E 1.4 LPG	B14XEL	08/14 ⇨
CORSAVAN III 1.2	A12XEL, A13DTC	07/09 ⇨
CORSAVAN III 1.3 CDTi	A13DTC, B13DTC	07/06 ⇨
CORSAVAN IV 1.2	B12XEL	10/14 ⇨
CORSAVAN IV 1.3 CDTi	B13DTC, N47D20A	10/14 ⇨
CORSAVAN IV 1.4	B14XEJ	10/14 ⇨

21.0089



WHEEL SPEED SENSORS

Adatt./Suitable:

- ATE**
10.0711-6197.3
10.0711-6419.3
- BMW**
34 52 6 760 424
34 52 6 785 020
34 52 6 870 075
6 760 424
- BOSCH**
0 986 594 540

- ITEM NOW AVAILABLE FROM PRODUCTION**
- ARTICOLO ORA DISPONIBILE PER LA VENDITA
- ARTICLE DISPONIBLE EN PRODUCTION COURANTE
- JETZT ZUM VERKAUF VERFÜGBARER ARTIKEL
- ARTICULO AHORA DISPONIBLE EN PRODUCCION

MARKET DIFFUSION: MEDIUM



L	L1		+ OUT
667	31	Hall Effect	

BMW		
11 120 d	N47D20A, N43B20A	09/06 ⇨ 12/13
11 120 i	N43B20A, N47D20B	09/06 ⇨ 12/13
11 123 d	N47D20B, N52B30A	03/07 ⇨ 12/13
11 125 i	N52B30A, N51B30A	10/07 ⇨
11 128 i	N51B30A, N52B30A	03/08 ⇨
11 130 i	N52B30A, N54B30A	03/05 ⇨ 09/12
11 135 i	N54B30A, N52B25A	10/07 ⇨ 12/13
3V 318 i	N43B20A	03/10 ⇨ 12/13
3V 320 d	M47D20(204D4), N43B20A	12/04 ⇨ 12/13
3V 320 i	N43B20A, N52B25A	03/05 ⇨ 12/13
3V 320 xd	--	03/07 ⇨
3V 323 i	N52B25A, M57D30(306D3)	09/05 ⇨
3V 325 d	M57D30(306D3), N52B25A	09/06 ⇨ 12/13
3V 325 i	N52B25A, N51B30A	12/04 ⇨
3V 328 i	N51B30A, M57D30(306D3)	07/05 ⇨
3V 330 d	M57D30(306D3), N52B30A	12/04 ⇨ 12/13
3V 330 i	N52B30A, M57D30(306D5)	12/04 ⇨ 12/13
3V 335 d	M57D30(306D5), N54B30A	03/06 ⇨ 03/13
3V 335 i	N54B30A, --	11/05 ⇨ 10/13
3 SERIES 325i Coupe [ExtraEU]	N52B25A, M47D20(204D4)	03/10 ⇨ 06/13

21.0092



WHEEL SPEED SENSORS

Adatt./Suitable:

- BOSCH**
0 265 004 268
0 265 007 788
- CITROËN**
4545 E7
96 552 700 80
98 137 596 80
- PEUGEOT**
4545 E7
98 137 596 80

MARKET DIFFUSION: HIGH



L	L1		+ OUT
725	---	Hall Effect	

CITROËN		
BERLINGO II 1.2 PureTech 110	--, N6A(TU5JP4)	02/16 ⇨
BERLINGO II 1.6	N6A(TU5JP4), BHY(DV6FD)	04/08 ⇨
BERLINGO II 1.6 BlueHdi 100	BHY(DV6FD), BHZ(DV6FC)	12/14 ⇨
BERLINGO II 1.6 BlueHdi 100 4x4	BHY(DV6FD)	12/14 ⇨
BERLINGO II 1.6 BlueHdi 120	BHZ(DV6FC), 9HN(DV6ETED)	12/14 ⇨
BERLINGO II 1.6 Hdi / BlueHdi 75	9HN(DV6ETED), 9HL(DV6C)	07/10 ⇨
BERLINGO II 1.6 Hdi 110	9HL(DV6C), 9HL(DV6C)	04/08 ⇨
BERLINGO II 1.6 Hdi 115	9HL(DV6C), 9HT(DV6BTED4)	07/10 ⇨
BERLINGO II 1.6 Hdi 115 4x4	--	02/12 ⇨
BERLINGO II 1.6 Hdi 75	9HT(DV6BTED4), 9HN(DV6ETED)	04/08 ⇨
BERLINGO II 1.6 Hdi 75 / BlueHdi 75	9HN(DV6ETED), 9HT(DV6BTED4)	04/08 ⇨
BERLINGO II 1.6 Hdi 75 16V	9HT(DV6BTED4), 9HF(DV6DTE)	04/08 ⇨
BERLINGO II 1.6 Hdi 75 4x4	9HN(DV6ETED)	02/12 ⇨
BERLINGO II 1.6 Hdi 90	9HF(DV6DTE), 9HS(DV6TETED4BU)	04/08 ⇨
BERLINGO II 1.6 Hdi 90 16V	9HS(DV6TETED4BU), 9HJ(DV6DTE)	04/08 ⇨
BERLINGO II 1.6 Hdi 90 4x4	9HF(DV6DTE)	02/12 ⇨
BERLINGO II 1.6 Hdi 92	9HJ(DV6DTE), 5F5(EP6C)	07/10 ⇨
BERLINGO II 1.6 Vti 120	5F5(EP6C), 5FK(EP6CB)	11/09 ⇨
BERLINGO II 1.6 Vti 95	5FK(EP6CB), Y4F1	07/10 ⇨
BERLINGO II Electric	Y4F1, 5FT(EP6DT)	01/13 ⇨
BERLINGO 1.6	EP6CB	04/08 ⇨ 12/10
C4 GRAND PICASSO I 1.6 16V	5FT(EP6DT), 9HY(DV6TETED4)	07/08 ⇨
C4 GRAND PICASSO I 1.6 Hdi	9HY(DV6TETED4), 9HL(DV6C)	10/06 ⇨ 06/11
C4 GRAND PICASSO I 1.6 Hdi 110	9HL(DV6C), 5FV(EP6CDT)	09/10 ⇨
C4 GRAND PICASSO I 1.6 THP 155	5FV(EP6CDT), 5FW(EP6)	09/10 ⇨ 08/13
C4 GRAND PICASSO I 1.6 Vti 120	5FW(EP6), 6FY(EW7A)	07/08 ⇨ 08/13
C4 GRAND PICASSO I 1.8 i 16V	6FY(EW7A), DW10BTED4	10/06 ⇨ 12/10
C4 GRAND PICASSO I 1.8 i 16V CNG	EW7ACNG	03/09 ⇨ 12/11
C4 GRAND PICASSO I 1.8 i 16V Flex	EW7A	06/09 ⇨ 01/13
C4 GRAND PICASSO I 2.0 Hdi 138	DW10BTED4, DW10CTED4	10/06 ⇨ 12/13

CITROËN		
C4 GRAND PICASSO I 2.0 HDi 150	DW10CTED4, DW10CTED4	07/09 → 08/13
C4 GRAND PICASSO I 2.0 HDi 165	DW10CTED4, EW10A	09/10 → 08/13
C4 GRAND PICASSO I 2.0 i 16V	EW10A, 5FX(EP6DT)	10/06 → 08/13
C4 PICASSO I 1.6 16V	5FX(EP6DT), 9HY(DV6TED4)	07/08 → 08/13
C4 PICASSO I 1.6 HDi	9HY(DV6TED4), 9HL(DV6C)	02/07 → 08/13
C4 PICASSO I 1.6 HDi 110	9HL(DV6C), 5FT(EP6DT)	09/10 →
C4 PICASSO I 1.6 THP 140	5FT(EP6DT), 5FV(EP6CDT)	07/08 → 08/13
C4 PICASSO I 1.6 THP 155	5FV(EP6CDT), 5FW(EP6)	09/10 → 08/13
C4 PICASSO I 1.6 VTi 120	5FW(EP6), 6FY(EW7A)	07/08 →
C4 PICASSO I 1.8 Bifuel	6FY(EW7A), 6FY(EW7A)	01/09 → 10/12
C4 PICASSO I 1.8 i 16V	6FY(EW7A), DW10BTEd4	02/07 → 12/11
C4 PICASSO I 2.0 HDi 138	DW10BTEd4, DW10CTED4	10/06 → 08/13
C4 PICASSO I 2.0 HDi 150	DW10CTED4, DW10CTED4	07/09 → 08/13
C4 PICASSO I 2.0 HDi 165	DW10CTED4, EW10A	09/10 →
C4 PICASSO I 2.0 i 16V	EW10A, 5FK(EP6CB)	09/07 → 08/13

PEUGEOT		
PARTNER 1.6 BlueHdi	DV6FD	04/15 →
PARTNER 1.6 HDi	DV6AUTED4	01/14 →
PARTNER II 1.6	5FK(EP6CB), BHY(DV6FD)	04/08 →
PARTNER II 1.6 BlueHdi 100	BHY(DV6FD), BHZ(DV6FC)	04/15 →
PARTNER II 1.6 BlueHdi 120	BHZ(DV6FC), 9HF(DV6DTEd)	04/15 →
PARTNER II 1.6 HDi	9HF(DV6DTEd), 9HN(DV6ETED)	04/08 →
PARTNER II 1.6 HDi / BlueHdi 75	9HN(DV6ETED), 9HS(DV6TED4BU)	07/11 →
PARTNER II 1.6 HDi 16V	9HS(DV6TED4BU), 9HS(DV6TED4BU)	04/08 →
PARTNER II 1.6 HDi 16V 4x4	9HS(DV6TED4BU), 9HP(DV6DTEd)	04/12 →
PARTNER II 1.6 HDi 90	9HP(DV6DTEd), EB2DT	04/10 →
PARTNER II Électrique	Y4F1	06/13 →
PARTNER II TEPEE 1.2 THP	EB2DT, BHY(DV6FD)	02/16 →
PARTNER II TEPEE 1.6 BlueHdi 100	BHY(DV6FD), BHZ(DV6FC)	12/14 →
PARTNER II TEPEE 1.6 BlueHdi 120	BHZ(DV6FC), 9HF(DV6DTEd)	12/14 →
PARTNER II TEPEE 1.6 HDi	9HF(DV6DTEd), 9HW(DV6FE)	04/08 →
PARTNER II TEPEE 1.6 HDi / BlueHdi 75	9HW(DV6FE), 9HV(DV6TED4)	01/15 →
PARTNER II TEPEE 1.6 HDi 16V	9HV(DV6TED4), 9HJ(DV6DTEdM)	04/08 →
PARTNER II TEPEE 1.6 HDi 90	9HJ(DV6DTEdM), 5FK(EP6CB)	04/10 →
PARTNER II TEPEE 1.6 VTi	5FK(EP6CB), M1JA	04/08 →

21.0095

04,5

WHEEL SPEED SENSORS

Adatt./Suitable:

BOSCH
 0 265 004 114
 0 265 008 128
 0 265 008 985

FORD
 1 516 502
 1 526 034
 1 560 622
 1 678 466
 1 761 079
 1 766 843
 1 771 552
 1 894 136
 8V51-2C204-A1A
 8V51-2C204-AC
 8V51-2C204-BB

MARKET DIFFUSION: HIGH



L	L1	Hall Effect	OUT +
725	27,9	Hall Effect	OUT +

FORD

B-MAX 1.0 EcoBoost	M1JA, SPJD	10/12 →
B-MAX 1.4	SPJD, UGJC	10/12 →
B-MAX 1.5 TDCi	UGJC, IQJA	10/12 →
B-MAX 1.6 TDCi	T3JB	10/12 →
B-MAX 1.6 Ti	IQJA, HXJB	10/12 →
FIESTA 1.6 Ti-VCT [ExtraEU]	HXJB, P4JA	03/15 →
FIESTA VI 1.0	P4JA, M1JE	10/12 →
FIESTA VI 1.0 EcoBoost	M1JE, YYJA	09/12 →
FIESTA VI 1.0 Sport	YYJA, SNJA	05/14 →
FIESTA VI 1.25	SNJA, --	06/08 →
FIESTA VI 1.4	--, RTJA	06/08 →
FIESTA VI 1.4 LPG	RTJA, F6JB	01/09 →
FIESTA VI 1.4 TDCi	F6JB, UGJC	01/09 →
FIESTA VI 1.5 TDCi	UGJC, JTJA	10/12 →
FIESTA VI 1.6	XTJA	03/15 →
FIESTA VI 1.6 EcoBoost	--	01/13 →
FIESTA VI 1.6 ST	JTJA, HHJC	03/13 →
FIESTA VI 1.6 ST200	JTJC	04/16 →
FIESTA VI 1.6 TDCi	HHJC, --	06/08 →
FIESTA VI 1.6 TDCi SOHC	--	02/10 →
FIESTA VI 1.6 Ti	--, HXJA	06/08 →
FIESTA VI 1.6 Ti-VCT	HXJA, B2KA	10/08 → 12/12
KA+ 1.2	B2KA, YSKD	06/16 →
KA+ 1.2 Ti-VCT	YSKD, --	06/16 →
KA+ 1.5 TDCi	--, --	01/16 →

21.0096

04,5

WHEEL SPEED SENSORS

Adatt./Suitable:

BOSCH
 0 265 007 789

CITROËN
 4545 E8
 96 536 631 80

PEUGEOT
 4545 E8

MARKET DIFFUSION: HIGH

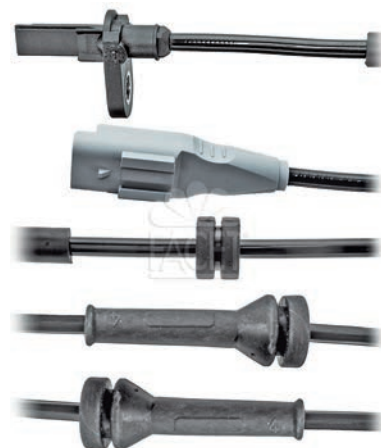

L	L1	Hall Effect	OUT +
989	26,5	Hall Effect	OUT +

CITROËN

BERLINGO II 1.2 PureTech 110	--, N6A(TU5JP4)	02/16 →
BERLINGO II 1.6	N6A(TU5JP4), BHY(DV6FD)	04/08 →
BERLINGO II 1.6 BlueHdi 100	BHY(DV6FD), BHZ(DV6FC)	12/14 →
BERLINGO II 1.6 BlueHdi 100 4x4	BHY(DV6FD)	12/14 →
BERLINGO II 1.6 BlueHdi 120	BHZ(DV6FC), 9HN(DV6ETED)	12/14 →
BERLINGO II 1.6 HDi / BlueHdi 75	9HN(DV6ETED), 9HL(DV6C)	07/10 →
BERLINGO II 1.6 HDi 110	9HL(DV6C), 9HL(DV6C)	04/08 →
BERLINGO II 1.6 HDi 115	9HL(DV6C), 9HT(DV6BTEd4)	07/10 →
BERLINGO II 1.6 HDi 115 4x4	--	02/12 →
BERLINGO II 1.6 HDi 75	9HT(DV6BTEd4), 9HN(DV6ETED)	04/08 →
BERLINGO II 1.6 HDi 75 / BlueHdi 75	9HN(DV6ETED), 9HT(DV6BTEd4)	04/08 →
BERLINGO II 1.6 HDi 75 16V	9HT(DV6BTEd4), 9HF(DV6DTEd)	04/08 →
BERLINGO II 1.6 HDi 75 4x4	9HN(DV6ETED)	02/12 →
BERLINGO II 1.6 HDi 90	9HF(DV6DTEd), 9HS(DV6TED4BU)	04/08 →
BERLINGO II 1.6 HDi 90 16V	9HS(DV6TED4BU), 9HJ(DV6DTEdM)	04/08 →
BERLINGO II 1.6 HDi 90 4x4	9HF(DV6DTEd)	02/12 →
BERLINGO II 1.6 HDi 92	9HJ(DV6DTEdM), 5FS(EP6C)	07/10 →
BERLINGO II 1.6 VTi 120	5FS(EP6C), 5FK(EP6CB)	11/09 →
BERLINGO II 1.6 VTi 95	5FK(EP6CB), 5FT(EP6DT)	07/10 →
BERLINGO 1.6	EP6CB	04/08 → 12/10
C4 GRAND PICASSO I 1.6 16V	5FT(EP6DT), 9HY(DV6TED4)	07/08 →
C4 GRAND PICASSO I 1.6 HDi	9HY(DV6TED4), 9HL(DV6C)	10/06 → 06/11
C4 GRAND PICASSO I 1.6 HDi 110	9HL(DV6C), 5FV(EP6CDT)	09/10 →
C4 GRAND PICASSO I 1.6 THP 155	5FV(EP6CDT), 5FW(EP6)	09/10 → 08/13
C4 GRAND PICASSO I 1.6 VTi 120	5FW(EP6), 6FY(EW7A)	07/08 → 08/13
C4 GRAND PICASSO I 1.8 i 16V	6FY(EW7A), DW10BTEd4	10/06 → 12/10
C4 GRAND PICASSO I 1.8 i 16V CNG	EW7ACNG	03/09 → 12/11
C4 GRAND PICASSO I 1.8 i 16V Flex	EW7A	06/09 → 01/13
C4 GRAND PICASSO I 2.0 HDi 138	DW10BTEd4, DW10CTED4	10/06 → 12/13
C4 GRAND PICASSO I 2.0 HDi 150	DW10CTED4, DW10CTED4	07/09 → 08/13

CITROËN		
C4 GRAND PICASSO I 2.0 HDi 165	DW10CTED4, EW10A	09/10 ⇨ 08/13
C4 GRAND PICASSO I 2.0 i 16V	EW10A, 5FX(EP6DT)	10/06 ⇨ 08/13
C4 PICASSO I 1.6 16V	5FX(EP6DT), 9HY(DV6TED4)	07/08 ⇨ 08/13
C4 PICASSO I 1.6 HDi	9HY(DV6TED4), 9HL(DV6C)	02/07 ⇨ 08/13
C4 PICASSO I 1.6 HDi 110	9HL(DV6C), 5FT(EP6DT)	09/10 ⇨
C4 PICASSO I 1.6 THP 140	5FT(EP6DT), 5FV(EP6CDT)	07/08 ⇨ 08/13
C4 PICASSO I 1.6 THP 155	5FV(EP6CDT), 5FW(EP6)	09/10 ⇨ 08/13
C4 PICASSO I 1.6 VTi 120	5FW(EP6), 6FY(EW7A)	07/08 ⇨
C4 PICASSO I 1.8 Bifuel	6FY(EW7A), 6FY(EW7A)	01/09 ⇨ 10/12
C4 PICASSO I 1.8 i 16V	6FY(EW7A), DW10BTED4	02/07 ⇨ 12/11
C4 PICASSO I 2.0 HDi 138	DW10BTED4, DW10CTED4	10/06 ⇨ 08/13
C4 PICASSO I 2.0 HDi 150	DW10CTED4, DW10CTED4	07/09 ⇨ 08/13
C4 PICASSO I 2.0 HDi 165	DW10CTED4, EW10A	09/10 ⇨
C4 PICASSO I 2.0 i 16V	EW10A, EB2DTS	09/07 ⇨ 08/13

PEUGEOT		
5008 1.2	EB2DTS, 5FS(EP6C)	01/15 ⇨
5008 1.6 16V	5FS(EP6C), BHZ(DV6FC)	09/09 ⇨
5008 1.6 BlueHdi 120	BHZ(DV6FC), 9HD(DV6CTED)	05/14 ⇨ 03/17
5008 1.6 HDi	9HD(DV6CTED), EP6CDTMD	09/09 ⇨
5008 1.6 THP 150	EP6CDTMD, 5GZ(EP6FDT)	02/12 ⇨
5008 1.6 THP 163	5GZ(EP6FDT), 5GZ(EP6FDT)	02/12 ⇨
5008 1.6 THP 165	5GZ(EP6FDT), DW10CBFAPDTR	02/12 ⇨
5008 2.0 HDi	DW10CBFAPDTR, AHV(DW10FD)	09/09 ⇨
5008 2.0 HDi 136 / BlueHdi 136	AHV(DW10FD), AHR(DW10FD)	02/12 ⇨
5008 2.0 HDi 150 / BlueHdi 150	AHR(DW10FD), 5FK(EP6CB)	06/09 ⇨
PARTNER 1.6 BlueHdi	DV6FD	04/15 ⇨
PARTNER 1.6 HDi	DV6AUTED4	01/14 ⇨
PARTNER II 1.6	5FK(EP6CB), BHY(DV6FD)	04/08 ⇨
PARTNER II 1.6 BlueHdi 100	BHY(DV6FD), BHZ(DV6FC)	04/15 ⇨
PARTNER II 1.6 BlueHdi 120	BHZ(DV6FC), 9HF(DV6DTEd)	04/15 ⇨
PARTNER II 1.6 HDi	9HF(DV6DTEd), 9HN(DV6ETED)	04/08 ⇨
PARTNER II 1.6 HDi / BlueHdi 75	9HN(DV6ETED), 9HS(DV6TED4BU)	07/11 ⇨
PARTNER II 1.6 HDi 16V	9HS(DV6TED4BU), 9HS(DV6TED4BU)	04/08 ⇨
PARTNER II 1.6 HDi 16V 4x4	9HS(DV6TED4BU), 9HP(DV6DTEd)	04/12 ⇨
PARTNER II 1.6 HDi 90	9HP(DV6DTEd), HNV(EB2DTM)	04/10 ⇨
PARTNER II TEPEE 1.2 THP	HNV(EB2DTM), BHY(DV6FD)	02/16 ⇨
PARTNER II TEPEE 1.6 BlueHdi 100	BHY(DV6FD), BHZ(DV6FC)	12/14 ⇨
PARTNER II TEPEE 1.6 BlueHdi 120	BHZ(DV6FC), 9HF(DV6DTEd)	12/14 ⇨
PARTNER II TEPEE 1.6 HDi	9HF(DV6DTEd), BHW(DV6FE)	04/08 ⇨
PARTNER II TEPEE 1.6 HDi / BlueHdi 75	BHW(DV6FE), 9HV(DV6TED4)	01/15 ⇨
PARTNER II TEPEE 1.6 HDi 16V	9HV(DV6TED4), 9HJ(DV6DTEdM)	04/08 ⇨
PARTNER II TEPEE 1.6 HDi 90	9HJ(DV6DTEdM), 5FK(EP6CB)	04/10 ⇨
PARTNER II TEPEE 1.6 VTi	5FK(EP6CB), 199A8.000	04/08 ⇨

21.0098

04,5

WHEEL SPEED SENSORS

Adatt./Suitable:

ABARTH
52012825
52070362
55700425

ALFA ROMEO
52012825
52070362
55700425

BOSCH
0 265 004 136
0 265 004 812
0 265 004 813
0 265 007 671

FIAT
52012825
52070362
55700425

MARKET DIFFUSION: HIGH



L	L1		
860	27,9	Hall Effect	

ABARTH

GRANDE PUNTO 1.4	199A8.000, 199A8.000	12/07 ⇨ 12/12
PUNTO 1.4	199A8.000, 955A8.000	03/12 ⇨
PUNTO EVO 1.4	955A8.000, 844A2.000	07/08 ⇨ 02/12

ALFA ROMEO

BRERA 2.0 JTDM	844A2.000, 199B6.000	03/08 ⇨ 06/10
MITO 0.9	199B6.000	12/13 ⇨
MITO 0.9 TwinAir	199B6.000, 199A3.000	07/11 ⇨
MITO 1.3 Multijet	199A3.000, 199A6.000	08/08 ⇨
MITO 1.4	199A6.000, 198A4.000	08/08 ⇨
MITO 1.4 Bifuel	198A4.000, 940A2.000	01/09 ⇨
MITO 1.4 MultiAir	940A2.000, 198A1.000	09/09 ⇨
MITO 1.4 TB	955B1.000	12/13 ⇨
MITO 1.4 TJet	198A1.000, 955A2.000	08/08 ⇨
MITO 1.4 Turbo MultiAir	955A2.000, 198A2.000	10/09 ⇨
MITO 1.6 JTDM	198A2.000, 199A2.000	08/08 ⇨

FIAT

GRANDE PUNTO 1.3 JTD Multijet	199A2.000, 169A4.000	02/06 ⇨ 06/13
GRANDE PUNTO 1.4	350A1.000	02/06 ⇨ 06/13
GRANDE PUNTO 1.4 LPG	350A1.000	03/09 ⇨ 12/12
GRANDE PUNTO 1.4 Natural Power	350A1000CNG	03/09 ⇨ 12/12
PUNTO III / GRANDE PUNTO 1.2	169A4.000, 199A2.000	10/05 ⇨
PUNTO III / GRANDE PUNTO 1.2 Actual	--	09/09 ⇨
PUNTO III / GRANDE PUNTO 1.2 LPG	199A4.000	07/08 ⇨
PUNTO III / GRANDE PUNTO 1.3 D Multijet	199A2.000, 199A7.000	10/05 ⇨
PUNTO III / GRANDE PUNTO 1.3 JTD	--	01/08 ⇨ 09/09
PUNTO III / GRANDE PUNTO 1.3 JTD Actual	--	09/09 ⇨
PUNTO III / GRANDE PUNTO 1.4	199A7.000, 350A1.000	06/05 ⇨ 12/15
PUNTO III / GRANDE PUNTO 1.4 16V	199A6.000	10/05 ⇨
PUNTO III / GRANDE PUNTO 1.4 Actual	--	09/09 ⇨
PUNTO III / GRANDE PUNTO 1.4 LPG	350A1.000	12/08 ⇨
PUNTO III / GRANDE PUNTO 1.4 Natural Power	350A1.000, 199A5.000	07/08 ⇨

PUNTO III / GRANDE PUNTO 1.4 T-Jet	198A4.000	09/07 ⇨
PUNTO III / GRANDE PUNTO 1.6 D Multijet	955A3.000	07/08 ⇨
PUNTO III / GRANDE PUNTO 1.9 D Multijet	199A5.000, 199B6.000	10/05 ⇨
PUNTO III EVO 1.2	169A4.000, 199A2.000	10/09 ⇨ 02/12
PUNTO III EVO 1.3 D Multijet	199A2.000, 199A7.000	07/08 ⇨
PUNTO III EVO 1.4	199A7.000, 955A2.000	03/09 ⇨
PUNTO III EVO 1.4 16V	955A2.000, 350A1.000	10/09 ⇨ 02/12
PUNTO III EVO 1.4 LPG	350A1.000	06/09 ⇨ 02/12
PUNTO III EVO 1.4 Natural Power	350A1.000, H5F404	10/09 ⇨ 02/12
PUNTO III EVO 1.6 D Multijet	955A3.000	10/09 ⇨ 02/12
PUNTO III 0.9	199B6.000, 169A4.000	07/13 ⇨
PUNTO III 0.9 Bifuel	312A2.000	03/12 ⇨
PUNTO III 0.9 Twinair Turbo	312A2.000	03/12 ⇨
PUNTO III 1.2	169A4.000, 199A2.000	03/12 ⇨
PUNTO III 1.3 D Multijet	199A2.000, 199A7.000	04/08 ⇨
PUNTO III 1.3 JTD Multijet	955B2.000	05/18 ⇨
PUNTO III 1.4	199A7.000, 350A1.000	04/08 ⇨
PUNTO III 1.4 Bifuel	350A1.000	03/12 ⇨
PUNTO III 1.4 LPG	350A1.000	03/09 ⇨
PUNTO III 1.4 Multi Air	955A6.000	03/12 ⇨
PUNTO III 1.4 Natural Power	350A1.000, 169A4.000	03/09 ⇨
PUNTO III 1.4 Turbo Multi Air	955A2.000	03/12 ⇨
PUNTO 1.4	350A1.000	03/12 ⇨
PUNTO 1.4 LPG	350A1.000	03/09 ⇨ 02/12
PUNTO 1.4 Natural Power	350A1000CNG	03/09 ⇨ 02/12

21.0102

04,5

WHEEL SPEED SENSORS

Adatt./Suitable:

BOSCH
0 265 008 941

DAICIA
47 91 000 04R
47 91 091 55R

NISSAN
47910-00Q0E
47910-9155R

RENAULT
47 91 000 04R
47 91 091 55R

MARKET DIFFUSION: HIGH



L	L1		
705	38	Hall Effect	

DAICIA

DUSTER 1.2 TCe 125	H5F404, K9K612	01/12 ⇨
DUSTER 1.2 TCe 125 4x4	H5F404	10/13 ⇨
DUSTER 1.5 dCi	K9K612, K9K656	04/10 ⇨
DUSTER 1.5 dCi 110	K9K656, K9K658	10/17 ⇨
DUSTER 1.5 dCi 110 4x4	K9K658	10/17 ⇨
DUSTER 1.5 dCi 4x4	K9K658, K4M642	06/10 ⇨
DUSTER 1.5 dCi 90	K9K656	10/17 ⇨
DUSTER 1.6	K4M642, K4M490	04/10 ⇨
DUSTER 1.6 16V	K4M490, K4M490	04/10 ⇨
DUSTER 1.6 16V 4x4	K4M490, K4M616	06/10 ⇨
DUSTER 1.6 16V Hi-Flex	K4M696	08/10 ⇨
DUSTER 1.6 16V LPG	K4M616, H4M438	04/11 ⇨
DUSTER 1.6 SCe 115	H4M438, H4M430	06/15 ⇨

DACIA		
DUSTER 1.6 SSe 115 4x4	H4M430, F4R400	06/15 →
DUSTER 1.6 SSe 115 LPG	H4M740	06/15 →
DUSTER 2.0	F4R400, H4M	04/10 →
NISSAN		
TERRANO III 1.6	H4M, H4M	09/13 →
TERRANO III 1.6 4x4	H4M, F4R	03/14 →
TERRANO III 2.0	F4R	09/13 →
TERRANO III 2.0 4x4	F4R, H4M438	03/14 →
RENAULT		
DUSTER 1.5 dCi [ExtraEU]	K9K796	06/11 →
DUSTER 1.5 dCi 4x4	K9K884	06/11 →
DUSTER 1.6 16V	H4M438, H4M430	02/12 →
DUSTER 1.6 16V 4x4	H4M430, F4R403	06/11 →
DUSTER 2.0	F4R403, F4R410	02/12 →
DUSTER 2.0 [ExtraEU]	F4R410, F4R400	10/11 →
DUSTER 2.0 4x4	F4R400, K9K656	02/12 →
FLUENCE 1.5 dCi	K9K656, H4M729	02/10 →
FLUENCE 1.6	H4M729, K4M838	01/13 →
FLUENCE 1.6 16V	K4M838, M4R714	02/10 →
FLUENCE 1.6 dCi	R9M402	07/14 →
FLUENCE 1.6 LPG 16V	K4M839	01/12 →
FLUENCE 2.0 [ExtraEU]	M4R714, M4R714	01/10 →
FLUENCE 2.0 16V	M4R714, M4R714	02/10 →
FLUENCE 2.0 Hi-Flex [ExtraEU]	M4R714, H5F400	02/10 → 11/18
FLUENCE Z.E.	5AM400	02/12 →
GRAND SCÉNIC III 1.2 Tce	H5F400, K9K636	04/12 →
GRAND SCÉNIC III 1.4 16V	H4J700	02/09 →
GRAND SCÉNIC III 1.5 dCi	K9K636, K4M866	02/09 →
GRAND SCÉNIC III 1.6 16V	K4M858	02/09 →
GRAND SCÉNIC III 1.6 16V Bifuel	K4M866, R9M402	02/09 →
GRAND SCÉNIC III 1.6 dCi	R9M402, F9Q870	04/11 →
GRAND SCÉNIC III 1.6 E85	K4M866	02/09 →
GRAND SCÉNIC III 1.9 dCi	F9Q870, M4R711	02/09 →
GRAND SCÉNIC III 2.0 16V	M4R711, M9R610	02/09 →
GRAND SCÉNIC III 2.0 dCi	M9R610, H4M429	02/09 →
KAPTUR 1.6	H4M429, K9K636	03/16 →
KAPTUR 2.0 4WD	F4R410	03/16 →
MEGANE 1.5 dCi	K9K636, H5F400	01/09 → 08/15
MEGANE 1.6 BiFuel	K4M858	05/09 → 08/15
MEGANE 1.6 VVT	K4M858	01/13 → 08/15
MEGANE III 1.2 Tce	H5F400, K9K636	03/12 →
MEGANE III 1.4 Tce	H4J700	04/09 →
MEGANE III 1.5 dCi	K9K636, K4M848	11/08 →
MEGANE III 1.6 16V	K4M848, R9M402	11/08 →
MEGANE III 1.6 16V Bifuel	K4M866	11/08 →
MEGANE III 1.6 BiFuel	K4M866	11/08 →
MEGANE III 1.6 dCi	R9M402, F9Q870	04/11 →
MEGANE III 1.9 dCi	F9Q870, M4R710	11/08 →
MEGANE III 2.0	M4R710, M4R711	01/11 →
MEGANE III 2.0 CVT	M4R711, M9R610	02/09 →
MEGANE III 2.0 dCi	M9R610, F4R870	04/09 →
MEGANE III 2.0 R.S.	F4R874	07/14 →
MEGANE III 2.0 Tce	F4R870, K9K834	11/08 →
MEGANE III 2.0 Tce 220	F4R874	11/13 →
MEGANE III HATCHBACK VAN 1.5 dCi	K9K834, H5F400	11/08 → 08/15
MEGANE CC 1.2 Tce	H5F400, K9K636	09/12 →
MEGANE CC 1.4 Tce	H4J700	06/10 →
MEGANE CC 1.5 dCi	K9K636, F9Q870	06/10 →
MEGANE CC 1.6 16V	K4M858	06/10 →
MEGANE CC 1.6 16V Hi-Flex	K4M866	06/10 →
MEGANE CC 1.6 dCi	R9M402	04/11 →
MEGANE CC 1.9 dCi	F9Q870, M4R711	06/10 →
MEGANE CC 2.0 CVT	M4R711, F4R870	06/10 →
MEGANE CC 2.0 dCi	M9R610	06/10 →
MEGANE CC 2.0 Tce	F4R870, H5F400	06/10 →
MEGANE CC 2.0 Turbo	F4R874	10/11 →
SCÉNIC III 1.2 Tce	H5F400, K9K636	04/12 →
SCÉNIC III 1.4 16V	H4J700	02/09 →
SCÉNIC III 1.5 dCi	K9K636, K4M866	02/09 →
SCÉNIC III 1.6 16V	K4M858	02/09 →
SCÉNIC III 1.6 16V Bifuel	K4M866, R9M402	02/09 →
SCÉNIC III 1.6 dCi	R9M402, F9Q870	04/11 →
SCÉNIC III 1.6 E85	K4M866	02/09 →
SCÉNIC III 1.9 dCi	F9Q870, M4R711	02/09 →
SCÉNIC III 2.0 16V	M4R711, M9R610	12/08 →
SCÉNIC III 2.0 dCi	M9R610, K9K656	02/09 →

21.0104

04,5

WHEEL SPEED SENSORS

Adatt./Suitable:

BOSCH
0 265 008 938**RENAULT**
47 90 000 10R
47 90 062 71RMARKET DIFFUSION: **HIGH**

L	L1		
855	---	Hall Effect	

RENAULT		
FLUENCE 1.5 dCi	K9K656, H4M729	02/10 →
FLUENCE 1.6	H4M729, K4M838	01/13 →
FLUENCE 1.6 16V	K4M838, M4R714	02/10 →
FLUENCE 1.6 dCi	R9M402	07/14 →
FLUENCE 1.6 LPG 16V	K4M839	01/12 →
FLUENCE 2.0 [ExtraEU]	M4R714, M4R714	01/10 →
FLUENCE 2.0 16V	M4R714, M4R714	02/10 →
FLUENCE 2.0 Hi-Flex [ExtraEU]	M4R714, H5F400	02/10 → 11/18
FLUENCE Z.E.	5AM400	02/12 →
GRAND SCÉNIC III 1.2 Tce	H5F400, K9K636	04/12 →
GRAND SCÉNIC III 1.4 16V	H4J700	02/09 →
GRAND SCÉNIC III 1.5 dCi	K9K636, K4M866	02/09 →
GRAND SCÉNIC III 1.6 16V	K4M858	02/09 →
GRAND SCÉNIC III 1.6 16V Bifuel	K4M866, R9M402	02/09 →
GRAND SCÉNIC III 1.6 dCi	R9M402, F9Q870	04/11 →
GRAND SCÉNIC III 1.6 E85	K4M866	02/09 →
GRAND SCÉNIC III 1.9 dCi	F9Q870, M4R711	02/09 →
GRAND SCÉNIC III 2.0 16V	M4R711, M9R610	02/09 →
GRAND SCÉNIC III 2.0 dCi	M9R610, K9K636	02/09 →
MEGANE 1.5 dCi	K9K636, H5F400	01/09 → 08/15
MEGANE 1.6 BiFuel	K4M858	05/09 → 08/15
MEGANE 1.6 VVT	K4M858	01/13 → 08/15
MEGANE III 1.2 Tce	H5F400, K9K636	03/12 →
MEGANE III 1.4 Tce	H4J700	04/09 →
MEGANE III 1.5 dCi	K9K636, K4M848	11/08 →
MEGANE III 1.6 16V	K4M848, R9M402	11/08 →
MEGANE III 1.6 16V Bifuel	K4M866	11/08 →
MEGANE III 1.6 BiFuel	K4M866	11/08 →
MEGANE III 1.6 dCi	R9M402, F9Q870	04/11 →
MEGANE III 1.9 dCi	F9Q870, M4R710	11/08 →
MEGANE III 2.0	M4R710, M4R711	01/11 →
MEGANE III 2.0 CVT	M4R711, M9R610	02/09 →
MEGANE III 2.0 dCi	M9R610, F4R874	04/09 →
MEGANE III 2.0 R.S.	F4R874, F4R870	11/08 →
MEGANE III 2.0 Tce	F4R870, K9K834	11/08 →
MEGANE III 2.0 Tce 220	F4R874	11/13 →
MEGANE III HATCHBACK VAN 1.5 dCi	K9K834, H5F400	11/08 → 08/15
MEGANE CC 1.2 Tce	H5F400, K9K636	09/12 →
MEGANE CC 1.4 Tce	H4J700	06/10 →
MEGANE CC 1.5 dCi	K9K636, F9Q870	06/10 →
MEGANE CC 1.6 16V	K4M858	06/10 →
MEGANE CC 1.6 16V Hi-Flex	K4M866	06/10 →
MEGANE CC 1.6 dCi	R9M402	04/11 →
MEGANE CC 1.9 dCi	F9Q870, M4R711	06/10 →
MEGANE CC 2.0 CVT	M4R711, F4R870	06/10 →
MEGANE CC 2.0 dCi	M9R610	06/10 →
MEGANE CC 2.0 Tce	F4R870, H5F400	06/10 →
MEGANE CC 2.0 Turbo	F4R874	10/11 →
SCÉNIC III 1.2 Tce	H5F400, K9K636	04/12 →
SCÉNIC III 1.4 16V	H4J700	02/09 →
SCÉNIC III 1.5 dCi	K9K636, K4M866	02/09 →
SCÉNIC III 1.6 16V	K4M858	02/09 →
SCÉNIC III 1.6 16V Bifuel	K4M866, R9M402	02/09 →
SCÉNIC III 1.6 dCi	R9M402, F9Q870	04/11 →

RENAULT		
SCÉNIC III 1.6 E85	K4M866	02/09 →
SCÉNIC III 1.9 dCi	F9Q870, M4R711	02/09 →
SCÉNIC III 2.0 16V	M4R711, M9R610	12/08 →
SCÉNIC III 2.0 dCi	M9R610, RJTC	02/09 →

21.0124

04,5

WHEEL SPEED SENSORS

Adatt./Suitable:

BOSCH
0 265 009 534
0 265 009 535**FORD**
1 809 552
2 094 990
8V51-2C204-CA
8V51-2C204-CBMARKET DIFFUSION: **MEDIUM**

L	L1		
741	27,9	Hall Effect	

FORD		
B-MAX 1.0 EcoBoost	YYJC	02/16 →
B-MAX 1.4 LPG	RJTC, XVJA	08/13 →
B-MAX 1.5 TDCi	XVJA, P4JA	04/15 →
FIESTA VI 1.0	P4JA, M1JE	10/12 →
FIESTA VI 1.0 EcoBoost	M1JE, YYJA	09/12 →
FIESTA VI 1.0 Sport	YYJA, RTJA	05/14 →
FIESTA VI 1.25	STJB	10/12 →
FIESTA VI 1.4	--	06/08 →
FIESTA VI 1.4 LPG	RTJA, UGJC	01/09 →
FIESTA VI 1.5 TDCi	UGJC, JTJA	10/12 →
FIESTA VI 1.6 EcoBoost	--	01/13 →
FIESTA VI 1.6 ST	JTJA, --	03/13 →
FIESTA VI 1.6 ST200	JTJC	04/16 →
FIESTA VI 1.6 TDCi SOHC	--	02/10 →
FIESTA VI 1.6 Ti	--, SFCA	04/10 →
TOURNEO COURIER 1.0 EcoBoost	SFCA, UGCA	02/14 →
TOURNEO COURIER 1.5 TDCi	UGCA, T3CA	02/14 →
TOURNEO COURIER 1.6 TDCi	T3CA, SFCA	02/14 →
TRANSIT COURIER 1.0 EcoBoost	SFCA, UGCA	02/14 →
TRANSIT COURIER 1.5 TDCi	UGCA, T3CA	02/14 →
TRANSIT COURIER 1.6 TDCi	T3CA, M1JA	02/14 →

21.0125



04,5

21.0126



04,5

21.0128



04,5

WHEEL SPEED SENSORS

Adatt./Suitable:

BOSCH
0 265 004 315
0 265 004 319
0 265 008 987

FORD

1 761 072
1 766 910
1 812 479
2 095 000
2 102 699
AY11-2C190-BA
AY11-2C190-BB
AY11-2C190-BC
C1BC-2C190-BA
C1BC-2C190-BB

ITEM NOW AVAILABLE FROM PRODUCTION

- ARTICOLO ORA DISPONIBILE PER LA VENDITA
- ARTICLE DISPONIBLE EN PRODUCTION COURANTE
- JETZT ZUM VERKAUF VERFÜGBARER ARTIKEL
- ARTICULO AHORA DISPONIBLE EN PRODUCCION

MARKET DIFFUSION: MEDIUM



L	L1	Hall Effect	OUT +
677	9,5	Hall Effect	

FORD

B-MAX 1.0 EcoBoost	M1JA, SPJD	10/12 ⇨
B-MAX 1.4	SPJD, RJTC	10/12 ⇨
B-MAX 1.4 LPG	RJTC, UGJC	08/13 ⇨
B-MAX 1.5 TDCi	UGJC, IQJA	10/12 ⇨
B-MAX 1.6 TDCi	T3JB	10/12 ⇨
B-MAX 1.6 Ti	IQJA, HXJB	10/12 ⇨
FIESTA 1.6 Ti-VCT [ExtraEU]	HXJB, P4JA	03/15 ⇨
FIESTA VI 1.0	P4JA, M1JE	10/12 ⇨
FIESTA VI 1.0 EcoBoost	M1JE, YYJA	09/12 ⇨
FIESTA VI 1.0 Sport	YYJA, RTJA	05/14 ⇨
FIESTA VI 1.25	STJB	10/12 ⇨
FIESTA VI 1.4	--	06/08 ⇨
FIESTA VI 1.4 LPG	RTJA, UGJC	01/09 ⇨
FIESTA VI 1.5 TDCi	UGJC, --	09/12 ⇨
FIESTA VI 1.6	XTJA	03/15 ⇨
FIESTA VI 1.6 EcoBoost	--	01/13 ⇨
FIESTA VI 1.6 TDCi SOHC	--	02/10 ⇨
FIESTA VI 1.6 Ti	--, M1JA	04/10 ⇨

WHEEL SPEED SENSORS

Adatt./Suitable:

BOSCH
0 265 009 620
0 265 009 621

FORD

1 761 071
1 809 603
2 094 995
AY11-2C190-AA
AY11-2C190-AB
AY11-2C190-AC

MARKET DIFFUSION: MEDIUM



L	L1	Hall Effect	OUT +
660	9,5	Hall Effect	

FORD

B-MAX 1.0 EcoBoost	M1JA, SPJD	10/12 ⇨
B-MAX 1.4	SPJD, RJTC	10/12 ⇨
B-MAX 1.4 LPG	RJTC, UGJC	08/13 ⇨
B-MAX 1.5 TDCi	UGJC, IQJA	10/12 ⇨
B-MAX 1.6 TDCi	T3JB	10/12 ⇨
B-MAX 1.6 Ti	IQJA, HXJB	10/12 ⇨
FIESTA 1.6 Ti-VCT [ExtraEU]	HXJB, P4JA	03/15 ⇨
FIESTA VI 1.0	P4JA, M1JE	10/12 ⇨
FIESTA VI 1.0 EcoBoost	M1JE, YYJA	09/12 ⇨
FIESTA VI 1.0 Sport	YYJA, RTJA	05/14 ⇨
FIESTA VI 1.25	STJB	10/12 ⇨
FIESTA VI 1.4	--	06/08 ⇨
FIESTA VI 1.4 LPG	RTJA, UGJC	01/09 ⇨
FIESTA VI 1.5 TDCi	UGJC, JTJA	09/12 ⇨
FIESTA VI 1.6	XTJA	03/15 ⇨
FIESTA VI 1.6 EcoBoost	--	01/13 ⇨
FIESTA VI 1.6 ST	JTJA, --	03/13 ⇨
FIESTA VI 1.6 ST200	JTJC	04/16 ⇨
FIESTA VI 1.6 TDCi SOHC	--	02/10 ⇨
FIESTA VI 1.6 Ti	--, SFCA	04/10 ⇨
TOURNEO COURIER 1.0 EcoBoost	SFCA, UGCA	02/14 ⇨
TOURNEO COURIER 1.5 TDCi	UGCA, T3CA	02/14 ⇨
TOURNEO COURIER 1.6 TDCi	T3CA, SFCA	02/14 ⇨
TRANSIT COURIER 1.0 EcoBoost	SFCA, UGCA	02/14 ⇨
TRANSIT COURIER 1.5 TDCi	UGCA, T3CA	02/14 ⇨
TRANSIT COURIER 1.6 TDCi	T3CA, B10XFL	02/14 ⇨

WHEEL SPEED SENSORS

Adatt./Suitable:

BOSCH
0 265 008 089

GENERAL MOTORS
13 381 153

OPEL

12 38 399
12 47 506
13381153
62 35 742
93189275
93191478

VAUXHALL

13381153
93189275
93191478

03 Supplied until depletion

- Fornibile fino ad esaurimento delle scorte
- Fourni jusqu'à épuisement du stock
- Lieferbar solange vorrat reicht
- Suministrado hasta el stock termina

1006 After depletion of stock this part is replaced by:

- Esaurite le scorte questo pezzo sarà sostituito da:
- Après épuisement du stock, cette pièce est remplacée par:
- Nach Vorraterschöpfung wird ersetzt durch:
- Despues agotamiento stock, sera sustituido por:

21.0098

MARKET DIFFUSION: HIGH



L	L1	Hall Effect	OUT +
820	27,9	Hall Effect	

OPEL

ADAM 1.0	B10XFL, A12XEL	07/14 ⇨
ADAM 1.2	A12XEL, A14XEL	10/12 ⇨
ADAM 1.4	A14XEL, A14XEL	10/12 ⇨
ADAM 1.4 LPG	A14XEL, A10XEP	07/13 ⇨
ADAM 1.4 S	B14NEH	11/14 ⇨
CORSA D 1.0	A10XEP, A12XEL	07/06 ⇨ 08/14
CORSA D 1.2	A12XEL, A12XER	07/06 ⇨ 08/14
CORSA D 1.2 LPG	A12XER, A13DTC	08/06 ⇨ 08/14
CORSA D 1.3 CDTI	A13DTC, A14NEL	07/06 ⇨ 08/14
CORSA D 1.4	A14NEL, A14XEL	07/06 ⇨ 08/14
CORSA D 1.4 LPG	A14XEL, A16LER	08/06 ⇨ 08/14
CORSA D 1.6 Turbo	A16LER, A17DTS	11/06 ⇨ 08/14
CORSA D 1.7 CDTI	A17DTS, B10XFL	08/06 ⇨ 08/14
CORSA E 1.0	B10XFL, B13DTC	09/14 ⇨
CORSA E 1.2	B12XEL	09/14 ⇨
CORSA E 1.3 CDTI	B13DTC, B14XEJ	09/14 ⇨
CORSA E 1.4	B14XEJ, B14XEL	09/14 ⇨
CORSA E 1.4 LPG	B14XEL, B14NEH	03/15 ⇨
CORSA E 1.4 Turbo	B14NEH, B10XFL	09/14 ⇨
CORSA E 1.6 Turbo	B16LES	03/15 ⇨

VAUXHALL

ADAM 1.0	B10XFL, A12XEL	07/14 ⇨
ADAM 1.2	A12XEL, A14XEL	10/12 ⇨
ADAM 1.4	A14XEL, A10XEP	10/12 ⇨
ADAM 1.4 LPG	A14XEL	07/13 ⇨
ADAM 1.4 S	B14NEH	11/14 ⇨
CORSA D 1.0	A10XEP, A12XEL	08/06 ⇨ 08/14
CORSA D 1.0 i 12V	A10XEP	01/10 ⇨ 08/14
CORSA D 1.2	A12XEL, A12XER	08/06 ⇨ 08/14
CORSA D 1.2 i 16V	A12XER	12/09 ⇨ 08/14
CORSA D 1.2 LPG	A12XER, A13DTC	09/09 ⇨ 08/14
CORSA D 1.3 CDTI	A13DTC, A14NEL	08/06 ⇨ 08/14
CORSA D 1.4	A14NEL, A14XEL	08/06 ⇨ 08/14
CORSA D 1.4 LPG	A14XEL, A16LER	07/06 ⇨ 08/14
CORSA D 1.6 SRi	A16LER, A16LER	05/07 ⇨ 08/14
CORSA D 1.6 VXR	A16LER, A17DTS	11/06 ⇨ 08/14
CORSA D 1.7 CDTI	A17DTS, B10XFL	11/06 ⇨ 08/14

VAUXHALL		
CORSA E 1.0	B10XFL, B13DTC	08/14 →
CORSA E 1.2	B12XEL	08/14 →
CORSA E 1.3 CDTi	B13DTC, B14NEH	08/14 →
CORSA E 1.4	B14NEH, A12XEL	08/14 →
CORSA E 1.4 LPG	B14XEL	08/14 →
CORSA E 1.6 VXR	B16LES	04/15 →
CORSAVAN III 1.2	A12XEL, A13DTC	07/09 →
CORSAVAN III 1.3 CDTi	A13DTC, B13DTC	07/06 →
CORSAVAN IV 1.2	B12XEL	10/14 →
CORSAVAN IV 1.3 CDTi	B13DTC, CHZD	10/14 →
CORSAVAN IV 1.4	B14XEJ	10/14 →

21.0134



3

WHEEL SPEED SENSORS

Adatt./Suitable:

ATE

10.0711-6337.3
10.0711-6438.3

AUDI

WHT 003 864 A
WHT 003 864 B

BOSCH

0 986 594 606

MAN

WHT 003 864 A
WHT 003 864 B

SEAT

WHT 003 864 A
WHT 003 864 B

SKODA

WHT 003 864 A
WHT 003 864 B

VW

WHT 003 864 A
WHT 003 864 B

MARKET DIFFUSION: HIGH



L	L1		OUT +
---	37,8	Hall Effect	

AUDI		
A3 III 1.0 TFSI	CHZD, CJZA	07/16 →
A3 III 1.2 TFSI	CJZA, CMBA	02/13 →
A3 III 1.4 TFSI	CMBA, CUKB	04/12 →
A3 III 1.4 TFSI e-tron	CUKB, CLHA	05/14 →
A3 III 1.4 TFSI g-tron	CPWA	11/13 →
A3 III 1.4 TFSI	CZEA	05/14 →
A3 III 1.5 TFSI	DADA	05/17 →
A3 III 1.6 TDI	CLHA, CJSA	10/12 →
A3 III 1.8 TFSI	CJSA, CRBC	04/12 →
A3 III 2.0 TDI	CRBC, CHHB	04/12 →
A3 III 2.0 TFSI	CHHB, DDYA	01/13 →
A3 III 2.0 TFSI [ExtraEU]	CHHB	11/15 →
A3 III 30 TDI	DDYA, CHZD	07/18 →
A3 III 30 TFSI	CHZD, CHZJ	07/18 →
A3 III 35 TFSI	DADA	10/18 →
Q2 1.0 TFSI	CHZJ, DDYA	10/16 →
Q2 1.4 TFSI	CZEA	06/16 →
Q2 1.6 TDI	DDYA, DDYA	06/16 → 10/18
Q2 2.0 TDI	DCYA	09/16 →
Q2 30 TDi	DDYA, CHZJ	07/18 →
Q2 30 TFSI	CHZJ, CJSA	07/18 →
Q2 35 TFSI	DADA	07/18 →
Q3 35 TDI	DFGA	09/18 →
Q3 35 TFSI	DADA	08/18 →
TT III 1.8 TFSI	CJSA, DAUA	08/15 →
TT III 2.0 TDI	CUNA	07/14 →
TT III 2.0 TFSI	CHHC	07/14 →

MAN		
TGE-SERIES 0.0	EBHA	07/18 →
TGE 2.0 TDI	DAUA, DASA	02/17 →
TGE 2.0 TDI RWD	DASA, CHZJ	05/17 →

SEAT		
ATECA 1.0 TSI	CHZJ, DDYA	05/16 →
ATECA 1.4 TSI	CZEA	06/16 →
ATECA 1.5 TSI	DADA	07/18 →
ATECA 1.6 TDI	DDYA, CRVA	04/16 →

SEAT		
ATECA 2.0 TDI	CRVA, CHZD	04/16 →
LEON III 1.0 TSI	CHZD, CJZA	05/15 →
LEON III 1.2 TSI	CJZA, CHPA	12/12 →
LEON III 1.4 TGI	CPWA	02/13 →
LEON III 1.4 TSI	CHPA, DACA	09/12 →
LEON III 1.5 TGI	DHFA	10/18 →
LEON III 1.5 TSI	DACA, CLHA	09/18 →
LEON III 1.6 TDI	CLHA, CJSA	09/12 →
LEON III 1.6 TSI	CWVA	05/15 →
LEON III 1.8 TFSI	CJSA	02/13 →
LEON III 1.8 TSI	CJSA	02/13 →
LEON III 1.8 TSI 4Drive	CJSA, CJXA	11/14 →
LEON III 2.0 Cupra	CJXA, CKFC	10/13 →
LEON III 2.0 Cupra R	CJXG	11/17 →
LEON III 2.0 TDI	CKFC, CJZB	09/12 →
LEON III 2.0 TDI 4Drive	CUNA	11/14 →
LEON III 2.0 TSI	DKZA	09/18 →
LEON ST 1.0 TSI	CHZD	05/15 →
LEON ST 1.2 TSI	CJZB, CZDA	01/13 →
LEON ST 1.4 TSI	CZDA, CRKB	05/14 →
LEON ST 1.6 TDI	CRKB, CJXA	09/13 →
LEON ST 1.8 TFSI	CJSA	10/13 →
LEON ST 2.0 Cupra	CJXA, CKFC	10/13 →
LEON ST 2.0 TDI	CKFC, CZCA	04/13 →
LEON ST 2.0 TDI 4Drive	CUNA	10/14 →

SKODA		
KAROQ 1.0 TSI	CHZJ	07/17 →
KAROQ 1.5 TSI	DADA	07/17 →
KAROQ 1.6 TDI	DDYA	07/17 →
KODIAQ 1.4 TSI	CZCA, CHZD	10/16 →
KODIAQ 1.5 TSI	DADA	07/18 →
KODIAQ 2.0 TDI	DBGC	10/16 →
OCTAVIA III 1.0 TSI	CHZD, CJZA	05/16 →
OCTAVIA III 1.2 TSI	CJZA, CHPA	11/12 →
OCTAVIA III 1.4 [CHN]	CSSA	02/14 →
OCTAVIA III 1.4 TSI	CHPA, CLHA	11/12 →
OCTAVIA III 1.4 TSI G-TEC	CPWA	11/13 →
OCTAVIA III 1.5 TSI	DADA	02/17 →
OCTAVIA III 1.6	CWVA	01/14 →
OCTAVIA III 1.6 [CHN]	CSRA	02/14 →
OCTAVIA III 1.6 TDI	CLHA, CJSA	11/12 →
OCTAVIA III 1.8 TSI	CJSA, CKFB	11/12 →
OCTAVIA III 2.0 TDI	CKFB, CUNA	11/12 →
OCTAVIA III 2.0 TDI RS	CUNA, CHHA	05/13 →
OCTAVIA III 2.0 TSI RS	CHHA, CZCA	11/12 →
SUPERB III 1.4 TSI	CZCA, CVRA	03/15 →
SUPERB III 1.6 TDI	CVRA, CJSA	03/15 →
SUPERB III 1.8 TSI	CJSA, CRGA	03/15 →
SUPERB III 2.0 TDI	CRGA, DBGA	03/15 →
SUPERB III 2.0 TSI	CHHB	03/15 →

VW		
ARTEON 1.5 TSI	DADA	11/17 →
ARTEON 2.0 TDI	DBGA, CUAA	04/17 →
ARTEON 2.0 TDI 4motion	CUAA, CZPB	04/17 →
ARTEON 2.0 TSI	CZPB, CHZG	05/17 →
ARTEON 2.0 TSI 4motion	DJHC	04/17 →
CADDY III 1.0 TSI	CHZG, CBZA	11/15 →
CADDY III 1.2 TSI	CBZA, CZCB	09/10 →
CADDY III 1.4 TGI CNG	CPWA	06/15 →
CADDY III 1.4 TSI	CZCB, BGU	05/15 →
CADDY III 1.6	BGU, BSF	04/04 →
CADDY III 1.6 BiFuel	BSF, CAYD	05/11 → 05/15
CADDY III 1.6 TDI	CAYD, CFHC	08/10 →
CADDY III 2.0 EcoFuel	BSX	04/06 → 05/15
CADDY III 2.0 TDI	CFHC, CFHC	08/10 →
CADDY III 2.0 TDI 16V	CFHC, DASB	11/10 → 05/15
CRAFTER 2.0 TDI	DASB, DASA	09/16 →
CRAFTER 2.0 TDI RWD	DASA, CJZA	11/16 →
CRAFTER e-Crafter	EBHA	07/18 →
GOLF VII 1.0 TSI	CHZC, CJZA	05/15 →
GOLF VII 1.2 TSI	CJZA, CPWA	08/12 →
GOLF VII 1.4 GTE Hybrid	CUKB	05/14 →
GOLF VII 1.4 TGI CNG	CPWA, CHPA	06/13 →
GOLF VII 1.4 TSI	CHPA, CPVA	08/12 →
GOLF VII 1.4 TSI MultiFuel	CPVA, DACA	04/13 →
GOLF VII 1.5 TGI	DACA	07/17 →
GOLF VII 1.5 TSI	DACA, CLHA	04/17 →
GOLF VII 1.6	CWVA	05/14 →
GOLF VII 1.6 TDI	CLHA, CUNA	08/12 →
GOLF VII 2.0 GTD	CUNA, CHHA	04/13 →
GOLF VII 2.0 GTI	CHHA, CKFC	04/13 →
GOLF VII 2.0 GTI Clubsport	CJXE	02/16 →
GOLF VII 2.0 GTI Clubsport S	CJXG	09/16 →
GOLF VII 2.0 TDI	CKFC, EAGA	08/12 →
GOLF VII e-Golf	EAGA, CZCA	03/14 →
GOLF 1.2 TSI BlueMotion	CJZA, CHPA	08/12 →
GOLF 1.4 TSI BlueMotion	CHPA, CLHA	08/12 →
GOLF 1.6 TDI BlueMotion	CLHA, CHHA	08/12 →

VW		
GOLF 2.0 GTD	CUNA	04/13 →
GOLF 2.0 GTi	CHHA, CJZA	04/13 →
GOLF VAN 1.2 TSI BlueMotion	CJZA, CHPA	04/13 → 03/17
GOLF VAN 1.4 TSI BlueMotion	CHPA, CLHA	05/13 → 03/17
GOLF VAN 1.6 TDI BlueMotion	CLHA, CHZC	05/13 → 03/17
PASSAT VI 1.4 GTE Hybrid	CUKC	06/15 →
PASSAT VI 1.4 TSI	CZCA, DCXA	11/14 →
PASSAT VI 1.5 TSI	DADA	08/18 →
PASSAT VI 1.6 TDI	DCXA, CJSA	08/14 →
PASSAT VI 1.8 TSI	CJSA, CRGA	02/15 →
PASSAT VI 2.0 TDI	CRGA, CHHB	11/14 →
PASSAT VI 2.0 TSI	CHHB, CZCA	02/15 →
T-ROC 1.0 TSI	CHZJ	07/17 →
T-ROC 1.6 TDI	DGTE	03/18 →
T-ROC 2.0 TDI	DFFA	03/18 →
TIGUAN I 1.5	DADA	11/18 →
TIGUAN I 1.4 TSI	CZCA, CRFD	01/16 →
TIGUAN II 1.5	DADA	11/18 →
TIGUAN II 1.6 TDI	DGDB	05/16 →
TIGUAN II 2.0 TDI	CRFD, CRKB	01/16 →
TOURAN II 1.2 TSI	CYVB	05/15 →
TOURAN II 1.4 TSI	CZDA	05/15 →
TOURAN II 1.6 TDI	CRKB, CRVA	05/15 →
TOURAN II 1.8 TSI	CJSA	11/15 →
TOURAN II 2.0 TDI	CRVA, 1KR	05/15 →
TOURAN II TSI	DADA	11/18 →

21.0135



04,5

WHEEL SPEED SENSORS

Adatt./Suitable:

BOSCH

0 265 008 632

CITROËN

B0 006 980 80

PEUGEOT

B0 006 980 80

TOYOTA

89542-0H020

MARKET DIFFUSION: HIGH



L	L1		OUT +
820	27,9	Hall Effect	

CITROËN		
C1 I 1.0	1KR, 1KR	06/05 →
C1 I 1.4 HDi	8HT(DV4TD)	06/05 → 09/14
PEUGEOT		
107 1.0	1KR, 8HT(DV4TD)	06/05 →
107 1.4 HDi	8HT(DV4TD), D4204T20	06/05 → 05/14
TOYOTA		
AYGO I 1.0	1KR-FE	07/05 → 05/14
AYGO I 1.0 GPL	1KR-FE	07/05 → 05/14
AYGO I 1.0 VVTi	1KR-FE	07/05 → 05/14

21.0136



WHEEL SPEED SENSORS

Adatt./Suitable:

ATE 10.0711-6221.3

FORD 6G9N-2B372-DD

VOLVO 30748148 30793636

MARKET DIFFUSION: MEDIUM



L	L1	Hall Effect	
---	13,5		

VOLVO

S60 II 1.5 T2	B4154T5	10/15 →
S60 II 1.5 T3	B4154T4	03/15 →
S60 II 2.0 D2	D4204T20, D4204T4	03/15 →
S60 II 2.0 D3	D4204T4, B4204T6	03/15 →
S60 II 2.0 D4	D4204T14	03/15 →
S60 II 2.0 D5	D4204T11	03/15 →
S60 II 2.0 T	B4204T6, D5204T2	04/10 → 12/15
S60 II 2.0 T3	B4204T37	03/15 →
S60 II 2.0 T4	B4204T19	03/15 →
S60 II 2.0 T5 DRIVE	B4204T7	09/14 → 12/15
S60 II 2.5 T	B5254T14	01/13 →
S60 II 2.5 T5	B5254T5	09/11 →
S60 II D3	D5204T2, D4204T5	04/10 → 12/15
S60 II D4	D4204T5, D5244T10	04/10 → 12/15
S60 II D5	D5244T10, B4204T11	04/10 → 12/15
S60 II D5 AWD	D5244T11	04/11 → 12/15
S60 II Drive / D2	D4162T	01/11 → 12/15
S60 II T	B5204T9	04/14 →
S60 II T3	B4164T3	04/10 → 12/15
S60 II T4	B4164T	04/10 → 12/15
S60 II T4F	B4164T2	04/11 → 12/15
S60 II T5	B4204T11, D5244T14	04/10 →
S60 II T6	B4204T9	09/13 →
S60 II T6 AWD	B6304T3	04/14 → 12/15
S80 II 1.6 D DRIVE	D4164T	01/10 → 12/11
S80 II 1.6 D2	D4162T	01/14 →
S80 II 1.6 DRIVE	D4162T	06/11 →
S80 II 2.0	B4204S3	01/08 → 09/12
S80 II 2.0 Drive- E	B4204T11	12/14 →
S80 II 2.0 FlexFuel	B4204S4	01/08 → 12/11
S80 II 2.0 T	B4204T6	01/10 →
S80 II 2.0 T5	B4204T15	01/14 →
S80 II 2.0 TDi	D4204T	02/08 → 03/11
S80 II 2.4 D	D5244T14, B5254T10	03/06 →
S80 II 2.5 T	B5254T10, B5254T11	03/06 →
S80 II 2.5 T FlexFuel	B5254T11, D5204T2	05/08 → 12/11
S80 II 3.2	B6324S5	01/10 →
S80 II D3	D5204T7	05/12 →
S80 II D3 / D4	D5204T2, D5244T10	01/10 →
S80 II D4	D4204T5	09/13 →
S80 II D5	D5244T10, B4204T11	03/06 →
S80 II T4	B4164T	10/10 →
S80 II T4F	B4164T2	05/11 →
S80 II T5	B4204T11, D4204T20	10/10 →
V50 2.4 AWD	B5244S4	08/06 → 12/09
V60 I 1.5 T2	B4154T5	10/15 →
V60 I 2.0 D2	D4204T20, D4204T11	03/15 →
V60 I 2.0 D3	D4204T9	03/15 →
V60 I 2.0 D4	D4204T14	03/15 →
V60 I 2.0 T	B5204T8	01/14 →
V60 I 2.0 T4	B4204T19	03/15 →
V60 I 2.0 T5	B4204T15	01/14 →
V60 I 2.4 D5 AWD	D5244T11	04/11 → 12/15
V60 I 3.0 T AWD	B6304T5	04/14 →
V60 I D5	D4204T11, B4154T4	04/14 →
V60 I T3	B4154T4, B4204T7	03/15 →

VOLVO		
V60 I T5	B4204T7, B5204T9	08/12 →
V70 2.0 D4/D4 DRIVE	D5204T3	09/13 →
V70 III 1.6 D	D4164T	07/09 → 12/11
V70 III 1.6 DRIVE / D2	D4162T	04/11 → 12/15
V70 III 1.6 T4F	B4164T2	01/11 → 12/15
V70 III 2.0	B4204S3	10/07 → 12/11
V70 III 2.0 BiFuel	B5204T9, D5244T14	03/13 → 12/15
V70 III 2.0 D	D4204T	10/07 → 12/15
V70 III 2.0 D3 DRIVE	D5204T7	09/13 →
V70 III 2.0 FlexiFuel	B4204S4	01/08 → 12/11
V70 III 2.0 GDI	B5204T9	04/12 → 12/15
V70 III 2.0 T	B4204T6	09/09 → 12/11
V70 III 2.4 D	D5244T14, D5244T11	04/07 → 12/10
V70 III 2.4 D4 AWD	D5244T17	09/13 →
V70 III 2.4 D5	D5244T11, B5254T10	09/13 →
V70 III 2.5 T	B5254T10, B5254T11	08/07 → 12/12
V70 III 2.5 T FlexiFuel	B5254T11, B6324S	05/08 → 12/11
V70 III 3.2	B6324S, D4204T9	08/07 → 12/14
V70 III D2	D4204T20	03/15 →
V70 III D3	D4204T9, D5204T2	10/07 →
V70 III D3 / D4	D5204T2, D5244T10	03/10 → 12/15
V70 III D4	D4204T5	10/13 →
V70 III D5	D5244T10, B4164T	04/07 →
V70 III T4	B4164T, B4204T11	10/10 →
V70 III T5	B4204T11, D5204T2	01/10 →
XC60 I D3	D4204T4	03/15 → 02/17
XC60 I D4	D4204T14	03/15 → 02/17
XC60 I D5	D5244T11	06/11 → 02/17
XC70 II 2.4 D	D5244T14	06/09 → 12/10
XC70 II 3.2	B6324S5	08/07 →
XC70 II D3	D5204T2, G6DG	04/10 → 12/15
XC70 II D4	D4204T5	10/13 →
XC70 II T5	B4204T11	10/13 →

21.0137



WHEEL SPEED SENSORS

Adatt./Suitable:

ATE 10.0711-6144.3 10.0711-6196.3 10.0711-6427.3 10.0711-6435.3

BOSCH 0 986 594 569

FORD 1 501 675 1 740 259 2 071 964 3M5T-2B372-CB 6G9N-2B372-EB BV6T-2C190-KB

VOLVO 30736634 30736895 31423573

MARKET DIFFUSION: MEDIUM

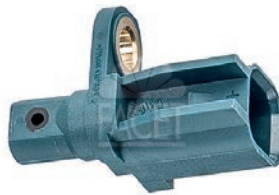

L	L1	Hall Effect	
---	13,5		

FORD

FOCUS III 2.3 RS AWD	YVDA	07/15 →
KUGA I 2.0 TDCi	--	03/10 →
KUGA I 2.0 TDCi 4x4	G6DG, HYDB	03/08 → 11/12
KUGA I 2.0 TDCi CR TC	--	03/10 →
KUGA I 2.5	HYDB	03/09 → 11/12
KUGA I 2.5 4x4	HYDB, C15HDTX	02/08 → 11/12
KUGA II 1.5 16V	--	03/13 →
KUGA II 1.5 EcoBoost 4x4	C15HDTX, --	09/14 →
KUGA II 1.6 EcoBoost	--, JQMA	01/13 →
KUGA II 1.6 EcoBoost 4x4	JQMA, T7MA	10/12 →
KUGA II 2.0 4x4	--	03/13 → 06/16
KUGA II 2.0 EcoBoost 4x4	R9MA	08/17 →
KUGA II 2.0 TDCi 4x4	T7MA, B5254T3	03/13 →

VOLVO

S40 II 2.4 AWD	B5244S4	08/06 → 12/12
S40 II T5 AWD	B5254T3, B5254T14	04/04 → 12/10
S60 II 2.0 Polestar AWD	B4204T43	06/15 →
S60 II 2.4 D4 AWD	D5244T21	03/15 →
S60 II 2.5 T	B5254T14	01/13 →
S60 II 2.5 T5 AWD	B5254T14, D5244T10	09/12 →
S60 II 3.0 T AWD	B6304T5	04/14 →
S60 II D5 AWD	D5244T10, B4204T11	04/10 → 12/15
S60 II T	B5204T9	04/14 →
S60 II T5 AWD	B4204T11, B4204T9	07/14 →
S60 II T6 AWD	B4204T9, B6324S	04/10 →
S80 II 2.5 T AWD	B5254T6	10/06 → 04/09
S80 II 3.2	B6324S	03/06 →
S80 II 3.2 AWD	B6324S, D5244T10	01/07 → 12/12
S80 II 4.4 V8 AWD	B8444S	03/06 → 03/12
S80 II D5 AWD	D5244T10, B6304T2	01/07 →
S80 II T6 AWD	B6304T2, B6304T2	01/07 → 12/16
S80L T6 AWD	B6304T2, B5254T3	01/08 →
V50 T5 AWD	B5254T3, D4204T4	04/04 → 12/10
V60 I 1.6 DRIVE	D4162T	02/11 → 12/15
V60 I 2.0 BiFuel	B5204T9	03/14 → 12/15
V60 I 2.0 D3	D4204T4, D5244T11	09/13 →
V60 I 2.0 D4	D4204T14	09/13 →
V60 I 2.0 Polestar AWD	B4204T43	06/15 →
V60 I 2.0 T	B4204T6	07/10 → 12/12
V60 I 2.4 D4 AWD	D5244T12	09/13 → 12/15
V60 I 2.4 D5	D5244T11, D5244T11	04/11 → 12/15
V60 I 2.4 D5 AWD	D5244T10, D5244T15	04/11 → 12/15
V60 I 2.4 D5 Hybrid AWD	D87PHEV	03/15 →
V60 I 2.4 Hybrid D6 AWD	D5244T15, D5204T2	06/12 → 12/15
V60 I D3	D5204T7	05/12 → 12/15
V60 I D3 / D4	D5204T2, D5244T12	07/10 → 12/14
V60 I D4	D4204T5	10/13 → 12/15
V60 I D4 AWD	D5244T12, D5244T10	05/12 →
V60 I D5	D5244T10, D5244T10	07/10 → 12/15
V60 I D5 AWD	D5244T10, B4204T11	07/10 → 12/15
V60 I D6 Hybrid AWD	D97PHEV	03/15 →
V60 I T3	B4164T3	09/10 → 12/15
V60 I T4	B4164T	09/10 → 12/15
V60 I T4F	B4164T2	04/11 → 12/15
V60 I T5	B4204T11, B4204T11	09/10 →
V60 I T5 AWD	B4204T11, B4204T9	07/14 →
V60 I T6	B4204T9	10/13 →
V60 I T6 AWD	B4204T9, B6324S	07/10 →
V70 III 3.0 T6 AWD	B6304T4	11/13 →
V70 III 3.2 AWD	B6324S, D5244T12	04/07 → 12/15
V70 III D4 AWD	D5244T12, D5244T10	10/07 →
V70 III D5 AWD	D5244T10, B6304T2	04/07 →
V70 III T6 AWD	B6304T2, D5244T16	08/07 → 12/15
XC60 I 2.0 T	B4204T6	12/09 → 12/12
XC60 I 2.4 D	D5244T14	04/09 → 12/10
XC60 I 2.4 D / D3 / D4 AWD	D5244T16, B6324S	05/08 → 02/17
XC60 I 3.2 AWD	B6324S, D5204T2	07/09 → 12/15
XC60 I D3	D5204T7	04/12 → 12/15
XC60 I D3 / D4	D5204T2, D5244T12	03/10 → 12/14
XC60 I D4	D4204T5	10/13 → 12/15
XC60 I D4 AWD	D5244T12, D5244T10	10/13 → 02/17
XC60 I D5 AWD	D5244T10, B4204T11	05/08 → 02/17
XC60 I T5	B4204T11, B4204T11	09/10 →
XC60 I T5 AWD	B4204T11, B4204T9	04/14 → 02/17
XC60 I T6	B4204T9	10/13 →
XC60 I T6 AWD	B4204T9, D5244T16	05/08 →
XC70 II 2.4 D / D4 AWD	D5244T16, B6324S	08/07 →
XC70 II 3.2 AWD	B6324S, D5244T10	08/07 →
XC70 II D3 AWD	D5204T2	08/11 →
XC70 II D4 AWD	D5244T12	10/13 →
XC70 II D5 AWD	D5244T10, B5254T14	04/07 →
XC70 II T5 AWD	B5254T12	08/15 →
XC70 II T6 AWD	B5254T14, 199B6000CNG	01/08 →



WHEEL SPEED SENSORS

Adatt./Suitable:

BOSCH
0 265 009 481**FIAT**
51938138

L	L1	Hall Effect	OUT 
720	27,9	Hall Effect	

FIAT		
500L 0.9	199B6.000	09/12 ⇨
500L 0.9 Natural Power	199B6000CNG, 199B4.000	03/13 ⇨
500L 1.3 D Multijet	199B4.000, 843A1.000	09/12 ⇨
500L 1.4	843A1.000, 199B5.000	09/12 ⇨
500L 1.4 [CAN]	--	01/13 ⇨
500L 1.4 LPG	940B7.000	02/14 ⇨
500L 1.6 D Multijet	199B5.000, 312A2.000	09/12 ⇨



WHEEL SPEED SENSORS

Adatt./Suitable:

BOSCH
0 265 009 051**FIAT**
51890528

MARKET DIFFUSION: MEDIUM



L	L1	Hall Effect	OUT 
820	27,9	Hall Effect	

FIAT		
500 0.9	312A4.000	12/13 ⇨
PANDA III 0.9	312A2.000, 312A2.000	02/12 ⇨
PANDA III 0.9 4x4	312A2.000	06/14 ⇨
PANDA III 0.9 Natural Power	312A2.000, 199A1.000	07/12 ⇨
PANDA III 1.2	169A4.000	02/12 ⇨
PANDA III 1.2 LPG	169A4.000	06/12 ⇨
PANDA III 1.3 D Multijet	199A1.000, AR32104	02/12 ⇨
PANDA III 1.3 D Multijet 4x4	199A9.000	06/12 ⇨



WHEEL SPEED SENSORS

Adatt./Suitable:

ALFA ROMEO
46839673
51791156**BOSCH**
0 265 008 007

MARKET DIFFUSION: MEDIUM



L	L1	Hall Effect	OUT 
1276	27,9	Hall Effect	

ALFA ROMEO		
147 1.6 16V T.SPARK	AR32104	01/01 ⇨ 03/10
147 1.6 16V T.SPARK ECO	AR37203	01/01 ⇨ 03/10
147 1.6 LPG	AR32104, 182B9.000	03/01 ⇨ 03/10
147 1.9 JTD	182B9.000, 192A5.000	04/01 ⇨ 03/10
147 1.9 JTD 16V	192A5.000, 937A2.000	11/02 ⇨ 03/10
147 1.9 JTDM	937A2.000, 937A5.000	10/04 ⇨ 03/10
147 1.9 JTDM 16V	937A5.000, 312A2.000	09/04 ⇨ 03/10
147 1.9 JTDM 8V	937A3.000	07/05 ⇨ 03/10
147 2.0 16V T.SPARK	AR32310	01/01 ⇨ 03/10
147 3.2 GTA	932A.000	02/03 ⇨ 03/10

21.0142



04,5

WHEEL SPEED SENSORS

Adatt./Suitable:

BOSCH
0 265 008 416**CHRYSLER**
51846677**FIAT**
51846677**LANCIA**
51846677

MARKET DIFFUSION: MEDIUM



L	L1		OUT
795	27,9	Hall Effect	

CHRYSLER

YPSILON 0.9 Twinair	312A2.000	05/11	⇌
YPSILON 1.2	169A4.000	05/11	⇌
YPSILON 1.3 Multijet	199B1.000	05/11	⇌

LANCIA

YPSILON I 1.2	169A4.000	08/10	⇌ 12/11
YPSILON II 0.9 CNG	312A2.000, 312A2.000	05/11	⇌
YPSILON II 0.9 TwinAir	312A2.000, 199B1.000	05/11	⇌
YPSILON II 1.2	169A4.000	05/11	⇌
YPSILON II 1.2 Bi-fuel	169A4.000	05/11	⇌
YPSILON II 1.3 D Multijet	199B1.000, 188A4.000	05/11	⇌

21.0143



04,5

WHEEL SPEED SENSORS

Adatt./Suitable:

BOSCH
0 265 008 188**FIAT**
51812551**LANCIA**
51812551

MARKET DIFFUSION: MEDIUM



L	L1		OUT
1000	27,9	Hall Effect	

LANCIA

YPSILON I 1.2	188A4.000, 199A2.000	10/03	⇌ 12/11
YPSILON I 1.3 D Multijet	199A2.000, K4M830CNG	09/06	⇌ 12/11
YPSILON I 1.3 JTD	188A9.000	10/03	⇌ 12/11
YPSILON I 1.4	350A1.000	02/06	⇌ 12/11
YPSILON I 1.4 16V	843A1.000	10/03	⇌ 12/11
YPSILON I 1.4 LPG	350A1.000	11/10	⇌ 12/11

21.0144



04,5

WHEEL SPEED SENSORS

Adatt./Suitable:

BOSCH
0 265 008 920**MERCEDES-BENZ**
A 415 905 31 00**RENAULT**
47 90 000 26R
82 00 441 403

MARKET DIFFUSION: MEDIUM



L	L1		OUT
585	---	Hall Effect	

MERCEDES-BENZ

CITAN 108 CDI	OM607.951	11/12	⇌
CITAN 109 CDI	OM607.951	11/12	⇌
CITAN 111 CDI	OM607.951	06/13	⇌
CITAN 112	M200.711	06/13	⇌

RENAULT

KANGOO 1.2 LPG	H5F400	07/13	⇌
KANGOO 1.6	K4M836	02/12	⇌

RENAULT

KANGOO 1.6 CNG	K4M830CNG, K4M834	10/07	⇌
KANGOO 1.6 Hi-Flex	K4M834	02/12	⇌
KANGOO 1.6 LPG	K4M834, H5F400	02/12	⇌
KANGOO II 1.2 TCe 115	H5F400, K9K608	07/13	⇌
KANGOO II 1.5 dCi	K9K608, K9K636	02/08	⇌
KANGOO II 1.5 dCi 110	K9K636, K9K608	09/10	⇌
KANGOO II 1.5 dCi 75	K9K608, K9K800	09/10	⇌
KANGOO II 1.5 dCi 85	K9K800, K9K608	02/08	⇌
KANGOO II 1.5 dCi 90	K9K608, K4M830	06/09	⇌
KANGOO II 1.6	K4M830, K4M830	02/08	⇌
KANGOO II 1.6 16V	K4M830, K4M834	02/08	⇌
KANGOO II 1.6 16V Flex	K4M834	02/08	⇌
KANGOO II 1.6 16V Hi-Flex	K4M834	02/08	⇌
KANGOO II 1.6 16V LPG	K4M834, K4M830CNG	12/08	⇌
KANGOO II Z.E.	5AM400	10/11	⇌

21.0145



04,5

WHEEL SPEED SENSORS

Adatt./Suitable:

BOSCH
0 265 008 921**MERCEDES-BENZ**
A 415 905 30 00**RENAULT**
47 95 020 46R
82 00 441 404

MARKET DIFFUSION: MEDIUM



L	L1		OUT
1595	---	Hall Effect	

MERCEDES-BENZ

CITAN 108 CDI	OM607.951	11/12	⇌
CITAN 109 CDI	OM607.951	11/12	⇌
CITAN 111 CDI	OM607.951	06/13	⇌
CITAN 112	M200.711	06/13	⇌

RENAULT

KANGOO 1.2 LPG	H5F400	07/13	⇌
KANGOO 1.6	K4M836	02/12	⇌
KANGOO 1.6 CNG	K4M830CNG, K4M834	10/07	⇌
KANGOO 1.6 Hi-Flex	K4M834	02/12	⇌
KANGOO 1.6 LPG	K4M834, H5F400	02/12	⇌
KANGOO II 1.2 TCe 115	H5F400, K9K608	07/13	⇌
KANGOO II 1.5 dCi	K9K608, K9K636	02/08	⇌
KANGOO II 1.5 dCi 110	K9K636, K9K608	09/10	⇌
KANGOO II 1.5 dCi 75	K9K608, K9K800	09/10	⇌
KANGOO II 1.5 dCi 85	K9K800, K9K608	02/08	⇌
KANGOO II 1.5 dCi 90	K9K608, K4M830	06/09	⇌
KANGOO II 1.6	K4M830, K4M830	02/08	⇌
KANGOO II 1.6 16V	K4M830, K4M834	02/08	⇌
KANGOO II 1.6 16V Flex	K4M834	02/08	⇌
KANGOO II 1.6 16V Hi-Flex	K4M834	02/08	⇌
KANGOO II 1.6 16V LPG	K4M834, M9R630	12/08	⇌
KANGOO II Z.E.	5AM400	10/11	⇌



WHEEL SPEED SENSORS

Adatt./Suitable:

BOSCH0 265 008 041
0 265 008 915**GENERAL MOTORS**93 859 336
93 865 950**NISSAN**47910-00Q0A
47910-00Q0D**OPEL**44 06 339
44 19 127
93859336
93865950**RENAULT**47 91 028 45R
82 00 675 748**VAUXHALL**93859336
93865950

MARKET DIFFUSION: MEDIUM



L	L1	Hall Effect	
700	---		

NISSAN

PRIMASTAR 2.5 dCi 115	G9U720	09/08 →
PRIMASTAR 2.5 dCi 150	G9U632	09/06 →
PRIMASTAR dCi 115	G9U720	09/08 →
PRIMASTAR dCi 150	G9U632	09/06 →

OPEL

VIVARO A 1.9 DI	F9Q762	08/01 →
VIVARO A 1.9 DTI	F9Q760	08/01 →
VIVARO A 2.0 CDTI	M9R630, G9MB6	01/06 →
VIVARO A 2.0 ECOTEC	F4R820	08/06 →
VIVARO A 2.5 CDTI	G9MB6, M9R630	08/06 →
VIVARO A 2.5 DTI	G9U730	05/03 →

RENAULT

MEGANE I 2.0 16V	F4R720	05/00 →
TRAFIC 2.0 dCi	M9R630, F9Q760	08/06 →
TRAFIC II 1.9 dCi	F9Q760, F9Q760	03/01 →
TRAFIC II 1.9 dCi 100	F9Q760	03/01 →
TRAFIC II 1.9 dCi 80	F9Q760, F4R720	03/01 →
TRAFIC II 2.0	F4R720, M9R630	03/01 →
TRAFIC II 2.0 16V	F4R820	08/06 →
TRAFIC II 2.0 dCi 115	M9R630, M9R630	08/06 →
TRAFIC II 2.0 dCi 90	M9R630, M9R630	08/06 →
TRAFIC II 2.5 dCi	G9U630	08/07 →
TRAFIC II 2.5 dCi 115	G9U630	02/08 →
TRAFIC II 2.5 dCi 135	G9U730	03/01 →
TRAFIC II 2.5 dCi 145	G9U630	08/06 →
TRAFIC II 2.5 DTi	G9U730	03/03 → 07/03

VAUXHALL

VIVARO 2.0 CDTI	M9R630, G9U630	01/06 → 07/14
VIVARO 2.0 ECOTEC	F4R820	08/06 → 07/14
VIVARO 2.5 CDTI	G9U630, F4R790	04/03 → 07/14
VIVARO 2.5 DTI	G9U630	07/03 → 07/14



WHEEL SPEED SENSORS

Adatt./Suitable:

ATE

10.0711-5203.1

RENAULT

82 00 539 280

MARKET DIFFUSION: MEDIUM



L	L1	Hall Effect	
697	---		

RENAULT

ESPACE IV 1.9 dCi	F9Q820	11/02 →
ESPACE IV 2.0	F4R790, M9R740	11/02 →
ESPACE IV 2.0 dCi	M9R740, G9T645	01/06 →
ESPACE IV 2.2 dCi	G9T645, P9X701	11/02 →
ESPACE IV 3.0 dCi	P9X701, V4Y711	11/02 →
ESPACE IV 3.5 V6	V4Y711, K4M830CNG	11/02 →



WHEEL SPEED SENSORS

Adatt./Suitable:

BOSCH0 265 008 917
0 265 009 525**MERCEDES-BENZ**A 415 905 29 00
A 415 905 41 00**RENAULT**47 91 080 20R
47 91 098 60R
82 00 441 401

MARKET DIFFUSION: MEDIUM



L	L1	Hall Effect	
770	---		

MERCEDES-BENZ

CITAN 108 CDI	OM607.951	11/12 →
CITAN 109 CDI	OM607.951	11/12 →
CITAN 111 CDI	OM607.951	06/13 →
CITAN 112	M200.711	06/13 →

RENAULT

KANGOO 1.2 LPG	H5F400	07/13 →
KANGOO 1.6	K4M836	02/12 →
KANGOO 1.6 CNG	K4M830CNG, K4M834	10/07 →
KANGOO 1.6 Hi-Flex	K4M834	02/12 →
KANGOO 1.6 LPG	K4M834, H5F400	02/12 →
KANGOO II 1.2 TCe 115	H5F400, K9K608	07/13 →
KANGOO II 1.5 dCi	K9K608, K9K636	02/08 →
KANGOO II 1.5 dCi 110	K9K636, K9K608	09/10 →
KANGOO II 1.5 dCi 75	K9K608, K9K800	09/10 →
KANGOO II 1.5 dCi 85	K9K800, K9K608	02/08 →
KANGOO II 1.5 dCi 90	K9K608, K4M830	06/09 →
KANGOO II 1.6	K4M830, K4M830	02/08 →
KANGOO II 1.6 16V	K4M830, K4M834	02/08 →
KANGOO II 1.6 16V Flex	K4M834	02/08 →
KANGOO II 1.6 16V Hi-Flex	K4M834	02/08 →
KANGOO II 1.6 16V LPG	K4M834, F4R720	12/08 →
KANGOO II Z.E.	5AM400	10/11 →

21.0149



04,5

WHEEL SPEED SENSORS

Adatt./Suitable:

BOSCH
0 265 008 077**GENERAL MOTORS**
93 192 439**NISSAN**
47910-00QAD
47910-00QAH**OPEL**
12 36 176
44 14 181
44 14 512
44 18 054
91165926
91169034
93192439**RENAULT**
82 00 003 512
82 00 003 513
82 00 184 209
82 00 583 498**VAUXHALL**
91165926
91169034
93192439

MARKET DIFFUSION: MEDIUM

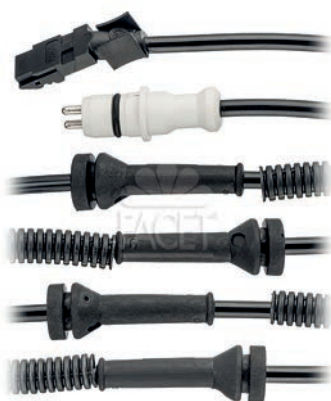

L	L1		OUT
692	---	Hall Effect	

NISSAN		
PRIMASTAR 1.9 dCi 100	F9Q760	07/02 ⇨
PRIMASTAR 1.9 dCi 80	F9Q762	07/02 ⇨
PRIMASTAR 2.0	F4R720, M9R630	03/01 ⇨
PRIMASTAR 2.0 dCi 115	M9R630, M9R630	09/06 ⇨
PRIMASTAR 2.0 dCi 90	M9R630, G9U630	09/06 ⇨
PRIMASTAR 2.5 dCi 115	G9U630, G9U630	09/08 ⇨
PRIMASTAR 2.5 dCi 140	G9U730	07/02 ⇨
PRIMASTAR 2.5 dCi 150	G9U630, G9U630	04/06 ⇨
PRIMASTAR dCi 100	F9Q760	03/01 ⇨
PRIMASTAR dCi 115	G9U630, M9R630	09/08 ⇨
PRIMASTAR dCi 120	M9R630, G9U630	09/06 ⇨
PRIMASTAR dCi 140	G9U730	07/03 ⇨
PRIMASTAR dCi 150	G9U630, M9R630	09/06 ⇨
PRIMASTAR dCi 80	F9Q762	03/01 ⇨
PRIMASTAR dCi 90	M9R630, F9Q762	09/06 ⇨

OPEL		
VIVARO A 1.9 DI	F9Q762, M9R630	08/01 ⇨
VIVARO A 1.9 DTI	F9Q760	08/01 ⇨
VIVARO A 2.0 16V	F4R720	08/01 ⇨
VIVARO A 2.0 CDTI	M9R630, G9MB6	01/06 ⇨
VIVARO A 2.0 ECOTEC	F4R820	08/06 ⇨
VIVARO A 2.5 CDTI	G9MB6, F9Q760	08/06 ⇨
VIVARO A 2.5 DTI	G9U730	05/03 ⇨

RENAULT		
MEGANE I 2.0 16V	F4R720	05/00 ⇨
TRAFIC II 1.9 dCi	F9Q762	04/01 ⇨ 07/03
TRAFIC II 1.9 dCi 100	F9Q760	03/01 ⇨
TRAFIC II 1.9 dCi 80	F9Q760, M9R630	03/01 ⇨
TRAFIC II 2.0	F4R722	03/01 ⇨
TRAFIC II 2.0 dCi 115	M9R630	08/06 ⇨
TRAFIC II 2.5 DTi	G9U730	03/03 ⇨ 07/03

VAUXHALL		
VIVARO 1.9 DI	F9Q762	08/01 ⇨ 07/14
VIVARO 1.9 DTI	F9Q760	08/01 ⇨ 12/06
VIVARO 2.0 16V	F4R720	08/01 ⇨ 07/14
VIVARO 2.0 CDTI	M9R630, G9U630	01/06 ⇨ 07/14

VAUXHALL		
VIVARO 2.0 ECOTEC	F4R820	08/06 ⇨ 07/14
VIVARO 2.5 CDTI	G9U630, G9U630	04/03 ⇨ 07/14
VIVARO 2.5 DTI	G9U630, EB2DTS	07/03 ⇨ 07/14

21.0150



04,5

WHEEL SPEED SENSORS

Adatt./Suitable:

CITROËN
96 741 957 80**PEUGEOT**
4545 J7
4545 K8

MARKET DIFFUSION: MEDIUM



L	L1		OUT
815	---	Hall Effect	

PEUGEOT		
3008 1.2	EB2DTS, BHZ(DV6FC)	01/15 ⇨ 08/16
3008 1.6 BlueHDi 120	BHZ(DV6FC), 9HR(DV6C)	05/14 ⇨ 08/16
3008 1.6 HDi	9HR(DV6C), BHX(DV6FC)	06/09 ⇨ 08/16
3008 1.6 HDi 115 / BlueHDi 115	BHX(DV6FC), 5FV(EP6CDT)	02/13 ⇨ 08/16
3008 1.6 THP	5FV(EP6CDT), 5GZ(EP6FDT)	06/09 ⇨
3008 1.6 THP [ExtraEU]	EP6CDTM	09/10 ⇨ 08/16
3008 1.6 Turbo	5GZ(EP6FDT), 5FS(EP6C)	05/14 ⇨ 08/16
3008 1.6 VTi	5FS(EP6C), DW10CB	06/09 ⇨ 08/16
3008 2.0 HDi	DW10CB, AHX(DW10FD)	06/09 ⇨
3008 2.0 HDi 150 / BlueHDi 150	AHX(DW10FD), --	06/09 ⇨ 08/16

21.0151



04,5

WHEEL SPEED SENSORS

Adatt./Suitable:

ATE
10.0711-5139.1**BOSCH**
0 986 594 557**FORD**
1 207 357
1 698 686
2N11-2B372-AA
2N11-2B372-AB

MARKET DIFFUSION: MEDIUM



L	L1		OUT
794	24,8	Hall Effect	

FORD		
FUSION 1.25	--, --	10/02 ⇨
FUSION 1.3	--, --	08/02 ⇨
FUSION 1.4	--, F6JA	08/02 ⇨
FUSION 1.4 LPG	UTJA	01/10 ⇨ 12/12
FUSION 1.4 TDCi	F6JA, FYJA	08/02 ⇨ 12/12
FUSION 1.6	FYJA, HHJA	08/02 ⇨ 11/08
FUSION 1.6 TDCi	HHJA, EYPA	11/04 ⇨ 12/12
FUSION 2.0	--	11/04 ⇨

21.0152



04,5

WHEEL SPEED SENSORS

Adatt./Suitable:

ATE
10.0711-5148.3

BOSCH
0 986 594 534

FORD
2T14-2B372-AA
2T14-2B372-AB
4 370 937
4 376 243

MARKET DIFFUSION: MEDIUM



L	L1	Hall Effect	
605	24,8		

FORD			
TOURNEO 1.8 BiFuel	EYPDCNG	08/05 ⇨ 12/06	
TOURNEO 1.8 LPG	EYPC	08/05 ⇨ 12/06	
TOURNEO CONNECT I 1.8 16V	EYPA, HCPA	06/02 ⇨ 12/13	
TOURNEO CONNECT I 1.8 TDCi	HCPA, BHPA	06/02 ⇨ 12/13	
TOURNEO CONNECT I 1.8 TDCi /TDDi /Di	BHPA, EYPA	06/02 ⇨ 12/13	
TRANSIT 1.8 CNG	EYPDCNG	05/02 ⇨ 12/13	
TRANSIT CONNECT I 1.8 16V	EYPA, EYPA	06/02 ⇨ 12/13	
TRANSIT CONNECT I 1.8 16V LPG	EYPA, BHPA	06/02 ⇨ 12/13	
TRANSIT CONNECT I 1.8 Di	BHPA, HCPA	06/02 ⇨ 12/13	
TRANSIT CONNECT I 1.8 TDCi	HCPA, K4M710	06/02 ⇨ 12/13	

21.0153



04,5

WHEEL SPEED SENSORS

Adatt./Suitable:

ATE
10.0711-5095.1

RENAULT
82 00 001 587
82 00 084 126

MARKET DIFFUSION: MEDIUM



L	L1	Hall Effect	
656	---		

RENAULT			
LAGUNA II 1.6	K4M710	03/01 ⇨ 10/05	
LAGUNA II 1.6 16V	K4M710, F4P770	03/01 ⇨	
LAGUNA II 1.6 Bifuel	K4M714	06/05 ⇨ 12/07	
LAGUNA II 1.6 LPG	K4M714	03/01 ⇨ 05/05	
LAGUNA II 1.8 16V	F4P770, F9Q650	03/01 ⇨	
LAGUNA II 1.9 dCi	F9Q650, F4R712	03/01 ⇨	
LAGUNA II 2.0 16V	F4R712, F5R700	08/02 ⇨ 12/07	
LAGUNA II 2.0 16V IDE	F5R700, F4R764	04/01 ⇨ 09/07	
LAGUNA II 2.0 16V Turbo	F4R764, M9R740	01/03 ⇨ 08/05	
LAGUNA II 2.0 dCi	M9R740, G9T600	08/05 ⇨ 12/07	
LAGUNA II 2.2 dCi	G9T600, L7X731	03/01 ⇨	
LAGUNA II 2.9 V6 24V	L7X731, L7X731	03/01 ⇨ 12/07	
LAGUNA II 3.0 V6 24V	L7X731, K4M711	03/01 ⇨	

21.0154



04,5

WHEEL SPEED SENSORS

Adatt./Suitable:

ATE
10.0711-5201.1

RENAULT
82 00 539 276

MARKET DIFFUSION: MEDIUM



L	L1	Hall Effect	
665	---		

RENAULT			
LAGUNA II 1.6 16V	K4M711, F4P770	03/01 ⇨	

RENAULT			
LAGUNA II 1.6 Bifuel	K4M714	06/05 ⇨ 12/07	
LAGUNA II 1.6 LPG	K4M714	03/01 ⇨ 05/05	
LAGUNA II 1.8 16V	F4P770, F9Q650	03/01 ⇨	
LAGUNA II 1.9 dCi	F9Q650, F4R713	03/01 ⇨	
LAGUNA II 2.0 16V	F4R713, F4R786	09/02 ⇨ 09/07	
LAGUNA II 2.0 16V Turbo	F4R786, M9R740	01/03 ⇨ 08/05	
LAGUNA II 2.0 dCi	M9R740, G9T600	08/05 ⇨ 12/07	
LAGUNA II 2.2 dCi	G9T600, L7X731	03/01 ⇨	
LAGUNA II 2.9 V6 24V	L7X731, L7X731	03/01 ⇨ 12/07	
LAGUNA II 3.0 V6 24V	L7X731, K9K728	03/01 ⇨	

21.0156



04,5

WHEEL SPEED SENSORS

Adatt./Suitable:

ATE
10.0711-5190.3

BOSCH
0 986 594 601

RENAULT
82 00 446 282

MARKET DIFFUSION: MEDIUM



L	L1	Hall Effect	
771	---		

RENAULT			
GRAND SCÉNIC II 1.5 dCi	K9K728, K4M761	04/04 ⇨	
GRAND SCÉNIC II 1.6	K4M761, F9Q803	04/04 ⇨	
GRAND SCÉNIC II 1.9 dCi	F9Q803, F4R770	04/04 ⇨	
GRAND SCÉNIC II 2.0	F4R770, M9R700	04/04 ⇨	
GRAND SCÉNIC II 2.0 dCi	M9R700, K4J730	09/05 ⇨	
MEGANE II 1.4	K4J730, K4J730	08/03 ⇨	
MEGANE II 1.4 16V	K4J730, K9K722	11/02 ⇨ 02/08	
MEGANE II 1.5 dCi	K9K722, K4M760	09/02 ⇨ 12/10	
MEGANE II 1.6	K4M760, K4M760	08/03 ⇨	
MEGANE II 1.6 16V	K4M760, F9Q800	11/02 ⇨	
MEGANE II 1.6 Bifuel	K4M788	06/05 ⇨ 02/08	
MEGANE II 1.9 dCi	F9Q800, F4R770	11/02 ⇨	
MEGANE II 2.0	F4R770, F4R770	08/03 ⇨	
MEGANE II 2.0 16V	F4R770, M9R700	11/02 ⇨ 02/08	
MEGANE II 2.0 16V Turbo	F4R776	05/04 ⇨ 03/09	
MEGANE II 2.0 dCi	M9R700, K4J730	09/05 ⇨	
MEGANE I 2.0 16V	F4R770	01/02 ⇨ 08/03	
SCÉNIC II 1.4	K4J730, K9K722	06/03 ⇨	
SCÉNIC II 1.5 dCi	K9K722, K4M761	06/03 ⇨	
SCÉNIC II 1.6	K4M761, K4M764	06/03 ⇨	
SCÉNIC II 1.6 16V	K4M764, F9Q803	05/03 ⇨	
SCÉNIC II 1.6 BiFuel	K4M764	08/03 ⇨ 05/06	
SCÉNIC II 1.6 Hi-Flex	K4M766	03/05 ⇨ 07/10	
SCÉNIC II 1.9 dCi	F9Q803, F4R770	06/03 ⇨	
SCÉNIC II 1.9 dCi 130	F9Q804	10/05 ⇨ 12/09	
SCÉNIC II 2.0	F4R770, M9R700	06/03 ⇨	
SCÉNIC II 2.0 16V Turbo	F4R776	05/04 ⇨	
SCÉNIC II 2.0 dCi	M9R700, F9Q680	09/05 ⇨	

21.0157



04,5

WHEEL SPEED SENSORS

Adatt./Suitable:

ATE

10.0711-5097.1

RENAULT

82 00 084 128

MARKET DIFFUSION: MEDIUM



L	L1		OUT
686	---	Hall Effect	

RENAULT

ESPACE IV 1.9 dCi	F9Q680, F4R790	11/02 ⇌
ESPACE IV 2.0	F4R790, F4R794	11/02 ⇌
ESPACE IV 2.0 dCi	M9R812	01/06 ⇌
ESPACE IV 2.0 Turbo	F4R794, G9T742	11/02 ⇌
ESPACE IV 2.2 dCi	G9T742, P9X701	11/02 ⇌
ESPACE IV 3.0 dCi	P9X701, V4Y711	11/02 ⇌
ESPACE IV 3.5 V6	V4Y711, 188A9.000	11/02 ⇌

21.0159



04,5

WHEEL SPEED SENSORS

Adatt./Suitable:

BOSCH

0 265 007 830

FIAT

46845597

51759509

LANCIA

46845597

51759509

MARKET DIFFUSION: MEDIUM



L	L1		OUT
1045	27,9	Hall Effect	

FIAT

IDEA 1.2	--	01/08 ⇌
----------	----	---------

FIAT

IDEA 1.2 16V	188A5.000	01/04 ⇌
IDEA 1.2 D	--	01/08 ⇌
IDEA 1.3 D Multijet	188A9.000, 192B2.000	01/04 ⇌
IDEA 1.4	192B2.000, --	12/03 ⇌
IDEA 1.4 16V	--, 188A9.000	01/04 ⇌
IDEA 1.4 LPG	350A1.000	03/09 ⇌
IDEA 1.9 D	--	01/08 ⇌
IDEA 1.9 JTD	188B2.000	01/04 ⇌

LANCIA

MUSA 1.3 D Multijet	188A9.000, 192B2.000	10/04 ⇌ 09/12
MUSA 1.4	192B2.000, 188A4.000	10/04 ⇌ 09/12
MUSA 1.9 D Multijet	188B2.000	10/04 ⇌ 09/12
YPSILON I 1.2	188A4.000, 199A2.000	10/03 ⇌ 12/11
YPSILON I 1.3 D Multijet	199A2.000, 188A9.000	09/06 ⇌ 12/11
YPSILON I 1.3 JTD	188A9.000	10/03 ⇌ 12/11
YPSILON I 1.4	350A1.000	02/06 ⇌ 12/11
YPSILON I 1.4 16V	843A1.000	10/03 ⇌ 12/11
YPSILON I 1.4 LPG	350A1.000	11/10 ⇌ 12/11

21.0160



04,5

WHEEL SPEED SENSORS

Adatt./Suitable:

FIAT

51779076

LANCIA

51779076

MARKET DIFFUSION: MEDIUM



L	L1		OUT
1045	27,9	Hall Effect	

FIAT

IDEA 1.2 16V	188A5.000	01/04 ⇌
IDEA 1.3 D Multijet	188A9.000, 192B2.000	01/04 ⇌
IDEA 1.4	192B2.000, --	12/03 ⇌
IDEA 1.4 16V	843A1.000	01/04 ⇌
IDEA 1.4 LPG	350A1.000	03/09 ⇌
IDEA 1.6 D Multijet	350A2.000	05/08 ⇌
IDEA 1.9 JTD	188B2.000	01/04 ⇌

LANCIA

MUSA 1.3 D Multijet	--, 192B2.000	10/04 ⇌ 12/12
MUSA 1.4	192B2.000, --	10/04 ⇌ 09/12
MUSA 1.4 16V	--	01/11 ⇌ 12/12
MUSA 1.4 8V	--	01/11 ⇌ 12/12
MUSA 1.4 LPG	350A1.000	11/10 ⇌ 09/12
MUSA 1.6 D Multijet	--, 312A2.000	07/08 ⇌ 12/12
MUSA 1.9 D Multijet	188B2.000	10/04 ⇌ 09/12

21.0161



04,5

WHEEL SPEED SENSORS

Adatt./Suitable:

BOSCH

0 265 004 130

0 265 004 808

0 265 008 415

CHRYSLER

52012823

FIAT

51846660

52012823

52070359

LANCIA

51846660

52012823

52070359

MARKET DIFFUSION: MEDIUM



L	L1		OUT
1160	27,9	Hall Effect	

CHRYSLER

YPSILON 0.9 Twinair	312A2.000	05/11 ⇌
YPSILON 1.2	169A4.000	05/11 ⇌
YPSILON 1.3 Multijet	199B1.000	05/11 ⇌

FIAT

500 0.9	312A4.000	12/13 ⇌
PANDA III 0.9	312A2.000, 312A2.000	02/12 ⇌
PANDA III 0.9 4x4	312A2.000	06/14 ⇌
PANDA III 0.9 Natural Power	312A2.000, 199A1.000	07/12 ⇌
PANDA III 1.2	169A4.000	02/12 ⇌
PANDA III 1.2 LPG	169A4.000	06/12 ⇌
PANDA III 1.3 D Multijet	199A1.000, 199A1.000	02/12 ⇌
PANDA III 1.3 D Multijet 4x4	199A1.000, 169A4.000	06/12 ⇌

LANCIA

YPSILON I 1.2	169A4.000, 312A2.000	10/03 ⇌ 12/11
YPSILON I 1.3 D Multijet	199A2.000	09/06 ⇌ 12/11
YPSILON II 0.9 CNG	312A5000CNG	01/14 ⇌
YPSILON II 0.9 TwinAir	312A2.000, 199B1.000	05/11 ⇌
YPSILON II 1.2	169A4.000	05/11 ⇌
YPSILON II 1.2 Bi-fuel	169A4.000	05/11 ⇌
YPSILON II 1.3 D Multijet	199B1.000, --	05/11 ⇌



WHEEL SPEED SENSORS

Adatt./Suitable:

BOSCH
0 265 008 003**CHRYSLER**
51792166**FIAT**
51702646
51792166**LANCIA**
51792166

MARKET DIFFUSION: MEDIUM



L	L1	Hall Effect	OUT 
880	27,9		

CHRYSLER

DELTA 1.4	198A4.000	08/11 ⇌
DELTA 1.4 16V	198A7.000	08/11 ⇌
DELTA 1.6 D Multijet	844A3000	08/11 ⇌
DELTA 2.0 D Multijet	198A5.000	08/11 ⇌

FIAT

BRAVO II 1.4	192B2.000	04/07 ⇌ 12/14
BRAVO II 1.4 16V	--	04/07 ⇌
BRAVO II 1.4 LPG	--	12/08 ⇌
BRAVO II 1.4 T-Jet	--	09/07 ⇌
BRAVO II 1.6 D Multijet	--, 192A1.000	09/07 ⇌
BRAVO II 1.6 JTD	198A3.000	03/08 ⇌ 12/14
BRAVO II 1.9 D Multijet	192A1.000, --	11/06 ⇌ 12/14
BRAVO II 1.9 D Multijet 8V	--	01/10 ⇌
BRAVO II 1.9 D Multijet 16V	--	01/10 ⇌
BRAVO II 2.0 D Multijet	--, 192B2.000	09/08 ⇌
STILO 1.2 16V	188A5.000	02/02 ⇌ 11/06
STILO 1.4	843A1.000	01/04 ⇌ 08/08
STILO 1.4 16V	192B2.000, --	01/04 ⇌ 08/08
STILO 1.6	--, 182B6.000	04/05 ⇌ 08/08
STILO 1.6 16V	182B6.000, 192A8.000	10/01 ⇌ 08/08
STILO 1.8 16V	192A4.000	10/01 ⇌ 08/08
STILO 1.9 D	192B5.000	09/04 ⇌ 08/08
STILO 1.9 D Multijet	192A8.000, 192A1.000	09/05 ⇌ 08/08
STILO 1.9 JTD	192A1.000, 198A1.000	10/01 ⇌ 08/08
STILO 2.4 20V	192A2.000	10/01 ⇌ 04/07

LANCIA

DELTA III 1.4	198A1.000, 198A2.000	09/08 ⇌ 08/14
DELTA III 1.4 16V	198A7.000	07/10 ⇌ 08/14
DELTA III 1.4 Bifuel	198A4.000	07/11 ⇌ 08/14
DELTA III 1.6 D Multijet	198A2.000, 198A5.000	08/08 ⇌ 08/14
DELTA III 1.8	939B1.000	01/09 ⇌ 08/14
DELTA III 1.9 D Multijet	844A1.000	01/09 ⇌ 08/14
DELTA III 2.0 D Multijet	198A5.000, --	09/08 ⇌ 08/14



WHEEL SPEED SENSORS

Adatt./Suitable:

BOSCH
0 265 007 401
0 265 008 002**CHRYSLER**
51792165**FIAT**
46816928
51792165**LANCIA**
51792165

MARKET DIFFUSION: MEDIUM



L	L1	Hall Effect	OUT 
1075	27,9		

CHRYSLER

DELTA 1.4	198A4.000	08/11 ⇌
DELTA 1.4 16V	198A7.000	08/11 ⇌
DELTA 1.6 D Multijet	844A3000	08/11 ⇌
DELTA 2.0 D Multijet	198A5.000	08/11 ⇌

FIAT

BRAVO II 1.4	192B2.000	04/07 ⇌ 12/14
BRAVO II 1.4 16V	--	04/07 ⇌
BRAVO II 1.4 LPG	--	12/08 ⇌
BRAVO II 1.4 T-Jet	--	09/07 ⇌
BRAVO II 1.6 D Multijet	--, 192A1.000	09/07 ⇌
BRAVO II 1.6 JTD	198A3.000	03/08 ⇌ 12/14
BRAVO II 1.9 D Multijet	192A1.000, --	11/06 ⇌ 12/14
BRAVO II 1.9 D Multijet 8V	--	01/10 ⇌
BRAVO II 1.9 D Multijet 16V	--	01/10 ⇌
BRAVO II 2.0 D Multijet	--, 192B2.000	09/08 ⇌
STILO 1.2 16V	188A5.000	02/02 ⇌ 11/06
STILO 1.4	843A1.000	01/04 ⇌ 08/08
STILO 1.4 16V	192B2.000, --	01/04 ⇌ 08/08
STILO 1.6	--, 182B6.000	04/05 ⇌ 08/08
STILO 1.6 16V	182B6.000, 192A8.000	10/01 ⇌ 08/08
STILO 1.8 16V	192A4.000	10/01 ⇌ 08/08
STILO 1.9 D	192B5.000	09/04 ⇌ 08/08
STILO 1.9 D Multijet	192A8.000, 192A1.000	09/05 ⇌ 08/08
STILO 1.9 JTD	192A1.000, 198A1.000	10/01 ⇌ 08/08
STILO 2.4 20V	192A2.000	10/01 ⇌ 04/07

LANCIA

DELTA III 1.4	198A1.000, 198A2.000	09/08 ⇌ 08/14
DELTA III 1.4 16V	198A7.000	07/10 ⇌ 08/14
DELTA III 1.4 Bifuel	198A4.000	07/11 ⇌ 08/14
DELTA III 1.6 D Multijet	198A2.000, 198A5.000	08/08 ⇌ 08/14
DELTA III 1.8	939B1.000	01/09 ⇌ 08/14
DELTA III 1.9 D Multijet	844A1.000	01/09 ⇌ 08/14
DELTA III 2.0 D Multijet	198A5.000, 199B6000CNG	09/08 ⇌ 08/14



WHEEL SPEED SENSORS

Adatt./Suitable:

BOSCH
0 265 004 132
0 265 004 810
0 265 008 761**FIAT**
51884745
52009180
52070360

L	L1	Hall Effect	OUT 
868	27,9		

FIAT

500L 0.9	199B6.000	09/12 ⇌
500L 0.9 Natural Power	199B6000CNG, 199B4.000	03/13 ⇌
500L 1.3 D Multijet	199B4.000, 843A1.000	09/12 ⇌
500L 1.4	843A1.000, 199B5.000	09/12 ⇌
500L 1.4 [CAN]	--	01/13 ⇌
500L 1.4 LPG	940B7.000	02/14 ⇌
500L 1.6 D Multijet	199B5.000, 312A4.000	09/12 ⇌

21.0166



04,5

21.0168



04,5

WHEEL SPEED SENSORS

Adatt./Suitable:

BOSCH

0 265 004 129
0 265 004 133
0 265 004 806
0 265 009 050

FIAT

51834734
52012827
52070358

LANCIA

51944751
52012828



L	L1	Hall Effect	OUT +
1183	27,9	Hall Effect	

FIAT			
500 0.9	312A4.000	12/13	⇒
PANDA III 0.9	312A4.000, 312A2.000	02/12	⇒
PANDA III 0.9 4x4	312A2.000, 312A2.000	09/12	⇒
PANDA III 0.9 Natural Power	312A2.000, 199A1.000	07/12	⇒
PANDA III 1.2	169A4.000	02/12	⇒
PANDA III 1.2 LPG	169A4.000	06/12	⇒
PANDA III 1.3 D Multijet	199A1.000, 199A1.000	02/12	⇒
PANDA III 1.3 D Multijet 4x4	199A1.000, 182B6.000	06/12	⇒
LANCIA			
YPSILON II 0.9 CNG	312A2.000	05/11	⇒

WHEEL SPEED SENSORS

Adatt./Suitable:

BOSCH

0 265 007 560

FIAT

51705196



L	L1	Hall Effect	OUT +
1315	27,9	Hall Effect	

FIAT			
MULTIPLA 1.6	182B6.000, 182B6.000	09/00	⇒ 06/10
MULTIPLA 1.6 100 16V	182A4.000	04/99	⇒ 06/10
MULTIPLA 1.6 16V	182B6.000	04/02	⇒ 06/10
MULTIPLA 1.6 16V Bipower	182B6.000, 186A3.000	10/01	⇒ 06/10
MULTIPLA 1.6 16V Blupower	186A3.000, K9K780	04/99	⇒ 06/10
MULTIPLA 1.6 16V GPL	182B6.000	10/01	⇒ 06/10
MULTIPLA 1.6 Natural Power	182B6000CNG	11/08	⇒ 06/10
MULTIPLA 1.9 JTD	186A9.000	04/02	⇒ 06/10
MULTIPLA 1.9 JTD 105	182B4.000	04/99	⇒ 06/10
MULTIPLA 1.9 JTD 110	186A6.000	03/01	⇒ 07/02
MULTIPLA 1.9 JTD 115	186A8.000	07/02	⇒ 06/10

21.0169



04,5

WHEEL SPEED SENSORS

Adatt./Suitable:

ATE

10.0711-5197.3

RENAULT

47 95 000 01R
47 95 000 05R

MARKET DIFFUSION: MEDIUM



L	L1	Hall Effect	OUT +
701	---	Hall Effect	

RENAULT			
LAGUNA III 1.5 dCi	K9K780, M4R704	10/07	⇒

RENAULT			
LAGUNA III 1.6 16V	K4M824	10/07	⇒ 12/15
LAGUNA III 2.0	F4R813	02/08	⇒
LAGUNA III 2.0 16V	M4R704	10/07	⇒ 12/15
LAGUNA III 2.0 16V Hi-Flex	M4R704, F4R811	10/07	⇒ 12/15
LAGUNA III 2.0 16V Turbo	F4R811, M9R742	10/07	⇒ 12/15
LAGUNA III 2.0 dCi	M9R742, M9R816	10/07	⇒
LAGUNA III 2.0 dCi GT	M9R816, F4R800	03/08	⇒ 12/15
LAGUNA III 2.0 GT	F4R800, V9X791	03/08	⇒ 12/15
LAGUNA III 3.0 dCi	V9X791, EB2ADT	09/08	⇒ 12/15
LAGUNA III 3.5 V6	V4Y713	04/08	⇒ 12/15

21.0170



04,5

WHEEL SPEED SENSORS

Adatt./Suitable:

BOSCH

0 265 008 771
0 265 009 501

CITROËN

98 050 660 80
98 050 665 80

PEUGEOT

98 050 660 80
98 050 665 80

MARKET DIFFUSION: HIGH



L	L1	Hall Effect	OUT +
765	27	Hall Effect	

CITROËN			
C3 III 1.2 PureTech 82	EB2FA	05/18	⇒
C3 III 1.2 THP 110	EB2ADT, EB2DT	07/16	⇒
C3 III 1.2 VTi 68	EB2FB	07/16	⇒
C3 III 1.2 VTi 82	EB2F	07/16	⇒
C3 III 1.5 BlueHdi 100	DV5RD	05/18	⇒
C3 III 1.6 BlueHdi 100	DV6FD	07/16	⇒
C3 III 1.6 BlueHdi 75	DV6FE	07/16	⇒
C3 III 1.6 VTi	EC5F	02/17	⇒
C3 AIRCROSS 1.2 PureTech 110	EB2ADT, EB2F	06/17	⇒
C3 AIRCROSS 1.2 PureTech 130	EB2DTS	07/17	⇒
C3 AIRCROSS 1.2 PureTech 82	EB2F, EB2ADT	06/17	⇒
C3 AIRCROSS 1.5 BlueHdi 100	DV5RD	08/18	⇒
C3 AIRCROSS 1.5 BlueHdi 120	DV5RC	08/18	⇒
C3 AIRCROSS 1.6 BlueHdi 100	DV6FD	07/17	⇒
C3 AIRCROSS 1.6 BlueHdi 115	DV6FC	06/17	⇒
C3 AIRCROSS 1.6 BlueHdi 120	DV6FC	07/17	⇒
C3 AIRCROSS 1.6 Hdi 92	DV6D	10/17	⇒
C3 PICASSO 1.2 THP 110	EB2DT, 8FN(EP3)	01/15	⇒
C3 PICASSO 1.4	EP3C	02/09	⇒
C3 PICASSO 1.4 VTi 95	8FN(EP3), BHY(DV6FD)	02/09	⇒
C3 PICASSO 1.4 VTi 95 LPG	8FN(EP3)	01/12	⇒
C3 PICASSO 1.6 BlueHdi 100	BHY(DV6FD), 9HX(DV6ATED4)	01/15	⇒
C3 PICASSO 1.6 Hdi	9HX(DV6ATED4), 9HR(DV6C)	02/09	⇒
C3 PICASSO 1.6 Hdi 110	9HR(DV6C), 9HD(DV6C)	05/10	⇒
C3 PICASSO 1.6 Hdi 115	9HD(DV6C), 5FS(EP6C)	01/13	⇒
C3 PICASSO 1.6 Hdi 90	9HP(DV6DTED)	07/10	⇒
C3 PICASSO 1.6 VTi 120	5FS(EP6C), EB2ADT	02/09	⇒
C4 CACTUS 1.2 PureTech 130	EB2DTS	11/17	⇒
C4 CACTUS 1.2 THP 110	EB2ADT, EB2	09/14	⇒
C4 CACTUS 1.2 VTi 75	EB2D	09/14	⇒
C4 CACTUS 1.2 VTi 82	EB2, DV6D	09/14	⇒
C4 CACTUS 1.5 BlueHdi 100	DV5RD	06/18	⇒

CITROËN			
C4 CACTUS 1.5 BlueHdi 120	DV5RC	09/18	→
C4 CACTUS 1.6 BlueHdi 100	DV6FD	09/14	→
C4 CACTUS 1.6 Hdi 90	DV6D, EB2M	09/14	→
C-ELYSEE 1.2 Vti 72	EB2M, BHY(DV6FD)	11/12	→
C-ELYSEE 1.2 Vti 82	EB2F	12/14	→
C-ELYSEE 1.5 BlueHdi 100 [ExtraEU]	DV5RD	05/18	→
C-ELYSEE 1.6 BlueHdi 100	BHY(DV6FD), 9HJ(DV6DTEDEM)	11/14	→
C-ELYSEE 1.6 Hdi 92	9HJ(DV6DTEDEM), ECS	11/12	→
C-ELYSEE 1.6 Vti 115	ECS, EB2DT	11/12	→

PEUGEOT			
207 1.4	KFT(TU3A), 8FR(EP3)	02/06	→
207 1.4 16V	8FR(EP3), 8HR(DV4C)	02/06	→
207 1.4 BiFuel	TU3A	08/07	→ 12/13
207 1.4 Flex	KFW(TU3A)	11/08	→
207 1.4 Hdi	8HR(DV4C), 5FS(EP6C)	02/06	→
207 1.6	N6A(TU5JP4)	08/08	→
207 1.6 16V	5FS(EP6C), 5FR(EP6DT)	02/06	→
207 1.6 16V RC	5FY(EP6DTS)	02/07	→
207 1.6 16V Turbo	5FR(EP6DT), 5FS(EP6C)	02/06	→
207 1.6 16V Vti	5FS(EP6C), 9HP(DV6DTEDEM)	02/07	→
207 1.6 Bioflex	N6A(TU5JP4)	01/08	→
207 1.6 Hdi	9HP(DV6DTEDEM), 5FS(EP6C)	02/06	→
207 1.6 Hdi 110	9HR(DV6C)	08/09	→
207 CC 1.6 16V	5FS(EP6C), 5FR(EP6DT)	02/07	→
207 CC 1.6 16V Turbo	5FR(EP6DT), 9HR(DV6C)	02/07	→
207 CC 1.6 Hdi	9HR(DV6C), EBO	02/07	→
208 1.0	EBO, EB2	03/12	→
208 1.2	EB2, EB2F	03/12	→
208 1.2 GPL	EB2F, EB2ADT	06/15	→
208 1.2 THP	EB2ADT, 8HP(DV4C)	01/13	→
208 1.2 Vti	HMZ(EB2)	09/13	→
208 1.4 GPL	EP3C	10/13	→
208 1.4 Hdi	8HP(DV4C), 8FS(EP3)	03/12	→
208 1.4 Vti	8FS(EP3), 5FS(EP6C)	03/12	→
208 1.5 BlueHdi 100	DV5RD	05/18	→
208 1.6	5FS(EP6C), BHY(DV6FD)	02/12	→
208 1.6 BlueHdi 100	BHY(DV6FD), BHZ(DV6FC)	01/15	→
208 1.6 BlueHdi 120	BHZ(DV6FC), BHW(DV6FE)	11/13	→
208 1.6 BlueHdi 75	BHW(DV6FE), 5FU(EP6CDTX)	04/15	→
208 1.6 GTi	5FU(EP6CDTX), 9HP(DV6DTEDEM)	08/12	→
208 1.6 Hdi	9HP(DV6DTEDEM), 9HK(DV6ETEDM)	03/12	→
208 1.6 Hdi / BlueHdi 75	9HK(DV6ETEDM), EB2M	01/13	→
208 1.6 Hdi 90	9HJ(DV6DTEDEM)	03/12	→
208 1.6 THP 165	EP6FDT	03/15	→
208 1.6 THP 210	5GM(EP6FDTX)	04/15	→
301 1.2	HMZ(EB2F)	11/12	→
301 1.2 Vti 72	EB2M, 9HF(DV6DTEDEM)	11/12	→
301 1.2 Vti 82	EB2F	12/14	→
301 1.5 [ExtraEU]	DV5RD	05/18	→
301 1.6 BlueHdi 100	DV6FD	04/14	→
301 1.6 Hdi 100	BHY(DV6FD)	11/12	→
301 1.6 Hdi 90	9HF(DV6DTEDEM), ECS	11/12	→
301 1.6 LPG	ECS	07/14	→
301 1.6 Vti 115	ECS, EBO	11/12	→
2008 1.2 PureTech 82	EB2FA	03/18	→
2008 1.2 THP 110	EB2DT, EB2DTS	01/15	→
2008 1.2 THP 130	EB2DTS, EB2	01/15	→
2008 1.2 Vti	EB2, 8HR(DV4C)	03/13	→
2008 1.4 Hdi	8HR(DV4C), BHX(DV6FC)	06/13	→
2008 1.5 BlueHdi 100	DV5RD	05/18	→
2008 1.5 BlueHdi 120	DV5RC	05/18	→
2008 1.6 BlueHdi	BHX(DV6FC), BHY(DV6FD)	07/14	→
2008 1.6 BlueHdi 100	BHY(DV6FD), BHZ(DV6FC)	01/15	→
2008 1.6 BlueHdi 120	BHZ(DV6FC), BHW(DV6FE)	07/14	→
2008 1.6 BlueHdi 75	BHW(DV6FE), 9HP(DV6DTEDEM)	01/15	→
2008 1.6 Hdi	9HP(DV6DTEDEM), 5FS(EP6C)	03/13	→
2008 1.6 Vti	5FS(EP6C), KFT(TU3A)	03/13	→

21.0171

04,5

WHEEL SPEED SENSORS

Adatt./Suitable:

BOSCH
0 265 008 777

CITROËN
98 000 359 80

DS
98 000 359 80

MARKET DIFFUSION: MEDIUM



L	L1		
715	27	Hall Effect	

CITROËN

C3 II 1.0 Vti 68	EBO, HFX(TU1JP)	08/12	→
C3 II 1.1	HFX(TU1JP), EB2DT	11/09	→
C3 II 1.1 BiFuel	TU1A	11/10	→
C3 II 1.2 THP 110	EB2DT, EB2	10/14	→
C3 II 1.2 Vti 82	EB2, TU3A	06/12	→
C3 II 1.4	TU3A, 8HR(DV4C)	11/09	→
C3 II 1.4 16V	EP3C	11/09	→
C3 II 1.4 Hdi	DV4C	06/10	→ 09/16
C3 II 1.4 Hdi 70	8HR(DV4C), 8FN(EP3)	11/09	→
C3 II 1.4 LPG	8FN(EP3), 8FR(EP3)	07/10	→
C3 II 1.4 Vti	8FR(EP3), 8FP(EP3)	11/09	→
C3 II 1.4 Vti 95	8FP(EP3), BHY(DV6FD)	11/09	→
C3 II 1.6 BlueHdi	DV6FE	03/15	→ 09/16
C3 II 1.6 BlueHdi 100	BHY(DV6FD), BHW(DV6FE)	07/14	→
C3 II 1.6 BlueHdi 75	BHW(DV6FE), 9HJ(DV6DTEDEM)	04/15	→
C3 II 1.6 Hdi	9HJ(DV6DTEDEM), 9HR(DV6C)	11/09	→
C3 II 1.6 Hdi 110	9HR(DV6C), 9HD(DV6C)	11/09	→
C3 II 1.6 Hdi 115	9HD(DV6C), 5FS(EP6C)	09/12	→
C3 II 1.6 Hdi 90	DV6GATED4	11/09	→
C4 CACTUS 1.2 THP 110	5FS(EP6C), EB2ADT	11/09	→
C4 CACTUS 1.2 Vti 75	EB2D, EB2	09/14	→
C4 CACTUS 1.2 Vti 82	EB2, BHY(DV6FD)	09/14	→
C4 CACTUS 1.6 BlueHdi 100	BHY(DV6FD), 9HP(DV6DTEDEM)	09/14	→
C4 CACTUS 1.6 Hdi 90	9HP(DV6DTEDEM), EB2DT	09/14	→
DS3 1.2 THP 110	EB2DT, EB2	10/14	→ 07/15
DS3 1.2 Vti 82	EB2, 8HR(DV4C)	01/13	→ 07/15
DS3 1.4 Hdi 70	8HR(DV4C), 8FP(EP3)	04/10	→ 07/15
DS3 1.4 Vti 95	8FP(EP3), 8FN(EP3)	04/10	→ 07/15
DS3 1.4 Vti 95 LPG	8FN(EP3), 8FR(EP3)	08/12	→ 07/15
DS3 1.4 Vti 98	8FR(EP3), 5FM(EP6DT)	11/09	→ 07/15
DS3 1.6	5FM(EP6DT), BHY(DV6FD)	02/11	→ 07/15
DS3 1.6 BlueHdi 100	BHY(DV6FD), BHX(DV6FC)	07/14	→ 07/15
DS3 1.6 BlueHdi 115	BHX(DV6FC), BHZ(DV6FC)	10/13	→ 07/15
DS3 1.6 BlueHdi 120	BHZ(DV6FC), BHW(DV6FE)	10/13	→ 07/15
DS3 1.6 BlueHdi 75	BHW(DV6FE), 9HR(DV6C)	03/15	→ 07/15
DS3 1.6 Hdi 110	9HR(DV6C), 9HD(DV6C)	11/09	→ 07/15
DS3 1.6 Hdi 115	9HD(DV6C), 9HP(DV6DTEDEM)	08/12	→ 07/15
DS3 1.6 Hdi 90	9HP(DV6DTEDEM), 5FD(EP6DTS)	11/09	→ 07/15
DS3 1.6 Racing	5FD(EP6DTS), 5FN(EP6CDT)	02/11	→ 07/15
DS3 1.6 THP 150	5FN(EP6CDT), 5FR(EP6DT)	01/10	→ 07/15
DS3 1.6 THP 155	5FR(EP6DT), 5GZ(EP6FDT)	04/10	→ 07/15
DS3 1.6 THP 165	5GZ(EP6FDT), 5FS(EP6C)	10/14	→ 07/15
DS3 1.6 Vti 120	5FS(EP6C), EB2ADT	04/10	→ 07/15

DS

DS3 1.2 THP 110	EB2ADT, EB2	04/15	→
DS3 1.2 THP 130	EB2DTS	09/15	→
DS3 1.2 Vti 82	EB2, BHY(DV6FD)	04/15	→
DS3 1.6 BlueHdi 100	BHY(DV6FD), BHZ(DV6FC)	04/15	→
DS3 1.6 BlueHdi 116	DV6FC	07/15	→
DS3 1.6 BlueHdi 120	BHZ(DV6FC), BHW(DV6FE)	07/15	→
DS3 1.6 BlueHdi 75	BHW(DV6FE), EP6FDT	07/15	→
DS3 1.6 THP	EP6FDT, 5GZ(EP6FDT)	07/15	→
DS3 1.6 THP 165	5GZ(EP6FDT), 5GR(EP6FDTX)	07/15	→
DS3 1.6 THP 208	5GR(EP6FDTX), CRBC	09/15	→

21.0172

1

WHEEL SPEED SENSORS

Adatt./Suitable:

ATE
10.0711-5401.3
10.0711-5558.3

AUDI
7L0 927 807 B
WHT 003 857 A
WHT 003 857 B

BOSCH
0 986 594 524

MAN
WHT 003 857 B

PORSCHE
955 606 405 10
955 606 405 11
955 606 405 12

SEAT
WHT 003 857 A
WHT 003 857 B

SKODA
WHT 003 857 A
WHT 003 857 B

VW
7L0 927 807 A
7L0 927 807 B
WHT 003 857 A
WHT 003 857 B

ITEM NOW AVAILABLE FROM PRODUCTION

- ARTICOLO ORA DISPONIBILE PER LA VENDITA
- ARTICLE DISPONIBLE EN PRODUCTION COURANTE
- JETZT ZUM VERKAUF VERFÜGBARER ARTIKEL
- ARTICULO AHORA DISPONIBLE EN PRODUCCION

MARKET DIFFUSION: MEDIUM



L	L1		
---	27,5	Hall Effect	

AUDI

A3 III 1.6 TDI quattro	CXXB	05/15	→
A3 III 1.8 TFSI quattro	CJSB	08/12	→
A3 III 2.0 quattro	CNTC	11/13	→
A3 III 2.0 TDI quattro	CRBC, CNTC	10/12	→
A3 III 2.0 TFSI [ExtraEU]	CYFB	05/14	→
A3 III 2.0 TFSI quattro	CNTC, CZGB	05/14	→
A3 III RS3 quattro	CZGB, CJXB	03/15	→
A3 III S3 quattro	CJXB, DFGA	11/12	→
Q2 2.0 TDI quattro	DFGA, CZPB	07/16	→
Q2 2.0 TFSI quattro	CZPB, CZPB	05/17	→
Q2 40 TFSI quattro	CZPB, CFFB	09/18	→
Q2 SQ2 TFSI quattro	DNUE	08/18	→
Q3 2.0 TDI quattro	CFFB, CCZC	06/11	→ 10/18
Q3 2.0 TFSI [ExtraEU]	CTTA	09/14	→ 10/18
Q3 2.0 TFSI quattro	CCZC, CTSA	06/11	→ 10/18
Q3 35 TDI quattro	DFGA	09/18	→
Q3 40 TDI quattro	DFHA	10/18	→
Q3 40 TFSI quattro	DKTC	07/18	→
Q3 45 TFSI quattro	DKTA	07/18	→
Q3 RS 2.5 quattro	CTSA, BUG	05/13	→ 10/18
Q3 RS performance 2.5 quattro	CZGB	01/15	→ 10/18
Q7 I 3.0 TDI quattro	BUG, CJTB	03/06	→ 08/15
Q7 I 3.0 TFSI quattro	CJTB, BTR	05/10	→ 08/15
Q7 I 3.6 FSI quattro	BHK	08/06	→ 05/10
Q7 I 4.2 FSI quattro	BAR	03/06	→ 05/10
Q7 I 4.2 TDI quattro	BTR, CHHC	03/07	→ 08/15
Q7 I 6.0 TDI quattro	CCGA	09/08	→ 05/14
TT III 2.0 TDI quattro	CUNA	01/17	→
TT III 2.0 TFSI quattro	CHHC, CJXF	07/14	→
TT III 2.0 TTS quattro	CJXF, DAZA	11/14	→

AUDI		
TT III 2.5 RS quattro	DAZA, DAUA	10/16 →
TT 2.0 TFSI [ExtraEU]	CYFB	07/15 →
MAN		
TGE 2.0 TDI AWL	DAUA, DASA	02/17 →
TGE 2.0 TDI RWD	DASA, MO2.2Y	05/17 →
PORSCHE		
CAYENNE I 3.0 TDI	M05.9D	02/09 → 09/10
CAYENNE I 3.2	MO2.2Y, M48.50S	08/03 → 09/07
CAYENNE I 3.6	M55.01	02/07 → 09/10
CAYENNE I GTS 4.8	M48.01	10/07 → 09/10
CAYENNE I S 4.5	M48.00	09/02 → 09/07
CAYENNE I S 4.8	M48.01	02/07 → 09/10
CAYENNE I Turbo 4.5	M48.50	09/02 → 09/07
CAYENNE I Turbo S 4.5	M48.50S, M48.51	01/04 → 09/07
CAYENNE I Turbo S 4.8	M48.51, CFFB	02/07 → 09/10
CAYENNE II 4.8 S	M48.02	06/10 →
CAYENNE II 4.8 Turbo	M48.52	06/10 →
SEAT		
ALHAMBRA III 2.0 Tdi 4Drive	CFFB, DFFA	05/11 →
ATECA 1.4 TSI 4Drive	CZEA	06/16 →
ATECA 1.5 TSI 4Drive	DADA	07/18 →
ATECA 2.0 TDI 4Drive	DFFA, CZPB	04/16 →
ATECA 2.0 TSI 4Drive	CZPB, CLHA	05/17 →
LEON III 1.6 TDI 4Drive	CLHA, CXJC	04/14 →
LEON III 2.0 Cupra 4Drive	CJXC, CRBC	11/16 →
LEON III 2.0 TDI 4Drive	CRBC, CRBC	04/14 →
LEON ST 2.0 Cupra 4Drive	CJXC	11/16 →
LEON ST 2.0 TDI 4Drive	CRBC, DFFA	09/14 →
SKODA		
KAROQ 1.5 TSI 4x4	DADA	07/17 →
KAROQ 2.0 TDI 4x4	DFFA, CZDA	07/17 →
KODIAQ 1.4 TSI 4x4	CZDA, DBGA	10/16 →
KODIAQ 1.5 TSI	DADA	07/18 →
KODIAQ 1.5 TSI 4x4	DADA	07/18 →
KODIAQ 2.0 TDI 4x4	DBGA, CLHA	10/16 →
KODIAQ 2.0 TSI 4x4	CZPA	10/16 →
OCTAVIA III 1.6 TDI	CXXA	05/15 →
OCTAVIA III 1.6 TDI 4x4	CLHA, CISA	11/12 →
OCTAVIA III 1.8 TSI 4x4	CJSA, CUNA	11/12 →
OCTAVIA III 2.0 TDI / TDI RS 4x4	CUNA, CKFC	09/14 →
OCTAVIA III 2.0 TDI 4x4	CKFC, CDA	11/12 →
SUPERB II 1.8 TSI 4x4	CDA, CBBB	11/08 → 05/15
SUPERB II 2.0 TDI 16V 4x4	CFFB	11/10 → 05/15
SUPERB II 2.0 TDI 4x4	CBBB, --	09/08 → 05/15
SUPERB II 3.6 FSI 4x4	--, CZDA	11/08 → 05/15
SUPERB II 3.6 V6 4x4	CDVA	10/09 → 05/15
SUPERB III 1.4 TSI 4x4	CZDA, CRLB	03/15 →
SUPERB III 2.0 TDI 4x4	CRLB, CDA	03/15 →
SUPERB III 2.0 TSI 4x4	CJXA	03/15 →
YETI 1.4 TSI 4x4	CZDA	05/15 → 12/17
YETI 1.8 TSI 4x4	CDA, CBDB	05/09 → 12/17
YETI 2.0 TDI 4x4	CBDB, DFSB	05/09 → 12/17
VW		
ATLAS 2.0 TSI 4motion	CXDA	12/17 →
ATLAS 3.6 FSI 4motion	CDVC	12/16 →
CADDY III 2.0 TDI	DFSB, CFHC	05/15 →
CADDY III 2.0 TDI 16V 4motion	CFHC	11/10 → 05/15
CADDY III 2.0 TDI 4motion	CFHC, DAUA	08/10 →
CC 2.0 TDI 4motion	CFGC	12/12 → 12/16
CRAFTER 2.0 TDi	DASB	11/17 →
CRAFTER 2.0 TDI 4motion	DAUA, DASA	03/17 →
CRAFTER 2.0 TDI RWD	DASA, CRBC	11/16 →
GOLF VII 1.6 TDI 4motion	CLHA, CJXB	11/12 →
GOLF VII 1.8 TSI 4motion	CJSB	12/14 →
GOLF VII 2.0 R 4motion	CJXB, CKFC	11/13 →
GOLF VII 2.0 TDI 4motion	CKFC, BLV	11/12 →
GOLF VII 2.0 TFSI	CYFB	11/13 →
GOLF 2.0 TDi BlueMotion 4motion	CRBC	05/13 →
GOLF VAN 1.6 TDi BlueMotion 4motion	CLHA	05/13 → 03/17
GOLF VAN 2.0 TDi BlueMotion 4motion	CRBC, CRBC	04/13 → 03/17
GOLF VAN 2.0 TDi BlueMotion 4motion	CRBC, CLHA	04/13 → 03/17
PASSAT V 2.0 TDI 4motion	CFFB, CRLB	08/10 → 12/14
PASSAT V 2.0 TSI 4motion	CCZB	01/12 → 12/14
PASSAT V 3.6 FSI 4motion	BWS	01/11 → 12/14
PASSAT VI 1.4 TSI 4motion	CZEA	02/15 →
PASSAT VI 2.0 TDI 4motion	CRLB, CHHB	08/14 →
PASSAT VI 2.0 TSI 4motion	CHHB, CFFB	05/15 →
PASSAT CC 3.6 FSI 4motion	BLV, CFFB	02/08 → 01/12
PASSAT 3.6 FSi 4motion	BWS	01/11 → 12/14
SHARAN II 2.0 TDI 4motion	CFFB, BWK	05/11 →
TIGUAN I 1.4 [CHN]	CFBA.	11/11 →
TIGUAN I 1.4 TSI 4motion	BWK, CBAA	09/07 →
TIGUAN I 1.8 [CHN]	CEAA	12/09 →

VW		
TIGUAN I 2.0 [CHN]	CGMA	12/09 →
TIGUAN I 2.0 TDI 4motion	CBAA, CAWA	09/07 →
TIGUAN I 2.0 TFSI 4motion	CAWA, CCZB	09/07 →
TIGUAN I 2.0 TSI 4motion	CCZB, CZDA	05/11 →
TIGUAN II 1.4 TSI	CFBA	06/17 →
TIGUAN II 1.4 TSI 4motion	CZDA, CRFD	05/16 →
TIGUAN II 2.0 TDI	CRFD, CUAA	01/16 →
TIGUAN II 2.0 TDI 4motion	CUAA, CHHB	01/16 →
TIGUAN II 2.0 TSI 4motion	CHHB, BAC	01/16 →
TOUAREG I 2.5 R5 TDI	BAC, BUN	01/03 → 05/10
TOUAREG I 3.0 TDI	BUN, BKS	04/06 → 05/10
TOUAREG I 3.0 V6 TDI	BKS, AZZ	11/04 → 05/10
TOUAREG I 3.2 V6	AZZ, BHK	10/02 → 11/06
TOUAREG I 3.6 V6 FSI	BHK, AYH	10/05 → 05/10
TOUAREG I 4.2 V8	AXQ	12/02 → 11/06
TOUAREG I 4.2 V8 FSI	BAR	06/06 → 05/10
TOUAREG I 5.0 R50 TDI	CBWA	08/07 → 05/10
TOUAREG I 5.0 V10 TDI	AYH, BJN	10/02 → 05/10
TOUAREG I 6.0 W12	BJN, CRBC	08/04 → 05/10

21.0173

WHEEL SPEED SENSORS

Adatt./Suitable:

ATE 10.0711-5402.3
10.0711-5529.3

AUDI 7L0 927 808 B
WHT 003 856 A
WHT 003 856 B

BOSCH 0 986 594 525

MAN WHT 003 856 B

PORSCHE 955 606 406 10
955 606 406 11
955 606 406 12

SEAT WHT 003 856 A
WHT 003 856 B

SKODA WHT 003 856 A
WHT 003 856 B

VW 7L0 927 808 A
7L0 927 808 B
WHT 003 856 A
WHT 003 856 B

- ITEM NOW AVAILABLE FROM PRODUCTION
- ARTICOLO ORA DISPONIBILE PER LA VENDITA
- ARTICLE DISPONIBLE EN PRODUCTION COURANTE
- JETZT ZUM VERKAUF VERFÜGBARER ARTIKEL
- ARTICULO AHORA DISPONIBLE EN PRODUCCION

199 Black color (Grey OE)

- Colore nero (OE Grigio)
- Couleur noire (gris OE)
- Schwarze Farbe (Grau OE)
- Color negro (gris OE)

MARKET DIFFUSION: MEDIUM



L	L1	Hall Effect	
---	27,5		

AUDI		
A3 III 1.6 TDI quattro	CXXB	05/15 →
A3 III 1.8 TFSI quattro	CJSB	08/12 →
A3 III 2.0 quattro	CNTC	11/13 →
A3 III 2.0 TDI quattro	CRBC, CNTC	10/12 →
A3 III 2.0 TFSI [ExtraEU]	CYFB	05/14 →
A3 III 2.0 TFSI quattro	CNTC, CZGB	05/14 →
A3 III RS3 quattro	CZGB, CJXB	03/15 →
A3 III S3 quattro	CJXB, DFGA	11/12 →
Q2 2.0 TDI quattro	DFGA, CZPB	07/16 →
Q2 2.0 TFSI quattro	CZPB, CZPB	05/17 →
Q2 40 TFSI quattro	CZPB, CFFB	09/18 →
Q2 SQ2 TFSI quattro	DNU	08/18 →
Q3 2.0 TDI quattro	CFFB, CCZC	06/11 → 10/18
Q3 2.0 TFSI [ExtraEU]	CCTA	09/14 → 10/18
Q3 2.0 TFSI quattro	CCZC, CTSA	06/11 → 10/18
Q3 35 TDI quattro	DFGA	09/18 →
Q3 40 TDI quattro	DFHA	10/18 →
Q3 40 TFSI quattro	DKTC	07/18 →
Q3 45 TFSI quattro	DKTA	07/18 →
Q3 RS 2.5 quattro	CTSA, BUG	05/13 → 10/18
Q3 RS performance 2.5	CZGB	01/15 → 10/18
Q7 13.0 TDI quattro	BUG, CJTB	03/06 → 08/15

AUDI		
Q7 I 3.0 TFSI quattro	CJTB, BTR	05/10 → 08/15
Q7 I 3.6 FSI quattro	BHK	08/06 → 05/10
Q7 I 4.2 FSI quattro	BAR	03/06 → 05/10
Q7 I 4.2 TDI quattro	BTR, CHHC	03/07 → 08/15
Q7 I 6.0 TDI quattro	CCGA	09/08 → 05/14
TT III 2.0 TDI quattro	CUNA	01/17 →
TT III 2.0 TFSI quattro	CHHC, CJXF	07/14 →
TT III 2.0 TTS quattro	CJXF, DAZA	11/14 →
TT III 2.5 RS quattro	DAZA, DAUA	10/16 →
TT 2.0 TFSI [ExtraEU]	CYFB	07/15 →

MAN		
TGE 2.0 TDI AWL	DAUA, DASA	02/17 →
TGE 2.0 TDI RWD	DASA, MO2.2Y	05/17 →

PORSCHE		
CAYENNE I 3.0 TDI	M05.9D	02/09 → 09/10
CAYENNE I 3.2	MO2.2Y, M48.50S	08/03 → 09/07
CAYENNE I 3.6	M55.01	02/07 → 09/10
CAYENNE I GTS 4.8	M48.01	10/07 → 09/10
CAYENNE I S 4.5	M48.00	09/02 → 09/07
CAYENNE I S 4.8	M48.01	02/07 → 09/10
CAYENNE I Turbo 4.5	M48.50	09/02 → 09/07
CAYENNE I Turbo S 4.5	M48.50S, M48.51	01/04 → 09/07
CAYENNE I Turbo S 4.8	M48.51, CFFB	02/07 → 09/10
CAYENNE II 4.8 S	M48.02	06/10 →
CAYENNE II 4.8 Turbo	M48.52	06/10 →

SEAT		
ALHAMBRA III 2.0 TDI 4Drive	CFFB, DFFA	05/11 →
ATECA 1.4 TSI 4Drive	CZEA	06/16 →
ATECA 1.5 TSI 4Drive	DADA	07/18 →
ATECA 2.0 TDI 4Drive	DFFA, CZPB	04/16 →
ATECA 2.0 TSI 4Drive	CZPB, CLHA	05/17 →
LEON III 1.6 TDI 4Drive	CLHA, CJXC	04/14 →
LEON III 2.0 Cupra 4Drive	CJXC, CRBC	11/16 →
LEON III 2.0 TDI 4Drive	CRBC, CRBC	04/14 →
LEON ST 2.0 Cupra 4Drive	CJXC	11/16 →
LEON ST 2.0 TDI 4Drive	CRBC, DFFA	09/14 →

SKODA		
KAROQ 1.5 TSI 4x4	DADA	07/17 →
KAROQ 2.0 TDI 4x4	DFFA, CZDA	07/17 →
KODIAQ 1.4 TSI 4x4	CZDA, DBGA	10/16 →
KODIAQ 1.5 TSI	DADA	07/18 →
KODIAQ 1.5 TSI 4x4	DADA	07/18 →
KODIAQ 2.0 TDI 4x4	DBGA, CLHA	10/16 →
KODIAQ 2.0 TSI 4x4	CZPA	10/16 →
OCTAVIA III 1.6 TDI	CXXA	05/15 →
OCTAVIA III 1.6 TDI 4x4	CLHA, CISA	11/12 →
OCTAVIA III 1.8 TSI 4x4	CJSA, CUNA	11/12 →
OCTAVIA III 2.0 TDI / TDI RS 4x4	CUNA, CKFC	09/14 →
OCTAVIA III 2.0 TDI 4x4	CKFC, CDA	11/12 →
SUPERB II 1.8 TSI 4x4	CDA, CBBB	11/08 → 05/15
SUPERB II 2.0 TDI 16V 4x4	CFFB	11/10 → 05/15
SUPERB II 2.0 TDI 4x4	CBBB, --	09/08 → 05/15
SUPERB II 3.6 FSI 4x4	--, CZDA	11/08 → 05/15
SUPERB II 3.6 V6 4x4	CDVA	10/09 → 05/15
SUPERB III 1.4 TSI 4x4	CZDA, CRLB	03/15 →
SUPERB III 2.0 TDI 4x4	CRLB, CDA	03/15 →
SUPERB III 2.0 TSI 4x4	CJXA	03/15 →
YETI 1.4 TSI 4x4	CZDA	05/15 → 12/17
YETI 1.8 TSI 4x4	CDA, CBDB	05/09 → 12/17
YETI 2.0 TDI 4x4	CBDB, DFSB	05/09 → 12/17

VW		
ARTEON 2.0 TSI 4motion	DNUA	09/18 →
ATLAS 2.0 TSI 4motion	CXDA	12/17 →
ATLAS 3.6 FSI 4motion	CDVC	12/16 →
CADDY III 2.0 TDI	DFSB, CFHC	05/15 →
CADDY III 2.0 TDI 16V 4motion	CFHC	11/10 → 05/15
CADDY III 2.0 TDI 4motion	CFHC, DAUA	08/10 →
CC 2.0 TDI 4motion	CFGC	12/12 → 12/16
CRAFTER 2.0 TDi	DASB	11/17 →
CRAFTER 2.0 TDI 4motion	DAUA, DASA	03/17 →
CRAFTER 2.0 TDI RWD	DASA, CRBC	11/16 →
GOLF VII 1.6 TDI 4motion	CLHA, CJXB	11/12 →
GOLF VII 1.8 TSI 4motion	CJSB	12/14 →
GOLF VII 2.0 R 4motion	CJXB, CKFC	11/13 →
GOLF VII 2.0 TDI 4motion	CKFC, BLV	11/12 →
GOLF VII 2.0 TFSI	CYFB	11/13 →
GOLF 2.0 TDi BlueMotion 4motion	CRBC	05/13 →
GOLF VAN 1.6 TDi BlueMotion 4motion	CLHA	05/13 → 03/17
GOLF VAN 2.0 TDi BlueMotion 4motion	CRBC, CRBC	04/13 → 03/17
GOLF VAN 2.0 TDI BlueMotion 4motion	CRBC, CLHA	04/13 → 03/17
PASSAT V 2.0 TDI 4motion	CFFB, CRLB	08/10 → 12/14
PASSAT V 2.0 TSI 4motion	CCZB	01/12 → 12/14
PASSAT V 3.6 FSI 4motion	BWS	01/11 → 12/14
PASSAT VI 1.4 TSI 4motion	CZEA	02/15 →
PASSAT VI 2.0 TDI 4motion	CRLB, CHHB	08/14 →
PASSAT VI 2.0 TSI 4motion	CHHB, CFFB	05/15 →
PASSAT CC 3.6 FSI 4motion	BLV, CFFB	02/08 → 01/12
PASSAT 3.6 FSi 4motion	BWS	01/11 → 12/14
SHARAN II 2.0 TDI 4motion	CFFB, BWK	05/11 →
TIGUAN I 1.4 [CHN]	CFBA.	11/11 →
TIGUAN I 1.4 TSI 4motion	BWK, CBAA	09/07 →
TIGUAN I 1.8 [CHN]	CEAA	12/09 →

VW		
PASSAT VI 1.4 TSI 4motion	CZEA	02/15 →
PASSAT VI 2.0 TDI 4motion	CRLB, CHHB	08/14 →
PASSAT VI 2.0 TSI 4motion	CHHB, CFFB	05/15 →
PASSAT CC 3.6 FSI 4motion	BLV, CFFB	02/08 → 01/12
PASSAT 3.6 FSI 4motion	BWS	01/11 → 12/14
T-ROC 2.0 TDI 4motion	DFFA	09/17 →
T-ROC 2.0 TSI 4motion	CZPB	07/17 →
SHARAN II 2.0 TDI 4motion	CFFB, BWK	05/11 →
TIGUAN I 1.4 [CHN]	CFBA	11/11 →
TIGUAN I 1.4 TSI 4motion	BWK, CBAA	09/07 →
TIGUAN I 1.8 [CHN]	CEAA	12/09 →
TIGUAN I 2.0 [CHN]	CGMA	12/09 →
TIGUAN I 2.0 TDI 4motion	CBAA, CAWA	09/07 →
TIGUAN I 2.0 TFSI 4motion	CAWA, CCZB	09/07 →
TIGUAN I 2.0 TSI 4motion	CCZB, CZDA	05/11 →
TIGUAN II 1.4 TSI	CZEA	06/17 →
TIGUAN II 1.4 TSI 4motion	CZDA, CRFD	05/16 →
TIGUAN II 2.0 TDI	CRFD, CUAA	01/16 →
TIGUAN II 2.0 TDI 4motion	CUAA, CHHB	01/16 →
TIGUAN II 2.0 TSI 4motion	CHHB, BAC	01/16 →
TOUAREG I 2.5 R5 TDI	BAC, BUN	01/03 → 05/10
TOUAREG I 3.0 TDI	BUN, BKS	04/06 → 05/10
TOUAREG I 3.0 V6 TDI	BKS, AZZ	11/04 → 05/10
TOUAREG I 3.2 V6	AZZ, BHK	10/02 → 11/06
TOUAREG I 3.6 V6 FSI	BHK, AYH	10/05 → 05/10
TOUAREG I 4.2 V8	AXQ	12/02 → 11/06
TOUAREG I 4.2 V8 FSI	BAR	06/06 → 05/10
TOUAREG I 5.0 R50 TDI	CBWA	08/07 → 05/10
TOUAREG I 5.0 V10 TDI	AYH, BJN	10/02 → 05/10
TOUAREG I 6.0 W12	BJN, CHPB	08/04 → 05/10

SKODA		
SUPERB II 2.0 TDI	BMP, BKD	03/08 → 05/15
SUPERB II 2.0 TDI 16V	BKD, CBZB	01/09 → 05/15
SUPERB II 2.0 TSI	CCZA	05/10 → 05/15
YETI 1.2 TSI	CBZB, CAXA	09/09 → 12/17
YETI 1.4 TSI	CAXA, CFHA	06/10 → 12/17
YETI 1.6	CWVA	04/14 → 12/17
YETI 1.6 TDI	CAYC	11/10 → 05/15
YETI 1.8	CDAB	02/11 →
YETI 2.0 TDI	CFHA, CAVD	11/09 →

VW		
TOURAN I 2.0 TDI	CFHC, CHPB	05/10 → 05/15

21.0175

3

WHEEL SPEED SENSORS

Adatt./Suitable:

ATE 10.0711-6436.3

AUDI 1KO 927 807 A

WHT 003 859 A

WHT 003 859 B

BOSCH 0 986 594 561

SEAT 1KO 927 807 A

WHT 003 859 A

WHT 003 859 B

SKODA WHT 003 859 A

WHT 003 859 B

VW 1KO 927 807 A

WHT 003 859 A

WHT 003 859 B

ITEM NOW AVAILABLE FROM PRODUCTION

- ARTICOLO ORA DISPONIBILE PER LA VENDITA
- ARTICLE DISPONIBLE EN PRODUCTION COURANTE
- JETZT ZUM VERKAUF VERFÜGBARER ARTIKEL
- ARTICULO AHORA DISPONIBLE EN PRODUCCION

119 Black color (OE gray)

- Colore nero (grigio OE)
- Couleur noire (gris OE)
- Schwarze Farbe (OE grau)
- Color negro (gris original)

MARKET DIFFUSION: HIGH



21.0174

3

WHEEL SPEED SENSORS

Adatt./Suitable:

ATE 10.0711-6336.3

10.0711-6437.3

AUDI 1KO 927 808 A

WHT 003 858 A

WHT 003 858 B

BOSCH 0 986 594 560

SEAT 1KO 927 808 A

WHT 003 858 A

WHT 003 858 B

SKODA WHT 003 858 A

WHT 003 858 B

VW 1KO 927 808 A

WHT 003 858 A

WHT 003 858 B

ITEM NOW AVAILABLE FROM PRODUCTION

- ARTICOLO ORA DISPONIBILE PER LA VENDITA
- ARTICLE DISPONIBLE EN PRODUCTION COURANTE
- JETZT ZUM VERKAUF VERFÜGBARER ARTIKEL
- ARTICULO AHORA DISPONIBLE EN PRODUCCION

119 Black color (OE gray)

- Colore nero (grigio OE)
- Couleur noire (gris OE)
- Schwarze Farbe (OE grau)
- Color negro (gris original)

MARKET DIFFUSION: HIGH



L	L1		+ OUT
---	39,6	Hall Effect	

AUDI		
Q3 1.4 TFSI	CZDB	07/16 → 10/18
Q3 1.4 TSI	CHPB, CFFA	10/13 → 10/18
Q3 2.0 TDI	CFFA, CCTA	06/11 →
Q3 2.0 TFSI	CCTA, CAVA	10/13 →

SEAT		
ALHAMBRA III 1.4 TSI	CAVA, CFFA	06/10 →
ALHAMBRA III 1.8 TSI	CDA	11/12 →
ALHAMBRA III 2.0 TDI	CFFA, CCZA	06/10 →
ALHAMBRA III 2.0 TSI	CCZA, BZB	11/10 →

SKODA		
SUPERB II 1.4 [CHN]	CFBA	03/10 →
SUPERB II 1.4 TSI	CAXC	07/08 → 05/15
SUPERB II 1.6 TDI	CAYC	09/10 → 05/15
SUPERB II 1.8 [CHN]	CEAA	04/09 →
SUPERB II 1.8 TSI	BZB, BLS	03/08 → 05/15
SUPERB II 1.9 TDI	BLS, BMP	03/08 → 11/10
SUPERB II 2.0 [CHN]	CGMA	04/09 →

VW		
BEETLE 1.2 TSI	CBZB	07/11 →
BEETLE 1.2 TSI 16V	CYVD	12/14 →
BEETLE 1.4 TSI	CAVD, CFFB	10/11 →
BEETLE 1.6 TDI	CAYC	10/11 → 07/16
BEETLE 2.0 TDI	CFFB, CBFA	04/11 →
BEETLE 2.0 TSI	CBFA, CBTA	04/11 →
BEETLE 2.5	CBTA, CKMA	04/11 →
CC 1.4 TSI	CKMA, CDA	11/11 → 12/16
CC 1.4 TSI MultiFuel	CKMA	11/11 → 12/16
CC 1.8 TSI	CDA, CFFA	11/11 → 12/16
CC 2.0 TDI	CFFA, CBFA	11/11 → 12/16
CC 2.0 TSI	CBFA, CAVD	11/11 →
CC 3.6 FSI	CNNA	11/11 →
EOS 1.4 TSI	CAVD, BVY	11/07 → 08/15
EOS 1.6 FSI	BLF	06/06 → 05/08
EOS 2.0 FSI	BVY, BMM	03/06 → 05/08
EOS 2.0 TDI	BMM, CBAB	06/06 → 08/15
EOS 2.0 TDI 16V	CBAB, BPY	05/08 → 08/15
EOS 2.0 TFSI	BPY, BUB	03/06 → 08/15
EOS 2.0 TSI	CCZB	11/09 → 08/15
EOS 3.2 V6	BUB, CJZA	06/06 → 05/09
GOLF VI 1.2 TSI	CBZB	03/11 → 05/16
GOLF VI 1.2 TSI 16V	CJZA, CAVD	11/13 → 05/16
GOLF VI 1.4 TSI	CAVD, CFHC	03/11 → 05/16
GOLF VI 1.6 TDI	CAYC	03/11 → 05/16
GOLF VI 2.0 GTI	CCZB	05/12 → 05/16
GOLF VI 2.0 R	CDLA	01/13 → 05/16
GOLF VI 2.0 TDI	CFHC, CDLC	11/11 → 05/16
GOLF VI 2.0 TSI	CDLC, CBZB	01/13 →
JETTA VI 1.2 TSI	CBZB, CAVA	10/10 →
JETTA VI 1.2 TSI 16V	CYVD	08/14 →
JETTA VI 1.4 TSI	CAVA, CNLA	04/11 →
JETTA VI 1.4 TSI Hybrid	CNLA, CFNA	04/11 →
JETTA VI 1.6	CFNA, CWVA	12/11 →
JETTA VI 1.6 [RUS]	CWVA, CPKA	01/15 →
JETTA VI 1.6 MPi	CWVB	09/15 → 04/18
JETTA VI 1.6 TDI	CAYC	04/10 → 07/14
JETTA VI 1.8 TSI	CPKA, CBPA	07/14 →
JETTA VI 2.0	CBPA, CFFB	06/10 → 12/17
JETTA VI 2.0 TDI	CFFB, CPLA	10/10 →
JETTA VI 2.0 TSI	CPLA, CBTA	12/12 →
JETTA VI 2.5	CBTA, CFFB	04/10 →
PASSAT 1.4 TSI BlueMotion	CAXA	08/10 → 12/14
PASSAT 1.6 TDi BlueMotion	CAYC	08/10 → 12/14
PASSAT 1.8 TFSI	CDA	08/10 → 12/14
PASSAT 2.0 Blue TDi/TDi/TDi BlueMotion [ExtraEU]	CFFB	08/10 → 12/14
PASSAT 2.0 TDi BlueMotion	CFFB, BLV	08/10 → 12/14
PASSAT 2.0 TFSI	CCZB	11/10 → 12/14
PASSAT V 1.4 TSI	CAXA, CDA	08/10 → 12/14
PASSAT V 1.4 TSI EcoFuel	CDGA	08/10 → 12/14
PASSAT V 1.4 TSI MultiFuel	CKMA	11/10 → 12/14
PASSAT V 1.6 TDI	CAYC	08/10 → 12/14
PASSAT V 1.8 TSI	CDA, CFFA	08/10 →
PASSAT V 2.0 TDI	CFFA, CBTA	08/10 →
PASSAT V 2.0 TSI	CCZB	11/10 → 12/15
PASSAT V 2.5 SRE	CBTA, CAVD	01/11 →
PASSAT V 3.6 FSI	CDVB	04/11 →
PASSAT CC 1.4 TSI MultiFuel	CKMA	01/11 → 01/12
PASSAT CC 2.0 TSI	CCTA	06/08 → 01/12
PASSAT CC 3.6 FSI	BLV, CAXA	06/08 →
SCIROCCO III 1.4 TSI	CAVD, CDLC	05/08 →
SCIROCCO III 2.0 R	CDLC, CUUB	11/09 → 11/17
SCIROCCO III 2.0 TDI	CUUB, CCZB	11/13 → 11/17
SCIROCCO III 2.0 TSI	CCZB, CAVA	11/09 → 11/17
SHARAN II 1.4 TSI	CAVA, CFFA	05/10 →
SHARAN II 1.8 TSI	CDA	11/11 →
SHARAN II 2.0 TDI	CFFA, CFFA	05/10 →
SHARAN II 2.0 TDI 4motion	CFFA, CCZA	05/11 →
SHARAN II 2.0 TSI	CCZA, CAVA	12/10 →
TIGUAN I 1.4 TSI	CAVA, CBAB	05/08 →
TIGUAN I 2.0 TDI	CBAB, CAVB	03/08 →
TIGUAN I 2.0 TFSI	CCTB	05/08 →
TIGUAN II 2.0 TDI	CUVE	05/15 →
TOURAN I 1.2 TSI	CBZB	05/10 → 05/15
TOURAN I 1.4 TSI	CAVB, CAYB	05/10 → 05/15
TOURAN I 1.4 TSI EcoFuel	CDGA	05/10 → 05/15
TOURAN I 1.6 TDI	CAYB, CFHC	05/10 → 05/15

L	L1		+ OUT
---	39,6	Hall Effect	

AUDI		
Q3 1.4 TFSI	CZDB	07/16 → 10/18
Q3 1.4 TSI	CHPB, CFFA	10/13 → 10/18
Q3 2.0 TDI	CFFA, CCTA	06/11 →
Q3 2.0 TFSI	CCTA, CAVA	10/13 →

SEAT		
ALHAMBRA III 1.4 TSI	CAVA, CFFA	06/10 →
ALHAMBRA III 1.8 TSI	CDA	11/12 →
ALHAMBRA III 2.0 TDI	CFFA, CCZA	06/10 →
ALHAMBRA III 2.0 TSI	CCZA, BZB	11/10 →

SKODA		
SUPERB II 1.4 [CHN]	CFBA	03/10 →
SUPERB II 1.4 TSI	CAXC	07/08 → 05/15
SUPERB II 1.6 TDI	CAYC	09/10 → 05/15
SUPERB II 1.8 [CHN]	CEAA	04/09 →
SUPERB II 1.8 TSI	BZB, BLS	03/08 → 05/15
SUPERB II 1.9 TDI	BLS, BMP	03/08 → 11/10
SUPERB II 2.0 [CHN]	CGMA	04/09 →
SUPERB II 2.0 TDI	BMP, BKD	03/08 → 05/15
SUPERB II 2.0 TDI 16V	BKD, CBZB	01/09 → 05/15
SUPERB II 2.0 TSI	CCZA	05/10 → 05/15
YETI 1.2 TSI	CBZB, CAXA	09/09 → 12/17
YETI 1.4 TSI	CAXA, CFHA	06/10 → 12/17
YETI 1.6	CWVA	04/14 → 12/17
YETI 1.6 TDI	CAYC	11/10 → 05/15
YETI 1.8	CDAB	02/11 →
YETI 2.0 TDI	CFHA, CAVD	11/09 →

VW		
BEETLE 1.2 TSI	CBZB	07/11 →
BEETLE 1.2 TSI 16V	CYVD	12/14 →
BEETLE 1.4 TSI	CAVD, CFFB	10/11 →
BEETLE 1.6 TDI	CAYC	10/11 → 07/16
BEETLE 2.0 TDI	CFFB, CBFA	04/11 →
BEETLE 2.0 TSI	CBFA, CBTA	04/11 →
BEETLE 2.5	CBTA, CFGC	04/11 →
CC 1.4 TSI	CZDA	05/15 → 12/16
CC 2.0 TDI	CFGC, CBFA	12/12 → 12/16
CC 2.0 TSI	CBFA, CAVD	11/11 →
CC 3.6 FSI	CNNA	11/11 →
EOS 1.4 TSI	CAVD, BVY	11/07 → 08/15
EOS 1.6 FSI	BLF	06/06 → 05/08
EOS 2.0 FSI	BVY, BMM	03/06 → 05/08
EOS 2.0 TDI	BMM, CBAB	06/06 → 08/15
EOS 2.0 TDI 16V	CBAB, BPY	05/08 → 08/15
EOS 2.0 TFSI	BPY, BUB	03/06 → 08/15
EOS 2.0 TSI	CCZB	11/09 → 08/15

VW			
EOS 3.2V6	BUB, CJZA	06/06 → 05/09	
GOLF VI 1.2 TSI	CBZB	03/11 → 05/16	
GOLF VI 1.2 TSI 16V	CJZA, CAVD	11/13 → 05/16	
GOLF VI 1.4 TSI	CAVD, CFHC	03/11 → 05/16	
GOLF VI 2.0 TDI	CAYC	03/11 → 05/16	
GOLF VI 2.0 GTI	CCZB	05/12 → 05/16	
GOLF VI 2.0 R	CDLA	01/13 → 05/16	
GOLF VI 2.0 TDI	CFHC, CDLC	11/11 → 05/16	
GOLF VI 2.0 TSI	CDLC, CBZB	01/13 →	
JETTA VI 1.2 TSI	CBZB, CAVA	10/10 →	
JETTA VI 1.2 TSI 16V	CYVD	08/14 →	
JETTA VI 1.4 TSI	CAVA, CNLA	04/11 →	
JETTA VI 1.4 TSI Hybrid	CNLA, CFNA	04/11 →	
JETTA VI 1.6	CFNA, CWVA	12/11 →	
JETTA VI 1.6 [RUS]	CWVA, CPKA	01/15 →	
JETTA VI 1.6 MPi	CWVB	09/15 → 04/18	
JETTA VI 1.6 TDI	CAYC	04/10 → 07/14	
JETTA VI 1.8 TSI	CPKA, CBPA	07/14 →	
JETTA VI 2.0	CBPA, CFFB	06/10 → 12/17	
JETTA VI 2.0 TDI	CFFB, CPLA	10/10 →	
JETTA VI 2.0 TSI	CPLA, CBTA	12/12 →	
JETTA VI 2.5	CBTA, CFFB	04/10 →	
PASSAT 1.4 TSI BlueMotion	CAXA	08/10 → 12/14	
PASSAT 1.6 TDi BlueMotion	CAYC	08/10 → 12/14	
PASSAT 1.8 TFSi	CDA A	08/10 → 12/14	
PASSAT 2.0 Blue TDi/TDi/TDi BlueMotion [ExtraEU]	CFFB	08/10 → 12/14	
PASSAT 2.0 TDi BlueMotion	CFFB, BLV	08/10 → 12/14	
PASSAT 2.0 TFSi	CCZB	11/10 → 12/14	
PASSAT V 1.4 TSI	CAXA, CDA A	08/10 → 12/14	
PASSAT V 1.4 TSI EcoFuel	CDGA	08/10 → 12/14	
PASSAT V 1.4 TSI MultiFuel	CKMA	11/10 → 12/14	
PASSAT V 1.6 TDI	CAYC	08/10 → 12/14	
PASSAT V 1.8 TSI	CDA A, CFFA	08/10 →	
PASSAT V 2.0 TDI	CFFA, CBTA	08/10 →	
PASSAT V 2.0 TSI	CCZB	11/10 → 12/15	
PASSAT V 2.5 SRE	CBTA, CAVD	01/11 →	
PASSAT V 3.6 FSI	CDVB	04/11 →	
PASSAT CC 1.4 TSI MultiFuel	CKMA	01/11 → 01/12	
PASSAT CC 2.0 TSI	CCTA	06/08 → 01/12	
PASSAT CC 3.6 FSI	BLV, CAXA	06/08 →	
SCIROCCO III 1.4 TSI	CAVD, CDLC	05/08 →	
SCIROCCO III 2.0 R	CDLC, CUUB	11/09 → 11/17	
SCIROCCO III 2.0 TDI	CUUB, CCZB	11/13 → 11/17	
SCIROCCO III 2.0 TSI	CCZB, CAVA	11/09 → 11/17	
SHARAN II 1.4 TSI	CAVA, CFFA	05/10 →	
SHARAN II 1.8 TSI	CDA A	11/11 →	
SHARAN II 2.0 TDI	CFFA, CFFA	05/10 →	
SHARAN II 2.0 TDI 4motion	CFFA, CZCA	05/11 →	
SHARAN II 2.0 TSI	CCZA, CAVA	12/10 →	
TIGUAN I 1.4 TSI	CAVA, CBAB	05/08 →	
TIGUAN I 2.0 TDI	CBAB, CAVB	03/08 →	
TIGUAN I 2.0 TFSi	CCTB	05/08 →	
TIGUAN II 2.0 TDI	CUVE	05/15 →	
TOURAN I 1.2 TSI	CBZB	05/10 → 05/15	
TOURAN I 1.4 TSI	CAVB, CAYB	05/10 → 05/15	
TOURAN I 1.4 TSI EcoFuel	CDGA	05/10 → 05/15	
TOURAN I 1.6 TDI	CAVB, CFHC	05/10 → 05/15	
TOURAN I 2.0 TDI	CFHC, D4204T20	05/10 → 05/15	

21.0181



WHEEL SPEED SENSORS

Adatt./Suitable:

- ATE 10.0711-5241.3 10.0711-5553.3
- FORD 8G9N-2B372-AA
- VOLVO 30793929 31423572

- ITEM NOW AVAILABLE FROM PRODUCTION
- ARTICOLO ORA DISPONIBILE PER LA VENDITA
- ARTICLE DISPONIBLE EN PRODUCTION COURANTE
- JETZT ZUM VERKAUF VERFÜGBARER ARTIKEL
- ARTICULO AHORA DISPONIBLE EN PRODUCCION

- 108 Black color (Beige OE)
- Colore nero (beige OE)
- Couleur noire (beige OE)
- Schwarze Farbe (Beige OE)
- Color negro (Beige OE)

MARKET DIFFUSION: MEDIUM



L	L1	Hall Sensor	
---	24,9		

VOLVO			
S60 II 1.5 T2	B4154T5	10/15 →	
S60 II 1.5 T3	B4154T4	03/15 →	
S60 II 2.0 D2	D4204T20, D4204T4	03/15 →	
S60 II 2.0 D3	D4204T4, B4204T6	03/15 →	
S60 II 2.0 D4	D4204T14	03/15 →	
S60 II 2.0 D5	D4204T11	03/15 →	
S60 II 2.0 Polestar AWD	B4204T43	06/15 →	
S60 II 2.0 T	B4204T6, B5254T14	04/10 → 12/15	
S60 II 2.0 T3	B4204T37	03/15 →	
S60 II 2.0 T4	B4204T19	03/15 →	
S60 II 2.0 T5 DRIVE	B4204T7	09/14 → 12/15	
S60 II 2.4 D4 AWD	D5244T21	03/15 →	
S60 II 2.5 T	B5254T14	01/13 →	
S60 II 2.5 T5	B5254T5	09/11 →	
S60 II 2.5 T5 AWD	B5254T14, D5204T2	09/12 →	
S60 II 3.0 T AWD	B6304T5	04/14 →	
S60 II D3	D5204T2, D4204T5	04/10 → 12/15	
S60 II D4	D4204T5, D5244T10	04/10 → 12/15	
S60 II D5	D5244T10, D5244T10	04/10 → 12/15	
S60 II D5 AWD	D5244T10, B4204T11	04/10 → 12/15	
S60 II DRIVE / D2	D4162T	01/11 → 12/15	
S60 II T	B5204T9	04/14 →	
S60 II T3	B4164T3	04/10 → 12/15	
S60 II T4	B4164T	04/10 → 12/15	
S60 II T4F	B4164T2	04/11 → 12/15	
S60 II T5	B4204T11, B4204T11	04/10 →	
S60 II T5 AWD	B4204T11, B4204T9	07/14 →	
S60 II T6	B4204T9	09/13 →	
S60 II T6 AWD	B4204T9, D5244T14	04/10 →	
S80 II 1.6 D DRIVE	D4164T	01/10 → 12/11	
S80 II 1.6 D2	D4162T	01/14 →	
S80 II 1.6 DRIVE	D4162T	06/11 →	
S80 II 2.0	B4204S3	01/08 → 09/12	
S80 II 2.0 Drive- E	B4204T11	12/14 →	
S80 II 2.0 FlexFuel	B4204S4	01/08 → 12/11	
S80 II 2.0 T	B4204T6	01/10 →	
S80 II 2.0 T5	B4204T15	01/14 →	
S80 II 2.0 TDi	D4204T	02/08 → 03/11	
S80 II 2.4 D	D5244T14, B5254T10	03/06 →	
S80 II 2.5 T	B5254T10, B5254T11	03/06 →	
S80 II 2.5 T AWD	B5254T6	10/06 → 04/09	
S80 II 2.5 T FlexFuel	B5254T11, B6324S	05/08 → 12/11	
S80 II 3.2	B6324S, B6324S	03/06 →	
S80 II 3.2 AWD	B6324S, D5204T2	01/07 → 12/12	

VOLVO			
S80 II 3.2 Flexifuel AWD	B6324S	01/09 → 03/10	
S80 II 4.4 V8 AWD	B8444S	03/06 → 03/12	
S80 II D3	D5204T7	05/12 →	
S80 II D3 / D4	D5204T2, D5244T10	01/10 →	
S80 II D4	D4204T5	09/13 →	
S80 II D5	D5244T10, D5244T10	03/06 →	
S80 II D5 AWD	D5244T10, B4204T11	01/07 →	
S80 II T4	B4164T	10/10 →	
S80 II T4F	B4164T2	05/11 →	
S80 II T5	B4204T11, B6304T2	10/10 →	
S80 II T6 AWD	B6304T2, B6304T2	01/07 → 12/16	
S80L 2.0 T	B4204T6	01/10 →	
S80L 2.5 T	B5254T6	01/08 →	
S80L 2.5 T5	B5254T12	01/12 →	
S80L T4	B5204T8	01/12 →	
S80L T5	B4204T7	01/12 →	
S80L T6 AWD	B6304T2, D4204T20	01/08 →	
V60 I 1.5 T2	B4154T5	10/15 →	
V60 I 1.6 DRiVe	D4162T	02/11 → 12/15	
V60 I 2.0 BiFuel	B5204T9	03/14 → 12/15	
V60 I 2.0 D2	D4204T20, D4204T4	03/15 →	
V60 I 2.0 D3	D4204T4, B4204T6	09/13 →	
V60 I 2.0 D4	D4204T14	09/13 →	
V60 I 2.0 Polestar AWD	B4204T43	06/15 →	
V60 I 2.0 T	B4204T6, D5244T11	07/10 →	
V60 I 2.0 T4	B4204T19	03/15 →	
V60 I 2.0 T5	B4204T15	01/14 →	
V60 I 2.4 D4 AWD	D5244T12	09/13 → 12/15	
V60 I 2.4 D5	D5244T11, D5244T11	04/11 → 12/15	
V60 I 2.4 D5 AWD	D5244T11, D5244T15	04/11 → 12/15	
V60 I 2.4 D5 Hybrid AWD	D87PHEV	03/15 →	
V60 I 2.4 Hybrid D6 AWD	D5244T15, D5204T2	06/12 → 12/15	
V60 I 3.0 T AWD	B6304T5	04/14 →	
V60 I D3	D5204T7	05/12 → 12/15	
V60 I D3 / D4	D5204T2, D5244T12	07/10 → 12/14	
V60 I D4	D4204T5	10/13 → 12/15	
V60 I D4 AWD	D5244T12, D4204T11	05/12 →	
V60 I D5	D4204T11, D5244T10	07/10 →	
V60 I D5 AWD	D5244T10, B4154T4	07/10 → 12/15	
V60 I D6 Hybrid AWD	D97PHEV	03/15 →	
V60 I T3	B4154T4, B4204T11	09/10 →	
V60 I T4	B4164T	09/10 → 12/15	
V60 I T4F	B4164T2	04/11 → 12/15	
V60 I T5	B4204T11, B4204T11	09/10 →	
V60 I T5 AWD	B4204T11, B4204T9	07/14 →	
V60 I T6	B4204T9	10/13 →	
V60 I T6 AWD	B4204T9, B5204T9	07/10 →	
V70 2.0 D4/D4 DRIVE	D5204T3	09/13 →	
V70 III 1.6 D	D4164T	07/09 → 12/11	
V70 III 1.6 DRiVe / D2	D4162T	04/11 → 12/15	
V70 III 1.6 T4F	B4164T2	01/11 → 12/15	
V70 III 2.0	B4204S3	10/07 → 12/11	
V70 III 2.0 BiFuel	B5204T9, D5244T14	03/13 → 12/15	
V70 III 2.0 D	D4204T	10/07 → 12/15	
V70 III 2.0 D3 DRIVE	D5204T7	09/13 →	
V70 III 2.0 FlexiFuel	B4204S4	01/08 → 12/11	
V70 III 2.0 GDI	B5204T9	04/12 → 12/15	
V70 III 2.0 T	B4204T6	09/09 → 12/11	
V70 III 2.4 D	D5244T14, D5244T11	04/07 → 12/10	
V70 III 2.4 D4 AWD	D5244T17	09/13 →	
V70 III 2.4 D5	D5244T11, B5254T10	09/13 →	
V70 III 2.5 T	B5254T10, B5254T11	08/07 → 12/12	
V70 III 2.5 T FlexiFuel	B5254T11, B6324S	05/08 → 12/11	
V70 III 3.0 T6 AWD	B6304T4	11/13 →	
V70 III 3.2	B6324S, B6324S	08/07 → 12/14	
V70 III 3.2 AWD	B6324S, D4204T9	04/07 → 12/15	
V70 III D2	D4204T20	03/15 →	
V70 III D3	D4204T9, D5204T2	10/07 →	
V70 III D3 / D4	D5204T2, D5244T12	03/10 → 12/15	
V70 III D4	D4204T5	10/13 →	
V70 III D4 AWD	D5244T12, D5244T10	10/07 →	
V70 III D5	D5244T10, D5244T10	04/07 →	
V70 III D5 AWD	D5244T10, B4164T	04/07 →	
V70 III T4	B4164T, B4204T11	10/10 →	
V70 III T5	B4204T11, B6304T2	01/10 →	
V70 III T6 AWD	B6304T2, D5244T16	08/07 → 12/15	
XC60 I 2.0 T	B4204T6	12/09 → 12/12	
XC60 I 2.4 D	D5244T14	04/09 → 12/10	
XC60 I 2.4 D / D3 / D4 AWD	D5244T16, B6324S	05/08 → 02/17	
XC60 I 3.2 AWD	B6324S, D4204T4	07/09 → 12/15	
XC60 I D3	D4204T4, D5204T2	04/12 → 02/17	
XC60 I D3 / D4	D5204T2, D4204T14	03/10 → 12/14	
XC60 I D4	D4204T14, D5244T12	10/13 → 02/17	
XC60 I D4 AWD	D5244T12, D5244T10	10/13 → 02/17	
XC60 I D5	D5244T11	06/11 → 02/17	
XC60 I D5 AWD	D5244T10, B4204T11	05/08 → 02/17	
XC60 I T5	B4204T11, B4204T11	09/10 →	
XC60 I T5 AWD	B4204T11, B4204T9	04/14 → 02/17	

VOLVO		
XC60 I T6	B4204T9	10/13 →
XC60 I T6 AWD	B4204T9, D5244T16	05/08 →
XC70 II 2.4 D	D5244T14	06/09 → 12/10
XC70 II 2.4 D / D4 AWD	D5244T16, B6324S	08/07 →
XC70 II 3.2	B6324S5	08/07 →
XC70 II 3.2 AWD	B6324S, D5204T2	08/07 →
XC70 II D3	D5204T2, D5244T10	04/10 → 12/15
XC70 II D3 AWD	D5204T2	08/11 →
XC70 II D4	D4204T5	10/13 →
XC70 II D4 AWD	D5244T12	10/13 →
XC70 II D5 AWD	D5244T10, B5254T14	04/07 →
XC70 II T5	B4204T11	10/13 →
XC70 II T5 AWD	B5254T12	08/15 →
XC70 II T6 AWD	B5254T14, E80	01/08 →

21.0182



04,5

WHEEL SPEED SENSORS

Adatt./Suitable:

BOSCH
0 265 008 772

PEUGEOT
96 755 302 80

ITEM NOW AVAILABLE FROM PRODUCTION

- ARTICOLO ORA DISPONIBILE PER LA VENDITA
- ARTICLE DISPONIBLE EN PRODUCTION COURANTE
- JETZT ZUM VERKAUF VERFÜGBARER ARTIKEL
- ARTICULO AHORA DISPONIBLE EN PRODUCCION

MARKET DIFFUSION: MEDIUM



L	L1		OUT
751	27,0	Hall Effect	

PEUGEOT

208 1.0	E80, E82	03/12 →
208 1.2	EB2, EB2ADT	03/12 →
208 1.2 GPL	HMZ(EB2F)	06/15 →
208 1.2 THP	EB2ADT, 8HP(DV4C)	01/13 →
208 1.2 VTi	HMZ(EB2)	09/13 →
208 1.4 HDi	8HP(DV4C), 8FS(EP3)	03/12 →
208 1.4 VTi	8FS(EP3), 5FS(EP6C)	03/12 →
208 1.6	5FS(EP6C), 9HP(DV6DTED)	02/12 →
208 1.6 BlueHDi 100	BHY(DV6FD)	01/15 →
208 1.6 BlueHDi 120	BHZ(DV6FC)	11/13 →
208 1.6 BlueHDi 75	BHW(DV6FE)	04/15 →
208 1.6 GTi	5FU(EP6CDTX)	08/12 →
208 1.6 HDi	9HP(DV6DTED), 9HK(DV6ETEDM)	03/12 →
208 1.6 HDi / BlueHDi 75	9HK(DV6ETEDM), 55263842	01/13 →
208 1.6 HDi 90	9HJ(DV6DTEDM)	03/12 →
208 1.6 THP 210	5GM(EP6FDTX)	04/15 →

21.0183



04,5

WHEEL SPEED SENSORS

Adatt./Suitable:

BOSCH
0 265 004 134
0 265 004 820

FIAT
51940921
52017671
52070218

JEEP
52017671
52070218

ITEM NOW AVAILABLE FROM PRODUCTION

- ARTICOLO ORA DISPONIBILE PER LA VENDITA
- ARTICLE DISPONIBLE EN PRODUCTION COURANTE
- JETZT ZUM VERKAUF VERFÜGBARER ARTIKEL
- ARTICULO AHORA DISPONIBLE EN PRODUCCION



L	L1		OUT
1243	27,9	Hall Effect	

FIAT

500X 1.0	55282151	09/18 →
500X 1.3	55282328	09/18 →
500X 1.3 D Multijet	55266963	11/14 →
500X 1.4	55263624	09/14 →
500X 1.4 4x4	55263623	02/15 →
500X 1.4 LPG	55277701	03/17 →
500X 1.6	55263842, 55263087	09/14 →
500X 1.6 D Multijet	55260384	09/14 →
500X 2.0 4x4	--	09/15 →
500X 2.0 D Multijet 4x4	55263087, --	09/14 →
500X 2.4 4x4	--, 55263624	05/15 →

JEEP

RENEGADE 1.0 T-GDi	55282151	08/18 →
RENEGADE 1.3 T-GDi	55282328	08/18 →
RENEGADE 1.3 T-GDi 4x4	55282328	08/18 →
RENEGADE 1.4	55263624, EAM	07/14 →
RENEGADE 1.4 4x4	EAM, EJH	07/14 →
RENEGADE 1.6	EJH, EJJ(55260384)	07/14 →
RENEGADE 1.6 CRD	EJJ(55260384), 55263088	07/14 →
RENEGADE 2.0 CRD 4x4	55263088, 55263842	07/14 →
RENEGADE 2.4	ED6	09/15 →
RENEGADE 2.4 4x4	ED6	09/15 →

21.0184



04,5

WHEEL SPEED SENSORS

Adatt./Suitable:

BOSCH
0 265 004 135
0 265 004 822

FIAT
51940922
51947672
52017672
52070219

JEEP
52017672
52070219

ITEM NOW AVAILABLE FROM PRODUCTION

- ARTICOLO ORA DISPONIBILE PER LA VENDITA
- ARTICLE DISPONIBLE EN PRODUCTION COURANTE
- JETZT ZUM VERKAUF VERFÜGBARER ARTIKEL
- ARTICULO AHORA DISPONIBLE EN PRODUCCION



L	L1		OUT
1243	27,9	Hall Effect	

FIAT

500X 1.0	55282151	09/18 →
500X 1.3	55282328	09/18 →
500X 1.3 D Multijet	55266963	11/14 →
500X 1.4	55263624	09/14 →
500X 1.4 4x4	55263623	02/15 →
500X 1.4 LPG	55277701	03/17 →
500X 1.6	55263842, 55263087	09/14 →
500X 1.6 D Multijet	55260384	09/14 →
500X 2.0 4x4	--	09/15 →
500X 2.0 D Multijet 4x4	55263087, --	09/14 →
500X 2.4 4x4	--, 55263624	05/15 →

JEEP

RENEGADE 1.0 T-GDi	55282151	08/18 →
RENEGADE 1.3 T-GDi	55282328	08/18 →
RENEGADE 1.3 T-GDi 4x4	55282328	08/18 →
RENEGADE 1.4	55263624, EAM	07/14 →
RENEGADE 1.4 4x4	EAM, EJH	07/14 →
RENEGADE 1.6	EJH, EJJ(55260384)	07/14 →
RENEGADE 1.6 CRD	EJJ(55260384), 55263088	07/14 →
RENEGADE 2.0 CRD 4x4	55263088, M271.820	07/14 →
RENEGADE 2.4	ED6	09/15 →
RENEGADE 2.4 4x4	ED6	09/15 →

21.0185



04,5

WHEEL SPEED SENSORS

Adatt./Suitable:

ATE

10.0711-6280.3
10.0711-6390.3

BOSCH

0 986 594 548

MERCEDES-BENZ

2049052905
2049057900
A 006 542 93 18
A 204 905 29 05
A 204 905 79 00

ITEM NOW AVAILABLE FROM PRODUCTION

- ARTICOLO ORA DISPONIBILE PER LA VENDITA
- ARTICLE DISPONIBLE EN PRODUCTION COURANTE
- JETZT ZUM VERKAUF VERFÜGBARER ARTIKEL
- ARTICULO AHORA DISPONIBLE EN PRODUCCION

MARKET DIFFUSION: MEDIUM



L	L1		OUT +
676	31	Hall Effect	

MERCEDES-BENZ

Model	Part Number	Availability
CLASSE C III C 180	M271.820, M271.820	06/11 ⇨
CLASSE C III C 180 CDI	OM651.913	01/11 ⇨ 08/14
CLASSE C III C 180 CGI	M271.820, M271.820	01/07 ⇨ 08/14
CLASSE C III C 180 Kompressor	M271.820, OM646.811	01/07 ⇨ 08/14
CLASSE C III C 200	M271.820	05/11 ⇨ 01/14
CLASSE C III C 200 CDI	OM646.811, M271.820	01/07 ⇨ 08/14
CLASSE C III C 200 CGI	M271.820, M271.820	01/07 ⇨
CLASSE C III C 200 Kompressor	M271.820, OM646.811	01/07 ⇨ 08/14
CLASSE C III C 220 CDI	OM646.811, M272.947	01/07 ⇨
CLASSE C III C 230	M272.921	01/07 ⇨ 08/14
CLASSE C III C 250	M271.860	01/07 ⇨
CLASSE C III C 250 CDI	OM651.911	08/08 ⇨
CLASSE C III C 250 CGI	M271.860	07/09 ⇨ 08/14
CLASSE C III C 280	M272.947	01/07 ⇨ 08/14
CLASSE C III C 300	M272.947, M272.961	08/07 ⇨ 08/14
CLASSE C III C 320 CDI	OM642.960	01/07 ⇨ 08/14
CLASSE C III C 350	M272.961, OM642.830	01/07 ⇨
CLASSE C III C 350 CDI	OM642.830, --	08/07 ⇨ 08/14
CLASSE C III C 350 CGI	M272.982	09/08 ⇨ 08/14
C-SERIES C200 CDI	OM651.913	01/10 ⇨ 01/14

21.0186



1

WHEEL SPEED SENSORS

Adatt./Suitable:

ATE

10.0711-6351.3
10.0711-6426.3
10.0711-6434.3

FORD

1 682 670
1 756 081
2 070 182
AV6T-2B372-EB
AV6T-2B372-EC

VOLVO

31317076
31423609

ITEM NOW AVAILABLE FROM PRODUCTION

- ARTICOLO ORA DISPONIBILE PER LA VENDITA
- ARTICLE DISPONIBLE EN PRODUCTION COURANTE
- JETZT ZUM VERKAUF VERFÜGBARER ARTIKEL
- ARTICULO AHORA DISPONIBLE EN PRODUCCION

19 Black color (OE gray)

- Colore nero (grigio OE)
- Couleur noire (gris OE)
- Schwarze Farbe (OE grau)
- Color negro (gris original)

MARKET DIFFUSION: HIGH



L	L1		OUT +
---	14	Hall Effect	

FORD

Model	Part Number	Availability
C-MAX II 1.0 EcoBoost	--, M8DB	10/12 ⇨
C-MAX II 1.5 16V	--	03/15 ⇨
C-MAX II 1.5 EcoBoost	M8DB, XWDA	03/15 ⇨
C-MAX II 1.5 TDCi	XWDA, JQDA	03/15 ⇨
C-MAX II 1.5 TDCi ECOnetic	AEDA	03/15 ⇨
C-MAX II 1.6	--	12/10 ⇨
C-MAX II 1.6 CNG	MUDACNG	01/13 ⇨
C-MAX II 1.6 EcoBoost	JQDA, MUDA	12/10 ⇨
C-MAX II 1.6 Flexifuel	MUDA, MUDA	02/11 ⇨
C-MAX II 1.6 LPG	MUDA, T1DA	02/12 ⇨
C-MAX II 1.6 TDCi	T1DA, IQDA	12/10 ⇨
C-MAX II 1.6 Ti	IQDA, --	12/10 ⇨
C-MAX II 2.0 Energi	--, --	01/15 ⇨
C-MAX II 2.0 TDCi	--, M1DA	04/10 ⇨
FOCUS III 1.0 EcoBoost	M1DA, M8DA	02/12 ⇨
FOCUS III 1.0 GTDI	--	07/12 ⇨
FOCUS III 1.5 DI TC SIGMA A	--	09/14 ⇨
FOCUS III 1.5 EcoBoost	M8DA, XWDA	09/14 ⇨
FOCUS III 1.5 TDCi	XWDA, AEDA	09/14 ⇨
FOCUS III 1.5 TDCi ECOnetic	AEDA, JQDA	09/14 ⇨
FOCUS III 1.6 EcoBoost	JQDA, MUDA	07/10 ⇨
FOCUS III 1.6 Flexifuel	MUDA, MUDA	07/10 ⇨
FOCUS III 1.6 LPG	MUDA, NGDA	02/12 ⇨
FOCUS III 1.6 TDCi	NGDA, NGDA	07/10 ⇨
FOCUS III 1.6 TDCi ECOnetic	NGDA, IQDA	05/12 ⇨
FOCUS III 1.6 Ti	IQDA, R9DA	07/10 ⇨
FOCUS III 1.6 Ti-VCT	--	07/10 ⇨
FOCUS III 2.0	XQDA	10/13 ⇨
FOCUS III 2.0 DI TIVCT	--	04/11 ⇨
FOCUS III 2.0 Gdi	MGDA	08/11 ⇨
FOCUS III 2.0 ST	R9DA, T7DA	07/12 ⇨
FOCUS III 2.0 TDCi	T7DA, M1DA	07/10 ⇨
FOCUS III 2.0 TDCi ST	T8DA	11/14 ⇨
FOCUS III 2.0 Ti-Gdi	MGDA	07/10 ⇨
FOCUS III 2.3 RS AWD	YVDA	07/15 ⇨
FOCUS III Electric	KDDA	07/13 ⇨
GRAND C-MAX 1.0 EcoBoost	M1DA, M8DB	10/12 ⇨
GRAND C-MAX 1.5 EcoBoost	M8DB, AEDA	03/15 ⇨
GRAND C-MAX 1.5 TDCi	AEDA, JQDA	03/15 ⇨
GRAND C-MAX 1.6 EcoBoost	JQDA, T1DA	12/10 ⇨
GRAND C-MAX 1.6 TDCi	T1DA, IQDA	12/10 ⇨
GRAND C-MAX 1.6 Ti	IQDA, T7DB	12/10 ⇨
GRAND C-MAX 2.0 TDCi	T7DB, BNMA	12/10 ⇨
KUGA II 1.5 16V	--	03/13 ⇨
KUGA II 1.5 EcoBoost	BNMA, C15HDTX	09/14 ⇨
KUGA II 1.5 EcoBoost 4x4	C15HDTX, --	09/14 ⇨
KUGA II 1.5 TDCi	--, --	07/16 ⇨

FORD

Model	Part Number	Availability
KUGA II 1.6 EcoBoost	--, JQMA	01/13 ⇨
KUGA II 1.6 EcoBoost 4x4	JQMA, T7MA	10/12 ⇨
KUGA II 2.0 4x4	--	03/13 ⇨ 06/16
KUGA II 2.0 EcoBoost	--	03/13 ⇨
KUGA II 2.0 EcoBoost 4x4	R9MA	08/17 ⇨
KUGA II 2.0 TDCi	T7MA, T7MA	03/13 ⇨
KUGA II 2.0 TDCi 4x4	T7MA, --	03/13 ⇨
KUGA II 2.5	--, T1BA	09/13 ⇨
KUGA II 2.5 PFI	--	03/13 ⇨
MONDEO III 1.6 TDCi	T1BA, M2GA	12/10 ⇨ 01/15
TOURNEO CONNECT II 1.0 EcoBoost	M2GA, --	11/13 ⇨
TOURNEO CONNECT II 1.5 TDCi	--, --	09/13 ⇨
TOURNEO CONNECT II 1.6 EcoBoost	--, T1GA	09/13 ⇨
TOURNEO CONNECT II 1.6 TDCi	T1GA, M2GA	09/13 ⇨
TOURNEO CONNECT II 2.5	--	09/13 ⇨
TRANSIT CONNECT II 1.0 EcoBoost	M2GA, --	02/13 ⇨
TRANSIT CONNECT II 1.5 TDCi	--, --	02/13 ⇨
TRANSIT CONNECT II 1.6 EcoBoost	--, T1GA	02/13 ⇨
TRANSIT CONNECT II 1.6 TDCi	T1GA, D4162T	02/13 ⇨
TRANSIT CONNECT II 2.5	--	02/13 ⇨

VOLVO

Model	Part Number	Availability
V40 II 1.6 D2/ DRIVE	D4162T	09/13 ⇨ 12/15
V40 II 2.0 D3	D5204T6	09/13 ⇨ 12/15
V40 II 2.0 D4	D5204T4	09/13 ⇨ 12/14
V40 II D2	D4162T, D4204T16	03/12 ⇨
V40 II D3	D4204T16, D4204T14	03/12 ⇨
V40 II D4	D4204T14, B4154T3	03/12 ⇨
V40 II T2	B4154T3, B4154T2	02/15 ⇨
V40 II T2 GTDi	B4164T4	03/13 ⇨ 12/15
V40 II T3	B4154T2, B4164T	02/15 ⇨
V40 II T3 GTDi	B4164T3	03/12 ⇨
V40 II T4	B4164T, B4204T21	07/13 ⇨
V40 II T4 AWD	B4204T21, B4204T11	07/13 ⇨
V40 II T4 GTDi	B4164T	03/12 ⇨
V40 II T5	B4204T11, B4204T11	12/12 ⇨
V40 II T5 AWD	B4204T11, M271.820	01/13 ⇨
V40 1.6 D2	D4162T	09/13 ⇨ 12/15
V40 2.0 D3	D5204T6	09/13 ⇨ 12/15
V40 2.0 D4	D5204T4	09/13 ⇨ 12/14



WHEEL SPEED SENSORS

Adatt./Suitable:

ATE
10.0711-6189.3
BOSCH
0 986 594 545
MERCEDES-BENZ
2045400117
A 204 540 01 17
A 204 905 00 00

ITEM NOW AVAILABLE FROM PRODUCTION

- ARTICOLO ORA DISPONIBILE PER LA VENDITA
- ARTICLE DISPONIBLE EN PRODUCTION COURANTE
- JETZT ZUM VERKAUF VERFÜGBARER ARTIKEL
- ARTICULO AHORA DISPONIBLE EN PRODUCCION

MARKET DIFFUSION: **MEDIUM**



L	L1	Hall Effect	
676	31		

MERCEDES-BENZ

CLASSE C III C 180 CDI	OM651.913	01/11 ⇨ 08/14
CLASSE C III C 180 CGI	M271.820, M271.820	01/07 ⇨ 08/14
CLASSE C III C 180 Kompressor	M271.820, OM646.811	01/07 ⇨ 08/14
CLASSE C III C 200	M271.820	05/11 ⇨ 01/14
CLASSE C III C 200 CDI	OM646.811, M271.820	01/07 ⇨ 08/14
CLASSE C III C 200 CGI	M271.820, M271.820	01/07 ⇨ 08/14
CLASSE C III C 200 Kompressor	M271.820, OM646.811	01/07 ⇨ 08/14
CLASSE C III C 220 CDI	OM646.811, OM642.830	01/07 ⇨ 08/14
CLASSE C III C 230	M272.921	01/07 ⇨ 08/14
CLASSE C III C 230 4-matic	M272.911	07/07 ⇨ 01/14
CLASSE C III C 250	M272.921	01/07 ⇨
CLASSE C III C 250 4-matic	M272.911	07/07 ⇨
CLASSE C III C 250 CDI	OM651.911	08/08 ⇨ 08/14
CLASSE C III C 250 CDI 4-matic	OM651.912	01/11 ⇨ 01/14
CLASSE C III C 250 CGI	M271.860	07/09 ⇨ 08/14
CLASSE C III C 280	M272.947	01/07 ⇨ 08/14
CLASSE C III C 280 4-matic	M272.948	07/07 ⇨ 01/14
CLASSE C III C 300	M272.947	08/07 ⇨ 08/14
CLASSE C III C 300 4-matic	M272.948	07/07 ⇨ 01/14
CLASSE C III C 300 CDI	OM642.832	01/11 ⇨ 01/14
CLASSE C III C 320 CDI	OM642.960	01/07 ⇨ 08/14
CLASSE C III C 320 CDI 4-matic	OM642.961	07/07 ⇨ 01/14
CLASSE C III C 350	M272.961	01/07 ⇨ 08/14
CLASSE C III C 350 4-matic	M272.971	07/07 ⇨ 01/14
CLASSE C III C 350 CDI	OM642.830, OM642.832	08/07 ⇨ 08/14
CLASSE C III C 350 CDI 4-matic	OM642.832, M271.820	07/09 ⇨ 01/14
CLASSE C III C 350 CGI	M272.982	09/08 ⇨ 01/14
CLASSE C III C 63 AMG	M156.985	02/08 ⇨ 01/14
CLASSE C III C 63 AMG DR 520	--	07/10 ⇨ 01/14
C-SERIES C200 CDI	OM651.913	01/10 ⇨ 01/14



WHEEL SPEED SENSORS

Adatt./Suitable:

ATE
10.0711-6191.3
10.0711-6200.3

BOSCH
0 986 594 546
0 986 594 547

MERCEDES-BENZ
2045400317
2045401317
A 204 540 03 17
A 204 540 13 17
A 204 905 01 00

ITEM NOW AVAILABLE FROM PRODUCTION

- ARTICOLO ORA DISPONIBILE PER LA VENDITA
- ARTICLE DISPONIBLE EN PRODUCTION COURANTE
- JETZT ZUM VERKAUF VERFÜGBARER ARTIKEL
- ARTICULO AHORA DISPONIBLE EN PRODUCCION

MARKET DIFFUSION: **MEDIUM**



L	L1	Hall Effect	
1055	31		

MERCEDES-BENZ

CLASSE C III C 180	M271.820, M271.820	06/11 ⇨
CLASSE C III C 180 CDI	OM651.913	01/11 ⇨ 08/14
CLASSE C III C 180 CGI	M271.820, M271.820	01/07 ⇨ 08/14
CLASSE C III C 180 Kompressor	M271.820, OM646.811	01/07 ⇨ 08/14
CLASSE C III C 200	M271.820	05/11 ⇨ 01/14
CLASSE C III C 200 CDI	OM646.811, M271.820	01/07 ⇨ 08/14
CLASSE C III C 200 CGI	M271.820, M271.820	01/07 ⇨
CLASSE C III C 200 Kompressor	M271.820, OM646.811	01/07 ⇨ 08/14
CLASSE C III C 220 CDI	OM646.811, M272.947	01/07 ⇨
CLASSE C III C 220 CDI 4-matic	OM651.912	02/13 ⇨ 08/14
CLASSE C III C 230	M272.921	01/07 ⇨ 08/14
CLASSE C III C 230 4-matic	M272.911	07/07 ⇨ 01/14
CLASSE C III C 250	M271.860	01/07 ⇨
CLASSE C III C 250 4-matic	M272.911	07/07 ⇨
CLASSE C III C 250 CDI	OM651.911	08/08 ⇨
CLASSE C III C 250 CDI 4-matic	OM651.912	04/10 ⇨ 08/14
CLASSE C III C 250 CGI	M271.860	07/09 ⇨ 08/14
CLASSE C III C 280	M272.947	01/07 ⇨ 08/14
CLASSE C III C 280 4-matic	M272.948	07/07 ⇨ 01/14
CLASSE C III C 300	M272.947, M272.948	08/07 ⇨ 08/14
CLASSE C III C 300 4-matic	M272.948, M272.961	07/07 ⇨ 01/14
CLASSE C III C 300 CDI	OM642.832	01/11 ⇨ 01/14
CLASSE C III C 320 CDI	OM642.960	01/07 ⇨ 08/14
CLASSE C III C 320 CDI 4-matic	OM642.961	07/07 ⇨ 01/14
CLASSE C III C 350	M272.961, M272.971	01/07 ⇨
CLASSE C III C 350 4-matic	M272.971, OM642.830	07/07 ⇨
CLASSE C III C 350 CDI	OM642.830, OM642.832	08/07 ⇨ 08/14
CLASSE C III C 350 CDI 4-matic	OM642.832, --	08/07 ⇨ 08/14
CLASSE C III C 350 CGI	M272.982	09/08 ⇨ 08/14
CLASSE C III C 63 AMG	--	02/08 ⇨
CLASSE C III C 63 AMG DR 520	--, OM651.913	07/10 ⇨ 01/14
CLASSE GLK 200	M274.920	08/13 ⇨ 06/15
CLASSE GLK 200 CDI	OM651.913, M272.948	07/10 ⇨ 06/15
CLASSE GLK 220 CDI	OM651.916	12/08 ⇨ 06/15
CLASSE GLK 220 CDI 4-matic	OM651.912	12/08 ⇨ 06/15
CLASSE GLK 250	M274.920	08/13 ⇨ 06/15

CLASSE GLK 250 4-matic	M274.920	08/13 ⇨ 06/15
CLASSE GLK 250 CDI 4-matic	OM651.912	09/09 ⇨ 06/15
CLASSE GLK 280 4-matic	M272.948	06/08 ⇨ 06/09
CLASSE GLK 300 4-matic	M272.948, M272.991	07/09 ⇨ 06/15
CLASSE GLK 320 CDI 4-matic	OM642.961	06/08 ⇨ 06/15
CLASSE GLK 350	M272.991, M272.971	04/09 ⇨
CLASSE GLK 350 4-matic	M272.971, OM642.832	06/08 ⇨ 06/15
CLASSE GLK 350 CDI 4-matic	OM642.832, OM611.962	07/09 ⇨
C-SERIES C200 CDI	OM651.913	01/10 ⇨ 01/14
C-SERIES C300 CDI/CDi BlueEFFICIENCY	OM642.832	01/11 ⇨ 01/14
GLK-SERIES GLK300 CGI [ExtraEU]	M276.957	09/09 ⇨



WHEEL SPEED SENSORS

Adatt./Suitable:

ATE
10.0711-6001.3
10.0711-6223.3

BOSCH
0 986 594 543

MERCEDES-BENZ
2035400417
A 203 540 04 17
A 209 540 12 17

ITEM NOW AVAILABLE FROM PRODUCTION

- ARTICOLO ORA DISPONIBILE PER LA VENDITA
- ARTICLE DISPONIBLE EN PRODUCTION COURANTE
- JETZT ZUM VERKAUF VERFÜGBARER ARTIKEL
- ARTICULO AHORA DISPONIBLE EN PRODUCCION

MARKET DIFFUSION: **HIGH**



L	L1	Hall Effect	
663	31		

MERCEDES-BENZ

CLASSE C II C 160 Kompressor	M271.921	05/02 ⇨ 05/08
CLASSE C II C 180	M111.951	10/00 ⇨ 05/02
CLASSE C II C 180 Kompressor	M271.946	05/02 ⇨ 05/08
CLASSE C II C 200 CDI	OM611.962, M111.955	09/00 ⇨ 05/08
CLASSE C II C 200 CGI Kompressor	M271.942	03/03 ⇨ 05/08
CLASSE C II C 200 Kompressor	M111.955, OM611.962	05/00 ⇨ 05/08
CLASSE C II C 220	M271.948	05/02 ⇨ 05/08
CLASSE C II C 220 CDI	OM611.962, M111.981	05/00 ⇨ 05/08
CLASSE C II C 230	M272.920	01/05 ⇨ 05/08
CLASSE C II C 230 Kompressor	M111.981, M271.911	03/01 ⇨ 05/08
CLASSE C II C 240	M112.912	05/00 ⇨ 08/07
CLASSE C II C 270 CDI	OM612.962	12/00 ⇨ 08/07
CLASSE C II C 280	M272.940	01/05 ⇨ 08/07
CLASSE C II C 30 CDI AMG	OM612.990	09/02 ⇨ 05/08
CLASSE C II C 32 AMG Kompressor	M112.961	02/01 ⇨ 08/07
CLASSE C II C 320	M112.946	05/00 ⇨ 05/08
CLASSE C II C 320 CDI	OM642.910	01/05 ⇨ 08/07
CLASSE C II C 350	M272.960	01/05 ⇨ 05/08
CLASSE C II C 55 AMG	M113.988	02/04 ⇨ 08/07
CLASSE CLC CLC 160	M271.911, M271.940	02/09 ⇨ 06/11
CLASSE CLC CLC 180 Kompressor	M271.940, OM646.962	05/08 ⇨ 06/11
CLASSE CLC CLC 200 CDI	OM646.962, M271.940	05/08 ⇨ 06/11
CLASSE CLC CLC 200 Kompressor	M271.957	05/08 ⇨ 06/11
CLASSE CLC CLC 220 CDI	OM646.963	05/08 ⇨ 06/11
CLASSE CLC CLC 230	M272.920	05/08 ⇨ 06/11
CLASSE CLC CLC 350	M272.960	05/08 ⇨ 06/11

MERCEDES-BENZ		
CLASSE CLC CLC250 [ExtraEU]	M272.920	06/09 ⇒ 06/11
CLASSE CLK II 200 CGI	M271.942	07/03 ⇒ 05/09
CLASSE CLK II 200 Kompressor	M271.940, OM612.962	09/02 ⇒ 05/09
CLASSE CLK II 220 CDI	OM646.966	01/05 ⇒ 05/09
CLASSE CLK II 240	M112.912	06/02 ⇒ 05/09
CLASSE CLK II 270 CDI	OM612.962, M113.968	10/02 ⇒ 05/09
CLASSE CLK II 280	M272.940	01/05 ⇒ 05/09
CLASSE CLK II 320	M112.955	06/02 ⇒ 05/09
CLASSE CLK II 320 CDI	OM642.910	01/05 ⇒ 05/09
CLASSE CLK II 350	M272.960	01/05 ⇒ 05/09
CLASSE CLK II 500	M113.968, M156.982	06/02 ⇒
CLASSE CLK II 55 AMG	M113.987	09/02 ⇒ 05/09
CLASSE CLK II 550	M273.967	06/06 ⇒
CLASSE CLK II 63 AMG	M156.982, M271.940	04/06 ⇒ 05/09
CLASSE CLK II CLK 200 CGI	M271.942	07/03 ⇒ 03/10
CLASSE CLK II CLK 200 Kompressor	M271.940, M113.968	02/03 ⇒ 03/10
CLASSE CLK II CLK 240	M112.912	02/03 ⇒ 03/10
CLASSE CLK II CLK 280	M272.940	01/05 ⇒ 03/10
CLASSE CLK II CLK 320	M112.955	02/03 ⇒ 03/10
CLASSE CLK II CLK 320 CDI	OM642.910	03/05 ⇒ 03/10
CLASSE CLK II CLK 350	M272.960	01/05 ⇒ 03/10
CLASSE CLK II CLK 500	M113.968, M271.944	02/03 ⇒ 03/10
CLASSE CLK II CLK 55 AMG	M113.987	02/03 ⇒ 03/10
CLASSE CLK II CLK 63 AMG	M156.982	04/06 ⇒ 03/10
CLASSE SLK II 200 Kompressor	M271.944, M272.963	03/04 ⇒ 02/11
CLASSE SLK II 280	M272.942	01/05 ⇒ 02/11
CLASSE SLK II 300	M272.942	04/09 ⇒ 02/11
CLASSE SLK II 350	M272.963, M113.989	06/04 ⇒ 02/11
CLASSE SLK II 55 AMG	M113.989, M276.822	06/04 ⇒ 02/11
CLC-SERIES CLC220 CDI	OM646.963	05/08 ⇒ 06/11
CLK-SERIES CLK63 AMG Black Series	M156.982	05/07 ⇒ 05/09
C-SERIES C160 Kompressor	M271.921	06/02 ⇒ 07/06

MERCEDES-BENZ		
CLASSE SLK III 250 CDI / d	OM651.980	01/12 ⇒
CLASSE SLK III 300	M274.920	07/15 ⇒
CLASSE SLK III 350	M276.956	02/11 ⇒
CLASSE SLK III 55 AMG	M152.980	01/12 ⇒
SLK-SERIES SLK200 CNG	274920CNG	04/15 ⇒
SLK-SERIES SLK200 Flexfuel	M274.920	04/15 ⇒

21.0193

04,5

WHEEL SPEED SENSORS

Adatt./Suitable:

ATE

10.0711-6188.3
10.0711-6240.3
10.0711-6418.3

BMW

34 52 6 760 425
34 52 6 785 021
34 52 6 870 076
6 760 425
6 785 021
6 870 076

BOSCH

0 986 594 571

ITEM NOW AVAILABLE FROM PRODUCTION

- ARTICOLO ORA DISPONIBILE PER LA VENDITA
- ARTICLE DISPONIBLE EN PRODUCTION COURANTE
- JETZ ZUM VERKAUF VERFÜGBARER ARTIKEL
- ARTICULO AHORA DISPONIBLE EN PRODUCCION

MARKET DIFFUSION: MEDIUM



L	L1		
962	31	Hall Effect	+ OUT

21.0194

04,5

WHEEL SPEED SENSORS

Adatt./Suitable:

BOSCH

0 265 009 813

CITROËN

98 023 177 80

ITEM NOW AVAILABLE FROM PRODUCTION

- ARTICOLO ORA DISPONIBILE PER LA VENDITA
- ARTICLE DISPONIBLE EN PRODUCTION COURANTE
- JETZ ZUM VERKAUF VERFÜGBARER ARTIKEL
- ARTICULO AHORA DISPONIBLE EN PRODUCCION



L	L1		
706	27	Hall Effect	+ OUT

21.0191

04,5

WHEEL SPEED SENSORS

Adatt./Suitable:

ATE

10.0711-6389.3

MERCEDES-BENZ

A 172 540 00 17

A 172 905 61 01

ITEM NOW AVAILABLE FROM PRODUCTION

- ARTICOLO ORA DISPONIBILE PER LA VENDITA
- ARTICLE DISPONIBLE EN PRODUCTION COURANTE
- JETZ ZUM VERKAUF VERFÜGBARER ARTIKEL
- ARTICULO AHORA DISPONIBLE EN PRODUCCION



L	L1		
626	31	Hall Effect	OUT +

MERCEDES-BENZ

CLASSE SLC 180	M274.910	01/16 ⇒
CLASSE SLC 200	M274.920	01/16 ⇒
CLASSE SLC 250 d	OM651.980	01/16 ⇒ 10/17
CLASSE SLC 300	M274.920	01/16 ⇒
CLASSE SLC AMG SLC 43	M276.822, M271.861	01/16 ⇒
CLASSE SLK III 200	M271.861, N47D20A	02/11 ⇒
CLASSE SLK III 250	M271.861	02/11 ⇒

BMW		
11 118 i	N43B20A	03/08 ⇒ 12/13
11 120 d	N47D20A, N43B20A	03/03 ⇒ 12/13
11 120 i	N43B20A, N52B30A	11/03 ⇒ 12/13
11 125 i	N52B30A, N51B30A	10/07 ⇒
11 128 i	N51B30A, N52B25A	03/08 ⇒
3 V 320 d	M47D20(204D4), N43B20A	12/04 ⇒ 06/13
3 V 320 i	N43B20A, N52B25A	01/07 ⇒ 12/13
3 V 320 xd	--	03/07 ⇒
3 V 323 i	N52B25A, N52B25A	09/05 ⇒
3 V 325 i	N52B25A, N51B30A	01/05 ⇒
3 V 328 i	N51B30A, EB2ADT	07/05 ⇒
3 SERIES 325i Coupe [ExtraEU]	N52B25A, M47D20(204D4)	03/10 ⇒ 06/13

CITROËN

C4 CACTUS 1.2 THP 110	EB2ADT, EB2D	09/14 ⇒
C4 CACTUS 1.2 Vti 75	EB2D, EB2	09/14 ⇒
C4 CACTUS 1.2 Vti 82	EB2, BHY(DV6FD)	09/14 ⇒
C4 CACTUS 1.6 BlueHDi 100	BHY(DV6FD), 9HP(DV6DTEd)	09/14 ⇒
C4 CACTUS 1.6 HDi 90	9HP(DV6DTEd), B37D15A	09/14 ⇒

21.0196



04,5

WHEEL SPEED SENSORS

Adatt./Suitable:

ATE
10.0711-6281.3
10.0711-6345.3
10.0711-6476.3

BMW
34 52 6 791 223
34 52 6 852 907
34 52 6 884 422
6 852 907
6 884 422

ITEM NOW AVAILABLE FROM

PRODUCTION

- ARTICOLO ORA DISPONIBILE PER LA VENDITA
- ARTICLE DISPONIBLE EN PRODUCTION COURANTE
- JETZT ZUM VERKAUF VERFÜGBARER ARTIKEL
- ARTICULO AHORA DISPONIBLE EN PRODUCCION

MARKET DIFFUSION: **HIGH**



L	L1	Hall Effect	
604	31		

BMW		
1 II 114 d	B37D15A, B37D15A	07/12 ⇨
1 II 114 i	N13B16A	11/11 ⇨
1 II 116 d	B37D15A, B38B15A	12/10 ⇨
1 II 116 i	B38B15A, B47D20A	12/10 ⇨
1 II 118 d	B47D20A, B38B15A	12/10 ⇨
1 II 118 i	B38B15A, B47D20A	11/10 ⇨
1 II 120 d	B47D20A, B48B20A	12/10 ⇨
1 II 120 i	B48B20A, B47D20B	03/15 ⇨
1 II 125 d	B47D20B, B48B20B	08/11 ⇨
1 II 125 i	B48B20B, B47D20A	08/11 ⇨
1 II 125i Flex [ExtraEU]	N20B20A	03/15 ⇨
1 II M 135 i	N55B30A	11/11 ⇨
1 II M 140 i	B58B30A	09/15 ⇨
1 SERIES 120i [ExtraEU]	B48B20A	10/15 ⇨
1 SERIES 125i Flex [ExtraEU]	N20B20A	08/14 ⇨
2 218 d	B47D20A, B47D20A	01/14 ⇨
2 220 d	B47D20A, B48B20A	10/12 ⇨
2 220 i	B48B20A, B47D20B	10/13 ⇨
2 225 d	B47D20B, B46B20B	01/14 ⇨
2 228 i	N20B20A	07/14 ⇨
2 230 i	B46B20B, B47D20A	09/15 ⇨
2 M 235 i	N55B30A	11/14 ⇨
2 M 240 i	B58B30A	09/15 ⇨
3 VI 316 d	B47D20A, B47D20A	05/11 ⇨
3 VI 316 i	N13B16A	03/12 ⇨ 08/16
3 VI 316 Li [CHN]	N13B16A	10/12 ⇨
3 VI 318 d	B47D20A, B47D20A	05/11 ⇨
3 VI 318 d xDrive	B47D20A	07/15 ⇨ 02/18
3 VI 318 i	B38B15A	01/15 ⇨
3 VI 320 d	B47D20A, B47D20A	03/11 ⇨
3 VI 320 d xDrive	B47D20A, B48B20A	03/13 ⇨
3 VI 320 i	B48B20A, B48B20A	04/11 ⇨
3 VI 320 i xDrive	B48B20A, N20B20A	11/12 ⇨
3 VI 320 Li [CHN]	--	02/12 ⇨
3 VI 320i [ExtraEU]	N20B20A, B47D20B	04/11 ⇨
3 VI 325 d	B47D20B, N20B20A	07/12 ⇨
3 VI 328 d [USA]	--	10/11 ⇨
3 VI 328 i	N20B20A, B46B20B	04/11 ⇨ 10/18
3 VI 328 Li [CHN]	N20B20A	10/11 ⇨
3 VI 330 d	N57D30A	01/12 ⇨

BMW		
3 VI 330 e	B48B20A	11/15 ⇨ 10/18
3 VI 330 i	B46B20B, N55B30A	09/14 ⇨
3 VI 335 i	N55B30A, B58B30A	04/11 ⇨
3 VI 335 Li [CHN]	N55B30A	10/11 ⇨
3 VI 340 i	B58B30A, B58B30A	10/14 ⇨
3 VI 340 i xDrive	B58B30A, B47D20A	09/15 ⇨
3 VI ActiveHybrid	N55B30A	11/11 ⇨ 05/15
4 418 d	B47D20A, B47D20A	03/14 ⇨
4 418 i	B38B15A	07/15 ⇨
4 420 d	B47D20A, B48B20A	07/13 ⇨
4 420 d xDrive	B47D20A	03/15 ⇨
4 420 i	B48B20A, B47D20B	11/13 ⇨
4 425 d	B47D20B, N20B20A	01/14 ⇨
4 428 i	N20B20A, N57D30A	07/13 ⇨
4 430 d	N57D30A, B37D15A	10/13 ⇨
4 430 i	B48B20B	03/16 ⇨
4 435 i	N55B30A	07/13 ⇨
4 440 i	B58B30A	03/16 ⇨

21.0197



04,5

WHEEL SPEED SENSORS

Adatt./Suitable:

ATE
10.0711-6282.3
10.0711-6412.3
10.0711-6413.3

BMW
34 52 6 791 224
34 52 6 852 908
34 52 6 869 320
34 52 6 869 323
6 869 320
6 869 323

ITEM NOW AVAILABLE FROM PRODUCTION

- ARTICOLO ORA DISPONIBILE PER LA VENDITA
- ARTICLE DISPONIBLE EN PRODUCTION COURANTE
- JETZT ZUM VERKAUF VERFÜGBARER ARTIKEL
- ARTICULO AHORA DISPONIBLE EN PRODUCCION

MARKET DIFFUSION: **HIGH**



L	L1	Hall Effect	
590	30,8		

BMW		
1 II 114 d	B37D15A, B37D15A	07/12 ⇨
1 II 116 d	B37D15A, B38B15A	12/10 ⇨
1 II 116 i	B38B15A, B47D20A	12/10 ⇨
1 II 118 d	B47D20A, B38B15A	12/10 ⇨
1 II 118 i	B38B15A, B47D20A	11/10 ⇨
1 II 120 d	B47D20A, B48B20A	12/10 ⇨
1 II 120 i	B48B20A, B47D20B	03/15 ⇨
1 II 125 d	B47D20B, B48B20B	08/11 ⇨
1 II 125 i	B48B20B, B47D20A	08/11 ⇨
1 II 125i Flex [ExtraEU]	N20B20A	03/15 ⇨
1 II M 135 i	N55B30A	11/11 ⇨
1 II M 140 i	B58B30A	09/15 ⇨
1 SERIES 120i [ExtraEU]	B48B20A	10/15 ⇨
1 SERIES 125i Flex [ExtraEU]	N20B20A	08/14 ⇨
2 218 d	B47D20A, B47D20A	01/14 ⇨
2 220 d	B47D20A, B48B20A	10/12 ⇨
2 220 i	B48B20A, B47D20B	10/13 ⇨
2 225 d	B47D20B, B46B20B	01/14 ⇨
2 228 i	N20B20A	07/14 ⇨

21.0198



04,5

WHEEL SPEED SENSORS

Adatt./Suitable:

BOSCH
0 265 007 043
FIAT
46530202

ITEM NOW AVAILABLE FROM PRODUCTION

- ARTICOLO ORA DISPONIBILE PER LA VENDITA
- ARTICLE DISPONIBLE EN PRODUCTION COURANTE
- JETZT ZUM VERKAUF VERFÜGBARER ARTIKEL
- ARTICULO AHORA DISPONIBLE EN PRODUCCION

MARKET DIFFUSION: **MEDIUM**



L	L1	Hall Effect	
1152	38		

FIAT		
SEICENTO / 600 0.9	1170A1.046	11/97 ⇨ 01/10

FIAT		
SEICENTO / 600 1.1	176B2.000, 188A4.000	01/98 ⇨ 01/10

21.0199

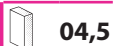

04,5

WHEEL SPEED SENSORS

Adatt./Suitable:

BOSCH
0 265 007 610
FIAT
46837686

ITEM NOW AVAILABLE FROM PRODUCTION

- ARTICOLO ORA DISPONIBILE PER LA VENDITA
- ARTICLE DISPONIBLE EN PRODUCTION COURANTE
- JETZT ZUM VERKAUF VERFÜGBARER ARTIKEL
- ARTICULO AHORA DISPONIBLE EN PRODUCCION

MARKET DIFFUSION: MEDIUM



L	L1	Hall Effect	
1135	38		

FIAT		
PUNTO II 1.2	188A4.000	06/03 ⇨
PUNTO II 1.2 16V	188A5.000	06/03 ⇨
PUNTO II 1.2 16V 80	188A5.000	09/99 ⇨ 12/06
PUNTO II 1.2 60	188A4.000	09/99 ⇨ 12/10
PUNTO II 1.2 Bifuel	188A4.000	08/07 ⇨ 03/12
PUNTO II 1.2 Bipower	188A4.000	08/01 ⇨ 05/03
PUNTO II 1.2 Natural Power	188A4.000, 199A6.000	01/03 ⇨ 03/12
PUNTO II 1.3 D Multijet	188A9.000	02/05 ⇨ 10/09
PUNTO II 1.3 JTD	188A9.000	06/03 ⇨ 10/05
PUNTO II 1.3 JTD 16V	188A9.000	06/03 ⇨ 03/12
PUNTO II 1.4	199A6.000, 183A1.000	09/03 ⇨
PUNTO II 1.8 130 HGT	183A1.000, 188A7.000	09/99 ⇨ 03/12
PUNTO II 1.8 16V	188A6.000	06/03 ⇨
PUNTO II 1.9 D 60	188A3.000	02/00 ⇨ 10/09
PUNTO II 1.9 DS 60	188A3.000	09/99 ⇨ 03/12
PUNTO II 1.9 JTD	188A7.000, D4F764	02/00 ⇨ 03/12
PUNTO II 1.9 JTD 80	188A2.000	09/99 ⇨ 03/12

21.0200



04,5

WHEEL SPEED SENSORS

Adatt./Suitable:

BOSCH
0 265 008 929
RENAULT
47 91 008 68R
82 00 415 812

ITEM NOW AVAILABLE FROM PRODUCTION

- ARTICOLO ORA DISPONIBILE PER LA VENDITA
- ARTICLE DISPONIBLE EN PRODUCTION COURANTE
- JETZT ZUM VERKAUF VERFÜGBARER ARTIKEL
- ARTICULO AHORA DISPONIBLE EN PRODUCCION

MARKET DIFFUSION: MEDIUM



L	L1	Hall	
743	38	Effect	

RENAULT		
TWINGO 1.2	D4F770	09/10 ⇨ 09/14
TWINGO 1.5 dCi	K9K820	10/10 ⇨ 09/14
TWINGO II 1.2	D7F800	03/07 ⇨
TWINGO II 1.2 16V	D4F764, D4F780	03/07 ⇨
TWINGO II 1.2 TCe 100	D4F780, D4F780	02/11 ⇨
TWINGO II 1.2 Turbo	D4F780, K9K718	03/07 ⇨
TWINGO II 1.5 dCi	K9K718, D4F780	03/07 ⇨
TWINGO II 1.5 dCi 75	K9K820	10/10 ⇨
TWINGO II 1.5 dCi 90	K9K820	10/10 ⇨
TWINGO II 1.6 RS	K4M854	05/08 ⇨
WIND 1.2	D4F780, AHM(DW10FUE)	07/10 ⇨
WIND 1.2 TCe 100	D4F780	02/11 ⇨
WIND 1.6	K4M854	07/10 ⇨

21.0201



04,5

WHEEL SPEED SENSORS

Adatt./Suitable:

BOSCH
0 265 007 685
CITROËN
4545 F1
FIAT
51725099
PEUGEOT
4545 F1

ITEM NOW AVAILABLE FROM PRODUCTION

- ARTICOLO ORA DISPONIBILE PER LA VENDITA
- ARTICLE DISPONIBLE EN PRODUCTION COURANTE
- JETZT ZUM VERKAUF VERFÜGBARER ARTIKEL
- ARTICULO AHORA DISPONIBLE EN PRODUCCION

MARKET DIFFUSION: MEDIUM



L	L1	Hall Effect	
1157	38		

CITROËN		
JUMPER III 2.0 BlueHdi 110	AHM(DW10FUE), AHN(DW10FUD)	07/15 ⇨
JUMPER III 2.0 BlueHdi 130	AHN(DW10FUD), AHP(DW10FUC)	07/15 ⇨
JUMPER III 2.0 BlueHdi 130 4x4	AHN(DW10FUD)	04/16 ⇨
JUMPER III 2.0 BlueHdi 160	AHP(DW10FUC), 4HV(P22DTE)	07/15 ⇨
JUMPER III 2.0 BlueHdi 160 4x4	AHP(DW10FUC)	04/16 ⇨
JUMPER III 2.2 Hdi 100	4HV(P22DTE), 4HG(P22DTE)	04/06 ⇨
JUMPER III 2.2 Hdi 110	4HG(P22DTE), 4HU(P22DTE)	07/11 ⇨
JUMPER III 2.2 Hdi 120	4HU(P22DTE), 4HH(P22DTE)	04/06 ⇨
JUMPER III 2.2 Hdi 130	4HH(P22DTE), 4HJ(P22DTE)	04/06 ⇨
JUMPER III 2.2 Hdi 150	4HJ(P22DTE), F300FAP	07/11 ⇨
JUMPER III 3.0 Hdi 145	F300FAP, F30DTFAP	07/10 ⇨
JUMPER III 3.0 Hdi 155	F30DTFAP, F30DTFAP	07/10 ⇨
JUMPER III 3.0 Hdi 160	F30DTFAP, F1AE0481N	09/06 ⇨
JUMPER III 3.0 Hdi 180	F30DT	07/11 ⇨
FIAT		
DUCATO III 115 Multijet 2,0 D	250A2.000	06/11 ⇨
DUCATO III 120 Multijet 2,3 D	FPT	07/06 ⇨
DUCATO III 120 Multijet 2,3 D 4x4	F1AE0481D	03/10 ⇨
DUCATO III 130 Multijet 2,3 D	F1AE0481N, AHN(DW10FUD)	07/06 ⇨
DUCATO III 140 Natural Power	F1CE0441A	04/09 ⇨
DUCATO III 150 Multijet 2,3 D	F1AGL411A	04/15 ⇨
DUCATO III 160 Multijet 3,0 D	F1CE3481M	07/06 ⇨
DUCATO III 180 Multijet 2,3 D	F1AGL411B	12/15 ⇨
DUCATO III 2.0	--	01/14 ⇨
DUCATO III 2.3	--	01/14 ⇨
DUCATO III 3.0	--	01/14 ⇨
PEUGEOT		
BOXER II 2.0 BlueHdi 110	DW10FUE	07/15 ⇨
BOXER II 2.0 BlueHdi 130	AHN(DW10FUD), AHP(DW10FUC)	07/15 ⇨
BOXER II 2.0 BlueHdi 160	AHP(DW10FUC), 4HV(P22DTE)	07/15 ⇨

PEUGEOT		
BOXER II 2.2 HDi 100	4HV(P22DTE), 4HG(P22DTE)	04/06 →
BOXER II 2.2 HDi 110	4HG(P22DTE), 4HU(P22DTE)	03/11 →
BOXER II 2.2 HDi 120	4HU(P22DTE), 4HH(P22DTE)	04/06 →
BOXER II 2.2 HDi 130	4HH(P22DTE), 4HJ(P22DTE)	03/11 →
BOXER II 2.2 HDi 150	4HJ(P22DTE), F1CE0481D(F30DT)	03/11 →
BOXER II 3.0 D	F30DT	09/08 → 12/09
BOXER II 3.0 HDi	F1CE0481D(F30DT), F1CE3481N(F30DTE)	07/06 →
BOXER II 3.0 HDi 145	F1CE3481N(F30DTE), F1CE0481D(F30DT)	04/10 →
BOXER II 3.0 HDi 160	F1CE0481D(F30DT), F1CE0481D(F30DT)	04/06 →
BOXER II 3.0 HDi 175	F1CE0481D(F30DT), M112.976	03/11 →

21.0202  **04,5**

WHEEL SPEED SENSORS

Adatt./Suitable:

BOSCH
0 265 007 715
0 986 594 591
MERCEDES-BENZ
6395401017
A 639 540 10 17

ITEM NOW AVAILABLE FROM PRODUCTION

- ARTICOLO ORA DISPONIBILE PER LA VENDITA
- ARTICLE DISPONIBLE EN PRODUCTION COURANTE
- JETZT ZUM VERKAUF VERFÜGBARER ARTIKEL
- ARTICULO AHORA DISPONIBLE EN PRODUCCION

MARKET DIFFUSION: MEDIUM



L	L1		OUT +
867	27,9	Hall Effect	

MERCEDES-BENZ		
VIANO 3,0	M112.951	09/03 →
VIANO 3.2	M112.951	09/03 →
VIANO 3.5	M272.978	09/07 →
VIANO 3.7	M112.976, OM646.981	06/04 →
VIANO CDI 2.0	OM646.981, OM646.982	08/05 →
VIANO CDI 2.0 4-matic	OM646.982, OM646.980	07/05 →
VIANO CDI 2.2	OM646.980, OM646.982	09/03 →
VIANO CDI 2.2 4-matic	OM646.982, OM642.890	07/05 →
VIANO CDI 3.0	OM642.890, OM646.980	03/06 →
VITO II 109 CDI	OM646.980, OM646.980	09/03 →
VITO II 109 CDI 4x4	OM646.981	09/07 →
VITO II 110 CDI	OM651.940	09/10 →
VITO II 111 CDI	OM646.980, OM646.980	09/03 →
VITO II 111 CDI 4x4	OM646.982	09/07 →
VITO II 113 CDI	OM651.940	09/10 →
VITO II 113 CDI 4x4	OM651.940	09/10 →
VITO II 115 CDI	OM646.980, M112.976	09/03 →
VITO II 115 CDI 4x4	OM646.982	07/06 →
VITO II 116 CDI	OM651.940	09/10 →
VITO II 116 CDI 4x4	OM651.940	09/10 →
VITO II 119	M112.951	09/03 →
VITO II 120 CDI	OM642.990	07/06 →
VITO II 122 CDI	OM642.890	09/10 →
VITO II 123	M112.976, OM646.985	06/04 →

MERCEDES-BENZ		
VITO II 126	M272.978	09/07 →

21.0203  **04,5**

WHEEL SPEED SENSORS

Adatt./Suitable:

BOSCH
0 265 007 657
MERCEDES-BENZ
A 906 540 03 17
VW
2E0 927 801 B

ITEM NOW AVAILABLE FROM PRODUCTION

- ARTICOLO ORA DISPONIBILE PER LA VENDITA
- ARTICLE DISPONIBLE EN PRODUCTION COURANTE
- JETZT ZUM VERKAUF VERFÜGBARER ARTIKEL
- ARTICULO AHORA DISPONIBLE EN PRODUCCION

MARKET DIFFUSION: MEDIUM



L	L1		OUT +
947	27,9	Hall Effect	

MERCEDES-BENZ		
SPRINTER II 209 CDI	OM646.984	06/06 → 12/09
SPRINTER II 210 CDI	OM651.955	03/09 →
SPRINTER II 211 CDI	OM646.985, OM646.986	06/06 →
SPRINTER II 213 CDI	OM646.986, OM646.986	06/06 →
SPRINTER II 214 CDI	OM651.955	04/16 →
SPRINTER II 215 CDI	OM646.986, OM651.955	06/06 → 12/09
SPRINTER II 216	M271.951	09/08 →
SPRINTER II 216 CDI	OM651.955, OM642.896	06/06 →
SPRINTER II 218 CDI	OM642.896, OM642.896	06/06 → 12/09
SPRINTER II 219 CDI / BlueTEC	OM642.896, OM651.955	03/09 →
SPRINTER II 224	M272.979	06/06 →
SPRINTER II 309 CDI	OM646.984	06/06 → 12/09
SPRINTER II 310 CDI	OM651.955, OM646.985	03/09 →
SPRINTER II 311 CDI	OM646.985, OM646.986	06/06 →
SPRINTER II 313 CDI	OM646.986, OM646.986	06/06 →
SPRINTER II 314 CDI	OM651.955	05/16 →
SPRINTER II 315 CDI	OM646.986, OM651.955	06/06 → 12/09
SPRINTER II 316	M271.951	09/08 →
SPRINTER II 316 CDI	OM651.955, 271951NGT	03/09 →
SPRINTER II 316 LGT	M271.951	09/08 →
SPRINTER II 316 NGT	271951NGT, OM642.896	09/08 →
SPRINTER II 318 CDI	OM642.896, OM642.896	06/06 → 12/09
SPRINTER II 319 CDI / BlueTEC	OM642.896, OM646.986	03/09 →
SPRINTER II 324	M272.979	06/06 → 12/13
SPRINTER II 411 CDI	OM646.985	06/09 → 12/18
SPRINTER II 413 CDI	OM646.986, OM646.986	06/06 →
SPRINTER II 414 CDI	OM651.955	05/16 →
SPRINTER II 415 CDI	OM646.986, OM642.896	06/06 → 12/09
SPRINTER II 416 CDI	OM651.957	03/09 →
SPRINTER II 418 CDI	OM642.896, OM642.896	06/06 → 05/16
SPRINTER II 419 CDI	OM642.896, OM646.985	03/09 →
SPRINTER II 424	M272.979	06/06 → 12/13
SPRINTER II 509 CDI	OM646.984	06/06 → 12/09
SPRINTER II 510 CDI	OM651.955	03/09 →
SPRINTER II 511 CDI	OM646.985, OM646.986	06/06 →
SPRINTER II 513 CDI	OM646.986, OM646.986	06/06 →
SPRINTER II 514 CDI	OM651.955	05/16 →
SPRINTER II 515 CDI	OM646.986, OM651.955	06/06 → 12/09
SPRINTER II 516 NGT	271951NGT, OM642.896	09/08 →
SPRINTER II 518 CDI	OM642.896, OM642.896	06/06 → 12/09

MERCEDES-BENZ		
SPRINTER II 519 CDI / BlueTEC	OM642.896, OM642.896	03/09 →
SPRINTER II 524	M272.979	06/06 → 12/13
SPRINTER SERIES Sprinter 213D CDI	OM646.986	04/12 →
SPRINTER SERIES Sprinter 318D CDI	OM642.896, CKTB	03/09 →
SPRINTER SERIES Sprinter 411D CDI/CDi BlueEFFICIENCY	OM651.955	04/16 →
SPRINTER SERIES Sprinter 516 NGT Supercharged	271951NGT	03/09 →
SPRINTER SERIES Sprinter 516 Supercharged	M271.951	03/09 →

VW		
CRAFTER 2.0 TDI	CKTB, CKUB	05/11 → 12/16
CRAFTER 2.0 TDI 4motion	CKUB, BJJ	11/11 → 12/16
CRAFTER 2.5 TDI	BJJ, OM651.955	04/06 →

21.0204  **04,5**

WHEEL SPEED SENSORS

Adatt./Suitable:

BOSCH
0 265 007 979
MERCEDES-BENZ
A 906 540 04 17



L	L1		OUT +
758	27,9	Hall Effect	

MERCEDES-BENZ		
SPRINTER II 311 CDI 4x4	OM646.985	02/08 → 12/09
SPRINTER II 313 CDI 4x4	OM651.955, OM646.986	06/06 →
SPRINTER II 314 CDI 4x4	OM651.955	05/16 →
SPRINTER II 315 CDI 4x4	OM646.986, OM651.955	02/08 → 12/09
SPRINTER II 316 CDI 4x4	OM651.955, OM642.896	03/09 →
SPRINTER II 318 CDI 4x4	OM642.896, OM642.896	02/08 → 12/09
SPRINTER II 319 CDI / BlueTEC 4x4	OM642.896, OM651.955	03/09 →
SPRINTER II 511 CDI 4x4	OM646.985	06/06 → 12/09
SPRINTER II 513 CDI 4x4	OM651.955, OM646.986	06/06 →
SPRINTER II 514 CDI 4x4	OM651.955	05/16 →
SPRINTER II 515 CDI 4x4	OM646.986, OM651.955	06/06 → 12/09
SPRINTER II 516 CDI 4x4	OM651.955, OM642.896	06/06 →
SPRINTER II 518 CDI 4x4	OM642.896, OM642.896	06/06 → 12/09
SPRINTER II 519 CDI / BlueTEC 4x4	OM642.896, EB2ADT	03/09 →
SPRINTER SERIES Sprinter 414D CDI	OM651.955	04/16 →
SPRINTER SERIES Sprinter 416D CDI	OM651.957	11/13 →
SPRINTER SERIES Sprinter 519D CDI	OM651.957	03/09 →

21.0205



04,5

WHEEL SPEED SENSORS

Adatt./Suitable:

BOSCH
0 265 009 502**CITROËN**
98 050 833 80**PEUGEOT**
98 050 833 80

ITEM NOW AVAILABLE FROM PRODUCTION

- ARTICOLO ORA DISPONIBILE PER LA VENDITA
- ARTICLE DISPONIBLE EN PRODUCTION COURANTE
- JETZT ZUM VERKAUF VERFÜGBARER ARTIKEL
- ARTICULO AHORA DISPONIBLE EN PRODUCCION

MARKET DIFFUSION: MEDIUM



L	L1		
751	27	Hall Effect	

CITROËN

C3 III 1.2 PureTech 82	EB2FA	05/18 →
C3 III 1.2 THP 110	EB2ADT, EB2ADT	07/16 →
C3 III 1.2 VTi 68	EB2FB	07/16 →
C3 III 1.2 VTi 82	EB2F	07/16 →
C3 III 1.5 BlueHdi 100	DV5RD	05/18 →
C3 III 1.6 BlueHdi 100	DV6FD	07/16 →
C3 III 1.6 BlueHdi 75	DV6FE	07/16 →
C3 III 1.6 VTi	EC5F	02/17 →
C3 AIRCROSS 1.2 PureTech 110	EB2ADT, EB2F	06/17 →
C3 AIRCROSS 1.2 PureTech 130	EB2DTS	07/17 →
C3 AIRCROSS 1.2 PureTech 82	EB2F, EB2ADT	06/17 →
C3 AIRCROSS 1.5 BlueHdi 100	DV5RD	08/18 →
C3 AIRCROSS 1.5 BlueHdi 120	DV5RC	08/18 →
C3 AIRCROSS 1.6 BlueHdi 100	DV6FD	07/17 →
C3 AIRCROSS 1.6 BlueHdi 115	DV6FC	06/17 →
C3 AIRCROSS 1.6 BlueHdi 120	DV6FC	07/17 →
C3 AIRCROSS 1.6 Hdi 92	DV6D	10/17 →
C4 CACTUS 1.2 PureTech 130	EB2DTS	11/17 →
C4 CACTUS 1.2 THP 110	EB2ADT, EB2	09/14 →
C4 CACTUS 1.2 VTi 75	EB2D	09/14 →
C4 CACTUS 1.2 VTi 82	EB2, DV6D	09/14 →
C4 CACTUS 1.5 BlueHdi 100	DV5RD	06/18 →
C4 CACTUS 1.5 BlueHdi 120	DV5RC	09/18 →
C4 CACTUS 1.6 BlueHdi 100	DV6FD	09/14 →
C4 CACTUS 1.6 Hdi 90	DV6D, EB2DT	09/14 →

PEUGEOT

208 1.0	EB0, EB2	03/12 →
208 1.2	EB2, EB2F	03/12 →
208 1.2 GPL	EB2F, EB2ADT	06/15 →
208 1.2 THP	EB2ADT, 8HP(DV4C)	01/13 →
208 1.2 VTi	HMZ(EB2)	09/13 →
208 1.4 GPL	EP3C	10/13 →
208 1.4 Hdi	8HP(DV4C), 8FS(EP3)	03/12 →
208 1.4 VTi	8FS(EP3), 5FS(EP6C)	03/12 →
208 1.5 BlueHdi 100	DV5RD	05/18 →
208 1.6	5FS(EP6C), BHY(DV6FD)	02/12 →
208 1.6 BlueHdi 100	BHY(DV6FD), BHZ(DV6FC)	01/15 →
208 1.6 BlueHdi 120	BHZ(DV6FC), BHW(DV6FE)	11/13 →
208 1.6 BlueHdi 75	BHW(DV6FE), 5FU(EP6CDTX)	04/15 →
208 1.6 GTi	5FU(EP6CDTX), 9HP(DV6DTED)	08/12 →
208 1.6 Hdi	9HP(DV6DTED), 9HK(DV6ETEDM)	03/12 →

PEUGEOT

208 1.6 Hdi / BlueHdi 75	9HK(DV6ETEDM), OM611.962	01/13 →
208 1.6 Hdi 90	9HJ(DV6ETEDM)	03/12 →
208 1.6 THP 165	EP6FDT	03/15 →
208 1.6 THP 210	5GM(EP6FDTX)	04/15 →
2008 1.2 PureTech 82	EB2FA	03/18 →
2008 1.2 THP 110	EB2DT, EB2DTS	01/15 →
2008 1.2 THP 130	EB2DTS, EB2	01/15 →
2008 1.2 VTi	EB2, 8HR(DV4C)	03/13 →
2008 1.4 Hdi	8HR(DV4C), BHX(DV6FC)	06/13 →
2008 1.5 BlueHdi 100	DV5RD	05/18 →
2008 1.5 BlueHdi 120	DV5RC	05/18 →
2008 1.6 BlueHdi	BHX(DV6FC), BHY(DV6FD)	07/14 →
2008 1.6 BlueHdi 100	BHY(DV6FD), BHZ(DV6FC)	01/15 →
2008 1.6 BlueHdi 120	BHZ(DV6FC), BHW(DV6FE)	07/14 →
2008 1.6 BlueHdi 75	BHW(DV6FE), 9HP(DV6DTED)	01/15 →
2008 1.6 Hdi	9HP(DV6DTED), 5FS(EP6C)	03/13 →
2008 1.6 VTi	5FS(EP6C), EBO	03/13 →

21.0207



04,5

WHEEL SPEED SENSORS

Adatt./Suitable:

ATE
10.0711-6053.3**BOSCH**
0 986 594 542**MERCEDES-BENZ**
2035401417
A 203 540 14 17

ITEM NOW AVAILABLE FROM PRODUCTION

- ARTICOLO ORA DISPONIBILE PER LA VENDITA
- ARTICLE DISPONIBLE EN PRODUCTION COURANTE
- JETZT ZUM VERKAUF VERFÜGBARER ARTIKEL
- ARTICULO AHORA DISPONIBLE EN PRODUCCION

MARKET DIFFUSION: MEDIUM



L	L1		
1010	31	Hall Effect	

MERCEDES-BENZ

CLASSE C II C 160 Kompressor	M271.921	05/02 → 05/08
CLASSE C II C 180	M111.951	10/00 → 05/02
CLASSE C II C 180 Kompressor	M271.946	05/02 → 05/08
CLASSE C II C 200 CDI	OM611.962, M111.955	09/00 → 05/08
CLASSE C II C 200 CGI Kompressor	M271.942	03/03 → 05/08
CLASSE C II C 200 Kompressor	M111.955, OM611.962	05/00 → 05/08
CLASSE C II C 220	M271.948	05/02 → 05/08
CLASSE C II C 220 CDI	OM611.962, M111.981	05/00 → 05/08
CLASSE C II C 230	M272.920	01/05 → 05/08
CLASSE C II C 230 Kompressor	M111.981, M271.911	03/01 → 05/08
CLASSE C II C 240	M112.912	05/00 → 08/07
CLASSE C II C 240 4-matic	M112.916	07/02 → 08/07
CLASSE C II C 270 CDI	OM612.962	12/00 → 08/07
CLASSE C II C 280	M272.940	01/05 → 08/07
CLASSE C II C 280 4-matic	M272.941	01/05 → 08/07
CLASSE C II C 30 CDI AMG Kompressor	OM612.990	09/02 → 05/08
CLASSE C II C 32 AMG Kompressor	M112.961	02/01 → 08/07

MERCEDES-BENZ

CLASSE C II C 320	M112.946	05/00 → 05/08
CLASSE C II C 320 4-matic	M112.953	07/02 → 08/07
CLASSE C II C 320 CDI	OM642.910	01/05 → 08/07
CLASSE C II C 350	M272.960	01/05 → 05/08
CLASSE C II C 350 4-matic	M272.970	01/05 → 08/07
CLASSE C II C 55 AMG	M113.988	02/04 → 08/07
CLASSE CLC CLC 160	M271.911, M271.940	02/09 → 06/11
CLASSE CLC CLC 180 Kompressor	M271.940, OM646.962	05/08 → 06/11
CLASSE CLC CLC 200 CDI	OM646.962, M271.940	05/08 → 06/11
CLASSE CLC CLC 200 Kompressor	M271.957	05/08 → 06/11
CLASSE CLC CLC 220 CDI	OM646.963	05/08 → 06/11
CLASSE CLC CLC 230	M272.920	05/08 → 06/11
CLASSE CLC CLC 350	M272.960	05/08 → 06/11
CLASSE CLC CLC250 [ExtraEU]	M272.920	06/09 → 06/11
CLASSE CLK II 200 CGI	M271.942	07/03 → 05/09
CLASSE CLK II 200 Kompressor	M271.940, OM612.962	09/02 → 05/09
CLASSE CLK II 220 CDI	OM646.966	01/05 → 05/09
CLASSE CLK II 240	M112.912	06/02 → 05/09
CLASSE CLK II 270 CDI	OM612.962, M113.968	10/02 → 05/09
CLASSE CLK II 280	M272.940	01/05 → 05/09
CLASSE CLK II 320	M112.955	06/02 → 05/09
CLASSE CLK II 320 CDI	OM642.910	01/05 → 05/09
CLASSE CLK II 350	M272.960	01/05 → 05/09
CLASSE CLK II 500	M113.968, M156.982	06/02 →
CLASSE CLK II 55 AMG	M113.987	09/02 → 05/09
CLASSE CLK II 550	M273.967	06/06 →
CLASSE CLK II 63 AMG	M156.982, M271.940	04/06 → 05/09
CLASSE CLK II CLK 200 CGI Kompressor	M271.942	07/03 → 03/10
CLASSE CLK II CLK 200 Kompressor	M271.940, M113.968	02/03 → 03/10
CLASSE CLK II CLK 240	M112.912	02/03 → 03/10
CLASSE CLK II CLK 280	M272.940	01/05 → 03/10
CLASSE CLK II CLK 320	M112.955	02/03 → 03/10
CLASSE CLK II CLK 320 CDI	OM642.910	03/05 → 03/10
CLASSE CLK II CLK 350	M272.960	01/05 → 03/10
CLASSE CLK II CLK 500	M113.968, M271.944	02/03 → 03/10
CLASSE CLK II CLK 55 AMG	M113.987	02/03 → 03/10
CLASSE CLK II CLK 63 AMG	M156.982	04/06 → 03/10
CLC-SERIES CLC220 Cdi	OM646.963	05/08 → 06/11
CLK-SERIES CLK63 AMG Black Series	M156.982	05/07 → 05/09
C-SERIES C160 Kompressor	M271.921	06/02 → 07/06

21.0208



04,5

WHEEL SPEED SENSORS

Adatt./Suitable:

ATE

10.0711-6109.3
10.0711-6283.3

BOSCH

0 986 594 550

MERCEDES-BENZ

1715400217
A 171 540 02 13
A 171 540 02 17

ITEM NOW AVAILABLE FROM PRODUCTION

- ARTICOLO ORA DISPONIBILE PER LA VENDITA
- ARTICLE DISPONIBLE EN PRODUCTION COURANTE
- JETZT ZUM VERKAUF VERFÜGBARER ARTIKEL
- ARTICULO AHORA DISPONIBLE EN PRODUCCION



L	L1		
1080	31	Hall Effect	

MERCEDES-BENZ

CLASSE SLK II 200 Kompressor	M271.944, M272.963	03/04 ⇨ 02/11
CLASSE SLK II 280	M272.942	01/05 ⇨ 02/11
CLASSE SLK II 300	M272.942	04/09 ⇨ 02/11
CLASSE SLK II 350	M272.963, M113.989	06/04 ⇨ 02/11
CLASSE SLK II 55 AMG	M113.989, --	06/04 ⇨ 02/11

21.0209



04,5

WHEEL SPEED SENSORS

Adatt./Suitable:

BOSCH

0 265 004 269
0 265 008 765

CITROËN

96 659 201 80
98 137 648 80

DS

96 659 201 80

PEUGEOT

98 137 648 80

ITEM NOW AVAILABLE FROM PRODUCTION

- ARTICOLO ORA DISPONIBILE PER LA VENDITA
- ARTICLE DISPONIBLE EN PRODUCTION COURANTE
- JETZT ZUM VERKAUF VERFÜGBARER ARTIKEL
- ARTICULO AHORA DISPONIBLE EN PRODUCCION

MARKET DIFFUSION: HIGH



L	L1		
1018	26,5	Hall Effect	

CITROËN

BERLINGO II 1.2 PureTech 110	--, N6A(TU5JP4)	02/16 ⇨
BERLINGO II 1.6	N6A(TU5JP4), BHY(DV6FD)	04/08 ⇨
BERLINGO II 1.6 BlueHdi 100	BHY(DV6FD), BHZ(DV6FC)	12/14 ⇨
BERLINGO II 1.6 BlueHdi 100 4x4	BHY(DV6FD)	12/14 ⇨
BERLINGO II 1.6 BlueHdi 120	BHZ(DV6FC), 9HN(DV6ETED)	12/14 ⇨
BERLINGO II 1.6 Hdi / BlueHdi 75	9HN(DV6ETED), 9HL(DV6C)	07/10 ⇨
BERLINGO II 1.6 Hdi 110	9HL(DV6C), 9HL(DV6C)	04/08 ⇨
BERLINGO II 1.6 Hdi 115	9HL(DV6C), 9HT(DV6BTED4)	07/10 ⇨
BERLINGO II 1.6 Hdi 115 4x4	--	02/12 ⇨
BERLINGO II 1.6 Hdi 75	9HT(DV6BTED4), 9HN(DV6ETED)	04/08 ⇨
BERLINGO II 1.6 Hdi 75 / BlueHdi 75	9HN(DV6ETED), 9HT(DV6BTED4)	04/08 ⇨
BERLINGO II 1.6 Hdi 75 16V	9HT(DV6BTED4), 9HF(DV6DTED)	04/08 ⇨
BERLINGO II 1.6 Hdi 75 4x4	9HN(DV6ETED)	02/12 ⇨
BERLINGO II 1.6 Hdi 90	9HF(DV6DTED), 9HS(DV6TED4BU)	04/08 ⇨
BERLINGO II 1.6 Hdi 90 16V	9HS(DV6TED4BU), 9HJ(DV6TDEM)	04/08 ⇨
BERLINGO II 1.6 Hdi 90 4x4	9HF(DV6DTED)	02/12 ⇨
BERLINGO II 1.6 Hdi 92	9HJ(DV6TDEM), 5FS(EP6C)	07/10 ⇨
BERLINGO II 1.6 VTi 120	5FS(EP6C), 5FK(EP6CB)	11/09 ⇨
BERLINGO II 1.6 VTi 95	5FK(EP6CB), Y4F1	07/10 ⇨
BERLINGO II Electric	Y4F1, 9HR(DV6C)	01/13 ⇨
DSS 1.6 BlueHdi 120	DV6FC	07/14 ⇨ 07/15
DSS 1.6 Hdi	DV6FC	11/13 ⇨ 07/15
DSS 1.6 Hdi 110	9HR(DV6C), DV6C	11/11 ⇨ 07/15
DSS 1.6 Hdi 115	DV6C, 5FV(EP6CDT)	06/12 ⇨ 07/15
DSS 1.6 THP 150	EP6CDTMD	11/11 ⇨ 07/15
DSS 1.6 THP 155	5FV(EP6CDT), 5FM(EP6DT)	11/11 ⇨ 07/15
DSS 1.6 THP 165	5FM(EP6DT), 5FU(EP6DTX)	01/12 ⇨ 07/15
DSS 1.6 THP 200	5FU(EP6DTX), AHW(DW10FC)	11/11 ⇨ 07/15
DSS 1.6 THP 210	5GM(EP6FDTX)	11/14 ⇨ 07/15
DSS 2.0 BlueHdi 150	DW10FD	07/14 ⇨ 07/15
DSS 2.0 BlueHdi 180	AHW(DW10FC), DW10CBOTR	08/13 ⇨ 07/15
DSS 2.0 Hdi 135	DW10CBOTR, DW10CTED4	11/11 ⇨ 07/15
DSS 2.0 Hdi 165	DW10CTED4, DV6C	11/11 ⇨ 07/15

DS		
DS 5 1.6 BlueHdi 115	DV6C, BHZ(DV6FC)	06/15 ⇨
DS 5 1.6 BlueHdi 120	BHZ(DV6FC), 5GZ(EP6FDT)	06/15 ⇨
DS 5 1.6 THP 165	5GZ(EP6FDT), 5GM(EP6FDTX)	07/15 ⇨
DS 5 1.6 THP 210	5GM(EP6FDTX), AHR(DW10FD)	04/15 ⇨
DS 5 2.0 BlueHdi 135	DW10FDD	06/15 ⇨
DS 5 2.0 BlueHdi 150	AHR(DW10FD), AHW(DW10FC)	04/15 ⇨
DS 5 2.0 BlueHdi 180	AHW(DW10FC), 5FK(EP6CB)	04/15 ⇨

PEUGEOT		
PARTNER 1.6 BlueHdi	DV6FD	04/15 ⇨
PARTNER 1.6 Hdi	DV6AUTED4	01/14 ⇨
PARTNER II 1.6	5FK(EP6CB), BHY(DV6FD)	04/08 ⇨
PARTNER II 1.6 BlueHdi 100	BHY(DV6FD), BHZ(DV6FC)	04/15 ⇨
PARTNER II 1.6 BlueHdi 120	BHZ(DV6FC), 9HF(DV6DTED)	04/15 ⇨
PARTNER II 1.6 Hdi	9HF(DV6DTED), 9HN(DV6ETED)	04/08 ⇨
PARTNER II 1.6 Hdi / BlueHdi 75	9HN(DV6ETED), 9HS(DV6TED4BU)	07/11 ⇨
PARTNER II 1.6 Hdi 16V	9HS(DV6TED4BU), 9HS(DV6TED4BU)	04/08 ⇨
PARTNER II 1.6 Hdi 16V 4x4	9HS(DV6TED4BU), 9HP(DV6DTED)	04/12 ⇨
PARTNER II 1.6 Hdi 90	9HP(DV6DTED), EB2DT	04/10 ⇨
PARTNER II Électrique	Y4F1	06/13 ⇨
PARTNER II TEPEE 1.2 THP	EB2DT, BHY(DV6FD)	02/16 ⇨
PARTNER II TEPEE 1.6 BlueHdi 100	BHY(DV6FD), BHZ(DV6FC)	12/14 ⇨
PARTNER II TEPEE 1.6 BlueHdi 120	BHZ(DV6FC), 9HF(DV6DTED)	12/14 ⇨
PARTNER II TEPEE 1.6 Hdi	9HF(DV6DTED), BHW(DV6FE)	04/08 ⇨
PARTNER II TEPEE 1.6 Hdi / BlueHdi 75	BHW(DV6FE), 9HV(DV6TED4)	01/15 ⇨
PARTNER II TEPEE 1.6 Hdi 16V	9HV(DV6TED4), 9HJ(DV6TDEM)	04/08 ⇨
PARTNER II TEPEE 1.6 Hdi 90	9HJ(DV6TDEM), 5FK(EP6CB)	04/10 ⇨
PARTNER II TEPEE 1.6 VTi	5FK(EP6CB), 350A1.000	04/08 ⇨

21.0210



04,5

WHEEL SPEED SENSORS

Adatt./Suitable:

BOSCH
0 265 008 035

FIAT
51787268

NEW - ITEM NOW AVAILABLE FROM PRODUCTION

- NUOVO - ARTICOLO ORA DISPONIBILE PER LA VENDITA
- NOUVEAU - ARTICLE DISPONIBLE EN PRODUCTION COURANTE
- NEU - JETZT ZUM VERKAUF VERFÜGBARER ARTIKEL
- NUEVO - ARTICULO AHORA DISPONIBLE EN PRODUCCION



L	L1	Hall Effect	OUT +
887	27,9		

FIAT		
PANDA II 1.2 Natural Power	188A4000CNG	01/07 ⇨ 12/11
PANDA II 1.4 16V	--	01/10 ⇨
PANDA II 1.4 Natural Power	350A1.000, 312A2.000	10/09 ⇨

21.0211



04,5

WHEEL SPEED SENSORS

Adatt./Suitable:

BOSCH
0 265 008 427

CHRYSLER
51834735

FIAT
51834735

LANCIA
51834735

NEW - ITEM NOW AVAILABLE FROM PRODUCTION

- NUOVO - ARTICOLO ORA DISPONIBILE PER LA VENDITA
- NOUVEAU - ARTICLE DISPONIBLE EN PRODUCTION COURANTE
- NEU - JETZT ZUM VERKAUF VERFÜGBARER ARTIKEL
- NUEVO - ARTICULO AHORA DISPONIBLE EN PRODUCCION

MARKET DIFFUSION: MEDIUM



L	L1	Hall Effect	OUT +
782	27,9		

CHRYSLER		
YPSILON 0.9 Twinair	312A2.000	05/11 ⇨
YPSILON 1.2	169A4.000	05/11 ⇨
LANCIA		
YPSILON I 1.2	169A4.000	08/10 ⇨ 12/11
YPSILON II 0.9 CNG	312A2.000, 312A2.000	05/11 ⇨
YPSILON II 0.9 TwinAir	312A2.000, 199B1.000	05/11 ⇨
YPSILON II 1.2	169A4.000	05/11 ⇨
YPSILON II 1.2 Bi-fuel	169A4.000	05/11 ⇨
YPSILON II 1.3 D Multijet	199B1.000, ZJ06	05/11 ⇨

21.0212



04,5

WHEEL SPEED SENSORS

Adatt./Suitable:

BOSCH
0 265 007 992

MAZDA
D651-43-70X
D651-43-70XB

NEW - ITEM NOW AVAILABLE FROM PRODUCTION

- NUOVO - ARTICOLO ORA DISPONIBILE PER LA VENDITA
- NOUVEAU - ARTICLE DISPONIBLE EN PRODUCTION COURANTE
- NEU - JETZT ZUM VERKAUF VERFÜGBARER ARTIKEL
- NUEVO - ARTICULO AHORA DISPONIBLE EN PRODUCCION

MARKET DIFFUSION: MEDIUM



L	L1	Hall Effect	OUT +
705	27,9		

MAZDA		
2 II 1.3	ZJ06, ZJ-46	07/07 ⇨ 06/15
2 II 1.3 BiFuel	ZJ-46	05/11 ⇨ 11/14
2 II 1.3 MZR	ZJ-46, ZY05	01/10 ⇨ 06/15
2 II 1.4 MZR-CD	Y404	01/08 ⇨ 06/15
2 II 1.5	ZY05, ZY05	10/07 ⇨ 06/15
2 II 1.5 i	ZY-DE	05/10 ⇨ 06/15
2 II 1.5 MZR	ZY05, Y406	06/11 ⇨ 06/15
2 II 1.6 MZ-CD	Y406, 10FDOX	10/08 ⇨ 06/15

21.0213



04,5

WHEEL SPEED SENSORS

Adatt./Suitable:

BOSCH
0 265 004 317
0 265 009 544

FORD
1 782 404
1 871 011
2 122 523
CN15-2C204-AA
CN15-2C204-AB
CN15-2C204-AC

NEW - ITEM NOW AVAILABLE FROM PRODUCTION

- NUOVO - ARTICOLO ORA DISPONIBILE PER LA VENDITA
- NOUVEAU - ARTICLE DISPONIBLE EN PRODUCTION COURANTE
- NEU - JETZT ZUM VERKAUF VERFÜGBARER ARTIKEL
- NUEVO - ARTICULO AHORA DISPONIBLE EN PRODUCCION



L	L1	Hall Effect	OUT +
794	27,9	Hall Effect	

FORD		
ECOSPORT 1.0 EcoBoost	10FD0X, UGJE	10/13 ⇔
ECOSPORT 1.5 TDCi	UGJE, UEJB	10/13 ⇔
ECOSPORT 1.5 Ti	UEJB, UEJB	10/13 ⇔
ECOSPORT 1.5 Ti-VCT [ExtraEU]	UEJB, 188A9.000	10/13 ⇔

21.0214



04,5

WHEEL SPEED SENSORS

Adatt./Suitable:

BOSCH
0 265 008 049

FIAT
51702279
51797945

LANCIA
51702279
51797945

NEW - ITEM NOW AVAILABLE FROM PRODUCTION

- NUOVO - ARTICOLO ORA DISPONIBILE PER LA VENDITA
- NOUVEAU - ARTICLE DISPONIBLE EN PRODUCTION COURANTE
- NEU - JETZT ZUM VERKAUF VERFÜGBARER ARTIKEL
- NUEVO - ARTICULO AHORA DISPONIBLE EN PRODUCCION

MARKET DIFFUSION: MEDIUM



L	L1	Hall Effect	OUT +
1207	27,9	Hall Effect	

FIAT		
IDEA 1.2	--	01/08 ⇔
IDEA 1.2 16V	188A5.000	01/04 ⇔
IDEA 1.2 D	--	01/08 ⇔
IDEA 1.3 D Multijet	188A9.000, 192B2.000	01/04 ⇔
IDEA 1.4	192B2.000, --	12/03 ⇔
IDEA 1.4 16V	--, 188A9.000	01/04 ⇔
IDEA 1.4 LPG	350A1.000	03/09 ⇔
IDEA 1.9 D	--	01/08 ⇔
IDEA 1.9 JTD	188B2.000	01/04 ⇔
LANCIA		
MUSA 1.3 D Multijet	188A9.000, 192B2.000	10/04 ⇔ 09/12
MUSA 1.4	192B2.000, 188A4.000	10/04 ⇔ 09/12
MUSA 1.9 D Multijet	188B2.000	10/04 ⇔ 09/12
YPSILON I 1.2	188A4.000, 199A2.000	10/03 ⇔ 12/11
YPSILON I 1.3 D Multijet	199A2.000, R9M408	09/06 ⇔ 12/11
YPSILON I 1.3 JTD	188A9.000	10/03 ⇔ 12/11
YPSILON I 1.4	350A1.000	02/06 ⇔ 12/11
YPSILON I 1.4 16V	843A1.000	10/03 ⇔ 12/11
YPSILON I 1.4 LPG	350A1.000	11/10 ⇔ 12/11

21.0219



04,5

WHEEL SPEED SENSORS

Adatt./Suitable:

BOSCH
0 265 009 391

FIAT
6000618006

GENERAL MOTORS
93 868 517

OPEL
44 22 416
93868517

RENAULT
47 91 088 92R

VAUXHALL
93868517

NEW - AVAILABLE FROM:

- NUOVO - DISPONIBILE DA:
- NOUVEAU - DISPONIBLE EN:
- NEU - VERFÜGBAR AB:
- NUEVO - DISPONIBLE EN:

20/Q1

L	L1	Effect Hall	OUT +
800	38	Effect Hall	

FIAT		
TALENTO 1.6 D	R9M408	06/16 ⇔
OPEL		
VIVARO B 1.6 CDTI	R9M408, R9M413	06/14 ⇔
RENAULT		
TRAFIC III 1.6 dCi 115	R9M408	05/14 ⇔
TRAFIC III 1.6 dCi 120	R9M413, R9M408	05/14 ⇔
TRAFIC III 1.6 dCi 125	R9M452	07/15 ⇔
TRAFIC III 1.6 dCi 140	R9M450	05/14 ⇔
TRAFIC III 1.6 dCi 145	R9M452	07/15 ⇔
TRAFIC III 1.6 dCi 90	R9M408	05/14 ⇔
TRAFIC III 1.6 dCi 95	R9M413	07/15 ⇔
VAUXHALL		
VIVARO 1.6 CDTi	R9M408, B12XE(EB2F)	05/14 ⇔

21.0220



04,5

WHEEL SPEED SENSORS

Adatt./Suitable:

GENERAL MOTORS
3 637 200**OPEL**
3637200**VAUXHALL**
3637200**NEW - AVAILABLE FROM:**

- NUOVO - DISPONIBILE DA:
- NOUVEAU - DISPONIBLE EN:
- NEU - VERFUEGBAR AB:
- NUEVO - DISPONIBLE EN:

20/Q2



L	L1		
1035	34,3	Hall Effect	

OPEL

CROSSLAND X 1.2	B12XE(EB2F), D15DT(DV5RC)	03/17 →
CROSSLAND X 1.2 LPG	B12XE(EB2F)	10/17 →
CROSSLAND X 1.5 Turbo D	D15DT(DV5RC), B16DT(DV6FD)	06/18 →
CROSSLAND X 1.6 Turbo D	B16DT(DV6FD), B12XE(EB2F)	03/17 →

VAUXHALL

CROSSLAND X 1.2	B12XE(EB2F), B16DT(DV6FD)	03/17 →
CROSSLAND X 1.5 Turbo D	D15DT(DV5RC)	06/18 →
CROSSLAND X 1.6 Turbo D	B16DT(DV6FD), CHZL	03/17 →

21.0221



1

WHEEL SPEED SENSORS

Adatt./Suitable:

ATE
10.0711-6432.3**AUDI**
WHT 003 863 A**SEAT**
WHT 003 863 A**VW**
WHT 003 863 A**NEW - AVAILABLE FROM:**

- NUOVO - DISPONIBILE DA:
- NOUVEAU - DISPONIBLE EN:
- NEU - VERFUEGBAR AB:
- NUEVO - DISPONIBLE EN:

20/Q2



L	L1		
---	23,6	Hall Effect	

AUDI

A1 25 TFSI	CHZL, DKJA	11/18 →
A1 30 TFSI	DKJA, CZPC	07/18 →
A1 35 TFSI	DADA	09/18 →
A1 40 TFSI	CZPC, CHZJ	09/18 →

SEAT

ARONA 1.0 TGI	DBYA	11/18 →
ARONA 1.0 TSI	CHZJ, DGTA	07/17 →

SEAT

ARONA 1.5 TSI	DADA	07/17 →
ARONA 1.6 SRE	CWVA	07/17 →
ARONA 1.6 TDI	DGTA, CHYB	07/17 →
IBIZA 1.6 SRE [ExtraEU]	CWVA	05/17 →
IBIZA V 1.0	CHYB, CHZJ	01/17 →
IBIZA V 1.0 MPI	DFNA	07/18 →
IBIZA V 1.0 TGI	DBYA	11/17 →
IBIZA V 1.0 TSI	CHZJ, DGTA	01/17 →
IBIZA V 1.5 TSI	DADA	07/17 →
IBIZA V 1.6 TDI	DGTA, CHYB	09/17 →

VW

POLO VI 1.0	CHYB, CHZJ	06/17 →
POLO VI 1.0 TGI	DBYA	09/17 →
POLO VI 1.0 TSI	CHZJ, DGTC	06/17 →
POLO VI 1.6 TDI	DGTC, CZPC	11/17 →
POLO VI 2.0 GTI	CZPC, CHZL	11/17 →

21.0222



1

WHEEL SPEED SENSORS

Adatt./Suitable:

AUDI
WHT 003 862 A**SEAT**
WHT 003 862 A**VW**
WHT 003 862 A

- NUOVO - DISPONIBILE DA:
- NOUVEAU - DISPONIBLE EN:
- NEU - VERFUEGBAR AB:
- NUEVO - DISPONIBLE EN:

20/Q2



L	L1		
---	23,6	Hall Effect	

AUDI

A1 25 TFSI	CHZL, DKJA	11/18 →
A1 30 TFSI	DKJA, CZPC	07/18 →
A1 35 TFSI	DADA	09/18 →
A1 40 TFSI	CZPC, CHZJ	09/18 →

SEAT

ARONA 1.0 TGI	DBYA	11/18 →
ARONA 1.0 TSI	CHZJ, DGTA	07/17 →
ARONA 1.5 TSI	DADA	07/17 →
ARONA 1.6 SRE	CWVA	07/17 →
ARONA 1.6 TDI	DGTA, CHYB	07/17 →
IBIZA 1.6 SRE [ExtraEU]	CWVA	05/17 →
IBIZA V 1.0	CHYB, CHZJ	01/17 →
IBIZA V 1.0 MPI	DFNA	07/18 →
IBIZA V 1.0 TGI	DBYA	11/17 →
IBIZA V 1.0 TSI	CHZJ, DGTA	01/17 →
IBIZA V 1.5 TSI	DADA	07/17 →
IBIZA V 1.6 TDI	DGTA, CHYB	09/17 →

VW

POLO VI 1.0	CHYB, CHZJ	06/17 →
POLO VI 1.0 TGI	DBYA	09/17 →
POLO VI 1.0 TSI	CHZJ, DGTC	06/17 →
POLO VI 1.6 TDI	DGTC, CZPC	11/17 →
POLO VI 2.0 GTI	CZPC, AMB	11/17 →

21.2047



04,5

WHEEL SPEED SENSORS

Adatt./Suitable:

AUDI
8E0 927 803 B**BOSCH**
0 265 006 808
0 265 006 809**SEAT**
8E0 927 803 B**VW**
8E0 927 803 B**AVAILABLE FROM:**

- DISPONIBILE DA:
- DISPONIBLE EN:
- VERFUEGBAR AB:
- DISPONIBLE EN:

19/Q3

MARKET DIFFUSION: HIGH



L	L1	ohm	
980	28	1657	

AUDI

A4 II 1.6	ALZ	11/00 → 12/04
A4 II 1.8 T	AMB, AMB	11/00 → 03/09
A4 II 1.8 T quattro	AMB, AVB	11/00 → 03/09
A4 II 1.9 TDI	AVB, BPW	11/00 → 12/04
A4 II 1.9 TDI quattro	AVF	11/01 → 12/04
A4 II 2.0	ALT	11/00 → 12/05
A4 II 2.0 FSI	AWA	07/02 → 12/04
A4 II 2.0 TDI	BPW, BWE	01/06 → 03/09
A4 II 2.0 TFSI 16V	BWE, AMM	01/06 → 03/09
A4 II 2.0 TFSI quattro	BWT	11/05 → 03/09
A4 II 2.4	AMM, AYM	09/01 → 12/05
A4 II 2.5 TDI	AYM, AKE	08/01 → 12/05
A4 II 2.5 TDI quattro	AKE, ASN	11/00 → 12/04
A4 II 2.7 TDI	BPP	06/06 → 03/09
A4 II 3.0	ASN, ASN	11/00 → 12/05
A4 II 3.0 quattro	ASN, ASB	11/00 → 12/05
A4 II 3.0 TDI quattro	ASB, BKE	01/06 → 03/09
A4 II 3.2 FSI	AUK	01/06 → 03/09
A4 II 3.2 FSI quattro	AUK	01/06 → 03/09
A4 II RS4 quattro	BNS	06/06 → 03/09
A4 II S4 quattro	BBK	03/03 → 03/09
A4 III 1.6	ALZ	11/04 → 06/08
A4 III 1.8 T	BFB	11/04 → 06/08
A4 III 1.8 T quattro	BFB	11/04 → 06/08
A4 III 1.9 TDI	BKE, BNA	11/04 → 06/08
A4 III 2.0	ALT	11/04 → 06/08
A4 III 2.0 TDI	BNA, BLB	11/04 → 06/08
A4 III 2.0 TDI 16V	BLB, BPW	11/04 → 06/08
A4 III 2.0 TDI quattro	BPW, BGB	01/06 → 06/08
A4 III 2.0 TFSI	BGB, BGB	11/04 → 06/08
A4 III 2.0 TFSI quattro	BGB, BPP	11/04 → 06/08
A4 III 2.5 TDI	BDG	11/04 → 05/06
A4 III 2.7 TDI	BPP, ASB	11/05 → 06/08
A4 III 3.0	BBJ	11/04 → 05/06
A4 III 3.0 quattro	BBJ	11/04 → 07/06
A4 III 3.0 TDI quattro	ASB, AUK	11/04 → 06/08
A4 III 3.2 FSI	AUK	01/05 → 06/08
A4 III 3.2 FSI quattro	AUK, BBK	01/05 → 06/08
A4 III RS4 quattro	BNS	09/05 → 06/08
A4 III S4 quattro	BBK, CDHA	11/04 → 06/08

SEAT

EXEO 1.6	ALZ	03/09 → 09/10
EXEO 1.8 T	CFMA	12/08 → 05/10
EXEO 1.8 TSI	CDHA, CAGA	05/10 →
EXEO 2.0 TDI	CAGA, BWE	12/08 →
EXEO 2.0 TFSI	BWE, Y13DT	03/09 →

21.2048



04,5

WHEEL SPEED SENSORS

Adatt./Suitable:

- BOSCH**
0 986 594 027
- GENERAL MOTORS**
9 115 064
- OPEL**
12 38 236
91 15 064
- VAUXHALL**
91 15064

ITEM NOW AVAILABLE FROM PRODUCTION

- ARTICOLO ORA DISPONIBILE PER LA VENDITA
- ARTICLE DISPONIBLE EN PRODUCTION COURANTE
- JETZT ZUM VERKAUF VERFÜGBARER ARTIKEL
- ARTICULO AHORA DISPONIBLE EN PRODUCCION

MARKET DIFFUSION: HIGH



L	L1	ohm	OUT GND
483	28	1640	

OPEL

COMBO C 1.3 CDTI 16V	Y13DT, Y16YNG	06/04 ⇨
COMBO C 1.4	Z14XEP	10/04 ⇨ 12/11
COMBO C 1.4 16V	Z14XEP	08/05 ⇨
COMBO C 1.6	Z16SE	10/01 ⇨
COMBO C 1.6 CNG	Y16YNG, Y16YNG	04/05 ⇨ 12/11
COMBO C 1.6 CNG 16V	Y16YNG, Z10XE	04/05 ⇨
COMBO C 1.7 CDTI 16V	Z17DTH	07/04 ⇨
COMBO C 1.7 DI 16V	Y17DTL	10/01 ⇨
COMBO C 1.7 DTI 16V	Y17DT	10/01 ⇨
CORSA C 1.0	Z10XE, Y13DT	09/00 ⇨ 12/09
CORSA C 1.2	Z12XE	09/00 ⇨ 12/09
CORSA C 1.2 16V	Z12XE	09/00 ⇨ 07/03
CORSA C 1.2 Twinport	Z12XEP	07/04 ⇨ 12/09
CORSA C 1.3 CDTI	Y13DT, Y13DT	06/03 ⇨
CORSA C 1.3 CDTI 16V	Z13DT	07/05 ⇨ 06/06
CORSA C 1.3 DTI	Y13DT	09/03 ⇨
CORSA C 1.4	Z14XE	07/00 ⇨
CORSA C 1.4 Twinport	Z14XEP	06/03 ⇨ 12/09
CORSA C 1.6	Z16SE	09/00 ⇨
CORSA C 1.6 CNG	Y16YNG	05/03 ⇨ 12/09
CORSA C 1.6 X	Z16YNG	08/05 ⇨
CORSA C 1.7 CDTI	Z17DTH	06/03 ⇨ 12/12
CORSA C 1.7 DI	Y17DTL	09/00 ⇨ 12/09
CORSA C 1.7 DI 16V	Y17DTL	09/00 ⇨ 07/03
CORSA C 1.7 DTI	Y17DT	09/00 ⇨
CORSA C 1.7 DTI 16V	Y17DT	09/00 ⇨ 07/03
CORSA C 1.8	Z18XE	09/00 ⇨ 12/09
MERIVA A 1.3 CDTI	Y13DT, Z16SE	09/03 ⇨ 05/10
MERIVA A 1.4 16V Twinport	Z14XEP	07/04 ⇨ 05/10
MERIVA A 1.4 16V Twinport LPG	Z14XEP	07/04 ⇨ 05/10
MERIVA A 1.6	Z16SE, A17DTR	05/03 ⇨ 05/10
MERIVA A 1.6 16V	Z16XE	05/03 ⇨ 01/06
MERIVA A 1.6 Turbo	Z16LET	09/05 ⇨ 05/10
MERIVA A 1.7 CDTI	A17DTR, Y13DT	09/03 ⇨ 05/10
MERIVA A 1.7 DTI	Y17DT	09/03 ⇨ 05/10
MERIVA A 1.8	Z18XE	05/03 ⇨ 05/10
TIGRA B 1.3 CDTI	Z13DT	06/04 ⇨ 12/10
TIGRA B 1.4	Z14XEP	06/04 ⇨ 12/10
TIGRA B 1.8	Z18XE	06/04 ⇨ 12/10
VAUXHALL		
COMBO C 1.3 CDTI 16V	Y13DT, Z16SE	09/04 ⇨ 02/12
COMBO C 1.4	Z14XEP	10/04 ⇨ 09/10
COMBO C 1.4 16V	Z14XE	10/01 ⇨ 05/07
COMBO C 1.4 i 16V	Z14XEP	01/04 ⇨ 11/11
COMBO C 1.6	Z16SE, Z16YNG	09/01 ⇨ 11/11
COMBO C 1.6 CNG	Z16YNG, Y16YNG	04/05 ⇨ 02/12
COMBO C 1.6 CNG 16V	Y16YNG, Z10XE	04/05 ⇨ 02/12
COMBO C 1.7 CDTI 16V	Z17DTH	12/04 ⇨ 11/11
COMBO C 1.7 DI 16V	Y17DTL	09/01 ⇨ 11/11
COMBO C 1.7 DTI 16V	Y17DT	10/01 ⇨ 02/12
CORSA C 1.0 12V	Z10XE, Y13DT	09/00 ⇨ 10/06
CORSA C 1.2 16V	Z12XE	09/00 ⇨ 10/06

VAUXHALL

CORSA C 1.2 16V Dualfuel	Z12XE	08/01 ⇨ 10/06
CORSA C 1.2 Twinport	Z12XEP	07/04 ⇨ 10/06
CORSA C 1.3 CDTI 16V	Y13DT, Z12XE	08/00 ⇨ 09/06
CORSA C 1.4 16V	Z14XE	09/00 ⇨ 10/06
CORSA C 1.4 Twinport	Z14XEP	06/03 ⇨ 10/06
CORSA C 1.7 CDTI 16V	Z17DTH	08/00 ⇨ 09/06
CORSA C 1.7 DI 16V	Y17DTL	08/00 ⇨ 09/06
CORSA C 1.7 DTI 16V	Y17DT	08/00 ⇨ 09/06
CORSA C 1.8 16V	Z18XE	08/00 ⇨ 09/06
CORSAVAN II 1.2 16V	Z12XE, Z12XE	09/00 ⇨ 11/06
CORSAVAN II 1.2 16V Dualfuel	Z12XE, Y13DT	08/01 ⇨ 06/06
CORSAVAN II 1.3 CDTI 16V	Z13DT	04/04 ⇨ 06/06
CORSAVAN II 1.4	Z14XEP	11/03 ⇨ 06/06
CORSAVAN II 1.7 DI 16V	Y17DTL	09/00 ⇨ 06/06
CORSAVAN II 1.7 DTI 16V	Y17DT	09/00 ⇨ 06/06
MERIVA I 1.3 CDTI	Y13DT, Z17DTH	01/03 ⇨ 06/10
MERIVA I 1.4 16V Twinport	Z14XEP	01/03 ⇨ 06/10
MERIVA I 1.6 i	Z16SE	01/03 ⇨ 06/10
MERIVA I 1.6 i 16V	Z16XE	01/03 ⇨ 09/05
MERIVA I 1.6 i 16V Twinport	Z16XEP	05/03 ⇨ 06/10
MERIVA I 1.6 Turbo	Z16LET	05/06 ⇨ 06/10
MERIVA I 1.7 CDTI	Z17DTH, K4M734	09/03 ⇨ 06/10
MERIVA I 1.7 DTI	Y17DT	06/03 ⇨ 06/10
MERIVA I 1.8 i 16V	Z18XE	05/03 ⇨ 06/10
TIGRA B 1.3 CDTI	Z13DT	06/04 ⇨ 08/09
TIGRA B 1.4	Z14XEP	06/04 ⇨ 08/09
TIGRA B 1.8	Z18XE	06/04 ⇨ 08/09

21.2078



04,5

WHEEL SPEED SENSORS

Adatt./Suitable:

- BOSCH**
0 265 006 383
0 265 006 528
- RENAULT**
77 00 313 681
77 00 411 747

AVAILABLE FROM:

- DISPONIBILE DA:
- DISPONIBILE EN:
- VERFUEGBAR AB:
- DISPONIBILE EN:

19/02

MARKET DIFFUSION: HIGH



L	L1	ohm	OUT GND
520	28	1720	

RENAULT

CLIO 1.2	D4F728	08/98 ⇨ 05/01
CLIO 1.2 BiFuel	D7F722	03/98 ⇨ 10/01
CLIO 1.4	K7J700	08/00 ⇨ 02/09
CLIO 1.6	K4M734, D7F710	07/00 ⇨ 02/10
CLIO 1.6 [ExtraEU]	K4M708	03/99 ⇨ 12/08
CLIO II 1.0	D7D760	02/00 ⇨ 05/01
CLIO II 1.0 16V	D4D700	01/01 ⇨
CLIO II 1.2	D7F710, D4F706	03/98 ⇨
CLIO II 1.2 16V	D4F706, D7F722	06/01 ⇨
CLIO II 1.2 LPG	D7F722, E7J634	09/98 ⇨ 06/09
CLIO II 1.4	E7J634, K4J700	09/98 ⇨
CLIO II 1.4 16V	K4J700, K9K700	02/00 ⇨
CLIO II 1.5 dCi	K9K700, K4M746	06/01 ⇨
CLIO II 1.6	K4M746, K4M708	09/98 ⇨
CLIO II 1.6 16V	K4M708, F8Q630	09/98 ⇨
CLIO II 1.6 Hi-Flex	K4M748	01/05 ⇨ 02/10
CLIO II 1.6i	K4M736	11/04 ⇨
CLIO II 1.9 D	F8Q630, F9Q780	02/00 ⇨
CLIO II 1.9 DTi	F9Q780, F4R730	02/00 ⇨

RENAULT

CLIO II 2.0 16V	F4R732	06/01 ⇨
CLIO II 2.0 16V Sport	F4R730, L7X760	02/00 ⇨
CLIO II 3.0 RS V6	L7X760, L7X760	01/03 ⇨
CLIO II 3.0 V6 Sport	L7X760, L7X760	11/00 ⇨
CLIO III 1.2 16V	D4F706	06/05 ⇨
CLIO IV 3.0 RS V6	L7X760, D7D700	03/13 ⇨
KANGOO 1.0	D7D700, D4F712	07/01 ⇨ 06/03
KANGOO 1.0 [ExtraEU]	D7D700	01/02 ⇨ 01/07
KANGOO 1.2	D4F712, D7F710	07/01 ⇨ 10/03
KANGOO 1.2 BiFuel	D7F710, K4M708	06/97 ⇨ 06/03
KANGOO 1.6 [ExtraEU]	K4M708, D7F710	06/01 ⇨ 03/09
KANGOO I 1.2	D7F710, D4F712	08/97 ⇨
KANGOO I 1.2 16V	D4F712, D7F710	06/01 ⇨
KANGOO I 1.2 BiFuel	D7F710, E7J634	07/98 ⇨ 07/01
KANGOO I 1.4	E7J634, K9K700	08/97 ⇨
KANGOO I 1.5 dCi	K9K700, K4M708	12/01 ⇨
KANGOO I 1.6	K7M746	09/99 ⇨ 06/01
KANGOO I 1.6 16V	K4M708, F9Q780	06/01 ⇨
KANGOO I 1.9 D	F8Q632	09/99 ⇨ 06/03
KANGOO I 1.9 dTi	F9Q780, F8Q630	02/00 ⇨
KANGOO I 1.9 RXED	F8Q632	09/99 ⇨ 06/01
KANGOO I D 55 1.9	F8Q662	08/97 ⇨
KANGOO I D 65 1.9	F8Q630, 5DC700	08/97 ⇨
KANGOO I Elect road RE	5DC700, K4J712	01/02 ⇨ 12/04
THALIA I 1.2 16V	D4F728	04/02 ⇨
THALIA I 1.4	K7J700	08/00 ⇨
THALIA I 1.4 16V	K4J712, K9K700	08/00 ⇨
THALIA I 1.5 dCi	K9K700, K4M742	06/01 ⇨
THALIA I 1.6	K7M746	03/98 ⇨
THALIA I 1.6 16V	K7M734	04/02 ⇨
THALIA I 1.6 Authentique Hi-Flex	K4M742, ADP	11/04 ⇨ 02/09
THALIA I 1.9 D	F8Q630	02/98 ⇨ 05/01

21.2122



04,5

WHEEL SPEED SENSORS

Adatt./Suitable:

- AUDI**
4B0 927 803 B
- BOSCH**
0 265 006 577
0 265 006 578
- VW**
4B0 927 803 B

AVAILABLE FROM:

- DISPONIBILE DA:
- DISPONIBILE EN:
- VERFUEGBAR AB:
- DISPONIBILE EN:

19/02

MARKET DIFFUSION: MEDIUM



L	L1	ohm	GND OUT
1040	28	1700	

AUDI

A41 1.6	ADP, ADR	07/00 ⇨ 09/01
A41 1.8	ADR, ADR	11/94 ⇨ 09/01

AUDI		
A4 I 1.8 quattro	ADR, AEB	01/95 → 09/01
A4 I 1.8 T	AEB, AEB	01/95 → 09/01
A4 I 1.8 T quattro	AEB, 1Z	01/95 → 09/01
A4 I 1.9 DUO	AHU	03/98 → 09/01
A4 I 1.9 TDI	1Z, AFN	03/00 → 09/01
A4 I 1.9 TDI quattro	AFN, AGA	03/00 → 09/01
A4 I 2.4	AGA, AGA	03/97 → 09/01
A4 I 2.4 quattro	AGA, AFB	03/97 → 09/01
A4 I 2.5 TDI	AFB, AFB	09/97 → 09/01
A4 I 2.5 TDI quattro	AFB, ACK	09/97 → 09/01
A4 I 2.8	ACK, ACK	10/96 → 09/01
A4 I 2.8 quattro	ACK, ASJ	10/96 → 09/01
A4 I RS4 quattro	ASJ, AEB	05/00 → 09/01
A6 II 1.8 T	AEB, AEB	01/97 → 01/05
A6 II 1.8 T quattro	AEB, AVF	02/97 → 01/05
A6 II 1.9 TDI	AVF, AJG	08/01 → 01/05
A6 II 2.0	ALT	08/01 → 01/05
A6 II 2.4	AJG, AKE	08/01 → 01/05
A6 II 2.4 quattro	BDV	08/01 → 01/05
A6 II 2.5 TDI	AKE, AKE	02/00 → 01/05
A6 II 2.5 TDI quattro	AKE, ARE	02/00 → 01/05
A6 II 2.7 T quattro	ARE, ASN	08/01 → 01/05
A6 II 3.0	ASN, ASN	06/01 → 01/05
A6 II 3.0 quattro	ASN, ARS	06/01 → 01/05
A6 II 4.2 quattro	ARS, ANK	11/98 → 01/05
A6 II S6 quattro	ANK, AVB	09/99 → 01/05

VW		
PASSAT IV 1.6	ALZ	11/00 → 05/05
PASSAT IV 1.8 T	AWM	05/02 → 08/05
PASSAT IV 1.8 T 20V	AWT	11/00 → 05/05
PASSAT IV 1.9 TDI	AVB, ALT	11/00 → 05/05
PASSAT IV 1.9 TDI 4motion	AVF	11/00 → 05/05
PASSAT IV 2.0	ALT, BGW	11/00 → 05/05
PASSAT IV 2.0 4motion	AZM	11/00 → 05/05
PASSAT IV 2.0 TDI	BGW, AKN	12/03 → 05/05
PASSAT IV 2.3 V5	AZX	11/00 → 05/05
PASSAT IV 2.3 V5 4motion	AZX	11/00 → 05/05
PASSAT IV 2.3 VR5	AZX	11/00 → 05/05
PASSAT IV 2.3 VR5 4motion	AZX	11/00 → 05/05
PASSAT IV 2.5 TDI	AKN, AKN	11/00 → 05/05
PASSAT IV 2.5 TDI 4motion	AKN, AMX	11/00 → 05/05
PASSAT IV 2.8	AMX, AMX	10/00 → 08/05
PASSAT IV 2.8 4motion	AMX, BDN	10/00 → 05/05
PASSAT IV 4.0 W8 4motion	BDN, AMB	09/01 → 09/04
PASSAT 2.8 [ExtraEU]	BBG	10/00 → 05/05

21.2123



04,5

WHEEL SPEED SENSORS

Adatt./Suitable:

AUDI
8E0 927 803 A

BOSCH
0 265 006 682
0 265 006 683

VW
8E0 927 803 A

• AVAILABLE FROM:

- DISPONIBILE DA:
- DISPONIBILE EN:
- VERFUEGBAR AB:
- DISPONIBILE EN:

19/Q2

MARKET DIFFUSION: MEDIUM



L	L1	ohm	
1000	28	1670	GND OUT

AUDI		
A4 II 1.6	ALZ	11/00 → 12/04
A4 II 1.8 T	AMB, AMB	11/00 → 03/09
A4 II 1.8 T quattro	AMB, AVB	11/00 → 03/09
A4 II 1.9 TDI	AVB, AMM	11/00 → 12/04
A4 II 1.9 TDI quattro	AVF	11/01 → 12/04
A4 II 2.0	ALT	11/00 → 12/05
A4 II 2.0 FSI	AWA	07/02 → 12/04
A4 II 2.4	AMM, AYM	09/01 → 12/05
A4 II 2.5 TDI	AYM, AKE	08/01 → 12/05
A4 II 2.5 TDI quattro	AKE, ASN	11/00 → 12/04
A4 II 3.0	ASN, ASN	11/00 → 12/05
A4 II 3.0 quattro	ASN, AEB	11/00 → 12/05
A4 II S4 quattro	BBK	03/03 → 03/09
A4 III S4 quattro	BBK	11/04 → 06/08

21.2124



04,5

21.2124

WHEEL SPEED SENSORS

Adatt./Suitable:

AUDI
4B0 927 803 E

BOSCH
0 265 006 764
0 265 006 765

VW
4B0 927 803 E

• AVAILABLE FROM:

- DISPONIBILE DA:
- DISPONIBILE EN:
- VERFUEGBAR AB:
- DISPONIBILE EN:

19/Q2



L	L1	ohm	
1030	28	1700	OUT GND

AUDI		
A6 II 1.8 T	AEB, AEB	01/97 → 01/05
A6 II 1.8 T quattro	AEB, AVF	02/97 → 01/05
A6 II 1.9 TDI	AVF, AJG	08/01 → 01/05
A6 II 2.0	ALT	08/01 → 01/05
A6 II 2.4	AJG, AKE	08/01 → 01/05
A6 II 2.4 quattro	BDV	08/01 → 01/05
A6 II 2.5 TDI	AKE, ARE	02/00 → 01/05
A6 II 2.7 T quattro	ARE, ASN	08/01 → 01/05
A6 II 3.0	ASN, ASN	06/01 → 01/05
A6 II 3.0 quattro	ASN, ARS	06/01 → 01/05
A6 II 4.2 quattro	ARS, ANK	11/98 → 01/05
A6 II RS6 plus quattro	BRV	04/04 → 01/05
A6 II RS6 quattro	BCY	07/02 → 01/05
A6 II S6 quattro	ANK, AQJ	09/99 → 01/05

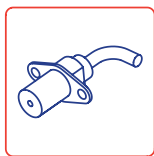

REVOLUTION AND TIMING (CKP AND CMP) SENSORS

SENSORI GIRI MOTORE E TRASMISSIONE
CAPTEURS DE RÉGIME ET DE POSITION
DREHZAHL- UND GETRIEBESENSOREN
SENSORES DE REVOLUCIONES Y POSICIÓN DE
CIGÜEÑAL Y ÁRBOL DE LEVAS

Code		New code
9.0038	E	
9.0176	E→	9.0299

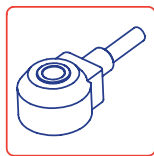

KNOCK SENSORS

SENSORI DI DETONAZIONE
CAPTEURS DE CLIQUETS
KLOPPSENSOREN
SENSORES DE PICADO

Code		New code
9.3029	S	
9.3032	S	
9.3035	S	
9.3038	S	
9.3040	S	
9.3043	S	
9.3046	S	
9.3047	S	
9.3084	S	
9.3088	E	
9.3096	E	
9.3098	E	
9.3099	S	
9.3176	S	
9.3177	E	
9.3179	S	
9.3181	S	
9.3186	E	
9.3188	S	
9.3189	S	
9.3190	S	
9.3192	S	
9.3200	S	
9.3201	S	

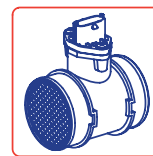

MASS AIR FLOW METERS (MAF)

SENSORI DI PORTATA ARIA (MAF)
CAPTEURS DE MASSE D'AIR
LUFTMASSENMESSER
CAUDALIMETROS

Code		New code
10.1384	E→	10.1556
10.1500	E→	10.1556

E	Dropped	Eliminato	Éliminé	Gestrichen	Eliminado
→	New code	Nuovo codice	Nouvelle reference	Neue Teile-NR.	Nuevo codigo
S	Supplied until depletion	Fornibile fino ad esaurimento	Fourni jusqu'à l'épuisement du stock	Lieferbar solange Vorrat reicht	Suministrado hasta el stock termina



VARIATIONS COMPARED TO PREVIOUS CATALOGUE EDITION

•VARIAZIONI RISPETTO AI PRECEDENTI CATALOGHI •VARIATIONS RAPPORTÉES AUX CATALOGUES PRÉCÉDENTS
 •ÄNDERUNGEN IM VERGLEICH ZU FRÜHEREN KATALOGAUSGABEN •VARIACIONES CON RESPECTO A CATALOGOS ANTERIORES

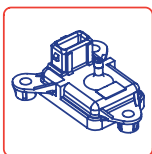

ABSOLUTE PRESSURE SENSORS (MAP)

SENSORI DI PRESSIONE ARIA ASSOLUTA
 CAPTEURS DE PRESSION D'AIR ABSOLU
 ABSOLUTLUFTDRUCKSENSOREN
 SENSORES DE PRESIÓN ABSOLUTA (MAP)

Code		New code
10.3020	E→	10.3355
10.3058	E→	10.3355
10.3176	E→	10.3092
10.3217	E→	10.3213

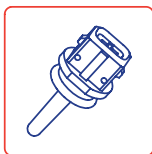

AIR TEMPERATURE SENSORS

SENSORI DI TEMPERATURA DELL'ARIA
 CAPTEURS DE TEMPERATURE D'AIR
 LUFTTEMPERATUR-SENSOREN
 TERMORESISTENCIAS PARA TEMPERATURA DE AIRE

Code		New code
10.4002	E→	10.4005
10.4035	E→	10.4005

E	Dropped	Eliminato	Éliminé	Gestrichen	Eliminado
→	New code	Nuovo codice	Nouvelle reference	Neue Teile-NR.	Nuevo codigo
S	Supplied until depletion	Fornibile fino ad esaurimento	Fourni jusqu'à l'épuisement du stock	Lieferbar solange Vorrat reicht	Suministrado hasta el stock termina

GENERAL CONDITIONS OF SALE

1. SCOPE AND EFFECTIVENESS

All supplies of products made by Facet S.r.l. (the «Seller») to a customer (the «Buyer») are governed by these general terms and conditions which shall prevail on purchase conditions of the Buyer, as well as by any special conditions provided for in offers and/or order confirmations by the Seller. In the case of conflict between the general terms and conditions and the special conditions, the latter shall prevail. The data and illustrations relating to products appearing in the Seller's catalogues or brochures are indicative in nature and not binding, unless expressly provided so in the order confirmation by the Seller and may be subject to changes in design and materials without notice. The original product codes indicated in the catalogues and in other documents are mentioned only for the purpose of identifying the spare parts. The Seller supplies only products of its own production identified with its own product codes and not products having OE codes.

2. COMPLETION OF THE CONTRACT

The supply contract is considered being completed only on the Seller's written confirmation accepting the Buyer's order. The Seller reserves the right not to accept orders in cases where there is a dispute with the customer relating to a previous order.

3. PRICES AND PAYMENTS

Unless otherwise agreed, payments of the price must be carried out by the Buyer in accordance with the terms and conditions provided and using the method provided for in the order confirmation at the domicile of the Seller. Payments made by the Buyer to finders and/or agents without a special Power of Attorney will not be enforceable on the Seller. In the event of a delay in payment, the Buyer will be liable for the payment of late payment default interest at the rate of the European Central Bank in force on that date plus 7 (seven) points. In every case, the Seller has the right to ask for compensation for the greater damage suffered. The Buyer will not for any reason, except with written authorisation, be able to off-set or retain sums due to the Seller, nor will he be able to suspend payments. The prices of the products are to be considered in Euros and do not include VAT, packaging, transport and insurance costs. The Seller may change the prices and rates in force at any time and without notice, except for ongoing orders. Price increases are possible for increases in raw materials, labour, transport, insurance premiums, etc.

4. TERMS OF DELIVERY AND PRODUCTION

Unless otherwise stated in the order confirmation, supplies of the products are intended for goods delivered in accordance with Incoterms 2010: FCA Orbassano. The goods always travel on behalf of and at the risk of the Buyer.

The terms of delivery are indicative and in the event of delay the Buyer is not entitled to request termination of the contract and/or compensation for damages.

5. RETENTION OF TITLE

The delivered products remain the property of the Seller until full payment of the price has been received.

The Buyer shall have the right to sell the purchased products, or the new products which incorporate the products supplied by the Seller, on the understanding that in such cases, all the proceeds will be transferred to the Seller right down to the agreed price due from the Buyer to the Seller for the supply of such products.

The right to sell the products shall lapse if the Buyer has failed to comply with payment obligations for a period greater than 20 (twenty) working days after the payment deadline. In such event, it will be the responsibility of the Seller to revoke the right to sell in writing to the Buyer. The Buyer should put in place every measure necessary for the protection of the products subject to the retention of title, and any other measure necessary to not confuse the products of the Seller with products from other suppliers and keep the products of the Seller in well defined areas and easily identifiable.

6. RESPONSIBILITY OF THE SELLER AND LIMITS

The Seller is exclusively responsible for the correct production of products supplied, which will require to have all the features provided by the Seller in the order confirmation. The Seller does not assume any responsibility, however, for possible faulty operation of machines or systems made by the Buyer using products supplied by the Seller.

The products must be properly installed by trained and qualified technicians only, in accordance with the vehicle specifications and complying with the requirements of national regulations.

In such cases, the Buyer will not be able seek damages for lost profits, loss of production, reputational damages, vehicle breakdown.

The liability of the Seller is, however, limited to the value of the goods supplied, unless due to serious negligence or willful misconduct within the meaning of the law.

7. FORCE MAJEURE

Should the Seller be unable to comply with the contract for reasons of force majeure or independent factors outside his control, the deadlines for the supply shall be automatically extended for a period equivalent to the lingering effects of the force majeure event. The following are to be regarded as causes of force majeure (without limitation): lack of energy or raw materials, strikes, public administration measures, impediments to circulation or to production activities.

8. COMPLAINTS and ACCEPTANCE OF PRODUCTS

Any complaint concerning the non-conformity of the goods delivered or for damages caused by transportation or for any missing quantities with respect to the products ordered, must be communicated by registered letter, with receipt acknowledgment, addressed directly to the Seller within 8 (eight) days from the date of delivery of the products in the case of visible defects and within 8 (eight) days from the discovery in the case of hidden defects, and in any case, within a month from delivery, with a detailed explanation of the facts. In the event of non-compliance with the above, the amounts invoiced are considered, to all effects, accepted and no longer contestable by the Buyer.

The return of goods will not be accepted unless previously agreed in writing by the Seller.

9. CONFORMITY TO THE SPECIFICATIONS AND GUARANTEE TERMS

The Seller guarantees that the products will be compliant with the technical specifications declared by the Seller to the Buyer in the order confirmation and the guarantee will be valid for 2 (two) years from the date of delivery of the products and for products or parts replaced, from the day of their replacement.

During the guarantee period, the Seller to whom the Buyer has made a formal notice of the defects, undertakes, at his own discretion, and within a reasonable period of time, to repair or replace the products or the defective parts free of charge. The costs and risks of transportation of the defective products to the Seller's address are borne by the Buyer. The replaced products remain the property of the Seller.

The guarantee is considered lapsed where the end use of the product does not conform with the regular use of such products or not provided for in the catalogues of the Seller or if the products have been modified or repaired without the Seller's authorisation.

10. GUARANTEE OF THE SUITABILITY OF THE PRODUCTS ONLY TO EU RULES

The Seller guarantees that the products will conform to the standards of the European Union (EU) as they may be applicable.

No guarantee is issued by the Seller for the conformity of these products with the rules and regulations, expressly including those rules regarding safety and accident prevention, in force in the Buyer's country, where those reside outside the EU, or more generally, in any country that does not belong to the EU in which the supplied products are used.

11. CONFIDENTIALITY AND DATA PROTECTION

Documents of any kind provided by the Seller shall remain the Seller's property and cannot be transferred to a third party or reproduced. The Buyer undertakes, even after the end of the contract, not to disclose commercial secrets and confidential information that the Buyer has been party to or which has come to his knowledge in the course of his relationship with the Seller.

The Seller herewith declares that he will use the personal data transferred by the Customer in respect of the terms provided under the Italian privacy law (Legislative Decree n. 196/03).

12. TERMINATION OF THE CONTRACT

The contract may be terminated pursuant to art. 1456 of the Italian Civil Code by virtue of a simple written declaration on the part of the Seller, taking advantage of this termination clause if the Buyer:

- omits or delays payments due;

- is placed in liquidation or has been subject to any insolvency proceedings.

13. INTELLECTUAL PROPERTY

The Seller retains the intellectual property of projects, studies, drawings, models and products which are realised or made in his name and on his behalf. The brands under which the products are sold may not be used by the Buyer if they are not identified as such.

14. APPLICABLE LAW AND DISPUTE RESOLUTION CLAUSE

All contracts with the Seller shall be governed by Italian law. Any dispute will be referred to the exclusive jurisdiction of the Court of Turin.

Date: _____ Stamp, Name, Surname and Signature of the Buyer: _____

Pursuant to articles. 1341 and 1342 of the Italian Civil Code, the Buyer declares to have read and specifically approved the terms contained in the following articles of general conditions: art. 3 Set-off Prohibition; art. 5 Retention of title; art. 6 Limitation of Liability; art. 8 Complaints and Acceptance of Products; art. 14 Dispute Resolution Clause.

Date: _____ Stamp, Name, Surname and Signature of the Buyer: _____

CONDIZIONI GENERALI DI VENDITA

1. AMBITO DI APPLICAZIONE E EFFICACIA

Tutte le forniture di prodotti effettuate da Facet S.r.l. (il "Venditore") a un cliente (l'"Acquirente") sono disciplinate dalle presenti condizioni generali che prevalgono sulle condizioni d'acquisto dell'Acquirente, nonché dalle condizioni particolari previste nelle offerte e/o conferme d'ordine del Venditore. In caso di contrasto fra quanto contenuto nelle condizioni generali e nelle condizioni particolari, queste ultime prevorranno.

I dati e le illustrazioni relative ai prodotti risultanti dai cataloghi o prospetti del Venditore hanno carattere indicativo e non valore vincolante se non espressamente previsto nella conferma d'ordine del Venditore e possono essere soggetti a modifiche di disegno e materiale senza preavviso.

I numeri originali (OE) indicati nei cataloghi od in altri documenti sono menzionati solamente al fine di identificare le parti di ricambio. Il venditore fornisce unicamente prodotti di propria produzione contrassegnati con il proprio codice articolo e non prodotti con i numeri OE.

2. FORMAZIONE DEL CONTRATTO

Il contratto di fornitura si perfeziona con la conferma scritta del Venditore di accettazione dell'ordine dell'Acquirente. Il Venditore si riserva il diritto di non accettare ordini nel caso in cui vi sia una controversia con il cliente relativa ad un ordine precedente.

3. PREZZI E PAGAMENTI

Salvo diverso accordo, i pagamenti del prezzo devono essere effettuati dall'Acquirente nei termini e con le modalità previsti nella conferma d'ordine presso il domicilio del Venditore. I pagamenti fatti dall'Acquirente a procuratori e/o agenti senza una procura specifica non saranno opponibili al Venditore.

In caso di ritardo nei pagamenti, l'Acquirente sarà tenuto al pagamento degli interessi moratori pari al tasso della Banca Centrale Europea in vigore a quella data, maggiorato di 7 (sette) punti, salvo in ogni caso la facoltà per il Venditore di chiedere il risarcimento del maggior danno subito.

L'Acquirente non potrà per qualunque motivo, salvo autorizzazione scritta, compensare o trattenere somme dovute al venditore, né potrà sospendere i pagamenti.

I prezzi dei prodotti si intendono in Euro e non comprendono IVA, imballo, spese di trasporto e assicurazione. Il Venditore può modificare i prezzi e le tariffe in vigore in ogni momento e senza preavviso, salvo per gli ordini in corso. Ciò se si verificano rincari delle materie prime, della manodopera, dei trasporti, dei premi d'assicurazione, etc.

4. TERMINI DI CONSEGNA E RESA

Se non diversamente stabilito nella conferma d'ordine, le forniture dei prodotti si intendono per merce resa secondo Incoterms 2010: FCA Orbassano. La merce viaggia sempre per conto e rischio dell'Acquirente.

I termini di consegna si intendono indicativi e in caso di ritardo l'Acquirente non ha il diritto di richiedere la risoluzione del contratto e/o il risarcimento dei danni.

5. RISERVA DI PROPRIETÀ

I prodotti consegnati restano di proprietà del Venditore fino al completo pagamento del relativo prezzo.

L'Acquirente avrà il diritto di vendere i prodotti acquistati, o i nuovi prodotti in cui i prodotti fornitigli dal Venditore siano stati incorporati, fermo restando che in tal caso tutti i proventi verranno trasferiti al Venditore fino alla concorrenza del prezzo dovuto dall'Acquirente al Venditore per la fornitura di tali Prodotti.

Tale diritto di vendere i prodotti decade qualora l'Acquirente sia rimasto inadempiente all'obbligo di pagamento per un periodo di tempo superiore a 20 (venti) giorni lavorativi rispetto alla scadenza. A tal fine, sarà onere del Venditore comunicare per iscritto all'Acquirente la revoca del diritto a vendere. L'Acquirente dovrà porre in essere ogni misura necessaria per la protezione dei prodotti oggetto della riserva di proprietà, nonché ogni misura per non confondere i prodotti del Venditore con i prodotti di altri fornitori e conservare i prodotti del Venditore in spazi ben delimitati e facilmente individuabili.

6. RESPONSABILITÀ DEL VENDITORE E LIMITI

Il Venditore è esclusivamente responsabile della corretta produzione dei prodotti forniti, che dovranno avere le caratteristiche previste nella conferma d'ordine del Venditore. Il Venditore non assume, invece, alcuna responsabilità per l'eventuale difettoso funzionamento di macchine o sistemi realizzati dall'Acquirente con i prodotti forniti dal Venditore.

I prodotti devono essere installati in modo appropriato solo da tecnici competenti e qualificati, conformemente alle specifiche del veicolo e rispettando i requisiti delle normative nazionali.

In ogni caso, l'Acquirente non potrà chiedere il risarcimento dei danni per mancato profitto, perdita di produzione, perdita di immagine, fermo dell'autoveicolo.

La responsabilità del Venditore è, comunque, limitata al valore della merce fornita, salvo dolo o colpa grave ai sensi di legge.

7. FORZA MAGGIORE

Qualora il Venditore sia impossibilitato a rispettare il contratto per cause di forza maggiore o comunque indipendenti dalla sua volontà, i termini previsti per l'esecuzione della fornitura sono automaticamente prorogati per un periodo equivalente al perdurare degli effetti dell'evento di forza maggiore. A tal fine, sono da considerarsi cause di forza maggiore, ai fini esplicativi e non esaustivi: carenza di energia o di materie prime, scioperi, provvedimenti della pubblica amministrazione, impedimenti alla circolazione o alle attività produttive.

8. RECLAMI ed ACCETTAZIONE DEI PRODOTTI

Qualsiasi reclamo relativo alla non conformità delle merci consegnate o per danni conseguenti al trasporto o per eventuali quantità mancanti rispetto ai prodotti ordinati dovrà essere comunicato per lettera raccomandata con avviso di ricezione indirizzata direttamente al venditore entro 8 (otto) giorni dalla data di consegna dei Prodotti, in caso di vizi palesi ed entro 8 (otto) giorni dalla scoperta in caso di vizi occulti, e, comunque, entro un mese dalla consegna, con una dettagliata esposizione dei fatti. In difetto, gli importi fatturati si intenderanno, a tutti gli effetti, accettati e non più contestabili dall'Acquirente. Non si accettano rese delle merci se non preventivamente autorizzate per iscritto dal Venditore.

9. CONFORMITÀ ALLE SPECIFICHE E TERMINI DI GARANZIA

Il Venditore garantisce che i prodotti saranno conformi alle specifiche tecniche dichiarate dal Venditore stesso all'Acquirente nella conferma d'ordine e detta garanzia avrà validità per 2 (due) anni decorrenti dalla data di consegna dei prodotti e, per i prodotti o componenti sostituiti, dal giorno della loro sostituzione.

Nel periodo di garanzia, il Venditore al quale l'Acquirente abbia denunciato i difetti, si impegna, a sua scelta, entro un termine ragionevole, a riparare o sostituire gratuitamente i prodotti o le parti di esse che fossero risultati difettosi. Le spese e i rischi per il trasporto dei prodotti risultati difettosi alla sede del Venditore sono a carico dell'Acquirente. I prodotti sostituiti restano di proprietà del Venditore.

La garanzia decade nel caso di utilizzo non conforme alla destinazione finale abituale dei prodotti o non prevista nei cataloghi del venditore oppure se i prodotti sono stati modificati o riparati senza l'autorizzazione del Venditore.

10. GARANZIA PER L'ADEGUATEZZA DEI PRODOTTI ALLE SOLE NORME UE

Il Venditore garantisce che i Prodotti saranno conformi alle norme dell'Unione europea (UE) a essi eventualmente applicabili.

Nessuna garanzia viene rilasciata dal Venditore in merito alla conformità di tali Prodotti con le norme e i regolamenti, ivi espressamente incluse le norme in tema di sicurezza e di antinfortunistica, in vigore nella nazione dell'Acquirente, ove questi risieda al di fuori della UE, o più in generale, in qualsivoglia nazione che non appartenga alla UE in cui i Prodotti forniti vengono utilizzati.

11. RISERVATEZZA E TUTELA DEI DATI

I documenti di qualsiasi natura forniti dal Venditore rimarranno di sua proprietà e non possono essere trasferiti a terzi o riprodotti. L'Acquirente si impegna, anche dopo la fine del contratto a non divulgare i segreti commerciali e le informazioni riservate che siano state al medesimo comunicati o dei quali venga a conoscenza nel corso del suo rapporto con il Venditore.

Il Venditore con le presenti dichiara che utilizzerà i dati personali trasferiti dal Cliente nel rispetto delle previsioni del codice italiano sulla privacy (Decreto Legislativo n. 196/03).

12. RISOLUZIONE DEL CONTRATTO

Il contratto di fornitura potrà essere risolto di diritto ai sensi dell'art. 1456 c.c. per effetto della semplice dichiarazione scritta del Venditore di avvalersi della presente clausola risolutiva espressa qualora l'Acquirente:

- Ometta o ritardi i pagamenti dovuti;
- Venga posto in liquidazione o sia stato assoggettato ad una qualsiasi procedura concorsuale.

13. PROPRIETÀ INTELLETTUALE

Il Venditore conserva la proprietà intellettuale dei progetti, degli studi, dei disegni, dei modelli e dei prodotti che realizza o che vengono realizzati a suo nome e per suo conto. I marchi sotto quali i prodotti sono venduti non possono essere utilizzati dall'Acquirente se non per identificarli.

14. LEGGE APPLICABILE E MODALITÀ DI RISOLUZIONE DELLE CONTROVERSIE

Tutti i contratti con il Venditore saranno disciplinati dalla legge italiana. Qualsiasi controversia sarà devoluta alla competenza esclusiva del Foro di Torino.

Data: _____ Timbro, Nome Cognome e firma dell'Acquirente: _____

Ai sensi degli artt. 1341 e 1342 c.c. l'Acquirente dichiara di avere letto e approvato specificamente le previsioni contenute nei seguenti articoli delle condizioni generali: art. 3 Divieto di compensazione art. 5 Riserva di proprietà; art. 6 Limitazione della responsabilità; art. 8 Reclami ed accettazione dei Prodotti; art. 14 Modalità di risoluzione delle controversie.

Data: _____ Timbro, Nome Cognome e firma dell'Acquirente: _____

CONDITIONS GÉNÉRALES DE VENTES

1. DOMAINE D'APPLICATION ET EFFICACITÉ

Toutes les fournitures de produits effectuées par Facet S.r.l. (le « Vendeur ») à un client (l'« Acheteur ») sont régies par les présentes conditions générales qui l'emportent sur les conditions générales d'achat de l'Acheteur ainsi que sur les conditions particulières établies dans les offres et/ou confirmations de commande du Vendeur. En cas de contraste entre ce qui est exposé dans les conditions générales et dans les conditions particulières, ces dernières l'emporteront.

Les données et les illustrations relatives aux produits telles qu'elles figurent aux catalogues ou brochures du Vendeur ont un caractère indicatif et n'ont aucune valeur contraignante sauf disposition contraire expresse dans la confirmation de commande du Vendeur et elles sont susceptibles de modifications sans préavis concernant le dessin et le matériel.

Les codes originaux (OE) indiqués dans les catalogues ou dans autres documents sont mentionnés uniquement pour identifier les pièces de rechange. Le Vendeur livre seulement produits de propre production et avec propre code article et non produits avec codes OE.

2. FORMATION DU CONTRAT

Le contrat de fourniture sera finalisé par la confirmation écrite du Vendeur d'acceptation de la commande de l'Acheteur. Le Vendeur se réserve le droit de ne pas accepter de commande en cas de litige en cours avec le client concernant une commande précédente.

3. PRIX ET PAIEMENTS

Sauf si les parties n'en conviennent autrement, les paiements du prix doivent être effectués par l'Acheteur dans les délais et aux conditions établis dans la confirmation de commande au domicile du Vendeur. Les paiements effectués par l'Acheteur à des apporteurs d'affaires et/ou agents sans mandat spécifique ne seront pas opposables au Vendeur.

En cas de retard de paiement, l'Acheteur sera tenu de verser des intérêts de retard au taux de la Banque Centrale Européenne en vigueur à la date en question, majoré de 7 (sept) points, sans préjudice de la faculté du Vendeur de demander les dommages intérêts pour tout dommage ultérieur.

L'Acheteur ne pourra pas, pour quelque raison que ce soit, sauf autorisation écrite, compenser ou garder toute somme due au Vendeur et il ne pourra non plus suspendre les paiements.

Les prix des produits s'entendent en Euros et sont hors TVA, emballage, frais de transport et d'assurance. Le Vendeur peut modifier les prix et les tarifs en vigueur à n'importe quel moment et sans préavis, sauf pour les commandes en cours. Cela en cas de renchérissement des matières premières, de la main d'œuvre, des transports, des prix d'assurance, etc.

4. DÉLAIS DE LIVRAISON ET MISE À DISPOSITION

Sauf si les parties n'en conviennent autrement dans la confirmation de commande, les fournitures des produits s'entendent pour mise à disposition de la marchandise selon les Incoterms 2010: FCA Orbassano. La marchandise voyage toujours pour le compte et aux risques et périls de l'Acheteur.

Les délais de livraison sont indicatifs et en cas de retard l'Acheteur n'aura aucun droit de demander la résiliation du contrat et/ou les dommages-intérêts.

5. RÉSERVE DE PROPRIÉTÉ

Les produits livrés restent la propriété du Vendeur jusqu'au complet paiement du prix relatif.

L'Acheteur aura le droit de vendre les produits achetés, ou les nouveaux produits ayant intégré les produits fournis par le Vendeur, étant entendu qu'en ce cas-là tous les revenus seront transférés au Vendeur jusqu'à concurrence du prix dû par l'Acheteur au Vendeur pour la fourniture desdits Produits.

Ce droit de vendre les produits expire dès lors que l'Acheteur n'aurait pas accompli son obligation de paiement pour une période de plus de 20 (vingt) jours ouvrables à partir de l'échéance. À cet effet, il incombe au Vendeur d'informer par écrit l'Acheteur de la révocation du droit de vendre. L'Acheteur devra mettre en œuvre toute mesure nécessaire pour la protection des produits faisant l'objet de la réserve de propriété ainsi que toute mesure permettant de ne pas confondre les produits du Vendeur avec les produits d'autres fournisseurs et de garder les produits du Vendeur dans des espaces bien délimités et facilement identifiables.

6. RESPONSABILITÉ DU VENDEUR ET LIMITATIONS

Le Vendeur ne sera responsable que de la bonne production des produits fournis, qui devront avoir les caractéristiques indiquées dans la confirmation de commande du Vendeur. Par contre, le Vendeur ne prend aucune responsabilité concernant l'éventuel mauvais fonctionnement de machines ou systèmes réalisés par l'Acheteur avec les produits fournis par le Vendeur.

Les produits doivent être correctement installés seulement par des techniciens formés et qualifiés, conformément aux spécifications du véhicule et en respect des réglementations nationales.

De toute manière, l'Acheteur ne pourra pas demander de dommages-intérêts pour manque à gagner, perte de production, perte d'image, immobilisation du véhicule automobile.

La responsabilité du Vendeur est de toute manière limitée à la valeur de la marchandise fournie, sauf en cas de dol ou de faute grave aux termes de la loi.

7. FORCE MAJEURE

Au cas où le Vendeur serait empêché de respecter le contrat pour des raisons de force majeure ou de toute manière indépendantes de sa volonté, les délais prévus pour l'exécution de la fourniture seront automatiquement prorogés d'une période correspondant à la durée des effets de l'événement de force majeure. À cet effet, on entend pour raisons de force majeure, à titre purement explicatif et non exhaustif: pénurie d'énergie ou de matières premières, grèves, mesures de l'administration publique, entraves à la circulation ou aux activités productives.

8. RÉCLAMATIONS et ACCEPTATION DES PRODUITS

Toute réclamation pour la non conformité des marchandises livrées ou pour des dommages découlant du transport ou pour des quantités manquantes par rapport aux produits commandés devra être communiquée par lettre recommandée avec avis de réception adressée directement au Vendeur dans un délai de 8 (huit) jours de la date de livraison des Produits, en cas de vices apparents et dans un délai de 8 (huit) jours de la découverte de vices cachés et, de toute manière, dans le délai d'un mois de la livraison, accompagnée de l'exposition détaillée des faits. À défaut de cela, les montants facturés seront considérés acceptés, à tous les effets, et ne seront plus contestables par l'Acheteur.

Aucun retour de marchandises ne sera accepté sans l'autorisation préalable écrite du Vendeur.

9. CONFORMITÉ AUX SPÉCIFICATIONS ET TERMES DE GARANTIE

Le Vendeur garantit que les produits seront conformes aux spécifications techniques déclarées par le Vendeur même à l'Acheteur dans la confirmation de commande et ladite garantie sera valable pour 2 (deux) ans à partir de la date de livraison des produits et, pour les produits ou les composants remplacés, à partir du jour de leur remplacement.

Pendant la période de garantie, le Vendeur auquel l'Acheteur aurait dénoncé les défauts, s'engage, de son choix, à réparer ou remplacer gratuitement dans un délai raisonnable les produits ou leurs parties résultant défectueux. Les frais et les risques du transport chez le Vendeur des produits résultant défectueux sont à la charge de l'Acheteur. Les produits remplacés restent la propriété du Vendeur.

La garantie expire en cas d'utilisation non conforme à la destination finale habituelle des produits ou non prévue dans les catalogues du vendeur ou bien si les produits ont été modifiés ou réparés sans l'autorisation du Vendeur.

10. GARANTIE DE LA CONFORMITÉ DES PRODUITS AUX SEULES NORMES UE

Le Vendeur garantit que les Produits seront conformes aux normes de l'Union européenne (UE) qui leur seront éventuellement applicables.

Le Vendeur ne délivre aucune garantie concernant la conformité de ces Produits aux normes et règlements, y compris expressément les normes en matière de sécurité et accidents, en vigueur dans la nation de l'Acheteur, si ce dernier est résident en dehors de l'UE ou, plus en général, en quelque nation que ce soit n'appartenant pas à l'UE dans laquelle les Produits fournis sont utilisés.

11. CONFIDENTIALITÉ ET PROTECTION DES DONNÉES

Les documents de quelque nature que ce soit fournis par le Vendeur resteront sa propriété et ne pourront être transférés à des tiers ou reproduits. L'Acheteur s'engage, également après la fin du contrat, à ne pas divulguer à des tiers les secrets commerciaux ou les informations réservées lui ayant été communiqués et dont il viendrait à connaissance au cours de son rapport avec le Vendeur.

Par les présentes le Vendeur déclare qu'il utilisera les données personnelles communiquées par le Client dans le respect des dispositions du code italien en matière de confidentialité (Décret Législatif n. 196/03).

12. RÉSILIATION DU CONTRAT

Le contrat de fourniture pourra être résilié de plein droit aux termes de l'art.1456 du code civil par la simple déclaration écrite du Vendeur de se prévaloir de la présente clause résolutoire expresse dans les cas suivants :

- en cas de défaut ou de retard de paiement de l'Acheteur
- si l'Acheteur est mis en liquidation judiciaire ou a été soumis à une procédure collective.

13. PROPRIÉTÉ INTELLECTUELLE

Le Vendeur garde la propriété intellectuelle des projets, des études, des dessins, des modèles et des produits qu'il réalise ou qui sont réalisés en son nom ou pour son compte. Les marques sous lesquelles les produits sont vendus ne peuvent être utilisées par l'Acheteur que pour les identifier.

14. LOI APPLICABLE ET MODALITÉS DE RÈGLEMENT DES LITIGES

Tous les contrats avec le Vendeur seront régis par le droit italien. Tout litige sera soumis à la compétence exclusive du Tribunal de Turin.

Date: _____ Cachet, Prénom Nom et signature de l'Acheteur: _____

Aux termes des articles 1341 et 1342 du c.v. l'Acheteur déclare avoir lu et approuvé spécifiquement les dispositions des articles suivants des conditions générales : art. 3 Interdiction de compensation art. 5 Réserve de propriété; art. 6 Limitation de la responsabilité; art. 8 Réclamation et Acceptation des Produits; art. 14 Modalités de règlement des litiges.

Date: _____ Cachet, Prénom Nom et signature de l'Acheteur: _____

ALLGEMEINE VERKAUFSBEDINGUNGEN

1. GELTUNGSBEREICH UND WIRKSAMKEIT

Für alle Lieferungen von Produkten durch die Gesellschaft Facet S.r.l. (der "Verkäufer") an einen Kunden (der "Käufer") gelten die vorliegenden allgemeinen Verkaufsbedingungen, die vor den Einkaufsbedingungen des Käufers sowie den besonderen Bedingungen in den Angeboten und/oder Auftragsbestätigungen des Verkäufers Vorrang haben. Sollten Widersprüche zwischen dem Inhalt der allgemeinen Bedingungen und dem Inhalt der besonderen Bedingungen bestehen, sind Letztere vorrangig.

Die Daten und Abbildungen in Bezug auf die Produkte in den Katalogen oder Broschüren des Verkäufers sind Beispiele und haben keinen bindenden Wert, wenn dies in der Auftragsbestätigung des Verkäufers nicht ausdrücklich vorgesehen ist. Zudem können diese Daten und Abbildungen Änderungen am Design und Material unterliegen, ohne dass diese vorher angekündigt werden müssen.

Die angegebenen Originalnummern in Katalogen oder anderen Dokumenten sind nur zum Zwecke der Identifikation angegeben. Der Verkäufer liefert nur Produkte aus eigener Produktion, die mit Facet Artikel-Nrn. und nicht OE P/Nr. identifiziert sind.

2. ZUSTANDEKOMMEN DES VERTRAGS

Der Liefervertrag kommt zustande, wenn der Verkäufer die Auftragsannahme des Käufers schriftlich bestätigt. Der Verkäufer behält sich das Recht vor, Aufträge nicht anzunehmen, wenn Streitigkeiten mit einem Kunden in Bezug auf einen vorhergehenden Auftrag vorliegen.

3. PREISE UND ZAHLUNGEN

Unbeschadet anderslautender Vereinbarungen, sind die Zahlungen vom Käufer innerhalb der in der Auftragsbestätigung vorgesehenen Zahlungsfristen und Modalitäten am Geschäftssitz des Verkäufers zu leisten. Zahlungen, die vom Käufer an Vermittler und/oder Vertreter geleistet werden, können ohne eine Sondervollmacht nicht beim Verkäufer geltend gemacht werden.

Im Fall von verspäteten Zahlungen ist der Käufer verpflichtet, Verzugszinsen in Höhe des von der Europäischen Zentralbank festgelegten und zu jenem Datum geltenden Zinssatzes zu zahlen, die um 7 (sieben) Prozent erhöht werden. Unbeschadet davon bleibt das Recht des Verkäufers, einen größeren Schaden geltend zu machen.

Der Käufer ist nicht befugt, aus welchem Grund auch immer, Summen, die dem Verkäufer zustehen, zu verrechnen oder einzubehalten oder die Zahlungen einzustellen, es sei denn, dies wurde schriftlich genehmigt.

Die Preise für die Produkte sind in Euro und ohne Mehrwertsteuer, Verpackung, Transportkosten und Versicherung angegeben. Der Verkäufer kann jederzeit geltende Preise und Tarife ohne Vorankündigung ändern. Dies gilt nicht für laufende Aufträge. Solche Änderungen können vorkommen, wenn sich die Preise für Rohstoffe, die Löhne, die Transportkosten und Versicherungspolice usw. erhöhen.

4. LIEFERFRISTEN UND WARENRÜCKNAHME

Insofern nicht anders in der Auftragsbestätigung vereinbart, erfolgt die Lieferung der Produkte nach den Incoterms 2010: FCA (frei Frachtführer) Orbassano. Die Ware wird stets im Namen und auf Risiko des Käufers transportiert.

Die Lieferfristen verstehen sich als Richtzeiten. Im Fall von Verspätungen ist der Käufer nicht berechtigt, die Auflösung des Vertrags und Schadensersatz geltend zu machen.

5. EIGENTUMSVORBEHALT

Die gelieferten Produkte bleiben bis zur vollständigen Bezahlung des entsprechenden Preises Eigentum des Verkäufers.

Der Käufer ist berechtigt, die erworbenen Produkte oder neue Produkte, in welche die gelieferten Waren eingefügt werden, weiterzuveräußern, vorausgesetzt, dass alle Erträge in diesem Fall an den Verkäufer gehen, bis diese den Preis erreichen, den der Käufer dem Verkäufer für die Lieferung dieser Produkte schuldig ist.

Sollte der Käufer seiner Zahlungspflicht länger als 20 (Zwanzig) Arbeitstage nach Fälligkeit der Zahlung nicht nachkommen, verfällt dieses Recht auf Weiterveräußerung der Produkte. Diesbezüglich obliegt es dem Verkäufer, dem Käufer den Widerruf des Rechts auf Weiterveräußerung schriftlich mitzuteilen. Der Käufer muss jede notwendige Maßnahme zum Schutz der Produkte, die dem Eigentumsvorbehalt unterliegen, sowie alle Maßnahmen umsetzen, damit die Produkte des Verkäufers nicht mit denen anderer Lieferanten verwechselt werden. Der Käufer muss die Produkte des Verkäufers in abgegrenzten und leicht erkennbaren Bereichen aufbewahren.

6. HAFTUNG DES VERKÄUFERS UND BESCHRÄNKUNGEN

Der Verkäufer ist ausschließlich für die ordnungsgemäße Herstellung der gelieferten Produkte verantwortlich. Die gelieferten Produkte müssen die in der Auftragsbestätigung des Verkäufers vorgesehenen Merkmale aufweisen. Hingegen übernimmt der Verkäufer keinerlei Haftung für den eventuellen mangelhaften Betrieb der Maschinen oder Systeme, die mit den vom Verkäufer gelieferten Produkten realisiert worden sind.

Die Produkte müssen in angemessener Weise nur von zuständigen und qualifizierten Technikern verbunden sein und müssen nach den Bestimmungen der nationalen Vorschriften den Angaben des Fahrzeugs entsprechen.

In jedem Fall kann der Käufer keinen Schadensersatz für Profitausfall, Produktionsausfall, Verlust des Images und Stillstand des Kraftfahrzeugs geltend machen.

Die Haftung des Verkäufers beschränkt sich nur auf den Wert der gelieferten Ware unter Vorbehalt des Vorsatzes und des groben Verschuldens im Sinne des Gesetzes.

7. HÖHERE GEWALT

Sollte es dem Verkäufer unmöglich sein, den Vertrag aufgrund von höherer Gewalt oder von Ereignissen, die nicht von ihm zu vertreten sind, einzuhalten, dann werden die Fristen für die Ausführung der Lieferung automatisch um die Dauer der Ereignisse verlängert. Diesbezüglich sind rein beispielhaft ohne Anspruch auf Vollständigkeit als Gründe für höhere Gewalt anzusehen: Stromausfall, Mangel an Rohstoffen, Streiks, Maßnahmen der öffentlichen Verwaltung, Störungen im Straßenverkehr oder Produktionsstörungen.

8. REKLAMATIONEN und ANNAHME DER PRODUKTE

Alle Reklamationen in Bezug auf die Nichtkonformität der gelieferten Ware, Schäden durch den Transport oder eventuell fehlende Mengen gegenüber der bestellten Produktmenge müssen dem Verkäufer direkt und per Einschreiben mit Rückschein mitgeteilt werden. Diese Mitteilung muss bei offensichtlichen Mängeln innerhalb von 8 (acht) Tagen ab dem Lieferdatum und bei versteckten Mängeln innerhalb von 8 (acht) Tagen ab dem Datum, an dem diese entdeckt worden sind, und in jedem Fall innerhalb eines Monats nach Lieferung der Produkte erfolgen und eine ausführliche Beschreibung der Mängel enthalten. Mangels dieser Mitteilung werden die abgerechneten Beträge mit voller Rechtswirksamkeit als angenommen angesehen und können vom Käufer nicht mehr beanstandet werden. Warenrücknahmen werden nicht angenommen, wenn diese nicht vorher vom Verkäufer genehmigt wurden.

9. ÜBEREINSTIMMUNG MIT DEN SPEZIFIKATIONEN UND GARANTIEBEDINGUNGEN

Der Verkäufer garantiert, dass die Produkte mit den technischen Spezifikationen übereinstimmen, die der Verkäufer in der Auftragsbestätigung für den Käufer angegeben hat. Die genannte Garantie gilt 2 (zwei) Jahre ab dem Datum der Lieferung der Produkte. Für die ersetzten Produkte oder Bestandteile gilt die Garantie ab dem Tag der Auswechslung.

Während der Garantiezeit verpflichtet sich der Verkäufer, die mangelhaften Produkte oder Teile davon innerhalb einer angemessenen Zeit wahlweise kostenlos zu reparieren oder zu ersetzen, wobei der Käufer dem Verkäufer diese Mängel mitzuteilen hat. Die Kosten und Risiken des Transports der mangelhaften Produkte an den Sitz des Verkäufers gehen zulasten des Käufers. Die ersetzten Produkte bleiben Eigentum des Verkäufers.

Die Garantie erlischt, wenn die Verwendung nicht mit dem bestimmungsgemäßen Gebrauch oder mit den in den Katalogen des Verkäufers vorgesehenen Gebrauch der Produkte übereinstimmt. Die Garantie erlischt ebenfalls, wenn die Produkte ohne die Genehmigung des Verkäufers verändert oder repariert wurden.

10. GEWÄHRLEISTUNG IN BEZUG AUF DIE ÜBEREINSTIMMUNG DER PRODUKTE MIT DEN EU-NORMEN

Der Verkäufer garantiert, dass die Produkte mit den eventuell anwendbaren Normen der Europäischen Union (EU) übereinstimmen.

Für die Übereinstimmung dieser Produkte mit Normen und Richtlinien, die im Land des Käufers gelten, sollte dieser seinen Sitz außerhalb der EU haben, oder allgemein die in jedem Land außerhalb der EU gelten, in dem die gelieferten Produkte verwendet werden, übernimmt der Verkäufer keine Garantie. Von der Garantie ausgeschlossen sind ausdrücklich die Normen über Sicherheit und Unfallverhütung.

11. VERTRAULICHKEIT UND DATENSCHUTZ

Dokumente jeder Art, die vom Verkäufer bereitgestellt werden, bleiben in dessen Besitz und dürfen nicht an Dritte weitergegeben oder vervielfältigt werden. Der Käufer verpflichtet sich, auch nach Vertragsende keine Geschäftsgeheimnisse und vertrauliche Informationen weiterzugeben, oder von deren er im Lauf der Beziehungen mit dem Verkäufer Kenntnis erlangt hat. Der Verkäufer erklärt hiermit, die vom Kunden angegebenen sensiblen Daten unter Einhaltung der Bestimmungen im italienischen Datenschutzkodex (Legislativdekret Nr. 196/03) zu behandeln.

12. AUFLÖSUNG DES VERTRAGS

Der Liefervertrag kann im Sinne von Art. 1456 des ital. ZGB („codice civile“) durch die einfache schriftliche Erklärung des Verkäufers, dass er von dieser ausdrücklichen Aufhebungs Klausel Gebrauch machen will, von Rechts wegen aufgehoben werden, wenn der Käufer:

- die fälligen Zahlungen unterlässt oder verspätet leistet;
- der Liquidation oder einem beliebigen Konkursverfahren unterzogen wird.

13. GEISTIGES EIGENTUM

Die Rechte am geistigen Eigentum in Bezug auf Projekte, Forschungen, Zeichnungen, Modelle und Produkte, die der Verkäufer realisiert oder die in seinem Namen und auf seine Rechnung realisiert werden, verbleiben beim Verkäufer. Die Marken, unter denen die Produkte verkauft werden, dürfen vom Käufer nur verwendet werden, um diese erkenntlich zu machen.

14. ANWENDBARES GESETZ UND MODALITÄTEN ZUR BEILEGUNG VON STREITIGKEITEN

Alle Verträge mit dem Verkäufer werden vom italienischen Gesetz geregelt. Alle Streitigkeiten werden der ausschließlichen Zuständigkeit des Gerichtsprengels in Turin zugewiesen.

Datum: _____ Stempel, Vor- und Zuname und Unterschrift des Käufers: _____

Der Käufer erklärt im Sinne der Art. 1341 und 1342 des ital. ZGB („codice civile“), die in den folgenden Artikeln der allgemeinen Verkaufsbedingungen enthaltenen Bedingungen gelesen zu haben und diese ausnahmslos anzunehmen: Art. 3) Verrechnungsverbot, Art. 5) Eigentumsvorbehalt, Art. 6) Haftungsbeschränkung, Art. 8) Reklamationen und Annahme der Produkte, Art. 14) Modalitäten zur Beilegung von Streitigkeiten.

Datum: _____ Stempel, Vor- und Zuname und Unterschrift des Käufers: _____

CONDICIONES GENERALES DE VENTA

1. AMBITO DE APLICACIÓN Y EFICACIA

Todas las entregas de productos efectuadas por Facet S.r.l. (el "Vendedor") a un cliente (el "Comprador") se regirán por las presentes condiciones generales que prevalecerán sobre las condiciones de adquisición del Comprador, así como las condiciones particulares previstas en las licitaciones y/o confirmación de pedido del Vendedor. En caso de conflicto entre lo estipulado en las condiciones generales y en las condiciones particulares, prevalecerán estas últimas.

Los datos y las ilustraciones referidas a los productos resultantes de los catálogos o prospectos del Vendedor tienen carácter indicativo y no valor vinculante, salvo lo dispuesto expresamente en la confirmación del pedido por parte del vendedor y pueden ser sujetos a modificaciones de diseño y material sin previo aviso.

Los números originales (OE) indicados en los catálogos o en otros documentos sólo son mencionados para identificar las partes de repuesto.

El vendedor suministra únicamente los productos de su propia producción contrasignados con su propio código de artículo y no productos con los números OE.

2. FORMALIZACIÓN DEL CONTRATO

El contrato de suministro se perfecciona con la confirmación escrita del Vendedor de aceptación del pedido del Comprador. El Vendedor se reserva el derecho de no aceptar pedidos en el caso que haya una controversia con el cliente relativa a un pedido anterior

3. PRECIOS Y FORMAS DE PAGO

Salvo pacto en contrario, los pagos del precio deben ser efectuados por el Comprador en los términos y con la modalidad prevista en la confirmación del pedido en la dirección del Vendedor. Los pagos realizados por el Comprador a Corredores de Comercio y/o Agentes sin un poder legal específico no tendrán fuerza ejecutiva contra el Vendedor.

En caso de retraso en los pagos, el Comprador deberá abonar los intereses de demora iguales a los establecidos por el Banco Central Europeo en vigor en la fecha, más 7 (siete) puntos, reservándose en cada caso la facultad el Vendedor de pedir daños y perjuicios.

El Comprador no podrá, por ningún motivo, salvo autorización escrita, compensar o retener cantidades adeudadas al Vendedor, ni podrá suspender los pagos.

Los precios de los productos se entienden en Euros y no incluyen el IVA, embalaje, gastos de transporte o seguro. El Vendedor podrá modificar los precios y las tarifas en vigor en cada momento sin previo aviso, salvo en el caso de los pedidos en curso. Es decir, si se verifican recargos en las materias primas, mano de obra, en los transportes, en las primas de seguros, etc.

4. CONDICIONES DE ENTREGA Y DEVOCIONES

A menos que se disponga lo contrario en la confirmación del pedido, el suministro de los productos se entiende realizado conforme a la Incoterms 2010: FCA Orbassano. La mercancía viaja siempre por cuenta y riesgo del Comprador.

Los plazos de entrega se entienden indicativos y en caso de retraso, el Comprador no tiene derecho a solicitar la resolución del contrato y/o el resarcimiento de los daños.

5. RESERVA DE PROPIEDAD

Los productos suministrados permanecerán de propiedad del Vendedor hasta el pago total del precio.

El Comprador tendrá el derecho de vender los productos adquiridos, o nuevos productos en los que los productos suministrados por el Vendedor hayan sido incorporados, salvo que en este caso, todos los ingresos serán transferidos al Vendedor hasta el total del precio debido al Vendedor por el Comprador por el suministro de tales Productos.

Tal derecho de vender los productos decae si el Comprador no ha cumplido la obligación de pago durante un periodo de tiempo superior a 20 (veinte) días laborables desde la fecha límite. A tal fin, será potestad del Vendedor comunicar por escrito al Comprador la revocación del derecho a vender. El Comprador deberá tomar todas las medidas necesarias para la protección de los productos objeto de la reserva de propiedad, así como las medidas para no confundir los productos del Vendedor con los productos de otros proveedores y conservar los productos del Vendedor en espacios bien delimitados y fácilmente individualizables.

6. RESPONSABILIDAD DEL VENDEDOR Y LIMITACIONES

El Vendedor es exclusivamente responsable de la correcta producción de los productos suministrados, que deberán tener las características previstas en la confirmación del pedido por parte del Vendedor. Sin embargo, el Vendedor no asume, ninguna responsabilidad por el eventual mal funcionamiento de equipos o sistemas realizados por el Comprador con los productos suministrados por el Vendedor.

Los productos deben ser instalados solamente por técnicos competentes y cualificados, en conformidad con las especificaciones del vehículo y cumpliendo con los requisitos de las normativas nacionales.

En cualquier caso, el Comprador no podrá reclamar el resarcimiento de los daños y perjuicios por el lucro cesante, pérdida de producción, daños de imagen o parada de vehículo.

La responsabilidad del Vendedor es, por lo tanto limitada al valor de la mercancía suministrada, salvo dolo o culpa grave de conformidad con la ley.

7. LA FUERZA MAYOR

Si el Vendedor no puede cumplir el contrato por causa de fuerza mayor o cualquier circunstancia ajena a su voluntad, los plazos previstos para la ejecución de la oferta son automáticamente prorrogados por un periodo equivalente al de los efectos del evento de fuerza mayor. A tal fin, son consideradas causas de fuerza mayor, con fines explicativos y no exhaustivos: ausencia de energía o de materias primas, huelgas, medidas de la Administración Pública, obstáculos en la circulación, o en las actividades productivas.

8. RECLAMACIONES y ACEPTACIÓN DE LOS PRODUCTOS

Toda reclamación relativa a la no conformidad de las mercancías consignadas o por daños debidos al transporte o por eventuales faltas de cantidad respecto a los productos encargados debe ser comunicada por carta registrada con acuse de recibo dirigida directamente al vendedor en los 8 (ocho) días desde la fecha de entrega de los Productos, en el caso de vicios ocultos y dentro de los 8 (ocho) días desde el descubrimiento y dentro del mes siguiente de la entrega, con una exposición detallada de los hechos. En su defecto, los importes facturados se entenderán, a todos los efectos, aceptados y no cuestionables por el Comprador.

No se aceptan productos devueltos si no han sido previamente autorizados por escrito por el Vendedor.

9. CONFORMIDAD DE LAS ESPECIFICACIONES Y CONDICIONES DE GARANTÍA

El Vendedor garantiza que los productos serán conformes a las especificaciones técnicas declaradas por el Vendedor mismo al Comprador en la confirmación del pedido y dicha garantía tendrá validez de 2 (dos) años desde la fecha de la consigna de los productos y para los productos o componentes en sustitución, desde la fecha de sustitución.

Durante el periodo de garantía, el Vendedor al que el Comprador haya denunciado los defectos, se compromete, a su elección, dentro de unos términos razonables, a reparar o sustituir gratuitamente los productos o las partes de los mismos que hubieran resultado defectuosos. Los costes y los riesgos debidos al transporte de los productos defectuosos a la sede del Vendedor, son a cargo del Comprador. Los productos sustituidos quedan de propiedad del Vendedor.

La garantía no es válida en el caso de uso no conforme al destino final habitual de los productos o no prevista en los catálogos del vendedor o incluso si los productos han sido modificados o reparados sin la autorización del Vendedor.

10. GARANTÍA DE ADECUACIÓN DE LOS PRODUCTOS A LAS NORMAS UE

El Vendedor garantiza que los Productos serán conformes a las normas de la Unión Europea (UE) y pueden eventualmente ser aplicables.

No existe ninguna garantía del Vendedor en relación a la conformidad de estos Productos con las normas y regulaciones, fuera de las expresamente incluidas en las normas relativas a la seguridad y prevención de accidentes, en vigor en el país del Comprador, cuando este tenga su residencia fuera de la UE, o más en general, en cualquier nación que no pertenezca a la UE en la que los Productos suministrados vengán siendo utilizados.

11. CONFIDENCIALIDAD Y PROTECCIÓN DE DATOS

Los documentos de cualquier naturaleza facilitados por el Vendedor permanecerán de su propiedad y no podrán ser transferidos a terceros o reproducidos. El Comprador se compromete, incluso después de la finalización del contrato a no divulgar los secretos comerciales y las informaciones confidenciales que le hayan sido comunicadas o de las cuales tenga conocimiento en el transcurso de su relación con el Vendedor.

El Vendedor con la presente declara que usará los datos personales transferidos por el Cliente con el respeto a lo establecido en el Código de Privacidad Italiano (Decreto Legislativo n. 196/03)

12. RESOLUCIÓN DEL CONTRATO

El contrato de suministro podrá ser resuelto conforme a derecho según el art. 1456 C.C. por medio de declaración simple por escrito del Vendedor haciendo uso de la presente cláusula de rescisión si el Comprador:

- Omite o retrasa los pagos adeudados
- Se somete a liquidación o se encuentra sujeto a cualquier procedimiento concursal

13. PROPIEDAD INTELECTUAL

El Vendedor conserva la propiedad intelectual de los proyectos, de los estudios de los diseños, de los modelos y de los productos que realice o sean realizados en su nombre o por su cuenta. Las marcas bajo las cuales los productos son vendidos no pueden ser usadas por el Comprador salvo para identificarlos.

14. LEYES APLICABLES Y MODOS DE RESOLUCION DE LAS CONTROVERSIAS

Todos los contratos con el Vendedor serán sometidos a la legislación italiana. Cualquier controversia será resuelta por la jurisdicción exclusiva del Foro de Turín.

Fecha: _____ Sello, Nombre y Apellido y firma del Comprador: _____

En el sentido de los arts. 1341 y 1342 C.C. el Comprador declara haber leído y aceptado específicamente las previsiones contenidas en los siguientes artículos de las condiciones generales: art. 3 Prohibición de compensación, art. 5 Reserva de la propiedad; art. 6 Limitación de la responsabilidad; art. 8 Reclamaciones y Aceptación de los Productos; art. 14 Modos de resolución de las controversias.

Fecha: _____ Sello, Nombre y Apellido y firma del Comprador: _____

OUR PACKAGING

FA-SEN19Q2

-LE NOSTRE CONFEZIONI -NOTRE CONDITIONNEMENT -UNSERE VERPACKUNGSTYPEN -NUESTROS ENVASES



(A)	Z X Y (mm) X x Y x Z	cm ³	(B)	(B)	(B)
			Q / P15 L589 X W389 X H299MM	Q / P25 L389 X W189 X H299MM	Q / P35 L389 X W189 X H149MM
1	27 X 45 X 62	75	720	200	100
3	40 X 46 X 98	180	360	90	20
3,5	74 X 80 X 42	250	252	72	36
04	77 X 97 X 74	550	120	36	18
04,5	37 X 126 X 144	815	90	30	15
05	97 X 128 X 74	920	72	21	9
05,5	72 X 76 X 194	1060	60	12	-
07	128 X 148 X 93	1760	36	12	5
07,5	128 X 185 X 100	2370	27	9	3
08	128 X 186 X 148	3520	18	6	-
08,5	194 X 380 X 72	5300	12	-	-
08,6	180 X 415 X 70	5220	8	-	-
08,7	120 X 470 X 70	3950	13	-	-
08,8	170 X 405 X 90	6200	6	-	-
09	145 X 293 X 127	5400	12	-	-

10.3333 **3,5**

DIFFERENTIAL PRESSURE SENSORS

Adult: Suitable:

NEW - ITEM NOW AVAILABLE FROM PRODUCTION

- NUOVO - ARTICOLO ORA DISPONIBILE PER LA VENDITA
- NOUVEAU - ARTICLE DISPONIBLE EN PRODUCTION COURANTE
- NEU - ARTIKEL UNMIDIG VERFÜGBAR AUS DER PRODUKTION
- BASES APTREIL
- NUEVO - ARTICULO AHORA DISPONIBLE EN PRODUCCION

without fastening clamp

- senza staffe fissaggio
- sans bride de fixation
- ohne Befestigungsteil
- sin empuje de soporte

TOYOTA: 89480-12040, 89480-12050, 89480-12060, 89480-12048, 89480-64020, 89481-00030

LEXUS: 200330

Adult: Suitable: 1210 01 L27, 1210 01 L27, 1210 01 L27, 1210 01 L27, 1210 01 L27

MPa mV

5.7-96.6 486.A-6581

(A) Packaging size

- FORMATO CONFEZIONE
- FORMAT DU CONDITIONNEMENT
- VERPACKUNGSGRÖSSE
- TAMAÑO DE ENVASE

Illustrated section

- PARTE FIGURATA
- PARTIE ILLUSTRÉE
- BILDTEIL BEISPIEL
- PARTE ILUSTRADA

P15

(B) Shipping box

- PACCO SPEDIZIONI
- COLIS D'EXPEDITION
- VERPACKUNG
- BULTO PARA EL DESPACHO





FA-TM Thermal management - Gestione Termica - Gestion thermique - ThermoManagement - Gestión térmica



FA-ACC Ignition - Accensione - Allumage - Zündung - Encendido



FA-SEN Sensors - Sensori - Capteurs - Sensoren - Sensores



FA-INT Switches - Interruttori - Interrupteurs - Shalter - Interruptores



FA-OS Oxygen Sensors - Sonde Lambda - Sondes de richesse - Lambdasonden - Sondas Lambda