

IGNITION

KW-IGN22Q1

• ACCENSIONE • ALLUMAGE • ZÜNDUNG • ENCENDIDO

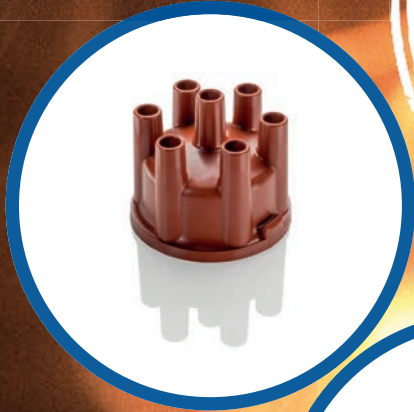

*Manufacturer of
automobile spare parts*



catalogo.facet.eu/kw













*Automotive spare parts
manufacturer since 1946*















INDEX

•INDICE •CONTENU •INHALT •CONTENIDO

KW-IGN22Q1

CATALOGUES BY PRODUCT CATEGORY		PAGE
	-CATALOGHI PER LINEE DI PRODOTTO -CATALOGUES PAR FAMILLE PRODUIT -KATALOGE NACH PRODUKTENGRUPPEN -CATALOGOS POR FAMILIA PRODUCTO	4
PRODUCT CATEGORIES BY CATALOGUE		
	-LINEE PRODOTTI PER CATALOGO -FAMILLES PRODUIT PAR CATALOGUE -PRODUKTENGRUPPE NACH KATALOG -FAMILIAS PRODUCTO POR CATALOGO	5
NEW ITEMS AND THEIR AVAILABILITY		
	-NUOVI ARTICOLI E LORO DISPONIBILITÀ -NOUVEAUX PRODUITS ET LEURS DISPONIBILITÉ -NEUE TEILE UND IHRE VERFÜGBARKEIT -NOVEDADES Y SU DISPONIBILIDAD	6
APPLICATION LIST		
EXPLICATION TO APPLICATION LIST		
	-SPIEGAZIONE ALLA GUIDA APPLICAZIONI -EXPLICATION À LA LISTE D'APPLICATIONS -ERKLÄRUNG ZUR ANWENDUNGSTABELLE -EXPLICACIÓN A LA LISTA DE APLICACIONES	12
VEHICLE MANUFACTURERS INDEX		
	-INDICE COSTRUTTORI VEICOLI -LISTE DES FABRICANTS VEHICULES -INHALTSVERZEICHNIS DER FAHRZEUGHERSTELLER -LISTA DE FABRICANTES DE VEHICULOS	13
BODY DESIGN		
	-TIPI DI CARROZZERIA -TYPES DE CARROSSERIE -KAROSSERIETYP -TIPOS DE CARROCERIA	15
APPLICATION LIST		
	-GUIDA APPLICAZIONI -LISTE D'APPLICATIONS -ANWENDUNGSTABELLE -LISTA DE APLICACIONES	16
GLOSSARY OF FUNCTIONS ON THE VEHICLE		
	-GLOSSARIO PER FUNZIONI SU VETTURA -GLOSSAIRE DES FONCTIONS SUR LE VÉHICULE -GLOSSAR NACH FUNKTION IN AUTO -GLOSSARIO DE LAS FUNCIONES EN LOS VEHICULOS	957
PRODUCTS BY VEHICLE MANUFACTURER		
	-ELENCO PRODOTTI PER MARCA -PRODUITS PAR FABRICANT VEHICULE -LISTE DER PRODUKTE JE NACH FAHRZEUGMARKE -PRODUCTOS POR FABRICANTE VEHÍCULO	958
APPLICATION LIST GLOSSARY		
	-GLOSSARIO GUIDA APPLICAZIONI -GLOSSAIRE LISTE D'APPLICATIONS -GLOSSAR DER VERWENDUNGSLISTE -GLOSSARIO LISTA DE APLICACIONES	974

ILLUSTRATED SECTION		
	CONDENSERS -CONDENSATORI -CONDENSATEURS -KONDENSATOREN -CONDENSADORES	980
	CONTACT SETS -COPPIE CONTATTI -RUPTEURS -KONTAKTSÄTZE -PLATINOS	985
	DISTRIBUTOR CAPS -CALOTTE -TETES D'ALLUMEUR -VERTEILERKAPPEN -TAPAS DEL DISTRIBUIDOR	999
	ROTORS -DISTRIBUTORI -DISRUPTEURS -VERTEILERLÄUFER -ROTORES DEL DISTRIBUIDOR	1045
	DIFFERENTIAL PRESSURE SENSORS -SENSORI DI PRESSIONE ARIA DIFFERENZIALE -CAPTEURS DE PRESSION D'AIR DIFFERENTIEL -DIFFERENZDRUCKSENSOREN -SENSORES DE PRESIÓN DIFERENCIAL (DPS)	1082
	PICK-UPS -IMPULSORI -CAPTEURS -IMPULSGEBER -CAPTADORES	1137
	IGNITION MODULES -MODULI DI ACCENSIONE -MODULES D'ALLUMAGE -ZÜNDMODULE -MÓDULOS DE ENCENDIDO	1146
	IGNITION COILS -BOBINE DI ACCENSIONE -BOBINES D'ALLUMAGE -ZÜNDSPULEN -BOBINAS DE ENCENDIDO	1153
CROSS REFERENCE LIST OEM/OES		
	-TABELLA COMPARATIVA OEM/OES -TABLE COMPARAISON OEM/OES -VERGLEICHSTABELLE OEM/OES -TABLA DE EQUIVALENCIAS OEM/OES	1244
CROSS REFERENCE LIST OTHER MANUFACTURERS		
	-TABELLA COMPARATIVA ALTRI COSTRUTTORI -TABLE COMPARAISON D'AUTRES FABRICANTS -VERGLEICHSTABELLE ANDERE HERSTELLER -TABLA DE EQUIVALENCIAS OTRAS FABRICANTES	1279
VARIATIONS COMPARED TO PREVIOUS CATALOGUE EDITION		
	-VARIAZIONI RISPETTO AI PRECEDENTI CATALOGHI -VARIATIONS RAPPORTÉES AUX CATALOGUES PRÉCÉDENTS -ÄNDERUNGEN IM VERGLEICH ZU FRÜHERE KATALOGAUSGABEN -VARIACIONES CON RESPECTO A CATALOGOS ANTERIORES	1299
GENERAL SALES TERMS		
	-CONDIZIONI GENERALI DI VENDITA -CONDITIONS GÉNÉRALES DE VENTE -ALLGEMEINE VERKAUFSBEDINGUNGEN -CONDICIONES GENERALES DE VENTA	1305
OUR PACKAGING UNITS		
	-LE NOSTRE CONFEZIONI -NOS UNITÉS DE CONDITIONNEMENT -UNSERE ABPACKENTYPEN -NUESTROS ENVASES	1310



PRODUCT CATEGORIES BY CATALOGUE

KW-IGN22Q1

-LINEE PRODOTTI PER CATALOGO -FAMILLES PRODUIT PAR CATALOGUE -PRODUKTENGRUPPE NACH KATALOG -FAMILIAS PRODUCTO POR CATALOGO

Code	PICTURE	Catalogue	Description
6xx xxx		●	CONDENSERS -CONDENSATORI -CONDENSATEURS -KONDENSATOREN -CONDENSADORES
7xx xxx		●	CONTACT SETS -COPIE CONTACTI -RUPTEURS -KONTAKTSÄTZE -PLATINOS
8xx xxx		●	DISTRIBUTOR CAPS -CALOTTE -TETES D'ALLUMEUR -VERTEILERKAPPEN -TAPAS DEL DISTRIBUIDOR
9xx xxx		●	ROTORS -DISTRIBUTORI -DISRUPTEURS -VERTEILERLÄUFER -ROTORES DEL DISTRIBUIDOR
3xx xxx		●	IGNITION CABLE SETS -SERIE CAVI ACCENSIONE COMPLETA -JEUX CABLES D'ALLUMAGE -ZÜNDKABELSÄTZE -JUEGOS DE CABLES DE ENCENDIDO
500 xxx		●	ENGINE OIL PRESSURE WARNING LIGHT SWITCHES -INTERRUTTORI SPIA PRESSIONE OLIO -MANOCONTACTS POUR TEMOIN DE PRESSION D'HUILE -ÖLDRUCKKONTROLLSCHALTER
500 6xx		●	OIL PRESSURE SENSORS -TRASMETTITORI PRESSIONE OLIO -TRANSMETTEURS DE PRESSION D'HUILE -ÖLDRUCK-IMPULSGEBER -TRANSMISORES DE PRESSION DE ACEITE
510 xxx		●	BRAKE/CLUTCH PEDAL SWITCHES -INTERRUTTORI PEDALI FRENO/FRIZIONE -CONTACTEURS DE FEUX STOP -BREMS-/ KUPPLUNGSPEDALSCHALTER
530 xxx		●	COOLANT/OIL/FUEL TEMPERATURE SENDERS -SENSORI DI TEMPERATURA REFRIGERANTE/OLIO/CARBURANTE -CAPTEURS DE TEMPERATURE REFRIGERANT/HUILE/CARBURANTS -TEMPERATURENSOR FÜR KÜHLMITTEL/ÖL/KRAFTSTOFF -SENSORES DE TEMPERATURA REFRIGERANTE/ACEITE/COMBUSTIBLE
530 5xx		●	WATER TEMPERATURE SENDERS WITH WARNING LIGHT SWITCH -TRASMETTITORI CON SPIA TEMPERATURA ACQUA -THERMORESISTANCES AVEC CONTACTEUR POUR TEMOIN TEMPERATURE D'EAU -WASSESTEMPERATUR-IMPULSGEBER MIT KONTROLLICHTSCHALTER -SENSORES DE TEMPERATURA REFRIGERANTE CON INTERRUPTOR PARA LUZ TESTIGO
540 xxx		●	WATER TEMPERATURE WARNING LIGHT SWITCHES -INTERRUTTORI COMANDO SPIA TEMPERATURA ACQUA -THERMOCONTACTS POUR TEMOIN TEMPERATURE D'EAU
550 xxx		●	THERMO-SWITCHES FOR ELECTRIC FANS -THERMOINTERRUTTORI PER ELETTROVENTILATORI -THERMOCONTACTS D'ELECTROVENTILATEURS -THERMO-SCHALTER FÜR LÜFTERMOTOR -THERMOCONTACTOS PARA ELECTROVENTILADORES
550 6xx		●	THERMO-SWITCHES FOR DOUBLE FAN OR TWO SPEEDS -THERMOINTERRUTTORI PER ELETTROVENTILATORE DOPPIO O A DUE VELOCITÀ -THERMOCONTACTS POUR DOUBLE VENTILATEUR OU A DEUX VITESSES -THERMO-SCHALTER FÜR DOPPELBELÜFTER ODER FÜR ZWEIGANG-LÜFTERMOTOR
560 xxx		●	REVERSING LIGHT SWITCHES -INTERRUTTORI LUCI RETROMARCIA -CONTACTEURS FEUX DE RECU -RÜCKFAHR-SCHWELFER-SCHALTER -INTERRUPTORES DE LUZ MARCHA ATRAS
580 xxx		●	THERMOSTATS -THERMOSTATI -THERMOSTATS -THERMOSTATE -THERMOSTATOS
590 xxx		●	GASKETS FOR THERMOSTATS -GUARNIZIONI PER THERMOSTATI -JOINTS POUR THERMOSTATS -DICHTUNGEN FÜR THERMOSTATEN -JUNTAS POR THERMOSTATOS
4xx xxx		●	PICK-UPS -IMPULSORI -CAPTEURS -IMPULSGEBER -CAPTADORES
453 xxx		●	REVOLUTION AND TIMING (CKP AND CMP) SENSORS -SENSORI GIRI MOTORE E TRASMISSIONE -CAPTEURS DE REGIME ET DE POSITION -DREHZAHL- UND GETRIEBESSENSOREN
457 xxx		●	KNOCK SENSORS -SENSORI DI DETONAZIONE -CAPTEURS DE CLIQUETIS -KLOPFSENSOREN -SENSORES DE PICADO
465 xxx		●	IGNITION MODULES -MODULI DI ACCENSIONE -MODULES D'ALLUMAGE -ZÜNDMODULE -MÓDULOS DE ENCENDIDO
470 xxx		●	IGNITION COILS -BOBINE DI ACCENSIONE -BOBINES D'ALLUMAGE -ZÜNDSPULEN -BOBINAS DE ENCENDIDO
490 xxx		●	ELECTRONIC IGNITION KITS -KIT PER ACCENSIONE ELETTRONICA -KIT POUR ALLUMAGE ELECTRONIQUES -ELEKTRONISCHE ZÜNDUNGSSATZ -JUEGOS DE ENCENDIDO ELECTRÓNICO
491 xxx		●	MASS AIR FLOW METERS (MAF) -SENSORI DI PORTATA ARIA (MAF) -CAPTEURS DE MASSE D'AIR -LUFTMASSENMESSER -CAUDALIMETROS
493 xxx		● ●	AIR PRESSURE SENSORS -SENSORI DI PRESSIONE ARIA -CAPTEURS DE PRESSION D'AIR -DRUCKSENSOREN -SENSORES DE PRESIÓN DEL AIRE
494 xxx		●	AIR TEMPERATURE SENSORS -SENSORI DI TEMPERATURA DELL'ARIA -CAPTEURS DE TEMPERATURE D'AIR -LUFTTEMPERATUR-SENSOREN
495 xxx		●	THROTTLE POSITION SENSORS -SENSORI DI POSIZIONE FARFALLA -SONDES DE POSITION DU PAPILLON -DROSSELKLAPPEN-POSITIONS-SENSOREN
497 xxx 498 xxx		●	OXYGEN SENSORS -SONDE LAMBDA -SONDES DE RICHESSE -LAMBDASENDEN -SONDAS LAMBDA
460 xxx		●	WHEEL SPEED SENSORS -SENSORI DI NUMERO DI GIRI RUOTA -CAPTEURS ABS -RADDREHZAHLSSENSOR -SENSORES DE REVOLUCIONES DE RUEDA
422 xxx		●	EXHAUST GAS TEMPERATURE SENSORS (EGT) -SENSORI DI TEMPERATURA GAS DI SCARICO (EGT) -CAPTEURS DE TEMPÉRATURE GAS D'ÉCHAPPEMENT (EGT) -ABGASTEMPERATURENSOREN (EGT) -SENSORES DE TEMPERATURA GASES DE ESCAPE (EGT)
463 xxx		●	EGR VALVES -VALVOLE EGR -EGR VALVES -ABGASRÜCKFÜHRUNGVENTILE -VALVULAS EGR



PRODUCT CATEGORIES BY CATALOGUE

KW-IGN22Q1

•LINEE PRODOTTI PER CATALOGO •FAMILLES PRODUIT PAR CATALOGUE •PRODUKTENGRUPPE NACH KATALOG •FAMILIAS PRODUCTO POR CATALOGO

CATALOGUE •Catalogo •Catalogue •Katalog •Catalogo			Code
	KW-IGNxxxx	●	6xx xxx 7xx xxx 8xx xxx 9xx xxx 3xx xxx 4xx xxx 465 xxx 470 xxx 490 xxx
	KW-SWIxxxx	●	500 xxx 500 6xx 510 xxx 560 xxx
	KW-TMxxxx	●	530 xxx 530 5xx 540 xxx 550 xxx 550 6xx 580 xxx 590 xxx
	KW-SENxxxx	●	453 xxx 457 xxx 491 xxx 493 xxx 494 xxx 495 xxx 460 xxx
	KW-EMxxxx	●	493 xxx 497 xxx 498 xxx 422 xxx 463 xxx

NEW ITEMS AND THEIR AVAILABILITY

KW-IGN22Q1

-Nuovi articoli e loro disponibilità -Nouveaux produits et leur disponibilité -Neue Teile und vorläufige Verfügbarkeit -Novedades y su disponibilidad

CONDENSERS

CONDENSATORI
CONDENSATEURS
KONDENSATOREN
CONDENSADORES

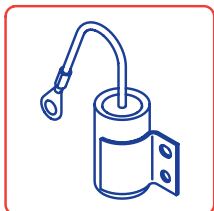

Products listed by date of availability

-Articoli raggruppati per data di **disponibilità**
-Produits groupés par date de **disponibilité**
-Produkte je nach **Verfügbarkeitsdatum** aufgelistet
-Artículos agrupados se gún fecha de **disponibilidad**

AVAILABILITY	CODE

CONTACT SETS

COPPIE CONTATTI
RUPTEURS
KONTAKTSÄTZE
PLATINOS

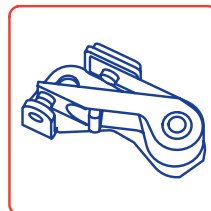

Products listed by date of availability

-Articoli raggruppati per data di **disponibilità**
-Produits groupés par date de **disponibilité**
-Produkte je nach **Verfügbarkeitsdatum** aufgelistet
-Artículos agrupados se gún fecha de **disponibilidad**

AVAILABILITY	CODE

Products listed by code sequence

-Articoli in ordine di **codice**
-Articles en sequence de **réf.**
-Produkte je nach **Artikel-Nr.**
-Artículos en secuencia de **codigo**

CODE	AVAILABILITY

Products listed by code sequence

-Articoli in ordine di **codice**
-Articles en sequence de **réf.**
-Produkte je nach **Artikel-Nr.**
-Artículos en secuencia de **codigo**

CODE	AVAILABILITY



AVAILABLE

NEW ITEMS AND THEIR AVAILABILITY

KW-IGN22Q1

-Nuovi articoli e loro disponibilità -Nouveaux produits et leur disponibilité -Neue Teile und vorläufige Verfügbarkeit -Novedades y su disponibilidad

DISTRIBUTOR CAPS

CALOTTE
TETES D'ALLUMEUR
VERTEILERKAPPEN
TAPAS DEL DISTRIBUIDOR

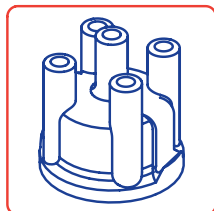

Products listed by date of availability

- Articoli raggruppati per data di **disponibilità**
- Produits groupés par date de **disponibilité**
- Produkte je nach **Verfügbarkeitsdatum** aufgelistet
- Artículos agrupados se gún fecha de **disponibilidad**

AVAILABILITY	CODE

ROTORS

DISTRIBUTORI
DISRUPTEURS
VERTEILERLÄUFER
ROTORES DEL DISTRIBUIDOR

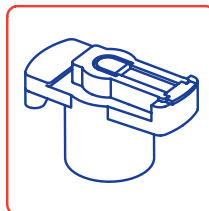

Products listed by date of availability

- Articoli raggruppati per data di **disponibilità**
- Produits groupés par date de **disponibilité**
- Produkte je nach **Verfügbarkeitsdatum** aufgelistet
- Artículos agrupados se gún fecha de **disponibilidad**

AVAILABILITY	CODE

Products listed by code sequence

- Articoli in ordine di **codice**
- Articles en sequence de **réf.**
- Produkte je nach **Artikel-Nr.**
- Artículos en secuencia de **codigo**

CODE	AVAILABILITY

Products listed by code sequence

- Articoli in ordine di **codice**
- Articles en sequence de **réf.**
- Produkte je nach **Artikel-Nr.**
- Artículos en secuencia de **codigo**

CODE	AVAILABILITY



AVAILABLE

NEW ITEMS AND THEIR AVAILABILITY

KW-IGN22Q1

-Nuovi articoli e loro disponibilità -Nouveaux produits et leur disponibilité -Neue Teile und vorläufige Verfügbarkeit -Novedades y su disponibilidad

IGNITION KIT

KIT ACCENSIONE
KIT ALLUMAGE
ZÜNDUNGSÄTZE
JUEGOS DE ENCENDIDO

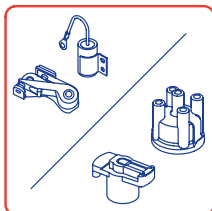

Products listed by date of availability

-Articoli raggruppati per data di **disponibilità**
-Produits groupés par date de **disponibilité**
-Produkte je nach **Verfügbarkeitsdatum** aufgelistet
-Artículos agrupados se gún fecha de **disponibilidad**

AVAILABILITY	CODE

IGNITION CABLE SETS

SERIE CAVI ACCENSIONE COMPLETA
JEUX CABLES D'ALLUMAGE
ZÜNDKABELSÄTZE
JUEGOS DE CABLES DE ENCENDIDO

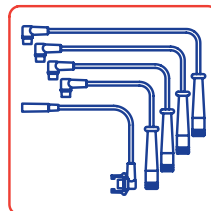

Products listed by date of availability

-Articoli raggruppati per data di **disponibilità**
-Produits groupés par date de **disponibilité**
-Produkte je nach **Verfügbarkeitsdatum** aufgelistet
-Artículos agrupados se gún fecha de **disponibilidad**

AVAILABILITY	CODE

Products listed by code sequence

-Articoli in ordine di **codice**
-Articles en sequence de **réf.**
-Produkte je nach **Artikel-Nr.**
-Artículos en secuencia de **codigo**

CODE	AVAILABILITY

Products listed by code sequence

-Articoli in ordine di **codice**
-Articles en sequence de **réf.**
-Produkte je nach **Artikel-Nr.**
-Artículos en secuencia de **codigo**

CODE	AVAILABILITY



AVAILABLE

NEW ITEMS AND THEIR AVAILABILITY

KW-IGN22Q1

-Nuovi articoli e loro disponibilità -Nouveaux produits et leur disponibilité -Neue Teile und vorläufige Verfügbarkeit -Novedades y su disponibilidad

PICK-UPS

IMPULSORI
CAPTEURS
IMPULSGEBER
CAPTADORES

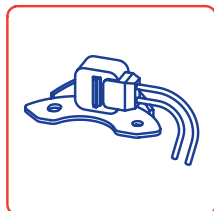

Products listed by date of availability

-Articoli raggruppati per data di **disponibilità**
-Produits groupés par date de **disponibilité**
-Produkte je nach **Verfügbarkeitsdatum** aufgelistet
-Artículos agrupados se gún fecha de **disponibilidad**

AVAILABILITY	CODE

IGNITION MODULES

MODULI DI ACCENSIONE
MODULES D'ALLUMAGE
ZÜNDMODULE
MÓDULOS DE ENCENDIDO

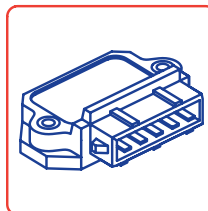

Products listed by date of availability

-Articoli raggruppati per data di **disponibilità**
-Produits groupés par date de **disponibilité**
-Produkte je nach **Verfügbarkeitsdatum** aufgelistet
-Artículos agrupados se gún fecha de **disponibilidad**

AVAILABILITY	CODE

Products listed by code sequence

-Articoli in ordine di **codice**
-Articles en sequence de **réf.**
-Produkte je nach **Artikel-Nr.**
-Artículos en secuencia de **codigo**

CODE	AVAILABILITY

Products listed by code sequence

-Articoli in ordine di **codice**
-Articles en sequence de **réf.**
-Produkte je nach **Artikel-Nr.**
-Artículos en secuencia de **codigo**

CODE	AVAILABILITY



AVAILABLE

NEW ITEMS AND THEIR AVAILABILITY

KW-IGN22Q1

-Nuovi articoli e loro disponibilità -Nouveaux produits et leur disponibilité -Neue Teile und vorläufige Verfügbarkeit -Novedades y su disponibilidad

IGNITION COILS

BOBINE DI ACCENSIONE
BOBINES D'ALLUMAGE
ZÜNDSPULEN
BOBINAS DE ENCENDIDO

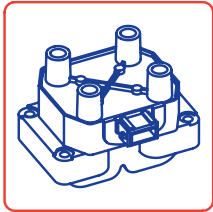

Products listed by code sequence

-Articoli in ordine di **codice**
-Articles en sequence de **réf.**
-Produkte je nach **Artikel-Nr.**
-Artículos en secuencia de **codigo**

CODE	AVAILABILITY
470 536	😊
470 538	😊
470 545	22/04
470 547	😊
470 549	😊
470 551	😊
470 596	😊
470 599	😊
470 602	😊
470 609	😊
470 613	😊
470 619	😊
470 620	😊
470 621	😊
470 622	😊
470 623	😊
470 626	😊
470 627	😊
470 631	😊
470 632	😊
470 636	😊
470 638	😊
470 645	😊
470 647	😊

Products listed by date of availability

-Articoli raggruppati per data di **disponibilità**
-Produits groupés par date de **disponibilité**
-Produkte je nach **Verfügbarkeitsdatum** aufgelistet
-Artículos agrupados se gún fecha de **disponibilidad**

AVAILABILITY	CODE
😊	470 536
😊	470 538
😊	470 547
😊	470 549
😊	470 551
😊	470 596
😊	470 599
😊	470 602
😊	470 609
😊	470 613
😊	470 619
😊	470 620
😊	470 621
😊	470 622
😊	470 623
😊	470 626
😊	470 627
😊	470 631
😊	470 632
😊	470 636
😊	470 638
😊	470 645
😊	470 647
22/04	470 545



AVAILABLE

APPLICATION LIST

KW-IGN22Q1

·GUIDA APPLICAZIONI ·LISTE D'APPLICATIONS ·ANWENDUNGSTABELLE ·LISTA DE APLICACIONES

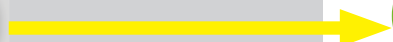
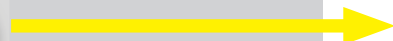



EXPLICATION TO APPLICATION LIST

KW-IGN22Q1

-SPIEGAZIONE ALLA GUIDA APPLICAZIONI -EXPLICATION À LA LISTE D'APPLICATIONS -ERKLÄRUNG ZUR ANWENDUNGSTABELLE -EXPLICACIÓN DE LA LISTA APLICACIONES

Fuel type

- Tipo carburante
- Carburant
- Kraftstoffart
- Tipo combustible

Vehicle production date

- Date di produzione del veicolo
- Date de production du véhicule
- Fahrzeugherstelldatum
- Fecha de producción del vehículo

Manufacturer

- Fabricante
- Constructeur
- Hersteller
- Fabricante

Car Models

- Modelli
- Modèles
- Modellen
- Modelos

Capacity

- Cilindrata
- Cilindrée
- Hubraum
- Cilindrada

Engine

- Motore
- Moteur
- Motor
- Motor

kW

- kW
- kW
- kW
- kW

Differentiation

- Variante
- Variante
- Abänderungsangabe
- Variación

KW

Function on the vehicle

- Funzione su vettura
- Fonction sur le véhicule
- Funktion im Auto
- Funciones en los vehículos

Vehicle	a. im.	kW	Date	Engine	FUNCTIONS ON THE VEHICLE												
					A10	A20	A40	A50	A70	C10 - C30	C20	E01					
100 II																	
1.6	Petrol	63	08/76-07/82	ENGINE YV													
Engine Information																	
All engines						706 069											
100 III																	
1.8	Petrol	55	08/82-12/87	ENGINE DR, RS													
Engine Information																	
All engines						706 069											
Eng. DR							806 079	906 021R									
Eng. DR										470 132	C10	465 004					
1.8	Petrol	65	02/86-07/90	ENGINE SH													
Engine Information																	
All engines							806 266	906 055R	406 219								
All engines										470 127	C10	465 007	359 768				
1.8	Petrol	66	08/83-12/90	ENGINE DS, JW, NP													
Engine Information																	
All engines						706 069		906 021R	406 219	470 127	C10	465 007	359 768				
All engines							806 129	906 055R	406 219								
Eng. NP							806 266										
Eng. DS, NP							815 068	915 099R									
1.8 Cat	Petrol	66	03/85-11/90	ENGINE 4B, PH													
Engine Information																	
All engines							806 266	906 055R	406 219								
All engines										470 127	C10	465 007	359 768				

A10 CONDENSER	A20 CONTACT SET	A40 DISTRIBUTOR CAP	A50 ROTOR	A70 PICK-UP
C10 COIL	C20 IGNITION MODULE	C30 ELECTRONIC IGNITION KIT	E01 IGNITION CABLE SET	

The present application list is a brief version. For the detailed information about the possibility of installation on a specific vehicle, please refer to our web-catalogue <http://catalogo.facet.eu/>



VEHICLE MANUFACTURERS INDEX

KW-IGN22Q1

-INDICE COSTRUTTORI VEICOLI -LISTE DES FABRICANTS VEHICULES -INHALVERZEICHNIS DER FAHRZEUGHERSTELLER -LISTA DE FABRICANTES DE VEHICULOS

Manufacturer	Page	Manufacturer	Page	Manufacturer	Page	Manufacturer	Page
A		G		O		Z	
ABARTH	16	GINETTA	314	OPEL	556	ZASTAVA	956
ACURA	17	H		P			
ALFA ROMEO	18	HOLDEN	315	PEUGEOT	597		
ALPINA	35	HONDA	322	PIAGGIO	635		
ALPINE	36	HYUNDAI	344	PORSCHE	636		
ASTON MARTIN	37	I		PUCH	643		
AUDI	38	INFINITI	372	R			
AUSTIN	84	INNOCENTI	375	RELIANT	644		
AUSTIN-HEALEY	86	ISUZU	376	RENAULT	645		
B		IVECO	377	RILEY	703		
BEDFORD	87	J		ROLLS-ROYCE	704		
BENTLEY	88	JAGUAR	379	ROVER	705		
BMW	89	JEEP	382	S			
BOND	148	JENSEN	384	SAAB	714		
BORGWARD	149	K		SEAT	718		
C		KIA	385	SKODA	740		
CHEVROLET	150	L		SMART	754		
CHRYSLER	158	LADA	405	SSANGYONG	758		
CITROËN	162	LANCIA	406	SUBARU	760		
CUPRA	199	LAND ROVER	417	SUZUKI	767		
D		LEXUS	420	T			
DACIA	200	LOTUS	427	TALBOT	782		
DAEWOO	210	M		TOYOTA	783		
DAIHATSU	215	MAN	428	TRIUMPH	822		
DAIMLER	219	MARUTI	429	TVR	825		
DS	220	MASERATI	430	V			
F		MAZDA	431	VAUXHALL	826		
FIAT	222	MERCEDES-BENZ	454	VOLKSWAGEN (BR)	850		
FIAT (BR)	266	MG	507	VOLVO	852		
FORD	269	MINI	510	VW	886		
FORD (BR)	309	MITSUBISHI	514	W			
FORD AUSTRALIA	310	MORRIS	532	WOLSELEY	954		
FORD USA	312	N		Y			
FSO	313	NISSAN	533	YUGO	955		
		NSU	555				



BODY DESIGN

KW-IGN22Q1

-TIPI DI CARROZZERIA -TYPES DE CARROSSERIE -KAROSSERIETYPEN -TIPOS DE CARROCERIA



Hatchback

- Coda spiovente
- Fastback
- Schräger
- Fastback



Station Wagon

- Familiare
- Break
- Kombi
- Ranchera familiar



MPV

- Monovolume
- Monospace
- Großraumlimousine
- Limusina



Closed off-road vehicle

- Fuori strada chiuso
- Véhicule tout terrain à carrosserie fermée
- Geländewagen geschlossen
- Todo terreno, cerrada



Bus

- Autobus
- Autobus/Autocar
- Bus
- Autobús



Flatbed/Chassis

- Pianale piatto/Autotelaio
- Camion plate-forme/Chassis
- Pritsche/Fahrgestell
- Caja/Chasis



Saloon

- Tre volumi
- A trois volumes
- Stufenheck
- Sedan



Convertible

- Cabriolet
- Décapotable
- Cabriolet
- Descapotable



Coupe

- Coupé
- Coupé
- Coupe
- Coupé



Open off-road vehicle

- Fuori strada aperto
- Véhicule tout terrain à carrosserie ouverte
- Geländewagen offen
- Todo terreno, abierta



Box

- Furgonato
- Camionnette
- Kasten
- Furgón

Vehicle	alim.	kW	Date	Engine	FUNCTIONS ON THE VEHICLE							
					A10	A20	A40	A50	A70	C10 - C30	C20	E01

PUNTO

1.4	Petrol	120	03/12->	ENGINE
				955 A8.000

Engine	Information	A10	A20	A40	A50	A70	C10 - C30	C20	E01
All engines	x 4, COIL ON PLUG						470 549	C10	

1.4 SUPERSPORT	Petrol	132	03/12->	ENGINE
				199 A8.000, 955 A8.000

Engine	Information	A10	A20	A40	A50	A70	C10 - C30	C20	E01
Eng. 199 A8.000	Qty: 4						470 549	C10	
Eng. 955 A8.000	x 4, COIL ON PLUG						470 549	C10	

PUNTO EVO

1.4	Petrol	120	10/09-02/12	ENGINE
				955 A8.000

Engine	Information	A10	A20	A40	A50	A70	C10 - C30	C20	E01
All engines	x 4, COIL ON PLUG						470 549	C10	

RITMO

125 TC 2.0	Petrol	92	11/81-12/87	ENGINE
				138 AR1.000

Engine	Information	A10	A20	A40	A50	A70	C10 - C30	C20	E01
All engines	version Marelli				930 054R	430 161/1			

A10	CONDENSER	A20	CONTACT SET	A40	DISTRIBUTOR CAP	A50	ROTOR	A70	PICK-UP
C10	COIL	C20	IGNITION MODULE	C30	ELECTRONIC IGNITION KIT	E01	IGNITION CABLE SET		

Vehicle	alim.	kW	Date	Engine	FUNCTIONS ON THE VEHICLE							
					A10	A20	A40	A50	A70	C10 - C30	C20	E01

INTEGRA I

				ENGINE
1.6	Petrol	74	01/85-12/90	D16A1, D16A3

Engine	Information	A10	A20	A40	A50	A70	C10 - C30	C20	E01
All engines	->year 31/01/88, version Hitachi			822 069					
All engines	->year 31/12/87, version Hitachi				922 056				
All engines	01/01/88 ->, ->year 31/12/88, version Hitachi				922 082				
All engines	->year 31/12/87						470 212	C10	
All engines	01/01/88 ->						470 213	C10	465 052

				ENGINE
1.6i	Petrol	88	01/85-12/90	D16A8

Engine	Information	A10	A20	A40	A50	A70	C10 - C30	C20	E01
All engines	->year 31/01/88, version Hitachi			822 069					
All engines	->year 31/12/87, version Hitachi				922 056				
All engines	01/01/88 ->, ->year 31/12/88, version Hitachi				922 082				
All engines	->year 31/12/87						470 212	C10	
All engines	01/01/88 ->						470 213	C10	465 052

INTEGRA II

				ENGINE
1.8	Petrol	77	10/90-09/93	F18A2

Engine	Information	A10	A20	A40	A50	A70	C10 - C30	C20	E01
All engines	01/01/92 ->, version Hitachi			822 068					
All engines	version Hitachi, no specific info conc. application available				922 095, 922 097R				
All engines	01/01/92 ->						470 214	C10	
All engines	->year 31/12/91						470 215	C10	
All engines									465 052

INTEGRA III

				ENGINE
1.8 GS-R	Petrol	147	10/93-09/01	F18C2

Engine	Information	A10	A20	A40	A50	A70	C10 - C30	C20	E01
All engines	version Hitachi				922 095				
All engines							470 214	C10	

				ENGINE
1.8 LS	Petrol	125	10/93-09/01	F18C1

Engine	Information	A10	A20	A40	A50	A70	C10 - C30	C20	E01
All engines	01/01/92 ->, version Hitachi			822 068					
All engines	version Hitachi, no specific info conc. application available				922 095, 922 097R				
All engines	01/01/92 ->						470 214	C10	

				ENGINE
1.8 Sport	Petrol	125	10/93-09/01	F18C1

Engine	Information	A10	A20	A40	A50	A70	C10 - C30	C20	E01
All engines	01/01/92 ->, version Hitachi			822 068					
All engines	version Hitachi, no specific info conc. application available				922 095, 922 097R				
All engines	01/01/92 ->						470 214	C10	









VIGOR

				ENGINE
2.5	Petrol	140	09/91->	G25A, G25A2

Engine	Information	A10	A20	A40	A50	A70	C10 - C30	C20	E01
All engines	version Hitachi			822 084					

A10	CONDENSER	A20	CONTACT SET	A40	DISTRIBUTOR CAP	A50	ROTOR	A70	PICK-UP
C10	COIL	C20	IGNITION MODULE	C30	ELECTRONIC IGNITION KIT	E01	IGNITION CABLE SET		

The present application list is a brief version. For the detailed information about the possibility of installation on a specific vehicle, please refer to our web-catalogue <http://catalogo.facet.eu/>









					FUNCTIONS ON THE VEHICLE							
Vehicle	alim.	kW	Date	Engine	 A10	 A20	 A40	 A50	 A70	 C10 - C30	 C20	 E01
145												
1.4 i.e. Petrol 66 07/94-12/96 AR 33501												
Engine	Information				A10	A20	A40	A50	A70	C10 - C30	C20	E01
All engines	x 1, D.I.S., connector type DIN									470 146	C10	
1.4 i.e. 16V T.S. Petrol 76 12/96-01/01 AR 33503												
Engine	Information				A10	A20	A40	A50	A70	C10 - C30	C20	E01
All engines	->VET. 3174687, x 4, SEMI-DIRECT									470 386	C10	
All engines	VET. 3174688 ->, x 4, SEMI-DIRECT									470 387	C10	
All engines												360 608
1.6 16V T.S. Petrol 82 09/97-12/00 AR 32102												
Engine	Information				A10	A20	A40	A50	A70	C10 - C30	C20	E01
All engines	x 4, SEMI-DIRECT									470 387	C10	
All engines												360 608
1.6 i.e. Petrol 76 10/94-12/96 AR 33201												
Engine	Information				A10	A20	A40	A50	A70	C10 - C30	C20	E01
All engines	->VET. 3014142, x 1, D.I.S., connector type, saw teeth									470 168	C10	
1.6 i.e. 16V T.S. Petrol 88 12/96-01/01 AR 32102, AR 67601												
Engine	Information				A10	A20	A40	A50	A70	C10 - C30	C20	E01
All engines	->VET. 3174687, x 4, SEMI-DIRECT									470 386	C10	
All engines	VET. 3174688 ->, x 4, SEMI-DIRECT									470 387	C10	
1.6 LPG LPG 88 01/98-01/01 AR 32102												
Engine	Information				A10	A20	A40	A50	A70	C10 - C30	C20	E01
All engines	->VET. 3174687, x 4, SEMI-DIRECT									470 386	C10	
All engines	VET. 3174688 ->, x 4, SEMI-DIRECT									470 387	C10	
1.7 i.e. 16V Petrol 95 10/94-12/96 AR 33401												
Engine	Information				A10	A20	A40	A50	A70	C10 - C30	C20	E01
All engines	x 1, D.I.S., connector type, saw teeth									470 168	C10	
1.8 i.e. 16V Petrol 106 03/98-01/01 AR 32201												
Engine	Information				A10	A20	A40	A50	A70	C10 - C30	C20	E01
All engines	x 4, SEMI-DIRECT									470 387	C10	
All engines												360 608
1.8 i.e. 16V T.S. Petrol 103 12/96-12/98 AR 67106												
Engine	Information				A10	A20	A40	A50	A70	C10 - C30	C20	E01
All engines	x 2, SEMI-DIRECT									470 386	C10	
All engines												360 608
1.8 i.e. 16V T.S. [BRA] Petrol 110 10/96-02/99 AR 67199												
Engine	Information				A10	A20	A40	A50	A70	C10 - C30	C20	E01
All engines	Qty: 4, without spark plug connector									470 386	C10	
All engines	incl. spark plug connector, Qty: 4									470 386K	C10	
All engines												360 608
2.0 16V Petrol 114 03/98-01/01 AR 32301												
Engine	Information				A10	A20	A40	A50	A70	C10 - C30	C20	E01
All engines	x 4, SEMI-DIRECT									470 387	C10	
All engines												360 608
2.0 16V T.S. Petrol 110 10/95-01/01 AR 67204												
Engine	Information				A10	A20	A40	A50	A70	C10 - C30	C20	E01
All engines	x 2, SEMI-DIRECT									470 386	C10	
All engines												360 608

A10 CONDENSER	A20 CONTACT SET	A40 DISTRIBUTOR CAP	A50 ROTOR	A70 PICK-UP
C10 COIL	C20 IGNITION MODULE	C30 ELECTRONIC IGNITION KIT	E01 IGNITION CABLE SET	

Vehicle	alim.	kW	Date	Engine	FUNCTIONS ON THE VEHICLE									
					A10	A20	A40	A50	A70	C10 - C30	C20	E01		
ENGINE														
2.0 16V T.SPARK [BRA]	Petrol	110	10/96-02/99	AR 67299										
Engine	Information				A10	A20	A40	A50	A70	C10 - C30	C20	E01		
All engines	without spark plug connector, Qty: 4									470 386	C10			
All engines	incl. spark plug connector, Qty: 4									470 386K	C10			
All engines													360 608	
ENGINE														
2.0 16V T.SPARK Q.V. [BRA]	Petrol	110	10/95-09/96	AR 67299										
Engine	Information				A10	A20	A40	A50	A70	C10 - C30	C20	E01		
All engines	Qty: 4									470 386K	C10			
146														
ENGINE														
1.4 i.e.	Petrol	66	12/94-12/96	AR 33501										
Engine	Information				A10	A20	A40	A50	A70	C10 - C30	C20	E01		
All engines	x 1, D.I.S., connector type DIN									470 146	C10			
ENGINE														
1.4 i.e. 16V T.S.	Petrol	76	11/96-01/01	AR 33503										
Engine	Information				A10	A20	A40	A50	A70	C10 - C30	C20	E01		
All engines	-> VET. 165088, x 4, SEMI-DIRECT									470 386	C10			
All engines	VET. 165089 ->, x 4, SEMI-DIRECT									470 387	C10			
All engines													360 608	
ENGINE														
1.6 16V T.S.	Petrol	82	09/97-12/00	AR 32102										
Engine	Information				A10	A20	A40	A50	A70	C10 - C30	C20	E01		
All engines	x 4, SEMI-DIRECT									470 387	C10			
All engines													360 608	
ENGINE														
1.6 i.e. 16V T.S.	Petrol	88	11/96-10/01	AR 32102, AR 67601										
Engine	Information				A10	A20	A40	A50	A70	C10 - C30	C20	E01		
All engines	-> VET. 165088, x 4, SEMI-DIRECT									470 386	C10			
All engines	VET. 165089 ->, x 4, SEMI-DIRECT									470 387	C10			
Eng. AR 67601													360 608	
ENGINE														
1.7 i.e. 16V	Petrol	95	12/94-12/96	AR 33401										
Engine	Information				A10	A20	A40	A50	A70	C10 - C30	C20	E01		
All engines	x 1, D.I.S., connector type, saw teeth									470 168	C10			
ENGINE														
1.8 i.e. 16V T.S.	Petrol	103	11/96-01/01	AR 67106										
Engine	Information				A10	A20	A40	A50	A70	C10 - C30	C20	E01		
All engines	x 2, SEMI-DIRECT									470 386	C10			
All engines													360 608	
ENGINE														
1.8 i.e. 16V T.S.	Petrol	106	03/98-01/01	AR 32201										
Engine	Information				A10	A20	A40	A50	A70	C10 - C30	C20	E01		
All engines	x 4, SEMI-DIRECT									470 387	C10			
All engines													360 608	
ENGINE														
2.0 16V	Petrol	114	03/97-10/01	AR 32301										
Engine	Information				A10	A20	A40	A50	A70	C10 - C30	C20	E01		
All engines	x 4, SEMI-DIRECT									470 387	C10			
All engines													360 608	
ENGINE														
2.0 16V T.S.	Petrol	110	10/95-01/01	AR 67204										
Engine	Information				A10	A20	A40	A50	A70	C10 - C30	C20	E01		
All engines	-> year 01/12/96, x 4, SEMI-DIRECT									470 386	C10			
All engines	01/03/99 ->, x 4, SEMI-DIRECT									470 387	C10			
All engines	01/01/97 ->, -> year 01/02/99, x 4, SEMI-DIRECT												360 608	
All engines														

A10 CONDENSER	A20 CONTACT SET	A40 DISTRIBUTOR CAP	A50 ROTOR	A70 PICK-UP
C10 COIL	C20 IGNITION MODULE	C30 ELECTRONIC IGNITION KIT	E01 IGNITION CABLE SET	

The present application list is a brief version. For the detailed information about the possibility of installation on a specific vehicle, please refer to our web-catalogue <http://catalogo.facet.eu/>

					FUNCTIONS ON THE VEHICLE							
Vehicle	alim.	kW	Date	Engine								
147												
1.6 16V T.SPARK	Petrol	88	01/01-03/10	ENGINE AR 32104								
Engine	Information				A10	A20	A40	A50	A70	C10 - C30	C20	E01
All engines	x 4, COIL ON PLUG									470 397	C10	
All engines												360 607
1.6 16V T.SPARK ECO												
1.6 16V T.SPARK ECO	Petrol	77	01/01-03/10	ENGINE AR 37203								
Engine	Information				A10	A20	A40	A50	A70	C10 - C30	C20	E01
All engines	x 4, COIL ON PLUG									470 397	C10	
All engines												360 607
1.6 LPG												
1.6 LPG	Petrol/ Liquified Petroleum Gas (LPG)	77	01/09-03/10	ENGINE AR 37203								
Engine	Information				A10	A20	A40	A50	A70	C10 - C30	C20	E01
All engines	x 4, COIL ON PLUG									470 397	C10	
All engines												360 607
1.6 LPG												
1.6 LPG	Petrol/ Liquified Petroleum Gas (LPG)	88	03/01-12/09	ENGINE AR 32104								
Engine	Information				A10	A20	A40	A50	A70	C10 - C30	C20	E01
All engines	x 4, COIL ON PLUG									470 397	C10	
All engines												360 607
2.0 16V T.SPARK												
2.0 16V T.SPARK	Petrol	110	01/01-03/10	ENGINE AR 32310								
Engine	Information				A10	A20	A40	A50	A70	C10 - C30	C20	E01
All engines	x 4, COIL ON PLUG									470 397	C10	
All engines												360 607
3.2 GTA												
3.2 GTA	Petrol	184	02/03-03/10	ENGINE 932 A.000								
Engine	Information				A10	A20	A40	A50	A70	C10 - C30	C20	E01
All engines	x 6, COIL ON PLUG									470 313	C10	
All engines												360 607
155												
1.6 16V T.S.	Petrol	88	05/96-12/97	ENGINE AR 67601								
Engine	Information				A10	A20	A40	A50	A70	C10 - C30	C20	E01
All engines	without spark plug connector, Qty: 4									470 386	C10	
All engines	incl. spark plug connector, Qty: 4									470 386K	C10	
All engines												360 608
1.7 T.S.												
1.7 T.S.	Petrol	83	04/93-04/96	ENGINE AR 67103								
Engine	Information				A10	A20	A40	A50	A70	C10 - C30	C20	E01
All engines	Qty: 2									470 168	C10	
All engines												359 623
1.7 T.S.												
1.7 T.S.	Petrol	85	04/93-04/96	ENGINE AR 67105								
Engine	Information				A10	A20	A40	A50	A70	C10 - C30	C20	E01
All engines	Qty: 2									470 168	C10	
All engines												359 623
1.7 T.S. 16V												
1.7 T.S. 16V	Petrol	103	05/96-12/97	ENGINE AR 67106								
Engine	Information				A10	A20	A40	A50	A70	C10 - C30	C20	E01
All engines	without spark plug connector, Qty: 4									470 386	C10	
All engines	incl. spark plug connector, Qty: 4									470 386K	C10	
All engines												360 608
1.8 T.S.												
1.8 T.S.	Petrol	95	02/92-05/94	ENGINE AR 67101								
Engine	Information				A10	A20	A40	A50	A70	C10 - C30	C20	E01
All engines	Qty: 2									470 168	C10	
All engines												359 623

A10 CONDENSER	A20 CONTACT SET	A40 DISTRIBUTOR CAP	A50 ROTOR	A70 PICK-UP
C10 COIL	C20 IGNITION MODULE	C30 ELECTRONIC IGNITION KIT	E01 IGNITION CABLE SET	

Vehicle	alim.	kW	Date	Engine	FUNCTIONS ON THE VEHICLE												
					A10	A20	A40	A50	A70	C10 - C30	C20	E01					
ENGINE																	
1.8 T.S. Sport	Petrol	93	03/92-12/96	AR 67101, AR 67102													
Engine	Information				A10	A20	A40	A50	A70	C10 - C30	C20	E01					
All engines	Qty: 2									470 168	C10						
All engines													359 623				
ENGINE																	
2.0 16V Turbo Q4	Petrol	137	01/92-12/97	AR 67203													
Engine	Information				A10	A20	A40	A50	A70	C10 - C30	C20	E01					
All engines	Qty: 2									470 146	C10						
ENGINE																	
2.0 16V Turbo Q4	Petrol	140	03/92-12/97	AR 67203													
Engine	Information				A10	A20	A40	A50	A70	C10 - C30	C20	E01					
All engines	Qty: 2									470 146	C10						
ENGINE																	
2.0 T.S.	Petrol	104	02/92-05/95	AR 67201, AR 67202													
Engine	Information				A10	A20	A40	A50	A70	C10 - C30	C20	E01					
All engines	Qty: 2									470 168	C10						
All engines													359 623				
ENGINE																	
2.0 T.S.	Petrol	106	02/92-01/95	AR 67201, AR 67202													
Engine	Information				A10	A20	A40	A50	A70	C10 - C30	C20	E01					
All engines	Qty: 2									470 168	C10						
All engines													359 623				
ENGINE																	
2.0 T.S. 16V	Petrol	110	03/95-12/97	AR 67204, AR 67299													
Engine	Information				A10	A20	A40	A50	A70	C10 - C30	C20	E01					
All engines	without spark plug connector, Qty: 4									470 386	C10						
All engines	incl. spark plug connector, Qty: 4									470 386K	C10						
All engines													360 608				
156																	
ENGINE																	
1.6 16V T.SPARK	Petrol	82	09/97-09/05	AR 32102													
Engine	Information				A10	A20	A40	A50	A70	C10 - C30	C20	E01					
All engines	x 4, SEMI-DIRECT									470 387	C10						
All engines													360 608				
ENGINE																	
1.6 16V T.SPARK	Petrol	88	09/97-09/05	AR 32102, AR 32103, AR 32104, AR 67601													
Engine	Information				A10	A20	A40	A50	A70	C10 - C30	C20	E01					
Eng. AR 67601	-> VET. 0084340, x 4, SEMI-DIRECT									470 386	C10						
Eng. AR 32102, AR 67601	VET. 0084341 -, x 4, SEMI-DIRECT									470 387	C10						
Eng. AR 32103, AR 32104	x 4, COIL ON PLUG									470 397	C10						
Eng. AR 32103, AR 32104													360 607				
Eng. AR 32102, AR 67601													360 608				
ENGINE																	
1.6 16V T.SPARK.	Petrol	81	07/00-07/05	AR 32103													
Engine	Information				A10	A20	A40	A50	A70	C10 - C30	C20	E01					
All engines	without spark plug connector, Qty: 4									470 397	C10						
All engines	incl. spark plug connector, Qty: 4									470 397K	C10						
All engines													360 607				
ENGINE																	
1.6 16V T.SPARK.	Petrol	88	05/00-05/06	AR 32102, AR 32103, AR 32104, AR 67601													
Engine	Information				A10	A20	A40	A50	A70	C10 - C30	C20	E01					
Eng. AR 67601	-> VET. 0084340, x 4, SEMI-DIRECT									470 386	C10						
Eng. AR 32102	without spark plug connector, Qty: 4									470 387	C10						
Eng. AR 67601	VET. 0084341 -, x 4, SEMI-DIRECT									470 387	C10						
Eng. AR 32102	incl. spark plug connector, Qty: 4									470 387K	C10						
Eng. AR 32103	without spark plug connector, Qty: 4									470 397	C10						
Eng. AR 32104	x 4, COIL ON PLUG									470 397	C10						
Eng. AR 32103	incl. spark plug connector, Qty: 4									470 397K	C10						
Eng. AR 32103, AR 32104													360 607				
Eng. AR 32102, AR 67601													360 608				
A10	CONDENSER	A20	CONTACT SET	A40	DISTRIBUTOR CAP	A50	ROTOR	A70	PICK-UP	C10	COIL	C20	IGNITION MODULE	C30	ELECTRONIC IGNITION KIT	E01	IGNITION CABLE SET









Vehicle	alim.	kW	Date	Engine	FUNCTIONS ON THE VEHICLE							
					A10	A20	A40	A50	A70	C10 - C30	C20	E01
ENGINE												
1.8 16V T.SPARK	Petrol	103	02/97-05/06	AR 32205								
Engine	Information			A10	A20	A40	A50	A70	C10 - C30	C20	E01	
All engines	euro 2, x 4, SEMI-DIRECT								470 387	C10		
All engines	euro 3, x 4, COIL ON PLUG								470 397	C10		
ENGINE												
1.8 16V T.SPARK	Petrol	106	09/97-10/00	AR 32201								
Engine	Information			A10	A20	A40	A50	A70	C10 - C30	C20	E01	
All engines	euro 2, x 4, SEMI-DIRECT								470 387	C10		
All engines	euro 3, x 4, COIL ON PLUG								470 397	C10		
All engines											360 608	
ENGINE												
2.0 16V T.SPARK	Petrol	110	10/00-03/02	AR 32310								
Engine	Information			A10	A20	A40	A50	A70	C10 - C30	C20	E01	
All engines	euro 2, x 4, SEMI-DIRECT								470 387	C10		
All engines	euro 3, x 4, COIL ON PLUG								470 397	C10		
All engines											360 607	
ENGINE												
2.0 16V T.SPARK	Petrol	114	09/97-06/02	AR 32301, AR 32310								
Engine	Information			A10	A20	A40	A50	A70	C10 - C30	C20	E01	
Eng. AR 32301	euro 2, x 4, SEMI-DIRECT								470 387	C10		
Eng. AR 32301	euro 3, x 4, COIL ON PLUG								470 397	C10		
Eng. AR 32310	without spark plug connector, Qty: 4								470 397	C10		
Eng. AR 32310	incl. spark plug connector, Qty: 4								470 397K	C10		
Eng. AR 32310											360 607	
Eng. AR 32301											360 608	
ENGINE												
2.0 Twin Spark	Petrol	118	11/97-04/00	AR 32303								
Engine	Information			A10	A20	A40	A50	A70	C10 - C30	C20	E01	
All engines	euro 2, x 4, SEMI-DIRECT								470 387	C10		
All engines	euro 3, x 4, COIL ON PLUG								470 397	C10		
ENGINE												
2.5 V6 24V	Petrol	140	02/97-08/03	AR 32401								
Engine	Information			A10	A20	A40	A50	A70	C10 - C30	C20	E01	
All engines	x 6, COIL ON PLUG								470 313	C10		
ENGINE												
2.5 V6 24V	Petrol	141	02/97-05/06	AR 32405								
Engine	Information			A10	A20	A40	A50	A70	C10 - C30	C20	E01	
All engines	x 6, COIL ON PLUG								470 313	C10		
ENGINE												
2.5 V6 24V [BRA]	Petrol	140	10/97-12/01	AR 32402								
Engine	Information			A10	A20	A40	A50	A70	C10 - C30	C20	E01	
All engines	Qty: 6								470 313	C10		
ENGINE												
3.2 GTA	Petrol	184	03/02-05/06	932 A.000								
Engine	Information			A10	A20	A40	A50	A70	C10 - C30	C20	E01	
All engines	x 6, COIL ON PLUG								470 313	C10		
159												
ENGINE												
1.8 MPI	Petrol	103	06/05-11/11	939 A4.000								
Engine	Information			A10	A20	A40	A50	A70	C10 - C30	C20	E01	
All engines	x 4, COIL ON PLUG								470 450	C10		
ENGINE												
1.8 Tbi	Petrol	147	05/09-12/12	939 B1.000								
Engine	Information			A10	A20	A40	A50	A70	C10 - C30	C20	E01	
All engines	x 4, COIL ON PLUG								470 549	C10		
164												
ENGINE												
2.0 T.S.	Petrol	105	06/87-09/92	AR 06416								
Engine	Information			A10	A20	A40	A50	A70	C10 - C30	C20	E01	
All engines	Qty: 2, version Bosch					806 079						

A10 CONDENSER	A20 CONTACT SET	A40 DISTRIBUTOR CAP	A50 ROTOR	A70 PICK-UP
C10 COIL	C20 IGNITION MODULE	C30 ELECTRONIC IGNITION KIT	E01 IGNITION CABLE SET	

Vehicle	alim.	kW	Date	Engine	FUNCTIONS ON THE VEHICLE									
					A10	A20	A40	A50	A70	C10 - C30	C20	E01		
ENGINE														
2.0 T.S.	Petrol	106	09/92-09/98	AR 64103										
ENGINE														
All engines					Qty: 2						470 168	C10		
2.0 T.S.	Petrol	109	06/87-09/92	AR 06420										
ENGINE														
All engines					Qty: 2, version Bosch			806 079						
2.0 Turbo	Petrol	128	10/87-09/98	AR 06476										
ENGINE														
All engines					version Marelli			830 115						
All engines					->year 01/07/90, version Marelli			930 055R						
All engines					01/07/90 ->, version Marelli			930 059						
2.0 Turbo	Petrol	129	02/88-10/92	AR 06476										
ENGINE														
All engines					version Marelli			830 115						
All engines					->year 01/07/90, version Marelli			930 055R						
All engines					01/07/90 ->, version Marelli			930 059						
2.0 Turbo	Petrol	148	07/90-10/92	AR 64102										
ENGINE														
All engines					version Bosch			806 236	906 119R					
All engines													359 666	
2.0 Twin Spark	Petrol	109	06/87-09/92	AR 06420										
ENGINE														
All engines					Qty: 2, version Bosch			806 079						
2.0 V6 Turbo	Petrol	148	09/92-09/98	AR 64102										
ENGINE														
All engines					version Bosch			806 236						
2.0 V6 Turbo	Petrol	150	03/91-09/92	AR 64101										
ENGINE														
All engines					version Bosch			806 236	906 119R					
All engines													359 666	
3.0	Petrol	138	11/87-09/91	AR 06410										
ENGINE														
All engines					version Bosch			806 236	906 119R					
3.0	Petrol	168	04/93-02/95	AR 64304										
ENGINE														
All engines					Qty: 6						470 313	C10		
3.0 24V	Petrol	154	03/95-10/97	AR 66302										
ENGINE														
All engines					Qty: 6						470 313	C10		
3.0 24V	Petrol	155	09/92-09/98	AR 66301, AR 66302										
ENGINE														
All engines					Qty: 6						470 313	C10		
3.0 24V Q4	Petrol	170	02/94-09/98	AR 64307, AR 64308										
ENGINE														
All engines					Qty: 6						470 313	C10		

A10	CONDENSER	A20	CONTACT SET	A40	DISTRIBUTOR CAP	A50	ROTOR	A70	PICK-UP
C10	COIL	C20	IGNITION MODULE	C30	ELECTRONIC IGNITION KIT	E01	IGNITION CABLE SET		

The present application list is a brief version. For the detailed information about the possibility of installation on a specific vehicle, please refer to our web-catalogue <http://catalogo.facet.eu/>

					FUNCTIONS ON THE VEHICLE							
Vehicle	alim.	kW	Date	Engine								
3.0 24V Q4												
Petrol 171 09/92-10/98 ENGINE AR 66304												
Engine	Information				A10	A20	A40	A50	A70	C10 - C30	C20	E01
All engines	Qty: 6									470 313	C10	
3.0 24V QV												
Petrol 171 09/92-09/98 ENGINE AR 64304												
Engine	Information				A10	A20	A40	A50	A70	C10 - C30	C20	E01
All engines	Qty: 6									470 313	C10	
3.0 24V QV [USA]												
Petrol 170 04/93-02/95 ENGINE AR 64308												
Engine	Information				A10	A20	A40	A50	A70	C10 - C30	C20	E01
All engines	Qty: 6									470 313	C10	
3.0 24V QV Trazione integrale												
Petrol 171 11/92-10/97 ENGINE AR 64307												
Engine	Information				A10	A20	A40	A50	A70	C10 - C30	C20	E01
All engines	Qty: 6									470 313	C10	
3.0 i.e. QV												
Petrol 147 09/90-09/92 ENGINE AR 64301												
Engine	Information				A10	A20	A40	A50	A70	C10 - C30	C20	E01
All engines	version Bosch						806 236	906 119R				
3.0 Lusso [USA] [CAN]												
Petrol 135 10/91-03/93 ENGINE AR 06412												
Engine	Information				A10	A20	A40	A50	A70	C10 - C30	C20	E01
All engines	version Bosch						806 236	906 119R				
3.0 Sport [CAN] [USA]												
Petrol 147 11/90-03/92 ENGINE AR 64301												
Engine	Information				A10	A20	A40	A50	A70	C10 - C30	C20	E01
All engines	version Bosch						806 236	906 119R				
3.0 V6												
Petrol 135 06/87-09/92 ENGINE AR 06412												
Engine	Information				A10	A20	A40	A50	A70	C10 - C30	C20	E01
All engines	version Bosch						806 236	906 119R				
3.0 V6												
Petrol 141 06/87-09/92 ENGINE AR 06410												
Engine	Information				A10	A20	A40	A50	A70	C10 - C30	C20	E01
All engines	version Bosch						806 236	906 119R				
3.0i 24V Super [BRA]												
Petrol 155 09/92-10/98 ENGINE 64306												
Engine	Information				A10	A20	A40	A50	A70	C10 - C30	C20	E01
All engines	Qty: 6									470 313	C10	
3.0i 24V Super Q4												
Petrol 171 03/95-12/98 ENGINE AR 66304												
Engine	Information				A10	A20	A40	A50	A70	C10 - C30	C20	E01
All engines	Qty: 6									470 313	C10	
166												
2.0 T.Spark												
Petrol 110 10/00-06/07 ENGINE AR 36301												
Engine	Information				A10	A20	A40	A50	A70	C10 - C30	C20	E01
All engines	x 4, COIL ON PLUG									470 397	C10	
All engines												360 607
2.0 T.Spark												
Petrol 114 09/98-10/00 ENGINE AR 34103												
Engine	Information				A10	A20	A40	A50	A70	C10 - C30	C20	E01
All engines	x 4, SEMI-DIRECT									470 387	C10	
All engines												360 608
2.5 V6 24V												
Petrol 138 10/00-06/07 ENGINE AR 36201												
Engine	Information				A10	A20	A40	A50	A70	C10 - C30	C20	E01
All engines	x 6, COIL ON PLUG									470 313	C10	

A10 CONDENSER	A20 CONTACT SET	A40 DISTRIBUTOR CAP	A50 ROTOR	A70 PICK-UP
C10 COIL	C20 IGNITION MODULE	C30 ELECTRONIC IGNITION KIT	E01 IGNITION CABLE SET	

Vehicle	alim.	kW	Date	Engine	FUNCTIONS ON THE VEHICLE									
					A10	A20	A40	A50	A70	C10 - C30	C20	E01		
ENGINE														
2.5 V6 24V	Petrol	140	09/98-12/06	AR 34201										
Engine	Information				A10	A20	A40	A50	A70	C10 - C30	C20	E01		
All engines	x 6, COIL ON PLUG									470 313	C10			
ENGINE														
3.0 V6 24V	Petrol	162	10/00-06/07	AR 36101										
Engine	Information				A10	A20	A40	A50	A70	C10 - C30	C20	E01		
All engines	x 6, COIL ON PLUG									470 313	C10			
ENGINE														
3.0 V6 24V	Petrol	166	09/98-06/07	AR 34301										
Engine	Information				A10	A20	A40	A50	A70	C10 - C30	C20	E01		
All engines	x 6, COIL ON PLUG									470 313	C10			
ENGINE														
3.2 V6 24V	Petrol	176	10/03-06/07	936 A.000										
Engine	Information				A10	A20	A40	A50	A70	C10 - C30	C20	E01		
All engines	x 6, COIL ON PLUG									470 313	C10			
1750-2000														
ENGINE														
1.7	Petrol	80	04/68-11/71	AR 10525										
Engine	Information				A10	A20	A40	A50	A70	C10 - C30	C20	E01		
All engines						706 047								
ENGINE														
1750	Petrol	83	03/68-10/72	AR 00548										
Engine	Information				A10	A20	A40	A50	A70	C10 - C30	C20	E01		
All engines						706 047								
33 I														
ENGINE														
1.2	Petrol	50	06/83-12/89	AR 30585										
Engine	Information				A10	A20	A40	A50	A70	C10 - C30	C20	E01		
All engines	version Bosch						806 079	906 061R						
All engines	version Ducellier						815 054							
ENGINE														
1.3	Petrol	55	06/83-12/89	AR 30586										
Engine	Information				A10	A20	A40	A50	A70	C10 - C30	C20	E01		
All engines	version Bosch						806 079	906 061R						
All engines	version Ducellier						815 054							
ENGINE														
1.3	Petrol	63	10/84-12/89	AR 30168, AR 30587										
Engine	Information				A10	A20	A40	A50	A70	C10 - C30	C20	E01		
All engines	version Bosch						806 079	906 061R						
All engines	version Ducellier						815 054							
Eng. AR 30168	version Marelli							930 051R						
Eng. AR 30168	version Bosch								406 153					
Eng. AR 30168											465 005			
ENGINE														
1.3 i.e.	Petrol	66	05/83-12/89	AR 30168										
Engine	Information				A10	A20	A40	A50	A70	C10 - C30	C20	E01		
All engines	version Bosch						806 079	906 061R	406 153					
All engines	version Ducellier						815 054							
All engines	version Marelli							930 051R						
All engines											465 005			
ENGINE														
1.4	Petrol	66	01/84-12/88	AR 30587										
Engine	Information				A10	A20	A40	A50	A70	C10 - C30	C20	E01		
All engines	version Bosch						806 079	906 061R						
All engines	version Ducellier						815 054							
ENGINE														
1.5	Petrol	75	07/86-12/89	AR 30588										
Engine	Information				A10	A20	A40	A50	A70	C10 - C30	C20	E01		
All engines	version Bosch						806 079	906 061R						
All engines	version Ducellier						815 054							

A10 CONDENSER	A20 CONTACT SET	A40 DISTRIBUTOR CAP	A50 ROTOR	A70 PICK-UP
C10 COIL	C20 IGNITION MODULE	C30 ELECTRONIC IGNITION KIT	E01 IGNITION CABLE SET	

The present application list is a brief version. For the detailed information about the possibility of installation on a specific vehicle, please refer to our web-catalogue <http://catalogo.facet.eu/>

				FUNCTIONS ON THE VEHICLE								
Vehicle	alim.	kW	Date	Engine								
				ENGINE								
1.5	Petrol	77	12/86-12/89	AR 30588								
Engine		Information		A10	A20	A40	A50	A70	C10 - C30	C20	E01	
All engines		version Bosch				806 079	906 061R					
All engines		version Ducellier				815 054						
				ENGINE								
1.5 4x4	Petrol	75	07/86-12/89	AR 30588								
Engine		Information		A10	A20	A40	A50	A70	C10 - C30	C20	E01	
All engines		version Bosch				806 079	906 061R					
All engines		version Ducellier				815 054						
				ENGINE								
1.5 4x4	Petrol	77	09/86-12/89	AR 30508, AR 30588								
Engine		Information		A10	A20	A40	A50	A70	C10 - C30	C20	E01	
All engines		version Bosch				806 079	906 061R					
All engines		version Ducellier				815 054						
Eng. AR 30508		version Marelli					930 051R					
Eng. AR 30508		version Bosch						406 153				
Eng. AR 30508										465 005		
				ENGINE								
1.5 QV	Petrol	77	06/84-12/89	AR 30146, AR 30508, AR 30588								
Engine		Information		A10	A20	A40	A50	A70	C10 - C30	C20	E01	
All engines		version Bosch				806 079	906 061R					
All engines		version Ducellier				815 054						
				ENGINE								
1.7	Petrol	87	01/86-06/90	AR 30550								
Engine		Information		A10	A20	A40	A50	A70	C10 - C30	C20	E01	
All engines		version Bosch				806 079	906 061R					
All engines		version Ducellier				815 054						
				ENGINE								
1.7	Petrol	95	01/86-12/89	AR 30550								
Engine		Information		A10	A20	A40	A50	A70	C10 - C30	C20	E01	
All engines		version Bosch				806 079	906 061R					
All engines		version Ducellier				815 054						
				ENGINE								
1.7 i.e.	Petrol	77	09/88-12/89	AR 30558								
Engine		Information		A10	A20	A40	A50	A70	C10 - C30	C20	E01	
All engines		version Bosch				806 079	906 061R					
All engines		for emission-controlled vehicles, version Bosch					906 121R					
				ENGINE								
1.7 i.e. 4x4	Petrol	77	09/88-12/89	AR 30558								
Engine		Information		A10	A20	A40	A50	A70	C10 - C30	C20	E01	
All engines		version Bosch				806 079	906 061R					
All engines		for emission-controlled vehicles, version Bosch					906 121R					
				ENGINE								
1.7 QV	Petrol	84	03/88-12/89	AR 30550								
Engine		Information		A10	A20	A40	A50	A70	C10 - C30	C20	E01	
All engines		version Bosch				806 079	906 061R					
All engines		version Ducellier				815 054						
				ENGINE								
				ENGINE								
				ENGINE								
1.2	Petrol	57	01/90-08/91	AR 30743								
Engine		Information		A10	A20	A40	A50	A70	C10 - C30	C20	E01	
All engines		version Bosch				806 079	906 061R					
				ENGINE								
1.3	Petrol	66	09/91-10/94	AR 30732								
Engine		Information		A10	A20	A40	A50	A70	C10 - C30	C20	E01	
All engines		version Bosch				806 079	906 061R					
				ENGINE								
1.4 4x4	Petrol	66	07/90-12/92	AR 30755								
Engine		Information		A10	A20	A40	A50	A70	C10 - C30	C20	E01	
All engines		version Bosch				806 079	906 121R					
				ENGINE								
				ENGINE								
				ENGINE								
A10		A20		A40		A50		A70				
CONDENSER		CONTACT SET		DISTRIBUTOR CAP		ROTOR		PICK-UP				
C10		C20		C30		E01						
COIL		IGNITION MODULE		ELECTRONIC IGNITION KIT		IGNITION CABLE SET						

Vehicle	alim.	kW	Date	Engine	FUNCTIONS ON THE VEHICLE								
					A10	A20	A40	A50	A70	C10 - C30	C20	E01	
1.4 i.e.	Petrol	65	06/91-09/94	ENGINE AR 30753, AR 30755									
Engine	Information			A10	A20	A40	A50	A70	C10 - C30	C20	E01		
Eng. AR 30755	version Bosch					806 079	906 121R						
Eng. AR 30753	Qty: 2								470 146	C10			
1.4 i.e.	Petrol	66	06/91-09/94	ENGINE AR 30753, AR 30755									
Engine	Information			A10	A20	A40	A50	A70	C10 - C30	C20	E01		
Eng. AR 30755	version Bosch					806 079	906 121R						
Eng. AR 30753	Qty: 2								470 146	C10			
1.4 i.e. 4x4	Petrol	66	07/90-09/94	ENGINE AR 30755									
Engine	Information			A10	A20	A40	A50	A70	C10 - C30	C20	E01		
All engines	version Bosch					806 079	906 121R						
1.5	Petrol	77	01/90-04/93	ENGINE AR 30734									
Engine	Information			A10	A20	A40	A50	A70	C10 - C30	C20	E01		
All engines	version Bosch					806 079	906 061R						
1.5 i.e.	Petrol	71	01/90-09/94	ENGINE AR 30751									
Engine	Information			A10	A20	A40	A50	A70	C10 - C30	C20	E01		
All engines	version Bosch					806 079	906 121R						
1.5 i.e.	Petrol	70	09/91-12/95	ENGINE AR 30738									
Engine	Information			A10	A20	A40	A50	A70	C10 - C30	C20	E01		
All engines									470 168	C10			
1.5 i.e.	Petrol	74	07/90-08/91	ENGINE AR 30750									
Engine	Information			A10	A20	A40	A50	A70	C10 - C30	C20	E01		
All engines	version Bosch					806 079	906 121R						
1.7 16V	Petrol	101	01/90-09/94	ENGINE AR 30746									
Engine	Information			A10	A20	A40	A50	A70	C10 - C30	C20	E01		
All engines	version Bosch					806 079	906 123R						
1.7 16V	Petrol	95	01/90-09/94	ENGINE AR 30747									
Engine	Information			A10	A20	A40	A50	A70	C10 - C30	C20	E01		
All engines	version Bosch					806 079	906 123R						
1.7 16V	Petrol	97	01/90-09/94	ENGINE AR 30747									
Engine	Information			A10	A20	A40	A50	A70	C10 - C30	C20	E01		
All engines	version Bosch					806 079	906 123R						
1.7 16V 4x4	Petrol	101	01/90-09/94	ENGINE AR 30746									
Engine	Information			A10	A20	A40	A50	A70	C10 - C30	C20	E01		
All engines	version Bosch					806 079	906 123R						
1.7 16V 4x4	Petrol	95	01/90-09/94	ENGINE AR 30747									
Engine	Information			A10	A20	A40	A50	A70	C10 - C30	C20	E01		
All engines	version Bosch					806 079	906 123R						
1.7 16V 4x4	Petrol	97	01/90-09/94	ENGINE AR 30747									
Engine	Information			A10	A20	A40	A50	A70	C10 - C30	C20	E01		
All engines	version Bosch					806 079	906 123R						
1.7 i.e.	Petrol	77	09/91-12/95	ENGINE AR 30737, AR 30740									
Engine	Information			A10	A20	A40	A50	A70	C10 - C30	C20	E01		
Eng. AR 30737	version Bosch					806 079	906 121R						
Eng. AR 30740									470 168	C10			

A10 CONDENSER	A20 CONTACT SET	A40 DISTRIBUTOR CAP	A50 ROTOR	A70 PICK-UP
C10 COIL	C20 IGNITION MODULE	C30 ELECTRONIC IGNITION KIT	E01 IGNITION CABLE SET	

The present application list is a brief version. For the detailed information about the possibility of installation on a specific vehicle, please refer to our web-catalogue <http://catalogo.facet.eu/>

Vehicle	alim.	kW	Date	Engine	FUNCTIONS ON THE VEHICLE									
					A10	A20	A40	A50	A70	C10 - C30	C20	E01		
ENGINE														
1.7 i.e.	Petrol	79	01/90-09/94	AR 30736, AR 30737										
Engine	Information				A10	A20	A40	A50	A70	C10 - C30	C20	E01		
All engines	version Bosch						806 079	906 121R						
ENGINE														
1.7 i.e. 4x4	Petrol	79	01/90-09/94	AR 30736, AR 30737										
Engine	Information				A10	A20	A40	A50	A70	C10 - C30	C20	E01		
All engines	version Bosch						806 079	906 121R						
ENGINE														
4C														
ENGINE														
1.8	Petrol	177	03/13-12/20	960 A1.000										
Engine	Information				A10	A20	A40	A50	A70	C10 - C30	C20	E01		
All engines	x 4, COIL ON PLUG, x 4, COIL ON PLUG									470 549	C10			
ENGINE														
6														
ENGINE														
2.0	Petrol	99	07/81-12/86	AR 01932										
Engine	Information				A10	A20	A40	A50	A70	C10 - C30	C20	E01		
All engines	version Bosch						806 081	906 024R						
ENGINE														
75														
ENGINE														
1.6	Petrol	81	05/85-09/89	AR 06100										
Engine	Information				A10	A20	A40	A50	A70	C10 - C30	C20	E01		
All engines	version Bosch						806 079	906 055R	406 153					
All engines													359 716	
ENGINE														
1.6 Cat	Petrol	81	05/89-02/92	AR 61101										
Engine	Information				A10	A20	A40	A50	A70	C10 - C30	C20	E01		
All engines	version Bosch						806 079							
ENGINE														
1.8	Petrol	85	09/85-06/89	AR 06202										
Engine	Information				A10	A20	A40	A50	A70	C10 - C30	C20	E01		
All engines	version Bosch						806 079		406 153					
All engines	LHD, version Bosch							906 061R						
All engines	RHD, version Bosch							906 121R						
All engines	version Marelli							930 054R						
All engines													359 716	
ENGINE														
1.8	Petrol	88	09/88-02/92	AR 06168, AR 61102										
Engine	Information				A10	A20	A40	A50	A70	C10 - C30	C20	E01		
All engines	version Bosch						806 079							
Eng. AR 06168	version Bosch							906 055R						
ENGINE														
1.8	Petrol	90	08/89-02/92	AR 61201										
Engine	Information				A10	A20	A40	A50	A70	C10 - C30	C20	E01		
All engines	version Bosch						806 079							
ENGINE														
1.8 i.e.	Petrol	88	08/89-02/92	61202										
Engine	Information				A10	A20	A40	A50	A70	C10 - C30	C20	E01		
All engines	version Bosch						806 079							
ENGINE														
1.8 i.e. Turbo America	Petrol	118	02/86-01/90	61203										
Engine	Information				A10	A20	A40	A50	A70	C10 - C30	C20	E01		
All engines	version Bosch						806 079	906 121R						
ENGINE														
1.8 Turbo	Petrol	110	09/86-02/92	AR 06134										
Engine	Information				A10	A20	A40	A50	A70	C10 - C30	C20	E01		
All engines	version Bosch						806 079	906 121R						
ENGINE														
2.0 T.S Cat	Petrol	109	05/85-02/92	AR 06224										
Engine	Information				A10	A20	A40	A50	A70	C10 - C30	C20	E01		
All engines	Qty: 2, version Bosch						806 079							
A10	CONDENSER		A20	CONTACT SET		A40	DISTRIBUTOR CAP		A50	ROTOR		A70	PICK-UP	
C10	COIL		C20	IGNITION MODULE		C30	ELECTRONIC IGNITION KIT		E01	IGNITION CABLE SET				

Vehicle	alim.	kW	Date	Engine	FUNCTIONS ON THE VEHICLE									
					A10	A20	A40	A50	A70	C10 - C30	C20	E01		
ENGINE														
2.0 T.S.	Petrol	107	01/87-02/92	AR 06166, AR 06224										
Engine	Information				A10	A20	A40	A50	A70	C10 - C30	C20	E01		
All engines	Qty: 2, version Bosch						806 079							
ENGINE														
2.0 T.S.	Petrol	109	01/87-12/88	AR 06224										
Engine	Information				A10	A20	A40	A50	A70	C10 - C30	C20	E01		
All engines	Qty: 2, version Bosch						806 079							
ENGINE														
2.5 V6	Petrol	110	05/85-08/86	AR 01646, AR 01648, AR 01911										
Engine	Information				A10	A20	A40	A50	A70	C10 - C30	C20	E01		
All engines	version Bosch						806 081							
Eng. AR 01911	version Bosch							906 113R						
All engines												359 660		
ENGINE														
3.0 V6	Petrol	136	01/87-12/90	AR 06120										
Engine	Information				A10	A20	A40	A50	A70	C10 - C30	C20	E01		
All engines	version Bosch						806 081	906 113R						
All engines												359 660		
ENGINE														
3.0 V6	Petrol	141	02/90-02/92	AR 61503										
Engine	Information				A10	A20	A40	A50	A70	C10 - C30	C20	E01		
All engines	version Bosch						806 081	906 113R						
All engines												359 660		
ENGINE														
3.0 V6 Cat	Petrol	136	01/87-02/92	AR 06124										
Engine	Information				A10	A20	A40	A50	A70	C10 - C30	C20	E01		
All engines	version Bosch						806 081	906 113R						
All engines												359 660		
90														
ENGINE														
1.8	Petrol	85	10/84-07/87	AR 06202										
Engine	Information				A10	A20	A40	A50	A70	C10 - C30	C20	E01		
All engines	version Bosch						806 079	906 061R	406 153					
All engines	FOR: (CH), version Bosch							906 121R						
All engines	version Marelli							930 054R						
ENGINE														
1.8	Petrol	89	10/84-07/87	AR 06202										
Engine	Information				A10	A20	A40	A50	A70	C10 - C30	C20	E01		
All engines	version Bosch						806 079	906 061R	406 153					
All engines	FOR: (CH), version Bosch							906 121R						
All engines	version Marelli							930 054R						
ENGINE														
2.0 i.e.	Petrol	97	10/84-07/87	AR 06210										
Engine	Information				A10	A20	A40	A50	A70	C10 - C30	C20	E01		
All engines	version Bosch						806 079	906 061R	406 153					
All engines	FOR: (CH), version Bosch							906 121R						
All engines	version Marelli							930 054R						
ENGINE														
2.5 i.e. V6	Petrol	110	10/84-07/87	AR 01646										
Engine	Information				A10	A20	A40	A50	A70	C10 - C30	C20	E01		
All engines	version Bosch						806 081							
ALFASUD														
ENGINE														
1.2	Petrol	46	06/72-09/84	AR 30102										
Engine	Information				A10	A20	A40	A50	A70	C10 - C30	C20	E01		
All engines	version Duellier				615 034		815 049							
All engines	version Marelli				630 117									
All engines	version Bosch					706 034HVS	806 079							
All engines										470 101D	C10			

A10	CONDENSER	A20	CONTACT SET	A40	DISTRIBUTOR CAP	A50	ROTOR	A70	PICK-UP
C10	COIL	C20	IGNITION MODULE	C30	ELECTRONIC IGNITION KIT	E01	IGNITION CABLE SET		

The present application list is a brief version. For the detailed information about the possibility of installation on a specific vehicle, please refer to our web-catalogue <http://catalogo.facet.eu/>









					FUNCTIONS ON THE VEHICLE							
Vehicle	alim.	kW	Date	Engine								
ENGINE												
1.5 ti	Petrol	70	05/80-06/84	AR 30128								
Engine	Information			A10	A20	A40	A50	A70	C10 - C30	C20	E01	
All engines	version Bosch					806 079		406 153				
All engines	version Ducellier					815 054						
All engines	version Marelli						930 051R					
ALFETTA												
ENGINE												
1.6	Petrol	79	01/75-12/84	AR 01600								
Engine	Information			A10	A20	A40	A50	A70	C10 - C30	C20	E01	
All engines	version Bosch					806 079	906 061R	406 153				
All engines	version Marelli						930 054R					
ENGINE												
1.8	Petrol	85	07/74-04/82	AR 01608 X								
Engine	Information			A10	A20	A40	A50	A70	C10 - C30	C20	E01	
All engines	version Marelli			630 117			930 042R					
All engines	version Bosch				706 034HVS	806 079	906 025R					
All engines								470 101D	C10			
ENGINE												
1.8	Petrol	89	10/79-12/84	AR 01608								
Engine	Information			A10	A20	A40	A50	A70	C10 - C30	C20	E01	
All engines	version Bosch					806 079	906 061R	406 153				
All engines	version Marelli						930 054R					
BRERA												
ENGINE												
1.8 TBi	Petrol	147	05/09-06/10	939 B1.000								
Engine	Information			A10	A20	A40	A50	A70	C10 - C30	C20	E01	
All engines	x 4, COIL ON PLUG								470 549	C10		
GIULIA												
ENGINE												
1300 Super	Petrol	64	01/74-12/78	AR 00530								
Engine	Information			A10	A20	A40	A50	A70	C10 - C30	C20	E01	
All engines					706 029HV							
ENGINE												
1300 TI	Petrol	62	04/69-07/75	--								
Engine	Information			A10	A20	A40	A50	A70	C10 - C30	C20	E01	
All engines					706 029HV							
ENGINE												
1600 Super	Petrol	71	06/64-08/69	AR 00526								
Engine	Information			A10	A20	A40	A50	A70	C10 - C30	C20	E01	
All engines					706 047							
GIULIETTA I												
ENGINE												
1.3	Petrol	66	10/77-06/83	AR 01644								
Engine	Information			A10	A20	A40	A50	A70	C10 - C30	C20	E01	
All engines	version Marelli			630 117			930 042R					
All engines	version Bosch				706 034HVS	806 079	906 025R					
All engines								470 101D	C10			
ENGINE												
1.6	Petrol	79	10/77-04/85	AR 01600								
Engine	Information			A10	A20	A40	A50	A70	C10 - C30	C20	E01	
All engines	version Bosch					806 079	906 061R	406 153				
All engines	version Marelli						930 054R					
ENGINE												
1.8	Petrol	90	04/79-04/85	AR 01678								
Engine	Information			A10	A20	A40	A50	A70	C10 - C30	C20	E01	
All engines	version Bosch					806 079	906 061R	406 153				
All engines	version Marelli						930 054R					
ENGINE												
2.0	Petrol	96	06/80-04/85	AR 01655								
Engine	Information			A10	A20	A40	A50	A70	C10 - C30	C20	E01	
All engines	version Bosch					806 079	906 061R	406 153				

A10 CONDENSER	A20 CONTACT SET	A40 DISTRIBUTOR CAP	A50 ROTOR	A70 PICK-UP
C10 COIL	C20 IGNITION MODULE	C30 ELECTRONIC IGNITION KIT	E01 IGNITION CABLE SET	

Vehicle	alim.	kW	Date	Engine	FUNCTIONS ON THE VEHICLE									
					A10	A20	A40	A50	A70	C10 - C30	C20	E01		
ENGINE														
2.0	Petrol	96	06/80-04/85	AR 01655										
Engine					A10	A20	A40	A50	A70	C10 - C30	C20	E01		
All engines								930 054R						
GIULIETTA II														
ENGINE														
1.4	Petrol	125	04/11-12/20	940 A2.000										
Engine					A10	A20	A40	A50	A70	C10 - C30	C20	E01		
All engines										470 549	C10			
ENGINE														
1.4 TB	Petrol	110	09/14-10/18	940 C2.000										
Engine					A10	A20	A40	A50	A70	C10 - C30	C20	E01		
All engines										470 549	C10			
ENGINE														
1.4 TB	Petrol	120	04/10-10/18	955 A8.000										
Engine					A10	A20	A40	A50	A70	C10 - C30	C20	E01		
All engines										470 549	C10			
ENGINE														
1.4 TB	Petrol	125	04/10-10/18	940 A2.000										
Engine					A10	A20	A40	A50	A70	C10 - C30	C20	E01		
All engines										470 549	C10			
ENGINE														
1.8	Petrol	173	04/11-02/16	940 A1.000										
Engine					A10	A20	A40	A50	A70	C10 - C30	C20	E01		
All engines										470 549	C10			
ENGINE														
1.8 TBi	Petrol	169	04/10-09/13	940 A1.000										
Engine					A10	A20	A40	A50	A70	C10 - C30	C20	E01		
All engines										470 549	C10			
ENGINE														
1.8 TBi	Petrol	173	04/10-02/16	940 A1.000										
Engine					A10	A20	A40	A50	A70	C10 - C30	C20	E01		
All engines										470 549	C10			
ENGINE														
1.8 TBi	Petrol	177	09/13-10/18	940 B2.000, 960 A1.000										
Engine					A10	A20	A40	A50	A70	C10 - C30	C20	E01		
Eng. 940 B2.000										470 549	C10			
Eng. 960 A1.000										470 549	C10			
GT														
ENGINE														
1.8	Petrol	80	04/68-11/71	AR 10525										
Engine					A10	A20	A40	A50	A70	C10 - C30	C20	E01		
All engines						706 047								
ENGINE														
1.8 TS	Petrol	103	11/03-09/10	AR 32205										
Engine					A10	A20	A40	A50	A70	C10 - C30	C20	E01		
All engines										470 397	C10			
All engines													360 607	
ENGINE														
1300 Junior	Petrol	64	01/66-12/77	AR 00530										
Engine					A10	A20	A40	A50	A70	C10 - C30	C20	E01		
All engines						706 047	806 062							
All engines							806 076							
ENGINE														
1600	Petrol	75	03/63-12/66	AR 00526 S										
Engine					A10	A20	A40	A50	A70	C10 - C30	C20	E01		
All engines							806 076							

A10	CONDENSER	A20	CONTACT SET	A40	DISTRIBUTOR CAP	A50	ROTOR	A70	PICK-UP
C10	COIL	C20	IGNITION MODULE	C30	ELECTRONIC IGNITION KIT	E01	IGNITION CABLE SET		

The present application list is a brief version. For the detailed information about the possibility of installation on a specific vehicle, please refer to our web-catalogue <http://catalogo.facet.eu/>

					FUNCTIONS ON THE VEHICLE							
Vehicle	alim.	kW	Date	Engine								
ENGINE												
3.2 GTA	Petrol	176	11/03-09/10	936 A.000								
Engine	Information				A10	A20	A40	A50	A70	C10 - C30	C20	E01
All engines	x 6, COIL ON PLUG									470 313	C10	
ENGINE												
A 1600	Petrol	83	01/65-12/70	AR 10538								
Engine	Information				A10	A20	A40	A50	A70	C10 - C30	C20	E01
All engines	version BOSCH						806 076					
ENGINE												
V 1750	Petrol	83	01/67-12/72	AR 00548								
Engine	Information				A10	A20	A40	A50	A70	C10 - C30	C20	E01
All engines						706 047						
GTV												
ENGINE												
1.8 16V	Petrol	106	05/98-10/05	AR 32201								
Engine	Information				A10	A20	A40	A50	A70	C10 - C30	C20	E01
All engines	x 4, SEMI-DIRECT									470 387	C10	
All engines												360 608
ENGINE												
2.0 T.SPARK 16V	Petrol	110	06/95-10/05	AR 16201, AR 32310								
Engine	Information				A10	A20	A40	A50	A70	C10 - C30	C20	E01
Eng. AR 16201	->year 01/08/98, x 4, SEMI-DIRECT									470 386	C10	
Eng. AR 16201	01/09/98 ->, x 4, SEMI-DIRECT									470 387	C10	
Eng. AR 32310	x 4, COIL ON PLUG									470 397	C10	
Eng. AR 32310												360 607
Eng. AR 16201												360 608
ENGINE												
2.0 T.SPARK 16V	Petrol	114	09/97-03/03	AR 32301								
Engine	Information				A10	A20	A40	A50	A70	C10 - C30	C20	E01
All engines	x 4, SEMI-DIRECT									470 387	C10	
All engines												360 608
ENGINE												
2.0 V6 Turbo	Petrol	148	06/95-09/98	AR 16202								
Engine	Information				A10	A20	A40	A50	A70	C10 - C30	C20	E01
All engines	version Bosch						806 236	906 119R				
ENGINE												
3.0 V6 24V	Petrol	160	10/00-10/05	AR 16105								
Engine	Information				A10	A20	A40	A50	A70	C10 - C30	C20	E01
All engines	x 6, COIL ON PLUG									470 313	C10	
ENGINE												
3.0 V6 24V	Petrol	162	10/96-10/00	AR 16102								
Engine	Information				A10	A20	A40	A50	A70	C10 - C30	C20	E01
All engines	x 6, COIL ON PLUG									470 313	C10	
ENGINE												
3.2 V6 24V	Petrol	176	04/03-10/05	936 A6.000								
Engine	Information				A10	A20	A40	A50	A70	C10 - C30	C20	E01
All engines	x 6, COIL ON PLUG									470 313	C10	
MITO												
ENGINE												
1.4	Petrol	51	05/11-10/18	955 A9.000								
Engine	Information				A10	A20	A40	A50	A70	C10 - C30	C20	E01
All engines	x 1, D.I.S.									470 423	C10	
All engines												358 170
ENGINE												
1.4	Petrol	57	03/11->	04Y, 350 A1.000								
Engine	Information				A10	A20	A40	A50	A70	C10 - C30	C20	E01
Eng. 350 A1.000	x 1, D.I.S.									470 423	C10	
All engines												358 170

A10 CONDENSER	A20 CONTACT SET	A40 DISTRIBUTOR CAP	A50 ROTOR	A70 PICK-UP
C10 COIL	C20 IGNITION MODULE	C30 ELECTRONIC IGNITION KIT	E01 IGNITION CABLE SET	

Vehicle	alim.	kW	Date	Engine	FUNCTIONS ON THE VEHICLE									
					A10	A20	A40	A50	A70	C10 - C30	C20	E01		
1.4	Petrol	58	08/08-08/13	ENGINE 04Y, 955A1000										
Engine	Information				A10	A20	A40	A50	A70	C10 - C30	C20	E01		
Eng. 955A1000	x 4, COIL ON PLUG, incl. spark plug connector									470 442	C10			
Eng. 04Y													358 170	
1.4	Petrol	70	09/08-08/13	ENGINE 199 A6.000										
Engine	Information				A10	A20	A40	A50	A70	C10 - C30	C20	E01		
All engines	x 4, COIL ON PLUG, incl. spark plug connector									470 442	C10			
1.4 MultiAir	Petrol	125	09/09-10/18	ENGINE 940 A2.000										
Engine	Information				A10	A20	A40	A50	A70	C10 - C30	C20	E01		
All engines	x 4, COIL ON PLUG									470 549	C10			
1.4 TB	Petrol	103	12/13-10/18	ENGINE 955 B1.000										
Engine	Information				A10	A20	A40	A50	A70	C10 - C30	C20	E01		
All engines	euro 6, euro5/euro6, x 4, COIL ON PLUG									470 549	C10			
1.4 Turbo MultiAir	Petrol	120	10/09-10/18	ENGINE 955 A8.000										
Engine	Information				A10	A20	A40	A50	A70	C10 - C30	C20	E01		
All engines	x 4, COIL ON PLUG									470 549	C10			
1.4 Turbo MultiAir	Petrol	99	10/09-12/14	ENGINE 955 A2.000, 955 A7.000										
Engine	Information				A10	A20	A40	A50	A70	C10 - C30	C20	E01		
All engines	x 4, COIL ON PLUG									470 549	C10			
SPIDER I														
1.7	Petrol	80	04/68-11/71	ENGINE AR 10525										
Engine	Information				A10	A20	A40	A50	A70	C10 - C30	C20	E01		
All engines						706 047								
1300	Petrol	64	01/68-12/77	ENGINE AR 00530										
Engine	Information				A10	A20	A40	A50	A70	C10 - C30	C20	E01		
All engines						706 047								
1600	Petrol	76	03/76-12/90	ENGINE AR 00526										
Engine	Information				A10	A20	A40	A50	A70	C10 - C30	C20	E01		
All engines	version Bosch						806 079	906 055R	406 153					
1600	Petrol	79	01/90-12/93	ENGINE AR 01563										
Engine	Information				A10	A20	A40	A50	A70	C10 - C30	C20	E01		
All engines	version Bosch						806 079	906 055R	406 153					
1600	Petrol	80	03/66-12/68	ENGINE AR 00526, AR 00536, AR 01600										
Engine	Information				A10	A20	A40	A50	A70	C10 - C30	C20	E01		
All engines						706 047								
1750	Petrol	83	01/67-12/71	ENGINE AR 00548										
Engine	Information				A10	A20	A40	A50	A70	C10 - C30	C20	E01		
All engines						706 047								
2.0i [CAN]	Petrol	88	09/90-10/93	ENGINE AR 01588										
Engine	Information				A10	A20	A40	A50	A70	C10 - C30	C20	E01		
All engines	version Bosch						806 079	906 123R						
2.0i [USA]	Petrol	88	09/90-10/93	ENGINE AR 01588										
Engine	Information				A10	A20	A40	A50	A70	C10 - C30	C20	E01		
All engines	version Bosch						806 079	906 123R						

A10 CONDENSER	A20 CONTACT SET	A40 DISTRIBUTOR CAP	A50 ROTOR	A70 PICK-UP
C10 COIL	C20 IGNITION MODULE	C30 ELECTRONIC IGNITION KIT	E01 IGNITION CABLE SET	

The present application list is a brief version. For the detailed information about the possibility of installation on a specific vehicle, please refer to our web-catalogue <http://catalogo.facet.eu/>

Vehicle	alim.	kW	Date	Engine	FUNCTIONS ON THE VEHICLE							
					A10	A20	A40	A50	A70	C10 - C30	C20	E01

ENGINE				
2.0i Veloce [CAN]	Petrol	88	09/90-10/93	AR 01588

Engine	Information	A10	A20	A40	A50	A70	C10 - C30	C20	E01
All engines	version Bosch			806 079	906 123R				

ENGINE				
2.0i Veloce [USA]	Petrol	88	09/90-10/93	AR 01588

Engine	Information	A10	A20	A40	A50	A70	C10 - C30	C20	E01
All engines	version Bosch			806 079	906 123R				

ENGINE				
2000	Petrol	85	08/86-12/90	AR 01544

Engine	Information	A10	A20	A40	A50	A70	C10 - C30	C20	E01
All engines	version Bosch			806 079	906 055R				

ENGINE				
2000	Petrol	88	01/90-12/93	AR 01588

Engine	Information	A10	A20	A40	A50	A70	C10 - C30	C20	E01
All engines	version Bosch			806 079					

ENGINE				
2000	Petrol	93	01/77-12/93	AR 01590

Engine	Information	A10	A20	A40	A50	A70	C10 - C30	C20	E01
All engines	version Bosch			806 079					

SPIDER II

ENGINE				
1.8 16V	Petrol	106	05/98-04/05	AR 32201

Engine	Information	A10	A20	A40	A50	A70	C10 - C30	C20	E01
All engines	x 4, SEMI-DIRECT						470 387	C10	
All engines									360 608

ENGINE				
2.0 T.SPARK 16V	Petrol	110	06/95-04/05	AR 16201, AR 32310

Engine	Information	A10	A20	A40	A50	A70	C10 - C30	C20	E01
Eng. AR 16201	x 2, SEMI-DIRECT						470 386	C10	
Eng. AR 32310	x 4, COIL ON PLUG						470 397	C10	
Eng. AR 32310									360 607
Eng. AR 16201									360 608

ENGINE				
2.0 T.SPARK 16V	Petrol	114	05/98-08/00	AR 32301

Engine	Information	A10	A20	A40	A50	A70	C10 - C30	C20	E01
All engines	x 4, SEMI-DIRECT						470 387	C10	
All engines									360 608

ENGINE				
2.0 V6 Turbo	Petrol	148	05/98-04/05	AR 16202

Engine	Information	A10	A20	A40	A50	A70	C10 - C30	C20	E01
All engines	version Bosch			806 236	906 119R				

ENGINE				
3.0 V6	Petrol	160	09/94-04/05	AR 16105

Engine	Information	A10	A20	A40	A50	A70	C10 - C30	C20	E01
All engines	x 6, COIL ON PLUG						470 313	C10	

ENGINE				
3.0 V6 24V	Petrol	162	01/99-10/03	AR 16102

Engine	Information	A10	A20	A40	A50	A70	C10 - C30	C20	E01
All engines	x 6, COIL ON PLUG						470 313	C10	

ENGINE				
3.2 V6 24V	Petrol	176	04/03-04/05	936 A6.000

Engine	Information	A10	A20	A40	A50	A70	C10 - C30	C20	E01
All engines	x 6, COIL ON PLUG						470 313	C10	

SPIDER III

ENGINE				
1.8 TBi	Petrol	147	05/09-03/11	939 B1.000

Engine	Information	A10	A20	A40	A50	A70	C10 - C30	C20	E01
All engines	x 4, COIL ON PLUG						470 549	C10	

A10 CONDENSER	A20 CONTACT SET	A40 DISTRIBUTOR CAP	A50 ROTOR	A70 PICK-UP
C10 COIL	C20 IGNITION MODULE	C30 ELECTRONIC IGNITION KIT	E01 IGNITION CABLE SET	

Vehicle	alim.	kW	Date	Engine	FUNCTIONS ON THE VEHICLE							
					A10	A20	A40	A50	A70	C10 - C30	C20	E01

B6

				ENGINE
4.4 Biturbo 4x4 [USA]	Petrol	441	03/14->	N63 M20 A

Engine	Information	A10	A20	A40	A50	A70	C10 - C30	C20	E01
All engines	Qty: 8						470 475	C10	

B7

				ENGINE
4.4 BiTurbo [USA]	Petrol	441	01/11->	N63 M20 A

Engine	Information	A10	A20	A40	A50	A70	C10 - C30	C20	E01
All engines	Qty: 8						470 475	C10	

				ENGINE
4.4 BiTurbo 4x4 [USA]	Petrol	441	01/12->	N63 M20 A

Engine	Information	A10	A20	A40	A50	A70	C10 - C30	C20	E01
All engines	Qty: 8						470 475	C10	

				ENGINE
BITURBO	Petrol	373	03/09-06/12	N63 M10 A

Engine	Information	A10	A20	A40	A50	A70	C10 - C30	C20	E01
All engines	Qty: 8						470 475	C10	

				ENGINE
BITURBO Trazione integrale	Petrol	373	09/10-06/12	N63 M10 A

Engine	Information	A10	A20	A40	A50	A70	C10 - C30	C20	E01
All engines	Qty: 8						470 475	C10	

A10 CONDENSER	A20 CONTACT SET	A40 DISTRIBUTOR CAP	A50 ROTOR	A70 PICK-UP
C10 COIL	C20 IGNITION MODULE	C30 ELECTRONIC IGNITION KIT	E01 IGNITION CABLE SET	

The present application list is a brief version. For the detailed information about the possibility of installation on a specific vehicle, please refer to our web-catalogue <http://catalogo.facet.eu/>

Vehicle	alim.	kW	Date	Engine	FUNCTIONS ON THE VEHICLE							
					A10	A20	A40	A50	A70	C10 - C30	C20	E01

V6				
GT	Petrol	116	01/85-12/90	ENGINE Z6W

Engine	Information	A10	A20	A40	A50	A70	C10 - C30	C20	E01
All engines	version Bosch				906 023R				

TURBO				
TURBO	Petrol	147	01/88-12/90	ENGINE Z7U 730, Z7U 732, Z7U 734

Engine	Information	A10	A20	A40	A50	A70	C10 - C30	C20	E01
All engines	version Bosch			806 236	906 119R				
All engines							470 107	C10	

A10	CONDENSER	A20	CONTACT SET	A40	DISTRIBUTOR CAP	A50	ROTOR	A70	PICK-UP
C10	COIL	C20	IGNITION MODULE	C30	ELECTRONIC IGNITION KIT	E01	IGNITION CABLE SET		

Vehicle	alim.	kW	Date	Engine	FUNCTIONS ON THE VEHICLE							
					A10	A20	A40	A50	A70	C10 - C30	C20	E01

CYGNET

1.3	Petrol	72	04/11-10/13	ENGINE
				1NR-FE

Engine	Information	A10	A20	A40	A50	A70	C10 - C30	C20	E01
All engines	x 4, COIL ON PLUG						470 537	C10	

DB6

4.0	Petrol	210	10/64-12/70	ENGINE
				--, AJ6

Engine	Information	A10	A20	A40	A50	A70	C10 - C30	C20	E01
All engines			728 083MHV		928 007				

4.0	Petrol	243	10/64-12/70	ENGINE
				--, AJ6

Engine	Information	A10	A20	A40	A50	A70	C10 - C30	C20	E01
All engines			728 083MHV		928 007				

DBS

4.0	Petrol	210	01/66-12/72	ENGINE
				--, AJ6

Engine	Information	A10	A20	A40	A50	A70	C10 - C30	C20	E01
All engines					928 007				

A10	CONDENSER	A20	CONTACT SET	A40	DISTRIBUTOR CAP	A50	ROTOR	A70	PICK-UP
C10	COIL	C20	IGNITION MODULE	C30	ELECTRONIC IGNITION KIT	E01	IGNITION CABLE SET		

The present application list is a brief version. For the detailed information about the possibility of installation on a specific vehicle, please refer to our web-catalogue <http://catalogo.facet.eu/>

FUNCTIONS ON THE VEHICLE

Vehicle	alim.	kW	Date	Engine	 A10	 A20	 A40	 A50	 A70	 C10 - C30	 C20	 E01
---------	-------	----	------	--------	---	---	---	--	---	---	---	---

100 III

1.8	Petrol	55	08/82-12/87	ENGINE DR, RS
-----	--------	----	-------------	------------------

Engine	Information	A10	A20	A40	A50	A70	C10 - C30	C20	E01
Eng. DR	version Bosch			806 079	906 055R				
All engines					906 021R				
Eng. DR							470 132	C10	465 004

1.8	Petrol	65	02/86-07/90	ENGINE SH
-----	--------	----	-------------	--------------

Engine	Information	A10	A20	A40	A50	A70	C10 - C30	C20	E01
All engines	version Bosch			806 266	906 055R	406 219			
All engines							470 127	C10	465 007
									359 768

1.8	Petrol	66	08/83-12/90	ENGINE DS, JW, NP
-----	--------	----	-------------	----------------------

Engine	Information	A10	A20	A40	A50	A70	C10 - C30	C20	E01
All engines	version Bosch			806 129	906 055R	406 219			
Eng. NP	version Bosch			806 266					
Eng. DS, NP	version Ducellier			815 068	915 099R				
All engines					906 021R		470 127	C10	465 007
									359 768

1.8 Cat	Petrol	66	03/85-11/90	ENGINE 4B, PH
---------	--------	----	-------------	------------------

Engine	Information	A10	A20	A40	A50	A70	C10 - C30	C20	E01
All engines	version Bosch			806 266	906 055R	406 219			
All engines							470 127	C10	465 007
									359 768

1.8 Cat quattro	Petrol	66	08/85-11/90	ENGINE 4B, PH
-----------------	--------	----	-------------	------------------

Engine	Information	A10	A20	A40	A50	A70	C10 - C30	C20	E01
Eng. 4B	version Bosch			806 129	906 055R	406 219			
All engines							470 127	C10	359 768
Eng. 4B									465 007

1.8 quattro	Petrol	65	08/86-07/90	ENGINE SH
-------------	--------	----	-------------	--------------

Engine	Information	A10	A20	A40	A50	A70	C10 - C30	C20	E01
All engines	version Bosch			806 129	906 055R	406 219			
All engines	version Ducellier			815 068	915 099R				
All engines							470 127	C10	465 007
									359 768

1.8 quattro	Petrol	66	10/84-07/88	ENGINE JW, NP
-------------	--------	----	-------------	------------------

Engine	Information	A10	A20	A40	A50	A70	C10 - C30	C20	E01
Eng. NP	version Bosch			806 129	906 055R	406 219			
Eng. NP	version Ducellier			815 068	915 099R				
All engines					906 021R				
Eng. NP							470 127	C10	465 007
									359 768

1.9	Petrol	74	08/82-07/84	ENGINE WH
-----	--------	----	-------------	--------------

Engine	Information	A10	A20	A40	A50	A70	C10 - C30	C20	E01
All engines	version Bosch			806 093	906 059R				
All engines							470 132	C10	465 004

2.0	Petrol	85	08/84-12/87	ENGINE KP
-----	--------	----	-------------	--------------

Engine	Information	A10	A20	A40	A50	A70	C10 - C30	C20	E01
All engines	version Bosch			806 231					
All engines	ch. 44-G-000 001 ->, version Bosch				906 055R				
All engines	->ch. 44-F-300 000, version Bosch				906 116R				
All engines	->ch. 44-F-300 000						470 125	C10	
All engines	ch. 44-G-000 001 ->						470 127	C10	
All engines									465 007
									360 682

2.0 Cat	Petrol	85	01/88-11/90	ENGINE RT
---------	--------	----	-------------	--------------









Engine	Information	A10	A20	A40	A50	A70	C10 - C30	C20	E01
All engines	version Bosch			806 231					
All engines	version Bosch, distr. num. 034 905 206				906 055R	406 219			

A10 CONDENSER	A20 CONTACT SET	A40 DISTRIBUTOR CAP	A50 ROTOR	A70 PICK-UP
C10 COIL	C20 IGNITION MODULE	C30 ELECTRONIC IGNITION KIT	E01 IGNITION CABLE SET	

Vehicle	alim.	kW	Date	Engine	FUNCTIONS ON THE VEHICLE							
					A10	A20	A40	A50	A70	C10 - C30	C20	E01
ENGINE												
2.0 Cat	Petrol	85	01/88-11/90	RT								
Engine	Information				A10	A20	A40	A50	A70	C10 - C30	C20	E01
All engines	version Bosch, distr. num. 034 905 205 H							906 121R				
All engines												360 682
ENGINE												
2.0 E	Petrol	85	01/85-12/87	KP								
Engine	Information				A10	A20	A40	A50	A70	C10 - C30	C20	E01
All engines	version Bosch						806 231					
All engines	ch. 44-G-000 001 ->, version Bosch							906 055R				
All engines	->ch. 44-F-300 000, version Bosch							906 116R				
All engines	->ch. 44-F-300 000									470 125	C10	
All engines	ch. 44-G-000 001 ->									470 127	C10	
All engines											465 007	360 682
ENGINE												
2.0 E Cat	Petrol	85	01/88-11/90	RT								
Engine	Information				A10	A20	A40	A50	A70	C10 - C30	C20	E01
All engines	version Bosch						806 231					
All engines	version Bosch, distr. num. 034 905 206							906 055R	406 219			
All engines	version Bosch, distr. num. 034 905 205 H							906 121R				
All engines												360 682
ENGINE												
2.2	Petrol	85	10/84-09/86	KZ								
Engine	Information				A10	A20	A40	A50	A70	C10 - C30	C20	E01
All engines	version Bosch						806 093					
All engines	01/01/84 ->, version Bosch							906 059R				
All engines	->year 01/01/84, version Bosch							906 116R				
All engines										470 125	C10	465 004
ENGINE												
2.2 Cat	Petrol	101	06/89-11/90	KU								
Engine	Information				A10	A20	A40	A50	A70	C10 - C30	C20	E01
All engines	version Bosch						806 231	906 055R				
All engines										470 127	C10	465 007
All engines												360 682
ENGINE												
2.2 Cat quattro	Petrol	101	06/89-11/90	KU								
Engine	Information				A10	A20	A40	A50	A70	C10 - C30	C20	E01
All engines	version Bosch						806 231	906 055R				
All engines										470 127	C10	465 007
All engines												360 682
ENGINE												
2.2 E Turbo quattro	Petrol	121	08/86-11/90	MC								
Engine	Information				A10	A20	A40	A50	A70	C10 - C30	C20	E01
All engines	version Bosch						806 231	906 121R				
All engines												360 682
ENGINE												
2.2 Turbo	Petrol	121	08/86-11/90	MC								
Engine	Information				A10	A20	A40	A50	A70	C10 - C30	C20	E01
All engines	version Bosch						806 231	906 121R				
All engines												360 682
ENGINE												
2.2 Turbo quattro	Petrol	121	08/86-11/90	MC								
Engine	Information				A10	A20	A40	A50	A70	C10 - C30	C20	E01
All engines												360 682
ENGINE												
2.3	Petrol	100	08/86-11/90	NF								
Engine	Information				A10	A20	A40	A50	A70	C10 - C30	C20	E01
All engines	version Bosch						806 231	906 121R				
All engines												360 682
ENGINE												
2.3	Petrol	98	03/90-11/90	NF								
Engine	Information				A10	A20	A40	A50	A70	C10 - C30	C20	E01
All engines	version Bosch						806 231	906 121R				
All engines												360 682

A10 CONDENSER	A20 CONTACT SET	A40 DISTRIBUTOR CAP	A50 ROTOR	A70 PICK-UP
C10 COIL	C20 IGNITION MODULE	C30 ELECTRONIC IGNITION KIT	E01 IGNITION CABLE SET	

The present application list is a brief version. For the detailed information about the possibility of installation on a specific vehicle, please refer to our web-catalogue <http://catalogo.facet.eu/>

				FUNCTIONS ON THE VEHICLE								
Vehicle	alim.	kW	Date	Engine								
				ENGINE								
2.3 E	Petrol	100	10/86-11/90	NF								
Engine	Information			A10	A20	A40	A50	A70	C10 - C30	C20	E01	
All engines	version Bosch					806 231	906 121R					
All engines												360 682
				ENGINE								
2.3 E	Petrol	98	01/90-11/90	NF								
Engine	Information			A10	A20	A40	A50	A70	C10 - C30	C20	E01	
All engines	version Bosch					806 231	906 121R					
All engines												360 682
				ENGINE								
2.3 E quattro	Petrol	100	08/86-11/90	NF								
Engine	Information			A10	A20	A40	A50	A70	C10 - C30	C20	E01	
All engines	version Bosch					806 231	906 121R					
All engines												360 682
				ENGINE								
2.3 quattro	Petrol	98	01/90-11/90	NF								
Engine	Information			A10	A20	A40	A50	A70	C10 - C30	C20	E01	
All engines	version Bosch					806 231	906 121R					
All engines												360 682
				ENGINE								
100 IV												
1.6	Petrol	75	03/92-07/93	ABB								
Engine	Information			A10	A20	A40	A50	A70	C10 - C30	C20	E01	
All engines	version Bosch					806 266	906 055R					
All engines								470 127	C10	465 007		359 768
				ENGINE								
2.0	Petrol	74	12/90-07/94	AAE								
Engine	Information			A10	A20	A40	A50	A70	C10 - C30	C20	E01	
All engines	version Bosch					806 266	906 121R					
All engines												359 768
				ENGINE								
2.0 E	Petrol	74	09/91-07/94	AAE								
Engine	Information			A10	A20	A40	A50	A70	C10 - C30	C20	E01	
All engines	version Bosch					806 266	906 121R					
All engines												359 768
				ENGINE								
2.0 E	Petrol	85	12/90-07/94	AAD, ABK								
Engine	Information			A10	A20	A40	A50	A70	C10 - C30	C20	E01	
All engines	version Bosch, version Bosch					806 266						
All engines	version Bosch						906 121R					
All engines												359 768
				ENGINE								
2.0 E 16V	Petrol	103	01/92-07/94	ACE								
Engine	Information			A10	A20	A40	A50	A70	C10 - C30	C20	E01	
All engines	version Bosch					806 248						
All engines												360 356
				ENGINE								
2.0 E 16V quattro	Petrol	103	07/92-07/94	ACE								
Engine	Information			A10	A20	A40	A50	A70	C10 - C30	C20	E01	
All engines	version Bosch					806 248						
All engines												360 356
				ENGINE								
2.0 E quattro	Petrol	85	12/90-07/92	AAD								
Engine	Information			A10	A20	A40	A50	A70	C10 - C30	C20	E01	
All engines	version Bosch					806 094	906 121R					
All engines												359 768
				ENGINE								
2.3 E	Petrol	98	12/90-07/94	7M15A-FKS								
Engine	Information			A10	A20	A40	A50	A70	C10 - C30	C20	E01	
All engines	version Bosch					806 231	906 121R					
All engines												360 682

A10 CONDENSER	A20 CONTACT SET	A40 DISTRIBUTOR CAP	A50 ROTOR	A70 PICK-UP
C10 COIL	C20 IGNITION MODULE	C30 ELECTRONIC IGNITION KIT	E01 IGNITION CABLE SET	

Vehicle	alim.	kW	Date	Engine	FUNCTIONS ON THE VEHICLE									
					A10	A20	A40	A50	A70	C10 - C30	C20	E01		
ENGINE														
2.3 E quattro	Petrol	98	12/90-07/94	7M15A-FKS										
Engine	Information				A10	A20	A40	A50	A70	C10 - C30	C20	E01		
All engines	version Bosch						806 231	906 121R						
All engines													360 682	
ENGINE														
2.6	Petrol	102	07/93-07/94	ACZ										
Engine	Information				A10	A20	A40	A50	A70	C10 - C30	C20	E01		
All engines											465 051			
ENGINE														
2.6	Petrol	110	03/92-07/94	ABC										
Engine	Information				A10	A20	A40	A50	A70	C10 - C30	C20	E01		
All engines											465 051			
ENGINE														
2.6 E quattro	Petrol	102	08/93-07/94	ACZ										
Engine	Information				A10	A20	A40	A50	A70	C10 - C30	C20	E01		
All engines											465 051			
ENGINE														
2.6 quattro	Petrol	110	04/92-07/94	ABC										
Engine	Information				A10	A20	A40	A50	A70	C10 - C30	C20	E01		
All engines											465 051			
ENGINE														
2.8 E	Petrol	128	12/90-07/94	AAH										
Engine	Information				A10	A20	A40	A50	A70	C10 - C30	C20	E01		
All engines											465 051			
ENGINE														
2.8 E quattro	Petrol	128	12/90-07/94	AAH										
Engine	Information				A10	A20	A40	A50	A70	C10 - C30	C20	E01		
All engines											465 051			
200 II														
ENGINE														
2.2	Petrol	101	08/84-07/85	KU										
Engine	Information				A10	A20	A40	A50	A70	C10 - C30	C20	E01		
All engines	version Bosch						806 231	906 059R						
All engines										470 125	C10	465 004		
ENGINE														
2.2 Turbo	Petrol	121	08/85-09/91	MC										
Engine	Information				A10	A20	A40	A50	A70	C10 - C30	C20	E01		
All engines	version Bosch						806 231	906 121R						
ENGINE														
2.2 Turbo	Petrol	147	02/88-12/90	1B										
Engine	Information				A10	A20	A40	A50	A70	C10 - C30	C20	E01		
All engines	version Bosch						806 231	906 121R						
ENGINE														
2.2 Turbo quattro	Petrol	121	01/85-12/91	MC										
Engine	Information				A10	A20	A40	A50	A70	C10 - C30	C20	E01		
All engines	version Bosch						806 231							
All engines	01/01/86 ->, version Bosch							906 055R						
All engines	->year 01/01/86, version Bosch							906 059R						
All engines										470 126	C10			
ENGINE														
2.2 Turbo quattro	Petrol	147	02/88-11/90	1B										
Engine	Information				A10	A20	A40	A50	A70	C10 - C30	C20	E01		
All engines	version Bosch						806 231	906 121R						
80 II														
ENGINE														
1.3	Petrol	44	09/78-07/86	EP										
Engine	Information				A10	A20	A40	A50	A70	C10 - C30	C20	E01		
All engines	version Bosch						806 094	906 055R	406 219					
All engines	->ch. 81-F-220 000									470 125	C10			
All engines	ch. 81-G-000 001 ->									470 127	C10			

A10	CONDENSER	A20	CONTACT SET	A40	DISTRIBUTOR CAP	A50	ROTOR	A70	PICK-UP
C10	COIL	C20	IGNITION MODULE	C30	ELECTRONIC IGNITION KIT	E01	IGNITION CABLE SET		

The present application list is a brief version. For the detailed information about the possibility of installation on a specific vehicle, please refer to our web-catalogue <http://catalogo.facet.eu/>

FUNCTIONS ON THE VEHICLE

Vehicle	alim.	kW	Date	Engine								
---------	-------	----	------	--------	---	---	---	--	---	---	---	---

80 II				ENGINE
1.3	Petrol	44	09/78-07/86	EP

Engine	Information	A10	A20	A40	A50	A70	C10 - C30	C20	E01
All engines								465 007	359 768

80 II				ENGINE
1.6	Petrol	54	02/86-07/86	SA

Engine	Information	A10	A20	A40	A50	A70	C10 - C30	C20	E01
All engines	version Bosch			806 266	906 055R	406 219			
All engines	->ch. 81-F-220 000						470 125	C10	
All engines	ch. 81-G-000 001 ->						470 127	C10	
All engines								465 007	359 768

80 II				ENGINE
1.6	Petrol	55	08/78-03/87	DT, JU, WV

Engine	Information	A10	A20	A40	A50	A70	C10 - C30	C20	E01
Eng. WV	version Bosch, ->year 01/01/85			806 079					
All engines	version Bosch, 01/01/85 ->			806 094					
Eng. DT	version Ducellier			815 068	915 099R				
All engines	version Bosch				906 055R				
All engines	version Bosch, 01/01/83 ->, ->year 01/01/85					406 219			
Eng. WV	version Bosch, 01/01/85 ->					406 231			
All engines	01/01/85 ->, ->ch. 81-F-220 000						470 125	C10	
Eng. DT, JU	ch. 81-G-000 001 ->						470 127	C10	
Eng. WV	->year 01/01/85						470 132	C10	
Eng. WV								465 004	
Eng. DT, JU								465 007	
All engines									359 768

80 II				ENGINE
1.8	Petrol	65	02/86-07/86	SF

Engine	Information	A10	A20	A40	A50	A70	C10 - C30	C20	E01
All engines	version Bosch			806 266	906 055R	406 219			
All engines	->ch. 81-F-220 000						470 125	C10	
All engines	ch. 81-G-000 001 ->						470 127	C10	
All engines								465 007	359 768

80 II				ENGINE
1.8	Petrol	66	01/83-08/86	DS

Engine	Information	A10	A20	A40	A50	A70	C10 - C30	C20	E01
All engines	version Bosch			806 094	906 055R	406 219			
All engines	version Ducellier			815 068	915 099R				
All engines	->ch. 81-F-220 000						470 125	C10	
All engines	ch. 81-G-000 001 ->						470 127	C10	
All engines								465 007	359 768

80 II				ENGINE
1.8	Petrol	68	08/83-08/86	JN

Engine	Information	A10	A20	A40	A50	A70	C10 - C30	C20	E01
All engines	version Bosch			806 094	906 055R	406 219			
All engines	->ch. 81-F-220 000						470 125	C10	
All engines	ch. 81-G-000 001 ->						470 127	C10	
All engines								465 007	359 768

80 II				ENGINE
1.8 CC quattro	Petrol	66	08/84-08/86	JV

Engine	Information	A10	A20	A40	A50	A70	C10 - C30	C20	E01
All engines	ch. 81-G-000 001 ->, version Bosch			806 094					
All engines	->ch. 81-F-220 000, version Bosch				906 055R				
All engines	version Bosch					406 219			
All engines	->ch. 81-F-220 000						470 125	C10	
All engines	ch. 81-G-000 001 ->						470 127	C10	
All engines								465 007	359 768

80 II				ENGINE
1.8 CC quattro	Petrol	68	08/85-08/86	JN









Engine	Information	A10	A20	A40	A50	A70	C10 - C30	C20	E01
All engines	version Bosch			806 094	906 055R	406 219			
All engines	->ch. 81-F-220 000						470 125	C10	

A10 CONDENSER	A20 CONTACT SET	A40 DISTRIBUTOR CAP	A50 ROTOR	A70 PICK-UP
C10 COIL	C20 IGNITION MODULE	C30 ELECTRONIC IGNITION KIT	E01 IGNITION CABLE SET	

Vehicle	alim.	kW	Date	Engine	FUNCTIONS ON THE VEHICLE							
					A10	A20	A40	A50	A70	C10 - C30	C20	E01
ENGINE												
1.8 CC quattro	Petrol	68	08/85-08/86	JN								
Engine	Information				A10	A20	A40	A50	A70	C10 - C30	C20	E01
All engines	ch. 81-G-000 001 ->									470 127	C10	
All engines											465 007	359 768
ENGINE												
1.8 GTE	Petrol	81	08/85-07/86	PV								
Engine	Information				A10	A20	A40	A50	A70	C10 - C30	C20	E01
All engines	version Bosch						806 266	906 121R				
All engines	->ch. 81-F-220 000									470 125	C10	
All engines	ch. 81-G-000 001 ->									470 127	C10	
All engines											465 007	359 768
ENGINE												
1.8 GTE	Petrol	82	06/84-03/87	DZ, MU								
Engine	Information				A10	A20	A40	A50	A70	C10 - C30	C20	E01
Eng. DZ	->ch. 81-F-220 000, version Bosch						806 094	906 116R				
All engines	ch. 81-G-000 001 ->, version Bosch						806 266	906 055R	406 219			
All engines	->ch. 81-F-220 000									470 125	C10	
All engines	ch. 81-G-000 001 ->									470 127	C10	
All engines											465 007	359 768
ENGINE												
2.0	Petrol	85	10/83-09/84	HP, JS								
Engine	Information				A10	A20	A40	A50	A70	C10 - C30	C20	E01
All engines	version Bosch						806 231					
All engines	ch. 81-G-000 001 ->, version Bosch							906 055R				
All engines	->ch. 81-F-220 000, version Bosch							906 116R				
Eng. JS	version Bosch								406 219			
All engines	->ch. 81-F-220 000									470 125	C10	
All engines	ch. 81-G-000 001 ->									470 127	C10	
All engines											465 007	360 682
ENGINE												
2.0 quattro	Petrol	85	10/83-09/84	JS								
Engine	Information				A10	A20	A40	A50	A70	C10 - C30	C20	E01
All engines	version Bosch						806 231		406 219			
All engines	ch. 81-G-000 001 ->, version Bosch							906 055R				
All engines	->ch. 81-F-220 000, version Bosch							906 116R				
All engines	->ch. 81-F-220 000									470 125	C10	
All engines	ch. 81-G-000 001 ->									470 127	C10	
All engines											465 007	360 682
80 III												
ENGINE												
1.4	Petrol	48	08/86-07/88	SE								
Engine	Information				A10	A20	A40	A50	A70	C10 - C30	C20	E01
All engines	version Bosch						806 266	906 055R	406 219			
All engines	version Ducellier						815 068	915 099R				
All engines										470 127	C10	465 007 359 768
ENGINE												
1.6	Petrol	51	09/86-09/91	PP, RNA								
Engine	Information				A10	A20	A40	A50	A70	C10 - C30	C20	E01
All engines	version Bosch						806 266	906 055R	406 219			
All engines	version Ducellier						815 068	915 099R				
All engines										470 127	C10	465 007 359 768
ENGINE												
1.6	Petrol	55	09/86-08/91	RN								
Engine	Information				A10	A20	A40	A50	A70	C10 - C30	C20	E01
All engines	version Bosch						806 266	906 055R	406 219			
All engines	version Ducellier						815 068	915 099R				
All engines										470 127	C10	465 007 359 768
ENGINE												
1.6	Petrol	75	08/90-10/91	ABB								
Engine	Information				A10	A20	A40	A50	A70	C10 - C30	C20	E01
All engines	version Bosch						806 266	906 055R				

A10 CONDENSER	A20 CONTACT SET	A40 DISTRIBUTOR CAP	A50 ROTOR	A70 PICK-UP
C10 COIL	C20 IGNITION MODULE	C30 ELECTRONIC IGNITION KIT	E01 IGNITION CABLE SET	

The present application list is a brief version. For the detailed information about the possibility of installation on a specific vehicle, please refer to our web-catalogue <http://catalogo.facet.eu/>

				FUNCTIONS ON THE VEHICLE									
Vehicle	alim.	kW	Date	Engine									
				ENGINE									
1.6	Petrol	75	08/90-10/91	ABB									
				ENGINE									
Engine		Information		A10	A20	A40	A50	A70	C10 - C30	C20	E01		
All engines		version Bosch, MODEL TO: 1991						406 219					
All engines									470 127	C10	465 007	359 768	
				ENGINE									
1.8	Petrol	55	10/86-01/90	RU									
				ENGINE									
Engine		Information		A10	A20	A40	A50	A70	C10 - C30	C20	E01		
All engines		version Bosch				806 266	906 055R	406 219					
All engines		version Ducellier				815 068	915 099R						
All engines									470 127	C10	465 007	359 768	
				ENGINE									
1.8	Petrol	83	09/86-07/88	SD									
				ENGINE									
Engine		Information		A10	A20	A40	A50	A70	C10 - C30	C20	E01		
All engines		version Bosch				806 266	906 121R						
All engines									470 127	C10	465 007	359 768	
				ENGINE									
1.8 E	Petrol	82	06/86-08/91	DZ									
				ENGINE									
Engine		Information		A10	A20	A40	A50	A70	C10 - C30	C20	E01		
All engines		version Bosch				806 266	906 055R	406 219					
All engines									470 127	C10	465 007	359 768	
				ENGINE									
1.8 E quattro	Petrol	82	09/86-08/91	DZ									
				ENGINE									
Engine		Information		A10	A20	A40	A50	A70	C10 - C30	C20	E01		
All engines									470 127	C10		359 768	
				ENGINE									
1.8 quattro	Petrol	83	09/86-08/90	SD									
				ENGINE									
Engine		Information		A10	A20	A40	A50	A70	C10 - C30	C20	E01		
All engines		version Bosch				806 129	906 121R	406 231					
All engines									470 127	C10	465 004	359 768	
				ENGINE									
1.8 S	Petrol	65	08/86-01/90	SF									
				ENGINE									
Engine		Information		A10	A20	A40	A50	A70	C10 - C30	C20	E01		
All engines		version Bosch				806 266	906 055R	406 219					
All engines									470 127	C10	465 007	359 768	
				ENGINE									
1.8 S	Petrol	66	09/86-10/91	JN, JV, NE, PM									
				ENGINE									
Engine		Information		A10	A20	A40	A50	A70	C10 - C30	C20	E01		
All engines		version Bosch				806 266							
Eng. NE		version Ducellier				815 068	915 099R						
All engines		->ch. 8A-L-500000, version Bosch					906 055R	406 219					
Eng. PM		ch. 8A-M-000001 ->, version Bosch					906 121R						
All engines		->ch. 8A-L-500000							470 127	C10			
All engines											465 007	359 768	
				ENGINE									
1.8 S quattro	Petrol	65	09/86-07/90	SF									
				ENGINE									
Engine		Information		A10	A20	A40	A50	A70	C10 - C30	C20	E01		
All engines									470 127	C10		359 768	
				ENGINE									
1.8 S quattro	Petrol	66	09/86-09/91	JN, NE, PM									
				ENGINE									
Engine		Information		A10	A20	A40	A50	A70	C10 - C30	C20	E01		
Eng. JN		version Bosch				806 129	906 055R	406 231					
All engines									470 127	C10		359 768	
Eng. JN											465 004		
				ENGINE									
2.0	Petrol	82	10/90-08/91	AAD									
				ENGINE									
Engine		Information		A10	A20	A40	A50	A70	C10 - C30	C20	E01		
All engines		version Bosch				806 266	906 121R						
All engines									470 127	C10	465 007	359 768	

A10 CONDENSER	A20 CONTACT SET	A40 DISTRIBUTOR CAP	A50 ROTOR	A70 PICK-UP
C10 COIL	C20 IGNITION MODULE	C30 ELECTRONIC IGNITION KIT	E01 IGNITION CABLE SET	

Vehicle	alim.	kW	Date	Engine	FUNCTIONS ON THE VEHICLE									
					A10	A20	A40	A50	A70	C10 - C30	C20	E01		
ENGINE														
2.0 E	Petrol	83	08/88-10/90	3A										
Engine	Information				A10	A20	A40	A50	A70	C10 - C30	C20	E01		
All engines	version Bosch						806 266	906 121R						
All engines											465 007	359 768		
ENGINE														
2.0 E 16V	Petrol	101	03/90-09/91	6A										
Engine	Information				A10	A20	A40	A50	A70	C10 - C30	C20	E01		
All engines	version Bosch						806 248							
All engines											465 007			
ENGINE														
2.0 E 16V quattro	Petrol	101	03/90-08/91	6A										
Engine	Information				A10	A20	A40	A50	A70	C10 - C30	C20	E01		
All engines	version Bosch						806 248							
ENGINE														
2.0 E quattro	Petrol	83	08/88-09/90	3A										
Engine	Information				A10	A20	A40	A50	A70	C10 - C30	C20	E01		
All engines	version Bosch						806 129	906 121R						
All engines												359 768		
ENGINE														
2.0 quattro	Petrol	82	08/88-07/90	3A										
Engine	Information				A10	A20	A40	A50	A70	C10 - C30	C20	E01		
All engines												359 768		
ENGINE														
2.0 quattro	Petrol	85	10/90-08/91	AA										
Engine	Information				A10	A20	A40	A50	A70	C10 - C30	C20	E01		
All engines												359 768		
ENGINE														
80 IV														
1.6	Petrol	52	09/91-12/94	ABM										
Engine	Information				A10	A20	A40	A50	A70	C10 - C30	C20	E01		
All engines	version Bosch						806 266	906 121R						
All engines												359 768		
ENGINE														
1.6	Petrol	75	03/92-05/93	ABB										
Engine	Information				A10	A20	A40	A50	A70	C10 - C30	C20	E01		
All engines	version Bosch						806 266	906 055R						
All engines										470 127	C10	465 007	359 768	
ENGINE														
1.6 E	Petrol	74	06/93-01/96	ADA										
Engine	Information				A10	A20	A40	A50	A70	C10 - C30	C20	E01		
All engines	version Bosch						806 266	906 121R	406 223					
All engines												359 768		
ENGINE														
2.0	Petrol	66	09/91-01/96	ABT										
Engine	Information				A10	A20	A40	A50	A70	C10 - C30	C20	E01		
All engines	version Bosch						806 266	906 121R						
All engines												359 768		
ENGINE														
2.0 E	Petrol	85	09/91-01/96	ABK										
Engine	Information				A10	A20	A40	A50	A70	C10 - C30	C20	E01		
All engines	version Bosch						806 266	906 121R						
All engines	->year 01/07/93									490 414	C30			
All engines												359 768		
ENGINE														
2.0 E 16V	Petrol	101	09/91-07/92	6A										
Engine	Information				A10	A20	A40	A50	A70	C10 - C30	C20	E01		
All engines	version Bosch						806 248							

A10	CONDENSER	A20	CONTACT SET	A40	DISTRIBUTOR CAP	A50	ROTOR	A70	PICK-UP
C10	COIL	C20	IGNITION MODULE	C30	ELECTRONIC IGNITION KIT	E01	IGNITION CABLE SET		

The present application list is a brief version. For the detailed information about the possibility of installation on a specific vehicle, please refer to our web-catalogue <http://catalogo.facet.eu/>

Vehicle	alim.	kW	Date	Engine	FUNCTIONS ON THE VEHICLE									
					A10	A20	A40	A50	A70	C10 - C30	C20	E01		
ENGINE														
2.0 E 16V	Petrol	103	08/92-01/96	ACE										
Engine	Information				A10	A20	A40	A50	A70	C10 - C30	C20	E01		
All engines	version Bosch						806 248							
ENGINE														
2.0 E quattro	Petrol	85	09/91-12/94	ABK										
Engine	Information				A10	A20	A40	A50	A70	C10 - C30	C20	E01		
All engines	version Bosch						806 094	906 121R						
All engines	->ch. 8C-P-300 000									490 414	C30			
All engines													359 768	
ENGINE														
2.0 quattro	Petrol	79	11/93-01/96	ADW										
Engine	Information				A10	A20	A40	A50	A70	C10 - C30	C20	E01		
All engines	version Bosch						806 266	906 121R						
All engines													359 768	
ENGINE														
2.3 E	Petrol	98	09/91-01/96	NG										
Engine	Information				A10	A20	A40	A50	A70	C10 - C30	C20	E01		
All engines	version Bosch						806 231	906 121R						
All engines													360 682	
ENGINE														
2.3 E quattro	Petrol	98	09/91-12/94	NG										
Engine	Information				A10	A20	A40	A50	A70	C10 - C30	C20	E01		
All engines							806 231	906 121R					360 682	
ENGINE														
2.6	Petrol	110	07/92-01/96	ABC										
Engine	Information				A10	A20	A40	A50	A70	C10 - C30	C20	E01		
All engines											465 051			
ENGINE														
2.6 E	Petrol	102	05/93-05/95	ACZ										
Engine	Information				A10	A20	A40	A50	A70	C10 - C30	C20	E01		
All engines											465 051			
ENGINE														
2.6 E quattro	Petrol	102	11/93-05/95	ACZ										
Engine	Information				A10	A20	A40	A50	A70	C10 - C30	C20	E01		
All engines											465 051			
ENGINE														
2.6 quattro	Petrol	102	08/94-01/96	ACZ										
Engine	Information				A10	A20	A40	A50	A70	C10 - C30	C20	E01		
All engines											465 051			
ENGINE														
2.6 quattro	Petrol	110	06/92-07/95	ABC										
Engine	Information				A10	A20	A40	A50	A70	C10 - C30	C20	E01		
All engines											465 051			
ENGINE														
2.8	Petrol	128	09/91-01/96	AAH										
Engine	Information				A10	A20	A40	A50	A70	C10 - C30	C20	E01		
All engines											465 051			
ENGINE														
2.8 quattro	Petrol	128	09/91-07/95	AAH										
Engine	Information				A10	A20	A40	A50	A70	C10 - C30	C20	E01		
All engines											465 051			
90 I														
ENGINE														
1.8	Petrol	66	06/84-03/87	JN										
Engine	Information				A10	A20	A40	A50	A70	C10 - C30	C20	E01		
All engines	version Bosch						806 094	906 055R	406 219					
All engines	->ch. 81-F-220 000									470 125	C10			
All engines	ch. 81-G-000 001 ->									470 127	C10			
All engines											465 007	359 768		

A10 CONDENSER	A20 CONTACT SET	A40 DISTRIBUTOR CAP	A50 ROTOR	A70 PICK-UP
C10 COIL	C20 IGNITION MODULE	C30 ELECTRONIC IGNITION KIT	E01 IGNITION CABLE SET	

Vehicle	alim.	kW	Date	Engine	FUNCTIONS ON THE VEHICLE							
					A10	A20	A40	A50	A70	C10 - C30	C20	E01

ENGINE				
2.0	Petrol	81	10/84-03/87	JL

Engine	Information	A10	A20	A40	A50	A70	C10 - C30	C20	E01
All engines	version Bosch			806 231	906 055R	406 219			
All engines	->ch. 81-F-220 000						470 125	C10	
All engines	ch. 81-G-000 001 ->						470 127	C10	
All engines								465 007	360 682

ENGINE				
2.0	Petrol	83	03/86-03/87	SK

Engine	Information	A10	A20	A40	A50	A70	C10 - C30	C20	E01
All engines	version Bosch			806 231	906 121R				
All engines	->ch. 81-F-220 000						470 125	C10	
All engines	ch. 81-G-000 001 ->						470 127	C10	
All engines								465 007	360 682

ENGINE				
2.0	Petrol	85	10/84-03/87	HP, JS

Engine	Information	A10	A20	A40	A50	A70	C10 - C30	C20	E01
All engines	version Bosch			806 231					
All engines	ch. 81-G-000 001 ->, version Bosch				906 055R				
All engines	->ch. 81-F-220 000, version Bosch				906 116R				
Eng. JS	version Bosch					406 219			
All engines	->ch. 81-F-220 000						470 125	C10	
All engines	ch. 81-G-000 001 ->						470 127	C10	
All engines								465 007	360 682

ENGINE				
2.0 quattro	Petrol	85	08/84-08/86	JS

Engine	Information	A10	A20	A40	A50	A70	C10 - C30	C20	E01
All engines	version Bosch			806 231		406 219			
All engines	ch. 81-G-000 001 ->, version Bosch				906 055R				
All engines	->ch. 81-F-220 000, version Bosch				906 116R				
All engines	->ch. 81-F-220 000						470 125	C10	
All engines	ch. 81-G-000 001 ->						470 127	C10	
All engines								465 007	360 682

ENGINE				
2.2	Petrol	100	10/84-03/87	9C54, HY

Engine	Information	A10	A20	A40	A50	A70	C10 - C30	C20	E01
All engines	version Bosch			806 231	906 116R				
Eng. 9C54	version Bosch					406 219			
All engines	->ch. 81-F-220 000						470 125	C10	
All engines	ch. 81-G-000 001 ->						470 127	C10	
All engines								465 007	360 682

ENGINE				
2.2	Petrol	85	01/85-03/87	KX

Engine	Information	A10	A20	A40	A50	A70	C10 - C30	C20	E01
All engines	version Bosch			806 231	906 055R	406 219			
All engines	->ch. 81-F-220 000						470 125	C10	
All engines	ch. 81-G-000 001 ->						470 127	C10	
All engines								465 007	









ENGINE				
2.2 E quattro	Petrol	100	11/84-03/87	9C54

Engine	Information	A10	A20	A40	A50	A70	C10 - C30	C20	E01
All engines	version Bosch			806 231	906 116R	406 219			
All engines	->ch. 81-F-220 000						470 125	C10	
All engines	ch. 81-G-000 001 ->						470 127	C10	
All engines								465 007	360 682

ENGINE				
2.0	Petrol	85	07/88-09/91	PS

Engine	Information	A10	A20	A40	A50	A70	C10 - C30	C20	E01
All engines	version Bosch			806 231					
All engines	version Bosch, distr. num. 034 905 206				906 055R	406 219			
All engines	version Bosch, distr. num. 034 905 205 H				906 121R				
All engines	-catalytic converter						470 127	C10	

A10	CONDENSER	A20	CONTACT SET	A40	DISTRIBUTOR CAP	A50	ROTOR	A70	PICK-UP
C10	COIL	C20	IGNITION MODULE	C30	ELECTRONIC IGNITION KIT	E01	IGNITION CABLE SET		









				FUNCTIONS ON THE VEHICLE								
Vehicle	alim.	kW	Date	Engine	 A10	 A20	 A40	 A50	 A70	 C10 - C30	 C20	 E01
90 II				ENGINE								
2.0	Petrol	85	07/88-09/91	PS								
Engine	Information				A10	A20	A40	A50	A70	C10 - C30	C20	E01
All engines											465 007	360 682
2.0 20 V				ENGINE								
Petrol	118	08/89-07/91	NM									
Engine	Information				A10	A20	A40	A50	A70	C10 - C30	C20	E01
All engines											465 007	
2.0 20 V quattro				ENGINE								
Petrol	118	08/88-09/91	NM									
Engine	Information				A10	A20	A40	A50	A70	C10 - C30	C20	E01
All engines	version Bosch						806 231					
2.2 E				ENGINE								
Petrol	100	04/87-07/91	9C54									
Engine	Information				A10	A20	A40	A50	A70	C10 - C30	C20	E01
All engines	version Bosch						806 231	906 055R	406 219			
All engines										470 127	C10	465 007
All engines												360 682
2.2 E quattro				ENGINE								
Petrol	100	04/87-09/91	9C54									
Engine	Information				A10	A20	A40	A50	A70	C10 - C30	C20	E01
All engines	version Bosch						806 231	906 055R	406 219			
All engines	->ch. 81-F-220 000									470 125	C10	
All engines	ch. 81-G-000 001 ->									470 127	C10	
All engines											465 004	360 682
2.3 E				ENGINE								
Petrol	100	04/87-07/91	NG									
Engine	Information				A10	A20	A40	A50	A70	C10 - C30	C20	E01
All engines	version Bosch						806 231	906 121R				
All engines											465 007	360 682
2.3 E				ENGINE								
Petrol	98	04/87-09/91	NG									
Engine	Information				A10	A20	A40	A50	A70	C10 - C30	C20	E01
All engines	version Bosch						806 231	906 121R				
All engines											465 007	360 682
2.3 E 20V				ENGINE								
Petrol	123	04/90-07/91	7A									
Engine	Information				A10	A20	A40	A50	A70	C10 - C30	C20	E01
All engines											465 007	
2.3 E 20V				ENGINE								
Petrol	125	08/88-07/91	7A									
Engine	Information				A10	A20	A40	A50	A70	C10 - C30	C20	E01
All engines											465 007	
2.3 E 20V quattro				ENGINE								
Petrol	125	06/88-09/91	7A									
Engine	Information				A10	A20	A40	A50	A70	C10 - C30	C20	E01
All engines	version Bosch						806 231	906 121R				
2.3 E quattro				ENGINE								
Petrol	100	04/87-07/91	NG									
Engine	Information				A10	A20	A40	A50	A70	C10 - C30	C20	E01
All engines												360 682
2.3 E quattro				ENGINE								
Petrol	98	04/87-09/91	NG									
Engine	Information				A10	A20	A40	A50	A70	C10 - C30	C20	E01
All engines	version Bosch						806 231	906 121R				
All engines												360 682
90 SUPER				ENGINE								
1.8	Petrol	66	09/66-08/71	21, 8921								
Engine	Information				A10	A20	A40	A50	A70	C10 - C30	C20	E01
All engines						706 029HV						

A10 CONDENSER	A20 CONTACT SET	A40 DISTRIBUTOR CAP	A50 ROTOR	A70 PICK-UP
C10 COIL	C20 IGNITION MODULE	C30 ELECTRONIC IGNITION KIT	E01 IGNITION CABLE SET	

Vehicle	alim.	kW	Date	Engine	FUNCTIONS ON THE VEHICLE							
					A10	A20	A40	A50	A70	C10 - C30	C20	E01
A1												
1.0 TFSI	Petrol	60	01/16-10/18	CHZE								
Engine	Information				A10	A20	A40	A50	A70	C10 - C30	C20	E01
All engines	x 3, BERU, ELDOR, COIL ON PLUG, incl. spark plug connector, Number of pins:4, incl. spark plug connector									470 599	C10	
1.0 TFSI	Petrol	70	03/15-10/18	CHZB, DKLD								
Engine	Information				A10	A20	A40	A50	A70	C10 - C30	C20	E01
All engines	x 3, BERU, ELDOR, COIL ON PLUG, incl. spark plug connector, Number of pins:4, incl. spark plug connector									470 599	C10	
1.2 TFSI	Petrol	63	05/10-04/15	CBZA								
Engine	Information				A10	A20	A40	A50	A70	C10 - C30	C20	E01
All engines										490 420	C30	358 248
1.4 TFSI	Petrol	103	04/12-04/15	CPTA								
Engine	Information				A10	A20	A40	A50	A70	C10 - C30	C20	E01
All engines	x 4, BERU, ELDOR, COIL ON PLUG, incl. spark plug connector, Number of pins:4, incl. spark plug connector									470 599	C10	
1.4 TFSI	Petrol	136	01/11-04/15	CAVG, CTHG								
Engine	Information				A10	A20	A40	A50	A70	C10 - C30	C20	E01
All engines	x 4, COIL ON PLUG, incl. spark plug connector									470 474	C10	
1.4 TFSI	Petrol	90	05/10-04/15	CAXA, CNVA								
Engine	Information				A10	A20	A40	A50	A70	C10 - C30	C20	E01
All engines	x 4, COIL ON PLUG, incl. spark plug connector									470 474	C10	
1.4 TFSI	Petrol	92	11/14-10/18	CZCA, CZDD								
Engine	Information				A10	A20	A40	A50	A70	C10 - C30	C20	E01
All engines	x 4, BERU, ELDOR, COIL ON PLUG, incl. spark plug connector, Number of pins:4, incl. spark plug connector									470 599	C10	
1.4 TSI	Petrol	110	11/14-10/18	CZEA								
Engine	Information				A10	A20	A40	A50	A70	C10 - C30	C20	E01
All engines	x 4, BERU, ELDOR, COIL ON PLUG, incl. spark plug connector, Number of pins:4, incl. spark plug connector									470 599	C10	
1.8 TFSI	Petrol	141	02/15-10/18	DAJB								
Engine	Information				A10	A20	A40	A50	A70	C10 - C30	C20	E01
All engines	x 4, HITACHI, COIL ON PLUG, incl. spark plug connector									470 636	C10	
2.0 TFSI quattro	Petrol	188	03/12-11/12	COLH								
Engine	Information				A10	A20	A40	A50	A70	C10 - C30	C20	E01
All engines	x 4, ELDOR, Housing Colour:Black, COIL ON PLUG, incl. spark plug connector									470 426	C10	
25 TFSI	Petrol	70	11/18->	DKLA, DLAC								
Engine	Information				A10	A20	A40	A50	A70	C10 - C30	C20	E01
All engines	x 3, BERU, ELDOR, COIL ON PLUG, incl. spark plug connector, Number of pins:4, incl. spark plug connector									470 599	C10	
30 TFSI	Petrol	81	09/20->	DLAA								
Engine	Information				A10	A20	A40	A50	A70	C10 - C30	C20	E01
All engines	x 3, ELDOR, COIL ON PLUG, incl. spark plug connector, Number of pins:4, incl. spark plug connector									470 599	C10	
30 TFSI	Petrol	85	07/18->	DKJA, DKRF								
Engine	Information				A10	A20	A40	A50	A70	C10 - C30	C20	E01
All engines	x 3, ELDOR, COIL ON PLUG, incl. spark plug connector, Number of pins:4, incl. spark plug connector									470 599	C10	
40 TFSI	Petrol	147	09/18->	CZPC, DKZC								
Engine	Information				A10	A20	A40	A50	A70	C10 - C30	C20	E01
All engines	x 4, HITACHI, COIL ON PLUG, incl. spark plug connector									470 636	C10	

A10 CONDENSER	A20 CONTACT SET	A40 DISTRIBUTOR CAP	A50 ROTOR	A70 PICK-UP
C10 COIL	C20 IGNITION MODULE	C30 ELECTRONIC IGNITION KIT	E01 IGNITION CABLE SET	

The present application list is a brief version. For the detailed information about the possibility of installation on a specific vehicle, please refer to our web-catalogue <http://catalogo.facet.eu/>









					FUNCTIONS ON THE VEHICLE							
Vehicle	alim.	kW	Date	Engine	 A10	 A20	 A40	 A50	 A70	 C10 - C30	 C20	 E01
ENGINE												
40 TFSI	Petrol	152	04/21->	DNND								
Engine	Information				A10	A20	A40	A50	A70	C10 - C30	C20	E01
All engines	x 4, HITACHI, COIL ON PLUG, incl. spark plug connector									470 636	C10	
A2												
1.4	Petrol	55	02/00-08/05	AUA, BBY								
Engine	Information				A10	A20	A40	A50	A70	C10 - C30	C20	E01
Eng. BBY	x 4, COIL ON PLUG, incl. spark plug connector									470 474	C10	
Eng. AUA										490 420	C30	360 575
ENGINE												
1.6 FSI	Petrol	81	05/02-08/05	BAD								
Engine	Information				A10	A20	A40	A50	A70	C10 - C30	C20	E01
All engines	x 4, COIL ON PLUG, incl. spark plug connector									470 474	C10	
A3 I												
1.6	Petrol	74	09/96-05/03	AEH, AKL, APF								
Engine	Information				A10	A20	A40	A50	A70	C10 - C30	C20	E01
All engines										490 420	C30	
Eng. AEH, AKL	ch. 8L-V-080 001 ->, ->ch. 8L-W-070 000											360 479
All engines	ch. 8L-W-070 001 ->											360 484
Eng. AEH	->ch. 8L-V-080 000											360 585
ENGINE												
1.6	Petrol	75	08/00-05/03	AVU, BFQ								
Engine	Information				A10	A20	A40	A50	A70	C10 - C30	C20	E01
All engines										490 420	C30	360 585
ENGINE												
1.8	Petrol	92	09/96-05/03	AGN, APG								
Engine	Information				A10	A20	A40	A50	A70	C10 - C30	C20	E01
All engines										490 420	C30	
All engines	ch. 8L-V-140 001 ->											360 489
ENGINE												
1.8 T	Petrol	110	12/96-05/03	AGU, ARZ, AUM								
Engine	Information				A10	A20	A40	A50	A70	C10 - C30	C20	E01
Eng. AGU	x 4, COIL ON PLUG									470 3545	C10	
Eng. AGU, AUM	x 4, COIL ON PLUG, incl. spark plug connector									470 429	C10	
Eng. ARZ	x 4, COIL ON PLUG, incl. spark plug connector									470 445	C10	
Eng. AGU											465 076	
ENGINE												
1.8 T	Petrol	132	12/98-05/03	AJQ, APP, ARY, AUQ								
Engine	Information				A10	A20	A40	A50	A70	C10 - C30	C20	E01
Eng. ARY, AUQ	x 4, COIL ON PLUG, incl. spark plug connector									470 429	C10	
Eng. AJQ, APP	x 4, COIL ON PLUG, incl. spark plug connector									470 445	C10	
ENGINE												
1.8 T quattro	Petrol	110	12/96-05/03	AGU, AQA, ARX								
Engine	Information				A10	A20	A40	A50	A70	C10 - C30	C20	E01
Eng. AGU	x 4, COIL ON PLUG									470 3545	C10	
Eng. ARX	x 4, COIL ON PLUG, incl. spark plug connector									470 429	C10	
Eng. AQA	x 4, COIL ON PLUG, incl. spark plug connector									470 445	C10	
Eng. AGU											465 076	
ENGINE												
1.8 T quattro	Petrol	132	10/98-05/03	AJQ, ARY								
Engine	Information				A10	A20	A40	A50	A70	C10 - C30	C20	E01
Eng. ARY	x 4, COIL ON PLUG, incl. spark plug connector									470 429	C10	
Eng. AJQ	x 4, COIL ON PLUG, incl. spark plug connector									470 445	C10	
ENGINE												
S3 quattro	Petrol	154	03/99-04/02	AMK, APY, AUL								
Engine	Information				A10	A20	A40	A50	A70	C10 - C30	C20	E01
All engines	S3 Quattro, 01/01/01 ->, x 4, COIL ON PLUG, incl. spark plug connector									470 429	C10	
All engines	S3 Quattro, ->year 01/12/00, x 4, COIL ON PLUG, incl. spark plug connector									470 445	C10	

A10 CONDENSER	A20 CONTACT SET	A40 DISTRIBUTOR CAP	A50 ROTOR	A70 PICK-UP
C10 COIL	C20 IGNITION MODULE	C30 ELECTRONIC IGNITION KIT	E01 IGNITION CABLE SET	

Vehicle	alim.	kW	Date	Engine	FUNCTIONS ON THE VEHICLE							
					A10	A20	A40	A50	A70	C10 - C30	C20	E01
S3 quattro												
ENGINE												
BAM												
Engine		Information			A10	A20	A40	A50	A70	C10 - C30	C20	E01
All engines		S3 Quattro, x 4, COIL ON PLUG, incl. spark plug connector								470 429	C10	
A3 II												
1.2 TFSI												
ENGINE												
CBZB												
Engine		Information			A10	A20	A40	A50	A70	C10 - C30	C20	E01
All engines										490 420	C30	358 248
1.2 TSI												
ENGINE												
CBZB												
Engine		Information			A10	A20	A40	A50	A70	C10 - C30	C20	E01
All engines										490 420	C30	358 248
1.4 TFSI												
ENGINE												
CAXC, CMSA												
Engine		Information			A10	A20	A40	A50	A70	C10 - C30	C20	E01
All engines		x 4, COIL ON PLUG, incl. spark plug connector								470 474	C10	
1.6												
ENGINE												
BGU, BSE, BSF, CCSA												
Engine		Information			A10	A20	A40	A50	A70	C10 - C30	C20	E01
All engines		Eng. BGU, BSE, BSF								490 420	C30	360 585
1.6 E-Power												
ENGINE												
CCSA, CMXA												
Engine	Petrol/ Ethanol	Information			A10	A20	A40	A50	A70	C10 - C30	C20	E01
All engines	75	01/11-03/13								490 420	C30	360 585
1.6 FSI												
ENGINE												
BAG, BLF, BLP												
Engine		Information			A10	A20	A40	A50	A70	C10 - C30	C20	E01
All engines		x 4, COIL ON PLUG, incl. spark plug connector								470 474	C10	
1.8 TFSI												
ENGINE												
BYT, BZB, CDAA												
Engine		Information			A10	A20	A40	A50	A70	C10 - C30	C20	E01
All engines		x 4, ELDOR, Housing Colour:Black, COIL ON PLUG, incl. spark plug connector								470 426	C10	
1.8 TFSI quattro												
ENGINE												
CDAA												
Engine		Information			A10	A20	A40	A50	A70	C10 - C30	C20	E01
All engines		x 4, ELDOR, Housing Colour:Black, COIL ON PLUG, incl. spark plug connector								470 426	C10	
2.0 FSI												
ENGINE												
AXW, BLR, BLX, BLY, BMB, BVY, BVZ												
Engine		Information			A10	A20	A40	A50	A70	C10 - C30	C20	E01
All engines		x 4, ELDOR, Housing Colour:Black, COIL ON PLUG, incl. spark plug connector								470 426	C10	
2.0 TFSI												
ENGINE												
AXX, BPY, BWA, CAWB, CBFA, CCZA												
Engine		Information			A10	A20	A40	A50	A70	C10 - C30	C20	E01
All engines		x 4, ELDOR, Housing Colour:Black, COIL ON PLUG, incl. spark plug connector								470 426	C10	
2.0 TFSI quattro												
ENGINE												
AXX, BPY, BWA, CCTA, CCZA												
Engine		Information			A10	A20	A40	A50	A70	C10 - C30	C20	E01
Eng. AXX, BPY, BWA, CCZA		x 4, ELDOR, Housing Colour:Black, COIL ON PLUG, incl. spark plug connector								470 426	C10	
Eng. CCTA		Qty: 4								470 426	C10	
3.2 V6 quattro												
ENGINE												
BDB, BMJ, BUB												
Engine		Information			A10	A20	A40	A50	A70	C10 - C30	C20	E01
All engines		x 6, COIL ON PLUG								470 434	C10	

A10 CONDENSER	A20 CONTACT SET	A40 DISTRIBUTOR CAP	A50 ROTOR	A70 PICK-UP
C10 COIL	C20 IGNITION MODULE	C30 ELECTRONIC IGNITION KIT	E01 IGNITION CABLE SET	

The present application list is a brief version. For the detailed information about the possibility of installation on a specific vehicle, please refer to our web-catalogue <http://catalogo.facet.eu/>







					FUNCTIONS ON THE VEHICLE							
Vehicle	alim.	kW	Date	Engine	 A10	 A20	 A40	 A50	 A70	 C10 - C30	 C20	 E01
ENGINE												
RS3 quattro	Petrol	250	01/11-12/12	CEPA								
Engine	Information				A10	A20	A40	A50	A70	C10 - C30	C20	E01
All engines	RS3 Sportback Quattro, x 5, ELDOR, Housing Colour:-Black, COIL ON PLUG, incl. spark plug connector									470 426	C10	
ENGINE												
S3 quattro	Petrol	188	02/07-03/13	BZC, CDLC								
Engine	Information				A10	A20	A40	A50	A70	C10 - C30	C20	E01
All engines	S3 Quattro, S3 Sportback Quattro, x 4, ELDOR, Housing Colour:Black, COIL ON PLUG, incl. spark plug connector									470 426	C10	
ENGINE												
S3 quattro	Petrol	195	11/06-03/13	BHZ, CDLA								
Engine	Information				A10	A20	A40	A50	A70	C10 - C30	C20	E01
All engines	S3 Quattro, S3 Sportback Quattro, x 4, ELDOR, Housing Colour:Black, COIL ON PLUG, incl. spark plug connector									470 426	C10	
Eng. BHZ	Qty: 4									470 426	C10	
A3 III												
ENGINE												
1.0 TFSI	Petrol	85	07/16-10/20	CHZD, DKRF								
Engine	Information				A10	A20	A40	A50	A70	C10 - C30	C20	E01
All engines	x 3, BERU, ELDOR, COIL ON PLUG, incl. spark plug connector, Number of pins:4, incl. spark plug connector									470 599	C10	
ENGINE												
1.2 TFSI	Petrol	77	02/13->	CJZA								
Engine	Information				A10	A20	A40	A50	A70	C10 - C30	C20	E01
All engines	x 4, BERU, ELDOR, COIL ON PLUG, incl. spark plug connector, Number of pins:4, incl. spark plug connector									470 599	C10	
ENGINE												
1.2 TFSI	Petrol	81	05/14->	CVVB								
Engine	Information				A10	A20	A40	A50	A70	C10 - C30	C20	E01
All engines	x 4, BERU, ELDOR, HITACHI, COIL ON PLUG, incl. spark plug connector, Number of pins:4, incl. spark plug connector									470 599	C10	
ENGINE												
1.4 TFSI	Petrol	103	03/13->	CPTA								
Engine	Information				A10	A20	A40	A50	A70	C10 - C30	C20	E01
All engines	x 4, BERU, ELDOR, COIL ON PLUG, incl. spark plug connector, Number of pins:4, incl. spark plug connector									470 599	C10	
ENGINE												
1.4 TFSI	Petrol	85	02/16-10/20	CZCC								
Engine	Information				A10	A20	A40	A50	A70	C10 - C30	C20	E01
All engines	x 4, BERU, ELDOR, COIL ON PLUG, incl. spark plug connector, Number of pins:4, incl. spark plug connector									470 599	C10	
ENGINE												
1.4 TFSI	Petrol	90	04/12-10/20	CMBA, CXSA								
Engine	Information				A10	A20	A40	A50	A70	C10 - C30	C20	E01
All engines	x 4, BERU, ELDOR, COIL ON PLUG, incl. spark plug connector, Number of pins:4, incl. spark plug connector									470 599	C10	
Eng. CMBA	Qty: 4									470 599	C10	
ENGINE												
1.4 TFSI	Petrol	92	09/13->	CXSB, CZCA								
Engine	Information				A10	A20	A40	A50	A70	C10 - C30	C20	E01
All engines	x 4, BERU, ELDOR, COIL ON PLUG, incl. spark plug connector, Number of pins:4, incl. spark plug connector									470 599	C10	
ENGINE												
1.4 TFSI e-tron	Petrol/ Electric	110	05/14-10/20	CUKB, CXUA, DGEA								
Engine	Information				A10	A20	A40	A50	A70	C10 - C30	C20	E01
All engines	x 4, BERU, ELDOR, COIL ON PLUG, incl. spark plug connector, Number of pins:4, incl. spark plug connector									470 599	C10	
ENGINE												
1.4 TFSI g-tron	Petrol/ Com- pressed Natural Gas (CNG)	81	11/13-10/20	CPWA								
Engine	Information				A10	A20	A40	A50	A70	C10 - C30	C20	E01
All engines	x 4, BERU, ELDOR, COIL ON PLUG, incl. spark plug connector, Number of pins:4, incl. spark plug connector									470 599	C10	

A10 CONDENSER	A20 CONTACT SET	A40 DISTRIBUTOR CAP	A50 ROTOR	A70 PICK-UP
C10 COIL	C20 IGNITION MODULE	C30 ELECTRONIC IGNITION KIT	E01 IGNITION CABLE SET	

Vehicle	alim.	kW	Date	Engine	FUNCTIONS ON THE VEHICLE								
					A10	A20	A40	A50	A70	C10 - C30	C20	E01	
ENGINE													
1.4 TFSI	Petrol	110	05/14-10/20	CZEA									
Engine	Information				A10	A20	A40	A50	A70	C10 - C30	C20	E01	
All engines	x 4, BERU, ELDOR, HITACHI, COIL ON PLUG, incl. spark plug connector, Number of pins:4, incl. spark plug connector									470 599	C10		
ENGINE													
1.8 TFSI	Petrol	125	11/13-10/20	CNSB									
Engine	Information				A10	A20	A40	A50	A70	C10 - C30	C20	E01	
All engines	x 4, HITACHI, COIL ON PLUG, incl. spark plug connector									470 636	C10		
ENGINE													
1.8 TFSI	Petrol	132	04/12->	CJSA, CJSB									
Engine	Information				A10	A20	A40	A50	A70	C10 - C30	C20	E01	
All engines	x 4, HITACHI, COIL ON PLUG, incl. spark plug connector									470 636	C10		
ENGINE													
1.8 TFSI quattro	Petrol	132	08/12->	CJSB									
Engine	Information				A10	A20	A40	A50	A70	C10 - C30	C20	E01	
All engines	x 4, HITACHI, COIL ON PLUG, incl. spark plug connector									470 636	C10		
ENGINE													
2.0 TFSI	Petrol	140	05/16-10/20	CZPB, DKZA									
Engine	Information				A10	A20	A40	A50	A70	C10 - C30	C20	E01	
All engines	01/11/18 ->, x 4, HITACHI, x 4, COIL ON PLUG, HITACHI, COIL ON PLUG, incl. spark plug connector, incl. spark plug connector									470 636	C10		
ENGINE													
2.0 TFSI quattro	Petrol	140	05/16-10/20	CZPB, DKZA									
Engine	Information				A10	A20	A40	A50	A70	C10 - C30	C20	E01	
All engines	01/11/18 ->, x 4, HITACHI, x 4, COIL ON PLUG, HITACHI, COIL ON PLUG, incl. spark plug connector, incl. spark plug connector									470 636	C10		
ENGINE													
30 TFSI	Petrol	85	07/18-10/20	CHZD, DKRF									
Engine	Information				A10	A20	A40	A50	A70	C10 - C30	C20	E01	
All engines	x 3, BERU, ELDOR, COIL ON PLUG, incl. spark plug connector, Number of pins:4, incl. spark plug connector									470 599	C10		
ENGINE													
40 TFSI	Petrol	140	07/18-10/20	CZPB, DKZA									
Engine	Information				A10	A20	A40	A50	A70	C10 - C30	C20	E01	
All engines	01/11/18 ->, x 4, HITACHI, COIL ON PLUG, incl. spark plug connector									470 636	C10		
ENGINE													
40 TFSI quattro	Petrol	140	07/18-10/20	CZPB, DKZA									
Engine	Information				A10	A20	A40	A50	A70	C10 - C30	C20	E01	
All engines	x 4, HITACHI, x 4, COIL ON PLUG, HITACHI, COIL ON PLUG, incl. spark plug connector, incl. spark plug connector									470 636	C10		
ENGINE													
RS3 quattro	Petrol	270	03/15->	CZGB									
Engine	Information				A10	A20	A40	A50	A70	C10 - C30	C20	E01	
All engines	RS3 Sportback Quattro, x 5, ELDOR, Housing Colour:-Black, COIL ON PLUG, incl. spark plug connector									470 426	C10		
ENGINE													
S3 quattro	Petrol	213	07/16-10/20	CJXD, DJHB									
Engine	Information				A10	A20	A40	A50	A70	C10 - C30	C20	E01	
All engines	S3 Cabrio Quattro, S3 Quattro, S3 Sportback Quattro, x 4, HITACHI, COIL ON PLUG, incl. spark plug connector									470 636	C10		
ENGINE													
S3 quattro	Petrol	221	11/12-10/20	DNUE									
Engine	Information				A10	A20	A40	A50	A70	C10 - C30	C20	E01	
All engines	S3 Cabrio Quattro, S3 Quattro, S3 Sportback Quattro, 01/12/19 ->, x 4, HITACHI, COIL ON PLUG, incl. spark plug connector									470 636	C10		
ENGINE													
S3 quattro	Petrol	228	06/16-10/20	CJXG, DJHA									
Engine	Information				A10	A20	A40	A50	A70	C10 - C30	C20	E01	
All engines	S3 Cabrio Quattro, S3 Quattro, S3 Sportback Quattro, x 4, HITACHI, COIL ON PLUG, incl. spark plug connector									470 636	C10		









A10 CONDENSER	A20 CONTACT SET	A40 DISTRIBUTOR CAP	A50 ROTOR	A70 PICK-UP
C10 COIL	C20 IGNITION MODULE	C30 ELECTRONIC IGNITION KIT	E01 IGNITION CABLE SET	

The present application list is a brief version. For the detailed information about the possibility of installation on a specific vehicle, please refer to our web-catalogue <http://catalogo.facet.eu/>

				FUNCTIONS ON THE VEHICLE								
Vehicle	alim.	kW	Date	Engine	 A10	 A20	 A40	 A50	 A70	 C10 - C30	 C20	 E01
A3 IV												
30 TFSI	Petrol	81	06/20->	DLAA								
				ENGINE								
Engine	Information				A10	A20	A40	A50	A70	C10 - C30	C20	E01
All engines	x 3, ELDOR, COIL ON PLUG, Number of pins:4, incl. spark plug connector									470 599	C10	
30 TFSI Mild Hybrid	Petrol/ Electric	81	06/20->	DLAA								
				ENGINE								
Engine	Information				A10	A20	A40	A50	A70	C10 - C30	C20	E01
All engines	x 3, ELDOR, COIL ON PLUG, Number of pins:4, incl. spark plug connector									470 599	C10	
40 TFSIe	Petrol/ Electric	110	06/20->	DGEA								
				ENGINE								
Engine	Information				A10	A20	A40	A50	A70	C10 - C30	C20	E01
All engines	x 4, ELDOR, COIL ON PLUG, Number of pins:4, incl. spark plug connector									470 599	C10	
45 TFSIe	Petrol/ Electric	110	07/21->	DGEA								
				ENGINE								
Engine	Information				A10	A20	A40	A50	A70	C10 - C30	C20	E01
All engines	x 4, ELDOR, COIL ON PLUG, Number of pins:4, incl. spark plug connector									470 599	C10	
S3 quattro	Petrol	228	06/20->	DNFB								
				ENGINE								
Engine	Information				A10	A20	A40	A50	A70	C10 - C30	C20	E01
All engines	S3 Quattro, S3 Sportback Quattro, x 4, HITACHI, COIL ON PLUG, incl. spark plug connector									470 636	C10	
A4 I												
1.6	Petrol	74	11/94-09/01	0D6-280 I-A, ADP, AHL, ANA, ARM								
				ENGINE								
Engine	Information				A10	A20	A40	A50	A70	C10 - C30	C20	E01
Eng. ADP	version Bosch						806 266	906 121R				
Eng. ADP	version Ducellier						815 068	915 099R				
Eng. ADP									406 223			360 353
Eng. AHL, ANA, ARM										490 420	C30	
Eng. 0D6-280 I-A, AHL, ANA												360 585
1.6	Petrol	75	07/00-09/01	ALZ								
				ENGINE								
Engine	Information				A10	A20	A40	A50	A70	C10 - C30	C20	E01
All engines										490 420	C30	360 585
1.8	Petrol	85	04/95-09/01	AFY								
				ENGINE								
Engine	Information				A10	A20	A40	A50	A70	C10 - C30	C20	E01
All engines												360 491
1.8	Petrol	92	11/94-09/01	ADR, APT, ARG, AVV								
				ENGINE								
Engine	Information				A10	A20	A40	A50	A70	C10 - C30	C20	E01
All engines												360 491
1.8 quattro	Petrol	85	07/95-09/01	AFY								
				ENGINE								
Engine	Information				A10	A20	A40	A50	A70	C10 - C30	C20	E01
All engines												360 491
1.8 quattro	Petrol	92	01/95-09/01	ADR, APT, ARG								
				ENGINE								
Engine	Information				A10	A20	A40	A50	A70	C10 - C30	C20	E01
All engines												360 491
1.8 T	Petrol	110	01/95-09/01	1HN9, AEB, ANB, APU, ARK, AWT								
				ENGINE								
Engine	Information				A10	A20	A40	A50	A70	C10 - C30	C20	E01
Eng. AEB, ANB, APU, ARK	x 4, COIL ON PLUG									470 354S	C10	
Eng. AWT	x 4, COIL ON PLUG, incl. spark plug connector									470 429	C10	
Eng. 1HN9, ANB, APU, ARK	ch. 8D-V-244 484 ->											465 072

A10 CONDENSER	A20 CONTACT SET	A40 DISTRIBUTOR CAP	A50 ROTOR	A70 PICK-UP
C10 COIL	C20 IGNITION MODULE	C30 ELECTRONIC IGNITION KIT	E01 IGNITION CABLE SET	

Vehicle	alim.	kW	Date	Engine	FUNCTIONS ON THE VEHICLE									
					A10	A20	A40	A50	A70	C10 - C30	C20	E01		
1.8 T	Petrol	110	01/95-09/01	ENGINE 1HN9, AEB, ANB, APU, ARK, AWT										
Engine	Information													
Eng. 1HN9	->ch. 8D-V-244 483											465 076		
1.8 T	Petrol	132	12/97-09/01	ENGINE AJL										
Engine	Information													
All engines	x 4, COIL ON PLUG									470 354S	C10			
All engines												465 072		
1.8 T quattro	Petrol	110	01/95-09/01	ENGINE 1HN9, AEB, ANB, APU, ARK, AWT										
Engine	Information													
Eng. AEB, ANB, APU, ARK, AWT	x 4, COIL ON PLUG									470 354S	C10			
Eng. AWT	Qty: 4									470 429	C10			
Eng. 1HN9, ANB, APU, ARK	ch. 8D-V-244 484 ->											465 072		
Eng. 1HN9	->ch. 8D-V-244 483											465 076		
1.8 T quattro	Petrol	132	12/97-09/01	ENGINE AJL										
Engine	Information													
All engines	x 4, COIL ON PLUG									470 354S	C10			
All engines												465 072		
2.4	Petrol	110	07/95-07/97	ENGINE AFM										
Engine	Information													
All engines												465 051		
2.6	Petrol	110	01/95-09/01	ENGINE ABC										
Engine	Information													
All engines												465 051		
2.6 quattro	Petrol	110	01/95-09/01	ENGINE ABC										
Engine	Information													
All engines												465 051		
2.8	Petrol	128	09/95-07/97	ENGINE AAH										
Engine	Information													
All engines												465 051		
2.8 quattro	Petrol	128	01/95-07/97	ENGINE AAH										
Engine	Information													
All engines												465 051		
RS4 quattro	Petrol	280	05/00-09/01	ENGINE ASJ, AZR										
Engine	Information													
All engines	RS4 Quattro, x 6, COIL ON PLUG									470 354S	C10			
Eng. AZR												359 768		
S4 quattro	Petrol	195	09/97-09/01	ENGINE AGB, AZB										
Engine	Information													
All engines	S4 Quattro, x 6, COIL ON PLUG									470 354S	C10			
A4 II				ENGINE										
1.6	Petrol	75	11/00-12/04	ENGINE ALZ										
Engine	Information													
All engines										490 420	C30		360 585	
1.8 T	Petrol	110	11/00-07/02	ENGINE AVJ										
Engine	Information													
All engines	x 4, COIL ON PLUG, incl. spark plug connector									470 429	C10			
All engines												465 076		
A10	CONDENSER		A20	CONTACT SET		A40	DISTRIBUTOR CAP		A50	ROTOR		A70	PICK-UP	
C10	COIL		C20	IGNITION MODULE		C30	ELECTRONIC IGNITION KIT		E01	IGNITION CABLE SET				

				FUNCTIONS ON THE VEHICLE								
Vehicle	alim.	kW	Date	Engine	 A10	 A20	 A40	 A50	 A70	 C10 - C30	 C20	 E01
				ENGINE								
1.8 T	Petrol	120	07/02-12/04	BFB								
Engine	Information				A10	A20	A40	A50	A70	C10 - C30	C20	E01
All engines	x 4, COIL ON PLUG, incl. spark plug connector									470 429	C10	
				ENGINE								
1.8 T	Petrol	125	07/01-12/04	AMB								
Engine	Information				A10	A20	A40	A50	A70	C10 - C30	C20	E01
All engines	x 4, COIL ON PLUG, incl. spark plug connector									470 429	C10	
				ENGINE								
1.8 T	Petrol	140	11/02-12/04	BEX								
Engine	Information				A10	A20	A40	A50	A70	C10 - C30	C20	E01
All engines	x 4, COIL ON PLUG, incl. spark plug connector									470 429	C10	
				ENGINE								
1.8 T quattro	Petrol	110	11/00-07/02	AVJ								
Engine	Information				A10	A20	A40	A50	A70	C10 - C30	C20	E01
All engines	x 4, COIL ON PLUG, incl. spark plug connector									470 429	C10	
All engines											465 076	
				ENGINE								
1.8 T quattro	Petrol	120	07/02-12/04	BFB								
Engine	Information				A10	A20	A40	A50	A70	C10 - C30	C20	E01
All engines	x 4, COIL ON PLUG, incl. spark plug connector									470 429	C10	
				ENGINE								
1.8 T quattro	Petrol	125	07/01-12/04	AMB								
Engine	Information				A10	A20	A40	A50	A70	C10 - C30	C20	E01
All engines	x 4, COIL ON PLUG, incl. spark plug connector									470 429	C10	
				ENGINE								
1.8 T quattro	Petrol	140	11/02-12/04	BEX								
Engine	Information				A10	A20	A40	A50	A70	C10 - C30	C20	E01
All engines	x 4, COIL ON PLUG, incl. spark plug connector									470 429	C10	
				ENGINE								
2.0	Petrol	96	11/00-12/04	ALT								
Engine	Information				A10	A20	A40	A50	A70	C10 - C30	C20	E01
All engines	x 4, Colour:Red, COIL ON PLUG, incl. spark plug connector									470 436	C10	
				ENGINE								
2.0 FSI	Petrol	110	07/02-12/04	AWA								
Engine	Information				A10	A20	A40	A50	A70	C10 - C30	C20	E01
All engines	x 4, Colour:Red, COIL ON PLUG, incl. spark plug connector									470 427	C10	
				ENGINE								
3.0	Petrol	160	04/01-12/04	BBJ								
Engine	Information				A10	A20	A40	A50	A70	C10 - C30	C20	E01
All engines	x 6, Colour:Red, COIL ON PLUG, incl. spark plug connector									470 436	C10	
				ENGINE								
3.0	Petrol	162	11/00-12/04	ASN, AVK								
Engine	Information				A10	A20	A40	A50	A70	C10 - C30	C20	E01
Eng. ASN	x 6, Colour:Red, COIL ON PLUG, incl. spark plug connector									470 436	C10	
Eng. AVK	Qty: 6									470 436	C10	
				ENGINE								
3.0 quattro	Petrol	160	04/01-12/04	BBJ								
Engine	Information				A10	A20	A40	A50	A70	C10 - C30	C20	E01
All engines	x 6, Colour:Red, COIL ON PLUG, incl. spark plug connector									470 436	C10	
				ENGINE								
3.0 quattro	Petrol	162	11/00-12/04	ASN, AVK								
Engine	Information				A10	A20	A40	A50	A70	C10 - C30	C20	E01
All engines	x 6, Colour:Red, COIL ON PLUG, incl. spark plug connector									470 436	C10	
Eng. AVK	Qty: 6									470 436	C10	
				ENGINE								
S4 quattro	Petrol	253	03/03-12/04	BBK								
Engine	Information				A10	A20	A40	A50	A70	C10 - C30	C20	E01
All engines	S4 Quattro, x 8, Colour:Red, COIL ON PLUG, incl. spark plug connector									470 433	C10	









A10 CONDENSER	A20 CONTACT SET	A40 DISTRIBUTOR CAP	A50 ROTOR	A70 PICK-UP
C10 COIL	C20 IGNITION MODULE	C30 ELECTRONIC IGNITION KIT	E01 IGNITION CABLE SET	

Vehicle	alim.	kW	Date	Engine	FUNCTIONS ON THE VEHICLE							
					A10	A20	A40	A50	A70	C10 - C30	C20	E01

A4 III					ENGINE									
1.6	Petrol	75	11/04-06/08	ALZ										
Engine	Information				A10	A20	A40	A50	A70	C10 - C30	C20	E01		
All engines										490 420	C30		360 585	
1.8 T	Petrol	120	07/02-03/09	BFB										
Engine	Information				A10	A20	A40	A50	A70	C10 - C30	C20	E01		
All engines	x 4, COIL ON PLUG, incl. spark plug connector									470 429	C10			
1.8 T quattro	Petrol	120	05/03-06/08	BFB										
Engine	Information				A10	A20	A40	A50	A70	C10 - C30	C20	E01		
All engines	x 4, COIL ON PLUG, incl. spark plug connector									470 429	C10			
2.0	Petrol	96	09/04-06/08	ALT										
Engine	Information				A10	A20	A40	A50	A70	C10 - C30	C20	E01		
All engines	x 4, COIL ON PLUG, incl. spark plug connector									470 429	C10			
All engines	x 4, Colour:Red, COIL ON PLUG, incl. spark plug connector									470 436	C10			
2.0 TFSI	Petrol	125	10/06-06/08	BPJ, BYK										
Engine	Information				A10	A20	A40	A50	A70	C10 - C30	C20	E01		
Eng. BPJ	x 4, ELDOR, Housing Colour:Black, COIL ON PLUG, incl. spark plug connector									470 426	C10			
Eng. BYK	Qty: 4									470 426	C10			
2.0 TFSI	Petrol	147	11/04-06/08	BGB, BPG, BWE, BWT										
Engine	Information				A10	A20	A40	A50	A70	C10 - C30	C20	E01		
All engines	x 4, ELDOR, Housing Colour:Black, COIL ON PLUG, incl. spark plug connector									470 426	C10			
2.0 TFSI	Petrol	162	06/05-06/08	BUL										
Engine	Information				A10	A20	A40	A50	A70	C10 - C30	C20	E01		
All engines	x 4, ELDOR, Housing Colour:Black, COIL ON PLUG, incl. spark plug connector									470 426	C10			
2.0 TFSI 16V	Petrol	147	01/06-03/09	BWE, BWT										
Engine	Information				A10	A20	A40	A50	A70	C10 - C30	C20	E01		
All engines	x 4, ELDOR, Housing Colour:Black, COIL ON PLUG, incl. spark plug connector									470 426	C10			
2.0 TFSI quattro	Petrol	147	11/04-03/09	BGB, BWE, BWT										
Engine	Information				A10	A20	A40	A50	A70	C10 - C30	C20	E01		
All engines	x 4, ELDOR, Housing Colour:Black, COIL ON PLUG, incl. spark plug connector									470 426	C10			
Eng. BWT	Qty: 4									470 426	C10			
2.0 TFSI quattro	Petrol	162	06/05-06/08	BUL										
Engine	Information				A10	A20	A40	A50	A70	C10 - C30	C20	E01		
All engines	x 4, ELDOR, Housing Colour:Black, COIL ON PLUG, incl. spark plug connector									470 426	C10			
3.0	Petrol	160	04/02-05/06	BBJ										
Engine	Information				A10	A20	A40	A50	A70	C10 - C30	C20	E01		
All engines	x 6, Colour:Red, COIL ON PLUG, incl. spark plug connector									470 436	C10			
3.0	Petrol	162	04/02-12/05	ASN										
Engine	Information				A10	A20	A40	A50	A70	C10 - C30	C20	E01		
All engines	x 6, Colour:Red, COIL ON PLUG, incl. spark plug connector									470 436	C10			
3.0 quattro	Petrol	160	11/04-07/06	BBJ										
Engine	Information				A10	A20	A40	A50	A70	C10 - C30	C20	E01		
All engines	x 6, Colour:Red, COIL ON PLUG, incl. spark plug connector									470 436	C10			

A10	CONDENSER	A20	CONTACT SET	A40	DISTRIBUTOR CAP	A50	ROTOR	A70	PICK-UP
C10	COIL	C20	IGNITION MODULE	C30	ELECTRONIC IGNITION KIT	E01	IGNITION CABLE SET		

The present application list is a brief version. For the detailed information about the possibility of installation on a specific vehicle, please refer to our web-catalogue <http://catalogo.facet.eu/>









				FUNCTIONS ON THE VEHICLE								
Vehicle	alim.	kW	Date	Engine								
				ENGINE								
3.0 quattro	Petrol	162	05/03-12/05	ASN								
Engine	Information			A10	A20	A40	A50	A70	C10 - C30	C20	E01	
All engines	x 6, Colour:Red, COIL ON PLUG, incl. spark plug connector								470 436	C10		
				ENGINE								
3.2 FSI	Petrol	188	01/05-03/09	AUK								
Engine	Information			A10	A20	A40	A50	A70	C10 - C30	C20	E01	
All engines	x 6, Colour:Red, COIL ON PLUG, incl. spark plug connector								470 427	C10		
				ENGINE								
3.2 FSI quattro	Petrol	188	01/05-03/09	AUK, BKH								
Engine	Information			A10	A20	A40	A50	A70	C10 - C30	C20	E01	
Eng. AUK	x 6, Colour:Red, COIL ON PLUG, incl. spark plug connector								470 427	C10		
Eng. BKH	Qty: 6								470 427	C10		
				ENGINE								
RS4 quattro	Petrol	309	09/05-12/08	BNS								
Engine	Information			A10	A20	A40	A50	A70	C10 - C30	C20	E01	
All engines	RS4 Cabrio Quattro, RS4 Quattro, x 8, ELDOR, Housing Colour:Black, COIL ON PLUG, incl. spark plug connector								470 426	C10		
				ENGINE								
S4 quattro	Petrol	253	03/04-03/09	BBK, BHF								
Engine	Information			A10	A20	A40	A50	A70	C10 - C30	C20	E01	
All engines	S4 Cabrio Quattro, S4 Quattro, x 8, Colour:Red, x 8, COIL ON PLUG, Colour:Red, COIL ON PLUG, incl. spark plug connector, incl. spark plug connector								470 433	C10		
				ENGINE								
A4 IV				ENGINE								
1.8 TFSI	Petrol	118	11/07-03/12	CABB, CDHB								
Engine	Information			A10	A20	A40	A50	A70	C10 - C30	C20	E01	
All engines	x 4, ELDOR, Housing Colour:Black, COIL ON PLUG, incl. spark plug connector								470 426	C10		
				ENGINE								
1.8 TFSI	Petrol	125	11/11-12/15	CJEB								
Engine	Information			A10	A20	A40	A50	A70	C10 - C30	C20	E01	
All engines	x 4, ELDOR, Colour:Black, COIL ON PLUG								470 636	C10		
				ENGINE								
1.8 TFSI	Petrol	88	01/08-12/15	CABA, CDHA								
Engine	Information			A10	A20	A40	A50	A70	C10 - C30	C20	E01	
All engines	x 4, ELDOR, Housing Colour:Black, COIL ON PLUG, incl. spark plug connector								470 426	C10		
				ENGINE								
1.8 TFSI quattro	Petrol	118	09/08-03/12	CDHB								
Engine	Information			A10	A20	A40	A50	A70	C10 - C30	C20	E01	
All engines	x 4, ELDOR, Housing Colour:Black, COIL ON PLUG, incl. spark plug connector								470 426	C10		
				ENGINE								
1.8 TFSI quattro	Petrol	125	11/11-12/15	CJEB								
Engine	Information			A10	A20	A40	A50	A70	C10 - C30	C20	E01	
All engines	x 4, ELDOR, Colour:Black, COIL ON PLUG								470 636	C10		
				ENGINE								
2.0 TFSI	Petrol	132	06/08-12/15	CAEA, CDNB, CFKA								
Engine	Information			A10	A20	A40	A50	A70	C10 - C30	C20	E01	
Eng. CAEA	Qty: 4								470 426	C10		
Eng. CDNB, CFKA	x 4, ELDOR, Housing Colour:Black, COIL ON PLUG, incl. spark plug connector								470 426	C10		
				ENGINE								
2.0 TFSI	Petrol	155	06/08-05/13	CAEB, CDNC								
Engine	Information			A10	A20	A40	A50	A70	C10 - C30	C20	E01	
All engines	x 4, ELDOR, Housing Colour:Black, COIL ON PLUG, incl. spark plug connector								470 426	C10		
Eng. CAEB	Qty: 4								470 426	C10		
				ENGINE								
2.0 TFSI	Petrol	162	05/13-12/15	CAED								
Engine	Information			A10	A20	A40	A50	A70	C10 - C30	C20	E01	
All engines	Qty: 4								470 426	C10		
All engines	x 4, ELDOR, Housing Colour:Black, COIL ON PLUG, incl. spark plug connector								470 426	C10		

A10 CONDENSER	A20 CONTACT SET	A40 DISTRIBUTOR CAP	A50 ROTOR	A70 PICK-UP
C10 COIL	C20 IGNITION MODULE	C30 ELECTRONIC IGNITION KIT	E01 IGNITION CABLE SET	

Vehicle	alim.	kW	Date	Engine	FUNCTIONS ON THE VEHICLE							
					A10	A20	A40	A50	A70	C10 - C30	C20	E01
ENGINE												
2.0 TFSI	Petrol	165	05/13-12/15	CNCD								
Engine	Information				A10	A20	A40	A50	A70	C10 - C30	C20	E01
All engines	->year 01/05/15, x4, HITACHI, COIL ON PLUG, incl. spark plug connector									470 636	C10	
ENGINE												
2.0 TFSI flexible fuel	Petrol/ Ethanol	132	11/09-12/15	CFKA								
Engine	Information				A10	A20	A40	A50	A70	C10 - C30	C20	E01
All engines	x 4, ELDOR, Housing Colour:Black, COIL ON PLUG, incl. spark plug connector									470 426	C10	
ENGINE												
2.0 TFSI flexible fuel quattro	Petrol/ Ethanol	132	11/09-12/15	CFKA								
Engine	Information				A10	A20	A40	A50	A70	C10 - C30	C20	E01
All engines	x 4, ELDOR, Housing Colour:Black, COIL ON PLUG, incl. spark plug connector									470 426	C10	
ENGINE												
2.0 TFSI quattro	Petrol	132	11/09-03/12	CFKA								
Engine	Information				A10	A20	A40	A50	A70	C10 - C30	C20	E01
All engines	x 4, ELDOR, Housing Colour:Black, COIL ON PLUG, incl. spark plug connector									470 426	C10	
ENGINE												
2.0 TFSI quattro	Petrol	155	06/08-12/15	CAEB, CDNC, CPMA								
Engine	Information				A10	A20	A40	A50	A70	C10 - C30	C20	E01
All engines	x 4, ELDOR, Housing Colour:Black, COIL ON PLUG, incl. spark plug connector									470 426	C10	
Eng. CAEB	Qty: 4									470 426	C10	
ENGINE												
2.0 TFSI quattro	Petrol	162	05/13-12/15	CAED, CPMB								
Engine	Information				A10	A20	A40	A50	A70	C10 - C30	C20	E01
All engines	x 4, ELDOR, Housing Colour:Black, COIL ON PLUG, incl. spark plug connector									470 426	C10	
ENGINE												
2.0 TFSI quattro	Petrol	165	05/13-12/15	CNCD								
Engine	Information				A10	A20	A40	A50	A70	C10 - C30	C20	E01
All engines	->year 01/05/15, x4, HITACHI, COIL ON PLUG, incl. spark plug connector									470 636	C10	
ENGINE												
3.0 TFSI quattro	Petrol	200	02/12-12/15	CMUA, CRED								
Engine	Information				A10	A20	A40	A50	A70	C10 - C30	C20	E01
All engines	x 6, Colour:Red, COIL ON PLUG, incl. spark plug connector									470 427	C10	
ENGINE												
3.2 FSI	Petrol	195	09/08-03/12	CALA								
Engine	Information				A10	A20	A40	A50	A70	C10 - C30	C20	E01
All engines	x 6, Colour:Red, COIL ON PLUG, incl. spark plug connector									470 427	C10	
ENGINE												
3.2 FSI quattro	Petrol	195	11/07-03/12	CALA								
Engine	Information				A10	A20	A40	A50	A70	C10 - C30	C20	E01
All engines	x 6, Colour:Red, COIL ON PLUG, incl. spark plug connector									470 427	C10	
ENGINE												
RS4 quattro	Petrol	331	05/12-08/15	CFSA								
Engine	Information				A10	A20	A40	A50	A70	C10 - C30	C20	E01
All engines	RS4 Quattro, x8, ELDOR, Housing Colour:Black, COIL ON PLUG, incl. spark plug connector									470 426	C10	
ENGINE												
S4 quattro	Petrol	245	11/08-12/15	CAKA, CCBA, CGWC, CGXC, CREC, CTUB								
Engine	Information				A10	A20	A40	A50	A70	C10 - C30	C20	E01
All engines	S4 Quattro, x 6, Colour:Red, COIL ON PLUG, incl. spark plug connector									470 427	C10	
A4 IV ALLROAD												
ENGINE												
2.0 TFSI quattro	Petrol	155	04/09-05/16	CDNC, CPMA								
Engine	Information				A10	A20	A40	A50	A70	C10 - C30	C20	E01
All engines	x 4, ELDOR, Housing Colour:Black, COIL ON PLUG, incl. spark plug connector									470 426	C10	

A10 CONDENSER	A20 CONTACT SET	A40 DISTRIBUTOR CAP	A50 ROTOR	A70 PICK-UP
C10 COIL	C20 IGNITION MODULE	C30 ELECTRONIC IGNITION KIT	E01 IGNITION CABLE SET	

The present application list is a brief version. For the detailed information about the possibility of installation on a specific vehicle, please refer to our web-catalogue <http://catalogo.facet.eu/>

				FUNCTIONS ON THE VEHICLE								
Vehicle	alim.	kW	Date	Engine								
				ENGINE								
2.0 TFSI quattro	Petrol	162	05/13-05/16	CPMB								
Engine	Information				A10	A20	A40	A50	A70	C10 - C30	C20	E01
All engines	x 4, ELDOR, Housing Colour:Black, COIL ON PLUG, incl. spark plug connector									470 426	C10	
				ENGINE								
2.0 TFSI quattro	Petrol	165	05/13-05/16	CNCD								
Engine	Information				A10	A20	A40	A50	A70	C10 - C30	C20	E01
All engines	->year 01/05/15, x 4, HITACHI, COIL ON PLUG, incl. spark plug connector									470 636	C10	
				ENGINE								
A4 V				CVNA								
1.4 TFSI	Petrol	110	08/15-11/19	CVNA								
Engine	Information				A10	A20	A40	A50	A70	C10 - C30	C20	E01
All engines	x 4, BERU, ELDOR, COIL ON PLUG, incl. spark plug connector, Number of pins:4, incl. spark plug connector									470 599	C10	
				ENGINE								
2.0 TFSI	Petrol	183	11/15-11/19	CYRC								
Engine	Information				A10	A20	A40	A50	A70	C10 - C30	C20	E01
All engines	x 4, HITACHI, COIL ON PLUG, incl. spark plug connector									470 636	C10	
				ENGINE								
2.0 TFSI	Petrol	185	05/15-11/19	CYMC, CYRB								
Engine	Information				A10	A20	A40	A50	A70	C10 - C30	C20	E01
All engines	x 4, HITACHI, COIL ON PLUG, incl. spark plug connector									470 636	C10	
				ENGINE								
2.0 TFSI Mild Hybrid	Petrol/ Electric	185	05/17-11/19	DDWA								
Engine	Information				A10	A20	A40	A50	A70	C10 - C30	C20	E01
All engines	x 4, HITACHI, COIL ON PLUG, incl. spark plug connector									470 636	C10	
				ENGINE								
2.0 TFSI Mild Hybrid quattro	Petrol/ Electric	185	05/17->	DDWA								
Engine	Information				A10	A20	A40	A50	A70	C10 - C30	C20	E01
All engines	x 4, HITACHI, COIL ON PLUG, incl. spark plug connector									470 636	C10	
				ENGINE								
2.0 TFSI quattro	Petrol	183	11/15-11/19	CYRC								
Engine	Information				A10	A20	A40	A50	A70	C10 - C30	C20	E01
All engines	x 4, HITACHI, COIL ON PLUG, incl. spark plug connector									470 636	C10	
				ENGINE								
2.0 TFSI quattro	Petrol	185	05/15->	CYMC, CYRB								
Engine	Information				A10	A20	A40	A50	A70	C10 - C30	C20	E01
All engines	x 4, HITACHI, COIL ON PLUG, incl. spark plug connector									470 636	C10	
				ENGINE								
35 TFSI Mild Hybrid	Petrol/ Electric	110	12/18->	DLVB, DMSB								
Engine	Information				A10	A20	A40	A50	A70	C10 - C30	C20	E01
All engines	x 4, HITACHI, COIL ON PLUG, incl. spark plug connector									470 636	C10	
				ENGINE								
40 TFSI Mild Hybrid	Petrol/ Electric	150	06/20->	DMSA								
Engine	Information				A10	A20	A40	A50	A70	C10 - C30	C20	E01
All engines	x 4, HITACHI, COIL ON PLUG, incl. spark plug connector									470 636	C10	
				ENGINE								
40 TFSI Mild Hybrid quattro	Petrol/ Electric	150	06/20->	DMSA								
Engine	Information				A10	A20	A40	A50	A70	C10 - C30	C20	E01
All engines	x 4, HITACHI, COIL ON PLUG, incl. spark plug connector									470 636	C10	
				ENGINE								
45 TFSI Mild Hybrid	Petrol/ Electric	180	07/18-11/19	DKNA								
Engine	Information				A10	A20	A40	A50	A70	C10 - C30	C20	E01
All engines	x 4, HITACHI, COIL ON PLUG, incl. spark plug connector									470 636	C10	

A10 CONDENSER	A20 CONTACT SET	A40 DISTRIBUTOR CAP	A50 ROTOR	A70 PICK-UP
C10 COIL	C20 IGNITION MODULE	C30 ELECTRONIC IGNITION KIT	E01 IGNITION CABLE SET	

Vehicle	alim.	kW	Date	Engine	FUNCTIONS ON THE VEHICLE							
					A10	A20	A40	A50	A70	C10 - C30	C20	E01

ENGINE				
45 TFSI Mild Hybrid quattro	Petrol/Electric	180	07/18-11/19	DKNA

Engine	Information	A10	A20	A40	A50	A70	C10 - C30	C20	E01
All engines	x 4, HITACHI, COIL ON PLUG, incl. spark plug connector						470 636	C10	

ENGINE				
45 TFSI Mild Hybrid quattro	Petrol/Electric	195	08/20->	DMTA

Engine	Information	A10	A20	A40	A50	A70	C10 - C30	C20	E01
All engines	x 4, HITACHI, COIL ON PLUG, incl. spark plug connector						470 636	C10	

A4 V ALLROAD

ENGINE				
2.0 TFSI Mild Hybrid quattro	Petrol/Electric	185	11/18-10/19	DDWA

Engine	Information	A10	A20	A40	A50	A70	C10 - C30	C20	E01
All engines	x 4, HITACHI, COIL ON PLUG, incl. spark plug connector						470 636	C10	

ENGINE				
2.0 TFSI quattro	Petrol	183	05/16-10/19	CYRC

Engine	Information	A10	A20	A40	A50	A70	C10 - C30	C20	E01
All engines	x 4, HITACHI, COIL ON PLUG, incl. spark plug connector						470 636	C10	

ENGINE				
2.0 TFSI quattro	Petrol	185	01/16->	CYMC, CYRB

Engine	Information	A10	A20	A40	A50	A70	C10 - C30	C20	E01
All engines	x 4, HITACHI, COIL ON PLUG, incl. spark plug connector						470 636	C10	

ENGINE				
45 TFSI Mild Hybrid quattro	Petrol/Electric	180	07/18->	DKNA

Engine	Information	A10	A20	A40	A50	A70	C10 - C30	C20	E01
All engines	x 4, HITACHI, COIL ON PLUG, incl. spark plug connector						470 636	C10	

ENGINE				
45 TFSI Mild Hybrid quattro	Petrol/Electric	195	08/20->	DMTA

Engine	Information	A10	A20	A40	A50	A70	C10 - C30	C20	E01
All engines	x 4, HITACHI, COIL ON PLUG, incl. spark plug connector						470 636	C10	

A5 I

ENGINE				
1.8 TFSI	Petrol	106	09/14-01/17	CJED

Engine	Information	A10	A20	A40	A50	A70	C10 - C30	C20	E01
All engines	->year 01/03/15, x 4, Colour:Black, COIL ON PLUG, incl. spark plug connector						470 636	C10	

ENGINE				
1.8 TFSI	Petrol	118	05/09-03/12	CDHB

Engine	Information	A10	A20	A40	A50	A70	C10 - C30	C20	E01
All engines	x 4, ELDOR, Housing Colour:Black, COIL ON PLUG, incl. spark plug connector						470 426	C10	

ENGINE				
1.8 TFSI	Petrol	125	10/07-01/17	CABD, CJEB

Engine	Information	A10	A20	A40	A50	A70	C10 - C30	C20	E01
Eng. CABD	Qty: 4						470 426	C10	
Eng. CABD	x 4, ELDOR, Housing Colour:Black, COIL ON PLUG, incl. spark plug connector						470 426	C10	
Eng. CJEB	->year 01/04/15, x 4, ELDOR, x 4, Colour:Black, ELDOR, x 4, COIL ON PLUG, Colour:Black, COIL ON PLUG, incl. spark plug connector, incl. spark plug connector						470 636	C10	

ENGINE				
1.8 TFSI	Petrol	130	05/15-01/17	CJEE









Engine	Information	A10	A20	A40	A50	A70	C10 - C30	C20	E01
All engines	->year 01/05/15, x 4, Colour:Black, COIL ON PLUG, incl. spark plug connector						470 636	C10	

ENGINE				
2.0 TFSI	Petrol	132	11/08-06/14	CAEA, CDNB

Engine	Information	A10	A20	A40	A50	A70	C10 - C30	C20	E01
All engines	x 4, ELDOR, Housing Colour:Black, COIL ON PLUG, incl. spark plug connector						470 426	C10	

A10 CONDENSER	A20 CONTACT SET	A40 DISTRIBUTOR CAP	A50 ROTOR	A70 PICK-UP
C10 COIL	C20 IGNITION MODULE	C30 ELECTRONIC IGNITION KIT	E01 IGNITION CABLE SET	

The present application list is a brief version. For the detailed information about the possibility of installation on a specific vehicle, please refer to our web-catalogue <http://catalogo.facet.eu/>

				FUNCTIONS ON THE VEHICLE								
Vehicle	alim.	kW	Date	Engine								
				ENGINE								
2.0 TFSI	Petrol	155	06/08-06/14	CAEB, CDNC								
Engine	Information			A10	A20	A40	A50	A70	C10 - C30	C20	E01	
All engines	x 4, ELDOR, Housing Colour:Black, COIL ON PLUG, incl. spark plug connector								470 426	C10		
				ENGINE								
2.0 TFSI	Petrol	162	05/13-12/14	CAED								
Engine	Information			A10	A20	A40	A50	A70	C10 - C30	C20	E01	
All engines	x 4, ELDOR, Housing Colour:Black, COIL ON PLUG, incl. spark plug connector								470 426	C10		
				ENGINE								
2.0 TFSI	Petrol	165	05/13-05/16	CNCD								
Engine	Information			A10	A20	A40	A50	A70	C10 - C30	C20	E01	
All engines	->year 01/05/15, x 4, HITACHI, COIL ON PLUG, incl. spark plug connector								470 636	C10		
				ENGINE								
2.0 TFSI quattro	Petrol	155	06/08-01/17	CAEB, CDNC, CPMA								
Engine	Information			A10	A20	A40	A50	A70	C10 - C30	C20	E01	
All engines	x 4, ELDOR, Housing Colour:Black, COIL ON PLUG, incl. spark plug connector								470 426	C10		
Eng. CAEB	Qty: 4								470 426	C10		
				ENGINE								
2.0 TFSI quattro	Petrol	162	03/12-01/17	CAED, CPMB								
Engine	Information			A10	A20	A40	A50	A70	C10 - C30	C20	E01	
All engines	x 4, ELDOR, Housing Colour:Black, COIL ON PLUG, incl. spark plug connector								470 426	C10		
Eng. CPMB	Qty: 4								470 426	C10		
				ENGINE								
2.0 TFSI quattro	Petrol	165	05/13-05/16	CNCD								
Engine	Information			A10	A20	A40	A50	A70	C10 - C30	C20	E01	
All engines	->year 01/05/15, x 4, HITACHI, COIL ON PLUG, incl. spark plug connector								470 636	C10		
				ENGINE								
3.0 TFSI quattro	Petrol	200	08/11->	CHMB, CMUA, CRED								
Engine	Information			A10	A20	A40	A50	A70	C10 - C30	C20	E01	
All engines	x 6, Colour:Red, COIL ON PLUG, incl. spark plug connector								470 427	C10		
Eng. CHMB	Qty: 6								470 427	C10		
				ENGINE								
3.2 FSI	Petrol	195	06/07-03/12	CALA								
Engine	Information			A10	A20	A40	A50	A70	C10 - C30	C20	E01	
All engines	x 6, Colour:Red, COIL ON PLUG, incl. spark plug connector								470 427	C10		
				ENGINE								
3.2 FSI quattro	Petrol	195	06/07-03/12	CALA								
Engine	Information			A10	A20	A40	A50	A70	C10 - C30	C20	E01	
All engines	x 6, Colour:Red, COIL ON PLUG, incl. spark plug connector								470 427	C10		
				ENGINE								
R55 quattro	Petrol	331	03/10-01/17	CFSA								
Engine	Information			A10	A20	A40	A50	A70	C10 - C30	C20	E01	
All engines	R55 Cabrio Quattro, R55 Quattro, x 8, ELDOR, Housing Colour:Black, COIL ON PLUG, incl. spark plug connector								470 426	C10		
				ENGINE								
S5 quattro	Petrol	245	06/09-01/17	CAKA, CCBA, CGWC, CGXC, CREC, CTDA, CTUB								
Engine	Information			A10	A20	A40	A50	A70	C10 - C30	C20	E01	
All engines	S5 Cabrio Quattro, S5 Quattro, S5 Sportback Quattro, x 6, Colour:Red, COIL ON PLUG, incl. spark plug connector								470 427	C10		
Eng. CGXC, CTUB	Qty: 6								470 427	C10		
				ENGINE								
S5 quattro	Petrol	260	06/07-03/12	CAUA								
Engine	Information			A10	A20	A40	A50	A70	C10 - C30	C20	E01	
All engines	S5 Quattro, x 8, Colour:Red, COIL ON PLUG, incl. spark plug connector								470 427	C10		
				A5 II								
				ENGINE								
1.4 TFSI	Petrol	110	11/16-02/20	CVNA								
Engine	Information			A10	A20	A40	A50	A70	C10 - C30	C20	E01	
All engines	x 4, HITACHI, COIL ON PLUG, incl. spark plug connector								470 599	C10		
				A10 CONDENSER								
				A20 CONTACT SET								
				A40 DISTRIBUTOR CAP								
				A50 ROTOR								
				A70 PICK-UP								
				C10 COIL								
				C20 IGNITION MODULE								
				C30 ELECTRONIC IGNITION KIT								
				E01 IGNITION CABLE SET								

Vehicle	alim.	kW	Date	Engine	FUNCTIONS ON THE VEHICLE									
					A10	A20	A40	A50	A70	C10 - C30	C20	E01		
ENGINE														
2.0 TFSI	Petrol	185	11/16-02/20	CYRB										
Engine	Information				A10	A20	A40	A50	A70	C10 - C30	C20	E01		
All engines	x 4, HITACHI, COIL ON PLUG, incl. spark plug connector									470 636	C10			
ENGINE														
2.0 TFSI Mild Hybrid	Petrol/ Electric	185	05/17-02/20	DDWA										
Engine	Information				A10	A20	A40	A50	A70	C10 - C30	C20	E01		
All engines	x 4, HITACHI, COIL ON PLUG, incl. spark plug connector									470 636	C10			
ENGINE														
2.0 TFSI Mild Hybrid quattro	Petrol/ Electric	185	05/17->	DDWA, DLHB										
Engine	Information				A10	A20	A40	A50	A70	C10 - C30	C20	E01		
All engines	x 4, HITACHI, COIL ON PLUG, incl. spark plug connector									470 636	C10			
ENGINE														
2.0 TFSI quattro	Petrol	183	06/16-02/20	CYRC										
Engine	Information				A10	A20	A40	A50	A70	C10 - C30	C20	E01		
All engines	x 4, HITACHI, COIL ON PLUG, incl. spark plug connector									470 636	C10			
ENGINE														
2.0 TFSI quattro	Petrol	185	06/16->	CYMC, CYRB										
Engine	Information				A10	A20	A40	A50	A70	C10 - C30	C20	E01		
All engines	x 4, HITACHI, COIL ON PLUG, incl. spark plug connector									470 636	C10			
ENGINE														
35 TFSI Mild Hybrid	Petrol/ Electric	110	08/18->	DLVB, DMSB										
Engine	Information				A10	A20	A40	A50	A70	C10 - C30	C20	E01		
All engines	x 4, HITACHI, COIL ON PLUG, incl. spark plug connector									470 636	C10			
ENGINE														
40 TFSI Mild Hybrid	Petrol/ Electric	150	05/20->	DMSA										
Engine	Information				A10	A20	A40	A50	A70	C10 - C30	C20	E01		
All engines	x 4, HITACHI, COIL ON PLUG, incl. spark plug connector									470 636	C10			
ENGINE														
40 TFSI Mild Hybrid quattro	Petrol/ Electric	150	06/20->	DMSA										
Engine	Information				A10	A20	A40	A50	A70	C10 - C30	C20	E01		
All engines	x 4, HITACHI, COIL ON PLUG, incl. spark plug connector									470 636	C10			
ENGINE														
45 TFSI Mild Hybrid	Petrol/ Electric	180	07/18-02/20	DKNA										
Engine	Information				A10	A20	A40	A50	A70	C10 - C30	C20	E01		
All engines	x 4, HITACHI, COIL ON PLUG, incl. spark plug connector									470 636	C10			
ENGINE														
45 TFSI Mild Hybrid quattro	Petrol/ Electric	180	07/18-02/20	DKNA										
Engine	Information				A10	A20	A40	A50	A70	C10 - C30	C20	E01		
All engines	x 4, HITACHI, COIL ON PLUG, incl. spark plug connector									470 636	C10			
ENGINE														
45 TFSI Mild Hybrid quattro	Petrol/ Electric	195	10/19->	DMTA, DPAA										
Engine	Information				A10	A20	A40	A50	A70	C10 - C30	C20	E01		
All engines	x 4, HITACHI, COIL ON PLUG, incl. spark plug connector									470 636	C10			
A6 I														
1.8 quattro	Petrol	92	12/95-12/97	ADR										
Engine	Information				A10	A20	A40	A50	A70	C10 - C30	C20	E01		
All engines													360 491	
ENGINE														
2.0	Petrol	74	06/94-12/97	AAE										
Engine	Information				A10	A20	A40	A50	A70	C10 - C30	C20	E01		
All engines	version Bosch						806 266	906 121R						
All engines													359 768	

A10 CONDENSER	A20 CONTACT SET	A40 DISTRIBUTOR CAP	A50 ROTOR	A70 PICK-UP
C10 COIL	C20 IGNITION MODULE	C30 ELECTRONIC IGNITION KIT	E01 IGNITION CABLE SET	









The present application list is a brief version. For the detailed information about the possibility of installation on a specific vehicle, please refer to our web-catalogue <http://catalogo.facet.eu/>

Vehicle	alim.	kW	Date	Engine	FUNCTIONS ON THE VEHICLE									
					A10	A20	A40	A50	A70	C10 - C30	C20	E01		
ENGINE														
2.0	Petrol	79	06/94-07/96	ADW										
Engine	Information				A10	A20	A40	A50	A70	C10 - C30	C20	E01		
All engines	version Bosch						806 266	906 121R						
All engines													359 768	
ENGINE														
2.0	Petrol	85	06/94-12/97	ABK										
Engine	Information				A10	A20	A40	A50	A70	C10 - C30	C20	E01		
All engines	version Bosch						806 266	906 121R						
All engines													359 768	
ENGINE														
2.0 16V	Petrol	103	06/94-12/97	ACE										
Engine	Information				A10	A20	A40	A50	A70	C10 - C30	C20	E01		
All engines	version Bosch						806 248							
All engines													360 356	
ENGINE														
2.0 16V quattro	Petrol	103	06/94-12/97	ACE										
Engine	Information				A10	A20	A40	A50	A70	C10 - C30	C20	E01		
All engines	version Bosch						806 248							
All engines													360 356	
ENGINE														
2.3	Petrol	98	06/94-12/95	7M15A-FKS										
Engine	Information				A10	A20	A40	A50	A70	C10 - C30	C20	E01		
All engines	version Bosch						806 231	906 121R						
All engines	ch. 4A-T-000 001 ->												360 682	
ENGINE														
2.3 quattro	Petrol	98	06/94-12/95	7M15A-FKS										
Engine	Information				A10	A20	A40	A50	A70	C10 - C30	C20	E01		
All engines	version Bosch						806 231	906 121R						
ENGINE														
2.4	Petrol	110	07/95-12/97	AFM										
Engine	Information				A10	A20	A40	A50	A70	C10 - C30	C20	E01		
All engines											465 051			
ENGINE														
2.6	Petrol	102	06/94-10/97	ACZ										
Engine	Information				A10	A20	A40	A50	A70	C10 - C30	C20	E01		
All engines											465 051			
ENGINE														
2.6	Petrol	110	06/94-12/97	ABC										
Engine	Information				A10	A20	A40	A50	A70	C10 - C30	C20	E01		
All engines											465 051			
ENGINE														
2.6 quattro	Petrol	102	06/94-04/97	ACZ										
Engine	Information				A10	A20	A40	A50	A70	C10 - C30	C20	E01		
All engines											465 051			
ENGINE														
2.6 quattro	Petrol	110	06/94-12/97	ABC										
Engine	Information				A10	A20	A40	A50	A70	C10 - C30	C20	E01		
All engines											465 051			
ENGINE														
2.8	Petrol	120	08/95-07/96	AEJ										
Engine	Information				A10	A20	A40	A50	A70	C10 - C30	C20	E01		
All engines											465 051			
ENGINE														
2.8	Petrol	128	06/94-12/97	AAH, AEJ										
Engine	Information				A10	A20	A40	A50	A70	C10 - C30	C20	E01		
All engines											465 051			
ENGINE														
2.8 quattro	Petrol	128	06/94-12/97	AAH, AEJ										
Engine	Information				A10	A20	A40	A50	A70	C10 - C30	C20	E01		
All engines											465 051			
ENGINE														
A10	CONDENSER	A20	CONTACT SET	A40	DISTRIBUTOR CAP	A50	ROTOR	A70	PICK-UP					
C10	COIL	C20	IGNITION MODULE	C30	ELECTRONIC IGNITION KIT	E01	IGNITION CABLE SET							

Vehicle	alim.	kW	Date	Engine	FUNCTIONS ON THE VEHICLE							
					A10	A20	A40	A50	A70	C10 - C30	C20	E01
S6 4.2 quattro					ENGINE							
Petrol	213	06/94-12/97	AEC		A10	A20	A40	A50	A70	C10 - C30	C20	E01
Engine	Information				A10	A20	A40	A50	A70	C10 - C30	C20	E01
All engines	Qty: 2, version Bosch						806 248					
S6 Plus quattro					ENGINE							
Petrol	240	04/96-12/97	AHK		A10	A20	A40	A50	A70	C10 - C30	C20	E01
Engine	Information				A10	A20	A40	A50	A70	C10 - C30	C20	E01
All engines	without spark plug connector, Qty: 8									470 354S	C10	
All engines	incl. spark plug connector, Qty: 8									470 422	C10	
All engines	Qty: 2										465 076	
A6 II					ENGINE							
1.8	Petrol	85	05/97-01/05	AFY	A10	A20	A40	A50	A70	C10 - C30	C20	E01
Engine	Information				A10	A20	A40	A50	A70	C10 - C30	C20	E01
All engines												360 491
1.8					ENGINE							
Petrol	92	07/97-01/05	AJP, AQE, ARH		A10	A20	A40	A50	A70	C10 - C30	C20	E01
Engine	Information				A10	A20	A40	A50	A70	C10 - C30	C20	E01
All engines	x 4, COIL ON PLUG, incl. spark plug connector									470 445	C10	
1.8 T					ENGINE							
Petrol	110	01/97-01/05	1HN9, AEB, ANB, APU, ARK, AWT		A10	A20	A40	A50	A70	C10 - C30	C20	E01
Engine	Information				A10	A20	A40	A50	A70	C10 - C30	C20	E01
Eng. AEB, ANB, APU, ARK	x 4, COIL ON PLUG									470 354S	C10	
Eng. AWT	x 4, COIL ON PLUG, incl. spark plug connector									470 429	C10	
Eng. 1HN9, ANB, APU, ARK	ch. 4B-W-014 501 ->										465 072	
Eng. 1HN9	->ch. 4B-W-014 500										465 076	
1.8 T					ENGINE							
Petrol	132	12/97-01/05	AJL		A10	A20	A40	A50	A70	C10 - C30	C20	E01
Engine	Information				A10	A20	A40	A50	A70	C10 - C30	C20	E01
All engines	x 4, COIL ON PLUG									470 354S	C10	
All engines											465 072	
1.8 T quattro					ENGINE							
Petrol	110	02/97-01/05	1HN9, AEB, ANB, APU, ARK, AWT		A10	A20	A40	A50	A70	C10 - C30	C20	E01
Engine	Information				A10	A20	A40	A50	A70	C10 - C30	C20	E01
Eng. AEB, ANB, APU, ARK	x 4, COIL ON PLUG									470 354S	C10	
Eng. AWT	x 4, COIL ON PLUG, incl. spark plug connector									470 429	C10	
Eng. 1HN9, ANB, APU, ARK	ch. 4B-W-014 501 ->										465 072	
Eng. 1HN9	->ch. 4B-W-014 500										465 076	
1.8 T quattro					ENGINE							
Petrol	132	12/97-01/05	AJL		A10	A20	A40	A50	A70	C10 - C30	C20	E01
Engine	Information				A10	A20	A40	A50	A70	C10 - C30	C20	E01
All engines	x 4, COIL ON PLUG									470 354S	C10	
All engines											465 072	
2.0					ENGINE							
Petrol	96	08/01-01/05	ALT		A10	A20	A40	A50	A70	C10 - C30	C20	E01
Engine	Information				A10	A20	A40	A50	A70	C10 - C30	C20	E01
All engines	x 4, Colour:Red, COIL ON PLUG, incl. spark plug connector									470 436	C10	
2.7 T					ENGINE							
Petrol	169	02/99-01/05	AJK		A10	A20	A40	A50	A70	C10 - C30	C20	E01
Engine	Information				A10	A20	A40	A50	A70	C10 - C30	C20	E01
All engines	x 6, COIL ON PLUG									470 354S	C10	
2.7 T quattro					ENGINE							
Petrol	169	12/97-01/05	AJK, AZA		A10	A20	A40	A50	A70	C10 - C30	C20	E01
Engine	Information				A10	A20	A40	A50	A70	C10 - C30	C20	E01
All engines	x 6, COIL ON PLUG									470 354S	C10	
2.7 T quattro					ENGINE							
Petrol	184	08/01-01/05	1457L77, ARE		A10	A20	A40	A50	A70	C10 - C30	C20	E01
Engine	Information				A10	A20	A40	A50	A70	C10 - C30	C20	E01
Eng. ARE	x 6, COIL ON PLUG									470 354S	C10	
Eng. 1457L77	x 6, COIL ON PLUG, incl. spark plug connector									470 429	C10	

A10 CONDENSER	A20 CONTACT SET	A40 DISTRIBUTOR CAP	A50 ROTOR	A70 PICK-UP
C10 COIL	C20 IGNITION MODULE	C30 ELECTRONIC IGNITION KIT	E01 IGNITION CABLE SET	

The present application list is a brief version. For the detailed information about the possibility of installation on a specific vehicle, please refer to our web-catalogue <http://catalogo.facet.eu/>









				FUNCTIONS ON THE VEHICLE								
Vehicle	alim.	kW	Date	Engine								
				ENGINE								
3.0	Petrol	160	06/01-01/05	BBJ								
Engine	Information				A10	A20	A40	A50	A70	C10 - C30	C20	E01
All engines	x 6, Colour:Red, COIL ON PLUG, incl. spark plug connector									470 436	C10	
				ENGINE								
3.0	Petrol	162	08/01-01/05	ASN								
Engine	Information				A10	A20	A40	A50	A70	C10 - C30	C20	E01
All engines	x 6, Colour:Red, COIL ON PLUG, incl. spark plug connector									470 436	C10	
				ENGINE								
3.0 quattro	Petrol	160	06/01-01/05	BBJ								
Engine	Information				A10	A20	A40	A50	A70	C10 - C30	C20	E01
All engines	x 6, Colour:Red, COIL ON PLUG, incl. spark plug connector									470 436	C10	
				ENGINE								
3.0 quattro	Petrol	162	08/01-01/05	ASN								
Engine	Information				A10	A20	A40	A50	A70	C10 - C30	C20	E01
All engines	x 6, Colour:Red, COIL ON PLUG, incl. spark plug connector									470 436	C10	
				ENGINE								
4.2 quattro	Petrol	220	11/98-01/05	ARS, ASG								
Engine	Information				A10	A20	A40	A50	A70	C10 - C30	C20	E01
All engines	x 8, COIL ON PLUG, incl. spark plug connector									470 445	C10	
				ENGINE								
RS6 plus quattro	Petrol	353	04/04-01/05	BRV								
Engine	Information				A10	A20	A40	A50	A70	C10 - C30	C20	E01
All engines	RS6 Quattro, x 8, COIL ON PLUG, incl. spark plug connector									470 445	C10	
				ENGINE								
RS6 quattro	Petrol	331	07/02-01/05	BCY								
Engine	Information				A10	A20	A40	A50	A70	C10 - C30	C20	E01
All engines	RS6 Quattro, x 8, COIL ON PLUG, incl. spark plug connector									470 445	C10	
				ENGINE								
S6 quattro	Petrol	250	09/99-01/05	ANK, AQJ								
Engine	Information				A10	A20	A40	A50	A70	C10 - C30	C20	E01
All engines	S6 Quattro, x 8, COIL ON PLUG, incl. spark plug connector									470 445	C10	
				ENGINE								
A6 III				ENGINE								
2.0 TFSI	Petrol	125	06/05-08/11	BPJ, BYK								
Engine	Information				A10	A20	A40	A50	A70	C10 - C30	C20	E01
Eng. BPJ	x 4, ELDOR, Housing Colour:Black, COIL ON PLUG, incl. spark plug connector									470 426	C10	
Eng. BYK	Qty: 4									470 426	C10	
				ENGINE								
2.4	Petrol	130	05/04-10/08	BDW								
Engine	Information				A10	A20	A40	A50	A70	C10 - C30	C20	E01
All engines	x 6, Colour:Red, COIL ON PLUG, incl. spark plug connector									470 427	C10	
				ENGINE								
2.4 [CHN]	Petrol	130	04/05->	BDW								
Engine	Information				A10	A20	A40	A50	A70	C10 - C30	C20	E01
All engines	Qty: 6									470 427	C10	
				ENGINE								
2.4 quattro	Petrol	130	01/05-10/08	BDW								
Engine	Information				A10	A20	A40	A50	A70	C10 - C30	C20	E01
All engines	x 6, Colour:Red, COIL ON PLUG, incl. spark plug connector									470 427	C10	
				ENGINE								
2.8 FSI	Petrol	140	10/08-08/11	CCDA								
Engine	Information				A10	A20	A40	A50	A70	C10 - C30	C20	E01
All engines	x 6, Colour:Red, COIL ON PLUG, incl. spark plug connector									470 427	C10	
				ENGINE								
2.8 FSI	Petrol	154	11/06-10/08	BDX								
Engine	Information				A10	A20	A40	A50	A70	C10 - C30	C20	E01
All engines	x 6, Colour:Red, COIL ON PLUG, incl. spark plug connector									470 427	C10	

A10 CONDENSER	A20 CONTACT SET	A40 DISTRIBUTOR CAP	A50 ROTOR	A70 PICK-UP
C10 COIL	C20 IGNITION MODULE	C30 ELECTRONIC IGNITION KIT	E01 IGNITION CABLE SET	

Vehicle	alim.	kW	Date	Engine	FUNCTIONS ON THE VEHICLE									
					A10	A20	A40	A50	A70	C10 - C30	C20	E01		
ENGINE														
2.8 FSI	Petrol	162	10/08-08/11	CCEA										
Engine	Information				A10	A20	A40	A50	A70	C10 - C30	C20	E01		
All engines	x 6, Colour:Red, COIL ON PLUG, incl. spark plug connector									470 427	C10			
ENGINE														
2.8 FSI quattro	Petrol	140	10/08-08/11	CCDA										
Engine	Information				A10	A20	A40	A50	A70	C10 - C30	C20	E01		
All engines	x 6, Colour:Red, COIL ON PLUG, incl. spark plug connector									470 427	C10			
ENGINE														
2.8 FSI quattro	Petrol	154	06/07-10/08	BDX										
Engine	Information				A10	A20	A40	A50	A70	C10 - C30	C20	E01		
All engines	x 6, Colour:Red, COIL ON PLUG, incl. spark plug connector									470 427	C10			
ENGINE														
2.8 FSI quattro	Petrol	162	10/08-08/11	CCEA										
Engine	Information				A10	A20	A40	A50	A70	C10 - C30	C20	E01		
All engines	x 6, Colour:Red, COIL ON PLUG, incl. spark plug connector									470 427	C10			
ENGINE														
3.0	Petrol	160	08/04-05/06	BBJ										
Engine	Information				A10	A20	A40	A50	A70	C10 - C30	C20	E01		
All engines	x 6, Colour:Red, COIL ON PLUG, incl. spark plug connector									470 436	C10			
ENGINE														
3.0 [CHN]	Petrol	160	04/05->	BBJ										
Engine	Information				A10	A20	A40	A50	A70	C10 - C30	C20	E01		
All engines	Qty: 6									470 436	C10			
ENGINE														
3.0 quattro	Petrol	160	05/04-05/06	BBJ										
Engine	Information				A10	A20	A40	A50	A70	C10 - C30	C20	E01		
All engines	x 6, Colour:Red, COIL ON PLUG, incl. spark plug connector									470 436	C10			
ENGINE														
3.0 TFSI quattro	Petrol	213	10/08-08/11	CAJA										
Engine	Information				A10	A20	A40	A50	A70	C10 - C30	C20	E01		
All engines	x 6, Colour:Red, COIL ON PLUG, incl. spark plug connector									470 427	C10			
ENGINE														
3.0 TFSI quattro	Petrol	220	10/08-08/11	CCAA										
Engine	Information				A10	A20	A40	A50	A70	C10 - C30	C20	E01		
All engines	x 6, Colour:Red, COIL ON PLUG, incl. spark plug connector									470 427	C10			
ENGINE														
3.2 FSI	Petrol	188	05/04-05/09	AUK, BKH										
Engine	Information				A10	A20	A40	A50	A70	C10 - C30	C20	E01		
All engines	x 6, Colour:Red, COIL ON PLUG, incl. spark plug connector									470 427	C10			
ENGINE														
3.2 FSI	Petrol	195	05/09-03/11	CALA										
Engine	Information				A10	A20	A40	A50	A70	C10 - C30	C20	E01		
All engines	x 6, Colour:Red, COIL ON PLUG, incl. spark plug connector									470 427	C10			
ENGINE														
3.2 FSI quattro	Petrol	183	09/06-10/08	BYU										
Engine	Information				A10	A20	A40	A50	A70	C10 - C30	C20	E01		
All engines	x 6, Colour:Red, COIL ON PLUG, incl. spark plug connector									470 427	C10			
ENGINE														
3.2 FSI quattro	Petrol	188	05/04-10/08	AUK, BKH										
Engine	Information				A10	A20	A40	A50	A70	C10 - C30	C20	E01		
All engines	x 6, Colour:Red, COIL ON PLUG, incl. spark plug connector									470 427	C10			
ENGINE														
4.2 FSI quattro	Petrol	257	05/06-08/11	BVJ										
Engine	Information				A10	A20	A40	A50	A70	C10 - C30	C20	E01		
All engines	x 8, Colour:Red, COIL ON PLUG, incl. spark plug connector									470 427	C10			
ENGINE														
4.2 quattro	Petrol	246	05/04-05/06	BAT										
Engine	Information				A10	A20	A40	A50	A70	C10 - C30	C20	E01		
All engines	x 8, Colour:Red, COIL ON PLUG, incl. spark plug connector									470 433	C10			

A10	CONDENSER	A20	CONTACT SET	A40	DISTRIBUTOR CAP	A50	ROTOR	A70	PICK-UP
C10	COIL	C20	IGNITION MODULE	C30	ELECTRONIC IGNITION KIT	E01	IGNITION CABLE SET		

The present application list is a brief version. For the detailed information about the possibility of installation on a specific vehicle, please refer to our web-catalogue <http://catalogo.facet.eu/>









					FUNCTIONS ON THE VEHICLE							
Vehicle	alim.	kW	Date	Engine								
ENGINE												
RS6 quattro	Petrol	426	04/08-08/10	BUH								
Engine	Information				A10	A20	A40	A50	A70	C10 - C30	C20	E01
All engines	RS6 Quattro, x 10, Colour:Red, COIL ON PLUG, incl. spark plug connector									470 427	C10	
ENGINE												
S6 quattro	Petrol	320	03/06-08/11	BXA								
Engine	Information				A10	A20	A40	A50	A70	C10 - C30	C20	E01
All engines	S6 Quattro, x 10, Colour:Red, COIL ON PLUG, incl. spark plug connector									470 427	C10	
ENGINE												
1.8 TFSI	Petrol	140	09/14-09/18	CYGA								
Engine	Information				A10	A20	A40	A50	A70	C10 - C30	C20	E01
All engines	->year 01/05/15, x 4, Colour:Black, COIL ON PLUG, incl. spark plug connector									470 636	C10	
ENGINE												
2.0 TFSI	Petrol	132	05/11-09/18	CDNB								
Engine	Information				A10	A20	A40	A50	A70	C10 - C30	C20	E01
All engines	x 4, ELDOR, Housing Colour:Black, COIL ON PLUG, incl. spark plug connector									470 426	C10	
ENGINE												
2.0 TFSI	Petrol	155	03/11-05/13	CAEB								
Engine	Information				A10	A20	A40	A50	A70	C10 - C30	C20	E01
All engines	x 4, ELDOR, Housing Colour:Black, COIL ON PLUG, incl. spark plug connector									470 426	C10	
ENGINE												
2.0 TFSI	Petrol	162	05/13->	CAED								
Engine	Information				A10	A20	A40	A50	A70	C10 - C30	C20	E01
All engines	Qty: 4									470 426	C10	
All engines	x 4, ELDOR, Housing Colour:Black, COIL ON PLUG, incl. spark plug connector									470 426	C10	
ENGINE												
2.0 TFSI	Petrol	185	09/14-09/18	CYNB, CYPA								
Engine	Information				A10	A20	A40	A50	A70	C10 - C30	C20	E01
All engines	->year 01/05/15, x 4, HITACHI, COIL ON PLUG, incl. spark plug connector ----- 01/02/18 ->, x 4, HITACHI, COIL ON PLUG, incl. spark plug connector									470 636	C10	
ENGINE												
2.0 TFSI hybrid	Petrol/ Electric	155	11/11-09/18	CHJA								
Engine	Information				A10	A20	A40	A50	A70	C10 - C30	C20	E01
All engines	x 4, ELDOR, Housing Colour:Black, COIL ON PLUG, incl. spark plug connector									470 426	C10	
ENGINE												
2.0 TFSI quattro	Petrol	155	05/12-05/13	CAEB								
Engine	Information				A10	A20	A40	A50	A70	C10 - C30	C20	E01
All engines	x 4, ELDOR, Housing Colour:Black, COIL ON PLUG, incl. spark plug connector									470 426	C10	
ENGINE												
2.0 TFSI quattro	Petrol	185	05/14-09/18	CYNB, CYPA								
Engine	Information				A10	A20	A40	A50	A70	C10 - C30	C20	E01
All engines	->year 01/05/15, x 4, HITACHI, COIL ON PLUG, incl. spark plug connector									470 636	C10	
ENGINE												
2.8 FSI	Petrol	150	11/10-04/15	CHVA								
Engine	Information				A10	A20	A40	A50	A70	C10 - C30	C20	E01
All engines	x 6, Colour:Red, COIL ON PLUG, incl. spark plug connector									470 427	C10	
ENGINE												
2.8 FSI quattro	Petrol	150	11/10-04/15	CHVA								
Engine	Information				A10	A20	A40	A50	A70	C10 - C30	C20	E01
All engines	x 6, Colour:Red, COIL ON PLUG, incl. spark plug connector									470 427	C10	
ENGINE												
2.8 FSI quattro	Petrol	162	09/14-09/18	CVPA								
Engine	Information				A10	A20	A40	A50	A70	C10 - C30	C20	E01
All engines	x 6, Colour:Red, COIL ON PLUG, incl. spark plug connector									470 427	C10	

A10 CONDENSER	A20 CONTACT SET	A40 DISTRIBUTOR CAP	A50 ROTOR	A70 PICK-UP
C10 COIL	C20 IGNITION MODULE	C30 ELECTRONIC IGNITION KIT	E01 IGNITION CABLE SET	

Vehicle	alim.	kW	Date	Engine	FUNCTIONS ON THE VEHICLE								
					A10	A20	A40	A50	A70	C10 - C30	C20	E01	
ENGINE													
3.0 TFSI	Petrol	250	09/14->	CREH									
Engine	Information				A10	A20	A40	A50	A70	C10 - C30	C20	E01	
All engines	Qty: 6									470 427	C10		
ENGINE													
3.0 TFSI quattro	Petrol	220	11/10-05/12	CGWB									
Engine	Information				A10	A20	A40	A50	A70	C10 - C30	C20	E01	
All engines	x 6, Colour:Red, COIL ON PLUG, incl. spark plug connector									470 427	C10		
ENGINE													
3.0 TFSI quattro	Petrol	228	03/11-09/18	CGWD, CGXB, CTUA									
Engine	Information				A10	A20	A40	A50	A70	C10 - C30	C20	E01	
All engines	x 6, Colour:Red, COIL ON PLUG, incl. spark plug connector									470 427	C10		
ENGINE													
3.0 TFSI quattro	Petrol	245	09/14-09/18	CREC									
Engine	Information				A10	A20	A40	A50	A70	C10 - C30	C20	E01	
All engines	x 6, Colour:Red, COIL ON PLUG, incl. spark plug connector									470 427	C10		
ENGINE													
3.0 TFSI quattro	Petrol	250	09/16-09/18	CREH									
Engine	Information				A10	A20	A40	A50	A70	C10 - C30	C20	E01	
All engines	x 6, Colour:Red, COIL ON PLUG, incl. spark plug connector									470 427	C10		
A6 V													
ENGINE													
40 TFSI	Petrol	150	09/20->	DMTC									
Engine	Information				A10	A20	A40	A50	A70	C10 - C30	C20	E01	
All engines	x 4, HITACHI, COIL ON PLUG, incl. spark plug connector									470 636	C10		
ENGINE													
45 TFSI Mild Hybrid	Petrol/ Electric	180	08/18->	DKNA, DLHA									
Engine	Information				A10	A20	A40	A50	A70	C10 - C30	C20	E01	
All engines	x 4, HITACHI, COIL ON PLUG, incl. spark plug connector									470 636	C10		
ENGINE													
45 TFSI Mild Hybrid	Petrol/ Electric	195	05/20->	DMTA									
Engine	Information				A10	A20	A40	A50	A70	C10 - C30	C20	E01	
All engines	x 4, HITACHI, COIL ON PLUG, incl. spark plug connector									470 636	C10		
ENGINE													
45 TFSI Mild Hybrid quattro	Petrol/ Electric	180	08/18->	DKNA, DLHA									
Engine	Information				A10	A20	A40	A50	A70	C10 - C30	C20	E01	
All engines	x 4, HITACHI, COIL ON PLUG, incl. spark plug connector									470 636	C10		
ENGINE													
45 TFSI Mild Hybrid quattro	Petrol/ Electric	195	05/20->	DMTA									
Engine	Information				A10	A20	A40	A50	A70	C10 - C30	C20	E01	
All engines	x 4, HITACHI, COIL ON PLUG, incl. spark plug connector									470 636	C10		
ENGINE													
50 TFSI e quattro	Petrol/ Electric	185	11/19->	DLGA									
Engine	Information				A10	A20	A40	A50	A70	C10 - C30	C20	E01	
All engines	x 4, HITACHI, COIL ON PLUG, incl. spark plug connector									470 636	C10		
ENGINE													
50 TFSI e quattro	Petrol/ Electric	195	02/21->	DRYA									
Engine	Information				A10	A20	A40	A50	A70	C10 - C30	C20	E01	
All engines	x 4, HITACHI, COIL ON PLUG, incl. spark plug connector									470 636	C10		
ENGINE													
50 TFSI e quattro	Petrol/ Electric	220	11/19->	DLGA, DRYA									
Engine	Information				A10	A20	A40	A50	A70	C10 - C30	C20	E01	
All engines	x 4, HITACHI, COIL ON PLUG, incl. spark plug connector									470 636	C10		

A10	CONDENSER	A20	CONTACT SET	A40	DISTRIBUTOR CAP	A50	ROTOR	A70	PICK-UP
C10	COIL	C20	IGNITION MODULE	C30	ELECTRONIC IGNITION KIT	E01	IGNITION CABLE SET		

The present application list is a brief version. For the detailed information about the possibility of installation on a specific vehicle, please refer to our web-catalogue <http://catalogo.facet.eu/>

					FUNCTIONS ON THE VEHICLE							
Vehicle	alim.	kW	Date	Engine	 A10	 A20	 A40	 A50	 A70	 C10 - C30	 C20	 E01
ENGINE												
55 TFSI e quattro	Petrol/ Electric	185	11/19->	DLGA								
Engine	Information				A10	A20	A40	A50	A70	C10 - C30	C20	E01
All engines	x 4, HITACHI, COIL ON PLUG, incl. spark plug connector									470 636	C10	
ENGINE												
55 TFSI e quattro	Petrol/ Electric	195	02/21->	DRYA								
Engine	Information				A10	A20	A40	A50	A70	C10 - C30	C20	E01
All engines	x 4, HITACHI, COIL ON PLUG, incl. spark plug connector									470 636	C10	
ENGINE												
55 TFSI e quattro	Petrol/ Electric	270	11/19->	DLGA								
Engine	Information				A10	A20	A40	A50	A70	C10 - C30	C20	E01
All engines	x 4, HITACHI, COIL ON PLUG, incl. spark plug connector									470 636	C10	
A7												
ENGINE												
2.0 50 TFSI e	Diesel/ Electro	220	11/19->	DLGA								
Engine	Information				A10	A20	A40	A50	A70	C10 - C30	C20	E01
All engines	x 4, HITACHI, COIL ON PLUG, incl. spark plug connector									470 636	C10	
ENGINE												
45 TFSI Mild Hybrid	Petrol/ Electric	180	07/18->	DKNA, DLHA								
Engine	Information				A10	A20	A40	A50	A70	C10 - C30	C20	E01
All engines	x 4, HITACHI, COIL ON PLUG, incl. spark plug connector									470 636	C10	
ENGINE												
45 TFSI Mild hybrid quattro	Petrol/ Electric	180	07/18->	DKNA, DLHA								
Engine	Information				A10	A20	A40	A50	A70	C10 - C30	C20	E01
All engines	x 4, HITACHI, COIL ON PLUG, incl. spark plug connector									470 636	C10	
ENGINE												
55 TFSI e quattro	Petrol/ Electric	185	07/19->	DLGA								
Engine	Information				A10	A20	A40	A50	A70	C10 - C30	C20	E01
All engines	x 4, HITACHI, COIL ON PLUG, incl. spark plug connector									470 636	C10	
ENGINE												
55 TFSI e quattro	Petrol/ Electric	270	07/19->	DLGA								
Engine	Information				A10	A20	A40	A50	A70	C10 - C30	C20	E01
All engines	x 4, HITACHI, COIL ON PLUG, incl. spark plug connector									470 636	C10	
A7 SPORTBACK												
ENGINE												
2.0 TFSI	Petrol	185	09/14-05/18	CYPA								
Engine	Information				A10	A20	A40	A50	A70	C10 - C30	C20	E01
All engines	->year 01/03/15, x 4, HITACHI, COIL ON PLUG, incl. spark plug connector									470 636	C10	
ENGINE												
2.0 TFSI quattro	Petrol	185	05/15-05/18	CYNB								
Engine	Information				A10	A20	A40	A50	A70	C10 - C30	C20	E01
All engines	15/04/16 ->, Qty: 4									470 427	C10	
ENGINE												
2.5 FSI	Petrol	150	05/12->	CLXB								
Engine	Information				A10	A20	A40	A50	A70	C10 - C30	C20	E01
All engines	Qty: 6									470 427	C10	
ENGINE												
2.8 FSI	Petrol	150	02/11-03/15	CHVA								
Engine	Information				A10	A20	A40	A50	A70	C10 - C30	C20	E01
All engines	x 6, Colour:Red, COIL ON PLUG, incl. spark plug connector									470 427	C10	
ENGINE												
2.8 FSI quattro	Petrol	150	10/10-03/15	CHVA, CNYA								
Engine	Information				A10	A20	A40	A50	A70	C10 - C30	C20	E01
Eng. CHVA	x 6, Colour:Red, COIL ON PLUG, incl. spark plug connector									470 427	C10	
Eng. CNYA	Qty: 6									470 427	C10	

A10 CONDENSER	A20 CONTACT SET	A40 DISTRIBUTOR CAP	A50 ROTOR	A70 PICK-UP
C10 COIL	C20 IGNITION MODULE	C30 ELECTRONIC IGNITION KIT	E01 IGNITION CABLE SET	

Vehicle	alim.	kW	Date	Engine	FUNCTIONS ON THE VEHICLE									
					A10	A20	A40	A50	A70	C10 - C30	C20	E01		
ENGINE														
2.8 FSI quattro	Petrol	162	09/14-05/18	CVPA										
Engine	Information				A10	A20	A40	A50	A70	C10 - C30	C20	E01		
All engines	x 6, Colour:Red, COIL ON PLUG, incl. spark plug connector									470 427	C10			
ENGINE														
2.8 TFSI	Petrol	162	09/14->	CVPA										
Engine	Information				A10	A20	A40	A50	A70	C10 - C30	C20	E01		
All engines	Qty: 6									470 427	C10			
ENGINE														
3.0 TFSI	Petrol	250	05/14->	CREH										
Engine	Information				A10	A20	A40	A50	A70	C10 - C30	C20	E01		
All engines	Qty: 6									470 427	C10			
ENGINE														
3.0 TFSI quattro	Petrol	220	10/10-05/12	CGWB, CHMA										
Engine	Information				A10	A20	A40	A50	A70	C10 - C30	C20	E01		
Eng. CGWB	x 6, Colour:Red, COIL ON PLUG, incl. spark plug connector									470 427	C10			
Eng. CHMA	Qty: 6									470 427	C10			
ENGINE														
3.0 TFSI quattro	Petrol	228	01/11-03/15	CGWD, CGXB, CTTA, CTUA										
Engine	Information				A10	A20	A40	A50	A70	C10 - C30	C20	E01		
Eng. CGWD, CGXB, CTTA	x 6, Colour:Red, COIL ON PLUG, incl. spark plug connector									470 427	C10			
Eng. CTUA	Qty: 6									470 427	C10			
ENGINE														
3.0 TFSI quattro	Petrol	245	05/14-05/18	CREC										
Engine	Information				A10	A20	A40	A50	A70	C10 - C30	C20	E01		
All engines	x 6, Colour:Red, COIL ON PLUG, incl. spark plug connector									470 427	C10			
ENGINE														
A8 I														
2.8	Petrol	120	07/95-03/96	AEJ										
Engine	Information				A10	A20	A40	A50	A70	C10 - C30	C20	E01		
All engines											465 051			
ENGINE														
2.8	Petrol	128	03/94-03/96	AAH										
Engine	Information				A10	A20	A40	A50	A70	C10 - C30	C20	E01		
All engines											465 051			
ENGINE														
2.8 quattro	Petrol	120	07/95-03/96	AEJ										
Engine	Information				A10	A20	A40	A50	A70	C10 - C30	C20	E01		
All engines											465 051			
ENGINE														
2.8 quattro	Petrol	128	03/94-03/96	AAH										
Engine	Information				A10	A20	A40	A50	A70	C10 - C30	C20	E01		
All engines											465 051			
ENGINE														
3.7	Petrol	169	07/95-12/98	AEW, AKJ										
Engine	Information				A10	A20	A40	A50	A70	C10 - C30	C20	E01		
Eng. AKJ	without spark plug connector, Qty: 8									470 3545	C10			
Eng. AKJ	incl. spark plug connector, Qty: 8									470 422	C10			
All engines	Qty: 2										465 076			
ENGINE														
3.7	Petrol	191	11/98-09/02	AKC, AQG										
Engine	Information				A10	A20	A40	A50	A70	C10 - C30	C20	E01		
All engines	x 8, COIL ON PLUG, incl. spark plug connector									470 445	C10			
ENGINE														
3.7 quattro	Petrol	169	07/95-11/98	AEW, AKJ										
Engine	Information				A10	A20	A40	A50	A70	C10 - C30	C20	E01		
All engines	Qty: 2										465 076			
ENGINE														
3.7 quattro	Petrol	191	11/98-09/02	AKC, AQG										
Engine	Information				A10	A20	A40	A50	A70	C10 - C30	C20	E01		
All engines	x 8, COIL ON PLUG, incl. spark plug connector									470 445	C10			
ENGINE														
A10	CONDENSER		A20	CONTACT SET		A40	DISTRIBUTOR CAP		A50	ROTOR		A70	PICK-UP	
C10	COIL		C20	IGNITION MODULE		C30	ELECTRONIC IGNITION KIT		E01	IGNITION CABLE SET				







				FUNCTIONS ON THE VEHICLE								
Vehicle	alim.	kW	Date	Engine								
				ENGINE								
4.2 quattro	Petrol	175	02/99-04/00	ARU								
Engine	Information			A10	A20	A40	A50	A70	C10 - C30	C20	E01	
All engines	x 8, COIL ON PLUG, incl. spark plug connector								470 445	C10		
				ENGINE								
4.2 quattro	Petrol	180	03/94-07/96	AEM								
Engine	Information			A10	A20	A40	A50	A70	C10 - C30	C20	E01	
All engines	01/08/95 ->, ch. 4DT000221 ->, x 8, COIL ON PLUG								470 3545	C10		
All engines	Qty: 2									465 076		
				ENGINE								
4.2 quattro	Petrol	210	07/95-09/98	AGH								
Engine	Information			A10	A20	A40	A50	A70	C10 - C30	C20	E01	
All engines	ch. 4D-T-000 221 ->, without spark plug connector, Qty: 8								470 3545	C10		
All engines	ch. 4D-T-000 221 ->, incl. spark plug connector, Qty: 8								470 422	C10		
All engines	Qty: 2									465 076		
				ENGINE								
4.2 quattro	Petrol	220	03/94-11/98	ABZ, AKG								
Engine	Information			A10	A20	A40	A50	A70	C10 - C30	C20	E01	
All engines	01/08/95 ->, ch. 4DT000221 ->, ->ch. 4DX004999, x 8, COIL ON PLUG								470 3545	C10		
All engines	01/01/99 ->, ch. DX005001 ->, x 8, COIL ON PLUG, incl. spark plug connector								470 445	C10		
All engines	Qty: 2									465 076		
				ENGINE								
4.2 quattro	Petrol	224	09/96-12/99	ABZ								
Engine	Information			A10	A20	A40	A50	A70	C10 - C30	C20	E01	
All engines	ch. 4D-X-005 001 ->, Qty: 8								470 445	C10		
				ENGINE								
4.2 quattro	Petrol	228	11/98-09/02	AQF, AUW								
Engine	Information			A10	A20	A40	A50	A70	C10 - C30	C20	E01	
All engines	->year 01/12/98, ->ch. 4DX004999, x 8, COIL ON PLUG								470 3545	C10		
All engines	01/01/99 ->, ch. DX005001 ->, x 8, COIL ON PLUG, incl. spark plug connector								470 445	C10		
				ENGINE								
S8 quattro	Petrol	250	07/96-06/99	2C2CNG, AHC, AKH								
Engine	Information			A10	A20	A40	A50	A70	C10 - C30	C20	E01	
Eng. AHC, AKH	S8 Quattro, x 8, COIL ON PLUG								470 3545	C10		
Eng. 2C2CNG, AKH	Qty: 2									465 076		
				ENGINE								
S8 quattro	Petrol	265	06/99-09/02	AQH, AVP, AYS, BCS								
Engine	Information			A10	A20	A40	A50	A70	C10 - C30	C20	E01	
All engines	S8 Quattro, x 8, COIL ON PLUG, incl. spark plug connector								470 445	C10		
Eng. AYS, BCS	Qty: 8								470 445	C10		
				ENGINE								
A8 II				ENGINE								
2.8 FSI	Petrol	154	08/07-07/10	BDX								
Engine	Information			A10	A20	A40	A50	A70	C10 - C30	C20	E01	
All engines	x 6, Colour:Red, COIL ON PLUG, incl. spark plug connector								470 427	C10		
				ENGINE								
2.8 FSI	Petrol	170	01/09-07/10	CJBA								
Engine	Information			A10	A20	A40	A50	A70	C10 - C30	C20	E01	
All engines	Qty: 6								470 427	C10		
				ENGINE								
3.0	Petrol	160	07/03-05/06	BBJ								
Engine	Information			A10	A20	A40	A50	A70	C10 - C30	C20	E01	
All engines	x 6, Colour:Red, COIL ON PLUG, incl. spark plug connector								470 436	C10		
				ENGINE								
3.0	Petrol	162	07/03-05/05	ASN								
Engine	Information			A10	A20	A40	A50	A70	C10 - C30	C20	E01	
All engines	x 6, Colour:Red, COIL ON PLUG, incl. spark plug connector								470 436	C10		

A10 CONDENSER	A20 CONTACT SET	A40 DISTRIBUTOR CAP	A50 ROTOR	A70 PICK-UP
C10 COIL	C20 IGNITION MODULE	C30 ELECTRONIC IGNITION KIT	E01 IGNITION CABLE SET	

Vehicle	alim.	kW	Date	Engine	FUNCTIONS ON THE VEHICLE									
					A10	A20	A40	A50	A70	C10 - C30	C20	E01		
ENGINE														
3.0 quattro	Petrol	160	11/03-05/04	BBJ										
Engine	Information				A10	A20	A40	A50	A70	C10 - C30	C20	E01		
All engines	x 6, Colour:Red, COIL ON PLUG, incl. spark plug connector									470 436	C10			
ENGINE														
3.0 quattro	Petrol	162	07/03-05/05	ASN										
Engine	Information				A10	A20	A40	A50	A70	C10 - C30	C20	E01		
All engines	x 6, Colour:Red, COIL ON PLUG, incl. spark plug connector									470 436	C10			
ENGINE														
3.2 FSI	Petrol	191	06/05-07/10	BPK										
Engine	Information				A10	A20	A40	A50	A70	C10 - C30	C20	E01		
All engines	x 6, Colour:Red, COIL ON PLUG, incl. spark plug connector									470 427	C10			
ENGINE														
3.2 FSI quattro	Petrol	191	06/05-07/10	BPK										
Engine	Information				A10	A20	A40	A50	A70	C10 - C30	C20	E01		
All engines	x 6, Colour:Red, COIL ON PLUG, incl. spark plug connector									470 427	C10			
ENGINE														
3.7 quattro	Petrol	206	10/02-05/06	BFL										
Engine	Information				A10	A20	A40	A50	A70	C10 - C30	C20	E01		
All engines	x 8, Colour:Red, COIL ON PLUG, incl. spark plug connector									470 433	C10			
ENGINE														
4.2 FSI quattro	Petrol	257	06/06-07/10	BJJ										
Engine	Information				A10	A20	A40	A50	A70	C10 - C30	C20	E01		
All engines	x 8, Colour:Red, COIL ON PLUG, incl. spark plug connector									470 427	C10			
ENGINE														
4.2 quattro	Petrol	246	10/02-07/10	BFM										
Engine	Information				A10	A20	A40	A50	A70	C10 - C30	C20	E01		
All engines	x 8, Colour:Red, COIL ON PLUG, incl. spark plug connector									470 433	C10			
ENGINE														
S8 quattro	Petrol	324	09/06-07/10	BSM										
Engine	Information				A10	A20	A40	A50	A70	C10 - C30	C20	E01		
All engines	S8 Quattro, x 10, Colour:Red, COIL ON PLUG, incl. spark plug connector									470 427	C10			
ENGINE														
S8 quattro	Petrol	331	06/06-07/10	BSM										
Engine	Information				A10	A20	A40	A50	A70	C10 - C30	C20	E01		
All engines	S8 Quattro, x 10, Colour:Red, COIL ON PLUG, incl. spark plug connector									470 427	C10			
A8 III														
ENGINE														
2.0 TFSI hybrid	Petrol/ Electric	155	02/12-11/15	CHJA										
Engine	Information				A10	A20	A40	A50	A70	C10 - C30	C20	E01		
All engines	x 4, ELDOR, Housing Colour:Black, COIL ON PLUG, incl. spark plug connector									470 426	C10			
ENGINE														
2.5 TFSI	Petrol	150	07/12-06/16	CPAA, CVBA										
Engine	Information				A10	A20	A40	A50	A70	C10 - C30	C20	E01		
All engines	x 6, Colour:Red, COIL ON PLUG, incl. spark plug connector									470 427	C10			
ENGINE														
3.0 TDI quattro	Diesel	176	11/12-06/16	CPNA, CPNB										
Engine	Information				A10	A20	A40	A50	A70	C10 - C30	C20	E01		
All engines	x 6, Colour:Red, COIL ON PLUG, incl. spark plug connector									470 427	C10			
ENGINE														
3.0 TFSI quattro	Petrol	213	07/10-04/14	CGWA, CREG										
Engine	Information				A10	A20	A40	A50	A70	C10 - C30	C20	E01		
All engines	x 6, Colour:Red, COIL ON PLUG, incl. spark plug connector									470 427	C10			
ENGINE														
3.0 TFSI quattro	Petrol	228	11/11-01/18	CGWD, CREA										
Engine	Information				A10	A20	A40	A50	A70	C10 - C30	C20	E01		
All engines	x 6, Colour:Red, COIL ON PLUG, incl. spark plug connector									470 427	C10			

A10	CONDENSER	A20	CONTACT SET	A40	DISTRIBUTOR CAP	A50	ROTOR	A70	PICK-UP
C10	COIL	C20	IGNITION MODULE	C30	ELECTRONIC IGNITION KIT	E01	IGNITION CABLE SET		

The present application list is a brief version. For the detailed information about the possibility of installation on a specific vehicle, please refer to our web-catalogue <http://catalogo.facet.eu/>

					FUNCTIONS ON THE VEHICLE							
Vehicle	alim.	kW	Date	Engine	 A10	 A20	 A40	 A50	 A70	 C10 - C30	 C20	 E01
ALLROAD												
3.0 TFSI quattro	Petrol	245	06/10-01/18	ENGINE CGXC, CMDA, CREC, CTDA, CTUB								
Engine	Information				A10	A20	A40	A50	A70	C10 - C30	C20	E01
Eng. CGXC, CMDA	x 6, Colour:Red, COIL ON PLUG, incl. spark plug connector									470 427	C10	
Eng. CREC, CTDA, CTUB	Qty: 6									470 427	C10	
4.2 FSI quattro	Petrol	273	11/09-12/12	ENGINE CDRA								
Engine	Information				A10	A20	A40	A50	A70	C10 - C30	C20	E01
All engines	x 8, Colour:Red, COIL ON PLUG, incl. spark plug connector									470 427	C10	
2.7 T quattro	Petrol	184	05/00-08/05	ENGINE 1457L77, ARE								
Engine	Information				A10	A20	A40	A50	A70	C10 - C30	C20	E01
All engines	x 6, COIL ON PLUG									470 354S	C10	
All engines	x 6, COIL ON PLUG, incl. spark plug connector									470 429	C10	
4.2 V8 quattro	Petrol	220	07/02-08/05	ENGINE BAS								
Engine	Information				A10	A20	A40	A50	A70	C10 - C30	C20	E01
All engines	x 8, Colour:Red, COIL ON PLUG, incl. spark plug connector									470 433	C10	
CABRIOLET												
1.8	Petrol	92	01/97-08/00	ENGINE ADR								
Engine	Information				A10	A20	A40	A50	A70	C10 - C30	C20	E01
All engines												360 491
2.0 16V	Petrol	103	06/95-07/96	ENGINE ACE								
Engine	Information				A10	A20	A40	A50	A70	C10 - C30	C20	E01
All engines	version Bosch						806 248					
2.0 E	Petrol	85	01/93-07/98	ENGINE ABK								
Engine	Information				A10	A20	A40	A50	A70	C10 - C30	C20	E01
All engines	version Bosch						806 266	906 121R				
All engines	->ch. 8G-P-015 000									490 414	C30	
All engines												359 768
2.3 E	Petrol	98	05/91-07/94	ENGINE NG								
Engine	Information				A10	A20	A40	A50	A70	C10 - C30	C20	E01
All engines	version Bosch						806 231	906 121R				
All engines												360 682
2.6	Petrol	102	05/95-08/00	ENGINE ACZ								
Engine	Information				A10	A20	A40	A50	A70	C10 - C30	C20	E01
All engines											465 051	
2.6	Petrol	110	06/93-08/00	ENGINE ABC								
Engine	Information				A10	A20	A40	A50	A70	C10 - C30	C20	E01
All engines											465 051	
2.8	Petrol	128	11/92-08/00	ENGINE AAH								
Engine	Information				A10	A20	A40	A50	A70	C10 - C30	C20	E01
All engines											465 051	
COUPE												
1.8	Petrol	82	08/89-07/91	ENGINE DZ								
Engine	Information				A10	A20	A40	A50	A70	C10 - C30	C20	E01
All engines	version Bosch						806 266	906 055R	406 219			
All engines										470 127	C10	465 007
2.0	Petrol	82	03/90-07/90	ENGINE 3A								
Engine	Information				A10	A20	A40	A50	A70	C10 - C30	C20	E01
All engines	version Bosch						806 266	906 121R				

A10 CONDENSER	A20 CONTACT SET	A40 DISTRIBUTOR CAP	A50 ROTOR	A70 PICK-UP
C10 COIL	C20 IGNITION MODULE	C30 ELECTRONIC IGNITION KIT	E01 IGNITION CABLE SET	

Vehicle	alim.	kW	Date	Engine	FUNCTIONS ON THE VEHICLE									
					A10	A20	A40	A50	A70	C10 - C30	C20	E01		
ENGINE														
2.0	Petrol	82	03/90-07/90	3A										
ENGINE														
All engines														359 768
ENGINE														
2.0	Petrol	83	05/89-03/90	3A										
ENGINE														
All engines							806 266	906 121R						
All engines														359 768
ENGINE														
2.0	Petrol	85	05/89-12/96	AAD, ABK										
ENGINE														
All engines							806 266	906 121R						
Eng. ABK										490 414	C30			
All engines														359 768
ENGINE														
2.0 16 V	Petrol	101	01/92-07/92	6A										
ENGINE														
All engines							806 248							
ENGINE														
2.0 16 V	Petrol	103	08/92-12/96	ACE										
ENGINE														
All engines							806 248							
ENGINE														
2.0 20 V	Petrol	118	08/89-07/91	NM										
ENGINE														
All engines							806 231							
ENGINE														
2.0 20 V quattro	Petrol	118	08/89-07/91	NM										
ENGINE														
All engines							806 231							
ENGINE														
2.2	Petrol	100	11/88-07/91	9C54										
ENGINE														
All engines							806 231	906 055R	406 219					
All engines										470 127	C10	465 007	360 682	
ENGINE														
2.2 GT	Petrol	100	09/84-10/88	9C54										
ENGINE														
All engines							806 231							
All engines								906 055R						
All engines								906 116R						
All engines										470 125	C10			
All engines										470 127	C10			
All engines												465 004		
All engines												465 007		
All engines													360 682	
ENGINE														
2.2 quattro	Petrol	100	10/84-07/91	9C54										
ENGINE														
All engines							806 231							
All engines								906 055R						
All engines								906 116R						
All engines									406 219					
All engines										470 125	C10			
All engines										470 127	C10			
All engines												465 004		
All engines												465 007		
All engines													360 682	
ENGINE														
2.2 quattro	Petrol	88	08/85-10/88	JT										
ENGINE														
All engines							806 231	906 055R						

A10	CONDENSER	A20	CONTACT SET	A40	DISTRIBUTOR CAP	A50	ROTOR	A70	PICK-UP
C10	COIL	C20	IGNITION MODULE	C30	ELECTRONIC IGNITION KIT	E01	IGNITION CABLE SET		

The present application list is a brief version. For the detailed information about the possibility of installation on a specific vehicle, please refer to our web-catalogue <http://catalogo.facet.eu/>

Vehicle	alim.	kW	Date	Engine	FUNCTIONS ON THE VEHICLE							
					A10	A20	A40	A50	A70	C10 - C30	C20	E01

ENGINE				
2.2 quattro	Petrol	88	08/85-10/88	JT

Engine	Information	A10	A20	A40	A50	A70	C10 - C30	C20	E01
All engines	->ch. 85-F-220 000						470 125	C10	
All engines	ch. 85-G-000 001 ->						470 127	C10	
All engines	->ch. 85-H-070 000							465 004	
All engines	ch. 85-J-000 001 ->							465 007	

ENGINE				
2.3	Petrol	100	10/88-07/94	NG

Engine	Information	A10	A20	A40	A50	A70	C10 - C30	C20	E01
All engines	version Bosch			806 231	906 121R				
All engines									360 682

ENGINE				
2.3	Petrol	98	03/90-12/96	NG

Engine	Information	A10	A20	A40	A50	A70	C10 - C30	C20	E01
All engines	version Bosch			806 231	906 121R				
All engines									360 682

ENGINE				
2.3 20V	Petrol	123	08/90-07/91	7A

Engine	Information	A10	A20	A40	A50	A70	C10 - C30	C20	E01
All engines	version Bosch			806 231					

ENGINE				
2.3 20V	Petrol	125	08/89-07/91	7A

Engine	Information	A10	A20	A40	A50	A70	C10 - C30	C20	E01
All engines	version Bosch			806 231					

ENGINE				
2.3 20V quattro	Petrol	123	05/90-12/96	7A

Engine	Information	A10	A20	A40	A50	A70	C10 - C30	C20	E01
All engines	version Bosch			806 231					

ENGINE				
2.3 20V quattro	Petrol	125	11/88-07/91	7A

Engine	Information	A10	A20	A40	A50	A70	C10 - C30	C20	E01
All engines	version Bosch			806 231					

ENGINE				
2.3 quattro	Petrol	100	11/88-12/92	NG

Engine	Information	A10	A20	A40	A50	A70	C10 - C30	C20	E01
All engines	version Bosch			806 231	906 121R				
All engines									360 682

ENGINE				
2.3 quattro	Petrol	98	01/87-12/96	NG

Engine	Information	A10	A20	A40	A50	A70	C10 - C30	C20	E01
All engines	version Bosch			806 231	906 121R	406 219			
All engines									360 682

ENGINE				
2.6	Petrol	110	08/92-12/96	ABC

Engine	Information	A10	A20	A40	A50	A70	C10 - C30	C20	E01
All engines								465 051	

ENGINE				
2.6 quattro	Petrol	110	08/92-12/96	ABC

Engine	Information	A10	A20	A40	A50	A70	C10 - C30	C20	E01
All engines								465 051	

ENGINE				
2.8	Petrol	128	09/91-12/96	AAH

Engine	Information	A10	A20	A40	A50	A70	C10 - C30	C20	E01
All engines								465 051	

ENGINE				
2.8 quattro	Petrol	128	08/91-12/96	AAH

Engine	Information	A10	A20	A40	A50	A70	C10 - C30	C20	E01
All engines								465 051	

A10 CONDENSER	A20 CONTACT SET	A40 DISTRIBUTOR CAP	A50 ROTOR	A70 PICK-UP
C10 COIL	C20 IGNITION MODULE	C30 ELECTRONIC IGNITION KIT	E01 IGNITION CABLE SET	

Vehicle	alim.	kW	Date	Engine	FUNCTIONS ON THE VEHICLE							
					A10	A20	A40	A50	A70	C10 - C30	C20	E01

ENGINE				
S2	Petrol	162	09/90-09/92	3B

Engine	Information	A10	A20	A40	A50	A70	C10 - C30	C20	E01
All engines	version Bosch			806 231					

ENGINE				
S2 quattro	Petrol	162	09/90-09/92	3B

Engine	Information	A10	A20	A40	A50	A70	C10 - C30	C20	E01
All engines	version Bosch			806 231					

ENGINE			
--------	--	--	--

1.0 TFSI	Petrol	85	10/16-10/20	CHZJ, DKRF
-----------------	--------	-----------	-------------	-------------------

Engine	Information	A10	A20	A40	A50	A70	C10 - C30	C20	E01
All engines	x 3, ELDOR, COIL ON PLUG, incl. spark plug connector, Number of pins:4, incl. spark plug connector						470 599	C10	

ENGINE				
1.4 TFSI	Petrol	110	06/16-08/18	CZEA

Engine	Information	A10	A20	A40	A50	A70	C10 - C30	C20	E01
All engines	x 4, BERU, version 1, version 2, COIL ON PLUG, ELDOR, COIL ON PLUG, incl. spark plug connector, incl. spark plug connector, Number of pins:4, incl. spark plug connector						470 599	C10	

ENGINE				
2.0 TFSI quattro	Petrol	140	05/17->	CZPB, DKZA

Engine	Information	A10	A20	A40	A50	A70	C10 - C30	C20	E01
All engines	01/04/18 ->, x 4, HITACHI, COIL ON PLUG, incl. spark plug connector						470 636	C10	

ENGINE				
30 TFSI	Petrol	81	08/20->	DLAA

Engine	Information	A10	A20	A40	A50	A70	C10 - C30	C20	E01
All engines	x 3, ELDOR, COIL ON PLUG, incl. spark plug connector, Number of pins:4, incl. spark plug connector						470 599	C10	

ENGINE				
30 TFSI	Petrol	85	07/18-10/20	CHZJ, DKRF

Engine	Information	A10	A20	A40	A50	A70	C10 - C30	C20	E01
All engines	x 3, ELDOR, COIL ON PLUG, incl. spark plug connector, Number of pins:4, incl. spark plug connector						470 599	C10	

ENGINE				
SQ2 TFSI quattro	Petrol	221	08/18->	DNFC, DNUE

Engine	Information	A10	A20	A40	A50	A70	C10 - C30	C20	E01
All engines	SQ2 Quattro, x 4, HITACHI, COIL ON PLUG, incl. spark plug connector						470 636	C10	

ENGINE			
--------	--	--	--

1.4 TFSI	Petrol	92	07/16-10/18	CZDB
-----------------	--------	-----------	-------------	-------------

Engine	Information	A10	A20	A40	A50	A70	C10 - C30	C20	E01
All engines	x 4, ELDOR, COIL ON PLUG, Number of pins:4, incl. spark plug connector						470 599	C10	

ENGINE				
1.4 TSI	Petrol	110	10/13-10/18	CHPB, CZDA, CZEA

Engine	Information	A10	A20	A40	A50	A70	C10 - C30	C20	E01
All engines	x 4, BERU, ELDOR, COIL ON PLUG, incl. spark plug connector, Number of pins:4, incl. spark plug connector						470 599	C10	

ENGINE				
2.0 TFSI	Petrol	147	10/13->	CCTA

Engine	Information	A10	A20	A40	A50	A70	C10 - C30	C20	E01
All engines	Qty: 4						470 426	C10	

ENGINE				
2.0 TFSI quattro	Petrol	125	06/11-04/15	CCZC

Engine	Information	A10	A20	A40	A50	A70	C10 - C30	C20	E01
All engines	x 4, ELDOR, Housing Colour:Black, COIL ON PLUG, incl. spark plug connector						470 426	C10	

ENGINE				
2.0 TFSI quattro	Petrol	147	09/14-10/18	CCTA

Engine	Information	A10	A20	A40	A50	A70	C10 - C30	C20	E01
All engines	x 4, ELDOR, Housing Colour:Black, COIL ON PLUG, incl. spark plug connector						470 426	C10	

A10 CONDENSER	A20 CONTACT SET	A40 DISTRIBUTOR CAP	A50 ROTOR	A70 PICK-UP
C10 COIL	C20 IGNITION MODULE	C30 ELECTRONIC IGNITION KIT	E01 IGNITION CABLE SET	

The present application list is a brief version. For the detailed information about the possibility of installation on a specific vehicle, please refer to our web-catalogue <http://catalogo.facet.eu/>









					FUNCTIONS ON THE VEHICLE							
Vehicle	alim.	kW	Date	Engine	A10	A20	A40	A50	A70	C10 - C30	C20	E01
ENGINE												
2.0 TFSI quattro	Petrol	155	06/11-04/15	CPSA								
Engine	Information				A10	A20	A40	A50	A70	C10 - C30	C20	E01
All engines	x 4, ELDOR, Housing Colour:Black, COIL ON PLUG, incl. spark plug connector									470 426	C10	
ENGINE												
RS 2.5 quattro	Petrol	228	10/13-10/18	CTSA								
Engine	Information				A10	A20	A40	A50	A70	C10 - C30	C20	E01
All engines	RSQ3 Quattro, x 5, ELDOR, Housing Colour:Black, COIL ON PLUG, incl. spark plug connector									470 426	C10	
ENGINE												
RS 2.5 quattro	Petrol	250	05/13-10/18	CZGA								
Engine	Information				A10	A20	A40	A50	A70	C10 - C30	C20	E01
All engines	RSQ3 Quattro, x 5, ELDOR, Housing Colour:Black, COIL ON PLUG, incl. spark plug connector									470 426	C10	
ENGINE												
RS performance 2.5 quattro	Petrol	270	01/15-10/18	CZGB								
Engine	Information				A10	A20	A40	A50	A70	C10 - C30	C20	E01
All engines	RSQ3 Quattro, x 5, ELDOR, Housing Colour:Black, COIL ON PLUG, incl. spark plug connector									470 426	C10	
Q5 I												
ENGINE												
2.0 Hybrid quattro	Petrol/ Electric	180	09/12-05/16	CHJA								
Engine	Information				A10	A20	A40	A50	A70	C10 - C30	C20	E01
All engines	x 4, ELDOR, Housing Colour:Black, COIL ON PLUG, incl. spark plug connector									470 426	C10	
ENGINE												
2.0 TFSI	Petrol	130	11/08->	CDNA								
Engine	Information				A10	A20	A40	A50	A70	C10 - C30	C20	E01
All engines	Qty: 6									470 426	C10	
ENGINE												
2.0 TFSI Hybrid quattro	Petrol/ Electric	155	06/11-06/16	CHJA								
Engine	Information				A10	A20	A40	A50	A70	C10 - C30	C20	E01
All engines	x 4, ELDOR, Housing Colour:Black, COIL ON PLUG, incl. spark plug connector									470 426	C10	
ENGINE												
2.0 TFSI quattro	Petrol	132	08/09-05/17	CDNB, CNCB								
Engine	Information				A10	A20	A40	A50	A70	C10 - C30	C20	E01
Eng. CDNB	x 4, ELDOR, Housing Colour:Black, COIL ON PLUG, incl. spark plug connector									470 426	C10	
Eng. CNCB	x 4, HITACHI, COIL ON PLUG, incl. spark plug connector									470 636	C10	
ENGINE												
2.0 TFSI quattro	Petrol	155	11/08-09/12	CAEB, CDNC, CPMA								
Engine	Information				A10	A20	A40	A50	A70	C10 - C30	C20	E01
Eng. CAEB, CDNC	x 4, ELDOR, Housing Colour:Black, COIL ON PLUG, incl. spark plug connector									470 426	C10	
Eng. CPMA	Qty: 4									470 426	C10	
ENGINE												
2.0 TFSI quattro	Petrol	162	05/13-05/17	CPMB								
Engine	Information				A10	A20	A40	A50	A70	C10 - C30	C20	E01
All engines	x 4, ELDOR, Housing Colour:Black, COIL ON PLUG, incl. spark plug connector									470 426	C10	
ENGINE												
2.0 TFSI quattro	Petrol	165	06/12-05/16	CNCD								
Engine	Information				A10	A20	A40	A50	A70	C10 - C30	C20	E01
All engines	->year 01/05/15, x 4, HITACHI, COIL ON PLUG, incl. spark plug connector									470 636	C10	
ENGINE												
2.0 TFSI quattro (CHN)	Petrol	155	09/09->	CADA								
Engine	Information				A10	A20	A40	A50	A70	C10 - C30	C20	E01
All engines	Qty: 4									470 426	C10	

A10 CONDENSER	A20 CONTACT SET	A40 DISTRIBUTOR CAP	A50 ROTOR	A70 PICK-UP
C10 COIL	C20 IGNITION MODULE	C30 ELECTRONIC IGNITION KIT	E01 IGNITION CABLE SET	

Vehicle	alim.	kW	Date	Engine	FUNCTIONS ON THE VEHICLE									
					A10	A20	A40	A50	A70	C10 - C30	C20	E01		
ENGINE														
3.0 TFSI quattro	Petrol	200	06/12-05/17	CTUC, CTVA										
Engine	Information				A10	A20	A40	A50	A70	C10 - C30	C20	E01		
All engines	x 6, Colour:Red, COIL ON PLUG, incl. spark plug connector									470 427	C10			
ENGINE														
3.2 FSI quattro	Petrol	199	11/08-12/12	CALB										
Engine	Information				A10	A20	A40	A50	A70	C10 - C30	C20	E01		
All engines	x 6, Colour:Red, COIL ON PLUG, incl. spark plug connector									470 427	C10			
ENGINE														
SQ5 TFSI quattro	Petrol	260	05/13-05/17	CTUD, CTXA										
Engine	Information				A10	A20	A40	A50	A70	C10 - C30	C20	E01		
All engines	SQ5 Quattro, x 6, Colour:Red, COIL ON PLUG, incl. spark plug connector									470 427	C10			
Q5 II														
ENGINE														
2.0 TFSI quattro	Petrol	183	01/17-11/20	DAXC										
Engine	Information				A10	A20	A40	A50	A70	C10 - C30	C20	E01		
All engines	x 4, BERU, HITACHI, COIL ON PLUG, incl. spark plug connector									470 636	C10			
ENGINE														
2.0 TFSI quattro	Petrol	185	06/16->	DAXB, DAYB										
Engine	Information				A10	A20	A40	A50	A70	C10 - C30	C20	E01		
All engines	x 4, BERU, HITACHI, COIL ON PLUG, incl. spark plug connector									470 636	C10			
ENGINE														
35 TDI	Diesel	120	10/21->	DTNA										
Engine	Information				A10	A20	A40	A50	A70	C10 - C30	C20	E01		
All engines	x 4, HITACHI, COIL ON PLUG, incl. spark plug connector									470 636	C10			
ENGINE														
45 TFSI Mild Hybrid quattro	Petrol/ Electric	180	12/18->	DNTA										
Engine	Information				A10	A20	A40	A50	A70	C10 - C30	C20	E01		
All engines	x 4, HITACHI, COIL ON PLUG, incl. spark plug connector									470 636	C10			
ENGINE														
45 TFSI Mild Hybrid quattro	Petrol/ Electric	195	08/20->	DPUA, DPVA										
Engine	Information				A10	A20	A40	A50	A70	C10 - C30	C20	E01		
All engines	x 4, HITACHI, COIL ON PLUG, incl. spark plug connector									470 636	C10			
ENGINE														
45 TFSI quattro	Petrol/ Electric	195	11/20->	DPVA										
Engine	Information				A10	A20	A40	A50	A70	C10 - C30	C20	E01		
All engines	x 4, HITACHI, COIL ON PLUG, incl. spark plug connector									470 636	C10			
ENGINE														
50 TFSI e quattro	Petrol/ Electric	185	04/19-11/20	DLGA										
Engine	Information				A10	A20	A40	A50	A70	C10 - C30	C20	E01		
All engines	x 4, HITACHI, COIL ON PLUG, incl. spark plug connector									470 636	C10			
ENGINE														
50 TFSI e quattro	Petrol/ Electric	220	04/19->	DLGA										
Engine	Information				A10	A20	A40	A50	A70	C10 - C30	C20	E01		
All engines	x 4, HITACHI, COIL ON PLUG, incl. spark plug connector									470 636	C10			
ENGINE														
55 TFSI e quattro	Petrol/ Electric	185	08/19-11/20	DLGA										
Engine	Information				A10	A20	A40	A50	A70	C10 - C30	C20	E01		
All engines	x 4, HITACHI, COIL ON PLUG, incl. spark plug connector									470 636	C10			
Q7 I														
ENGINE														
3.0 TFSI quattro	Petrol	200	05/10-08/15	CJTC, CJWC										
Engine	Information				A10	A20	A40	A50	A70	C10 - C30	C20	E01		
All engines	x 6, Colour:Red, COIL ON PLUG, incl. spark plug connector									470 427	C10			

A10 CONDENSER	A20 CONTACT SET	A40 DISTRIBUTOR CAP	A50 ROTOR	A70 PICK-UP
C10 COIL	C20 IGNITION MODULE	C30 ELECTRONIC IGNITION KIT	E01 IGNITION CABLE SET	

The present application list is a brief version. For the detailed information about the possibility of installation on a specific vehicle, please refer to our web-catalogue <http://catalogo.facet.eu/>









					FUNCTIONS ON THE VEHICLE							
Vehicle	alim.	kW	Date	Engine	 A10	 A20	 A40	 A50	 A70	 C10 - C30	 C20	 E01
ENGINE												
3.0 TFSI quattro	Petrol	206	05/11-08/15	CJWE, CTWB								
Engine	Information				A10	A20	A40	A50	A70	C10 - C30	C20	E01
All engines	x 6, Colour:Red, COIL ON PLUG, incl. spark plug connector									470 427	C10	
ENGINE												
3.0 TFSI quattro	Petrol	245	05/10-08/15	CJTB, CJWB, CNA, CTWA								
Engine	Information				A10	A20	A40	A50	A70	C10 - C30	C20	E01
All engines	x 6, Colour:Red, COIL ON PLUG, incl. spark plug connector									470 427	C10	
ENGINE												
4.2 FSI quattro	Petrol	257	03/06-05/10	BAR								
Engine	Information				A10	A20	A40	A50	A70	C10 - C30	C20	E01
All engines	x 8, Colour:Red, COIL ON PLUG, incl. spark plug connector									470 427	C10	
ENGINE												
4.2 quattro	Petrol	231	03/06-12/10	BAR								
Engine	Information				A10	A20	A40	A50	A70	C10 - C30	C20	E01
All engines	x 8, Colour:Red, COIL ON PLUG, incl. spark plug connector									470 427	C10	
Q7 II												
ENGINE												
2.0 TFSI	Petrol	185	08/15->	CVJA								
Engine	Information				A10	A20	A40	A50	A70	C10 - C30	C20	E01
All engines	Qty: 4									470 636	C10	
ENGINE												
2.0 TFSI quattro	Petrol	185	08/15->	CYRB								
Engine	Information				A10	A20	A40	A50	A70	C10 - C30	C20	E01
All engines	x 4, HITACHI, COIL ON PLUG, incl. spark plug connector									470 636	C10	
ENGINE												
3.0 TFSI quattro	Petrol	245	01/15-12/19	CREC								
Engine	Information				A10	A20	A40	A50	A70	C10 - C30	C20	E01
All engines	x 6, Colour:Red, COIL ON PLUG, incl. spark plug connector									470 427	C10	
Q8												
ENGINE												
45 TFSI	Petrol	180	07/20->	DMFA, DNEA								
Engine	Information				A10	A20	A40	A50	A70	C10 - C30	C20	E01
All engines	x 4, HITACHI, COIL ON PLUG, incl. spark plug connector									470 636	C10	
ENGINE												
45 TFSI quattro	Petrol	180	10/19->	DMFA, DNEA								
Engine	Information				A10	A20	A40	A50	A70	C10 - C30	C20	E01
All engines	x 4, HITACHI, COIL ON PLUG, incl. spark plug connector									470 636	C10	
R8												
ENGINE												
4.2 FSI quattro	Petrol	309	04/07-09/10	BYH								
Engine	Information				A10	A20	A40	A50	A70	C10 - C30	C20	E01
All engines	x 8, Colour:Red, COIL ON PLUG, incl. spark plug connector									470 427	C10	
ENGINE												
4.2 FSI quattro	Petrol	316	07/10-07/15	CNDA								
Engine	Information				A10	A20	A40	A50	A70	C10 - C30	C20	E01
All engines	x 8, Colour:Red, COIL ON PLUG, incl. spark plug connector									470 427	C10	
ENGINE												
5.2 FSI	Petrol	397	09/17->	DKAB								
Engine	Information				A10	A20	A40	A50	A70	C10 - C30	C20	E01
All engines	x 10, Colour:Red, COIL ON PLUG									470 427	C10	
ENGINE												
5.2 FSI	Petrol	404	07/12-07/15	CTPA								
Engine	Information				A10	A20	A40	A50	A70	C10 - C30	C20	E01
All engines	x 10, Colour:Red, COIL ON PLUG, incl. spark plug connector									470 427	C10	
ENGINE												
5.2 FSI	Petrol	419	07/12->	CTPB, DKAC								
Engine	Information				A10	A20	A40	A50	A70	C10 - C30	C20	E01
All engines	x 10, Colour:Red, COIL ON PLUG, incl. spark plug connector									470 427	C10	

A10 CONDENSER	A20 CONTACT SET	A40 DISTRIBUTOR CAP	A50 ROTOR	A70 PICK-UP
C10 COIL	C20 IGNITION MODULE	C30 ELECTRONIC IGNITION KIT	E01 IGNITION CABLE SET	

Vehicle	alim.	kW	Date	Engine	FUNCTIONS ON THE VEHICLE									
					A10	A20	A40	A50	A70	C10 - C30	C20	E01		
ENGINE														
5.2 FSI quattro	Petrol	386	04/09-07/15	BUJ, CTYA										
Engine	Information				A10	A20	A40	A50	A70	C10 - C30	C20	E01		
All engines	x 10, Colour:Red, COIL ON PLUG, incl. spark plug connector									470 427	C10			
ENGINE														
5.2 FSI quattro	Petrol	397	07/15->	CSPB										
Engine	Information				A10	A20	A40	A50	A70	C10 - C30	C20	E01		
All engines	x 10, Colour:Red, COIL ON PLUG									470 427	C10			
ENGINE														
5.2 FSI quattro	Petrol	404	05/12-07/15	CTPA										
Engine	Information				A10	A20	A40	A50	A70	C10 - C30	C20	E01		
All engines	x 10, Colour:Red, COIL ON PLUG, incl. spark plug connector									470 427	C10			
ENGINE														
5.2 FSI quattro	Petrol	412	11/10-07/15	CPMA										
Engine	Information				A10	A20	A40	A50	A70	C10 - C30	C20	E01		
All engines	x 10, ELTOR, Housing Colour:Black, COIL ON PLUG, incl. spark plug connector									470 426	C10			
ENGINE														
5.2 FSI quattro	Petrol	419	07/14->	CTPB, DKAC										
Engine	Information				A10	A20	A40	A50	A70	C10 - C30	C20	E01		
All engines	x 10, Colour:Red, COIL ON PLUG, incl. spark plug connector									470 427	C10			
ENGINE														
5.2 FSI quattro	Petrol	449	07/15->	CSPA, DKAA										
Engine	Information				A10	A20	A40	A50	A70	C10 - C30	C20	E01		
All engines	x 10, Colour:Red, COIL ON PLUG									470 427	C10			
ENGINE														
5.2 FSI quattro	Petrol	456	09/18->	DMWA										
Engine	Information				A10	A20	A40	A50	A70	C10 - C30	C20	E01		
All engines	x 10, Colour:Red, COIL ON PLUG									470 427	C10			
TT I														
ENGINE														
1.8 T	Petrol	110	01/01-06/06	AUM										
Engine	Information				A10	A20	A40	A50	A70	C10 - C30	C20	E01		
All engines	x 4, COIL ON PLUG, incl. spark plug connector									470 429	C10			
ENGINE														
1.8 T	Petrol	120	09/05-06/06	BVP										
Engine	Information				A10	A20	A40	A50	A70	C10 - C30	C20	E01		
All engines	x 4, COIL ON PLUG, incl. spark plug connector									470 429	C10			
ENGINE														
1.8 T	Petrol	132	10/98-06/06	AJQ, APP, ATC, AUQ										
Engine	Information				A10	A20	A40	A50	A70	C10 - C30	C20	E01		
All engines	01/08/00 ->, ch. 8N1010001 ->, x 4, COIL ON PLUG, incl. spark plug connector									470 429	C10			
All engines	->year 01/07/00, ->ch. 8N1010000, x 4, COIL ON PLUG, incl. spark plug connector									470 445	C10			
ENGINE														
1.8 T	Petrol	140	09/05-06/06	BVR										
Engine	Information				A10	A20	A40	A50	A70	C10 - C30	C20	E01		
All engines	x 4, COIL ON PLUG, incl. spark plug connector									470 429	C10			
ENGINE														
1.8 T quattro	Petrol	132	10/98-06/06	AJQ, ARY, ATC, AUQ										
Engine	Information				A10	A20	A40	A50	A70	C10 - C30	C20	E01		
All engines	01/08/00 ->, ch. 8N1010001 ->, x 4, COIL ON PLUG, incl. spark plug connector									470 429	C10			
All engines	->year 01/07/00, ->ch. 8N1010000, x 4, COIL ON PLUG, incl. spark plug connector									470 445	C10			
ENGINE														
1.8 T quattro	Petrol	140	09/05-06/06	BVR										
Engine	Information				A10	A20	A40	A50	A70	C10 - C30	C20	E01		
All engines	x 4, COIL ON PLUG, incl. spark plug connector									470 429	C10			

A10 CONDENSER	A20 CONTACT SET	A40 DISTRIBUTOR CAP	A50 ROTOR	A70 PICK-UP
C10 COIL	C20 IGNITION MODULE	C30 ELECTRONIC IGNITION KIT	E01 IGNITION CABLE SET	

The present application list is a brief version. For the detailed information about the possibility of installation on a specific vehicle, please refer to our web-catalogue <http://catalogo.facet.eu/>

				FUNCTIONS ON THE VEHICLE								
Vehicle	alim.	kW	Date	Engine	 A10	 A20	 A40	 A50	 A70	 C10 - C30	 C20	 E01
				ENGINE								
1.8 T quattro	Petrol	165	10/98-06/06	APX, BAM								
Engine	Information				A10	A20	A40	A50	A70	C10 - C30	C20	E01
All engines	01/08/00 ->, x 4, COIL ON PLUG, incl. spark plug connector									470 429	C10	
All engines	->year 01/07/00, x 4, COIL ON PLUG, incl. spark plug connector									470 445	C10	
				ENGINE								
1.8 T quattro	Petrol	180	03/05-06/06	BFV								
Engine	Information				A10	A20	A40	A50	A70	C10 - C30	C20	E01
All engines	x 4, COIL ON PLUG, incl. spark plug connector									470 429	C10	
				ENGINE								
3.2 VR6 quattro	Petrol	184	07/03-06/06	BHE, BPF								
Engine	Information				A10	A20	A40	A50	A70	C10 - C30	C20	E01
All engines	x 6, COIL ON PLUG									470 434	C10	
				TT II								
				ENGINE								
1.8 TFSI	Petrol	118	06/08-06/14	CDA A								
Engine	Information				A10	A20	A40	A50	A70	C10 - C30	C20	E01
All engines	x 4, ELDOR, Housing Colour:Black, COIL ON PLUG, incl. spark plug connector									470 426	C10	
				ENGINE								
2.0 TFSI	Petrol	147	08/06-06/10	BPY, BWA, CCTA								
Engine	Information				A10	A20	A40	A50	A70	C10 - C30	C20	E01
Eng. BPY, CCTA	Qty: 4									470 426	C10	
Eng. BWA	x 4, ELDOR, Housing Colour:Black, COIL ON PLUG, incl. spark plug connector									470 426	C10	
				ENGINE								
2.0 TFSI	Petrol	155	05/10-06/14	CESA								
Engine	Information				A10	A20	A40	A50	A70	C10 - C30	C20	E01
All engines	x 4, ELDOR, Housing Colour:Black, COIL ON PLUG, incl. spark plug connector									470 426	C10	
				ENGINE								
2.0 TFSI quattro	Petrol	147	06/08-06/10	BWA, CCZA								
Engine	Information				A10	A20	A40	A50	A70	C10 - C30	C20	E01
Eng. BWA	Qty: 4									470 426	C10	
Eng. CCZA	x 4, ELDOR, Housing Colour:Black, COIL ON PLUG, incl. spark plug connector									470 426	C10	
				ENGINE								
2.0 TFSI quattro	Petrol	155	05/10-06/14	CESA, CETA								
Engine	Information				A10	A20	A40	A50	A70	C10 - C30	C20	E01
All engines	x 4, ELDOR, Housing Colour:Black, COIL ON PLUG, incl. spark plug connector									470 426	C10	
				ENGINE								
2.0 TTS quattro	Petrol	195	05/08-06/14	CDLA, CDMA								
Engine	Information				A10	A20	A40	A50	A70	C10 - C30	C20	E01
All engines	TTS Quattro, x 4, ELDOR, Housing Colour:Black, COIL ON PLUG, incl. spark plug connector									470 426	C10	
				ENGINE								
2.0 TTS quattro	Petrol	200	05/08-06/14	CDLB								
Engine	Information				A10	A20	A40	A50	A70	C10 - C30	C20	E01
All engines	TTS Quattro, x 4, ELDOR, Housing Colour:Black, COIL ON PLUG, incl. spark plug connector									470 426	C10	
				ENGINE								
2.5 RS quattro	Petrol	250	07/09-06/14	CEPA								
Engine	Information				A10	A20	A40	A50	A70	C10 - C30	C20	E01
All engines	TTRS Quattro, x 5, ELDOR, Housing Colour:Black, COIL ON PLUG, incl. spark plug connector									470 426	C10	
				ENGINE								
2.5 RS quattro	Petrol	265	05/11-06/14	CEPB								
Engine	Information				A10	A20	A40	A50	A70	C10 - C30	C20	E01
All engines	TTRS Quattro, x 5, ELDOR, Housing Colour:Black, COIL ON PLUG, incl. spark plug connector									470 426	C10	
				ENGINE								
3.2 V6 quattro	Petrol	184	08/06-06/10	BUB								
Engine	Information				A10	A20	A40	A50	A70	C10 - C30	C20	E01
All engines	x 6, COIL ON PLUG									470 434	C10	

A10 CONDENSER	A20 CONTACT SET	A40 DISTRIBUTOR CAP	A50 ROTOR	A70 PICK-UP
C10 COIL	C20 IGNITION MODULE	C30 ELECTRONIC IGNITION KIT	E01 IGNITION CABLE SET	

Vehicle	alim.	kW	Date	Engine	FUNCTIONS ON THE VEHICLE							
					A10	A20	A40	A50	A70	C10 - C30	C20	E01

TT III

				ENGINE
1.8 TFSI	Petrol	132	07/15-08/18	CJSA, CJSB

Engine	Information	A10	A20	A40	A50	A70	C10 - C30	C20	E01
All engines	x 4, HITACHI, COIL ON PLUG, incl. spark plug connector						470 636	C10	

				ENGINE
2.0 TTS quattro	Petrol	210	02/15->	CJXF

Engine	Information	A10	A20	A40	A50	A70	C10 - C30	C20	E01
All engines	TTS Quattro, x 4, HITACHI, COIL ON PLUG, incl. spark plug connector						470 636	C10	

				ENGINE
2.0 TTS quattro	Petrol	215	07/15->	CYFB

Engine	Information	A10	A20	A40	A50	A70	C10 - C30	C20	E01
All engines	TTS Quattro, x 4, HITACHI, COIL ON PLUG, incl. spark plug connector						470 636	C10	

				ENGINE
2.0 TTS quattro	Petrol	225	08/18->	DNUF

Engine	Information	A10	A20	A40	A50	A70	C10 - C30	C20	E01
All engines	x 4, HITACHI, COIL ON PLUG, incl. spark plug connector						470 636	C10	

				ENGINE
2.0 TTS quattro	Petrol	228	11/14->	CJXG

Engine	Information	A10	A20	A40	A50	A70	C10 - C30	C20	E01
All engines	TTS Quattro, x 4, HITACHI, COIL ON PLUG, incl. spark plug connector						470 636	C10	

				ENGINE
40 TFSI	Petrol	145	07/18->	DKZB, DNNB

Engine	Information	A10	A20	A40	A50	A70	C10 - C30	C20	E01
All engines	01/11/18 ->, x 4, HITACHI, COIL ON PLUG, incl. spark plug connector						470 636	C10	

V8

				ENGINE
3.6 quattro	Petrol	180	04/93-02/94	PT

Engine	Information	A10	A20	A40	A50	A70	C10 - C30	C20	E01
All engines	Qty: 2			806 248					

				ENGINE
3.6 quattro	Petrol	184	10/88-02/94	PT









Engine	Information	A10	A20	A40	A50	A70	C10 - C30	C20	E01
All engines	Qty: 2			806 248					

				ENGINE
4.2 quattro	Petrol	206	10/91-02/94	ABH

Engine	Information	A10	A20	A40	A50	A70	C10 - C30	C20	E01
All engines	Qty: 2			806 248					

A10	CONDENSER	A20	CONTACT SET	A40	DISTRIBUTOR CAP	A50	ROTOR	A70	PICK-UP
C10	COIL	C20	IGNITION MODULE	C30	ELECTRONIC IGNITION KIT	E01	IGNITION CABLE SET		

The present application list is a brief version. For the detailed information about the possibility of installation on a specific vehicle, please refer to our web-catalogue <http://catalogo.facet.eu/>

				FUNCTIONS ON THE VEHICLE								
Vehicle	alim.	kW	Date	Engine								
1000-SERIES												
1100	Petrol	32	01/70-12/74	--	ENGINE							
Engine	Information			A10	A20	A40	A50	A70	C10 - C30	C20	E01	
All engines					728 083MHV	828 075	928 006					
1300	Petrol	39	01/70-12/74	--	ENGINE							
Engine	Information			A10	A20	A40	A50	A70	C10 - C30	C20	E01	
All engines					728 083MHV	828 075	928 006					
1300 GT	Petrol	50	01/70-12/74	--	ENGINE							
Engine	Information			A10	A20	A40	A50	A70	C10 - C30	C20	E01	
All engines					728 083MHV	828 075	928 006					
ALLEGRO												
1.1	Petrol	33	05/73-10/81	10 H	ENGINE							
Engine	Information			A10	A20	A40	A50	A70	C10 - C30	C20	E01	
All engines						828 075	928 006					
1.3	Petrol	40	05/73-03/82	12 H	ENGINE							
Engine	Information			A10	A20	A40	A50	A70	C10 - C30	C20	E01	
All engines					728 083MHV	828 075	928 006					
1.5 Super	Petrol	50	05/73-03/82	14 H	ENGINE							
Engine	Information			A10	A20	A40	A50	A70	C10 - C30	C20	E01	
All engines					728 083MHV	828 075	928 006					
APACHE												
1300	Petrol	44	11/71-10/74	--	ENGINE							
Engine	Information			A10	A20	A40	A50	A70	C10 - C30	C20	E01	
All engines						828 075	928 006					
1300 TC	Petrol	52	11/71-10/74	--	ENGINE							
Engine	Information			A10	A20	A40	A50	A70	C10 - C30	C20	E01	
All engines						828 075	928 006					
MAXI												
1500	Petrol	50	04/69-07/80	--, 14 H	ENGINE							
Engine	Information			A10	A20	A40	A50	A70	C10 - C30	C20	E01	
All engines					728 083MHV	828 075	928 006					
1750	Petrol	53	04/69-10/80	17 H	ENGINE							
Engine	Information			A10	A20	A40	A50	A70	C10 - C30	C20	E01	
All engines					728 083MHV	828 075	928 006					
1750 HL	Petrol	66	10/72-10/80	--, 17 LA	ENGINE							
Engine	Information			A10	A20	A40	A50	A70	C10 - C30	C20	E01	
All engines					728 083MHV	828 075	928 006					
MINI												
1.3	Petrol	53	09/69-09/80	12 HC	ENGINE							
Engine	Information			A10	A20	A40	A50	A70	C10 - C30	C20	E01	
All engines						828 075	928 006					
1000	Petrol	26	10/67-09/84	--	ENGINE							
Engine	Information			A10	A20	A40	A50	A70	C10 - C30	C20	E01	
All engines						828 075	928 006					
1000	Petrol	28	01/69-08/81	--, 99 H	ENGINE							
Engine	Information			A10	A20	A40	A50	A70	C10 - C30	C20	E01	
All engines						828 075	928 006					

A10 CONDENSER	A20 CONTACT SET	A40 DISTRIBUTOR CAP	A50 ROTOR	A70 PICK-UP
C10 COIL	C20 IGNITION MODULE	C30 ELECTRONIC IGNITION KIT	E01 IGNITION CABLE SET	

Vehicle	alim.	kW	Date	Engine	FUNCTIONS ON THE VEHICLE									
					A10	A20	A40	A50	A70	C10 - C30	C20	E01		
ENGINE														
1000	Petrol	29	10/67-09/84	99 H										
ENGINE														
All engines						728 083MHV	828 075	928 006						
ENGINE														
1275 GT	Petrol	39	10/69-08/80	12 H										
ENGINE														
All engines						728 083MHV	828 075	928 006						
ENGINE														
850	Petrol	25	01/60-12/69	--										
ENGINE														
All engines								928 006						
MINI I														
ENGINE														
1.0	Petrol	44	09/62-08/69	--										
ENGINE														
All engines								928 006						
ENGINE														
1.1	Petrol	46	11/62-08/64	--										
ENGINE														
All engines								928 006						
ENGINE														
1.3	Petrol	57	09/62-08/69	--										
ENGINE														
All engines								928 006						
ENGINE														
850	Petrol	25	06/59-08/69	781Y										
ENGINE														
All engines							828 075	928 006						
ENGINE														
Cooper	Petrol	41	01/61-12/67	99 H										
ENGINE														
All engines								928 006						
ENGINE														
Cooper S	Petrol	57	09/62-12/71	--										
ENGINE														
All engines							828 075	928 006						
MONTEGO														
ENGINE														
1.3	Petrol	50	10/84-08/88	--, 12 HL										
ENGINE														
All engines							828 094	928 025						
ENGINE														
1.6 LS	Petrol	61	10/84-08/88	16 HC37										
ENGINE														
All engines							828 093	928 024R						
ENGINE														
1.6 LS, HL	Petrol	61	04/84-08/88	16 HC37										
ENGINE														
All engines							828 093	928 024R						
ENGINE														
2.0	Petrol	74	04/84-08/88	20 HSC										
ENGINE														
All engines							828 093	928 024R						
ENGINE														
2.0 Turbo	Petrol	110	04/84-08/88	20 HC85										
ENGINE														
All engines							828 093	928 024R						

A10 CONDENSER	A20 CONTACT SET	A40 DISTRIBUTOR CAP	A50 ROTOR	A70 PICK-UP
C10 COIL	C20 IGNITION MODULE	C30 ELECTRONIC IGNITION KIT	E01 IGNITION CABLE SET	

The present application list is a brief version. For the detailed information about the possibility of installation on a specific vehicle, please refer to our web-catalogue <http://catalogo.facet.eu/>

Vehicle	alim.	kW	Date	Engine	FUNCTIONS ON THE VEHICLE							
					A10	A20	A40	A50	A70	C10 - C30	C20	E01

3000

				ENGINE
3.0 Sport	Petrol	110	03/64-10/68	--

Engine	Information	A10	A20	A40	A50	A70	C10 - C30	C20	E01
All engines					928 007				

SPRITE

				ENGINE
1.3	Petrol	48	03/66-10/71	--, 12CC

Engine	Information	A10	A20	A40	A50	A70	C10 - C30	C20	E01
All engines					928 006				

SPRITE MK.III

				ENGINE
1.1	Petrol	41	03/64-09/66	--

Engine	Information	A10	A20	A40	A50	A70	C10 - C30	C20	E01
All engines					928 006				

A10 CONDENSER	A20 CONTACT SET	A40 DISTRIBUTOR CAP	A50 ROTOR	A70 PICK-UP
C10 COIL	C20 IGNITION MODULE	C30 ELECTRONIC IGNITION KIT	E01 IGNITION CABLE SET	

Vehicle	alim.	kW	Date	Engine	FUNCTIONS ON THE VEHICLE							
					 A10	 A20	 A40	 A50	 A70	 C10 - C30	 C20	 E01

CHEVANNE

				ENGINE
1.3	Petrol	39	06/76-02/80	13D









Engine	Information	A10	A20	A40	A50	A70	C10 - C30	C20	E01
All engines					912 090				

				ENGINE
1.3	Petrol	40	03/80-12/82	LW4

Engine	Information	A10	A20	A40	A50	A70	C10 - C30	C20	E01
All engines					912 090				

A10	CONDENSER	A20	CONTACT SET	A40	DISTRIBUTOR CAP	A50	ROTOR	A70	PICK-UP
C10	COIL	C20	IGNITION MODULE	C30	ELECTRONIC IGNITION KIT	E01	IGNITION CABLE SET		

The present application list is a brief version. For the detailed information about the possibility of installation on a specific vehicle, please refer to our web-catalogue <http://catalogo.facet.eu/>

					FUNCTIONS ON THE VEHICLE							
Vehicle	alim.	kW	Date	Engine								
					A10	A20	A40	A50	A70	C10 - C30	C20	E01

BENTAYGA

				ENGINE
3.0 Hybrid	Petrol/ Electric	250	08/18->	DCBE

Engine	Information	A10	A20	A40	A50	A70	C10 - C30	C20	E01
All engines	x 6, ELDOR, COIL ON PLUG						470 636	C10	

				ENGINE
4.0	Petrol	404	01/18->	DCUA

Engine	Information	A10	A20	A40	A50	A70	C10 - C30	C20	E01
All engines	x 8, COIL ON PLUG						470 636	C10	

A10	CONDENSER	A20	CONTACT SET	A40	DISTRIBUTOR CAP	A50	ROTOR	A70	PICK-UP
C10	COIL	C20	IGNITION MODULE	C30	ELECTRONIC IGNITION KIT	E01	IGNITION CABLE SET		

Vehicle	alim.	kW	Date	Engine	FUNCTIONS ON THE VEHICLE									
					A10	A20	A40	A50	A70	C10 - C30	C20	E01		
1 l														
116 i	Petrol	85	06/04-12/11	ENGINE N43 B16 A, N45 B16 A										
Engine	Information				A10	A20	A40	A50	A70	C10 - C30	C20	E01		
Eng. N45 B16 A	x 4, DELPHI, ELDOR, COIL ON PLUG									470 475	C10			
Eng. N43 B16 A	Qty: 4									470 607	C10			
116 i	Petrol	90	03/07-12/11	ENGINE N43 B16 AA, N43 B20 A										
Engine	Information				A10	A20	A40	A50	A70	C10 - C30	C20	E01		
All engines	x 4, BOSCH, COIL ON PLUG									470 607	C10			
118 d	Diesel	90	06/04-02/07	ENGINE M47 D20 (204D4)										
Engine	Information				A10	A20	A40	A50	A70	C10 - C30	C20	E01		
All engines	Qty: 4									470 607	C10			
118 i	Petrol	100	09/06-12/13	ENGINE N46 B20 B										
Engine	Information				A10	A20	A40	A50	A70	C10 - C30	C20	E01		
All engines	x 4, DELPHI, ELDOR, COIL ON PLUG									470 475	C10			
118 i	Petrol	105	09/06-12/13	ENGINE N43 B20 A										
Engine	Information				A10	A20	A40	A50	A70	C10 - C30	C20	E01		
All engines	x 4, BOSCH, COIL ON PLUG									470 607	C10			
118 i	Petrol	125	03/07-12/07	ENGINE N43 B20 A										
Engine	Information				A10	A20	A40	A50	A70	C10 - C30	C20	E01		
All engines	x 4, BOSCH, COIL ON PLUG									470 607	C10			
118 i	Petrol	95	07/04-02/08	ENGINE N46 B20 B										
Engine	Information				A10	A20	A40	A50	A70	C10 - C30	C20	E01		
All engines	x 4, DELPHI, COIL ON PLUG									470 475	C10			
120 i	Petrol	110	06/04-02/07	ENGINE N46 B20 B, N46 B20 BD, N46 B20 C										
Engine	Information				A10	A20	A40	A50	A70	C10 - C30	C20	E01		
All engines	x 4, DELPHI, COIL ON PLUG									470 475	C10			
120 i	Petrol	115	03/07-12/13	ENGINE N46 B20 B, N46 B20 BD, N46 B20 C										
Engine	Information				A10	A20	A40	A50	A70	C10 - C30	C20	E01		
Eng. N46 B20 B, N46 B20 C	x 4, DELPHI, COIL ON PLUG									470 475	C10			
Eng. N46 B20 BD	Qty: 4									470 607	C10			
120 i	Petrol	120	03/07-12/13	ENGINE N43 B20 A, N46 B20 C										
Engine	Information				A10	A20	A40	A50	A70	C10 - C30	C20	E01		
Eng. N46 B20 C	Qty: 4									470 475	C10			
Eng. N43 B20 A	x 4, BOSCH, COIL ON PLUG									470 607	C10			
120 i	Petrol	125	03/07-10/13	ENGINE N43 B20 A										
Engine	Information				A10	A20	A40	A50	A70	C10 - C30	C20	E01		
All engines	x 4, BOSCH, COIL ON PLUG									470 607	C10			
125 i	Petrol	160	10/07->	ENGINE N52 B30 A, N52 B30 B, N52 B30 BF										
Engine	Information				A10	A20	A40	A50	A70	C10 - C30	C20	E01		
All engines	x 6, DELPHI, COIL ON PLUG									470 475	C10			
Eng. N52 B30 B, N52 B30 BF	Qty: 6									470 475	C10			
128 i	Petrol	172	12/07->	ENGINE N51 B30 A, N52 B30 A										
Engine	Information				A10	A20	A40	A50	A70	C10 - C30	C20	E01		
All engines	Qty: 6									470 475	C10			

A10 CONDENSER	A20 CONTACT SET	A40 DISTRIBUTOR CAP	A50 ROTOR	A70 PICK-UP
C10 COIL	C20 IGNITION MODULE	C30 ELECTRONIC IGNITION KIT	E01 IGNITION CABLE SET	

The present application list is a brief version. For the detailed information about the possibility of installation on a specific vehicle, please refer to our web-catalogue <http://catalogo.facet.eu/>









					FUNCTIONS ON THE VEHICLE							
Vehicle	alim.	kW	Date	Engine	A10	A20	A40	A50	A70	C10 - C30	C20	E01
ENGINE												
130 i	Petrol	190	09/06-12/11	N52 B30 A, N52 B30 B, N52 B30 BF								
Engine					A10	A20	A40	A50	A70	C10 - C30	C20	E01
Information										470 475	C10	
Engine												
130 i	Petrol	195	09/05-12/11	N52 B30 A, N52 B30 B, N52 B30 BF								
Engine					A10	A20	A40	A50	A70	C10 - C30	C20	E01
Information										470 475	C10	
Engine												
135 i	Petrol	225	10/07-10/13	N54 B30 A, N55 B30 A								
Engine					A10	A20	A40	A50	A70	C10 - C30	C20	E01
Information										470 475	C10	
Engine												
135 i	Petrol	240	10/07-12/13	N54 B30 A, N55 B30 A								
Engine					A10	A20	A40	A50	A70	C10 - C30	C20	E01
Information										470 475	C10	
Engine												
Eng. N54 B30 A										470 475	C10	
Information												
Eng. N55 B30 A										470 475	C10	
Information												
Engine												
M	Petrol	250	03/11-06/12	N54 B30 A								
Engine					A10	A20	A40	A50	A70	C10 - C30	C20	E01
Information										470 475	C10	
Engine												
1 II												
ENGINE												
114 i	Petrol	75	12/11->	N13 B16 A								
Engine					A10	A20	A40	A50	A70	C10 - C30	C20	E01
Information										470 475	C10	
Engine												
116 i	Petrol	100	07/11->	N13 B16 A								
Engine					A10	A20	A40	A50	A70	C10 - C30	C20	E01
Information										470 475	C10	
Engine												
116 i	Petrol	80	03/15->	B38 B15 A								
Engine					A10	A20	A40	A50	A70	C10 - C30	C20	E01
Information										470 632	C10	
Engine												
118 i	Petrol	100	03/15->	B38 B15 A, N13 B16 A								
Engine					A10	A20	A40	A50	A70	C10 - C30	C20	E01
Information										470 475	C10	
Eng. N13 B16 A										470 475	C10	
Information												
Eng. B38 B15 A										470 632	C10	
Information												
Engine												
118 i	Petrol	125	07/11->	N13 B16 A								
Engine					A10	A20	A40	A50	A70	C10 - C30	C20	E01
Information										470 475	C10	
Engine												
120 i	Petrol	130	03/15->	N13 B16 A								
Engine					A10	A20	A40	A50	A70	C10 - C30	C20	E01
Information										470 475	C10	
Engine												
120 i	Petrol	135	07/16->	B48 B20 A								
Engine					A10	A20	A40	A50	A70	C10 - C30	C20	E01
Information										470 632	C10	
Engine												
125 i	Petrol	160	12/11-12/19	N20 B20 A								
Engine					A10	A20	A40	A50	A70	C10 - C30	C20	E01
Information										470 475	C10	
Engine												
125 i	Petrol	165	10/15->	B48 B20 B								
Engine					A10	A20	A40	A50	A70	C10 - C30	C20	E01
Information										470 632	C10	

A10 CONDENSER	A20 CONTACT SET	A40 DISTRIBUTOR CAP	A50 ROTOR	A70 PICK-UP
C10 COIL	C20 IGNITION MODULE	C30 ELECTRONIC IGNITION KIT	E01 IGNITION CABLE SET	

Vehicle	alim.	kW	Date	Engine	FUNCTIONS ON THE VEHICLE									
					A10	A20	A40	A50	A70	C10 - C30	C20	E01		
ENGINE														
125 i	Petrol	175	03/12->	N20 B20 A										
Engine	Information				A10	A20	A40	A50	A70	C10 - C30	C20	E01		
All engines	x 4, DELPHI, COIL ON PLUG									470 475	C10			
ENGINE														
125 i Active Flex	Petrol/ Ethanol	160	11/14-11/17	N20 B20 A										
Engine	Information				A10	A20	A40	A50	A70	C10 - C30	C20	E01		
All engines	x 4, DELPHI, COIL ON PLUG									470 475	C10			
ENGINE														
M 135 i	Petrol	235	12/11->	N55 B30 A										
Engine	Information				A10	A20	A40	A50	A70	C10 - C30	C20	E01		
All engines	x 6, DELPHI, COIL ON PLUG									470 475	C10			
ENGINE														
M 135 i	Petrol	240	03/15->	N55 B30 A										
Engine	Information				A10	A20	A40	A50	A70	C10 - C30	C20	E01		
All engines	x 6, DELPHI, COIL ON PLUG									470 475	C10			
ENGINE														
M 135 i xDrive	Petrol	235	02/12->	N55 B30 A										
Engine	Information				A10	A20	A40	A50	A70	C10 - C30	C20	E01		
All engines	x 6, DELPHI, COIL ON PLUG									470 475	C10			
ENGINE														
M 135 i xDrive	Petrol	240	03/15->	N55 B30 A										
Engine	Information				A10	A20	A40	A50	A70	C10 - C30	C20	E01		
All engines	x 6, DELPHI, COIL ON PLUG									470 475	C10			
ENGINE														
M 140 i	Petrol	250	10/15->	B58 B30 A										
Engine	Information				A10	A20	A40	A50	A70	C10 - C30	C20	E01		
All engines	x 6, COIL ON PLUG									470 632	C10			
ENGINE														
M 140 i xDrive	Petrol	250	09/15->	B58 B30 A										
Engine	Information				A10	A20	A40	A50	A70	C10 - C30	C20	E01		
All engines	x 6, COIL ON PLUG									470 632	C10			
1 III														
ENGINE														
116 i	Petrol	80	11/20->	B38 A15 A										
Engine	Information				A10	A20	A40	A50	A70	C10 - C30	C20	E01		
All engines	x 3, COIL ON PLUG									470 632	C10			
ENGINE														
118 i	Petrol	100	11/20->	B38 A15 A										
Engine	Information				A10	A20	A40	A50	A70	C10 - C30	C20	E01		
All engines	x 3, COIL ON PLUG									470 632	C10			
ENGINE														
118 i	Petrol	103	07/19->	B38 A15 A										
Engine	Information				A10	A20	A40	A50	A70	C10 - C30	C20	E01		
All engines	x 3, COIL ON PLUG									470 632	C10			
ENGINE														
120 i	Petrol	131	11/20->	B48 A20 A, B48 A20 F										
Engine	Information				A10	A20	A40	A50	A70	C10 - C30	C20	E01		
All engines	x 4, COIL ON PLUG									470 632	C10			
ENGINE														
128 ti	Petrol	180	11/20->	B48 A20 B										
Engine	Information				A10	A20	A40	A50	A70	C10 - C30	C20	E01		
All engines	x 4, COIL ON PLUG									470 632	C10			
ENGINE														
128 ti	Petrol	195	11/20->	B48 A20 E										
Engine	Information				A10	A20	A40	A50	A70	C10 - C30	C20	E01		
All engines	x 4, COIL ON PLUG									470 632	C10			

A10 CONDENSER	A20 CONTACT SET	A40 DISTRIBUTOR CAP	A50 ROTOR	A70 PICK-UP
C10 COIL	C20 IGNITION MODULE	C30 ELECTRONIC IGNITION KIT	E01 IGNITION CABLE SET	

The present application list is a brief version. For the detailed information about the possibility of installation on a specific vehicle, please refer to our web-catalogue <http://catalogo.facet.eu/>









					FUNCTIONS ON THE VEHICLE							
Vehicle	alim.	kW	Date	Engine	 A10	 A20	 A40	 A50	 A70	 C10 - C30	 C20	 E01
M 135 i xDrive												
Petrol 225 07/19-> ENGINE B48 A20 E												
Engine		Information			A10	A20	A40	A50	A70	C10 - C30	C20	E01
All engines		x 4, COIL ON PLUG								470 632	C10	
1500-2000												
1600												
Petrol 61 04/64-04/68 ENGINE M10 B16 (16A)												
Engine		Information			A10	A20	A40	A50	A70	C10 - C30	C20	E01
All engines						706 029HV						
1800												
Petrol 66 08/63-09/69 ENGINE M118												
Engine		Information			A10	A20	A40	A50	A70	C10 - C30	C20	E01
All engines						706 029HV						
1800 Ti												
Petrol 81 10/63-04/68 ENGINE M118												
Engine		Information			A10	A20	A40	A50	A70	C10 - C30	C20	E01
All engines						706 029HV						
1800 Ti												
Petrol 96 10/63-04/68 ENGINE M118												
Engine		Information			A10	A20	A40	A50	A70	C10 - C30	C20	E01
All engines						706 029HV						
2000												
Petrol 74 09/68-07/72 ENGINE 18F209												
Engine		Information			A10	A20	A40	A50	A70	C10 - C30	C20	E01
All engines								906 018R				
2000 Ti/Tilux												
Petrol 88 01/66-07/72 ENGINE 18F209												
Engine		Information			A10	A20	A40	A50	A70	C10 - C30	C20	E01
All engines						706 029HV						
1502-2002												
1600 Ti												
Petrol 77 09/67-11/69 ENGINE M10 B16 (16A)												
Engine		Information			A10	A20	A40	A50	A70	C10 - C30	C20	E01
All engines						706 029HV						
1602												
Petrol 63 04/71-07/75 ENGINE M10 B16 A												
Engine		Information			A10	A20	A40	A50	A70	C10 - C30	C20	E01
All engines							806 062					
2002												
Petrol 74 02/68-07/75 ENGINE 18F209, M10 B20 A												
Engine		Information			A10	A20	A40	A50	A70	C10 - C30	C20	E01
All engines						706 029HV						
Eng. M10 B20 A							906 018R					
2002 Ti												
Petrol 88 06/68-04/72 ENGINE 18F209												
Engine		Information			A10	A20	A40	A50	A70	C10 - C30	C20	E01
All engines						706 029HV						
2002 Tii												
Petrol 96 01/71-07/75 ENGINE 18F209, M10 B20 (23EA)												
Engine		Information			A10	A20	A40	A50	A70	C10 - C30	C20	E01
All engines						706 029HV						
1600 GT												
1.6												
Petrol 77 10/67-05/69 ENGINE M10 B16 (16A)												
Engine		Information			A10	A20	A40	A50	A70	C10 - C30	C20	E01
All engines						706 029HV						
2												
216 i												
Petrol 75 09/14-02/18 ENGINE B38 A15 A												
Engine		Information			A10	A20	A40	A50	A70	C10 - C30	C20	E01
All engines		x 3, COIL ON PLUG								470 632	C10	

A10 CONDENSER	A20 CONTACT SET	A40 DISTRIBUTOR CAP	A50 ROTOR	A70 PICK-UP
C10 COIL	C20 IGNITION MODULE	C30 ELECTRONIC IGNITION KIT	E01 IGNITION CABLE SET	

Vehicle	alim.	kW	Date	Engine	FUNCTIONS ON THE VEHICLE								
					A10	A20	A40	A50	A70	C10 - C30	C20	E01	
216 i	Petrol	80	03/18->	ENGINE B38 A15 A									
Engine	Information				A10	A20	A40	A50	A70	C10 - C30	C20	E01	
All engines	x 3, COIL ON PLUG									470 632	C10		
218 i	Petrol	100	07/14->	ENGINE B38 A15 A, B38 B15 A									
Engine	Information				A10	A20	A40	A50	A70	C10 - C30	C20	E01	
All engines	x 3, COIL ON PLUG									470 632	C10		
218 i	Petrol	103	04/17->	ENGINE B38 A15 A									
Engine	Information				A10	A20	A40	A50	A70	C10 - C30	C20	E01	
All engines	x 3, COIL ON PLUG									470 632	C10		
220 i	Petrol	120	03/14->	ENGINE B48 A20 A									
Engine	Information				A10	A20	A40	A50	A70	C10 - C30	C20	E01	
All engines	x 4, COIL ON PLUG									470 632	C10		
220 i	Petrol	131	11/20->	ENGINE B48 A20 A, B48 A20 F									
Engine	Information				A10	A20	A40	A50	A70	C10 - C30	C20	E01	
All engines	x 4, COIL ON PLUG									470 632	C10		
220 i	Petrol	135	10/13->	ENGINE B48 B20 A, N20 B20 A, N20 B20 B									
Engine	Information				A10	A20	A40	A50	A70	C10 - C30	C20	E01	
Eng. N20 B20 A, N20 B20 B	x 4, DELPHI, COIL ON PLUG									470 475	C10		
Eng. B48 B20 A	x 4, COIL ON PLUG									470 632	C10		
220 i	Petrol	141	03/14->	ENGINE B48 A20 A, B48 A20 F									
Engine	Information				A10	A20	A40	A50	A70	C10 - C30	C20	E01	
All engines	x 4, COIL ON PLUG									470 632	C10		
220 i xDrive	Petrol	131	03/21->	ENGINE B48 A20 A									
Engine	Information				A10	A20	A40	A50	A70	C10 - C30	C20	E01	
All engines	x 4, COIL ON PLUG									470 632	C10		
225 i	Petrol	170	11/13->	ENGINE B48 A20 B									
Engine	Information				A10	A20	A40	A50	A70	C10 - C30	C20	E01	
All engines	x 4, COIL ON PLUG									470 632	C10		
225 i xDrive	Petrol	170	03/14->	ENGINE B48 A20 B									
Engine	Information				A10	A20	A40	A50	A70	C10 - C30	C20	E01	
All engines	x 4, COIL ON PLUG									470 632	C10		
225 xe Plug-in-Hybrid	Petrol/ Electric	100	11/14->	ENGINE B38 A15 A									
Engine	Information				A10	A20	A40	A50	A70	C10 - C30	C20	E01	
All engines	x 3, COIL ON PLUG									470 632	C10		
225 xe Plug-in-Hybrid	Petrol/ Electric	162	11/20->	ENGINE B38 A15 A									
Engine	Information				A10	A20	A40	A50	A70	C10 - C30	C20	E01	
All engines	x 3, COIL ON PLUG									470 632	C10		
225 xe Plug-in-Hybrid	Petrol/ Electric	165	11/14->	ENGINE B38 A15 A									
Engine	Information				A10	A20	A40	A50	A70	C10 - C30	C20	E01	
All engines	x 3, COIL ON PLUG									470 632	C10		
225 xe Plug-in-Hybrid	Petrol/ Electric	92	11/20->	ENGINE B38 A15 A									
Engine	Information				A10	A20	A40	A50	A70	C10 - C30	C20	E01	
All engines	x 3, COIL ON PLUG									470 632	C10		

A10 CONDENSER	A20 CONTACT SET	A40 DISTRIBUTOR CAP	A50 ROTOR	A70 PICK-UP
C10 COIL	C20 IGNITION MODULE	C30 ELECTRONIC IGNITION KIT	E01 IGNITION CABLE SET	

The present application list is a brief version. For the detailed information about the possibility of installation on a specific vehicle, please refer to our web-catalogue <http://catalogo.facet.eu/>





					FUNCTIONS ON THE VEHICLE							
Vehicle	alim.	kW	Date	Engine	 A10	 A20	 A40	 A50	 A70	 C10 - C30	 C20	 E01
ENGINE												
228 i	Petrol	180	07/14->	N20 B20 A								
Engine	Information				A10	A20	A40	A50	A70	C10 - C30	C20	E01
All engines	x 4, DELPHI, COIL ON PLUG									470 475	C10	
ENGINE												
230 i	Petrol	185	07/16->	B48 B20 B								
Engine	Information				A10	A20	A40	A50	A70	C10 - C30	C20	E01
All engines	x 4, COIL ON PLUG									470 632	C10	
ENGINE												
M 235 i	Petrol	240	10/13->	N55 B30 A								
Engine	Information				A10	A20	A40	A50	A70	C10 - C30	C20	E01
All engines	x 6, DELPHI, COIL ON PLUG									470 475	C10	
ENGINE												
M 235 i xDrive	Petrol	225	11/19->	B48 A20 E								
Engine	Information				A10	A20	A40	A50	A70	C10 - C30	C20	E01
All engines	x 4, COIL ON PLUG									470 632	C10	
ENGINE												
M 235 i xDrive	Petrol	240	07/14->	N55 B30 A								
Engine	Information				A10	A20	A40	A50	A70	C10 - C30	C20	E01
All engines	x 6, DELPHI, COIL ON PLUG									470 475	C10	
ENGINE												
M 240 i	Petrol	250	09/15->	B58 B30 A								
Engine	Information				A10	A20	A40	A50	A70	C10 - C30	C20	E01
All engines	x 6, COIL ON PLUG									470 632	C10	
ENGINE												
M 240 i xDrive	Petrol	250	09/15->	B58 B30 A								
Engine	Information				A10	A20	A40	A50	A70	C10 - C30	C20	E01
All engines	x 6, COIL ON PLUG									470 632	C10	
ENGINE												
M2	Petrol	272	11/15-06/18	N55 B30 A								
Engine	Information				A10	A20	A40	A50	A70	C10 - C30	C20	E01
All engines	x 6, DELPHI, COIL ON PLUG									470 475	C10	
ENGINE												
M2 Competition	Petrol	302	06/18->	S55 B30 A								
Engine	Information				A10	A20	A40	A50	A70	C10 - C30	C20	E01
All engines	x 6, DELPHI, COIL ON PLUG									470 475	C10	
ENGINE												
M2 CS	Petrol	331	11/19->	S55 B30 A								
Engine	Information				A10	A20	A40	A50	A70	C10 - C30	C20	E01
All engines	x 6, DELPHI, COIL ON PLUG									470 475	C10	
2000												
ENGINE												
CS	Petrol	88	10/65-06/70	18F209								
Engine	Information				A10	A20	A40	A50	A70	C10 - C30	C20	E01
All engines						706 029HV						
2500-3.3												
ENGINE												
3.0 S	Petrol	132	05/71-04/77	M30 B30								
Engine	Information				A10	A20	A40	A50	A70	C10 - C30	C20	E01
All engines						706 062						
3 l												
ENGINE												
315	Petrol	55	03/81-03/84	M10 B16 (164VB)								
Engine	Information				A10	A20	A40	A50	A70	C10 - C30	C20	E01
All engines	version Bosch						806 094	906 115R				
All engines											465 005	
ENGINE												
320 i	Petrol	92	06/75-08/82	18F209								
Engine	Information				A10	A20	A40	A50	A70	C10 - C30	C20	E01
All engines						706 062						

A10 CONDENSER	A20 CONTACT SET	A40 DISTRIBUTOR CAP	A50 ROTOR	A70 PICK-UP
C10 COIL	C20 IGNITION MODULE	C30 ELECTRONIC IGNITION KIT	E01 IGNITION CABLE SET	

Vehicle	alim.	kW	Date	Engine	FUNCTIONS ON THE VEHICLE									
					A10	A20	A40	A50	A70	C10 - C30	C20	E01		
3 II														
316	Petrol	66	09/83-06/88	ENGINE M10 B18 (184VC), M10 B18 (184VD)										
Engine	Information													
All engines	version Bosch					806 094	906 115R							
All engines	->year 30/09/83										465 005			
All engines	without marten protection												359 572	
316 i	Petrol	73	09/87-06/94	ENGINE M40 B16 (164E1)										
Engine	Information													
All engines	version Bosch					806 247	906 119R							
All engines	without marten protection												359 573	
316 i	Petrol	75	08/87-06/94	ENGINE M10 B18 (184KA), M40 B16 (164E1)										
Engine	Information													
Eng. M10 B18 (184KA)	version Bosch					806 094	906 055R							
Eng. M40 B16 (164E1)	version Bosch					806 247	906 119R							
Eng. M10 B18 (184KA)	without marten protection												359 572	
Eng. M40 B16 (164E1)	without marten protection												359 573	
318 i	Petrol	75	12/84-08/88	ENGINE M10 B18 (184KA)										
Engine	Information													
All engines	version Bosch					806 094	906 055R, 906 115R							
All engines	without marten protection												359 572	
318 i	Petrol	77	09/82-08/87	ENGINE M10 B18 (184EA)										
Engine	Information													
All engines	version Bosch					806 094	906 055R, 906 115R							
All engines	without marten protection												359 572	
318 i	Petrol	83	06/87-06/94	ENGINE M40 B18 (184E1)										
Engine	Information													
All engines	version Bosch					806 247	906 119R							
All engines	without marten protection												359 573	
318 i	Petrol	85	09/87-06/91	ENGINE M40 B18 (184E1)										
Engine	Information													
All engines	version Bosch					806 247	906 119R							
All engines	without marten protection												359 573	
318 is	Petrol	100	09/89-08/91	ENGINE M42 B18 (184S1)										
Engine	Information													
All engines	Qty: 4									470 162S	C10			
320 i	Petrol	110	12/85-06/90	ENGINE M20 B20 (206KA)										
Engine	Information													
All engines	version Bosch					806 238	906 119R							
All engines	+automatic transmission												359 587	
All engines	+manual transmission												359 597	
320 i	Petrol	92	09/82-12/91	ENGINE M20 B20 (206EB)										
Engine	Information													
All engines	version Bosch					806 238	906 119R							
All engines	+automatic transmission												359 587	
All engines	+manual transmission												359 597	
320 i	Petrol	93	07/87-10/93	ENGINE M20 B20 (206KA)										
Engine	Information													
All engines	version Bosch					806 238	906 119R							

A10	CONDENSER	A20	CONTACT SET	A40	DISTRIBUTOR CAP	A50	ROTOR	A70	PICK-UP
C10	COIL	C20	IGNITION MODULE	C30	ELECTRONIC IGNITION KIT	E01	IGNITION CABLE SET		

The present application list is a brief version. For the detailed information about the possibility of installation on a specific vehicle, please refer to our web-catalogue <http://catalogo.facet.eu/>









					FUNCTIONS ON THE VEHICLE							
Vehicle	alim.	kW	Date	Engine	 A10	 A20	 A40	 A50	 A70	 C10 - C30	 C20	 E01
ENGINE												
320 i	Petrol	93	07/87-10/93	M20 B20 (206KA)								
Engine	Information				A10	A20	A40	A50	A70	C10 - C30	C20	E01
All engines	+automatic transmission											359 587
All engines	+manual transmission											359 597
ENGINE												
320 i	Petrol	95	05/86-11/93	M20 B20 (206KA)								
Engine	Information				A10	A20	A40	A50	A70	C10 - C30	C20	E01
All engines	version Bosch						806 238	906 119R				
All engines	+automatic transmission											359 587
All engines	+manual transmission											359 597
ENGINE												
323 i	Petrol	102	09/82-08/83	M20 B23 (236EC)								
Engine	Information				A10	A20	A40	A50	A70	C10 - C30	C20	E01
All engines	version Bosch						806 121	906 060R, 906 112R				
All engines	->year 30/09/84										465 005	
ENGINE												
323 i	Petrol	110	09/83-09/86	M20 B23 (236EC)								
Engine	Information				A10	A20	A40	A50	A70	C10 - C30	C20	E01
All engines	version Bosch						806 121	906 060R, 906 112R				
All engines	->year 30/09/84										465 005	
ENGINE												
325 e 2.7	Petrol	90	10/83-12/88	M20 B27 (276KA), M20 B27 (276KB)								
Engine	Information				A10	A20	A40	A50	A70	C10 - C30	C20	E01
All engines	version Bosch						806 238	906 119R				
ENGINE												
325 e 2.7	Petrol	95	01/85-08/87	M20 B27 (276KB)								
Engine	Information				A10	A20	A40	A50	A70	C10 - C30	C20	E01
All engines	version Bosch						806 238	906 119R				
ENGINE												
325 i	Petrol	125	12/86-11/93	M20 B25 (256E1), M20 B25 (256E2), M20 B25 (256EX), M20 B25 (256K1)								
Engine	Information				A10	A20	A40	A50	A70	C10 - C30	C20	E01
All engines	version Bosch						806 238	906 119R				
All engines	+automatic transmission, 01/10/87 ->											359 587
All engines	->year 30/09/87											359 597
ENGINE												
325 i	Petrol	126	09/83-11/89	M20 B25 (256E2)								
Engine	Information				A10	A20	A40	A50	A70	C10 - C30	C20	E01
All engines	version Bosch						806 238	906 119R				
All engines	+automatic transmission, 01/10/87 ->											359 587
All engines	->year 30/09/87											359 597
ENGINE												
325 i X	Petrol	125	09/86-10/93	M20 B25 (256E1), M20 B25 (256E2), M20 B25 (256EX), M20 B25 (256K1)								
Engine	Information				A10	A20	A40	A50	A70	C10 - C30	C20	E01
All engines	version Bosch						806 238	906 119R				
ENGINE												
325 i X	Petrol	126	03/86-12/87	M20 B25 (256E1), M20 B25 (256E2), M20 B25 (256EX), M20 B25 (256K1)								
Engine	Information				A10	A20	A40	A50	A70	C10 - C30	C20	E01
All engines	version Bosch						806 238	906 119R				

A10 CONDENSER	A20 CONTACT SET	A40 DISTRIBUTOR CAP	A50 ROTOR	A70 PICK-UP
C10 COIL	C20 IGNITION MODULE	C30 ELECTRONIC IGNITION KIT	E01 IGNITION CABLE SET	

Vehicle	alim.	kW	Date	Engine	FUNCTIONS ON THE VEHICLE							
					A10	A20	A40	A50	A70	C10 - C30	C20	E01
3 III												
316 g	Petrol/ Com- pressed Natural Gas (CNG)	75	02/96-08/00	M43 B16 (164E2)								
Engine	Information				A10	A20	A40	A50	A70	C10 - C30	C20	E01
All engines	without marten protection											359 900
316 i	Petrol	73	03/91-08/93	M40 B16 (164E1)								
Engine	Information				A10	A20	A40	A50	A70	C10 - C30	C20	E01
All engines	version Bosch						806 247	906 119R				
All engines	E36, without marten protection											359 605
316 i	Petrol	75	09/90-08/00	M43 B16 (164E2)								
Engine	Information				A10	A20	A40	A50	A70	C10 - C30	C20	E01
All engines	version Bosch						806 247	906 119R				
All engines	E36, without marten protection											359 605
All engines	without marten protection											359 900
316 i	Petrol	77	01/99-08/00	M43 B19 (194E1)								
Engine	Information				A10	A20	A40	A50	A70	C10 - C30	C20	E01
All engines	without marten protection											359 900
318 i	Petrol	83	09/90-08/93	M40 B18 (184E1)								
Engine	Information				A10	A20	A40	A50	A70	C10 - C30	C20	E01
All engines	version Bosch						806 247	906 119R				
All engines	E36, without marten protection											359 605
318 i	Petrol	85	09/93-11/99	M43 B18 (184E2)								
Engine	Information				A10	A20	A40	A50	A70	C10 - C30	C20	E01
All engines	without marten protection											359 900
318 is	Petrol	103	01/92-04/99	M42 B18 (184S1), M44 B19 (194S1)								
Engine	Information				A10	A20	A40	A50	A70	C10 - C30	C20	E01
Eng. M42 B18 (184S1)	->year 30/09/93, Qty: 4									470 162S	C10	
All engines	01/10/93 ->											360 921
318 ti	Petrol	103	09/94-08/99	M42 B18 (184S1), M44 B19 (194S1)								
Engine	Information				A10	A20	A40	A50	A70	C10 - C30	C20	E01
All engines												360 921
320 i	Petrol	110	01/91-11/99	M50 B20 (206S1), M50 B20 (206S2), M52 B20 (206S3)								
Engine	Information				A10	A20	A40	A50	A70	C10 - C30	C20	E01
All engines	without spark plug connector, Qty: 6									470 162S	C10	
All engines	+automatic transmission, RHD, without spark plug connector, Qty: 6									470 352	C10	
All engines	incl. spark plug connector, Qty: 6									470 412	C10	
All engines	+automatic transmission, RHD, incl. spark plug connector, Qty: 6									470 413	C10	
320 i	Petrol	135	11/19->	B46 B20 B, B48 B20 A								
Engine	Information				A10	A20	A40	A50	A70	C10 - C30	C20	E01
All engines	x 4, COIL ON PLUG									470 632	C10	
323 i	Petrol	125	05/95-11/99	M52 B25 (256S3)								
Engine	Information				A10	A20	A40	A50	A70	C10 - C30	C20	E01
All engines	without spark plug connector, Qty: 6									470 352	C10	
All engines	incl. spark plug connector, Qty: 6									470 413	C10	

A10 CONDENSER	A20 CONTACT SET	A40 DISTRIBUTOR CAP	A50 ROTOR	A70 PICK-UP
C10 COIL	C20 IGNITION MODULE	C30 ELECTRONIC IGNITION KIT	E01 IGNITION CABLE SET	

The present application list is a brief version. For the detailed information about the possibility of installation on a specific vehicle, please refer to our web-catalogue <http://catalogo.facet.eu/>

					FUNCTIONS ON THE VEHICLE							
Vehicle	alim.	kW	Date	Engine	 A10	 A20	 A40	 A50	 A70	 C10 - C30	 C20	 E01
ENGINE												
323 ti	Petrol	120	01/99-08/00	M52 B25 (256S3)								
Engine	Information				A10	A20	A40	A50	A70	C10 - C30	C20	E01
All engines	without spark plug connector, Qty: 6									470 352	C10	
All engines	incl. spark plug connector, Qty: 6									470 413	C10	
ENGINE												
323 ti	Petrol	125	09/97-08/00	M52 B25 (256S3)								
Engine	Information				A10	A20	A40	A50	A70	C10 - C30	C20	E01
All engines	without spark plug connector, Qty: 6									470 352	C10	
All engines	incl. spark plug connector, Qty: 6									470 413	C10	
ENGINE												
325 i	Petrol	141	09/90-12/95	M50 B25 (256S1), M50 B25 (256S2)								
Engine	Information				A10	A20	A40	A50	A70	C10 - C30	C20	E01
All engines	without spark plug connector, Qty: 6									470 162S	C10	
All engines	incl. spark plug connector, Qty: 6									470 412	C10	
ENGINE												
328 i	Petrol	142	01/95-11/99	M52 B28 (286S1)								
Engine	Information				A10	A20	A40	A50	A70	C10 - C30	C20	E01
All engines	without spark plug connector, Qty: 6									470 352	C10	
All engines	incl. spark plug connector, Qty: 6									470 413	C10	
ENGINE												
330 i	Petrol	190	07/19->	B48 B20 B								
Engine	Information				A10	A20	A40	A50	A70	C10 - C30	C20	E01
All engines	x 4, COIL ON PLUG									470 632	C10	
ENGINE												
M 340 i xDrive	Petrol	275	11/19->	B58 B30 B								
Engine	Information				A10	A20	A40	A50	A70	C10 - C30	C20	E01
All engines	x 6, COIL ON PLUG									470 632	C10	
ENGINE												
M3 3.0	Petrol	210	11/92-07/95	S50 B30 (306S1)								
Engine	Information				A10	A20	A40	A50	A70	C10 - C30	C20	E01
All engines	without spark plug connector, Qty: 6									470 162S	C10	
All engines	incl. spark plug connector, Qty: 6									470 412	C10	
ENGINE												
M3 3.0	Petrol	217	09/93-05/95	S50 B30 (306S1)								
Engine	Information				A10	A20	A40	A50	A70	C10 - C30	C20	E01
All engines	without spark plug connector, Qty: 6									470 162S	C10	
All engines	incl. spark plug connector, Qty: 6									470 412	C10	
ENGINE												
M3 3.2	Petrol	236	10/95-09/99	S50 B32 (326S1)								
Engine	Information				A10	A20	A40	A50	A70	C10 - C30	C20	E01
All engines	without spark plug connector, Qty: 6									470 352	C10	
All engines	incl. spark plug connector, Qty: 6									470 413	C10	
3 IV												
ENGINE												
316 Ci	Petrol	77	04/00-07/06	M43 B16 (164E3)								
Engine	Information				A10	A20	A40	A50	A70	C10 - C30	C20	E01
All engines												358 069
ENGINE												
316 Ci	Petrol	85	10/01->	N40 B16 A, N45 B16 A								
Engine	Information				A10	A20	A40	A50	A70	C10 - C30	C20	E01
Eng. N40 B16 A	Qty: 4									470 475	C10	
Eng. N45 B16 A	x 4, DELPHI, ELDOR, COIL ON PLUG									470 475	C10	
ENGINE												
316 i	Petrol	77	12/98-02/05	M43 B16 (164E3), M43 B19 (194E1)								
Engine	Information				A10	A20	A40	A50	A70	C10 - C30	C20	E01
All engines												358 069

A10 CONDENSER	A20 CONTACT SET	A40 DISTRIBUTOR CAP	A50 ROTOR	A70 PICK-UP
C10 COIL	C20 IGNITION MODULE	C30 ELECTRONIC IGNITION KIT	E01 IGNITION CABLE SET	

Vehicle	alim.	kW	Date	Engine	FUNCTIONS ON THE VEHICLE									
					A10	A20	A40	A50	A70	C10 - C30	C20	E01		
316 i	Petrol	85	02/02-02/05	ENGINE N40 B16 A, N42 B18 A, N45 B16 A, N46 B18 A										
Engine	Information													
All engines	01/04/03 ->, x 4, BREMI, x 4, COIL ON PLUG, DELPHI, ELDOR, x 4, COIL ON PLUG, DELPHI, COIL ON PLUG									470 475	C10			
Eng. N45 B16 A	Qty: 4									470 475	C10			
316 ti	Petrol	85	06/01-02/05	ENGINE N40 B16 A, N42 B18 A, N45 B16 A, N46 B18 A										
Engine	Information													
All engines	01/04/03 ->, x 4, BREMI, x 4, COIL ON PLUG, DELPHI, ELDOR, x 4, COIL ON PLUG, DELPHI, COIL ON PLUG									470 475	C10			
318 Ci	Petrol	100	12/00-08/06	ENGINE N42 B20 A, N46 B20 A										
Engine	Information													
All engines	01/04/03 ->, x 4, DELPHI, x 4, COIL ON PLUG, DELPHI, COIL ON PLUG									470 475	C10			
Eng. N46 B20 A	Qty: 4									470 475	C10			
318 Ci	Petrol	105	09/01-12/07	ENGINE N42 B20 A, N46 B20 A										
Engine	Information													
All engines	01/04/03 ->, x 4, BREMI, x 4, COIL ON PLUG, DELPHI, x 4, COIL ON PLUG, DELPHI, COIL ON PLUG									470 475	C10			
Eng. N46 B20 A	Qty: 4									470 475	C10			
318 Ci	Petrol	110	03/04-08/06	ENGINE N46 B20 A, N46 B20 B, N46 B20 C										
Engine	Information													
Eng. N46 B20 A, N46 B20 C	x 4, DELPHI, COIL ON PLUG									470 475	C10			
Eng. N46 B20 B	Qty: 4									470 475	C10			
318 Ci	Petrol	85	12/99-08/01	ENGINE M43 B19 (194E1)										
Engine	Information													
All engines													358 069	
318 Ci	Petrol	87	12/99-08/01	ENGINE M43 B19 (194E1)										
Engine	Information													
All engines													358 069	
318 i	Petrol	100	09/01-02/05	ENGINE N42 B20 A										
Engine	Information													
All engines	01/03/03 ->, x 4, DELPHI, COIL ON PLUG									470 475	C10			
318 i	Petrol	105	09/01-07/05	ENGINE N42 B20 A, N46 B20 A, N46 B20 C										
Engine	Information													
All engines	01/04/03 ->, x 4, BREMI, x 4, COIL ON PLUG, DELPHI, x 4, COIL ON PLUG, DELPHI, COIL ON PLUG									470 475	C10			
318 i	Petrol	85	10/99-09/01	ENGINE M43 B19 (194E1)										
Engine	Information													
All engines													358 069	
318 i	Petrol	87	12/97-09/01	ENGINE M43 B19 (194E1)										
Engine	Information													
All engines													358 069	
318 ti	Petrol	100	03/01-12/04	ENGINE N42 B20 A, N46 B20 A										
Engine	Information													
All engines	01/03/03 ->, x 4, DELPHI, COIL ON PLUG									470 475	C10			
318 ti	Petrol	105	03/01-12/04	ENGINE N42 B20 A, N46 B20 A										
Engine	Information													
All engines	01/04/03 ->, x 4, BREMI, COIL ON PLUG, x 4, DELPHI, COIL ON PLUG									470 475	C10			
A10	CONDENSER		A20	CONTACT SET		A40	DISTRIBUTOR CAP		A50	ROTOR		A70	PICK-UP	
C10	COIL		C20	IGNITION MODULE		C30	ELECTRONIC IGNITION KIT		E01	IGNITION CABLE SET				

FUNCTIONS ON THE VEHICLE

Vehicle	alim.	kW	Date	Engine	 A10	 A20	 A40	 A50	 A70	 C10 - C30	 C20	 E01
ENGINE												
320 Ci	Petrol	110	02/99-08/01	M52 B20 (206S4), M52B206S4								
Engine	Information				A10	A20	A40	A50	A70	C10 - C30	C20	E01
Eng. M52 B20 (206S4)	->year 30/09/02, without spark plug connector, Qty: 6									470 352	C10	
Eng. M52B206S4	x 6, BOSCH, BREMI, COIL ON PLUG, incl. spark plug connector									470 352	C10	
Eng. M52 B20 (206S4)	->year 30/09/02, incl. spark plug connector, Qty: 6									470 413	C10	
Eng. M52 B20 (206S4)	01/10/02 ->, Qty: 6									470 475	C10	
ENGINE												
320 Ci	Petrol	120	01/00-12/07	M54 B22 (226S1), M54B226S1								
Engine	Information				A10	A20	A40	A50	A70	C10 - C30	C20	E01
Eng. M54 B22 (226S1)	->year 30/09/02, without spark plug connector, Qty: 6									470 352	C10	
Eng. M54B226S1	->year 01/09/02, x 6, BREMI, COIL ON PLUG									470 352	C10	
Eng. M54 B22 (226S1)	->year 30/09/02, incl. spark plug connector, Qty: 6									470 413	C10	
Eng. M54 B22 (226S1)	01/10/02 ->, Qty: 6									470 475	C10	
Eng. M54B226S1	01/09/02 ->, x 6, DELPHI, COIL ON PLUG									470 475	C10	
	01/10/02 ->, x 6, DELPHI, COIL ON PLUG											
ENGINE												
320 Ci	Petrol	125	01/00-12/07	M54 B22 (226S1), M54B226S1								
Engine	Information				A10	A20	A40	A50	A70	C10 - C30	C20	E01
Eng. M54 B22 (226S1)	->year 30/09/02, without spark plug connector, Qty: 6									470 352	C10	
Eng. M54B226S1	->year 01/09/02, x 6, BOSCH, BREMI, COIL ON PLUG, incl. spark plug connector									470 352	C10	
Eng. M54 B22 (226S1)	->year 30/09/02, incl. spark plug connector, Qty: 6									470 413	C10	
Eng. M54 B22 (226S1)	01/10/02 ->, Qty: 6									470 475	C10	
Eng. M54B226S1	01/10/02 ->, x 6, DELPHI, COIL ON PLUG									470 475	C10	
ENGINE												
320 i	Petrol	110	03/98-09/00	M52 B20 (206S4), M52B206S4								
Engine	Information				A10	A20	A40	A50	A70	C10 - C30	C20	E01
Eng. M52 B20 (206S4)	->year 30/09/02, without spark plug connector, Qty: 6									470 352	C10	
Eng. M52B206S4	x 6, BOSCH, BREMI, COIL ON PLUG, incl. spark plug connector									470 352	C10	
Eng. M52 B20 (206S4)	->year 30/09/02, incl. spark plug connector, Qty: 6									470 413	C10	
Eng. M52 B20 (206S4)	01/10/02 ->, Qty: 6									470 475	C10	
ENGINE												
320 i	Petrol	120	09/00-02/05	4F8Q 636, M54 B22 (226S1), M54B226S1								
Engine	Information				A10	A20	A40	A50	A70	C10 - C30	C20	E01
Eng. 4F8Q 636, M54B226S1	->year 01/08/02, x 6, BREMI, COIL ON PLUG									470 352	C10	
Eng. M54 B22 (226S1)	->year 30/09/02, without spark plug connector, Qty: 6									470 352	C10	
Eng. M54 B22 (226S1)	->year 30/09/02, incl. spark plug connector, Qty: 6									470 413	C10	
Eng. 4F8Q 636, M54B226S1	01/09/02 ->, x 6, DELPHI, COIL ON PLUG									470 475	C10	
Eng. M54 B22 (226S1)	01/10/02 ->, Qty: 6									470 475	C10	
ENGINE												
320 i	Petrol	125	09/00-02/05	4F8Q 636, M54 B22 (226S1), M54B226S1								
Engine	Information				A10	A20	A40	A50	A70	C10 - C30	C20	E01
Eng. 4F8Q 636, M54B226S1	->year 01/09/02, x 6, BOSCH, BREMI, COIL ON PLUG, incl. spark plug connector									470 352	C10	
Eng. M54 B22 (226S1)	->year 30/09/02, without spark plug connector, Qty: 6									470 352	C10	
Eng. M54 B22 (226S1)	->year 30/09/02, incl. spark plug connector, Qty: 6									470 413	C10	
Eng. 4F8Q 636, M54B226S1	01/10/02 ->, x 6, DELPHI, COIL ON PLUG									470 475	C10	
Eng. M54 B22 (226S1)	01/10/02 ->, Qty: 6									470 475	C10	
ENGINE												
323 Ci	Petrol	120	04/99-09/00	8CLS, M52 B25 (256S4), M52B256S4								
Engine	Information				A10	A20	A40	A50	A70	C10 - C30	C20	E01
Eng. 8CLS, M52B256S4	x 6, BREMI, COIL ON PLUG									470 352	C10	
Eng. M52 B25 (256S4)	without spark plug connector, Qty: 6									470 352	C10	
Eng. M52 B25 (256S4)	incl. spark plug connector, Qty: 6									470 413	C10	

A10 CONDENSER	A20 CONTACT SET	A40 DISTRIBUTOR CAP	A50 ROTOR	A70 PICK-UP
C10 COIL	C20 IGNITION MODULE	C30 ELECTRONIC IGNITION KIT	E01 IGNITION CABLE SET	

Vehicle	alim.	kW	Date	Engine	FUNCTIONS ON THE VEHICLE								
					A10	A20	A40	A50	A70	C10 - C30	C20	E01	
323 Ci	Petrol	125	04/99-09/00	ENGINE 0LF8, M52 B25 (256S4), M52B256S4									
Engine	Information			A10	A20	A40	A50	A70	C10 - C30	C20	E01		
Eng. 0LF8, M52B256S4	x 6, BOSCH, BREMI, COIL ON PLUG, incl. spark plug connector								470 352	C10			
Eng. M52 B25 (256S4)	without spark plug connector, Qty: 6								470 352	C10			
Eng. M52 B25 (256S4)	incl. spark plug connector, Qty: 6								470 413	C10			
323 i	Petrol	120	03/98-09/00	ENGINE M52 B25 (256S4), M52B256S4									
Engine	Information			A10	A20	A40	A50	A70	C10 - C30	C20	E01		
Eng. M52 B25 (256S4)	without spark plug connector, Qty: 6								470 352	C10			
Eng. M52B256S4	x 6, BREMI, COIL ON PLUG								470 352	C10			
Eng. M52 B25 (256S4)	incl. spark plug connector, Qty: 6								470 413	C10			
323 i	Petrol	125	03/98-09/00	ENGINE M52 B25 (256S4), M52B256S4									
Engine	Information			A10	A20	A40	A50	A70	C10 - C30	C20	E01		
Eng. M52 B25 (256S4)	without spark plug connector, Qty: 6								470 352	C10			
Eng. M52B256S4	x 6, BOSCH, BREMI, COIL ON PLUG, incl. spark plug connector								470 352	C10			
Eng. M52 B25 (256S4)	incl. spark plug connector, Qty: 6								470 413	C10			
323 i	Petrol	135	03/99-12/03	ENGINE - (24 6 S3)									
Engine	Information			A10	A20	A40	A50	A70	C10 - C30	C20	E01		
All engines	without spark plug connector, Qty: 6								470 352	C10			
All engines	incl. spark plug connector, Qty: 6								470 413	C10			
325 Ci	Petrol	137	01/01->	ENGINE M56256S6									
Engine	Information			A10	A20	A40	A50	A70	C10 - C30	C20	E01		
All engines	->year 30/09/02, without spark plug connector, Qty: 6								470 352	C10			
All engines	->year 30/09/02, incl. spark plug connector, Qty: 6								470 413	C10			
All engines	01/10/02 ->, Qty: 6								470 475	C10			
325 Ci	Petrol	141	09/00-08/06	ENGINE 4CSS, M54 B25 (256S5), M54B256S5									
Engine	Information			A10	A20	A40	A50	A70	C10 - C30	C20	E01		
Eng. 4CSS, M54B256S5	x 6, BOSCH, BREMI, COIL ON PLUG, incl. spark plug connector								470 352	C10			
Eng. M54 B25 (256S5)	->year 30/09/02, without spark plug connector, Qty: 6								470 352	C10			
Eng. M54 B25 (256S5)	->year 30/09/02, incl. spark plug connector, Qty: 6								470 413	C10			
Eng. 4CSS, M54B256S5	01/10/02 ->, x 6, DELPHI, COIL ON PLUG								470 475	C10			
Eng. M54 B25 (256S5)	01/10/02 ->, Qty: 6								470 475	C10			
325 i	Petrol	137	01/01->	ENGINE M56256S6									
Engine	Information			A10	A20	A40	A50	A70	C10 - C30	C20	E01		
All engines	->year 30/09/02, without spark plug connector, Qty: 6								470 352	C10			
All engines	->year 30/09/02, incl. spark plug connector, Qty: 6								470 413	C10			
All engines	01/10/02 ->, Qty: 6								470 475	C10			
325 i	Petrol	141	09/00->	ENGINE - (24 6 S4), M54 B25 (256S5), M54B256S5									
Engine	Information			A10	A20	A40	A50	A70	C10 - C30	C20	E01		
Eng. - (24 6 S4), M54 B25 (256S5)	->year 30/09/02, without spark plug connector, Qty: 6								470 352	C10			
Eng. M54B256S5	->year 01/09/02, x 6, BREMI, COIL ON PLUG								470 352	C10			
Eng. - (24 6 S4), M54 B25 (256S5)	->year 30/09/02, incl. spark plug connector, Qty: 6								470 413	C10			
Eng. - (24 6 S4), M54 B25 (256S5)	01/10/02 ->, Qty: 6								470 475	C10			
Eng. M54B256S5	01/10/02 ->, x 6, DELPHI, COIL ON PLUG								470 475	C10			
325 ti	Petrol	141	04/01-12/04	ENGINE M54 B25 (256S5), M54B256S5									
Engine	Information			A10	A20	A40	A50	A70	C10 - C30	C20	E01		
Eng. M54 B25 (256S5)	->year 30/09/02, without spark plug connector, Qty: 6								470 352	C10			

A10	CONDENSER	A20	CONTACT SET	A40	DISTRIBUTOR CAP	A50	ROTOR	A70	PICK-UP
C10	COIL	C20	IGNITION MODULE	C30	ELECTRONIC IGNITION KIT	E01	IGNITION CABLE SET		

The present application list is a brief version. For the detailed information about the possibility of installation on a specific vehicle, please refer to our web-catalogue <http://catalogo.facet.eu/>

FUNCTIONS ON THE VEHICLE

Vehicle	alim.	kW	Date	Engine	 A10	 A20	 A40	 A50	 A70	 C10 - C30	 C20	 E01
---------	-------	----	------	--------	---	---	---	--	---	---	---	---

ENGINE				
325 ti	Petrol	141	04/01-12/04	M54 B25 (256S5), M54B256S5

Engine	Information	A10	A20	A40	A50	A70	C10 - C30	C20	E01
Eng. M54B256S5	x 6, BOSCH, BREMI, COIL ON PLUG, incl. spark plug connector						470 352	C10	
Eng. M54 B25 (256S5)	->year 30/09/02, incl. spark plug connector, Qty: 6						470 413	C10	
Eng. M54 B25 (256S5)	01/10/02 ->, Qty: 6						470 475	C10	
Eng. M54B256S5	01/10/02 ->, x 6, DELPHI, COIL ON PLUG						470 475	C10	

ENGINE				
325 xi	Petrol	141	09/00-02/05	M54 B25 (256S5), M54B256S5

Engine	Information	A10	A20	A40	A50	A70	C10 - C30	C20	E01
Eng. M54 B25 (256S5)	->year 30/09/02, without spark plug connector, Qty: 6						470 352	C10	
Eng. M54B256S5	->year 01/09/02, x 6, BREMI, COIL ON PLUG						470 352	C10	
Eng. M54 B25 (256S5)	->year 30/09/02, incl. spark plug connector, Qty: 6						470 413	C10	
Eng. M54 B25 (256S5)	01/10/02 ->, Qty: 6						470 475	C10	
Eng. M54B256S5	01/10/02 ->, x 6, DELPHI, COIL ON PLUG						470 475	C10	

ENGINE				
328 Ci	Petrol	142	12/98-05/00	M52 B28 (286S2), M52B286S2

Engine	Information	A10	A20	A40	A50	A70	C10 - C30	C20	E01
Eng. M52 B28 (286S2)	without spark plug connector, Qty: 6						470 352	C10	
Eng. M52B286S2	x 6, BOSCH, BREMI, COIL ON PLUG, incl. spark plug connector						470 352	C10	
Eng. M52 B28 (286S2)	incl. spark plug connector, Qty: 6						470 413	C10	

ENGINE				
328 i	Petrol	142	02/98-06/00	1LGX, M52 B28 (286S2), M52B286S2

Engine	Information	A10	A20	A40	A50	A70	C10 - C30	C20	E01
Eng. 1LGX, M52B286S2	x 6, BOSCH, BREMI, COIL ON PLUG, incl. spark plug connector						470 352	C10	
Eng. M52 B28 (286S2)	without spark plug connector, Qty: 6						470 352	C10	
Eng. M52 B28 (286S2)	incl. spark plug connector, Qty: 6						470 413	C10	

ENGINE				
330 Ci	Petrol	170	06/00-08/06	7ACR, M54 B30 (306S3), M54B306S3

Engine	Information	A10	A20	A40	A50	A70	C10 - C30	C20	E01
Eng. 7ACR, M54B306S3	x 6, BOSCH, BREMI, COIL ON PLUG, incl. spark plug connector						470 352	C10	
Eng. M54 B30 (306S3)	->year 30/09/02, without spark plug connector, Qty: 6						470 352	C10	
Eng. M54 B30 (306S3)	->year 30/09/02, incl. spark plug connector, Qty: 6						470 413	C10	
Eng. 7ACR, M54B306S3	01/10/02 ->, x 6, DELPHI, COIL ON PLUG						470 475	C10	
Eng. M54 B30 (306S3)	01/10/02 ->, Qty: 6						470 475	C10	

ENGINE				
330 i	Petrol	168	01/01-04/05	M54B306S3

Engine	Information	A10	A20	A40	A50	A70	C10 - C30	C20	E01
All engines	->year 01/09/02, x 6, BREMI, COIL ON PLUG						470 352	C10	
All engines	01/10/02 ->, x 6, DELPHI, COIL ON PLUG						470 475	C10	

ENGINE				
330 i	Petrol	170	06/00-02/05	M54 B30 (306S3), M54B306S3

Engine	Information	A10	A20	A40	A50	A70	C10 - C30	C20	E01
Eng. M54 B30 (306S3)	->year 30/09/02, without spark plug connector, Qty: 6						470 352	C10	
Eng. M54B306S3	->year 01/09/02, x 6, BREMI, COIL ON PLUG						470 352	C10	
Eng. M54 B30 (306S3)	->year 30/09/02, incl. spark plug connector, Qty: 6						470 413	C10	
Eng. M54 B30 (306S3)	01/10/02 ->, Qty: 6						470 475	C10	
Eng. M54B306S3	01/10/02 ->, x 6, DELPHI, COIL ON PLUG						470 475	C10	

ENGINE				
330 xi	Petrol	170	06/00-07/06	M54 B30 (306S3), M54B306S3









Engine	Information	A10	A20	A40	A50	A70	C10 - C30	C20	E01
Eng. M54 B30 (306S3)	->year 30/09/02, without spark plug connector, Qty: 6						470 352	C10	
Eng. M54B306S3	->year 01/09/02, x 6, BREMI, COIL ON PLUG						470 352	C10	
Eng. M54 B30 (306S3)	->year 30/09/02, incl. spark plug connector, Qty: 6						470 413	C10	
Eng. M54 B30 (306S3)	01/10/02 ->, Qty: 6						470 475	C10	
Eng. M54B306S3	01/10/02 ->, x 6, DELPHI, COIL ON PLUG						470 475	C10	

A10 CONDENSER	A20 CONTACT SET	A40 DISTRIBUTOR CAP	A50 ROTOR	A70 PICK-UP
C10 COIL	C20 IGNITION MODULE	C30 ELECTRONIC IGNITION KIT	E01 IGNITION CABLE SET	

Vehicle	alim.	kW	Date	Engine	FUNCTIONS ON THE VEHICLE								
					A10	A20	A40	A50	A70	C10 - C30	C20	E01	
ENGINE													
M3	Petrol	252	07/00-08/06	S54 B32 (326S4), S54B326S4									
Engine	Information				A10	A20	A40	A50	A70	C10 - C30	C20	E01	
Eng. S54 B32 (326S4)	Qty: 6									470 475	C10		
Eng. S54B326S4	x 6, BREMI, DELPHI, ELDOR, COIL ON PLUG									470 475	C10		
ENGINE													
M3 CSL	Petrol	265	05/03-12/03	S54 B32 (326S4), S54B326S4									
Engine	Information				A10	A20	A40	A50	A70	C10 - C30	C20	E01	
Eng. S54 B32 (326S4)	Qty: 6									470 475	C10		
Eng. S54B326S4	x 6, BREMI, DELPHI, ELDOR, COIL ON PLUG									470 475	C10		
3 SERIES													
ENGINE													
325i xDrive	Petrol	160	09/08-10/11	N52 B25 A									
Engine	Information				A10	A20	A40	A50	A70	C10 - C30	C20	E01	
All engines	x 6, DELPHI, COIL ON PLUG									470 475	C10		
3 V													
ENGINE													
316 i	Petrol	85	09/05-10/11	N45 B16 A									
Engine	Information				A10	A20	A40	A50	A70	C10 - C30	C20	E01	
All engines	x 4, DELPHI, ELDOR, COIL ON PLUG									470 475	C10		
ENGINE													
316 i	Petrol	90	09/07-06/13	N43 B16 A, N43 B16 AA									
Engine	Information				A10	A20	A40	A50	A70	C10 - C30	C20	E01	
All engines	x 4, BOSCH, COIL ON PLUG									470 607	C10		
ENGINE													
318 i	Petrol	100	09/07-03/12	N43 B20 A, N46 B20 B									
Engine	Information				A10	A20	A40	A50	A70	C10 - C30	C20	E01	
Eng. N46 B20 B	Qty: 4									470 475	C10		
Eng. N46 B20 B	x 4, DELPHI, COIL ON PLUG									470 475	C10		
Eng. N43 B20 A	x 4, BOSCH, COIL ON PLUG									470 607	C10		
ENGINE													
318 i	Petrol	105	05/07-12/13	N43 B20 A									
Engine	Information				A10	A20	A40	A50	A70	C10 - C30	C20	E01	
All engines	x 4, BOSCH, COIL ON PLUG									470 607	C10		
ENGINE													
318 i	Petrol	95	09/05-08/07	N46 B20 B									
Engine	Information				A10	A20	A40	A50	A70	C10 - C30	C20	E01	
All engines	x 4, DELPHI, COIL ON PLUG									470 475	C10		
ENGINE													
320 i	Petrol	110	12/04-06/12	N46 B20 A, N46 B20 B, N46 B20 C, N46 B20 CB									
Engine	Information				A10	A20	A40	A50	A70	C10 - C30	C20	E01	
Eng. N46 B20 A	Qty: 4									470 475	C10		
Eng. N46 B20 B, N46 B20 C, N46 B20 CB	x 4, DELPHI, COIL ON PLUG									470 475	C10		
ENGINE													
320 i	Petrol	115	09/05-12/13	N43 B20 A, N46 B20 B, N46 B20 C									
Engine	Information				A10	A20	A40	A50	A70	C10 - C30	C20	E01	
Eng. N46 B20 B, N46 B20 C	x 4, DELPHI, COIL ON PLUG									470 475	C10		
Eng. N43 B20 A	x 4, BOSCH, COIL ON PLUG									470 607	C10		
ENGINE													
320 i	Petrol	120	09/06-12/13	N43 B20 A									
Engine	Information				A10	A20	A40	A50	A70	C10 - C30	C20	E01	
All engines	x 4, BOSCH, COIL ON PLUG									470 607	C10		
ENGINE													
320 i	Petrol	125	02/07-12/13	N43 B20 A									
Engine	Information				A10	A20	A40	A50	A70	C10 - C30	C20	E01	
All engines	x 4, BOSCH, COIL ON PLUG									470 607	C10		

A10	CONDENSER	A20	CONTACT SET	A40	DISTRIBUTOR CAP	A50	ROTOR	A70	PICK-UP
C10	COIL	C20	IGNITION MODULE	C30	ELECTRONIC IGNITION KIT	E01	IGNITION CABLE SET		









The present application list is a brief version. For the detailed information about the possibility of installation on a specific vehicle, please refer to our web-catalogue <http://catalogo.facet.eu/>

					FUNCTIONS ON THE VEHICLE									
Vehicle	alim.	kW	Date	Engine	 A10	 A20	 A40	 A50	 A70	 C10 - C30	 C20	 E01		
ENGINE														
320 si	Petrol	127	09/05-08/06	N45 B20 A										
ENGINE														
Engine		Information			A10	A20	A40	A50	A70	C10 - C30	C20	E01		
All engines		x 4, DELPHI, ELDOR, COIL ON PLUG								470 475	C10			
ENGINE														
323 i	Petrol	130	09/05->	N52 B25 A, N52 B25 B, N52 B25 BE, N52 B25 BF, N52B25B, N52B25BE, N52N B25 A, N52NB-25BF										
ENGINE														
Engine		Information			A10	A20	A40	A50	A70	C10 - C30	C20	E01		
Eng. N52 B25 A, N52 B25 B, N52 B25 BE, N52 B25 BF		x 6, BOSCH, DELPHI, COIL ON PLUG								470 475	C10			
Eng. N52 B25 A, N52B25B, N52B25BE, N52N B25 A, N52NB25BF		Qty: 6, Qty: 6								470 475	C10			
ENGINE														
323 i	Petrol	140	04/06-02/12	N52 B25 A, N52 B25 BF										
ENGINE														
Engine		Information			A10	A20	A40	A50	A70	C10 - C30	C20	E01		
All engines		x 6, DELPHI, ELDOR, COIL ON PLUG								470 475	C10			
ENGINE														
325 i	Petrol	150	05/05-10/13	N52 B25 A, N52 B25 AF, N52 B25 BF										
ENGINE														
Engine		Information			A10	A20	A40	A50	A70	C10 - C30	C20	E01		
All engines		x 6, DELPHI, COIL ON PLUG								470 475	C10			
Eng. N52 B25 A		Qty: 6								470 475	C10			
ENGINE														
325 i	Petrol	155	12/04-12/13	N52 B25 A, N52 B25 AF, N52 B25 BF, N53 B30 A										
ENGINE														
Engine		Information			A10	A20	A40	A50	A70	C10 - C30	C20	E01		
Eng. N52 B25 A, N52 B25 AF, N52 B25 BF		x 6, DELPHI, x 6, BOSCH, COIL ON PLUG, DELPHI, x 6, BOSCH, COIL ON PLUG, DELPHI, COIL ON PLUG								470 475	C10			
Eng. N52 B25 A		x 6, DELPHI, COIL ON PLUG								470 475	C10			
Eng. N53 B30 A		x 6, BOSCH, COIL ON PLUG								470 607	C10			
ENGINE														
325 i	Petrol	160	12/04->	N52 B25 A, N52 B25 AF, N52 B25 B, N52 B25 BF, N52B25B, N53 B30 A										
ENGINE														
Engine		Information			A10	A20	A40	A50	A70	C10 - C30	C20	E01		
Eng. N52 B25 A, N52 B25 AF, N52 B25 B, N52 B25 BF		x 6, DELPHI, x 6, BOSCH, COIL ON PLUG, DELPHI, COIL ON PLUG								470 475	C10			
Eng. N52 B25 BF, N52B25B		Qty: 6								470 475	C10			
Eng. N53 B30 A		x 6, BOSCH, COIL ON PLUG								470 607	C10			
ENGINE														
325 i xDrive	Petrol	150	03/10-04/13	N52 B25 A										
ENGINE														
Engine		Information			A10	A20	A40	A50	A70	C10 - C30	C20	E01		
All engines		x 6, DELPHI, ELDOR, COIL ON PLUG								470 475	C10			
ENGINE														
325 i xDrive	Petrol	155	09/08-06/13	N53 B30 A										
ENGINE														
Engine		Information			A10	A20	A40	A50	A70	C10 - C30	C20	E01		
All engines		x 6, BOSCH, COIL ON PLUG								470 607	C10			
ENGINE														
325 i xDrive	Petrol	160	09/08-12/13	N53 B30 A										
ENGINE														
Engine		Information			A10	A20	A40	A50	A70	C10 - C30	C20	E01		
All engines		x 6, BOSCH, COIL ON PLUG								470 607	C10			
ENGINE														
325 xi	Petrol	155	09/07-08/08	N53 B30 A										
ENGINE														
Engine		Information			A10	A20	A40	A50	A70	C10 - C30	C20	E01		
All engines		x 6, BOSCH, COIL ON PLUG								470 607	C10			
ENGINE														
325 xi	Petrol	160	01/05->	N52 B25 A, N52 B30 A, N53 B30 A										
ENGINE														
Engine		Information			A10	A20	A40	A50	A70	C10 - C30	C20	E01		
Eng. N52 B25 A		x 6, DELPHI, x 6, BOSCH, COIL ON PLUG, DELPHI, COIL ON PLUG								470 475	C10			
Eng. N52 B30 A		x 6, BOSCH, DELPHI, COIL ON PLUG								470 475	C10			
Eng. N53 B30 A		Qty: 6								470 475	C10			
A10	CONDENSER		A20	CONTACT SET		A40	DISTRIBUTOR CAP		A50	ROTOR		A70	PICK-UP	
C10	COIL		C20	IGNITION MODULE		C30	ELECTRONIC IGNITION KIT		E01	IGNITION CABLE SET				

Vehicle	alim.	kW	Date	Engine	FUNCTIONS ON THE VEHICLE									
					A10	A20	A40	A50	A70	C10 - C30	C20	E01		
ENGINE														
325 xi	Petrol	160	01/05->	N52 B25 A, N52 B30 A, N53 B30 A										
Engine	Information				A10	A20	A40	A50	A70	C10 - C30	C20	E01		
Eng. N53 B30 A	x 6, BOSCH, COIL ON PLUG									470 607	C10			
ENGINE														
328 i	Petrol	172	06/06->	N51 B30 A, N52 B30 A										
Engine	Information				A10	A20	A40	A50	A70	C10 - C30	C20	E01		
All engines	Qty: 6									470 475	C10			
Eng. N51 B30 A	x 6, DELPHI, COIL ON PLUG									470 475	C10			
ENGINE														
328 i	Petrol	187	07/05-11/07	N52N B30 A										
Engine	Information				A10	A20	A40	A50	A70	C10 - C30	C20	E01		
All engines	Qty: 6									470 475	C10			
ENGINE														
328 xi	Petrol	172	09/06->	N51 B30 A, N52 B30 A										
Engine	Information				A10	A20	A40	A50	A70	C10 - C30	C20	E01		
All engines	Qty: 6									470 475	C10			
ENGINE														
330 i	Petrol	190	12/04-10/13	N52 B30 A, N52 B30 BF										
Engine	Information				A10	A20	A40	A50	A70	C10 - C30	C20	E01		
All engines	x 6, DELPHI, x 6, BOSCH, COIL ON PLUG, DELPHI, COIL ON PLUG									470 475	C10			
ENGINE														
330 i	Petrol	200	09/06-10/13	N52 B30 A, N52 B30 B, N52 B30 BF, N53 B30 A										
Engine	Information				A10	A20	A40	A50	A70	C10 - C30	C20	E01		
Eng. N52 B30 A, N52 B30 BF, N53 B30 A	-eng. N53B30A, x 6, DELPHI, x 6, COIL ON PLUG, DELPHI, COIL ON PLUG									470 475	C10			
Eng. N52 B30 B	Qty: 6									470 475	C10			
Eng. N52 B30 A, N52 B30 BF, N53 B30 A	x 6, BOSCH, x 6, BOSCH, COIL ON PLUG, COIL ON PLUG									470 607	C10			
ENGINE														
330 i xDrive	Petrol	200	09/07-06/13	N53 B30 A										
Engine	Information				A10	A20	A40	A50	A70	C10 - C30	C20	E01		
All engines	->year 01/12/08, x 6, BOSCH, x 6, BOSCH, COIL ON PLUG, COIL ON PLUG ----- 01/04/12->, x 6, BOSCH, COIL ON PLUG									470 607	C10			
ENGINE														
330 xi	Petrol	190	09/05-08/07	N52 B30 A										
Engine	Information				A10	A20	A40	A50	A70	C10 - C30	C20	E01		
All engines	x 6, DELPHI, x 6, BOSCH, COIL ON PLUG, DELPHI, COIL ON PLUG									470 475	C10			
ENGINE														
330 xi	Petrol	200	09/06-06/12	N52 B30 A, N53 B30 A										
Engine	Information				A10	A20	A40	A50	A70	C10 - C30	C20	E01		
Eng. N52 B30 A	x 6, DELPHI, ELDOR, COIL ON PLUG									470 475	C10			
Eng. N53 B30 A	x 6, BOSCH, x 6, BOSCH, COIL ON PLUG, COIL ON PLUG									470 607	C10			
ENGINE														
335 i	Petrol	220	03/06-12/11	N54 B30 A, N55 B30 A										
Engine	Information				A10	A20	A40	A50	A70	C10 - C30	C20	E01		
All engines	x 6, DELPHI, ELDOR, COIL ON PLUG									470 475	C10			
ENGINE														
335 i	Petrol	224	03/06-12/11	N54 B30 A, N55 B30 A										
Engine	Information				A10	A20	A40	A50	A70	C10 - C30	C20	E01		
All engines	x 6, DELPHI, ELDOR, COIL ON PLUG									470 475	C10			
ENGINE														
335 i	Petrol	225	06/06-10/13	N54 B30 A, N54 B30 B, N55 B30 A										
Engine	Information				A10	A20	A40	A50	A70	C10 - C30	C20	E01		
Eng. N54 B30 A, N55 B30 A	x 6, DELPHI, ELDOR, COIL ON PLUG									470 475	C10			
Eng. N54 B30 B	Qty: 6									470 475	C10			

A10	CONDENSER	A20	CONTACT SET	A40	DISTRIBUTOR CAP	A50	ROTOR	A70	PICK-UP
C10	COIL	C20	IGNITION MODULE	C30	ELECTRONIC IGNITION KIT	E01	IGNITION CABLE SET		

The present application list is a brief version. For the detailed information about the possibility of installation on a specific vehicle, please refer to our web-catalogue <http://catalogo.facet.eu/>

					FUNCTIONS ON THE VEHICLE							
Vehicle	alim.	kW	Date	Engine								
ENGINE												
335 i	Petrol	240	03/06-10/13	N54 B30 A, N55 B30 A								
Engine	Information				A10	A20	A40	A50	A70	C10 - C30	C20	E01
All engines	x 6, DELPHI, ELDOR, COIL ON PLUG									470 475	C10	
ENGINE												
335 i xDrive	Petrol	224	05/08-06/13	N54 B30 A, N55 B30 A								
Engine	Information				A10	A20	A40	A50	A70	C10 - C30	C20	E01
All engines	x 6, DELPHI, ELDOR, x 6, COIL ON PLUG, DELPHI, COIL ON PLUG									470 475	C10	
ENGINE												
335 i xDrive	Petrol	225	09/08-12/13	N54 B30 A, N55 B30 A								
Engine	Information				A10	A20	A40	A50	A70	C10 - C30	C20	E01
All engines	x 6, DELPHI, ELDOR, COIL ON PLUG									470 475	C10	
ENGINE												
335 i xDrive	Petrol	240	05/08-06/13	N54 B30 A, N55 B30 A								
Engine	Information				A10	A20	A40	A50	A70	C10 - C30	C20	E01
All engines	x 6, DELPHI, ELDOR, COIL ON PLUG									470 475	C10	
ENGINE												
335 xi	Petrol	224	09/06-06/08	N54 B30 A, N55 B30 A								
Engine	Information				A10	A20	A40	A50	A70	C10 - C30	C20	E01
All engines	x 6, ELDOR, x 6, COIL ON PLUG, DELPHI, COIL ON PLUG									470 475	C10	
ENGINE												
335 xi	Petrol	225	03/07-02/10	N54 B30 A, N55 B30 A								
Engine	Information				A10	A20	A40	A50	A70	C10 - C30	C20	E01
Eng. N54 B30 A	x 6, DELPHI, ELDOR, COIL ON PLUG									470 475	C10	
Eng. N55 B30 A	Qty: 6									470 475	C10	
ENGINE												
335 xi	Petrol	240	09/06-02/10	N54 B30 A, N55 B30 A								
Engine	Information				A10	A20	A40	A50	A70	C10 - C30	C20	E01
All engines	x 6, DELPHI, ELDOR, x 6, COIL ON PLUG, DELPHI, ELDOR, COIL ON PLUG									470 475	C10	
3 VI												
ENGINE												
316 i	Petrol	100	07/12-08/16	N13 B16 A								
Engine	Information				A10	A20	A40	A50	A70	C10 - C30	C20	E01
All engines	x 4, DELPHI, COIL ON PLUG									470 475	C10	
ENGINE												
316 Li [CHN]	Petrol	100	10/12->	N13 B16 A								
Engine	Information				A10	A20	A40	A50	A70	C10 - C30	C20	E01
All engines	Qty: 4									470 475	C10	
ENGINE												
318 i	Petrol	100	07/15-06/19	B38 B15 A								
Engine	Information				A10	A20	A40	A50	A70	C10 - C30	C20	E01
All engines	x 3, COIL ON PLUG									470 632	C10	
ENGINE												
320 i	Petrol	120	11/12->	B48 B20 A, N20 B20 A, N20 B20 B								
Engine	Information				A10	A20	A40	A50	A70	C10 - C30	C20	E01
Eng. N20 B20 A, N20 B20 B	x 4, DELPHI, COIL ON PLUG									470 475	C10	
Eng. N20 B20 B	Qty: 4									470 475	C10	
Eng. B48 B20 A	x 4, COIL ON PLUG									470 632	C10	
ENGINE												
320 i	Petrol	125	11/12-06/16	N13 B16 A								
Engine	Information				A10	A20	A40	A50	A70	C10 - C30	C20	E01
All engines	x 4, DELPHI, COIL ON PLUG									470 475	C10	
ENGINE												
320 i	Petrol	135	03/12->	B48 B20 A, N20 B20 A, N20 B20 B								
Engine	Information				A10	A20	A40	A50	A70	C10 - C30	C20	E01
Eng. N20 B20 A, N20 B20 B	x 4, DELPHI, COIL ON PLUG									470 475	C10	
Eng. B48 B20 A	x 4, COIL ON PLUG									470 632	C10	

A10 CONDENSER	A20 CONTACT SET	A40 DISTRIBUTOR CAP	A50 ROTOR	A70 PICK-UP
C10 COIL	C20 IGNITION MODULE	C30 ELECTRONIC IGNITION KIT	E01 IGNITION CABLE SET	

Vehicle	alim.	kW	Date	Engine	FUNCTIONS ON THE VEHICLE								
					A10	A20	A40	A50	A70	C10 - C30	C20	E01	
320 i xDrive	Petrol	120	03/13->	ENGINE B48 B20 A, N20 B20 A, N20 B20 B									
Engine	Information				A10	A20	A40	A50	A70	C10 - C30	C20	E01	
Eng. N20 B20 A, N20 B20 B	x 4, DELPHI, COIL ON PLUG									470 475	C10		
Eng. N20 B20 B	Qty: 4									470 475	C10		
Eng. B48 B20 A	x 4, COIL ON PLUG									470 632	C10		
320 i xDrive	Petrol	135	07/12->	ENGINE B48 B20 A, N20 B20 A, N20 B20 B									
Engine	Information				A10	A20	A40	A50	A70	C10 - C30	C20	E01	
Eng. N20 B20 A, N20 B20 B	x 4, DELPHI, COIL ON PLUG									470 475	C10		
Eng. N20 B20 B	Qty: 4									470 475	C10		
Eng. B48 B20 A	x 4, COIL ON PLUG									470 632	C10		
320 Li [CHN]	Petrol	0	02/12->	ENGINE --									
Engine	Information				A10	A20	A40	A50	A70	C10 - C30	C20	E01	
All engines	Qty: 4									470 475	C10		
328 i	Petrol	180	11/11-10/18	ENGINE N20 B20 A, N26 B20 A									
Engine	Information				A10	A20	A40	A50	A70	C10 - C30	C20	E01	
All engines	x 4, DELPHI, COIL ON PLUG									470 475	C10		
Eng. N26 B20 A	Qty: 4									470 475	C10		
328 i xDrive	Petrol	180	07/12-08/16	ENGINE N20 B20 A, N26 B20 A									
Engine	Information				A10	A20	A40	A50	A70	C10 - C30	C20	E01	
Eng. N20 B20 A	x 4, DELPHI, COIL ON PLUG									470 475	C10		
Eng. N26 B20 A	Qty: 4									470 475	C10		
328 i xDrive [USA]	Petrol	0	10/11->	ENGINE --									
Engine	Information				A10	A20	A40	A50	A70	C10 - C30	C20	E01	
All engines	Qty: 4									470 475	C10		
328 Li [CHN]	Petrol	180	10/11->	ENGINE N20 B20 A									
Engine	Information				A10	A20	A40	A50	A70	C10 - C30	C20	E01	
All engines	Qty: 4									470 475	C10		
328 Li xDrive [CHN]	Petrol	0	10/11->	ENGINE --									
Engine	Information				A10	A20	A40	A50	A70	C10 - C30	C20	E01	
All engines	Qty: 4									470 475	C10		
328i	Petrol	160	11/11-06/15	ENGINE N20 B20 A									
Engine	Information				A10	A20	A40	A50	A70	C10 - C30	C20	E01	
All engines	x 4, DELPHI, COIL ON PLUG									470 475	C10		
330 e	Petrol/ Electric	135	11/15-10/18	ENGINE B48 B20 A									
Engine	Information				A10	A20	A40	A50	A70	C10 - C30	C20	E01	
All engines	x 4, COIL ON PLUG									470 632	C10		
330 e	Petrol/ Electric	185	11/15-10/18	ENGINE B48 B20 A									
Engine	Information				A10	A20	A40	A50	A70	C10 - C30	C20	E01	
All engines	x 4, COIL ON PLUG									470 632	C10		
330 i	Petrol	185	07/15->	ENGINE B46 B20 B, B48 B20 B									
Engine	Information				A10	A20	A40	A50	A70	C10 - C30	C20	E01	
All engines	x 4, COIL ON PLUG									470 632	C10		
330 i xDrive	Petrol	183	07/16->	ENGINE B48 B20 B									
Engine	Information				A10	A20	A40	A50	A70	C10 - C30	C20	E01	
All engines	x 4, COIL ON PLUG									470 632	C10		

A10 CONDENSER	A20 CONTACT SET	A40 DISTRIBUTOR CAP	A50 ROTOR	A70 PICK-UP
C10 COIL	C20 IGNITION MODULE	C30 ELECTRONIC IGNITION KIT	E01 IGNITION CABLE SET	

The present application list is a brief version. For the detailed information about the possibility of installation on a specific vehicle, please refer to our web-catalogue <http://catalogo.facet.eu/>









Vehicle	alim.	kW	Date	Engine	FUNCTIONS ON THE VEHICLE								
					A10	A20	A40	A50	A70	C10 - C30	C20	E01	
330 i xDrive	Petrol	185	07/15->	ENGINE B48 B20 B									
Engine	Information				A10	A20	A40	A50	A70	C10 - C30	C20	E01	
All engines	x 4, COIL ON PLUG									470 632	C10		
335 i	Petrol	225	11/11-06/16	ENGINE N55 B30 A									
Engine	Information				A10	A20	A40	A50	A70	C10 - C30	C20	E01	
All engines	x 6, DELPHI, COIL ON PLUG									470 475	C10		
335 i	Petrol	240	11/11-03/14	ENGINE N55 B30 A									
Engine	Information				A10	A20	A40	A50	A70	C10 - C30	C20	E01	
All engines	x 6, DELPHI, COIL ON PLUG									470 475	C10		
335 i	Petrol	250	07/13-06/16	ENGINE N55 B30 A									
Engine	Information				A10	A20	A40	A50	A70	C10 - C30	C20	E01	
All engines	x 6, DELPHI, COIL ON PLUG									470 475	C10		
335 i xDrive	Petrol	225	07/12-06/16	ENGINE N55 B30 A									
Engine	Information				A10	A20	A40	A50	A70	C10 - C30	C20	E01	
All engines	x 6, DELPHI, COIL ON PLUG									470 475	C10		
335 i xDrive	Petrol	240	07/12-03/14	ENGINE N55 B30 A									
Engine	Information				A10	A20	A40	A50	A70	C10 - C30	C20	E01	
All engines	x 6, DELPHI, COIL ON PLUG									470 475	C10		
335 i xDrive	Petrol	250	07/13-06/16	ENGINE N55 B30 A									
Engine	Information				A10	A20	A40	A50	A70	C10 - C30	C20	E01	
All engines	x 6, DELPHI, COIL ON PLUG									470 475	C10		
340 i	Petrol	240	07/15->	ENGINE B58 B30 A									
Engine	Information				A10	A20	A40	A50	A70	C10 - C30	C20	E01	
All engines	x 6, COIL ON PLUG									470 632	C10		
340 i	Petrol	265	07/15->	ENGINE B58 B30 A									
Engine	Information				A10	A20	A40	A50	A70	C10 - C30	C20	E01	
All engines	x 6, COIL ON PLUG									470 632	C10		
340 i xDrive	Petrol	240	07/15->	ENGINE B58 B30 A									
Engine	Information				A10	A20	A40	A50	A70	C10 - C30	C20	E01	
All engines	x 6, COIL ON PLUG									470 632	C10		
340 i xDrive	Petrol	265	07/15->	ENGINE B58 B30 A									
Engine	Information				A10	A20	A40	A50	A70	C10 - C30	C20	E01	
All engines	x 6, COIL ON PLUG									470 632	C10		
ActiveHybrid	Petrol/ Electric	225	07/12-06/15	ENGINE N55 B30 A									
Engine	Information				A10	A20	A40	A50	A70	C10 - C30	C20	E01	
All engines	x 6, DELPHI, COIL ON PLUG									470 475	C10		
ActiveHybrid	Petrol/ Electric	250	07/12-06/15	ENGINE N55 B30 A									
Engine	Information				A10	A20	A40	A50	A70	C10 - C30	C20	E01	
All engines	x 6, DELPHI, COIL ON PLUG									470 475	C10		
M3	Petrol	317	03/14-10/18	ENGINE S55 B30 A									
Engine	Information				A10	A20	A40	A50	A70	C10 - C30	C20	E01	
All engines	x 6, DELPHI, COIL ON PLUG									470 475	C10		

A10 CONDENSER	A20 CONTACT SET	A40 DISTRIBUTOR CAP	A50 ROTOR	A70 PICK-UP
C10 COIL	C20 IGNITION MODULE	C30 ELECTRONIC IGNITION KIT	E01 IGNITION CABLE SET	

Vehicle	alim.	kW	Date	Engine	FUNCTIONS ON THE VEHICLE								
					A10	A20	A40	A50	A70	C10 - C30	C20	E01	
M3 Competition					ENGINE								
Petrol	331	03/16-10/18	S55 B30 A										
Engine	Information				A10	A20	A40	A50	A70	C10 - C30	C20	E01	
All engines	x 6, DELPHI, COIL ON PLUG									470 475	C10		
M3 CS					ENGINE								
Petrol	338	01/18-10/18	S55 B30 A										
Engine	Information				A10	A20	A40	A50	A70	C10 - C30	C20	E01	
All engines	x 6, DELPHI, COIL ON PLUG									470 475	C10		
3 VII					ENGINE								
318 i					ENGINE								
Petrol	115	03/20->	B48 B20 A										
Engine	Information				A10	A20	A40	A50	A70	C10 - C30	C20	E01	
All engines	x 4, COIL ON PLUG									470 632	C10		
320 e Plug-in-Hybrid					ENGINE								
Petrol/ Electric	120	07/20->	B48 B20 A										
Engine	Information				A10	A20	A40	A50	A70	C10 - C30	C20	E01	
All engines	x 4, COIL ON PLUG									470 632	C10		
320 e Plug-in-Hybrid					ENGINE								
Petrol/ Electric	150	07/20->	B48 B20 A										
Engine	Information				A10	A20	A40	A50	A70	C10 - C30	C20	E01	
All engines	x 4, COIL ON PLUG									470 632	C10		
320 e Plug-in-Hybrid xDrive					ENGINE								
Petrol/ Electric	120	03/21->	B48 B20 A										
Engine	Information				A10	A20	A40	A50	A70	C10 - C30	C20	E01	
All engines	x 4, COIL ON PLUG									470 632	C10		
320 e Plug-in-Hybrid xDrive					ENGINE								
Petrol/ Electric	150	03/21->	B48 B20 A										
Engine	Information				A10	A20	A40	A50	A70	C10 - C30	C20	E01	
All engines	x 4, COIL ON PLUG									470 632	C10		
320 i					ENGINE								
Petrol	135	03/19->	B46 B20 B, B48 B20 A, B48 B20 B										
Engine	Information				A10	A20	A40	A50	A70	C10 - C30	C20	E01	
All engines	x 4, COIL ON PLUG									470 632	C10		
320 i 1.6					ENGINE								
Petrol	125	03/19->	B48 B16 A										
Engine	Information				A10	A20	A40	A50	A70	C10 - C30	C20	E01	
All engines	x 4, COIL ON PLUG									470 632	C10		
320 i xDrive					ENGINE								
Petrol	135	07/19->	B48 B20 A										
Engine	Information				A10	A20	A40	A50	A70	C10 - C30	C20	E01	
All engines	x 4, COIL ON PLUG									470 632	C10		
330 e Plug-in-Hybrid					ENGINE								
Petrol/ Electric	135	07/19->	B46 B20 B, B48 B20 A										
Engine	Information				A10	A20	A40	A50	A70	C10 - C30	C20	E01	
All engines	x 4, COIL ON PLUG									470 632	C10		
330 e Plug-in-Hybrid					ENGINE								
Petrol/ Electric	185	07/19-02/20	B46 B20 B, B48 B20 A										
Engine	Information				A10	A20	A40	A50	A70	C10 - C30	C20	E01	
All engines	x 4, COIL ON PLUG									470 632	C10		
330 e Plug-in-Hybrid					ENGINE								
Petrol/ Electric	215	03/20->	B46 B20 B, B48 B20 A										
Engine	Information				A10	A20	A40	A50	A70	C10 - C30	C20	E01	
All engines	x 4, COIL ON PLUG									470 632	C10		

A10 CONDENSER	A20 CONTACT SET	A40 DISTRIBUTOR CAP	A50 ROTOR	A70 PICK-UP
C10 COIL	C20 IGNITION MODULE	C30 ELECTRONIC IGNITION KIT	E01 IGNITION CABLE SET	

The present application list is a brief version. For the detailed information about the possibility of installation on a specific vehicle, please refer to our web-catalogue <http://catalogo.facet.eu/>









					FUNCTIONS ON THE VEHICLE							
Vehicle	alim.	kW	Date	Engine	 A10	 A20	 A40	 A50	 A70	 C10 - C30	 C20	 E01
ENGINE												
330 e Plug-in-Hybrid xDrive	Petrol/ Electric	135	07/20->	B48 B20 A								
Engine	Information				A10	A20	A40	A50	A70	C10 - C30	C20	E01
All engines	x 4, COIL ON PLUG									470 632	C10	
ENGINE												
330 e Plug-in-Hybrid xDrive	Petrol/ Electric	215	07/20->	B48 B20 A								
Engine	Information				A10	A20	A40	A50	A70	C10 - C30	C20	E01
All engines	x 4, COIL ON PLUG									470 632	C10	
ENGINE												
330 i	Petrol	190	11/18->	B48 B20 B								
Engine	Information				A10	A20	A40	A50	A70	C10 - C30	C20	E01
All engines	x 4, COIL ON PLUG									470 632	C10	
ENGINE												
330 i xDrive	Petrol	190	11/18->	B46 B20 B, B48 B20 B								
Engine	Information				A10	A20	A40	A50	A70	C10 - C30	C20	E01
All engines	x 4, COIL ON PLUG									470 632	C10	
ENGINE												
M 340 i Mild-Hybrid xDrive	Petrol/ Electric	275	11/20->	B58 B30 B								
Engine	Information				A10	A20	A40	A50	A70	C10 - C30	C20	E01
All engines	x 6, COIL ON PLUG									470 632	C10	
ENGINE												
M 340 i xDrive	Petrol	275	07/19->	B58 B30 B								
Engine	Information				A10	A20	A40	A50	A70	C10 - C30	C20	E01
All engines	x 6, COIL ON PLUG									470 632	C10	
ENGINE												
M 340 i xDrive	Petrol	285	03/19->	B58 B30 B								
Engine	Information				A10	A20	A40	A50	A70	C10 - C30	C20	E01
All engines	x 6, COIL ON PLUG									470 632	C10	
ENGINE												
M3	Petrol	353	11/20->	S58B30B								
Engine	Information				A10	A20	A40	A50	A70	C10 - C30	C20	E01
All engines	x 6, COIL ON PLUG									470 632	C10	
ENGINE												
M3 Competition	Petrol	375	11/20->	S58 B30 A								
Engine	Information				A10	A20	A40	A50	A70	C10 - C30	C20	E01
All engines	x 6, COIL ON PLUG									470 632	C10	
ENGINE												
M3 Competition xDrive	Petrol	375	05/21->	S58 B30 A								
Engine	Information				A10	A20	A40	A50	A70	C10 - C30	C20	E01
All engines	x 6, COIL ON PLUG									470 632	C10	
4												
ENGINE												
418 i	Petrol	100	07/15->	B38 B15 A								
Engine	Information				A10	A20	A40	A50	A70	C10 - C30	C20	E01
All engines	x 3, COIL ON PLUG									470 632	C10	
ENGINE												
420 i	Petrol	120	11/13->	B48 B20 A, N20 B20 A, N20 B20 B								
Engine	Information				A10	A20	A40	A50	A70	C10 - C30	C20	E01
Eng. N20 B20 A, N20 B20 B	x 4, DELPHI, COIL ON PLUG									470 475	C10	
Eng. B48 B20 A	x 4, COIL ON PLUG									470 632	C10	
ENGINE												
420 i	Petrol	135	11/13->	B46 B20 B, B48 B20 A, N20 B20 A, N20 B20 B								
Engine	Information				A10	A20	A40	A50	A70	C10 - C30	C20	E01
Eng. N20 B20 A, N20 B20 B	x 4, DELPHI, COIL ON PLUG									470 475	C10	
Eng. B46 B20 B, B48 B20 A	x 4, COIL ON PLUG									470 632	C10	

A10 CONDENSER	A20 CONTACT SET	A40 DISTRIBUTOR CAP	A50 ROTOR	A70 PICK-UP
C10 COIL	C20 IGNITION MODULE	C30 ELECTRONIC IGNITION KIT	E01 IGNITION CABLE SET	

Vehicle	alim.	kW	Date	Engine	FUNCTIONS ON THE VEHICLE									
					A10	A20	A40	A50	A70	C10 - C30	C20	E01		
420 i 1.6	Petrol	125	11/20->	ENGINE B48 B16 A										
Engine	Information				A10	A20	A40	A50	A70	C10 - C30	C20	E01		
All engines	x 4, COIL ON PLUG									470 632	C10			
420 i xDrive	Petrol	120	11/13->	ENGINE B48 B20 A, N20 B20 A, N20 B20 B										
Engine	Information				A10	A20	A40	A50	A70	C10 - C30	C20	E01		
Eng. N20 B20 A	Qty: 4									470 475	C10			
Eng. N20 B20 B	x 4, DELPHI, COIL ON PLUG									470 475	C10			
Eng. B48 B20 A	x 4, COIL ON PLUG									470 632	C10			
420 i xDrive	Petrol	135	11/13->	ENGINE B48 B20 A, N20 B20 A, N20 B20 B										
Engine	Information				A10	A20	A40	A50	A70	C10 - C30	C20	E01		
Eng. N20 B20 A	Qty: 4									470 475	C10			
Eng. N20 B20 B	x 4, DELPHI, COIL ON PLUG									470 475	C10			
Eng. B48 B20 A	x 4, COIL ON PLUG									470 632	C10			
428 i	Petrol	180	07/13-02/17	ENGINE N20 B20 A, N26 B20 A										
Engine	Information				A10	A20	A40	A50	A70	C10 - C30	C20	E01		
All engines	x 4, DELPHI, COIL ON PLUG									470 475	C10			
Eng. N26 B20 A	Qty: 4									470 475	C10			
428 i xDrive	Petrol	180	07/13-02/16	ENGINE N20 B20 A, N26 B20 A										
Engine	Information				A10	A20	A40	A50	A70	C10 - C30	C20	E01		
Eng. N20 B20 A	x 4, DELPHI, COIL ON PLUG									470 475	C10			
Eng. N26 B20 A	Qty: 4									470 475	C10			
430 i	Petrol	180	07/21->	ENGINE B46 B20 B, B48 B20 B										
Engine	Information				A10	A20	A40	A50	A70	C10 - C30	C20	E01		
All engines	x 4, COIL ON PLUG									470 632	C10			
430 i	Petrol	183	03/16->	ENGINE B48 B20 B										
Engine	Information				A10	A20	A40	A50	A70	C10 - C30	C20	E01		
All engines	x 4, COIL ON PLUG									470 632	C10			
430 i	Petrol	185	03/16->	ENGINE B46 B20 B, B48 B20 B										
Engine	Information				A10	A20	A40	A50	A70	C10 - C30	C20	E01		
All engines	x 4, COIL ON PLUG									470 632	C10			
430 i	Petrol	190	07/20->	ENGINE B46 B20 B, B48 B20 B										
Engine	Information				A10	A20	A40	A50	A70	C10 - C30	C20	E01		
All engines	x 4, COIL ON PLUG									470 632	C10			
430 i xDrive	Petrol	180	07/21->	ENGINE B48 B20 B										
Engine	Information				A10	A20	A40	A50	A70	C10 - C30	C20	E01		
All engines	x 4, COIL ON PLUG									470 632	C10			
430 i xDrive	Petrol	183	03/16->	ENGINE B48 B20 B										
Engine	Information				A10	A20	A40	A50	A70	C10 - C30	C20	E01		
All engines	x 4, COIL ON PLUG									470 632	C10			
430 i xDrive	Petrol	185	03/16->	ENGINE B48 B20 B										
Engine	Information				A10	A20	A40	A50	A70	C10 - C30	C20	E01		
All engines	x 4, COIL ON PLUG									470 632	C10			
430 i xDrive	Petrol	190	07/21->	ENGINE B48 B20 B										
Engine	Information				A10	A20	A40	A50	A70	C10 - C30	C20	E01		
All engines	x 4, COIL ON PLUG									470 632	C10			

A10 CONDENSER	A20 CONTACT SET	A40 DISTRIBUTOR CAP	A50 ROTOR	A70 PICK-UP
C10 COIL	C20 IGNITION MODULE	C30 ELECTRONIC IGNITION KIT	E01 IGNITION CABLE SET	

The present application list is a brief version. For the detailed information about the possibility of installation on a specific vehicle, please refer to our web-catalogue <http://catalogo.facet.eu/>









					FUNCTIONS ON THE VEHICLE							
Vehicle	alim.	kW	Date	Engine								
ENGINE												
435 i	Petrol	225	07/13-02/16	N55 B30 A								
Engine	Information				A10	A20	A40	A50	A70	C10 - C30	C20	E01
All engines	x 6, DELPHI, COIL ON PLUG									470 475	C10	
ENGINE												
435 i	Petrol	250	07/13-02/16	N55 B30 A								
Engine	Information				A10	A20	A40	A50	A70	C10 - C30	C20	E01
All engines	x 6, DELPHI, COIL ON PLUG									470 475	C10	
ENGINE												
435 i xDrive	Petrol	225	07/13-02/16	N55 B30 A								
Engine	Information				A10	A20	A40	A50	A70	C10 - C30	C20	E01
All engines	x 6, DELPHI, COIL ON PLUG									470 475	C10	
ENGINE												
435 i xDrive	Petrol	250	07/13-02/16	N55 B30 A								
Engine	Information				A10	A20	A40	A50	A70	C10 - C30	C20	E01
All engines	x 6, DELPHI, COIL ON PLUG									470 475	C10	
ENGINE												
440 i	Petrol	240	03/16->	B58 B30 A								
Engine	Information				A10	A20	A40	A50	A70	C10 - C30	C20	E01
All engines	x 6, COIL ON PLUG									470 632	C10	
ENGINE												
440 i	Petrol	265	03/16->	B58 B30 A								
Engine	Information				A10	A20	A40	A50	A70	C10 - C30	C20	E01
All engines	x 6, COIL ON PLUG									470 632	C10	
ENGINE												
440 i xDrive	Petrol	240	03/16->	B58 B30 A								
Engine	Information				A10	A20	A40	A50	A70	C10 - C30	C20	E01
All engines	x 6, COIL ON PLUG									470 632	C10	
ENGINE												
440 i xDrive	Petrol	265	03/16->	B58 B30 A								
Engine	Information				A10	A20	A40	A50	A70	C10 - C30	C20	E01
All engines	x 6, COIL ON PLUG									470 632	C10	
ENGINE												
M 440 i Mild-Hybrid	Petrol/ Electric	275	07/21->	B58 B30 B								
Engine	Information				A10	A20	A40	A50	A70	C10 - C30	C20	E01
All engines	x 6, COIL ON PLUG									470 632	C10	
ENGINE												
M 440 i Mild-Hybrid xDrive	Petrol/ Electric	275	11/20->	B58 B30 B								
Engine	Information				A10	A20	A40	A50	A70	C10 - C30	C20	E01
All engines	x 6, COIL ON PLUG									470 632	C10	
ENGINE												
M 440 i Mild-Hybrid xDrive	Petrol/ Electric	285	07/20->	B58 B30 B								
Engine	Information				A10	A20	A40	A50	A70	C10 - C30	C20	E01
All engines	x 6, COIL ON PLUG									470 632	C10	
ENGINE												
M4	Petrol	317	03/14->	S55 B30 A								
Engine	Information				A10	A20	A40	A50	A70	C10 - C30	C20	E01
All engines	x 6, DELPHI, COIL ON PLUG									470 475	C10	
ENGINE												
M4	Petrol	353	11/20->	S58B30B								
Engine	Information				A10	A20	A40	A50	A70	C10 - C30	C20	E01
All engines	x 6, COIL ON PLUG									470 632	C10	
ENGINE												
M4 Competition	Petrol	331	03/16->	S55 B30 A								
Engine	Information				A10	A20	A40	A50	A70	C10 - C30	C20	E01
All engines	x 6, DELPHI, COIL ON PLUG									470 475	C10	

A10 CONDENSER	A20 CONTACT SET	A40 DISTRIBUTOR CAP	A50 ROTOR	A70 PICK-UP
C10 COIL	C20 IGNITION MODULE	C30 ELECTRONIC IGNITION KIT	E01 IGNITION CABLE SET	

Vehicle	alim.	kW	Date	Engine	FUNCTIONS ON THE VEHICLE									
					A10	A20	A40	A50	A70	C10 - C30	C20	E01		
M4 Competition					ENGINE									
	Petrol	375	11/20->	S58 B30 A										
Engine	Information				A10	A20	A40	A50	A70	C10 - C30	C20	E01		
All engines	x 6, COIL ON PLUG									470 632	C10			
M4 Competition M xDrive					ENGINE									
	Petrol	375	07/21->	S58 B30 A										
Engine	Information				A10	A20	A40	A50	A70	C10 - C30	C20	E01		
All engines	x 6, COIL ON PLUG									470 632	C10			
M4 CS					ENGINE									
	Petrol	338	07/17-06/19	S55 B30 A										
Engine	Information				A10	A20	A40	A50	A70	C10 - C30	C20	E01		
All engines	x 6, DELPHI, COIL ON PLUG									470 475	C10			
M4 GTS					ENGINE									
	Petrol	368	03/16-02/17	S55 B30 A										
Engine	Information				A10	A20	A40	A50	A70	C10 - C30	C20	E01		
All engines	x 6, DELPHI, COIL ON PLUG									470 475	C10			
4 SERIES					ENGINE									
M440i xDrive Coupe Mild-Hybrid					ENGINE									
	Petrol/ Electric	275	11/20->	B58 B30 B										
Engine	Information				A10	A20	A40	A50	A70	C10 - C30	C20	E01		
All engines	x 6, COIL ON PLUG									470 632	C10			
5 I					ENGINE									
518					ENGINE									
	Petrol	66	07/74-05/81	M10 B18 (184VB)										
Engine	Information				A10	A20	A40	A50	A70	C10 - C30	C20	E01		
All engines	version Bosch						806 062				465 005	359 572		
All engines	version Bosch						806 094	906 115R						
5 II					ENGINE									
518					ENGINE									
	Petrol	66	06/81-09/84	M10 B18 (184VC), M10 B18 (184VD)										
Engine	Information				A10	A20	A40	A50	A70	C10 - C30	C20	E01		
All engines	version Bosch						806 094	906 115R						
All engines	->year 30/09/83										465 005			
All engines	without marten protection											359 572		
518 i					ENGINE									
	Petrol	75	05/81-12/87	M10 B18 (184EB)										
Engine	Information				A10	A20	A40	A50	A70	C10 - C30	C20	E01		
All engines	version Bosch						806 094	906 055R, 906 115R						
All engines	without marten protection											359 572		
518 i					ENGINE									
	Petrol	77	05/81-12/87	M10 B18 (184EB)										
Engine	Information				A10	A20	A40	A50	A70	C10 - C30	C20	E01		
All engines	version Bosch						806 094	906 055R, 906 115R						
All engines	without marten protection											359 572		
520 i					ENGINE									
	Petrol	110	12/86-12/87	M20 B20 (206KA)										
Engine	Information				A10	A20	A40	A50	A70	C10 - C30	C20	E01		
All engines	version Bosch						806 238	906 119R						
All engines	->year 30/09/83										465 005			
520 i					ENGINE									
	Petrol	92	06/81-12/87	M20 B20 (206EA)										
Engine	Information				A10	A20	A40	A50	A70	C10 - C30	C20	E01		
All engines	version Bosch						806 121	906 060R, 906 112R						
All engines	->year 30/09/83										465 005			
520 i					ENGINE									
	Petrol	95	08/85-12/87	M20 B20 (206KA)										
Engine	Information				A10	A20	A40	A50	A70	C10 - C30	C20	E01		
All engines	version Bosch						806 238	906 119R						

A10	CONDENSER	A20	CONTACT SET	A40	DISTRIBUTOR CAP	A50	ROTOR	A70	PICK-UP
C10	COIL	C20	IGNITION MODULE	C30	ELECTRONIC IGNITION KIT	E01	IGNITION CABLE SET		

The present application list is a brief version. For the detailed information about the possibility of installation on a specific vehicle, please refer to our web-catalogue <http://catalogo.facet.eu/>









				FUNCTIONS ON THE VEHICLE								
Vehicle	alim.	kW	Date	Engine								
				ENGINE								
520 i	Petrol	95	08/85-12/87	M20 B20 (206KA)								
				ENGINE								
Engine		Information			A10	A20	A40	A50	A70	C10 - C30	C20	E01
All engines		->year 30/09/83									465 005	
				ENGINE								
525 e	Petrol	90	09/81-12/87	M20 B27 (276EB), M20 B27 (276KA), M20 B27 (276KB)								
				ENGINE								
Engine		Information			A10	A20	A40	A50	A70	C10 - C30	C20	E01
All engines		version Bosch					806 238	906 119R				
				ENGINE								
525 e	Petrol	92	03/83-12/87	M20 B27 (276EA)								
				ENGINE								
Engine		Information			A10	A20	A40	A50	A70	C10 - C30	C20	E01
All engines		version Bosch					806 238	906 119R				
				ENGINE								
525 e	Petrol	95	09/85-12/87	M20 B27 (276KB)								
				ENGINE								
Engine		Information			A10	A20	A40	A50	A70	C10 - C30	C20	E01
All engines		version Bosch					806 238	906 119R				
				ENGINE								
525 i	Petrol	110	06/81-12/87	M30 B25 (256EA)								
				ENGINE								
Engine		Information			A10	A20	A40	A50	A70	C10 - C30	C20	E01
All engines		version Bosch					806 081	906 060R, 906 112R				
All engines											465 005	
				ENGINE								
528 i	Petrol	135	06/81-12/87	M30 B28 (286EA)								
				ENGINE								
Engine		Information			A10	A20	A40	A50	A70	C10 - C30	C20	E01
All engines		version Bosch					806 081	906 060R, 906 112R				
All engines											465 005	
				ENGINE								
528 i (USA)	Petrol	0	01/81-12/87	--								
				ENGINE								
Engine		Information			A10	A20	A40	A50	A70	C10 - C30	C20	E01
All engines		01/01/85 ->, version Bosch					806 238	906 119R				
All engines											465 005	
				ENGINE								
530 i	Petrol	0	01/84-12/88	--								
				ENGINE								
Engine		Information			A10	A20	A40	A50	A70	C10 - C30	C20	E01
All engines		version Bosch					806 238	906 119R				
All engines									470 112	C10		359 578
				ENGINE								
535 i	Petrol	162	01/85-12/87	M30 B34 (346EC)								
				ENGINE								
Engine		Information			A10	A20	A40	A50	A70	C10 - C30	C20	E01
All engines		version Bosch					806 238	906 119R				
				ENGINE								
535 i, M 535 i	Petrol	136	01/85-12/87	M30 B34 (346KA)								
				ENGINE								
Engine		Information			A10	A20	A40	A50	A70	C10 - C30	C20	E01
All engines		version Bosch					806 238	906 119R				
				ENGINE								
535 i, M 535 i	Petrol	141	01/85-12/87	M30 B35 (Motronic)								
				ENGINE								
Engine		Information			A10	A20	A40	A50	A70	C10 - C30	C20	E01
All engines		version Bosch					806 238	906 119R				
				ENGINE								
M5	Petrol	210	08/85-12/87	S38 B35 (356ED)								
				ENGINE								
Engine		Information			A10	A20	A40	A50	A70	C10 - C30	C20	E01
All engines		version Bosch					806 238	906 119R				
				ENGINE								
				ENGINE								
518 i	Petrol	83	09/89-04/94	M40 B18 (184E1), M43 B18 (184E2)								
				ENGINE								
Engine		Information			A10	A20	A40	A50	A70	C10 - C30	C20	E01
All engines		version Bosch					806 247	906 119R				

A10 CONDENSER	A20 CONTACT SET	A40 DISTRIBUTOR CAP	A50 ROTOR	A70 PICK-UP
C10 COIL	C20 IGNITION MODULE	C30 ELECTRONIC IGNITION KIT	E01 IGNITION CABLE SET	

Vehicle	alim.	kW	Date	Engine	FUNCTIONS ON THE VEHICLE								
					A10	A20	A40	A50	A70	C10 - C30	C20	E01	
520 i	Petrol	110	07/91-07/96	ENGINE M50 B20 (206S1), M50 B20 (206S2)									
Engine	Information				A10	A20	A40	A50	A70	C10 - C30	C20	E01	
All engines	without spark plug connector, Qty: 6									470 162S	C10		
All engines	incl. spark plug connector, Qty: 6									470 412	C10		
520 i	Petrol	95	06/87-09/90	ENGINE M20 B20 (206KA)									
Engine	Information				A10	A20	A40	A50	A70	C10 - C30	C20	E01	
All engines	version Bosch						806 238	906 119R					
All engines	01/10/88 ->, without marten protection											359 597	
520 i 24V	Petrol	110	04/90-08/95	ENGINE M50 B20 (206S1), M50 B20 (206S2)									
Engine	Information				A10	A20	A40	A50	A70	C10 - C30	C20	E01	
All engines	without spark plug connector, Qty: 6									470 162S	C10		
All engines	incl. spark plug connector, Qty: 6									470 412	C10		
525 i	Petrol	125	02/88-08/90	ENGINE M20 B25 (256K1)									
Engine	Information				A10	A20	A40	A50	A70	C10 - C30	C20	E01	
All engines	version Bosch						806 238	906 119R					
All engines	01/10/88 ->, without marten protection											359 597	
525 i	Petrol	141	07/91-07/96	ENGINE M50 B25 (256S1), M50 B25 (256S2)									
Engine	Information				A10	A20	A40	A50	A70	C10 - C30	C20	E01	
All engines	without spark plug connector, Qty: 6									470 162S	C10		
All engines	incl. spark plug connector, Qty: 6									470 412	C10		
525 i 24V	Petrol	141	03/90-08/95	ENGINE M50 B25 (256S2)									
Engine	Information				A10	A20	A40	A50	A70	C10 - C30	C20	E01	
All engines	without spark plug connector, Qty: 6									470 162S	C10		
All engines	incl. spark plug connector, Qty: 6									470 412	C10		
525 ix	Petrol	141	01/92-03/96	ENGINE M50 B25 (256S1)									
Engine	Information				A10	A20	A40	A50	A70	C10 - C30	C20	E01	
All engines	without spark plug connector, Qty: 6									470 162S	C10		
All engines	incl. spark plug connector, Qty: 6									470 412	C10		
525 ix 24V	Petrol	141	10/91-08/95	ENGINE M50 B25 (256S1), M50 B25 (256S2)									
Engine	Information				A10	A20	A40	A50	A70	C10 - C30	C20	E01	
All engines	without spark plug connector, Qty: 6									470 162S	C10		
All engines	incl. spark plug connector, Qty: 6									470 412	C10		
530 i	Petrol	138	01/88-04/90	ENGINE M30 B30 (306KA)									
Engine	Information				A10	A20	A40	A50	A70	C10 - C30	C20	E01	
All engines	version Bosch						806 238	906 119R					
All engines	->year 31/10/88											359 578	
530 i	Petrol	160	09/92-07/96	ENGINE M60 B30 (308S1)									
Engine	Information				A10	A20	A40	A50	A70	C10 - C30	C20	E01	
All engines	without spark plug connector, Qty: 8									470 162S	C10		
All engines	incl. spark plug connector, Qty: 8									470 412	C10		
530 i V8	Petrol	160	09/92-12/95	ENGINE M60 B30 (308S1)									
Engine	Information				A10	A20	A40	A50	A70	C10 - C30	C20	E01	
All engines	without spark plug connector, Qty: 8									470 162S	C10		
All engines	incl. spark plug connector, Qty: 8									470 412	C10		

A10	CONDENSER	A20	CONTACT SET	A40	DISTRIBUTOR CAP	A50	ROTOR	A70	PICK-UP
C10	COIL	C20	IGNITION MODULE	C30	ELECTRONIC IGNITION KIT	E01	IGNITION CABLE SET		









The present application list is a brief version. For the detailed information about the possibility of installation on a specific vehicle, please refer to our web-catalogue <http://catalogo.facet.eu/>

					FUNCTIONS ON THE VEHICLE									
Vehicle	alim.	kW	Date	Engine	 A10	 A20	 A40	 A50	 A70	 C10 - C30	 C20	 E01		
ENGINE														
535 i	Petrol	155	11/87-02/93	M30 B34 (346KB)										
Engine	Information				A10	A20	A40	A50	A70	C10 - C30	C20	E01		
All engines	version Bosch						806 238	906 119R						
All engines	->year 31/10/88											359 578		
ENGINE														
540 i	Petrol	210	09/93-07/96	M60 B40 (408S1)										
Engine	Information				A10	A20	A40	A50	A70	C10 - C30	C20	E01		
All engines	without spark plug connector, Qty: 8									470 162S	C10			
All engines	incl. spark plug connector, Qty: 8									470 412	C10			
ENGINE														
540 i V8	Petrol	210	09/92-12/95	M60 B40 (408S1)										
Engine	Information				A10	A20	A40	A50	A70	C10 - C30	C20	E01		
All engines	without spark plug connector, Qty: 8									470 162S	C10			
All engines	incl. spark plug connector, Qty: 8									470 412	C10			
ENGINE														
M5	Petrol	232	09/88-03/92	S38 B36 (366S1)										
Engine	Information				A10	A20	A40	A50	A70	C10 - C30	C20	E01		
All engines	version Bosch						806 238	906 119R						
All engines										470 112	C10			
ENGINE														
M5	Petrol	250	01/92-07/95	S38 B38 (386S1)										
Engine	Information				A10	A20	A40	A50	A70	C10 - C30	C20	E01		
All engines	without spark plug connector, Qty: 6									470 162S	C10			
ENGINE														
M5 Cat	Petrol	232	09/88-03/92	S38 B36 (366S1)										
Engine	Information				A10	A20	A40	A50	A70	C10 - C30	C20	E01		
All engines	version Bosch						806 238	906 119R						
All engines										470 112	C10			
5 IV														
ENGINE														
520 i	Petrol	100	01/96-06/03	6BJT, 8TJ376QE, M52B206S3, M52B206S4										
Engine	Information				A10	A20	A40	A50	A70	C10 - C30	C20	E01		
All engines	x 6, BOSCH, BREMI, COIL ON PLUG, incl. spark plug connector									470 352	C10			
ENGINE														
520 i	Petrol	110	01/96-06/03	6BJT, 8TJ376QE, M52B206S3, M52B206S4										
Engine	Information				A10	A20	A40	A50	A70	C10 - C30	C20	E01		
All engines	x 6, BOSCH, BREMI, COIL ON PLUG, incl. spark plug connector									470 352	C10			
ENGINE														
520 i	Petrol	120	09/00-12/03	M54 B22 (226S1), M54B226S1										
Engine	Information				A10	A20	A40	A50	A70	C10 - C30	C20	E01		
Eng. M54 B22 (226S1)	->year 30/09/02, without spark plug connector, Qty: 6									470 352	C10			
Eng. M54B226S1	->year 01/08/02, x 6, BREMI, COIL ON PLUG									470 352	C10			
Eng. M54 B22 (226S1)	->year 30/09/02, incl. spark plug connector, Qty: 6									470 413	C10			
Eng. M54 B22 (226S1)	01/10/02 ->, Qty: 6									470 475	C10			
Eng. M54B226S1	01/09/02 ->, x 6, DELPHI, COIL ON PLUG									470 475	C10			
ENGINE														
520 i	Petrol	125	09/00-12/03	M54 B22 (226S1), M54B226S1										
Engine	Information				A10	A20	A40	A50	A70	C10 - C30	C20	E01		
Eng. M54 B22 (226S1)	->year 30/09/02, without spark plug connector, Qty: 6									470 352	C10			
Eng. M54B226S1	->year 01/09/02, x 6, BREMI, x 6, BOSCH, COIL ON PLUG, COIL ON PLUG, incl. spark plug connector									470 352	C10			
Eng. M54 B22 (226S1)	->year 30/09/02, incl. spark plug connector, Qty: 6									470 413	C10			
Eng. M54 B22 (226S1)	01/10/02 ->, Qty: 6									470 475	C10			
Eng. M54B226S1	01/10/02 ->, x 6, DELPHI, COIL ON PLUG									470 475	C10			
ENGINE														
A10	CONDENSER		A20	CONTACT SET		A40	DISTRIBUTOR CAP		A50	ROTOR		A70	PICK-UP	
C10	COIL		C20	IGNITION MODULE		C30	ELECTRONIC IGNITION KIT		E01	IGNITION CABLE SET				

Vehicle	alim.	kW	Date	Engine	FUNCTIONS ON THE VEHICLE								
					A10	A20	A40	A50	A70	C10 - C30	C20	E01	
523 i	Petrol	120	09/98-08/00	ENGINE 8K7M 818									
Engine					A10	A20	A40	A50	A70	C10 - C30	C20	E01	
All engines										470 352	C10		
523 i	Petrol	125	09/95-08/00	ENGINE 1LD5, 4M18A, 6GW491Q-E, M52 B25 (256S3), M52B256S3									
Engine					A10	A20	A40	A50	A70	C10 - C30	C20	E01	
Eng. 1LD5, 4M18A, 6GW491Q-E, M52B256S3										470 352	C10		
Eng. M52 B25 (256S3)										470 352	C10		
Eng. M52 B25 (256S3)										470 413	C10		
525 i	Petrol	141	09/00-05/04	ENGINE 8CUG, M54 B25 (256S5), M54B256S5									
Engine					A10	A20	A40	A50	A70	C10 - C30	C20	E01	
Eng. 8CUG, M54B256S5										470 352	C10		
Eng. M54 B25 (256S5)										470 352	C10		
Eng. M54 B25 (256S5)										470 413	C10		
Eng. 8CUG, M54B256S5										470 475	C10		
Eng. M54 B25 (256S5)										470 475	C10		
528 i	Petrol	142	09/95-08/00	ENGINE 9D 0836 LE 501, M52 B28 (286S1), M52 B28 (286S2), M52B286S1, M52B286S2									
Engine					A10	A20	A40	A50	A70	C10 - C30	C20	E01	
Eng. 9D 0836 LE 501, M52B286S1, M52B286S2										470 352	C10		
Eng. M52 B28 (286S1), M52 B28 (286S2)										470 352	C10		
Eng. M52 B28 (286S1), M52 B28 (286S2)										470 413	C10		
530 i	Petrol	170	09/00-12/03	ENGINE 2CBL, M54 B30 (306S3), M54B306S3									
Engine					A10	A20	A40	A50	A70	C10 - C30	C20	E01	
Eng. 2CBL, M54B306S3										470 352	C10		
Eng. M54 B30 (306S3)										470 352	C10		
Eng. M54 B30 (306S3)										470 413	C10		
Eng. 2CBL, M54B306S3										470 475	C10		
Eng. M54 B30 (306S3)										470 475	C10		
535 i	Petrol	173	06/96-08/98	ENGINE 1H4B 410, M62 B35 (358S2)									
Engine					A10	A20	A40	A50	A70	C10 - C30	C20	E01	
Eng. 1H4B 410										470 352	C10		
Eng. M62 B35 (358S2)										470 352	C10		
Eng. M62 B35 (358S2)										470 413	C10		
535 i	Petrol	180	09/98-06/03	ENGINE 6DAM15B									
Engine					A10	A20	A40	A50	A70	C10 - C30	C20	E01	
All engines										470 352	C10		
540 i	Petrol	210	03/96-12/03	ENGINE 0JL465QH, 54A91S, 9K20C3, M62 B44 (448S1), M62 B44 (448S2), M62B448S2									
Engine					A10	A20	A40	A50	A70	C10 - C30	C20	E01	
Eng. 0JL465QH, 54A91S, 9K20C3, M62B448S2										470 352	C10		
Eng. M62 B44 (448S1), M62 B44 (448S2)										470 352	C10		
Eng. M62 B44 (448S1), M62 B44 (448S2)										470 413	C10		

A10 CONDENSER	A20 CONTACT SET	A40 DISTRIBUTOR CAP	A50 ROTOR	A70 PICK-UP
C10 COIL	C20 IGNITION MODULE	C30 ELECTRONIC IGNITION KIT	E01 IGNITION CABLE SET	







The present application list is a brief version. For the detailed information about the possibility of installation on a specific vehicle, please refer to our web-catalogue <http://catalogo.facet.eu/>

					FUNCTIONS ON THE VEHICLE												
Vehicle	alim.	kW	Date	Engine	 A10	 A20	 A40	 A50	 A70	 C10 - C30	 C20	 E01					
ENGINE																	
M5	Petrol	294	10/98-06/03	8D 0836 LF 40, S62 B50 (508S1)													
Engine	Information				A10	A20	A40	A50	A70	C10 - C30	C20	E01					
Eng. 8D 0836 LF 40	x 8, BOSCH, BREMI, COIL ON PLUG, incl. spark plug connector									470 352	C10						
Eng. S62 B50 (508S1)	without spark plug connector, Qty: 8									470 352	C10						
Eng. S62 B50 (508S1)	incl. spark plug connector, Qty: 8									470 413	C10						
5 V																	
520 i	Petrol	115	09/07-02/10	N46 B20 B													
Engine	Information				A10	A20	A40	A50	A70	C10 - C30	C20	E01					
All engines	x 4, DELPHI, COIL ON PLUG									470 475	C10						
520 i	Petrol	120	12/06-08/10	N43 B20 A													
Engine	Information				A10	A20	A40	A50	A70	C10 - C30	C20	E01					
All engines	x 4, BOSCH, COIL ON PLUG									470 607	C10						
520 i	Petrol	125	07/03->	M54 226 S1, M54 B22 (226S1), M54B226S1, N43 B20 A													
Engine	Information				A10	A20	A40	A50	A70	C10 - C30	C20	E01					
Eng. M54 226 S1, M54 B22 (226S1)	Qty: 6									470 475	C10						
Eng. M54B226S1	x 6, DELPHI, COIL ON PLUG									470 475	C10						
Eng. N43 B20 A	x 4, BOSCH, COIL ON PLUG									470 607	C10						
520Li	Petrol	115	09/07->	N46 B20 B, N46 B20 C													
Engine	Information				A10	A20	A40	A50	A70	C10 - C30	C20	E01					
All engines	Qty: 4									470 475	C10						
523 i	Petrol	0	07/05->	N52B25B													
Engine	Information				A10	A20	A40	A50	A70	C10 - C30	C20	E01					
All engines	Qty: 6									470 475	C10						
523 i	Petrol	130	10/04->	N52 B25 A, N52 B25 B, N52 B25 BE, N52 B25 BF, N52B25B													
Engine	Information				A10	A20	A40	A50	A70	C10 - C30	C20	E01					
Eng. N52 B25 A, N52 B25 B, N52 B25 BE	x 6, BOSCH, DELPHI, COIL ON PLUG									470 475	C10						
Eng. N52 B25 BF, N52B25B	Qty: 6									470 475	C10						
523 i	Petrol	140	01/07-12/10	N52 B25 A, N52 B25 BE, N53 B25 A													
Engine	Information				A10	A20	A40	A50	A70	C10 - C30	C20	E01					
Eng. N52 B25 A, N52 B25 BE	x 6, DELPHI, COIL ON PLUG									470 475	C10						
Eng. N53 B25 A	x 6, BOSCH, COIL ON PLUG									470 607	C10						
523Li	Petrol	130	07/05->	N52 B25 A, N52B25B, N52B25BE													
Engine	Information				A10	A20	A40	A50	A70	C10 - C30	C20	E01					
All engines	Qty: 6									470 475	C10						
525 i	Petrol	141	09/03-12/10	M54 B25 (256S5), M54B256S5													
Engine	Information				A10	A20	A40	A50	A70	C10 - C30	C20	E01					
Eng. M54 B25 (256S5)	Qty: 6									470 475	C10						
Eng. M54B256S5	x 6, DELPHI, COIL ON PLUG									470 475	C10						
525 i	Petrol	155	03/05-12/10	N52 B25 A, N53 B30 A													
Engine	Information				A10	A20	A40	A50	A70	C10 - C30	C20	E01					
Eng. N52 B25 A	x 6, DELPHI, x 6, BOSCH, COIL ON PLUG, DELPHI, COIL ON PLUG									470 475	C10						
Eng. N53 B30 A	x 6, DELPHI, COIL ON PLUG									470 607	C10						
A10	CONDENSER	A20	CONTACT SET	A40	DISTRIBUTOR CAP	A50	ROTOR	A70	PICK-UP	C10	COIL	C20	IGNITION MODULE	C30	ELECTRONIC IGNITION KIT	E01	IGNITION CABLE SET

Vehicle	alim.	kW	Date	Engine	FUNCTIONS ON THE VEHICLE									
					A10	A20	A40	A50	A70	C10 - C30	C20	E01		
ENGINE														
525 i	Petrol	160	03/05->	N52 B25 A, N52 B25 B, N52 B25 BF, N52 B30 A, N52 B30 B, N52 B30 BF, N52B25B, N53 B30 A										
Engine	Information			A10	A20	A40	A50	A70	C10 - C30	C20	E01			
Eng. N52 B25 A, N52 B25 B, N52 B25 BF	x 6, BOSCH, DELPHI, COIL ON PLUG, x 6, BOSCH, DELPHI, COIL ON PLUG								470 475	C10				
Eng. N52 B25 BF, N52 B30 A, N52 B30 B, N52 B30 BF, N52B25B	Qty: 6								470 475	C10				
Eng. N53 B30 A	x 6, BOSCH, COIL ON PLUG								470 607	C10				
ENGINE														
525 i xDrive	Petrol	160	09/08-12/10	N53 B30 A										
Engine	Information			A10	A20	A40	A50	A70	C10 - C30	C20	E01			
All engines	x 6, BOSCH, COIL ON PLUG								470 607	C10				
ENGINE														
525 xi	Petrol	160	04/05-12/10	N52 B25 A, N53 B30 A										
Engine	Information			A10	A20	A40	A50	A70	C10 - C30	C20	E01			
All engines	x 6, DELPHI, x 6, BOSCH, COIL ON PLUG, DELPHI, COIL ON PLUG								470 475	C10				
Eng. N53 B30 A	x 6, BOSCH, COIL ON PLUG								470 607	C10				
ENGINE														
525 xi	Petrol	218	07/05->	N52 B30 A										
Engine	Information			A10	A20	A40	A50	A70	C10 - C30	C20	E01			
All engines	Qty: 6								470 475	C10				
ENGINE														
525Li	Petrol	160	07/05->	N52 B25 A, N52 B25 BF, N52B25B										
Engine	Information			A10	A20	A40	A50	A70	C10 - C30	C20	E01			
All engines	Qty: 6								470 475	C10				
ENGINE														
528 xi	Petrol	172	03/07->	N52 B30 A										
Engine	Information			A10	A20	A40	A50	A70	C10 - C30	C20	E01			
All engines	Qty: 6								470 475	C10				
ENGINE														
530 i	Petrol	170	12/01->	3CA4GB16, M54 306 S3, M54 B30 (306S3)										
Engine	Information			A10	A20	A40	A50	A70	C10 - C30	C20	E01			
Eng. 3CA4GB16	x 6, DELPHI, COIL ON PLUG								470 475	C10				
Eng. M54 306 S3, M54 B30 (306S3)	Qty: 6								470 475	C10				
ENGINE														
530 i	Petrol	187	03/05-03/10	N52 B30 A										
Engine	Information			A10	A20	A40	A50	A70	C10 - C30	C20	E01			
All engines	x 6, DELPHI, ELDOR, COIL ON PLUG								470 475	C10				
ENGINE														
530 i	Petrol	190	09/04-03/07	N52 B30 A, N52 B30 BF										
Engine	Information			A10	A20	A40	A50	A70	C10 - C30	C20	E01			
All engines	x 6, BOSCH, DELPHI, COIL ON PLUG								470 475	C10				
ENGINE														
530 i	Petrol	200	09/06-12/10	N52 B30 A, N52 B30 BF, N53 B30 A										
Engine	Information			A10	A20	A40	A50	A70	C10 - C30	C20	E01			
All engines	-eng. N53B30A, x 6, DELPHI, COIL ON PLUG								470 475	C10				
Eng. N53 B30 A	x 6, BOSCH, COIL ON PLUG								470 607	C10				
ENGINE														
530 i xDrive	Petrol	200	09/08-05/10	N53 B30 A										
Engine	Information			A10	A20	A40	A50	A70	C10 - C30	C20	E01			
All engines	x 6, BOSCH, COIL ON PLUG								470 607	C10				
ENGINE														
530 xi	Petrol	190	09/04-02/07	N52 B30 A										
Engine	Information			A10	A20	A40	A50	A70	C10 - C30	C20	E01			
All engines	x 6, BOSCH, DELPHI, x 6, BOSCH, COIL ON PLUG, DELPHI, COIL ON PLUG								470 475	C10				

A10	CONDENSER	A20	CONTACT SET	A40	DISTRIBUTOR CAP	A50	ROTOR	A70	PICK-UP
C10	COIL	C20	IGNITION MODULE	C30	ELECTRONIC IGNITION KIT	E01	IGNITION CABLE SET		

The present application list is a brief version. For the detailed information about the possibility of installation on a specific vehicle, please refer to our web-catalogue <http://catalogo.facet.eu/>









					FUNCTIONS ON THE VEHICLE							
Vehicle	alim.	kW	Date	Engine	 A10	 A20	 A40	 A50	 A70	 C10 - C30	 C20	 E01
530 xi												
Petrol												
		200	09/06-05/10	ENGINE N52 B30 A, N53 B30 A								
Engine	Information				A10	A20	A40	A50	A70	C10 - C30	C20	E01
Eng. N52 B30 A	x 6, DELPHI, COIL ON PLUG									470 475	C10	
Eng. N53 B30 A	x 6, BOSCH, COIL ON PLUG									470 607	C10	
530Li												
Petrol												
		190	07/05->	ENGINE N52 B30 A, N52 B30 B, N52 B30 BF								
Engine	Information				A10	A20	A40	A50	A70	C10 - C30	C20	E01
All engines	Qty: 6									470 475	C10	
535 i												
Petrol												
		225	04/06-12/09	ENGINE N54 B30 A								
Engine	Information				A10	A20	A40	A50	A70	C10 - C30	C20	E01
All engines	Qty: 6									470 475	C10	
535xi												
Petrol												
		225	03/07->	ENGINE N54 B30 A								
Engine	Information				A10	A20	A40	A50	A70	C10 - C30	C20	E01
All engines	Qty: 6									470 475	C10	
540 i												
Petrol												
		220	09/05-02/07	ENGINE N62 B40 A								
Engine	Information				A10	A20	A40	A50	A70	C10 - C30	C20	E01
All engines	x 8, DELPHI, COIL ON PLUG									470 475	C10	
540 i												
Petrol												
		225	03/07-12/09	ENGINE N62 B40 A								
Engine	Information				A10	A20	A40	A50	A70	C10 - C30	C20	E01
All engines	x 8, DELPHI, COIL ON PLUG									470 475	C10	
545 i												
Petrol												
		245	09/03-12/10	ENGINE N62 B44 A								
Engine	Information				A10	A20	A40	A50	A70	C10 - C30	C20	E01
All engines	x 8, DELPHI, ELDOR, COIL ON PLUG									470 475	C10	
550 i												
Petrol												
		270	07/05-12/10	ENGINE N62 B48 A, N62 B48 B								
Engine	Information				A10	A20	A40	A50	A70	C10 - C30	C20	E01
Eng. N62 B48 A	Qty: 8									470 475	C10	
Eng. N62 B48 B	x 8, DELPHI, COIL ON PLUG									470 475	C10	
5 VI												
520 i												
Petrol												
		120	09/11-02/17	ENGINE N20 B20 A, N20 B20 B								
Engine	Information				A10	A20	A40	A50	A70	C10 - C30	C20	E01
All engines	x 4, DELPHI, COIL ON PLUG									470 475	C10	
520 i												
Petrol												
		125	07/13-10/16	ENGINE N20 B16 A								
Engine	Information				A10	A20	A40	A50	A70	C10 - C30	C20	E01
All engines	x 4, DELPHI, COIL ON PLUG									470 475	C10	
520 i												
Petrol												
		135	10/10-02/17	ENGINE N20 B20 A, N20 B20 B								
Engine	Information				A10	A20	A40	A50	A70	C10 - C30	C20	E01
All engines	x 4, DELPHI, COIL ON PLUG									470 475	C10	
520Li [CHN]												
Petrol												
		0	01/11->	ENGINE N20 B20 D								
Engine	Information				A10	A20	A40	A50	A70	C10 - C30	C20	E01
All engines	pole nr. 4									470 475	C10	
520Li [CHN]												
Petrol												
		115	01/09->	ENGINE N52 B25 AF								
Engine	Information				A10	A20	A40	A50	A70	C10 - C30	C20	E01
All engines	Qty: 6									470 475	C10	

A10 CONDENSER	A20 CONTACT SET	A40 DISTRIBUTOR CAP	A50 ROTOR	A70 PICK-UP
C10 COIL	C20 IGNITION MODULE	C30 ELECTRONIC IGNITION KIT	E01 IGNITION CABLE SET	

Vehicle	alim.	kW	Date	Engine	FUNCTIONS ON THE VEHICLE									
					A10	A20	A40	A50	A70	C10 - C30	C20	E01		
523 i	Petrol	150	06/09-08/11	ENGINE N52 B25 A, N52 B25 AF, N52 B25 B, N52 B25 BF, N53 B30 A										
Engine	Information													
Eng. N52 B25 A, N52 B25 AF, N52 B25 B, N52 B25 BF	x 6, DELPHI, COIL ON PLUG									470 475	C10			
Eng. N53 B30 A	x 6, BOSCH, COIL ON PLUG									470 607	C10			
523 i	Petrol	155	01/10-08/11	ENGINE N53 B30 A										
Engine	Information													
All engines	x 6, BOSCH, COIL ON PLUG									470 607	C10			
523 i	Petrol	160	06/09-08/11	ENGINE N53 B30 A										
Engine	Information													
All engines	Qty: 6									470 607	C10			
523Li [CHN]	Petrol	130	01/09->	ENGINE N52 B25 AF										
Engine	Information													
All engines	Qty: 6									470 475	C10			
525 d	Diesel	155	09/11-10/16	ENGINE N47D20D(N47S1)										
Engine	Information													
All engines	Qty: 4									470 475	C10			
525Li [CHN]	Petrol	120	09/11->	ENGINE N20 B20 A										
Engine	Information													
All engines	Qty: 4									470 475	C10			
528 i	Petrol	180	09/11-02/17	ENGINE N20 B20 A										
Engine	Information													
All engines	x 4, DELPHI, COIL ON PLUG									470 475	C10			
528 i	Petrol	190	11/09->	ENGINE N52 B30 BF, N53 B30 A										
Engine	Information													
Eng. N52 B30 BF	Qty: 6									470 475	C10			
Eng. N53 B30 A	x 6, BOSCH, COIL ON PLUG									470 607	C10			
528 i xDrive	Petrol	180	09/11-02/17	ENGINE N20 B20 A										
Engine	Information													
All engines	x 4, DELPHI, COIL ON PLUG									470 475	C10			
528Li [CHN]	Petrol	0	01/13->	ENGINE N20 B20 C										
Engine	Information													
All engines	Qty: 4									470 475	C10			
528Li [CHN]	Petrol	190	09/10->	ENGINE N52 B30 AF										
Engine	Information													
All engines	Qty: 6									470 475	C10			
530 Hybrid [CHN]	Petrol/ Electric	0	01/13->	ENGINE --										
Engine	Information													
All engines	Qty: 2									470 475	C10			
530 i	Petrol	190	03/10-06/13	ENGINE N52 B30 A, N52 B30 AF, N52 B30 BF										
Engine	Information													
All engines	x 6, DELPHI, COIL ON PLUG									470 475	C10			

A10 CONDENSER	A20 CONTACT SET	A40 DISTRIBUTOR CAP	A50 ROTOR	A70 PICK-UP
C10 COIL	C20 IGNITION MODULE	C30 ELECTRONIC IGNITION KIT	E01 IGNITION CABLE SET	

The present application list is a brief version. For the detailed information about the possibility of installation on a specific vehicle, please refer to our web-catalogue <http://catalogo.facet.eu/>







				FUNCTIONS ON THE VEHICLE								
Vehicle	alim.	kW	Date	Engine								
				ENGINE								
530 i	Petrol	200	05/11-06/13	N53 B30 A								
Engine		Information			A10	A20	A40	A50	A70	C10 - C30	C20	E01
All engines		x 6, BOSCH, COIL ON PLUG								470 607	C10	
				ENGINE								
530Li [CHN]	Petrol	190	09/10->	N52 B30 AF								
Engine		Information			A10	A20	A40	A50	A70	C10 - C30	C20	E01
All engines		Qty: 6								470 475	C10	
				ENGINE								
535 i	Petrol	225	01/10-02/17	N55 B30 A								
Engine		Information			A10	A20	A40	A50	A70	C10 - C30	C20	E01
All engines		x 6, DELPHI, COIL ON PLUG								470 475	C10	
				ENGINE								
535 i	Petrol	240	07/13-02/17	N55 B30 A								
Engine		Information			A10	A20	A40	A50	A70	C10 - C30	C20	E01
All engines		x 6, DELPHI, COIL ON PLUG								470 475	C10	
				ENGINE								
535 i xDrive	Petrol	225	03/11-02/17	N55 B30 A								
Engine		Information			A10	A20	A40	A50	A70	C10 - C30	C20	E01
All engines		x 6, DELPHI, COIL ON PLUG								470 475	C10	
				ENGINE								
535 i xDrive	Petrol	240	07/13-02/17	N55 B30 A								
Engine		Information			A10	A20	A40	A50	A70	C10 - C30	C20	E01
All engines		x 6, DELPHI, COIL ON PLUG								470 475	C10	
				ENGINE								
535Li [CHN]	Petrol	225	01/09->	N55 B30 A								
Engine		Information			A10	A20	A40	A50	A70	C10 - C30	C20	E01
All engines		Qty: 6								470 475	C10	
				ENGINE								
550 i	Petrol	300	03/10-06/13	N63 B44 A								
Engine		Information			A10	A20	A40	A50	A70	C10 - C30	C20	E01
All engines		x 8, DELPHI, ELDOR, COIL ON PLUG								470 475	C10	
				ENGINE								
550 i	Petrol	330	07/13-02/17	N63 B44 B								
Engine		Information			A10	A20	A40	A50	A70	C10 - C30	C20	E01
All engines		x 8, BOSCH, DELPHI, COIL ON PLUG								470 475	C10	
				ENGINE								
550 i xDrive	Petrol	300	08/10-06/13	N63 B44 A								
Engine		Information			A10	A20	A40	A50	A70	C10 - C30	C20	E01
All engines		x 8, DELPHI, ELDOR, COIL ON PLUG								470 475	C10	
				ENGINE								
550 i xDrive	Petrol	330	07/13-10/16	N63 B44 B								
Engine		Information			A10	A20	A40	A50	A70	C10 - C30	C20	E01
All engines		x 8, BOSCH, DELPHI, COIL ON PLUG								470 475	C10	
				ENGINE								
ActiveHybrid	Petrol/ Electric	225	12/11-10/16	N55 B30 A								
Engine		Information			A10	A20	A40	A50	A70	C10 - C30	C20	E01
All engines		x 6, DELPHI, COIL ON PLUG								470 475	C10	
				ENGINE								
ActiveHybrid	Petrol/ Electric	250	12/11-10/16	N55 B30 A								
Engine		Information			A10	A20	A40	A50	A70	C10 - C30	C20	E01
All engines		x 6, DELPHI, COIL ON PLUG								470 475	C10	
				ENGINE								
M5	Petrol	412	09/11-10/16	S63 B44 B								
Engine		Information			A10	A20	A40	A50	A70	C10 - C30	C20	E01
All engines		x 8, BOSCH, DELPHI, COIL ON PLUG								470 475	C10	

A10 CONDENSER	A20 CONTACT SET	A40 DISTRIBUTOR CAP	A50 ROTOR	A70 PICK-UP
C10 COIL	C20 IGNITION MODULE	C30 ELECTRONIC IGNITION KIT	E01 IGNITION CABLE SET	

Vehicle	alim.	kW	Date	Engine	FUNCTIONS ON THE VEHICLE									
					A10	A20	A40	A50	A70	C10 - C30	C20	E01		
ENGINE														
M5 30th Anniversary	Petrol	441	07/14-10/16	S63 B44 B										
Engine	Information				A10	A20	A40	A50	A70	C10 - C30	C20	E01		
All engines	x 8, BOSCH, DELPHI, COIL ON PLUG									470 475	C10			
ENGINE														
M5 Competition	Petrol	423	02/13-10/16	S63 B44 B										
Engine	Information				A10	A20	A40	A50	A70	C10 - C30	C20	E01		
All engines	x 8, BOSCH, DELPHI, COIL ON PLUG									470 475	C10			
5 VI GT														
ENGINE														
528 i	Petrol	180	07/13-02/17	N20 B20 A										
Engine	Information				A10	A20	A40	A50	A70	C10 - C30	C20	E01		
All engines	x 4, DELPHI, COIL ON PLUG									470 475	C10			
ENGINE														
535 i	Petrol	225	01/09-02/17	N55 B30 A										
Engine	Information				A10	A20	A40	A50	A70	C10 - C30	C20	E01		
All engines	x 6, DELPHI, COIL ON PLUG									470 475	C10			
ENGINE														
535 i xDrive	Petrol	225	09/10-02/17	N55 B30 A										
Engine	Information				A10	A20	A40	A50	A70	C10 - C30	C20	E01		
All engines	x 6, DELPHI, COIL ON PLUG									470 475	C10			
ENGINE														
550 i	Petrol	298	10/09-06/12	N63 B44 A										
Engine	Information				A10	A20	A40	A50	A70	C10 - C30	C20	E01		
All engines	Qty: 8									470 475	C10			
ENGINE														
550 i	Petrol	300	08/09-06/12	N63 B44 A										
Engine	Information				A10	A20	A40	A50	A70	C10 - C30	C20	E01		
All engines	x 8, DELPHI, ELDOR, COIL ON PLUG									470 475	C10			
ENGINE														
550 i	Petrol	330	07/12-02/17	N63 B44 B										
Engine	Information				A10	A20	A40	A50	A70	C10 - C30	C20	E01		
All engines	x 8, BOSCH, DELPHI, COIL ON PLUG									470 475	C10			
ENGINE														
550 i xDrive	Petrol	300	06/10-03/14	N63 B40 A, N63 B44 A										
Engine	Information				A10	A20	A40	A50	A70	C10 - C30	C20	E01		
Eng. N63 B40 A	Qty: 8									470 475	C10			
Eng. N63 B44 A	x 8, DELPHI, ELDOR, COIL ON PLUG									470 475	C10			
ENGINE														
550 i xDrive	Petrol	330	07/12-02/17	N63 B44 B										
Engine	Information				A10	A20	A40	A50	A70	C10 - C30	C20	E01		
All engines	x 8, BOSCH, DELPHI, COIL ON PLUG									470 475	C10			
5 VII														
ENGINE														
520 E PLUG-IN-HYBRID	Petrol/ Electric	120	03/21->	B48 B20 A										
Engine	Information				A10	A20	A40	A50	A70	C10 - C30	C20	E01		
All engines	x 4, COIL ON PLUG									470 632	C10			
ENGINE														
520 E PLUG-IN-HYBRID	Petrol/ Electric	150	03/21->	B48 B20 A										
Engine	Information				A10	A20	A40	A50	A70	C10 - C30	C20	E01		
All engines	x 4, COIL ON PLUG									470 632	C10			
ENGINE														
520 i	Petrol	120	07/17-06/20	B48 B20 A, B48 B20 B										
Engine	Information				A10	A20	A40	A50	A70	C10 - C30	C20	E01		
All engines	x 4, COIL ON PLUG									470 632	C10			
ENGINE														
520 i	Petrol	125	07/17->	B48 B16 A										
Engine	Information				A10	A20	A40	A50	A70	C10 - C30	C20	E01		
All engines	x 4, COIL ON PLUG									470 632	C10			

A10 CONDENSER	A20 CONTACT SET	A40 DISTRIBUTOR CAP	A50 ROTOR	A70 PICK-UP
C10 COIL	C20 IGNITION MODULE	C30 ELECTRONIC IGNITION KIT	E01 IGNITION CABLE SET	

The present application list is a brief version. For the detailed information about the possibility of installation on a specific vehicle, please refer to our web-catalogue <http://catalogo.facet.eu/>









					FUNCTIONS ON THE VEHICLE							
Vehicle	alim.	kW	Date	Engine	 A10	 A20	 A40	 A50	 A70	 C10 - C30	 C20	 E01
ENGINE												
520 i	Petrol	135	07/17->	B48 B20 A, B48 B20 B								
Engine	Information				A10	A20	A40	A50	A70	C10 - C30	C20	E01
All engines	x 4, COIL ON PLUG									470 632	C10	
ENGINE												
520 i	Petrol	155	07/17-06/20	B48 B20 A, B48 B20 B								
Engine	Information				A10	A20	A40	A50	A70	C10 - C30	C20	E01
All engines	x 4, COIL ON PLUG									470 632	C10	
ENGINE												
520 i Mild-Hybrid	Petrol/ Electric	120	07/20->	B48 B20 A								
Engine	Information				A10	A20	A40	A50	A70	C10 - C30	C20	E01
All engines	x 4, COIL ON PLUG									470 632	C10	
ENGINE												
520 i Mild-Hybrid	Petrol/ Electric	135	07/20->	B48 B20 A								
Engine	Information				A10	A20	A40	A50	A70	C10 - C30	C20	E01
All engines	x 4, COIL ON PLUG									470 632	C10	
ENGINE												
530 e Plug-in-Hybrid	Petrol/ Electric	120	07/19->	B48 B20 A								
Engine	Information				A10	A20	A40	A50	A70	C10 - C30	C20	E01
All engines	x 4, COIL ON PLUG									470 632	C10	
ENGINE												
530 e Plug-in-Hybrid	Petrol/ Electric	135	03/17->	B46 B20 B, B48 B20 A								
Engine	Information				A10	A20	A40	A50	A70	C10 - C30	C20	E01
All engines	x 4, COIL ON PLUG									470 632	C10	
ENGINE												
530 e Plug-in-Hybrid	Petrol/ Electric	170	07/19-06/20	B48 B20 A								
Engine	Information				A10	A20	A40	A50	A70	C10 - C30	C20	E01
All engines	x 4, COIL ON PLUG									470 632	C10	
ENGINE												
530 e Plug-in-Hybrid	Petrol/ Electric	200	07/20->	B48 B20 A								
Engine	Information				A10	A20	A40	A50	A70	C10 - C30	C20	E01
All engines	x 4, COIL ON PLUG									470 632	C10	
ENGINE												
530 e Plug-in-Hybrid	Petrol/ Electric	215	07/20->	B46 B20 B, B48 B20 A								
Engine	Information				A10	A20	A40	A50	A70	C10 - C30	C20	E01
All engines	x 4, COIL ON PLUG									470 632	C10	
ENGINE												
530 e Plug-in-Hybrid xDrive	Petrol/ Electric	120	07/19->	B48 B20 A								
Engine	Information				A10	A20	A40	A50	A70	C10 - C30	C20	E01
All engines	x 4, COIL ON PLUG									470 632	C10	
ENGINE												
530 e Plug-in-Hybrid xDrive	Petrol/ Electric	135	03/17->	B46 B20 B, B48 B20 A								
Engine	Information				A10	A20	A40	A50	A70	C10 - C30	C20	E01
All engines	x 4, COIL ON PLUG									470 632	C10	
ENGINE												
530 e Plug-in-Hybrid xDrive	Petrol/ Electric	170	07/19-06/20	B48 B20 A								
Engine	Information				A10	A20	A40	A50	A70	C10 - C30	C20	E01
All engines	x 4, COIL ON PLUG									470 632	C10	
ENGINE												
530 e Plug-in-Hybrid xDrive	Petrol/ Electric	185	03/17-06/20	B46 B20 B, B48 B20 A								
Engine	Information				A10	A20	A40	A50	A70	C10 - C30	C20	E01
All engines	x 4, COIL ON PLUG									470 632	C10	

A10 CONDENSER	A20 CONTACT SET	A40 DISTRIBUTOR CAP	A50 ROTOR	A70 PICK-UP
C10 COIL	C20 IGNITION MODULE	C30 ELECTRONIC IGNITION KIT	E01 IGNITION CABLE SET	

Vehicle	alim.	kW	Date	Engine	FUNCTIONS ON THE VEHICLE								
					A10	A20	A40	A50	A70	C10 - C30	C20	E01	
ENGINE													
530 e Plug-in-Hybrid xDrive	Petrol/ Electric	200	07/20->	B48 B20 A									
Engine	Information				A10	A20	A40	A50	A70	C10 - C30	C20	E01	
All engines	x 4, COIL ON PLUG									470 632	C10		
ENGINE													
530 e Plug-in-Hybrid xDrive	Petrol/ Electric	215	07/20->	B46 B20 B, B48 B20 A									
Engine	Information				A10	A20	A40	A50	A70	C10 - C30	C20	E01	
All engines	x 4, COIL ON PLUG									470 632	C10		
ENGINE													
530 i	Petrol	185	09/16->	B46 B20 B, B48 B20 B									
Engine	Information				A10	A20	A40	A50	A70	C10 - C30	C20	E01	
All engines	x 4, COIL ON PLUG									470 632	C10		
ENGINE													
530 i Mild-Hybrid	Petrol/ Electric	185	07/20->	B48 B20 B									
Engine	Information				A10	A20	A40	A50	A70	C10 - C30	C20	E01	
All engines	x 4, COIL ON PLUG									470 632	C10		
ENGINE													
530 i Mild-Hybrid xDrive	Petrol/ Electric	185	07/20->	B48 B20 B									
Engine	Information				A10	A20	A40	A50	A70	C10 - C30	C20	E01	
All engines	x 4, COIL ON PLUG									470 632	C10		
ENGINE													
530 i xDrive	Petrol	183	09/16->	B46 B20 B									
Engine	Information				A10	A20	A40	A50	A70	C10 - C30	C20	E01	
All engines	->year 01/06/19, x 4, COIL ON PLUG 01/07/19 ->, x 4, COIL ON PLUG									470 632	C10		
ENGINE													
530 i xDrive	Petrol	185	09/16->	B46 B20 B, B48 B20 B									
Engine	Information				A10	A20	A40	A50	A70	C10 - C30	C20	E01	
All engines	x 4, COIL ON PLUG									470 632	C10		
ENGINE													
540 i	Petrol	250	09/16-06/20	B58 B30 A									
Engine	Information				A10	A20	A40	A50	A70	C10 - C30	C20	E01	
All engines	x 6, COIL ON PLUG									470 632	C10		
ENGINE													
540 i	Petrol	265	09/16-06/20	B58 B30 A									
Engine	Information				A10	A20	A40	A50	A70	C10 - C30	C20	E01	
All engines	x 6, COIL ON PLUG									470 632	C10		
ENGINE													
540 i Mild-Hybrid	Petrol/ Electric	245	07/20->	B58 B30 C									
Engine	Information				A10	A20	A40	A50	A70	C10 - C30	C20	E01	
All engines	x 6, COIL ON PLUG									470 632	C10		
ENGINE													
540 i Mild-Hybrid xDrive	Petrol/ Electric	245	07/20->	B58 B30 C									
Engine	Information				A10	A20	A40	A50	A70	C10 - C30	C20	E01	
All engines	x 6, COIL ON PLUG									470 632	C10		
ENGINE													
540 i xDrive	Petrol	250	09/16->	B58 B30 A									
Engine	Information				A10	A20	A40	A50	A70	C10 - C30	C20	E01	
All engines	x 6, COIL ON PLUG									470 632	C10		
ENGINE													
540 i xDrive	Petrol	265	09/16-06/20	B58 B30 A									
Engine	Information				A10	A20	A40	A50	A70	C10 - C30	C20	E01	
All engines	x 6, COIL ON PLUG									470 632	C10		

A10 CONDENSER	A20 CONTACT SET	A40 DISTRIBUTOR CAP	A50 ROTOR	A70 PICK-UP
C10 COIL	C20 IGNITION MODULE	C30 ELECTRONIC IGNITION KIT	E01 IGNITION CABLE SET	

The present application list is a brief version. For the detailed information about the possibility of installation on a specific vehicle, please refer to our web-catalogue <http://catalogo.facet.eu/>

					FUNCTIONS ON THE VEHICLE							
Vehicle	alim.	kW	Date	Engine	 A10	 A20	 A40	 A50	 A70	 C10 - C30	 C20	 E01
ENGINE												
545 e Plug-in-Hybrid xDrive	Petrol/ Electric	210	11/20->	B58 B30 C								
Engine	Information				A10	A20	A40	A50	A70	C10 - C30	C20	E01
All engines	x 4, COIL ON PLUG									470 632	C10	
ENGINE												
545 e Plug-in-Hybrid xDrive	Petrol/ Electric	290	11/20->	B58 B30 C								
Engine	Information				A10	A20	A40	A50	A70	C10 - C30	C20	E01
All engines	x 4, COIL ON PLUG									470 632	C10	
ENGINE												
M 550 i xDrive	Petrol	340	03/17-06/19	N63 B44 C								
Engine	Information				A10	A20	A40	A50	A70	C10 - C30	C20	E01
All engines	x 8, DELPHI, COIL ON PLUG									470 475	C10	
ENGINE												
M5	Petrol	441	09/17->	S63 B44 B								
Engine	Information				A10	A20	A40	A50	A70	C10 - C30	C20	E01
All engines	x 8, DELPHI, COIL ON PLUG									470 475	C10	
ENGINE												
M5 Competition	Petrol	460	07/18->	S63 B44 B								
Engine	Information				A10	A20	A40	A50	A70	C10 - C30	C20	E01
All engines	x 8, DELPHI, COIL ON PLUG									470 475	C10	
ENGINE												
M5 CS	Petrol	467	03/21->	S63 B44 B								
Engine	Information				A10	A20	A40	A50	A70	C10 - C30	C20	E01
All engines	x 8, DELPHI, COIL ON PLUG									470 475	C10	
6 I												
ENGINE												
628 Ci	Petrol	135	09/79-08/87	M30 B28								
Engine	Information				A10	A20	A40	A50	A70	C10 - C30	C20	E01
All engines	version Bosch						806 081	906 112R				
All engines											465 005	
ENGINE												
633 Ci	Petrol	145	09/78-08/84	0SU18								
Engine	Information				A10	A20	A40	A50	A70	C10 - C30	C20	E01
All engines											465 005	
ENGINE												
633 Ci	Petrol	147	10/75-12/81	0SU18								
Engine	Information				A10	A20	A40	A50	A70	C10 - C30	C20	E01
All engines											465 005	
ENGINE												
635 Ci	Petrol	160	06/78-04/82	M30 B35 (Motronic, 9.3:1)								
Engine	Information				A10	A20	A40	A50	A70	C10 - C30	C20	E01
All engines	01/01/85 ->, version Bosch						806 238	906 119R				
All engines											465 005	
ENGINE												
M 635 CSi	Petrol	191	04/86-02/89	S38 B35 (356ED)								
Engine	Information				A10	A20	A40	A50	A70	C10 - C30	C20	E01
All engines	version Bosch						806 238	906 119R				
ENGINE												
M 635 CSi	Petrol	210	04/84-12/88	M88 B35 (356ED)								
Engine	Information				A10	A20	A40	A50	A70	C10 - C30	C20	E01
All engines	version Bosch						806 238	906 119R				
6 II												
ENGINE												
630 i	Petrol	190	09/04-08/07	N52 B30 A, N52 B30 B, N52 B30 BF								
Engine	Information				A10	A20	A40	A50	A70	C10 - C30	C20	E01
All engines	x 6, ELDOR, x 6, BOSCH, COIL ON PLUG, DELPHI, COIL ON PLUG									470 475	C10	

A10 CONDENSER	A20 CONTACT SET	A40 DISTRIBUTOR CAP	A50 ROTOR	A70 PICK-UP
C10 COIL	C20 IGNITION MODULE	C30 ELECTRONIC IGNITION KIT	E01 IGNITION CABLE SET	

Vehicle	alim.	kW	Date	Engine	FUNCTIONS ON THE VEHICLE									
					A10	A20	A40	A50	A70	C10 - C30	C20	E01		
ENGINE														
630 i	Petrol	200	09/07-08/10	N52 B30 A, N52 B30 B, N52 B30 BF, N53 B30 A										
Engine	Information													
Eng. N52 B30 A, N52 B30 B, N52 B30 BF	x 6, DELPHI, COIL ON PLUG									470 475	C10			
Eng. N53 B30 A	x 6, BOSCH, COIL ON PLUG									470 607	C10			
ENGINE														
645 Ci	Petrol	245	09/03-08/05	N62 B44 A										
Engine	Information													
All engines	x 8, ELDOR, COIL ON PLUG									470 475	C10			
ENGINE														
650 i	Petrol	270	09/05-08/10	N62 B48 B										
Engine	Information													
All engines	x 8, DELPHI, ELDOR, COIL ON PLUG									470 475	C10			
6 III														
ENGINE														
640 i	Petrol	235	07/11-10/18	N55 B30 A										
Engine	Information													
All engines	x 6, DELPHI, COIL ON PLUG									470 475	C10			
ENGINE														
640 i xDrive	Petrol	235	03/13-10/18	N55 B30 A										
Engine	Information													
All engines	x 6, DELPHI, COIL ON PLUG									470 475	C10			
ENGINE														
650 i	Petrol	298	09/11-12/12	N63 B44 A										
Engine	Information													
All engines	x 8, ELDOR, COIL ON PLUG									470 475	C10			
ENGINE														
650 i	Petrol	300	12/10-06/12	N63 B44 A										
Engine	Information													
All engines	x 8, DELPHI, ELDOR, COIL ON PLUG									470 475	C10			
ENGINE														
650 i	Petrol	330	07/12-10/18	N63 B44 A, N63 B44 B										
Engine	Information													
Eng. N63 B44 A	Qty: 8									470 475	C10			
Eng. N63 B44 B	x 8, BOSCH, DELPHI, COIL ON PLUG									470 475	C10			
ENGINE														
650 i xDrive	Petrol	0	11/11->	N63 B40 A										
Engine	Information													
All engines	Qty: 8									470 475	C10			
ENGINE														
650 i xDrive	Petrol	300	09/11-02/15	N63 B44 A										
Engine	Information													
All engines	x 8, DELPHI, ELDOR, COIL ON PLUG									470 475	C10			
ENGINE														
650 i xDrive	Petrol	330	07/12-10/18	N63 B44 A, N63 B44 B										
Engine	Information													
Eng. N63 B44 A	Qty: 8									470 475	C10			
Eng. N63 B44 B	x 8, BOSCH, DELPHI, COIL ON PLUG									470 475	C10			
ENGINE														
650 i xDrive 4.0	Petrol	330	06/11->	N63 B40 A										
Engine	Information													
All engines	Qty: 8									470 475	C10			
ENGINE														
M6	Petrol	412	03/12-10/18	S63 B44 B										
Engine	Information													
All engines	x 8, BOSCH, DELPHI, COIL ON PLUG									470 475	C10			
ENGINE														
M6 Competition	Petrol	423	07/13-02/15	S63 B44 B										
Engine	Information													
All engines	x 8, BOSCH, COIL ON PLUG									470 475	C10			

A10	CONDENSER	A20	CONTACT SET	A40	DISTRIBUTOR CAP	A50	ROTOR	A70	PICK-UP
C10	COIL	C20	IGNITION MODULE	C30	ELECTRONIC IGNITION KIT	E01	IGNITION CABLE SET		

The present application list is a brief version. For the detailed information about the possibility of installation on a specific vehicle, please refer to our web-catalogue <http://catalogo.facet.eu/>









					FUNCTIONS ON THE VEHICLE							
Vehicle	alim.	kW	Date	Engine								
M6 Competition												
ENGINE												
Petrol		441	03/15-10/18	S63 B44 B								
Engine	Information				A10	A20	A40	A50	A70	C10 - C30	C20	E01
All engines	x 8, BOSCH, DELPHI, COIL ON PLUG									470 475	C10	
6 IV GT												
ENGINE												
Petrol		183	06/17-06/20	B48 B20 B								
Engine	Information				A10	A20	A40	A50	A70	C10 - C30	C20	E01
All engines	->year 01/06/19, x 4, COIL ON PLUG 01/07/19->, x 4, COIL ON PLUG									470 632	C10	
ENGINE												
Petrol		190	07/17-06/20	B48 B20 B								
Engine	Information				A10	A20	A40	A50	A70	C10 - C30	C20	E01
All engines	x 4, COIL ON PLUG									470 632	C10	
ENGINE												
Petrol/ Electric		190	07/20->	B48 B20 B								
Engine	Information				A10	A20	A40	A50	A70	C10 - C30	C20	E01
All engines	x 4, COIL ON PLUG									470 632	C10	
ENGINE												
Petrol		190	07/19->	B58 B30 C								
Engine	Information				A10	A20	A40	A50	A70	C10 - C30	C20	E01
All engines	x 6, COIL ON PLUG									470 632	C10	
ENGINE												
Petrol		250	06/17-06/20	B58 B30 A, B58 B30 C								
Engine	Information				A10	A20	A40	A50	A70	C10 - C30	C20	E01
All engines	x 6, COIL ON PLUG									470 632	C10	
ENGINE												
Petrol		265	06/17-06/20	B58 B30 A, B58 B30 C								
Engine	Information				A10	A20	A40	A50	A70	C10 - C30	C20	E01
All engines	x 6, COIL ON PLUG									470 632	C10	
ENGINE												
Petrol/ Electric		245	07/20->	B58 B30 C								
Engine	Information				A10	A20	A40	A50	A70	C10 - C30	C20	E01
All engines	x 6, COIL ON PLUG									470 632	C10	
ENGINE												
Petrol/ Electric		245	07/20->	B58 B30 C								
Engine	Information				A10	A20	A40	A50	A70	C10 - C30	C20	E01
All engines	x 6, COIL ON PLUG									470 632	C10	
ENGINE												
Petrol		250	06/17-06/20	B58 B30 A, B58 B30 C								
Engine	Information				A10	A20	A40	A50	A70	C10 - C30	C20	E01
All engines	x 6, COIL ON PLUG									470 632	C10	
ENGINE												
Petrol		265	06/17-06/20	B58 B30 A, B58 B30 C								
Engine	Information				A10	A20	A40	A50	A70	C10 - C30	C20	E01
All engines	x 6, COIL ON PLUG									470 632	C10	
7 I												
ENGINE												
Petrol		125	05/77-08/79	M30 B28								
Engine	Information				A10	A20	A40	A50	A70	C10 - C30	C20	E01
All engines	version Bosch						806 081					
All engines											465 005	
ENGINE												
Petrol		135	09/77-08/86	M30 B28								
Engine	Information				A10	A20	A40	A50	A70	C10 - C30	C20	E01
All engines	->year 31/12/80, version Bosch						806 081					
All engines											465 005	

A10 CONDENSER	A20 CONTACT SET	A40 DISTRIBUTOR CAP	A50 ROTOR	A70 PICK-UP
C10 COIL	C20 IGNITION MODULE	C30 ELECTRONIC IGNITION KIT	E01 IGNITION CABLE SET	

Vehicle	alim.	kW	Date	Engine	FUNCTIONS ON THE VEHICLE									
					A10	A20	A40	A50	A70	C10 - C30	C20	E01		
ENGINE														
730	Petrol	135	05/77-08/79	M30 B30										
Engine	Information				A10	A20	A40	A50	A70	C10 - C30	C20	E01		
All engines	version Bosch						806 081							
All engines											465 005			
ENGINE														
735 i	Petrol	141	04/85-08/86	M30 B35 (Motronic)										
Engine	Information				A10	A20	A40	A50	A70	C10 - C30	C20	E01		
All engines	version Bosch						806 238	906 119R						
7 II														
ENGINE														
730 i, iL	Petrol	138	03/87-03/94	M30 B30 (306KA)										
Engine	Information				A10	A20	A40	A50	A70	C10 - C30	C20	E01		
All engines	version Bosch						806 238	906 119R						
All engines	->year 30/09/88, 01/03/88 ->												359 578	
ENGINE														
730 i, iL	Petrol	145	03/85-01/89	M30 B30 (306EA)										
Engine	Information				A10	A20	A40	A50	A70	C10 - C30	C20	E01		
All engines	version Bosch						806 238	906 119R						
All engines	->year 30/09/88, 01/03/88 ->												359 578	
ENGINE														
730 i, iL V8	Petrol	160	04/92-09/94	M60 B30 (308S1)										
Engine	Information				A10	A20	A40	A50	A70	C10 - C30	C20	E01		
All engines	without spark plug connector, Qty: 8									470 162S	C10			
All engines	incl. spark plug connector, Qty: 8									470 412	C10			
ENGINE														
735 i, iL	Petrol	155	06/86-07/92	M30 B34 (346KB)										
Engine	Information				A10	A20	A40	A50	A70	C10 - C30	C20	E01		
All engines	version Bosch						806 238	906 119R						
All engines	01/03/88 ->, ->year 30/09/88												359 578	
ENGINE														
735 i, iL	Petrol	162	07/86-01/89	M30 B35 (Motronic, 9.2:1)										
Engine	Information				A10	A20	A40	A50	A70	C10 - C30	C20	E01		
All engines	version Bosch						806 238	906 119R						
All engines	01/03/88 ->, ->year 30/09/88												359 578	
ENGINE														
740 i, iL V8	Petrol	210	05/92-03/94	M60 B40 (408S1)										
Engine	Information				A10	A20	A40	A50	A70	C10 - C30	C20	E01		
All engines	without spark plug connector, Qty: 8									470 162S	C10			
All engines	incl. spark plug connector, Qty: 8									470 412	C10			
ENGINE														
750 i, iL V12	Petrol	220	09/87-09/94	M70 B50 (5012A)										
Engine	Information				A10	A20	A40	A50	A70	C10 - C30	C20	E01		
All engines	Qty: 2, version Bosch						806 238	906 119R						
All engines	to engine cylinder:1-6									470 112	C10			
7 III														
ENGINE														
728 i, iL	Petrol	142	08/95-11/01	M52 B28 (286S1), M52 B28 (286S2)										
Engine	Information				A10	A20	A40	A50	A70	C10 - C30	C20	E01		
All engines	without spark plug connector, Qty: 6									470 352	C10			
All engines	incl. spark plug connector, Qty: 6									470 413	C10			
ENGINE														
728i X	Petrol	142	11/95-09/01	M52 B28 (286S1)										
Engine	Information				A10	A20	A40	A50	A70	C10 - C30	C20	E01		
All engines	without spark plug connector, Qty: 6									470 352	C10			
All engines	incl. spark plug connector, Qty: 6									470 413	C10			
ENGINE														
730 i, iL	Petrol	155	10/94-11/01	M60 B30 (308S1)										
Engine	Information				A10	A20	A40	A50	A70	C10 - C30	C20	E01		
All engines	without spark plug connector, Qty: 8									470 162S	C10			

A10	CONDENSER	A20	CONTACT SET	A40	DISTRIBUTOR CAP	A50	ROTOR	A70	PICK-UP
C10	COIL	C20	IGNITION MODULE	C30	ELECTRONIC IGNITION KIT	E01	IGNITION CABLE SET		

The present application list is a brief version. For the detailed information about the possibility of installation on a specific vehicle, please refer to our web-catalogue <http://catalogo.facet.eu/>







					FUNCTIONS ON THE VEHICLE							
Vehicle	alim.	kW	Date	Engine	 A10	 A20	 A40	 A50	 A70	 C10 - C30	 C20	 E01
ENGINE												
730 i, iL	Petrol	155	10/94-11/01	M60 B30 (308S1)								
Engine	Information				A10	A20	A40	A50	A70	C10 - C30	C20	E01
All engines	incl. spark plug connector, Qty: 8									470 412	C10	
ENGINE												
730 i, iL	Petrol	160	03/94-02/96	M60 B30 (308S1)								
Engine	Information				A10	A20	A40	A50	A70	C10 - C30	C20	E01
All engines	without spark plug connector, Qty: 8									470 1625	C10	
All engines	incl. spark plug connector, Qty: 8									470 412	C10	
ENGINE												
735 i, iL	Petrol	173	03/96-08/98	M62 B35 (358S1)								
Engine	Information				A10	A20	A40	A50	A70	C10 - C30	C20	E01
All engines	without spark plug connector, Qty: 8									470 352	C10	
All engines	incl. spark plug connector, Qty: 8									470 413	C10	
ENGINE												
740 i, iL	Petrol	210	03/94-07/01	M60 B40 (408S1), M62 B44 (448S1), M62 B44 (448S2)								
Engine	Information				A10	A20	A40	A50	A70	C10 - C30	C20	E01
Eng. M60 B40 (408S1)	without spark plug connector, Qty: 8									470 1625	C10	
Eng. M62 B44 (448S1), M62 B44 (448S2)	without spark plug connector, Qty: 8									470 352	C10	
Eng. M60 B40 (408S1)	incl. spark plug connector, Qty: 8									470 412	C10	
Eng. M62 B44 (448S1), M62 B44 (448S2)	incl. spark plug connector, Qty: 8									470 413	C10	
ENGINE												
750 i, iL	Petrol	240	11/94-07/01	M73 B54 (54121), M73 B54 (54122)								
Engine	Information				A10	A20	A40	A50	A70	C10 - C30	C20	E01
All engines	Qty: 2, version Bosch						806 238	906 119R				
7 IV												
ENGINE												
730 i, Li	Petrol	170	03/03-07/08	1CYA, M54 B30 (306S3)								
Engine	Information				A10	A20	A40	A50	A70	C10 - C30	C20	E01
Eng. 1CYA	x 6, DELPHI, COIL ON PLUG									470 475	C10	
Eng. M54 B30 (306S3)	Qty: 6									470 475	C10	
ENGINE												
730 i, Li	Petrol	184	03/05-07/08	N52 B30 A								
Engine	Information				A10	A20	A40	A50	A70	C10 - C30	C20	E01
All engines	Qty: 6									470 475	C10	
ENGINE												
730 i, Li	Petrol	190	03/05-08/08	N52 B30 A, N52 B30 BF								
Engine	Information				A10	A20	A40	A50	A70	C10 - C30	C20	E01
All engines	x 6, BOSCH, DELPHI, ELDOR, COIL ON PLUG									470 475	C10	
ENGINE												
730 i, Li	Petrol	190	03/05->	N52 B30 B								
Engine	Information				A10	A20	A40	A50	A70	C10 - C30	C20	E01
All engines	Qty: 6									470 475	C10	
ENGINE												
735 i, Li	Petrol	200	11/01-02/05	N62 B36 A								
Engine	Information				A10	A20	A40	A50	A70	C10 - C30	C20	E01
All engines	x 8, ELDOR, COIL ON PLUG									470 475	C10	
ENGINE												
740 i, Li	Petrol	225	03/05-08/08	N62 B40 A								
Engine	Information				A10	A20	A40	A50	A70	C10 - C30	C20	E01
All engines	x 8, DELPHI, ELDOR, COIL ON PLUG									470 475	C10	
ENGINE												
745 i, Li	Petrol	245	07/01-03/05	N62 B44 A								
Engine	Information				A10	A20	A40	A50	A70	C10 - C30	C20	E01
All engines	x 8, DELPHI, ELDOR, COIL ON PLUG									470 475	C10	

A10 CONDENSER	A20 CONTACT SET	A40 DISTRIBUTOR CAP	A50 ROTOR	A70 PICK-UP
C10 COIL	C20 IGNITION MODULE	C30 ELECTRONIC IGNITION KIT	E01 IGNITION CABLE SET	

Vehicle	alim.	kW	Date	Engine	FUNCTIONS ON THE VEHICLE									
					A10	A20	A40	A50	A70	C10 - C30	C20	E01		
ENGINE														
750 i, Li	Petrol	270	03/05-08/08	N62 B48 B										
Engine	Information				A10	A20	A40	A50	A70	C10 - C30	C20	E01		
All engines	x 8, DELPHI, ELDOR, COIL ON PLUG									470 475	C10			
ENGINE														
760 i, Li	Petrol	327	01/03-08/08	N73 B60 A, N73 B60 B										
Engine	Information				A10	A20	A40	A50	A70	C10 - C30	C20	E01		
All engines	x 12, ELDOR, COIL ON PLUG									470 475	C10			
ENGINE														
B7 Alpina	Petrol	0	01/06->	H1										
Engine	Information				A10	A20	A40	A50	A70	C10 - C30	C20	E01		
All engines	Qty: 8									470 475	C10			
7 V														
ENGINE														
730 i, Li	Petrol	190	09/09-06/15	N52 B30 A, N52 B30 AF, N52 B30 BF										
Engine	Information				A10	A20	A40	A50	A70	C10 - C30	C20	E01		
All engines	x 6, DELPHI, COIL ON PLUG									470 475	C10			
ENGINE														
740 i, Li	Petrol	235	07/12-12/15	N55 B30 A										
Engine	Information				A10	A20	A40	A50	A70	C10 - C30	C20	E01		
All engines	x 6, DELPHI, COIL ON PLUG									470 475	C10			
ENGINE														
740 i, Li	Petrol	240	09/08-06/12	N54 B30 A										
Engine	Information				A10	A20	A40	A50	A70	C10 - C30	C20	E01		
All engines	x 6, DELPHI, ELDOR, COIL ON PLUG									470 475	C10			
ENGINE														
740 i, Li xDrive	Petrol	235	07/12-12/15	N55 B30 A										
Engine	Information				A10	A20	A40	A50	A70	C10 - C30	C20	E01		
All engines	x 6, DELPHI, COIL ON PLUG									470 475	C10			
ENGINE														
750 i, Li	Petrol	300	09/08-06/12	N63 B44 A										
Engine	Information				A10	A20	A40	A50	A70	C10 - C30	C20	E01		
All engines	x 8, DELPHI, ELDOR, COIL ON PLUG									470 475	C10			
ENGINE														
750 i, Li	Petrol	330	07/12-06/15	N63 B44 B										
Engine	Information				A10	A20	A40	A50	A70	C10 - C30	C20	E01		
All engines	x 8, BOSCH, COIL ON PLUG									470 475	C10			
ENGINE														
750 i, Li xDrive	Petrol	300	09/09-06/12	N63 B44 A, N63 B44 B										
Engine	Information				A10	A20	A40	A50	A70	C10 - C30	C20	E01		
Eng. N63 B44 A	x 8, DELPHI, ELDOR, COIL ON PLUG									470 475	C10			
Eng. N63 B44 B	Qty: 8									470 475	C10			
ENGINE														
750 i, Li xDrive	Petrol	330	07/12-06/15	N63 B44 B										
Engine	Information				A10	A20	A40	A50	A70	C10 - C30	C20	E01		
All engines	x 8, BOSCH, COIL ON PLUG									470 475	C10			
ENGINE														
750Li xDrive	Petrol	0	01/11->	N63 B40 A										
Engine	Information				A10	A20	A40	A50	A70	C10 - C30	C20	E01		
All engines	Qty: 8									470 475	C10			
ENGINE														
760 i, Li	Petrol	400	09/09-12/15	N74 B60 A										
Engine	Information				A10	A20	A40	A50	A70	C10 - C30	C20	E01		
All engines	x 12, DELPHI, COIL ON PLUG									470 475	C10			
ENGINE														
ActiveHybrid 7	Petrol/ Electric	235	08/12-06/15	N55 B30 A										
Engine	Information				A10	A20	A40	A50	A70	C10 - C30	C20	E01		
All engines	x 6, DELPHI, COIL ON PLUG									470 475	C10			

A10 CONDENSER	A20 CONTACT SET	A40 DISTRIBUTOR CAP	A50 ROTOR	A70 PICK-UP
C10 COIL	C20 IGNITION MODULE	C30 ELECTRONIC IGNITION KIT	E01 IGNITION CABLE SET	

The present application list is a brief version. For the detailed information about the possibility of installation on a specific vehicle, please refer to our web-catalogue <http://catalogo.facet.eu/>









					FUNCTIONS ON THE VEHICLE							
Vehicle	alim.	kW	Date	Engine	 A10	 A20	 A40	 A50	 A70	 C10 - C30	 C20	 E01
ENGINE												
ActiveHybrid 7	Petrol/ Electric	260	08/12-06/15	N55 B30 A								
Engine	Information				A10	A20	A40	A50	A70	C10 - C30	C20	E01
All engines	x 6, DELPHI, COIL ON PLUG									470 475	C10	
ENGINE												
ActiveHybrid 7	Petrol/ Electric	330	04/10-06/12	N63 B44 A								
Engine	Information				A10	A20	A40	A50	A70	C10 - C30	C20	E01
All engines	x 8, DELPHI, ELDOR, COIL ON PLUG									470 475	C10	
ENGINE												
ActiveHybrid 7	Petrol/ Electric	342	04/10-06/12	N63 B44 A								
Engine	Information				A10	A20	A40	A50	A70	C10 - C30	C20	E01
All engines	x 8, DELPHI, ELDOR, COIL ON PLUG									470 475	C10	
7 VI												
ENGINE												
730 i	Petrol	183	11/15->	B48 B20 B								
Engine	Information				A10	A20	A40	A50	A70	C10 - C30	C20	E01
All engines	x 4, COIL ON PLUG									470 632	C10	
ENGINE												
730 i, Li	Petrol	190	11/15-02/19	B48 B20 B								
Engine	Information				A10	A20	A40	A50	A70	C10 - C30	C20	E01
All engines	x 4, COIL ON PLUG									470 632	C10	
ENGINE												
730 i, Li	Petrol	195	03/19->	B48 B20 B								
Engine	Information				A10	A20	A40	A50	A70	C10 - C30	C20	E01
All engines	x 4, COIL ON PLUG									470 632	C10	
ENGINE												
740 e, Le	Petrol/ Electric	190	07/16-02/19	B48 B20 B								
Engine	Information				A10	A20	A40	A50	A70	C10 - C30	C20	E01
All engines	x 4, COIL ON PLUG									470 632	C10	
ENGINE												
740 e, Le	Petrol/ Electric	240	07/16-02/19	B48 B20 B								
Engine	Information				A10	A20	A40	A50	A70	C10 - C30	C20	E01
All engines	x 4, COIL ON PLUG									470 632	C10	
ENGINE												
740 i, Li	Petrol	240	07/15-02/19	B58 B30 A								
Engine	Information				A10	A20	A40	A50	A70	C10 - C30	C20	E01
All engines	x 6, COIL ON PLUG									470 632	C10	
ENGINE												
740 i, Li	Petrol	250	03/19->	B58 B30 C								
Engine	Information				A10	A20	A40	A50	A70	C10 - C30	C20	E01
All engines	x 6, COIL ON PLUG									470 632	C10	
ENGINE												
740 Le xDrive	Petrol/ Electric	190	07/16-02/19	B48 B20 B								
Engine	Information				A10	A20	A40	A50	A70	C10 - C30	C20	E01
All engines	x 4, COIL ON PLUG									470 632	C10	
ENGINE												
740 Le xDrive	Petrol/ Electric	240	07/16-02/19	B48 B20 B								
Engine	Information				A10	A20	A40	A50	A70	C10 - C30	C20	E01
All engines	x 4, COIL ON PLUG									470 632	C10	
ENGINE												
740 Li xDrive	Petrol	240	03/16-02/19	B58 B30 A								
Engine	Information				A10	A20	A40	A50	A70	C10 - C30	C20	E01
All engines	x 6, COIL ON PLUG									470 632	C10	

A10 CONDENSER	A20 CONTACT SET	A40 DISTRIBUTOR CAP	A50 ROTOR	A70 PICK-UP
C10 COIL	C20 IGNITION MODULE	C30 ELECTRONIC IGNITION KIT	E01 IGNITION CABLE SET	

Vehicle	alim.	kW	Date	Engine	FUNCTIONS ON THE VEHICLE									
					A10	A20	A40	A50	A70	C10 - C30	C20	E01		
ENGINE														
740 Li xDrive	Petrol	250	03/19->	B58 B30 C										
Engine	Information				A10	A20	A40	A50	A70	C10 - C30	C20	E01		
All engines	x 6, COIL ON PLUG									470 632	C10			
ENGINE														
745 e, Le Plug-in-Hybrid	Petrol/ Electric	210	03/19->	B58 B30 C										
Engine	Information				A10	A20	A40	A50	A70	C10 - C30	C20	E01		
All engines	x 6, COIL ON PLUG									470 632	C10			
ENGINE														
745 e, Le Plug-in-Hybrid	Petrol/ Electric	290	03/19->	B58 B30 C										
Engine	Information				A10	A20	A40	A50	A70	C10 - C30	C20	E01		
All engines	x 6, COIL ON PLUG									470 632	C10			
ENGINE														
745 Le Plug-in-Hybrid xDrive	Petrol/ Electric	210	03/19->	B58 B30 C										
Engine	Information				A10	A20	A40	A50	A70	C10 - C30	C20	E01		
All engines	x 6, COIL ON PLUG									470 632	C10			
ENGINE														
745 Le Plug-in-Hybrid xDrive	Petrol/ Electric	290	03/19->	B58 B30 C										
Engine	Information				A10	A20	A40	A50	A70	C10 - C30	C20	E01		
All engines	x 6, COIL ON PLUG									470 632	C10			
ENGINE														
750 i, Li	Petrol	330	11/15-02/19	N63 B44 C										
Engine	Information				A10	A20	A40	A50	A70	C10 - C30	C20	E01		
All engines	x 8, DELPHI, COIL ON PLUG									470 475	C10			
ENGINE														
750 i, Li xDrive	Petrol	330	09/15-02/19	N63 B44 C										
Engine	Information				A10	A20	A40	A50	A70	C10 - C30	C20	E01		
All engines	x 8, DELPHI, COIL ON PLUG									470 475	C10			
ENGINE														
750 Li xDrive	Petrol	330	03/16->	N63 B40 B										
Engine	Information				A10	A20	A40	A50	A70	C10 - C30	C20	E01		
All engines	x 8, DELPHI, COIL ON PLUG									470 475	C10			
ENGINE														
M 760 i, Li xDrive	Petrol	448	12/16-02/19	N74 B66 B										
Engine	Information				A10	A20	A40	A50	A70	C10 - C30	C20	E01		
All engines	x 12, DELPHI, COIL ON PLUG									470 475	C10			
ENGINE														
M 760 Li xDrive	Petrol	430	03/19->	N74 B66 C										
Engine	Information				A10	A20	A40	A50	A70	C10 - C30	C20	E01		
All engines	x 12, DELPHI, COIL ON PLUG									470 475	C10			
8														
ENGINE														
840 Ci	Petrol	210	03/96-06/99	M62 B44 (448S1)										
Engine	Information				A10	A20	A40	A50	A70	C10 - C30	C20	E01		
All engines	without spark plug connector, Qty: 8									470 352	C10			
All engines	incl. spark plug connector, Qty: 8									470 413	C10			
ENGINE														
840 i	Petrol	210	03/93-02/96	M60 B40 (408S1)										
Engine	Information				A10	A20	A40	A50	A70	C10 - C30	C20	E01		
All engines	without spark plug connector, Qty: 8									470 162S	C10			
All engines	incl. spark plug connector, Qty: 8									470 412	C10			
ENGINE														
840 i	Petrol	245	11/20->	B58 B30 C										
Engine	Information				A10	A20	A40	A50	A70	C10 - C30	C20	E01		
All engines	x 6, COIL ON PLUG									470 632	C10			

A10	CONDENSER	A20	CONTACT SET	A40	DISTRIBUTOR CAP	A50	ROTOR	A70	PICK-UP
C10	COIL	C20	IGNITION MODULE	C30	ELECTRONIC IGNITION KIT	E01	IGNITION CABLE SET		

The present application list is a brief version. For the detailed information about the possibility of installation on a specific vehicle, please refer to our web-catalogue <http://catalogo.facet.eu/>

				FUNCTIONS ON THE VEHICLE								
Vehicle	alim.	kW	Date	Engine								
				ENGINE								
840 i	Petrol	250	07/19-10/20	B58 B30 C								
				ENGINE								
Engine		Information			A10	A20	A40	A50	A70	C10 - C30	C20	E01
All engines		x 6, COIL ON PLUG								470 632	C10	
840 i xDrive	Petrol	245	11/20->	B58 B30 C								
				ENGINE								
Engine		Information			A10	A20	A40	A50	A70	C10 - C30	C20	E01
All engines		x 6, COIL ON PLUG								470 632	C10	
840 i xDrive	Petrol	250	07/19->	B58 B30 C								
				ENGINE								
Engine		Information			A10	A20	A40	A50	A70	C10 - C30	C20	E01
All engines		x 6, COIL ON PLUG								470 632	C10	
850 Si	Petrol	280	11/92-12/96	S70 B56 (56121)								
				ENGINE								
Engine		Information			A10	A20	A40	A50	A70	C10 - C30	C20	E01
All engines		Qty: 2, version Bosch					806 238	906 119R				
All engines		to engine cylinder:1-6								470 112	C10	
850 i, Ci	Petrol	220	01/90-08/94	M70 B50 (5012A)								
				ENGINE								
Engine		Information			A10	A20	A40	A50	A70	C10 - C30	C20	E01
All engines		Qty: 2, version Bosch					806 238	906 119R				
All engines		to engine cylinder:1-6								470 112	C10	
M8	Petrol	441	07/19->	S63 B44 B								
				ENGINE								
Engine		Information			A10	A20	A40	A50	A70	C10 - C30	C20	E01
All engines		x 8, DELPHI, COIL ON PLUG								470 475	C10	
M8 Competition	Petrol	460	07/19->	S63 B44 B								
				ENGINE								
Engine		Information			A10	A20	A40	A50	A70	C10 - C30	C20	E01
All engines		x 8, DELPHI, COIL ON PLUG								470 475	C10	
X1 I				ENGINE								
sDrive 16 i	Petrol	105	03/13-06/15	N20 B16 A								
				ENGINE								
Engine		Information			A10	A20	A40	A50	A70	C10 - C30	C20	E01
All engines		x 4, DELPHI, COIL ON PLUG								470 475	C10	
sDrive 18 i	Petrol	100	03/10-06/15	N46 B20 B								
				ENGINE								
Engine		Information			A10	A20	A40	A50	A70	C10 - C30	C20	E01
All engines		x 4, ELDOR, COIL ON PLUG								470 475	C10	
sDrive 18 i	Petrol	110	03/10-06/15	N46 B20 B, N46 B20 BD								
				ENGINE								
Engine		Information			A10	A20	A40	A50	A70	C10 - C30	C20	E01
All engines		x 4, ELDOR, COIL ON PLUG								470 475	C10	
sDrive 18 i [CHN]	Petrol	135	01/13->	N20 B20 C								
				ENGINE								
Engine		Information			A10	A20	A40	A50	A70	C10 - C30	C20	E01
All engines		Qty: 4								470 475	C10	
sDrive 20 i	Petrol	135	09/11-06/15	N20 B20 A								
				ENGINE								
Engine		Information			A10	A20	A40	A50	A70	C10 - C30	C20	E01
All engines		x 4, DELPHI, COIL ON PLUG								470 475	C10	
sDrive 28 i [USA]	Petrol	180	01/09->	N20 B20 A								
				ENGINE								
Engine		Information			A10	A20	A40	A50	A70	C10 - C30	C20	E01
All engines		Qty: 4								470 475	C10	
xDrive 20 i	Petrol	135	09/11-06/15	N20 B20 A								
				ENGINE								
Engine		Information			A10	A20	A40	A50	A70	C10 - C30	C20	E01
All engines		x 4, DELPHI, COIL ON PLUG								470 475	C10	

A10 CONDENSER	A20 CONTACT SET	A40 DISTRIBUTOR CAP	A50 ROTOR	A70 PICK-UP
C10 COIL	C20 IGNITION MODULE	C30 ELECTRONIC IGNITION KIT	E01 IGNITION CABLE SET	

Vehicle	alim.	kW	Date	Engine	FUNCTIONS ON THE VEHICLE									
					A10	A20	A40	A50	A70	C10 - C30	C20	E01		
ENGINE														
xDrive 25 i	Petrol	160	03/10-08/11	N52 B30 A										
Engine	Information				A10	A20	A40	A50	A70	C10 - C30	C20	E01		
All engines	x 6, DELPHI, ELDOR, COIL ON PLUG									470 475	C10			
ENGINE														
xDrive 28 i	Petrol	180	03/11-06/15	N20 B20 A										
Engine	Information				A10	A20	A40	A50	A70	C10 - C30	C20	E01		
All engines	x 4, DELPHI, COIL ON PLUG									470 475	C10			
ENGINE														
xDrive 28 i	Petrol	190	09/09-08/11	N52 B30 A										
Engine	Information				A10	A20	A40	A50	A70	C10 - C30	C20	E01		
All engines	x 6, DELPHI, COIL ON PLUG									470 475	C10			
ENGINE														
xDrive 28 i	Petrol	194	03/10-06/11	N52 B30 A										
Engine	Information				A10	A20	A40	A50	A70	C10 - C30	C20	E01		
All engines	x 6, DELPHI, COIL ON PLUG									470 475	C10			
ENGINE														
xDrive 35 i	Petrol	225	03/11-06/15	N55 B30 A										
Engine	Information				A10	A20	A40	A50	A70	C10 - C30	C20	E01		
All engines	Qty: 6									470 475	C10			
X1 II														
ENGINE														
sDrive 18 i	Petrol	100	11/15->	B38 A15 A										
Engine	Information				A10	A20	A40	A50	A70	C10 - C30	C20	E01		
All engines	x 3, COIL ON PLUG									470 632	C10			
ENGINE														
sDrive 18 i	Petrol	103	07/17->	B38 A15 A										
Engine	Information				A10	A20	A40	A50	A70	C10 - C30	C20	E01		
All engines	x 3, COIL ON PLUG									470 632	C10			
ENGINE														
sDrive 20 i	Petrol	131	11/20->	B48 A20 A, B48 A20 F										
Engine	Information				A10	A20	A40	A50	A70	C10 - C30	C20	E01		
All engines	x 4, COIL ON PLUG									470 632	C10			
ENGINE														
sDrive 20 i	Petrol	141	07/15->	B48 A20 A, B48 A20 F										
Engine	Information				A10	A20	A40	A50	A70	C10 - C30	C20	E01		
All engines	x 4, COIL ON PLUG									470 632	C10			
ENGINE														
xDrive 20 i	Petrol	131	11/20->	B48 A20 A, B48 A20 F										
Engine	Information				A10	A20	A40	A50	A70	C10 - C30	C20	E01		
All engines	x 4, COIL ON PLUG									470 632	C10			
ENGINE														
xDrive 20 i	Petrol	141	07/15->	B48 A20 B										
Engine	Information				A10	A20	A40	A50	A70	C10 - C30	C20	E01		
All engines	x 4, COIL ON PLUG									470 632	C10			
ENGINE														
xDrive 25 e Plug-in-Hybrid	Petrol/ Electric	162	03/20->	B38 A15 A										
Engine	Information				A10	A20	A40	A50	A70	C10 - C30	C20	E01		
All engines	x 3, COIL ON PLUG									470 632	C10			
ENGINE														
xDrive 25 e Plug-in-Hybrid	Petrol/ Electric	92	03/20->	B38 A15 A										
Engine	Information				A10	A20	A40	A50	A70	C10 - C30	C20	E01		
All engines	x 3, COIL ON PLUG									470 632	C10			
ENGINE														
xDrive 25 i	Petrol	170	07/15->	B46 A20 B, B48 A20 B										
Engine	Information				A10	A20	A40	A50	A70	C10 - C30	C20	E01		
All engines	x 4, COIL ON PLUG									470 632	C10			

A10 CONDENSER	A20 CONTACT SET	A40 DISTRIBUTOR CAP	A50 ROTOR	A70 PICK-UP
C10 COIL	C20 IGNITION MODULE	C30 ELECTRONIC IGNITION KIT	E01 IGNITION CABLE SET	

The present application list is a brief version. For the detailed information about the possibility of installation on a specific vehicle, please refer to our web-catalogue <http://catalogo.facet.eu/>

Vehicle	alim.	kW	Date	Engine	FUNCTIONS ON THE VEHICLE							
					A10	A20	A40	A50	A70	C10 - C30	C20	E01

X2

					ENGINE
M35 i	Petrol	225	11/18->		B48 A20 E

Engine	Information	A10	A20	A40	A50	A70	C10 - C30	C20	E01
All engines	x 4, COIL ON PLUG						470 632	C10	

					ENGINE
sDrive 18 i	Petrol	100	03/18->		B32 S15 A, B38 A15 A

Engine	Information	A10	A20	A40	A50	A70	C10 - C30	C20	E01
All engines	x 3, COIL ON PLUG						470 632	C10	

					ENGINE
sDrive 18 i	Petrol	103	03/18->		B38 A15 A

Engine	Information	A10	A20	A40	A50	A70	C10 - C30	C20	E01
All engines	x 3, COIL ON PLUG						470 632	C10	

					ENGINE
sDrive 20 i	Petrol	131	11/20->		B48 A20 A, B48 A20 F

Engine	Information	A10	A20	A40	A50	A70	C10 - C30	C20	E01
All engines	x 4, COIL ON PLUG						470 632	C10	

					ENGINE
sDrive 20 i	Petrol	141	11/17->		B42 S20 A, B48 A20 A

Engine	Information	A10	A20	A40	A50	A70	C10 - C30	C20	E01
All engines	x 4, COIL ON PLUG						470 632	C10	

					ENGINE
xDrive 20 i	Petrol	131	11/20->		B48 A20 A

Engine	Information	A10	A20	A40	A50	A70	C10 - C30	C20	E01
All engines	x 4, COIL ON PLUG						470 632	C10	

					ENGINE
xDrive 20 i	Petrol	141	03/18-10/20		B48 A20 A

Engine	Information	A10	A20	A40	A50	A70	C10 - C30	C20	E01
All engines	x 4, COIL ON PLUG						470 632	C10	

					ENGINE
xDrive 25 e Plug-in-Hybrid	Petrol/ Electric	162	03/20->		B38 A15 A

Engine	Information	A10	A20	A40	A50	A70	C10 - C30	C20	E01
All engines	x 3, COIL ON PLUG						470 632	C10	

					ENGINE
xDrive 25 e Plug-in-Hybrid	Petrol/ Electric	92	03/20->		B38 A15 A

Engine	Information	A10	A20	A40	A50	A70	C10 - C30	C20	E01
All engines	x 3, COIL ON PLUG						470 632	C10	

X3 I

					ENGINE
2.0 i	Petrol	110	07/05-08/08		N46 B20 B

Engine	Information	A10	A20	A40	A50	A70	C10 - C30	C20	E01
All engines	x 4, DELPHI, COIL ON PLUG						470 475	C10	

					ENGINE
2.5 i	Petrol	141	03/04-07/06		M54 B25 (256S5), M54B256S5

Engine	Information	A10	A20	A40	A50	A70	C10 - C30	C20	E01
Eng. M54 B25 (256S5)	Qty: 6						470 475	C10	
Eng. M54B256S5	x 6, DELPHI, COIL ON PLUG						470 475	C10	

					ENGINE
2.5 si	Petrol	160	08/06-08/08		N52 B25 A, N52 B25 AF, N52 B25 BF









Engine	Information	A10	A20	A40	A50	A70	C10 - C30	C20	E01
All engines	x 6, DELPHI, COIL ON PLUG						470 475	C10	

					ENGINE
2.5 si xDrive	Petrol	155	08/06-08/08		N52 B25 A, N52 B25 AF, N52 B25 BF

Engine	Information	A10	A20	A40	A50	A70	C10 - C30	C20	E01
All engines	x 6, DELPHI, COIL ON PLUG						470 475	C10	

A10 CONDENSER	A20 CONTACT SET	A40 DISTRIBUTOR CAP	A50 ROTOR	A70 PICK-UP
C10 COIL	C20 IGNITION MODULE	C30 ELECTRONIC IGNITION KIT	E01 IGNITION CABLE SET	

Vehicle	alim.	kW	Date	Engine	FUNCTIONS ON THE VEHICLE								
					A10	A20	A40	A50	A70	C10 - C30	C20	E01	
3.0 i xDrive	Petrol	170	09/03-07/06	ENGINE M54 B30 (306S3), M54B306S3									
Engine	Information												
Eng. M54 B30 (306S3)	Qty: 6									470 475	C10		
Eng. M54B306S3	x 6, DELPHI, COIL ON PLUG									470 475	C10		
3.0 si	Petrol	194	09/06-08/08	ENGINE N52 B30 A, N52KB30									
Engine	Information												
All engines	x 6, DELPHI, ELDOR, COIL ON PLUG									470 475	C10		
Eng. N52 B30 A	Qty: 6									470 475	C10		
3.0 si	Petrol	200	08/06-08/08	ENGINE N52 B30 A, N52 B30 BF									
Engine	Information												
All engines	x 6, DELPHI, COIL ON PLUG									470 475	C10		
xDrive 2.5si	Petrol	160	09/06->	ENGINE N52 B25 BF, N52B25B									
Engine	Information												
All engines	Qty: 6									470 475	C10		
xDrive 20 i	Petrol	110	09/08-08/11	ENGINE N46 B20 B									
Engine	Information												
All engines	x 4, DELPHI, COIL ON PLUG									470 475	C10		
xDrive 25 i	Petrol	155	09/08-08/10	ENGINE N52 B25 A, N52 B25 AF, N52 B25 BF									
Engine	Information												
All engines	x 6, DELPHI, COIL ON PLUG									470 475	C10		
xDrive 25 i	Petrol	160	09/08-08/10	ENGINE N52 B25 A, N52 B25 AF, N52 B25 BF									
Engine	Information												
All engines	x 6, DELPHI, COIL ON PLUG									470 475	C10		
xDrive 3.0si	Petrol	200	09/06->	ENGINE N52 B30 B, N52 B30 BF									
Engine	Information												
All engines	Qty: 6									470 475	C10		
xDrive 30 i	Petrol	200	09/08-08/10	ENGINE N52 B30 A, N52 B30 BF									
Engine	Information												
All engines	x 6, DELPHI, COIL ON PLUG									470 475	C10		
X3 II													
sDrive 20 i	Petrol	125	04/14-08/17	ENGINE N20 B16 A									
Engine	Information												
All engines	x 4, DELPHI, COIL ON PLUG									470 475	C10		
sDrive 20 i	Petrol	135	04/14-08/17	ENGINE N20 B20 A									
Engine	Information												
All engines	x 4, DELPHI, COIL ON PLUG									470 475	C10		
sDrive 28 i [USA]	Petrol	135	01/13->	ENGINE N20 B20 A									
Engine	Information												
All engines	Qty: 4									470 475	C10		
xDrive 20 i	Petrol	135	10/11-08/17	ENGINE N20 B20 A									
Engine	Information												
All engines	x 4, DELPHI, COIL ON PLUG									470 475	C10		
xDrive 28 i	Petrol	180	04/12-08/17	ENGINE N20 B20 A									
Engine	Information												
All engines	x 4, DELPHI, COIL ON PLUG									470 475	C10		
A10	CONDENSER	A20	CONTACT SET	A40	DISTRIBUTOR CAP	A50	ROTOR	A70	PICK-UP				
C10	COIL	C20	IGNITION MODULE	C30	ELECTRONIC IGNITION KIT	E01	IGNITION CABLE SET						

					FUNCTIONS ON THE VEHICLE							
Vehicle	alim.	kW	Date	Engine	 A10	 A20	 A40	 A50	 A70	 C10 - C30	 C20	 E01
ENGINE												
xDrive 28 i	Petrol	190	01/11-10/12	N52 B30 A, N52 B30 AF, N52 B30 BF								
Engine	Information				A10	A20	A40	A50	A70	C10 - C30	C20	E01
All engines	x 6, DELPHI, ELDOR, COIL ON PLUG									470 475	C10	
ENGINE												
xDrive 35 i	Petrol	225	09/10-08/17	N55 B30 A								
Engine	Information				A10	A20	A40	A50	A70	C10 - C30	C20	E01
All engines	x 6, DELPHI, COIL ON PLUG									470 475	C10	
X3 III												
ENGINE												
M	Petrol	353	03/19->	S58 B30 A								
Engine	Information				A10	A20	A40	A50	A70	C10 - C30	C20	E01
All engines	x 6, COIL ON PLUG									470 632	C10	
ENGINE												
M Competition	Petrol	375	03/19->	S58 B30 A								
Engine	Information				A10	A20	A40	A50	A70	C10 - C30	C20	E01
All engines	x 6, COIL ON PLUG									470 632	C10	
ENGINE												
sDrive 20 i	Petrol	135	12/17->	B48 B20 A								
Engine	Information				A10	A20	A40	A50	A70	C10 - C30	C20	E01
All engines	x 4, COIL ON PLUG									470 632	C10	
ENGINE												
sDrive 20 i 1.6	Petrol	125	12/17->	B48 B16 A								
Engine	Information				A10	A20	A40	A50	A70	C10 - C30	C20	E01
All engines	x 4, COIL ON PLUG									470 632	C10	
ENGINE												
xDrive 20 i	Petrol	135	12/17->	B48 B20 A								
Engine	Information				A10	A20	A40	A50	A70	C10 - C30	C20	E01
All engines	x 4, COIL ON PLUG									470 632	C10	
ENGINE												
xDrive 20 i Mild Hybrid	Petrol/ Electric	135	08/21->	B48 B20 B								
Engine	Information				A10	A20	A40	A50	A70	C10 - C30	C20	E01
All engines	x 4, COIL ON PLUG									470 632	C10	
ENGINE												
xDrive 30 e Plug-in-Hybrid	Petrol/ Electric	120	12/19->	B48 B20 A								
Engine	Information				A10	A20	A40	A50	A70	C10 - C30	C20	E01
All engines	x 4, COIL ON PLUG									470 632	C10	
ENGINE												
xDrive 30 e Plug-in-Hybrid	Petrol/ Electric	135	12/19->	B46 B20 B, B48 B20 A								
Engine	Information				A10	A20	A40	A50	A70	C10 - C30	C20	E01
All engines	x 4, COIL ON PLUG									470 632	C10	
ENGINE												
xDrive 30 e Plug-in-Hybrid	Petrol/ Electric	170	12/19->	B48 B20 A								
Engine	Information				A10	A20	A40	A50	A70	C10 - C30	C20	E01
All engines	x 4, COIL ON PLUG									470 632	C10	
ENGINE												
xDrive 30 e Plug-in-Hybrid	Petrol/ Electric	185	12/19->	B46 B20 B, B48 B20 A								
Engine	Information				A10	A20	A40	A50	A70	C10 - C30	C20	E01
All engines	x 4, COIL ON PLUG									470 632	C10	
ENGINE												
xDrive 30 i	Petrol	183	08/17->	B48 B20 B								
Engine	Information				A10	A20	A40	A50	A70	C10 - C30	C20	E01
All engines	x 4, COIL ON PLUG									470 632	C10	

A10 CONDENSER	A20 CONTACT SET	A40 DISTRIBUTOR CAP	A50 ROTOR	A70 PICK-UP
C10 COIL	C20 IGNITION MODULE	C30 ELECTRONIC IGNITION KIT	E01 IGNITION CABLE SET	

Vehicle	alim.	kW	Date	Engine	FUNCTIONS ON THE VEHICLE								
					A10	A20	A40	A50	A70	C10 - C30	C20	E01	
ENGINE													
xDrive 30 i	Petrol	185	08/17->	B46 B20 B, B48 B20 B									
Engine	Information				A10	A20	A40	A50	A70	C10 - C30	C20	E01	
Eng. B46 B20 B	COIL ON PLUG, Qty: 4									470 632	C10		
Eng. B48 B20 B	x 4, COIL ON PLUG									470 632	C10		
ENGINE													
xDrive 30 i Mild Hybrid	Petrol/ Electric	180	08/21->	B48 B20 B									
Engine	Information				A10	A20	A40	A50	A70	C10 - C30	C20	E01	
All engines	x 4, COIL ON PLUG									470 632	C10		
ENGINE													
xDrive M40 i	Petrol	260	09/18-08/19	B58 B30 A									
Engine	Information				A10	A20	A40	A50	A70	C10 - C30	C20	E01	
All engines	x 6, COIL ON PLUG									470 632	C10		
ENGINE													
xDrive M40 i	Petrol	265	08/17->	B58 B30 A									
Engine	Information				A10	A20	A40	A50	A70	C10 - C30	C20	E01	
All engines	x 6, COIL ON PLUG									470 632	C10		
ENGINE													
xDrive M40 i	Petrol	285	09/19->	B58 B30 B									
Engine	Information				A10	A20	A40	A50	A70	C10 - C30	C20	E01	
All engines	x 6, COIL ON PLUG									470 632	C10		
ENGINE													
X4 I													
M 40 i	Petrol	265	12/15-03/18	N55 B30 A									
Engine	Information				A10	A20	A40	A50	A70	C10 - C30	C20	E01	
All engines	x 6, DELPHI, COIL ON PLUG									470 475	C10		
ENGINE													
xDrive 20 i	Petrol	135	04/14-03/18	N20 B20 A									
Engine	Information				A10	A20	A40	A50	A70	C10 - C30	C20	E01	
All engines	x 4, DELPHI, COIL ON PLUG									470 475	C10		
ENGINE													
xDrive 28 i	Petrol	180	04/14-03/18	N20 B20 A									
Engine	Information				A10	A20	A40	A50	A70	C10 - C30	C20	E01	
All engines	x 4, DELPHI, COIL ON PLUG									470 475	C10		
ENGINE													
xDrive 35 i	Petrol	225	04/14-03/18	N55 B30 A									
Engine	Information				A10	A20	A40	A50	A70	C10 - C30	C20	E01	
All engines	x 6, DELPHI, COIL ON PLUG									470 475	C10		
ENGINE													
X4 II													
M	Petrol	353	03/19->	S58 B30 A									
Engine	Information				A10	A20	A40	A50	A70	C10 - C30	C20	E01	
All engines	x 6, COIL ON PLUG									470 632	C10		
ENGINE													
M Competition	Petrol	375	03/19->	S58 B30 A									
Engine	Information				A10	A20	A40	A50	A70	C10 - C30	C20	E01	
All engines	x 6, COIL ON PLUG									470 632	C10		
ENGINE													
M40 i xDrive	Petrol	260	04/18-08/19	B58 B30 A									
Engine	Information				A10	A20	A40	A50	A70	C10 - C30	C20	E01	
All engines	x 6, COIL ON PLUG									470 632	C10		
ENGINE													
M40 i xDrive	Petrol	265	04/18->	B58 B30 A									
Engine	Information				A10	A20	A40	A50	A70	C10 - C30	C20	E01	
All engines	x 6, COIL ON PLUG									470 632	C10		
ENGINE													
M40 i xDrive	Petrol	285	09/19->	B58 B30 B									
Engine	Information				A10	A20	A40	A50	A70	C10 - C30	C20	E01	
All engines	x 6, COIL ON PLUG									470 632	C10		

A10 CONDENSER	A20 CONTACT SET	A40 DISTRIBUTOR CAP	A50 ROTOR	A70 PICK-UP
C10 COIL	C20 IGNITION MODULE	C30 ELECTRONIC IGNITION KIT	E01 IGNITION CABLE SET	

The present application list is a brief version. For the detailed information about the possibility of installation on a specific vehicle, please refer to our web-catalogue <http://catalogo.facet.eu/>

					FUNCTIONS ON THE VEHICLE							
Vehicle	alim.	kW	Date	Engine	A10	A20	A40	A50	A70	C10 - C30	C20	E01
ENGINE												
xDrive 20 i	Petrol	135	04/18->	B48 B20 A								
Engine	Information											
All engines	x 4, COIL ON PLUG									470 632	C10	
ENGINE												
xDrive 20 i Mild Hybrid	Petrol/ Electric	135	08/21->	B46 B20 B, B48 B20 A								
Engine	Information											
All engines	x 4, COIL ON PLUG									470 632	C10	
ENGINE												
xDrive 30 i	Petrol	183	04/18->	B48 B20 B								
Engine	Information											
All engines	x 4, COIL ON PLUG									470 632	C10	
ENGINE												
xDrive 30 i	Petrol	185	04/18->	B48 B20 B								
Engine	Information											
All engines	x 4, COIL ON PLUG									470 632	C10	
ENGINE												
xDrive 30 i Mild Hybrid	Petrol/ Electric	180	07/21->	B46 B20 B, B48 B20 B								
Engine	Information											
All engines	x 4, COIL ON PLUG									470 632	C10	
X5 I												
ENGINE												
3.0 i	Petrol	163	05/00-12/06	M54 B30 (306S3)								
Engine	Information											
All engines	->year 31/10/02, without spark plug connector, Qty: 6									470 352	C10	
All engines	->year 31/10/02, incl. spark plug connector, Qty: 6									470 413	C10	
All engines	01/11/02->, Qty: 6									470 475	C10	
ENGINE												
3.0 i	Petrol	170	04/00-10/06	5CNG, M54 B30 (306S3)								
Engine	Information											
Eng. M54 B30 (306S3)	->year 31/10/02, without spark plug connector, Qty: 6									470 352	C10	
Eng. M54 B30 (306S3)	->year 31/10/02, incl. spark plug connector, Qty: 6									470 413	C10	
Eng. 5CNG	x 6, DELPHI, COIL ON PLUG									470 475	C10	
Eng. M54 B30 (306S3)	01/11/02->, Qty: 6									470 475	C10	
ENGINE												
4.4 i	Petrol	210	01/00-09/03	M62 B44 (448S2), M62B448S2								
Engine	Information											
Eng. M62 B44 (448S2)	without spark plug connector, Qty: 8									470 352	C10	
Eng. M62B448S2	x 8, BREMI, COIL ON PLUG									470 352	C10	
Eng. M62 B44 (448S2)	incl. spark plug connector, Qty: 8									470 413	C10	
ENGINE												
4.4 i	Petrol	235	10/03-10/06	N62 B44, N62 B44 A								
Engine	Information											
Eng. N62 B44	Qty: 8									470 475	C10	
Eng. N62 B44 A	x 8, DELPHI, ELDOR, COIL ON PLUG									470 475	C10	
ENGINE												
4.6 is	Petrol	255	10/01-09/03	M62 B46 (468S1), M62B468S1								
Engine	Information											
Eng. M62 B46 (468S1)	without spark plug connector, Qty: 8									470 352	C10	
Eng. M62B468S1	x 8, BREMI, COIL ON PLUG									470 352	C10	
Eng. M62 B46 (468S1)	incl. spark plug connector, Qty: 8									470 413	C10	
ENGINE												
4.8 is	Petrol	265	04/04-09/06	N62 B48 A								
Engine	Information											
All engines	x 8, DELPHI, ELDOR, COIL ON PLUG									470 475	C10	

A10 CONDENSER	A20 CONTACT SET	A40 DISTRIBUTOR CAP	A50 ROTOR	A70 PICK-UP
C10 COIL	C20 IGNITION MODULE	C30 ELECTRONIC IGNITION KIT	E01 IGNITION CABLE SET	

Vehicle	alim.	kW	Date	Engine	FUNCTIONS ON THE VEHICLE							
					A10	A20	A40	A50	A70	C10 - C30	C20	E01

X5 II

				ENGINE
3.0 si	Petrol	200	10/06-09/08	N52 B30 A, N52 B30 AF, N52 B30 B, N52 B30 BF

Engine	Information	A10	A20	A40	A50	A70	C10 - C30	C20	E01
Eng. N52 B30 A, N52 B30 AF, N52 B30 BF	x 6, DELPHI, COIL ON PLUG						470 475	C10	
Eng. N52 B30 B	Qty: 6						470 475	C10	

				ENGINE
4.8 i xDrive	Petrol	261	10/06-09/08	N62 B48 B

Engine	Information	A10	A20	A40	A50	A70	C10 - C30	C20	E01
All engines	x 8, DELPHI, COIL ON PLUG						470 475	C10	

				ENGINE
M	Petrol	408	07/09-07/13	S63 B44 A

Engine	Information	A10	A20	A40	A50	A70	C10 - C30	C20	E01
All engines	x 8, DELPHI, ELDOR, COIL ON PLUG						470 475	C10	

				ENGINE
xDrive 30 i	Petrol	171	09/08-12/10	N52 B30 A

Engine	Information	A10	A20	A40	A50	A70	C10 - C30	C20	E01
All engines	Qty: 6						470 475	C10	

				ENGINE
xDrive 30 i	Petrol	172	02/07-12/12	N52 B30 A

Engine	Information	A10	A20	A40	A50	A70	C10 - C30	C20	E01
All engines	x 4, DELPHI, COIL ON PLUG						470 475	C10	

				ENGINE
xDrive 30 i	Petrol	200	10/08-03/10	N52 B30 A

Engine	Information	A10	A20	A40	A50	A70	C10 - C30	C20	E01
All engines	x 6, DELPHI, COIL ON PLUG						470 475	C10	

				ENGINE
xDrive 35 i	Petrol	225	04/10-07/13	N55 B30 A

Engine	Information	A10	A20	A40	A50	A70	C10 - C30	C20	E01
All engines	x 6, DELPHI, COIL ON PLUG						470 475	C10	

				ENGINE
xDrive 35 i	Petrol	235	02/12-06/13	N55 B30 A

Engine	Information	A10	A20	A40	A50	A70	C10 - C30	C20	E01
All engines	x 6, DELPHI, COIL ON PLUG						470 475	C10	

				ENGINE
xDrive 40 i	Petrol	225	01/12-06/13	N55 B30 A

Engine	Information	A10	A20	A40	A50	A70	C10 - C30	C20	E01
All engines	x 6, DELPHI, COIL ON PLUG						470 475	C10	

				ENGINE
xDrive 48 i	Petrol	261	10/08-03/10	N62 B48 B

Engine	Information	A10	A20	A40	A50	A70	C10 - C30	C20	E01
All engines	x 8, DELPHI, COIL ON PLUG						470 475	C10	

				ENGINE
xDrive 50 i	Petrol	300	04/10-07/13	N63 B44 A

Engine	Information	A10	A20	A40	A50	A70	C10 - C30	C20	E01
All engines	x 8, DELPHI, ELDOR, COIL ON PLUG						470 475	C10	

X5 III

				ENGINE
M	Petrol	423	12/14-07/18	S63 B44 B

Engine	Information	A10	A20	A40	A50	A70	C10 - C30	C20	E01
All engines	x 8, BOSCH, DELPHI, COIL ON PLUG						470 475	C10	

				ENGINE
sDrive 35 i [USA]	Petrol	225	01/13->	N55 B30 A









Engine	Information	A10	A20	A40	A50	A70	C10 - C30	C20	E01
All engines	Qty: 6						470 475	C10	

				ENGINE
xDrive 28 i	Petrol	180	06/15-07/18	N20 B20 A

Engine	Information	A10	A20	A40	A50	A70	C10 - C30	C20	E01
All engines	x 4, DELPHI, COIL ON PLUG						470 475	C10	

A10 CONDENSER	A20 CONTACT SET	A40 DISTRIBUTOR CAP	A50 ROTOR	A70 PICK-UP
C10 COIL	C20 IGNITION MODULE	C30 ELECTRONIC IGNITION KIT	E01 IGNITION CABLE SET	

The present application list is a brief version. For the detailed information about the possibility of installation on a specific vehicle, please refer to our web-catalogue <http://catalogo.facet.eu/>









					FUNCTIONS ON THE VEHICLE							
Vehicle	alim.	kW	Date	Engine								
ENGINE												
xDrive 35 i	Petrol	225	12/13-07/18	N55 B30 A								
Engine	Information				A10	A20	A40	A50	A70	C10 - C30	C20	E01
All engines	x 6, DELPHI, COIL ON PLUG									470 475	C10	
ENGINE												
xDrive 35 i	Petrol	240	12/13-07/18	N55 B30 A								
Engine	Information				A10	A20	A40	A50	A70	C10 - C30	C20	E01
All engines	x 6, DELPHI, COIL ON PLUG									470 475	C10	
ENGINE												
xDrive 40e	Petrol/ Electric	155	08/15-07/18	N20 B20 A								
Engine	Information				A10	A20	A40	A50	A70	C10 - C30	C20	E01
All engines	x 4, DELPHI, COIL ON PLUG									470 475	C10	
ENGINE												
xDrive 40e	Petrol/ Electric	180	08/15-07/18	N20 B20 A								
Engine	Information				A10	A20	A40	A50	A70	C10 - C30	C20	E01
All engines	x 4, DELPHI, COIL ON PLUG									470 475	C10	
ENGINE												
xDrive 40e	Petrol/ Electric	205	08/15-07/18	N20 B20 A								
Engine	Information				A10	A20	A40	A50	A70	C10 - C30	C20	E01
All engines	x 4, DELPHI, COIL ON PLUG									470 475	C10	
ENGINE												
xDrive 40e	Petrol/ Electric	230	08/15-07/18	N20 B20 A								
Engine	Information				A10	A20	A40	A50	A70	C10 - C30	C20	E01
All engines	x 4, DELPHI, COIL ON PLUG									470 475	C10	
ENGINE												
xDrive 50 i	Petrol	330	08/13-07/18	N63 B44 B								
Engine	Information				A10	A20	A40	A50	A70	C10 - C30	C20	E01
All engines	x 8, BOSCH, DELPHI, COIL ON PLUG									470 475	C10	
ENGINE												
xDrive 50i	Petrol	0	07/13->	N63 B40 A								
Engine	Information				A10	A20	A40	A50	A70	C10 - C30	C20	E01
All engines	Qty: 8									470 475	C10	
X5 IV												
ENGINE												
M	Petrol	441	12/19->	S63 B44 B								
Engine	Information				A10	A20	A40	A50	A70	C10 - C30	C20	E01
All engines	x 8, DELPHI, COIL ON PLUG									470 475	C10	
ENGINE												
M Competition	Petrol	460	12/19->	S63 B44 B								
Engine	Information				A10	A20	A40	A50	A70	C10 - C30	C20	E01
All engines	x 8, DELPHI, COIL ON PLUG									470 475	C10	
ENGINE												
xDrive 40 i	Petrol	250	08/18->	B58 B30 C								
Engine	Information				A10	A20	A40	A50	A70	C10 - C30	C20	E01
All engines	x 6, COIL ON PLUG									470 632	C10	
ENGINE												
xDrive 40 i Mil-d-Hybrid	Petrol/ Electric	245	12/20->	B58 B30 C								
Engine	Information				A10	A20	A40	A50	A70	C10 - C30	C20	E01
All engines	x 6, COIL ON PLUG									470 632	C10	
ENGINE												
xDrive 45 e Plug-in-Hybrid	Petrol/ Electric	155	06/19->	B58 B30 C								
Engine	Information				A10	A20	A40	A50	A70	C10 - C30	C20	E01
All engines	x 6, COIL ON PLUG									470 632	C10	

A10 CONDENSER	A20 CONTACT SET	A40 DISTRIBUTOR CAP	A50 ROTOR	A70 PICK-UP
C10 COIL	C20 IGNITION MODULE	C30 ELECTRONIC IGNITION KIT	E01 IGNITION CABLE SET	

Vehicle	alim.	kW	Date	Engine	FUNCTIONS ON THE VEHICLE								
					A10	A20	A40	A50	A70	C10 - C30	C20	E01	
ENGINE													
xDrive 45 e Plug-in-Hybrid	Petrol/ Electric	210	06/19->	B58 B30 C									
Engine	Information				A10	A20	A40	A50	A70	C10 - C30	C20	E01	
All engines	x 6, COIL ON PLUG									470 632	C10		
ENGINE													
xDrive 45 e Plug-in-Hybrid	Petrol/ Electric	235	06/19->	B58 B30 C									
Engine	Information				A10	A20	A40	A50	A70	C10 - C30	C20	E01	
All engines	x 6, COIL ON PLUG									470 632	C10		
ENGINE													
xDrive 45 e Plug-in-Hybrid	Petrol/ Electric	290	06/19->	B58 B30 C									
Engine	Information				A10	A20	A40	A50	A70	C10 - C30	C20	E01	
All engines	x 6, COIL ON PLUG									470 632	C10		
ENGINE													
xDrive 50 i	Petrol	340	08/18->	N63 B44 D									
Engine	Information				A10	A20	A40	A50	A70	C10 - C30	C20	E01	
All engines	x 8, DELPHI, COIL ON PLUG									470 475	C10		
X6 I													
ENGINE													
35 i	Petrol	225	05/08-08/08	N54 B30 A									
Engine	Information				A10	A20	A40	A50	A70	C10 - C30	C20	E01	
All engines	Qty: 6									470 475	C10		
ENGINE													
50 i	Petrol	300	05/08-06/14	N63 B44 A									
Engine	Information				A10	A20	A40	A50	A70	C10 - C30	C20	E01	
All engines	Qty: 8									470 475	C10		
ENGINE													
ActiveHybrid	Petrol/ Electric	357	01/09-10/11	N63 B44 A									
Engine	Information				A10	A20	A40	A50	A70	C10 - C30	C20	E01	
All engines	x 8, DELPHI, ELDOR, COIL ON PLUG									470 475	C10		
ENGINE													
ActiveHybrid xDrive	Petrol/ Electric	300	01/09-10/11	N63 B44 A									
Engine	Information				A10	A20	A40	A50	A70	C10 - C30	C20	E01	
All engines	x 8, DELPHI, ELDOR, COIL ON PLUG									470 475	C10		
ENGINE													
M	Petrol	408	07/09-07/14	S63 B44 A									
Engine	Information				A10	A20	A40	A50	A70	C10 - C30	C20	E01	
All engines	x 8, DELPHI, ELDOR, COIL ON PLUG									470 475	C10		
ENGINE													
xDrive 35 i	Petrol	224	01/08-06/14	N54 B30 A, N55 B30 A									
Engine	Information				A10	A20	A40	A50	A70	C10 - C30	C20	E01	
All engines	x 6, DELPHI, ELDOR, COIL ON PLUG									470 475	C10		
ENGINE													
xDrive 35 i	Petrol	225	01/08-07/14	N54 B30 A, N55 B30 A									
Engine	Information				A10	A20	A40	A50	A70	C10 - C30	C20	E01	
All engines	x 6, DELPHI, ELDOR, COIL ON PLUG									470 475	C10		
ENGINE													
xDrive 35 i	Petrol	235	07/09-06/14	N55 B30 A									
Engine	Information				A10	A20	A40	A50	A70	C10 - C30	C20	E01	
All engines	x 6, DELPHI, COIL ON PLUG									470 475	C10		
ENGINE													
xDrive 35 i	Petrol	240	06/07-03/10	N54 B30 A									
Engine	Information				A10	A20	A40	A50	A70	C10 - C30	C20	E01	
All engines	x 6, DELPHI, ELDOR, COIL ON PLUG									470 475	C10		
ENGINE													
xDrive 40 i	Petrol	235	01/12->	N55 B30 A									
Engine	Information				A10	A20	A40	A50	A70	C10 - C30	C20	E01	
All engines	Qty: 6									470 475	C10		









A10	CONDENSER	A20	CONTACT SET	A40	DISTRIBUTOR CAP	A50	ROTOR	A70	PICK-UP
C10	COIL	C20	IGNITION MODULE	C30	ELECTRONIC IGNITION KIT	E01	IGNITION CABLE SET		

The present application list is a brief version. For the detailed information about the possibility of installation on a specific vehicle, please refer to our web-catalogue <http://catalogo.facet.eu/>

					FUNCTIONS ON THE VEHICLE							
Vehicle	alim.	kW	Date	Engine								
X6 II												
xDrive 50 i	Petrol	300	07/08-07/14	ENGINE N63 B44 A								
Engine	Information				A10	A20	A40	A50	A70	C10 - C30	C20	E01
All engines	x 8, DELPHI, ELDOR, COIL ON PLUG									470 475	C10	
xDrive 50 i	Petrol	330	10/07-06/14	ENGINE N63 B44 A								
Engine	Information				A10	A20	A40	A50	A70	C10 - C30	C20	E01
All engines	x 8, DELPHI, ELDOR, COIL ON PLUG									470 475	C10	
X6 II												
35 i [USA]	Petrol	225	08/14->	ENGINE N55 B30 A								
Engine	Information				A10	A20	A40	A50	A70	C10 - C30	C20	E01
All engines	Qty: 6									470 475	C10	
M	Petrol	423	12/14-07/19	ENGINE S63 B44 B								
Engine	Information				A10	A20	A40	A50	A70	C10 - C30	C20	E01
All engines	x 8, BOSCH, DELPHI, COIL ON PLUG									470 475	C10	
xDrive 35 i	Petrol	225	08/14-07/19	ENGINE N55 B30 A								
Engine	Information				A10	A20	A40	A50	A70	C10 - C30	C20	E01
All engines	x 6, DELPHI, COIL ON PLUG									470 475	C10	
xDrive 35 i	Petrol	240	08/14-07/19	ENGINE N55 B30 A								
Engine	Information				A10	A20	A40	A50	A70	C10 - C30	C20	E01
All engines	x 6, DELPHI, COIL ON PLUG									470 475	C10	
xDrive 50 i	Petrol	0	08/14->	ENGINE N63 B40 A								
Engine	Information				A10	A20	A40	A50	A70	C10 - C30	C20	E01
All engines	Qty: 8									470 475	C10	
xDrive 50 i	Petrol	330	08/14-07/19	ENGINE N63 B44 B								
Engine	Information				A10	A20	A40	A50	A70	C10 - C30	C20	E01
All engines	x 8, BOSCH, DELPHI, COIL ON PLUG									470 475	C10	
xDrive 50 i [USA]	Petrol	330	08/14->	ENGINE N63 B44 B								
Engine	Information				A10	A20	A40	A50	A70	C10 - C30	C20	E01
All engines	Qty: 8									470 475	C10	
X6 III												
M	Petrol	441	12/19->	ENGINE S63 B44 B								
Engine	Information				A10	A20	A40	A50	A70	C10 - C30	C20	E01
All engines	x 8, DELPHI, COIL ON PLUG									470 475	C10	
M Competition	Petrol	460	12/19->	ENGINE S63 B44 B								
Engine	Information				A10	A20	A40	A50	A70	C10 - C30	C20	E01
All engines	x 8, DELPHI, COIL ON PLUG									470 475	C10	
xDrive 40 i	Petrol	250	08/19->	ENGINE B58 B30 C								
Engine	Information				A10	A20	A40	A50	A70	C10 - C30	C20	E01
All engines	x 6, COIL ON PLUG									470 632	C10	
xDrive 40 i Mil-d-Hybrid	Petrol/ Electric	245	12/20->	ENGINE B58 B30 C								
Engine	Information				A10	A20	A40	A50	A70	C10 - C30	C20	E01
All engines	x 6, COIL ON PLUG									470 632	C10	
X7												
xDrive 40 i	Petrol	250	03/19->	ENGINE B58 B30 C								
Engine	Information				A10	A20	A40	A50	A70	C10 - C30	C20	E01
All engines	x 6, COIL ON PLUG									470 632	C10	

A10 CONDENSER	A20 CONTACT SET	A40 DISTRIBUTOR CAP	A50 ROTOR	A70 PICK-UP
C10 COIL	C20 IGNITION MODULE	C30 ELECTRONIC IGNITION KIT	E01 IGNITION CABLE SET	

Vehicle	alim.	kW	Date	Engine	FUNCTIONS ON THE VEHICLE												
					A10	A20	A40	A50	A70	C10 - C30	C20	E01					
ENGINE																	
xDrive 40 i Mild-Hybrid	Petrol/ Electric	245	12/20->	B58 B30 C													
Engine	Information				A10	A20	A40	A50	A70	C10 - C30	C20	E01					
All engines	x 6, COIL ON PLUG									470 632	C10						
ENGINE																	
xDrive M 50 i	Petrol	390	07/19->	N63 B44 D													
Engine	Information				A10	A20	A40	A50	A70	C10 - C30	C20	E01					
All engines	x 8, DELPHI, COIL ON PLUG									470 475	C10						
Z1																	
2.5	Petrol	125	06/88-06/91	M20 B25 (256K1)													
Engine	Information				A10	A20	A40	A50	A70	C10 - C30	C20	E01					
All engines	version Bosch						806 238	906 119R									
All engines										470 112	C10						
Z3																	
1.8 i	Petrol	85	10/95-10/98	M43 B18 (184E2)													
Engine	Information				A10	A20	A40	A50	A70	C10 - C30	C20	E01					
All engines	without marten protection												359 900				
ENGINE																	
1.9 i	Petrol	103	11/95-03/99	M44 B19 (194S1)													
Engine	Information				A10	A20	A40	A50	A70	C10 - C30	C20	E01					
All engines													360 921				
ENGINE																	
1.9 i	Petrol	85	01/99-01/03	M43 B19 (194E1)													
Engine	Information				A10	A20	A40	A50	A70	C10 - C30	C20	E01					
All engines	without marten protection												359 900				
ENGINE																	
1.9 i	Petrol	87	07/98-01/03	M43 B19 (194E1)													
Engine	Information				A10	A20	A40	A50	A70	C10 - C30	C20	E01					
All engines	without marten protection												359 900				
ENGINE																	
2.0 i	Petrol	110	04/99-01/03	M52 B20 (206S4)													
Engine	Information				A10	A20	A40	A50	A70	C10 - C30	C20	E01					
All engines	without spark plug connector, Qty: 6									470 352	C10						
All engines	incl. spark plug connector, Qty: 6									470 413	C10						
ENGINE																	
2.2 i	Petrol	120	08/00-01/03	M54 B22 (226S1)													
Engine	Information				A10	A20	A40	A50	A70	C10 - C30	C20	E01					
All engines	without spark plug connector, Qty: 6									470 352	C10						
All engines	incl. spark plug connector, Qty: 6									470 413	C10						
ENGINE																	
2.2 i	Petrol	125	10/00-06/02	M54 B22 (226S1)													
Engine	Information				A10	A20	A40	A50	A70	C10 - C30	C20	E01					
All engines	without spark plug connector, Qty: 6									470 352	C10						
All engines	incl. spark plug connector, Qty: 6									470 413	C10						
ENGINE																	
2.8 i	Petrol	142	11/96-05/00	M52 B28 (286S1)													
Engine	Information				A10	A20	A40	A50	A70	C10 - C30	C20	E01					
All engines	without spark plug connector, Qty: 6									470 352	C10						
All engines	incl. spark plug connector, Qty: 6									470 413	C10						
ENGINE																	
2.8 i	Petrol	143	01/96-07/00	M52 B28 (286S1), M52 B28 (286S2)													
Engine	Information				A10	A20	A40	A50	A70	C10 - C30	C20	E01					
All engines	without spark plug connector, Qty: 6									470 352	C10						
All engines	incl. spark plug connector, Qty: 6									470 413	C10						
ENGINE																	
3.0 i	Petrol	170	06/00-06/03	M54 B30 (306S3)													
Engine	Information				A10	A20	A40	A50	A70	C10 - C30	C20	E01					
All engines	without spark plug connector, Qty: 6									470 352	C10						
A10	CONDENSER	A20	CONTACT SET	A40	DISTRIBUTOR CAP	A50	ROTOR	A70	PICK-UP	C10	COIL	C20	IGNITION MODULE	C30	ELECTRONIC IGNITION KIT	E01	IGNITION CABLE SET

					FUNCTIONS ON THE VEHICLE							
Vehicle	alim.	kW	Date	Engine								
ENGINE												
3.0 i	Petrol	170	06/00-06/03	M54 B30 (306S3)								
ENGINE												
Engine		Information			A10	A20	A40	A50	A70	C10 - C30	C20	E01
All engines		incl. spark plug connector, Qty: 6								470 413	C10	
M	Petrol	236	02/98-06/01	S50 B32 (326S1)								
ENGINE												
Engine		Information			A10	A20	A40	A50	A70	C10 - C30	C20	E01
All engines		without spark plug connector, Qty: 6								470 352	C10	
All engines		incl. spark plug connector, Qty: 6								470 413	C10	
M	Petrol	239	06/01-06/03	S54 B32 (326S4)								
ENGINE												
Engine		Information			A10	A20	A40	A50	A70	C10 - C30	C20	E01
All engines		Qty: 6								470 475	C10	
M 3.2	Petrol	236	01/97-06/00	S50 B32 (326S1)								
ENGINE												
Engine		Information			A10	A20	A40	A50	A70	C10 - C30	C20	E01
All engines		without spark plug connector, Qty: 6								470 352	C10	
All engines		incl. spark plug connector, Qty: 6								470 413	C10	
M 3.2	Petrol	239	06/01-01/03	S54 B32 (326S4)								
ENGINE												
Engine		Information			A10	A20	A40	A50	A70	C10 - C30	C20	E01
All engines		Qty: 6								470 475	C10	
Z4 I												
ENGINE												
2.0 i	Petrol	110	03/05-02/09	N46 B20 A								
ENGINE												
Engine		Information			A10	A20	A40	A50	A70	C10 - C30	C20	E01
All engines		Qty: 4								470 475	C10	
2.2 i	Petrol	125	10/03-10/05	M54 B22 (226S1)								
ENGINE												
Engine		Information			A10	A20	A40	A50	A70	C10 - C30	C20	E01
All engines		Qty: 6								470 475	C10	
2.5 i	Petrol	130	01/06->	N52 B25 B								
ENGINE												
Engine		Information			A10	A20	A40	A50	A70	C10 - C30	C20	E01
All engines		Qty: 6								470 475	C10	
2.5 i	Petrol	141	12/02-12/05	M54 B25 (256S5)								
ENGINE												
Engine		Information			A10	A20	A40	A50	A70	C10 - C30	C20	E01
All engines		Qty: 6								470 475	C10	
2.5 si	Petrol	160	01/06->	N52 B25 B								
ENGINE												
Engine		Information			A10	A20	A40	A50	A70	C10 - C30	C20	E01
All engines		Qty: 6								470 475	C10	
3.0 i	Petrol	0	01/06->	N52 B30 A								
ENGINE												
Engine		Information			A10	A20	A40	A50	A70	C10 - C30	C20	E01
All engines		Qty: 6								470 475	C10	
3.0 i	Petrol	170	12/02-12/05	M54 B30 (306S3)								
ENGINE												
Engine		Information			A10	A20	A40	A50	A70	C10 - C30	C20	E01
All engines		Qty: 6								470 475	C10	
3.0 si	Petrol	195	01/06->	N52 B30 B								
ENGINE												
Engine		Information			A10	A20	A40	A50	A70	C10 - C30	C20	E01
All engines		Qty: 6								470 475	C10	
M	Petrol	252	01/06-08/08	S54 B32 (326S4)								
ENGINE												
Engine		Information			A10	A20	A40	A50	A70	C10 - C30	C20	E01
All engines		Qty: 6								470 475	C10	

A10 CONDENSER	A20 CONTACT SET	A40 DISTRIBUTOR CAP	A50 ROTOR	A70 PICK-UP
C10 COIL	C20 IGNITION MODULE	C30 ELECTRONIC IGNITION KIT	E01 IGNITION CABLE SET	

Vehicle	alim.	kW	Date	Engine	FUNCTIONS ON THE VEHICLE							
					A10	A20	A40	A50	A70	C10 - C30	C20	E01

Z4 II

				ENGINE
sDrive30i	Petrol	190	05/09->	N52 B30 B, N52 B30 BF

Engine	Information	A10	A20	A40	A50	A70	C10 - C30	C20	E01
All engines	Qty: 6						470 475	C10	

Z8

				ENGINE
4.9	Petrol	294	01/00-12/03	S62 B50 (508S1)

Engine	Information	A10	A20	A40	A50	A70	C10 - C30	C20	E01
All engines	without spark plug connector, Qty: 8						470 352	C10	
All engines	incl. spark plug connector, Qty: 8						470 413	C10	

A10	CONDENSER	A20	CONTACT SET	A40	DISTRIBUTOR CAP	A50	ROTOR	A70	PICK-UP
C10	COIL	C20	IGNITION MODULE	C30	ELECTRONIC IGNITION KIT	E01	IGNITION CABLE SET		

The present application list is a brief version. For the detailed information about the possibility of installation on a specific vehicle, please refer to our web-catalogue <http://catalogo.facet.eu/>

Vehicle	alim.	kW	Date	Engine	FUNCTIONS ON THE VEHICLE							
					A10	A20	A40	A50	A70	C10 - C30	C20	E01
												

EQUIPE

				ENGINE
1300 GT	Petrol	56	01/67-12/70	--

Engine	Information	A10	A20	A40	A50	A70	C10 - C30	C20	E01
All engines				828 075	928 006				

				ENGINE
2.0 GT	Petrol	77	01/68-12/71	--

Engine	Information	A10	A20	A40	A50	A70	C10 - C30	C20	E01
All engines					912 090, 928 007				

A10 CONDENSER	A20 CONTACT SET	A40 DISTRIBUTOR CAP	A50 ROTOR	A70 PICK-UP
C10 COIL	C20 IGNITION MODULE	C30 ELECTRONIC IGNITION KIT	E01 IGNITION CABLE SET	

Vehicle	alim.	kW	Date	Engine	FUNCTIONS ON THE VEHICLE							
					 A10	 A20	 A40	 A50	 A70	 C10 - C30	 C20	 E01

ISABELLA				ENGINE
1.5	Petrol	55	06/54-02/62	--

Engine	Information	A10	A20	A40	A50	A70	C10 - C30	C20	E01
All engines					906 018R				

A10	CONDENSER	A20	CONTACT SET	A40	DISTRIBUTOR CAP	A50	ROTOR	A70	PICK-UP
C10	COIL	C20	IGNITION MODULE	C30	ELECTRONIC IGNITION KIT	E01	IGNITION CABLE SET		

The present application list is a brief version. For the detailed information about the possibility of installation on a specific vehicle, please refer to our web-catalogue <http://catalogo.facet.eu/>

Vehicle	alim.	kW	Date	Engine	FUNCTIONS ON THE VEHICLE							
					A10	A20	A40	A50	A70	C10 - C30	C20	E01

AVEO I

VEHICLE INFORMATION					FUNCTIONS ON THE VEHICLE							
Vehicle	alim.	kW	Date	ENGINE	A10	A20	A40	A50	A70	C10 - C30	C20	E01
1.2	Petrol	53	03/05->	B12S1, F12S3, LQ5								
Engine Information												358 006
1.2	Petrol	55	01/08->	B12D1, LMU								
Engine Information												358 249
1.2	Petrol	56	01/07-09/12	B12S1, LY4								
Engine Information												358 006
1.2	Petrol	62	01/08->	B12D1, LMU								
Engine Information												358 249
1.2 LPG	Petrol/ Liquified Petro- leum Gas (LPG)	62	04/08->	B12D1, LMU								
Engine Information												358 249
1.4	Petrol	61	03/05->	F14S3								
Engine Information												360 731
1.4	Petrol	69	03/05-05/13	F14D3, L14								
Engine Information												360 680
1.4	Petrol	74	04/08->	A 14 XER								
Engine Information										470 547	C10	
1.4 16V	Petrol	69	05/03-05/08	F14D3								
Engine Information												360 680
1.4 CNG	CNG	69	01/10->	L95								
Engine Information												360 680
1.5	Petrol	62	01/05->	F15S3, LX6								
Engine Information												358 249
Engine Information												360 731
1.6	Petrol	76	05/05->	F16D3, LXV								
Engine Information												360 680
1.6	Petrol	77	09/03-12/08	A16DMS, LXT, LXV								
Engine Information												360 680

A10 CONDENSER	A20 CONTACT SET	A40 DISTRIBUTOR CAP	A50 ROTOR	A70 PICK-UP
C10 COIL	C20 IGNITION MODULE	C30 ELECTRONIC IGNITION KIT	E01 IGNITION CABLE SET	

Vehicle	alim.	kW	Date	Engine	FUNCTIONS ON THE VEHICLE							
					A10	A20	A40	A50	A70	C10 - C30	C20	E01
AVEO II												
1.2	Petrol	51	03/11->	LWD								
ENGINE												
Engine	Information				A10	A20	A40	A50	A70	C10 - C30	C20	E01
All engines										470 547	C10	
All engines	x 1, x 4, COIL ON PLUG									470 547	C10	
1.2	Petrol	63	03/11->	LDC								
ENGINE												
Engine	Information				A10	A20	A40	A50	A70	C10 - C30	C20	E01
All engines										470 547	C10	
All engines	x 1, version 1, version 2, COIL ON PLUG									470 547	C10	
1.2 LPG	Petrol/ Liquified Petroleum Gas (LPG)	63	11/12-12/15	LDC								
ENGINE												
Engine	Information				A10	A20	A40	A50	A70	C10 - C30	C20	E01
All engines	x 4, COIL ON PLUG									470 547	C10	
1.4	Petrol	74	03/11->	LDD								
ENGINE												
Engine	Information				A10	A20	A40	A50	A70	C10 - C30	C20	E01
All engines										470 547	C10	
All engines	x 1, x 4, COIL ON PLUG									470 547	C10	
1.4 Turbo	Petrol	103	08/13->	A 14 NET								
ENGINE												
Engine	Information				A10	A20	A40	A50	A70	C10 - C30	C20	E01
All engines	x 4, COIL ON PLUG									470 547	C10	
1.6	Petrol	85	03/11->	LDE								
ENGINE												
Engine	Information				A10	A20	A40	A50	A70	C10 - C30	C20	E01
All engines	x 4, COIL ON PLUG									470 545	C10	
CAPTIVA												
2.4	Petrol	100	06/06->	Z 24 SED								
ENGINE												
Engine	Information				A10	A20	A40	A50	A70	C10 - C30	C20	E01
All engines												358 247
2.4 4WD	Petrol	100	06/06-02/11	Z 24 SED								
ENGINE												
Engine	Information				A10	A20	A40	A50	A70	C10 - C30	C20	E01
All engines												358 247
2.4 LPG	Petrol/ Liquified Petroleum Gas (LPG)	100	01/07->	Z 24 SED								
ENGINE												
Engine	Information				A10	A20	A40	A50	A70	C10 - C30	C20	E01
All engines												358 247
2.4 LPG 4WD	Petrol/ Liquified Petroleum Gas (LPG)	100	01/07-02/11	Z 24 SED								
ENGINE												
Engine	Information				A10	A20	A40	A50	A70	C10 - C30	C20	E01
All engines												358 247
CRUZE												
1.4	Petrol	103	09/10->	A 14 NET, LUJ								
ENGINE												
Engine	Information				A10	A20	A40	A50	A70	C10 - C30	C20	E01
All engines	x 4, COIL ON PLUG									470 547	C10	
Eng. LUJ										470 547	C10	

A10 CONDENSER	A20 CONTACT SET	A40 DISTRIBUTOR CAP	A50 ROTOR	A70 PICK-UP
C10 COIL	C20 IGNITION MODULE	C30 ELECTRONIC IGNITION KIT	E01 IGNITION CABLE SET	







The present application list is a brief version. For the detailed information about the possibility of installation on a specific vehicle, please refer to our web-catalogue <http://catalogo.facet.eu/>

Vehicle	alim.	kW	Date	Engine	FUNCTIONS ON THE VEHICLE									
					A10	A20	A40	A50	A70	C10 - C30	C20	E01		
ENGINE														
1.4	Petrol	74	07/13->	A 14 XER, LDD										
Engine	Information				A10	A20	A40	A50	A70	C10 - C30	C20	E01		
All engines	x 4, COIL ON PLUG									470 547	C10			
Eng. LDD										470 547	C10			
ENGINE														
1.6	Petrol	80	05/09->	F16D3, LXT										
Engine	Information				A10	A20	A40	A50	A70	C10 - C30	C20	E01		
All engines														360 680
ENGINE														
1.6	Petrol	86	12/12->	LDE										
Engine	Information				A10	A20	A40	A50	A70	C10 - C30	C20	E01		
All engines	x 4, COIL ON PLUG									470 545	C10			
ENGINE														
1.6	Petrol	91	06/11->	LDE										
Engine	Information				A10	A20	A40	A50	A70	C10 - C30	C20	E01		
All engines	01/01/12->, 01/01/14->, x 4, COIL ON PLUG									470 545	C10			
EPICA														
ENGINE														
2.0	Petrol	98	01/05-12/06	T20SED										
Engine	Information				A10	A20	A40	A50	A70	C10 - C30	C20	E01		
All engines														360 677
EVANDA														
ENGINE														
2.0	Petrol	96	03/05-12/06	X 20 SED										
Engine	Information				A10	A20	A40	A50	A70	C10 - C30	C20	E01		
All engines														360 677
KALOS														
ENGINE														
1.2	Petrol	53	03/05->	B12S1, F12S3										
Engine	Information				A10	A20	A40	A50	A70	C10 - C30	C20	E01		
All engines														358 006
ENGINE														
1.4 16V	Petrol	69	03/05->	F14D3										
Engine	Information				A10	A20	A40	A50	A70	C10 - C30	C20	E01		
All engines														360 680
LACETTI														
ENGINE														
1.4	Petrol	69	03/05-03/13	F14D3, L14(85CUL4)										
Engine	Information				A10	A20	A40	A50	A70	C10 - C30	C20	E01		
Eng. L14(85CUL4)	x 1, D.I.S.									470 585	C10			
Eng. F14D3														360 509
ENGINE														
1.4	Petrol	70	03/05->	F14D3										
Engine	Information				A10	A20	A40	A50	A70	C10 - C30	C20	E01		
All engines										470 585	C10			360 509
ENGINE														
1.4 16V	Petrol	70	03/05-03/13	F14D3, L14(85CUL4)										
Engine	Information				A10	A20	A40	A50	A70	C10 - C30	C20	E01		
Eng. L14(85CUL4)	x 1, D.I.S.									470 585	C10			
Eng. F14D3														360 509
ENGINE														
1.4 LPG	Petrol/ Liquified Petro- leum Gas (LPG)	69	01/05-12/12	L14(85CUL4)										
Engine	Information				A10	A20	A40	A50	A70	C10 - C30	C20	E01		
All engines	x 1, D.I.S.									470 585	C10			
ENGINE														
1.6	Petrol	80	03/05->	F16D3, LXT										
Engine	Information				A10	A20	A40	A50	A70	C10 - C30	C20	E01		
Eng. LXT	x 1, D.I.S.									470 585	C10			
LEGEND														
A10	CONDENSER	A20	CONTACT SET	A40	DISTRIBUTOR CAP	A50	ROTOR	A70	PICK-UP					
C10	COIL	C20	IGNITION MODULE	C30	ELECTRONIC IGNITION KIT	E01	IGNITION CABLE SET							

Vehicle	alim.	kW	Date	Engine	FUNCTIONS ON THE VEHICLE									
					A10	A20	A40	A50	A70	C10 - C30	C20	E01		
ENGINE														
1.6	Petrol	80	03/05->	F16D3, LXT										
ENGINE														
Engine	Information				A10	A20	A40	A50	A70	C10 - C30	C20	E01		
Eng. F16D3													360 509	
ENGINE														
1.6 LPG	Petrol/ Liquified Petro- leum Gas (LPG)	80	06/09-12/11	LXT										
ENGINE														
Engine	Information				A10	A20	A40	A50	A70	C10 - C30	C20	E01		
All engines	x 1, D.I.S.									470 585	C10			
ENGINE														
1.8	Petrol	66	08/05-12/09	LDA										
ENGINE														
Engine	Information				A10	A20	A40	A50	A70	C10 - C30	C20	E01		
All engines	x 1, D.I.S.									470 585	C10			
ENGINE														
1.8	Petrol	89	08/05-12/11	LDA										
ENGINE														
Engine	Information				A10	A20	A40	A50	A70	C10 - C30	C20	E01		
All engines	x 1, D.I.S.									470 585	C10			
ENGINE														
1.8	Petrol	90	03/05->	LDA, T18SED										
ENGINE														
Engine	Information				A10	A20	A40	A50	A70	C10 - C30	C20	E01		
Eng. LDA	x 1, D.I.S.									470 585	C10			
Eng. T18SED													360 677	
ENGINE														
2.0	Petrol	89	03/05->	U20SED										
ENGINE														
Engine	Information				A10	A20	A40	A50	A70	C10 - C30	C20	E01		
All engines													360 677	
LANOS														
ENGINE														
1.5	Petrol	63	11/05->	A15SMS										
ENGINE														
Engine	Information				A10	A20	A40	A50	A70	C10 - C30	C20	E01		
All engines													360 731	
ENGINE														
1.5	Petrol	64	11/05-12/18	A15SMS										
ENGINE														
Engine	Information				A10	A20	A40	A50	A70	C10 - C30	C20	E01		
All engines													360 731	
ENGINE														
1.6 16V	Petrol	78	11/05->	A16DMS										
ENGINE														
Engine	Information				A10	A20	A40	A50	A70	C10 - C30	C20	E01		
All engines													360 680	
MATIZ														
ENGINE														
0.8	Petrol	38	03/05-12/13	LBF(49CUL3), LQ2(49CUL3)										
ENGINE														
Engine	Information				A10	A20	A40	A50	A70	C10 - C30	C20	E01		
All engines	VET. 577031 ->												358 007	
All engines	->VET. 577030												360 634	
ENGINE														
0.8 LPG	Petrol/ Liquified Petro- leum Gas (LPG)	38	03/05-12/07	F8CV										
ENGINE														
Engine	Information				A10	A20	A40	A50	A70	C10 - C30	C20	E01		
All engines	VET. 577031 ->												358 007	
All engines	->VET. 577030												360 634	
ENGINE														
1.0	Petrol	46	01/08-12/13	B10S										
ENGINE														
Engine	Information				A10	A20	A40	A50	A70	C10 - C30	C20	E01		
All engines													358 006	

A10 CONDENSER	A20 CONTACT SET	A40 DISTRIBUTOR CAP	A50 ROTOR	A70 PICK-UP
C10 COIL	C20 IGNITION MODULE	C30 ELECTRONIC IGNITION KIT	E01 IGNITION CABLE SET	

The present application list is a brief version. For the detailed information about the possibility of installation on a specific vehicle, please refer to our web-catalogue <http://catalogo.facet.eu/>









					FUNCTIONS ON THE VEHICLE							
Vehicle	alim.	kW	Date	Engine								
ENGINE												
1.0	Petrol	47	03/05-12/07	B10S								
ENGINE												
Engine Information					A10	A20	A40	A50	A70	C10 - C30	C20	E01
All engines												358 006
ENGINE												
1.0	Petrol	49	03/05->	B10S1, LQ4(61CUL4)								
ENGINE												
Engine Information					A10	A20	A40	A50	A70	C10 - C30	C20	E01
All engines												358 006
ENGINE												
1.0 LPG	Petrol/ Liquified Petro- leum Gas (LPG)	49	03/05-03/11	B10S1								
ENGINE												
Engine Information					A10	A20	A40	A50	A70	C10 - C30	C20	E01
All engines												358 006
ENGINE												
ENGINE												
1.4	Petrol	69	01/05-12/07	F14D3, L14(85CUL4)								
ENGINE												
Engine Information					A10	A20	A40	A50	A70	C10 - C30	C20	E01
Eng. L14(85CUL4)										470 585	C10	
Eng. F14D3												360 509
ENGINE												
1.4	Petrol	70	01/06-12/08	F14D3, L14(85CUL4)								
ENGINE												
Engine Information					A10	A20	A40	A50	A70	C10 - C30	C20	E01
Eng. L14(85CUL4)										470 585	C10	
Eng. F14D3												360 509
ENGINE												
1.6	Petrol	76	01/10->	LXT								
ENGINE												
Engine Information					A10	A20	A40	A50	A70	C10 - C30	C20	E01
All engines										470 585	C10	360 509
ENGINE												
1.6	Petrol	80	03/05-12/11	F16D3, L44(96CUL4), LXT								
ENGINE												
Engine Information					A10	A20	A40	A50	A70	C10 - C30	C20	E01
Eng. L44(96CUL4), LXT										470 585	C10	
Eng. F16D3												360 509
ENGINE												
1.6 LPG	Petrol/ Liquified Petro- leum Gas (LPG)	80	03/05-12/10	L44(96CUL4), LXT								
ENGINE												
Engine Information					A10	A20	A40	A50	A70	C10 - C30	C20	E01
All engines										470 585	C10	
ENGINE												
1.8	Petrol	89	08/05-12/11	LDA								
ENGINE												
Engine Information					A10	A20	A40	A50	A70	C10 - C30	C20	E01
All engines										470 585	C10	
ENGINE												
1.8	Petrol	90	03/05-12/09	LDA, T18SED								
ENGINE												
Engine Information					A10	A20	A40	A50	A70	C10 - C30	C20	E01
Eng. LDA										470 585	C10	
Eng. T18SED												360 677
ENGINE												
ENGINE												
1.4 16V	Petrol	70	03/05->	F14D3								
ENGINE												
Engine Information					A10	A20	A40	A50	A70	C10 - C30	C20	E01
All engines										470 585	C10	360 509
ENGINE												
1.6	Petrol	78	08/03-12/08	LXT								
ENGINE												
Engine Information					A10	A20	A40	A50	A70	C10 - C30	C20	E01
All engines										470 585	C10	360 509

A10 CONDENSER	A20 CONTACT SET	A40 DISTRIBUTOR CAP	A50 ROTOR	A70 PICK-UP
C10 COIL	C20 IGNITION MODULE	C30 ELECTRONIC IGNITION KIT	E01 IGNITION CABLE SET	

Vehicle	alim.	kW	Date	Engine	FUNCTIONS ON THE VEHICLE									
					A10	A20	A40	A50	A70	C10 - C30	C20	E01		
ENGINE														
1.6	Petrol	80	08/03-12/08	F16D3										
Engine Information					A10	A20	A40	A50	A70	C10 - C30	C20	E01		
All engines										470 585	C10		360 509	
ENGINE														
1.6 SRV	Petrol	74	06/06->	F16D3										
Engine Information					A10	A20	A40	A50	A70	C10 - C30	C20	E01		
All engines										470 585	C10		360 509	
ENGINE														
1.8	Petrol	90	08/03-12/08	T18SED										
Engine Information					A10	A20	A40	A50	A70	C10 - C30	C20	E01		
All engines													360 677	
ENGINE														
1.8 SRV	Petrol	90	06/06->	T18SED										
Engine Information					A10	A20	A40	A50	A70	C10 - C30	C20	E01		
All engines													360 677	
ENGINE														
2.0	Petrol	0	03/05->	U20SED										
Engine Information					A10	A20	A40	A50	A70	C10 - C30	C20	E01		
All engines													360 677	
ENGINE														
2.0	Petrol	98	06/99-07/03	X 20 SED										
Engine Information					A10	A20	A40	A50	A70	C10 - C30	C20	E01		
All engines													360 677	
ORLANDO														
ENGINE														
1.4	Petrol	103	06/12->	LUJ										
Engine Information					A10	A20	A40	A50	A70	C10 - C30	C20	E01		
All engines										x 4, COIL ON PLUG	470 547	C10		
REZZO														
ENGINE														
1.6	Petrol	77	03/05->	A16DMS										
Engine Information					A10	A20	A40	A50	A70	C10 - C30	C20	E01		
All engines													360 680	
ENGINE														
1.6	Petrol	79	08/05->	A16DMS										
Engine Information					A10	A20	A40	A50	A70	C10 - C30	C20	E01		
All engines													360 680	
ENGINE														
2.0	Petrol	89	03/05->	T20SED										
Engine Information					A10	A20	A40	A50	A70	C10 - C30	C20	E01		
All engines													360 677	
ENGINE														
2.0	Petrol	90	08/05-09/09	T20SED										
Engine Information					A10	A20	A40	A50	A70	C10 - C30	C20	E01		
All engines													360 677	
SPARK I														
ENGINE														
0.8	Petrol	38	09/00-12/06	F8CV										
Engine Information					A10	A20	A40	A50	A70	C10 - C30	C20	E01		
All engines							831 139	931 131						
All engines							831 172	931 139						
All engines										470 219	C10		360 634	
All engines													358 007	
ENGINE														
1.0	Petrol	47	11/02-12/04	G 10 CV										
Engine Information					A10	A20	A40	A50	A70	C10 - C30	C20	E01		
All engines													358 006	

A10 CONDENSER	A20 CONTACT SET	A40 DISTRIBUTOR CAP	A50 ROTOR	A70 PICK-UP
C10 COIL	C20 IGNITION MODULE	C30 ELECTRONIC IGNITION KIT	E01 IGNITION CABLE SET	

The present application list is a brief version. For the detailed information about the possibility of installation on a specific vehicle, please refer to our web-catalogue <http://catalogo.facet.eu/>

					FUNCTIONS ON THE VEHICLE							
Vehicle	alim.	kW	Date	Engine								
SPARK II												
0.8	Petrol	37	05/05-02/10	ENGINE F8CV								
Engine Information					A10	A20	A40	A50	A70	C10 - C30	C20	E01
All engines												358 007
All engines												360 634
1.0 LPG												
Bi-Fuel	46	05/05->	ENGINE B10S									
Engine Information					A10	A20	A40	A50	A70	C10 - C30	C20	E01
All engines												358 006
1.0 SX												
Petrol	46	05/05->	ENGINE B10S, LA2									
Engine Information					A10	A20	A40	A50	A70	C10 - C30	C20	E01
All engines												358 006
1.0 SX												
Petrol	49	05/05->	ENGINE B10S1									
Engine Information					A10	A20	A40	A50	A70	C10 - C30	C20	E01
All engines												358 006
SPARK III												
1.0	Petrol	50	03/10->	ENGINE B10D1								
Engine Information					A10	A20	A40	A50	A70	C10 - C30	C20	E01
All engines												358 249
1.0 LPG												
Petrol/ Liquified Petro- leum Gas (LPG)	48	07/10->	ENGINE B10D1									
Engine Information					A10	A20	A40	A50	A70	C10 - C30	C20	E01
All engines												358 249
1.0 LPG												
Petrol/ Liquified Petro- leum Gas (LPG)	50	03/10->	ENGINE B10D1, LMT									
Engine Information					A10	A20	A40	A50	A70	C10 - C30	C20	E01
All engines												358 249
1.2												
Petrol	60	03/10->	ENGINE B12D1, LMU									
Engine Information					A10	A20	A40	A50	A70	C10 - C30	C20	E01
All engines												358 249
1.2												
Petrol	61	01/11->	ENGINE Z 12 XE									
Engine Information					A10	A20	A40	A50	A70	C10 - C30	C20	E01
All engines												358 249
1.2 LPG												
Petrol/ Liquified Petro- leum Gas (LPG)	60	03/10->	ENGINE B12D1, LMU									
Engine Information					A10	A20	A40	A50	A70	C10 - C30	C20	E01
All engines												358 249
TACUMA												
1.6	Petrol	79	02/05->	ENGINE A16DMS								
Engine Information					A10	A20	A40	A50	A70	C10 - C30	C20	E01
All engines												360 680
2.0												
Petrol	90	02/05->	ENGINE X 20 SED									
Engine Information					A10	A20	A40	A50	A70	C10 - C30	C20	E01
All engines												360 677

A10 CONDENSER	A20 CONTACT SET	A40 DISTRIBUTOR CAP	A50 ROTOR	A70 PICK-UP
C10 COIL	C20 IGNITION MODULE	C30 ELECTRONIC IGNITION KIT	E01 IGNITION CABLE SET	

Vehicle	alim.	kW	Date	Engine	FUNCTIONS ON THE VEHICLE							
					A10	A20	A40	A50	A70	C10 - C30	C20	E01

TRAX

Vehicle	alim.	kW	Date	ENGINE
1.4	Petrol	103	12/12->	A 14 NET

Engine	Information	A10	A20	A40	A50	A70	C10 - C30	C20	E01
All engines	x 4, COIL ON PLUG						470 547	C10	

Vehicle	alim.	kW	Date	ENGINE
1.4 AWD	Petrol	103	12/12->	A 14 NET

Engine	Information	A10	A20	A40	A50	A70	C10 - C30	C20	E01
All engines	x 4, COIL ON PLUG						470 547	C10	

Vehicle	alim.	kW	Date	ENGINE
1.4 LPG	Petrol/ Liquified Petro- leum Gas (LPG)	103	04/13->	A 14 NET

Engine	Information	A10	A20	A40	A50	A70	C10 - C30	C20	E01
All engines	x 4, COIL ON PLUG						470 547	C10	

Vehicle	alim.	kW	Date	ENGINE
1.6	Petrol	85	12/12->	LDE

Engine	Information	A10	A20	A40	A50	A70	C10 - C30	C20	E01
All engines	x 4, COIL ON PLUG						470 545	C10	

Vehicle	alim.	kW	Date	ENGINE
1.8	Petrol	103	03/13->	2H0

Engine	Information	A10	A20	A40	A50	A70	C10 - C30	C20	E01
All engines	x 4, COIL ON PLUG						470 545	C10	

Vehicle	alim.	kW	Date	ENGINE
1.8 AWD	Petrol	103	03/13->	2H0

Engine	Information	A10	A20	A40	A50	A70	C10 - C30	C20	E01
All engines	x 4, COIL ON PLUG						470 545	C10	

VIVANT

Vehicle	alim.	kW	Date	ENGINE
1.6	Petrol	77	01/05->	A16DMS

Engine	Information	A10	A20	A40	A50	A70	C10 - C30	C20	E01
All engines									360 680

Vehicle	alim.	kW	Date	ENGINE
1.6	Petrol	78	08/01->	A16DMS

Engine	Information	A10	A20	A40	A50	A70	C10 - C30	C20	E01
All engines									360 680

Vehicle	alim.	kW	Date	ENGINE
1.8	Petrol	72	05/00->	F18S2

Engine	Information	A10	A20	A40	A50	A70	C10 - C30	C20	E01
All engines									360 730

Vehicle	alim.	kW	Date	ENGINE
2.0	Petrol	89	08/00->	X 20 SED

Engine	Information	A10	A20	A40	A50	A70	C10 - C30	C20	E01
All engines									360 677

Vehicle	alim.	kW	Date	ENGINE
2.0 CX	Petrol	89	01/05->	T20SED









Engine	Information	A10	A20	A40	A50	A70	C10 - C30	C20	E01
All engines									360 677

VOLT

Vehicle	alim.	kW	Date	ENGINE
EV 150	Petrol/ Electric	111	11/11->	LUU



Engine	Information	A10	A20	A40	A50	A70	C10 - C30	C20	E01
All engines	x 4, COIL ON PLUG						470 547	C10	

A10 CONDENSER	A20 CONTACT SET	A40 DISTRIBUTOR CAP	A50 ROTOR	A70 PICK-UP
C10 COIL	C20 IGNITION MODULE	C30 ELECTRONIC IGNITION KIT	E01 IGNITION CABLE SET	

				FUNCTIONS ON THE VEHICLE								
Vehicle	alim.	kW	Date	Engine	 A10	 A20	 A40	 A50	 A70	 C10 - C30	 C20	 E01
CIRRUS												
2.0 LX	Petrol	98	10/97-09/00	ENGINE ECB								
Engine	Information			A10	A20	A40	A50	A70	C10 - C30	C20	E01	
All engines											360 507	
2.4 LX	Petrol	103	05/94-09/00	ENGINE EDZ								
Engine	Information			A10	A20	A40	A50	A70	C10 - C30	C20	E01	
All engines											360 508	
2.5 LX	Petrol	120	10/94-09/00	ENGINE EEB								
Engine	Information			A10	A20	A40	A50	A70	C10 - C30	C20	E01	
All engines	version Mitsubishi					831 161						
CROSSFIRE												
3.2	Petrol	160	07/03-12/08	ENGINE EGX								
Engine	Information			A10	A20	A40	A50	A70	C10 - C30	C20	E01	
All engines	x 6, COIL ON PLUG								470 417	C10		
SRT-6	Petrol	246	09/04-12/07	ENGINE EGZ								
Engine	Information			A10	A20	A40	A50	A70	C10 - C30	C20	E01	
All engines	x 6, COIL ON PLUG								470 417	C10		
DELTA												
1.4 16V	Petrol	103	08/11->	ENGINE 198 A7.000								
Engine	Information			A10	A20	A40	A50	A70	C10 - C30	C20	E01	
All engines	x 4, COIL ON PLUG								470 549	C10		
LE BARON												
2.2 i	Petrol	109	10/83-09/87	ENGINE EDG								
Engine	Information			A10	A20	A40	A50	A70	C10 - C30	C20	E01	
All engines	version Chrysler						910 179					
2.2 i	Petrol	69	09/89-12/94	ENGINE --								
Engine	Information			A10	A20	A40	A50	A70	C10 - C30	C20	E01	
All engines	version Chrysler						910 179					
2.2 i Turbo	Petrol	109	09/86-12/90	ENGINE --								
Engine	Information			A10	A20	A40	A50	A70	C10 - C30	C20	E01	
All engines	version Chrysler						910 179					
2.2 i Turbo	Petrol	130	10/83-01/91	ENGINE EDG, EDR								
Engine	Information			A10	A20	A40	A50	A70	C10 - C30	C20	E01	
All engines	version Chrysler						910 179					
2.5 i	Petrol	75	09/86-12/94	ENGINE EDM								
Engine	Information			A10	A20	A40	A50	A70	C10 - C30	C20	E01	
All engines	version Chrysler						910 179					
2.5 i Turbo	Petrol	112	01/89-12/94	ENGINE EDT								
Engine	Information			A10	A20	A40	A50	A70	C10 - C30	C20	E01	
All engines	version Chrysler						910 179					
3.0 i V6	Petrol	105	01/90-12/96	ENGINE 6G72, EFA								
Engine	Information			A10	A20	A40	A50	A70	C10 - C30	C20	E01	
All engines	version Mitsubishi					831 116	931 109					
NEON I												
1.8 16V	Petrol	85	09/97-08/99	ENGINE EBD								
Engine	Information			A10	A20	A40	A50	A70	C10 - C30	C20	E01	
All engines											360 507	

A10 CONDENSER	A20 CONTACT SET	A40 DISTRIBUTOR CAP	A50 ROTOR	A70 PICK-UP
C10 COIL	C20 IGNITION MODULE	C30 ELECTRONIC IGNITION KIT	E01 IGNITION CABLE SET	

Vehicle	alim.	kW	Date	Engine	FUNCTIONS ON THE VEHICLE									
					A10	A20	A40	A50	A70	C10 - C30	C20	E01		
ENGINE														
2.0	Petrol	118	10/96-09/00	ECC										
Engine					A10	A20	A40	A50	A70	C10 - C30	C20	E01		
All engines													360 508	
ENGINE														
2.0 16V	Petrol	107	06/94-08/99	ECC										
Engine					A10	A20	A40	A50	A70	C10 - C30	C20	E01		
All engines													360 508	
ENGINE														
2.0 16V	Petrol	109	04/96-08/99	420T										
Engine					A10	A20	A40	A50	A70	C10 - C30	C20	E01		
All engines													360 508	
ENGINE														
2.0 16V	Petrol	98	05/94-08/99	420H										
Engine					A10	A20	A40	A50	A70	C10 - C30	C20	E01		
All engines													360 507	
NEON II														
ENGINE														
1.6	Petrol	85	11/01-12/06	EJD										
Engine					A10	A20	A40	A50	A70	C10 - C30	C20	E01		
All engines													360 719	
ENGINE														
2.0 16V	Petrol	98	08/99-12/06	420H										
Engine					A10	A20	A40	A50	A70	C10 - C30	C20	E01		
All engines													360 507	
PT CRUISER														
ENGINE														
1.6	Petrol	85	11/01-12/10	EJD										
Engine					A10	A20	A40	A50	A70	C10 - C30	C20	E01		
All engines													360 719	
ENGINE														
2.0	Petrol	104	06/00-09/04	ECC										
Engine					A10	A20	A40	A50	A70	C10 - C30	C20	E01		
All engines													360 511	
ENGINE														
2.4	Petrol	105	03/04-03/08	EDZ										
Engine					A10	A20	A40	A50	A70	C10 - C30	C20	E01		
All engines													360 511	
ENGINE														
2.4 GT	Petrol	164	03/04-03/08	EDV										
Engine					A10	A20	A40	A50	A70	C10 - C30	C20	E01		
All engines													360 990	
ENGINE														
GT 2.4	Petrol	164	08/03-12/10	EDV										
Engine					A10	A20	A40	A50	A70	C10 - C30	C20	E01		
All engines													360 990	
SEBRING I														
ENGINE														
2.5 LE	Petrol	120	05/95-12/96	EEB										
Engine					A10	A20	A40	A50	A70	C10 - C30	C20	E01		
All engines							831 161							
SEBRING II														
ENGINE														
2.0	Petrol	104	04/01-06/07	ECC										
Engine					A10	A20	A40	A50	A70	C10 - C30	C20	E01		
All engines													360 507	
All engines													360 511	
ENGINE														
2.4	Petrol	112	04/01-06/07	EDZ										
Engine					A10	A20	A40	A50	A70	C10 - C30	C20	E01		
All engines													360 511, 360 764	
ENGINE														
A10	CONDENSER		A20	CONTACT SET		A40	DISTRIBUTOR CAP		A50	ROTOR		A70	PICK-UP	
C10	COIL		C20	IGNITION MODULE		C30	ELECTRONIC IGNITION KIT		E01	IGNITION CABLE SET				

					FUNCTIONS ON THE VEHICLE							
Vehicle	alim.	kW	Date	Engine								

STRATUS

				ENGINE								
2.0 16V	Petrol	98	12/95-04/01	ECB								
Engine	Information			A10	A20	A40	A50	A70	C10 - C30	C20	E01	
All engines												360 507
				ENGINE								
2.0 LE	Petrol	96	12/95-04/01	420X, C00								
Engine	Information			A10	A20	A40	A50	A70	C10 - C30	C20	E01	
All engines												360 507
				ENGINE								
2.4 16 V	Petrol	103	12/95-04/01	EDZ								
Engine	Information			A10	A20	A40	A50	A70	C10 - C30	C20	E01	
All engines												360 508
				ENGINE								
2.4 16V	Petrol	112	12/95-04/01	EDZ								
Engine	Information			A10	A20	A40	A50	A70	C10 - C30	C20	E01	
All engines												360 508
				ENGINE								
2.5 LX	Petrol	120	04/96-04/01	625H								
Engine	Information			A10	A20	A40	A50	A70	C10 - C30	C20	E01	
All engines	version Mitsubishi					831 161						
				ENGINE								
2.5 LX V6	Petrol	120	12/95-04/01	5RG225								
Engine	Information			A10	A20	A40	A50	A70	C10 - C30	C20	E01	
All engines	version Mitsubishi					831 161						
				ENGINE								
2.5 V6	Petrol	125	12/95-04/01	5RG225								
Engine	Information			A10	A20	A40	A50	A70	C10 - C30	C20	E01	
All engines	version Mitsubishi					831 161						

VOYAGER

				ENGINE								
2.5 i	Petrol	72	01/91-09/95	K00								
Engine	Information			A10	A20	A40	A50	A70	C10 - C30	C20	E01	
All engines	version Chrysler						910 179					
				ENGINE								
2.5 i	Petrol	74	08/90-09/95	K								
Engine	Information			A10	A20	A40	A50	A70	C10 - C30	C20	E01	
All engines	version Chrysler						910 179					
				ENGINE								
3.0 i	Petrol	108	01/91-09/95	300, 6G72								
Engine	Information			A10	A20	A40	A50	A70	C10 - C30	C20	E01	
All engines	version Mitsubishi					831 116	931 109					
				ENGINE								
3.3	Petrol	112	10/89-09/90	EGA								
Engine	Information			A10	A20	A40	A50	A70	C10 - C30	C20	E01	
All engines	version Mitsubishi					831 116	931 109					

VOYAGER I

				ENGINE								
3.0 i [USA]	Petrol	108	10/84-07/90	EFA								
Engine	Information			A10	A20	A40	A50	A70	C10 - C30	C20	E01	
All engines	version Mitsubishi					831 116	931 109					

VOYAGER II

				ENGINE								
2.0 i	Petrol	98	01/95-03/01	C00								
Engine	Information			A10	A20	A40	A50	A70	C10 - C30	C20	E01	
All engines												360 507
				ENGINE								
2.4 i	Petrol	111	01/95-03/01	B00								
Engine	Information			A10	A20	A40	A50	A70	C10 - C30	C20	E01	
All engines												360 508



A10 CONDENSER	A20 CONTACT SET	A40 DISTRIBUTOR CAP	A50 ROTOR	A70 PICK-UP
C10 COIL	C20 IGNITION MODULE	C30 ELECTRONIC IGNITION KIT	E01 IGNITION CABLE SET	

Vehicle	alim.	kW	Date	Engine	FUNCTIONS ON THE VEHICLE									
					A10	A20	A40	A50	A70	C10 - C30	C20	E01		
ENGINE														
3.3 i	Petrol	116	01/95-03/01	R00										
Engine	Information				A10	A20	A40	A50	A70	C10 - C30	C20	E01		
All engines													360 343	
ENGINE														
3.8 i AWD	Petrol	122	01/95-03/01	L00										
Engine	Information				A10	A20	A40	A50	A70	C10 - C30	C20	E01		
All engines													360 343	
ENGINE														
3.8 i AWD	Petrol	131	01/95-03/01	EGH										
Engine	Information				A10	A20	A40	A50	A70	C10 - C30	C20	E01		
All engines													360 343	
VOYAGER III														
ENGINE														
2.4	Petrol	108	02/00-12/08	EDZ										
Engine	Information				A10	A20	A40	A50	A70	C10 - C30	C20	E01		
All engines													360 511	
ENGINE														
3.3	Petrol	128	02/00-12/08	EGA										
Engine	Information				A10	A20	A40	A50	A70	C10 - C30	C20	E01		
All engines													360 345	
ENGINE														
3.3 AWD	Petrol	128	02/00-12/08	EGA										
Engine	Information				A10	A20	A40	A50	A70	C10 - C30	C20	E01		
All engines													360 345	
YPSILON														
ENGINE														
1.2	Petrol	51	05/11->	169 A4.000										
Engine	Information				A10	A20	A40	A50	A70	C10 - C30	C20	E01		
All engines	x 1, D.I.S.									470 423	C10			

A10	CONDENSER	A20	CONTACT SET	A40	DISTRIBUTOR CAP	A50	ROTOR	A70	PICK-UP
C10	COIL	C20	IGNITION MODULE	C30	ELECTRONIC IGNITION KIT	E01	IGNITION CABLE SET		

The present application list is a brief version. For the detailed information about the possibility of installation on a specific vehicle, please refer to our web-catalogue <http://catalogo.facet.eu/>

FUNCTIONS ON THE VEHICLE

Vehicle	alim.	kW	Date	Engine								
---------	-------	----	------	--------	---	---	---	--	---	---	---	---

2 CV

6	Petrol	21	02/70-10/85	ENGINE A06/635, A06/664
---	--------	----	-------------	----------------------------

Engine	Information	A10	A20	A40	A50	A70	C10 - C30	C20	E01
All engines	version Ducellier		715 064						

ACADIANE

6	Petrol	22	08/78-10/88	ENGINE M28 (AM2)
---	--------	----	-------------	---------------------

Engine	Information	A10	A20	A40	A50	A70	C10 - C30	C20	E01
All engines	version Ducellier		715 064						

AX

1.3 Sport	Petrol	70	04/87-12/88	ENGINE M4A
-----------	--------	----	-------------	---------------

Engine	Information	A10	A20	A40	A50	A70	C10 - C30	C20	E01
All engines	version Bosch			806 241	906 056R				
All engines	version Ducellier			815 074	915 102R	415 019			
All engines	Kit, version Ducellier			815 087					
All engines	->year 27/04/91						470 105	C10	
All engines	28/04/91 ->						470 155	C10	
All engines									360 376

1.4 GTi	Petrol	66	08/91-12/96	ENGINE KFY (TU3FJ2)
---------	--------	----	-------------	------------------------

Engine	Information	A10	A20	A40	A50	A70	C10 - C30	C20	E01
All engines							470 189	C10	360 374

1.4 GTi	Petrol	69	06/91-12/96	ENGINE KFZ (TU3FJ2)
---------	--------	----	-------------	------------------------

Engine	Information	A10	A20	A40	A50	A70	C10 - C30	C20	E01
All engines							470 189	C10	360 374

1.4 GTi	Petrol	74	06/91-12/92	ENGINE KFZ (TU3FJ2)
---------	--------	----	-------------	------------------------

Engine	Information	A10	A20	A40	A50	A70	C10 - C30	C20	E01
All engines							470 189	C10	360 374

10	Petrol	32	09/86-06/92	ENGINE C1A
----	--------	----	-------------	---------------

Engine	Information	A10	A20	A40	A50	A70	C10 - C30	C20	E01
All engines	version Bosch			806 241	906 056R				
All engines	version Ducellier			815 074	915 102R	415 019			
All engines	Kit, version Ducellier			815 087					
All engines	version Marelli				930 060				
All engines	->year 27/04/91						470 105	C10	
All engines	28/04/91 ->						470 155	C10	
All engines									360 376

10	Petrol	33	07/86-12/98	ENGINE CDY (TU9M)
----	--------	----	-------------	----------------------

Engine	Information	A10	A20	A40	A50	A70	C10 - C30	C20	E01
All engines							470 189	C10	360 374

10	Petrol	37	02/87-12/98	ENGINE CDZ (TU9M)
----	--------	----	-------------	----------------------

Engine	Information	A10	A20	A40	A50	A70	C10 - C30	C20	E01
All engines							470 189	C10	360 374

10 E	Petrol	30	12/86-12/88	ENGINE C3A
------	--------	----	-------------	---------------

Engine	Information	A10	A20	A40	A50	A70	C10 - C30	C20	E01
All engines	version Bosch			806 241	906 056R				
All engines	version Ducellier			815 074	915 102R	415 019			
All engines	Kit, version Ducellier			815 087					
All engines	version Marelli				930 060				
All engines	->year 27/04/91						470 105	C10	
All engines	28/04/91 ->						470 155	C10	
All engines									360 376

A10 CONDENSER	A20 CONTACT SET	A40 DISTRIBUTOR CAP	A50 ROTOR	A70 PICK-UP
C10 COIL	C20 IGNITION MODULE	C30 ELECTRONIC IGNITION KIT	E01 IGNITION CABLE SET	

Vehicle	alim.	kW	Date	Engine	FUNCTIONS ON THE VEHICLE							
					A10	A20	A40	A50	A70	C10 - C30	C20	E01

ENGINE				
11	Petrol	40	12/86-04/94	H1A, H1B

Engine	Information	A10	A20	A40	A50	A70	C10 - C30	C20	E01
All engines	version Bosch			806 241	906 056R				
All engines	version Ducellier			815 074	915 102R	415 019			
All engines	Kit, version Ducellier			815 087					
All engines	version Marelli				930 060				
All engines	->year 27/04/91						470 105	C10	
All engines	28/04/91 ->						470 155	C10	
All engines									360 376

ENGINE				
11	Petrol	44	09/86-06/98	HDY, HDZ (TU1M)

Engine	Information	A10	A20	A40	A50	A70	C10 - C30	C20	E01
All engines	version Bosch			806 241	906 056R				
All engines	version Ducellier			815 074	915 102R	415 019			
All engines	Kit, version Ducellier			815 087					
All engines	->year 27/04/91						470 105	C10	
All engines	28/04/91 ->, ->year 04/05/92						470 155	C10	
All engines	05/05/92 ->						470 189	C10	360 374
All engines	->year 04/05/92								360 376

ENGINE				
11 4x4	Petrol	40	06/91-07/92	H1A

Engine	Information	A10	A20	A40	A50	A70	C10 - C30	C20	E01
All engines	version Bosch			806 241	906 056R				
All engines	version Ducellier			815 074	915 102R	415 019			
All engines	Kit, version Ducellier			815 087					
All engines	version Marelli				930 060				
All engines	->year 27/04/91						470 105	C10	
All engines	28/04/91 ->						470 155	C10	
All engines									360 376

ENGINE				
11 Cat	Petrol	40	09/88-12/89	HAZ (TU1CP)

Engine	Information	A10	A20	A40	A50	A70	C10 - C30	C20	E01
All engines	version Bosch			806 241	906 056R				
All engines	version Ducellier			815 074	915 102R	415 019			
All engines	Kit, version Ducellier			815 087					
All engines	version Marelli				930 060				
All engines	->year 27/04/91						470 105	C10	
All engines	28/04/91 ->						470 155	C10	
All engines									360 376

ENGINE				
14	Petrol	44	12/86-12/88	K1B, KAY (TU3CP)

Engine	Information	A10	A20	A40	A50	A70	C10 - C30	C20	E01
All engines	version Bosch			806 241	906 056R				
All engines	version Ducellier			815 074	915 102R	415 019			
All engines	Kit, version Ducellier			815 087					
All engines	->year 27/04/91						470 105	C10	
All engines	28/04/91 ->						470 155	C10	
All engines									360 376

ENGINE				
14	Petrol	49	06/88-12/89	K1F

Engine	Information	A10	A20	A40	A50	A70	C10 - C30	C20	E01
All engines	version Bosch			806 241	906 056R				
All engines	version Ducellier			815 074	915 102R	415 019			
All engines	Kit, version Ducellier			815 087					
All engines	->year 27/04/91						470 105	C10	
All engines	28/04/91 ->						470 155	C10	
All engines									360 376

ENGINE				
14	Petrol	51	01/89-12/91	K1G

Engine	Information	A10	A20	A40	A50	A70	C10 - C30	C20	E01
All engines	version Bosch			806 241	906 056R				
All engines	version Ducellier			815 074	915 102R	415 019			

A10	CONDENSER	A20	CONTACT SET	A40	DISTRIBUTOR CAP	A50	ROTOR	A70	PICK-UP
C10	COIL	C20	IGNITION MODULE	C30	ELECTRONIC IGNITION KIT	E01	IGNITION CABLE SET		

FUNCTIONS ON THE VEHICLE

Vehicle	alim.	kW	Date	Engine								
---------	-------	----	------	--------	---	---	---	--	---	---	---	---

ENGINE				
14	Petrol	51	01/89-12/91	K1G

Engine	Information	A10	A20	A40	A50	A70	C10 - C30	C20	E01
All engines	Kit, version Ducellier			815 087					
All engines	->year 27/04/91						470 105	C10	
All engines	28/04/91 ->						470 155	C10	
All engines									360 376

ENGINE				
14	Petrol	55	04/87-04/97	K2D, KDX (TU3M/Z), KDY (TU3FM), KDY (TU3M), KDZ (TU3M/Z)

Engine	Information	A10	A20	A40	A50	A70	C10 - C30	C20	E01
All engines	version Bosch			806 241	906 056R				
All engines	version Ducellier			815 074	915 102R	415 019			
All engines	Kit, version Ducellier			815 087					
Eng. K2D, KDX (TU3M/Z), KDY (TU3FM)	->year 27/04/91						470 105	C10	
All engines	28/04/91 ->, ->year 04/01/93						470 155	C10	
Eng. KDX (TU3M/Z), KDY (TU3FM)	05/01/93 ->						470 189	C10	360 374
All engines	->year 04/01/93								360 376

ENGINE				
14	Petrol	61	01/88-12/92	K2A

Engine	Information	A10	A20	A40	A50	A70	C10 - C30	C20	E01
All engines	version Bosch			806 241	906 056R				
All engines	version Ducellier			815 074	915 102R	415 019			
All engines	Kit, version Ducellier			815 087					
All engines	->year 27/04/91						470 105	C10	
All engines	28/04/91 ->						470 155	C10	
All engines									360 376

ENGINE				
14	Petrol	62	01/88-12/92	K2A, K2B

Engine	Information	A10	A20	A40	A50	A70	C10 - C30	C20	E01
All engines	version Bosch			806 241	906 056R				
All engines	version Ducellier			815 074	915 102R	415 019			
All engines	Kit, version Ducellier			815 087					
All engines	->year 27/04/91						470 105	C10	
All engines	28/04/91 ->						470 155	C10	
All engines									360 376

ENGINE				
14 4x4	Petrol	55	08/91-12/96	KDX (TU3M/Z), KDY (TU3FM), KDY (TU3M), KDZ (TU3M/Z)

Engine	Information	A10	A20	A40	A50	A70	C10 - C30	C20	E01
All engines	version Bosch			806 241	906 056R				
All engines	version Ducellier			815 074	915 102R	415 019			
All engines	Kit, version Ducellier			815 087					
Eng. KDY (TU3FM)	->year 27/04/91						470 105	C10	
All engines	28/04/91 ->, ->year 04/01/93						470 155	C10	
Eng. KDY (TU3FM)	05/01/93 ->						470 189	C10	360 374
All engines	->year 04/01/93								360 376

ENGINE				
14 GT	Petrol	59	01/89-12/91	KDZ (TU3M/Z)









Engine	Information	A10	A20	A40	A50	A70	C10 - C30	C20	E01
All engines	version Bosch			806 241	906 056R				
All engines	version Ducellier			815 074	915 102R	415 019			
All engines	Kit, version Ducellier			815 087					
All engines							470 105	C10	360 376

AXEL

ENGINE				
11	Petrol	42	01/84-03/91	G11/631

Engine	Information	A10	A20	A40	A50	A70	C10 - C30	C20	E01
All engines	version Ducellier	615 034		815 058	915 088				

A10	CONDENSER	A20	CONTACT SET	A40	DISTRIBUTOR CAP	A50	ROTOR	A70	PICK-UP
C10	COIL	C20	IGNITION MODULE	C30	ELECTRONIC IGNITION KIT	E01	IGNITION CABLE SET		

				FUNCTIONS ON THE VEHICLE								
Vehicle	alim.	kW	Date	Engine								
				ENGINE								
1.4 i	Petrol	55	07/96-12/11	KFW (TU3JP), KFX (TU3JP)								
				ENGINE								
Engine		Information		A10	A20	A40	A50	A70	C10 - C30	C20	E01	
All engines		euro 3, x 1, COIL ON PLUG							470 405	C10		
				ENGINE								
1.4 i	Petrol	57	08/99-05/08	KFW (TU3JP), KFX (TU3JP)								
				ENGINE								
Engine		Information		A10	A20	A40	A50	A70	C10 - C30	C20	E01	
All engines		x 1, Electricfil, COIL ON PLUG							470 403	C10		
All engines		x 1, COIL ON PLUG							470 405	C10		
				ENGINE								
1.4 i bivalent	Petrol/ Com- pressed Natural Gas (CNG)	55	04/03-10/08	KFW (TU3JP)								
				ENGINE								
Engine		Information		A10	A20	A40	A50	A70	C10 - C30	C20	E01	
All engines		->year 31/05/98							470 188	C10		360 374
All engines		euro 2, x 4, Electricfil, COIL ON PLUG							470 403	C10		
All engines		euro 3, x 1, COIL ON PLUG							470 405	C10		
				ENGINE								
1.6 16V	Petrol	80	10/00-12/11	NFU (TU5JP4)								
				ENGINE								
Engine		Information		A10	A20	A40	A50	A70	C10 - C30	C20	E01	
All engines		x 1, COIL ON PLUG							470 407	C10		
				ENGINE								
1.6 16V	Petrol	81	11/02-10/08	NFU (TU5JP4)								
				ENGINE								
Engine		Information		A10	A20	A40	A50	A70	C10 - C30	C20	E01	
All engines		x 1, COIL ON PLUG							470 407	C10		
				ENGINE								
1.8 i	Petrol	66	05/97-10/02	LFX (XU7JB)								
				ENGINE								
Engine		Information		A10	A20	A40	A50	A70	C10 - C30	C20	E01	
All engines		x 1, D.I.S., connector type, saw teeth							470 188	C10		
All engines												359 674
				ENGINE								
1.8 i 4WD	Petrol	66	04/97-10/01	LFX (XU7JB)								
				ENGINE								
Engine		Information		A10	A20	A40	A50	A70	C10 - C30	C20	E01	
All engines									470 188	C10		359 674
				ENGINE								
BERLINGO II				ENGINE								
1.2 PureTech 110	Petrol	81	02/16->	--, EB2DT, HNZ (EB2DT)								
				ENGINE								
Engine		Information		A10	A20	A40	A50	A70	C10 - C30	C20	E01	
Eng. --, EB2DT		Qty: 3							470 620	C10		
Eng. HNZ (EB2DT)		x 3, COIL ON PLUG							470 620	C10		
				ENGINE								
1.6	Petrol	66	04/08->	NFR (TU5JP4B)								
				ENGINE								
Engine		Information		A10	A20	A40	A50	A70	C10 - C30	C20	E01	
All engines		x 1, COIL ON PLUG							470 407	C10		
				ENGINE								
1.6	Petrol	80	04/08->	N6A (TU5JP4), NFU (TU5JP4)								
				ENGINE								
Engine		Information		A10	A20	A40	A50	A70	C10 - C30	C20	E01	
Eng. N6A (TU5JP4)									470 407	C10		
Eng. NFU (TU5JP4)		x 1, COIL ON PLUG							470 407	C10		
				ENGINE								
1.6 Vti 120	Petrol	88	11/09->	5FS (EP6C)								
				ENGINE								
Engine		Information		A10	A20	A40	A50	A70	C10 - C30	C20	E01	
All engines		x 4, COIL ON PLUG							470 475	C10		
				ENGINE								
1.6 Vti 95	Petrol	72	07/10->	5FK (EP6CB)								
				ENGINE								
Engine		Information		A10	A20	A40	A50	A70	C10 - C30	C20	E01	
All engines		x 4, COIL ON PLUG							470 475	C10		

A10 CONDENSER	A20 CONTACT SET	A40 DISTRIBUTOR CAP	A50 ROTOR	A70 PICK-UP
C10 COIL	C20 IGNITION MODULE	C30 ELECTRONIC IGNITION KIT	E01 IGNITION CABLE SET	

Vehicle	alim.	kW	Date	Engine	FUNCTIONS ON THE VEHICLE							
					A10	A20	A40	A50	A70	C10 - C30	C20	E01

BX				
1.1	Petrol	40	06/88-06/91	ENGINE H1A

Engine	Information	A10	A20	A40	A50	A70	C10 - C30	C20	E01
All engines	15/05/88 ->, version Bosch			806 241	906 056R				
All engines	->year 14/05/88, version Ducellier			815 058					
All engines	15/05/88 ->, version Ducellier			815 074	915 102R	415 019			
All engines	Kit, 15/05/88 ->, version Ducellier			815 087					
All engines	->year 15/05/88, version Ducellier				915 094				
All engines	15/05/88 ->						470 105	C10	360 376
All engines	->year 14/05/88							465 005	

1.4				
1.4	Petrol	50	07/86-12/94	ENGINE K1F

Engine	Information	A10	A20	A40	A50	A70	C10 - C30	C20	E01
All engines	->year 01/05/88, version Bosch			806 124					
All engines	02/05/88 ->, version Bosch			806 241					
All engines	->year 01/05/88, version Ducellier, distr. num. 2525578A, 2525579A			815 058					
All engines	->year 01/05/88, version Ducellier, distr. num. 2525577A/B/C, distr. num. 2525578B, distr. num. 2525621, 2525579B			815 067					
All engines	02/05/88 ->, version Ducellier			815 074	915 102R	415 019			
All engines	Kit, 02/05/88 ->, version Ducellier			815 087					
All engines	version Bosch				906 056R				
All engines	->year 01/05/88, version Ducellier				915 094				
All engines	02/05/88 ->						470 105	C10	360 376
All engines	->year 01/05/88							465 005	

1.4				
1.4	Petrol	52	01/87-01/92	ENGINE 150C

Engine	Information	A10	A20	A40	A50	A70	C10 - C30	C20	E01
All engines	->year 01/05/88, version Bosch			806 124					
All engines	02/05/88 ->, version Bosch			806 241					
All engines	->year 01/05/88, version Ducellier, distr. num. 2525578A, 2525579A			815 058					
All engines	->year 01/05/88, version Ducellier, distr. num. 2525577A/B/C, distr. num. 2525578B, distr. num. 2525621, 2525579B			815 067					
All engines	02/05/88 ->, version Ducellier			815 074	915 102R	415 019			
All engines	Kit, 02/05/88 ->, version Ducellier			815 087					
All engines	version Bosch				906 056R				
All engines	->year 01/05/88, version Ducellier				915 094				
All engines	02/05/88 ->						470 105	C10	360 376
All engines	->year 01/05/88							465 005	

1.4				
1.4	Petrol	55	09/91-09/93	ENGINE K2D

Engine	Information	A10	A20	A40	A50	A70	C10 - C30	C20	E01
All engines	->year 01/05/88, version Bosch			806 124					
All engines	02/05/88 ->, version Bosch			806 241					
All engines	->year 01/05/88, version Ducellier, distr. num. 2525578A, 2525579A			815 058					
All engines	->year 01/05/88, version Ducellier, distr. num. 2525577A/B/C, distr. num. 2525578B, distr. num. 2525621, 2525579B			815 067					
All engines	02/05/88 ->, version Ducellier			815 074	915 102R	415 019			
All engines	Kit, 02/05/88 ->, version Ducellier			815 087					
All engines	version Bosch				906 056R				
All engines	->year 01/05/88, version Ducellier				915 094				
All engines	02/05/88 ->						470 105	C10	360 376
All engines	->year 01/05/88							465 005	

1.4 E				
1.4 E	Petrol	46	05/86-06/88	ENGINE KAZ

Engine	Information	A10	A20	A40	A50	A70	C10 - C30	C20	E01
All engines	->year 01/05/88, version Bosch			806 124					
All engines	02/05/88 ->, version Bosch			806 241					
All engines	->year 01/05/88, version Ducellier, distr. num. 2525578A, 2525579A			815 058					
All engines	->year 01/05/88, version Ducellier, distr. num. 2525577A/B/C, distr. num. 2525578B, distr. num. 2525621, 2525579B			815 067					
All engines	02/05/88 ->, version Ducellier			815 074	915 102R	415 019			

A10 CONDENSER	A20 CONTACT SET	A40 DISTRIBUTOR CAP	A50 ROTOR	A70 PICK-UP
C10 COIL	C20 IGNITION MODULE	C30 ELECTRONIC IGNITION KIT	E01 IGNITION CABLE SET	

FUNCTIONS ON THE VEHICLE

Vehicle	alim.	kW	Date	Engine								
ENGINE												
1.4 E	Petrol	46	05/86-06/88	KAZ								
Engine	Information			A10	A20	A40	A50	A70	C10 - C30	C20	E01	
All engines	Kit, 02/05/88 ->, version Ducellier					815 087						
All engines	version Bosch						906 056R					
All engines	->year 01/05/88, version Ducellier						915 094					
All engines	02/05/88 ->								470 105	C10		360 376
All engines	->year 01/05/88										465 005	
ENGINE												
1.4 E	Petrol	50	07/86-12/94	K1F								
Engine	Information			A10	A20	A40	A50	A70	C10 - C30	C20	E01	
All engines	->year 01/05/88, version Bosch					806 124						
All engines	02/05/88 ->, version Bosch					806 241						
All engines	->year 01/05/88, version Ducellier, distr. num. 2525578A, 2525579A					815 058						
All engines	->year 01/05/88, version Ducellier, distr. num. 2525577A/B/C, distr. num. 2525578B, distr. num. 2525621, 2525579B					815 067						
All engines	02/05/88 ->, version Ducellier					815 074	915 102R	415 019				
All engines	Kit, 02/05/88 ->, version Ducellier					815 087						
All engines	version Bosch						906 056R					
All engines	->year 01/05/88, version Ducellier						915 094					
All engines	02/05/88 ->								470 105	C10		360 376
All engines	->year 01/05/88										465 005	
ENGINE												
1.4 E	Petrol	59	09/82-12/86	150B (XY8)								
Engine	Information			A10	A20	A40	A50	A70	C10 - C30	C20	E01	
All engines	->year 01/05/88, version Bosch					806 124						
All engines	02/05/88 ->, version Bosch					806 241						
All engines	->year 01/05/88, version Ducellier, distr. num. 2525578A, 2525579A					815 058						
All engines	->year 01/05/88, version Ducellier, distr. num. 2525577A/B/C, distr. num. 2525578B, distr. num. 2525621, 2525579B					815 067						
All engines	02/05/88 ->, version Ducellier					815 074	915 102R	415 019				
All engines	Kit, 02/05/88 ->, version Ducellier					815 087						
All engines	version Bosch						906 056R					
All engines	->year 01/05/88, version Ducellier						915 094					
All engines	02/05/88 ->								470 105	C10		360 376
All engines	->year 01/05/88										465 005	
ENGINE												
1.6	Petrol	85	01/87-01/92	B6D, B6E								
Engine	Information			A10	A20	A40	A50	A70	C10 - C30	C20	E01	
All engines	->year 31/10/89, version Bosch					806 124						
All engines	01/11/89 ->, version Bosch					806 241						
All engines	version Bosch						906 056R					
All engines	01/11/89 ->								470 105	C10		359 491
All engines	->year 31/10/89										465 005	
All engines	->year 31/10/89											359 747
ENGINE												
14	Petrol	53	01/86-02/93	150C								
Engine	Information			A10	A20	A40	A50	A70	C10 - C30	C20	E01	
All engines	->year 01/05/88, version Bosch					806 124						
All engines	02/05/88 ->, version Bosch					806 241						
All engines	->year 01/05/88, version Ducellier, distr. num. 2525578A, 2525579A					815 058						
All engines	->year 01/05/88, version Ducellier, distr. num. 2525577A/B/C, distr. num. 2525578B, distr. num. 2525621, 2525579B					815 067						
All engines	02/05/88 ->, version Ducellier					815 074	915 102R	415 019				
All engines	Kit, 02/05/88 ->, version Ducellier					815 087						
All engines	version Bosch						906 056R					
All engines	->year 01/05/88, version Ducellier						915 094					
All engines	02/05/88 ->								470 105	C10		360 376
All engines	->year 01/05/88										465 005	

A10 CONDENSER	A20 CONTACT SET	A40 DISTRIBUTOR CAP	A50 ROTOR	A70 PICK-UP
C10 COIL	C20 IGNITION MODULE	C30 ELECTRONIC IGNITION KIT	E01 IGNITION CABLE SET	

Vehicle	alim.	kW	Date	Engine	FUNCTIONS ON THE VEHICLE							
					A10	A20	A40	A50	A70	C10 - C30	C20	E01

ENGINE				
14	Petrol	55	01/89-02/93	KDY (TU3M), KDZ (TU3M/Z)

Engine	Information	A10	A20	A40	A50	A70	C10 - C30	C20	E01
All engines	version Bosch			806 241	906 056R				
All engines	version Ducellier			815 074	915 102R	415 019			
All engines	Kit, version Ducellier			815 087					
All engines							470 105	C10	360 376

ENGINE				
14 E	Petrol	45	10/82-06/88	150A

Engine	Information	A10	A20	A40	A50	A70	C10 - C30	C20	E01
All engines	->year 01/05/88, version Bosch			806 124					
All engines	02/05/88 ->, version Bosch			806 241					
All engines	->year 01/05/88, version Ducellier, distr. num. 2525578A, 2525579A			815 058					
All engines	->year 01/05/88, version Ducellier, distr. num. 2525577A/B/C, distr. num. 2525578B, distr. num. 2525621, 2525579B			815 067					
All engines	02/05/88 ->, version Ducellier			815 074	915 102R	415 019			
All engines	Kit, 02/05/88 ->, version Ducellier			815 087					
All engines	version Bosch				906 056R				
All engines	->year 01/05/88, version Ducellier				915 094				
All engines	02/05/88 ->						470 105	C10	360 376
All engines	->year 01/05/88							465 005	

ENGINE				
14 E	Petrol	52	04/83-07/89	150C, K1G

Engine	Information	A10	A20	A40	A50	A70	C10 - C30	C20	E01
All engines	->year 01/05/88, version Bosch			806 124					
All engines	02/05/88 ->, version Bosch, 02/05/88 ->			806 241					
All engines	->year 01/05/88, version Ducellier, distr. num. 2525578A, 2525579A			815 058					
All engines	->year 01/05/88, version Ducellier, distr. num. 2525577A/B/C, distr. num. 2525578B, distr. num. 2525621, 2525579B			815 067					
All engines	02/05/88 ->, version Ducellier			815 074	915 102R	415 019			
All engines	Kit, 02/05/88 ->, version Ducellier			815 087					
All engines	version Bosch				906 056R				
All engines	->year 01/05/88, version Ducellier				915 094				
All engines	02/05/88 ->						470 105	C10	360 376
All engines	->year 01/05/88							465 005	

ENGINE				
14 E	Petrol	53	04/83-02/93	150C

Engine	Information	A10	A20	A40	A50	A70	C10 - C30	C20	E01
All engines	->year 01/05/88, version Bosch			806 124					
All engines	02/05/88 ->, version Bosch			806 241					
All engines	->year 01/05/88, version Ducellier, distr. num. 2525578A, 2525579A			815 058					
All engines	->year 01/05/88, version Ducellier, distr. num. 2525577A/B/C, distr. num. 2525578B, distr. num. 2525621, 2525579B			815 067					
All engines	02/05/88 ->, version Ducellier			815 074	915 102R	415 019			
All engines	Kit, 02/05/88 ->, version Ducellier			815 087					
All engines	version Bosch				906 056R				
All engines	->year 01/05/88, version Ducellier				915 094				
All engines	02/05/88 ->						470 105	C10	360 376
All engines	->year 01/05/88							465 005	

ENGINE				
15	Petrol	58	01/87-01/92	B1E (XU51C)

Engine	Information	A10	A20	A40	A50	A70	C10 - C30	C20	E01
All engines	version Bosch			806 124	906 056R				
All engines	->year 01/10/89, version Ducellier			815 067	915 094	415 017			
All engines	02/10/89 ->, version Ducellier			815 074	915 102R	415 019			
All engines	Kit, 02/10/89 ->, version Ducellier			815 087					
All engines	02/10/89 ->						470 106	C10	
All engines	->year 01/10/89							465 005	

A10 CONDENSER	A20 CONTACT SET	A40 DISTRIBUTOR CAP	A50 ROTOR	A70 PICK-UP
C10 COIL	C20 IGNITION MODULE	C30 ELECTRONIC IGNITION KIT	E01 IGNITION CABLE SET	

The present application list is a brief version. For the detailed information about the possibility of installation on a specific vehicle, please refer to our web-catalogue <http://catalogo.facet.eu/>

FUNCTIONS ON THE VEHICLE

Vehicle	alim.	kW	Date	Engine	 A10	 A20	 A40	 A50	 A70	 C10 - C30	 C20	 E01
---------	-------	----	------	--------	---	---	---	--	---	---	---	---

ENGINE				
15	Petrol	59	10/87-05/92	B1E (XU51C)

Engine	Information	A10	A20	A40	A50	A70	C10 - C30	C20	E01
All engines	version Bosch			806 124	906 056R				
All engines	->year 01/10/89, version Ducellier			815 067	915 094	415 017			
All engines	02/10/89 ->, version Ducellier			815 074	915 102R	415 019			
All engines	Kit, 02/10/89 ->, version Ducellier			815 087					
All engines	02/10/89 ->						470 106	C10	
All engines	->year 01/10/89							465 005	

ENGINE				
16	Petrol	53	01/87-12/94	B1E (XU51C)

Engine	Information	A10	A20	A40	A50	A70	C10 - C30	C20	E01
All engines	version Bosch			806 124	906 056R				
All engines	->year 01/10/89, version Ducellier			815 067	915 094	415 017			
All engines	version Ducellier, 02/10/89 ->			815 074	915 102R	415 019			
All engines	Kit, version Ducellier, 02/10/89 ->			815 087					
All engines	02/10/89 ->						470 106	C10	
All engines	->year 01/10/89							465 005	

ENGINE				
16	Petrol	55	09/88-12/94	BAY (XU5CP), BAZ (XU5CP)

Engine	Information	A10	A20	A40	A50	A70	C10 - C30	C20	E01
All engines	version Bosch, FOR: (D), FOR: (S), FOR: (CH)			806 124					
All engines	version Bosch, 28/03/88 ->			806 241					
All engines	->year 27/03/88, version Ducellier			815 058					
All engines	version Ducellier, FOR: (A), FOR: (S), 01/07/87 ->, FOR: (CH)			815 067	915 094	415 017			
All engines	28/03/88 ->, version Ducellier			815 074	915 102R	415 019			
All engines	Kit, 28/03/88 ->, version Ducellier			815 087					
All engines	version Bosch				906 056R				
All engines	28/03/88 ->						470 106	C10	
All engines	->year 27/03/88							465 005	

ENGINE				
16	Petrol	58	09/87-02/93	23DH

Engine	Information	A10	A20	A40	A50	A70	C10 - C30	C20	E01
All engines	version Bosch			806 124	906 056R				
All engines	->year 01/10/89, version Ducellier			815 067	915 094	415 017			
All engines	version Ducellier, 02/10/89 ->			815 074	915 102R	415 019			
All engines	Kit, version Ducellier, 02/10/89 ->			815 087					
All engines	02/10/89 ->						470 106	C10	
All engines	->year 01/10/89							465 005	

ENGINE				
16	Petrol	64	07/85-12/94	171D

Engine	Information	A10	A20	A40	A50	A70	C10 - C30	C20	E01
All engines	version Bosch, FOR: (D), FOR: (S), FOR: (CH)			806 124					
All engines	version Bosch, 28/03/88 ->			806 241					
All engines	->year 27/03/88, version Ducellier			815 058					
All engines	version Ducellier, FOR: (A), FOR: (S), 01/07/87 ->, FOR: (CH)			815 067	915 094	415 017			
All engines	28/03/88 ->, version Ducellier			815 074	915 102R	415 019			
All engines	Kit, 28/03/88 ->, version Ducellier			815 087					
All engines	version Bosch				906 056R				
All engines	28/03/88 ->						470 106	C10	
All engines	->year 27/03/88							465 005	







ENGINE				
16	Petrol	65	05/89-12/94	BDY (XU5M), BDZ (XU5M)

Engine	Information	A10	A20	A40	A50	A70	C10 - C30	C20	E01
All engines	->year 28/04/91, version Ducellier			815 074	915 102R				
All engines	->year 28/04/91, Kit, version Ducellier			815 087					
All engines	->year 28/04/91						470 106	C10	
All engines	29/04/91 ->						470 188	C10	359 674

A10 CONDENSER	A20 CONTACT SET	A40 DISTRIBUTOR CAP	A50 ROTOR	A70 PICK-UP
C10 COIL	C20 IGNITION MODULE	C30 ELECTRONIC IGNITION KIT	E01 IGNITION CABLE SET	

Vehicle	alim.	kW	Date	Engine	FUNCTIONS ON THE VEHICLE									
					A10	A20	A40	A50	A70	C10 - C30	C20	E01		
16	Petrol	66	10/82-06/88	ENGINE 171A, 171B, 171C										
Engine	Information			A10	A20	A40	A50	A70	C10 - C30	C20	E01			
All engines	version Bosch, FOR: (D), FOR: (S), FOR: (CH)					806 124								
All engines	version Bosch, 28/03/88 ->					806 241								
All engines	->year 27/03/88, version Ducellier					815 058								
All engines	version Ducellier, FOR: (A), FOR: (S), 01/07/87 ->, FOR: (CH)					815 067	915 094	415 017						
All engines	28/03/88 ->, version Ducellier					815 074	915 102R	415 019						
All engines	Kit, 28/03/88 ->, version Ducellier					815 087								
All engines	version Bosch						906 056R							
All engines	28/03/88 ->								470 106	C10				
All engines	->year 27/03/88										465 005			
16	Petrol	68	04/83-01/92	ENGINE 171C										
Engine	Information			A10	A20	A40	A50	A70	C10 - C30	C20	E01			
All engines	version Bosch, FOR: (D), FOR: (S), FOR: (CH)					806 124								
All engines	version Bosch, 28/03/88 ->					806 241								
All engines	->year 27/03/88, version Ducellier					815 058								
All engines	version Ducellier, FOR: (A), FOR: (S), 01/07/87 ->, FOR: (CH)					815 067	915 094	415 017						
All engines	28/03/88 ->, version Ducellier					815 074	915 102R	415 019						
All engines	Kit, 28/03/88 ->, version Ducellier					815 087								
All engines	version Bosch						906 056R							
All engines	28/03/88 ->								470 106	C10				
All engines	->year 27/03/88										465 005			
16	Petrol	76	03/86-12/94	ENGINE 180Z										
Engine	Information			A10	A20	A40	A50	A70	C10 - C30	C20	E01			
All engines	->year 31/10/89, version Bosch					806 124								
All engines	01/11/89 ->, version Bosch					806 241								
All engines	version Bosch						906 056R							
All engines	01/11/89 ->								470 105	C10		359 491		
All engines	->year 31/10/89										465 005		359 747	
16 E	Petrol	65	05/89-02/93	ENGINE BDY (XU5M), BDZ (XU5M)										
Engine	Information			A10	A20	A40	A50	A70	C10 - C30	C20	E01			
All engines	->year 28/04/91, version Ducellier					815 074	915 102R							
All engines	->year 28/04/91, Kit, version Ducellier					815 087								
All engines	->year 28/04/91								470 106	C10				
All engines	29/04/91 ->								470 188	C10		359 674		
19	Petrol	70	09/86-12/89	ENGINE D2C (XU92C)										
Engine	Information			A10	A20	A40	A50	A70	C10 - C30	C20	E01			
All engines	distr. num. 0237009058, distr. num. 0237009068, version Bosch					806 124								
All engines	distr. num. 0237009623, version Bosch					806 241								
All engines	distr. num. 2525691, distr. num. 2525692A, distr. num. 2525692B, version Ducellier					815 067	915 094	415 017						
All engines	distr. num. 2525717A, 2525747, version Ducellier					815 074	915 102R	415 019						
All engines	Kit, distr. num. 2525717A, 2525747, version Ducellier					815 087								
All engines	version Bosch						906 056R							
All engines	23/05/89 ->								470 106	C10				
All engines	->year 22/05/89										465 005			
19	Petrol	75	07/86-12/94	ENGINE 159A, D2A (XU92C)										
Engine	Information			A10	A20	A40	A50	A70	C10 - C30	C20	E01			
All engines	distr. num. 0237009058, distr. num. 0237009068, version Bosch					806 124								
All engines	distr. num. 0237009623, version Bosch					806 241								
All engines	distr. num. 2525691, distr. num. 2525692A, distr. num. 2525692B, version Ducellier					815 067	915 094	415 017						
All engines	distr. num. 2525717A, 2525747, version Ducellier					815 074	915 102R	415 019						
All engines	Kit, distr. num. 2525717A, 2525747, version Ducellier					815 087								
All engines	version Bosch						906 056R							
All engines	23/05/89 ->								470 106	C10				
All engines	->year 22/05/89										465 005			
A10	CONDENSER		A20	CONTACT SET		A40	DISTRIBUTOR CAP		A50	ROTOR		A70	PICK-UP	
C10	COIL		C20	IGNITION MODULE		C30	ELECTRONIC IGNITION KIT		E01	IGNITION CABLE SET				

FUNCTIONS ON THE VEHICLE

Vehicle	alim.	kW	Date	Engine								
ENGINE												
19	Petrol	75	07/86-12/94	159A, D2A (XU92C)								
Engine	Information				A10	A20	A40	A50	A70	C10 - C30	C20	E01
All engines	23/05/89 ->									470 106	C10	
All engines	->year 22/05/89										465 005	
ENGINE												
19	Petrol	76	01/87-01/92	D2A (XU92C)								
Engine	Information				A10	A20	A40	A50	A70	C10 - C30	C20	E01
All engines	distr. num. 0237009058, distr. num. 0237009068, version Bosch						806 124					
All engines	distr. num. 0237009623, version Bosch						806 241					
All engines	distr. num. 2525691, distr. num. 2525692A, distr. num. 2525692B, version Ducellier						815 067	915 094	415 017			
All engines	distr. num. 2525717A, 2525747, version Ducellier						815 074	915 102R	415 019			
All engines	Kit, distr. num. 2525717A, 2525747, version Ducellier						815 087					
All engines	version Bosch							906 056R				
All engines	23/05/89 ->									470 106	C10	
All engines	->year 22/05/89										465 005	
ENGINE												
19	Petrol	77	07/86-05/89	D2A (XU92C)								
Engine	Information				A10	A20	A40	A50	A70	C10 - C30	C20	E01
All engines	distr. num. 0237009058, distr. num. 0237009068, version Bosch						806 124					
All engines	distr. num. 0237009623, version Bosch						806 241					
All engines	distr. num. 2525691, distr. num. 2525692A, distr. num. 2525692B, version Ducellier						815 067	915 094	415 017			
All engines	distr. num. 2525717A, 2525747, version Ducellier						815 074	915 102R	415 019			
All engines	Kit, distr. num. 2525717A, 2525747, version Ducellier						815 087					
All engines	version Bosch							906 056R				
All engines	23/05/89 ->									470 106	C10	
All engines	->year 22/05/89										465 005	
ENGINE												
19	Petrol	78	09/84-01/92	D2E								
Engine	Information				A10	A20	A40	A50	A70	C10 - C30	C20	E01
All engines	distr. num. 0237009058, distr. num. 0237009068, version Bosch						806 124					
All engines	distr. num. 0237009623, version Bosch						806 241					
All engines	distr. num. 2525691, distr. num. 2525692A, distr. num. 2525692B, version Ducellier						815 067	915 094	415 017			
All engines	distr. num. 2525717A, 2525747, version Ducellier						815 074	915 102R	415 019			
All engines	Kit, distr. num. 2525717A, 2525747, version Ducellier						815 087					
All engines	version Bosch							906 056R				
All engines	23/05/89 ->									470 106	C10	
All engines	->year 22/05/89										465 005	
ENGINE												
19	Petrol	80	06/88-12/94	DDZ (XU9M)								
Engine	Information				A10	A20	A40	A50	A70	C10 - C30	C20	E01
All engines	version Ducellier						815 074	915 102R				
All engines	Kit, version Ducellier						815 087					
ENGINE												
19	Petrol	88	06/88-12/94	DKZ (XU9JA)								
Engine	Information				A10	A20	A40	A50	A70	C10 - C30	C20	E01
All engines	version Bosch, ->year 05/06/88, version Export, FOR: (J)						806 124					
All engines	version Bosch, ->year 02/05/90						806 241					
All engines	version Ducellier, ->year 05/06/88, version Export, distr. num. 2525678, FOR: (J)						815 067	915 094	415 017			
All engines	version Ducellier, ->year 02/05/90, 06/06/88 ->, version Export, distr. num. 2525709A, FOR: (J)						815 074	915 102R				
All engines	Kit, version Ducellier, ->year 02/05/90, 06/06/88 ->, version Export, distr. num. 2525709A, FOR: (J)						815 087					
All engines	->year 02/05/90, version Bosch, ->year 05/06/88, version Export, FOR: (J)							906 056R				
All engines	->year 02/05/90, version Ducellier								415 019			
All engines	02/07/90 ->, version Export									470 105	C10	
All engines	27/05/87 ->, ->year 02/05/90									470 106	C10	
All engines	03/05/90 ->									470 188	C10	
All engines	->year 26/05/87, version Export, FOR: (J)										465 005	
All engines	27/05/87 ->, FOR: (A), ->year 02/05/90, FOR: (J)											359 747

A10 CONDENSER	A20 CONTACT SET	A40 DISTRIBUTOR CAP	A50 ROTOR	A70 PICK-UP
C10 COIL	C20 IGNITION MODULE	C30 ELECTRONIC IGNITION KIT	E01 IGNITION CABLE SET	

Vehicle	alim.	kW	Date	Engine	FUNCTIONS ON THE VEHICLE									
					A10	A20	A40	A50	A70	C10 - C30	C20	E01		
19	Petrol	90	07/86-01/92	ENGINE D6A (XU9J2)										
Engine	Information				A10	A20	A40	A50	A70	C10 - C30	C20	E01		
All engines	version Bosch, ->year 05/06/88, version Export, FOR: (J)						806 124							
All engines	->year 02/05/90, version Bosch						806 241							
All engines	version Ducellier, ->year 05/06/88, version Export, distr. num. 2525678, FOR: (J)						815 067	915 094	415 017					
All engines	->year 02/05/90, version Ducellier, 06/06/88 ->, version Export, distr. num. 2525709A, FOR: (J)						815 074	915 102R						
All engines	Kit, ->year 02/05/90, version Ducellier, 06/06/88 ->, version Export, distr. num. 2525709A, FOR: (J)						815 087							
All engines	->year 02/05/90, version Bosch, ->year 05/06/88, version Export, FOR: (J)							906 056R						
All engines	->year 02/05/90, version Ducellier								415 019					
All engines	02/07/90 ->, version Export									470 105	C10			
All engines	->year 02/05/90, 27/05/87 ->									470 106	C10			
All engines	03/05/90 ->									470 188	C10			
All engines	->year 26/05/87, version Export, FOR: (J)											465 005		
All engines	->year 02/05/90, 27/05/87 ->, FOR: (A), FOR: (J)													359 747
19 4x4	Petrol	80	10/90-05/91	ENGINE DDZ (XU9M)										
Engine	Information				A10	A20	A40	A50	A70	C10 - C30	C20	E01		
All engines	version Ducellier						815 074	915 102R						
All engines	Kit, version Ducellier						815 087							
19 Cat	Petrol	75	07/86-12/94	ENGINE DFZ (XU9J1)										
Engine	Information				A10	A20	A40	A50	A70	C10 - C30	C20	E01		
All engines	version Bosch, ->year 05/06/88, version Export, FOR: (J)						806 124							
All engines	->year 02/05/90, version Bosch						806 241							
All engines	version Ducellier, ->year 05/06/88, version Export, distr. num. 2525678, FOR: (J)						815 067	915 094	415 017					
All engines	->year 02/05/90, version Ducellier, 06/06/88 ->, version Export, distr. num. 2525709A, FOR: (J)						815 074	915 102R						
All engines	Kit, ->year 02/05/90, version Ducellier, 06/06/88 ->, version Export, distr. num. 2525709A, FOR: (J)						815 087							
All engines	->year 02/05/90, version Bosch, ->year 05/06/88, version Export, FOR: (J)							906 056R						
All engines	->year 02/05/90, version Ducellier								415 019					
All engines	02/07/90 ->, version Export									470 105	C10			
All engines	->year 02/05/90, 27/05/87 ->									470 106	C10			
All engines	03/05/90 ->									470 188	C10			
All engines	->year 26/05/87, version Export, FOR: (J)											465 005		
All engines	->year 02/05/90, 27/05/87 ->, FOR: (A), FOR: (J)													359 747
19 E	Petrol	80	06/88-02/93	ENGINE DDZ (XU9M)										
Engine	Information				A10	A20	A40	A50	A70	C10 - C30	C20	E01		
All engines	version Ducellier						815 074	915 102R						
All engines	Kit, version Ducellier						815 087							
19 E 4x4	Petrol	80	04/89-02/93	ENGINE D2F										
Engine	Information				A10	A20	A40	A50	A70	C10 - C30	C20	E01		
All engines	distr. num. 0237009058, distr. num. 0237009068, version Bosch						806 124							
All engines	distr. num. 0237009623, version Bosch						806 241							
All engines	distr. num. 2525691, distr. num. 2525692A, distr. num. 2525692B, version Ducellier						815 067	915 094	415 017					
All engines	distr. num. 2525717A, 2525747, version Ducellier						815 074	915 102R	415 019					
All engines	Kit, distr. num. 2525717A, 2525747, version Ducellier						815 087							
All engines	version Bosch							906 056R						
All engines	23/05/89 ->									470 106	C10			
All engines	->year 22/05/89											465 005		
19 GTi	Petrol	88	06/88-02/93	ENGINE DKZ (XU9JA)										
Engine	Information				A10	A20	A40	A50	A70	C10 - C30	C20	E01		
All engines	version Bosch, ->year 05/06/88, version Export, FOR: (J)						806 124							
All engines	->year 02/05/90, version Bosch						806 241							
All engines	version Ducellier, ->year 05/06/88, version Export, distr. num. 2525678, FOR: (J)						815 067	915 094	415 017					
All engines	->year 02/05/90, version Ducellier, 06/06/88 ->, version Export, distr. num. 2525709A, FOR: (J)						815 074	915 102R						

A10	CONDENSER	A20	CONTACT SET	A40	DISTRIBUTOR CAP	A50	ROTOR	A70	PICK-UP
C10	COIL	C20	IGNITION MODULE	C30	ELECTRONIC IGNITION KIT	E01	IGNITION CABLE SET		

The present application list is a brief version. For the detailed information about the possibility of installation on a specific vehicle, please refer to our web-catalogue <http://catalogo.facet.eu/>

Vehicle	alim.	kW	Date	Engine	FUNCTIONS ON THE VEHICLE							
					A10	A20	A40	A50	A70	C10 - C30	C20	E01

ENGINE				
19 GTi	Petrol	88	06/88-02/93	DKZ (XU9JA)

Engine	Information	A10	A20	A40	A50	A70	C10 - C30	C20	E01
All engines	Kit, ->year 02/05/90, version Ducellier, 06/06/88 ->, version Export, distr. num. 2525709A, FOR: (J)			815 087					
All engines	->year 02/05/90, version Bosch, ->year 05/06/88, version Export, FOR: (J)				906 056R				
All engines	->year 02/05/90, version Ducellier					415 019			
All engines	02/07/90 ->, version Export						470 105	C10	
All engines	->year 02/05/90, 27/05/87 ->						470 106	C10	
All engines	03/05/90 ->						470 188	C10	
All engines	->year 26/05/87, version Export, FOR: (J)							465 005	
All engines	->year 02/05/90, 27/05/87 ->, FOR: (A), FOR: (J)								359 747

ENGINE				
19 GTi	Petrol	90	07/86-02/93	D6A (XU9J2)

Engine	Information	A10	A20	A40	A50	A70	C10 - C30	C20	E01
All engines	version Bosch, ->year 05/06/88, version Export, FOR: (J)			806 124					
All engines	->year 02/05/90, version Bosch			806 241					
All engines	version Ducellier, ->year 05/06/88, version Export, distr. num. 2525678, FOR: (J)			815 067	915 094	415 017			
All engines	->year 02/05/90, version Ducellier, 06/06/88 ->, version Export, distr. num. 2525709A, FOR: (J)			815 074	915 102R				
All engines	Kit, ->year 02/05/90, version Ducellier, 06/06/88 ->, version Export, distr. num. 2525709A, FOR: (J)			815 087					
All engines	->year 02/05/90, version Bosch, ->year 05/06/88, version Export, FOR: (J)				906 056R				
All engines	->year 02/05/90, version Ducellier					415 019			
All engines	02/07/90 ->, version Export						470 105	C10	
All engines	->year 02/05/90, 27/05/87 ->						470 106	C10	
All engines	03/05/90 ->						470 188	C10	
All engines	->year 26/05/87, version Export, FOR: (J)							465 005	
All engines	->year 02/05/90, 27/05/87 ->, FOR: (A), FOR: (J)								359 747

ENGINE				
19 GTi 16V	Petrol	108	03/88-02/93	DFW (XU9J4)

Engine	Information	A10	A20	A40	A50	A70	C10 - C30	C20	E01
All engines	version Ducellier			815 077	915 104				
All engines	Kit, version Ducellier			815 078					
All engines							470 106	C10	465 005

ENGINE				
19 GTi 16V	Petrol	116	09/87-12/88	D6C (XU9J4)

Engine	Information	A10	A20	A40	A50	A70	C10 - C30	C20	E01
All engines	version Ducellier			815 077	915 104				
All engines	Kit, version Ducellier			815 078					
All engines							470 106	C10	465 005

ENGINE				
19 GTi 4x4	Petrol	88	06/88-02/93	DKZ (XU9JA)

Engine	Information	A10	A20	A40	A50	A70	C10 - C30	C20	E01
All engines	version Bosch, ->year 05/06/88, version Export, FOR: (J)			806 124					
All engines	->year 02/05/90, version Bosch			806 241					
All engines	version Ducellier, ->year 05/06/88, version Export, distr. num. 2525678, FOR: (J)			815 067	915 094	415 017			
All engines	->year 02/05/90, version Ducellier, 06/06/88 ->, version Export, distr. num. 2525709A, FOR: (J)			815 074	915 102R				
All engines	Kit, ->year 02/05/90, version Ducellier, 06/06/88 ->, version Export, distr. num. 2525709A, FOR: (J)			815 087					
All engines	->year 02/05/90, version Bosch, ->year 05/06/88, version Export, FOR: (J)				906 056R				
All engines	->year 02/05/90, version Ducellier					415 019			
All engines	02/07/90 ->, version Export						470 105	C10	
All engines	->year 02/05/90, 27/05/87 ->						470 106	C10	
All engines	03/05/90 ->						470 188	C10	
All engines	->year 26/05/87, version Export, FOR: (J)							465 005	
All engines	->year 02/05/90, 27/05/87 ->, FOR: (A), FOR: (J)								359 747

ENGINE				
1.0	Petrol	50	06/05-09/14	CFA (384F), CFB (1KR)

Engine	Information	A10	A20	A40	A50	A70	C10 - C30	C20	E01
All engines	x 3, COIL ON PLUG						470 461	C10	

A10	CONDENSER	A20	CONTACT SET	A40	DISTRIBUTOR CAP	A50	ROTOR	A70	PICK-UP
C10	COIL	C20	IGNITION MODULE	C30	ELECTRONIC IGNITION KIT	E01	IGNITION CABLE SET		

Vehicle	alim.	kW	Date	Engine	FUNCTIONS ON THE VEHICLE							
					A10	A20	A40	A50	A70	C10 - C30	C20	E01

C1 II

1.0 VTI 68	Petrol	51	04/14->	ENGINE CFB (1KR)
------------	--------	----	---------	---------------------

Engine	Information	A10	A20	A40	A50	A70	C10 - C30	C20	E01
All engines	euro5/euro6, x 3, COIL ON PLUG						470 459	C10	

1.0 VTI 72	Petrol	53	06/18->	ENGINE CFB (1KR)
------------	--------	----	---------	---------------------

Engine	Information	A10	A20	A40	A50	A70	C10 - C30	C20	E01
All engines	euro5/euro6, x 3, COIL ON PLUG						470 459	C10	

1.2 VTI 82	Petrol	60	04/14->	ENGINE 177L, HMT (EB2D), HMZ (EB2F)
------------	--------	----	---------	--

Engine	Information	A10	A20	A40	A50	A70	C10 - C30	C20	E01
All engines	x 3, COIL ON PLUG						470 609	C10	

C15

1.0	Petrol	30	10/84-07/88	ENGINE 108C
-----	--------	----	-------------	----------------

Engine	Information	A10	A20	A40	A50	A70	C10 - C30	C20	E01
All engines	version Bosch			806 124	906 056R				
All engines	version Ducellier			815 058	915 094				
All engines								465 005	

1.0	Petrol	32	07/86-10/92	ENGINE C1A
-----	--------	----	-------------	---------------

Engine	Information	A10	A20	A40	A50	A70	C10 - C30	C20	E01
All engines	version Bosch			806 241	906 056R				
All engines	version Ducellier			815 074	915 102R	415 019			
All engines	Kit, version Ducellier			815 087					
All engines							470 105	C10	360 376

1.0	Petrol	33	10/84-12/97	ENGINE 108C (XV8), C1A (TU9/K), C1B (TU9/W), TU9
-----	--------	----	-------------	---

Engine	Information	A10	A20	A40	A50	A70	C10 - C30	C20	E01
All engines	version Bosch			806 241	906 056R				
All engines	version Ducellier			815 074	915 102R	415 019			
All engines	Kit, version Ducellier			815 087					
All engines							470 105	C10	360 376

1.0 E	Petrol	37	11/92-07/96	ENGINE TU9K
-------	--------	----	-------------	----------------

Engine	Information	A10	A20	A40	A50	A70	C10 - C30	C20	E01
All engines	version Bosch			806 124	906 056R				
All engines	version Ducellier			815 058	915 094				
All engines								465 005	

1.1	Petrol	35	10/84-12/96	ENGINE 109K, E1A
-----	--------	----	-------------	---------------------

Engine	Information	A10	A20	A40	A50	A70	C10 - C30	C20	E01
All engines	version Bosch			806 124					
All engines	version Ducellier			815 058	915 094				
Eng. 109K	version Bosch				906 056R				
Eng. E1A	version Bosch				906 061R				
Eng. E1A							470 106	C10	
All engines									465 005





1.1	Petrol	36	06/85-10/88	ENGINE XW7
-----	--------	----	-------------	---------------

Engine	Information	A10	A20	A40	A50	A70	C10 - C30	C20	E01
All engines	version Bosch			806 124	906 056R				
All engines	version Ducellier			815 058	915 094				
All engines								465 005	

1.1	Petrol	40	11/88-07/96	ENGINE H1A
-----	--------	----	-------------	---------------

Engine	Information	A10	A20	A40	A50	A70	C10 - C30	C20	E01
All engines	version Bosch			806 241	906 056R				
All engines	version Ducellier			815 074	915 102R	415 019			
All engines	Kit, version Ducellier			815 087					

A10	CONDENSER	A20	CONTACT SET	A40	DISTRIBUTOR CAP	A50	ROTOR	A70	PICK-UP
C10	COIL	C20	IGNITION MODULE	C30	ELECTRONIC IGNITION KIT	E01	IGNITION CABLE SET		









					FUNCTIONS ON THE VEHICLE							
Vehicle	alim.	kW	Date	Engine	 A10	 A20	 A40	 A50	 A70	 C10 - C30	 C20	 E01
ENGINE												
1.1	Petrol	40	11/88-07/96	H1A								
ENGINE												
ENGINE												
1.1	Petrol	44	08/88-07/96	HDZ (TU1M)								
ENGINE												
ENGINE												
1.1 i	Petrol	44	07/88-12/96	HDZ (TU1M), TU1MZ								
ENGINE												
ENGINE												
1.3	Petrol	47	07/87-05/88	G1A								
ENGINE												
ENGINE												
1.4	Petrol	44	05/87-10/92	150D (XY7)								
ENGINE												
ENGINE												
1.4	Petrol	49	07/87-12/96	K1H (TU3A)								
ENGINE												
ENGINE												
1.4	Petrol	51	08/87-04/91	K1G								
ENGINE												
ENGINE												
1.4	Petrol	55	05/91-07/96	KDY (TU3M)								
ENGINE												
ENGINE												
1.4 E	Petrol	40	07/86-12/96	K3A, KAZ								
ENGINE												
ENGINE												
1.4 E	Petrol	44	05/87-12/96	150D (XY7)								
ENGINE												
ENGINE												

A10 CONDENSER	A20 CONTACT SET	A40 DISTRIBUTOR CAP	A50 ROTOR	A70 PICK-UP
C10 COIL	C20 IGNITION MODULE	C30 ELECTRONIC IGNITION KIT	E01 IGNITION CABLE SET	

Vehicle	alim.	kW	Date	Engine	FUNCTIONS ON THE VEHICLE									
					A10	A20	A40	A50	A70	C10 - C30	C20	E01		
ENGINE														
1.4 E	Petrol	44	05/87-12/96	150D (XY7)										
Engine	Information				A10	A20	A40	A50	A70	C10 - C30	C20	E01		
All engines	version Ducellier						815 067	915 094						
All engines											465 005			
ENGINE														
1.4 E	Petrol	52	08/87-10/92	K1F										
Engine	Information				A10	A20	A40	A50	A70	C10 - C30	C20	E01		
All engines	version Bosch						806 241	906 056R						
All engines	version Ducellier						815 074	915 102R	415 019					
All engines	Kit, version Ducellier						815 087							
All engines										470 105	C10		360 376	
ENGINE														
1.4 E	Petrol	55	05/91-12/96	K2D										
Engine	Information				A10	A20	A40	A50	A70	C10 - C30	C20	E01		
All engines	version Bosch						806 241	906 056R						
All engines	version Ducellier						815 074	915 102R	415 019					
All engines	Kit, version Ducellier						815 087							
All engines										470 105	C10		360 376	
ENGINE														
1.4 i	Petrol	55	05/91-12/96	KDY (TU3FM), KDY (TU3M)										
Engine	Information				A10	A20	A40	A50	A70	C10 - C30	C20	E01		
All engines	version Bosch						806 241	906 056R						
All engines	version Ducellier						815 074	915 102R	415 019					
All engines	Kit, version Ducellier						815 087							
All engines										470 105	C10		360 376	
C2														
ENGINE														
1.1	Petrol	44	09/03-09/12	HFX (TU1JP)										
Engine	Information				A10	A20	A40	A50	A70	C10 - C30	C20	E01		
All engines										470 405	C10			
ENGINE														
1.4	Petrol	54	09/03-12/09	KFV (TU3JP)										
Engine	Information				A10	A20	A40	A50	A70	C10 - C30	C20	E01		
All engines										470 405	C10			
ENGINE														
1.4	Petrol	55	10/06-12/09	KFV (TU3JP)										
Engine	Information				A10	A20	A40	A50	A70	C10 - C30	C20	E01		
All engines	x 1, COIL ON PLUG									470 405	C10			
ENGINE														
1.4 16V	Petrol	65	04/05-12/09	KFU (ET3J4)										
Engine	Information				A10	A20	A40	A50	A70	C10 - C30	C20	E01		
All engines	x 1, COIL ON PLUG									470 483	C10			
ENGINE														
1.6	Petrol	80	07/03-10/10	NFU (TU5JP4)										
Engine	Information				A10	A20	A40	A50	A70	C10 - C30	C20	E01		
All engines	x 1, COIL ON PLUG									470 407	C10			
ENGINE														
1.6 VTS	Petrol	90	10/04-12/09	NFS (TU5JP4S)										
Engine	Information				A10	A20	A40	A50	A70	C10 - C30	C20	E01		
All engines	x 1, COIL ON PLUG									470 407	C10			
C3 AIRCROSS														
ENGINE														
1.2 PureTech 82	Petrol	60	06/17->	HMR (EB2FA), HMZ (EB2F)										
Engine	Information				A10	A20	A40	A50	A70	C10 - C30	C20	E01		
All engines	x 3, COIL ON PLUG									470 609	C10			
ENGINE														
PureTech 82	Petrol	60	05/19->	HMZ (EB2F)										
Engine	Information				A10	A20	A40	A50	A70	C10 - C30	C20	E01		
All engines	x 3, COIL ON PLUG									470 609	C10			









A10	CONDENSER	A20	CONTACT SET	A40	DISTRIBUTOR CAP	A50	ROTOR	A70	PICK-UP
C10	COIL	C20	IGNITION MODULE	C30	ELECTRONIC IGNITION KIT	E01	IGNITION CABLE SET		

The present application list is a brief version. For the detailed information about the possibility of installation on a specific vehicle, please refer to our web-catalogue <http://catalogo.facet.eu/>

					FUNCTIONS ON THE VEHICLE							
Vehicle	alim.	kW	Date	Engine								
PureTech 82												
ENGINE												
Petrol 81 05/19-> HNZ (EB2DT)												
Engine												
All engines					x 3, COIL ON PLUG							
					A10	A20	A40	A50	A70	C10 - C30	C20	E01
										470 620	C10	
C3 I												
1.1 i												
ENGINE												
Petrol 44 02/02-> HFX (TU1A), HFX (TU1JP)												
Engine												
All engines					x 4, COIL ON PLUG							
					A10	A20	A40	A50	A70	C10 - C30	C20	E01
										470 405	C10	
1.1 LPG												
ENGINE												
Petrol/Liquified Petro-leum Gas (LPG) 44 06/06-12/09 HFX (TU1A)												
Engine												
All engines					x 4, COIL ON PLUG							
					A10	A20	A40	A50	A70	C10 - C30	C20	E01
										470 405	C10	
1.4 16V												
ENGINE												
Petrol 65 12/03-> KFV (ET3J4)												
Engine												
All engines					x 1, COIL ON PLUG							
					A10	A20	A40	A50	A70	C10 - C30	C20	E01
										470 483	C10	
1.4 BiFuel												
ENGINE												
Petrol/Liquified Petro-leum Gas (LPG) 54 09/08-12/09 KFV (TU3JP)												
Engine												
All engines					x 1, COIL ON PLUG							
					A10	A20	A40	A50	A70	C10 - C30	C20	E01
										470 405	C10	
1.4 i												
ENGINE												
Petrol 54 02/02-11/10 KFV (TU3A), KFV (TU3JP)												
Engine												
All engines					x 1, COIL ON PLUG							
					A10	A20	A40	A50	A70	C10 - C30	C20	E01
										470 405	C10	
1.4 i Bivalent												
ENGINE												
Petrol/Compressed Natural Gas (CNG) 54 02/02-> KFV (TU3JP)												
Engine												
All engines					x 1, COIL ON PLUG							
					A10	A20	A40	A50	A70	C10 - C30	C20	E01
										470 405	C10	
1.6 16V												
ENGINE												
Petrol 80 02/02-> N6A (TU5JP4), NFU (TU5JP4)												
Engine												
Eng. N6A (TU5JP4)					x 1, COIL ON PLUG							
Eng. NFU (TU5JP4)					x 1, COIL ON PLUG							
					A10	A20	A40	A50	A70	C10 - C30	C20	E01
										470 407	C10	
										470 407	C10	
1.6 16V												
ENGINE												
Petrol 81 05/03-09/05 NFU (TU5JP4)												
Engine												
All engines					x 1, COIL ON PLUG							
					A10	A20	A40	A50	A70	C10 - C30	C20	E01
										470 407	C10	
C3 I PLURIEL												
1.4												
ENGINE												
Petrol 54 05/03-> KFV (TU3A), KFV (TU3JP)												
Engine												
All engines					x 1, COIL ON PLUG							
					A10	A20	A40	A50	A70	C10 - C30	C20	E01
										470 405	C10	
1.4												
ENGINE												
Petrol 55 07/03-> KFV (TU3A)												
Engine												
All engines					x 4, COIL ON PLUG							
					A10	A20	A40	A50	A70	C10 - C30	C20	E01
										470 405	C10	
1.4 Hybrid												
ENGINE												
Petrol/Electric 54 05/05-> KFV (TU3JP)												
Engine												
All engines					x 1, COIL ON PLUG							
					A10	A20	A40	A50	A70	C10 - C30	C20	E01
										470 405	C10	

A10 CONDENSER	A20 CONTACT SET	A40 DISTRIBUTOR CAP	A50 ROTOR	A70 PICK-UP
C10 COIL	C20 IGNITION MODULE	C30 ELECTRONIC IGNITION KIT	E01 IGNITION CABLE SET	

Vehicle	alim.	kW	Date	Engine	FUNCTIONS ON THE VEHICLE												
					A10	A20	A40	A50	A70	C10 - C30	C20	E01					
ENGINE																	
1.6	Petrol	80	05/03->	NFU (TU5JP4)													
Engine					A10	A20	A40	A50	A70	C10 - C30	C20	E01					
Information										470 407	C10						
All engines																	
Information																	
x 1, COIL ON PLUG																	
C3 II																	
ENGINE																	
1.0VTi 68	Petrol	50	08/12->	ZMZ (EB0)													
Engine					A10	A20	A40	A50	A70	C10 - C30	C20	E01					
Information										470 609	C10						
All engines																	
x 3, COIL ON PLUG																	
ENGINE																	
1.1 BiFuel	Petrol/ Liquified Petro- leum Gas (LPG)	44	11/10->	HFX (TU1A)													
Engine					A10	A20	A40	A50	A70	C10 - C30	C20	E01					
Information										470 405	C10						
All engines																	
x 4, COIL ON PLUG																	
ENGINE																	
1.1 i	Petrol	44	09/09-01/13	HFV (TU1A), HFX (TU1A)													
Engine					A10	A20	A40	A50	A70	C10 - C30	C20	E01					
Information										470 405	C10						
All engines																	
x 1, COIL ON PLUG																	
ENGINE																	
1.2 THP 110	Petrol	81	10/14->	HNZ (EB2DT)													
Engine					A10	A20	A40	A50	A70	C10 - C30	C20	E01					
Information										470 620	C10						
All engines																	
x 3, COIL ON PLUG																	
ENGINE																	
1.2 VTi 82	Petrol	60	06/12-09/16	177L, HMZ (EB2F)													
Engine					A10	A20	A40	A50	A70	C10 - C30	C20	E01					
Information										470 609	C10						
All engines																	
x 3, COIL ON PLUG																	
ENGINE																	
1.4	Petrol	54	11/09-09/16	K6E (TU3A), KFT (TU3A), KFT (TU3AE5)													
Engine					A10	A20	A40	A50	A70	C10 - C30	C20	E01					
Information										470 405	C10						
All engines																	
x 4, COIL ON PLUG																	
ENGINE																	
1.4 16V	Petrol	70	11/09->	EP3C													
Engine					A10	A20	A40	A50	A70	C10 - C30	C20	E01					
Information										470 475	C10						
All engines																	
Qty: 4																	
ENGINE																	
1.4 i	Petrol	55	11/09->	TU 3 JP													
Engine					A10	A20	A40	A50	A70	C10 - C30	C20	E01					
Information										470 405	C10						
All engines																	
ENGINE																	
1.4 LPG	Petrol/ Liquified Petro- leum Gas (LPG)	54	07/10->	KFT (TU3A)													
Engine					A10	A20	A40	A50	A70	C10 - C30	C20	E01					
Information										470 405	C10						
All engines																	
x 4, COIL ON PLUG																	
ENGINE																	
1.4 LPG	Petrol/ Liquified Petro- leum Gas (LPG)	70	06/13->	8FN (EP3)													
Engine					A10	A20	A40	A50	A70	C10 - C30	C20	E01					
Information										470 475	C10						
All engines																	
x 4, COIL ON PLUG																	
ENGINE																	
1.4 VTi	Petrol	72	11/09->	8FR (EP3)													
Engine					A10	A20	A40	A50	A70	C10 - C30	C20	E01					
Information										470 475	C10						
All engines																	
x 4, COIL ON PLUG																	
ENGINE																	
1.4 VTi 95	Petrol	70	11/09->	8FP (EP3C)													
Engine					A10	A20	A40	A50	A70	C10 - C30	C20	E01					
Information										470 475	C10						
All engines																	
x 4, COIL ON PLUG																	
ENGINE																	
A10	CONDENSER			A20	CONTACT SET			A40	DISTRIBUTOR CAP			A50	ROTOR		A70	PICK-UP	
C10	COIL			C20	IGNITION MODULE			C30	ELECTRONIC IGNITION KIT			E01	IGNITION CABLE SET				









					FUNCTIONS ON THE VEHICLE							
Vehicle	alim.	kW	Date	Engine								
ENGINE												
1.6 Flex	Petrol/ Ethanol	81	11/09->	NFX (TU5JP4)								
ENGINE												
All engines										470 407	C10	
ENGINE												
1.6 Vti 120	Petrol	88	11/09->	5FS (EP6C)								
ENGINE												
All engines										470 475	C10	
C3 III												
ENGINE												
1.2 PureTech 82	Petrol	61	05/18->	HMR (EB2FA)								
ENGINE												
All engines										470 609	C10	
ENGINE												
1.2 PureTech 82 LPG	Petrol/ Liquified Petro- leum Gas (LPG)	61	05/18->	HMR (EB2FA)								
ENGINE												
All engines										470 609	C10	
ENGINE												
1.2 Vti 68	Petrol	50	07/16->	HMM (EB2FAD), HMP (EB2FB)								
ENGINE												
All engines										470 609	C10	
ENGINE												
1.2 Vti 82	Petrol	60	07/16->	HMZ (EB2F)								
ENGINE												
All engines										470 609	C10	
ENGINE												
1.2 Vti 82 LPG	Petrol/ Liquified Petro- leum Gas (LPG)	60	07/16->	HMZ (EB2F)								
ENGINE												
All engines										470 609	C10	
ENGINE												
PureTech 110	Petrol	81	03/19->	HNZ (EB2DT)								
ENGINE												
All engines										470 620	C10	
ENGINE												
PureTech 82	Petrol	61	03/19->	HMR (EB2FA)								
ENGINE												
All engines										470 609	C10	
C3 PICASSO												
ENGINE												
1.2 THP 110	Petrol	81	01/15->	HNZ (EB2DT)								
ENGINE												
All engines										470 620	C10	
ENGINE												
1.4 Vti 95	Petrol	70	02/09->	8FN (EP3), 8FP (EP3C), 8FS (EP3)								
ENGINE												
All engines										470 475	C10	
ENGINE												
1.4 Vti 95 LPG	Petrol/ Liquified Petro- leum Gas (LPG)	70	01/12->	8FN (EP3)								
ENGINE												
All engines										470 475	C10	

A10 CONDENSER	A20 CONTACT SET	A40 DISTRIBUTOR CAP	A50 ROTOR	A70 PICK-UP
C10 COIL	C20 IGNITION MODULE	C30 ELECTRONIC IGNITION KIT	E01 IGNITION CABLE SET	

Vehicle	alim.	kW	Date	Engine	FUNCTIONS ON THE VEHICLE								
					A10	A20	A40	A50	A70	C10 - C30	C20	E01	
ENGINE													
1.6 VTi	Petrol	84	07/09->	5FP (EP6)									
Engine	Information				A10	A20	A40	A50	A70	C10 - C30	C20	E01	
All engines	x 4, COIL ON PLUG									470 475	C10		
ENGINE													
1.6 VTi 120	Petrol	88	02/09->	5FS (EP6C), 5FW (EP6)									
Engine	Information				A10	A20	A40	A50	A70	C10 - C30	C20	E01	
All engines	x 4, COIL ON PLUG									470 475	C10		
C4 AIRCROSS													
ENGINE													
1.6	Petrol	86	04/12->	4A92, NKZ (4A92)									
Engine	Information				A10	A20	A40	A50	A70	C10 - C30	C20	E01	
All engines	x 4, COIL ON PLUG									470 505	C10		
ENGINE													
2.0	Petrol	110	04/12->	4B11									
Engine	Information				A10	A20	A40	A50	A70	C10 - C30	C20	E01	
All engines	Qty: 4									470 497	C10		
All engines	x 4, COIL ON PLUG									470 497	C10		
ENGINE													
2.0 AWC	Petrol	110	04/12->	4B11									
Engine	Information				A10	A20	A40	A50	A70	C10 - C30	C20	E01	
All engines	Qty: 4									470 497	C10		
All engines	x 4, COIL ON PLUG									470 497	C10		
C4 CACTUS													
ENGINE													
1.2 VTi 75 / PureTech 75	Petrol	55	09/14->	HMU (EB2D), HMU (EB2FD)									
Engine	Information				A10	A20	A40	A50	A70	C10 - C30	C20	E01	
All engines	x 3, COIL ON PLUG									470 609	C10		
ENGINE													
1.2 VTi 82	Petrol	60	09/14->	HMZ (EB2F)									
Engine	Information				A10	A20	A40	A50	A70	C10 - C30	C20	E01	
All engines	x 3, COIL ON PLUG									470 609	C10		
ENGINE													
PureTech 130	Petrol	96	05/19->	HNY (EB2DTS)									
Engine	Information				A10	A20	A40	A50	A70	C10 - C30	C20	E01	
All engines	x 3, COIL ON PLUG									470 620	C10		
ENGINE													
PureTech 82	Petrol	60	05/19->	177L									
Engine	Information				A10	A20	A40	A50	A70	C10 - C30	C20	E01	
All engines	x 3, COIL ON PLUG									470 609	C10		
C4 GRAND PICASSO I													
ENGINE													
1.6 16V	Petrol	103	07/08-12/10	5FT (EP6DT)									
Engine	Information				A10	A20	A40	A50	A70	C10 - C30	C20	E01	
All engines	x 4, COIL ON PLUG									470 475	C10		
ENGINE													
1.6 16V	Petrol	110	10/08-08/13	5FX (EP6DT)									
Engine	Information				A10	A20	A40	A50	A70	C10 - C30	C20	E01	
All engines	x 4, COIL ON PLUG									470 475	C10		
ENGINE													
1.6 16V	Petrol	88	07/08->	EP6C									
Engine	Information				A10	A20	A40	A50	A70	C10 - C30	C20	E01	
All engines	Qty: 4									470 475	C10		
ENGINE													
1.6 THP 155	Petrol	115	09/10-08/13	5FV (EP6CDT)									
Engine	Information				A10	A20	A40	A50	A70	C10 - C30	C20	E01	
All engines	x 4, COIL ON PLUG									470 475	C10		

A10 CONDENSER	A20 CONTACT SET	A40 DISTRIBUTOR CAP	A50 ROTOR	A70 PICK-UP
C10 COIL	C20 IGNITION MODULE	C30 ELECTRONIC IGNITION KIT	E01 IGNITION CABLE SET	

The present application list is a brief version. For the detailed information about the possibility of installation on a specific vehicle, please refer to our web-catalogue <http://catalogo.facet.eu/>

				FUNCTIONS ON THE VEHICLE								
Vehicle	alim.	kW	Date	Engine								
				ENGINE								
1.6 VtI 120	Petrol	88	07/08-08/13	5FW (EP6)								
Engine	Information				A10	A20	A40	A50	A70	C10 - C30	C20	E01
All engines	x 4, COIL ON PLUG									470 475	C10	
				ENGINE								
1.8 i 16V	Petrol	92	10/06-12/10	6FY (EW7A)								
Engine	Information				A10	A20	A40	A50	A70	C10 - C30	C20	E01
All engines	x 1, COIL ON PLUG									470 476	C10	
				ENGINE								
1.8 i 16V Flex	Petrol/ Ethanol	86	06/09-01/13	6FY (EW7A)								
Engine	Information				A10	A20	A40	A50	A70	C10 - C30	C20	E01
All engines	x 1, COIL ON PLUG									470 476	C10	
				ENGINE								
2.0 i 16V	Petrol	103	10/06-08/13	RFJ (EW10A)								
Engine	Information				A10	A20	A40	A50	A70	C10 - C30	C20	E01
All engines	x 1, COIL ON PLUG									470 476	C10	
				ENGINE								
2.0 i 16V	Petrol	105	01/10-08/13	RFJ (EW10A)								
Engine	Information				A10	A20	A40	A50	A70	C10 - C30	C20	E01
All engines										470 476	C10	
				ENGINE								
C4 GRAND PICASSO II				ENGINE								
1.2 THP 130	Petrol	96	04/14->	HNY (EB2DTS)								
Engine	Information				A10	A20	A40	A50	A70	C10 - C30	C20	E01
All engines	x 3, COIL ON PLUG									470 620	C10	
				ENGINE								
1.6 THP 150	Petrol	110	09/14->	5FX (EP6DT)								
Engine	Information				A10	A20	A40	A50	A70	C10 - C30	C20	E01
All engines	x 4, COIL ON PLUG									470 475	C10	
				ENGINE								
1.6 THP 155	Petrol	115	09/13->	5FV (EP6CDT)								
Engine	Information				A10	A20	A40	A50	A70	C10 - C30	C20	E01
All engines	x 4, COIL ON PLUG									470 475	C10	
				ENGINE								
1.6 THP 165	Petrol	121	07/14->	5GZ (EP6FDT)								
Engine	Information				A10	A20	A40	A50	A70	C10 - C30	C20	E01
All engines	x 4, COIL ON PLUG									470 475	C10	
				ENGINE								
1.6 VtI 120	Petrol	88	09/13->	5FS (EP6C)								
Engine	Information				A10	A20	A40	A50	A70	C10 - C30	C20	E01
All engines	x 4, COIL ON PLUG									470 475	C10	
				ENGINE								
C4 I				ENGINE								
1.4 16V	Petrol	65	11/04-07/11	KFU (ET3J4)								
Engine	Information				A10	A20	A40	A50	A70	C10 - C30	C20	E01
All engines	x 1, COIL ON PLUG									470 483	C10	
				ENGINE								
1.6 16V	Petrol	80	11/04-07/11	NFU (TU5JP4)								
Engine	Information				A10	A20	A40	A50	A70	C10 - C30	C20	E01
All engines	x 1, COIL ON PLUG									470 407	C10	
				ENGINE								
1.6 16V Bio-Flex	Petrol	80	09/07->	N6A (TU5JP4)								
Engine	Information				A10	A20	A40	A50	A70	C10 - C30	C20	E01
All engines										470 407	C10	
All engines	x 1, COIL ON PLUG									470 407	C10	
				ENGINE								
1.6 16V Flex Fuel	Petrol	80	02/09->	N6A (TU5JP4)								
Engine	Information				A10	A20	A40	A50	A70	C10 - C30	C20	E01
All engines										470 407	C10	

A10 CONDENSER	A20 CONTACT SET	A40 DISTRIBUTOR CAP	A50 ROTOR	A70 PICK-UP
C10 COIL	C20 IGNITION MODULE	C30 ELECTRONIC IGNITION KIT	E01 IGNITION CABLE SET	

Vehicle	alim.	kW	Date	Engine	FUNCTIONS ON THE VEHICLE									
					A10	A20	A40	A50	A70	C10 - C30	C20	E01		
ENGINE														
1.6 Flex	Petrol/ Ethanol	81	02/09-07/11	--										
Engine	Information				A10	A20	A40	A50	A70	C10 - C30	C20	E01		
All engines										470 407	C10			
ENGINE														
1.6 THP	Petrol	103	06/08-07/11	5FT (EP6DT)										
Engine	Information				A10	A20	A40	A50	A70	C10 - C30	C20	E01		
All engines	x 4, COIL ON PLUG									470 475	C10			
ENGINE														
1.6 THP 140	Petrol	103	07/08-07/11	5FT (EP6DT)										
Engine	Information				A10	A20	A40	A50	A70	C10 - C30	C20	E01		
All engines	x 4, COIL ON PLUG									470 475	C10			
ENGINE														
1.6 THP 150	Petrol	110	07/08-07/11	5FX (EP6DT)										
Engine	Information				A10	A20	A40	A50	A70	C10 - C30	C20	E01		
All engines	x 4, COIL ON PLUG									470 475	C10			
ENGINE														
1.6 VTi 120	Petrol	88	07/08-07/11	5FW (EP6)										
Engine	Information				A10	A20	A40	A50	A70	C10 - C30	C20	E01		
All engines	x 4, COIL ON PLUG									470 475	C10			
ENGINE														
2.0 16V	Petrol	100	11/04-07/07	RFN (EW10J4)										
Engine	Information				A10	A20	A40	A50	A70	C10 - C30	C20	E01		
All engines	x 4, COIL ON PLUG									470 408	C10			
ENGINE														
2.0 16V	Petrol	103	11/04-07/11	RFJ (EW10A)										
Engine	Information				A10	A20	A40	A50	A70	C10 - C30	C20	E01		
All engines										470 476	C10			
All engines	x 1, COIL ON PLUG									470 476	C10			
ENGINE														
2.0 16V	Petrol	105	09/06-07/09	RFJ (EW10A)										
Engine	Information				A10	A20	A40	A50	A70	C10 - C30	C20	E01		
All engines	x 1, COIL ON PLUG									470 476	C10			
ENGINE														
2.0 16V	Petrol	130	11/04-12/10	RFK (EW10J4S)										
Engine	Information				A10	A20	A40	A50	A70	C10 - C30	C20	E01		
All engines	x 4, COIL ON PLUG									470 509	C10			
ENGINE														
2.0 VTR	Petrol	103	10/06-12/07	RFJ (EW10A)										
Engine	Information				A10	A20	A40	A50	A70	C10 - C30	C20	E01		
All engines	x 1, COIL ON PLUG									470 476	C10			
C4 II														
ENGINE														
1.2 THP 110	Petrol	81	02/15-12/17	8D4HH, HNZ (EB2DT)										
Engine	Information				A10	A20	A40	A50	A70	C10 - C30	C20	E01		
All engines	x 3, COIL ON PLUG									470 620	C10			
ENGINE														
1.2 THP 130	Petrol	96	04/14->	HNY (EB2DTS)										
Engine	Information				A10	A20	A40	A50	A70	C10 - C30	C20	E01		
All engines	x 3, COIL ON PLUG									470 620	C10			
ENGINE														
1.4 16V	Petrol	70	11/09->	EP3C										
Engine	Information				A10	A20	A40	A50	A70	C10 - C30	C20	E01		
All engines	Qty: 4									470 475	C10			
ENGINE														
1.4 VTi 95	Petrol	70	11/09->	8FP (EP3C)										
Engine	Information				A10	A20	A40	A50	A70	C10 - C30	C20	E01		
All engines	x 4, COIL ON PLUG									470 475	C10			

A10 CONDENSER	A20 CONTACT SET	A40 DISTRIBUTOR CAP	A50 ROTOR	A70 PICK-UP
C10 COIL	C20 IGNITION MODULE	C30 ELECTRONIC IGNITION KIT	E01 IGNITION CABLE SET	

The present application list is a brief version. For the detailed information about the possibility of installation on a specific vehicle, please refer to our web-catalogue <http://catalogo.facet.eu/>

				FUNCTIONS ON THE VEHICLE								
Vehicle	alim.	kW	Date	Engine	A10	A20	A40	A50	A70	C10 - C30	C20	E01
				ENGINE								
1.6 16V	Petrol	147	10/10->	EP6FDTX								
Engine		Information			A10	A20	A40	A50	A70	C10 - C30	C20	E01
All engines		Qty: 4								470 475	C10	
				ENGINE								
1.6 Flex	Petrol/ Ethanol	81	11/09->	NFX (TU5JP4)								
Engine		Information			A10	A20	A40	A50	A70	C10 - C30	C20	E01
All engines										470 407	C10	
				ENGINE								
1.6 THP 155	Petrol	115	11/09-12/16	5FV (EP6CDT)								
Engine		Information			A10	A20	A40	A50	A70	C10 - C30	C20	E01
All engines		x 4, COIL ON PLUG								470 475	C10	
				ENGINE								
1.6 VTi 120	Petrol	88	11/09-12/16	5FS (EP6C)								
Engine		Information			A10	A20	A40	A50	A70	C10 - C30	C20	E01
All engines		x 4, COIL ON PLUG								470 475	C10	
				ENGINE								
1.6 VTi 120 LPG	Petrol/ Liquified Petro- leum Gas (LPG)	88	09/11->	5FS (EP6C)								
Engine		Information			A10	A20	A40	A50	A70	C10 - C30	C20	E01
All engines		x 4, COIL ON PLUG								470 475	C10	
				ENGINE								
2.0 Flex	Petrol/ Ethanol	103	11/09->	RFJ (EW10A)								
Engine		Information			A10	A20	A40	A50	A70	C10 - C30	C20	E01
All engines										470 476	C10	
				C4 III								
				ENGINE								
1.2 PureTech 110	Petrol	81	04/18->	HNX (EB2DTS)								
Engine		Information			A10	A20	A40	A50	A70	C10 - C30	C20	E01
All engines		x 3, COIL ON PLUG								470 620	C10	
				ENGINE								
1.6 THP 165	Petrol	121	04/18->	5GZ (EP6FDT)								
Engine		Information			A10	A20	A40	A50	A70	C10 - C30	C20	E01
All engines		x 4, COIL ON PLUG								470 475	C10	
				ENGINE								
PureTech 130	Petrol	96	05/19->	HNY (EB2DTS)								
Engine		Information			A10	A20	A40	A50	A70	C10 - C30	C20	E01
All engines		x 3, COIL ON PLUG								470 620	C10	
				C4 PICASSO I								
				ENGINE								
1.6 16V	Petrol	110	07/08-08/13	5FX (EP6DT)								
Engine		Information			A10	A20	A40	A50	A70	C10 - C30	C20	E01
All engines		x 4, COIL ON PLUG								470 475	C10	
				ENGINE								
1.6 THP 140	Petrol	103	07/08-08/13	5FT (EP6DT)								
Engine		Information			A10	A20	A40	A50	A70	C10 - C30	C20	E01
All engines		x 4, COIL ON PLUG								470 475	C10	
				ENGINE								
1.6 THP 155	Petrol	115	09/10-08/13	5FV (EP6CDT)								
Engine		Information			A10	A20	A40	A50	A70	C10 - C30	C20	E01
All engines		x 4, COIL ON PLUG								470 475	C10	
				ENGINE								
1.6 VTi 120	Petrol	88	07/08-08/13	5FW (EP6)								
Engine		Information			A10	A20	A40	A50	A70	C10 - C30	C20	E01
All engines		x 4, COIL ON PLUG								470 475	C10	

A10 CONDENSER	A20 CONTACT SET	A40 DISTRIBUTOR CAP	A50 ROTOR	A70 PICK-UP
C10 COIL	C20 IGNITION MODULE	C30 ELECTRONIC IGNITION KIT	E01 IGNITION CABLE SET	

Vehicle	alim.	kW	Date	Engine	FUNCTIONS ON THE VEHICLE									
					A10	A20	A40	A50	A70	C10 - C30	C20	E01		
ENGINE														
1.8 Bifuel	Petrol/ Ethanol	92	01/09-10/12	6FY (EW7A)										
Engine	Information				A10	A20	A40	A50	A70	C10 - C30	C20	E01		
All engines	x 1, COIL ON PLUG									470 476	C10			
ENGINE														
1.8 i 16V	Petrol	92	02/07-12/11	6FY (EW7A)										
Engine	Information				A10	A20	A40	A50	A70	C10 - C30	C20	E01		
All engines	x 1, COIL ON PLUG									470 476	C10			
ENGINE														
2.0 i 16V	Petrol	103	09/07-08/13	RFJ (EW10A)										
Engine	Information				A10	A20	A40	A50	A70	C10 - C30	C20	E01		
All engines	x 1, COIL ON PLUG									470 476	C10			
C4 PICASSO II														
ENGINE														
1.2 THP 130	Petrol	96	04/14->	HNY (EB2DTS)										
Engine	Information				A10	A20	A40	A50	A70	C10 - C30	C20	E01		
All engines	x 3, COIL ON PLUG									470 620	C10			
ENGINE														
1.6 THP 150	Petrol	110	09/14->	5FX (EP6DT)										
Engine	Information				A10	A20	A40	A50	A70	C10 - C30	C20	E01		
All engines	x 4, COIL ON PLUG									470 475	C10			
ENGINE														
1.6 THP 155	Petrol	115	02/13->	5FV (EP6CDT)										
Engine	Information				A10	A20	A40	A50	A70	C10 - C30	C20	E01		
All engines	x 4, COIL ON PLUG									470 475	C10			
ENGINE														
1.6 THP 165	Petrol	121	07/14->	5GZ (EP6FDT)										
Engine	Information				A10	A20	A40	A50	A70	C10 - C30	C20	E01		
All engines	x 4, COIL ON PLUG									470 475	C10			
ENGINE														
1.6 VTi 120	Petrol	88	02/13->	5FS (EP6C)										
Engine	Information				A10	A20	A40	A50	A70	C10 - C30	C20	E01		
All engines	x 4, COIL ON PLUG									470 475	C10			
ENGINE														
THP 155	Petrol	115	02/13->	5FV (EP6CDT)										
Engine	Information				A10	A20	A40	A50	A70	C10 - C30	C20	E01		
All engines	x 4, COIL ON PLUG									470 475	C10			
ENGINE														
VTi 120	Petrol	88	02/13->	5FS (EP6C)										
Engine	Information				A10	A20	A40	A50	A70	C10 - C30	C20	E01		
All engines	x 4, COIL ON PLUG									470 475	C10			
C5 AIRCROSS														
ENGINE														
1.6 Hybrid	Petrol/ Electric	133	04/20->	5GF (EP6FADTXD)										
Engine	Information				A10	A20	A40	A50	A70	C10 - C30	C20	E01		
All engines	Emission Standard:Euro 6.2, x 4, COIL ON PLUG									470 475	C10			
ENGINE														
1.6 Hybrid	Petrol/ Electric	165	04/20->	5GF (EP6FADTXD)										
Engine	Information				A10	A20	A40	A50	A70	C10 - C30	C20	E01		
All engines	Emission Standard:Euro 6.2, x 4, COIL ON PLUG									470 475	C10			
ENGINE														
1.6 PureTech 180	Petrol	133	11/18->	5GF (EP6FADTXD)										
Engine	Information				A10	A20	A40	A50	A70	C10 - C30	C20	E01		
All engines	x 4, COIL ON PLUG									470 475	C10			
ENGINE														
1.6 THP 150	Petrol	110	09/19->	5GX (EP6FTMD)										
Engine	Information				A10	A20	A40	A50	A70	C10 - C30	C20	E01		
All engines	x 4, COIL ON PLUG									470 475	C10			

A10 CONDENSER	A20 CONTACT SET	A40 DISTRIBUTOR CAP	A50 ROTOR	A70 PICK-UP
C10 COIL	C20 IGNITION MODULE	C30 ELECTRONIC IGNITION KIT	E01 IGNITION CABLE SET	









The present application list is a brief version. For the detailed information about the possibility of installation on a specific vehicle, please refer to our web-catalogue <http://catalogo.facet.eu/>

FUNCTIONS ON THE VEHICLE

Vehicle	alim.	kW	Date	Engine								
C5 I												
1.6 THP 165	Petrol	121	05/19->	ENGINE 5GY (EP6FDTM)								
Engine	Information			A10	A20	A40	A50	A70	C10 - C30	C20	E01	
All engines	x 4, COIL ON PLUG								470 475	C10		
1.8	Petrol	85	09/04-08/05	ENGINE 6FZ (EW7J4)								
Engine	Information			A10	A20	A40	A50	A70	C10 - C30	C20	E01	
All engines	x 4, COIL ON PLUG								470 408	C10		
1.8 16V	Petrol	85	03/01->	ENGINE 6FZ (EW7J4)								
Engine	Information			A10	A20	A40	A50	A70	C10 - C30	C20	E01	
All engines	x 4, COIL ON PLUG								470 408	C10		
1.8 16V	Petrol	92	09/05->	ENGINE 6FY (EW7A)								
Engine	Information			A10	A20	A40	A50	A70	C10 - C30	C20	E01	
All engines	x 1, COIL ON PLUG								470 476	C10		
2.0	Petrol	103	11/04-01/08	ENGINE RFJ (EW10A)								
Engine	Information			A10	A20	A40	A50	A70	C10 - C30	C20	E01	
All engines	x 1, COIL ON PLUG								470 476	C10		
2.0 16V	Petrol	100	03/01-08/04	ENGINE RFN (EW10J4)								
Engine	Information			A10	A20	A40	A50	A70	C10 - C30	C20	E01	
All engines	x 4, COIL ON PLUG								470 408	C10		
2.0 16V	Petrol	103	09/04->	ENGINE RFJ (EW10A)								
Engine	Information			A10	A20	A40	A50	A70	C10 - C30	C20	E01	
All engines	x 1, COIL ON PLUG								470 476	C10		
C5 II												
1.6 THP 150	Petrol	110	04/09->	ENGINE 5FN (EP6CDT)								
Engine	Information			A10	A20	A40	A50	A70	C10 - C30	C20	E01	
All engines	x 4, COIL ON PLUG								470 475	C10		
1.6 THP 155	Petrol	115	04/09->	ENGINE 5FV (EP6CDT)								
Engine	Information			A10	A20	A40	A50	A70	C10 - C30	C20	E01	
All engines	x 4, COIL ON PLUG								470 475	C10		
1.6 Vti 120	Petrol	88	07/10->	ENGINE 5FS (EP6C)								
Engine	Information			A10	A20	A40	A50	A70	C10 - C30	C20	E01	
All engines	x 4, COIL ON PLUG								470 475	C10		
1.8 16V	Petrol	92	02/08->	ENGINE 6FY (EW7A)								
Engine	Information			A10	A20	A40	A50	A70	C10 - C30	C20	E01	
All engines	x 1, COIL ON PLUG								470 476	C10		
2.0 16V	Petrol	103	02/08->	ENGINE RFJ (EW10A)								
Engine	Information			A10	A20	A40	A50	A70	C10 - C30	C20	E01	
All engines	x 1, COIL ON PLUG								470 476	C10		
2.0 16V BioFlex	Petrol/ Ethanol	103	02/08->	ENGINE RFJ (EW10A)								
Engine	Information			A10	A20	A40	A50	A70	C10 - C30	C20	E01	
All engines	x 1, COIL ON PLUG								470 476	C10		
C8												
2.0	Petrol	100	07/02->	ENGINE RFN (EW10J4)								
Engine	Information			A10	A20	A40	A50	A70	C10 - C30	C20	E01	
All engines	x 4, COIL ON PLUG								470 408	C10		

A10 CONDENSER	A20 CONTACT SET	A40 DISTRIBUTOR CAP	A50 ROTOR	A70 PICK-UP
C10 COIL	C20 IGNITION MODULE	C30 ELECTRONIC IGNITION KIT	E01 IGNITION CABLE SET	

Vehicle	alim.	kW	Date	Engine	FUNCTIONS ON THE VEHICLE									
					A10	A20	A40	A50	A70	C10 - C30	C20	E01		
ENGINE														
2.0	Petrol	103	06/04-12/11	RFJ (EW10A)										
Engine					A10	A20	A40	A50	A70	C10 - C30	C20	E01		
All engines										470 476	C10			
ENGINE														
2.0 16V	Petrol	103	09/05->	RFJ (EW10A)										
Engine					A10	A20	A40	A50	A70	C10 - C30	C20	E01		
All engines										470 476	C10			
ENGINE														
2.0 16V	Petrol	104	09/05->	RFJ (EW10A)										
Engine					A10	A20	A40	A50	A70	C10 - C30	C20	E01		
All engines										470 476	C10			
ENGINE														
2.2	Petrol	116	07/02->	3FZ (EW12J4)										
Engine					A10	A20	A40	A50	A70	C10 - C30	C20	E01		
All engines										470 509	C10			
C-CROSSER														
ENGINE														
2.0	Petrol	108	11/10->	4B11										
Engine					A10	A20	A40	A50	A70	C10 - C30	C20	E01		
All engines										470 497	C10			
ENGINE														
2.0 Trazione integrale	Petrol	108	11/10->	4B11										
Engine					A10	A20	A40	A50	A70	C10 - C30	C20	E01		
All engines										470 497	C10			
ENGINE														
2.4 16V	Petrol	125	08/08->	SFZ (4B12 MMC)										
Engine					A10	A20	A40	A50	A70	C10 - C30	C20	E01		
All engines										470 497	C10			
C-CROSSER ENTERPRISE														
ENGINE														
2.4 16V	Petrol	125	01/09->	4B12										
Engine					A10	A20	A40	A50	A70	C10 - C30	C20	E01		
All engines										470 497	C10			
C-ELYSEE														
ENGINE														
1.2 PureTech 82	Petrol	61	02/18->	HMR (EB2FA)										
Engine					A10	A20	A40	A50	A70	C10 - C30	C20	E01		
All engines										470 609	C10			
ENGINE														
1.2 VTi 72	Petrol	53	11/12->	HMY (EB2M)										
Engine					A10	A20	A40	A50	A70	C10 - C30	C20	E01		
All engines										470 609	C10			
ENGINE														
1.2 VTi 82	Petrol	60	12/14->	177L, EB2F, HMZ (EB2F)										
Engine					A10	A20	A40	A50	A70	C10 - C30	C20	E01		
Eng. 177L, HMZ (EB2F)										470 609	C10			
Eng. EB2F										470 609	C10			
Qty: 3														
CX I														
ENGINE														
2000	Petrol	78	06/79-08/85	829 A5										
Engine					A10	A20	A40	A50	A70	C10 - C30	C20	E01		
All engines							815 058	915 094						
ENGINE														
2400	Petrol	85	08/76-06/80	M23-623										
Engine					A10	A20	A40	A50	A70	C10 - C30	C20	E01		
All engines					615 034		815 059	915 091						
ENGINE														
2400 GTI	Petrol	94	06/77-06/83	M23-622										
Engine					A10	A20	A40	A50	A70	C10 - C30	C20	E01		
All engines							815 059	915 083R						
A10	CONDENSER		A20	CONTACT SET		A40	DISTRIBUTOR CAP		A50	ROTOR		A70	PICK-UP	
C10	COIL		C20	IGNITION MODULE		C30	ELECTRONIC IGNITION KIT		E01	IGNITION CABLE SET				

				FUNCTIONS ON THE VEHICLE								
Vehicle	alim.	kW	Date	Engine								
				ENGINE								
2400 GTi	Petrol	96	06/77-06/82	M23-622								
Engine		Information			A10	A20	A40	A50	A70	C10 - C30	C20	E01
All engines		version Ducellier					815 059	915 083R				
				ENGINE								
CX II												
20 RE	Petrol	78	08/85-12/92	829 A5								
Engine		Information			A10	A20	A40	A50	A70	C10 - C30	C20	E01
All engines		version Ducellier					815 058	915 094				
All engines											465 005	
				ENGINE								
22 TRS	Petrol	83	07/85-12/92	J6T A500								
Engine		Information			A10	A20	A40	A50	A70	C10 - C30	C20	E01
All engines		version Ducellier					815 058	915 094				
All engines											465 005	
				ENGINE								
DS3												
1.2 THP 110	Petrol	81	10/14-07/15	HNZ (EB2DT)								
Engine		Information			A10	A20	A40	A50	A70	C10 - C30	C20	E01
All engines		x 3, COIL ON PLUG								470 620	C10	
				ENGINE								
1.2 VTi 82	Petrol	60	01/13-07/15	177L, HMZ (EB2F)								
Engine		Information			A10	A20	A40	A50	A70	C10 - C30	C20	E01
All engines		x 3, COIL ON PLUG								470 609	C10	
				ENGINE								
1.4 VTi 95	Petrol	70	04/10-07/15	8FP (EP3C)								
Engine		Information			A10	A20	A40	A50	A70	C10 - C30	C20	E01
All engines		x 4, COIL ON PLUG								470 475	C10	
				ENGINE								
1.4 VTi 95 LPG	Petrol/ Liquified Petro- leum Gas (LPG)	70	08/12-07/15	8FR (EP3C)								
Engine		Information			A10	A20	A40	A50	A70	C10 - C30	C20	E01
All engines		x 4, COIL ON PLUG								470 475	C10	
				ENGINE								
1.4 VTi 98	Petrol	72	11/09-07/15	8FR (EP3C)								
Engine		Information			A10	A20	A40	A50	A70	C10 - C30	C20	E01
All engines		x 4, COIL ON PLUG								470 475	C10	
				ENGINE								
1.6	Petrol	153	02/11-07/15	5GM (EP6FTX)								
Engine		Information			A10	A20	A40	A50	A70	C10 - C30	C20	E01
All engines		Qty: 4								470 475	C10	
				ENGINE								
1.6 Racing	Petrol	149	02/11-07/15	5FF (EP6DTS)								
Engine		Information			A10	A20	A40	A50	A70	C10 - C30	C20	E01
All engines		x 4, COIL ON PLUG								470 475	C10	
				ENGINE								
1.6 Racing	Petrol	152	02/11-07/15	5FD (EP6DTS)								
Engine		Information			A10	A20	A40	A50	A70	C10 - C30	C20	E01
All engines		x 4, COIL ON PLUG								470 475	C10	
				ENGINE								
1.6 THP 150	Petrol	110	01/10-07/15	5FN (EP6CDT), 5FX (EP6DT)								
Engine		Information			A10	A20	A40	A50	A70	C10 - C30	C20	E01
All engines		x 4, COIL ON PLUG								470 475	C10	
				ENGINE								
1.6 THP 155	Petrol	115	04/10-07/15	5FR (EP6DT), 5FV (EP6CDT)								
Engine		Information			A10	A20	A40	A50	A70	C10 - C30	C20	E01
All engines		x 4, COIL ON PLUG								470 475	C10	

A10 CONDENSER	A20 CONTACT SET	A40 DISTRIBUTOR CAP	A50 ROTOR	A70 PICK-UP
C10 COIL	C20 IGNITION MODULE	C30 ELECTRONIC IGNITION KIT	E01 IGNITION CABLE SET	

Vehicle	alim.	kW	Date	Engine	FUNCTIONS ON THE VEHICLE									
					A10	A20	A40	A50	A70	C10 - C30	C20	E01		
ENGINE														
1.6 THP 165	Petrol	121	10/14-07/15	5GZ (EP6FDT)										
Engine	Information				A10	A20	A40	A50	A70	C10 - C30	C20	E01		
All engines	x 4, COIL ON PLUG									470 475	C10			
ENGINE														
1.6 VTi 120	Petrol	88	04/10-07/15	5FS (EP6C)										
Engine	Information				A10	A20	A40	A50	A70	C10 - C30	C20	E01		
All engines	x 4, COIL ON PLUG									470 475	C10			
DS4														
ENGINE														
1.2 THP 130	Petrol	96	07/14-07/15	HNY (EB2DTS)										
Engine	Information				A10	A20	A40	A50	A70	C10 - C30	C20	E01		
All engines	x 3, COIL ON PLUG									470 620	C10			
ENGINE														
1.6 THP 150	Petrol	110	04/11-07/15	5FE (EP6CDTMD)										
Engine	Information				A10	A20	A40	A50	A70	C10 - C30	C20	E01		
All engines	x 4, COIL ON PLUG									470 475	C10			
ENGINE														
1.6 THP 155	Petrol	115	04/11-07/15	5FV (EP6CDT)										
Engine	Information				A10	A20	A40	A50	A70	C10 - C30	C20	E01		
All engines	x 4, COIL ON PLUG									470 475	C10			
ENGINE														
1.6 THP 160	Petrol	120	04/12-07/15	5FM (EP6CDTM)										
Engine	Information				A10	A20	A40	A50	A70	C10 - C30	C20	E01		
All engines	x 4, COIL ON PLUG									470 475	C10			
ENGINE														
1.6 THP 165	Petrol	121	01/12-07/15	5FM (EP6CDTM), 5FM (EP6DT), 5GZ (EP6FDT)										
Engine	Information				A10	A20	A40	A50	A70	C10 - C30	C20	E01		
Eng. 5FM (EP6CDTM), 5GZ (EP6FDT)	x 4, COIL ON PLUG									470 475	C10			
Eng. 5FM (EP6DT)	Qty: 4									470 475	C10			
ENGINE														
1.6 THP 200	Petrol	147	04/11-07/15	5FU (EP6DTX)										
Engine	Information				A10	A20	A40	A50	A70	C10 - C30	C20	E01		
All engines	x 4, COIL ON PLUG									470 475	C10			
ENGINE														
1.6 THP 210	Petrol	155	07/15-07/15	5GM (EP6FDTX)										
Engine	Information				A10	A20	A40	A50	A70	C10 - C30	C20	E01		
All engines	Qty: 4									470 475	C10			
ENGINE														
1.6 VTi 120	Petrol	88	04/11-07/15	5FS (EP6C)										
Engine	Information				A10	A20	A40	A50	A70	C10 - C30	C20	E01		
All engines	x 4, COIL ON PLUG									470 475	C10			
DS5														
ENGINE														
1.6 THP 150	Petrol	110	11/11-07/15	5FE (EP6CDTMD)										
Engine	Information				A10	A20	A40	A50	A70	C10 - C30	C20	E01		
All engines	x 4, COIL ON PLUG									470 475	C10			
ENGINE														
1.6 THP 155	Petrol	115	11/11-07/15	5FV (EP6CDT)										
Engine	Information				A10	A20	A40	A50	A70	C10 - C30	C20	E01		
All engines	x 4, COIL ON PLUG									470 475	C10			
ENGINE														
1.6 THP 165	Petrol	121	01/12-07/15	5FM (EP6CDTM), 5FM (EP6DT), 5GZ (EP6FDT)										
Engine	Information				A10	A20	A40	A50	A70	C10 - C30	C20	E01		
All engines	x 4, COIL ON PLUG									470 475	C10			

A10 CONDENSER	A20 CONTACT SET	A40 DISTRIBUTOR CAP	A50 ROTOR	A70 PICK-UP
C10 COIL	C20 IGNITION MODULE	C30 ELECTRONIC IGNITION KIT	E01 IGNITION CABLE SET	

The present application list is a brief version. For the detailed information about the possibility of installation on a specific vehicle, please refer to our web-catalogue <http://catalogo.facet.eu/>

					FUNCTIONS ON THE VEHICLE							
Vehicle	alim.	kW	Date	Engine	A10	A20	A40	A50	A70	C10 - C30	C20	E01
ENGINE												
1.6 THP 165 Hybrid	Petrol/ Electric	121	06/12-07/15	5GZ (EP6FDT)								
Engine	Information				A10	A20	A40	A50	A70	C10 - C30	C20	E01
All engines	x 4, COIL ON PLUG									470 475	C10	
ENGINE												
1.6 THP 200	Petrol	147	11/11-07/15	5FU (EP6DTX)								
Engine	Information				A10	A20	A40	A50	A70	C10 - C30	C20	E01
All engines	x 4, COIL ON PLUG									470 475	C10	
ENGINE												
1.6 THP 210	Petrol	155	11/14-07/15	5GM (EP6FTX)								
Engine	Information				A10	A20	A40	A50	A70	C10 - C30	C20	E01
All engines	Qty: 4									470 475	C10	
DYANE												
4	Petrol	17	04/68-07/75	A79/1 (AYA2)								
Engine	Information				A10	A20	A40	A50	A70	C10 - C30	C20	E01
All engines	version Ducellier					715 064						
EVASION												
1.8	Petrol	73	05/97-07/02	LFZ (XU7JP)								
Engine	Information				A10	A20	A40	A50	A70	C10 - C30	C20	E01
All engines												359 674
ENGINE												
1.8	Petrol	76	02/96-12/96	LFZ (XU7JP)								
Engine	Information				A10	A20	A40	A50	A70	C10 - C30	C20	E01
All engines	x 1, D.I.S., connector type, saw teeth									470 188	C10	
ENGINE												
2.0	Petrol	89	06/94-07/02	RFU (XU10J2/C)								
Engine	Information				A10	A20	A40	A50	A70	C10 - C30	C20	E01
All engines	x 1, D.I.S., connector type, saw teeth									470 188	C10	
All engines												359 494
ENGINE												
2.0 16V	Petrol	100	05/00-07/02	RFN (EW10J4)								
Engine	Information				A10	A20	A40	A50	A70	C10 - C30	C20	E01
All engines	x 4, COIL ON PLUG									470 408	C10	
ENGINE												
2.0 Turbo C.T.	Petrol	108	06/94-07/02	RGX (XU10J2TE)								
Engine	Information				A10	A20	A40	A50	A70	C10 - C30	C20	E01
All engines	x 1, D.I.S., connector type, saw teeth									470 188	C10	
All engines												359 494
GRAND C4 SPACETOURER												
ENGINE												
1.6 PureTech 180	Petrol	133	04/18->	5GF (EP6FADTXD)								
Engine	Information				A10	A20	A40	A50	A70	C10 - C30	C20	E01
All engines	x 4, COIL ON PLUG									470 475	C10	
ENGINE												
1.6 THP 165	Petrol	110	04/18->	5GX (EP6FTMD)								
Engine	Information				A10	A20	A40	A50	A70	C10 - C30	C20	E01
All engines	x 4, COIL ON PLUG									470 475	C10	
ENGINE												
1.6 THP 165	Petrol	121	04/18->	5GZ (EP6FDT)								
Engine	Information				A10	A20	A40	A50	A70	C10 - C30	C20	E01
All engines	x 4, COIL ON PLUG									470 475	C10	
ENGINE												
PureTech 130	Petrol	96	05/19->	HNY (EB2DTS)								
Engine	Information				A10	A20	A40	A50	A70	C10 - C30	C20	E01
All engines	x 3, COIL ON PLUG									470 620	C10	

A10 CONDENSER	A20 CONTACT SET	A40 DISTRIBUTOR CAP	A50 ROTOR	A70 PICK-UP
C10 COIL	C20 IGNITION MODULE	C30 ELECTRONIC IGNITION KIT	E01 IGNITION CABLE SET	

Vehicle	alim.	kW	Date	Engine	FUNCTIONS ON THE VEHICLE							
					A10	A20	A40	A50	A70	C10 - C30	C20	E01
GS												
A 1.3	Petrol	48	07/78-07/86	G13/625								
Engine	Information			A10	A20	A40	A50	A70	C10 - C30	C20	E01	
All engines	version Ducellier					815 058	915 094					
All engines										465 005		
JUMPER I												
2.0	Petrol	79	02/94-02/02	XU102C								
Engine	Information			A10	A20	A40	A50	A70	C10 - C30	C20	E01	
All engines	version Ducellier					815 074	915 102R	415 019				
All engines	Kit, version Ducellier					815 087						
2.0	Petrol	80	02/94-04/02	RFW (XU10J2U)								
Engine	Information			A10	A20	A40	A50	A70	C10 - C30	C20	E01	
All engines									470 188	C10	359 674	
2.0 4x4	Petrol	80	08/96-04/02	RFW (XU10J2U)								
Engine	Information			A10	A20	A40	A50	A70	C10 - C30	C20	E01	
All engines									470 188	C10	359 674	
JUMPER II												
2.0	Petrol	81	04/02->	XU10J2								
Engine	Information			A10	A20	A40	A50	A70	C10 - C30	C20	E01	
All engines	x 1, D.I.S., connector type, saw teeth								470 188	C10		
All engines											359 674	
2.0 bivalent	Petrol/ Compressed Natural Gas (CNG)	81	02/03->	XU10J2								
Engine	Information			A10	A20	A40	A50	A70	C10 - C30	C20	E01	
All engines	x 1, D.I.S., connector type, saw teeth								470 188	C10		
All engines											359 674	
JUMPY I												
1.6	Petrol	58	10/95-08/00	1580 SPI, 220 A2.000								
Engine	Information			A10	A20	A40	A50	A70	C10 - C30	C20	E01	
All engines	x 1, D.I.S., connector type, saw teeth								470 168	C10		
All engines											359 655	
1.6	Petrol	59	10/95-08/00	220 A2.000								
Engine	Information			A10	A20	A40	A50	A70	C10 - C30	C20	E01	
All engines									470 168	C10	359 655	
1.6 i	Petrol	58	10/95-08/00	1580 SPI, 220 A2.000								
Engine	Information			A10	A20	A40	A50	A70	C10 - C30	C20	E01	
All engines	x 1, D.I.S., connector type, saw teeth								470 168	C10		
All engines											359 655	
2.0	Petrol	100	04/00-12/06	RFN (EW10J4)								
Engine	Information			A10	A20	A40	A50	A70	C10 - C30	C20	E01	
All engines									470 408	C10		
All engines	x 4, COIL ON PLUG								470 408	C10		
2.0 i 16V	Petrol	102	03/00-10/06	RFN (EW10J4)								
Engine	Information			A10	A20	A40	A50	A70	C10 - C30	C20	E01	
All engines	x 4, COIL ON PLUG								470 408	C10		

A10	CONDENSER	A20	CONTACT SET	A40	DISTRIBUTOR CAP	A50	ROTOR	A70	PICK-UP
C10	COIL	C20	IGNITION MODULE	C30	ELECTRONIC IGNITION KIT	E01	IGNITION CABLE SET		

FUNCTIONS ON THE VEHICLE

Vehicle	alim.	kW	Date	Engine								
---------	-------	----	------	--------	---	---	---	--	---	---	---	---

JUMPY II

				ENGINE
2.0i	Petrol	103	01/07-03/16	RFH (EW10A), RFJ (EW10A)

Engine	Information	A10	A20	A40	A50	A70	C10 - C30	C20	E01
All engines	x 1, COIL ON PLUG						470 476	C10	

LNA

				ENGINE
1.1	Petrol	37	07/82-04/85	109/5E

Engine	Information	A10	A20	A40	A50	A70	C10 - C30	C20	E01
All engines	version Bosch			806 124	906 056R				
All engines	version Ducellier			815 058	915 094				
All engines								465 005	

MEHARI

				ENGINE
0.6	Petrol	19	05/68-10/79	M28/1 (AK2)

Engine	Information	A10	A20	A40	A50	A70	C10 - C30	C20	E01
All engines	version Ducellier		715 064						

NEMO

				ENGINE
1.4	Petrol	54	02/08->	KFT (TU3A), KFV (TU3A)

Engine	Information	A10	A20	A40	A50	A70	C10 - C30	C20	E01
All engines	x 4, COIL ON PLUG						470 405	C10	

SAXO

				ENGINE
1.0	Petrol	33	10/97-06/03	CDZ (TU9M)

Engine	Information	A10	A20	A40	A50	A70	C10 - C30	C20	E01
All engines	x 1, D.I.S., connector type, saw teeth						470 188	C10	

				ENGINE
1.0	Petrol	37	08/99-06/03	CDZ (TU9M)

Engine	Information	A10	A20	A40	A50	A70	C10 - C30	C20	E01
All engines	x 1, D.I.S., connector type, saw teeth						470 188	C10	

				ENGINE
1.0 X	Petrol	33	05/96-11/98	CDY (TU9M), CDZ (TU9M)

Engine	Information	A10	A20	A40	A50	A70	C10 - C30	C20	E01
Eng. CDY (TU9M)	x 1, D.I.S., connector type, saw teeth						470 188	C10	
Eng. CDZ (TU9M)									360 374

				ENGINE
1.0 X	Petrol	37	05/98-06/03	CDZ (TU9M)

Engine	Information	A10	A20	A40	A50	A70	C10 - C30	C20	E01
All engines	x 1, D.I.S., connector type, saw teeth						470 188	C10	
All engines									360 374

				ENGINE
1.1 BiFuel	Petrol/ Liquified Petro- leum Gas (LPG)	44	07/00-06/03	HDZ (TU1M)

Engine	Information	A10	A20	A40	A50	A70	C10 - C30	C20	E01
All engines	x 1, D.I.S., connector type, saw teeth						470 188	C10	

				ENGINE
1.1 X, SX	Petrol	40	05/96-09/03	HDZ (TU1M)

Engine	Information	A10	A20	A40	A50	A70	C10 - C30	C20	E01
All engines	x 1, D.I.S., connector type, saw teeth						470 188	C10	
All engines									360 374

				ENGINE
1.1 X, SX	Petrol	44	05/96-09/03	HDZ (TU1M), HFX (TU1JP)

Engine	Information	A10	A20	A40	A50	A70	C10 - C30	C20	E01
Eng. HDZ (TU1M)							470 188	C10	360 374
Eng. HFX (TU1JP)							470 405	C10	

A10 CONDENSER	A20 CONTACT SET	A40 DISTRIBUTOR CAP	A50 ROTOR	A70 PICK-UP
C10 COIL	C20 IGNITION MODULE	C30 ELECTRONIC IGNITION KIT	E01 IGNITION CABLE SET	

Vehicle	alim.	kW	Date	Engine	FUNCTIONS ON THE VEHICLE									
					A10	A20	A40	A50	A70	C10 - C30	C20	E01		
ENGINE														
1.4 VTS	Petrol	55	05/96-06/03	KFW (TU3JP), KFX (TU3JP)										
Engine	Information				A10	A20	A40	A50	A70	C10 - C30	C20	E01		
All engines	->year 01/01/98, NOT FOR: (USA), x 1, D.I.S., connector type, saw teeth									470 188	C10			
All engines	01/02/98 ->, NOT FOR: (USA), x 4, Electricfil, COIL ON PLUG									470 403	C10			
All engines	FOR: (USA), x 1, COIL ON PLUG									470 405	C10			
Eng. KFX (TU3JP)	+manual transmission, ->year 04/01/98, +automatic transmission												360 374	
ENGINE														
1.6	Petrol	66	02/96-06/03	NFZ (TU5JP)										
Engine	Information				A10	A20	A40	A50	A70	C10 - C30	C20	E01		
All engines	->year 01/06/98, x 1, D.I.S., connector type, saw teeth									470 188	C10			
All engines	01/07/98 ->, x 4, Electricfil, COIL ON PLUG									470 403	C10			
All engines	+manual transmission, ->year 31/05/98, +automatic transmission												360 374	
ENGINE														
1.6	Petrol	74	02/01-04/04	NFT (TU5JP)										
Engine	Information				A10	A20	A40	A50	A70	C10 - C30	C20	E01		
All engines	+automatic transmission									470 188	C10		360 374	
All engines	x 1, COIL ON PLUG									470 405	C10			
ENGINE														
1.6 VTL, VTR	Petrol	65	05/96-06/03	NFZ (TU5JP)										
Engine	Information				A10	A20	A40	A50	A70	C10 - C30	C20	E01		
All engines	->year 01/06/98, x 1, D.I.S., connector type, saw teeth									470 188	C10			
All engines	01/07/98 ->, x 4, Electricfil, COIL ON PLUG									470 403	C10			
All engines	+manual transmission, ->year 31/05/98, +automatic transmission												360 374	
ENGINE														
1.6 VTS	Petrol	72	09/00-09/03	NFT (TU5JP)										
Engine	Information				A10	A20	A40	A50	A70	C10 - C30	C20	E01		
All engines	+automatic transmission									470 188	C10		360 374	
All engines	x 1, COIL ON PLUG									470 405	C10			
VISA														
ENGINE														
11 E	Petrol	35	09/78-06/88	109K										
Engine	Information				A10	A20	A40	A50	A70	C10 - C30	C20	E01		
All engines	version Bosch						806 124	906 056R						
All engines	version Duellier						815 058	915 094						
All engines												465 005		
XANTIA I														
ENGINE														
1.6 i	Petrol	65	03/93-03/01	BFZ (XU5JP)										
Engine	Information				A10	A20	A40	A50	A70	C10 - C30	C20	E01		
All engines										470 188	C10		359 674	
ENGINE														
1.8 i	Petrol	66	04/97-04/03	LFX (XU7JB)										
Engine	Information				A10	A20	A40	A50	A70	C10 - C30	C20	E01		
All engines										470 188	C10		359 674	
ENGINE														
1.8 i	Petrol	74	03/93-01/98	LFX (XU7JP)										
Engine	Information				A10	A20	A40	A50	A70	C10 - C30	C20	E01		
All engines										470 188	C10		359 674	
ENGINE														
2.0	Petrol	95	03/93-05/95	RFX XU10J2C/Z L3										
Engine	Information				A10	A20	A40	A50	A70	C10 - C30	C20	E01		
All engines										470 188	C10		359 494	
ENGINE														
2.0 i	Petrol	89	03/93-04/03	RFX (XU10J2C)										
Engine	Information				A10	A20	A40	A50	A70	C10 - C30	C20	E01		
All engines										470 188	C10		359 494	

A10 CONDENSER	A20 CONTACT SET	A40 DISTRIBUTOR CAP	A50 ROTOR	A70 PICK-UP
C10 COIL	C20 IGNITION MODULE	C30 ELECTRONIC IGNITION KIT	E01 IGNITION CABLE SET	









The present application list is a brief version. For the detailed information about the possibility of installation on a specific vehicle, please refer to our web-catalogue <http://catalogo.facet.eu/>

FUNCTIONS ON THE VEHICLE

Vehicle	alim.	kW	Date	Engine								
ENGINE												
2.0 Turbo	Petrol	108	06/95-04/03	RGX (XU10J2TE)								
Engine	Information				A10	A20	A40	A50	A70	C10 - C30	C20	E01
All engines										470 188	C10	359 494
XANTIA II												
ENGINE												
1.6 i SX	Petrol	65	01/98-03/01	BFZ (XU5JP)								
Engine	Information				A10	A20	A40	A50	A70	C10 - C30	C20	E01
All engines										470 188	C10	359 674
ENGINE												
1.8 i	Petrol	66	01/98-04/03	LFX (XU7JB)								
Engine	Information				A10	A20	A40	A50	A70	C10 - C30	C20	E01
All engines										470 188	C10	359 674
ENGINE												
2.0 i	Petrol	89	01/98-04/03	RFX (XU10J2C)								
Engine	Information				A10	A20	A40	A50	A70	C10 - C30	C20	E01
All engines										470 188	C10	359 494
ENGINE												
2.0 Turbo	Petrol	108	01/98-04/03	RGX (XU10J2TE)								
Engine	Information				A10	A20	A40	A50	A70	C10 - C30	C20	E01
All engines										470 188	C10	359 494
XM I												
ENGINE												
2.0	Petrol	84	05/89-04/94	--								
Engine	Information				A10	A20	A40	A50	A70	C10 - C30	C20	E01
All engines	version Ducellier						815 074	915 102R	415 019			
All engines	Kit, version Ducellier						815 087					
ENGINE												
2.0 i	Petrol	79	05/89-04/94	RDZ (XU10MZ)								
Engine	Information				A10	A20	A40	A50	A70	C10 - C30	C20	E01
All engines	->year 04/06/90, version Ducellier						815 074					
All engines	->year 04/06/90, Kit, version Ducellier						815 087					
All engines	->year 02/05/90, version Ducellier							915 102R				
All engines	->year 04/06/90									470 155	C10	465 005
All engines	05/06/90 ->									470 188	C10	359 494
ENGINE												
2.0 i	Petrol	89	05/89-06/94	RFZ (XU10J2)								
Engine	Information				A10	A20	A40	A50	A70	C10 - C30	C20	E01
All engines	version Ducellier, +manual transmission, ->year 14/05/90, +automatic transmission						815 074	915 102R	415 019			
All engines	Kit, version Ducellier, +manual transmission, ->year 14/05/90, +automatic transmission						815 087					
All engines	+manual transmission, ->year 14/05/90, +automatic transmission									470 155	C10	
All engines	+manual transmission, 15/05/90 ->									470 188	C10	359 494
ENGINE												
2.0 i Turbo	Petrol	104	09/92-06/94	RGY (XU10J2TE/Z)								
Engine	Information				A10	A20	A40	A50	A70	C10 - C30	C20	E01
All engines										470 188	C10	359 494
ENGINE												
2.0 Turbo	Petrol	104	09/92-04/94	RGY (XU10J2TE/Z)								
Engine	Information				A10	A20	A40	A50	A70	C10 - C30	C20	E01
All engines										470 188	C10	359 494
ENGINE												
3.0	Petrol	123	05/89-05/94	UFZ (ZPJ/Z)								
Engine	Information				A10	A20	A40	A50	A70	C10 - C30	C20	E01
All engines	version Bosch						806 252	906 119R				
All engines											465 034	
ENGINE												
3.0 V6	Petrol	123	05/89-06/94	SFZ (ZPJ/Z), UFZ (ZPJ/Z)								
Engine	Information				A10	A20	A40	A50	A70	C10 - C30	C20	E01
All engines	version Bosch						806 252	906 119R				
All engines											465 034	

A10 CONDENSER	A20 CONTACT SET	A40 DISTRIBUTOR CAP	A50 ROTOR	A70 PICK-UP
C10 COIL	C20 IGNITION MODULE	C30 ELECTRONIC IGNITION KIT	E01 IGNITION CABLE SET	

Vehicle	alim.	kW	Date	Engine	FUNCTIONS ON THE VEHICLE									
					A10	A20	A40	A50	A70	C10 - C30	C20	E01		
ENGINE														
3.0 V6 24V	Petrol	147	07/90-06/94	SKZ (ZPJ4/Z), UKZ (ZPJ4/Z)										
Engine					A10	A20	A40	A50	A70	C10 - C30	C20	E01		
All engines							806 252	906 119R						
All engines											465 034			
XM II														
ENGINE														
2.0	Petrol	89	08/94-07/99	XU10J2										
Engine					A10	A20	A40	A50	A70	C10 - C30	C20	E01		
All engines										470 188	C10		359 494	
ENGINE														
2.0 Turbo	Petrol	108	05/94-10/00	RGX (XU10J2TE), RGY (XU10J2TE/Z)										
Engine					A10	A20	A40	A50	A70	C10 - C30	C20	E01		
All engines										470 188	C10		359 494	
ENGINE														
3.0 V6	Petrol	123	05/94-10/00	SFZ (ZPJ/Z), UFZ (ZPJ/Z)										
Engine					A10	A20	A40	A50	A70	C10 - C30	C20	E01		
All engines							806 252	906 119R						
All engines											465 034			
ENGINE														
3.0 V6 24V	Petrol	147	05/94-10/00	SKZ (ZPJ4/Z), UKZ (ZPJ4/Z)										
Engine					A10	A20	A40	A50	A70	C10 - C30	C20	E01		
All engines							806 252	906 119R						
All engines											465 034			
XSARA														
ENGINE														
1.4	Petrol	55	05/98-03/05	KFX (TU3JP)										
Engine					A10	A20	A40	A50	A70	C10 - C30	C20	E01		
All engines										470 403	C10			
All engines										470 405	C10			
ENGINE														
1.4 i	Petrol	55	04/97-08/05	KFW (TU3JP), KFX (TU3JP)										
Engine					A10	A20	A40	A50	A70	C10 - C30	C20	E01		
Eng. KFW (TU3JP)										470 188	C10		360 374	
All engines										470 188	C10			
All engines										470 403	C10			
All engines										470 405	C10			
ENGINE														
1.4 LPG	Petrol/ Liquified Petro- leum Gas (LPG)	55	05/98-08/00	KFW (TU3JP), KFX (TU3JP)										
Engine					A10	A20	A40	A50	A70	C10 - C30	C20	E01		
Eng. KFW (TU3JP)										470 188	C10			
All engines										470 403	C10			
ENGINE														
1.6 16V	Petrol	80	09/00-08/05	NFU (TU5JP4)										
Engine					A10	A20	A40	A50	A70	C10 - C30	C20	E01		
All engines										470 407	C10			
ENGINE														
1.6 i	Petrol	65	04/97-09/00	NFZ (TU5JP)										
Engine					A10	A20	A40	A50	A70	C10 - C30	C20	E01		
All engines										470 188	C10		360 374	
All engines										470 188	C10			
All engines										470 403	C10			
A10	CONDENSER		A20	CONTACT SET		A40	DISTRIBUTOR CAP		A50	ROTOR		A70	PICK-UP	
C10	COIL		C20	IGNITION MODULE		C30	ELECTRONIC IGNITION KIT		E01	IGNITION CABLE SET				

				FUNCTIONS ON THE VEHICLE								
Vehicle	alim.	kW	Date	Engine								
				ENGINE								
1.8 i	Petrol	66	04/97-09/00	LFX (XU7JB)								
Engine	Information			A10	A20	A40	A50	A70	C10 - C30	C20	E01	
All engines	x 1, D.I.S., connector type, saw teeth								470 188	C10		
All engines												359 674
				ENGINE								
1.8 i	Petrol	74	02/98-09/00	LFZ (XU7JP)								
Engine	Information			A10	A20	A40	A50	A70	C10 - C30	C20	E01	
All engines	x 1, D.I.S., connector type, saw teeth								470 188	C10		
All engines												359 674
				ENGINE								
1.8 i Aut.	Petrol	74	04/97-09/00	LFZ (XU7JP)								
Engine	Information			A10	A20	A40	A50	A70	C10 - C30	C20	E01	
All engines	x 1, D.I.S., connector type, saw teeth								470 188	C10		
All engines												359 674
				ENGINE								
2.0 16V	Petrol	100	09/00-08/05	RFN (EW10J4)								
Engine	Information			A10	A20	A40	A50	A70	C10 - C30	C20	E01	
All engines	x 4, COIL ON PLUG								470 408	C10		
				ENGINE								
XSARA PICASSO												
				ENGINE								
1.6	Petrol	65	12/99-09/01	NFZ (TU5JP)								
Engine	Information			A10	A20	A40	A50	A70	C10 - C30	C20	E01	
All engines	x 4, Electricfil, COIL ON PLUG								470 403	C10		
				ENGINE								
1.6	Petrol	67	06/02-08/05	NFZ (TU5JP)								
Engine	Information			A10	A20	A40	A50	A70	C10 - C30	C20	E01	
All engines	x 4, Electricfil, COIL ON PLUG								470 403	C10		
				ENGINE								
1.6	Petrol	70	12/99-12/10	NFV (TU5JP)								
Engine	Information			A10	A20	A40	A50	A70	C10 - C30	C20	E01	
All engines	x 1, COIL ON PLUG								470 405	C10		
				ENGINE								
1.6 16V	Petrol	80	03/05->	N6A (TU5JP4), NFU (TU5JP4)								
Engine	Information			A10	A20	A40	A50	A70	C10 - C30	C20	E01	
Eng. N6A (TU5JP4)									470 407	C10		
Eng. NFU (TU5JP4)	x 1, COIL ON PLUG								470 407	C10		
				ENGINE								
1.6 16V	Petrol	81	06/05-09/06	NFU (TU5JP4)								
Engine	Information			A10	A20	A40	A50	A70	C10 - C30	C20	E01	
All engines	x 1, COIL ON PLUG								470 407	C10		
				ENGINE								
1.6 Chrono	Petrol	74	04/01-10/04	NFV (TU5JP)								
Engine	Information			A10	A20	A40	A50	A70	C10 - C30	C20	E01	
All engines	x 1, COIL ON PLUG								470 405	C10		
				ENGINE								
1.8 16V	Petrol	85	02/00-08/05	6FZ (EW7J4)								
Engine	Information			A10	A20	A40	A50	A70	C10 - C30	C20	E01	
All engines	x 4, COIL ON PLUG								470 408	C10		
				ENGINE								
2.0	Petrol	88	02/04-10/04	RFN (EW10J4)								
Engine	Information			A10	A20	A40	A50	A70	C10 - C30	C20	E01	
All engines	x 1, COIL ON PLUG								470 408	C10		
				ENGINE								
2.0 16V	Petrol	100	01/03-06/12	RFN (EW10J4)								
Engine	Information			A10	A20	A40	A50	A70	C10 - C30	C20	E01	
All engines	x 4, COIL ON PLUG								470 408	C10		

A10 CONDENSER	A20 CONTACT SET	A40 DISTRIBUTOR CAP	A50 ROTOR	A70 PICK-UP
C10 COIL	C20 IGNITION MODULE	C30 ELECTRONIC IGNITION KIT	E01 IGNITION CABLE SET	

Vehicle	alim.	kW	Date	Engine	FUNCTIONS ON THE VEHICLE									
					A10	A20	A40	A50	A70	C10 - C30	C20	E01		
ENGINE														
2.0 16V	Petrol	101	12/99-11/11	RFN (EW10J4)										
Engine	Information				A10	A20	A40	A50	A70	C10 - C30	C20	E01		
All engines	x 1, COIL ON PLUG									470 408	C10			
ZX														
ENGINE														
1.1	Petrol	40	03/91-08/93	H1A, H1B										
Engine	Information				A10	A20	A40	A50	A70	C10 - C30	C20	E01		
All engines	version Bosch						806 241	906 056R						
All engines	version Ducellier						815 074	915 102R	415 019					
All engines	Kit, version Ducellier						815 087							
All engines	version Magneti Marelli						930 060							
All engines										470 155	C10		360 376	
ENGINE														
1.1	Petrol	44	03/91-06/97	HDZ (TU1M)										
Engine	Information				A10	A20	A40	A50	A70	C10 - C30	C20	E01		
All engines	version Bosch, ->year 14/04/94						806 241	906 056R						
All engines	version Ducellier, ->year 14/04/94						815 074	915 102R	415 019					
All engines	Kit, version Ducellier, ->year 14/04/94						815 087							
All engines	->year 14/04/94									470 155	C10		360 376	
All engines	15/04/94 ->									470 189	C10		360 374	
ENGINE														
1.4	Petrol	55	03/91-06/97	KDX (TU3M/Z)										
Engine	Information				A10	A20	A40	A50	A70	C10 - C30	C20	E01		
All engines										470 189	C10		360 374	
ENGINE														
1.4 i	Petrol	55	03/91-10/97	KDX (TU3M/Z), KDY (TU3M), KDZ (TU3M/Z), KFX (TU3JP), TU32										
Engine	Information				A10	A20	A40	A50	A70	C10 - C30	C20	E01		
Eng. KDY (TU3M), TU32	version Bosch						806 241	906 056R						
Eng. KDY (TU3M), TU32	version Ducellier						815 074	915 102R	415 019					
Eng. KDY (TU3M), TU32	Kit, version Ducellier						815 087							
Eng. KDX (TU3M/Z), TU32										470 155	C10		360 376	
Eng. KFX (TU3JP)										470 188	C10			
Eng. KDX (TU3M/Z), KDZ (TU3M/Z)										470 189	C10			
Eng. KDX (TU3M/Z), KDZ (TU3M/Z), KFX (TU3JP)													360 374	
ENGINE														
1.6	Petrol	66	07/94-10/97	BDY (XU5M), BFZ (XU5JP)										
Engine	Information				A10	A20	A40	A50	A70	C10 - C30	C20	E01		
All engines										470 188	C10		359 674	
ENGINE														
1.6 i	Petrol	65	03/91-10/97	BDY (XU5M), BFZ (XU5JP)										
Engine	Information				A10	A20	A40	A50	A70	C10 - C30	C20	E01		
All engines										470 188	C10		359 674	
ENGINE														
1.8	Petrol	76	03/91-10/97	LFZ (XU7JP)										
Engine	Information				A10	A20	A40	A50	A70	C10 - C30	C20	E01		
All engines										470 188	C10		359 674	
ENGINE														
1.8 i	Petrol	74	07/92-10/97	LFZ (XU7JP)										
Engine	Information				A10	A20	A40	A50	A70	C10 - C30	C20	E01		
All engines										470 188	C10		359 674	
ENGINE														
1.9	Petrol	93	03/91-06/97	D6E (XU9JA)										
Engine	Information				A10	A20	A40	A50	A70	C10 - C30	C20	E01		
All engines	version Ducellier, version Export						815 074	915 102R						
All engines	Kit, version Export, version Ducellier						815 087							
All engines	version Export									470 155	C10	465 005	359 491	
All engines										470 188	C10		359 674	
A10	CONDENSER	A20	CONTACT SET	A40	DISTRIBUTOR CAP	A50	ROTOR	A70	PICK-UP					
C10	COIL	C20	IGNITION MODULE	C30	ELECTRONIC IGNITION KIT	E01	IGNITION CABLE SET							

Vehicle	alim.	kW	Date	Engine	FUNCTIONS ON THE VEHICLE							
					A10	A20	A40	A50	A70	C10 - C30	C20	E01

ENGINE				
1.9	Petrol	96	03/91-09/93	D6E (XU9JA)

Engine	Information	A10	A20	A40	A50	A70	C10 - C30	C20	E01
All engines	version Ducellier, version Export			815 074	915 102R				
All engines	Kit, version Export, version Ducellier			815 087					
All engines	version Export						470 155	C10	465 005
All engines							470 188	C10	359 674

ENGINE				
1.9 i	Petrol	88	03/91-06/97	DKZ (XU9JA)

Engine	Information	A10	A20	A40	A50	A70	C10 - C30	C20	E01
All engines	version Ducellier, version Export			815 074	915 102R				
All engines	Kit, version Export, version Ducellier			815 087					
All engines	version Export						470 155	C10	465 005
All engines							470 188	C10	359 674

ENGINE				
2.0	Petrol	90	07/94-10/97	RFX (XU10J2C)

Engine	Information	A10	A20	A40	A50	A70	C10 - C30	C20	E01
All engines							470 188	C10	359 494

ENGINE				
2.0 i	Petrol	89	07/92-06/97	RFX (XU10J2C)

Engine	Information	A10	A20	A40	A50	A70	C10 - C30	C20	E01
All engines							470 188	C10	359 494

ENGINE				
2.0 i	Petrol	90	07/94-10/97	XU10J2

Engine	Information	A10	A20	A40	A50	A70	C10 - C30	C20	E01
All engines							470 188	C10	359 494

A10	CONDENSER	A20	CONTACT SET	A40	DISTRIBUTOR CAP	A50	ROTOR	A70	PICK-UP
C10	COIL	C20	IGNITION MODULE	C30	ELECTRONIC IGNITION KIT	E01	IGNITION CABLE SET		

Vehicle	alim.	kW	Date	Engine	FUNCTIONS ON THE VEHICLE							
					A10	A20	A40	A50	A70	C10 - C30	C20	E01

FORMENTOR

				ENGINE
1.4 e-Hybrid	Petrol/ Electric	110	01/21->	DGEA

Engine	Information	A10	A20	A40	A50	A70	C10 - C30	C20	E01
All engines	x 4, ELDOR, COIL ON PLUG, incl. spark plug connector, Number of pins:4, incl. spark plug connector						470 599	C10	

				ENGINE
1.4 e-Hybrid	Petrol/ Electric	150	01/21->	DGEA

Engine	Information	A10	A20	A40	A50	A70	C10 - C30	C20	E01
All engines	x 4, ELDOR, COIL ON PLUG, incl. spark plug connector, Number of pins:4, incl. spark plug connector						470 599	C10	

				ENGINE
2.0 TSI	Petrol	180	03/21->	DNPA

Engine	Information	A10	A20	A40	A50	A70	C10 - C30	C20	E01
All engines	x 4, HITACHI, COIL ON PLUG, incl. spark plug connector						470 636	C10	

				ENGINE
2.0 TSI 4Drive	Petrol	140	08/20->	DNNA

Engine	Information	A10	A20	A40	A50	A70	C10 - C30	C20	E01
All engines	x 4, HITACHI, COIL ON PLUG, incl. spark plug connector						470 636	C10	

				ENGINE
2.0 TSI 4Drive	Petrol	228	07/20->	DNFB

Engine	Information	A10	A20	A40	A50	A70	C10 - C30	C20	E01
All engines	x 4, HITACHI, COIL ON PLUG, incl. spark plug connector						470 636	C10	

				ENGINE
VZ 1.4 e-Hybrid	Petrol/ Electric	180	02/21->	DGEA

Engine	Information	A10	A20	A40	A50	A70	C10 - C30	C20	E01
All engines	x 4, ELDOR, COIL ON PLUG, incl. spark plug connector, Number of pins:4, incl. spark plug connector						470 599	C10	

LEON

				ENGINE
1.4 e-HYBRID	Petrol/ Electric	110	09/20->	DGEA

Engine	Information	A10	A20	A40	A50	A70	C10 - C30	C20	E01
All engines	x 4, ELDOR, COIL ON PLUG, Number of pins:4, incl. spark plug connector						470 599	C10	

				ENGINE
1.4 e-HYBRID	Petrol/ Electric	150	09/20->	DGEA

Engine	Information	A10	A20	A40	A50	A70	C10 - C30	C20	E01
All engines	x 4, ELDOR, COIL ON PLUG, Number of pins:4, incl. spark plug connector						470 599	C10	

				ENGINE
2.0 TSI	Petrol	221	06/21->	DNFC

Engine	Information	A10	A20	A40	A50	A70	C10 - C30	C20	E01
All engines	x 4, HITACHI, COIL ON PLUG, incl. spark plug connector						470 636	C10	

				ENGINE
2.0 TSI 4Drive	Petrol	228	06/21->	DNFB

Engine	Information	A10	A20	A40	A50	A70	C10 - C30	C20	E01
All engines	x 4, HITACHI, COIL ON PLUG, incl. spark plug connector						470 636	C10	

				ENGINE
VZ 1.4 e-HYBRID	Petrol/ Electric	180	09/20->	DGEA

Engine	Information	A10	A20	A40	A50	A70	C10 - C30	C20	E01
All engines	x 4, ELDOR, COIL ON PLUG, Number of pins:4, incl. spark plug connector						470 599	C10	

A10 CONDENSER	A20 CONTACT SET	A40 DISTRIBUTOR CAP	A50 ROTOR	A70 PICK-UP
C10 COIL	C20 IGNITION MODULE	C30 ELECTRONIC IGNITION KIT	E01 IGNITION CABLE SET	

The present application list is a brief version. For the detailed information about the possibility of installation on a specific vehicle, please refer to our web-catalogue <http://catalogo.facet.eu/>

				FUNCTIONS ON THE VEHICLE								
Vehicle	alim.	kW	Date	Engine								
1210				ENGINE								
1.2	Petrol	36	01/69->	--								
Engine	Information				A10	A20	A40	A50	A70	C10 - C30	C20	E01
All engines	version Ducellier				615 023	715 055		915 091				
All engines	->year 31/12/79, version Ducellier						815 049					
All engines									470 101D	C10		
1310				ENGINE								
1.3	Petrol	40	05/83-07/04	810-02/-99								
Engine	Information				A10	A20	A40	A50	A70	C10 - C30	C20	E01
All engines	version Ducellier				615 023	715 055	815 049	915 091				
All engines										470 101D	C10	
1410				ENGINE								
1.4	Petrol	43	01/69->	--								
Engine	Information				A10	A20	A40	A50	A70	C10 - C30	C20	E01
All engines	version Ducellier				615 023	715 055		915 091				
All engines	->year 31/12/79, version Ducellier						815 049					
All engines	01/01/80->, version Ducellier						815 054					
All engines										470 101D	C10	
ARO				ENGINE								
10	Petrol	0	01/72-12/80	--								
Engine	Information				A10	A20	A40	A50	A70	C10 - C30	C20	E01
All engines	version Ducellier				615 023	715 101	815 049	915 091				
All engines												359 511
DOKKER				ENGINE								
1.2Tce	Petrol	0	11/12->	H5F 408								
Engine	Information				A10	A20	A40	A50	A70	C10 - C30	C20	E01
All engines	Qty: 4									470 613	C10	
1.2Tce	Petrol	85	11/12->	H5F 402, H5F 408								
Engine	Information				A10	A20	A40	A50	A70	C10 - C30	C20	E01
All engines	x 4, COIL ON PLUG									470 613	C10	
1.2Tce 115	Petrol	84	12/12->	H5F 402								
Engine	Information				A10	A20	A40	A50	A70	C10 - C30	C20	E01
All engines	x 4, COIL ON PLUG									470 613	C10	
1.2Tce 115	Petrol	85	07/15->	--, H5F 408								
Engine	Information				A10	A20	A40	A50	A70	C10 - C30	C20	E01
Eng. --	Qty: 4									470 613	C10	
Eng. H5F 408	x 4, COIL ON PLUG									470 613	C10	
1.6	Petrol	0	11/12->	H4M 738, H4M 740								
Engine	Information				A10	A20	A40	A50	A70	C10 - C30	C20	E01
All engines	Qty: 4									470 613	C10	
1.6	Petrol	61	11/12->	K7M 812, K7M 828								
Engine	Information				A10	A20	A40	A50	A70	C10 - C30	C20	E01
All engines	x 1, D.I.S.									470 596	C10	
All engines												358 252
1.6	Petrol	75	04/15->	H4M 738								
Engine	Information				A10	A20	A40	A50	A70	C10 - C30	C20	E01
All engines	x 4, COIL ON PLUG									470 613	C10	

A10 CONDENSER	A20 CONTACT SET	A40 DISTRIBUTOR CAP	A50 ROTOR	A70 PICK-UP
C10 COIL	C20 IGNITION MODULE	C30 ELECTRONIC IGNITION KIT	E01 IGNITION CABLE SET	

Vehicle	alim.	kW	Date	Engine	FUNCTIONS ON THE VEHICLE									
					A10	A20	A40	A50	A70	C10 - C30	C20	E01		
ENGINE														
1.6 LPG	Petrol/ Liquified Petro- leum Gas (LPG)	61	11/13->	K7M 812, K7M 828										
ENGINE														
Engine		Information				A10	A20	A40	A50	A70	C10 - C30	C20	E01	
All engines		x 1, D.I.S.									470 596	C10		
All engines													358 252	
ENGINE														
1.6 LPG	Petrol/ Liquified Petro- leum Gas (LPG)	75	04/15->	H4M 740										
ENGINE														
Engine		Information				A10	A20	A40	A50	A70	C10 - C30	C20	E01	
All engines		x 4, COIL ON PLUG									470 613	C10		
ENGINE														
1.6 LPG	Petrol/ Liquified Petro- leum Gas (LPG)	80	08/18->	H4M 740										
ENGINE														
Engine		Information				A10	A20	A40	A50	A70	C10 - C30	C20	E01	
All engines		x 4, COIL ON PLUG									470 613	C10		
DUSTER														
ENGINE														
1.0 LPG	Petrol/ Liquified Petro- leum Gas (LPG)	74	01/19->	H4D 450, H4D 460										
ENGINE														
Engine		Information				A10	A20	A40	A50	A70	C10 - C30	C20	E01	
All engines		x 3, COIL ON PLUG									470 552	C10		
ENGINE														
1.0 TCe 100	Petrol	74	01/19->	H4D 450, H4D 460										
ENGINE														
Engine		Information				A10	A20	A40	A50	A70	C10 - C30	C20	E01	
All engines		x 3, COIL ON PLUG									470 552	C10		
ENGINE														
1.0 TCe 100 4x4	Petrol	74	01/19->	H4D 450, H4D 460										
ENGINE														
Engine		Information				A10	A20	A40	A50	A70	C10 - C30	C20	E01	
All engines		x 3, COIL ON PLUG									470 552	C10		
ENGINE														
1.0 TCe 90	Petrol	67	05/21->	H4D470										
ENGINE														
Engine		Information				A10	A20	A40	A50	A70	C10 - C30	C20	E01	
All engines		x 3, COIL ON PLUG									470 552	C10		
ENGINE														
1.2 TCe 125	Petrol	0	01/12->	H5F 408										
ENGINE														
Engine		Information				A10	A20	A40	A50	A70	C10 - C30	C20	E01	
All engines		Qty: 4									470 613	C10		
ENGINE														
1.2 TCe 125	Petrol	92	10/13->	H5F 404, H5F 408										
ENGINE														
Engine		Information				A10	A20	A40	A50	A70	C10 - C30	C20	E01	
All engines		x 4, COIL ON PLUG									470 613	C10		
ENGINE														
1.2 TCe 125 4x4	Petrol	92	10/13->	H5F 404, H5F 410										
ENGINE														
Engine		Information				A10	A20	A40	A50	A70	C10 - C30	C20	E01	
All engines		x 4, COIL ON PLUG									470 613	C10		
ENGINE														
1.6	Petrol	0	04/10->	K4M 642, K4M 646, K4M 694, K4M 842, K4M 884										
ENGINE														
Engine		Information				A10	A20	A40	A50	A70	C10 - C30	C20	E01	
All engines		Qty: 4									470 432	C10		
ENGINE														
1.6 16V	Petrol	0	04/10->	K4M 490										
ENGINE														
Engine		Information				A10	A20	A40	A50	A70	C10 - C30	C20	E01	
All engines		Qty: 4									470 432	C10		

A10 CONDENSER	A20 CONTACT SET	A40 DISTRIBUTOR CAP	A50 ROTOR	A70 PICK-UP
C10 COIL	C20 IGNITION MODULE	C30 ELECTRONIC IGNITION KIT	E01 IGNITION CABLE SET	

The present application list is a brief version. For the detailed information about the possibility of installation on a specific vehicle, please refer to our web-catalogue <http://catalogo.facet.eu/>

					FUNCTIONS ON THE VEHICLE							
Vehicle	alim.	kW	Date	Engine	A10	A20	A40	A50	A70	C10 - C30	C20	E01
ENGINE												
1.6 16V	Petrol	77	04/10->	K4M 606, K4M 616, K4M 694, K4M 696, K4M 842, K4M 896						470 432	C10	
ENGINE												
Engine		Information			A10	A20	A40	A50	A70	C10 - C30	C20	E01
Eng. K4M 606, K4M 694, K4M 696, K4M 842, K4M 896		HSAB/HSMA/HSAP/HSAN, x 4, SAGEM, COIL ON PLUG								470 432	C10	
Eng. K4M 616		Qty: 4								470 432	C10	
ENGINE												
1.6 16V 4x4	Petrol	77	06/10->	K4M 490, K4M 606, K4M 646, K4M 690						470 432	C10	
ENGINE												
Engine		Information			A10	A20	A40	A50	A70	C10 - C30	C20	E01
All engines		x 4, SAGEM, COIL ON PLUG, HSAS/HSAB/HSAN, x 4, SAGEM, COIL ON PLUG								470 432	C10	
ENGINE												
1.6 16V Hi-Flex	Petrol/Ethanol	77	08/10->	K4M 696						470 432	C10	
ENGINE												
Engine		Information			A10	A20	A40	A50	A70	C10 - C30	C20	E01
All engines		x 4, SAGEM, COIL ON PLUG								470 432	C10	
ENGINE												
1.6 16V LPG	Petrol/Liquified Petroleum Gas (LPG)	77	04/11-01/18	K4M 616, K4M 642, K4M 696						470 432	C10	
ENGINE												
Engine		Information			A10	A20	A40	A50	A70	C10 - C30	C20	E01
Eng. K4M 616, K4M 642		x 4, SAGEM, COIL ON PLUG								470 432	C10	
Eng. K4M 696		Qty: 4								470 432	C10	
ENGINE												
1.6 SCe 115	Petrol	84	06/15->	H4M 438, H4M 738						470 613	C10	
ENGINE												
Engine		Information			A10	A20	A40	A50	A70	C10 - C30	C20	E01
Eng. H4M 438		Qty: 4								470 613	C10	
Eng. H4M 738		x 4, COIL ON PLUG								470 613	C10	
ENGINE												
1.6 SCe 115 4x4	Petrol	84	06/15->	H4M 430, H4M 730, H4M 738						470 613	C10	
ENGINE												
Engine		Information			A10	A20	A40	A50	A70	C10 - C30	C20	E01
Eng. H4M 430		Qty: 4								470 613	C10	
Eng. H4M 730, H4M 738		x 4, COIL ON PLUG								470 613	C10	
ENGINE												
1.6 SCe 115 LPG	Petrol/Ethanol	84	06/15-01/18	H4M 740						470 613	C10	
ENGINE												
Engine		Information			A10	A20	A40	A50	A70	C10 - C30	C20	E01
All engines		x 4, COIL ON PLUG								470 613	C10	
ENGINE												
1.6 SCe 115 LPG	Petrol/Liquified Petroleum Gas (LPG)	80	10/17->	H4M 740						470 613	C10	
ENGINE												
Engine		Information			A10	A20	A40	A50	A70	C10 - C30	C20	E01
All engines		x 4, COIL ON PLUG								470 613	C10	
ENGINE												
2.0	Petrol	0	04/10->	F4R 400, F4R 401, F4R 403, F4R 404, F4R 405, F4R 408, F4R 410, F4R 412, F4R 414, F4R 416						470 432	C10	
ENGINE												
Engine		Information			A10	A20	A40	A50	A70	C10 - C30	C20	E01
All engines		Qty: 4								470 432	C10	
ENGINE												
2.0	Petrol	104	04/10->	F4R 402						470 432	C10	
ENGINE												
Engine		Information			A10	A20	A40	A50	A70	C10 - C30	C20	E01
All engines		Qty: 4								470 432	C10	
LODGY												
ENGINE												
1.2 Tce	Petrol	0	03/12->	H5F 408						470 613	C10	
ENGINE												
Engine		Information			A10	A20	A40	A50	A70	C10 - C30	C20	E01
All engines		Qty: 4								470 613	C10	

A10 CONDENSER	A20 CONTACT SET	A40 DISTRIBUTOR CAP	A50 ROTOR	A70 PICK-UP
C10 COIL	C20 IGNITION MODULE	C30 ELECTRONIC IGNITION KIT	E01 IGNITION CABLE SET	

Vehicle	alim.	kW	Date	Engine	FUNCTIONS ON THE VEHICLE									
					A10	A20	A40	A50	A70	C10 - C30	C20	E01		
ENGINE														
1.2 Tce	Petrol	85	03/12->	H5F 402, H5F 408										
ENGINE														
Engine														
All engines											470 613	C10		
1.6	Petrol	0	03/12->	H4M 738, K4M 845										
ENGINE														
Engine														
Eng. K4M 845											470 432	C10		
Eng. H4M 738											470 613	C10		
1.6	Petrol	61	03/12->	K7M 812, K7M 828										
ENGINE														
Engine														
Eng. K7M 812											470 596	C10		
Eng. K7M 828											470 596	C10		
All engines														358 252
1.6 LPG	Petrol/ Liquified Petro- leum Gas (LPG)	61	11/13->	K7M 812, K7M 828										
ENGINE														
Engine														
All engines											470 596	C10		
All engines														358 252
1.6 LPG	Petrol/ Liquified Petro- leum Gas (LPG)	75	04/15->	H4M 740										
ENGINE														
Engine														
All engines											470 613	C10		
1.6 LPG	Petrol/ Liquified Petro- leum Gas (LPG)	80	08/18->	H4M 740										
ENGINE														
Engine														
All engines											470 613	C10		
1.6 Sce 100	Petrol	75	06/15->	H4M 738, H4M 740										
ENGINE														
Engine														
Eng. H4M 738											470 613	C10		
Eng. H4M 740											470 613	C10		
LOGAN I														
1.0 Hi-Flex	Petrol/ Ethanol	56	01/11-10/12	D4D760										
ENGINE														
Engine														
All engines											470 518	C10		
1.2 16V	Petrol	55	02/06->	D4F 732										
ENGINE														
Engine														
All engines											470 518	C10		
All engines														358 246
1.2 16V LPG	Petrol/ Liquified Petro- leum Gas (LPG)	55	02/06->	D4F 734										
ENGINE														
Engine														
All engines											470 518	C10		
1.4	Petrol	55	09/04->	K7J 710										
ENGINE														
Engine														
All engines											470 596	C10		358 252
A10	CONDENSER		A20	CONTACT SET		A40	DISTRIBUTOR CAP		A50	ROTOR		A70	PICK-UP	
C10	COIL		C20	IGNITION MODULE		C30	ELECTRONIC IGNITION KIT		E01	IGNITION CABLE SET				

FUNCTIONS ON THE VEHICLE

Vehicle	alim.	kW	Date	Engine								
---------	-------	----	------	--------	---	---	---	--	---	---	---	---

ENGINE				
1.4	Petrol	55	09/04->	K7J 710

Engine	Information	A10	A20	A40	A50	A70	C10 - C30	C20	E01
All engines	x 1, D.I.S.						470 596	C10	
All engines	->year 18/03/05								358 244
All engines	18/03/05 ->								358 252

ENGINE				
1.4 MPI LPG	Petrol/ Liquified Petro- leum Gas (LPG)	55	02/06-12/12	K7J 710, K7J 714

Engine	Information	A10	A20	A40	A50	A70	C10 - C30	C20	E01
Eng. K7J 710							470 596	C10	358 252
Eng. K7J 714	x 1, D.I.S.						470 596	C10	

ENGINE				
1.6	Petrol	64	09/04->	K7M 710

Engine	Information	A10	A20	A40	A50	A70	C10 - C30	C20	E01
All engines	->year 01/11/11, x 1, D.I.S., x 1, D.I.S. 01/12/11 ->, x 1, D.I.S.						470 596	C10	
All engines	->year 18/03/05								358 244
All engines									358 252
All engines	18/03/05 ->								358 252

ENGINE				
1.6 16V	Petrol	77	12/05->	K4M 690, K4M 694, K4M 696, K4M 697, K4M 698

Engine	Information	A10	A20	A40	A50	A70	C10 - C30	C20	E01
All engines	x 4, SAGEM, COIL ON PLUG						470 432	C10	
Eng. K4M 694	Qty: 4						470 432	C10	

ENGINE				
1.6 16V Flexifuel	Petrol/ Ethanol	77	07/10->	K4M 696

Engine	Information	A10	A20	A40	A50	A70	C10 - C30	C20	E01
All engines	x 4, SAGEM, COIL ON PLUG						470 432	C10	

ENGINE				
1.6 16V Hi-Flex	Petrol/ Ethanol	77	11/09->	K4M 690, K4M 696

Engine	Information	A10	A20	A40	A50	A70	C10 - C30	C20	E01
Eng. K4M 690	Qty: 4						470 432	C10	
Eng. K4M 696	x 4, SAGEM, COIL ON PLUG						470 432	C10	

ENGINE				
1.6 Bifuel	Bi-Fuel	62	05/10->	K7M 800

Engine	Information	A10	A20	A40	A50	A70	C10 - C30	C20	E01
All engines							470 596	C10	358 252
Eng. K7M 800							470 596	C10	358 252
Eng. K7M 718, K7M 818	x 1, D.I.S.						470 596	C10	

ENGINE				
1.6 Bifuel	Petrol/ Liquified Petro- leum Gas (LPG)	64	11/08->	K7M 710, K7M 718

Engine	Information	A10	A20	A40	A50	A70	C10 - C30	C20	E01
Eng. K7M 710							470 596	C10	
Eng. K7M 718	x 1, D.I.S.						470 596	C10	
Eng. K7M 710	->year 18/03/05								358 244
Eng. K7M 710	18/03/05 ->								358 252

ENGINE				
1.6 LPG	Petrol/ Liquified Petro- leum Gas (LPG)	62	05/10-12/12	K7M 818









Engine	Information	A10	A20	A40	A50	A70	C10 - C30	C20	E01
All engines	x 1, D.I.S.						470 596	C10	

A10 CONDENSER	A20 CONTACT SET	A40 DISTRIBUTOR CAP	A50 ROTOR	A70 PICK-UP
C10 COIL	C20 IGNITION MODULE	C30 ELECTRONIC IGNITION KIT	E01 IGNITION CABLE SET	

Vehicle	alim.	kW	Date	Engine	FUNCTIONS ON THE VEHICLE									
					A10	A20	A40	A50	A70	C10 - C30	C20	E01		
ENGINE														
1.6 LPG	Petrol/ Liquified Petro- leum Gas (LPG)	64	08/04-03/11	K7M 718										
Engine		Information			A10	A20	A40	A50	A70	C10 - C30	C20	E01		
All engines		x 1, D.I.S.								470 596	C10			
ENGINE														
1.6 MPI 85	Petrol	62	05/10->	K7M 800										
Engine		Information			A10	A20	A40	A50	A70	C10 - C30	C20	E01		
All engines		x 1, D.I.S.								470 596	C10			
All engines												358 252		
LOGAN II														
ENGINE														
1.0	Petrol	0	10/12->	D4D 754										
Engine		Information			A10	A20	A40	A50	A70	C10 - C30	C20	E01		
All engines										470 518	C10			
ENGINE														
1.2	Petrol	54	05/15->	D4F 732										
Engine		Information			A10	A20	A40	A50	A70	C10 - C30	C20	E01		
All engines		x 1, D.I.S.								470 518	C10			
ENGINE														
1.2	Petrol	55	10/12->	D4F 732, D4F 734										
Engine		Information			A10	A20	A40	A50	A70	C10 - C30	C20	E01		
All engines		x 1, D.I.S.								470 518	C10			
ENGINE														
1.2 LPG	Petrol/ Liquified Petro- leum Gas (LPG)	53	02/13->	D4F 734										
Engine		Information			A10	A20	A40	A50	A70	C10 - C30	C20	E01		
All engines		x 1, D.I.S.								470 518	C10			
ENGINE														
1.2 LPG	Petrol/ Liquified Petro- leum Gas (LPG)	55	10/12->	D4F 732, D4F 734										
Engine		Information			A10	A20	A40	A50	A70	C10 - C30	C20	E01		
All engines		x 1, D.I.S.								470 518	C10			
ENGINE														
1.6	Petrol	63	06/13-08/16	K7M 812										
Engine		Information			A10	A20	A40	A50	A70	C10 - C30	C20	E01		
All engines		x 1, D.I.S.								470 596	C10			
ENGINE														
1.6 16V	Petrol	0	10/12->	K4M 845, K7M 812										
Engine		Information			A10	A20	A40	A50	A70	C10 - C30	C20	E01		
Eng. K4M 845		Qty: 4								470 432	C10			
Eng. K7M 812										470 596	C10		358 252	
ENGINE														
1.6 16V	Petrol	77	01/13->	K4M 842, K7M 764										
Engine		Information			A10	A20	A40	A50	A70	C10 - C30	C20	E01		
Eng. K4M 842		x 4, SAGEM, COIL ON PLUG								470 432	C10			
Eng. K7M 764										470 596	C10		358 252	
ENGINE														
2.0	Petrol	0	10/12->	F4R 412, F4R 416										
Engine		Information			A10	A20	A40	A50	A70	C10 - C30	C20	E01		
All engines		Qty: 4								470 432	C10			
ENGINE														
TCe 90	Petrol	0	10/12->	H4B 408, H4B 410										
Engine		Information			A10	A20	A40	A50	A70	C10 - C30	C20	E01		
All engines		Qty: 3								470 613	C10			

A10 CONDENSER	A20 CONTACT SET	A40 DISTRIBUTOR CAP	A50 ROTOR	A70 PICK-UP
C10 COIL	C20 IGNITION MODULE	C30 ELECTRONIC IGNITION KIT	E01 IGNITION CABLE SET	

The present application list is a brief version. For the detailed information about the possibility of installation on a specific vehicle, please refer to our web-catalogue <http://catalogo.facet.eu/>

					FUNCTIONS ON THE VEHICLE							
Vehicle	alim.	kW	Date	Engine	 A10	 A20	 A40	 A50	 A70	 C10 - C30	 C20	 E01
ENGINE												
TCe 90	Petrol	66	10/12->	H4B 400, H4B 408								
ENGINE												
Engine		Information			A10	A20	A40	A50	A70	C10 - C30	C20	E01
All engines		x 3, COIL ON PLUG								470 613	C10	
ENGINE												
TCe 90 LPG	Petrol/ Liquified Petroleum Gas (LPG)	66	09/15->	H4B 410								
ENGINE												
Engine		Information			A10	A20	A40	A50	A70	C10 - C30	C20	E01
All engines		x 3, COIL ON PLUG								470 613	C10	
LOGAN II MCV												
ENGINE												
1.0 LPG	Petrol/ Liquified Petroleum Gas (LPG)	74	11/19->	H4D 450, H4D 460								
ENGINE												
Engine		Information			A10	A20	A40	A50	A70	C10 - C30	C20	E01
All engines		x 3, COIL ON PLUG								470 552	C10	
ENGINE												
1.0 TCe 100	Petrol	74	11/19->	H4D 450, H4D 460								
ENGINE												
Engine		Information			A10	A20	A40	A50	A70	C10 - C30	C20	E01
All engines		x 3, COIL ON PLUG								470 552	C10	
ENGINE												
1.2	Petrol	54	05/15->	D4F 732								
ENGINE												
Engine		Information			A10	A20	A40	A50	A70	C10 - C30	C20	E01
All engines		x 1, D.I.S.								470 518	C10	
ENGINE												
1.2	Petrol	55	02/13->	D4F 732								
ENGINE												
Engine		Information			A10	A20	A40	A50	A70	C10 - C30	C20	E01
All engines		x 1, D.I.S.								470 518	C10	
ENGINE												
1.2 LPG	Petrol/ Liquified Petroleum Gas (LPG)	53	02/13->	D4F 734								
ENGINE												
Engine		Information			A10	A20	A40	A50	A70	C10 - C30	C20	E01
All engines		x 1, D.I.S.								470 518	C10	
ENGINE												
1.2 LPG	Petrol/ Liquified Petroleum Gas (LPG)	55	02/13->	D4F 732, D4F 734								
ENGINE												
Engine		Information			A10	A20	A40	A50	A70	C10 - C30	C20	E01
All engines		x 1, D.I.S.								470 518	C10	
ENGINE												
1.6	Petrol	62	06/13->	K7M 812								
ENGINE												
Engine		Information			A10	A20	A40	A50	A70	C10 - C30	C20	E01
All engines		x 1, D.I.S.								470 596	C10	
ENGINE												
TCe 90	Petrol	66	02/13->	H4B 400, H4B 408								
ENGINE												
Engine		Information			A10	A20	A40	A50	A70	C10 - C30	C20	E01
All engines		x 3, COIL ON PLUG								470 613	C10	
ENGINE												
TCe 90 LPG	Petrol/ Liquified Petroleum Gas (LPG)	66	09/15->	H4B 410								
ENGINE												
Engine		Information			A10	A20	A40	A50	A70	C10 - C30	C20	E01
All engines		K8M1, x 3, COIL ON PLUG								470 613	C10	

A10 CONDENSER	A20 CONTACT SET	A40 DISTRIBUTOR CAP	A50 ROTOR	A70 PICK-UP
C10 COIL	C20 IGNITION MODULE	C30 ELECTRONIC IGNITION KIT	E01 IGNITION CABLE SET	

Vehicle	alim.	kW	Date	Engine	FUNCTIONS ON THE VEHICLE							
					A10	A20	A40	A50	A70	C10 - C30	C20	E01

SANDERO

				ENGINE
1.0 TcE 100	Petrol	74	01/21->	H4D480

Engine	Information	A10	A20	A40	A50	A70	C10 - C30	C20	E01
All engines	x 3, COIL ON PLUG						470 552	C10	

				ENGINE
1.0 TcE 100 ECO-G	Petrol/ Liquified Petro- leum Gas (LPG)	74	01/21->	H4D480

Engine	Information	A10	A20	A40	A50	A70	C10 - C30	C20	E01
All engines	x 3, COIL ON PLUG						470 552	C10	

				ENGINE
1.0 TcE 90	Petrol	67	01/21->	H4D470

Engine	Information	A10	A20	A40	A50	A70	C10 - C30	C20	E01
All engines	x 3, COIL ON PLUG						470 552	C10	

				ENGINE
1.0 TcE 90 ECO-G	Petrol/ Liquified Petro- leum Gas (LPG)	67	01/21->	H4D470

Engine	Information	A10	A20	A40	A50	A70	C10 - C30	C20	E01
All engines	x 3, COIL ON PLUG						470 552	C10	

SANDERO I

				ENGINE
1.0 Hi-Flex	Petrol/ Ethanol	56	01/11-12/12	D4D760

Engine	Information	A10	A20	A40	A50	A70	C10 - C30	C20	E01
All engines	x 1, D.I.S.						470 518	C10	

				ENGINE
1.2 16V	Petrol	55	11/08->	D4F 732

Engine	Information	A10	A20	A40	A50	A70	C10 - C30	C20	E01
All engines	x 1, D.I.S.						470 518	C10	
All engines									358 246

				ENGINE
1.2 16V LPG	Petrol/ Liquified Petro- leum Gas (LPG)	55	11/08->	D4F 732, D4F 734

Engine	Information	A10	A20	A40	A50	A70	C10 - C30	C20	E01
Eng. D4F 732							470 518	C10	358 246
Eng. D4F 734	x 1, D.I.S.						470 518	C10	

				ENGINE
1.4	Petrol	55	06/08->	K7J 710

Engine	Information	A10	A20	A40	A50	A70	C10 - C30	C20	E01
All engines	x 1, D.I.S.						470 596	C10	
All engines	->year 18/03/05								358 244
All engines	18/03/05 ->								358 252

				ENGINE
1.4 MPI LPG	Petrol/ Liquified Petro- leum Gas (LPG)	53	01/09->	K7J 714

Engine	Information	A10	A20	A40	A50	A70	C10 - C30	C20	E01
All engines	x 1, D.I.S.						470 596	C10	

				ENGINE
1.6	Petrol	62	06/08->	K7M 718









Engine	Information	A10	A20	A40	A50	A70	C10 - C30	C20	E01
All engines							470 596	C10	358 252

				ENGINE
1.6	Petrol	64	06/08->	K7M 710

Engine	Information	A10	A20	A40	A50	A70	C10 - C30	C20	E01
All engines	x 1, D.I.S.						470 596	C10	
All engines									358 252

A10 CONDENSER	A20 CONTACT SET	A40 DISTRIBUTOR CAP	A50 ROTOR	A70 PICK-UP
C10 COIL	C20 IGNITION MODULE	C30 ELECTRONIC IGNITION KIT	E01 IGNITION CABLE SET	

The present application list is a brief version. For the detailed information about the possibility of installation on a specific vehicle, please refer to our web-catalogue <http://catalogo.facet.eu/>







					FUNCTIONS ON THE VEHICLE								
Vehicle	alim.	kW	Date	Engine									
ENGINE													
1.6 16V	Petrol	77	07/11->	K4M 690, K4M 694									
ENGINE													
All engines					x 4, SAGEM, COIL ON PLUG						470 432	C10	
1.6 16V Bifuel	Petrol/ Ethanol	77	01/11->	K4M 690, K4M 696									
ENGINE													
Eng. K4M 690					Qty: 4						470 432	C10	
Eng. K4M 696					x 4, SAGEM, COIL ON PLUG						470 432	C10	
1.6 Hi-Flex	Petrol/ Ethanol	64	06/08-12/12	K7M 732									
ENGINE													
All engines					x 1, D.I.S.						470 596	C10	
1.6 LPG	Petrol/ Liquified Petro- leum Gas (LPG)	60	01/11-12/12	K7M 818									
ENGINE													
All engines					x 1, D.I.S.						470 596	C10	
1.6 LPG	Petrol/ Liquified Petro- leum Gas (LPG)	62	05/10-10/12	K7M 818									
ENGINE													
All engines					x 1, D.I.S.						470 596	C10	
1.6 LPG	Petrol/ Liquified Petro- leum Gas (LPG)	64	06/08-12/12	K7M 718									
ENGINE													
All engines					x 1, D.I.S.						470 596	C10	
1.6 MPI 85	Petrol	62	05/10-06/13	K7M 800									
ENGINE													
All engines					x 1, D.I.S.						470 596	C10	
All engines												358 252	
SANDERO II													
ENGINE													
1.0	Petrol	0	10/12->	D4D 754									
ENGINE													
All engines											470 518	C10	
1.0 LPG	Petrol/ Liquified Petro- leum Gas (LPG)	74	11/19->	H4D 450, H4D 460									
ENGINE													
All engines					x 3, COIL ON PLUG						470 552	C10	
1.0 TCe 100	Petrol	74	11/19->	H4D 450, H4D 460									
ENGINE													
All engines					x 3, COIL ON PLUG						470 552	C10	
1.0 TCE 90 GPF	Petrol	67	01/21->	H4D470									
ENGINE													
All engines					x 3, COIL ON PLUG						470 552	C10	

A10 CONDENSER	A20 CONTACT SET	A40 DISTRIBUTOR CAP	A50 ROTOR	A70 PICK-UP
C10 COIL	C20 IGNITION MODULE	C30 ELECTRONIC IGNITION KIT	E01 IGNITION CABLE SET	

Vehicle	alim.	kW	Date	Engine	FUNCTIONS ON THE VEHICLE									
					A10	A20	A40	A50	A70	C10 - C30	C20	E01		
ENGINE														
1.2	Petrol	54	05/15->	D4F 732										
ENGINE														
All engines														
Information					A10	A20	A40	A50	A70	C10 - C30	C20	E01		
x 1, D.I.S.										470 518	C10			
1.2	Petrol	55	10/12->	D4F 732, D4F 734										
ENGINE														
All engines														
Information					A10	A20	A40	A50	A70	C10 - C30	C20	E01		
x 1, D.I.S.										470 518	C10			
1.2 LPG	Petrol/ Liquified Petro- leum Gas (LPG)	55	10/12->	D4F 732, D4F 734										
ENGINE														
All engines														
Information					A10	A20	A40	A50	A70	C10 - C30	C20	E01		
Eng. D4F 734										470 518	C10			
x 1, D.I.S.										470 518	C10			
1.6	Petrol	63	11/12->	K7M 812										
ENGINE														
All engines														
Information					A10	A20	A40	A50	A70	C10 - C30	C20	E01		
All engines										470 596	C10		358 252	
1.6 16V	Petrol	77	01/13->	K4M 842, K4M 845										
ENGINE														
All engines														
Information					A10	A20	A40	A50	A70	C10 - C30	C20	E01		
Qty: 4										470 432	C10			
1.6 I	Petrol	77	10/12->	K7M 764										
ENGINE														
All engines														
Information					A10	A20	A40	A50	A70	C10 - C30	C20	E01		
All engines										470 596	C10		358 252	
2.0	Petrol	0	10/12->	F4R 416										
ENGINE														
All engines														
Information					A10	A20	A40	A50	A70	C10 - C30	C20	E01		
Qty: 4										470 432	C10			
2.0 LPG	Petrol/ Liquified Petro- leum Gas (LPG)	0	10/12->	F4R 412										
ENGINE														
All engines														
Information					A10	A20	A40	A50	A70	C10 - C30	C20	E01		
Qty: 4										470 432	C10			
TcE 90	Petrol	0	10/12->	--										
ENGINE														
All engines														
Information					A10	A20	A40	A50	A70	C10 - C30	C20	E01		
Qty: 3										470 613	C10			
TcE 90	Petrol	66	10/12->	H4B 400, H4B 408										
ENGINE														
All engines														
Information					A10	A20	A40	A50	A70	C10 - C30	C20	E01		
x 3, COIL ON PLUG										470 613	C10			
TcE 90 LPG	Petrol/ Liquified Petro- leum Gas (LPG)	66	09/15->	H4B 410										
ENGINE														
All engines														
Information					A10	A20	A40	A50	A70	C10 - C30	C20	E01		
x 3, COIL ON PLUG										470 613	C10			
SOLENZA														
1.4	Petrol	55	02/03-10/05	E7J 262										
ENGINE														
All engines														
Information					A10	A20	A40	A50	A70	C10 - C30	C20	E01		
x 1, D.I.S.										470 596	C10			

A10 CONDENSER	A20 CONTACT SET	A40 DISTRIBUTOR CAP	A50 ROTOR	A70 PICK-UP
C10 COIL	C20 IGNITION MODULE	C30 ELECTRONIC IGNITION KIT	E01 IGNITION CABLE SET	

The present application list is a brief version. For the detailed information about the possibility of installation on a specific vehicle, please refer to our web-catalogue <http://catalogo.facet.eu/>

				FUNCTIONS ON THE VEHICLE								
Vehicle	alim.	kW	Date	Engine	 A10	 A20	 A40	 A50	 A70	 C10 - C30	 C20	 E01
ARANOS												
1.5	Petrol	66	01/95-11/97	ENGINE V15L								
Engine		Information			A10	A20	A40	A50	A70	C10 - C30	C20	E01
All engines		version Delco Remy					812 075					
All engines												360 433
1.8												
1.8	Petrol	70	01/95-11/97	ENGINE Y18L								
Engine		Information			A10	A20	A40	A50	A70	C10 - C30	C20	E01
All engines		version Delco Remy					812 075	912 098				
ESPERO												
1.5	Petrol	55	10/97-09/99	ENGINE G15MF								
Engine		Information			A10	A20	A40	A50	A70	C10 - C30	C20	E01
All engines												360 433
1.5 16V												
1.5 16V	Petrol	66	02/95-06/99	ENGINE A15MF								
Engine		Information			A10	A20	A40	A50	A70	C10 - C30	C20	E01
All engines		version Delco Remy					812 075					
All engines												360 433
1.8												
1.8	Petrol	70	02/95-06/99	ENGINE C18LE								
Engine		Information			A10	A20	A40	A50	A70	C10 - C30	C20	E01
All engines		version Delco Remy					812 075	912 098				
2.0												
2.0	Petrol	77	02/95-06/99	ENGINE C20LE								
Engine		Information			A10	A20	A40	A50	A70	C10 - C30	C20	E01
All engines		version Delco Remy					812 075	912 098				
EVANDA												
2.0	Petrol	96	08/02->	ENGINE L88, X 20 SED								
Engine		Information			A10	A20	A40	A50	A70	C10 - C30	C20	E01
All engines												360 677
KALOS												
1.2	Petrol	53	04/03->	ENGINE B12S1, F12S3								
Engine		Information			A10	A20	A40	A50	A70	C10 - C30	C20	E01
All engines												358 006
1.4												
1.4	Petrol	61	09/02->	ENGINE F14S3								
Engine		Information			A10	A20	A40	A50	A70	C10 - C30	C20	E01
All engines												360 731
1.4												
1.4	Petrol	69	05/03-12/04	ENGINE F14D3								
Engine		Information			A10	A20	A40	A50	A70	C10 - C30	C20	E01
All engines												360 680
1.4 16V												
1.4 16V	Petrol	69	04/03->	ENGINE F14D3								
Engine		Information			A10	A20	A40	A50	A70	C10 - C30	C20	E01
All engines												360 680
KORANDO												
2.0	Petrol	93	12/98-02/01	ENGINE E20								
Engine		Information			A10	A20	A40	A50	A70	C10 - C30	C20	E01
All engines		x 1, D.I.S.								470 316	C10	
2.0 16V												
2.0 16V	Petrol	94	02/99->	ENGINE E20, M 161.950								
Engine		Information			A10	A20	A40	A50	A70	C10 - C30	C20	E01
Eng. E20		x 1, D.I.S.								470 316	C10	
Eng. M 161.950		Qty: 2								470 316	C10	

A10 CONDENSER	A20 CONTACT SET	A40 DISTRIBUTOR CAP	A50 ROTOR	A70 PICK-UP
C10 COIL	C20 IGNITION MODULE	C30 ELECTRONIC IGNITION KIT	E01 IGNITION CABLE SET	

Vehicle	alim.	kW	Date	Engine	FUNCTIONS ON THE VEHICLE									
					A10	A20	A40	A50	A70	C10 - C30	C20	E01		
ENGINE														
2.3	Petrol	103	01/99-02/01	E23										
Engine	Information				A10	A20	A40	A50	A70	C10 - C30	C20	E01		
All engines	x 1, D.I.S.									470 316	C10			
ENGINE														
2.3	Petrol	105	01/99->	E23, M 161.970										
Engine	Information				A10	A20	A40	A50	A70	C10 - C30	C20	E01		
Eng. E23	x 1, D.I.S.									470 316	C10			
Eng. M 161.970	Qty: 2									470 316	C10			
ENGINE														
3.2 4x4	Petrol	156	01/99->	E32, M 104.995										
Engine	Information				A10	A20	A40	A50	A70	C10 - C30	C20	E01		
Eng. E32	x 1, D.I.S.									470 316	C10			
Eng. M 104.995	Qty: 3									470 316	C10			
LACETTI														
ENGINE														
1.4	Petrol	70	02/04->	F14D3										
Engine	Information				A10	A20	A40	A50	A70	C10 - C30	C20	E01		
All engines													360 509	
ENGINE														
1.6	Petrol	80	02/04->	F16D3										
Engine	Information				A10	A20	A40	A50	A70	C10 - C30	C20	E01		
All engines	x 1, D.I.S.									470 585	C10			
All engines													360 509	
ENGINE														
1.8	Petrol	90	02/04->	T18SED										
Engine	Information				A10	A20	A40	A50	A70	C10 - C30	C20	E01		
All engines													360 677	
LANOS														
ENGINE														
1.3	Petrol	55	05/97->	A14SMS										
Engine	Information				A10	A20	A40	A50	A70	C10 - C30	C20	E01		
All engines													360 731	
ENGINE														
1.5	Petrol	63	05/97->	A15SMS										
Engine	Information				A10	A20	A40	A50	A70	C10 - C30	C20	E01		
All engines													360 731	
ENGINE														
1.6 16V	Petrol	78	02/97->	A16DMS										
Engine	Information				A10	A20	A40	A50	A70	C10 - C30	C20	E01		
All engines													360 680	
LEGANZA														
ENGINE														
2.0 16V	Petrol	93	07/00-04/04	T20SED										
Engine	Information				A10	A20	A40	A50	A70	C10 - C30	C20	E01		
All engines													360 677	
ENGINE														
2.0 16V	Petrol	98	06/97-12/02	X 20 SED										
Engine	Information				A10	A20	A40	A50	A70	C10 - C30	C20	E01		
All engines													360 677	
ENGINE														
2.2 16V	Petrol	100	04/99-12/02	T22SED										
Engine	Information				A10	A20	A40	A50	A70	C10 - C30	C20	E01		
All engines													360 677	
MATIZ														
ENGINE														
0.8	Petrol	38	08/98->	F8CV										
Engine	Information				A10	A20	A40	A50	A70	C10 - C30	C20	E01		
All engines	version Mando						831 139	931 131						
All engines	version Dac						831 172	931 139						
All engines	->VET. 577030									470 219	C10		360 634	
All engines	->ch. 577030, x 1, DISTRIBUTOR									470 219	C10			
A10	CONDENSER		A20	CONTACT SET		A40	DISTRIBUTOR CAP		A50	ROTOR		A70	PICK-UP	
C10	COIL		C20	IGNITION MODULE		C30	ELECTRONIC IGNITION KIT		E01	IGNITION CABLE SET				

Vehicle	alim.	kW	Date	Engine	FUNCTIONS ON THE VEHICLE							
					A10	A20	A40	A50	A70	C10 - C30	C20	E01

MATIZ

				ENGINE
0.8	Petrol	38	08/98->	F8CV

Engine	Information	A10	A20	A40	A50	A70	C10 - C30	C20	E01
All engines	VEV.577031->								358 007

				ENGINE
1.0	Petrol	46	04/03-12/04	B10S

Engine	Information	A10	A20	A40	A50	A70	C10 - C30	C20	E01
All engines									358 006

				ENGINE
1.0	Petrol	47	01/03->	B10S

Engine	Information	A10	A20	A40	A50	A70	C10 - C30	C20	E01
All engines									358 006

MUSSO

				ENGINE
2.3	Petrol	103	01/99->	M 111.970

Engine	Information	A10	A20	A40	A50	A70	C10 - C30	C20	E01
All engines	Musso, x 1, D.I.S.						470 316	C10	

				ENGINE
3.2 4x4	Petrol	162	01/99->	M 104.992, M162E32

Engine	Information	A10	A20	A40	A50	A70	C10 - C30	C20	E01
Eng. M 104.992	Qty: 3						470 316	C10	
Eng. M162E32	Musso, x 1, D.I.S.						470 316	C10	

NEXIA

				ENGINE
1.5	Petrol	44	08/96-08/97	G15MF

Engine	Information	A10	A20	A40	A50	A70	C10 - C30	C20	E01
All engines	version Delco Remy			812 075	912 098				
All engines									360 942

				ENGINE
1.5	Petrol	52	02/95-08/97	G15MF

Engine	Information	A10	A20	A40	A50	A70	C10 - C30	C20	E01
All engines	version Delco Remy			812 075	912 098				
All engines									360 942

				ENGINE
1.5	Petrol	55	02/95-08/97	G15MF

Engine	Information	A10	A20	A40	A50	A70	C10 - C30	C20	E01
All engines	version Delco Remy			812 075	912 098				
All engines									360 942

				ENGINE
1.5 16V	Petrol	66	02/95-08/97	A15MF

Engine	Information	A10	A20	A40	A50	A70	C10 - C30	C20	E01
All engines	version Delco Remy			812 075					
All engines									360 433

NUBIRA I

				ENGINE
1.6 16V	Petrol	76	07/00->	A16DMS

Engine	Information	A10	A20	A40	A50	A70	C10 - C30	C20	E01
All engines									360 680

				ENGINE
1.6 16V	Petrol	78	05/97-05/99	A16DMS

Engine	Information	A10	A20	A40	A50	A70	C10 - C30	C20	E01
All engines									360 680

				ENGINE
2.0 16V	Petrol	93	12/00->	T20SED

Engine	Information	A10	A20	A40	A50	A70	C10 - C30	C20	E01
All engines									360 677

				ENGINE
2.0 16V	Petrol	98	05/97->	X 20 SED, Z20L

Engine	Information	A10	A20	A40	A50	A70	C10 - C30	C20	E01
All engines									360 677

A10 CONDENSER	A20 CONTACT SET	A40 DISTRIBUTOR CAP	A50 ROTOR	A70 PICK-UP
C10 COIL	C20 IGNITION MODULE	C30 ELECTRONIC IGNITION KIT	E01 IGNITION CABLE SET	

Vehicle	alim.	kW	Date	Engine	FUNCTIONS ON THE VEHICLE									
					A10	A20	A40	A50	A70	C10 - C30	C20	E01		
REZZO														
2.0 CDX	Petrol	93	08/02-07/03	ENGINE T20SED										
Engine	Information				A10	A20	A40	A50	A70	C10 - C30	C20	E01		
All engines													360 677	
NUBIRA II														
1.4	Petrol	69	10/03-12/04	ENGINE F14D3										
Engine	Information				A10	A20	A40	A50	A70	C10 - C30	C20	E01		
All engines	x 1, D.I.S.									470 585	C10			
All engines													360 509	
1.6	Petrol	80	07/03->	ENGINE F16D3										
Engine	Information				A10	A20	A40	A50	A70	C10 - C30	C20	E01		
All engines	x 1, D.I.S.									470 585	C10			
All engines													360 509	
1.8	Petrol	90	07/03->	ENGINE T18SED										
Engine	Information				A10	A20	A40	A50	A70	C10 - C30	C20	E01		
All engines													360 677	
REXTON														
3.2 V6	Petrol	162	04/02->	ENGINE M 162.992										
Engine	Information				A10	A20	A40	A50	A70	C10 - C30	C20	E01		
All engines	Qty: 3									470 316	C10			
REZZO														
1.6	Petrol	77	09/00->	ENGINE A16DMS										
Engine	Information				A10	A20	A40	A50	A70	C10 - C30	C20	E01		
All engines													360 680	
1.8	Petrol	66	09/00->	ENGINE --										
Engine	Information				A10	A20	A40	A50	A70	C10 - C30	C20	E01		
All engines													360 730	
1.8	Petrol	67	09/00->	ENGINE F18D2										
Engine	Information				A10	A20	A40	A50	A70	C10 - C30	C20	E01		
All engines													360 730	
1.8	Petrol	72	09/00->	ENGINE A18DMS										
Engine	Information				A10	A20	A40	A50	A70	C10 - C30	C20	E01		
All engines													360 730	
1.8	Petrol	74	09/00->	ENGINE --										
Engine	Information				A10	A20	A40	A50	A70	C10 - C30	C20	E01		
All engines													360 730	
2.0	Petrol	89	09/01-12/04	ENGINE X 20 SED										
Engine	Information				A10	A20	A40	A50	A70	C10 - C30	C20	E01		
All engines													360 677	
2.0	Petrol	94	09/00->	ENGINE T20SED										
Engine	Information				A10	A20	A40	A50	A70	C10 - C30	C20	E01		
All engines													360 677	
TACUMA														
1.6	Petrol	77	09/00-01/05	ENGINE A16DMS										
Engine	Information				A10	A20	A40	A50	A70	C10 - C30	C20	E01		
All engines													360 680	

A10 CONDENSER	A20 CONTACT SET	A40 DISTRIBUTOR CAP	A50 ROTOR	A70 PICK-UP
C10 COIL	C20 IGNITION MODULE	C30 ELECTRONIC IGNITION KIT	E01 IGNITION CABLE SET	

The present application list is a brief version. For the detailed information about the possibility of installation on a specific vehicle, please refer to our web-catalogue <http://catalogo.facet.eu/>

Vehicle	alim.	kW	Date	Engine	FUNCTIONS ON THE VEHICLE							
					A10	A20	A40	A50	A70	C10 - C30	C20	E01

					ENGINE
2.0	Petrol	89	09/00-01/05		X 20 SED

Engine	Information	A10	A20	A40	A50	A70	C10 - C30	C20	E01
All engines									360 677

A10	CONDENSER	A20	CONTACT SET	A40	DISTRIBUTOR CAP	A50	ROTOR	A70	PICK-UP
C10	COIL	C20	IGNITION MODULE	C30	ELECTRONIC IGNITION KIT	E01	IGNITION CABLE SET		

Vehicle	alim.	kW	Date	Engine	FUNCTIONS ON THE VEHICLE							
					A10	A20	A40	A50	A70	C10 - C30	C20	E01

850

				ENGINE
0.8	Petrol	34	07/86-12/89	--

Engine	Information	A10	A20	A40	A50	A70	C10 - C30	C20	E01
All engines	version Denso		713 011HV						
All engines	->year 30/11/86, version Denso				913 014				
All engines	01/12/86 ->, version Denso				913 030				

APPLAUSE I

				ENGINE
1.6 16V	Petrol	66	06/89-07/97	HD

Engine	Information	A10	A20	A40	A50	A70	C10 - C30	C20	E01
All engines	version Denso			813 258	913 028				

				ENGINE
1.6 16V	Petrol	77	06/89-07/97	HD-E

Engine	Information	A10	A20	A40	A50	A70	C10 - C30	C20	E01
All engines	version Denso			813 258	913 028				

				ENGINE
1.6 16V 4WD	Petrol	77	06/89-07/97	HD-E

Engine	Information	A10	A20	A40	A50	A70	C10 - C30	C20	E01
All engines	version Denso			813 258	913 028				

CHARADE III

				ENGINE
1.0	Petrol	38	03/87-12/92	CB 23

Engine	Information	A10	A20	A40	A50	A70	C10 - C30	C20	E01
All engines	version Denso		713 011HV	813 094					
All engines	->year 31/12/88, version Denso				913 014				
All engines	01/01/89 ->, version Denso				913 030				

				ENGINE
1.0	Petrol	40	11/90-12/92	CB 90

Engine	Information	A10	A20	A40	A50	A70	C10 - C30	C20	E01
All engines	version Denso				913 029				

				ENGINE
1.0 GTi	Petrol	74	03/87-12/92	CB 80 T

Engine	Information	A10	A20	A40	A50	A70	C10 - C30	C20	E01
All engines	version Denso				913 029				

				ENGINE
1.0i	Petrol	0	01/88->	G102

Engine	Information	A10	A20	A40	A50	A70	C10 - C30	C20	E01
All engines	version Denso				913 028				
All engines							470 252	C10	

				ENGINE
1.0i [USA]	Petrol	0	01/89->	CB

Engine	Information	A10	A20	A40	A50	A70	C10 - C30	C20	E01
All engines	version Denso				913 029				

				ENGINE
1.0i 12v GTti	Petrol	74	11/90-02/93	CB 70

Engine	Information	A10	A20	A40	A50	A70	C10 - C30	C20	E01
All engines	version Denso				913 029				

				ENGINE
1.3	Petrol	56	09/88-01/92	HC-C

Engine	Information	A10	A20	A40	A50	A70	C10 - C30	C20	E01
All engines	version Denso			813 258	913 028				
All engines							470 252	C10	

				ENGINE
1.3	Petrol	66	11/90-02/93	HC-E

Engine	Information	A10	A20	A40	A50	A70	C10 - C30	C20	E01
All engines	version Denso				913 028				
All engines							470 252	C10	



A10 CONDENSER	A20 CONTACT SET	A40 DISTRIBUTOR CAP	A50 ROTOR	A70 PICK-UP
C10 COIL	C20 IGNITION MODULE	C30 ELECTRONIC IGNITION KIT	E01 IGNITION CABLE SET	

					FUNCTIONS ON THE VEHICLE												
Vehicle	alim.	kW	Date	Engine	A10	A20	A40	A50	A70	C10 - C30	C20	E01					
ENGINE																	
1.3 i	Petrol	66	06/88-12/92	HC-E													
Engine	Information				A10	A20	A40	A50	A70	C10 - C30	C20	E01					
All engines	version Denso							913 028									
All engines										470 252	C10						
ENGINE																	
1.3 i 4WD	Petrol	66	06/88-01/93	HC-E													
Engine	Information				A10	A20	A40	A50	A70	C10 - C30	C20	E01					
All engines	version Denso							913 028									
All engines										470 252	C10						
ENGINE																	
1.3i [USA]	Petrol	0	01/89->	HC-E													
Engine	Information				A10	A20	A40	A50	A70	C10 - C30	C20	E01					
All engines	version Denso						813 258	913 028									
CHARADE VI																	
ENGINE																	
1.33 16V	Petrol	73	05/11->	1NR-FE													
Engine	Information				A10	A20	A40	A50	A70	C10 - C30	C20	E01					
All engines	Charade, x 4, COIL ON PLUG									470 537	C10						
CUORE II																	
ENGINE																	
0.8	Petrol	29	11/89-12/90	ED 10													
Engine	Information				A10	A20	A40	A50	A70	C10 - C30	C20	E01					
All engines	version Denso						813 128										
All engines	->year 28/02/87, version Denso							913 014									
All engines	01/03/87->, version Denso							913 030									
ENGINE																	
0.8	Petrol	32	09/85-06/90	ED 10													
Engine	Information				A10	A20	A40	A50	A70	C10 - C30	C20	E01					
All engines	version Denso						813 128										
All engines	->year 28/02/87, version Denso							913 014									
All engines	01/03/87->, version Denso							913 030									
ENGINE																	
0.8 4WD	Petrol	32	09/86-10/88	ED 10													
Engine	Information				A10	A20	A40	A50	A70	C10 - C30	C20	E01					
All engines	version Denso						813 128										
All engines	->year 28/02/87, version Denso							913 014									
All engines	01/03/87->, version Denso							913 030									
CUORE III																	
ENGINE																	
0.8	Petrol	30	10/90-12/94	ED 10 K													
Engine	Information				A10	A20	A40	A50	A70	C10 - C30	C20	E01					
All engines	01/08/92->											360 436					
CUORE IV																	
ENGINE																	
0.8	Petrol	32	01/95-08/98	ED 20													
Engine	Information				A10	A20	A40	A50	A70	C10 - C30	C20	E01					
All engines	->year 30/11/96, LHD											360 436					
CUORE VII																	
ENGINE																	
1.0 LPG	Petrol/ Liquified Petroleum Gas (LPG)	51	09/11-12/12	1KR-FE													
Engine	Information				A10	A20	A40	A50	A70	C10 - C30	C20	E01					
All engines	x 3, COIL ON PLUG									470 461	C10						
DOMINO																	
ENGINE																	
0.8	Petrol	32	08/85-07/90	ED													
Engine	Information				A10	A20	A40	A50	A70	C10 - C30	C20	E01					
All engines	version Denso						813 128										
All engines	->year 28/02/87, version Denso							913 014									
All engines	01/03/87->, version Denso							913 030									
A10	CONDENSER	A20	CONTACT SET	A40	DISTRIBUTOR CAP	A50	ROTOR	A70	PICK-UP	C10	COIL	C20	IGNITION MODULE	C30	ELECTRONIC IGNITION KIT	E01	IGNITION CABLE SET

Vehicle	alim.	kW	Date	Engine	FUNCTIONS ON THE VEHICLE									
					A10	A20	A40	A50	A70	C10 - C30	C20	E01		
ENGINE														
0.8i	Petrol	32	08/90-10/98	ED20										
ENGINE														
Engine	Information				A10	A20	A40	A50	A70	C10 - C30	C20	E01		
All engines	01/08/92 ->												360 436	
FEROZA														
ENGINE														
1.6 16V	Petrol	63	10/88-12/99	HD-C										
ENGINE														
Engine	Information				A10	A20	A40	A50	A70	C10 - C30	C20	E01		
All engines	version Denso						813 257							
All engines	->year 31/12/95, version Denso							913 028						
All engines													360 732	
ENGINE														
1.6 16V 4x4	Petrol	63	10/88-12/99	HD-C										
ENGINE														
Engine	Information				A10	A20	A40	A50	A70	C10 - C30	C20	E01		
All engines	version Denso						813 257	913 028						
All engines													360 732	
ENGINE														
1.6 i 16V	Petrol	70	10/88-12/99	HD-E										
ENGINE														
Engine	Information				A10	A20	A40	A50	A70	C10 - C30	C20	E01		
All engines	->year 31/12/95, version Denso						813 257	913 028						
All engines													360 732	
ENGINE														
1.6 i 16V 4x4	Petrol	70	10/88-12/99	HD-E										
ENGINE														
Engine	Information				A10	A20	A40	A50	A70	C10 - C30	C20	E01		
All engines	->year 31/12/95, version Denso						813 257	913 028						
All engines													360 732	
ENGINE														
1.6i	Petrol	0	01/84->	--										
ENGINE														
Engine	Information				A10	A20	A40	A50	A70	C10 - C30	C20	E01		
All engines	version Denso					713 011HV	813 257							
All engines	->year 31/12/89, version Denso							913 014						
All engines	01/01/90 ->, version Denso							913 028						
All engines													360 732	
HIJET I														
ENGINE														
1.0	Petrol	33	06/86-12/89	CB										
ENGINE														
Engine	Information				A10	A20	A40	A50	A70	C10 - C30	C20	E01		
All engines	version Denso					713 011HV		913 014						
HIJET II														
ENGINE														
1.3 i 16V	Petrol	48	05/98-10/05	HC-E										
ENGINE														
Engine	Information				A10	A20	A40	A50	A70	C10 - C30	C20	E01		
All engines	01/05/98 ->									470 252	C10			
MIRA														
ENGINE														
0.8i	Petrol	32	12/94-02/97	ED20										
ENGINE														
Engine	Information				A10	A20	A40	A50	A70	C10 - C30	C20	E01		
All engines	->year 31/12/96, LHD													360 436
MOVE														
ENGINE														
0.8	Petrol	31	01/97-11/99	ED 20										
ENGINE														
Engine	Information				A10	A20	A40	A50	A70	C10 - C30	C20	E01		
All engines														360 436
ROCKY														
ENGINE														
2.0i [USA]	Petrol	0	01/89->	--										
ENGINE														
Engine	Information				A10	A20	A40	A50	A70	C10 - C30	C20	E01		
All engines	version Denso						813 257	913 028						
All engines													360 732	

A10	CONDENSER	A20	CONTACT SET	A40	DISTRIBUTOR CAP	A50	ROTOR	A70	PICK-UP
C10	COIL	C20	IGNITION MODULE	C30	ELECTRONIC IGNITION KIT	E01	IGNITION CABLE SET		

The present application list is a brief version. For the detailed information about the possibility of installation on a specific vehicle, please refer to our web-catalogue <http://catalogo.facet.eu/>

					FUNCTIONS ON THE VEHICLE							
Vehicle	alim.	kW	Date	Engine								
					A10	A20	A40	A50	A70	C10 - C30	C20	E01

SPORTTRACK				
				ENGINE
1.6 16v 4x4	Petrol	62	10/88-08/93	HD-C

Engine	Information	A10	A20	A40	A50	A70	C10 - C30	C20	E01
All engines	version Denso			813 257	913 028				
All engines									360 732

A10	CONDENSER	A20	CONTACT SET	A40	DISTRIBUTOR CAP	A50	ROTOR	A70	PICK-UP
C10	COIL	C20	IGNITION MODULE	C30	ELECTRONIC IGNITION KIT	E01	IGNITION CABLE SET		

Vehicle	alim.	kW	Date	Engine	FUNCTIONS ON THE VEHICLE							
					 A10	 A20	 A40	 A50	 A70	 C10 - C30	 C20	 E01

2.8 - 5.3

				ENGINE
Sovereign 2.8	Petrol	110	10/69-05/75	--

Engine	Information	A10	A20	A40	A50	A70	C10 - C30	C20	E01
All engines					928 007				

				ENGINE
Sovereign 4.2	Petrol	127	09/73-03/79	--









Engine	Information	A10	A20	A40	A50	A70	C10 - C30	C20	E01
All engines					928 007				

				ENGINE
Sovereign 4.2	Petrol	137	10/69-09/73	--

Engine	Information	A10	A20	A40	A50	A70	C10 - C30	C20	E01
All engines					928 007				

A10	CONDENSER	A20	CONTACT SET	A40	DISTRIBUTOR CAP	A50	ROTOR	A70	PICK-UP
C10	COIL	C20	IGNITION MODULE	C30	ELECTRONIC IGNITION KIT	E01	IGNITION CABLE SET		

The present application list is a brief version. For the detailed information about the possibility of installation on a specific vehicle, please refer to our web-catalogue <http://catalogo.facet.eu/>

					FUNCTIONS ON THE VEHICLE							
Vehicle	alim.	kW	Date	Engine								
DS 4												
PureTech 180	Petrol	133	10/21->	ENGINE 5GF (EP6FADTXD)								
Engine	Information				A10	A20	A40	A50	A70	C10 - C30	C20	E01
All engines	x 4, COIL ON PLUG									470 475	C10	
DS 5												
1.6 THP 165	Petrol	121	07/15-12/18	ENGINE 5GZ (EP6FDT)								
Engine	Information				A10	A20	A40	A50	A70	C10 - C30	C20	E01
All engines	x 4, COIL ON PLUG									470 475	C10	
1.6 THP 210	Petrol	155	04/15-12/18	ENGINE 5GM (EP6FDTX)								
Engine	Information				A10	A20	A40	A50	A70	C10 - C30	C20	E01
All engines	x 4, COIL ON PLUG									470 475	C10	
DS 7												
1.6 PureTech 180	Petrol	133	04/18->	ENGINE 5GF (EP6FADTXD)								
Engine	Information				A10	A20	A40	A50	A70	C10 - C30	C20	E01
All engines	x 4, COIL ON PLUG									470 475	C10	
1.6 PureTech 225	Petrol	165	09/17->	ENGINE 5GC (EP6FADTX)								
Engine	Information				A10	A20	A40	A50	A70	C10 - C30	C20	E01
All engines	x 4, COIL ON PLUG									470 475	C10	
E-TENSE	Petrol/ Electric	133	10/19->	ENGINE 5GQ (EP6FADTXHP)								
Engine	Information				A10	A20	A40	A50	A70	C10 - C30	C20	E01
All engines	x 4, COIL ON PLUG									470 475	C10	
E-TENSE 225	Petrol/ Electric	133	05/21->	ENGINE 5GQ (EP6FADTXHP)								
Engine	Information				A10	A20	A40	A50	A70	C10 - C30	C20	E01
All engines	x 4, COIL ON PLUG									470 475	C10	
E-TENSE 225	Petrol/ Electric	165	05/21->	ENGINE 5GQ (EP6FADTXHP)								
Engine	Information				A10	A20	A40	A50	A70	C10 - C30	C20	E01
All engines	x 4, COIL ON PLUG									470 475	C10	
E-TENSE 4x4	Petrol/ Electric	147	05/19->	ENGINE 5GB (EP6FADTXHP)								
Engine	Information				A10	A20	A40	A50	A70	C10 - C30	C20	E01
All engines	x 4, COIL ON PLUG									470 475	C10	
E-TENSE 4x4	Petrol/ Electric	221	05/19->	ENGINE 5GB (EP6FADTXHP)								
Engine	Information				A10	A20	A40	A50	A70	C10 - C30	C20	E01
All engines	x 4, COIL ON PLUG									470 475	C10	
DS3												
1.2 THP 110 / PureTech 110	Petrol	81	04/15-07/19	ENGINE HNP (EB2ADT), HNZ (EB2DT)								
Engine	Information				A10	A20	A40	A50	A70	C10 - C30	C20	E01
All engines	x 3, COIL ON PLUG									470 620	C10	
1.2 THP 130	Petrol	96	09/15-07/19	ENGINE HNY (EB2DTS)								
Engine	Information				A10	A20	A40	A50	A70	C10 - C30	C20	E01
All engines	x 3, COIL ON PLUG									470 620	C10	
1.2 VTi 82	Petrol	60	04/15-07/19	ENGINE HMZ (EB2), HMZ (EB2F)								
Engine	Information				A10	A20	A40	A50	A70	C10 - C30	C20	E01
All engines	x 3, COIL ON PLUG									470 609	C10	

A10 CONDENSER	A20 CONTACT SET	A40 DISTRIBUTOR CAP	A50 ROTOR	A70 PICK-UP
C10 COIL	C20 IGNITION MODULE	C30 ELECTRONIC IGNITION KIT	E01 IGNITION CABLE SET	

Vehicle	alim.	kW	Date	Engine	FUNCTIONS ON THE VEHICLE								
					A10	A20	A40	A50	A70	C10 - C30	C20	E01	
ENGINE													
1.6 THP	Petrol	110	07/15-07/19	5GW (EP6FDT), 5GX (EP6FDTMD)									
Engine	Information				A10	A20	A40	A50	A70	C10 - C30	C20	E01	
All engines	x 4, COIL ON PLUG									470 475	C10		
ENGINE													
1.6 THP	Petrol	120	07/15-07/19	5GZ (EP6FDT)									
Engine	Information				A10	A20	A40	A50	A70	C10 - C30	C20	E01	
All engines	x 4, COIL ON PLUG									470 475	C10		
ENGINE													
1.6 THP 165	Petrol	121	07/15-07/19	5GZ (EP6FDT)									
Engine	Information				A10	A20	A40	A50	A70	C10 - C30	C20	E01	
All engines	x 4, COIL ON PLUG									470 475	C10		
ENGINE													
1.6 THP 208	Petrol	153	09/15-07/19	5GR (EP6FDTX)									
Engine	Information				A10	A20	A40	A50	A70	C10 - C30	C20	E01	
All engines	x 4, COIL ON PLUG									470 475	C10		
DS4 / DS4 CROSSBACK													
ENGINE													
1.2 THP 130	Petrol	96	07/15-12/18	HNY (EB2DTS)									
Engine	Information				A10	A20	A40	A50	A70	C10 - C30	C20	E01	
All engines	x 3, COIL ON PLUG									470 620	C10		
ENGINE													
1.6 THP 150	Petrol	110	10/16-12/18	5FE (EP6CDTMD)									
Engine	Information				A10	A20	A40	A50	A70	C10 - C30	C20	E01	
All engines	x 4, COIL ON PLUG									470 475	C10		
ENGINE													
1.6 THP 160	Petrol	120	07/15-12/18	5FM (EP6CDTM)									
Engine	Information				A10	A20	A40	A50	A70	C10 - C30	C20	E01	
All engines	x 4, COIL ON PLUG									470 475	C10		
ENGINE													
1.6 THP 165	Petrol	121	07/15-12/18	5GZ (EP6FDT)									
Engine	Information				A10	A20	A40	A50	A70	C10 - C30	C20	E01	
All engines	x 4, COIL ON PLUG									470 475	C10		
ENGINE													
1.6 THP 210	Petrol	155	07/15-12/18	5GM (EP6FDTX)									
Engine	Information				A10	A20	A40	A50	A70	C10 - C30	C20	E01	
All engines	x 4, COIL ON PLUG									470 475	C10		

A10	CONDENSER	A20	CONTACT SET	A40	DISTRIBUTOR CAP	A50	ROTOR	A70	PICK-UP
C10	COIL	C20	IGNITION MODULE	C30	ELECTRONIC IGNITION KIT	E01	IGNITION CABLE SET		

The present application list is a brief version. For the detailed information about the possibility of installation on a specific vehicle, please refer to our web-catalogue <http://catalogo.facet.eu/>

					FUNCTIONS ON THE VEHICLE								
Vehicle	alim.	kW	Date	Engine									
124													
1200	Petrol	44	07/66-10/73	124 A.000									
Engine	Information				A10	A20	A40	A50	A70	C10 - C30	C20	E01	
All engines	version Ducellier					715 056	815 059	915 083R					
All engines	version Marelli					730 132	830 069	930 054R					
All engines										470 101D	C10		
1400 Special													
1400 Special	Petrol	51	12/68-12/72	124 B2.000									
Engine	Information				A10	A20	A40	A50	A70	C10 - C30	C20	E01	
All engines	version Ducellier					715 056	815 059	915 083R					
All engines	version Marelli					730 132	830 069	930 054R					
All engines										470 101D	C10		
1600 Special T													
1600 Special T	Petrol	70	01/73-07/75	132 AC.000									
Engine	Information				A10	A20	A40	A50	A70	C10 - C30	C20	E01	
All engines	version Ducellier					715 056	815 059	915 083R					
All engines	version Marelli					730 132	830 069	930 054R					
All engines										470 101D	C10		
125													
1.6	Petrol	66	07/67-03/74	125 A.000									
Engine	Information				A10	A20	A40	A50	A70	C10 - C30	C20	E01	
All engines								930 037					
126													
600	Petrol	17	09/72-06/77	126 A.000									
Engine	Information				A10	A20	A40	A50	A70	C10 - C30	C20	E01	
All engines	version Marelli					730 120	830 086	930 040					
All engines										470 101D	C10	359 507	
650													
650	Petrol	17	07/77-09/87	126 A1.048									
Engine	Information				A10	A20	A40	A50	A70	C10 - C30	C20	E01	
All engines	version Marelli					730 150M							
All engines												359 432	
700													
700	Petrol	19	09/87-06/96	126 A2.000, 126 A2.048									
Engine	Information				A10	A20	A40	A50	A70	C10 - C30	C20	E01	
All engines	version Marelli				630 128								
All engines												359 351	
127													
0.9	Petrol	29	06/71-05/83	100 GL.048									
Engine	Information				A10	A20	A40	A50	A70	C10 - C30	C20	E01	
All engines	version Ducellier				615 023	715 101	815 058	915 083R					
All engines	version Marelli				630 117	730 142		930 042R					
All engines	version Femsas					717 020	817 016	917 052R					
All engines										470 101D	C10	359 429	
0.9													
0.9	Petrol	33	09/71-12/84	100 GL.000									
Engine	Information				A10	A20	A40	A50	A70	C10 - C30	C20	E01	
All engines	version Marelli					730 139		930 037R					
All engines										470 101D	C10	359 429	
1.0													
1.0	Petrol	37	01/77-12/86	127 A.000									
Engine	Information				A10	A20	A40	A50	A70	C10 - C30	C20	E01	
All engines	version Marelli				630 117	730 142	830 090	930 042R					
All engines										470 101D	C10		

A10 CONDENSER	A20 CONTACT SET	A40 DISTRIBUTOR CAP	A50 ROTOR	A70 PICK-UP
C10 COIL	C20 IGNITION MODULE	C30 ELECTRONIC IGNITION KIT	E01 IGNITION CABLE SET	

Vehicle	alim.	kW	Date	Engine	FUNCTIONS ON THE VEHICLE							
					A10	A20	A40	A50	A70	C10 - C30	C20	E01

128

				ENGINE
1.1	Petrol	40	03/69-12/84	128 A.000

Engine	Information	A10	A20	A40	A50	A70	C10 - C30	C20	E01
All engines	version Ducellier	615 023	715 056HV	815 049	915 083R				
All engines	version Marelli		730 142	830 081	930 036R				
All engines							470 101D	C10	

131

				ENGINE
1.3 Mirafiori	Petrol	40	10/74-09/81	131 A6.000

Engine	Information	A10	A20	A40	A50	A70	C10 - C30	C20	E01
All engines	version Ducellier	615 023	715 056HV	815 059	915 083R				
All engines	01/01/76 ->, version Marelli	630 117	730 142		930 042R				
All engines	version Femsas		717 020		917 052				
All engines	->year 31/12/75, version Marelli		730 139		930 037R				
All engines					930 037		470 101D	C10	

1.3 Super Mirafiori

Engine	Information	A10	A20	A40	A50	A70	C10 - C30	C20	E01
All engines					930 037				

1.4 Mirafiori

Engine	Information	A10	A20	A40	A50	A70	C10 - C30	C20	E01
All engines					930 037				

1.6

Engine	Information	A10	A20	A40	A50	A70	C10 - C30	C20	E01
All engines					930 037				

1.6 Super

Engine	Information	A10	A20	A40	A50	A70	C10 - C30	C20	E01
All engines					930 037				

2.0 Super

Engine	Information	A10	A20	A40	A50	A70	C10 - C30	C20	E01
All engines					930 037				

132

				ENGINE
1.6	Petrol	65	05/77-09/82	132 C.000

Engine	Information	A10	A20	A40	A50	A70	C10 - C30	C20	E01
All engines	version Ducellier	615 023	715 056HV	815 059	915 091				
All engines	version Marelli	630 117	730 142	830 090	930 042R				
All engines	version Femsas		717 020		917 052R				
All engines	+air conditioning, version Marelli		730 139						
All engines	+air conditioning, RHD, version Marelli				930 037R				
All engines	+air conditioning, LHD, version Marelli				930 041				
All engines							470 101D	C10	

2.0









Engine	Information	A10	A20	A40	A50	A70	C10 - C30	C20	E01
All engines	version Bosch			806 079	906 025R				
All engines	+air conditioning, LHD, version Marelli			830 093					
All engines	version Marelli				930 054R	430 161/1			

242

				ENGINE
1.6	Petrol	46	10/75-07/82	124 B3.000

Engine	Information	A10	A20	A40	A50	A70	C10 - C30	C20	E01
All engines	version Ducellier	615 023	715 055	815 045					
All engines	version Marelli		730 139						
All engines							470 101D	C10	

A10	CONDENSER	A20	CONTACT SET	A40	DISTRIBUTOR CAP	A50	ROTOR	A70	PICK-UP
C10	COIL	C20	IGNITION MODULE	C30	ELECTRONIC IGNITION KIT	E01	IGNITION CABLE SET		

					FUNCTIONS ON THE VEHICLE							
Vehicle	alim.	kW	Date	Engine	 A10	 A20	 A40	 A50	 A70	 C10 - C30	 C20	 E01
500												
0.5	Petrol	11	01/60-12/66	ENGINE 120.000								
Engine	Information				A10	A20	A40	A50	A70	C10 - C30	C20	E01
All engines	version Marelli					730 120	830 059	930 029				
All engines										470 101D	C10	
0.5												
0.5	Petrol	13	01/65-12/75	ENGINE 110 F.000, 120.000								
Engine	Information				A10	A20	A40	A50	A70	C10 - C30	C20	E01
All engines	version Marelli					730 120	830 059	930 029				
All engines										470 101D	C10	
0.6												
0.6	Petrol	13	08/68-01/76	ENGINE 111A000								
Engine	Information				A10	A20	A40	A50	A70	C10 - C30	C20	E01
All engines	version Marelli					730 120	830 086	930 029				
All engines										470 101D	C10	
0.9												
0.9	Petrol	44	12/13->	ENGINE 312 A4.000, 312 A6.000								
Engine	Information				A10	A20	A40	A50	A70	C10 - C30	C20	E01
Eng. 312 A4.000	naturally Asp. Eng., Qty: 2									470 442	C10	
Eng. 312 A6.000	x 2, COIL ON PLUG, incl. spark plug connector									470 442	C10	
0.9												
0.9	Petrol	48	09/12->	ENGINE 312 A4.000								
Engine	Information				A10	A20	A40	A50	A70	C10 - C30	C20	E01
All engines	x 2, COIL ON PLUG, incl. spark plug connector									470 442	C10	
1.2												
1.2	Petrol	51	07/07->	ENGINE 169 A4.000								
Engine	Information				A10	A20	A40	A50	A70	C10 - C30	C20	E01
All engines	x 1, D.I.S.									470 423	C10	
All engines												358 170
1.2 LPG	Petrol/ Liquified Petroleum Gas (LPG)	51	12/10->	ENGINE 169 A4.000								
Engine	Information				A10	A20	A40	A50	A70	C10 - C30	C20	E01
All engines	x 1, D.I.S.									470 423	C10	
1.4												
1.4	Petrol	74	10/07->	ENGINE 169 A3.000								
Engine	Information				A10	A20	A40	A50	A70	C10 - C30	C20	E01
All engines	x 4, COIL ON PLUG, incl. spark plug connector									470 442	C10	
1.4												
1.4	Petrol	75	09/08->	ENGINE 169 A3.000								
Engine	Information				A10	A20	A40	A50	A70	C10 - C30	C20	E01
All engines	x 4, COIL ON PLUG, incl. spark plug connector									470 442	C10	
500 C												
0.9	Petrol	44	12/13->	ENGINE 312 A6.000								
Engine	Information				A10	A20	A40	A50	A70	C10 - C30	C20	E01
All engines	x 2, COIL ON PLUG, incl. spark plug connector									470 442	C10	
0.9												
0.9	Petrol	48	09/12->	ENGINE 312 A4.000								
Engine	Information				A10	A20	A40	A50	A70	C10 - C30	C20	E01
All engines	x 2, COIL ON PLUG, incl. spark plug connector									470 442	C10	
1.2												
1.2	Petrol	51	09/09->	ENGINE 169 A4.000								
Engine	Information				A10	A20	A40	A50	A70	C10 - C30	C20	E01
All engines	x 1, D.I.S.									470 423	C10	
All engines												358 170

A10 CONDENSER	A20 CONTACT SET	A40 DISTRIBUTOR CAP	A50 ROTOR	A70 PICK-UP
C10 COIL	C20 IGNITION MODULE	C30 ELECTRONIC IGNITION KIT	E01 IGNITION CABLE SET	

Vehicle	alim.	kW	Date	Engine	FUNCTIONS ON THE VEHICLE									
					A10	A20	A40	A50	A70	C10 - C30	C20	E01		
ENGINE														
1.4	Petrol	74	09/09->	169 A3.000										
ENGINE														
All engines											470 442	C10		
ENGINE														
1.4	Petrol	75	09/11->	169 A3.000, EAB										
ENGINE														
Eng. 169 A3.000											470 442	C10		
Eng. EAB											470 442	C10		
500 MY12														
ENGINE														
0.9	Petrol	48	01/12->	--										
ENGINE														
All engines											470 442	C10		
ENGINE														
0.9	Petrol	62	01/12->	--										
ENGINE														
All engines											470 442	C10		
ENGINE														
0.9	Petrol	77	01/12->	--										
ENGINE														
All engines											470 442	C10		
ENGINE														
1.2	Petrol	51	01/12->	--										
ENGINE														
All engines											470 423	C10		358 170
ENGINE														
1.4	Petrol	74	01/12->	--										
ENGINE														
All engines											470 442	C10		
500 MY15														
ENGINE														
0.9	Petrol	48	01/15->	--										
ENGINE														
All engines											470 442	C10		
ENGINE														
0.9	Petrol	62	01/15->	--										
ENGINE														
All engines											470 442	C10		
ENGINE														
0.9	Petrol	77	01/15->	--										
ENGINE														
All engines											470 442	C10		
ENGINE														
1.2	Petrol	0	01/15->	--										
ENGINE														
All engines											470 423	C10		358 170
ENGINE														
1.2 LPG	Petrol	0	01/15->	--										
ENGINE														
All engines											470 423	C10		358 170
ENGINE														
1.4	Petrol	0	01/15->	--										
ENGINE														
All engines											470 442	C10		
500L														
ENGINE														
1.4	Petrol	70	09/12->	843 A1.000										
ENGINE														
All engines											470 442	C10		

A10 CONDENSER	A20 CONTACT SET	A40 DISTRIBUTOR CAP	A50 ROTOR	A70 PICK-UP
C10 COIL	C20 IGNITION MODULE	C30 ELECTRONIC IGNITION KIT	E01 IGNITION CABLE SET	

The present application list is a brief version. For the detailed information about the possibility of installation on a specific vehicle, please refer to our web-catalogue <http://catalogo.facet.eu/>

Vehicle	alim.	kW	Date	Engine	FUNCTIONS ON THE VEHICLE							
					A10	A20	A40	A50	A70	C10 - C30	C20	E01

500X

ENGINE				
1.4	Petrol	100	09/14->	552 63 624

Engine	Information	A10	A20	A40	A50	A70	C10 - C30	C20	E01
All engines	x 4, COIL ON PLUG						470 549	C10	

ENGINE				
1.4	Petrol	103	09/14->	552 63 624

Engine	Information	A10	A20	A40	A50	A70	C10 - C30	C20	E01
All engines	x 4, COIL ON PLUG						470 549	C10	

ENGINE				
1.4 4x4	Petrol	120	02/15->	552 63 623

Engine	Information	A10	A20	A40	A50	A70	C10 - C30	C20	E01
All engines	x 4, version 1, COIL ON PLUG						470 549	C10	

ENGINE				
1.4 LPG	Petrol/ Liquified Petro- leum Gas (LPG)	88	03/17->	552 77 701

Engine	Information	A10	A20	A40	A50	A70	C10 - C30	C20	E01
All engines	01/07/17->, x 4, COIL ON PLUG						470 549	C10	

600

ENGINE				
0.6	Petrol	15	03/55-05/61	--

Engine	Information	A10	A20	A40	A50	A70	C10 - C30	C20	E01
All engines	version Marelli		730 120		930 029				
All engines							470 101D	C10	

850

ENGINE				
0.8	Petrol	25	07/64-10/72	100 G.000

Engine	Information	A10	A20	A40	A50	A70	C10 - C30	C20	E01
All engines	version Ducellier		715 056	815 049	915 083R				
All engines	version Marelli		730 132	830 069	930 037R				
All engines					930 037		470 101D	C10	

ENGINE				
0.8	Petrol	27	07/64-10/72	100 G.002

Engine	Information	A10	A20	A40	A50	A70	C10 - C30	C20	E01
All engines					930 037				

ENGINE				
0.8 Special	Petrol	35	03/68-10/72	100 GB.000

Engine	Information	A10	A20	A40	A50	A70	C10 - C30	C20	E01
All engines					930 037				

ENGINE				
0.9 Sport	Petrol	38	02/68-12/72	--, 100 GL.040

Engine	Information	A10	A20	A40	A50	A70	C10 - C30	C20	E01
All engines					930 037				

ARGENTA

ENGINE				
1600	Petrol	72	04/81-12/85	132 D.000

Engine	Information	A10	A20	A40	A50	A70	C10 - C30	C20	E01
All engines	->year 01/05/82, version Marelli	630 117	730 142	830 090	930 042R				
All engines	01/05/82->, version Marelli		730 139		930 041				
All engines							470 101D	C10	

ENGINE				
1600 i.e	Petrol	66	04/81-12/85	132 D.000

Engine	Information	A10	A20	A40	A50	A70	C10 - C30	C20	E01
All engines	->year 01/05/82, version Marelli	630 117	730 142	830 090	930 042R				
All engines	01/05/82->, version Marelli		730 139		930 041				
All engines							470 101D	C10	

ENGINE				
2000	Petrol	83	06/78-12/85	132 D1.000









Engine	Information	A10	A20	A40	A50	A70	C10 - C30	C20	E01
All engines	version Bosch			806 079	906 025R				

A10 CONDENSER	A20 CONTACT SET	A40 DISTRIBUTOR CAP	A50 ROTOR	A70 PICK-UP
C10 COIL	C20 IGNITION MODULE	C30 ELECTRONIC IGNITION KIT	E01 IGNITION CABLE SET	

Vehicle	alim.	kW	Date	Engine	FUNCTIONS ON THE VEHICLE									
					A10	A20	A40	A50	A70	C10 - C30	C20	E01		
2000					ENGINE									
	Petrol	83	06/78-12/85	132 D1.000										
Engine	Information				A10	A20	A40	A50	A70	C10 - C30	C20	E01		
All engines	version Marelli						830 082	930 054R						
All engines	+automatic transmission, version Marelli						830 093	930 037R						
2000 i.e.					ENGINE									
	Petrol	90	06/81-07/86	132 C3.000										
Engine	Information				A10	A20	A40	A50	A70	C10 - C30	C20	E01		
All engines	version Marelli						830 093	930 054R						
All engines										470 103	C10			
BARCETTA					ENGINE									
1.8 16V	Petrol	96	04/95-05/05	183 A1.000, 188 A6.000										
Engine	Information				A10	A20	A40	A50	A70	C10 - C30	C20	E01		
All engines	01/06/98 ->, x 4, COIL ON PLUG, x 4, COIL ON PLUG, incl. spark plug connector, incl. spark plug connector									470 384	C10			
BRAVA					ENGINE									
1.2 16V	Petrol	64	12/98-12/02	182 B2.000										
Engine	Information				A10	A20	A40	A50	A70	C10 - C30	C20	E01		
All engines										470 168	C10		360 505	
1.2 16V 80					ENGINE									
	Petrol	59	10/00-10/01	188 A5.000										
Engine	Information				A10	A20	A40	A50	A70	C10 - C30	C20	E01		
All engines	x 1, D.I.S., connector type, saw teeth									470 168	C10			
All engines													360 505	
1.2 16V 80					ENGINE									
	Petrol	60	12/98-12/02	182 B2.000										
Engine	Information				A10	A20	A40	A50	A70	C10 - C30	C20	E01		
All engines	x 1, D.I.S., connector type, saw teeth									470 168	C10			
All engines													360 505	
1.4					ENGINE									
	Petrol	55	10/95-10/01	182 A5.000										
Engine	Information				A10	A20	A40	A50	A70	C10 - C30	C20	E01		
All engines	x 1, D.I.S., connector type, saw teeth									470 168	C10			
All engines													360 363	
1.4 12 V					ENGINE									
	Petrol	59	10/95-08/98	182 A3.000										
Engine	Information				A10	A20	A40	A50	A70	C10 - C30	C20	E01		
All engines	x 1, D.I.S., connector type, saw teeth									470 168	C10			
All engines													360 363	
1.6 16V					ENGINE									
	Petrol	66	10/95-10/01	182 A6.000										
Engine	Information				A10	A20	A40	A50	A70	C10 - C30	C20	E01		
All engines	x 1, D.I.S., connector type, saw teeth									470 345	C10			
All engines													360 503	
1.6 16V					ENGINE									
	Petrol	76	10/95-12/02	182 A4.000, 182 A4.027, 182 B6.000										
Engine	Information				A10	A20	A40	A50	A70	C10 - C30	C20	E01		
Eng. 182 A4.000, 182 B6.000	x 1, D.I.S., connector type, saw teeth									470 345	C10			
Eng. 182 A4.027										470 345	C10			
All engines													360 503	
BRAVO I					ENGINE									
1.2 16V 80	Petrol	59	10/00-10/01	188 A5.000										
Engine	Information				A10	A20	A40	A50	A70	C10 - C30	C20	E01		
All engines	x 1, D.I.S., connector type, saw teeth									470 168	C10			
All engines													360 505	
1.2 16V 80					ENGINE									
	Petrol	60	12/98-10/00	182 B2.000										
Engine	Information				A10	A20	A40	A50	A70	C10 - C30	C20	E01		
All engines	x 1, D.I.S., connector type, saw teeth									470 168	C10			

A10 CONDENSER	A20 CONTACT SET	A40 DISTRIBUTOR CAP	A50 ROTOR	A70 PICK-UP
C10 COIL	C20 IGNITION MODULE	C30 ELECTRONIC IGNITION KIT	E01 IGNITION CABLE SET	

The present application list is a brief version. For the detailed information about the possibility of installation on a specific vehicle, please refer to our web-catalogue <http://catalogo.facet.eu/>

				FUNCTIONS ON THE VEHICLE													
Vehicle	alim.	kW	Date	Engine													
				ENGINE													
1.2 16V 80	Petrol	60	12/98-10/00	182 B2.000													
Engine	Information				A10	A20	A40	A50	A70	C10 - C30	C20	E01					
All engines												360 505					
				ENGINE													
1.2 16V 80	Petrol	64	12/98-10/01	182 B2.000													
Engine	Information				A10	A20	A40	A50	A70	C10 - C30	C20	E01					
All engines										470 168	C10	360 505					
				ENGINE													
1.4	Petrol	55	10/95-10/01	182 A5.000													
Engine	Information				A10	A20	A40	A50	A70	C10 - C30	C20	E01					
All engines	x 1, D.I.S., connector type, saw teeth									470 168	C10						
All engines												360 363					
				ENGINE													
1.4	Petrol	59	10/95-10/01	182 A3.000													
Engine	Information				A10	A20	A40	A50	A70	C10 - C30	C20	E01					
All engines	x 1, D.I.S., connector type, saw teeth									470 168	C10						
All engines												360 363					
				ENGINE													
1.6	Petrol	76	09/00-10/01	182 B6.000													
Engine	Information				A10	A20	A40	A50	A70	C10 - C30	C20	E01					
All engines	x 1, D.I.S., connector type, saw teeth									470 345	C10						
All engines												360 503					
				ENGINE													
1.6 16V	Petrol	66	10/95-10/01	182 A6.000													
Engine	Information				A10	A20	A40	A50	A70	C10 - C30	C20	E01					
All engines	x 1, D.I.S., connector type, saw teeth									470 345	C10						
All engines												360 503					
				ENGINE													
1.6 16V	Petrol	76	03/96-10/01	178 A8.011, 182 A4.000													
Engine	Information				A10	A20	A40	A50	A70	C10 - C30	C20	E01					
Eng. 178 A8.011										470 345	C10						
Eng. 182 A4.000	x 1, D.I.S., connector type, saw teeth									470 345	C10						
All engines												360 503					
				ENGINE													
1.8 GT	Petrol	83	10/95-10/01	182 A2.000													
Engine	Information				A10	A20	A40	A50	A70	C10 - C30	C20	E01					
All engines	01/08/99 ->, ch. 4873622 ->, x 4, COIL ON PLUG, incl. spark plug connector									470 384	C10						
				ENGINE													
2.0 HGT 20V	Petrol	108	10/95-07/98	182 A1.000													
Engine	Information				A10	A20	A40	A50	A70	C10 - C30	C20	E01					
All engines	x 5, COIL ON PLUG, incl. spark plug connector									470 314	C10						
				BRAVO II													
				ENGINE													
1.4	Petrol	66	04/07-12/14	192 B2.000													
Engine	Information				A10	A20	A40	A50	A70	C10 - C30	C20	E01					
All engines	x 4, COIL ON PLUG, incl. spark plug connector									470 442	C10						
				ENGINE													
1.4 16V	Petrol	103	01/10->	--, 198 A7.000													
Engine	Information				A10	A20	A40	A50	A70	C10 - C30	C20	E01					
Eng. --	Qty: 4									470 549	C10						
Eng. 198 A7.000	x 4, COIL ON PLUG									470 549	C10						
				ENGINE													
1.4 16V	Petrol	70	04/07->	--													
Engine	Information				A10	A20	A40	A50	A70	C10 - C30	C20	E01					
All engines	naturally Asp. Eng., Qty: 4									470 442	C10						
All engines	turbo/Interc., Qty: 4									470 549	C10						
				ENGINE													
1.4 LPG	Petrol	66	01/10->	--													
Engine	Information				A10	A20	A40	A50	A70	C10 - C30	C20	E01					
All engines	Qty: 4									470 442	C10						
				FUNCTIONS ON THE VEHICLE													
A10	CONDENSER	A20	CONTACT SET	A40	DISTRIBUTOR CAP	A50	ROTOR	A70	PICK-UP	C10	COIL	C20	IGNITION MODULE	C30	ELECTRONIC IGNITION KIT	E01	IGNITION CABLE SET

Vehicle	alim.	kW	Date	Engine	FUNCTIONS ON THE VEHICLE									
					A10	A20	A40	A50	A70	C10 - C30	C20	E01		
ENGINE														
1.4 LPG	Petrol	66	01/10->	--										
Engine	Information				A10	A20	A40	A50	A70	C10 - C30	C20	E01		
All engines	x 4, COIL ON PLUG, incl. spark plug connector									470 442	C10			
ENGINE														
1.4 T-Jet	Petrol	110	09/07-12/14	198 A1.000										
Engine	Information				A10	A20	A40	A50	A70	C10 - C30	C20	E01		
All engines	naturally Asp. Eng., Qty: 4									470 442	C10			
ENGINE														
1.4 T-Jet	Petrol	88	10/07-12/14	198 A4.000										
Engine	Information				A10	A20	A40	A50	A70	C10 - C30	C20	E01		
All engines	naturally Asp. Eng., Qty: 4									470 442	C10			
All engines	x 4, COIL ON PLUG, incl. spark plug connector									470 442	C10			
CINQUECENTO														
ENGINE														
0.7	Petrol	23	12/91-01/96	170 A.000										
Engine	Information				A10	A20	A40	A50	A70	C10 - C30	C20	E01		
All engines										470 146	C10			
ENGINE														
0.7 i	Petrol	22	07/94-01/98	170 A.046										
Engine	Information				A10	A20	A40	A50	A70	C10 - C30	C20	E01		
All engines										470 146	C10			
ENGINE														
0.9	Petrol	30	07/91-12/93	170 A1.000										
Engine	Information				A10	A20	A40	A50	A70	C10 - C30	C20	E01		
All engines	Qty: 2									470 146	C10			
All engines												359 615		
ENGINE														
0.9 i.e.	Petrol	30	07/91-09/94	170 A1.046										
Engine	Information				A10	A20	A40	A50	A70	C10 - C30	C20	E01		
All engines	Qty: 2									470 146	C10			
All engines												359 615		
ENGINE														
0.9 i.e. S	Petrol	29	07/91-07/99	1170 A1.000, 1170 A1.046										
Engine	Information				A10	A20	A40	A50	A70	C10 - C30	C20	E01		
All engines	Qty: 2									470 146	C10			
All engines												359 615		
ENGINE														
1.1 Sporting	Petrol	40	10/94-01/98	176 B2.000										
Engine	Information				A10	A20	A40	A50	A70	C10 - C30	C20	E01		
All engines	Qty: 2									470 146	C10			
All engines												359 616		
COUPE														
ENGINE														
1.8 16V	Petrol	96	03/96-08/00	183 A1.000										
Engine	Information				A10	A20	A40	A50	A70	C10 - C30	C20	E01		
All engines	01/05/98 ->, Qty: 4									470 384	C10			
ENGINE														
2.0 16V	Petrol	102	11/93-08/96	836 A3.000										
Engine	Information				A10	A20	A40	A50	A70	C10 - C30	C20	E01		
All engines	version Marelli						830 114	930 060	430 177/1					
All engines										490 303	C30	359 650		
ENGINE														
2.0 16V [BRA]	Petrol	102	11/93-08/96	836 A3.011										
Engine	Information				A10	A20	A40	A50	A70	C10 - C30	C20	E01		
All engines	version Marelli						830 114	930 060	430 177/1					
All engines										490 303	C30	359 650		
ENGINE														
2.0 16V Turbo	Petrol	140	11/93-08/96	175 A1.000										
Engine	Information				A10	A20	A40	A50	A70	C10 - C30	C20	E01		
All engines	Qty: 2									470 146	C10			
A10	CONDENSER		A20	CONTACT SET		A40	DISTRIBUTOR CAP		A50	ROTOR		A70	PICK-UP	
C10	COIL		C20	IGNITION MODULE		C30	ELECTRONIC IGNITION KIT		E01	IGNITION CABLE SET				

					FUNCTIONS ON THE VEHICLE							
Vehicle	alim.	kW	Date	Engine	 A10	 A20	 A40	 A50	 A70	 C10 - C30	 C20	 E01
ENGINE												
2.0 16V Turbo	Petrol	140	11/93-08/96	175 A1.000								
Engine	Information			A10	A20	A40	A50	A70	C10 - C30	C20	E01	
All engines												359 456
ENGINE												
2.0 20V	Petrol	108	08/96-09/98	182 A1.000								
Engine	Information			A10	A20	A40	A50	A70	C10 - C30	C20	E01	
All engines	Qty: 5								470 314	C10		
ENGINE												
2.0 20V Turbo	Petrol	162	08/96-08/00	175 A3.000								
Engine	Information			A10	A20	A40	A50	A70	C10 - C30	C20	E01	
All engines	Qty: 5								470 314	C10		
CROMA I												
ENGINE												
1600	Petrol	61	12/85-12/90	154 A.048								
Engine	Information			A10	A20	A40	A50	A70	C10 - C30	C20	E01	
All engines	eng. type 1125932 ->, version Marelli					830 098						
All engines	->eng. 1125932, version Marelli					830 104						
All engines	version Marelli						930 055R					
All engines									470 103	C10		
ENGINE												
2000 16V	Petrol	101	08/92-08/96	154 E1.000								
Engine	Information			A10	A20	A40	A50	A70	C10 - C30	C20	E01	
All engines									470 168	C10		359 700
ENGINE												
2000 CHT	Petrol	66	12/85-02/89	154 A1.000								
Engine	Information			A10	A20	A40	A50	A70	C10 - C30	C20	E01	
All engines	version Marelli					830 098						
All engines	->ch. 0145533, version Marelli						930 047R					
All engines	->eng. 1129540, ch. 0145534 ->, version Marelli						930 055R					
All engines	eng. type 1129540 ->, version Marelli						930 059					
All engines	01/01/89 ->								470 102	C10		
All engines	->year 01/01/89								470 103	C10		
ENGINE												
2000 CHT	Petrol	74	01/91-09/92	154 A1.000, 154 C5.000								
Engine	Information			A10	A20	A40	A50	A70	C10 - C30	C20	E01	
All engines	version Marelli					830 098						
All engines	->ch. 0145533, version Marelli						930 047R					
All engines	->eng. 1129540, ch. 0145534 ->, version Marelli						930 055R					
All engines	eng. type 1129540 ->, version Marelli						930 059					
All engines									470 148	C10		359 398
ENGINE												
2000 i.e.	Petrol	83	03/86-09/90	834 B.048								
Engine	Information			A10	A20	A40	A50	A70	C10 - C30	C20	E01	
All engines	version Marelli					830 098						
All engines	->eng. 957159, version Marelli						930 057R					
All engines	eng. type 957159 ->, version Marelli						930 060					
All engines								430 177/1				359 398
ENGINE												
2000 i.e.	Petrol	85	10/87-08/96	154 C3.046, 834 B.146								
Engine	Information			A10	A20	A40	A50	A70	C10 - C30	C20	E01	
All engines	version Marelli					830 115						
All engines	FOR: (CSI), Country Version:Algeria, version Marelli						930 059					
All engines									470 148	C10		359 398
ENGINE												
2000 i.e.	Petrol	86	05/91-12/96	154 C3.000								
Engine	Information			A10	A20	A40	A50	A70	C10 - C30	C20	E01	
All engines	version Marelli					830 115						
All engines	FOR: (CSI), Country Version:Algeria, version Marelli						930 059					
All engines									470 148	C10		359 398

A10 CONDENSER	A20 CONTACT SET	A40 DISTRIBUTOR CAP	A50 ROTOR	A70 PICK-UP
C10 COIL	C20 IGNITION MODULE	C30 ELECTRONIC IGNITION KIT	E01 IGNITION CABLE SET	

Vehicle	alim.	kW	Date	Engine	FUNCTIONS ON THE VEHICLE							
					A10	A20	A40	A50	A70	C10 - C30	C20	E01
ENGINE												
2000 i.e.	Petrol	88	03/87-09/92	154 C3.000, 834 B.000								
Engine	Information			A10	A20	A40	A50	A70	C10 - C30	C20	E01	
All engines	version Marelli					830 115						
All engines	->eng. 957159, version Marelli						930 057R					
All engines	eng. type 957159 ->, version Marelli						930 060					
All engines								430 177/1	490 303	C30		
ENGINE												
2000 i.e. 16V	Petrol	101	03/95-12/96	154 E1.027								
Engine	Information			A10	A20	A40	A50	A70	C10 - C30	C20	E01	
All engines									470 168	C10	359 700	
ENGINE												
2000 i.e. Turbo	Petrol	110	06/87-08/96	154 C4.046, 834 C.146								
Engine	Information			A10	A20	A40	A50	A70	C10 - C30	C20	E01	
All engines	version Marelli					830 115	930 059					
All engines									490 303	C30	359 398	
ENGINE												
2000 i.e. Turbo	Petrol	111	11/86-11/88	834 C.146								
Engine	Information			A10	A20	A40	A50	A70	C10 - C30	C20	E01	
All engines	version Marelli					830 115	930 059					
All engines									490 303	C30	359 398	
ENGINE												
2000 i.e. Turbo	Petrol	114	12/85-06/90	154 A2.000								
Engine	Information			A10	A20	A40	A50	A70	C10 - C30	C20	E01	
All engines	version Marelli					830 098						
All engines	->eng. 1129191, version Marelli						930 055R					
All engines	eng. type 1129191 ->, version Marelli						930 059					
All engines											359 398	
ENGINE												
2000 i.e. Turbo	Petrol	116	03/91-10/94	154 C4.000								
Engine	Information			A10	A20	A40	A50	A70	C10 - C30	C20	E01	
All engines	version Marelli					830 115	930 059					
All engines									490 303	C30	359 398	
CROMA II												
ENGINE												
1.8 16V	Petrol	103	12/05->	939 A4.000								
Engine	Information			A10	A20	A40	A50	A70	C10 - C30	C20	E01	
All engines	x 4, COIL ON PLUG								470 450	C10		
DOBLO I												
ENGINE												
1.2	Petrol	48	03/01->	223 A5.000								
Engine	Information			A10	A20	A40	A50	A70	C10 - C30	C20	E01	
All engines	x 1, D.I.S., connector type DIN								470 146	C10		
All engines											360 451	
ENGINE												
1.4	Petrol	57	10/05->	350 A1.000								
Engine	Information			A10	A20	A40	A50	A70	C10 - C30	C20	E01	
All engines	x 1, D.I.S.								470 423	C10		
All engines											358 170	
ENGINE												
1.6 Natural Power	Petrol/ Com- pressed Natural Gas (CNG)	68	02/04-07/09	182B6000CNG								
Engine	Information			A10	A20	A40	A50	A70	C10 - C30	C20	E01	
All engines	x 1, D.I.S., connector type, saw teeth								470 345	C10		

A10 CONDENSER	A20 CONTACT SET	A40 DISTRIBUTOR CAP	A50 ROTOR	A70 PICK-UP
C10 COIL	C20 IGNITION MODULE	C30 ELECTRONIC IGNITION KIT	E01 IGNITION CABLE SET	

The present application list is a brief version. For the detailed information about the possibility of installation on a specific vehicle, please refer to our web-catalogue <http://catalogo.facet.eu/>

FUNCTIONS ON THE VEHICLE

Vehicle	alim.	kW	Date	Engine	 A10	 A20	 A40	 A50	 A70	 C10 - C30	 C20	 E01
---------	-------	----	------	--------	---	---	---	--	---	---	---	---

ENGINE				
1.6 Natural Power	Petrol/ Compressed Natural Gas (CNG)	76	09/02->	182 B6.000, 182B6000CNG

Engine	Information	A10	A20	A40	A50	A70	C10 - C30	C20	E01
Eng. 182 B6.000							470 345	C10	360 503
Eng. 182B6000CNG	x 1, D.I.S., connector type, saw teeth						470 345	C10	

DOBLO II				
1.4	Petrol	70	02/10->	843 A1.000

Engine	Information	A10	A20	A40	A50	A70	C10 - C30	C20	E01
All engines	x 4, COIL ON PLUG, incl. spark plug connector						470 442	C10	

ENGINE				
1.4 Natural Power	Petrol/ Compressed Natural Gas (CNG)	88	06/10->	198A4000CNG

Engine	Information	A10	A20	A40	A50	A70	C10 - C30	C20	E01
All engines	x 4, COIL ON PLUG, incl. spark plug connector						470 442	C10	

DUCATO I				
1.8	Petrol	49	01/82-10/88	169 B

Engine	Information	A10	A20	A40	A50	A70	C10 - C30	C20	E01
All engines	version Ducellier	615 034	715 105	815 054	915 091				
All engines	version Marelli		730 139						
All engines	version Bosch			806 079	906 025R				
All engines	no specific info conc. application available						470 101D	C10	
All engines								465 005	

ENGINE				
1.8	Petrol	51	07/82-12/88	XM7T

Engine	Information	A10	A20	A40	A50	A70	C10 - C30	C20	E01
All engines	version Ducellier	615 034	715 105	815 054	915 091				
All engines	version Marelli		730 139						
All engines	version Bosch			806 079	906 025R				
All engines	no specific info conc. application available						470 101D	C10	
All engines								465 005	

ENGINE				
2.0	Petrol	55	07/85-02/94	170 B, XN 1T

Engine	Information	A10	A20	A40	A50	A70	C10 - C30	C20	E01
All engines	version Ducellier			815 054	915 094				
All engines								465 005	

ENGINE				
2.0	Petrol	58	01/82-08/90	XN 1T

Engine	Information	A10	A20	A40	A50	A70	C10 - C30	C20	E01
All engines	version Ducellier			815 054	915 094				
All engines								465 005	

ENGINE				
2.0	Petrol	62	07/90-03/94	170 D

Engine	Information	A10	A20	A40	A50	A70	C10 - C30	C20	E01
All engines	version Ducellier			815 058	915 096R				
All engines								465 005	

ENGINE				
2.0	Petrol	63	06/90-05/94	170 D, 170C (XN1T)

Engine	Information	A10	A20	A40	A50	A70	C10 - C30	C20	E01
All engines	version Ducellier			815 054	915 094				
All engines								465 005	

ENGINE				
2.0 4x4	Petrol	63	06/90-05/94	170 D

Engine	Information	A10	A20	A40	A50	A70	C10 - C30	C20	E01
All engines	version Ducellier			815 054	915 094				
All engines								465 005	

A10 CONDENSER	A20 CONTACT SET	A40 DISTRIBUTOR CAP	A50 ROTOR	A70 PICK-UP
C10 COIL	C20 IGNITION MODULE	C30 ELECTRONIC IGNITION KIT	E01 IGNITION CABLE SET	

Vehicle	alim.	kW	Date	Engine	FUNCTIONS ON THE VEHICLE							
					A10	A20	A40	A50	A70	C10 - C30	C20	E01

DUCATO II

2.0	Petrol	74	06/94-12/95	ENGINE
-----	--------	----	-------------	--------

Engine	Information	A10	A20	A40	A50	A70	C10 - C30	C20	E01
All engines	Kit, version Ducellier			815 087					
All engines	version Ducellier					415 019			

2.0	Petrol	80	03/94-04/02	ENGINE
-----	--------	----	-------------	--------

Engine	Information	A10	A20	A40	A50	A70	C10 - C30	C20	E01
All engines							470 188	C10	359 674

2.0	Petrol	81	04/02->	ENGINE
-----	--------	----	---------	--------

Engine	Information	A10	A20	A40	A50	A70	C10 - C30	C20	E01
Eng. RFL	Ducato 11, Ducato 15, x 1, PEUGEOT, D.I.S., connector type, saw teeth						470 188	C10	
Eng. RFL (XU10J2U)									359 674

2.0 4x4	Petrol	80	11/94-04/02	ENGINE
---------	--------	----	-------------	--------

Engine	Information	A10	A20	A40	A50	A70	C10 - C30	C20	E01
All engines							470 188	C10	359 674

2.0 4x4	Petrol	81	05/02-07/06	ENGINE
---------	--------	----	-------------	--------

Engine	Information	A10	A20	A40	A50	A70	C10 - C30	C20	E01
Eng. RFL	Ducato 11, Ducato 15, x 1, PEUGEOT, D.I.S., connector type, saw teeth						470 188	C10	
Eng. RFL (XU10J2U)									359 674

2.0 Bipower	Petrol/ Com- pressed Natural Gas (CNG)	81	11/02->	ENGINE
-------------	---	----	---------	--------

Engine	Information	A10	A20	A40	A50	A70	C10 - C30	C20	E01
Eng. RFL	Ducato 15, x 1, PEUGEOT, D.I.S., connector type, saw teeth						470 188	C10	
Eng. RFL (XU10J2U)									359 674

2.0 LPG	Petrol/ Liquified Petro- leum Gas (LPG)	71	11/02-07/06	ENGINE
---------	---	----	-------------	--------

Engine	Information	A10	A20	A40	A50	A70	C10 - C30	C20	E01
All engines	Ducato 15, x 1, PEUGEOT, D.I.S., connector type, saw teeth						470 188	C10	

2.0 Panorama/Com- binato	Petrol	80	03/94-04/02	ENGINE
-----------------------------	--------	----	-------------	--------

Engine	Information	A10	A20	A40	A50	A70	C10 - C30	C20	E01
All engines							470 188	C10	359 674

DUCATO III

140 Natural Power	CNG	100	04/09->	ENGINE
-------------------	-----	-----	---------	--------

Engine	Information	A10	A20	A40	A50	A70	C10 - C30	C20	E01
All engines	Ducato 35, x 4, COIL ON PLUG						470 442	C10	

DUNA

60 1.1	Petrol	43	01/87-12/91	ENGINE
--------	--------	----	-------------	--------

Engine	Information	A10	A20	A40	A50	A70	C10 - C30	C20	E01
All engines	version Marelli			830 101	930 047R	430 176M			
All engines							470 158	C10	465 020

70 1.3	Petrol	49	01/87-12/91	ENGINE
--------	--------	----	-------------	--------

Engine	Information	A10	A20	A40	A50	A70	C10 - C30	C20	E01
All engines	version Marelli			830 101	930 047R	430 176M			
All engines							470 158	C10	465 020

A10 CONDENSER	A20 CONTACT SET	A40 DISTRIBUTOR CAP	A50 ROTOR	A70 PICK-UP
C10 COIL	C20 IGNITION MODULE	C30 ELECTRONIC IGNITION KIT	E01 IGNITION CABLE SET	

					FUNCTIONS ON THE VEHICLE							
Vehicle	alim.	kW	Date	Engine								

ELBA

				ENGINE
1.3	Petrol	49	04/91-02/95	146 A5.000

Engine	Information	A10	A20	A40	A50	A70	C10 - C30	C20	E01
All engines	version Marelli			830 101		430 176M			
All engines	no specific info conc. application available, version Marelli				930 047R, 930 060				
All engines							470 158	C10	465 020

				ENGINE
1.4	Petrol	49	10/93-02/95	146 D5.000

Engine	Information	A10	A20	A40	A50	A70	C10 - C30	C20	E01
All engines							470 188	C10	359 655

				ENGINE
1.5	Petrol	49	01/92-12/96	149 C1.000

Engine	Information	A10	A20	A40	A50	A70	C10 - C30	C20	E01
All engines	->year 31/05/93, version Marelli			830 104					
All engines	01/06/93 ->, version Marelli			830 114					
All engines	version Marelli				930 059				
All engines							470 148	C10	

				ENGINE
1.5	Petrol	55	01/92-12/96	149 C1.000

Engine	Information	A10	A20	A40	A50	A70	C10 - C30	C20	E01
All engines	->year 31/05/93, version Marelli			830 104					
All engines	01/06/93 ->, version Marelli			830 114					
All engines	version Marelli				930 059				
All engines							470 148	C10	

FIORINO I

				ENGINE
1.0	Petrol	37	01/80-12/87	127 A.000

Engine	Information	A10	A20	A40	A50	A70	C10 - C30	C20	E01
All engines	version Marelli	630 117	730 142	830 090	930 042R				
All engines							470 101D	C10	

				ENGINE
1.1 60	Petrol	40	11/86-04/88	146 A9.000

Engine	Information	A10	A20	A40	A50	A70	C10 - C30	C20	E01
All engines	version Marelli			830 101		430 176M			
All engines	->eng. 3854060, version Marelli				930 047R				
All engines	eng. type 3854060 ->, version Marelli				930 060				
All engines							470 158	C10	465 020

				ENGINE
1.3	Petrol	49	12/87-08/93	146 A5.000

Engine	Information	A10	A20	A40	A50	A70	C10 - C30	C20	E01
All engines	version Marelli			830 101		430 176M			
All engines	->eng. 03854060, version Marelli				930 047R				
All engines	eng. type 03854060 ->, version Marelli				930 060				
All engines							470 158	C10	465 020

				ENGINE
1.5	Petrol	55	01/88-08/93	149 C1.000

Engine	Information	A10	A20	A40	A50	A70	C10 - C30	C20	E01
All engines	->year 01/05/93, version Marelli			830 104					
All engines	01/05/93 ->, version Marelli			830 114					
All engines	->year 01/05/90, version Marelli				930 055R				
All engines	01/05/90 ->, version Marelli				930 059				
All engines	VET. 8098787, 8150978 ->						470 102	C10	
All engines	->VET. 8098787, 8150978						470 103	C10	

				ENGINE
1050	Petrol	37	01/80-12/87	127 A.000

Engine	Information	A10	A20	A40	A50	A70	C10 - C30	C20	E01
All engines	version Marelli	630 117	730 142	830 090	930 042R				
All engines							470 101D	C10	

A10	CONDENSER	A20	CONTACT SET	A40	DISTRIBUTOR CAP	A50	ROTOR	A70	PICK-UP
C10	COIL	C20	IGNITION MODULE	C30	ELECTRONIC IGNITION KIT	E01	IGNITION CABLE SET		

Vehicle	alim.	kW	Date	Engine	FUNCTIONS ON THE VEHICLE									
					A10	A20	A40	A50	A70	C10 - C30	C20	E01		
900	Petrol	33	10/77-10/86	ENGINE 100 GL.000										
Engine	Information	A10	A20	A40	A50	A70	C10 - C30	C20	E01					
All engines	version Ducellier	615 023	715 056HV	815 045	915 083R									
All engines	version Marelli	630 117	730 142		930 042R									
All engines	01/01/82 ->, version Marelli			830 090										
All engines							470 101D	C10						
FIORINO II														
1.0 iE	Petrol	33	11/92-04/96	ENGINE 156 A2.246										
Engine	Information	A10	A20	A40	A50	A70	C10 - C30	C20	E01					
All engines	version Marelli			830 109	930 060	430 180M								
All engines							470 108	C10	465 020			359 347		
1.3	Petrol	49	01/88-12/94	ENGINE 146 A5.000										
Engine	Information	A10	A20	A40	A50	A70	C10 - C30	C20	E01					
All engines	version Marelli			830 101		430 176M								
All engines	->eng. 03854060, version Marelli				930 047R									
All engines	eng. type 03854060 ->, version Marelli				930 060									
All engines							470 158	C10	465 020					
1.4	Petrol	49	05/94-05/01	ENGINE 146 D5.000										
Engine	Information	A10	A20	A40	A50	A70	C10 - C30	C20	E01					
All engines							470 168	C10				359 655		
1.4	Petrol	52	11/92-10/96	ENGINE 146 C5.000										
Engine	Information	A10	A20	A40	A50	A70	C10 - C30	C20	E01					
All engines							470 168	C10				359 655		
1.5 iE	Petrol	55	01/88-10/92	ENGINE 149 C1.000										
Engine	Information	A10	A20	A40	A50	A70	C10 - C30	C20	E01					
All engines	->year 01/05/93, version Marelli			830 104										
All engines	01/05/93 ->, version Marelli			830 114										
All engines	->year 01/05/90, version Marelli				930 055R									
All engines	01/05/90 ->, version Marelli				930 059									
All engines	VET. 8098787, 8150978 ->						470 102	C10						
All engines	->VET. 8098787, 8150978						470 103	C10						
1.6	Petrol	55	01/94-05/01	ENGINE 146 C6.000, 146 D6.000										
Engine	Information	A10	A20	A40	A50	A70	C10 - C30	C20	E01					
Eng. 146 C6.000	version Marelli			830 115	930 059	430 177/1								
Eng. 146 C6.000							470 148	C10						
Eng. 146 D6.000							470 168	C10				359 655		
60 1.1	Petrol	40	05/88-12/93	ENGINE 146 A9.000										
Engine	Information	A10	A20	A40	A50	A70	C10 - C30	C20	E01					
All engines	version Marelli			830 101		430 176M								
All engines	->eng. 3854060, version Marelli				930 047R									
All engines	eng. type 3854060 ->, version Marelli				930 060									
All engines							470 158	C10	465 020					
70 1.3	Petrol	49	01/88-12/94	ENGINE 146 A5.000										
Engine	Information	A10	A20	A40	A50	A70	C10 - C30	C20	E01					
All engines	version Marelli			830 101		430 176M								
All engines	->eng. 03854060, version Marelli				930 047R									
All engines	eng. type 03854060 ->, version Marelli				930 060									
All engines							470 158	C10	465 020					
70 i.e. 1.4	Petrol	49	05/94-05/01	ENGINE 146 C5.000, 146 D5.000										
Engine	Information	A10	A20	A40	A50	A70	C10 - C30	C20	E01					
Eng. 146 C5.000	version Marelli			830 114	930 059									
Eng. 146 C5.000							470 148	C10						

A10 CONDENSER	A20 CONTACT SET	A40 DISTRIBUTOR CAP	A50 ROTOR	A70 PICK-UP
C10 COIL	C20 IGNITION MODULE	C30 ELECTRONIC IGNITION KIT	E01 IGNITION CABLE SET	

The present application list is a brief version. For the detailed information about the possibility of installation on a specific vehicle, please refer to our web-catalogue <http://catalogo.facet.eu/>

Vehicle	alim.	kW	Date	Engine	FUNCTIONS ON THE VEHICLE							
					A10	A20	A40	A50	A70	C10 - C30	C20	E01

ENGINE				
70 i.e. 1.4	Petrol	49	05/94-05/01	146 C5.000, 146 D5.000

Engine	Information	A10	A20	A40	A50	A70	C10 - C30	C20	E01
Eng. 146 D5.000							470 168	C10	359 655

ENGINE				
75 i.e. 1.5	Petrol	55	05/88-12/93	149 C1.000

Engine	Information	A10	A20	A40	A50	A70	C10 - C30	C20	E01
All engines	->year 01/05/93, version Marelli			830 104					
All engines	01/05/93 ->, version Marelli			830 114					
All engines	->year 01/05/90, version Marelli				930 055R				
All engines	01/05/90 ->, version Marelli				930 059				
All engines	VET. 8098787, 8150978 ->						470 102	C10	
All engines	->VET. 8098787, 8150978						470 103	C10	

ENGINE				
75 i.e. 1.6	Petrol	55	10/93-05/01	146 C6.000, 146 D6.000

Engine	Information	A10	A20	A40	A50	A70	C10 - C30	C20	E01
Eng. 146 C6.000	version Marelli			830 115	930 059	430 177/1			
Eng. 146 C6.000							470 148	C10	
Eng. 146 D6.000							470 168	C10	359 655

FIORINO III

ENGINE				
1.4	Petrol	54	11/07->	KFT, KFV

Engine	Information	A10	A20	A40	A50	A70	C10 - C30	C20	E01
All engines	x 4, COIL ON PLUG						470 405	C10	
All engines	01/01/16 ->								358 170

ENGINE				
1.4	Petrol	57	10/09->	350 A1.000

Engine	Information	A10	A20	A40	A50	A70	C10 - C30	C20	E01
All engines	x 1, D.I.S.						470 423	C10	
All engines	01/01/16 ->								358 170

ENGINE				
1.4 CNG	Petrol/Compressed Natural Gas (CNG)	51	07/14->	350A1000CNG

Engine	Information	A10	A20	A40	A50	A70	C10 - C30	C20	E01
All engines	x 1, D.I.S.						470 423	C10	

ENGINE				
1.4 CNG	Petrol/Compressed Natural Gas (CNG)	57	06/08->	350A1000CNG

Engine	Information	A10	A20	A40	A50	A70	C10 - C30	C20	E01
All engines	x 1, D.I.S.						470 423	C10	

ENGINE				
1.4 Natural Power	Petrol/Compressed Natural Gas (CNG)	51	06/08->	350A1000CNG

Engine	Information	A10	A20	A40	A50	A70	C10 - C30	C20	E01
All engines	x 1, D.I.S.						470 423	C10	

ENGINE				
1.4 Natural Power	Petrol/Compressed Natural Gas (CNG)	57	06/08->	350 A1.000, 350A1000CNG

Engine	Information	A10	A20	A40	A50	A70	C10 - C30	C20	E01
Eng. 350 A1.000							470 423	C10	358 170
Eng. 350A1000CNG	x 1, D.I.S.						470 423	C10	

A10 CONDENSER	A20 CONTACT SET	A40 DISTRIBUTOR CAP	A50 ROTOR	A70 PICK-UP
C10 COIL	C20 IGNITION MODULE	C30 ELECTRONIC IGNITION KIT	E01 IGNITION CABLE SET	

Vehicle	alim.	kW	Date	Engine	FUNCTIONS ON THE VEHICLE							
					A10	A20	A40	A50	A70	C10 - C30	C20	E01

GRANDE PUNTO

				ENGINE
1.4	Petrol	57	02/06-06/13	350 A1.000

Engine	Information	A10	A20	A40	A50	A70	C10 - C30	C20	E01
All engines	x 1, D.I.S.						470 423	C10	

				ENGINE
1.4 LPG	Petrol/ Liquified Petro- leum Gas (LPG)	57	03/09-12/12	350 A1.000

Engine	Information	A10	A20	A40	A50	A70	C10 - C30	C20	E01
All engines	x 1, D.I.S.						470 423	C10	

				ENGINE
1.4 Natural Power	Petrol/ Com- pressed Natural Gas (CNG)	57	03/09-12/12	350A1000CNG

Engine	Information	A10	A20	A40	A50	A70	C10 - C30	C20	E01
All engines	x 1, D.I.S.						470 423	C10	

IDEA

				ENGINE
1.2	Petrol	59	01/08->	--

Engine	Information	A10	A20	A40	A50	A70	C10 - C30	C20	E01
All engines	Qty: 4						470 442	C10	

				ENGINE
1.2 16V	Petrol	59	01/04->	188 A5.000

Engine	Information	A10	A20	A40	A50	A70	C10 - C30	C20	E01
All engines	x 4, COIL ON PLUG, incl. spark plug connector						470 442	C10	

				ENGINE
1.4	Petrol	57	10/05->	350 A1.000

Engine	Information	A10	A20	A40	A50	A70	C10 - C30	C20	E01
All engines	x 1, D.I.S.						470 423	C10	
All engines									358 170

				ENGINE
1.4	Petrol	66	12/03->	192 B2.000

Engine	Information	A10	A20	A40	A50	A70	C10 - C30	C20	E01
All engines	x 4, COIL ON PLUG, incl. spark plug connector						470 442	C10	

				ENGINE
1.4	Petrol	70	10/04-12/12	843 A1.000

Engine	Information	A10	A20	A40	A50	A70	C10 - C30	C20	E01
All engines	x 4, COIL ON PLUG, incl. spark plug connector						470 442	C10	

				ENGINE
1.4 16V	Petrol	59	08/10->	--

Engine	Information	A10	A20	A40	A50	A70	C10 - C30	C20	E01
All engines	Qty: 4						470 442	C10	

				ENGINE
1.4 16V	Petrol	70	01/04->	843 A1.000

Engine	Information	A10	A20	A40	A50	A70	C10 - C30	C20	E01
All engines	x 4, COIL ON PLUG, incl. spark plug connector						470 442	C10	

				ENGINE
1.4 LPG	Petrol/ Liquified Petro- leum Gas (LPG)	57	03/09->	350 A1.000

Engine	Information	A10	A20	A40	A50	A70	C10 - C30	C20	E01
All engines	x 1, D.I.S.						470 423	C10	

LINEA

				ENGINE
1.4	Petrol	57	06/07->	350 A1.000

Engine	Information	A10	A20	A40	A50	A70	C10 - C30	C20	E01
All engines	x 1, D.I.S.						470 423	C10	
All engines									358 170

A10 CONDENSER	A20 CONTACT SET	A40 DISTRIBUTOR CAP	A50 ROTOR	A70 PICK-UP
C10 COIL	C20 IGNITION MODULE	C30 ELECTRONIC IGNITION KIT	E01 IGNITION CABLE SET	

The present application list is a brief version. For the detailed information about the possibility of installation on a specific vehicle, please refer to our web-catalogue <http://catalogo.facet.eu/>

Vehicle	alim.	kW	Date	Engine	FUNCTIONS ON THE VEHICLE							
					A10	A20	A40	A50	A70	C10 - C30	C20	E01

ENGINE				
1.4 16V [IND]	Petrol	70	06/07->	--

Engine	Information	A10	A20	A40	A50	A70	C10 - C30	C20	E01
All engines	Qty: 4						470 442	C10	

ENGINE				
1.4 T-Jet	Petrol	88	05/07->	198 A4.000

Engine	Information	A10	A20	A40	A50	A70	C10 - C30	C20	E01
All engines	MADE BY: (IND), x 4, COIL ON PLUG, incl. spark plug connector						470 442	C10	

MAREA

ENGINE				
1.2 16V	Petrol	60	10/98-05/02	182 B2.000

Engine	Information	A10	A20	A40	A50	A70	C10 - C30	C20	E01
All engines	x 1, D.I.S., connector type, saw teeth						470 168	C10	
All engines									360 505

ENGINE				
1.4 80 12V	Petrol	59	09/96-05/02	182 A3.000

Engine	Information	A10	A20	A40	A50	A70	C10 - C30	C20	E01
All engines	x 1, D.I.S., connector type, saw teeth						470 168	C10	
All engines									360 363

ENGINE				
1.6	Petrol	68	03/99-08/00	185 A3.000

Engine	Information	A10	A20	A40	A50	A70	C10 - C30	C20	E01
All engines	x 1, D.I.S., connector type, saw teeth						470 345	C10	
All engines									360 503

ENGINE				
1.6	Petrol	76	09/00-08/02	182 B6.000

Engine	Information	A10	A20	A40	A50	A70	C10 - C30	C20	E01
All engines	x 1, D.I.S., connector type, saw teeth						470 345	C10	
All engines									360 503

ENGINE				
1.6 100 16V	Petrol	76	09/96-05/02	182 A4.000

Engine	Information	A10	A20	A40	A50	A70	C10 - C30	C20	E01
All engines	x 1, D.I.S., connector type, saw teeth						470 345	C10	
All engines									360 503

ENGINE				
1.6 100 16V Bipower	Petrol/ Com- pressed Natural Gas (CNG)	76	04/99-05/02	182 A4.000, 185 A3.000

Engine	Information	A10	A20	A40	A50	A70	C10 - C30	C20	E01
Eng. 185 A3.000							470 345	C10	360 503
Eng. 182 A4.000	x 1, D.I.S., connector type, saw teeth						470 345	C10	

ENGINE				
1.6 16V	Petrol	75	04/97-02/99	185 A3.000

Engine	Information	A10	A20	A40	A50	A70	C10 - C30	C20	E01
All engines	x 1, D.I.S., connector type, saw teeth						470 345	C10	
All engines									360 503

ENGINE				
1.6 SX	Petrol	72	09/00-08/02	182 B5.098

Engine	Information	A10	A20	A40	A50	A70	C10 - C30	C20	E01
All engines	x 1, D.I.S., connector type, saw teeth						470 345	C10	
All engines									360 503

ENGINE				
2.0 150 20V	Petrol	108	09/96-04/99	182 A1.000

Engine	Information	A10	A20	A40	A50	A70	C10 - C30	C20	E01
All engines	x 5, COIL ON PLUG, incl. spark plug connector						470 314	C10	

ENGINE				
2.0i 20v [BRA]	Petrol	108	10/96-04/99	182 A1.011

Engine	Information	A10	A20	A40	A50	A70	C10 - C30	C20	E01
All engines	Qty: 5						470 314	C10	

A10 CONDENSER	A20 CONTACT SET	A40 DISTRIBUTOR CAP	A50 ROTOR	A70 PICK-UP
C10 COIL	C20 IGNITION MODULE	C30 ELECTRONIC IGNITION KIT	E01 IGNITION CABLE SET	

Vehicle	alim.	kW	Date	Engine	FUNCTIONS ON THE VEHICLE							
					A10	A20	A40	A50	A70	C10 - C30	C20	E01

MULTIPLA

ENGINE				
1.6	Petrol	68	05/04-08/05	182 B6.000

Engine	Information	A10	A20	A40	A50	A70	C10 - C30	C20	E01
All engines	x 1, D.I.S., connector type, saw teeth						470 345	C10	
All engines									360 503

ENGINE				
1.6	Petrol	74	03/01-08/05	182 B6.000

Engine	Information	A10	A20	A40	A50	A70	C10 - C30	C20	E01
All engines							470 345	C10	360 503

ENGINE				
1.6	Petrol	76	09/00-06/10	182 B6.000

Engine	Information	A10	A20	A40	A50	A70	C10 - C30	C20	E01
All engines	x 1, D.I.S., connector type, saw teeth						470 345	C10	
All engines									360 503

ENGINE				
1.6 100 16V	Petrol	76	04/99-06/10	182 A4.000

Engine	Information	A10	A20	A40	A50	A70	C10 - C30	C20	E01
All engines	x 1, D.I.S., connector type, saw teeth						470 345	C10	
All engines									360 503

ENGINE				
1.6 16V	Petrol	70	04/02-06/10	182 B6.000

Engine	Information	A10	A20	A40	A50	A70	C10 - C30	C20	E01
All engines	x 1, D.I.S., connector type, saw teeth						470 345	C10	
All engines									360 503

ENGINE				
1.6 16V Bipower	Petrol/ Com- pressed Natural Gas (CNG)	76	04/99-06/10	182 B6.000, 186 A4.000

Engine	Information	A10	A20	A40	A50	A70	C10 - C30	C20	E01
All engines	x 1, D.I.S., connector type, saw teeth						470 345	C10	
All engines									360 503

ENGINE				
1.6 16V Blupower	Petrol/ Com- pressed Natural Gas (CNG)	70	04/99-06/10	186 A3.000, 186A3000C- NG

Engine	Information	A10	A20	A40	A50	A70	C10 - C30	C20	E01
Eng. 186 A3.000							470 345	C10	360 503
Eng. 186A3000CNG	x 1, D.I.S., connector type, saw teeth						470 345	C10	

ENGINE				
1.6 16V GPL	Petrol/ Liquified Petro- leum Gas (LPG)	76	10/01-06/10	182 B6.000

Engine	Information	A10	A20	A40	A50	A70	C10 - C30	C20	E01
All engines	x 1, D.I.S., connector type, saw teeth						470 345	C10	
All engines									360 503

ENGINE				
1.6 Natural Power	Petrol/ Com- pressed Natural Gas (CNG)	77	11/08-06/10	182B6000CNG

Engine	Information	A10	A20	A40	A50	A70	C10 - C30	C20	E01
All engines	x 1, D.I.S., connector type, saw teeth						470 345	C10	

MULTIPLA VAN

ENGINE				
1.6	Petrol	76	09/00-06/10	182 B6.000

Engine	Information	A10	A20	A40	A50	A70	C10 - C30	C20	E01
All engines	x 1, D.I.S., connector type, saw teeth						470 345	C10	

A10 CONDENSER	A20 CONTACT SET	A40 DISTRIBUTOR CAP	A50 ROTOR	A70 PICK-UP
C10 COIL	C20 IGNITION MODULE	C30 ELECTRONIC IGNITION KIT	E01 IGNITION CABLE SET	

The present application list is a brief version. For the detailed information about the possibility of installation on a specific vehicle, please refer to our web-catalogue <http://catalogo.facet.eu/>

					FUNCTIONS ON THE VEHICLE							
Vehicle	alim.	kW	Date	Engine	 A10	 A20	 A40	 A50	 A70	 C10 - C30	 C20	 E01
Bipower					ENGINE							
	Petrol/ Ethanol	76	10/01-06/10	182 B6.000								
Engine	Information				A10	A20	A40	A50	A70	C10 - C30	C20	E01
All engines	x 1, D.I.S., connector type, saw teeth									470 345	C10	
PALIO					ENGINE							
1.0	Petrol	45	04/96-10/03	178 A1.000								
Engine	Information				A10	A20	A40	A50	A70	C10 - C30	C20	E01
All engines	x 1, D.I.S., connector type DIN									470 146	C10	
All engines												360 451
1.0					ENGINE							
	Petrol	56	04/96-10/03	178 A1.000								
Engine	Information				A10	A20	A40	A50	A70	C10 - C30	C20	E01
All engines	x 1, D.I.S., connector type DIN									470 146	C10	
All engines												360 451
1.0 GLX					ENGINE							
	Petrol	45	07/98-10/03	--								
Engine	Information				A10	A20	A40	A50	A70	C10 - C30	C20	E01
All engines	Qty: 2									470 146	C10	
All engines												360 451
1.1					ENGINE							
	Petrol	40	07/97-10/03	178 B9.033								
Engine	Information				A10	A20	A40	A50	A70	C10 - C30	C20	E01
All engines	version Marelli						830 109	930 060	430 180M			
All engines	x 1, DISTRIBUTOR, connector type DIN									470 108	C10	
All engines											465 020	359 347
1.1					ENGINE							
	Petrol	42	06/06->	187 A1.000								
Engine	Information				A10	A20	A40	A50	A70	C10 - C30	C20	E01
All engines	Qty: 2									470 146	C10	
All engines												360 451
1.2					ENGINE							
	Petrol	44	07/97-10/04	178 B7.045, 178 C4.066, 188 A4.000								
Engine	Information				A10	A20	A40	A50	A70	C10 - C30	C20	E01
All engines	x 1, D.I.S., connector type DIN									470 146	C10	
Eng. 178 C4.066	Qty: 2									470 146	C10	
All engines	->eng. 2935743											359 616
All engines	eng. type 2935743 ->											360 451
1.2					ENGINE							
	Petrol	50	06/99-10/02	178 E2.000								
Engine	Information				A10	A20	A40	A50	A70	C10 - C30	C20	E01
All engines	x 1, D.I.S., connector type DIN									470 146	C10	
All engines	->eng. 2935743											359 616
All engines	eng. type 2935743 ->											360 451
1.2					ENGINE							
	Petrol	53	07/01-06/05	178 B5.000								
Engine	Information				A10	A20	A40	A50	A70	C10 - C30	C20	E01
All engines	Qty: 2									470 146	C10	
All engines	->eng. 2935743											359 616
All engines	eng. type 2935743 ->											360 451
1.2					ENGINE							
	Petrol	54	04/96->	176 A8.000, 178 B5.000, 178 E2.000								
Engine	Information				A10	A20	A40	A50	A70	C10 - C30	C20	E01
Eng. 176 A8.000, 178 E2.000	Qty: 2									470 146	C10	
Eng. 178 B5.000	x 1, D.I.S., connector type DIN									470 146	C10	
All engines	->eng. 2935743											359 616
All engines	eng. type 2935743 ->											360 451

A10 CONDENSER	A20 CONTACT SET	A40 DISTRIBUTOR CAP	A50 ROTOR	A70 PICK-UP
C10 COIL	C20 IGNITION MODULE	C30 ELECTRONIC IGNITION KIT	E01 IGNITION CABLE SET	

Vehicle	alim.	kW	Date	Engine	FUNCTIONS ON THE VEHICLE								
					A10	A20	A40	A50	A70	C10 - C30	C20	E01	
1.2	Petrol	59	03/00-10/04	ENGINE 178 D6.011, 188 A5.000									
Engine	Information												
All engines	x 1, D.I.S., connector type, saw teeth									470 168	C10		
Eng. 188 A5.000													360 505
1.2 75	Petrol	54	03/98->	ENGINE 178 B7.045									
Engine	Information												
All engines	Qty: 2									470 146	C10		
All engines	->eng. 2935743												359 616
All engines	eng. type 2935743 ->												360 451
1.2 MPI	Petrol	44	01/02->	ENGINE 178 C4.066									
Engine	Information												
All engines	Qty: 2									470 146	C10		
All engines	->eng. 2935743												359 616
All engines	eng. type 2935743 ->												360 451
1.4	Petrol	51	04/96-10/02	ENGINE 178 B2.000, 178 B2.016									
Engine	Information												
All engines	x 1, D.I.S., version 1, connector type DIN, D.I.S., connector type DIN									470 146	C10		
1.4	Petrol	63	10/02-10/04	ENGINE 350 A1.000									
Engine	Information												
All engines	x 1, D.I.S.									470 423	C10		
1.4	Petrol	70	06/03->	ENGINE 834 A1.000									
Engine	Information												
All engines										470 423	C10		358 170
1.4 Cat	Petrol	51	04/96-08/01	ENGINE 178 B2.000, 178 B2.016									
Engine	Information												
All engines	x 1, version 1, D.I.S., connector type DIN									470 146	C10		
1.5	Petrol	62	02/02->	ENGINE 178 E5.022									
Engine	Information												
All engines	x 1, D.I.S., connector type DIN									470 146	C10		
1.6	Petrol	68	07/97-10/00	ENGINE 178 D2.011									
Engine	Information												
All engines										470 345	C10		360 503
1.6	Petrol	70	06/99->	ENGINE 178 D2.011									
Engine	Information												
All engines										470 345	C10		360 503
1.6	Petrol	76	06/99-10/00	ENGINE 178 C7.098									
Engine	Information												
All engines	x 1, D.I.S., connector type, saw teeth									470 345	C10		
1.6 16V	Petrol	68	07/97-10/03	ENGINE 178 C7.098, 178 D2.011									
Engine	Information												
All engines										470 345	C10		360 503
1.6 16V	Petrol	74	04/96->	ENGINE 178 B3.000, 182 B6.000									
Engine	Information												
Eng. 178 B3.000	x 1, D.I.S., connector type, saw teeth									470 345	C10		
Eng. 182 B6.000										470 345	C10		
All engines													360 503

A10 CONDENSER	A20 CONTACT SET	A40 DISTRIBUTOR CAP	A50 ROTOR	A70 PICK-UP
C10 COIL	C20 IGNITION MODULE	C30 ELECTRONIC IGNITION KIT	E01 IGNITION CABLE SET	

The present application list is a brief version. For the detailed information about the possibility of installation on a specific vehicle, please refer to our web-catalogue <http://catalogo.facet.eu/>

					FUNCTIONS ON THE VEHICLE							
Vehicle	alim.	kW	Date	Engine	 A10	 A20	 A40	 A50	 A70	 C10 - C30	 C20	 E01
ENGINE												
1.6 16V	Petrol	76	02/01-01/12	182 B6.000								
Engine	Information				A10	A20	A40	A50	A70	C10 - C30	C20	E01
All engines	x 1, D.I.S., connector type, saw teeth									470 345	C10	
All engines												360 503
ENGINE												
1.6 16V 100	Petrol	69	01/98->	178 C8.098								
Engine	Information				A10	A20	A40	A50	A70	C10 - C30	C20	E01
All engines	Qty: 2									470 146	C10	
ENGINE												
1.6 16V 100	Petrol	74	01/98->	178 C8.098								
Engine	Information				A10	A20	A40	A50	A70	C10 - C30	C20	E01
All engines	Qty: 2									470 146	C10	
ENGINE												
1.6 16V Sport	Petrol	76	10/01->	178 E7.000								
Engine	Information				A10	A20	A40	A50	A70	C10 - C30	C20	E01
All engines										470 345	C10	
PANDA I												
ENGINE												
1.1	Petrol	37	05/91-03/95	156 C.046								
Engine	Information				A10	A20	A40	A50	A70	C10 - C30	C20	E01
All engines	->year 01/01/93, version Marelli						830 109	930 060	430 180M			
All engines	->year 01/01/93, version Bosch SPi									470 108	C10	359 347
All engines	01/01/93 ->, Qty: 2, version Weber SPi									470 146	C10	
All engines	->year 01/01/93										465 020	
All engines	eng. type 5524923 ->, version Weber SPi											359 616
All engines	->eng. 5524923, version Weber SPi											359 887
ENGINE												
1.1	Petrol	40	09/00-02/04	187 A1.000								
Engine	Information				A10	A20	A40	A50	A70	C10 - C30	C20	E01
All engines	Qty: 2									470 146	C10	
All engines												360 451
ENGINE												
1.1 AWD	Petrol	40	09/00-02/04	187 A1.000								
Engine	Information				A10	A20	A40	A50	A70	C10 - C30	C20	E01
All engines	Qty: 2									470 146	C10	
All engines												360 451
ENGINE												
1000	Petrol	32	01/86-04/92	156 A2.100								
Engine	Information				A10	A20	A40	A50	A70	C10 - C30	C20	E01
All engines	version Marelli						830 109	930 060	430 180M			
All engines										470 158	C10	465 020 359 347
ENGINE												
1000	Petrol	37	01/85-12/92	156 A3.000								
Engine	Information				A10	A20	A40	A50	A70	C10 - C30	C20	E01
All engines	version Marelli						830 109	930 060	430 180M			
All engines										470 158	C10	465 020 359 347
ENGINE												
1000 4x4	Petrol	32	01/86-07/89	156 A2.100								
Engine	Information				A10	A20	A40	A50	A70	C10 - C30	C20	E01
All engines	version Marelli						830 109	930 060	430 180M			
All engines										470 158	C10	465 020 359 347
ENGINE												
1000 4x4	Petrol	33	05/86-12/94	141 C2.000, 156 A2.246								
Engine	Information				A10	A20	A40	A50	A70	C10 - C30	C20	E01
Eng. 156 A2.246	version Marelli						830 109	930 060	430 180M			
All engines	->year 01/05/91, version Bosch SPi									470 108	C10	
Eng. 141 C2.000	Qty: 2, version Weber SPi									470 146	C10	
Eng. 156 A2.246	01/05/91 ->									470 158	C10	
Eng. 156 A2.246											465 020	359 347
Eng. 141 C2.000												359 616

A10 CONDENSER	A20 CONTACT SET	A40 DISTRIBUTOR CAP	A50 ROTOR	A70 PICK-UP
C10 COIL	C20 IGNITION MODULE	C30 ELECTRONIC IGNITION KIT	E01 IGNITION CABLE SET	

Vehicle	alim.	kW	Date	Engine	FUNCTIONS ON THE VEHICLE							
					A10	A20	A40	A50	A70	C10 - C30	C20	E01
ENGINE												
1000 4x4	Petrol	37	01/86-12/92	156 A3.000								
Engine	Information			A10	A20	A40	A50	A70	C10 - C30	C20	E01	
All engines	version Marelli					830 109	930 060	430 180M				
All engines									470 158	C10	465 020	359 347
ENGINE												
1000 Fire [CHE]	Petrol	33	11/87-04/91	156 A2.146								
Engine	Information			A10	A20	A40	A50	A70	C10 - C30	C20	E01	
All engines	version Marelli					830 109	930 060	430 180M				
All engines									470 108	C10	465 020	359 347
ENGINE												
1000 Fire [DEU]	Petrol	33	01/86-07/89	156 A2.048								
Engine	Information			A10	A20	A40	A50	A70	C10 - C30	C20	E01	
All engines	version Marelli					830 109	930 060	430 180M				
All engines									470 101D	C10	465 020	359 347
ENGINE												
1000 i.e	Petrol	33	08/92-02/04	156 A2.246								
Engine	Information			A10	A20	A40	A50	A70	C10 - C30	C20	E01	
All engines	version Bosch SPi, version Marelli					830 109	930 060	430 180M				
All engines	version Bosch SPi								470 108	C10	465 020	359 347
All engines	Qty: 2, version Weber SPi								470 146	C10		
All engines	eng. type 5524923 ->, version Weber SPi											359 616
All engines	->eng. 5524923, version Weber SPi											359 887
ENGINE												
1000 i.e. Cat	Petrol	33	10/87-08/98	141 C2.000, 156 A2.246								
Engine	Information			A10	A20	A40	A50	A70	C10 - C30	C20	E01	
Eng. 156 A2.246	version Bosch SPi, version Marelli					830 109	930 060	430 180M				
All engines	version Bosch SPi								470 108	C10		
All engines	Qty: 2, version Weber SPi								470 146	C10		
Eng. 156 A2.246	version Bosch SPi										465 020	359 347
All engines	eng. type 5524923 ->, version Weber SPi											359 616
Eng. 156 A2.246	->eng. 5524923, version Weber SPi											359 887
ENGINE												
1100	Petrol	37	05/91-12/99	156 C.046								
Engine	Information			A10	A20	A40	A50	A70	C10 - C30	C20	E01	
All engines	Qty: 2								470 146	C10		
All engines	eng. type 5524923 ->											359 616
All engines	->eng. 5524923											359 887
ENGINE												
1100	Petrol	40	02/95-09/03	176 B2.000, 187 A1.000								
Engine	Information			A10	A20	A40	A50	A70	C10 - C30	C20	E01	
All engines	Qty: 2								470 146	C10		
Eng. 176 B2.000												359 616
Eng. 187 A1.000												360 451
ENGINE												
1100 4x4	Petrol	40	02/95-07/04	176 B2.000								
Engine	Information			A10	A20	A40	A50	A70	C10 - C30	C20	E01	
All engines	Qty: 2								470 146	C10		
All engines												359 616
ENGINE												
1100 i.e.	Petrol	37	01/86-04/91	156 C.046								
Engine	Information			A10	A20	A40	A50	A70	C10 - C30	C20	E01	
All engines	version Marelli					830 109	930 060	430 180M				
All engines									470 108	C10	465 020	
ENGINE												
1100 i.e. 4x4	Petrol	37	12/00->	187 A1.000								
Engine	Information			A10	A20	A40	A50	A70	C10 - C30	C20	E01	
All engines	Qty: 2								470 146	C10		
All engines												360 451

A10	CONDENSER	A20	CONTACT SET	A40	DISTRIBUTOR CAP	A50	ROTOR	A70	PICK-UP
C10	COIL	C20	IGNITION MODULE	C30	ELECTRONIC IGNITION KIT	E01	IGNITION CABLE SET		

FUNCTIONS ON THE VEHICLE

Vehicle	alim.	kW	Date	Engine								
---------	-------	----	------	--------	---	---	---	--	---	---	---	---

ENGINE				
1100 Trekking 4x4	Petrol	37	10/91-07/04	156 C.046

Engine	Information	A10	A20	A40	A50	A70	C10 - C30	C20	E01
All engines	->year 01/01/93, version Marelli			830 109	930 060	430 180M			
All engines	->year 01/01/93, version Bosch SPi						470 108	C10	359 347
All engines	01/01/93 ->, version Weber SPi, Qty: 2						470 146	C10	
All engines	->year 01/01/93							465 020	
All engines	eng. type 5524923 ->, version Weber SPi								359 616
All engines	->eng. 5524923, version Weber SPi								359 887

ENGINE				
650	Petrol	22	01/82-07/04	141 A.000

Engine	Information	A10	A20	A40	A50	A70	C10 - C30	C20	E01
All engines	version Marelli		730 120						

ENGINE				
750	Petrol	25	01/86-10/03	141 B.000, 156 A4.000

Engine	Information	A10	A20	A40	A50	A70	C10 - C30	C20	E01
Eng. 141 B.000	version Ducellier	615 039	715 122	815 058	915 083R				
Eng. 141 B.000	version Marelli	630 128	730 146M	830 098	930 047R				
Eng. 156 A4.000	version Marelli		730 149M	830 109	930 060				
Eng. 156 A4.000	version Ducellier			815 080	915 094				
All engines							470 101D	C10	
Eng. 156 A4.000									359 347
Eng. 141 B.000									359 466

ENGINE				
750 Cat	Petrol	25	01/95-10/03	156 A4.048

Engine	Information	A10	A20	A40	A50	A70	C10 - C30	C20	E01
All engines	version Ducellier			815 080	915 094			465 029	
All engines	version Marelli			830 109	930 060	430 180M		465 020	
All engines							470 158	C10	359 347

ENGINE				
750 Fire	Petrol	25	11/88-04/91	156 A4.048

Engine	Information	A10	A20	A40	A50	A70	C10 - C30	C20	E01
All engines	version Ducellier			815 080	915 094			465 029	
All engines	version Marelli			830 109	930 060	430 180M		465 020	
All engines							470 158	C10	359 347

ENGINE				
800	Petrol	25	02/81-12/85	100 GL6.000

Engine	Information	A10	A20	A40	A50	A70	C10 - C30	C20	E01
All engines	version Ducellier	615 039	715 106	815 058	915 083R				
All engines	version Marelli	630 117	730 142		930 042R				
All engines	version Femsas		717 020		917 052R				
All engines							470 101D	C10	359 386

ENGINE				
900	Petrol	29	04/92-12/96	1170 A1.046

Engine	Information	A10	A20	A40	A50	A70	C10 - C30	C20	E01
All engines	Qty: 2						470 146	C10	
All engines	->year 01/10/96								359 615
All engines	01/10/96 ->								360 527

ENGINE				
900	Petrol	33	10/80-06/94	100 GL3.000

Engine	Information	A10	A20	A40	A50	A70	C10 - C30	C20	E01
All engines	version Ducellier	615 039	715 122	815 058	915 083R				
All engines	version Marelli	630 128	730 146M	830 098	930 047R				
All engines							470 101D	C10	359 466

ENGINE				
900 CL	Petrol	33	01/86-12/92	146 A.048

Engine	Information	A10	A20	A40	A50	A70	C10 - C30	C20	E01
All engines	version Ducellier	615 039	715 122	815 058	915 083R				
All engines	version Marelli	630 128	730 146M	830 098	930 047R				
All engines							470 101D	C10	359 466

A10 CONDENSER	A20 CONTACT SET	A40 DISTRIBUTOR CAP	A50 ROTOR	A70 PICK-UP
C10 COIL	C20 IGNITION MODULE	C30 ELECTRONIC IGNITION KIT	E01 IGNITION CABLE SET	

Vehicle	alim.	kW	Date	Engine	FUNCTIONS ON THE VEHICLE							
					A10	A20	A40	A50	A70	C10 - C30	C20	E01
ENGINE												
900 i.e.	Petrol	29	01/98->	1170 A1.046								
Engine	Information			A10	A20	A40	A50	A70	C10 - C30	C20	E01	
All engines	Qty: 2								470 146	C10		
All engines											360 527	
ENGINE												
950	Petrol	35	09/82-08/83	A 112 B1.054								
Engine	Information			A10	A20	A40	A50	A70	C10 - C30	C20	E01	
All engines	version Marelli			630 117	730 142		930 042R					
All engines									470 101D	C10	359 386	
ENGINE												
950 4x4	Petrol	35	09/83-12/86	A 112 B1.054								
Engine	Information			A10	A20	A40	A50	A70	C10 - C30	C20	E01	
All engines	version Marelli			630 117	730 142		930 042R					
All engines									470 101D	C10		
PANDA II												
ENGINE												
1.1	Petrol	40	09/03->	187 A1.000								
Engine	Information			A10	A20	A40	A50	A70	C10 - C30	C20	E01	
All engines	x 1, D.I.S., connector type DIN								470 146	C10		
All engines											360 451	
ENGINE												
1.2	Petrol	44	09/03->	188 A4.000								
Engine	Information			A10	A20	A40	A50	A70	C10 - C30	C20	E01	
All engines	x 1, D.I.S., connector type DIN								470 146	C10		
All engines											360 451	
ENGINE												
1.2	Petrol	51	03/10->	169 A4.000								
Engine	Information			A10	A20	A40	A50	A70	C10 - C30	C20	E01	
All engines	x 1, D.I.S.								470 423	C10		
All engines											358 170	
ENGINE												
1.2 4x4	Petrol	44	09/04->	188 A4.000								
Engine	Information			A10	A20	A40	A50	A70	C10 - C30	C20	E01	
All engines	x 1, D.I.S., connector type DIN								470 146	C10		
All engines											360 451	
ENGINE												
1.2 4x4	Petrol	51	04/10->	169 A4.000								
Engine	Information			A10	A20	A40	A50	A70	C10 - C30	C20	E01	
All engines	x 1, D.I.S.								470 423	C10		
All engines											358 170	
ENGINE												
1.2 Bipower	Petrol/ Ethanol	44	09/04-12/11	188 A4.000								
Engine	Information			A10	A20	A40	A50	A70	C10 - C30	C20	E01	
All engines	x 1, D.I.S., connector type DIN								470 146	C10		
ENGINE												
1.2 LPG	Petrol/ Liquified Petro- leum Gas (LPG)	44	04/09->	188 A4.000								
Engine	Information			A10	A20	A40	A50	A70	C10 - C30	C20	E01	
All engines	x 1, D.I.S., connector type DIN								470 146	C10		
All engines											360 451	
ENGINE												
1.2 LPG	Petrol/ Liquified Petro- leum Gas (LPG)	51	09/10->	169 A4.000								
Engine	Information			A10	A20	A40	A50	A70	C10 - C30	C20	E01	
All engines	x 1, D.I.S.								470 423	C10		

A10	CONDENSER	A20	CONTACT SET	A40	DISTRIBUTOR CAP	A50	ROTOR	A70	PICK-UP
C10	COIL	C20	IGNITION MODULE	C30	ELECTRONIC IGNITION KIT	E01	IGNITION CABLE SET		

The present application list is a brief version. For the detailed information about the possibility of installation on a specific vehicle, please refer to our web-catalogue <http://catalogo.facet.eu/>

Vehicle	alim.	kW	Date	Engine	FUNCTIONS ON THE VEHICLE							
					A10	A20	A40	A50	A70	C10 - C30	C20	E01

ENGINE				
1.2 Natural Power	Petrol/ Compressed Natural Gas (CNG)	44	01/07-12/11	188 A4.000, 188A4000C-NG

Engine	Information	A10	A20	A40	A50	A70	C10 - C30	C20	E01
Eng. 188 A4.000	Qty: 2						470 146	C10	
Eng. 188A4000CNG	x 1, D.I.S., connector type DIN						470 146	C10	
Eng. 188A4000CNG	x 1, D.I.S.						470 423	C10	
Eng. 188 A4.000									360 451

ENGINE				
1.4	Petrol	74	10/06->	169 A3.000

Engine	Information	A10	A20	A40	A50	A70	C10 - C30	C20	E01
All engines	x 4, COIL ON PLUG, incl. spark plug connector						470 442	C10	

ENGINE				
1.4 16V	Petrol	51	01/10->	--

Engine	Information	A10	A20	A40	A50	A70	C10 - C30	C20	E01
All engines							470 423	C10	358 170

ENGINE				
1.4 Natural Power	Petrol/ Compressed Natural Gas (CNG)	51	01/12-12/12	350 A1.000

Engine	Information	A10	A20	A40	A50	A70	C10 - C30	C20	E01
All engines							470 423	C10	358 170

ENGINE				
1.4 Natural Power	Petrol/ Compressed Natural Gas (CNG)	57	10/09->	350 A1.000, 350A1000C-NG

Engine	Information	A10	A20	A40	A50	A70	C10 - C30	C20	E01
Eng. 350 A1.000							470 423	C10	358 170
Eng. 350A1000CNG	x 1, D.I.S.						470 423	C10	

PANDA III

ENGINE				
0.9	Petrol	44	12/13->	312 A4.000, 312 A6.000

Engine	Information	A10	A20	A40	A50	A70	C10 - C30	C20	E01
Eng. 312 A4.000	naturally Asp. Eng., Qty: 2						470 442	C10	
Eng. 312 A6.000	x 2, COIL ON PLUG, incl. spark plug connector						470 442	C10	

ENGINE				
0.9	Petrol	48	02/12->	312 A4.000

Engine	Information	A10	A20	A40	A50	A70	C10 - C30	C20	E01
All engines	x 2, COIL ON PLUG, incl. spark plug connector						470 442	C10	

ENGINE				
0.9	Petrol	57	02/12->	312 A7.000

Engine	Information	A10	A20	A40	A50	A70	C10 - C30	C20	E01
All engines	naturally Asp. Eng., Qty: 2						470 442	C10	

ENGINE				
0.9	Petrol	59	11/13->	312 A5.000

Engine	Information	A10	A20	A40	A50	A70	C10 - C30	C20	E01
All engines	naturally Asp. Eng., Qty: 2						470 442	C10	

ENGINE				
0.9 4x4	Petrol	66	06/14->	312 A2.000

Engine	Information	A10	A20	A40	A50	A70	C10 - C30	C20	E01
All engines	naturally Asp. Eng., Qty: 2						470 442	C10	

ENGINE				
1.2	Petrol	51	02/12->	169 A4.000

Engine	Information	A10	A20	A40	A50	A70	C10 - C30	C20	E01
All engines	x 1, D.I.S.						470 423	C10	
All engines									358 170

A10 CONDENSER	A20 CONTACT SET	A40 DISTRIBUTOR CAP	A50 ROTOR	A70 PICK-UP
C10 COIL	C20 IGNITION MODULE	C30 ELECTRONIC IGNITION KIT	E01 IGNITION CABLE SET	

Vehicle	alim.	kW	Date	Engine	FUNCTIONS ON THE VEHICLE									
					A10	A20	A40	A50	A70	C10 - C30	C20	E01		
ENGINE														
1.2 LPG	Petrol/ Liquified Petroleum Gas (LPG)	51	06/12->	169 A4.000										
ENGINE														
Engine					A10	A20	A40	A50	A70	C10 - C30	C20	E01		
All engines										470 423	C10			
All engines													358 170	
PUNTO I														
ENGINE														
1.1	Petrol	40	04/96-02/00	176 B2.000										
ENGINE														
Engine					A10	A20	A40	A50	A70	C10 - C30	C20	E01		
All engines										470 146	C10			
All engines													359 616	
ENGINE														
1.2 16V	Petrol	63	04/97-09/99	176 B9.000										
ENGINE														
Engine					A10	A20	A40	A50	A70	C10 - C30	C20	E01		
All engines										470 146	C10			
All engines													360 504	
ENGINE														
1.4 GT Turbo	Petrol	96	09/96-07/99	176 B6.000										
ENGINE														
Engine					A10	A20	A40	A50	A70	C10 - C30	C20	E01		
All engines										470 168	C10		359 613	
ENGINE														
1.4 GT Turbo	Petrol	98	10/93-03/97	176 A4.000										
ENGINE														
Engine					A10	A20	A40	A50	A70	C10 - C30	C20	E01		
All engines										470 168	C10		359 613	
ENGINE														
1.6	Petrol	65	01/94-04/97	176 A9.000										
ENGINE														
Engine					A10	A20	A40	A50	A70	C10 - C30	C20	E01		
All engines													359 888	
ENGINE														
55 1.1	Petrol	40	09/93-09/99	176 A6.000, 176 B2.000										
ENGINE														
Engine					A10	A20	A40	A50	A70	C10 - C30	C20	E01		
All engines										470 146	C10			
All engines													359 616	
ENGINE														
60 1.2	Petrol	43	01/94-06/00	176 A7.000										
ENGINE														
Engine					A10	A20	A40	A50	A70	C10 - C30	C20	E01		
All engines										470 146	C10			
All engines													359 616	
ENGINE														
60 1.2	Petrol	44	09/93-06/00	176 B1.000, 176 B4.000										
ENGINE														
Engine					A10	A20	A40	A50	A70	C10 - C30	C20	E01		
All engines										470 146	C10			
All engines													359 616	
ENGINE														
75 1.2	Petrol	54	10/93-09/99	176 A8.000										
ENGINE														
Engine					A10	A20	A40	A50	A70	C10 - C30	C20	E01		
All engines										470 146	C10			
All engines													359 616	
ENGINE														
85 16V 1.2	Petrol	63	04/97-06/00	176 B9.000										
ENGINE														
Engine					A10	A20	A40	A50	A70	C10 - C30	C20	E01		
All engines										470 146	C10			
All engines													360 504	
ENGINE														
90 1.6	Petrol	65	04/94-04/97	176 A9.000										
ENGINE														
Engine					A10	A20	A40	A50	A70	C10 - C30	C20	E01		
All engines													359 888	

A10	CONDENSER	A20	CONTACT SET	A40	DISTRIBUTOR CAP	A50	ROTOR	A70	PICK-UP
C10	COIL	C20	IGNITION MODULE	C30	ELECTRONIC IGNITION KIT	E01	IGNITION CABLE SET		

The present application list is a brief version. For the detailed information about the possibility of installation on a specific vehicle, please refer to our web-catalogue <http://catalogo.facet.eu/>

Vehicle	alim.	kW	Date	Engine	FUNCTIONS ON THE VEHICLE							
					A10	A20	A40	A50	A70	C10 - C30	C20	E01

PUNTO II

				ENGINE
1.2 16V	Petrol	59	06/03->	188 A5.000

Engine	Information	A10	A20	A40	A50	A70	C10 - C30	C20	E01
All engines							470 168	C10	360 505

				ENGINE
1.2 16V 80	Petrol	59	09/99-04/06	188 A5.000

Engine	Information	A10	A20	A40	A50	A70	C10 - C30	C20	E01
All engines	x 1, D.I.S., connector type, saw teeth						470 168	C10	
All engines									360 505

				ENGINE
1.2 60	Petrol	44	09/99-12/10	188 A4.000

Engine	Information	A10	A20	A40	A50	A70	C10 - C30	C20	E01
All engines	x 1, D.I.S., connector type DIN						470 146	C10	
All engines									360 451

				ENGINE
1.2 Bifuel	Petrol/ Liquified Petro- leum Gas (LPG)	44	08/07-03/12	188 A4.000

Engine	Information	A10	A20	A40	A50	A70	C10 - C30	C20	E01
All engines	x 1, D.I.S., connector type DIN						470 146	C10	
All engines									360 451

				ENGINE
1.2 Bipower	Petrol/ Ethanol	44	08/01-05/03	188 A4.000

Engine	Information	A10	A20	A40	A50	A70	C10 - C30	C20	E01
All engines	x 1, D.I.S., connector type DIN						470 146	C10	

				ENGINE
1.2 Natural Power	Petrol/ Com- pressed Natural Gas (CNG)	38	04/04-04/06	188 A4.000, 188A4000C- NG

Engine	Information	A10	A20	A40	A50	A70	C10 - C30	C20	E01
Eng. 188 A4.000	Qty: 2						470 146	C10	
Eng. 188A4000CNG	x 1, D.I.S., connector type DIN						470 146	C10	
Eng. 188 A4.000									360 451

				ENGINE
1.2 Natural Power	Petrol/ Com- pressed Natural Gas (CNG)	44	01/03-03/12	188 A4.000, 188A4000C- NG

Engine	Information	A10	A20	A40	A50	A70	C10 - C30	C20	E01
Eng. 188 A4.000	Qty: 2						470 146	C10	
Eng. 188A4000CNG	x 1, D.I.S., connector type DIN						470 146	C10	
Eng. 188 A4.000									360 451

				ENGINE
1.4	Petrol	70	09/03-03/12	843 A1.000

Engine	Information	A10	A20	A40	A50	A70	C10 - C30	C20	E01
All engines	x 4, COIL ON PLUG, incl. spark plug connector						470 442	C10	

				ENGINE
1.4	Petrol	71	11/05->	199 A6.000

Engine	Information	A10	A20	A40	A50	A70	C10 - C30	C20	E01
All engines	Qty: 4						470 442	C10	

				ENGINE
1.8 130 HGT	Petrol	96	09/99-03/12	183 A1.000, 188 A6.000

Engine	Information	A10	A20	A40	A50	A70	C10 - C30	C20	E01
All engines	x 4, COIL ON PLUG, incl. spark plug connector						470 384	C10	

				ENGINE
1.8 16V	Petrol	96	06/03->	188 A6.000

Engine	Information	A10	A20	A40	A50	A70	C10 - C30	C20	E01
All engines	Qty: 4						470 384	C10	

A10 CONDENSER	A20 CONTACT SET	A40 DISTRIBUTOR CAP	A50 ROTOR	A70 PICK-UP
C10 COIL	C20 IGNITION MODULE	C30 ELECTRONIC IGNITION KIT	E01 IGNITION CABLE SET	

Vehicle	alim.	kW	Date	Engine	FUNCTIONS ON THE VEHICLE							
					A10	A20	A40	A50	A70	C10 - C30	C20	E01

PUNTO III

1.2	Petrol	49	02/14->	ENGINE 199 B9.000
-----	--------	----	---------	----------------------

Engine	Information	A10	A20	A40	A50	A70	C10 - C30	C20	E01
All engines	x 1, D.I.S.						470 423	C10	
All engines									358 170

1.2	Petrol	51	03/12->	ENGINE 169 A4.000
-----	--------	----	---------	----------------------

Engine	Information	A10	A20	A40	A50	A70	C10 - C30	C20	E01
All engines	x 1, D.I.S.						470 423	C10	
All engines									358 170

1.4	Petrol	55	03/12->	ENGINE 199A7000
-----	--------	----	---------	--------------------

Engine	Information	A10	A20	A40	A50	A70	C10 - C30	C20	E01
All engines	x 1, D.I.S.						470 423	C10	

1.4	Petrol	57	03/12->	ENGINE 350 A1.000
-----	--------	----	---------	----------------------

Engine	Information	A10	A20	A40	A50	A70	C10 - C30	C20	E01
All engines	x 1, D.I.S.						470 423	C10	
All engines									358 170

1.4 Bifuel	Petrol/ Liquified Petro- leum Gas (LPG)	57	03/12->	ENGINE 350 A1.000
------------	---	----	---------	----------------------

Engine	Information	A10	A20	A40	A50	A70	C10 - C30	C20	E01
All engines	x 1, D.I.S.						470 423	C10	

1.4 LPG	Petrol/ Liquified Petro- leum Gas (LPG)	57	03/12->	ENGINE 350 A1.000
---------	---	----	---------	----------------------

Engine	Information	A10	A20	A40	A50	A70	C10 - C30	C20	E01
All engines									358 170

1.4 Natural Power	Petrol/ Com- pressed Natural Gas (CNG)	57	03/09->	ENGINE 350 A1.000, 350A1000C- NG
-------------------	---	----	---------	--

Engine	Information	A10	A20	A40	A50	A70	C10 - C30	C20	E01
Eng. 350 A1.000							470 423	C10	358 170
Eng. 350A1000CNG	x 1, D.I.S.						470 423	C10	

1.4 Turbo Multi Air	Petrol	99	03/12->	ENGINE 955 A2.000
---------------------	--------	----	---------	----------------------

Engine	Information	A10	A20	A40	A50	A70	C10 - C30	C20	E01
All engines	x 4, COIL ON PLUG						470 549	C10	

PUNTO III / GRANDE PUNTO

1.2	Petrol	48	10/05->	ENGINE 199 A4.000
-----	--------	----	---------	----------------------

Engine	Information	A10	A20	A40	A50	A70	C10 - C30	C20	E01
All engines	x 1, D.I.S.						470 423	C10	
All engines									358 170

1.2	Petrol	51	09/10->	ENGINE 169 A4.000
-----	--------	----	---------	----------------------

Engine	Information	A10	A20	A40	A50	A70	C10 - C30	C20	E01
All engines	x 1, D.I.S.						470 423	C10	
All engines									358 170

1.2 [IND]	Petrol	48	01/08->	ENGINE --
-----------	--------	----	---------	--------------

Engine	Information	A10	A20	A40	A50	A70	C10 - C30	C20	E01
All engines							470 423	C10	358 170

A10 CONDENSER	A20 CONTACT SET	A40 DISTRIBUTOR CAP	A50 ROTOR	A70 PICK-UP
C10 COIL	C20 IGNITION MODULE	C30 ELECTRONIC IGNITION KIT	E01 IGNITION CABLE SET	

The present application list is a brief version. For the detailed information about the possibility of installation on a specific vehicle, please refer to our web-catalogue <http://catalogo.facet.eu/>

Vehicle	alim.	kW	Date	Engine	FUNCTIONS ON THE VEHICLE							
					A10	A20	A40	A50	A70	C10 - C30	C20	E01

ENGINE				
1.2 Actual	Petrol	48	09/09->	--

Engine	Information	A10	A20	A40	A50	A70	C10 - C30	C20	E01
All engines							470 423	C10	358 170

ENGINE				
1.2 LPG	Petrol/ Liquified Petro- leum Gas (LPG)	51	06/08-12/12	199 A4.000

Engine	Information	A10	A20	A40	A50	A70	C10 - C30	C20	E01
All engines	x 1, D.I.S.						470 423	C10	
All engines									358 170

ENGINE				
1.4	Petrol	55	10/05-07/07	199A7000, 8S8Y1

Engine	Information	A10	A20	A40	A50	A70	C10 - C30	C20	E01
Eng. 199A7000	x 1, D.I.S.						470 423	C10	
Eng. 8S8Y1									358 170

ENGINE				
1.4	Petrol	57	06/05-12/15	350 A1.000

Engine	Information	A10	A20	A40	A50	A70	C10 - C30	C20	E01
All engines	x 1, D.I.S.						470 423	C10	
All engines									358 170

ENGINE				
1.4 16V	Petrol	70	10/05-08/11	199 A6.000

Engine	Information	A10	A20	A40	A50	A70	C10 - C30	C20	E01
All engines	x 4, COIL ON PLUG, incl. spark plug connector						470 442	C10	

ENGINE				
1.4 16V [IND]	Petrol	70	01/08->	--

Engine	Information	A10	A20	A40	A50	A70	C10 - C30	C20	E01
All engines	Qty: 4						470 442	C10	

ENGINE				
1.4 Actual	Petrol	57	09/09->	--

Engine	Information	A10	A20	A40	A50	A70	C10 - C30	C20	E01
All engines							470 423	C10	358 170

ENGINE				
1.4 LPG	Petrol/ Liquified Petro- leum Gas (LPG)	57	12/08->	350 A1.000

Engine	Information	A10	A20	A40	A50	A70	C10 - C30	C20	E01
All engines	x 1, D.I.S.						470 423	C10	
All engines									358 170

ENGINE				
1.4 Natural Power	Petrol/ Com- pressed Natural Gas (CNG)	57	07/08->	350 A1.000, 350A1000C- NG

Engine	Information	A10	A20	A40	A50	A70	C10 - C30	C20	E01
Eng. 350 A1.000							470 423	C10	358 170
Eng. 350A1000CNG	x 1, D.I.S.						470 423	C10	

PUNTO III EVO

ENGINE				
1.2	Petrol	48	10/09-02/12	199 A4.000

Engine	Information	A10	A20	A40	A50	A70	C10 - C30	C20	E01
All engines	x 1, D.I.S.						470 423	C10	
All engines									358 170

ENGINE				
1.2	Petrol	51	10/09-02/12	169 A4.000

Engine	Information	A10	A20	A40	A50	A70	C10 - C30	C20	E01
All engines	x 1, D.I.S.						470 423	C10	
All engines									358 170

A10 CONDENSER	A20 CONTACT SET	A40 DISTRIBUTOR CAP	A50 ROTOR	A70 PICK-UP
C10 COIL	C20 IGNITION MODULE	C30 ELECTRONIC IGNITION KIT	E01 IGNITION CABLE SET	

Vehicle	alim.	kW	Date	Engine	FUNCTIONS ON THE VEHICLE									
					A10	A20	A40	A50	A70	C10 - C30	C20	E01		
ENGINE														
1.4	Petrol	55	07/09-02/12	199A7000, 8S8Y1										
ENGINE														
Engine					A10	A20	A40	A50	A70	C10 - C30	C20	E01		
Eng. 199A7000										470 423	C10			
Eng. 8S8Y1													358 170	
ENGINE														
1.4	Petrol	57	03/09->	350 A1.000										
ENGINE														
Engine					A10	A20	A40	A50	A70	C10 - C30	C20	E01		
All engines										470 423	C10		358 170	
All engines										470 423	C10			
ENGINE														
1.4 16V	Petrol	99	10/09-02/12	955 A2.000										
ENGINE														
Engine					A10	A20	A40	A50	A70	C10 - C30	C20	E01		
All engines										470 549	C10			
All engines														
ENGINE														
1.4 LPG	Petrol/ Liquified Petro- leum Gas (LPG)	57	06/09-02/12	350 A1.000										
ENGINE														
Engine					A10	A20	A40	A50	A70	C10 - C30	C20	E01		
All engines										470 423	C10			
All engines													358 170	
ENGINE														
1.4 Natural Power	Petrol/ Com- pressed Natural Gas (CNG)	57	10/09-02/12	350 A1.000, 350A1000C- NG										
ENGINE														
Engine					A10	A20	A40	A50	A70	C10 - C30	C20	E01		
Eng. 350 A1.000										470 423	C10		358 170	
Eng. 350A1000CNG										470 423	C10			
ENGINE														
QUBO														
1.4	Petrol	54	02/08->	KFT, KFV										
ENGINE														
Engine					A10	A20	A40	A50	A70	C10 - C30	C20	E01		
All engines										470 405	C10			
All engines													358 170	
ENGINE														
1.4	Petrol	57	10/09->	350 A1.000										
ENGINE														
Engine					A10	A20	A40	A50	A70	C10 - C30	C20	E01		
All engines										470 423	C10			
All engines													358 170	
ENGINE														
1.4 Natural Power	Petrol/ Com- pressed Natural Gas (CNG)	57	10/09->	350 A1.000, 350A1000C- NG										
ENGINE														
Engine					A10	A20	A40	A50	A70	C10 - C30	C20	E01		
Eng. 350 A1.000										470 423	C10		358 170	
Eng. 350A1000CNG										470 423	C10			
ENGINE														
REGATA														
1.1 60, 60 L	Petrol	43	10/83-08/86	138 B.000										
ENGINE														
Engine					A10	A20	A40	A50	A70	C10 - C30	C20	E01		
All engines					615 039		815 054	915 083R						
All engines						730 146M	830 101	930 047R						
All engines										470 101D	C10		359 354	
ENGINE														
1.6	Petrol	60	10/84-06/89	149 A.000										
ENGINE														
Engine					A10	A20	A40	A50	A70	C10 - C30	C20	E01		
All engines					615 039		815 054	915 083R						
All engines					630 127	730 146M	830 101	930 047R						

A10	CONDENSER	A20	CONTACT SET	A40	DISTRIBUTOR CAP	A50	ROTOR	A70	PICK-UP
C10	COIL	C20	IGNITION MODULE	C30	ELECTRONIC IGNITION KIT	E01	IGNITION CABLE SET		

The present application list is a brief version. For the detailed information about the possibility of installation on a specific vehicle, please refer to our web-catalogue <http://catalogo.facet.eu/>

					FUNCTIONS ON THE VEHICLE							
Vehicle	alim.	kW	Date	Engine	 A10	 A20	 A40	 A50	 A70	 C10 - C30	 C20	 E01
ENGINE												
1.6	Petrol	60	10/84-06/89	149 A.000								
Engine	Information				A10	A20	A40	A50	A70	C10 - C30	C20	E01
All engines										470 101D	C10	
ENGINE												
100 Super 1.6	Petrol	74	10/83-12/90	149 A2.000								
Engine	Information				A10	A20	A40	A50	A70	C10 - C30	C20	E01
All engines	version Marelli						830 104	930 055R				
All engines										470 103	C10	
ENGINE												
70 1.3	Petrol	48	09/83-07/89	149 A3.000								
Engine	Information				A10	A20	A40	A50	A70	C10 - C30	C20	E01
All engines	->year 30/09/85, version Ducellier				615 039		815 054	915 083R				
All engines	version Marelli				630 127	730 146M	830 101	930 047R	430 176M			
All engines	->year 30/09/85									470 101D	C10	
All engines	01/10/85 ->									470 102	C10	465 020 359 354
ENGINE												
70 1.3	Petrol	50	09/83-07/89	138 B2.000								
Engine	Information				A10	A20	A40	A50	A70	C10 - C30	C20	E01
All engines	->year 30/09/85, version Ducellier				615 039		815 054	915 083R				
All engines	version Marelli				630 127	730 146M	830 101	930 047R	430 176M			
All engines	->year 30/09/85									470 101D	C10	
All engines	01/10/85 ->									470 102	C10	465 020 359 354
ENGINE												
85 1.5	Petrol	58	05/85-12/87	149 A5.000								
Engine	Information				A10	A20	A40	A50	A70	C10 - C30	C20	E01
All engines	+automatic transmission, version Marelli						830 101	930 047R				
All engines	version Marelli						830 104	930 055R				
All engines	+automatic transmission									470 102	C10	
All engines										470 103	C10	
ENGINE												
85 1.6	Petrol	60	10/83-06/90	149 A.000								
Engine	Information				A10	A20	A40	A50	A70	C10 - C30	C20	E01
All engines	version Ducellier				615 039		815 054	915 083R				
All engines	version Marelli				630 127	730 146M	830 101	930 047R				
All engines										470 101D	C10	
ENGINE												
90 i.e. 1.6	Petrol	66	01/87-07/89	149 C2.000								
Engine	Information				A10	A20	A40	A50	A70	C10 - C30	C20	E01
All engines	version Marelli						830 098	930 057R				
All engines									430 177/1			
RITMO I												
ENGINE												
1.1	Petrol	43	04/85-12/87	146 A4.048								
Engine	Information				A10	A20	A40	A50	A70	C10 - C30	C20	E01
All engines	version Ducellier				615 039		815 054	915 083R				
All engines	version Marelli					730 146M	830 101	930 047R				
All engines										470 101D	C10	
ENGINE												
1.3	Petrol	48	11/83-08/85	149 A3.000								
Engine	Information				A10	A20	A40	A50	A70	C10 - C30	C20	E01
All engines	version Ducellier				615 039	715 106	815 049	915 083R				
All engines	version Marelli						830 101	930 047R	430 176M			
All engines	->year 31/12/82									470 101D	C10	
All engines	01/01/83 ->									470 102	C10	
All engines											465 020	
ENGINE												
1.5	Petrol	55	10/85-05/87	138 C2.048								
Engine	Information				A10	A20	A40	A50	A70	C10 - C30	C20	E01
All engines	version Marelli						830 104	930 055R				
All engines										470 102	C10	

A10 CONDENSER	A20 CONTACT SET	A40 DISTRIBUTOR CAP	A50 ROTOR	A70 PICK-UP
C10 COIL	C20 IGNITION MODULE	C30 ELECTRONIC IGNITION KIT	E01 IGNITION CABLE SET	

Vehicle	alim.	kW	Date	Engine	FUNCTIONS ON THE VEHICLE							
					A10	A20	A40	A50	A70	C10 - C30	C20	E01

				ENGINE
1.6	Petrol	74	01/83-12/87	149 A4.000

Engine	Information	A10	A20	A40	A50	A70	C10 - C30	C20	E01
All engines	version Marelli			830 104	930 055R				
All engines							470 103	C10	

				ENGINE
105 1.6	Petrol	77	01/83-12/87	138 AR.000

Engine	Information	A10	A20	A40	A50	A70	C10 - C30	C20	E01
All engines	version Marelli				930 054R	430 161/1			

				ENGINE
75 1.5	Petrol	55	09/85-12/88	138 A2.000

Engine	Information	A10	A20	A40	A50	A70	C10 - C30	C20	E01
All engines	version Ducellier	615 039	715 106	815 049	915 083R				
All engines	version Marelli			830 104	930 055R				
All engines	->year 31/12/82						470 101D	C10	
All engines	01/01/83 ->						470 103	C10	

				ENGINE
2.0	Petrol	100	09/99-10/06	RFN

Engine	Information	A10	A20	A40	A50	A70	C10 - C30	C20	E01
All engines	x 4, COIL ON PLUG						470 408	C10	

				ENGINE
1.6	Petrol	58	02/96-12/06	220 A 2.000

Engine	Information	A10	A20	A40	A50	A70	C10 - C30	C20	E01
All engines	x 1, D.I.S., connector type, saw teeth						470 168	C10	
All engines									359 655

				ENGINE
2.0	Petrol	100	05/00-12/06	RFN, RFN (EW10J4)

Engine	Information	A10	A20	A40	A50	A70	C10 - C30	C20	E01
Eng. RFN	x 4, COIL ON PLUG						470 408	C10	
Eng. RFN (EW10J4)	incl. spark plug connector						470 408	C10	

				ENGINE
2.0 16V	Petrol	100	06/00-12/06	RFN, RFN (EW10J4)

Engine	Information	A10	A20	A40	A50	A70	C10 - C30	C20	E01
Eng. RFN	x 4, COIL ON PLUG						470 408	C10	
Eng. RFN (EW10J4)	incl. spark plug connector						470 408	C10	

				ENGINE
1.6 16V	Petrol	79	06/06-10/14	M16A

Engine	Information	A10	A20	A40	A50	A70	C10 - C30	C20	E01
All engines	x 2, SEMI-DIRECT						470 570	C10	
All engines	->year 15/06/09								358 013

				ENGINE
1.6 16V	Petrol	88	06/06-10/14	M16A

Engine	Information	A10	A20	A40	A50	A70	C10 - C30	C20	E01
All engines	->year 01/06/09, Fitting Position:for cylinder 1, Fitting Position:for cylinder 3, x 2, SEMI-DIRECT						470 570	C10	
All engines	->year 15/06/09								358 013

				ENGINE
1.6 16V 4x4	Petrol	79	06/06-10/14	M16A

Engine	Information	A10	A20	A40	A50	A70	C10 - C30	C20	E01
All engines	x 2, SEMI-DIRECT						470 570	C10	
All engines	->year 15/06/09								358 013

				ENGINE
1.6 16V 4x4	Petrol	88	06/06-10/14	M16A

Engine	Information	A10	A20	A40	A50	A70	C10 - C30	C20	E01
All engines	->year 15/06/09								358 013

A10	CONDENSER	A20	CONTACT SET	A40	DISTRIBUTOR CAP	A50	ROTOR	A70	PICK-UP
C10	COIL	C20	IGNITION MODULE	C30	ELECTRONIC IGNITION KIT	E01	IGNITION CABLE SET		

The present application list is a brief version. For the detailed information about the possibility of installation on a specific vehicle, please refer to our web-catalogue <http://catalogo.facet.eu/>

FUNCTIONS ON THE VEHICLE

Vehicle	alim.	kW	Date	Engine								
---------	-------	----	------	--------	---	---	---	--	---	---	---	---

SEICENTO / 600

				ENGINE
0.9	Petrol	29	11/97-01/10	1170 A1.046

Engine	Information	A10	A20	A40	A50	A70	C10 - C30	C20	E01
All engines	x 1, D.I.S., connector type DIN						470 146	C10	
All engines									359 615

				ENGINE
1.1	Petrol	40	01/98-01/10	176 B2.000, 187 A1.000

Engine	Information	A10	A20	A40	A50	A70	C10 - C30	C20	E01
All engines	x 1, D.I.S., connector type DIN						470 146	C10	
Eng. 176 B2.000									359 616
Eng. 187 A1.000									360 451

SIENA

				ENGINE
1.2	Petrol	44	01/98->	178 B7.045

Engine	Information	A10	A20	A40	A50	A70	C10 - C30	C20	E01
All engines	Qty: 2						470 146	C10	
All engines	->eng. 2935743								359 616
All engines	eng. type 2935743 ->								360 451

				ENGINE
1.3	Petrol	44	09/01-12/12	178 C4.066, 188 A4.000

Engine	Information	A10	A20	A40	A50	A70	C10 - C30	C20	E01
Eng. 178 C4.066	Qty: 2						470 146	C10	
Eng. 188 A4.000	x 1, D.I.S., connector type DIN						470 146	C10	
All engines	->eng. 2935743								359 616
All engines	eng. type 2935743 ->								360 451

				ENGINE
1.3	Petrol	54	09/98-12/02	178 B5.000

Engine	Information	A10	A20	A40	A50	A70	C10 - C30	C20	E01
All engines	x 1, D.I.S., connector type DIN						470 146	C10	
All engines	->eng. 2935743								359 616
All engines	eng. type 2935743 ->								360 451

				ENGINE
1.3	Petrol	59	09/01-12/09	188 A5.000

Engine	Information	A10	A20	A40	A50	A70	C10 - C30	C20	E01
All engines	FOR: (EU), x 1, D.I.S., connector type, saw teeth						470 168	C10	
All engines	NOT FOR: (EU), x 1, D.I.S.						470 416	C10	
All engines	->eng. 2935743								359 616
All engines	eng. type 2935743 ->								360 451

				ENGINE
1.4	Petrol	51	04/96-12/09	178 B2.000, 178 B2.016

Engine	Information	A10	A20	A40	A50	A70	C10 - C30	C20	E01
All engines	x 1, D.I.S., connector type DIN						470 146	C10	

				ENGINE
1.4 Cat	Petrol	51	04/96-12/09	178 B2.000, 178 B2.016

Engine	Information	A10	A20	A40	A50	A70	C10 - C30	C20	E01
All engines	x 1, D.I.S., connector type DIN						470 146	C10	

				ENGINE
1.5	Petrol	62	06/04->	178 E5.022

Engine	Information	A10	A20	A40	A50	A70	C10 - C30	C20	E01
All engines	Qty: 2						470 146	C10	
All engines	x 1, D.I.S., connector type DIN						470 146	C10	

				ENGINE
1.6	Petrol	76	11/00-12/12	182 B6.000

Engine	Information	A10	A20	A40	A50	A70	C10 - C30	C20	E01
All engines	x 1, D.I.S., connector type, saw teeth						470 345	C10	
All engines									360 503

				ENGINE
1.6 16V	Petrol	74	09/98-12/09	178 B3.000

Engine	Information	A10	A20	A40	A50	A70	C10 - C30	C20	E01
All engines	x 1, D.I.S., connector type, saw teeth						470 345	C10	
All engines									360 503

A10 CONDENSER	A20 CONTACT SET	A40 DISTRIBUTOR CAP	A50 ROTOR	A70 PICK-UP
C10 COIL	C20 IGNITION MODULE	C30 ELECTRONIC IGNITION KIT	E01 IGNITION CABLE SET	

Vehicle	alim.	kW	Date	Engine	FUNCTIONS ON THE VEHICLE									
					A10	A20	A40	A50	A70	C10 - C30	C20	E01		
ENGINE														
1.6 16V	Petrol	76	03/99->	178 D2.011, 182 B6.000										
Engine	Information				A10	A20	A40	A50	A70	C10 - C30	C20	E01		
All engines										470 345	C10		360 503	
STILO														
ENGINE														
1.2 16V	Petrol	59	02/02-11/06	188 A5.000										
Engine	Information				A10	A20	A40	A50	A70	C10 - C30	C20	E01		
All engines	x 4, COIL ON PLUG, incl. spark plug connector									470 442	C10			
ENGINE														
1.4	Petrol	70	01/04-08/08	843 A1.000										
Engine	Information				A10	A20	A40	A50	A70	C10 - C30	C20	E01		
All engines	x 4, COIL ON PLUG, incl. spark plug connector									470 442	C10			
ENGINE														
1.4 16V	Petrol	66	03/05-08/08	192 B2.000										
Engine	Information				A10	A20	A40	A50	A70	C10 - C30	C20	E01		
All engines	x 4, COIL ON PLUG, incl. spark plug connector									470 442	C10			
ENGINE														
1.4 16V	Petrol	70	10/03-08/08	843 A1.000										
Engine	Information				A10	A20	A40	A50	A70	C10 - C30	C20	E01		
All engines	x 4, COIL ON PLUG, incl. spark plug connector									470 442	C10			
ENGINE														
1.6	Petrol	77	04/05-08/08	192 B3.000										
Engine	Information				A10	A20	A40	A50	A70	C10 - C30	C20	E01		
All engines	x 4, COIL ON PLUG									470 450	C10			
ENGINE														
1.6 16V	Petrol	77	03/05-12/07	192 B3.000										
Engine	Information				A10	A20	A40	A50	A70	C10 - C30	C20	E01		
All engines	x 4, COIL ON PLUG									470 450	C10			
ENGINE														
1.8 16V	Petrol	98	10/01-08/08	192 A4.000										
Engine	Information				A10	A20	A40	A50	A70	C10 - C30	C20	E01		
All engines	x 4, COIL ON PLUG, incl. spark plug connector									470 384	C10			
STRADA														
ENGINE														
1.2	Petrol	44	04/03->	188 A4.000										
Engine	Information				A10	A20	A40	A50	A70	C10 - C30	C20	E01		
All engines	x 1, D.I.S., connector type DIN									470 146	C10			
All engines	->eng. 2935743												359 616	
All engines	eng. type 2935743 ->												360 451	
ENGINE														
1.2	Petrol	54	06/99->	178 B5.000, 178 B7.045										
Engine	Information				A10	A20	A40	A50	A70	C10 - C30	C20	E01		
Eng. 178 B5.000	x 1, D.I.S., connector type DIN									470 146	C10			
Eng. 178 B7.045	Qty: 2									470 146	C10			
All engines	->eng. 2935743												359 616	
All engines	eng. type 2935743 ->												360 451	
ENGINE														
1.2 Trekking	Petrol	60	11/05->	--, 178 B7.045										
Engine	Information				A10	A20	A40	A50	A70	C10 - C30	C20	E01		
Eng. --	Qty: 2									470 146	C10			
Eng. 178 B7.045	x 1, D.I.S., connector type DIN									470 146	C10			
Eng. --	->eng. 2935743												359 616	
Eng. --	eng. type 2935743 ->												360 451	
TALENTO														
ENGINE														
2.0	Petrol	55	03/89-03/94	170 B										
Engine	Information				A10	A20	A40	A50	A70	C10 - C30	C20	E01		
All engines	version Ducellier						815 054	915 094						
All engines											465 005			

A10 CONDENSER	A20 CONTACT SET	A40 DISTRIBUTOR CAP	A50 ROTOR	A70 PICK-UP
C10 COIL	C20 IGNITION MODULE	C30 ELECTRONIC IGNITION KIT	E01 IGNITION CABLE SET	

The present application list is a brief version. For the detailed information about the possibility of installation on a specific vehicle, please refer to our web-catalogue <http://catalogo.facet.eu/>

Vehicle	alim.	kW	Date	Engine	FUNCTIONS ON THE VEHICLE							
					A10	A20	A40	A50	A70	C10 - C30	C20	E01

TEMPRA				
1.4 i.e.	Petrol	51	04/90-08/96	ENGINE 159 A2.000, 160 A1.046, 836 A4.000

Engine	Information	A10	A20	A40	A50	A70	C10 - C30	C20	E01
Eng. 159 A2.000	version Marelli			830 101		430 176M			
Eng. 160 A1.046	->eng. 8503995, version Marelli			830 104					
Eng. 160 A1.046	eng. type 8503995 -, version Marelli			830 115					
Eng. 159 A2.000, 160 A1.046	->eng. 8813854, version Marelli				930 059				
Eng. 159 A2.000, 160 A1.046	eng. type 8813854 -, version Marelli				930 060				
Eng. 160 A1.046	eng. type 8813854 -, version Marelli					430 177/1			
Eng. 159 A2.000, 160 A1.046	->year 31/03/93						470 108	C10	
Eng. 160 A1.046	01/04/93 ->						470 148	C10	
Eng. 836 A4.000							470 168	C10	359 655
Eng. 159 A2.000								465 020	359 354
Eng. 160 A1.046	->eng. 8503995								359 808
Eng. 160 A1.046	eng. type 8503995 ->								359 815

TEMPRA				
1.4 i.e.	Petrol	57	03/91-08/96	ENGINE 159 A2.000

Engine	Information	A10	A20	A40	A50	A70	C10 - C30	C20	E01
All engines	version Marelli			830 101		430 176M			
All engines	->eng. 8813854, version Marelli				930 059				
All engines	eng. type 8813854 -, version Marelli				930 060				
All engines							470 108	C10	465 020
									359 354

TEMPRA				
1.6	Petrol	51	04/90-07/96	ENGINE 159 A3.048

Engine	Information	A10	A20	A40	A50	A70	C10 - C30	C20	E01
All engines	+automatic transmission, +air conditioning, +power steering, eng. type 8327193 -, ->eng. 8503995, version Marelli			830 104					
All engines	+air conditioning, Selecta, 01/01/93 -, version Marelli			830 114					
All engines	->eng. 8327193, version Marelli, +automatic transmission, +power steering, +air conditioning, eng. type 8503995 -, ->year 01/01/93, 01/01/93 -, Selecta			830 115					
All engines	version Marelli, Colour:Black				930 055R				
All engines	->eng. 8813854, version Marelli, Colour:White				930 059				
All engines	eng. type 8813854 -, version Marelli, Colour:White				930 060				
All engines	eng. type 8813854 -, version Marelli					430 177/1			
All engines							470 148	C10	359 815
All engines	Selecta								359 808

TEMPRA				
1.6	Petrol	63	03/90-12/96	ENGINE 159 A3.000

Engine	Information	A10	A20	A40	A50	A70	C10 - C30	C20	E01
All engines	+automatic transmission, +air conditioning, +power steering, eng. type 8327193 -, ->eng. 8503995, version Marelli			830 104					
All engines	+air conditioning, Selecta, 01/01/93 -, version Marelli			830 114					
All engines	->eng. 8327193, version Marelli, +automatic transmission, +power steering, +air conditioning, eng. type 8503995 -, ->year 01/01/93, 01/01/93 -, Selecta			830 115					
All engines	version Marelli, Colour:Black				930 055R				
All engines	->eng. 8813854, version Marelli, Colour:White				930 059				
All engines	eng. type 8813854 -, version Marelli, Colour:White				930 060				
All engines	eng. type 8813854 -, version Marelli					430 177/1			
All engines							470 148	C10	359 815
All engines	Selecta								359 808

TEMPRA				
1.6 i.e.	Petrol	55	06/92-08/96	ENGINE 159 A3.048, 835 C1.000

Engine	Information	A10	A20	A40	A50	A70	C10 - C30	C20	E01
Eng. 159 A3.048	+automatic transmission, +air conditioning, +power steering, eng. type 8327193 -, ->eng. 8503995, version Marelli			830 104					
Eng. 159 A3.048	+air conditioning, Selecta, 01/01/93 -, version Marelli			830 114					
Eng. 159 A3.048	->eng. 8327193, version Marelli, +automatic transmission, +power steering, +air conditioning, eng. type 8503995 -, ->year 01/01/93, 01/01/93 -, Selecta			830 115					
Eng. 159 A3.048	version Marelli, Colour:Black				930 055R				
Eng. 159 A3.048	->eng. 8813854, version Marelli, Colour:White				930 059				
Eng. 159 A3.048	eng. type 8813854 -, version Marelli, Colour:White				930 060				
Eng. 159 A3.048	eng. type 8813854 -, version Marelli					430 177/1			

A10 CONDENSER	A20 CONTACT SET	A40 DISTRIBUTOR CAP	A50 ROTOR	A70 PICK-UP
C10 COIL	C20 IGNITION MODULE	C30 ELECTRONIC IGNITION KIT	E01 IGNITION CABLE SET	

Vehicle	alim.	kW	Date	Engine	FUNCTIONS ON THE VEHICLE							
					A10	A20	A40	A50	A70	C10 - C30	C20	E01

ENGINE				
1.6 i.e.	Petrol	55	06/92-08/96	159 A3.048, 835 C1.000

Engine	Information	A10	A20	A40	A50	A70	C10 - C30	C20	E01
Eng. 159 A3.048							470 148	C10	
Eng. 835 C1.000							470 168	C10	359 655
Eng. 159 A3.048	->eng. 7747268, +automatic transmission, +power steering, ->eng. 8503995, +automatic transmission, +power steering, +air conditioning								359 808
Eng. 159 A3.048	eng. type 7747268 ->, +automatic transmission, +power steering, eng. type 8503995 ->								359 815

ENGINE				
1.6 i.e.	Petrol	57	06/90-08/96	159 A3.046, 835 C1.000

Engine	Information	A10	A20	A40	A50	A70	C10 - C30	C20	E01
Eng. 159 A3.046	+automatic transmission, +air conditioning, +power steering, eng. type 8327193 ->, ->eng. 8503995, version Marelli			830 104					
Eng. 159 A3.046	+air conditioning, Selecta, 01/01/93 ->, version Marelli			830 114					
Eng. 159 A3.046	->eng. 8327193, version Marelli, +automatic transmission, +power steering, +air conditioning, eng. type 8503995 ->, ->year 01/01/93, 01/01/93 ->, Selecta			830 115					
Eng. 159 A3.046	version Marelli, Colour:Black				930 055R				
Eng. 159 A3.046	->eng. 8813854, version Marelli, Colour:White				930 059				
Eng. 159 A3.046	eng. type 8813854 ->, version Marelli, Colour:White				930 060				
Eng. 159 A3.046							470 148	C10	
Eng. 835 C1.000							470 168	C10	359 655
Eng. 159 A3.046	->eng. 7747268, +automatic transmission, +power steering, ->eng. 8503995, +automatic transmission, +power steering, +air conditioning								359 808
Eng. 159 A3.046	eng. type 7747268 ->, +automatic transmission, +power steering, eng. type 8503995 ->								359 815

ENGINE				
1.6 i.e.	Petrol	63	06/94-08/96	159 B9.000

Engine	Information	A10	A20	A40	A50	A70	C10 - C30	C20	E01
All engines									359 888

ENGINE				
1.6 i.e.	Petrol	66	06/94-08/96	159 B9.000

Engine	Information	A10	A20	A40	A50	A70	C10 - C30	C20	E01
All engines									359 888

ENGINE				
1.8 4x4	Petrol	80	07/92-06/93	159 A4.000

Engine	Information	A10	A20	A40	A50	A70	C10 - C30	C20	E01
All engines	+automatic transmission, ->eng. 1339267, version Marelli			830 104					
All engines	+automatic transmission, eng. type 1339267 ->, version Marelli			830 114					
All engines	version Marelli			830 115	930 060	430 177/1			
All engines							490 303	C30	359 692
All engines	FOR: (SA)								359 398

ENGINE				
1.8 i.e.	Petrol	66	09/93-08/96	835 C4.000

Engine	Information	A10	A20	A40	A50	A70	C10 - C30	C20	E01
All engines	Qty: 2						470 146	C10	
All engines									359 889

ENGINE				
1.8 i.e.	Petrol	74	10/94-08/96	836 A5.000

Engine	Information	A10	A20	A40	A50	A70	C10 - C30	C20	E01
All engines	Qty: 2						470 146	C10	
All engines									359 889

ENGINE				
1.8 i.e.	Petrol	76	09/93-08/96	835 C2.000

Engine	Information	A10	A20	A40	A50	A70	C10 - C30	C20	E01
All engines	Qty: 2						470 146	C10	
All engines									359 889

ENGINE				
1.8 i.e.	Petrol	77	03/92-08/96	159 A4.046

Engine	Information	A10	A20	A40	A50	A70	C10 - C30	C20	E01
All engines	+automatic transmission, ->eng. 1339267, version Marelli			830 104					
All engines	+automatic transmission, eng. type 1339267 ->, version Marelli			830 114					

A10 CONDENSER	A20 CONTACT SET	A40 DISTRIBUTOR CAP	A50 ROTOR	A70 PICK-UP
C10 COIL	C20 IGNITION MODULE	C30 ELECTRONIC IGNITION KIT	E01 IGNITION CABLE SET	

Vehicle	alim.	kW	Date	Engine	FUNCTIONS ON THE VEHICLE							
					A10	A20	A40	A50	A70	C10 - C30	C20	E01

ENGINE				
1.8 i.e.	Petrol	77	03/92-08/96	159 A4.046

Engine	Information	A10	A20	A40	A50	A70	C10 - C30	C20	E01
All engines	version Marelli			830 115	930 060	430 177/1			
All engines							490 303	C30	359 692
All engines	FOR: (SA)								359 398

ENGINE				
1.8 i.e.	Petrol	81	03/90-08/96	159 A4.000

Engine	Information	A10	A20	A40	A50	A70	C10 - C30	C20	E01
All engines	+automatic transmission, ->eng. 1339267, version Marelli			830 104					
All engines	+automatic transmission, eng. type 1339267 ->, version Marelli			830 114					
All engines	version Marelli			830 115	930 060	430 177/1			
All engines							490 303	C30	359 692
All engines	FOR: (SA)								359 398

ENGINE				
2.0	Petrol	80	04/90-06/93	159 A6.046

Engine	Information	A10	A20	A40	A50	A70	C10 - C30	C20	E01
All engines	+automatic transmission, ->eng. 1339267, version Marelli			830 104					
All engines	+automatic transmission, eng. type 1339267 ->, version Marelli			830 114					
All engines	version Marelli			830 115	930 060	430 177/1			
All engines							490 303	C30	
All engines	->eng. 1518014								359 692

ENGINE				
2.0 i.e.	Petrol	83	10/90-09/96	159 A6.046

Engine	Information	A10	A20	A40	A50	A70	C10 - C30	C20	E01
All engines	+automatic transmission, ->eng. 1339267, version Marelli			830 104					
All engines	+automatic transmission, eng. type 1339267 ->, version Marelli			830 114					
All engines	version Marelli			830 115	930 060	430 177/1			
All engines							490 303	C30	
All engines	->eng. 1518014								359 692

ENGINE				
2.0 i.e. [BRA]	Petrol	81	04/93-12/96	159 A6.011

Engine	Information	A10	A20	A40	A50	A70	C10 - C30	C20	E01
All engines	+automatic transmission, version Marelli			830 114					
All engines	version Marelli			830 115	930 060	430 177/1			
All engines							490 303	C30	
All engines	->eng. 1518014								359 692

ENGINE				
2.0 i.e. 4x4	Petrol	83	03/92-03/95	159 A6.046

Engine	Information	A10	A20	A40	A50	A70	C10 - C30	C20	E01
All engines	+automatic transmission, ->eng. 1339267, version Marelli			830 104					
All engines	+automatic transmission, eng. type 1339267 ->, version Marelli			830 114					
All engines	version Marelli			830 115	930 060	430 177/1			
All engines							490 303	C30	
All engines	->eng. 1518014								359 692

TIPO I

ENGINE				
1.1	Petrol	41	01/88-10/91	160 A3.000

Engine	Information	A10	A20	A40	A50	A70	C10 - C30	C20	E01
All engines	version Ducellier			815 080	915 094			465 029	
All engines	version Marelli			830 109	930 060	430 180M		465 020	
All engines							470 108	C10	359 347

ENGINE				
1.1 i.e.	Petrol	37	10/94-10/95	156 C.046

Engine	Information	A10	A20	A40	A50	A70	C10 - C30	C20	E01
All engines							470 168	C10	359 694

A10 CONDENSER	A20 CONTACT SET	A40 DISTRIBUTOR CAP	A50 ROTOR	A70 PICK-UP
C10 COIL	C20 IGNITION MODULE	C30 ELECTRONIC IGNITION KIT	E01 IGNITION CABLE SET	

Vehicle	alim.	kW	Date	Engine	FUNCTIONS ON THE VEHICLE							
					A10	A20	A40	A50	A70	C10 - C30	C20	E01

ENGINE				
1.4	Petrol	52	07/87-12/89	160 A1.000, 160 A1.048

Engine	Information	A10	A20	A40	A50	A70	C10 - C30	C20	E01
Eng. 160 A1.000	version Marelli			830 101	930 047R	430 176M			
Eng. 160 A1.048	version Marelli			830 104					
Eng. 160 A1.048	->VET. 2415766, version Marelli				930 055R				
Eng. 160 A1.048	version Marelli, VET. 2415766 ->				930 059				
Eng. 160 A1.000							470 108	C10	465 020
Eng. 160 A1.048							470 148	C10	359 354

ENGINE				
1.4 i.e.	Petrol	51	05/89-04/95	160 A1.046, 836 A4.000

Engine	Information	A10	A20	A40	A50	A70	C10 - C30	C20	E01
Eng. 160 A1.046	->eng. 8503995, version Marelli			830 104					
Eng. 160 A1.046	eng. type 8503995 ->, version Marelli			830 115					
Eng. 160 A1.046	->VET. 2415766, version Marelli				930 055R				
Eng. 160 A1.046	version Marelli, VET. 2415766 ->				930 059				
Eng. 160 A1.046							470 148	C10	
Eng. 836 A4.000							470 168	C10	359 655
Eng. 160 A1.046	->eng. 8503995								359 808
Eng. 160 A1.046	eng. type 8503995 ->								359 815

ENGINE				
1.4 i.e.	Petrol	57	05/89-04/95	159 A2.000

Engine	Information	A10	A20	A40	A50	A70	C10 - C30	C20	E01
All engines	+automatic transmission, +air conditioning, +power steering, version Marelli			830 098					
All engines	version Marelli			830 101	930 060	430 176M			
All engines							470 108	C10	465 020

ENGINE				
1.6	Petrol	56	03/93-10/95	159 A3.048, 835 C1.000

Engine	Information	A10	A20	A40	A50	A70	C10 - C30	C20	E01
All engines	+automatic transmission, +air conditioning, +power steering, eng. type 8327193 ->, ->eng. 8503995, version Marelli			830 104					
All engines	+air conditioning, Selecta, 01/01/93 ->, version Marelli			830 114					
All engines	->eng. 8327193, version Marelli, +automatic transmission, +power steering, +air conditioning, eng. type 8503995 ->, ->year 01/01/93, 01/01/93 ->, Selecta			830 115					
All engines	version Marelli				930 059				
Eng. 159 A3.048	eng. type 8813854 ->, version Marelli					430 177/1			
Eng. 159 A3.048							470 148	C10	
Eng. 835 C1.000							470 168	C10	359 655
Eng. 159 A3.048	+automatic transmission, +power steering, ->eng. 8503995, +automatic transmission, +power steering, +air conditioning								359 808
Eng. 159 A3.048	->year 31/12/93, +automatic transmission, +power steering, eng. type 8503995 ->								359 815

ENGINE				
1.6	Petrol	58	03/88-10/92	160 A2.000

Engine	Information	A10	A20	A40	A50	A70	C10 - C30	C20	E01
All engines	version Marelli			830 104	930 055R				
All engines							470 148	C10	359 808

ENGINE				
1.6	Petrol	61	01/88-10/91	160 A2.000

Engine	Information	A10	A20	A40	A50	A70	C10 - C30	C20	E01
All engines	version Marelli			830 104	930 055R				
All engines							470 148	C10	359 808

ENGINE				
1.6 i.e.	Petrol	55	10/92-04/95	159 A3.048, 835 C1.000

Engine	Information	A10	A20	A40	A50	A70	C10 - C30	C20	E01
All engines	+automatic transmission, +air conditioning, +power steering, eng. type 8327193 ->, ->eng. 8503995, version Marelli			830 104					
All engines	+air conditioning, Selecta, 01/01/93 ->, version Marelli			830 114					
All engines	->eng. 8327193, version Marelli, +automatic transmission, +power steering, +air conditioning, eng. type 8503995 ->, ->year 01/01/93, 01/01/93 ->, Selecta			830 115					
All engines	version Marelli				930 059				
Eng. 159 A3.048	eng. type 8813854 ->, version Marelli					430 177/1			
Eng. 159 A3.048							470 148	C10	

A10	CONDENSER	A20	CONTACT SET	A40	DISTRIBUTOR CAP	A50	ROTOR	A70	PICK-UP
C10	COIL	C20	IGNITION MODULE	C30	ELECTRONIC IGNITION KIT	E01	IGNITION CABLE SET		

Vehicle	alim.	kW	Date	Engine	FUNCTIONS ON THE VEHICLE							
					A10	A20	A40	A50	A70	C10 - C30	C20	E01

ENGINE				
1.6 i.e.	Petrol	55	10/92-04/95	159 A3.048, 835 C1.000

Engine	Information	A10	A20	A40	A50	A70	C10 - C30	C20	E01
Eng. 835 C1.000							470 168	C10	359 655
Eng. 159 A3.048	+automatic transmission, +power steering, ->eng. 8503995, +automatic transmission, +power steering, +air conditioning								359 808
Eng. 159 A3.048	->year 31/12/93, +automatic transmission, +power steering, eng. type 8503995 ->								359 815

ENGINE				
1.6 i.e.	Petrol	57	07/90-01/93	159 A3.046

Engine	Information	A10	A20	A40	A50	A70	C10 - C30	C20	E01
All engines	+automatic transmission, +air conditioning, +power steering, eng. type 8327193 ->, ->eng. 8503995, version Marelli			830 104					
All engines	+air conditioning, Selecta, 01/01/93 ->, version Marelli			830 114					
All engines	->eng. 8327193, version Marelli, +automatic transmission, +power steering, +air conditioning, eng. type 8503995 ->, ->year 01/01/93, 01/01/93 ->, Selecta			830 115					
All engines	version Marelli				930 059				
All engines							470 148	C10	
All engines	+automatic transmission, +power steering, ->eng. 8503995, +automatic transmission, +power steering, +air conditioning								359 808
All engines	->year 31/12/93, +automatic transmission, +power steering, eng. type 8503995 ->								359 815

ENGINE				
1.6 i.e. [BRA]	Petrol	60	03/93-04/95	160 E2.011

Engine	Information	A10	A20	A40	A50	A70	C10 - C30	C20	E01
All engines	+automatic transmission, +air conditioning, +power steering, eng. type 8327193 ->, ->eng. 8503995, version Marelli			830 104					
All engines	+air conditioning, Selecta, 01/01/93 ->, version Marelli			830 114					
All engines	->eng. 8327193, version Marelli, +automatic transmission, +power steering, +air conditioning, eng. type 8503995 ->, ->year 01/01/93, 01/01/93 ->, Selecta			830 115					
All engines	version Marelli				930 059				
All engines							470 168	C10	359 655

ENGINE				
1.6 SX DGT	Petrol	66	05/89-10/95	159 A3.000

Engine	Information	A10	A20	A40	A50	A70	C10 - C30	C20	E01
All engines	+automatic transmission, +power steering, version Marelli			830 104					
All engines	version Marelli			830 115					
All engines	->eng. 8327193, version Marelli				930 055R				
All engines	eng. type 8327193 ->, version Marelli, +automatic transmission, +power steering				930 059				
All engines							470 148	C10	359 815
All engines	+automatic transmission								359 808

ENGINE				
1.8 i.e	Petrol	71	03/93-04/95	836 A5.000

Engine	Information	A10	A20	A40	A50	A70	C10 - C30	C20	E01
All engines	Qty: 2						470 146	C10	
All engines	eng. type 1486450 ->								359 889

ENGINE				
1.8 i.e.	Petrol	66	03/93-10/95	835 C4.000, 836 A6.000

Engine	Information	A10	A20	A40	A50	A70	C10 - C30	C20	E01
All engines	Qty: 2						470 146	C10	
All engines	eng. type 1486450 ->, eng. type 1486450 ->								359 889

ENGINE				
1.8 i.e.	Petrol	74	10/94-10/95	836 A5.000

Engine	Information	A10	A20	A40	A50	A70	C10 - C30	C20	E01
All engines	Qty: 2						470 146	C10	
All engines	eng. type 1486450 ->								359 889

ENGINE				
1.8 i.e.	Petrol	76	04/93-04/95	835 C2.000

Engine	Information	A10	A20	A40	A50	A70	C10 - C30	C20	E01
All engines	Qty: 2						470 146	C10	
All engines	eng. type 1486450 ->								359 889









A10 CONDENSER	A20 CONTACT SET	A40 DISTRIBUTOR CAP	A50 ROTOR	A70 PICK-UP
C10 COIL	C20 IGNITION MODULE	C30 ELECTRONIC IGNITION KIT	E01 IGNITION CABLE SET	

Vehicle	alim.	kW	Date	Engine	FUNCTIONS ON THE VEHICLE							
					A10	A20	A40	A50	A70	C10 - C30	C20	E01
ENGINE												
1.8 i.e.	Petrol	77	10/90-06/93	159 A4.046								
Engine	Information			A10	A20	A40	A50	A70	C10 - C30	C20	E01	
All engines	+automatic transmission, ->eng. 1339559, version Marelli					830 104						
All engines	+automatic transmission, eng. type 1339559 ->, version Marelli					830 114						
All engines	version Marelli					830 115	930 060	430 177/1				
All engines									490 303	C30		
All engines	LHD										359 692	
ENGINE												
1.8 i.e.	Petrol	81	10/90-06/93	159 A4.000								
Engine	Information			A10	A20	A40	A50	A70	C10 - C30	C20	E01	
All engines	+automatic transmission, ->eng. 1339559, version Marelli					830 104						
All engines	+automatic transmission, eng. type 1339559 ->, version Marelli					830 114						
All engines	version Marelli					830 115	930 060	430 177/1				
All engines									490 303	C30		
All engines	LHD										359 692	
ENGINE												
1.8 i.e. 16V Sport	Petrol	100	11/89-06/92	160 A5.000								
Engine	Information			A10	A20	A40	A50	A70	C10 - C30	C20	E01	
All engines	version Marelli					830 104	930 060	430 177/1				
All engines									490 303	C30		
ENGINE												
2.0	Petrol	104	03/93-04/95	836 A3.011								
Engine	Information			A10	A20	A40	A50	A70	C10 - C30	C20	E01	
All engines	version Marelli					830 114	930 060	430 177/1				
All engines									490 303	C30	359 650	
ENGINE												
2.0	Petrol	85	10/90-10/92	159 A5.046, 159 A6.046								
Engine	Information			A10	A20	A40	A50	A70	C10 - C30	C20	E01	
All engines	+automatic transmission, ->eng. 1339559, version Marelli					830 104						
All engines	+automatic transmission, +air conditioning, eng. type 1339559 ->, version Marelli					830 114						
All engines	version Marelli					830 115	930 060	430 177/1				
All engines									490 303	C30		
All engines	->eng. 1518014, LHD										359 692	
ENGINE												
2.0 16V	Petrol	107	07/91-04/95	160 A8.046								
Engine	Information			A10	A20	A40	A50	A70	C10 - C30	C20	E01	
All engines	->year 01/11/91, version Marelli					830 104						
All engines	01/11/91 ->, version Marelli					830 114						
All engines	version Marelli						930 060	430 177/1				
All engines									490 303	C30	359 650	
ENGINE												
2.0 i.e.	Petrol	80	06/90-03/92	159 A5.046								
Engine	Information			A10	A20	A40	A50	A70	C10 - C30	C20	E01	
All engines	+automatic transmission, ->eng. 1339559, version Marelli					830 104						
All engines	+automatic transmission, +air conditioning, eng. type 1339559 ->, version Marelli					830 114						
All engines	version Marelli					830 115	930 060	430 177/1				
All engines									490 303	C30		
All engines	LHD										359 692	
ENGINE												
2.0 i.e.	Petrol	83	03/90-04/95	159 A6.046								
Engine	Information			A10	A20	A40	A50	A70	C10 - C30	C20	E01	
All engines	+automatic transmission, ->eng. 1339559, version Marelli					830 104						
All engines	+automatic transmission, +air conditioning, eng. type 1339559 ->, version Marelli					830 114						
All engines	version Marelli					830 115	930 060	430 177/1				
All engines									490 303	C30		
All engines	->eng. 1518014										359 692	

A10 CONDENSER	A20 CONTACT SET	A40 DISTRIBUTOR CAP	A50 ROTOR	A70 PICK-UP
C10 COIL	C20 IGNITION MODULE	C30 ELECTRONIC IGNITION KIT	E01 IGNITION CABLE SET	

The present application list is a brief version. For the detailed information about the possibility of installation on a specific vehicle, please refer to our web-catalogue <http://catalogo.facet.eu/>

FUNCTIONS ON THE VEHICLE

Vehicle	alim.	kW	Date	Engine								
2.0 i.e. [BRA]												
Petrol	85	03/93-10/95	ENGINE									
				159 A6.011								
Engine	Information	A10	A20	A40	A50	A70	C10 - C30	C20	E01			
All engines	+automatic transmission, ->eng. 1339559, version Marelli			830 104								
All engines	+automatic transmission, +air conditioning, eng. type 1339559 ->, version Marelli			830 114								
All engines	version Marelli			830 115	930 060	430 177/1						
All engines							490 303	C30				
All engines	->eng. 1518014											359 692
2.0 i.e. 16V Sport												
Petrol	102	03/93-04/95	ENGINE									
				836 A3.000								
Engine	Information	A10	A20	A40	A50	A70	C10 - C30	C20	E01			
All engines	version Marelli			830 114	930 060	430 177/1						
All engines							490 303	C30				359 650
TIPO II												
1.4												
Petrol	70	10/15->	ENGINE									
				843 A1.000								
Engine	Information	A10	A20	A40	A50	A70	C10 - C30	C20	E01			
All engines	x 4, COIL ON PLUG, incl. spark plug connector						470 442	C10				
ULYSSE I												
1.8												
Petrol	73	05/97-08/02	ENGINE									
				LFW (XU7JP)								
Engine	Information	A10	A20	A40	A50	A70	C10 - C30	C20	E01			
All engines							470 188	C10				359 674
2.0												
Petrol	89	06/94-08/02	ENGINE									
				RFU (XU10J2C)								
Engine	Information	A10	A20	A40	A50	A70	C10 - C30	C20	E01			
All engines							470 188	C10				359 494
2.0 16V												
Petrol	100	09/00-08/02	ENGINE									
				RFN (EW10J4)								
Engine	Information	A10	A20	A40	A50	A70	C10 - C30	C20	E01			
All engines	incl. spark plug connector						470 408	C10				
2.0 Turbo												
Petrol	108	06/94-08/02	ENGINE									
				RGX (XU10J2CTE)								
Engine	Information	A10	A20	A40	A50	A70	C10 - C30	C20	E01			
All engines							470 188	C10				359 494
ULYSSE II												
2.0												
Petrol	100	08/02-06/11	ENGINE									
				RFN, RFN (EW10J4)								
Engine	Information	A10	A20	A40	A50	A70	C10 - C30	C20	E01			
Eng. RFN	x 4, COIL ON PLUG						470 408	C10				
Eng. RFN (EW10J4)							470 408	C10				
UNO												
1.0												
Petrol	31	06/89-02/92	ENGINE									
				156 A2.000								
Engine	Information	A10	A20	A40	A50	A70	C10 - C30	C20	E01			
All engines	Qty: 2						470 146	C10				
1.0												
Petrol	35	11/94-08/00	ENGINE									
				146 A2.166								
Engine	Information	A10	A20	A40	A50	A70	C10 - C30	C20	E01			
All engines	version Marelli			830 109	930 060	430 180M						
All engines											465 020	
1.0 i.e.												
Petrol	33	09/89-03/94	ENGINE									
				146 C7.000								
Engine	Information	A10	A20	A40	A50	A70	C10 - C30	C20	E01			
All engines	Qty: 2						470 146	C10				
1.3 Turbo i.e.												
Petrol	74	09/89-03/91	ENGINE									
				146 A2.246								
Engine	Information	A10	A20	A40	A50	A70	C10 - C30	C20	E01			
All engines	version Marelli			830 115	930 059							
All engines							490 303	C30				

A10 CONDENSER	A20 CONTACT SET	A40 DISTRIBUTOR CAP	A50 ROTOR	A70 PICK-UP
C10 COIL	C20 IGNITION MODULE	C30 ELECTRONIC IGNITION KIT	E01 IGNITION CABLE SET	

Vehicle	alim.	kW	Date	Engine	FUNCTIONS ON THE VEHICLE								
					A10	A20	A40	A50	A70	C10 - C30	C20	E01	
ENGINE													
1.3 Turbo i.e.	Petrol	77	04/85-08/89	146 A2.000									
Engine	Information			A10	A20	A40	A50	A70	C10 - C30	C20	E01		
All engines	version Marelli					830 098	930 055R						
All engines	+catalytic converter								490 303	C30			
ENGINE													
1.4 Turbo i.e.	Petrol	82	09/89-09/93	146 A8.046									
Engine	Information			A10	A20	A40	A50	A70	C10 - C30	C20	E01		
All engines	version Marelli					830 101	930 055R						
All engines									490 303	C30			
ENGINE													
1.4 Turbo i.e.	Petrol	87	12/89-12/96	146 A8.000									
Engine	Information			A10	A20	A40	A50	A70	C10 - C30	C20	E01		
All engines	version Marelli					830 101	930 055R						
All engines									490 303	C30			
ENGINE													
45 0.9	Petrol	33	03/83-07/96	146 A.000, 146 A1.000									
Engine	Information			A10	A20	A40	A50	A70	C10 - C30	C20	E01		
All engines	version Ducellier			615 039	715 122	815 058	915 083R						
All engines	version Marelli			630 128	730 146M	830 098	930 047R						
All engines									470 101D	C10			
ENGINE													
45 0.9	Petrol	34	02/84-12/88	146 A.000									
Engine	Information			A10	A20	A40	A50	A70	C10 - C30	C20	E01		
All engines	version Ducellier			615 039	715 122	815 058	915 083R						
All engines	version Marelli			630 128	730 146M	830 098	930 047R						
All engines									470 101D	C10			
ENGINE													
45 0.9 Trend	Petrol	33	09/89-09/92	146 A.048									
Engine	Information			A10	A20	A40	A50	A70	C10 - C30	C20	E01		
All engines	version Ducellier			615 039	715 122	815 058	915 083R						
All engines	version Marelli			630 128	730 146M	830 098	930 047R						
All engines									470 101D	C10	359 386		
ENGINE													
45 1.0	Petrol	32	06/86-12/93	156 A2.100									
Engine	Information			A10	A20	A40	A50	A70	C10 - C30	C20	E01		
All engines	version Marelli					830 109	930 060	430 180M		465 020			
All engines									470 108	C10	359 347		
All engines	version Ducellier									465 029			
ENGINE													
45 i.e. 1.0	Petrol	33	10/84-10/95	156 A2.246									
Engine	Information			A10	A20	A40	A50	A70	C10 - C30	C20	E01		
All engines	version Marelli					830 109	930 060	430 180M					
All engines									470 108	C10	465 020		
All engines											359 347		
ENGINE													
50 1.1	Petrol	37	01/90-12/93	156 C.046									
Engine	Information			A10	A20	A40	A50	A70	C10 - C30	C20	E01		
All engines	version Marelli					830 109	930 060	430 180M					
All engines									470 108	C10	465 020		
All engines											359 347		
ENGINE													
50 i.e. 1.1	Petrol	36	06/92-12/93	146 C3.000									
Engine	Information			A10	A20	A40	A50	A70	C10 - C30	C20	E01		
All engines	version Marelli					830 109	930 060	430 180M					
All engines									470 108	C10	465 020		
All engines											359 347		
ENGINE													
55 1.1	Petrol	40	01/83-08/89	138 B.000									
Engine	Information			A10	A20	A40	A50	A70	C10 - C30	C20	E01		
All engines											359 354		

A10 CONDENSER	A20 CONTACT SET	A40 DISTRIBUTOR CAP	A50 ROTOR	A70 PICK-UP
C10 COIL	C20 IGNITION MODULE	C30 ELECTRONIC IGNITION KIT	E01 IGNITION CABLE SET	

The present application list is a brief version. For the detailed information about the possibility of installation on a specific vehicle, please refer to our web-catalogue <http://catalogo.facet.eu/>

					FUNCTIONS ON THE VEHICLE							
Vehicle	alim.	kW	Date	Engine								
ENGINE												
60 1.1	Petrol	42	04/89-12/92	160 A3.000								
Engine	Information			A10	A20	A40	A50	A70	C10 - C30	C20	E01	
All engines	version Ducellier					815 080	915 094				465 029	
All engines	version Marelli					830 109	930 060	430 180M			465 020	
All engines									470 108	C10		359 347
ENGINE												
60 1.1	Petrol	43	05/85-02/92	146 A4.048, 146 A6.000								
Engine	Information			A10	A20	A40	A50	A70	C10 - C30	C20	E01	
All engines	version Marelli					830 101	930 047R	430 176M				
Eng. 146 A4.048	version Marelli						930 060					
All engines									470 108	C10	465 020	
Eng. 146 A4.048												359 354
ENGINE												
70 1.3	Petrol	50	01/83-04/85	138 B2.000								
Engine	Information			A10	A20	A40	A50	A70	C10 - C30	C20	E01	
All engines												359 354
ENGINE												
70 1.3i SX	Petrol	0	01/83-12/89	--								
Engine	Information			A10	A20	A40	A50	A70	C10 - C30	C20	E01	
All engines	version Marelli					830 104	930 055R					
All engines	version Bosch						906 061R	406 153				
All engines									470 103	C10		
ENGINE												
70 i.e. 1.4	Petrol	51	09/89-07/96	160 A1.046								
Engine	Information			A10	A20	A40	A50	A70	C10 - C30	C20	E01	
All engines	->eng. 8818804, version Marelli					830 104						
All engines	eng. type 8818804 ->, version Marelli					830 114						
All engines	->eng. 7768530, version Marelli						930 055R					
All engines	eng. type 7768530 ->, version Marelli						930 059					
All engines									470 148	C10		359 808
ENGINE												
70 i.e. 1.4	Petrol	53	09/89-12/93	146 C1.000								
Engine	Information			A10	A20	A40	A50	A70	C10 - C30	C20	E01	
All engines	->eng. 8818804, version Marelli					830 104						
All engines	eng. type 8818804 ->, version Marelli					830 114						
All engines	->eng. 7768530, version Marelli						930 055R					
All engines	eng. type 7768530 ->, version Marelli						930 059					
All engines									470 148	C10		359 808
ENGINE												
70 S 1.4	Petrol	52	10/88-06/06	160 A1.048								
Engine	Information			A10	A20	A40	A50	A70	C10 - C30	C20	E01	
All engines	->eng. 8818804, version Marelli					830 104						
All engines	eng. type 8818804 ->, version Marelli					830 114						
All engines	->eng. 7768530, version Marelli						930 055R					
All engines	eng. type 7768530 ->, version Marelli						930 059					
All engines									470 148	C10		359 808
ENGINE												
75 i.e. 1.5	Petrol	55	10/85-12/93	138 C2.048, 149 C1.000								
Engine	Information			A10	A20	A40	A50	A70	C10 - C30	C20	E01	
All engines	->eng. 8818804, version Marelli					830 104						
Eng. 149 C1.000	eng. type 8818804 ->, version Marelli					830 114						
Eng. 138 C2.048	version Bosch						906 061R	406 153				
All engines	->eng. 7768530, version Marelli						930 055R					
Eng. 149 C1.000	eng. type 7768530 ->, version Marelli						930 059					
Eng. 138 C2.048									470 103	C10		
Eng. 149 C1.000									470 148	C10		359 808
ENGINE												
CS 1.1	Petrol	43	09/87-09/91	146 A6.000								
Engine	Information			A10	A20	A40	A50	A70	C10 - C30	C20	E01	
All engines	version Marelli					830 101	930 047R	430 176M				
All engines									470 158	C10	465 020	

A10 CONDENSER	A20 CONTACT SET	A40 DISTRIBUTOR CAP	A50 ROTOR	A70 PICK-UP
C10 COIL	C20 IGNITION MODULE	C30 ELECTRONIC IGNITION KIT	E01 IGNITION CABLE SET	

Vehicle	alim.	kW	Date	Engine	FUNCTIONS ON THE VEHICLE									
					A10	A20	A40	A50	A70	C10 - C30	C20	E01		
Mondo 1.0					ENGINE									
Mondo 1.0	Petrol	33	01/98->	146 A2.166										
Engine	Information				A10	A20	A40	A50	A70	C10 - C30	C20	E01		
All engines	version Marelli						830 109	930 060	430 180M					
All engines										470 108	C10	465 020	359 347	
Mondo 1.0 [IND]					ENGINE									
Mondo 1.0 [IND]	Petrol	33	01/98->	146 A2.166										
Engine	Information				A10	A20	A40	A50	A70	C10 - C30	C20	E01		
All engines	version Marelli						830 109	930 060	430 180M					
All engines										470 108	C10	465 020	359 347	
Mondo 1.0 i.e.					ENGINE									
Mondo 1.0 i.e.	Petrol	33	01/96->	146 D8.000										
Engine	Information				A10	A20	A40	A50	A70	C10 - C30	C20	E01		
All engines										470 168	C10		359 694	
Mondo 1.2 i.e. [IND]					ENGINE									
Mondo 1.2 i.e. [IND]	Petrol	44	01/96->	178 D5.066										
Engine	Information				A10	A20	A40	A50	A70	C10 - C30	C20	E01		
All engines	Qty: 2									470 146	C10			
All engines													359 616	
X 1/9					ENGINE									
1.3	Petrol	54	10/75-06/78	128 AS.000										
Engine	Information				A10	A20	A40	A50	A70	C10 - C30	C20	E01		
All engines	version Marelli					730 140		930 036R						
All engines										470 101D	C10			

A10	CONDENSER	A20	CONTACT SET	A40	DISTRIBUTOR CAP	A50	ROTOR	A70	PICK-UP
C10	COIL	C20	IGNITION MODULE	C30	ELECTRONIC IGNITION KIT	E01	IGNITION CABLE SET		

The present application list is a brief version. For the detailed information about the possibility of installation on a specific vehicle, please refer to our web-catalogue <http://catalogo.facet.eu/>

Vehicle	alim.	kW	Date	Engine	FUNCTIONS ON THE VEHICLE							
					A10	A20	A40	A50	A70	C10 - C30	C20	E01

BRAVA

1.6i 16v	Petrol	78	01/00->	ENGINE
				1.6 Mpi

Engine	Information	A10	A20	A40	A50	A70	C10 - C30	C20	E01
All engines							470 345	C10	360 503

1.8i 16v	Petrol	97	01/00->	ENGINE
				1.8 Mpi

Engine	Information	A10	A20	A40	A50	A70	C10 - C30	C20	E01
All engines	Qty: 4						470 384	C10	

COUPÈ

2.0i 16V	Petrol	0	01/95-12/97	ENGINE
				2.0 Mpi

Engine	Information	A10	A20	A40	A50	A70	C10 - C30	C20	E01
All engines	version Marelli			830 114	930 060	430 177/1			
All engines							490 303	C30	359 650

MAREA

1.8i 16v	Petrol	97	01/00-12/01	ENGINE
				1.8 Mpi

Engine	Information	A10	A20	A40	A50	A70	C10 - C30	C20	E01
All engines	Qty: 4						470 384	C10	

2.0i 20v	Petrol	104	01/99-12/00	ENGINE
				2.0 Mpi

Engine	Information	A10	A20	A40	A50	A70	C10 - C30	C20	E01
All engines	Qty: 5						470 314	C10	

PALIO

1.0i	Petrol	0	01/96->	ENGINE
				1.0 Mpi, 1.0 Mpi Fire

Engine	Information	A10	A20	A40	A50	A70	C10 - C30	C20	E01
All engines	Qty: 2						470 146	C10	

1.0i 16v	Petrol	0	01/01->	ENGINE
				1.0 Mpi 16v Fire

Engine	Information	A10	A20	A40	A50	A70	C10 - C30	C20	E01
All engines							470 416	C10	360 505

1.3i 16v	Petrol	0	01/00->	ENGINE
				1.3 Mpi 16v Fire

Engine	Information	A10	A20	A40	A50	A70	C10 - C30	C20	E01
All engines							470 416	C10	360 505

1.5i	Petrol	0	01/96-12/00	ENGINE
				1.5 Mpi

Engine	Information	A10	A20	A40	A50	A70	C10 - C30	C20	E01
All engines	Qty: 2						470 146	C10	

1.6i	Petrol	0	01/99-12/00	ENGINE
				1.6 Mpi, 1.6 Spi

Engine	Information	A10	A20	A40	A50	A70	C10 - C30	C20	E01
Eng. 1.6 Spi	Qty: 2						470 146	C10	
Eng. 1.6 Mpi							470 345	C10	360 503

1.6i 16v	Petrol	0	01/96->	ENGINE
				1.6 Mpi 16v

Engine	Information	A10	A20	A40	A50	A70	C10 - C30	C20	E01
All engines							470 345	C10	360 503

SIENA

1.0i	Petrol	0	01/99-12/00	ENGINE
				1.0 Mpi

Engine	Information	A10	A20	A40	A50	A70	C10 - C30	C20	E01
All engines	Qty: 2						470 146	C10	

1.3i 16v	Petrol	0	01/00-12/00	ENGINE
				1.3 Mpi Fire



Engine	Information	A10	A20	A40	A50	A70	C10 - C30	C20	E01
All engines							470 416	C10	360 505

A10 CONDENSER	A20 CONTACT SET	A40 DISTRIBUTOR CAP	A50 ROTOR	A70 PICK-UP
C10 COIL	C20 IGNITION MODULE	C30 ELECTRONIC IGNITION KIT	E01 IGNITION CABLE SET	

Vehicle	alim.	kW	Date	Engine	FUNCTIONS ON THE VEHICLE									
					A10	A20	A40	A50	A70	C10 - C30	C20	E01		
ENGINE														
1.5i	Petrol	0	01/99-12/00	1.5 Mpi										
ENGINE														
Engine Information					A10	A20	A40	A50	A70	C10 - C30	C20	E01		
All engines Qty: 2										470 146	C10			
1.6i	Petrol	0	01/98-12/00	1.6 Mpi, 1.6 Spi										
ENGINE														
Engine Information					A10	A20	A40	A50	A70	C10 - C30	C20	E01		
All engines Qty: 2										470 146	C10			
1.6i 16v	Petrol	0	01/98-12/99	1.6 Mpi										
ENGINE														
Engine Information					A10	A20	A40	A50	A70	C10 - C30	C20	E01		
All engines										470 345	C10		360 503	
STRADA														
ENGINE														
1.5i	Petrol	0	01/99-12/01	1.5 Mpi										
ENGINE														
Engine Information					A10	A20	A40	A50	A70	C10 - C30	C20	E01		
All engines Qty: 2										470 146	C10			
1.6i 16v	Petrol	0	01/99->	1.6 Mpi										
ENGINE														
Engine Information					A10	A20	A40	A50	A70	C10 - C30	C20	E01		
All engines										470 345	C10		360 503	
1.6i 8v	Petrol	0	01/99-12/00	1.6 Mpi										
ENGINE														
Engine Information					A10	A20	A40	A50	A70	C10 - C30	C20	E01		
All engines Qty: 2										470 146	C10			
TIPO														
ENGINE														
1.6i	Petrol	0	01/93-12/97	1.6 Mpi, 1.6 Spi										
ENGINE														
Engine Information					A10	A20	A40	A50	A70	C10 - C30	C20	E01		
All engines Eng. 1.6 Spi										470 168	C10		359 655	
2.0i 16V	Petrol	0	01/94-12/95	2.0 Mpi										
ENGINE														
Engine Information					A10	A20	A40	A50	A70	C10 - C30	C20	E01		
All engines version Marelli							830 114	930 060	430 177/1					
All engines										490 303	C30		359 650	
2.0i 8v	Petrol	0	01/94-12/95	2.0 Mpi										
ENGINE														
Engine Information					A10	A20	A40	A50	A70	C10 - C30	C20	E01		
All engines version Marelli							830 115	930 060	430 177/1					
All engines										490 303	C30			
UNO														
ENGINE														
1.4i Turbo	Petrol	0	01/94-12/96	1.4 Mpi										
ENGINE														
Engine Information					A10	A20	A40	A50	A70	C10 - C30	C20	E01		
All engines ->ch. 5.407.526, version Marelli							830 101	930 055R						
All engines ch. 5.407.527 ->, version Marelli							830 115	930 059						
All engines										490 303	C30			
1.5i	Petrol	0	01/92-12/96	1.5 Spi										
ENGINE														
Engine Information					A10	A20	A40	A50	A70	C10 - C30	C20	E01		
All engines Qty: 2										470 146	C10			
1.5i Furgoneta	Petrol	0	01/92->	1.5 Mpi, 1.5 Spi										
ENGINE														
Engine Information					A10	A20	A40	A50	A70	C10 - C30	C20	E01		
All engines Qty: 2										470 146	C10			
1.6i	Petrol	0	01/95-12/96	1.6 Mpi										
ENGINE														
Engine Information					A10	A20	A40	A50	A70	C10 - C30	C20	E01		
All engines										470 168	C10			

A10 CONDENSER	A20 CONTACT SET	A40 DISTRIBUTOR CAP	A50 ROTOR	A70 PICK-UP
C10 COIL	C20 IGNITION MODULE	C30 ELECTRONIC IGNITION KIT	E01 IGNITION CABLE SET	

The present application list is a brief version. For the detailed information about the possibility of installation on a specific vehicle, please refer to our web-catalogue <http://catalogo.facet.eu/>

				FUNCTIONS ON THE VEHICLE								
Vehicle	alim.	kW	Date	Engine								
					A10	A20	A40	A50	A70	C10 - C30	C20	E01

UNO CS

				ENGINE
1.5i	Petrol	0	01/92-12/96	1.5 Spi

Engine	Information	A10	A20	A40	A50	A70	C10 - C30	C20	E01
All engines	Qty: 2						470 146	C10	

UNO MILLE

				ENGINE
1.0i	Petrol	0	01/96->	1.0 Mpi, 1.0 Mpi Fire, 1.0 Spi

Engine	Information	A10	A20	A40	A50	A70	C10 - C30	C20	E01
All engines	Qty: 2						470 146	C10	

A10	CONDENSER	A20	CONTACT SET	A40	DISTRIBUTOR CAP	A50	ROTOR	A70	PICK-UP
C10	COIL	C20	IGNITION MODULE	C30	ELECTRONIC IGNITION KIT	E01	IGNITION CABLE SET		

Vehicle	alim.	kW	Date	Engine	FUNCTIONS ON THE VEHICLE							
					A10	A20	A40	A50	A70	C10 - C30	C20	E01

B-MAX

				ENGINE
1.0 EcoBoost	Petrol	103	02/16->	YYJC

Engine	Information	A10	A20	A40	A50	A70	C10 - C30	C20	E01
All engines	x 3, COIL ON PLUG						470 619	C10	

				ENGINE
1.0 EcoBoost	Petrol	74	10/12->	SFJA, SFJB, SFJC, SFJD

Engine	Information	A10	A20	A40	A50	A70	C10 - C30	C20	E01
All engines	x 3, COIL ON PLUG						470 619	C10	

				ENGINE
1.0 EcoBoost	Petrol	88	08/12->	M1JA

Engine	Information	A10	A20	A40	A50	A70	C10 - C30	C20	E01
All engines	x 3, COIL ON PLUG						470 619	C10	

				ENGINE
1.0 EcoBoost	Petrol	92	10/12->	M1JE, M1JH

Engine	Information	A10	A20	A40	A50	A70	C10 - C30	C20	E01
All engines	x 3, COIL ON PLUG						470 619	C10	

				ENGINE
1.4	Petrol	66	10/12->	SPJD, SPJE

Engine	Information	A10	A20	A40	A50	A70	C10 - C30	C20	E01
All engines	x 1, D.I.S.						470 481	C10	
Eng. SPJD									358 242

				ENGINE
1.4 LPG	Petrol/ Liquified Petro- leum Gas (LPG)	64	08/13->	RTJC

Engine	Information	A10	A20	A40	A50	A70	C10 - C30	C20	E01
All engines	x 1, D.I.S.						470 481	C10	
All engines									358 242

				ENGINE
1.4 LPG	Petrol/ Liquified Petro- leum Gas (LPG)	66	10/12->	RTJC

Engine	Information	A10	A20	A40	A50	A70	C10 - C30	C20	E01
All engines	x 1, D.I.S.						470 481	C10	
All engines									358 242

				ENGINE
1.6 Ti	Petrol	77	10/12->	IQJA, IQJC

Engine	Information	A10	A20	A40	A50	A70	C10 - C30	C20	E01
All engines	x 1, D.I.S.						470 481	C10	
Eng. IQJA									358 242

CAPRI III

				ENGINE
1.3	Petrol	40	01/78-06/85	J1E

Engine	Information	A10	A20	A40	A50	A70	C10 - C30	C20	E01
All engines	version Bosch			806 079	906 012R				

C-MAX I

				ENGINE
1.6	Petrol	74	02/07-09/10	HWDA, HWDB, SHDA, SHDB, SHDC

Engine	Information	A10	A20	A40	A50	A70	C10 - C30	C20	E01
All engines	x 1, D.I.S.						470 481	C10	
All engines									358 242









				ENGINE
1.6	Petrol	85	04/07-09/10	HXDA, HXDB, SIDA

Engine	Information	A10	A20	A40	A50	A70	C10 - C30	C20	E01
All engines	x 1, D.I.S.						470 481	C10	

				ENGINE
1.8	Petrol	90	02/07-09/10	QQDC

Engine	Information	A10	A20	A40	A50	A70	C10 - C30	C20	E01
All engines	x 4, COIL ON PLUG						470 480	C10	

A10 CONDENSER	A20 CONTACT SET	A40 DISTRIBUTOR CAP	A50 ROTOR	A70 PICK-UP
C10 COIL	C20 IGNITION MODULE	C30 ELECTRONIC IGNITION KIT	E01 IGNITION CABLE SET	

					FUNCTIONS ON THE VEHICLE							
Vehicle	alim.	kW	Date	Engine								
ENGINE												
1.8	Petrol	92	02/07-09/10	QQDA, QQDB								
ENGINE												
Engine		Information			A10	A20	A40	A50	A70	C10 - C30	C20	E01
All engines		x 4, COIL ON PLUG								470 480	C10	
ENGINE												
1.8 Flexifuel	Petrol/ Ethanol	92	02/07-09/10	Q7DA								
ENGINE												
Engine		Information			A10	A20	A40	A50	A70	C10 - C30	C20	E01
All engines		x 4, COIL ON PLUG								470 480	C10	
ENGINE												
2.0	Petrol	107	02/07-09/10	AODA, AODB, AODE, SYDA								
ENGINE												
Engine		Information			A10	A20	A40	A50	A70	C10 - C30	C20	E01
All engines		x 4, COIL ON PLUG								470 480	C10	
ENGINE												
2.0 CNG	Petrol/ Com- pressed Natural Gas (CNG)	107	04/09-09/10	SYDA								
ENGINE												
Engine		Information			A10	A20	A40	A50	A70	C10 - C30	C20	E01
All engines		x 4, COIL ON PLUG								470 480	C10	
ENGINE												
2.0 LPG	Petrol/ Liquified Petro- leum Gas (LPG)	107	06/08-09/10	SYDA								
ENGINE												
Engine		Information			A10	A20	A40	A50	A70	C10 - C30	C20	E01
All engines		x 4, COIL ON PLUG								470 480	C10	
C-MAX II												
ENGINE												
1.0 EcoBoost	Petrol	74	10/12-06/19	M2DA, M2DC, SFDA								
ENGINE												
Engine		Information			A10	A20	A40	A50	A70	C10 - C30	C20	E01
Eng. M2DA, M2DC		->year 01/06/15, x 3, COIL ON PLUG								470 619	C10	
Eng. SFDA		Qty: 3								470 619	C10	
ENGINE												
1.0 EcoBoost	Petrol	88	10/12->	--								
ENGINE												
Engine		Information			A10	A20	A40	A50	A70	C10 - C30	C20	E01
All engines		Qty: 3								470 619	C10	
ENGINE												
1.0 EcoBoost	Petrol	92	10/12-06/19	M1DA, M1DD								
ENGINE												
Engine		Information			A10	A20	A40	A50	A70	C10 - C30	C20	E01
All engines		->year 01/06/15, x 3, COIL ON PLUG								470 619	C10	
ENGINE												
1.5 16V	Petrol	0	03/15->	--								
ENGINE												
Engine		Information			A10	A20	A40	A50	A70	C10 - C30	C20	E01
All engines		Qty: 4								470 623	C10	
ENGINE												
1.5 EcoBoost	Petrol	110	03/15-06/19	M8DB, M8DF								
ENGINE												
Engine		Information			A10	A20	A40	A50	A70	C10 - C30	C20	E01
All engines		x 4, COIL ON PLUG								470 623	C10	
ENGINE												
1.5 EcoBoost	Petrol	134	03/15-06/19	M9DB								
ENGINE												
Engine		Information			A10	A20	A40	A50	A70	C10 - C30	C20	E01
All engines		x 4, COIL ON PLUG								470 623	C10	
ENGINE												
1.6 CNG	Petrol/ Com- pressed Natural Gas (CNG)	86	01/13-12/14	MUDA								
ENGINE												
Engine		Information			A10	A20	A40	A50	A70	C10 - C30	C20	E01
All engines		x 1, D.I.S.								470 481	C10	

A10 CONDENSER	A20 CONTACT SET	A40 DISTRIBUTOR CAP	A50 ROTOR	A70 PICK-UP
C10 COIL	C20 IGNITION MODULE	C30 ELECTRONIC IGNITION KIT	E01 IGNITION CABLE SET	

Vehicle	alim.	kW	Date	Engine	FUNCTIONS ON THE VEHICLE							
					A10	A20	A40	A50	A70	C10 - C30	C20	E01
ENGINE												
1.6 Flexifuel	Petrol/ Ethanol	88	02/11-06/19	MUDA, MUDD								
Engine	Information											
All engines	x 1, D.I.S.			A10	A20	A40	A50	A70	C10 - C30	C20	E01	
									470 481	C10		
ENGINE												
1.6 LPG	Petrol/ Liquified Petro- leum Gas (LPG)	86	02/12-06/19	MUDA, MUDD								
Engine	Information											
All engines	x 1, D.I.S.			A10	A20	A40	A50	A70	C10 - C30	C20	E01	
									470 481	C10		
ENGINE												
1.6 LPG	Petrol/ Liquified Petro- leum Gas (LPG)	88	02/12-06/19	MUDA, MUDD								
Engine	Information											
All engines	x 1, D.I.S.			A10	A20	A40	A50	A70	C10 - C30	C20	E01	
									470 481	C10		
ENGINE												
1.6 Ti	Petrol	63	12/10-06/19	XTDA, XTDB								
Engine	Information											
All engines	x 1, D.I.S.			A10	A20	A40	A50	A70	C10 - C30	C20	E01	
Eng. XTDA									470 481	C10		
											358 242	
ENGINE												
1.6 Ti	Petrol	77	10/10-06/19	IQDA, IQDB								
Engine	Information											
All engines	x 1, D.I.S.			A10	A20	A40	A50	A70	C10 - C30	C20	E01	
All engines									470 481	C10		
											358 242	
ENGINE												
1.6 Ti	Petrol	88	02/12-06/19	MUDA, MUDD								
Engine	Information											
All engines	x 1, D.I.S.			A10	A20	A40	A50	A70	C10 - C30	C20	E01	
									470 481	C10		
ENGINE												
1.6 Ti	Petrol	92	12/10-06/19	PNDA, PNDD								
Engine	Information											
All engines	x 1, D.I.S.			A10	A20	A40	A50	A70	C10 - C30	C20	E01	
Eng. PNDA									470 481	C10		
											358 242	
CORSAIR												
ENGINE												
1.5	Petrol	40	10/63-09/65	EV 15 N								
Engine	Information											
All engines				A10	A20	A40	A50	A70	C10 - C30	C20	E01	
						828 070	928 006					
ENGINE												
1.5	Petrol	43	10/63-09/65	EV 15 LN								
Engine	Information											
All engines				A10	A20	A40	A50	A70	C10 - C30	C20	E01	
						828 070	928 006					
ENGINE												
1.5 GT	Petrol	56	10/63-09/65	EV 15 LH								
Engine	Information											
All engines				A10	A20	A40	A50	A70	C10 - C30	C20	E01	
						828 070	928 006					
CORTINA												
ENGINE												
1200	Petrol	34	10/62-09/66	--								
Engine	Information											
All engines				A10	A20	A40	A50	A70	C10 - C30	C20	E01	
					728 083MHV	828 070, 828 075	928 006					
ENGINE												
1200	Petrol	35	10/62-09/66	--								
Engine	Information											
All engines				A10	A20	A40	A50	A70	C10 - C30	C20	E01	
					728 083MHV	828 070, 828 075	928 006					

A10	CONDENSER	A20	CONTACT SET	A40	DISTRIBUTOR CAP	A50	ROTOR	A70	PICK-UP
C10	COIL	C20	IGNITION MODULE	C30	ELECTRONIC IGNITION KIT	E01	IGNITION CABLE SET		

The present application list is a brief version. For the detailed information about the possibility of installation on a specific vehicle, please refer to our web-catalogue <http://catalogo.facet.eu/>

FUNCTIONS ON THE VEHICLE

Vehicle	alim.	kW	Date	Engine	 A10	 A20	 A40	 A50	 A70	 C10 - C30	 C20	 E01
---------	-------	----	------	--------	---	---	---	--	---	---	---	---

				ENGINE
1300	Petrol	42	10/70-03/72	KL 13 H

Engine	Information	A10	A20	A40	A50	A70	C10 - C30	C20	E01
All engines	version Ford		719 043HV	819 083	919 085				
All engines	version Bosch			806 109	906 025R				
All engines									360 078

				ENGINE
1500	Petrol	43	10/62-09/66	--

Engine	Information	A10	A20	A40	A50	A70	C10 - C30	C20	E01
All engines			728 083MHV	828 070, 828 075	928 006				

				ENGINE
1500 GT	Petrol	56	10/62-09/66	--

Engine	Information	A10	A20	A40	A50	A70	C10 - C30	C20	E01
All engines				828 070, 828 075	928 006				

				ENGINE
GT	Petrol	56	10/62-09/66	--

Engine	Information	A10	A20	A40	A50	A70	C10 - C30	C20	E01
All engines			728 083MHV	828 070, 828 075	928 006				

				ENGINE
Lotus	Petrol	78	10/62-09/70	--

Engine	Information	A10	A20	A40	A50	A70	C10 - C30	C20	E01
All engines					928 006				

				ENGINE
Lotus Spezial	Petrol	103	10/62-09/66	--

Engine	Information	A10	A20	A40	A50	A70	C10 - C30	C20	E01
All engines					928 006				

COUGAR

				ENGINE
2.0 16V	Petrol	96	08/98-12/01	EDBA, EDBB, EDBC, EDBD

Engine	Information	A10	A20	A40	A50	A70	C10 - C30	C20	E01
All engines	x 1, D.I.S.						470 532	C10	
All engines									360 624

				ENGINE
2.5 ST 200	Petrol	151	01/00-12/01	SGA

Engine	Information	A10	A20	A40	A50	A70	C10 - C30	C20	E01
All engines	->year 01/09/00, x 1, D.I.S.						470 170	C10	

				ENGINE
2.5 V6 24V	Petrol	125	08/98-12/01	JP25LCBD, LCBA, LCBB, LCBC, LCBE

Engine	Information	A10	A20	A40	A50	A70	C10 - C30	C20	E01
All engines	->year 01/09/00, x 1, D.I.S.						470 170	C10	
Eng. LCBB, LCBC, LCBE							470 170	C10	

ECOSPORT

				ENGINE
1.0 EcoBoost	Petrol	103	03/16->	YYJD, YYJF

Engine	Information	A10	A20	A40	A50	A70	C10 - C30	C20	E01
All engines	x 3, COIL ON PLUG						470 619	C10	

				ENGINE
1.0 EcoBoost	Petrol	74	04/18->	SFJL

Engine	Information	A10	A20	A40	A50	A70	C10 - C30	C20	E01
All engines	x 3, COIL ON PLUG						470 619	C10	

				ENGINE
1.0 EcoBoost	Petrol	92	10/13->	M1JC, M1JJ, M1JU

Engine	Information	A10	A20	A40	A50	A70	C10 - C30	C20	E01
All engines	x 3, COIL ON PLUG						470 619	C10	

				ENGINE
1.5 Ti	Petrol	82	10/13->	UEJB, UEJE

Engine	Information	A10	A20	A40	A50	A70	C10 - C30	C20	E01
All engines	x 1, D.I.S.						470 481	C10	

A10 CONDENSER	A20 CONTACT SET	A40 DISTRIBUTOR CAP	A50 ROTOR	A70 PICK-UP
C10 COIL	C20 IGNITION MODULE	C30 ELECTRONIC IGNITION KIT	E01 IGNITION CABLE SET	

Vehicle	alim.	kW	Date	Engine	FUNCTIONS ON THE VEHICLE									
					A10	A20	A40	A50	A70	C10 - C30	C20	E01		
ENGINE														
1.5 Ti-VCT	Petrol	81	10/13->	UEJB, UEJE										
Engine	Information				A10	A20	A40	A50	A70	C10 - C30	C20	E01		
All engines	x 1, D.I.S.									470 481	C10			
ENGINE														
1.6 Ti-VCT	Petrol	90	08/12->	HXJD, IQJB										
Engine	Information				A10	A20	A40	A50	A70	C10 - C30	C20	E01		
All engines	x 1, D.I.S.									470 481	C10			
ENGINE														
2.0 4x4	Petrol	103	08/12->	C20HDEA										
Engine	Information				A10	A20	A40	A50	A70	C10 - C30	C20	E01		
All engines	x 4, COIL ON PLUG									470 480	C10			
ESCORT I														
ENGINE														
RS 1600	Petrol	84	01/70-10/74	--										
Engine	Information				A10	A20	A40	A50	A70	C10 - C30	C20	E01		
All engines							828 075	928 006						
ENGINE														
RS 1600	Petrol	90	01/70-10/74	BDA										
Engine	Information				A10	A20	A40	A50	A70	C10 - C30	C20	E01		
All engines							828 075	928 006						
ENGINE														
Twin Cam	Petrol	80	03/68-08/71	K5										
Engine	Information				A10	A20	A40	A50	A70	C10 - C30	C20	E01		
All engines								928 006						
ESCORT II														
ENGINE														
1.6 RS	Petrol	62	12/74-08/80	LC										
Engine	Information				A10	A20	A40	A50	A70	C10 - C30	C20	E01		
All engines							828 075	928 006						
ENGINE														
1.8	Petrol	115	12/74-08/80	--										
Engine	Information				A10	A20	A40	A50	A70	C10 - C30	C20	E01		
All engines							828 075	928 006						
ENGINE														
RS 1800	Petrol	92	03/75-08/77	KL 18 S										
Engine	Information				A10	A20	A40	A50	A70	C10 - C30	C20	E01		
All engines							828 075	928 006						
ESCORT III														
ENGINE														
1.1	Petrol	37	08/83-07/90	GSE, GSG										
Engine	Information				A10	A20	A40	A50	A70	C10 - C30	C20	E01		
Eng. GSE	version Bosch					706 049HDV5	806 079	906 025R						
Eng. GSG												360 007		
ENGINE														
1.3	Petrol	46	07/88-07/90	JBA										
Engine	Information				A10	A20	A40	A50	A70	C10 - C30	C20	E01		
All engines										470 312	C10			
ENGINE														
1.3	Petrol	51	09/80-02/86	JPA										
Engine	Information				A10	A20	A40	A50	A70	C10 - C30	C20	E01		
All engines	version Lucas						828 083							
All engines	version Bosch							906 060R						
All engines										470 169	C10			
ENGINE														
1.4 i	Petrol	54	02/86-07/90	F6B, F6D, FUC										
Engine	Information				A10	A20	A40	A50	A70	C10 - C30	C20	E01		
All engines	version Bosch						806 079							
Eng. F6D, FUC	version Lucas						828 096	928 026R						
Eng. F6D, FUC	version Bosch							906 061R						
Eng. F6B	version Bosch							906 121R						

A10	CONDENSER	A20	CONTACT SET	A40	DISTRIBUTOR CAP	A50	ROTOR	A70	PICK-UP
C10	COIL	C20	IGNITION MODULE	C30	ELECTRONIC IGNITION KIT	E01	IGNITION CABLE SET		

The present application list is a brief version. For the detailed information about the possibility of installation on a specific vehicle, please refer to our web-catalogue <http://catalogo.facet.eu/>

Vehicle	alim.	kW	Date	Engine	FUNCTIONS ON THE VEHICLE							
					A10	A20	A40	A50	A70	C10 - C30	C20	E01

				ENGINE
1.4 i	Petrol	54	02/86-07/90	F6B, F6D, FUC

Engine	Information	A10	A20	A40	A50	A70	C10 - C30	C20	E01
All engines							470 169, 470 312	C10	
Eng. F6D, FUC									360 281

				ENGINE
1.6	Petrol	58	09/80-12/85	LP1, LPA

Engine	Information	A10	A20	A40	A50	A70	C10 - C30	C20	E01
All engines	version Lucas			828 083					
All engines	version Bosch				906 060R				
All engines							470 169	C10	

				ENGINE
1.6 i	Petrol	77	09/83-12/85	LR1

Engine	Information	A10	A20	A40	A50	A70	C10 - C30	C20	E01
All engines	version Bosch				906 112R				
All engines							470 169	C10	

				ENGINE
1.6 XR3i	Petrol	77	10/82-12/85	LR1, LRA

Engine	Information	A10	A20	A40	A50	A70	C10 - C30	C20	E01
All engines	version Bosch				906 112R				
All engines							470 169	C10	

ESCORT IV

				ENGINE
1.1	Petrol	37	12/85-07/90	GSG

Engine	Information	A10	A20	A40	A50	A70	C10 - C30	C20	E01
All engines									360 007

				ENGINE
1.3	Petrol	44	01/95-08/97	J6A, JBD

Engine	Information	A10	A20	A40	A50	A70	C10 - C30	C20	E01
All engines	x 1, D.I.S.						470 135	C10	

				ENGINE
1.3	Petrol	46	07/88-12/94	JBA, JBD

Engine	Information	A10	A20	A40	A50	A70	C10 - C30	C20	E01
All engines							470 312	C10	

				ENGINE
1.4	Petrol	52	07/90-12/94	F6F, F6G

Engine	Information	A10	A20	A40	A50	A70	C10 - C30	C20	E01
All engines							470 135, 470 312	C10	359 864

				ENGINE
1.4	Petrol	54	01/86-08/00	F4B, F6B, F6D, FUC

Engine	Information	A10	A20	A40	A50	A70	C10 - C30	C20	E01
Eng. F6B, F6D, FUC	version Bosch			806 079					
Eng. F6D, FUC	version Lucas			828 096	928 026R				
Eng. F6D, FUC	version Bosch				906 061R				
Eng. F6B	version Bosch				906 121R				
Eng. F4B	x 1, D.I.S.						470 135	C10	
Eng. F6B, F6D, FUC							470 169, 470 312	C10	
Eng. F4B									359 864
Eng. F6D, FUC									360 281

				ENGINE
1.4	Petrol	55	01/86-07/90	FUA

Engine	Information	A10	A20	A40	A50	A70	C10 - C30	C20	E01
All engines	version Bosch			806 079	906 061R				
All engines	version Lucas			828 096	928 026R				
All engines							470 169, 470 312	C10	

				ENGINE
1.6	Petrol	65	04/89-07/90	LUG

Engine	Information	A10	A20	A40	A50	A70	C10 - C30	C20	E01
All engines							470 312	C10	

A10 CONDENSER	A20 CONTACT SET	A40 DISTRIBUTOR CAP	A50 ROTOR	A70 PICK-UP
C10 COIL	C20 IGNITION MODULE	C30 ELECTRONIC IGNITION KIT	E01 IGNITION CABLE SET	

Vehicle	alim.	kW	Date	Engine	FUNCTIONS ON THE VEHICLE									
					A10	A20	A40	A50	A70	C10 - C30	C20	E01		
ENGINE														
1.6 16V	Petrol	66	10/98-07/00	L1E, L1K										
Engine	Information				A10	A20	A40	A50	A70	C10 - C30	C20	E01		
All engines	x 1, D.I.S.									470 532	C10			
Eng. L1E													360 630	
ENGINE														
1.6 i	Petrol	66	01/86-07/90	L4B										
Engine	Information				A10	A20	A40	A50	A70	C10 - C30	C20	E01		
All engines										470 312	C10			
ENGINE														
1.6 Turbo RS	Petrol	97	01/86-07/90	LNB										
Engine	Information				A10	A20	A40	A50	A70	C10 - C30	C20	E01		
All engines	version Bosch						806 079	906 121R	406 233					
All engines										470 169, 470 312	C10			
ENGINE														
1.6 XR3i	Petrol	77	01/86-07/90	LR2, LRB										
Engine	Information				A10	A20	A40	A50	A70	C10 - C30	C20	E01		
All engines	version Bosch						806 079							
All engines	+catalytic converter, version Bosch							906 121R						
All engines										470 169, 470 312	C10		360 281	
ESCORT V														
ENGINE														
1.3	Petrol	44	07/90-01/95	J4B, J6A, JBE										
Engine	Information				A10	A20	A40	A50	A70	C10 - C30	C20	E01		
Eng. J4B, J6A										470 312	C10			
All engines										470 364	C10			
Eng. J6A, JBE													360 007	
ENGINE														
1.4	Petrol	52	07/90-01/95	F6F, F6G										
Engine	Information				A10	A20	A40	A50	A70	C10 - C30	C20	E01		
All engines										470 135, 470 312	C10		359 864	
ENGINE														
1.4	Petrol	55	09/90-01/95	F4B, FUH										
Engine	Information				A10	A20	A40	A50	A70	C10 - C30	C20	E01		
All engines										470 135, 470 312	C10		359 864	
ENGINE														
1.4 i	Petrol	55	07/93-01/95	F4B										
Engine	Information				A10	A20	A40	A50	A70	C10 - C30	C20	E01		
All engines										470 135, 470 312	C10		359 864	
ENGINE														
1.6	Petrol	66	07/90-08/92	LUJ, LUK										
Engine	Information				A10	A20	A40	A50	A70	C10 - C30	C20	E01		
All engines										470 135, 470 312	C10		359 864	
ENGINE														
1.6	Petrol	77	07/90-08/93	LJF										
Engine	Information				A10	A20	A40	A50	A70	C10 - C30	C20	E01		
All engines										470 135, 470 312	C10		359 864	
ENGINE														
1.6 16V XR3i	Petrol	66	12/92-01/95	L1E										
Engine	Information				A10	A20	A40	A50	A70	C10 - C30	C20	E01		
All engines										470 299, 470 312	C10		360 630	
ENGINE														
1.6 i 16V	Petrol	65	01/94-01/95	L1H										
Engine	Information				A10	A20	A40	A50	A70	C10 - C30	C20	E01		
All engines										470 299, 470 312	C10		360 630	

A10 CONDENSER	A20 CONTACT SET	A40 DISTRIBUTOR CAP	A50 ROTOR	A70 PICK-UP
C10 COIL	C20 IGNITION MODULE	C30 ELECTRONIC IGNITION KIT	E01 IGNITION CABLE SET	

The present application list is a brief version. For the detailed information about the possibility of installation on a specific vehicle, please refer to our web-catalogue <http://catalogo.facet.eu/>

Vehicle	alim.	kW	Date	Engine	FUNCTIONS ON THE VEHICLE							
					A10	A20	A40	A50	A70	C10 - C30	C20	E01

ENGINE				
1.6 i 16V	Petrol	66	09/92-01/95	L1E, L1K

Engine	Information	A10	A20	A40	A50	A70	C10 - C30	C20	E01
All engines							470 299, 470 312	C10	360 630

ENGINE				
1.8 16V	Petrol	77	02/92-01/95	RDA

Engine	Information	A10	A20	A40	A50	A70	C10 - C30	C20	E01
All engines							470 299	C10	360 630

ENGINE				
1.8 16V XR3i	Petrol	77	02/92-01/95	RDA

Engine	Information	A10	A20	A40	A50	A70	C10 - C30	C20	E01
All engines							470 299	C10	360 630

ENGINE				
1.8 16V XR3i	Petrol	96	02/92-01/95	99BFR1740

Engine	Information	A10	A20	A40	A50	A70	C10 - C30	C20	E01
All engines							470 299, 470 312	C10	360 630

ENGINE				
1.8 i 16V	Petrol	77	09/92-01/95	RDA

Engine	Information	A10	A20	A40	A50	A70	C10 - C30	C20	E01
All engines							470 299, 470 312	C10	360 630

ENGINE				
1.8 i 16V	Petrol	96	02/93-01/95	99BFR1740

Engine	Information	A10	A20	A40	A50	A70	C10 - C30	C20	E01
All engines							470 299, 470 312	C10	360 630

ENGINE				
1.8 XR3i 16V 4x4	Petrol	77	08/93-01/95	RDA

Engine	Information	A10	A20	A40	A50	A70	C10 - C30	C20	E01
All engines							470 299	C10	360 630

ENGINE				
1.8 XR3i 16V 4x4	Petrol	96	08/93-01/95	99BFR1740

Engine	Information	A10	A20	A40	A50	A70	C10 - C30	C20	E01
All engines							470 299, 470 312	C10	360 630

ENGINE				
RS 2000	Petrol	110	05/91-01/95	N7A

Engine	Information	A10	A20	A40	A50	A70	C10 - C30	C20	E01
All engines									360 145

ENGINE				
RS Cosworth 4x4	Petrol	162	10/91-01/95	NSF

Engine	Information	A10	A20	A40	A50	A70	C10 - C30	C20	E01
All engines	->year 01/06/94, -catalytic converter, version Marelli			830 098					
All engines	+catalytic converter, ->year 01/06/94, version Marelli			830 101					
All engines	->year 01/06/94, version Marelli				930 057R				
All engines	->year 30/06/94						470 169	C10	

ESCORT VI

ENGINE				
1.3	Petrol	44	01/95-02/99	J4B, J6A

Engine	Information	A10	A20	A40	A50	A70	C10 - C30	C20	E01
Eng. J6A							470 312, 470 364	C10	360 007
All engines	x 1, D.I.S.						470 532	C10	
Eng. J4B	01/10/98 ->								360 568
Eng. J4B	->year 30/09/98								360 639

ENGINE				
1.4	Petrol	54	01/95-12/99	F4B

Engine	Information	A10	A20	A40	A50	A70	C10 - C30	C20	E01
All engines	x 1, D.I.S.						470 135	C10	
All engines									359 864

A10 CONDENSER	A20 CONTACT SET	A40 DISTRIBUTOR CAP	A50 ROTOR	A70 PICK-UP
C10 COIL	C20 IGNITION MODULE	C30 ELECTRONIC IGNITION KIT	E01 IGNITION CABLE SET	

Vehicle	alim.	kW	Date	Engine	FUNCTIONS ON THE VEHICLE									
					A10	A20	A40	A50	A70	C10 - C30	C20	E01		
ENGINE														
1.4	Petrol	55	01/95-02/99	F4B, F6B, F6D, FUH										
Engine	Information				A10	A20	A40	A50	A70	C10 - C30	C20	E01		
All engines	x 1, D.I.S.									470 135	C10			
Eng. F4B										470 135, 470 312	C10		359 864	
ENGINE														
1.6 16V	Petrol	66	01/95-07/00	L1E, L1K										
Engine	Information				A10	A20	A40	A50	A70	C10 - C30	C20	E01		
All engines	x 1, D.I.S.									470 532	C10			
Eng. L1E													360 630	
ENGINE														
1.6 16V 4x4	Petrol	66	01/95-10/98	L1E										
Engine	Information				A10	A20	A40	A50	A70	C10 - C30	C20	E01		
All engines	x 1, D.I.S.									470 532	C10			
All engines													360 630	
ENGINE														
1.6 16V XR3i	Petrol	65	02/95-12/96	L1H										
Engine	Information				A10	A20	A40	A50	A70	C10 - C30	C20	E01		
All engines	x 1, D.I.S.									470 532	C10			
All engines													360 630	
ENGINE														
1.6 16V XR3i	Petrol	66	02/95-09/99	L1E, L1K										
Engine	Information				A10	A20	A40	A50	A70	C10 - C30	C20	E01		
All engines	x 1, D.I.S.									470 532	C10			
Eng. L1E													360 630	
ENGINE														
1.6 i 16V	Petrol	65	01/95-08/95	L1H										
Engine	Information				A10	A20	A40	A50	A70	C10 - C30	C20	E01		
All engines	x 1, D.I.S.									470 532	C10			
All engines													360 630	
ENGINE														
1.6 i 16V	Petrol	66	01/95-02/99	L1E, L1K										
Engine	Information				A10	A20	A40	A50	A70	C10 - C30	C20	E01		
All engines	x 1, D.I.S.									470 532	C10			
All engines													360 630	
ENGINE														
1.8 16V	Petrol	77	01/95-08/95	RDA										
Engine	Information				A10	A20	A40	A50	A70	C10 - C30	C20	E01		
All engines	x 1, D.I.S.									470 532	C10			
All engines													360 630	
ENGINE														
1.8 16V	Petrol	85	01/95-02/99	RKC										
Engine	Information				A10	A20	A40	A50	A70	C10 - C30	C20	E01		
All engines	x 1, D.I.S.									470 532	C10			
All engines													360 630	
ENGINE														
1.8 16V XR3i	Petrol	77	02/95-08/98	RDA										
Engine	Information				A10	A20	A40	A50	A70	C10 - C30	C20	E01		
All engines	x 1, D.I.S.									470 532	C10			
All engines													360 630	
ENGINE														
1.8 16V XR3i	Petrol	85	10/95-08/98	RKC										
Engine	Information				A10	A20	A40	A50	A70	C10 - C30	C20	E01		
All engines	x 1, D.I.S.									470 532	C10			
All engines													360 630	
ENGINE														
1.8 16V XR3i	Petrol	96	02/95-08/00	RQB										
Engine	Information				A10	A20	A40	A50	A70	C10 - C30	C20	E01		
All engines	x 1, D.I.S.									470 532	C10			

A10	CONDENSER	A20	CONTACT SET	A40	DISTRIBUTOR CAP	A50	ROTOR	A70	PICK-UP
C10	COIL	C20	IGNITION MODULE	C30	ELECTRONIC IGNITION KIT	E01	IGNITION CABLE SET		

The present application list is a brief version. For the detailed information about the possibility of installation on a specific vehicle, please refer to our web-catalogue <http://catalogo.facet.eu/>

Vehicle	alim.	kW	Date	Engine	FUNCTIONS ON THE VEHICLE							
					A10	A20	A40	A50	A70	C10 - C30	C20	E01

				ENGINE
RS 2000	Petrol	110	02/95-02/98	N7A

Engine	Information	A10	A20	A40	A50	A70	C10 - C30	C20	E01
All engines									360 145

				ENGINE
RS 2000 4x4	Petrol	110	02/95-10/98	N7A

Engine	Information	A10	A20	A40	A50	A70	C10 - C30	C20	E01
All engines									360 145

				ENGINE
ESCORT-NOMADE				
1.6	Petrol	66	01/95-04/00	8LH7(98CUL4), ZH16L1E

Engine	Information	A10	A20	A40	A50	A70	C10 - C30	C20	E01
All engines	x 1, D.I.S.						470 532	C10	

				ENGINE
1.8	Petrol	77	01/95-04/00	0LW2(273CUV8)

Engine	Information	A10	A20	A40	A50	A70	C10 - C30	C20	E01
All engines	x 1, D.I.S.						470 532	C10	

				ENGINE
FIESTA				
1.2	Petrol	55	01/96-04/02	DHA, DHB, DHC, DHD, DHF, DHG

Engine	Information	A10	A20	A40	A50	A70	C10 - C30	C20	E01
All engines	->year 01/05/98, x 1, D.I.S.						470 2995	C10	
All engines	01/06/98->, x 1, D.I.S.						470 532	C10	

				ENGINE
1.3	Petrol	44	09/95-08/03	J4C, J4J, J4R

Engine	Information	A10	A20	A40	A50	A70	C10 - C30	C20	E01
All engines	x 1, D.I.S.						470 532	C10	

				ENGINE
FIESTA I				
0.9	Petrol	29	05/76-08/83	TKA, TKW

Engine	Information	A10	A20	A40	A50	A70	C10 - C30	C20	E01
All engines	version Bosch		706 049HDVS	806 079	906 025R				
All engines	version Ford		719 043HV	819 083	919 085				

				ENGINE
0.9	Petrol	33	05/76-08/83	TLA

Engine	Information	A10	A20	A40	A50	A70	C10 - C30	C20	E01
All engines	version Bosch		706 049HDVS	806 079	906 025R				
All engines	version Ford		719 043HV	819 083	919 085				

				ENGINE
1.1	Petrol	39	05/76-08/83	GLA

Engine	Information	A10	A20	A40	A50	A70	C10 - C30	C20	E01
All engines	version Bosch		706 049HDVS	806 079	906 025R				

				ENGINE
1.1	Petrol	40	02/81-08/83	GLW

Engine	Information	A10	A20	A40	A50	A70	C10 - C30	C20	E01
All engines	version Bosch		706 049HDVS	806 079	906 025R				

				ENGINE
1.3	Petrol	49	08/77-08/83	J3E

Engine	Information	A10	A20	A40	A50	A70	C10 - C30	C20	E01
All engines	version Ford		719 043HV	819 083					

				ENGINE
1.6 XR2	Petrol	62	08/81-08/83	L3E

Engine	Information	A10	A20	A40	A50	A70	C10 - C30	C20	E01
All engines	version Bosch			806 079	906 025R				

				ENGINE
FIESTA II				
1.1	Petrol	36	05/86-02/89	GSH

Engine	Information	A10	A20	A40	A50	A70	C10 - C30	C20	E01
All engines	version Bosch			806 079	906 061R				

A10	CONDENSER	A20	CONTACT SET	A40	DISTRIBUTOR CAP	A50	ROTOR	A70	PICK-UP
C10	COIL	C20	IGNITION MODULE	C30	ELECTRONIC IGNITION KIT	E01	IGNITION CABLE SET		

Vehicle	alim.	kW	Date	Engine	FUNCTIONS ON THE VEHICLE									
					A10	A20	A40	A50	A70	C10 - C30	C20	E01		
ENGINE														
1.1	Petrol	37	09/83-02/89	GLC, GSF										
Engine		Information			A10	A20	A40	A50	A70	C10 - C30	C20	E01		
All engines		version Bosch				706 049HDVS	806 079	906 025R						
ENGINE														
1.3	Petrol	51	09/83-09/89	JPC										
Engine		Information			A10	A20	A40	A50	A70	C10 - C30	C20	E01		
All engines		version Bosch					806 079	906 025R						
ENGINE														
1.4	Petrol	52	10/86-02/89	F6A, F6C										
Engine		Information			A10	A20	A40	A50	A70	C10 - C30	C20	E01		
All engines										470 312	C10			
ENGINE														
1.4	Petrol	54	02/87-02/89	FUD										
Engine		Information			A10	A20	A40	A50	A70	C10 - C30	C20	E01		
All engines		version Bosch					806 079	906 061R						
All engines										470 169	C10		360 281	
ENGINE														
1.4	Petrol	55	10/85-11/89	FUB										
Engine		Information			A10	A20	A40	A50	A70	C10 - C30	C20	E01		
All engines		version Bosch					806 079	906 061R						
All engines										470 169	C10		360 281	
ENGINE														
1.6 XR2	Petrol	70	03/84-02/89	LUD										
Engine		Information			A10	A20	A40	A50	A70	C10 - C30	C20	E01		
All engines		version Lucas					828 096	928 026R						
All engines										470 169	C10		360 281	
ENGINE														
1.6 XR2	Petrol	71	04/84-02/89	LUB										
Engine		Information			A10	A20	A40	A50	A70	C10 - C30	C20	E01		
All engines		version Lucas					828 096	928 026R						
All engines										470 169	C10		360 281	
FIESTA III														
ENGINE														
1.0	Petrol	33	03/89-12/95	TLB										
Engine		Information			A10	A20	A40	A50	A70	C10 - C30	C20	E01		
All engines										470 364	C10		360 007	
ENGINE														
1.1	Petrol	37	03/89-12/95	G6A										
Engine		Information			A10	A20	A40	A50	A70	C10 - C30	C20	E01		
All engines										470 312, 470 364	C10		360 007	
ENGINE														
1.1	Petrol	40	03/89-12/95	GUD, GUE										
Engine		Information			A10	A20	A40	A50	A70	C10 - C30	C20	E01		
All engines										470 312, 470 364	C10		360 007	
ENGINE														
1.3	Petrol	44	03/89-02/96	J6B, JBB, JBC										
Engine		Information			A10	A20	A40	A50	A70	C10 - C30	C20	E01		
Eng. J6B, JBC										470 312	C10			
All engines										470 364	C10		360 007	
ENGINE														
1.3 Cat	Petrol	44	05/91-01/97	J6B										
Engine		Information			A10	A20	A40	A50	A70	C10 - C30	C20	E01		
All engines										470 312, 470 364	C10		360 007	
ENGINE														
1.4	Petrol	52	03/89-12/95	F6E										
Engine		Information			A10	A20	A40	A50	A70	C10 - C30	C20	E01		
All engines		version Bosch					806 079	906 121R						
All engines		version Lucas					828 096	928 026R						

A10	CONDENSER	A20	CONTACT SET	A40	DISTRIBUTOR CAP	A50	ROTOR	A70	PICK-UP
C10	COIL	C20	IGNITION MODULE	C30	ELECTRONIC IGNITION KIT	E01	IGNITION CABLE SET		

The present application list is a brief version. For the detailed information about the possibility of installation on a specific vehicle, please refer to our web-catalogue <http://catalogo.facet.eu/>

Vehicle	alim.	kW	Date	Engine	FUNCTIONS ON THE VEHICLE							
					A10	A20	A40	A50	A70	C10 - C30	C20	E01

1.4	Petrol	52	03/89-12/95	F6E
------------	--------	-----------	-------------	------------

Engine	Information	A10	A20	A40	A50	A70	C10 - C30	C20	E01
All engines							470 169, 470 312	C10	360 281

1.4	Petrol	54	03/89-12/95	FUG, FUJ
------------	--------	-----------	-------------	-----------------

Engine	Information	A10	A20	A40	A50	A70	C10 - C30	C20	E01
All engines							470 135, 470 312	C10	359 864

1.4 Cat	Petrol	54	03/89-12/95	F4A
----------------	--------	-----------	-------------	------------

Engine	Information	A10	A20	A40	A50	A70	C10 - C30	C20	E01
All engines							470 135, 470 312	C10	359 864

1.6	Petrol	65	01/89-01/94	LUH
------------	--------	-----------	-------------	------------

Engine	Information	A10	A20	A40	A50	A70	C10 - C30	C20	E01
All engines							470 135, 470 312	C10	359 864

1.6	Petrol	66	03/89-12/92	LUH
------------	--------	-----------	-------------	------------

Engine	Information	A10	A20	A40	A50	A70	C10 - C30	C20	E01
All engines							470 135	C10	359 864

1.6 i 16V	Petrol	65	01/94-12/95	L1G
------------------	--------	-----------	-------------	------------

Engine	Information	A10	A20	A40	A50	A70	C10 - C30	C20	E01
All engines							470 299, 470 312	C10	360 630

1.6 Turbo	Petrol	96	03/90-10/92	LHA
------------------	--------	-----------	-------------	------------

Engine	Information	A10	A20	A40	A50	A70	C10 - C30	C20	E01
All engines							470 135, 470 312	C10	

1.6 XR2i	Petrol	76	03/89-03/93	LJD
-----------------	--------	-----------	-------------	------------

Engine	Information	A10	A20	A40	A50	A70	C10 - C30	C20	E01
All engines							470 135, 470 312	C10	

1.6 XR2i	Petrol	81	03/89-01/94	LJC
-----------------	--------	-----------	-------------	------------

Engine	Information	A10	A20	A40	A50	A70	C10 - C30	C20	E01
All engines							470 135, 470 312	C10	

1.8 16V	Petrol	77	02/92-12/95	RDB
----------------	--------	-----------	-------------	------------

Engine	Information	A10	A20	A40	A50	A70	C10 - C30	C20	E01
All engines							470 299, 470 312	C10	360 630

1.8 XR2i 16V	Petrol	96	02/92-12/95	RQC
---------------------	--------	-----------	-------------	------------

Engine	Information	A10	A20	A40	A50	A70	C10 - C30	C20	E01
All engines							470 299, 470 312	C10	360 630

FIESTA IV

1.0 i	Petrol	38	04/96-09/99	OEAL
--------------	--------	-----------	-------------	-------------

Engine	Information	A10	A20	A40	A50	A70	C10 - C30	C20	E01
All engines	->year 30/09/98						470 364	C10	360 639
All engines	01/10/98 ->						470 532	C10	360 568

1.25 i 16V	Petrol	55	08/95-01/02	DHA, DHB, DHC, DHD, DHE, DHF, DHG
-------------------	--------	-----------	-------------	--

Engine	Information	A10	A20	A40	A50	A70	C10 - C30	C20	E01
All engines	->year 01/05/98, x 1, D.I.S.						470 2995	C10	
All engines	01/06/98 ->, x 1, D.I.S.						470 532	C10	
All engines	->year 31/05/98								360 619

A10 CONDENSER	A20 CONTACT SET	A40 DISTRIBUTOR CAP	A50 ROTOR	A70 PICK-UP
C10 COIL	C20 IGNITION MODULE	C30 ELECTRONIC IGNITION KIT	E01 IGNITION CABLE SET	

Vehicle	alim.	kW	Date	Engine	FUNCTIONS ON THE VEHICLE									
					A10	A20	A40	A50	A70	C10 - C30	C20	E01		
ENGINE														
1.25 i 16V	Petrol	55	08/95-01/02	DHA, DHB, DHC, DHD, DHE, DHF, DHG										
Engine	Information				A10	A20	A40	A50	A70	C10 - C30	C20	E01		
All engines	01/06/98 ->													360 625
ENGINE														
1.3	Petrol	44	02/96-08/03	J4C										
Engine	Information				A10	A20	A40	A50	A70	C10 - C30	C20	E01		
All engines	01/10/98 ->													360 568
All engines	->year 30/09/98													360 639
ENGINE														
1.3 i	Petrol	37	08/95-01/02	JJA, JJC, JJE, JJJ, JJK, JJM										
Engine	Information				A10	A20	A40	A50	A70	C10 - C30	C20	E01		
All engines	x 1, D.I.S.									470 532	C10			
All engines	01/10/98 ->													360 568
All engines	->year 30/09/98													360 639
ENGINE														
1.3 i	Petrol	44	08/95-01/02	J4C, J4J, J4L, J4Q, J4R, J4T, JBC										
Engine	Information				A10	A20	A40	A50	A70	C10 - C30	C20	E01		
Eng. JBC										470 312	C10			
Eng. JBC	->year 30/09/98									470 364	C10			
Eng. J4C, J4J, J4L, J4Q, J4R, J4T	x 1, D.I.S.									470 532	C10			
Eng. JBC	01/10/98 ->									470 532	C10			
All engines	01/10/98 ->													360 568
All engines	->year 30/09/98													360 639
ENGINE														
1.4	Petrol	66	08/98-04/02	FHA										
Engine	Information				A10	A20	A40	A50	A70	C10 - C30	C20	E01		
All engines	x 1, D.I.S.									470 532	C10			
ENGINE														
1.4 i 16V	Petrol	66	04/96-01/02	FHA, FHE										
Engine	Information				A10	A20	A40	A50	A70	C10 - C30	C20	E01		
All engines	x 1, D.I.S.									470 532	C10			
All engines	->year 31/05/98													360 619
All engines	01/06/98 ->													360 625
ENGINE														
1.6 16V Sport	Petrol	76	02/00-01/02	L1T, L1V										
Engine	Information				A10	A20	A40	A50	A70	C10 - C30	C20	E01		
All engines	x 1, D.I.S.									470 532	C10			
All engines														360 625
FIESTA V														
ENGINE														
1.25 16V	Petrol	51	03/03-06/08	M7JA, M7JB										
Engine	Information				A10	A20	A40	A50	A70	C10 - C30	C20	E01		
All engines	01/03/05 ->, x 1, D.I.S.									470 481	C10			
All engines	->year 01/02/05, x 1, D.I.S.									470 532	C10			
All engines	01/02/07 ->													358 242
All engines	->year 01/02/07													360 625
ENGINE														
1.25 16V	Petrol	55	05/02-06/08	FUJA, FUJB										
Engine	Information				A10	A20	A40	A50	A70	C10 - C30	C20	E01		
All engines	01/03/05 ->, x 1, D.I.S.									470 481	C10			
All engines	->year 01/02/05, x 1, D.I.S.									470 532	C10			
All engines	01/02/07 ->													358 242
All engines	->year 01/02/07													360 625
ENGINE														
1.3	Petrol	44	11/01-08/08	BAJA										
Engine	Information				A10	A20	A40	A50	A70	C10 - C30	C20	E01		
All engines	01/03/05 ->, x 1, D.I.S.									470 481	C10			
All engines	->year 01/02/05, x 1, D.I.S.									470 532	C10			
All engines	03/07/02 ->													358 208

A10 CONDENSER	A20 CONTACT SET	A40 DISTRIBUTOR CAP	A50 ROTOR	A70 PICK-UP
C10 COIL	C20 IGNITION MODULE	C30 ELECTRONIC IGNITION KIT	E01 IGNITION CABLE SET	

The present application list is a brief version. For the detailed information about the possibility of installation on a specific vehicle, please refer to our web-catalogue <http://catalogo.facet.eu/>

Vehicle	alim.	kW	Date	Engine	FUNCTIONS ON THE VEHICLE							
					A10	A20	A40	A50	A70	C10 - C30	C20	E01

ENGINE				
1.3	Petrol	51	11/01-06/08	A9JA, A9JB

Engine	Information	A10	A20	A40	A50	A70	C10 - C30	C20	E01
All engines	01/03/05 ->, 01/08/07 ->, x 1, D.I.S.						470 481	C10	
Eng. A9JB	23/08/07 ->						470 481	C10	
All engines	->year 01/02/05, ->year 01/07/07, x 1, D.I.S.						470 532	C10	
Eng. A9JB	->year 23/08/07						470 532	C10	
All engines	03/07/02 ->								358 208

ENGINE				
1.4	Petrol	59	05/02-09/05	FXJA

Engine	Information	A10	A20	A40	A50	A70	C10 - C30	C20	E01
All engines	01/03/05 ->, x 1, D.I.S.						470 481	C10	
All engines	->year 01/02/05, x 1, D.I.S.						470 532	C10	

ENGINE				
1.4 16V	Petrol	59	11/01-06/08	FXJA, FXJB

Engine	Information	A10	A20	A40	A50	A70	C10 - C30	C20	E01
All engines	01/03/05 ->, x 1, D.I.S.						470 481	C10	
All engines	->year 01/02/05, x 1, D.I.S.						470 532	C10	
All engines	01/02/07 ->								358 242
All engines	->year 01/02/07								360 625

ENGINE				
1.6 16V	Petrol	74	11/01-06/08	FYJA, FYJB

Engine	Information	A10	A20	A40	A50	A70	C10 - C30	C20	E01
All engines	01/03/05 ->, x 1, D.I.S.						470 481	C10	
All engines	->year 01/02/05, x 1, D.I.S.						470 532	C10	
All engines	01/02/07 ->								358 242
All engines	->year 01/02/07								360 625

ENGINE				
ST150	Petrol	110	03/05-06/08	N4JB

Engine	Information	A10	A20	A40	A50	A70	C10 - C30	C20	E01
All engines	x 1, D.I.S.						470 481	C10	
All engines	->year 01/02/05, x 1, D.I.S.						470 532	C10	

FIESTA VI

ENGINE				
1.0	Petrol	48	01/13->	XMJA, XMJB, XMJC, XMJD

Engine	Information	A10	A20	A40	A50	A70	C10 - C30	C20	E01
All engines	x 3, COIL ON PLUG						470 619	C10	

ENGINE				
1.0	Petrol	59	10/12->	P4JA, P4JB, P4JC, P4JD

Engine	Information	A10	A20	A40	A50	A70	C10 - C30	C20	E01
All engines	x 3, COIL ON PLUG						470 619	C10	

ENGINE				
1.0 EcoBoost	Petrol	103	05/14->	YYJA, YYJB

Engine	Information	A10	A20	A40	A50	A70	C10 - C30	C20	E01
All engines	x 3, COIL ON PLUG						470 619	C10	

ENGINE				
1.0 EcoBoost	Petrol	74	01/13->	SFJA, SFJB, SFJC, SFJD

Engine	Information	A10	A20	A40	A50	A70	C10 - C30	C20	E01
All engines	x 3, COIL ON PLUG						470 619	C10	

ENGINE				
1.0 EcoBoost	Petrol	92	09/12->	M1JE, M1JH

Engine	Information	A10	A20	A40	A50	A70	C10 - C30	C20	E01
All engines	Qty: 3						470 619	C10	
All engines	x 3, COIL ON PLUG						470 619	C10	

ENGINE				
1.0 Sport	Petrol	103	05/14-04/17	YYJA, YYJB

Engine	Information	A10	A20	A40	A50	A70	C10 - C30	C20	E01
All engines	x 3, COIL ON PLUG						470 619	C10	

A10 CONDENSER	A20 CONTACT SET	A40 DISTRIBUTOR CAP	A50 ROTOR	A70 PICK-UP
C10 COIL	C20 IGNITION MODULE	C30 ELECTRONIC IGNITION KIT	E01 IGNITION CABLE SET	

Vehicle	alim.	kW	Date	Engine	FUNCTIONS ON THE VEHICLE										
					A10	A20	A40	A50	A70	C10 - C30	C20	E01			
ENGINE															
1.25	Petrol	44	06/08->	STJA, STJB, STJC, STJD											
ENGINE															
1.25					Petrol	60	06/08->	SNJA, SNJB, SNJC, SNJD							
ENGINE															
1.4					Petrol	66	10/08->	--							
ENGINE															
1.4					Petrol	70	06/08->	--							
ENGINE															
1.4					Petrol	71	10/08-12/12	24KH1CT5H1, 8MA1.77, RTJA, SPJA, SPJC, SPJE							
ENGINE															
1.4 LPG					Petrol/ Liquified Petroleum Gas (LPG)	68	01/09-04/17	RTJA, RTJB, RTJD							
ENGINE															
1.4 LPG					Petrol/ Liquified Petroleum Gas (LPG)	71	01/09-04/17	RTJA, RTJB, RTJD, SPJA, SPJC, SPJE							
ENGINE															
1.6					Petrol	62	03/15->	XTJA							
ENGINE															
1.6 Ti					Petrol	62	09/12->	--							
ENGINE															
1.6 Ti					Petrol	77	09/12->	IQJA, IQJC, IQJE							
ENGINE															
1.6 Ti					Petrol	88	06/08->	68GR-FKS, HXJA, HXJB, HXJE, RVJA							
ENGINE															

A10 CONDENSER	A20 CONTACT SET	A40 DISTRIBUTOR CAP	A50 ROTOR	A70 PICK-UP
C10 COIL	C20 IGNITION MODULE	C30 ELECTRONIC IGNITION KIT	E01 IGNITION CABLE SET	

The present application list is a brief version. For the detailed information about the possibility of installation on a specific vehicle, please refer to our web-catalogue <http://catalogo.facet.eu/>

Vehicle	alim.	kW	Date	Engine	FUNCTIONS ON THE VEHICLE							
					A10	A20	A40	A50	A70	C10 - C30	C20	E01

				ENGINE
1.6 Ti	Petrol	99	12/10->	U5JA

Engine	Information	A10	A20	A40	A50	A70	C10 - C30	C20	E01
All engines	x 1, D.I.S.						470 481	C10	
All engines									358 242

				ENGINE
1.6 Ti-VCT	Petrol	88	10/08-12/12	HXJA, HXJB

Engine	Information	A10	A20	A40	A50	A70	C10 - C30	C20	E01
All engines	x 1, D.I.S.						470 481	C10	

FIESTA VII

				ENGINE
1.0 EcoBoost	Petrol	103	06/17->	YYJE, YYJG

Engine	Information	A10	A20	A40	A50	A70	C10 - C30	C20	E01
All engines	x 3, COIL ON PLUG						470 619	C10	

				ENGINE
1.0 EcoBoost	Petrol	63	04/18->	QOJA, QOJB, QOJC, QOJD

Engine	Information	A10	A20	A40	A50	A70	C10 - C30	C20	E01
All engines	x 3, COIL ON PLUG						470 619	C10	

				ENGINE
1.0 EcoBoost	Petrol	74	05/17->	SFJE, SFJF, SFJH, SFJJ, SFJK, SFJN, SFJP

Engine	Information	A10	A20	A40	A50	A70	C10 - C30	C20	E01
All engines	x 3, COIL ON PLUG						470 619	C10	

				ENGINE
1.0 EcoBoost	Petrol	92	05/17->	M1JL, M1JM, M1JP

Engine	Information	A10	A20	A40	A50	A70	C10 - C30	C20	E01
All engines	x 3, COIL ON PLUG						470 619	C10	

				ENGINE
1.0 EcoBoost Active	Petrol	103	04/18->	YYJE, YYJG

Engine	Information	A10	A20	A40	A50	A70	C10 - C30	C20	E01
All engines	x 3, COIL ON PLUG						470 619	C10	

				ENGINE
1.0 EcoBoost Active	Petrol	74	04/18->	SFJE, SFJF, SFJH, SFJJ, SFJK, SFJN, SFJP

Engine	Information	A10	A20	A40	A50	A70	C10 - C30	C20	E01
All engines	x 3, COIL ON PLUG						470 619	C10	

				ENGINE
1.0 EcoBoost Active	Petrol	92	04/18->	M1JL, M1JM, M1JP

Engine	Information	A10	A20	A40	A50	A70	C10 - C30	C20	E01
All engines	x 3, COIL ON PLUG						470 619	C10	

				ENGINE
1.0 EcoBoost mHEV	Petrol/ Electric	114	07/20->	BZJA

Engine	Information	A10	A20	A40	A50	A70	C10 - C30	C20	E01
All engines	x 4, COIL ON PLUG						470 619	C10	

				ENGINE
1.0 EcoBoost mHEV Active	Petrol/ Electric	114	01/21->	BZJA

Engine	Information	A10	A20	A40	A50	A70	C10 - C30	C20	E01
All engines	x 4, COIL ON PLUG						470 619	C10	

FOCUS C-MAX

				ENGINE
1.6	Petrol	74	10/03-03/07	HWDA, HWDB, SHDA, SHDB, SHDC

Engine	Information	A10	A20	A40	A50	A70	C10 - C30	C20	E01
All engines	01/03/05->, x 1, D.I.S.						470 481	C10	
All engines	->year 01/02/05, x 1, D.I.S.						470 532	C10	
Eng. HWDA, HWDB	26/03/07->								358 242
Eng. HWDA, HWDB	->year 26/03/07								360 625

				ENGINE
1.6 Ti	Petrol	85	08/04-03/07	HXDA, HXDB, SIDA









Engine	Information	A10	A20	A40	A50	A70	C10 - C30	C20	E01
All engines	01/03/05->, x 1, D.I.S.						470 481	C10	

A10 CONDENSER	A20 CONTACT SET	A40 DISTRIBUTOR CAP	A50 ROTOR	A70 PICK-UP
C10 COIL	C20 IGNITION MODULE	C30 ELECTRONIC IGNITION KIT	E01 IGNITION CABLE SET	

Vehicle	alim.	kW	Date	Engine	FUNCTIONS ON THE VEHICLE									
					A10	A20	A40	A50	A70	C10 - C30	C20	E01		
ENGINE														
1.6 Ti	Petrol	85	08/04-03/07	HXDA, HXDB, SIDA										
ENGINE														
All engines											470 532	C10		
Eng. HXDA, SIDA														358 242
Eng. HXDA, SIDA														360 625
ENGINE														
1.8	Petrol	88	10/03-03/07	CSDA, CSDB										
ENGINE														
All engines											470 480	C10		
ENGINE														
1.8	Petrol	90	09/05-03/07	QQDC										
ENGINE														
All engines											470 480	C10		
ENGINE														
1.8	Petrol	92	04/04-03/07	Q7DA, QQDA, QQDB										
ENGINE														
All engines											470 480	C10		
ENGINE														
1.8 Flexifuel	Petrol/ Ethanol	92	01/06-03/07	Q7DA										
ENGINE														
All engines											470 480	C10		
ENGINE														
2.0	Petrol	107	03/04-03/07	AODA, AODB, AODE, SYDA										
ENGINE														
All engines											470 480	C10		
FOCUS I														
ENGINE														
1.4	Petrol	55	04/99-03/05	FXDA, FXDB, FXDC, FXDD										
ENGINE														
All engines											470 532	C10		
ENGINE														
1.4 16V	Petrol	55	10/98-11/04	FXDA, FXDB, FXDC, FXDD										
ENGINE														
All engines											470 532	C10		
Eng. FXDA											470 532	C10		
All engines														360 625
ENGINE														
1.6	Petrol	74	04/99-03/05	FYDA, FYDB, FYDC, FYDD										
ENGINE														
All engines											470 532	C10		
ENGINE														
1.6 16V	Petrol	66	02/01-11/04	--										
ENGINE														
All engines											470 532	C10		360 624
ENGINE														
1.6 16V	Petrol	74	10/98-11/04	FYDA, FYDB, FYDC, FYDD, FYDH										
ENGINE														
All engines											470 532	C10		
All engines														360 625
ENGINE														
1.6 16V Flexifuel	Petrol/ Ethanol	75	01/02-11/04	FYDH										
ENGINE														
All engines											470 532	C10		
All engines														358 208

A10	CONDENSER	A20	CONTACT SET	A40	DISTRIBUTOR CAP	A50	ROTOR	A70	PICK-UP
C10	COIL	C20	IGNITION MODULE	C30	ELECTRONIC IGNITION KIT	E01	IGNITION CABLE SET		

The present application list is a brief version. For the detailed information about the possibility of installation on a specific vehicle, please refer to our web-catalogue <http://catalogo.facet.eu/>

					FUNCTIONS ON THE VEHICLE							
Vehicle	alim.	kW	Date	Engine								
1.8	Petrol	85	04/99-03/05	ENGINE EYDB, EYDC, EYDD, EYDE, EYDF, EYDG								
Engine					A10	A20	A40	A50	A70	C10 - C30	C20	E01
Information										470 532	C10	
All engines												
All engines												360 624
1.8 16V	Petrol	85	10/98-11/04	ENGINE EYDB, EYDC, EYDD, EYDE, EYDF, EYDG, EYDI, EYDJ, EYDL								
Engine					A10	A20	A40	A50	A70	C10 - C30	C20	E01
Information										470 532	C10	
All engines												
All engines												360 624
1.8 16V BiFuel	Petrol/ Liquified Petroleum Gas (LPG)	85	09/02-07/04	ENGINE EYDD, EYDG, EYDI								
Engine					A10	A20	A40	A50	A70	C10 - C30	C20	E01
Information										470 532	C10	
All engines												
All engines												360 624
1.8 BiFuel	Petrol/ Liquified Petroleum Gas (LPG)	82	02/03-01/05	ENGINE EYDL								
Engine					A10	A20	A40	A50	A70	C10 - C30	C20	E01
Information										470 532	C10	
All engines												
All engines												360 624
2.0 16V	Petrol	96	10/98-11/04	ENGINE EDDB, EDDC, EDDD, EDDF								
Engine					A10	A20	A40	A50	A70	C10 - C30	C20	E01
Information										470 532	C10	
All engines												
All engines												360 624
RS	Petrol	158	10/02-11/04	ENGINE HMDA								
Engine					A10	A20	A40	A50	A70	C10 - C30	C20	E01
Information										470 532	C10	
All engines												
All engines												360 624
ST170	Petrol	127	03/02-11/04	ENGINE ALDA								
Engine					A10	A20	A40	A50	A70	C10 - C30	C20	E01
Information										470 532	C10	
All engines												
All engines												360 624
FOCUS II												
1.4	Petrol	59	07/04-09/12	ENGINE ASDA, ASDB								
Engine					A10	A20	A40	A50	A70	C10 - C30	C20	E01
Information										470 481	C10	
All engines												
All engines										470 532	C10	
All engines												358 242
All engines												360 625
1.6	Petrol	74	07/04-09/12	ENGINE HWDA, HWDB, SHDA, SHDB, SHDC								
Engine					A10	A20	A40	A50	A70	C10 - C30	C20	E01
Information										470 481	C10	
All engines												
All engines										470 532	C10	
All engines												358 242
All engines												360 625

A10 CONDENSER	A20 CONTACT SET	A40 DISTRIBUTOR CAP	A50 ROTOR	A70 PICK-UP
C10 COIL	C20 IGNITION MODULE	C30 ELECTRONIC IGNITION KIT	E01 IGNITION CABLE SET	

Vehicle	alim.	kW	Date	Engine	FUNCTIONS ON THE VEHICLE									
					A10	A20	A40	A50	A70	C10 - C30	C20	E01		
ENGINE														
1.6 LPG	Petrol/ Liquified Petroleum Gas (LPG)	85	10/09-09/12	SIDA										
Engine	Information				A10	A20	A40	A50	A70	C10 - C30	C20	E01		
All engines	x 1, D.I.S.									470 481	C10			
ENGINE														
1.6 Ti	Petrol	85	07/04-09/12	HXDA, HXDB, SIDA										
Engine	Information				A10	A20	A40	A50	A70	C10 - C30	C20	E01		
All engines	01/03/05 ->, 01/03/11 ->, ->year 01/02/11, x 1, D.I.S., x 1, D.I.S.									470 481	C10			
All engines	->year 01/02/05, x 1, D.I.S.									470 532	C10			
Eng. HXDA, HXDB	26/03/07 ->											358 242		
Eng. HXDA, HXDB	->year 26/03/07											360 625		
ENGINE														
1.6 Ti-VCT	Petrol	85	09/05-07/11	HXDA, HXDB, SIDA										
Engine	Information				A10	A20	A40	A50	A70	C10 - C30	C20	E01		
All engines	x 1, D.I.S.									470 481	C10			
ENGINE														
1.8	Petrol	92	03/06-09/12	Q7DA, QQDA, QQDB										
Engine	Information				A10	A20	A40	A50	A70	C10 - C30	C20	E01		
All engines	x 4, COIL ON PLUG									470 480	C10			
ENGINE														
1.8 Flexifuel	Petrol/ Ethanol	92	01/06-09/12	Q7DA, QQDA, QQDB										
Engine	Information				A10	A20	A40	A50	A70	C10 - C30	C20	E01		
All engines	x 4, COIL ON PLUG									470 480	C10			
ENGINE														
1.8 Flexifuel	Petrol/ Ethanol	96	12/05-01/08	--, 1LQ4(364CUV8), 4LQ2(122CUL4), QQDD										
Engine	Information				A10	A20	A40	A50	A70	C10 - C30	C20	E01		
Eng. --, QQDD	Qty: 4									470 480	C10			
Eng. 1LQ4(364CUV8), 4LQ2(122CUL4)	x 4, COIL ON PLUG									470 480	C10			
ENGINE														
1.8 Flexifuel	Petrol/ Ethanol	97	12/05-01/08	--										
Engine	Information				A10	A20	A40	A50	A70	C10 - C30	C20	E01		
All engines	Qty: 4									470 480	C10			
ENGINE														
2.0	Petrol	104	06/05-09/08	SYDA										
Engine	Information				A10	A20	A40	A50	A70	C10 - C30	C20	E01		
All engines	x 4, COIL ON PLUG									470 480	C10			
ENGINE														
2.0	Petrol	107	07/04-09/12	AODA, AODB, AODE, SYDA										
Engine	Information				A10	A20	A40	A50	A70	C10 - C30	C20	E01		
All engines	x 4, COIL ON PLUG									470 480	C10			
ENGINE														
2.0 CNG	Petrol/ Com- pressed Natural Gas (CNG)	107	04/09-07/11	SYDA										
Engine	Information				A10	A20	A40	A50	A70	C10 - C30	C20	E01		
All engines	x 4, COIL ON PLUG									470 480	C10			
ENGINE														
2.0 Flex	Petrol/ Ethanol	107	10/08-03/10	SYDA										
Engine	Information				A10	A20	A40	A50	A70	C10 - C30	C20	E01		
All engines	x 4, COIL ON PLUG									470 480	C10			

A10 CONDENSER	A20 CONTACT SET	A40 DISTRIBUTOR CAP	A50 ROTOR	A70 PICK-UP
C10 COIL	C20 IGNITION MODULE	C30 ELECTRONIC IGNITION KIT	E01 IGNITION CABLE SET	

The present application list is a brief version. For the detailed information about the possibility of installation on a specific vehicle, please refer to our web-catalogue <http://catalogo.facet.eu/>

					FUNCTIONS ON THE VEHICLE							
Vehicle	alim.	kW	Date	Engine								

				ENGINE
2.0 LPG	Petrol/ Liquified Petro- leum Gas (LPG)	107	06/08-07/11	SYDA

Engine	Information	A10	A20	A40	A50	A70	C10 - C30	C20	E01
All engines	x 4, COIL ON PLUG						470 480	C10	

				ENGINE
2.5 RS	Petrol	224	01/09-07/11	JZDA

Engine	Information	A10	A20	A40	A50	A70	C10 - C30	C20	E01
All engines	x 5, COIL ON PLUG						470 478	C10	

				ENGINE
2.5 RS 500	Petrol	257	05/10-07/11	JZDA

Engine	Information	A10	A20	A40	A50	A70	C10 - C30	C20	E01
All engines	x 5, COIL ON PLUG						470 478	C10	

				ENGINE
2.5 ST	Petrol	166	10/05-09/12	HYDA

Engine	Information	A10	A20	A40	A50	A70	C10 - C30	C20	E01
All engines	x 5, COIL ON PLUG						470 478	C10	

FOCUS III

				ENGINE
1.0 EcoBoost	Petrol	103	10/17->	M1DH

Engine	Information	A10	A20	A40	A50	A70	C10 - C30	C20	E01
All engines	x 3, COIL ON PLUG						470 619	C10	

				ENGINE
1.0 EcoBoost	Petrol	74	02/12->	M2DA, M2DB, M2DC, SFDA, SFDB

Engine	Information	A10	A20	A40	A50	A70	C10 - C30	C20	E01
All engines	x 3, COIL ON PLUG						470 619	C10	

				ENGINE
1.0 EcoBoost	Petrol	92	02/12->	M1DA, M1DC, M1DD

Engine	Information	A10	A20	A40	A50	A70	C10 - C30	C20	E01
All engines	x 3, COIL ON PLUG						470 619	C10	

				ENGINE
1.5 EcoBoost	Petrol	110	09/14->	M8DA, M8DB, M8DD, M8DE

Engine	Information	A10	A20	A40	A50	A70	C10 - C30	C20	E01
All engines	x 4, COIL ON PLUG						470 623	C10	

				ENGINE
1.5 EcoBoost	Petrol	134	09/14->	M9DA, M9DB

Engine	Information	A10	A20	A40	A50	A70	C10 - C30	C20	E01
All engines	x 4, COIL ON PLUG						470 623	C10	

				ENGINE
1.6 Flexifuel	Petrol/ Ethanol	88	07/10->	MUDA, MUDD

Engine	Information	A10	A20	A40	A50	A70	C10 - C30	C20	E01
All engines	x 1, D.I.S.						470 481	C10	
Eng. MUDA									358 242

				ENGINE
1.6 LPG	Petrol/ Liquified Petro- leum Gas (LPG)	86	02/12->	MUDA

Engine	Information	A10	A20	A40	A50	A70	C10 - C30	C20	E01
All engines	x 1, D.I.S.						470 481	C10	
All engines									358 242

				ENGINE
1.6 LPG	Petrol/ Liquified Petro- leum Gas (LPG)	88	02/12->	MUDA, MUDD









Engine	Information	A10	A20	A40	A50	A70	C10 - C30	C20	E01
All engines	x 1, D.I.S.						470 481	C10	
Eng. MUDA									358 242

A10	CONDENSER	A20	CONTACT SET	A40	DISTRIBUTOR CAP	A50	ROTOR	A70	PICK-UP
C10	COIL	C20	IGNITION MODULE	C30	ELECTRONIC IGNITION KIT	E01	IGNITION CABLE SET		

Vehicle	alim.	kW	Date	Engine	FUNCTIONS ON THE VEHICLE									
					A10	A20	A40	A50	A70	C10 - C30	C20	E01		
ENGINE														
1.6 Ti	Petrol	63	08/11->	XTDA, XTDB										
Engine	Information													
All engines	x 1, D.I.S.									470 481	C10			
Eng. XTDA														358 242
ENGINE														
1.6 Ti	Petrol	77	07/10->	IQDA, IQDB, IQDC										
Engine	Information													
All engines	x 1, D.I.S., x 1, D.I.S.									470 481	C10			
Eng. IQDB														358 242
ENGINE														
1.6 Ti	Petrol	88	02/12->	MUDA, MUDD										
Engine	Information													
All engines	x 1, D.I.S.									470 481	C10			
Eng. MUDA														358 242
ENGINE														
1.6 Ti	Petrol	92	07/10->	PNDA, PNDD										
Engine	Information													
All engines	x 1, D.I.S.									470 481	C10			
Eng. PNDA														358 242
ENGINE														
1.6 Ti-VCT	Petrol	90	07/10->	--										
Engine	Information													
All engines										470 481	C10			358 242
FUSION														
1.25	Petrol	51	10/02->	--										
Engine	Information													
All engines	21/02/05 ->									470 481	C10			
All engines	->year 21/02/05									470 532	C10			
All engines	01/02/07 ->													358 242
All engines	->year 01/02/07													360 625
ENGINE														
1.25	Petrol	55	08/04-12/12	FUJA, FUJB										
Engine	Information													
All engines	01/03/05 ->, x 1, D.I.S.									470 481	C10			
All engines	->year 01/02/05, x 1, D.I.S.									470 532	C10			
All engines	01/02/07 ->													358 242
All engines	->year 01/02/07													360 625
ENGINE														
1.3	Petrol	44	11/02->	BAJA										
Engine	Information													
All engines	01/03/05 ->, x 1, D.I.S.									470 481	C10			
All engines	23/08/07 ->									470 481	C10			
All engines	->year 01/02/05, x 1, D.I.S.									470 532	C10			
All engines	->year 23/08/07									470 532	C10			
All engines														358 208
ENGINE														
1.4	Petrol	55	08/02->	--										
Engine	Information													
All engines	21/02/05 ->									470 481	C10			
All engines	->year 21/02/05									470 532	C10			
All engines	01/02/07 ->													358 242
All engines	->year 01/02/07													360 625
ENGINE														
1.4	Petrol	59	08/02-12/12	FXJA, FXJB, FXJC										
Engine	Information													
All engines	01/03/05 ->, 01/03/11 ->, ->year 01/02/11, x 1, D.I.S., x 1, D.I.S.									470 481	C10			
All engines	->year 01/02/05, x 1, D.I.S.									470 532	C10			
All engines	01/02/07 ->													358 242
All engines	->year 01/02/07													360 625

A10	CONDENSER	A20	CONTACT SET	A40	DISTRIBUTOR CAP	A50	ROTOR	A70	PICK-UP
C10	COIL	C20	IGNITION MODULE	C30	ELECTRONIC IGNITION KIT	E01	IGNITION CABLE SET		

The present application list is a brief version. For the detailed information about the possibility of installation on a specific vehicle, please refer to our web-catalogue <http://catalogo.facet.eu/>

					FUNCTIONS ON THE VEHICLE							
Vehicle	alim.	kW	Date	Engine								

ENGINE				
1.4 LPG	Petrol/ Liquified Petroleum Gas (LPG)	59	01/10-12/12	UTJA

Engine	Information	A10	A20	A40	A50	A70	C10 - C30	C20	E01
All engines	x 1, D.I.S.						470 481	C10	
All engines									358 242

ENGINE				
1.6	Petrol	74	08/02-11/09	FYJA, FYJB, FYJC

Engine	Information	A10	A20	A40	A50	A70	C10 - C30	C20	E01
All engines	01/03/11 ->, x 1, D.I.S.						470 481	C10	
All engines	->year 01/02/05, x 1, D.I.S.						470 532	C10	
All engines	01/02/07 ->								358 242
All engines	->year 01/02/07								360 625

ENGINE				
2.0	Petrol	85	03/96-03/06	ZVSA

Engine	Information	A10	A20	A40	A50	A70	C10 - C30	C20	E01
All engines	x 1, D.I.S.						470 532	C10	

ENGINE				
2.0i	Petrol	85	11/95-05/06	NSE, ZVSA

Engine	Information	A10	A20	A40	A50	A70	C10 - C30	C20	E01
All engines	x 1, D.I.S.						470 532	C10	
All engines	----- x 1, D.I.S.								

ENGINE				
2.3	Petrol	103	11/02-03/06	ESSB

Engine	Information	A10	A20	A40	A50	A70	C10 - C30	C20	E01
All engines	x 1, D.I.S.						470 532	C10	

ENGINE				
2.3	Petrol	107	05/00-10/02	ESSA

Engine	Information	A10	A20	A40	A50	A70	C10 - C30	C20	E01
All engines	x 1, D.I.S.						470 532	C10	

ENGINE				
2.3 16V	Petrol	103	09/01-05/06	ESSB

Engine	Information	A10	A20	A40	A50	A70	C10 - C30	C20	E01
All engines	x 1, D.I.S.						470 532	C10	
All engines									360 976

ENGINE				
2.3 16V	Petrol	107	01/97-05/06	ESSA, Y5B

Engine	Information	A10	A20	A40	A50	A70	C10 - C30	C20	E01
All engines	01/04/00 ->, x 1, D.I.S.						470 532	C10	
All engines	01/04/00 ->, ->year 01/12/00, x 1, D.I.S.								
Eng. Y5B	01/01/01 ->, x 1, D.I.S.								360 145
Eng. ESSA									360 976

ENGINE				
2.8	Petrol	128	11/95-07/00	AAA

Engine	Information	A10	A20	A40	A50	A70	C10 - C30	C20	E01
All engines	01/04/00 ->, x 6, COIL ON PLUG						470 435	C10	

ENGINE				
2.8	Petrol	150	05/00-03/06	AYL

Engine	Information	A10	A20	A40	A50	A70	C10 - C30	C20	E01
All engines	x 6, COIL ON PLUG						470 435	C10	

ENGINE				
2.8 i V6	Petrol	128	11/95-04/00	AAA, AMY

Engine	Information	A10	A20	A40	A50	A70	C10 - C30	C20	E01
All engines	01/04/00 ->, x 6, COIL ON PLUG						470 435	C10	

ENGINE				
2.8 V6	Petrol	150	04/00-05/06	AYL

Engine	Information	A10	A20	A40	A50	A70	C10 - C30	C20	E01
All engines	x 6, COIL ON PLUG						470 435	C10	

A10 CONDENSER	A20 CONTACT SET	A40 DISTRIBUTOR CAP	A50 ROTOR	A70 PICK-UP
C10 COIL	C20 IGNITION MODULE	C30 ELECTRONIC IGNITION KIT	E01 IGNITION CABLE SET	

Vehicle	alim.	kW	Date	Engine	FUNCTIONS ON THE VEHICLE									
					A10	A20	A40	A50	A70	C10 - C30	C20	E01		
GALAXY II														
2.0	Petrol	107	05/06-06/15	ENGINE AOWA, AOWB, TBWA, TBWB										
Engine		Information			A10	A20	A40	A50	A70	C10 - C30	C20	E01		
All engines		x 4, COIL ON PLUG								470 480	C10			
2.0 Flexifuel	Petrol/ Ethanol	107	05/06-06/15	ENGINE TBWA, TBWB										
Engine		Information			A10	A20	A40	A50	A70	C10 - C30	C20	E01		
All engines		x 4, COIL ON PLUG								470 480	C10			
2.5 ST	Petrol	162	05/06->	ENGINE HUWA										
Engine		Information			A10	A20	A40	A50	A70	C10 - C30	C20	E01		
All engines		Qty: 5								470 478	C10			
GALAXY III														
1.5 EcoBoost	Petrol	118	01/15-06/18	ENGINE UNCJ, UNCK										
Engine		Information			A10	A20	A40	A50	A70	C10 - C30	C20	E01		
All engines		x 4, COIL ON PLUG								470 623	C10			
1.5 EcoBoost	Petrol	121	07/18->	ENGINE C15HDTX										
Engine		Information			A10	A20	A40	A50	A70	C10 - C30	C20	E01		
All engines		x 4, COIL ON PLUG								470 623	C10			
GRANADA														
1.7	Petrol	51	08/77-05/82	ENGINE TV 17 LC										
Engine		Information			A10	A20	A40	A50	A70	C10 - C30	C20	E01		
All engines		version Bosch					806 079	906 121R						
All engines										470 169	C10		360 078	
2.0	Petrol	74	08/79-08/85	ENGINE NEP										
Engine		Information			A10	A20	A40	A50	A70	C10 - C30	C20	E01		
All engines		version Bosch					806 079	906 121R						
All engines										470 169	C10		360 078	
GRAND C-MAX														
1.0 EcoBoost	Petrol	74	10/12-06/19	ENGINE M2DA, M2DC, SFDA										
Engine		Information			A10	A20	A40	A50	A70	C10 - C30	C20	E01		
Eng. M2DA, M2DC		x 3, COIL ON PLUG								470 619	C10			
Eng. SFDA		Qty: 3								470 619	C10			
1.0 EcoBoost	Petrol	92	10/12-06/19	ENGINE M1DA, M1DD										
Engine		Information			A10	A20	A40	A50	A70	C10 - C30	C20	E01		
All engines		x 3, COIL ON PLUG								470 619	C10			
1.5 EcoBoost	Petrol	110	03/15-06/19	ENGINE M8DB, M8DF										
Engine		Information			A10	A20	A40	A50	A70	C10 - C30	C20	E01		
All engines		x 4, COIL ON PLUG								470 623	C10			
1.5 EcoBoost	Petrol	134	03/15-06/19	ENGINE M9DB										
Engine		Information			A10	A20	A40	A50	A70	C10 - C30	C20	E01		
All engines		x 4, COIL ON PLUG								470 623	C10			
1.6 Ti	Petrol	63	12/10-06/19	ENGINE XTDA										
Engine		Information			A10	A20	A40	A50	A70	C10 - C30	C20	E01		
All engines		x 1, D.I.S.								470 481	C10			
1.6 Ti	Petrol	77	12/10-06/19	ENGINE IQDA, IQDB										
Engine		Information			A10	A20	A40	A50	A70	C10 - C30	C20	E01		
All engines		x 1, D.I.S.								470 481	C10			
All engines													358 242	

A10 CONDENSER	A20 CONTACT SET	A40 DISTRIBUTOR CAP	A50 ROTOR	A70 PICK-UP
C10 COIL	C20 IGNITION MODULE	C30 ELECTRONIC IGNITION KIT	E01 IGNITION CABLE SET	

The present application list is a brief version. For the detailed information about the possibility of installation on a specific vehicle, please refer to our web-catalogue <http://catalogo.facet.eu/>

Vehicle	alim.	kW	Date	Engine	FUNCTIONS ON THE VEHICLE							
					A10	A20	A40	A50	A70	C10 - C30	C20	E01

ENGINE				
1.6 Ti	Petrol	92	12/10-06/19	PNDA, PNDD

Engine	Information	A10	A20	A40	A50	A70	C10 - C30	C20	E01
All engines	x 1, D.I.S.						470 481	C10	
Eng. PNDA									358 242

ENGINE				
1.3	Petrol	51	09/02-03/04	A9A, A9B

Engine	Information	A10	A20	A40	A50	A70	C10 - C30	C20	E01
All engines	x 1, D.I.S.						470 532	C10	

ENGINE				
1.3 i	Petrol	36	06/98-11/08	JJD, JJF, JJG, JJH, JJL

Engine	Information	A10	A20	A40	A50	A70	C10 - C30	C20	E01
All engines	x 1, D.I.S.						470 532	C10	
All engines	15/09/98 ->								360 568
All engines	->year 15/09/98								360 639

ENGINE				
1.3 i	Petrol	37	09/96-10/02	JJB

Engine	Information	A10	A20	A40	A50	A70	C10 - C30	C20	E01
All engines	x 1, D.I.S.						470 532	C10	
All engines	15/09/98 ->								360 568
All engines	->year 15/09/98								360 639

ENGINE				
1.3 i	Petrol	44	09/96-11/08	BAA, J4D, J4K, J4M, J4N, J4P, J4S

Engine	Information	A10	A20	A40	A50	A70	C10 - C30	C20	E01
All engines	01/08/07 ->, x 1, D.I.S.						470 481	C10	
All engines	->year 01/07/07, x 1, D.I.S., x 1, D.I.S.						470 532	C10	
Eng. BAA									358 208
Eng. J4D, J4K, J4M, J4N, J4P, J4S	15/09/98 ->								360 568
Eng. J4D, J4K, J4M, J4N, J4P, J4S	->year 15/09/98								360 639

ENGINE				
1.3 i ROCAM	Petrol	51	08/02-11/08	A9A, A9B

Engine	Information	A10	A20	A40	A50	A70	C10 - C30	C20	E01
All engines	01/07/07 ->, x 1, D.I.S.						470 481	C10	
All engines	->year 01/06/07, x 1, D.I.S.						470 532	C10	
All engines									358 208

ENGINE				
1.6	Petrol	70	09/00-11/08	CDB, CDC

Engine	Information	A10	A20	A40	A50	A70	C10 - C30	C20	E01
All engines									358 208

ENGINE				
1.6 i	Petrol	70	02/01-11/08	CCA, CDB, CDC

Engine	Information	A10	A20	A40	A50	A70	C10 - C30	C20	E01
Eng. CDB, CDC	01/08/07 ->, x 1, D.I.S.						470 481	C10	
Eng. CCA							470 532	C10	
Eng. CDB, CDC	->year 01/07/07, x 1, D.I.S.						470 532	C10	
All engines									358 208

ENGINE				
1.6 i	Petrol	71	11/05-09/08	HL16SL9B

Engine	Information	A10	A20	A40	A50	A70	C10 - C30	C20	E01
All engines	01/07/07 ->, x 1, D.I.S.						470 481	C10	
All engines	->year 01/06/07, x 1, D.I.S.						470 532	C10	

ENGINE				
1.2	Petrol	51	10/08-05/16	169A4000, FP4

Engine	Information	A10	A20	A40	A50	A70	C10 - C30	C20	E01
All engines	x 1, D.I.S.						470 423	C10	
Eng. FP4									358 170

A10 CONDENSER	A20 CONTACT SET	A40 DISTRIBUTOR CAP	A50 ROTOR	A70 PICK-UP
C10 COIL	C20 IGNITION MODULE	C30 ELECTRONIC IGNITION KIT	E01 IGNITION CABLE SET	

Vehicle	alim.	kW	Date	Engine	FUNCTIONS ON THE VEHICLE							
					A10	A20	A40	A50	A70	C10 - C30	C20	E01

KA+				ENGINE
1.2	Petrol	51	06/16->	B2KA

Engine	Information	A10	A20	A40	A50	A70	C10 - C30	C20	E01
All engines	x 1, D.I.S.						470 481	C10	
All engines									358 242

KA+				ENGINE
1.2	Petrol	63	06/16->	YSKD, YSKE

Engine	Information	A10	A20	A40	A50	A70	C10 - C30	C20	E01
All engines	x 1, D.I.S.						470 481	C10	

1.2 Ti-VCT				ENGINE
Petrol	63	06/16->	YSKD, YSKE	

Engine	Information	A10	A20	A40	A50	A70	C10 - C30	C20	E01
All engines	x 1, D.I.S.						470 481	C10	
All engines									358 242

KUGA I				ENGINE
2.5	Petrol	147	02/08-11/12	HYDB, HYDC

Engine	Information	A10	A20	A40	A50	A70	C10 - C30	C20	E01
All engines	x 5, COIL ON PLUG						470 478	C10	

2.5 4x4				ENGINE
Petrol	147	02/08-11/12	HYDB	

Engine	Information	A10	A20	A40	A50	A70	C10 - C30	C20	E01
All engines	x 5, COIL ON PLUG						470 478	C10	

KUGA II				ENGINE
1.5 16V	Petrol	0	03/13->	--

Engine	Information	A10	A20	A40	A50	A70	C10 - C30	C20	E01
All engines	Qty: 4						470 623	C10	

1.5 EcoBoost				ENGINE
Petrol	110	09/14->	M8MA, M8MB, M8MC, M8MD, M8ME	

Engine	Information	A10	A20	A40	A50	A70	C10 - C30	C20	E01
All engines	x 4, COIL ON PLUG						470 623	C10	

1.5 EcoBoost				ENGINE
Petrol	88	01/16->	BNMA	

Engine	Information	A10	A20	A40	A50	A70	C10 - C30	C20	E01
All engines	x 4, COIL ON PLUG						470 623	C10	

1.5 EcoBoost 4x4				ENGINE
Petrol	110	07/16->	OCEAA, M8MA, M8MB, M8MD	

Engine	Information	A10	A20	A40	A50	A70	C10 - C30	C20	E01
All engines	x 4, COIL ON PLUG						470 623	C10	

1.5 EcoBoost 4x4				ENGINE
Petrol	129	08/18->	37F3P674K, M9ME	

Engine	Information	A10	A20	A40	A50	A70	C10 - C30	C20	E01
All engines	x 4, COIL ON PLUG						470 623	C10	

1.5 EcoBoost 4x4				ENGINE
Petrol	134	09/14->	285ZV604, 65M4R730, M9MA, M9MC	

Engine	Information	A10	A20	A40	A50	A70	C10 - C30	C20	E01
All engines	x 4, COIL ON PLUG						470 623	C10	

MAVERICK				ENGINE
2.0 16V	Petrol	91	02/01->	YF

Engine	Information	A10	A20	A40	A50	A70	C10 - C30	C20	E01
All engines	x 1, D.I.S.						470 532	C10	
All engines									360 624

2.0 16V FWD				ENGINE
Petrol	91	02/01->	YF	

Engine	Information	A10	A20	A40	A50	A70	C10 - C30	C20	E01
All engines	x 1, D.I.S.						470 532	C10	

A10 CONDENSER	A20 CONTACT SET	A40 DISTRIBUTOR CAP	A50 ROTOR	A70 PICK-UP
C10 COIL	C20 IGNITION MODULE	C30 ELECTRONIC IGNITION KIT	E01 IGNITION CABLE SET	

The present application list is a brief version. For the detailed information about the possibility of installation on a specific vehicle, please refer to our web-catalogue <http://catalogo.facet.eu/>

Vehicle	alim.	kW	Date	Engine	FUNCTIONS ON THE VEHICLE							
					A10	A20	A40	A50	A70	C10 - C30	C20	E01

ENGINE				
2.3 16V	Petrol	110	03/04->	GZ, ZH23HYU

Engine	Information	A10	A20	A40	A50	A70	C10 - C30	C20	E01
Eng. GZ	Qty: 4						470 480	C10	
Eng. ZH23HYU	x 4, COIL ON PLUG						470 480	C10	

ENGINE				
2.4 i	Petrol	85	09/96-04/98	KA24

Engine	Information	A10	A20	A40	A50	A70	C10 - C30	C20	E01
All engines	version Hitachi			822 089	922 102				
All engines									360 789

ENGINE				
2.4 i	Petrol	87	09/96-04/98	KA24

Engine	Information	A10	A20	A40	A50	A70	C10 - C30	C20	E01
All engines	version Hitachi			822 089	922 102				
All engines									360 789

ENGINE				
2.4 i	Petrol	91	02/93-08/96	KA24E

Engine	Information	A10	A20	A40	A50	A70	C10 - C30	C20	E01
All engines	version Hitachi			822 046	922 070				

MONDEO I

ENGINE				
1.6 i	Petrol	66	08/96-09/00	L1J

Engine	Information	A10	A20	A40	A50	A70	C10 - C30	C20	E01
All engines	x 1, D.I.S.						470 532	C10	
All engines	01/05/98 ->								360 624
All engines	->year 01/05/98								360 630

ENGINE				
1.6 i 16V	Petrol	65	07/94-08/96	L1J

Engine	Information	A10	A20	A40	A50	A70	C10 - C30	C20	E01
All engines							470 299, 470 312	C10	360 630

ENGINE				
1.6 i 16V	Petrol	66	02/93-08/96	L1F

Engine	Information	A10	A20	A40	A50	A70	C10 - C30	C20	E01
All engines							470 299, 470 312	C10	360 630

ENGINE				
1.6 i 16V	Petrol	70	05/98-09/00	L1L, L1N, L1Q

Engine	Information	A10	A20	A40	A50	A70	C10 - C30	C20	E01
All engines	x 1, D.I.S.						470 532	C10	
All engines	01/05/98 ->								360 624
All engines	->year 01/05/98								360 630

ENGINE				
1.8 4x4	Petrol	85	02/93-08/96	RKA

Engine	Information	A10	A20	A40	A50	A70	C10 - C30	C20	E01
All engines							470 299	C10	360 630

ENGINE				
1.8 i	Petrol	85	08/96-09/00	RKA, RKB, RKF, RKH, RKJ, RKK

Engine	Information	A10	A20	A40	A50	A70	C10 - C30	C20	E01
All engines	x 1, D.I.S.						470 532	C10	
Eng. RKB, RKF, RKH, RKJ, RKK	01/05/98 ->								360 624
Eng. RKB, RKF, RKH, RKJ, RKK	->year 01/05/98								360 630

ENGINE				
1.8 i 16V	Petrol	82	01/94-08/96	RKB

Engine	Information	A10	A20	A40	A50	A70	C10 - C30	C20	E01
All engines							470 299, 470 312	C10	360 630

ENGINE				
1.8 i 16V	Petrol	85	02/93-08/96	RKA









Engine	Information	A10	A20	A40	A50	A70	C10 - C30	C20	E01
All engines							470 299, 470 312	C10	360 630

A10 CONDENSER	A20 CONTACT SET	A40 DISTRIBUTOR CAP	A50 ROTOR	A70 PICK-UP
C10 COIL	C20 IGNITION MODULE	C30 ELECTRONIC IGNITION KIT	E01 IGNITION CABLE SET	

Vehicle	alim.	kW	Date	Engine	FUNCTIONS ON THE VEHICLE									
					A10	A20	A40	A50	A70	C10 - C30	C20	E01		
ENGINE														
1.8 i 16V 4x4	Petrol	85	02/93-08/96	RKA										
Engine	Information				A10	A20	A40	A50	A70	C10 - C30	C20	E01		
All engines										470 299, 470 312	C10		360 630	
ENGINE														
2.0 i	Petrol	96	08/96-09/00	NGA, NGB, NGC, NGD										
Engine	Information				A10	A20	A40	A50	A70	C10 - C30	C20	E01		
All engines	x 1, D.I.S.									470 532	C10			
All engines	01/05/98 ->												360 624	
All engines	->year 01/05/98												360 630	
ENGINE														
2.0 i 16V	Petrol	100	02/93-08/96	NGA										
Engine	Information				A10	A20	A40	A50	A70	C10 - C30	C20	E01		
All engines										470 299, 470 312	C10		360 630	
ENGINE														
2.0 i 16V	Petrol	97	01/93-08/96	NGA										
Engine	Information				A10	A20	A40	A50	A70	C10 - C30	C20	E01		
All engines										470 299	C10		360 630	
ENGINE														
2.0 i 16V 4x4	Petrol	100	02/93-08/96	NGA										
Engine	Information				A10	A20	A40	A50	A70	C10 - C30	C20	E01		
All engines										470 299, 470 312	C10		360 630	
ENGINE														
2.0 i 16V 4x4	Petrol	97	12/94-08/96	NGA										
Engine	Information				A10	A20	A40	A50	A70	C10 - C30	C20	E01		
All engines										470 299, 470 312	C10		360 630	
ENGINE														
2.5 24V	Petrol	125	08/96-09/00	SEA, SEB, SEC										
Engine	Information				A10	A20	A40	A50	A70	C10 - C30	C20	E01		
All engines	x 1, D.I.S.									470 170	C10			
ENGINE														
2.5 i 24V	Petrol	125	07/94-08/96	SEA										
Engine	Information				A10	A20	A40	A50	A70	C10 - C30	C20	E01		
All engines										470 170	C10			
ENGINE														
2.5 ST 200	Petrol	151	05/99-09/00	SGA										
Engine	Information				A10	A20	A40	A50	A70	C10 - C30	C20	E01		
All engines	x 1, D.I.S.									470 170	C10			
MONDEO II														
ENGINE														
1.8 16V	Petrol	81	10/00-03/07	CGBA, CGBB										
Engine	Information				A10	A20	A40	A50	A70	C10 - C30	C20	E01		
All engines	01/03/05 ->, x 1, D.I.S.									470 481	C10			
All engines	->year 01/02/05, x 1, D.I.S.									470 532	C10			
ENGINE														
1.8 16V	Petrol	92	10/00-03/07	CHBA, CHBB										
Engine	Information				A10	A20	A40	A50	A70	C10 - C30	C20	E01		
All engines	01/03/05 ->, x 1, D.I.S.									470 481	C10			
All engines	->year 01/02/05, x 1, D.I.S.									470 532	C10			
ENGINE														
2.0 16V	Petrol	107	10/00-03/07	CJBA, CJBB										
Engine	Information				A10	A20	A40	A50	A70	C10 - C30	C20	E01		
All engines	01/03/05 ->, x 1, D.I.S.									470 481	C10			
All engines	->year 01/02/05, x 1, D.I.S.									470 532	C10			
ENGINE														
3.0 V6 24V	Petrol	150	09/04-03/07	REBA										
Engine	Information				A10	A20	A40	A50	A70	C10 - C30	C20	E01		
All engines													358 214	

A10 CONDENSER	A20 CONTACT SET	A40 DISTRIBUTOR CAP	A50 ROTOR	A70 PICK-UP
C10 COIL	C20 IGNITION MODULE	C30 ELECTRONIC IGNITION KIT	E01 IGNITION CABLE SET	

The present application list is a brief version. For the detailed information about the possibility of installation on a specific vehicle, please refer to our web-catalogue <http://catalogo.facet.eu/>

				FUNCTIONS ON THE VEHICLE								
Vehicle	alim.	kW	Date	Engine	 A10	 A20	 A40	 A50	 A70	 C10 - C30	 C20	 E01
				ENGINE								
ST220	Petrol	166	04/02-03/07	MEBA								
				ENGINE	A10	A20	A40	A50	A70	C10 - C30	C20	E01
All engines				Information								358 214
				MONDEO III								
1.6 Ti	Petrol	81	03/07-01/15	RHBA								
				ENGINE	A10	A20	A40	A50	A70	C10 - C30	C20	E01
All engines				Information						470 481	C10	
All engines				x 1, D.I.S.								358 242
All engines				19/03/07 ->								360 625
All engines				->year 19/03/07								
1.6 Ti	Petrol	88	03/10-01/15	KGBA								
				ENGINE	A10	A20	A40	A50	A70	C10 - C30	C20	E01
All engines				Information						470 481	C10	
All engines				x 1, D.I.S.								358 242
All engines				19/03/07 ->								360 625
All engines				->year 19/03/07								
1.6 Ti	Petrol	92	03/07-01/15	PNBA								
				ENGINE	A10	A20	A40	A50	A70	C10 - C30	C20	E01
All engines				Information						470 481	C10	
All engines				x 1, D.I.S.								358 242
All engines				19/03/07 ->								360 625
All engines				->year 19/03/07								
2.0	Petrol	107	03/07-01/15	AOBA, AOBC, TBBA, TBBA								
				ENGINE	A10	A20	A40	A50	A70	C10 - C30	C20	E01
All engines				Information						470 480	C10	
All engines				x 4, COIL ON PLUG								358 242
All engines				19/03/07 ->								360 625
All engines				->year 19/03/07								
2.0 Flexifuel	Petrol/ Ethanol	107	03/09-01/15	TBBA, TBBA								
				ENGINE	A10	A20	A40	A50	A70	C10 - C30	C20	E01
All engines				Information						470 480	C10	
All engines				x 4, COIL ON PLUG								358 242
All engines				19/03/07 ->								360 625
All engines				->year 19/03/07								
2.0 LPG	Petrol/ Liquified Petro- leum Gas (LPG)	107	07/09-01/15	TBBA, TBBA								
				ENGINE	A10	A20	A40	A50	A70	C10 - C30	C20	E01
All engines				Information						470 480	C10	
All engines				x 4, COIL ON PLUG								358 242
All engines				19/03/07 ->								360 625
All engines				->year 19/03/07								
2.5	Petrol	162	03/07-01/15	HUBA								
				ENGINE	A10	A20	A40	A50	A70	C10 - C30	C20	E01
All engines				Information						470 478	C10	
All engines				x 5, COIL ON PLUG								358 242
All engines				19/03/07 ->								360 625
All engines				->year 19/03/07								
				MONDEO IV								
1.0 EcoBoost	Petrol	92	02/15->	M1CA, M1CB								
				ENGINE	A10	A20	A40	A50	A70	C10 - C30	C20	E01
All engines				Information						470 619	C10	
All engines				x 3, COIL ON PLUG								358 242
All engines				19/03/07 ->								360 625
All engines				->year 19/03/07								
1.5 EcoBoost	Petrol	118	09/14->	UNCA, UNCB, UNCE, UNCF								
				ENGINE	A10	A20	A40	A50	A70	C10 - C30	C20	E01
All engines				Information						470 623	C10	
All engines				x 4, COIL ON PLUG								358 242
All engines				19/03/07 ->								360 625
All engines				->year 19/03/07								
1.5 EcoBoost	Petrol	121	05/18->	UNCN								
				ENGINE	A10	A20	A40	A50	A70	C10 - C30	C20	E01
All engines				Information						470 623	C10	
All engines				x 4, COIL ON PLUG								358 242
All engines				19/03/07 ->								360 625
All engines				->year 19/03/07								
1.5 GTDI	Petrol	0	09/14->	--								
				ENGINE	A10	A20	A40	A50	A70	C10 - C30	C20	E01
All engines				Information						470 623	C10	
All engines				Qty: 4								358 242
All engines				19/03/07 ->								360 625
All engines				->year 19/03/07								

A10 CONDENSER	A20 CONTACT SET	A40 DISTRIBUTOR CAP	A50 ROTOR	A70 PICK-UP
C10 COIL	C20 IGNITION MODULE	C30 ELECTRONIC IGNITION KIT	E01 IGNITION CABLE SET	

Vehicle	alim.	kW	Date	Engine	FUNCTIONS ON THE VEHICLE									
					A10	A20	A40	A50	A70	C10 - C30	C20	E01		
ENGINE														
2.0	Petrol	107	03/07-09/14	A0BC										
Engine	Information				A10	A20	A40	A50	A70	C10 - C30	C20	E01		
All engines	x 4, COIL ON PLUG									470 480	C10			
ORION I														
ENGINE														
1.3	Petrol	51	07/83-07/88	JPA										
Engine	Information				A10	A20	A40	A50	A70	C10 - C30	C20	E01		
All engines	version Bosch						806 079	906 060R, 906 061R						
All engines	version Lucas						828 083							
All engines										470 169	C10			
ENGINE														
1.4	Petrol	54	01/86-07/90	FUC										
Engine	Information				A10	A20	A40	A50	A70	C10 - C30	C20	E01		
All engines	version Bosch						806 079	906 061R						
All engines	version Lucas						828 096	928 026R						
All engines										470 169	C10			
ENGINE														
1.4	Petrol	55	12/85-07/90	FUA										
Engine	Information				A10	A20	A40	A50	A70	C10 - C30	C20	E01		
All engines	version Bosch						806 079	906 061R						
All engines	version Lucas						828 096	928 026R						
All engines										470 169, 470 312	C10			
ENGINE														
1.4 Cat	Petrol	54	02/87-07/90	F6B, F6D										
Engine	Information				A10	A20	A40	A50	A70	C10 - C30	C20	E01		
All engines	version Bosch						806 079							
Eng. F6D	version Lucas						828 096	928 026R						
Eng. F6D	version Bosch							906 061R						
Eng. F6B	version Bosch							906 121R						
All engines										470 169	C10			
Eng. F6D													360 281	
ENGINE														
1.6	Petrol	58	07/83-03/86	LP1, LPA										
Engine	Information				A10	A20	A40	A50	A70	C10 - C30	C20	E01		
All engines	version Lucas						828 083							
All engines	version Bosch							906 060R						
All engines										470 169	C10			
ENGINE														
1.6i	Petrol	77	07/83-07/90	LR1, LRA, LRB										
Engine	Information				A10	A20	A40	A50	A70	C10 - C30	C20	E01		
Eng. LRB	version Bosch						806 079							
Eng. LR1, LRA	version Bosch							906 112R						
Eng. LRB	+catalytic converter, version Bosch							906 121R						
All engines										470 169	C10			
Eng. LRB													360 281	
ORION II														
ENGINE														
1.3	Petrol	44	07/90-12/93	J4B, J6A										
Engine	Information				A10	A20	A40	A50	A70	C10 - C30	C20	E01		
All engines										470 312, 470 364	C10		360 007	
ENGINE														
1.4	Petrol	52	07/90-12/93	F6F, F6G										
Engine	Information				A10	A20	A40	A50	A70	C10 - C30	C20	E01		
All engines										470 135, 470 312	C10		359 864	
ENGINE														
1.4	Petrol	54	07/90-12/93	FUH										
Engine	Information				A10	A20	A40	A50	A70	C10 - C30	C20	E01		
All engines										470 312	C10			

A10	CONDENSER	A20	CONTACT SET	A40	DISTRIBUTOR CAP	A50	ROTOR	A70	PICK-UP
C10	COIL	C20	IGNITION MODULE	C30	ELECTRONIC IGNITION KIT	E01	IGNITION CABLE SET		

The present application list is a brief version. For the detailed information about the possibility of installation on a specific vehicle, please refer to our web-catalogue <http://catalogo.facet.eu/>

Vehicle	alim.	kW	Date	Engine	FUNCTIONS ON THE VEHICLE							
					A10	A20	A40	A50	A70	C10 - C30	C20	E01

ENGINE				
1.6	Petrol	66	07/90-12/92	LUJ, LUK

Engine	Information	A10	A20	A40	A50	A70	C10 - C30	C20	E01
All engines							470 135, 470 312	C10	359 864

ENGINE				
1.6 i	Petrol	77	07/90-09/92	HL16EFI-LJE, LJF

Engine	Information	A10	A20	A40	A50	A70	C10 - C30	C20	E01
All engines							470 135	C10	359 864
Eng. LJF							470 312	C10	

ENGINE				
1.6 i 16V	Petrol	66	07/92-12/93	L1E, L1K

Engine	Information	A10	A20	A40	A50	A70	C10 - C30	C20	E01
All engines							470 299, 470 312	C10	360 630

ENGINE				
1.8 i 16V	Petrol	77	02/92-12/93	RDA

Engine	Information	A10	A20	A40	A50	A70	C10 - C30	C20	E01
All engines							470 299, 470 312	C10	360 630

ENGINE				
1.8 i 16V	Petrol	96	01/92-12/93	99BFR1740

Engine	Information	A10	A20	A40	A50	A70	C10 - C30	C20	E01
All engines							470 299, 470 312	C10	360 630

P 100

ENGINE				
1.6	Petrol	54	04/82-09/87	LCR

Engine	Information	A10	A20	A40	A50	A70	C10 - C30	C20	E01
All engines									360 078

ENGINE				
2.0	Petrol	57	10/87-12/92	NAE

Engine	Information	A10	A20	A40	A50	A70	C10 - C30	C20	E01
All engines	version Bosch			806 109	906 025R				
All engines									360 078

PROBE

ENGINE				
2.0 16V	Petrol	85	01/93-09/97	A20LE-FS

Engine	Information	A10	A20	A40	A50	A70	C10 - C30	C20	E01
All engines	01/12/94 ->, version Mitsubishi				931 132				
All engines	->year 30/11/94, version Mitsubishi				931 137				

PUMA

ENGINE				
1.4 16V	Petrol	66	11/97-10/00	FHD, FHF

Engine	Information	A10	A20	A40	A50	A70	C10 - C30	C20	E01
All engines	->year 01/05/98, x 1, D.I.S.						470 2995	C10	
All engines	01/06/98 ->, x 1, D.I.S.						470 532	C10	
All engines	->year 15/05/98								360 619
All engines	15/05/98 ->								360 625

ENGINE				
1.6 16V	Petrol	76	08/00-06/02	L1W

Engine	Information	A10	A20	A40	A50	A70	C10 - C30	C20	E01
All engines	x 1, D.I.S.						470 532	C10	
All engines									360 625

ENGINE				
1.7 16V	Petrol	92	03/97-06/02	MHA, MHB







Engine	Information	A10	A20	A40	A50	A70	C10 - C30	C20	E01
All engines	->year 01/04/00, x 1, D.I.S.						470 2995	C10	
All engines	01/05/00 ->, x 1, D.I.S.						470 532	C10	
All engines	->year 15/05/98								360 619
All engines	15/05/98 ->								360 625

A10 CONDENSER	A20 CONTACT SET	A40 DISTRIBUTOR CAP	A50 ROTOR	A70 PICK-UP
C10 COIL	C20 IGNITION MODULE	C30 ELECTRONIC IGNITION KIT	E01 IGNITION CABLE SET	

Vehicle	alim.	kW	Date	Engine	FUNCTIONS ON THE VEHICLE							
					A10	A20	A40	A50	A70	C10 - C30	C20	E01
Racing ST 160												
ENGINE												
Petrol 114 06/99-06/02 MHA												
Engine	Information				A10	A20	A40	A50	A70	C10 - C30	C20	E01
All engines	-> year 01/04/00, x 1, D.I.S.									470 299S	C10	
All engines	01/05/00 ->, x 1, D.I.S.									470 532	C10	
RANGER IV												
ENGINE												
2.2 Petrol 78 03/02-09/05 --, F2D6												
Engine	Information				A10	A20	A40	A50	A70	C10 - C30	C20	E01
Eng. --	version Mitsubishi						831 121					
Eng. F2D6	x 1, DISTRIBUTOR									470 366S	C10	
ENGINE												
2.2 EFI Petrol 0 03/99-> --												
Engine	Information				A10	A20	A40	A50	A70	C10 - C30	C20	E01
All engines	version Mitsubishi						831 121					
ENGINE												
2.6 Petrol 80 10/02-09/04 --												
Engine	Information				A10	A20	A40	A50	A70	C10 - C30	C20	E01
All engines	version Mitsubishi						831 121					
All engines	without fastening clamp									470 366S	C10	
ENGINE												
4.0 Petrol 152 10/05-06/06 --												
Engine	Information				A10	A20	A40	A50	A70	C10 - C30	C20	E01
All engines										470 289	C10	
ENGINE												
4.0 4x4 Petrol 152 10/05-06/06 --												
Engine	Information				A10	A20	A40	A50	A70	C10 - C30	C20	E01
All engines										470 289	C10	
SCORPIO I												
ENGINE												
1.8 Petrol 66 04/85-02/92 REC												
Engine	Information				A10	A20	A40	A50	A70	C10 - C30	C20	E01
All engines	version Bosch						806 079	906 121R				
All engines										470 169	C10	360 078
ENGINE												
2.0 i Petrol 85 04/85-09/94 N9F, NRA, NRI												
Engine	Information				A10	A20	A40	A50	A70	C10 - C30	C20	E01
Eng. NRA, NRI	no specific info conc. application available, version Bosch						806 079	906 121R				
All engines	no specific info conc. application available, version Bosch						806 253	906 140R				
Eng. NRA, NRI	version Ford						819 092					
All engines										470 169	C10	
Eng. NRA, NRI	no specific info conc. application available											360 078
ENGINE												
2.0 i Petrol 88 05/89-09/94 N9D												
Engine	Information				A10	A20	A40	A50	A70	C10 - C30	C20	E01
All engines	no specific info conc. application available, version Bosch						806 253	906 140R				
All engines										470 169	C10	
ENGINE												
2.0 i Petrol 90 11/92-09/94 N9B												
Engine	Information				A10	A20	A40	A50	A70	C10 - C30	C20	E01
All engines	no specific info conc. application available, version Bosch						806 253	906 140R				
All engines										470 169	C10	
ENGINE												
2.4 i Petrol 96 09/86-09/88 ARC												
Engine	Information				A10	A20	A40	A50	A70	C10 - C30	C20	E01
All engines	version Ford							919 092				
All engines										470 169	C10	
ENGINE												
2.9 24V Petrol 143 08/93-09/94 BOA												
Engine	Information				A10	A20	A40	A50	A70	C10 - C30	C20	E01
All engines										470 170	C10	

A10 CONDENSER	A20 CONTACT SET	A40 DISTRIBUTOR CAP	A50 ROTOR	A70 PICK-UP
C10 COIL	C20 IGNITION MODULE	C30 ELECTRONIC IGNITION KIT	E01 IGNITION CABLE SET	

The present application list is a brief version. For the detailed information about the possibility of installation on a specific vehicle, please refer to our web-catalogue <http://catalogo.facet.eu/>

				FUNCTIONS ON THE VEHICLE								
Vehicle	alim.	kW	Date	Engine								
				ENGINE								
2.9 i	Petrol	107	09/86-12/94	BRD, BRE, BRF								
Engine		Information		A10	A20	A40	A50	A70	C10 - C30	C20	E01	
All engines		version Ford					919 092					
All engines									470 169	C10		
				ENGINE								
2.9 i	Petrol	110	09/86-09/94	BRC								
Engine		Information		A10	A20	A40	A50	A70	C10 - C30	C20	E01	
All engines		version Ford					919 092					
All engines									470 169	C10		
				ENGINE								
2.9 i 24V	Petrol	143	04/91-09/94	BOA								
Engine		Information		A10	A20	A40	A50	A70	C10 - C30	C20	E01	
All engines									470 170	C10		
				ENGINE								
2.9 i 4x4	Petrol	107	05/88-10/94	BRD, BRE, BRF								
Engine		Information		A10	A20	A40	A50	A70	C10 - C30	C20	E01	
All engines		version Ford					919 092					
All engines									470 169	C10		
				ENGINE								
2.9 i 4x4	Petrol	110	09/86-09/94	BRC								
Engine		Information		A10	A20	A40	A50	A70	C10 - C30	C20	E01	
All engines		version Ford					919 092					
All engines									470 169	C10		
				ENGINE								
2.9 i Cat	Petrol	107	10/87-09/94	BRE								
Engine		Information		A10	A20	A40	A50	A70	C10 - C30	C20	E01	
All engines		version Ford					919 092					
All engines									470 169	C10		
				SCORPIO II								
				ENGINE								
2.0 i 16V	Petrol	100	10/94-08/98	N3A								
Engine		Information		A10	A20	A40	A50	A70	C10 - C30	C20	E01	
All engines												360 145
				ENGINE								
2.3 i 16V	Petrol	108	06/96-08/98	Y5A								
Engine		Information		A10	A20	A40	A50	A70	C10 - C30	C20	E01	
All engines												360 145
				ENGINE								
2.9 i	Petrol	110	02/95-08/98	BRG								
Engine		Information		A10	A20	A40	A50	A70	C10 - C30	C20	E01	
All engines		version Ford					919 092					
All engines		x 1, Colour:Red, DISTRIBUTOR, 12 Volt, Dia: 55 mm, connector type DIN							470 169	C10		
				ENGINE								
2.9 i 24V	Petrol	152	10/94-08/98	BOB								
Engine		Information		A10	A20	A40	A50	A70	C10 - C30	C20	E01	
All engines		x 1, D.I.S.							470 170	C10		
				SIERRA I								
				ENGINE								
1.3	Petrol	44	08/82-12/86	JCT								
Engine		Information		A10	A20	A40	A50	A70	C10 - C30	C20	E01	
All engines		version Bosch				806 109	906 025R					
All engines									470 169	C10		360 078
				ENGINE								
1.8	Petrol	66	10/84-12/86	REB								
Engine		Information		A10	A20	A40	A50	A70	C10 - C30	C20	E01	
All engines		version Bosch				806 235	906 121R					
All engines									470 169	C10		

A10 CONDENSER	A20 CONTACT SET	A40 DISTRIBUTOR CAP	A50 ROTOR	A70 PICK-UP
C10 COIL	C20 IGNITION MODULE	C30 ELECTRONIC IGNITION KIT	E01 IGNITION CABLE SET	

Vehicle	alim.	kW	Date	Engine	FUNCTIONS ON THE VEHICLE							
					A10	A20	A40	A50	A70	C10 - C30	C20	E01
ENGINE												
2.0	Petrol	66	08/82-10/84	NYT								
Engine	Information			A10	A20	A40	A50	A70	C10 - C30	C20	E01	
All engines	01/10/85 ->, version Bosch					806 079						
All engines	->year 01/10/84, version Bosch					806 109						
All engines	01/10/84 ->, ->year 01/10/85, version Bosch					806 235						
All engines	version Bosch						906 025R					
ENGINE												
2.0	Petrol	74	10/85-12/86	NRD								
Engine	Information			A10	A20	A40	A50	A70	C10 - C30	C20	E01	
All engines	version Bosch					806 079	906 121R					
ENGINE												
2.0	Petrol	77	08/82-12/86	NET								
Engine	Information			A10	A20	A40	A50	A70	C10 - C30	C20	E01	
All engines	01/10/85 ->, version Bosch					806 079						
All engines	->year 01/10/84, version Bosch					806 109	906 025R					
All engines	01/10/84 ->, ->year 01/10/85, version Bosch					806 235						
All engines	01/10/84 ->, version Bosch						906 121R					
All engines								470 169	C10			
ENGINE												
2.0	Petrol	85	03/85-12/86	NR2								
Engine	Information			A10	A20	A40	A50	A70	C10 - C30	C20	E01	
All engines	version Bosch					806 079	906 121R					
All engines	version Ford					819 092						
ENGINE												
2.0 i	Petrol	85	03/85-12/86	NR2								
Engine	Information			A10	A20	A40	A50	A70	C10 - C30	C20	E01	
All engines	version Bosch					806 079	906 121R					
All engines	version Ford					819 092						
All engines								470 169	C10			
SIERRA II												
ENGINE												
1.6 i	Petrol	59	10/89-02/93	L6B								
Engine	Information			A10	A20	A40	A50	A70	C10 - C30	C20	E01	
All engines									470 135, 470 312	C10		
ENGINE												
1.8	Petrol	64	05/88-02/93	R2C, R6A								
Engine	Information			A10	A20	A40	A50	A70	C10 - C30	C20	E01	
All engines	version Ford						919 094R					
All engines								470 169, 470 312	C10			
ENGINE												
1.8 i	Petrol	0	01/92-12/93	HL18CFI-R6A								
Engine	Information			A10	A20	A40	A50	A70	C10 - C30	C20	E01	
All engines									470 135	C10		
ENGINE												
2.0	Petrol	77	01/87-02/93	N8C, NES								
Engine	Information			A10	A20	A40	A50	A70	C10 - C30	C20	E01	
All engines	version Bosch					806 079	906 121R					
All engines								470 169	C10			
ENGINE												
2.0 i	Petrol	85	01/87-02/93	N4A, N4I								
Engine	Information			A10	A20	A40	A50	A70	C10 - C30	C20	E01	
All engines	version Bosch					806 253	906 140R					
All engines								470 169	C10			
ENGINE												
2.0 i	Petrol	92	06/89-02/93	N9B								
Engine	Information			A10	A20	A40	A50	A70	C10 - C30	C20	E01	
All engines	version Bosch					806 253	906 140R					
All engines								470 169	C10			

A10	CONDENSER	A20	CONTACT SET	A40	DISTRIBUTOR CAP	A50	ROTOR	A70	PICK-UP
C10	COIL	C20	IGNITION MODULE	C30	ELECTRONIC IGNITION KIT	E01	IGNITION CABLE SET		

The present application list is a brief version. For the detailed information about the possibility of installation on a specific vehicle, please refer to our web-catalogue <http://catalogo.facet.eu/>

Vehicle	alim.	kW	Date	Engine	FUNCTIONS ON THE VEHICLE							
					A10	A20	A40	A50	A70	C10 - C30	C20	E01

S-MAX I

Vehicle	alim.	kW	Date	ENGINE
2.0	Petrol	107	05/06-12/14	AODA, AODB, AODE, AOWA, AOWB

Engine	Information	A10	A20	A40	A50	A70	C10 - C30	C20	E01
All engines	x 4, COIL ON PLUG						470 480	C10	

Vehicle	alim.	kW	Date	ENGINE
2.0 Flexifuel	Petrol/ Ethanol	107	05/06-12/14	TBWA, TBWB

Engine	Information	A10	A20	A40	A50	A70	C10 - C30	C20	E01
All engines	x 4, COIL ON PLUG						470 480	C10	

Vehicle	alim.	kW	Date	ENGINE
2.5 ST	Petrol	162	05/06-12/14	HUWA

Engine	Information	A10	A20	A40	A50	A70	C10 - C30	C20	E01
All engines	x 5, COIL ON PLUG						470 478	C10	

S-MAX II

Vehicle	alim.	kW	Date	ENGINE
1.5 EcoBoost	Petrol	118	01/15-06/18	UNCI, UNCJ, UNCK

Engine	Information	A10	A20	A40	A50	A70	C10 - C30	C20	E01
All engines	x 4, COIL ON PLUG						470 623	C10	

Vehicle	alim.	kW	Date	ENGINE
1.5 EcoBoost	Petrol	121	07/18->	6CF4G15, C15HDTX

Engine	Information	A10	A20	A40	A50	A70	C10 - C30	C20	E01
All engines	x 4, COIL ON PLUG						470 623	C10	

STREET KA

Vehicle	alim.	kW	Date	ENGINE
1.6	Petrol	70	05/03-07/05	CDRA, CDRB

Engine	Information	A10	A20	A40	A50	A70	C10 - C30	C20	E01
All engines	x 1, D.I.S.						470 532	C10	
All engines									358 208

TAUNUS

Vehicle	alim.	kW	Date	ENGINE
1.6	Petrol	54	07/79-07/82	LJ

Engine	Information	A10	A20	A40	A50	A70	C10 - C30	C20	E01
All engines	version Ford		719 044HV	819 083	919 085				

TAUNUS 12M

Vehicle	alim.	kW	Date	ENGINE
1.2	Petrol	28	12/51-02/63	--

Engine	Information	A10	A20	A40	A50	A70	C10 - C30	C20	E01
All engines			706 021						

Vehicle	alim.	kW	Date	ENGINE
1.2	Petrol	29	07/62-04/67	--

Engine	Information	A10	A20	A40	A50	A70	C10 - C30	C20	E01
All engines			706 021						

Vehicle	alim.	kW	Date	ENGINE
1.2	Petrol	31	09/58-08/62	--

Engine	Information	A10	A20	A40	A50	A70	C10 - C30	C20	E01
All engines			706 021						

Vehicle	alim.	kW	Date	ENGINE
1.5	Petrol	37	07/62-04/67	--

Engine	Information	A10	A20	A40	A50	A70	C10 - C30	C20	E01
All engines			706 021						

Vehicle	alim.	kW	Date	ENGINE
1.5	Petrol	40	09/58-02/63	--

Engine	Information	A10	A20	A40	A50	A70	C10 - C30	C20	E01
All engines			706 021						

Vehicle	alim.	kW	Date	ENGINE
1.5 TS	Petrol	37	12/62-04/67	--

Engine	Information	A10	A20	A40	A50	A70	C10 - C30	C20	E01
All engines			706 021						

A10 CONDENSER	A20 CONTACT SET	A40 DISTRIBUTOR CAP	A50 ROTOR	A70 PICK-UP
C10 COIL	C20 IGNITION MODULE	C30 ELECTRONIC IGNITION KIT	E01 IGNITION CABLE SET	

Vehicle	alim.	kW	Date	Engine	FUNCTIONS ON THE VEHICLE								
					A10	A20	A40	A50	A70	C10 - C30	C20	E01	
1.5 TS					ENGINE								
Petrol	48	12/62-04/67	--		A10	A20	A40	A50	A70	C10 - C30	C20	E01	
Engine	Information				A10	A20	A40	A50	A70	C10 - C30	C20	E01	
All engines						706 021							
TAUNUS 15M					ENGINE								
1.5					--, TV 15 H								
Petrol	40	12/54-07/71			A10	A20	A40	A50	A70	C10 - C30	C20	E01	
Engine	Information				A10	A20	A40	A50	A70	C10 - C30	C20	E01	
All engines						706 021							
1.5					ENGINE								
Petrol	44	09/54-08/58	--		A10	A20	A40	A50	A70	C10 - C30	C20	E01	
Engine	Information				A10	A20	A40	A50	A70	C10 - C30	C20	E01	
All engines						706 021							
1.5 XL/RS					ENGINE								
Petrol	40	01/68-06/71	--, TV 15 H		A10	A20	A40	A50	A70	C10 - C30	C20	E01	
Engine	Information				A10	A20	A40	A50	A70	C10 - C30	C20	E01	
All engines						706 021							
TAUNUS 17M					ENGINE								
1.5					ENGINE								
Petrol	40	09/60-01/65	--		A10	A20	A40	A50	A70	C10 - C30	C20	E01	
Engine	Information				A10	A20	A40	A50	A70	C10 - C30	C20	E01	
All engines						706 021							
1.5					ENGINE								
Petrol	44	09/64-10/68	--		A10	A20	A40	A50	A70	C10 - C30	C20	E01	
Engine	Information				A10	A20	A40	A50	A70	C10 - C30	C20	E01	
All engines						706 021	806 062						
1.7					ENGINE								
Petrol	44	08/57-11/60	--		A10	A20	A40	A50	A70	C10 - C30	C20	E01	
Engine	Information				A10	A20	A40	A50	A70	C10 - C30	C20	E01	
All engines						706 021		906 018R					
1.7					ENGINE								
Petrol	48	09/64-04/74	--		A10	A20	A40	A50	A70	C10 - C30	C20	E01	
Engine	Information				A10	A20	A40	A50	A70	C10 - C30	C20	E01	
All engines						706 021							
1.7					ENGINE								
Petrol	55	12/67-04/74	--		A10	A20	A40	A50	A70	C10 - C30	C20	E01	
Engine	Information				A10	A20	A40	A50	A70	C10 - C30	C20	E01	
All engines						706 021							
1.7 S					ENGINE								
Petrol	48	09/60-01/65	--		A10	A20	A40	A50	A70	C10 - C30	C20	E01	
Engine	Information				A10	A20	A40	A50	A70	C10 - C30	C20	E01	
All engines						706 021							
1.7 S					ENGINE								
Petrol	55	11/61-01/65	--		A10	A20	A40	A50	A70	C10 - C30	C20	E01	
Engine	Information				A10	A20	A40	A50	A70	C10 - C30	C20	E01	
All engines						706 021							
TOURNEO					ENGINE								
1.8 BiFuel					EYPDCNG								
CNG	85	08/05-12/06			A10	A20	A40	A50	A70	C10 - C30	C20	E01	
Engine	Information				A10	A20	A40	A50	A70	C10 - C30	C20	E01	
All engines	x 1, D.I.S.									470 532	C10		
1.8 LPG					ENGINE								
LPG	85	08/05-12/06	EYPC		A10	A20	A40	A50	A70	C10 - C30	C20	E01	
Engine	Information				A10	A20	A40	A50	A70	C10 - C30	C20	E01	
All engines	x 1, D.I.S.									470 532	C10		
TOURNEO CONNECT I					ENGINE								
1.8 16V					EYPA, EYPC, EYPD								
Petrol	85	06/02-12/13			A10	A20	A40	A50	A70	C10 - C30	C20	E01	
Engine	Information				A10	A20	A40	A50	A70	C10 - C30	C20	E01	
All engines	x 1, D.I.S.									470 532	C10		
All engines												360 624	

A10 CONDENSER	A20 CONTACT SET	A40 DISTRIBUTOR CAP	A50 ROTOR	A70 PICK-UP
C10 COIL	C20 IGNITION MODULE	C30 ELECTRONIC IGNITION KIT	E01 IGNITION CABLE SET	

The present application list is a brief version. For the detailed information about the possibility of installation on a specific vehicle, please refer to our web-catalogue <http://catalogo.facet.eu/>

					FUNCTIONS ON THE VEHICLE							
Vehicle	alim.	kW	Date	Engine								

TOURNEO COURIER

				ENGINE
1.0 EcoBoost	Petrol	74	02/14->	SFCA, SFCB, SFCC, SFCD, SFCE, SFCF

Engine	Information	A10	A20	A40	A50	A70	C10 - C30	C20	E01
All engines	x 3, COIL ON PLUG						470 619	C10	

TOURNEO CUSTOM

				ENGINE
1.0 EcoBoost PHEV	Petrol/ Electric	92	04/20->	M1FA

Engine	Information	A10	A20	A40	A50	A70	C10 - C30	C20	E01
All engines	x 3, COIL ON PLUG						470 619	C10	

TRANSIT

				ENGINE
1.8 CNG	CNG	85	05/02-12/13	EYPDCNG

Engine	Information	A10	A20	A40	A50	A70	C10 - C30	C20	E01
All engines	Transit Connect, x 1, D.I.S.						470 532	C10	

				ENGINE
2.0	CNG	84	06/94-03/00	NSHCNG

Engine	Information	A10	A20	A40	A50	A70	C10 - C30	C20	E01
All engines	Transit 100, Transit 150, ->year 01/08/94, x 1, Colour:Red, DISTRIBUTOR, 12 Volt, Dia: 55 mm, connector type DIN						470 169	C10	

TRANSIT CONNECT I

				ENGINE
1.8 16V	Petrol	85	06/02-12/13	EYPA, EYPC, EYPD

Engine	Information	A10	A20	A40	A50	A70	C10 - C30	C20	E01
All engines	Transit Connect, x 1, D.I.S.						470 532	C10	
All engines									360 624

				ENGINE
1.8 16V LPG	Petrol/ Liquified Petro- leum Gas (LPG)	85	06/02-12/13	EYPA, EYPC, EYPD

Engine	Information	A10	A20	A40	A50	A70	C10 - C30	C20	E01
All engines	Transit Connect, x 1, D.I.S.						470 532	C10	
Eng. EYPC									360 624

TRANSIT CONNECT II

				ENGINE
1.0 EcoBoost	Petrol	74	02/13->	M2GA, M2GB

Engine	Information	A10	A20	A40	A50	A70	C10 - C30	C20	E01
All engines	Transit Connect, x 3, COIL ON PLUG						470 619	C10	

TRANSIT COURIER

				ENGINE
1.0 EcoBoost	Petrol	74	02/14->	SFCA, SFCB, SFCC, SFCD, SFCE, SFCF

Engine	Information	A10	A20	A40	A50	A70	C10 - C30	C20	E01
All engines	x 3, COIL ON PLUG						470 619	C10	

TRANSIT CUSTOM

				ENGINE
1.0 EcoBoost PHEV	Petrol/ Electric	92	04/20->	M1FA

Engine	Information	A10	A20	A40	A50	A70	C10 - C30	C20	E01
All engines	Transit Custom 320, Transit Custom 340, x 3, COIL ON PLUG						470 619	C10	

TRANSIT I

				ENGINE
1.5	Petrol	40	06/58-08/65	--

Engine	Information	A10	A20	A40	A50	A70	C10 - C30	C20	E01
All engines			706 021						

				ENGINE
1.6	Petrol	48	11/77-10/86	4RB





Engine	Information	A10	A20	A40	A50	A70	C10 - C30	C20	E01
All engines	version Ford		719 044HV	819 083	919 085				
All engines	version Bosch, alternatively			806 079, 806 109					

A10 CONDENSER	A20 CONTACT SET	A40 DISTRIBUTOR CAP	A50 ROTOR	A70 PICK-UP
C10 COIL	C20 IGNITION MODULE	C30 ELECTRONIC IGNITION KIT	E01 IGNITION CABLE SET	

Vehicle	alim.	kW	Date	Engine	FUNCTIONS ON THE VEHICLE									
					A10	A20	A40	A50	A70	C10 - C30	C20	E01		
ENGINE														
1.6	Petrol	48	11/77-10/86	4RB										
ENGINE														
Engine		Information			A10	A20	A40	A50	A70	C10 - C30	C20	E01		
All engines		version Bosch						906 012R						
ENGINE														
1250 S-2 Klein-LKW	Petrol	40	10/57-07/67	--										
ENGINE														
Engine		Information			A10	A20	A40	A50	A70	C10 - C30	C20	E01		
All engines						706 021								
ENGINE														
2.0	Petrol	43	11/77-07/82	4RC										
ENGINE														
Engine		Information			A10	A20	A40	A50	A70	C10 - C30	C20	E01		
All engines		version Ford				719 044HV	819 083	919 085						
All engines		version Bosch					806 079	906 012R						
ENGINE														
K-40 1.5	Petrol	40	04/55-04/67	--										
ENGINE														
Engine		Information			A10	A20	A40	A50	A70	C10 - C30	C20	E01		
All engines						706 021								
TRANSIT II														
ENGINE														
1.6	Petrol	46	09/85-09/92	LAC, LAT										
ENGINE														
Engine		Information			A10	A20	A40	A50	A70	C10 - C30	C20	E01		
All engines		version Bosch				706 049HDVS		906 025R						
All engines		version Bosch, alternatively					806 079, 806 109							
All engines										470 169	C10		360 078	
ENGINE														
2.0	Petrol	56	10/85-03/91	NAW										
ENGINE														
Engine		Information			A10	A20	A40	A50	A70	C10 - C30	C20	E01		
All engines		version Bosch				706 049HDVS		906 025R						
All engines		version Bosch, alternatively					806 079, 806 109							
All engines										470 169	C10			
All engines		->year 31/08/91											360 078	
ENGINE														
2.0	Petrol	57	09/85-09/92	NAT, NAV										
ENGINE														
Engine		Information			A10	A20	A40	A50	A70	C10 - C30	C20	E01		
All engines		version Bosch				706 049HDVS		906 025R						
All engines		version Bosch, alternatively					806 079, 806 109							
All engines										470 169	C10			
All engines		->year 31/08/91											360 078	
ENGINE														
2.0	Petrol	60	10/85-03/91	N6TS										
ENGINE														
Engine		Information			A10	A20	A40	A50	A70	C10 - C30	C20	E01		
All engines		version Bosch					806 079	906 121R						
All engines										470 169	C10			
All engines		->year 31/08/91											360 078	
ENGINE														
2.0	Petrol	66	09/91-09/94	NBA										
ENGINE														
Engine		Information			A10	A20	A40	A50	A70	C10 - C30	C20	E01		
All engines		version Bosch, alternatively					806 079, 806 109							
All engines		version Bosch						906 025R						
All engines										470 169	C10			
ENGINE														
2.0	Petrol	72	09/91-08/94	NCA										
ENGINE														
Engine		Information			A10	A20	A40	A50	A70	C10 - C30	C20	E01		
All engines		version Bosch, alternatively					806 079, 806 109							
All engines		version Bosch						906 025R						
All engines										470 169	C10			

A10	CONDENSER	A20	CONTACT SET	A40	DISTRIBUTOR CAP	A50	ROTOR	A70	PICK-UP
C10	COIL	C20	IGNITION MODULE	C30	ELECTRONIC IGNITION KIT	E01	IGNITION CABLE SET		

The present application list is a brief version. For the detailed information about the possibility of installation on a specific vehicle, please refer to our web-catalogue <http://catalogo.facet.eu/>

					FUNCTIONS ON THE VEHICLE							
Vehicle	alim.	kW	Date	Engine								

ENGINE				
2.0	Petrol	84	06/94-03/00	NSF, NSG, NSH

Engine	Information	A10	A20	A40	A50	A70	C10 - C30	C20	E01
Eng. NSF, NSG	version Bosch			806 253	906 140R				
All engines	Transit 100, Transit 80, -> year 01/08/94, x 1, Colour:Red, DISTRIBUTOR, 12 Volt, Dia: 55 mm, connector type DIN						470 169	C10	

ENGINE				
2.0 Cat	Petrol	57	11/85-09/92	N6T

Engine	Information	A10	A20	A40	A50	A70	C10 - C30	C20	E01
All engines	version Bosch			806 079	906 121R				
All engines							470 169	C10	
All engines	-> year 31/08/91								360 078

ENGINE				
2.0 CNG	Petrol/ Com- pressed Natural Gas (CNG)	84	06/94-03/00	NSH

Engine	Information	A10	A20	A40	A50	A70	C10 - C30	C20	E01
All engines	version Bosch			806 253	906 140R				

ENGINE				
2.0 i	Petrol	72	09/91-07/94	NCA

Engine	Information	A10	A20	A40	A50	A70	C10 - C30	C20	E01
All engines	version Bosch, alternatively			806 079, 806 109					
All engines	version Bosch				906 025R				
All engines							470 169	C10	

ENGINE				
2.0 L	Petrol	56	10/85-03/91	NAW, NAX

Engine	Information	A10	A20	A40	A50	A70	C10 - C30	C20	E01
All engines	version Bosch		706 049HDVS		906 025R				
All engines	version Bosch, alternatively			806 079, 806 109					
All engines							470 169	C10	360 078

ENGINE				
2.9 i	Petrol	107	01/91-09/94	BRT

Engine	Information	A10	A20	A40	A50	A70	C10 - C30	C20	E01
All engines	version Bosch			806 081					
All engines							470 169	C10	

TRANSIT III

ENGINE				
2.3	Petrol	105	03/01-03/06	ESFC

Engine	Information	A10	A20	A40	A50	A70	C10 - C30	C20	E01
All engines	version Bosch								360 145

ENGINE				
2.3	Petrol	107	08/00-03/06	ESFA

Engine	Information	A10	A20	A40	A50	A70	C10 - C30	C20	E01
All engines	version Bosch								360 145

ENGINE				
2.3 16V	Petrol	107	04/01-05/06	ESFA, ESFC

Engine	Information	A10	A20	A40	A50	A70	C10 - C30	C20	E01
All engines	version Bosch								360 145

ENGINE				
2.3 16V CNG RWD	Petrol/ Com- pressed Natural Gas (CNG)	100	04/06-08/14	GZFC

Engine	Information	A10	A20	A40	A50	A70	C10 - C30	C20	E01
All engines	Transit 300, x 4, COIL ON PLUG						470 480	C10	

A10 CONDENSER	A20 CONTACT SET	A40 DISTRIBUTOR CAP	A50 ROTOR	A70 PICK-UP
C10 COIL	C20 IGNITION MODULE	C30 ELECTRONIC IGNITION KIT	E01 IGNITION CABLE SET	

Vehicle	alim.	kW	Date	Engine	FUNCTIONS ON THE VEHICLE									
					A10	A20	A40	A50	A70	C10 - C30	C20	E01		
ENGINE														
2.3 16V LPG RWD	Petrol/ Liquified Petro- leum Gas (LPG)	107	04/06-08/14	GZFC										
Engine					Information	A10	A20	A40	A50	A70	C10 - C30	C20	E01	
All engines					Transit 300, x 4, COIL ON PLUG						470 480	C10		
ENGINE														
2.3 16V RWD	Petrol	107	08/00-08/14	ESFA, ESFC, GZFA, GZFB, GZFC										
Engine					Information	A10	A20	A40	A50	A70	C10 - C30	C20	E01	
Eng. GZFA, GZFB, GZFC					Transit 300, x 4, COIL ON PLUG						470 480	C10		
Eng. ESFA, ESFC					version Bosch								360 145	
TRANSIT TOURNEO														
ENGINE														
2.0	Petrol	84	11/94-12/00	NSF, NSG, NSH										
Engine					Information	A10	A20	A40	A50	A70	C10 - C30	C20	E01	
Eng. NSH					version Bosch			806 253	906 140R					
All engines					->year 01/08/94, x 1, Colour:Red, DISTRIBUTOR, 12 Volt, Dia: 55 mm, connector type DIN						470 169	C10		
WINDSTAR														
ENGINE														
3.0i 12V	Petrol	109	04/95-07/97	99U										
Engine					Information	A10	A20	A40	A50	A70	C10 - C30	C20	E01	
All engines											470 170	C10		
ENGINE														
3.0i 12V S	Petrol	112	08/97->	99U										
Engine					Information	A10	A20	A40	A50	A70	C10 - C30	C20	E01	
All engines											470 170	C10		
ZEPHYR														
ENGINE														
1.7	Petrol	41	12/62-10/66	--										
Engine					Information	A10	A20	A40	A50	A70	C10 - C30	C20	E01	
All engines							828 070	928 006						
ENGINE														
1.7	Petrol	44	03/62-03/68	--, EL 17 L										
Engine					Information	A10	A20	A40	A50	A70	C10 - C30	C20	E01	
All engines							828 070	928 006						
ENGINE														
1.7	Petrol	48	03/62-03/68	EL 17 L										
Engine					Information	A10	A20	A40	A50	A70	C10 - C30	C20	E01	
All engines							828 070	928 006						
ENGINE														
2.0	Petrol	57	03/68-10/72	EV 20 A										
Engine					Information	A10	A20	A40	A50	A70	C10 - C30	C20	E01	
All engines									928 007					
ENGINE														
2.0	Petrol	61	03/68-10/72	EV 20 B										
Engine					Information	A10	A20	A40	A50	A70	C10 - C30	C20	E01	
All engines								928 007						
ENGINE														
2.5	Petrol	65	03/62-03/68	EL25										
Engine					Information	A10	A20	A40	A50	A70	C10 - C30	C20	E01	
All engines								928 007						
ENGINE														
2.5	Petrol	68	03/62-03/68	EL 25 L										
Engine					Information	A10	A20	A40	A50	A70	C10 - C30	C20	E01	
All engines								928 007						
ENGINE														
2.5	Petrol	73	03/68-10/72	EV 25 B										
Engine					Information	A10	A20	A40	A50	A70	C10 - C30	C20	E01	
All engines								928 007						

A10 CONDENSER	A20 CONTACT SET	A40 DISTRIBUTOR CAP	A50 ROTOR	A70 PICK-UP
C10 COIL	C20 IGNITION MODULE	C30 ELECTRONIC IGNITION KIT	E01 IGNITION CABLE SET	

The present application list is a brief version. For the detailed information about the possibility of installation on a specific vehicle, please refer to our web-catalogue <http://catalogo.facet.eu/>

Vehicle	alim.	kW	Date	Engine	FUNCTIONS ON THE VEHICLE							
					A10	A20	A40	A50	A70	C10 - C30	C20	E01

ENGINE				
2.5	Petrol	76	03/68-10/72	EV 25 L

Engine	Information	A10	A20	A40	A50	A70	C10 - C30	C20	E01
All engines					928 007				

ENGINE				
3.0	Petrol	88	03/68-10/72	EV 30 A

Engine	Information	A10	A20	A40	A50	A70	C10 - C30	C20	E01
All engines					928 007				

ENGINE				
3.0	Petrol	94	03/68-10/72	EV30B

Engine	Information	A10	A20	A40	A50	A70	C10 - C30	C20	E01
All engines					928 007				

ZODIAK

ENGINE				
2.5	Petrol	73	03/62-10/72	EL 25 LV

Engine	Information	A10	A20	A40	A50	A70	C10 - C30	C20	E01
All engines					928 007				

ENGINE				
2.5	Petrol	78	03/62-10/72	EL 25 HV

Engine	Information	A10	A20	A40	A50	A70	C10 - C30	C20	E01
All engines					928 007				

A10 CONDENSER	A20 CONTACT SET	A40 DISTRIBUTOR CAP	A50 ROTOR	A70 PICK-UP
C10 COIL	C20 IGNITION MODULE	C30 ELECTRONIC IGNITION KIT	E01 IGNITION CABLE SET	

Vehicle	alim.	kW	Date	Engine	FUNCTIONS ON THE VEHICLE							
					 A10	 A20	 A40	 A50	 A70	 C10 - C30	 C20	 E01

FIESTA

				ENGINE
1.0i	Petrol	48	07/99->	ZL10

Engine	Information	A10	A20	A40	A50	A70	C10 - C30	C20	E01
All engines							470 532	C10	360 691

				ENGINE
1.6i	Petrol	70	07/99->	ZL16

Engine	Information	A10	A20	A40	A50	A70	C10 - C30	C20	E01
All engines							470 532	C10	360 691

A10	CONDENSER	A20	CONTACT SET	A40	DISTRIBUTOR CAP	A50	ROTOR	A70	PICK-UP
C10	COIL	C20	IGNITION MODULE	C30	ELECTRONIC IGNITION KIT	E01	IGNITION CABLE SET		

The present application list is a brief version. For the detailed information about the possibility of installation on a specific vehicle, please refer to our web-catalogue <http://catalogo.facet.eu/>

					FUNCTIONS ON THE VEHICLE									
Vehicle	alim.	kW	Date	Engine	 A10	 A20	 A40	 A50	 A70	 C10 - C30	 C20	 E01		
CORTINA														
2.0	Petrol	66	06/77-08/82	ENGINE --										
Engine	Information				A10	A20	A40	A50	A70	C10 - C30	C20	E01		
All engines	version Bosch					706 034HVS	806 079	906 012R						
FAIRLANE														
3.2i Efi	Petrol	0	01/89->	ENGINE --										
Engine	Information				A10	A20	A40	A50	A70	C10 - C30	C20	E01		
All engines	version Bosch						806 244	906 131						
3.9i Efi	Petrol	0	01/89->	ENGINE --										
Engine	Information				A10	A20	A40	A50	A70	C10 - C30	C20	E01		
All engines	version Bosch						806 244	906 131						
3.9i MPEFi	Petrol	0	01/89->	ENGINE --										
Engine	Information				A10	A20	A40	A50	A70	C10 - C30	C20	E01		
All engines	version Bosch						806 244	906 131						
4.0i MPEFi	Petrol	0	01/89->	ENGINE --										
Engine	Information				A10	A20	A40	A50	A70	C10 - C30	C20	E01		
All engines	version Bosch						806 244	906 131						
FALCON														
3.2 Efi	Petrol	90	03/88-12/88	ENGINE --										
Engine	Information				A10	A20	A40	A50	A70	C10 - C30	C20	E01		
All engines	version Bosch						806 244	906 131						
3.3	Petrol	88	02/86-12/87	ENGINE --										
Engine	Information				A10	A20	A40	A50	A70	C10 - C30	C20	E01		
All engines	version Bosch						806 244							
3.3	Petrol	90	10/84-02/86	ENGINE --										
Engine	Information				A10	A20	A40	A50	A70	C10 - C30	C20	E01		
All engines	version Bosch						806 244							
3.9 Efi	Petrol	120	07/91-04/92	ENGINE --										
Engine	Information				A10	A20	A40	A50	A70	C10 - C30	C20	E01		
All engines	version Bosch						806 244	906 131						
3.9 MPFi	Petrol	139	03/88-04/92	ENGINE --										
Engine	Information				A10	A20	A40	A50	A70	C10 - C30	C20	E01		
All engines	version Bosch						806 244	906 131						
3.9 SPFFi	Petrol	120	03/88-04/92	ENGINE --										
Engine	Information				A10	A20	A40	A50	A70	C10 - C30	C20	E01		
All engines	version Bosch						806 244	906 131						
4.1	Petrol	103	10/84-02/86	ENGINE --										
Engine	Information				A10	A20	A40	A50	A70	C10 - C30	C20	E01		
All engines	version Bosch						806 244							
LASER														
1.3	Petrol	49	03/81-09/87	ENGINE E3										
Engine	Information				A10	A20	A40	A50	A70	C10 - C30	C20	E01		
All engines	version Mitsubishi						831 003/001, 831 109, 831 118	931 023						
1.5	Petrol	54	03/81-09/85	ENGINE E5										
Engine	Information				A10	A20	A40	A50	A70	C10 - C30	C20	E01		
All engines	version Mitsubishi						831 003/001, 831 109	931 023						
A10	CONDENSER		A20	CONTACT SET		A40	DISTRIBUTOR CAP		A50	ROTOR		A70	PICK-UP	
C10	COIL		C20	IGNITION MODULE		C30	ELECTRONIC IGNITION KIT		E01	IGNITION CABLE SET				

Vehicle	alim.	kW	Date	Engine	FUNCTIONS ON THE VEHICLE									
					A10	A20	A40	A50	A70	C10 - C30	C20	E01		
ENGINE														
1.5	Petrol	59	03/83-09/85	E5										
Engine		Information			A10	A20	A40	A50	A70	C10 - C30	C20	E01		
All engines		version Mitsubishi					831 109							
ENGINE														
1.5 Sport	Petrol	58	03/81-02/83	E5										
Engine		Information			A10	A20	A40	A50	A70	C10 - C30	C20	E01		
All engines		version Mitsubishi					831 003/001	931 023						
ENGINE														
1.6	Petrol	64	03/90-09/91	B6 (SOHC 16 V)										
Engine		Information			A10	A20	A40	A50	A70	C10 - C30	C20	E01		
All engines		version Mitsubishi					831 131	931 119						
ENGINE														
1.6 i	Petrol	80	10/94-03/99	B6 (DOHC 16 V)										
Engine		Information			A10	A20	A40	A50	A70	C10 - C30	C20	E01		
All engines		version Mitsubishi					831 150	931 132						
ENGINE														
1.8 i	Petrol	92	10/94-03/99	BP (DOHC)										
Engine		Information			A10	A20	A40	A50	A70	C10 - C30	C20	E01		
All engines		version Mitsubishi					831 150	931 132						
METEOR														
ENGINE														
1.5	Petrol	54	04/82-09/85	E5										
Engine		Information			A10	A20	A40	A50	A70	C10 - C30	C20	E01		
All engines		version Mitsubishi					831 109							
ENGINE														
1.5	Petrol	59	04/82-09/85	E5										
Engine		Information			A10	A20	A40	A50	A70	C10 - C30	C20	E01		
All engines		version Mitsubishi					831 109							
TAURUS														
ENGINE														
3.0i V6	Petrol	0	01/96->	--										
Engine		Information			A10	A20	A40	A50	A70	C10 - C30	C20	E01		
All engines										470 170	C10			
TELSTAR														
ENGINE														
2.0 Efi	Petrol	85	10/94-11/96	F5										
Engine		Information			A10	A20	A40	A50	A70	C10 - C30	C20	E01		
All engines		version Hitachi, no specific info conc. application available					822 077, 822 092	922 094, 922 102						
ENGINE														
2.0 TX5	Petrol	70	05/83-10/87	FE										
Engine		Information			A10	A20	A40	A50	A70	C10 - C30	C20	E01		
All engines		version Mitsubishi					831 109							
ENGINE														
2.5	Petrol	120	01/92-08/94	KL-ZE										
Engine		Information			A10	A20	A40	A50	A70	C10 - C30	C20	E01		
All engines		version Mitsubishi, no specific info conc. application available					831 137, 831 149	931 133, 931 134						
ENGINE														
2.5	Petrol	123	01/92-10/95	KL-ZE										
Engine		Information			A10	A20	A40	A50	A70	C10 - C30	C20	E01		
All engines		version Mitsubishi, no specific info conc. application available					831 137, 831 149	931 133, 931 134						
ENGINE														
2.5 TX5 Efi	Petrol	120	10/94-11/96	KL-ZE										
Engine		Information			A10	A20	A40	A50	A70	C10 - C30	C20	E01		
All engines		version Mitsubishi, no specific info conc. application available					831 137, 831 149	931 133, 931 134						

A10	CONDENSER	A20	CONTACT SET	A40	DISTRIBUTOR CAP	A50	ROTOR	A70	PICK-UP
C10	COIL	C20	IGNITION MODULE	C30	ELECTRONIC IGNITION KIT	E01	IGNITION CABLE SET		

The present application list is a brief version. For the detailed information about the possibility of installation on a specific vehicle, please refer to our web-catalogue <http://catalogo.facet.eu/>

Vehicle	alim.	kW	Date	Engine	FUNCTIONS ON THE VEHICLE							
					A10	A20	A40	A50	A70	C10 - C30	C20	E01

EXPLORER

4.0 V6 4WD	Petrol	115	03/95-12/01	ENGINE								
------------	--------	-----	-------------	--------	--	--	--	--	--	--	--	--

Engine	Information	A10	A20	A40	A50	A70	C10 - C30	C20	E01
All engines							470 289	C10	

4.0 V6 4WD	Petrol	121	01/93-12/94	ENGINE								
------------	--------	-----	-------------	--------	--	--	--	--	--	--	--	--

Engine	Information	A10	A20	A40	A50	A70	C10 - C30	C20	E01
All engines							470 289	C10	

4.0 V6 4WD	Petrol	150	10/98-12/01	ENGINE								
------------	--------	-----	-------------	--------	--	--	--	--	--	--	--	--

Engine	Information	A10	A20	A40	A50	A70	C10 - C30	C20	E01
All engines							470 289	C10	

4.0 V6 4WD	Petrol	152	10/96-12/01	ENGINE								
------------	--------	-----	-------------	--------	--	--	--	--	--	--	--	--

Engine	Information	A10	A20	A40	A50	A70	C10 - C30	C20	E01
All engines							470 289	C10	

MUSTANG

4.0 V6	Petrol	157	12/04-12/10	ENGINE								
--------	--------	-----	-------------	--------	--	--	--	--	--	--	--	--

Engine	Information	A10	A20	A40	A50	A70	C10 - C30	C20	E01
All engines							470 289	C10	

PROBE II

2.5 V6 24V	Petrol	119	10/93-03/98	ENGINE								
------------	--------	-----	-------------	--------	--	--	--	--	--	--	--	--

Engine	Information	A10	A20	A40	A50	A70	C10 - C30	C20	E01
All engines	->year 30/11/94, version Mitsubishi			831 137	931 133				
All engines	01/12/94 ->, version Mitsubishi				931 134				

2.5 V6 24V	Petrol	120	12/94-03/98	ENGINE								
------------	--------	-----	-------------	--------	--	--	--	--	--	--	--	--

Engine	Information	A10	A20	A40	A50	A70	C10 - C30	C20	E01
All engines	->year 30/11/94, version Mitsubishi			831 137	931 133				
All engines	01/12/94 ->, version Mitsubishi				931 134				

WINDSTAR

3.0 V6	Petrol	108	01/95-12/00	ENGINE								
--------	--------	-----	-------------	--------	--	--	--	--	--	--	--	--

Engine	Information	A10	A20	A40	A50	A70	C10 - C30	C20	E01
All engines	x 1, D.I.S.						470 170	C10	

3.0 V6	Petrol	109	03/95-02/99	ENGINE								
--------	--------	-----	-------------	--------	--	--	--	--	--	--	--	--

Engine	Information	A10	A20	A40	A50	A70	C10 - C30	C20	E01
Eng. --							470 170	C10	
Eng. 99U30	x 1, D.I.S.						470 170	C10	

A10 CONDENSER	A20 CONTACT SET	A40 DISTRIBUTOR CAP	A50 ROTOR	A70 PICK-UP
C10 COIL	C20 IGNITION MODULE	C30 ELECTRONIC IGNITION KIT	E01 IGNITION CABLE SET	

Vehicle	alim.	kW	Date	Engine	FUNCTIONS ON THE VEHICLE							
					A10	A20	A40	A50	A70	C10 - C30	C20	E01

126P				ENGINE
0.6	Petrol	17	09/72-07/77	--

Engine	Information	A10	A20	A40	A50	A70	C10 - C30	C20	E01
All engines	->year 31/07/77, version Marelli		730 120	830 086	930 040				
All engines	->year 31/07/77						470 101D	C10	

0.6				ENGINE
0.6	Petrol	22	07/77-12/91	126 A1.048



Engine	Information	A10	A20	A40	A50	A70	C10 - C30	C20	E01
All engines	01/08/77 ->, version Marelli	630 128							
All engines	01/01/87 ->, version Marelli		730 146M						
All engines	01/08/77 ->, ->year 31/12/86, version Marelli		730 150M						
All engines	version Zelmot		749 350						

POLONEZ I				ENGINE
1.5	Petrol	55	10/77-08/88	AA

Engine	Information	A10	A20	A40	A50	A70	C10 - C30	C20	E01
All engines	version Marelli		730 127						
All engines							470 101D	C10	

A10	CONDENSER	A20	CONTACT SET	A40	DISTRIBUTOR CAP	A50	ROTOR	A70	PICK-UP
C10	COIL	C20	IGNITION MODULE	C30	ELECTRONIC IGNITION KIT	E01	IGNITION CABLE SET		

The present application list is a brief version. For the detailed information about the possibility of installation on a specific vehicle, please refer to our web-catalogue <http://catalogo.facet.eu/>

					FUNCTIONS ON THE VEHICLE							
Vehicle	alim.	kW	Date	Engine	 A10	 A20	 A40	 A50	 A70	 C10 - C30	 C20	 E01

G15				
				ENGINE
0.9	Petrol	38	01/67-12/75	--

Engine	Information	A10	A20	A40	A50	A70	C10 - C30	C20	E01
All engines					928 006				

A10	CONDENSER	A20	CONTACT SET	A40	DISTRIBUTOR CAP	A50	ROTOR	A70	PICK-UP
C10	COIL	C20	IGNITION MODULE	C30	ELECTRONIC IGNITION KIT	E01	IGNITION CABLE SET		

Vehicle	alim.	kW	Date	Engine	FUNCTIONS ON THE VEHICLE							
					A10	A20	A40	A50	A70	C10 - C30	C20	E01

APOLLO

2.0	Petrol	82	08/89-08/91	ENGINE
				3S-FC

Engine	Information	A10	A20	A40	A50	A70	C10 - C30	C20	E01
All engines	version Denso			813 278	913 029				
All engines							470 199	C10	

2.0 i	Petrol	88	08/89-02/93	ENGINE
				3S-FE

Engine	Information	A10	A20	A40	A50	A70	C10 - C30	C20	E01
All engines	version Denso				913 029				
All engines							470 197	C10	

2.2 i	Petrol	93	03/93-05/97	ENGINE
				08GR-FXS

Engine	Information	A10	A20	A40	A50	A70	C10 - C30	C20	E01
All engines	01/10/93 ->, version Denso			813 267					
All engines	version Denso				913 029				
All engines							470 198	C10	
All engines	01/10/93 ->								360 793

ASTRA LB

1.5	Petrol	51	08/84-01/86	ENGINE
				E15

Engine	Information	A10	A20	A40	A50	A70	C10 - C30	C20	E01
All engines	->year 31/01/85, version Hitachi		722 056HV	822 003					
All engines	01/02/85 ->, version Hitachi			822 057	922 052				

ASTRA LC

1.6	Petrol	52	02/86-06/87	ENGINE
				E16S

Engine	Information	A10	A20	A40	A50	A70	C10 - C30	C20	E01
All engines	version Hitachi			822 057	922 052				

ASTRA LD

1.6i	Petrol	55	07/87-07/89	ENGINE
				16LE

Engine	Information	A10	A20	A40	A50	A70	C10 - C30	C20	E01
All engines	version Delco Remy			812 075	912 098				

1.8i Hatchback	Petrol	79	07/87-07/89	ENGINE
				18LE

Engine	Information	A10	A20	A40	A50	A70	C10 - C30	C20	E01
All engines	version Delco Remy			812 075	912 098				

1.8i Sedan	Petrol	79	07/87-07/89	ENGINE
				18LE

Engine	Information	A10	A20	A40	A50	A70	C10 - C30	C20	E01
All engines	version Delco Remy			812 075	912 098				

ASTRA TR

1.8i 16v Hatchback	Petrol	85	09/96-09/98	ENGINE
				C18SEL

Engine	Information	A10	A20	A40	A50	A70	C10 - C30	C20	E01
All engines							470 272	C10	360 562

1.8i 16v Sedan	Petrol	85	09/96-09/98	ENGINE
				C18SEL

Engine	Information	A10	A20	A40	A50	A70	C10 - C30	C20	E01
All engines							470 272	C10	360 562

2.0i 16V Hatchback	Petrol	100	09/96-09/98	ENGINE
				X20XEV

Engine	Information	A10	A20	A40	A50	A70	C10 - C30	C20	E01
All engines							470 272	C10	360 562









BARINA

1.3	Petrol	50	08/86-12/89	ENGINE
				G13A

Engine	Information	A10	A20	A40	A50	A70	C10 - C30	C20	E01
All engines	version Denso				913 028				

A10 CONDENSER	A20 CONTACT SET	A40 DISTRIBUTOR CAP	A50 ROTOR	A70 PICK-UP
C10 COIL	C20 IGNITION MODULE	C30 ELECTRONIC IGNITION KIT	E01 IGNITION CABLE SET	

The present application list is a brief version. For the detailed information about the possibility of installation on a specific vehicle, please refer to our web-catalogue <http://catalogo.facet.eu/>

				FUNCTIONS ON THE VEHICLE								
Vehicle	alim.	kW	Date	Engine								
				ENGINE								
1.3 GL	Petrol	50	02/89-05/94	410UF01 5G02								
Engine	Information			A10	A20	A40	A50	A70	C10 - C30	C20	E01	
All engines	ch. JSAE8MG6800148088 ->, ch. JSAE8MS7700141225 ->, version Mitsubishi					831 131						
All engines	->ch. JSAE8MG6800148087, ->ch. JSAE8MS7700141225, version Mitsubishi					831 132	931 108					
All engines	ch. JSAE8MG6800148088 ->, ch. JSAE8MS7700141226 ->, version Mitsubishi						931 119					
				ENGINE								
1.3 GL	Petrol	52	02/85-08/86	G13A								
Engine	Information			A10	A20	A40	A50	A70	C10 - C30	C20	E01	
All engines	version Denso						913 028					
				ENGINE								
1.4 i	Petrol	44	04/94-07/97	C14 NZ								
Engine	Information			A10	A20	A40	A50	A70	C10 - C30	C20	E01	
All engines	version Bosch					806 256	906 121R					
All engines	version Lucas					828 100	928 028R					
All engines								470 140	C10	465 036	360 237	
				ENGINE								
1.6	Petrol	78	05/97-08/00	X16 XE								
Engine	Information			A10	A20	A40	A50	A70	C10 - C30	C20	E01	
All engines												359 688
				ENGINE								
BARINA_SB				ENGINE								
1.2i	Petrol	33	04/94-07/97	C12NZ								
Engine	Information			A10	A20	A40	A50	A70	C10 - C30	C20	E01	
All engines	version Bosch					806 256	906 121R					
All engines	version Lucas					828 100	928 028R					
All engines								470 140	C10	465 036	360 237	
				ENGINE								
1.6i	Petrol	78	12/95-09/98	X16XE								
Engine	Information			A10	A20	A40	A50	A70	C10 - C30	C20	E01	
All engines												359 688
				ENGINE								
1.6i	Petrol	80	04/94-11/95	C16XE								
Engine	Information			A10	A20	A40	A50	A70	C10 - C30	C20	E01	
All engines												359 688
				ENGINE								
CALAIS				ENGINE								
3.0 Executive	Petrol	114	10/88-09/90	--								
Engine	Information			A10	A20	A40	A50	A70	C10 - C30	C20	E01	
All engines									470 219	C10		
				ENGINE								
CALAIS_VL				ENGINE								
2.0i	Petrol	95	01/86-07/88	2.0 PFI								
Engine	Information			A10	A20	A40	A50	A70	C10 - C30	C20	E01	
All engines									470 219	C10		
				ENGINE								
3.0i Turbo	Petrol	154	01/86-07/88	3.0 EFI TURBO								
Engine	Information			A10	A20	A40	A50	A70	C10 - C30	C20	E01	
All engines									470 219	C10		
				ENGINE								
CALAIS_VN				ENGINE								
5.0i	Petrol	165	08/88-09/91	5.0 V8 EFI								
Engine	Information			A10	A20	A40	A50	A70	C10 - C30	C20	E01	
All engines	version Bosch					806 112	906 131					
				ENGINE								
CALAIS_VP				ENGINE								
5.0i Sedan	Petrol	165	10/91-07/93	5.0 V8 EFI								
Engine	Information			A10	A20	A40	A50	A70	C10 - C30	C20	E01	
All engines	version Bosch					806 112	906 131					

A10 CONDENSER	A20 CONTACT SET	A40 DISTRIBUTOR CAP	A50 ROTOR	A70 PICK-UP
C10 COIL	C20 IGNITION MODULE	C30 ELECTRONIC IGNITION KIT	E01 IGNITION CABLE SET	

Vehicle	alim.	kW	Date	Engine	FUNCTIONS ON THE VEHICLE							
					A10	A20	A40	A50	A70	C10 - C30	C20	E01

CALAIS_VR

				ENGINE
5.0i Sedan	Petrol	165	07/93-04/95	5.0 PFI V8

Engine	Information	A10	A20	A40	A50	A70	C10 - C30	C20	E01
All engines	version Bosch			806 112	906 131				

CALAIS_VS

				ENGINE
5.0i Sedan	Petrol	165	04/95-05/96	5.0 V8 PFI

Engine	Information	A10	A20	A40	A50	A70	C10 - C30	C20	E01
All engines	version Bosch			806 112	906 131				

CALAIS_VS-II

				ENGINE
5.0i Sedan	Petrol	165	06/96-08/97	5.0 V8 PFI

Engine	Information	A10	A20	A40	A50	A70	C10 - C30	C20	E01
All engines	version Bosch			806 112	906 131				

CALIBRA_YE

				ENGINE
2.0i	Petrol	85	09/91-07/95	C20NE

Engine	Information	A10	A20	A40	A50	A70	C10 - C30	C20	E01
All engines	version Bosch			806 257	906 127R				
All engines	eng. type 14672353 ->								359 689

				ENGINE
2.0i 16V	Petrol	100	08/95-10/97	X20XEV

Engine	Information	A10	A20	A40	A50	A70	C10 - C30	C20	E01
All engines							470 272	C10	360 562

				ENGINE
2.0i 16V	Petrol	110	09/91-07/95	C20XE

Engine	Information	A10	A20	A40	A50	A70	C10 - C30	C20	E01
All engines	version Bosch			806 257					
All engines	ch. P1000001, P9000001 ->						470 273	C10	359 688

				ENGINE
2.0i 16V Turbo	Petrol	150	06/94-10/97	C20LET

Engine	Information	A10	A20	A40	A50	A70	C10 - C30	C20	E01
All engines	version Bosch			806 257					

CAMIRA

				ENGINE
1.6	Petrol	64	08/82-02/86	16JH

Engine	Information	A10	A20	A40	A50	A70	C10 - C30	C20	E01
All engines	version Bosch			806 080	906 056R				

				ENGINE
1.8 MPFI	Petrol	83	11/84-01/86	6TZ204XS85K01

Engine	Information	A10	A20	A40	A50	A70	C10 - C30	C20	E01
All engines	version Bosch			806 080	906 056R				

				ENGINE
1.8 SPFI	Petrol	63	02/86-03/87	6TZ204XS85K01

Engine	Information	A10	A20	A40	A50	A70	C10 - C30	C20	E01
All engines	version Bosch			806 080	906 056R				
All engines	version Delco Remy			812 075	912 098				

				ENGINE
2.0 i	Petrol	85	04/87-07/89	C20 JE

Engine	Information	A10	A20	A40	A50	A70	C10 - C30	C20	E01
All engines	version Delco Remy			812 075	912 098				

CAPRICE_VQ

				ENGINE
5.0i Sedan	Petrol	165	03/90-11/93	5.0 V8 EFI

Engine	Information	A10	A20	A40	A50	A70	C10 - C30	C20	E01
All engines	version Bosch			806 112	906 131				

CAPRICE_VR

				ENGINE
5.0i Sedan	Petrol	165	12/93-04/95	5.0 PFI V8

Engine	Information	A10	A20	A40	A50	A70	C10 - C30	C20	E01
All engines	version Bosch			806 112	906 131				

A10	CONDENSER	A20	CONTACT SET	A40	DISTRIBUTOR CAP	A50	ROTOR	A70	PICK-UP
C10	COIL	C20	IGNITION MODULE	C30	ELECTRONIC IGNITION KIT	E01	IGNITION CABLE SET		

					FUNCTIONS ON THE VEHICLE							
Vehicle	alim.	kW	Date	Engine								
					A10	A20	A40	A50	A70	C10 - C30	C20	E01

CAPRICE_VS

				ENGINE
5.0i Sedan	Petrol	165	03/95-08/96	5.0 V8 PFI

Engine	Information	A10	A20	A40	A50	A70	C10 - C30	C20	E01
All engines	version Bosch			806 112	906 131				

CAPRICE_VS-II

				ENGINE
5.0i Sedan	Petrol	165	09/96-08/97	5.0 V8 PFI

Engine	Information	A10	A20	A40	A50	A70	C10 - C30	C20	E01
All engines	version Bosch			806 112	906 131				

COMBO

				ENGINE
1.4i	Petrol	44	03/96-07/97	C14 NZ

Engine	Information	A10	A20	A40	A50	A70	C10 - C30	C20	E01	
All engines	version Bosch			806 256	906 121R					
All engines	version Lucas			828 100	928 028R					
All engines							470 140	C10	465 036	360 237

COMBO_SB

				ENGINE
1.4i	Petrol	44	04/94-07/97	C14NZ

Engine	Information	A10	A20	A40	A50	A70	C10 - C30	C20	E01	
All engines	version Bosch			806 256	906 121R					
All engines	version Lucas			828 100	928 028R					
All engines							470 140	C10	465 036	360 237

COMMODORE

				ENGINE
1.9	Petrol	54	09/78-04/86	--, 1X

Engine	Information	A10	A20	A40	A50	A70	C10 - C30	C20	E01
All engines	version Bosch		706 034HVS						

				ENGINE
1.9	Petrol	58	04/80-09/81	1X

Engine	Information	A10	A20	A40	A50	A70	C10 - C30	C20	E01
All engines	version Bosch		706 034HVS						

				ENGINE
3.0 Efi	Petrol	114	03/86-09/88	2552 63 088

Engine	Information	A10	A20	A40	A50	A70	C10 - C30	C20	E01
All engines							470 219	C10	

				ENGINE
3.0 Efi Turbo	Petrol	150	01/86-08/88	RB30ET

Engine	Information	A10	A20	A40	A50	A70	C10 - C30	C20	E01
All engines							470 219	C10	

				ENGINE
VR 5.0i	Petrol	165	07/93-04/95	5.0 PFI V8

Engine	Information	A10	A20	A40	A50	A70	C10 - C30	C20	E01
All engines	version Bosch			806 112	906 131				

				ENGINE
VR 5.0i Wagon	Petrol	165	07/93-04/95	5.0 PFI V8

Engine	Information	A10	A20	A40	A50	A70	C10 - C30	C20	E01
All engines	version Bosch			806 112	906 131				

				ENGINE
VS 5.0i	Petrol	165	04/95-05/96	5.0 V8 PFI

Engine	Information	A10	A20	A40	A50	A70	C10 - C30	C20	E01
All engines	version Bosch			806 112	906 131				

				ENGINE
VS-II 5.0i	Petrol	165	06/96-08/97	5.0 V8 PFI

Engine	Information	A10	A20	A40	A50	A70	C10 - C30	C20	E01
All engines	version Bosch			806 112	906 131				

COMMODORE_VL

				ENGINE
2.0i	Petrol	95	01/86-07/88	2.0 PFI







Engine	Information	A10	A20	A40	A50	A70	C10 - C30	C20	E01
All engines							470 219	C10	

A10 CONDENSER	A20 CONTACT SET	A40 DISTRIBUTOR CAP	A50 ROTOR	A70 PICK-UP
C10 COIL	C20 IGNITION MODULE	C30 ELECTRONIC IGNITION KIT	E01 IGNITION CABLE SET	

Vehicle	alim.	kW	Date	Engine	FUNCTIONS ON THE VEHICLE									
					A10	A20	A40	A50	A70	C10 - C30	C20	E01		
ENGINE														
2.0i Wagon	Petrol	95	01/86-07/88	2.0 PFI										
Engine	Information				A10	A20	A40	A50	A70	C10 - C30	C20	E01		
All engines										470 219	C10			
ENGINE														
5.0i Group A SS	Petrol	122	02/87-07/88	5.0 V8 EFI										
Engine	Information				A10	A20	A40	A50	A70	C10 - C30	C20	E01		
All engines	version Bosch						806 112	906 131						
COMMODORE_VN														
ENGINE														
5.0i	Petrol	165	08/88-09/91	5.0 V8 EFI										
Engine	Information				A10	A20	A40	A50	A70	C10 - C30	C20	E01		
All engines	version Bosch						806 112	906 131						
ENGINE														
5.0i Group A SS	Petrol	215	08/88-09/91	5.0 V8 EFI										
Engine	Information				A10	A20	A40	A50	A70	C10 - C30	C20	E01		
All engines	version Bosch						806 112	906 131						
COMMODORE_VP														
ENGINE														
5.0i	Petrol	165	10/91-07/93	5.0 V8 EFI										
Engine	Information				A10	A20	A40	A50	A70	C10 - C30	C20	E01		
All engines	version Bosch						806 112	906 131						
DROVER														
ENGINE														
QB 1.3	Petrol	47	02/85-12/87	G13A										
Engine	Information				A10	A20	A40	A50	A70	C10 - C30	C20	E01		
All engines	version Denso						813 093	913 030						
All engines													358 020	
FORMULA_VR (8VK19)														
ENGINE														
5.0i	Petrol	165	07/93-04/95	5.0 PFI V8										
Engine	Information				A10	A20	A40	A50	A70	C10 - C30	C20	E01		
All engines	version Bosch						806 112	906 131						
FRONTERA_UT (8MB25)														
ENGINE														
2.0i	Petrol	85	10/95-03/99	X20SE										
Engine	Information				A10	A20	A40	A50	A70	C10 - C30	C20	E01		
All engines										470 273	C10		360 947	
GEMINI_RB (8RB69)														
ENGINE														
1.5	Petrol	52	04/85-06/87	4XC1										
Engine	Information				A10	A20	A40	A50	A70	C10 - C30	C20	E01		
All engines	version Denso						813 092	913 030						
JACKAROO_UBS														
ENGINE														
2.2 4x4	Petrol	68	03/87-10/88	4ZD1										
Engine	Information				A10	A20	A40	A50	A70	C10 - C30	C20	E01		
All engines	version Denso						813 093	913 014						
ENGINE														
2.6i 4x4	Petrol	84	11/88-12/91	4ZE1										
Engine	Information				A10	A20	A40	A50	A70	C10 - C30	C20	E01		
All engines	version Hitachi							922 069						
NOVA_LF														
ENGINE														
1.6i Hatchback	Petrol	76	08/91-03/93	4AFE										
Engine	Information				A10	A20	A40	A50	A70	C10 - C30	C20	E01		
All engines	version Denso							913 029						
ENGINE														
1.6i Sedan	Petrol	76	08/91-03/93	4AFE										
Engine	Information				A10	A20	A40	A50	A70	C10 - C30	C20	E01		
All engines	version Denso							913 029						

A10 CONDENSER	A20 CONTACT SET	A40 DISTRIBUTOR CAP	A50 ROTOR	A70 PICK-UP
C10 COIL	C20 IGNITION MODULE	C30 ELECTRONIC IGNITION KIT	E01 IGNITION CABLE SET	

The present application list is a brief version. For the detailed information about the possibility of installation on a specific vehicle, please refer to our web-catalogue <http://catalogo.facet.eu/>

				FUNCTIONS ON THE VEHICLE								
Vehicle	alim.	kW	Date	Engine	 A10	 A20	 A40	 A50	 A70	 C10 - C30	 C20	 E01
				ENGINE								
1.8i Hatchback	Petrol	86	08/91-03/93	7AFE								
Engine	Information			A10	A20	A40	A50	A70	C10 - C30	C20	E01	
All engines	version Denso					813 265	913 029					
All engines									470 199	C10		360 209
				ENGINE								
1.8i Sedan	Petrol	86	08/91-03/93	7AFE								
Engine	Information			A10	A20	A40	A50	A70	C10 - C30	C20	E01	
All engines	version Denso					813 265	913 029					
All engines									470 199	C10		360 209
				ENGINE								
NOVA_LG				ENGINE								
1.6i Hatchback	Petrol	76	09/94-09/96	4AFE								
Engine	Information			A10	A20	A40	A50	A70	C10 - C30	C20	E01	
All engines	version Denso					813 265	913 029					
All engines									470 199	C10		360 209
				ENGINE								
1.6i Sedan	Petrol	76	09/94-09/96	4AFE								
Engine	Information			A10	A20	A40	A50	A70	C10 - C30	C20	E01	
All engines	version Denso					813 265	913 029					
All engines									470 199	C10		360 209
				ENGINE								
1.8i Hatchback	Petrol	86	09/94-09/96	7AFE								
Engine	Information			A10	A20	A40	A50	A70	C10 - C30	C20	E01	
All engines	version Denso					813 265	913 029					
All engines									470 199	C10		360 209
				ENGINE								
1.8i Sedan	Petrol	86	09/94-09/96	7AFE								
Engine	Information			A10	A20	A40	A50	A70	C10 - C30	C20	E01	
All engines	version Denso					813 265	913 029					
All engines									470 199	C10		360 209
				ENGINE								
PIAZZA_YB				ENGINE								
2.0i Turbo	Petrol	110	04/86-12/87	2L H.C.								
Engine	Information			A10	A20	A40	A50	A70	C10 - C30	C20	E01	
All engines	version Denso						913 027					
				ENGINE								
RODEO_TF				ENGINE								
2.2	Petrol	69	03/91-08/93	4ZD1								
Engine	Information			A10	A20	A40	A50	A70	C10 - C30	C20	E01	
All engines	version Denso					813 254	913 014					
				ENGINE								
2.6i	Petrol	88	08/88-03/96	4ZE1								
Engine	Information			A10	A20	A40	A50	A70	C10 - C30	C20	E01	
All engines	version Hitachi					822 060	922 069					
				ENGINE								
2.6i 4x4	Petrol	88	08/88-03/96	4ZE1								
Engine	Information			A10	A20	A40	A50	A70	C10 - C30	C20	E01	
All engines	version Hitachi					822 060	922 069					
				ENGINE								
SCURRY_NB				ENGINE								
1.0	Petrol	33	10/85-05/86	F10A								
Engine	Information			A10	A20	A40	A50	A70	C10 - C30	C20	E01	
All engines	version Denso				713 011HV	813 093	913 030					
				ENGINE								
SHUTTLE_WFR				ENGINE								
2.0	Petrol	69	06/86-06/89	4ZC1								
Engine	Information			A10	A20	A40	A50	A70	C10 - C30	C20	E01	
All engines	version Denso					813 093						
All engines	->year 31/10/87, version Denso						913 014					
All engines	01/11/87 ->, version Denso						913 030					

A10 CONDENSER	A20 CONTACT SET	A40 DISTRIBUTOR CAP	A50 ROTOR	A70 PICK-UP
C10 COIL	C20 IGNITION MODULE	C30 ELECTRONIC IGNITION KIT	E01 IGNITION CABLE SET	

Vehicle	alim.	kW	Date	Engine	FUNCTIONS ON THE VEHICLE							
					A10	A20	A40	A50	A70	C10 - C30	C20	E01

STATESMAN_VQ

5.0i	Petrol	165	03/90-11/93	ENGINE
				5.0 V8 EFI

Engine	Information	A10	A20	A40	A50	A70	C10 - C30	C20	E01
All engines	version Bosch			806 112	906 131				

STATESMAN_VR

5.0i	Petrol	165	12/93-04/95	ENGINE
				5.0 PFI V8

Engine	Information	A10	A20	A40	A50	A70	C10 - C30	C20	E01
All engines	version Bosch			806 112	906 131				

STATESMAN_VS

5.0i	Petrol	165	03/95-08/96	ENGINE
				5.0 V8 PFI

Engine	Information	A10	A20	A40	A50	A70	C10 - C30	C20	E01
All engines	version Bosch			806 112	906 131				

STATESMAN_VS-II

5.0i	Petrol	165	09/96-08/97	ENGINE
				5.0 V8 PFI

Engine	Information	A10	A20	A40	A50	A70	C10 - C30	C20	E01
All engines	version Bosch			806 112	906 131				

UTILITY_VG (8VK80)

5.0i	Petrol	165	08/88-09/91	ENGINE
				5.0 V8 EFI

Engine	Information	A10	A20	A40	A50	A70	C10 - C30	C20	E01
All engines	version Bosch			806 112	906 131				

UTILITY_VP (8VK80)

5.0i	Petrol	165	10/91-07/93	ENGINE
				5.0 V8 EFI

Engine	Information	A10	A20	A40	A50	A70	C10 - C30	C20	E01
All engines	version Bosch			806 112	906 131				

UTILITY_VR COUPÈ (8VK80)

5.0i	Petrol	165	07/93-04/95	ENGINE
				5.0 PFI V8

Engine	Information	A10	A20	A40	A50	A70	C10 - C30	C20	E01
All engines	version Bosch			806 112	906 131				

A10	CONDENSER	A20	CONTACT SET	A40	DISTRIBUTOR CAP	A50	ROTOR	A70	PICK-UP
C10	COIL	C20	IGNITION MODULE	C30	ELECTRONIC IGNITION KIT	E01	IGNITION CABLE SET		

Vehicle	alim.	kW	Date	Engine	FUNCTIONS ON THE VEHICLE							
					A10	A20	A40	A50	A70	C10 - C30	C20	E01

ACCORD

1.6	Petrol	79	10/98-12/01	ENGINE D16B7
-----	--------	----	-------------	-----------------

Engine	Information	A10	A20	A40	A50	A70	C10 - C30	C20	E01
All engines	->year 01/12/99, x 1, D.I.S.						470 168	C10	

ACCORD III

1.6 L	Petrol	65	11/85-12/89	ENGINE A16A1
-------	--------	----	-------------	-----------------

Engine	Information	A10	A20	A40	A50	A70	C10 - C30	C20	E01
All engines	version Hitachi			822 022	922 056				

2.0	Petrol	101	01/86-12/86	ENGINE A20A2
-----	--------	-----	-------------	-----------------

Engine	Information	A10	A20	A40	A50	A70	C10 - C30	C20	E01
All engines	version Hitachi			822 022					
All engines	version Hitachi, no specific info conc. application available				922 056				

2.0 12V	Petrol	75	01/86-03/88	ENGINE A20A1
---------	--------	----	-------------	-----------------

Engine	Information	A10	A20	A40	A50	A70	C10 - C30	C20	E01
All engines	version Hitachi, no specific info conc. application available				922 056				

2.0 12V	Petrol	85	01/87-12/89	ENGINE A20A3
---------	--------	----	-------------	-----------------

Engine	Information	A10	A20	A40	A50	A70	C10 - C30	C20	E01
All engines	version Hitachi, no specific info conc. application available				922 056				

2.0 16V EXS	Petrol	101	01/88-12/89	ENGINE B20A2
-------------	--------	-----	-------------	-----------------

Engine	Information	A10	A20	A40	A50	A70	C10 - C30	C20	E01
All engines	version Hitachi			822 022	922 056				

2.0 EX	Petrol	75	11/85-12/89	ENGINE A20A1
--------	--------	----	-------------	-----------------

Engine	Information	A10	A20	A40	A50	A70	C10 - C30	C20	E01
All engines	version Hitachi, no specific info conc. application available				922 056				

2.0 EX	Petrol	76	11/85-12/89	ENGINE A20A1
--------	--------	----	-------------	-----------------

Engine	Information	A10	A20	A40	A50	A70	C10 - C30	C20	E01
All engines	version Hitachi, no specific info conc. application available				922 056				

2.0 EX	Petrol	78	11/85-05/89	ENGINE A20A2
--------	--------	----	-------------	-----------------

Engine	Information	A10	A20	A40	A50	A70	C10 - C30	C20	E01
All engines	version Hitachi			822 022					
All engines	version Hitachi, no specific info conc. application available				922 056				

2.0 EXi	Petrol	85	01/86-12/89	ENGINE A20A3
---------	--------	----	-------------	-----------------

Engine	Information	A10	A20	A40	A50	A70	C10 - C30	C20	E01
All engines	version Hitachi, no specific info conc. application available				922 056				

2.0 EXi	Petrol	90	11/85-12/87	ENGINE A20A4
---------	--------	----	-------------	-----------------

Engine	Information	A10	A20	A40	A50	A70	C10 - C30	C20	E01
All engines	version Hitachi, no specific info conc. application available				922 056				

2.0 i 16V	Petrol	101	01/87-12/87	ENGINE B20A2
-----------	--------	-----	-------------	-----------------

Engine	Information	A10	A20	A40	A50	A70	C10 - C30	C20	E01
All engines	version Hitachi			822 022	922 056				

2.0 i 16V	Petrol	98	10/87-12/89	ENGINE B20A8
-----------	--------	----	-------------	-----------------

Engine	Information	A10	A20	A40	A50	A70	C10 - C30	C20	E01
All engines	version Hitachi			822 022	922 056				

A10 CONDENSER	A20 CONTACT SET	A40 DISTRIBUTOR CAP	A50 ROTOR	A70 PICK-UP
C10 COIL	C20 IGNITION MODULE	C30 ELECTRONIC IGNITION KIT	E01 IGNITION CABLE SET	

Vehicle	alim.	kW	Date	Engine	FUNCTIONS ON THE VEHICLE							
					A10	A20	A40	A50	A70	C10 - C30	C20	E01

ACCORD IV

				ENGINE
1.8	Petrol	77	01/90-12/91	--

Engine	Information	A10	A20	A40	A50	A70	C10 - C30	C20	E01
All engines	version Hitachi			822 071	922 081				
All engines							470 216	C10	360 711

				ENGINE
2.0 16V	Petrol	66	01/90-03/93	F20A6

Engine	Information	A10	A20	A40	A50	A70	C10 - C30	C20	E01
All engines	version Hitachi			822 071	922 081				
All engines							470 216	C10	360 711

				ENGINE
2.0 16V	Petrol	81	01/90-03/93	F20A2, F20A3

Engine	Information	A10	A20	A40	A50	A70	C10 - C30	C20	E01
All engines	version Hitachi			822 071	922 081				
All engines							470 216	C10	360 711

				ENGINE
2.0 16V	Petrol	98	01/90-12/93	F20A5

Engine	Information	A10	A20	A40	A50	A70	C10 - C30	C20	E01
All engines	version Hitachi			822 068	922 092				
All engines							470 214	C10	465 052
All engines									360 711

				ENGINE
2.0 i 16V	Petrol	98	01/90-12/93	F20A4, F20A7, F20A8, F20Z3

Engine	Information	A10	A20	A40	A50	A70	C10 - C30	C20	E01
All engines	version Hitachi			822 068					
Eng. F20A7, F20A8, F20Z3	version Hitachi				922 092				
All engines							470 214	C10	465 052
All engines									360 711

				ENGINE
2.2	Petrol	103	05/92-12/93	F22A6

Engine	Information	A10	A20	A40	A50	A70	C10 - C30	C20	E01
All engines	version Hitachi			822 068	922 092				
All engines							470 214	C10	465 052
All engines									360 711

				ENGINE
2.2 i 16V	Petrol	108	01/91-12/93	F22A8

Engine	Information	A10	A20	A40	A50	A70	C10 - C30	C20	E01
All engines	version Hitachi			822 068	922 092				
All engines							470 214	C10	465 052
All engines									360 711

				ENGINE
2.2 i 16V	Petrol	110	01/90-12/93	F22A3, F22A7

Engine	Information	A10	A20	A40	A50	A70	C10 - C30	C20	E01
All engines	version Hitachi			822 068	922 092				
All engines							470 214	C10	465 052
All engines									360 711

				ENGINE
2.2 i 16V Automatik	Petrol	108	01/90-03/93	F22A3

Engine	Information	A10	A20	A40	A50	A70	C10 - C30	C20	E01
All engines	version Hitachi			822 068	922 092				
All engines							470 214	C10	465 052
All engines									360 711

ACCORD V

				ENGINE
1.8 16V	Petrol	85	01/94-12/95	F18A3

Engine	Information	A10	A20	A40	A50	A70	C10 - C30	C20	E01
All engines	version Hitachi			822 068	922 095				
All engines							470 214	C10	360 711

				ENGINE
1.9 i	Petrol	85	02/96-10/98	F18A3

Engine	Information	A10	A20	A40	A50	A70	C10 - C30	C20	E01
All engines	version Hitachi			822 082	922 098				
All engines							470 347	C10	360 711

A10 CONDENSER	A20 CONTACT SET	A40 DISTRIBUTOR CAP	A50 ROTOR	A70 PICK-UP
C10 COIL	C20 IGNITION MODULE	C30 ELECTRONIC IGNITION KIT	E01 IGNITION CABLE SET	

The present application list is a brief version. For the detailed information about the possibility of installation on a specific vehicle, please refer to our web-catalogue <http://catalogo.facet.eu/>

					FUNCTIONS ON THE VEHICLE							
Vehicle	alim.	kW	Date	Engine								

					ENGINE
2.0	Petrol	100	09/93-12/97	F20B3	

Engine	Information	A10	A20	A40	A50	A70	C10 - C30	C20	E01
All engines	->year 31/12/96, version Hitachi			822 068					
All engines	01/01/97 ->, version Hitachi			822 076					
All engines	version Hitachi				922 095				
All engines							470 214	C10	360 711
All engines	->year 31/12/96							465 052	

					ENGINE
2.0 i	Petrol	85	03/93-01/96	F20Z2	

Engine	Information	A10	A20	A40	A50	A70	C10 - C30	C20	E01
All engines	version Hitachi			822 068	922 095				
All engines							470 214	C10	360 711
All engines	->eng. E100030							465 052	

					ENGINE
2.0 i LS	Petrol	96	02/96-10/98	F20Z1	

Engine	Information	A10	A20	A40	A50	A70	C10 - C30	C20	E01
All engines	version Hitachi			822 082	922 098				
All engines							470 347	C10	360 711

					ENGINE
2.0 i LS 16V	Petrol	100	09/93-02/98	F20B3	

Engine	Information	A10	A20	A40	A50	A70	C10 - C30	C20	E01
All engines	->year 31/12/96, version Hitachi			822 068					
All engines	01/01/97 ->, version Hitachi			822 076					
All engines	version Hitachi				922 095				
All engines							470 214	C10	360 711
All engines	->year 31/12/96							465 052	

					ENGINE
2.0 i S	Petrol	96	03/93-01/96	F20Z1	

Engine	Information	A10	A20	A40	A50	A70	C10 - C30	C20	E01
All engines	version Hitachi			822 068	922 095				
All engines							470 214	C10	360 711
All engines	->eng. E100030							465 052	

					ENGINE
2.2	Petrol	103	04/96-12/97	F22Z2	

Engine	Information	A10	A20	A40	A50	A70	C10 - C30	C20	E01
All engines	version Hitachi			822 082	922 098				
All engines							470 347	C10	

					ENGINE
2.2	Petrol	107	10/93-12/97	F22B1	

Engine	Information	A10	A20	A40	A50	A70	C10 - C30	C20	E01
All engines	version Hitachi			822 082	922 098				
All engines							470 347	C10	

					ENGINE
2.2 16V	Petrol	96	01/96-09/98	F22Z1	

Engine	Information	A10	A20	A40	A50	A70	C10 - C30	C20	E01
All engines	version Hitachi			822 082	922 098				
All engines							470 347	C10	360 711

					ENGINE
2.2 i [USA]	Petrol	110	01/94-12/95	--	

Engine	Information	A10	A20	A40	A50	A70	C10 - C30	C20	E01
All engines	version Hitachi, no specific info conc. application available			822 076, 822 082	922 095, 922 098				
All engines								465 052	
All engines	no specific info conc. application available								360 711

					ENGINE
2.2 i 16V	Petrol	110	08/95-12/97	F22B4	

Engine	Information	A10	A20	A40	A50	A70	C10 - C30	C20	E01
All engines	->year 31/12/96, version Hitachi			822 068					
All engines	01/01/97 ->, version Hitachi			822 076					
All engines	version Hitachi				922 095				
All engines							470 214	C10	360 711
All engines	->year 31/12/96							465 052	

A10 CONDENSER	A20 CONTACT SET	A40 DISTRIBUTOR CAP	A50 ROTOR	A70 PICK-UP
C10 COIL	C20 IGNITION MODULE	C30 ELECTRONIC IGNITION KIT	E01 IGNITION CABLE SET	

Vehicle	alim.	kW	Date	Engine	FUNCTIONS ON THE VEHICLE							
					A10	A20	A40	A50	A70	C10 - C30	C20	E01
ENGINE												
2.2 i ES	Petrol	110	09/93-02/98	F22B5								
Engine	Information			A10	A20	A40	A50	A70	C10 - C30	C20	E01	
All engines	->year 31/12/96, version Hitachi					822 068						
All engines	01/01/97 ->, version Hitachi					822 076						
All engines	version Hitachi						922 095					
All engines								470 214	C10		360 711	
All engines	->year 31/12/96									465 052		
ENGINE												
2.2 i VTEC	Petrol	110	02/96-10/98	F22Z2								
Engine	Information			A10	A20	A40	A50	A70	C10 - C30	C20	E01	
All engines	version Hitachi					822 082	922 098					
All engines								470 347	C10			
ENGINE												
2.3 i SR	Petrol	116	03/93-01/96	H23A3								
Engine	Information			A10	A20	A40	A50	A70	C10 - C30	C20	E01	
All engines	version Hitachi					822 068	922 095					
All engines								470 214	C10			
ACCORD VI												
ENGINE												
1.6	Petrol	65	10/98-12/02	A16A5								
Engine	Information			A10	A20	A40	A50	A70	C10 - C30	C20	E01	
All engines	version Hitachi					822 022	922 056					
ENGINE												
1.6	Petrol	85	12/99-12/02	D16B6								
Engine	Information			A10	A20	A40	A50	A70	C10 - C30	C20	E01	
All engines	->year 01/12/99, x 1, D.I.S.								470 168	C10		
ENGINE												
1.6 i	Petrol	85	10/98-12/02	D16B6								
Engine	Information			A10	A20	A40	A50	A70	C10 - C30	C20	E01	
All engines	->year 01/12/99, x 1, D.I.S.								470 168	C10		
ENGINE												
1.6 LS	Petrol	79	10/98-12/02	D16B7								
Engine	Information			A10	A20	A40	A50	A70	C10 - C30	C20	E01	
All engines	->year 01/12/99, x 1, D.I.S.								470 168	C10		
ENGINE												
1.8 16V Vtec	Petrol	100	04/99->	3B630WM, F18B3								
Engine	Information			A10	A20	A40	A50	A70	C10 - C30	C20	E01	
All engines	version Hitachi						922 098					
All engines								470 347	C10			
ENGINE												
1.8 i	Petrol	100	10/98-12/02	3B630WM, F18B2, F18B4								
Engine	Information			A10	A20	A40	A50	A70	C10 - C30	C20	E01	
Eng. 3B630WM	version Hitachi						922 098					
Eng. F18B2, F18B4	x 1, HITACHI, LUCAS, x 1, DISTRIBUTOR, HITACHI, LUCAS, DISTRIBUTOR								470 347	C10		
ENGINE												
1.8 i 16V Vtec	Petrol	100	11/98-12/99	F18B4								
Engine	Information			A10	A20	A40	A50	A70	C10 - C30	C20	E01	
All engines	version Hitachi						922 098					
All engines								470 347	C10			
ENGINE												
2.0	Petrol	107	11/99-10/02	F20B7								
Engine	Information			A10	A20	A40	A50	A70	C10 - C30	C20	E01	
All engines	version Hitachi						922 098					
All engines	x 1, DISTRIBUTOR								470 347	C10		
ENGINE												
2.0	Petrol	108	12/99-12/02	F20B6								
Engine	Information			A10	A20	A40	A50	A70	C10 - C30	C20	E01	
All engines	version Hitachi						922 098					
All engines	x 1, HITACHI, LUCAS, DISTRIBUTOR								470 347	C10		

A10 CONDENSER	A20 CONTACT SET	A40 DISTRIBUTOR CAP	A50 ROTOR	A70 PICK-UP
C10 COIL	C20 IGNITION MODULE	C30 ELECTRONIC IGNITION KIT	E01 IGNITION CABLE SET	

The present application list is a brief version. For the detailed information about the possibility of installation on a specific vehicle, please refer to our web-catalogue <http://catalogo.facet.eu/>





				FUNCTIONS ON THE VEHICLE								
Vehicle	alim.	kW	Date	Engine	A10	A20	A40	A50	A70	C10 - C30	C20	E01
				ENGINE								
2.0 16V Vtec	Petrol	108	04/99->	F20B6								
Engine	Information			A10	A20	A40	A50	A70	C10 - C30	C20	E01	
All engines	version Hitachi						922 098					
All engines									470 347	C10		
				ENGINE								
2.0 i	Petrol	108	10/98-01/01	F20B6								
Engine	Information			A10	A20	A40	A50	A70	C10 - C30	C20	E01	
All engines	version Hitachi						922 098					
All engines	x 1, HITACHI, LUCAS, DISTRIBUTOR								470 347	C10		
				ENGINE								
2.0 i 16V	Petrol	108	02/98-06/03	F20B5, F20B7								
Engine	Information			A10	A20	A40	A50	A70	C10 - C30	C20	E01	
All engines	version Hitachi						922 098					
All engines	x 1, DISTRIBUTOR								470 347	C10		
				ENGINE								
2.2 Type-R	Petrol	156	02/99-12/02	H22A7								
Engine	Information			A10	A20	A40	A50	A70	C10 - C30	C20	E01	
All engines	version Hitachi					822 068	922 095					
All engines	x 1, TEC, DISTRIBUTOR								470 214	C10		
				ENGINE								
2.3	Petrol	113	11/00-06/03	F23Z5								
Engine	Information			A10	A20	A40	A50	A70	C10 - C30	C20	E01	
All engines	version Hitachi						922 098					
All engines	x 1, HITACHI, LUCAS, DISTRIBUTOR								470 347	C10		
				ENGINE								
2.3 i 16V Vtec	Petrol	113	11/00->	F23Z5								
Engine	Information			A10	A20	A40	A50	A70	C10 - C30	C20	E01	
All engines	version Hitachi						922 098					
All engines									470 347	C10		
				ENGINE								
2.3 VTi	Petrol	113	02/98-10/02	F23A3								
Engine	Information			A10	A20	A40	A50	A70	C10 - C30	C20	E01	
All engines	version Hitachi						922 098					
All engines									470 347	C10		
				ENGINE								
3.0 V6 24V	Petrol	147	02/98-06/03	J30A1								
Engine	Information			A10	A20	A40	A50	A70	C10 - C30	C20	E01	
All engines	01/01/01->, x 1, DISTRIBUTOR								470 457	C10		
				ENGINE								
3.0 Vtec	Petrol	147	03/97-12/03	J30A1								
Engine	Information			A10	A20	A40	A50	A70	C10 - C30	C20	E01	
All engines	01/01/01->, Qty: 6								470 457	C10		
				ENGINE								
3.0 Vtec	Petrol	152	10/01-06/03	J30A2								
Engine	Information			A10	A20	A40	A50	A70	C10 - C30	C20	E01	
All engines	Qty: 6								470 457	C10		
				ENGINE								
2.0 i	Petrol	115	06/08-06/15	R20A3								
Engine	Information			A10	A20	A40	A50	A70	C10 - C30	C20	E01	
All engines	x 4, COIL ON PLUG								470 522	C10		
				ENGINE								
1.6i	Petrol	118	01/97-02/01	B16A6								
Engine	Information			A10	A20	A40	A50	A70	C10 - C30	C20	E01	
All engines	version Hitachi					822 068	922 095					
All engines									470 214	C10		

A10 CONDENSER	A20 CONTACT SET	A40 DISTRIBUTOR CAP	A50 ROTOR	A70 PICK-UP
C10 COIL	C20 IGNITION MODULE	C30 ELECTRONIC IGNITION KIT	E01 IGNITION CABLE SET	

Vehicle	alim.	kW	Date	Engine	FUNCTIONS ON THE VEHICLE									
					A10	A20	A40	A50	A70	C10 - C30	C20	E01		
ENGINE														
1.6i	Petrol	89	01/96-02/01	D16Y9										
Engine	Information				A10	A20	A40	A50	A70	C10 - C30	C20	E01		
All engines	version Hitachi						822 093	922 102						
All engines													360 702	
ENGINE														
1.8 i	Petrol	103	01/96-02/01	B18B4										
Engine	Information				A10	A20	A40	A50	A70	C10 - C30	C20	E01		
All engines	version Hitachi						822 068	922 095						
All engines										470 214	C10		360 709	
CITY														
ENGINE														
1.2	Petrol	58	05/03-09/05	L12A2										
Engine	Information				A10	A20	A40	A50	A70	C10 - C30	C20	E01		
All engines	Qty: 4									470 529, 470 608	C10			
ENGINE														
1.3	Petrol	60	10/05-07/08	L13A3										
Engine	Information				A10	A20	A40	A50	A70	C10 - C30	C20	E01		
All engines	Qty: 4, version A									470 529	C10			
All engines	Qty: 4, version B									470 608	C10			
ENGINE														
1.4 i-VTEC	Petrol	73	09/08->	L13Z1										
Engine	Information				A10	A20	A40	A50	A70	C10 - C30	C20	E01		
All engines	x 4, COIL ON PLUG									470 603	C10			
ENGINE														
1.5 i i-DSI	Petrol	66	11/02->	L15A2										
Engine	Information				A10	A20	A40	A50	A70	C10 - C30	C20	E01		
All engines	Qty: 4, version A									470 529	C10			
All engines	Qty: 4, version B									470 608	C10			
ENGINE														
1.5 i-VTEC	Petrol	85	08/09->	L15-A7										
Engine	Information				A10	A20	A40	A50	A70	C10 - C30	C20	E01		
All engines	Qty: 4									470 603	C10			
CIVIC III														
ENGINE														
1.5 i Si [USA]	Petrol	0	01/84-12/87	--										
Engine	Information				A10	A20	A40	A50	A70	C10 - C30	C20	E01		
All engines	version Hitachi						822 022	922 056						
All engines										470 212	C10			
CIVIC IV														
ENGINE														
1.2	Petrol	41	01/88-12/91	D12B1										
Engine	Information				A10	A20	A40	A50	A70	C10 - C30	C20	E01		
All engines	version Hitachi						822 071	922 081						
All engines										470 216	C10			
ENGINE														
1.3	Petrol	55	10/87-12/89	D13B1										
Engine	Information				A10	A20	A40	A50	A70	C10 - C30	C20	E01		
All engines	version Hitachi						822 071	922 081						
All engines										470 216	C10			
ENGINE														
1.3 16V Cat	Petrol	55	09/89-09/91	D13B2										
Engine	Information				A10	A20	A40	A50	A70	C10 - C30	C20	E01		
All engines	version Hitachi						822 071	922 081						
All engines										470 216	C10			
ENGINE														
1.4 L	Petrol	66	10/87-12/89	D14A1										
Engine	Information				A10	A20	A40	A50	A70	C10 - C30	C20	E01		
All engines	version Hitachi						822 071	922 081						
All engines										470 216	C10			

A10 CONDENSER	A20 CONTACT SET	A40 DISTRIBUTOR CAP	A50 ROTOR	A70 PICK-UP
C10 COIL	C20 IGNITION MODULE	C30 ELECTRONIC IGNITION KIT	E01 IGNITION CABLE SET	

The present application list is a brief version. For the detailed information about the possibility of installation on a specific vehicle, please refer to our web-catalogue <http://catalogo.facet.eu/>

				FUNCTIONS ON THE VEHICLE								
Vehicle	alim.	kW	Date	Engine	 A10	 A20	 A40	 A50	 A70	 C10 - C30	 C20	 E01
				ENGINE								
1.4i 16V	Petrol	66	01/90-12/91	D14A1								
Engine	Information											
All engines	version Hitachi					822 071	922 081					
All engines									470 216	C10		
				ENGINE								
1.5	Petrol	60	01/88-12/89	D15B1								
Engine	Information											
All engines	->eng. 4700494, version Hitachi						922 082					
All engines									470 215	C10	465 052	
				ENGINE								
1.5i 16V	Petrol	66	10/87-09/91	D15B2								
Engine	Information											
All engines	version Hitachi					822 069						
All engines	->eng. 4700494, version Hitachi						922 082					
All engines	->year 31/12/89								470 213	C10		
All engines	01/01/90 ->								470 215	C10		
All engines											465 052	
				ENGINE								
1.5i 16V	Petrol	69	10/87-09/91	D15B2								
Engine	Information											
All engines	version Hitachi					822 069						
All engines	->eng. 4700494, version Hitachi						922 082					
All engines	->year 31/12/89								470 213	C10		
All engines	01/01/90 ->								470 215	C10		
All engines											465 052	
				ENGINE								
1.6 16V 4x4	Petrol	79	11/87-09/91	D16A6								
Engine	Information											
All engines	version Hitachi						922 082					
All engines	->year 31/12/89								470 213	C10		
All engines	01/01/90 ->								470 216	C10		
All engines											465 052	
				ENGINE								
1.6i 16V	Petrol	80	10/87-09/91	D16A6								
Engine	Information											
All engines	->eng. 1600956, version Hitachi						922 082					
All engines	->year 31/12/89								470 213	C10		
All engines	01/01/90 ->								470 216	C10		
All engines											465 052	
				ENGINE								
1.6i 16V	Petrol	81	10/87-09/91	D16Z2								
Engine	Information											
All engines	->eng. 1600956, version Hitachi						922 082					
All engines									470 215	C10	465 052	
				ENGINE								
1.6i 16V	Petrol	96	09/87-09/91	D16A9								
Engine	Information											
All engines	->eng. 1600956, version Hitachi						922 082					
All engines									470 213	C10	465 052	
				ENGINE								
1.6i 16V 4x4	Petrol	80	10/89-09/91	D16A6								
Engine	Information											
All engines	version Hitachi						922 082					
All engines	->year 31/12/89								470 213	C10		
All engines	01/01/90 ->								470 216	C10		
All engines											465 052	
				ENGINE								
1.6i 16V 4x4	Petrol	81	01/89-12/91	D16Z2								
Engine	Information											
All engines	->eng. 1600956, version Hitachi						922 082					
All engines									470 215	C10	465 052	

A10 CONDENSER	A20 CONTACT SET	A40 DISTRIBUTOR CAP	A50 ROTOR	A70 PICK-UP
C10 COIL	C20 IGNITION MODULE	C30 ELECTRONIC IGNITION KIT	E01 IGNITION CABLE SET	

Vehicle	alim.	kW	Date	Engine	FUNCTIONS ON THE VEHICLE							
					A10	A20	A40	A50	A70	C10 - C30	C20	E01
ENGINE												
1.6i	Petrol	0	01/90-12/91	--								
Engine	Information			A10	A20	A40	A50	A70	C10 - C30	C20	E01	
All engines	01/01/92 ->, version Hitachi					822 068	922 095					
All engines	->year 31/12/91, version Hitachi					822 069	922 097R					
All engines	01/01/92 ->							470 214	C10			
All engines	->year 31/12/91							470 215	C10			
All engines										465 052		
ENGINE												
1.6i 16V	Petrol	118	01/88-12/91	D16A1								
Engine	Information			A10	A20	A40	A50	A70	C10 - C30	C20	E01	
All engines									470 215	C10	465 052	
ENGINE												
1.6i 16V	Petrol	79	01/90-05/92	D16A7								
Engine	Information			A10	A20	A40	A50	A70	C10 - C30	C20	E01	
All engines	version Hitachi, no specific info conc. application available						922 082					
All engines								470 213	C10	465 052		
ENGINE												
1.6i 16V	Petrol	91	01/88-05/92	D16A8, D16A9								
Engine	Information			A10	A20	A40	A50	A70	C10 - C30	C20	E01	
All engines	->eng. 1600956, version Hitachi, no specific info conc. application available						922 082					
All engines								470 213	C10	465 052		
ENGINE												
1.6i 16V 4WD	Petrol	118	01/88-12/89	D16A1								
Engine	Information			A10	A20	A40	A50	A70	C10 - C30	C20	E01	
All engines	version Hitachi						922 082					
All engines	->year 31/12/89							470 213	C10			
All engines	01/01/90 ->							470 216	C10			
All engines										465 052		
ENGINE												
1.6i 16V 4WD	Petrol	81	01/89-12/91	D16Z2								
Engine	Information			A10	A20	A40	A50	A70	C10 - C30	C20	E01	
All engines	version Hitachi						922 082					
All engines	->year 31/12/89							470 213	C10			
All engines	01/01/90 ->							470 216	C10			
All engines										465 052		
CIVIC IV SHUTTLE												
ENGINE												
1.4i 16V	Petrol	66	01/88-12/92	D14A1								
Engine	Information			A10	A20	A40	A50	A70	C10 - C30	C20	E01	
All engines	version Hitachi					822 071	922 081					
All engines								470 216	C10			
ENGINE												
1.5i 16V	Petrol	69	01/88-11/91	D15B2								
Engine	Information			A10	A20	A40	A50	A70	C10 - C30	C20	E01	
All engines	version Hitachi					822 069						
All engines	->eng. 4708638, version Hitachi						922 082					
All engines	->year 31/12/89							470 213	C10			
All engines	01/01/90 ->							470 215	C10			
All engines										465 052		
ENGINE												
1.6 4x4	Petrol	85	01/88-12/92	D16A, D16A7								
Engine	Information			A10	A20	A40	A50	A70	C10 - C30	C20	E01	
All engines	version Hitachi						922 082					
All engines								470 213	C10	465 052		
ENGINE												
1.6i 16V 4WD	Petrol	80	01/88-12/89	D16A6								
Engine	Information			A10	A20	A40	A50	A70	C10 - C30	C20	E01	
All engines	version Hitachi						922 082					
All engines	->year 31/12/89							470 213	C10			
All engines	01/01/90 ->							470 216	C10			

A10 CONDENSER	A20 CONTACT SET	A40 DISTRIBUTOR CAP	A50 ROTOR	A70 PICK-UP
C10 COIL	C20 IGNITION MODULE	C30 ELECTRONIC IGNITION KIT	E01 IGNITION CABLE SET	

The present application list is a brief version. For the detailed information about the possibility of installation on a specific vehicle, please refer to our web-catalogue <http://catalogo.facet.eu/>

				FUNCTIONS ON THE VEHICLE								
Vehicle	alim.	kW	Date	Engine	A10	A20	A40	A50	A70	C10 - C30	C20	E01
				ENGINE								
1.6 i 16V 4WD	Petrol	80	01/88-12/89	D16A6								
Engine	Information				A10	A20	A40	A50	A70	C10 - C30	C20	E01
All engines											465 052	
				ENGINE								
1.6 i 16V 4WD	Petrol	81	01/88-02/95	D16A6								
Engine	Information				A10	A20	A40	A50	A70	C10 - C30	C20	E01
All engines	version Hitachi							922 082				
All engines	->year 31/12/89									470 213	C10	
All engines	01/01/90 ->									470 216	C10	
All engines											465 052	
				ENGINE								
1.6i	Petrol	0	01/88-12/91	--								
Engine	Information				A10	A20	A40	A50	A70	C10 - C30	C20	E01
All engines	version Hitachi						822 069					
All engines	->year 31/12/89									470 213	C10	
All engines	01/01/90 ->									470 215	C10	
All engines											465 052	
				ENGINE								
1.6i 16V 4WD	Petrol	81	01/88-12/92	D16Z2								
Engine	Information				A10	A20	A40	A50	A70	C10 - C30	C20	E01
All engines	version Hitachi						822 069	922 082				
All engines										470 215	C10	465 052
				ENGINE								
1.4 i-VTEC	Petrol	73	02/12->	L13Z4								
Engine	Information				A10	A20	A40	A50	A70	C10 - C30	C20	E01
All engines	x 4, COIL ON PLUG									470 603	C10	
				ENGINE								
1.3	Petrol	55	01/92-12/92	D13B2								
Engine	Information				A10	A20	A40	A50	A70	C10 - C30	C20	E01
All engines	version Hitachi						822 071	922 081				
All engines										470 216	C10	
				ENGINE								
1.3 16V	Petrol	55	10/91-11/95	D13B2								
Engine	Information				A10	A20	A40	A50	A70	C10 - C30	C20	E01
All engines	version Hitachi						822 071	922 081				
All engines										470 216	C10	
				ENGINE								
1.5	Petrol	61	01/92-12/92	D15B2								
Engine	Information				A10	A20	A40	A50	A70	C10 - C30	C20	E01
All engines	->eng. 4700494, version Hitachi							922 082				
All engines										470 215	C10	465 052
				ENGINE								
1.5	Petrol	69	08/93-12/95	D15B7								
Engine	Information				A10	A20	A40	A50	A70	C10 - C30	C20	E01
All engines	version Hitachi						822 068	922 095				
All engines										470 214	C10	
				ENGINE								
1.5i 16V	Petrol	66	10/91-11/95	D15B2								
Engine	Information				A10	A20	A40	A50	A70	C10 - C30	C20	E01
All engines	version Hitachi						822 068	922 095				
All engines										470 214	C10	
All engines	->year 31/12/93										465 052	
				ENGINE								
1.5i 16V	Petrol	69	10/91-11/95	D15B2, D15Z1								
Engine	Information				A10	A20	A40	A50	A70	C10 - C30	C20	E01
All engines	version Hitachi						822 068	922 095				
All engines										470 214	C10	
All engines	->year 31/12/93										465 052	









A10 CONDENSER	A20 CONTACT SET	A40 DISTRIBUTOR CAP	A50 ROTOR	A70 PICK-UP
C10 COIL	C20 IGNITION MODULE	C30 ELECTRONIC IGNITION KIT	E01 IGNITION CABLE SET	

Vehicle	alim.	kW	Date	Engine	FUNCTIONS ON THE VEHICLE									
					A10	A20	A40	A50	A70	C10 - C30	C20	E01		
ENGINE														
1.5 i LSi	Petrol	74	08/93-11/95	D15B7										
Engine	Information				A10	A20	A40	A50	A70	C10 - C30	C20	E01		
All engines	version Hitachi						822 068	922 095						
All engines										470 214	C10			
ENGINE														
1.6 16V Vtec	Petrol	92	10/91-11/95	D16Z6, D16Z7										
Engine	Information				A10	A20	A40	A50	A70	C10 - C30	C20	E01		
All engines	version Hitachi						822 068	922 095						
All engines										470 214	C10			
All engines	->year 31/12/93											465 052		
ENGINE														
1.6 4x4	Petrol	92	01/92-10/95	D16Z7										
Engine	Information				A10	A20	A40	A50	A70	C10 - C30	C20	E01		
All engines	version Hitachi						822 068	922 095						
All engines										470 214	C10			
All engines	->year 31/12/93											465 052		
ENGINE														
1.6 EX	Petrol	88	08/93-10/95	D16A7										
Engine	Information				A10	A20	A40	A50	A70	C10 - C30	C20	E01		
All engines	version Hitachi						822 068	922 095						
All engines										470 214	C10			
ENGINE														
1.6 i	Petrol	77	01/94-11/95	D16Y7										
Engine	Information				A10	A20	A40	A50	A70	C10 - C30	C20	E01		
All engines	version Hitachi						822 068	922 095						
All engines										470 214	C10		360 702	
ENGINE														
1.6 i Vtec	Petrol	118	01/94-11/95	B16A2										
Engine	Information				A10	A20	A40	A50	A70	C10 - C30	C20	E01		
All engines	version Hitachi						822 068	922 095						
All engines										470 214	C10			
All engines	->eng. 1109264											465 052		
ENGINE														
1.6 i Vtec	Petrol	92	01/94-03/96	D16Y6, D16Z9										
Engine	Information				A10	A20	A40	A50	A70	C10 - C30	C20	E01		
Eng. D16Z9	version Hitachi						822 068	922 095						
Eng. D16Y6	version Hitachi						822 082	922 098						
Eng. D16Z9										470 214	C10			
Eng. D16Y6										470 347	C10		360 702	
ENGINE														
1.6 VTi	Petrol	118	10/91-11/95	B16A2										
Engine	Information				A10	A20	A40	A50	A70	C10 - C30	C20	E01		
All engines	version Hitachi						822 068	922 095						
All engines										470 214	C10			
All engines	->eng. 1109264											465 052		
ENGINE														
1.6 VTi 16V	Petrol	118	10/91-11/95	B16A2										
Engine	Information				A10	A20	A40	A50	A70	C10 - C30	C20	E01		
All engines	version Hitachi						822 068	922 095						
All engines										470 214	C10			
All engines	->eng. 1109264											465 052		
CIVIC VI														
ENGINE														
1.4	Petrol	55	11/95-10/98	D14A4										
Engine	Information				A10	A20	A40	A50	A70	C10 - C30	C20	E01		
All engines	version Hitachi						822 093	922 102						
All engines													360 702	
ENGINE														
1.4 16V	Petrol	55	01/97-02/01	D14A7, D14Z3										
Engine	Information				A10	A20	A40	A50	A70	C10 - C30	C20	E01		
Eng. D14A7	version Hitachi						828 106	922 102						

A10	CONDENSER	A20	CONTACT SET	A40	DISTRIBUTOR CAP	A50	ROTOR	A70	PICK-UP
C10	COIL	C20	IGNITION MODULE	C30	ELECTRONIC IGNITION KIT	E01	IGNITION CABLE SET		

The present application list is a brief version. For the detailed information about the possibility of installation on a specific vehicle, please refer to our web-catalogue <http://catalogo.facet.eu/>

FUNCTIONS ON THE VEHICLE

Vehicle	alim.	kW	Date	Engine								
ENGINE												
1.4 16V	Petrol	55	01/97-02/01	D14A7, D14Z3								
Engine	Information			A10	A20	A40	A50	A70	C10 - C30		C20	E01
All engines	x 1, HITACHI, DISTRIBUTOR									470 347	C10	
Eng. D14A7												360 686
ENGINE												
1.4 16V	Petrol	66	04/98-02/01	D14A8								
Engine	Information			A10	A20	A40	A50	A70	C10 - C30		C20	E01
All engines	version Hitachi					828 106	922 102					
All engines												360 686
ENGINE												
1.4 i	Petrol	55	09/95-02/01	D14A3, D14A5, D14A7, D14Z1, D14Z3								
Engine	Information			A10	A20	A40	A50	A70	C10 - C30		C20	E01
Eng. D14A5	->year 31/12/95, version Hitachi					822 068	922 095					
Eng. D14A5	01/01/96->, version Hitachi					822 082	922 098					
Eng. D14A3, D14Z1	version Hitachi					822 093	922 102					
Eng. D14A3, D14Z1	x 1, TEC, DISTRIBUTOR									470 214	C10	
All engines	x 1, HITACHI, DISTRIBUTOR									470 347	C10	
Eng. D14A3, D14Z1												360 702
ENGINE												
1.4 i	Petrol	66	06/95-02/01	D14A2, D14A4, D14A8, D14Z2, D14Z4								
Engine	Information			A10	A20	A40	A50	A70	C10 - C30		C20	E01
Eng. D14A2, D14Z2	->year 31/12/95, version Hitachi					822 068	922 095					
Eng. D14A2	01/01/96->, version Hitachi					822 082	922 098					
Eng. D14A4	version Hitachi					822 093						
Eng. D14A8	version Hitachi					828 106						
Eng. D14A4, D14A8	version Hitachi						922 102					
Eng. D14A2, D14Z2, D14Z4	x 1, TEC, DISTRIBUTOR									470 214	C10	
Eng. D14Z2										470 214	C10	
Eng. D14Z4	x 1, HITACHI, DISTRIBUTOR									470 347	C10	
Eng. D14A8												360 686
Eng. D14A4, D14Z2												360 702
ENGINE												
1.4 i S	Petrol	66	11/95-02/01	D14A2, D14A4, D14Z2, D14Z4								
Engine	Information			A10	A20	A40	A50	A70	C10 - C30		C20	E01
Eng. D14Z2	version Hitachi					822 068	922 095					
Eng. D14A4	version Hitachi					822 093	922 102					
Eng. D14A2, D14Z2, D14Z4	x 1, TEC, DISTRIBUTOR									470 214	C10	
Eng. D14Z4	x 1, HITACHI, DISTRIBUTOR									470 347	C10	
Eng. D14A4, D14Z2												360 702
ENGINE												
1.4 LPG	Petrol/ Liquified Petro- leum Gas (LPG)	66	01/97-02/01	D14A4, D14Z4								
Engine	Information			A10	A20	A40	A50	A70	C10 - C30		C20	E01
All engines	x 1, HITACHI, DISTRIBUTOR									470 347	C10	
ENGINE												
1.4 i	Petrol	66	01/99->	D14A6								
Engine	Information			A10	A20	A40	A50	A70	C10 - C30		C20	E01
All engines	version Hitachi					828 106	922 102					
All engines												360 686
ENGINE												
1.4 i 16V	Petrol	55	11/98-03/01	D14Z1, D14Z3								
Engine	Information			A10	A20	A40	A50	A70	C10 - C30		C20	E01
Eng. D14Z1	version Hitachi					822 068	922 095					
Eng. D14Z3	version Hitachi					822 082	922 098					
Eng. D14Z1										470 214	C10	360 702
Eng. D14Z3										470 347	C10	360 686









A10 CONDENSER	A20 CONTACT SET	A40 DISTRIBUTOR CAP	A50 ROTOR	A70 PICK-UP
C10 COIL	C20 IGNITION MODULE	C30 ELECTRONIC IGNITION KIT	E01 IGNITION CABLE SET	

Vehicle	alim.	kW	Date	Engine	FUNCTIONS ON THE VEHICLE									
					A10	A20	A40	A50	A70	C10 - C30	C20	E01		
ENGINE														
1.4i 16V	Petrol	66	11/98-10/00	D14Z4										
Engine	Information				A10	A20	A40	A50	A70	C10 - C30	C20	E01		
All engines	version Hitachi						822 082	922 098						
All engines										470 347	C10		360 686	
ENGINE														
1.4i 16V Vtec	Petrol	66	01/99->	D14Z4										
Engine	Information				A10	A20	A40	A50	A70	C10 - C30	C20	E01		
All engines	version Hitachi						822 082	922 098						
All engines										470 347	C10		360 686	
ENGINE														
1.5	Petrol	66	11/95-12/96	D15Z3										
Engine	Information				A10	A20	A40	A50	A70	C10 - C30	C20	E01		
All engines	x 1, TEC, DISTRIBUTOR									470 214	C10			
ENGINE														
1.5 16V	Petrol	84	01/97-02/01	D15Z6, D15Z8										
Engine	Information				A10	A20	A40	A50	A70	C10 - C30	C20	E01		
Eng. D15Z8	version Hitachi						822 082	922 098						
All engines	x 1, TEC, DISTRIBUTOR									470 214	C10			
Eng. D15Z8	x 1, HITACHI, x 1, DISTRIBUTOR, HITACHI, DISTRIBUTOR									470 347	C10			
Eng. D15Z8													360 686	
ENGINE														
1.5 i	Petrol	84	11/95-02/01	D15Z6, D15Z8										
Engine	Information				A10	A20	A40	A50	A70	C10 - C30	C20	E01		
Eng. D15Z6	version Hitachi						822 068	922 095						
All engines	x 1, TEC, x 1, DISTRIBUTOR, TEC, DISTRIBUTOR									470 214	C10			
Eng. D15Z8	x 1, HITACHI, DISTRIBUTOR									470 347	C10			
Eng. D15Z6													360 702	
ENGINE														
1.5 i Vtec-E	Petrol	66	09/94-01/97	D15Z3										
Engine	Information				A10	A20	A40	A50	A70	C10 - C30	C20	E01		
All engines	version Hitachi						822 068	922 095						
All engines	x 1, TEC, DISTRIBUTOR									470 214	C10			
ENGINE														
1.6	Petrol	79	10/95-12/00	--, D16Y2										
Engine	Information				A10	A20	A40	A50	A70	C10 - C30	C20	E01		
Eng. --	version Hitachi						822 068	922 095						
Eng. --										470 214	C10		360 702	
Eng. D16Y2	x 1, TEC, DISTRIBUTOR									470 214	C10			
Eng. D16Y2	x 1, HITACHI, DISTRIBUTOR									470 347	C10			
ENGINE														
1.6	Petrol	92	11/98-03/01	D16W4										
Engine	Information				A10	A20	A40	A50	A70	C10 - C30	C20	E01		
All engines	version Hitachi						822 082	922 098						
All engines	x 1, HITACHI, DISTRIBUTOR									470 347	C10			
All engines													360 686	
ENGINE														
1.6	Petrol	93	10/95-03/01	D16Y2										
Engine	Information				A10	A20	A40	A50	A70	C10 - C30	C20	E01		
All engines	x 1, TEC, DISTRIBUTOR									470 214	C10			
ENGINE														
1.6 16V	Petrol	85	01/97-02/01	D16B2, D16W3										
Engine	Information				A10	A20	A40	A50	A70	C10 - C30	C20	E01		
Eng. D16B2	version Hitachi						828 106	922 102						
All engines	x 1, TEC, DISTRIBUTOR									470 214	C10			
All engines	x 1, HITACHI, DISTRIBUTOR									470 347	C10			
Eng. D16B2													360 686	
ENGINE														
1.6 16V	Petrol	92	04/98-02/01	D16W4										
Engine	Information				A10	A20	A40	A50	A70	C10 - C30	C20	E01		
All engines	x 1, HITACHI, DISTRIBUTOR									470 347	C10			

A10	CONDENSER	A20	CONTACT SET	A40	DISTRIBUTOR CAP	A50	ROTOR	A70	PICK-UP
C10	COIL	C20	IGNITION MODULE	C30	ELECTRONIC IGNITION KIT	E01	IGNITION CABLE SET		

The present application list is a brief version. For the detailed information about the possibility of installation on a specific vehicle, please refer to our web-catalogue <http://catalogo.facet.eu/>

FUNCTIONS ON THE VEHICLE









Vehicle	alim.	kW	Date	Engine	 A10	 A20	 A40	 A50	 A70	 C10 - C30	 C20	 E01
ENGINE												
1.6i	Petrol	77	03/96-03/00	D16Y7								
Engine	Information											
All engines	version Hitachi					822 068	922 095					
All engines	x 1, TEC, DISTRIBUTOR									470 214	C10	
All engines												360 702
ENGINE												
1.6i	Petrol	83	09/94-01/97	D16Y3								
Engine	Information											
All engines	->year 31/12/95, version Hitachi					822 068	922 095					
All engines	01/01/96 ->, version Hitachi					822 082	922 098					
All engines	x 1, TEC, DISTRIBUTOR									470 214	C10	
ENGINE												
1.6i	Petrol	84	11/95-02/01	D16Y5								
Engine	Information											
All engines	version Hitachi					822 082	922 098					
All engines	x 1, HITACHI, DISTRIBUTOR									470 347	C10	
All engines												360 702
ENGINE												
1.6i Vtec	Petrol	118	04/99-12/00	B16A2								
Engine	Information											
All engines	version Hitachi					822 068	922 095					
All engines	x 1, TEC, DISTRIBUTOR									470 214	C10	
ENGINE												
1.6i Vtec	Petrol	92	11/95-02/01	D16Y6, D16Y8								
Engine	Information											
Eng. D16Y8	version Hitachi					822 068	922 095					
Eng. D16Y6	version Hitachi					822 082	922 098					
Eng. D16Y8	x 1, TEC, DISTRIBUTOR									470 214	C10	
Eng. D16Y6										470 347	C10	
All engines												360 702
ENGINE												
1.6i Vtec	Petrol	93	09/94-01/97	D16Y2								
Engine	Information											
All engines	version Hitachi					822 068	922 095					
All engines										470 214	C10	
ENGINE												
1.6 VTi	Petrol	118	11/95-02/01	B16A2								
Engine	Information											
All engines	version Hitachi					822 068	922 095					
All engines	x 1, TEC, DISTRIBUTOR									470 214	C10	
All engines	->year 31/12/98											360 702
ENGINE												
1.6i 16V	Petrol	77	01/96->	D16Y7								
Engine	Information											
All engines	version Hitachi					822 068	922 095					
All engines										470 214	C10	360 702
ENGINE												
1.6i 16V	Petrol	85	11/98-12/00	D16W3								
Engine	Information											
All engines	version Hitachi					822 082	922 098					
All engines										470 347	C10	360 686
ENGINE												
1.6i 16V Vtec	Petrol	92	01/96-09/99	D16Y8								
Engine	Information											
All engines	version Hitachi					822 068	922 095					
All engines										470 214	C10	360 702
ENGINE												
1.8 16V	Petrol	124	01/97-02/01	B18C4								
Engine	Information											
All engines	x 1, TEC, DISTRIBUTOR									470 214	C10	
All engines	x 1, HITACHI, DISTRIBUTOR									470 347	C10	

A10 CONDENSER	A20 CONTACT SET	A40 DISTRIBUTOR CAP	A50 ROTOR	A70 PICK-UP
C10 COIL	C20 IGNITION MODULE	C30 ELECTRONIC IGNITION KIT	E01 IGNITION CABLE SET	

Vehicle	alim.	kW	Date	Engine	FUNCTIONS ON THE VEHICLE									
					A10	A20	A40	A50	A70	C10 - C30	C20	E01		
ENGINE														
1.8 i 16V Vtec	Petrol	124	01/97-12/98	D18C4										
Engine	Information				A10	A20	A40	A50	A70	C10 - C30	C20	E01		
All engines										470 214	C10			
CIVIC VII														
ENGINE														
1.3 IMA	Petrol/ Electric	61	10/03-09/05	LDA1										
Engine	Information				A10	A20	A40	A50	A70	C10 - C30	C20	E01		
All engines	FP: Front, x 4, COIL ON PLUG									470 529	C10			
All engines	FP: Rear, x 4, COIL ON PLUG									470 608	C10			
ENGINE														
1.4	Petrol	66	12/00-09/05	D14Z5										
Engine	Information				A10	A20	A40	A50	A70	C10 - C30	C20	E01		
All engines	x 4, COIL ON PLUG									470 457	C10			
ENGINE														
1.4 i	Petrol	55	02/01-09/05	D14Z6										
Engine	Information				A10	A20	A40	A50	A70	C10 - C30	C20	E01		
All engines	x 4, COIL ON PLUG									470 457	C10			
ENGINE														
1.4 iS	Petrol	66	02/01-09/05	D14Z5, D14Z6										
Engine	Information				A10	A20	A40	A50	A70	C10 - C30	C20	E01		
Eng. D14Z5	Qty: 4									470 457	C10			
Eng. D14Z6	x 4, COIL ON PLUG									470 457	C10			
ENGINE														
1.4i 16V	Petrol	66	02/01->	D14Z6										
Engine	Information				A10	A20	A40	A50	A70	C10 - C30	C20	E01		
All engines	Qty: 4									470 457	C10			
ENGINE														
1.5	Petrol	82	02/03-09/05	D15Y3										
Engine	Information				A10	A20	A40	A50	A70	C10 - C30	C20	E01		
All engines	x 4, COIL ON PLUG									470 457	C10			
ENGINE														
1.5 i 16V	Petrol	0	01/01->	D15Y2, D15Y3										
Engine	Information				A10	A20	A40	A50	A70	C10 - C30	C20	E01		
All engines	Qty: 4									470 457	C10			
ENGINE														
1.6	Petrol	81	02/01-09/05	D16V1, D16W7										
Engine	Information				A10	A20	A40	A50	A70	C10 - C30	C20	E01		
Eng. D16V1	Qty: 4									470 457	C10			
Eng. D16W7	x 4, COIL ON PLUG									470 457	C10			
ENGINE														
1.6 i	Petrol	81	02/01-12/05	D16V1, D16W7										
Engine	Information				A10	A20	A40	A50	A70	C10 - C30	C20	E01		
All engines	x 4, COIL ON PLUG									470 457	C10			
Eng. D16V1	Qty: 4									470 457	C10			
ENGINE														
1.6i 16V	Petrol	81	04/01->	D16W7										
Engine	Information				A10	A20	A40	A50	A70	C10 - C30	C20	E01		
All engines	Qty: 4									470 457	C10			
ENGINE														
1.6i 16V Vtec	Petrol	81	04/01->	D16V3										
Engine	Information				A10	A20	A40	A50	A70	C10 - C30	C20	E01		
All engines	Qty: 4									470 457	C10			
ENGINE														
1.7	Petrol	85	02/01-09/05	D17A6										
Engine	Information				A10	A20	A40	A50	A70	C10 - C30	C20	E01		
All engines	Qty: 4									470 457	C10			

A10 CONDENSER	A20 CONTACT SET	A40 DISTRIBUTOR CAP	A50 ROTOR	A70 PICK-UP
C10 COIL	C20 IGNITION MODULE	C30 ELECTRONIC IGNITION KIT	E01 IGNITION CABLE SET	

The present application list is a brief version. For the detailed information about the possibility of installation on a specific vehicle, please refer to our web-catalogue <http://catalogo.facet.eu/>

				FUNCTIONS ON THE VEHICLE								
Vehicle	alim.	kW	Date	Engine								
				ENGINE								
1.7	Petrol	92	01/00-08/05	D17A6								
				ENGINE								
Engine		Information			A10	A20	A40	A50	A70	C10 - C30	C20	E01
All engines		Qty: 4								470 457	C10	
1.7 i	Petrol	88	05/01-12/05	D17A8								
				ENGINE								
Engine		Information			A10	A20	A40	A50	A70	C10 - C30	C20	E01
All engines		x 4, COIL ON PLUG								470 457	C10	
1.7 i 16VTi	Petrol	0	11/01->	D17Z4								
				ENGINE								
Engine		Information			A10	A20	A40	A50	A70	C10 - C30	C20	E01
All engines		Qty: 4								470 457	C10	
1.7 i 16VTi	Petrol	92	02/01->	D17A5								
				ENGINE								
Engine		Information			A10	A20	A40	A50	A70	C10 - C30	C20	E01
All engines		Qty: 4								470 457	C10	
1.7 i VTEC	Petrol	92	05/01-12/05	D17A5, D17A9								
				ENGINE								
Engine		Information			A10	A20	A40	A50	A70	C10 - C30	C20	E01
All engines		x 4, COIL ON PLUG								470 457	C10	
CIVIC VIII												
1.3 IMA	Petrol/ Electric	70	01/06->	LDA2								
				ENGINE								
Engine		Information			A10	A20	A40	A50	A70	C10 - C30	C20	E01
All engines		FP: Front, x 4, COIL ON PLUG								470 529	C10	
All engines		FP: Rear, x 4, COIL ON PLUG								470 608	C10	
1.3 IMA	Petrol/ Electric	85	01/10-02/12	LDA2								
				ENGINE								
Engine		Information			A10	A20	A40	A50	A70	C10 - C30	C20	E01
All engines		FP: Front, x 4, COIL ON PLUG								470 529	C10	
All engines		FP: Rear, x 4, COIL ON PLUG								470 608	C10	
1.4	Petrol	61	09/05->	L13A7								
				ENGINE								
Engine		Information			A10	A20	A40	A50	A70	C10 - C30	C20	E01
All engines		FP: Front, x 4, COIL ON PLUG								470 529	C10	
All engines		FP: Rear, x 4, COIL ON PLUG								470 608	C10	
1.4	Petrol	73	10/08->	L13Z1								
				ENGINE								
Engine		Information			A10	A20	A40	A50	A70	C10 - C30	C20	E01
All engines		x 4, COIL ON PLUG								470 603	C10	
1.6	Petrol	84	09/05->	R16A1, R16A2								
				ENGINE								
Engine		Information			A10	A20	A40	A50	A70	C10 - C30	C20	E01
Eng. R16A1		Qty: 4								470 522	C10	
Eng. R16A2		x 4, COIL ON PLUG								470 522	C10	
1.6	Petrol	92	09/05->	R16A1								
				ENGINE								
Engine		Information			A10	A20	A40	A50	A70	C10 - C30	C20	E01
All engines		x 4, COIL ON PLUG								470 522	C10	
1.8	Petrol	103	09/05->	R18A1, R18A2								
				ENGINE								
Engine		Information			A10	A20	A40	A50	A70	C10 - C30	C20	E01
All engines		x 4, COIL ON PLUG								470 522	C10	
Eng. R18A2		Qty: 4								470 522	C10	
1.8 EXS Flex	Petrol/ Ethanol	103	11/06->	R18A1								
				ENGINE								
Engine		Information			A10	A20	A40	A50	A70	C10 - C30	C20	E01
All engines		x 4, COIL ON PLUG								470 522	C10	

A10 CONDENSER	A20 CONTACT SET	A40 DISTRIBUTOR CAP	A50 ROTOR	A70 PICK-UP
C10 COIL	C20 IGNITION MODULE	C30 ELECTRONIC IGNITION KIT	E01 IGNITION CABLE SET	

Vehicle	alim.	kW	Date	Engine	FUNCTIONS ON THE VEHICLE							
					A10	A20	A40	A50	A70	C10 - C30	C20	E01

CONCERTO

				ENGINE
1.4	Petrol	61	10/89-10/92	D14A1

Engine	Information	A10	A20	A40	A50	A70	C10 - C30	C20	E01
All engines	version Hitachi			822 071	922 081				
All engines							470 216	C10	

				ENGINE
1.4	Petrol	66	08/89-10/91	D14A1

Engine	Information	A10	A20	A40	A50	A70	C10 - C30	C20	E01
All engines	version Hitachi			822 071	922 081				
All engines							470 216	C10	

				ENGINE
1.5 i	Petrol	0	01/90-12/91	--

Engine	Information	A10	A20	A40	A50	A70	C10 - C30	C20	E01
All engines	version Hitachi			822 069	922 082				
All engines							470 215	C10	

				ENGINE
1.5 i 16V	Petrol	66	08/89-05/95	D15B2

Engine	Information	A10	A20	A40	A50	A70	C10 - C30	C20	E01
All engines							470 215	C10	465 052

				ENGINE
1.6 16V	Petrol	78	08/89-03/95	D16Z2

Engine	Information	A10	A20	A40	A50	A70	C10 - C30	C20	E01
All engines							470 213	C10	465 052

				ENGINE
1.6 i 16V	Petrol	82	08/89-03/95	D16Z2

Engine	Information	A10	A20	A40	A50	A70	C10 - C30	C20	E01
All engines							470 213	C10	465 052

				ENGINE
1.6 i 16V	Petrol	90	08/89-03/95	D16A8

Engine	Information	A10	A20	A40	A50	A70	C10 - C30	C20	E01
All engines							470 213	C10	465 052

				ENGINE
1.6i	Petrol	88	01/90-12/91	D16A

Engine	Information	A10	A20	A40	A50	A70	C10 - C30	C20	E01
All engines	version Hitachi			822 071	922 081				
All engines							470 216	C10	

				ENGINE
1.6i DOHC	Petrol	0	01/90-12/91	--

Engine	Information	A10	A20	A40	A50	A70	C10 - C30	C20	E01
All engines	version Hitachi			822 069	922 082				
All engines							470 213	C10	465 052

				ENGINE
1.6i SOHC	Petrol	0	01/90-12/91	--

Engine	Information	A10	A20	A40	A50	A70	C10 - C30	C20	E01
All engines	version Hitachi			822 069	922 082				
All engines							470 213	C10	

CR-V I

				ENGINE
2.0	Petrol	98	04/99-02/02	B20Z1

Engine	Information	A10	A20	A40	A50	A70	C10 - C30	C20	E01
All engines	version Hitachi			822 068	922 095				
All engines							470 214	C10	360 709

				ENGINE
2.0 16V 4WD	Petrol	108	01/99-02/02	B20Z1, B20Z3

Engine	Information	A10	A20	A40	A50	A70	C10 - C30	C20	E01
Eng. B20Z1	version Hitachi			822 068	922 095				
All engines	x 1, TEC, DISTRIBUTOR						470 214	C10	
Eng. B20Z1									360 709

A10	CONDENSER	A20	CONTACT SET	A40	DISTRIBUTOR CAP	A50	ROTOR	A70	PICK-UP
C10	COIL	C20	IGNITION MODULE	C30	ELECTRONIC IGNITION KIT	E01	IGNITION CABLE SET		

The present application list is a brief version. For the detailed information about the possibility of installation on a specific vehicle, please refer to our web-catalogue <http://catalogo.facet.eu/>

Vehicle	alim.	kW	Date	Engine	FUNCTIONS ON THE VEHICLE							
					A10	A20	A40	A50	A70	C10 - C30	C20	E01

ENGINE				
2.0 16V 4WD	Petrol	94	10/95-12/01	B20B, B20B3, B20B9

Engine	Information	A10	A20	A40	A50	A70	C10 - C30	C20	E01
Eng. B20B	version Hitachi			822 068	922 095				
Eng. B20B							470 214	C10	360 709
Eng. B20B3, B20B9	x 1, TEC, DISTRIBUTOR						470 214	C10	

ENGINE				
2.0 i 16V	Petrol	108	02/97-02/02	B20B3, B20Z3

Engine	Information	A10	A20	A40	A50	A70	C10 - C30	C20	E01
All engines	version Hitachi			822 068	922 095				
All engines							470 214	C10	360 709

ENGINE				
2.0 i 16V	Petrol	94	02/98-04/99	B20B4

Engine	Information	A10	A20	A40	A50	A70	C10 - C30	C20	E01
All engines	version Hitachi			822 068	922 095				
All engines							470 214	C10	360 709

ENGINE				
2.0 i 16V	Petrol	98	04/99-02/02	B20B9

Engine	Information	A10	A20	A40	A50	A70	C10 - C30	C20	E01
All engines	version Hitachi			822 068	922 095				
All engines							470 214	C10	360 709

ENGINE				
2.0	Petrol	110	06/04->	R20A1

Engine	Information	A10	A20	A40	A50	A70	C10 - C30	C20	E01
All engines	Qty: 4						470 522	C10	

ENGINE				
2.0 i	Petrol	110	01/07->	R20A2

Engine	Information	A10	A20	A40	A50	A70	C10 - C30	C20	E01
All engines	Qty: 4						470 522	C10	

ENGINE				
2.0 i-VTEC	Petrol	110	01/07-06/12	R20A2

Engine	Information	A10	A20	A40	A50	A70	C10 - C30	C20	E01
All engines	x 4, COIL ON PLUG						470 522	C10	

ENGINE				
2.0 i-VTEC 4WD	Petrol	110	10/06-06/12	R20A2

Engine	Information	A10	A20	A40	A50	A70	C10 - C30	C20	E01
All engines	x 4, COIL ON PLUG						470 522	C10	

ENGINE				
2.0	Petrol	110	01/12->	R20A9

Engine	Information	A10	A20	A40	A50	A70	C10 - C30	C20	E01
All engines	->year 01/12/12, x 4, COIL ON PLUG						470 522	C10	

ENGINE				
1.6 i 16V	Petrol	91	10/87-02/92	D16Z5

Engine	Information	A10	A20	A40	A50	A70	C10 - C30	C20	E01
All engines	->eng. 1401684, version Hitachi				922 082				
All engines							470 213	C10	465 052

ENGINE				
1.6 i 16V	Petrol	96	10/87-12/89	D16A9

Engine	Information	A10	A20	A40	A50	A70	C10 - C30	C20	E01
All engines	->eng. 1401684, version Hitachi				922 082				
All engines							470 213	C10	465 052

ENGINE				
1.6 i 16V Vtec	Petrol	110	10/89-02/92	B16A1

Engine	Information	A10	A20	A40	A50	A70	C10 - C30	C20	E01
All engines							470 215	C10	465 052

A10	CONDENSER	A20	CONTACT SET	A40	DISTRIBUTOR CAP	A50	ROTOR	A70	PICK-UP
C10	COIL	C20	IGNITION MODULE	C30	ELECTRONIC IGNITION KIT	E01	IGNITION CABLE SET		

Vehicle	alim.	kW	Date	Engine	FUNCTIONS ON THE VEHICLE							
					A10	A20	A40	A50	A70	C10 - C30	C20	E01

CRX III

				ENGINE
1.6 ESi	Petrol	92	03/92-12/98	D16Y8, D16Z6

Engine	Information	A10	A20	A40	A50	A70	C10 - C30	C20	E01
All engines	version Hitachi			822 068	922 095				
All engines							470 214	C10	
All engines	->year 31/12/93							465 052	

				ENGINE
1.6 i Vti	Petrol	118	03/92-12/98	B16A2

Engine	Information	A10	A20	A40	A50	A70	C10 - C30	C20	E01
All engines	version Hitachi			822 068	922 095				
All engines							470 214	C10	
All engines	->eng. 1109264							465 052	

CR-Z

				ENGINE
1.5 IMA	Petrol/ Electric	84	06/10->	LEA1

Engine	Information	A10	A20	A40	A50	A70	C10 - C30	C20	E01
All engines	x 4, COIL ON PLUG						470 603	C10	

				ENGINE
1.5 IMA	Petrol/ Electric	89	11/12->	LEA3

Engine	Information	A10	A20	A40	A50	A70	C10 - C30	C20	E01
All engines	x 4, COIL ON PLUG						470 603	C10	

FR-V

				ENGINE
1.7	Petrol	92	08/04->	D17A2

Engine	Information	A10	A20	A40	A50	A70	C10 - C30	C20	E01
All engines	x 4, COIL ON PLUG						470 457	C10	

				ENGINE
1.8	Petrol	103	01/07->	R18A1

Engine	Information	A10	A20	A40	A50	A70	C10 - C30	C20	E01
All engines	x 4, COIL ON PLUG						470 522	C10	

HR-V

				ENGINE
1.6 16V	Petrol	77	03/99->	350Y, D16W1

Engine	Information	A10	A20	A40	A50	A70	C10 - C30	C20	E01
Eng. 350Y	version Hitachi			822 068	922 095				
Eng. D16W1	x 1, TEC, DISTRIBUTOR						470 214	C10	
Eng. 350Y									360 699

				ENGINE
1.6 16V 4WD	Petrol	77	03/99->	350Y, D16W1

Engine	Information	A10	A20	A40	A50	A70	C10 - C30	C20	E01
Eng. 350Y	version Hitachi			822 068	922 095				
Eng. D16W1	x 1, TEC, DISTRIBUTOR						470 214	C10	
Eng. 350Y									360 699

				ENGINE
1.6 16V 4WD	Petrol	91	10/99-09/05	D16W5

Engine	Information	A10	A20	A40	A50	A70	C10 - C30	C20	E01
All engines	version Hitachi			822 068	922 095				
All engines	x 1, TEC, DISTRIBUTOR						470 214	C10	
All engines									360 699

				ENGINE
1.6i 16V	Petrol	77	04/99->	D16W2



Engine	Information	A10	A20	A40	A50	A70	C10 - C30	C20	E01
All engines	version Hitachi			822 068	922 095				
All engines							470 214	C10	360 699

INSIGHT

				ENGINE
1.3 IMA	Petrol/ Electric	65	04/09->	LDA3

Engine	Information	A10	A20	A40	A50	A70	C10 - C30	C20	E01
All engines	FP: Upper, x 4, COIL ON PLUG						470 527	C10	

A10 CONDENSER	A20 CONTACT SET	A40 DISTRIBUTOR CAP	A50 ROTOR	A70 PICK-UP
C10 COIL	C20 IGNITION MODULE	C30 ELECTRONIC IGNITION KIT	E01 IGNITION CABLE SET	

					FUNCTIONS ON THE VEHICLE									
Vehicle	alim.	kW	Date	Engine	 A10	 A20	 A40	 A50	 A70	 C10 - C30	 C20	 E01		
JAZZ III														
1.3 IMA	Petrol/ Electric	73	04/09->	ENGINE LDA3										
Engine		Information			A10	A20	A40	A50	A70	C10 - C30	C20	E01		
All engines		FP: Upper, x 4, COIL ON PLUG								470 527	C10			
INTEGRA														
1.8 i	Petrol	106	01/98->	ENGINE B18B1, B18C3										
Engine		Information			A10	A20	A40	A50	A70	C10 - C30	C20	E01		
Eng. B18B1		version Hitachi					822 068	922 095						
All engines										470 214	C10			
Eng. B18B1												360 709		
1.8 Type-R	Petrol	140	11/97-10/01	ENGINE B18C6										
Engine		Information			A10	A20	A40	A50	A70	C10 - C30	C20	E01		
All engines		x 1, TEC, DISTRIBUTOR								470 214	C10			
JAZZ I														
1.2 i-DSI	Petrol	57	03/02-07/08	ENGINE L12A1, L12A3, L12A4										
Engine		Information			A10	A20	A40	A50	A70	C10 - C30	C20	E01		
All engines		FP: Front, x 4, COIL ON PLUG								470 529	C10			
All engines		FP: Rear, x 4, COIL ON PLUG								470 608	C10			
1.3 iDSi	Petrol	61	03/02-07/08	ENGINE L13A1, L13A6										
Engine		Information			A10	A20	A40	A50	A70	C10 - C30	C20	E01		
All engines		FP: Front, x 4, COIL ON PLUG								470 529	C10			
All engines		FP: Rear, x 4, COIL ON PLUG								470 608	C10			
1.4	Petrol	65	04/05-07/08	ENGINE L13A5										
Engine		Information			A10	A20	A40	A50	A70	C10 - C30	C20	E01		
All engines		Qty: 4								470 529, 470 608	C10			
1.4 iDSi	Petrol	61	12/06-10/08	ENGINE L13A1, L13A6										
Engine		Information			A10	A20	A40	A50	A70	C10 - C30	C20	E01		
All engines		FP: Front, x 4, COIL ON PLUG								470 529	C10			
All engines		FP: Rear, x 4, COIL ON PLUG								470 608	C10			
45 1.2	Petrol	33	02/84-10/86	ENGINE ER2										
Engine		Information			A10	A20	A40	A50	A70	C10 - C30	C20	E01		
All engines		version Hitachi						922 056						
JAZZ III														
1.2	Petrol	66	07/08->	ENGINE L12B1, L12B2										
Engine		Information			A10	A20	A40	A50	A70	C10 - C30	C20	E01		
All engines		x 4, COIL ON PLUG								470 603	C10			
1.3 HYBRID	Petrol/ Electric	65	04/11->	ENGINE LDA3										
Engine		Information			A10	A20	A40	A50	A70	C10 - C30	C20	E01		
All engines		FP: Upper, x 4, COIL ON PLUG								470 527	C10			
1.3 i	Petrol	73	07/08->	ENGINE L13Z1, L13Z2										
Engine		Information			A10	A20	A40	A50	A70	C10 - C30	C20	E01		
All engines		x 4, COIL ON PLUG								470 603	C10			
1.4	Petrol	74	11/08->	ENGINE L13Z1										
Engine		Information			A10	A20	A40	A50	A70	C10 - C30	C20	E01		
All engines		x 4, COIL ON PLUG								470 603	C10			
1.5 i-VTEC	Petrol	88	07/08-06/14	ENGINE L15-A7										
Engine		Information			A10	A20	A40	A50	A70	C10 - C30	C20	E01		
All engines		Qty: 4								470 603	C10			
A10	CONDENSER		A20	CONTACT SET		A40	DISTRIBUTOR CAP		A50	ROTOR		A70	PICK-UP	
C10	COIL		C20	IGNITION MODULE		C30	ELECTRONIC IGNITION KIT		E01	IGNITION CABLE SET				

Vehicle	alim.	kW	Date	Engine	FUNCTIONS ON THE VEHICLE							
					A10	A20	A40	A50	A70	C10 - C30	C20	E01

LEGEND I

Vehicle	alim.	kW	Date	ENGINE
2.7 i 24V	Petrol	124	10/87-12/90	C27A1

Engine	Information	A10	A20	A40	A50	A70	C10 - C30	C20	E01
All engines	version Hitachi						470 211	C10	

LEGEND IV

Vehicle	alim.	kW	Date	ENGINE
3.5 i	Petrol	217	10/04->	J35A8

Engine	Information	A10	A20	A40	A50	A70	C10 - C30	C20	E01
All engines	Qty: 6						470 457	C10	

Vehicle	alim.	kW	Date	ENGINE
3.5 V6 4WD	Petrol	217	05/06-12/12	J35A8

Engine	Information	A10	A20	A40	A50	A70	C10 - C30	C20	E01
All engines	x 6, COIL ON PLUG						470 457	C10	

Vehicle	alim.	kW	Date	ENGINE
3.5 VTEC V6	Petrol	221	10/04-06/09	C35A8

Engine	Information	A10	A20	A40	A50	A70	C10 - C30	C20	E01
All engines	Qty: 6						470 457	C10	

Vehicle	alim.	kW	Date	ENGINE
3.7 VTEC V6 4WD	Petrol	226	08/08-12/13	J37A3

Engine	Information	A10	A20	A40	A50	A70	C10 - C30	C20	E01
All engines	->year 01/12/08, x 6, COIL ON PLUG						470 457	C10	

LOGO

Vehicle	alim.	kW	Date	ENGINE
1.3	Petrol	48	03/99-03/02	D13B7

Engine	Information	A10	A20	A40	A50	A70	C10 - C30	C20	E01
All engines	version Hitachi			822 068	922 095				
All engines	x 1, TEC, DISTRIBUTOR						470 214	C10	

MR-V

Vehicle	alim.	kW	Date	ENGINE
3.5	Petrol	179	01/03->	J35A4, J35A6, J35A9

Engine	Information	A10	A20	A40	A50	A70	C10 - C30	C20	E01
All engines	Qty: 6						470 457	C10	

ODYSSEY

Vehicle	alim.	kW	Date	ENGINE
2.3	Petrol	110	10/97-09/03	F23A, F23A7

Engine	Information	A10	A20	A40	A50	A70	C10 - C30	C20	E01
All engines	version Hitachi				922 098				
All engines							470 347	C10	

Vehicle	alim.	kW	Date	ENGINE
2.3 4x4	Petrol	110	10/97-09/03	F23A

Engine	Information	A10	A20	A40	A50	A70	C10 - C30	C20	E01
All engines	version Hitachi				922 098				
All engines							470 347	C10	

Vehicle	alim.	kW	Date	ENGINE
3.5	Petrol	171	01/05->	J35A6

Engine	Information	A10	A20	A40	A50	A70	C10 - C30	C20	E01
All engines	Qty: 6						470 457	C10	

Vehicle	alim.	kW	Date	ENGINE
3.5	Petrol	179	01/02-08/04	J35A4

Engine	Information	A10	A20	A40	A50	A70	C10 - C30	C20	E01
All engines	Qty: 6						470 457	C10	

PASSPORT

Vehicle	alim.	kW	Date	ENGINE
2.6 i [USA]	Petrol	88	01/94->	4ZE1

Engine	Information	A10	A20	A40	A50	A70	C10 - C30	C20	E01
All engines	version Hitachi			822 060	922 069				

PRELUDE IV

Vehicle	alim.	kW	Date	ENGINE
2.0 i 16V	Petrol	98	02/92-09/96	F20A4

Engine	Information	A10	A20	A40	A50	A70	C10 - C30	C20	E01
All engines	version Hitachi			822 068	922 095				

A10 CONDENSER	A20 CONTACT SET	A40 DISTRIBUTOR CAP	A50 ROTOR	A70 PICK-UP
C10 COIL	C20 IGNITION MODULE	C30 ELECTRONIC IGNITION KIT	E01 IGNITION CABLE SET	

Vehicle	alim.	kW	Date	Engine	FUNCTIONS ON THE VEHICLE							
					A10	A20	A40	A50	A70	C10 - C30	C20	E01

PRELUDE IV

2.0 i 16V	Petrol	98	02/92-09/96	ENGINE F20A4
-----------	--------	----	-------------	-----------------

Engine	Information	A10	A20	A40	A50	A70	C10 - C30	C20	E01
All engines							470 214	C10	360 711
All engines	->eng. 9204631							465 052	

2.2 i 16V Vtec	Petrol	136	02/93-09/96	ENGINE H22A2
----------------	--------	-----	-------------	-----------------

Engine	Information	A10	A20	A40	A50	A70	C10 - C30	C20	E01
All engines	version Hitachi			822 068	922 095				
All engines							470 214	C10	
All engines	->eng. 1001957							465 052	

2.3 i 16V	Petrol	118	02/92-09/96	ENGINE H23A2
-----------	--------	-----	-------------	-----------------

Engine	Information	A10	A20	A40	A50	A70	C10 - C30	C20	E01
All engines	version Hitachi			822 068	922 095				
All engines							470 214	C10	
All engines	->eng. 2001742							465 052	

PRELUDE V

2.0 16V	Petrol	98	10/96-10/00	ENGINE F20A4
---------	--------	----	-------------	-----------------

Engine	Information	A10	A20	A40	A50	A70	C10 - C30	C20	E01
All engines	version Hitachi			822 068	922 095				
All engines	x 1, TEC, DISTRIBUTOR						470 214	C10	
All engines									360 711

2.2 16V	Petrol	136	10/96-10/00	ENGINE H22A5
---------	--------	-----	-------------	-----------------

Engine	Information	A10	A20	A40	A50	A70	C10 - C30	C20	E01
All engines	version Hitachi			822 068	922 095				
All engines	x 1, TEC, DISTRIBUTOR						470 214	C10	

2.2 16V	Petrol	147	10/96-10/00	ENGINE H22A5, H22A8
---------	--------	-----	-------------	------------------------

Engine	Information	A10	A20	A40	A50	A70	C10 - C30	C20	E01
Eng. H22A5	version Hitachi			822 068	922 095				
All engines	x 1, TEC, DISTRIBUTOR						470 214	C10	

2.2 i 16V	Petrol	136	10/96-10/01	ENGINE F22A2
-----------	--------	-----	-------------	-----------------

Engine	Information	A10	A20	A40	A50	A70	C10 - C30	C20	E01
All engines	version Hitachi			822 068	922 095				
All engines							470 214	C10	360 711

2.2 i 16V Vti-R	Petrol	147	10/96-12/01	ENGINE H22A4, H22A8, H22Z1
-----------------	--------	-----	-------------	-------------------------------

Engine	Information	A10	A20	A40	A50	A70	C10 - C30	C20	E01
Eng. H22A8	version Hitachi			822 068					
Eng. H22A4, H22Z1	version Hitachi			822 076					
All engines	version Hitachi				922 095				
Eng. H22A8							470 214	C10	

2.2 Si	Petrol	118	03/97-07/02	ENGINE F22Z6
--------	--------	-----	-------------	-----------------

Engine	Information	A10	A20	A40	A50	A70	C10 - C30	C20	E01
All engines	version Hitachi			822 068	922 095				
All engines							470 214	C10	

SHUTTLE

2.2 16V	Petrol	110	10/94-02/98	ENGINE F22B8
---------	--------	-----	-------------	-----------------

Engine	Information	A10	A20	A40	A50	A70	C10 - C30	C20	E01
All engines	version Hitachi			822 068	922 095				
All engines							470 214	C10	360 711

2.3 16V	Petrol	110	10/97-06/04	ENGINE F23A7
---------	--------	-----	-------------	-----------------

Engine	Information	A10	A20	A40	A50	A70	C10 - C30	C20	E01
All engines	version Hitachi				922 098				

A10 CONDENSER	A20 CONTACT SET	A40 DISTRIBUTOR CAP	A50 ROTOR	A70 PICK-UP
C10 COIL	C20 IGNITION MODULE	C30 ELECTRONIC IGNITION KIT	E01 IGNITION CABLE SET	

Vehicle	alim.	kW	Date	Engine	FUNCTIONS ON THE VEHICLE							
					 A10	 A20	 A40	 A50	 A70	 C10 - C30	 C20	 E01

					ENGINE
2.3 16V	Petrol	110	10/97-06/04	F23A7	

Engine	Information	A10	A20	A40	A50	A70	C10 - C30	C20	E01
All engines							470 347	C10	

STREAM

					ENGINE
1.7 16V	Petrol	92	05/01-09/06	D17A2	

Engine	Information	A10	A20	A40	A50	A70	C10 - C30	C20	E01
All engines	x 4, COIL ON PLUG						470 457	C10	

A10 CONDENSER	A20 CONTACT SET	A40 DISTRIBUTOR CAP	A50 ROTOR	A70 PICK-UP
C10 COIL	C20 IGNITION MODULE	C30 ELECTRONIC IGNITION KIT	E01 IGNITION CABLE SET	

The present application list is a brief version. For the detailed information about the possibility of installation on a specific vehicle, please refer to our web-catalogue <http://catalogo.facet.eu/>

Vehicle	alim.	kW	Date	Engine	FUNCTIONS ON THE VEHICLE							
					A10	A20	A40	A50	A70	C10 - C30	C20	E01

ACCENT

				ENGINE
1.4 CVT	Petrol	79	11/10->	G4FA

Engine	Information	A10	A20	A40	A50	A70	C10 - C30	C20	E01
All engines	x 4, COIL ON PLUG						470 543	C10	

ACCENT I

				ENGINE
1.3	Petrol	44	10/94-01/00	G4EH

Engine	Information	A10	A20	A40	A50	A70	C10 - C30	C20	E01
All engines									358 119

				ENGINE
1.3	Petrol	55	10/94-01/00	G4EH

Engine	Information	A10	A20	A40	A50	A70	C10 - C30	C20	E01
All engines									358 119

				ENGINE
1.3 i 12V	Petrol	62	10/94-01/00	G4EH

Engine	Information	A10	A20	A40	A50	A70	C10 - C30	C20	E01
All engines									358 119

				ENGINE
1.5	Petrol	63	10/94-07/99	G4EK

Engine	Information	A10	A20	A40	A50	A70	C10 - C30	C20	E01
All engines									358 119

				ENGINE
1.5 i 12V	Petrol	65	10/94-01/00	G4EK

Engine	Information	A10	A20	A40	A50	A70	C10 - C30	C20	E01
All engines									358 119

				ENGINE
1.5 i 16V	Petrol	73	10/95-01/00	G4ER

Engine	Information	A10	A20	A40	A50	A70	C10 - C30	C20	E01
All engines	09/12/96 ->								358 111

ACCENT II

				ENGINE
1.3	Petrol	55	01/00-11/05	G4EA

Engine	Information	A10	A20	A40	A50	A70	C10 - C30	C20	E01
All engines	FP: Left, FP: Left Front, x 1, D.I.S.						470 583	C10	
All engines	FP: right, x 1, D.I.S.						470 585	C10	
All engines									358 119

				ENGINE
1.3	Petrol	61	01/00-11/05	G4EA

Engine	Information	A10	A20	A40	A50	A70	C10 - C30	C20	E01
All engines	FP: Left, FP: Left Front, x 1, D.I.S.						470 583	C10	
All engines	FP: right, x 1, D.I.S.						470 585	C10	
All engines									358 119

				ENGINE
1.3	Petrol	62	08/02-11/05	G4EA, G4EH

Engine	Information	A10	A20	A40	A50	A70	C10 - C30	C20	E01
Eng. G4EH							470 582, 470 583	C10	358 119
Eng. G4EA	FP: Left, FP: Left Front, x 1, D.I.S.						470 583	C10	
Eng. G4EA	FP: right, x 1, D.I.S.						470 585	C10	
Eng. G4EH	Kit						470 585	C10	

				ENGINE
1.3	Petrol	63	01/00-11/05	G4EA

Engine	Information	A10	A20	A40	A50	A70	C10 - C30	C20	E01
All engines	FP: Left, FP: Left Front, x 1, D.I.S.						470 583	C10	
All engines	FP: right, x 1, D.I.S.						470 585	C10	
All engines									358 119

				ENGINE
1.5	Petrol	65	09/99-10/02	G4EK

Engine	Information	A10	A20	A40	A50	A70	C10 - C30	C20	E01
All engines							470 582, 470 583	C10	358 119
All engines	Kit						470 585	C10	

A10 CONDENSER	A20 CONTACT SET	A40 DISTRIBUTOR CAP	A50 ROTOR	A70 PICK-UP
C10 COIL	C20 IGNITION MODULE	C30 ELECTRONIC IGNITION KIT	E01 IGNITION CABLE SET	

Vehicle	alim.	kW	Date	Engine	FUNCTIONS ON THE VEHICLE									
					A10	A20	A40	A50	A70	C10 - C30	C20	E01		
ENGINE														
1.5	Petrol	66	01/00-11/05	G4EB										
Engine	Information				A10	A20	A40	A50	A70	C10 - C30	C20	E01		
All engines	FP: Left, FP: Left Front, x 1, D.I.S.									470 583	C10			
All engines	FP: right, x 1, D.I.S.									470 585	C10			
All engines													358 119	
ENGINE														
1.5	Petrol	68	01/00-10/02	G4EK										
Engine	Information				A10	A20	A40	A50	A70	C10 - C30	C20	E01		
All engines	FP: Left, FP: Left Front, x 1, D.I.S.									470 583	C10			
All engines	FP: right, x 1, D.I.S.									470 585	C10			
ENGINE														
1.5	Petrol	69	01/00-12/06	G4EK										
Engine	Information				A10	A20	A40	A50	A70	C10 - C30	C20	E01		
All engines	FP: Left, FP: Left Front, x 1, D.I.S.									470 583	C10			
All engines	FP: right, x 1, D.I.S.									470 585	C10			
ENGINE														
1.5	Petrol	73	09/99-10/02	G4FK										
Engine	Information				A10	A20	A40	A50	A70	C10 - C30	C20	E01		
All engines	x 1, D.I.S.									470 585	C10			
ENGINE														
1.5	Petrol	75	09/99-11/05	G4EC-G, G4FK										
Engine	Information				A10	A20	A40	A50	A70	C10 - C30	C20	E01		
Eng. G4FK	FP: right, x 1, D.I.S.									470 582	C10			
Eng. G4FK	FP: Left, FP: Left Front, x 1, D.I.S.									470 584	C10			
Eng. G4EC-G	x 1, D.I.S.									470 585	C10			
All engines													358 111	
ENGINE														
1.5	Petrol	77	09/99-10/02	G4FK										
Engine	Information				A10	A20	A40	A50	A70	C10 - C30	C20	E01		
All engines	x 1, D.I.S.									470 585	C10			
ENGINE														
1.6	Petrol	77	12/02-11/05	G4ED, G4ED-G										
Engine	Information				A10	A20	A40	A50	A70	C10 - C30	C20	E01		
Eng. G4ED-G										470 582, 470 584	C10		358 111	
Eng. G4ED	x 1, D.I.S.									470 586	C10			
Eng. G4ED-G	Kit									470 586	C10			
ACCENT III														
ENGINE														
1.4 GL	Petrol	71	11/05-11/10	G4EE										
Engine	Information				A10	A20	A40	A50	A70	C10 - C30	C20	E01		
All engines	Fitting Position:for cylinder 1, Fitting Position:for cylinder 4, x 1, D.I.S.									470 582	C10			
All engines	Fitting Position:for cylinder 2, Fitting Position:for cylinder 3, x 1, D.I.S.									470 584	C10			
All engines													358 111	
ENGINE														
1.6 GLS	Petrol	82	11/05-11/10	G4ED										
Engine	Information				A10	A20	A40	A50	A70	C10 - C30	C20	E01		
All engines													358 111	
ACCENT IV														
ENGINE														
1.4	Petrol	74	11/10->	G4LC										
Engine	Information				A10	A20	A40	A50	A70	C10 - C30	C20	E01		
All engines	x 4, COIL ON PLUG									470 622	C10			
ENGINE														
1.4	Petrol	79	11/10->	G4FA										
Engine	Information				A10	A20	A40	A50	A70	C10 - C30	C20	E01		
All engines	x 4, COIL ON PLUG									470 543	C10			

A10	CONDENSER	A20	CONTACT SET	A40	DISTRIBUTOR CAP	A50	ROTOR	A70	PICK-UP
C10	COIL	C20	IGNITION MODULE	C30	ELECTRONIC IGNITION KIT	E01	IGNITION CABLE SET		

The present application list is a brief version. For the detailed information about the possibility of installation on a specific vehicle, please refer to our web-catalogue <http://catalogo.facet.eu/>

					FUNCTIONS ON THE VEHICLE							
Vehicle	alim.	kW	Date	Engine	 A10	 A20	 A40	 A50	 A70	 C10 - C30	 C20	 E01
1.4 CVT												
Petrol 0 11/10-> ENGINE												
All engines					--							
Engine Information					A10	A20	A40	A50	A70	C10 - C30	C20	E01
All engines Qty: 4										470 622	C10	
1.6												
Petrol 90 11/10-> ENGINE												
All engines					G4FC							
Engine Information					A10	A20	A40	A50	A70	C10 - C30	C20	E01
All engines x 4, COIL ON PLUG										470 543	C10	
1.6												
Petrol 91 11/10-> ENGINE												
All engines					G4FC							
Engine Information					A10	A20	A40	A50	A70	C10 - C30	C20	E01
All engines Qty: 4										470 543	C10	
ACCENT V												
1.4												
Petrol 74 07/18-> ENGINE												
All engines					G4LC							
Engine Information					A10	A20	A40	A50	A70	C10 - C30	C20	E01
All engines x 4, COIL ON PLUG										470 622	C10	
ATOS												
1.0 i												
Petrol 40 02/98-12/00 ENGINE												
All engines					G4HC							
Engine Information					A10	A20	A40	A50	A70	C10 - C30	C20	E01
All engines -->year 13/11/98, version Mitsubishi							831 121					
All engines 13/11/98 ->, ->year 14/08/00, version Mitsubishi							831 170	931 138				
All engines x 1, D.I.S., connector type DIN										470 394	C10	
All engines -->year 01/08/00, x 1, D.I.S., connector type DIN										470 496	C10	
All engines 01/09/01 ->, x 2, D.I.S., connector type DIN												358 120
All engines -->year 14/08/00												358 235
All engines 14/08/00 ->												358 235
1.0 i												
Petrol 41 02/98-03/02 ENGINE												
All engines					G4HC							
Engine Information					A10	A20	A40	A50	A70	C10 - C30	C20	E01
All engines -->year 13/11/98, version Mitsubishi							831 121					
All engines 13/11/98 ->, ->year 14/08/00, version Mitsubishi							831 170	931 138				
All engines -->year 14/08/00												358 120
All engines 14/08/00 ->												358 235
1.0 i												
Petrol 43 03/01-07/03 ENGINE												
All engines					G4HC, G4HC-E							
Engine Information					A10	A20	A40	A50	A70	C10 - C30	C20	E01
Eng. G4HC x 2, D.I.S., connector type DIN										470 496	C10	
Eng. G4HC-E 15/04/03 ->												358 119
Eng. G4HC-E -->year 15/04/03												358 235
1.1												
Petrol 43 08/03-12/08 ENGINE												
All engines					G4HD							
Engine Information					A10	A20	A40	A50	A70	C10 - C30	C20	E01
All engines Fitting Position:for cylinder 1-4, Fitting Position:for cylinder 2, x 1, D.I.S., Fitting Position:for cylinder 3, x 1, D.I.S., x 1, D.I.S.										470 496	C10	
All engines												358 119
1.1												
Petrol 45 06/03-12/10 ENGINE												
All engines					G4HG							
Engine Information					A10	A20	A40	A50	A70	C10 - C30	C20	E01
All engines Qty: 2										470 496	C10	
All engines												358 119
1.1												
Petrol 46 08/03-12/08 ENGINE												
All engines					G4HG							
Engine Information					A10	A20	A40	A50	A70	C10 - C30	C20	E01
All engines x 1, D.I.S.										470 496	C10	
All engines												358 119
ATOS PRIME												
1.0 i												
Petrol 40 08/99-> ENGINE												
All engines					G4HC							
Engine Information					A10	A20	A40	A50	A70	C10 - C30	C20	E01
All engines -->year 13/11/98, version Mitsubishi							831 121					

A10 CONDENSER	A20 CONTACT SET	A40 DISTRIBUTOR CAP	A50 ROTOR	A70 PICK-UP
C10 COIL	C20 IGNITION MODULE	C30 ELECTRONIC IGNITION KIT	E01 IGNITION CABLE SET	

Vehicle	alim.	kW	Date	Engine	FUNCTIONS ON THE VEHICLE							
					A10	A20	A40	A50	A70	C10 - C30	C20	E01

ATOS PRIME

				ENGINE
1.0 i	Petrol	40	08/99->	G4HC

Engine	Information	A10	A20	A40	A50	A70	C10 - C30	C20	E01
All engines	13/11/98 ->, ->year 14/08/00, version Mitsubishi			831 170	931 138				
All engines	->year 14/08/00								358 120
All engines	14/08/00 ->								358 235

				ENGINE
1.0 i	Petrol	43	03/01-07/03	G4HC-E

Engine	Information	A10	A20	A40	A50	A70	C10 - C30	C20	E01
All engines	Qty: 2						470 496	C10	
All engines	15/04/03 ->								358 119
All engines	->year 15/04/03								358 235

				ENGINE
1.1	Petrol	43	08/03-05/05	G4HD

Engine	Information	A10	A20	A40	A50	A70	C10 - C30	C20	E01
All engines	Qty: 2						470 496	C10	
All engines									358 119

				ENGINE
1.1	Petrol	46	01/97-12/08	G4HG

Engine	Information	A10	A20	A40	A50	A70	C10 - C30	C20	E01
All engines	Qty: 2						470 496	C10	
All engines									358 119

BAYON

				ENGINE
1.4 MPI	Petrol	74	05/21->	G4LC

Engine	Information	A10	A20	A40	A50	A70	C10 - C30	C20	E01
All engines	x 4, COIL ON PLUG						470 622	C10	

COUPE I

				ENGINE
1.6 16V	Petrol	85	03/98-04/02	G4GR

Engine	Information	A10	A20	A40	A50	A70	C10 - C30	C20	E01
All engines	Coupe, 01/07/00 ->, x 1, D.I.S.						470 586	C10	
All engines	01/06/00 ->								358 111
All engines	->year 01/06/00								360 385

				ENGINE
1.6 i 16V	Petrol	84	12/96-04/02	G4G1, G4GR

Engine	Information	A10	A20	A40	A50	A70	C10 - C30	C20	E01
Eng. 4G61	01/06/00 ->, Kit						470 586	C10	
Eng. G4GR	Coupe, 01/07/00 ->, x 1, D.I.S.						470 586	C10	
Eng. 4G61	01/06/00 ->								358 111
Eng. 4G61	->year 01/06/00								360 385

				ENGINE
2.0 16V	Petrol	102	08/96-04/02	G4GF

Engine	Information	A10	A20	A40	A50	A70	C10 - C30	C20	E01
All engines									360 385

COUPE II

				ENGINE
1.6 16V	Petrol	77	03/02-08/09	G4ED, G4ED-G

Engine	Information	A10	A20	A40	A50	A70	C10 - C30	C20	E01
Eng. G4ED-G							470 582, 470 584	C10	358 111
Eng. G4ED	Coupe, x 1, D.I.S.						470 586	C10	
Eng. G4ED-G	Kit						470 586	C10	

				ENGINE
1.6 16V	Petrol	79	03/02-08/09	G4ED, G4ED-G

Engine	Information	A10	A20	A40	A50	A70	C10 - C30	C20	E01
Eng. G4ED-G							470 582, 470 584	C10	358 111
Eng. G4ED	Coupe, x 1, D.I.S.						470 586	C10	
Eng. G4ED-G	Kit						470 586	C10	

A10 CONDENSER	A20 CONTACT SET	A40 DISTRIBUTOR CAP	A50 ROTOR	A70 PICK-UP
C10 COIL	C20 IGNITION MODULE	C30 ELECTRONIC IGNITION KIT	E01 IGNITION CABLE SET	

VEHICLE					FUNCTIONS ON THE VEHICLE							
Vehicle	alim.	kW	Date	Engine								

2.0	Petrol	100	08/01-08/09	ENGINE G4GC, G4GC-G
------------	--------	------------	-------------	--------------------------------------

Engine	Information	A10	A20	A40	A50	A70	C10 - C30	C20	E01
Eng. G4GC	Coupe, 01/09/02 ->, x 1, D.I.S.						470 581	C10	
Eng. G4GC-G	01/09/02 ->, Qty: 2						470 581	C10	
Eng. G4GC-G									360 385

2.0	Petrol	102	03/02-08/09	ENGINE G4GC, G4GC-G
------------	--------	------------	-------------	--------------------------------------

Engine	Information	A10	A20	A40	A50	A70	C10 - C30	C20	E01
Eng. G4GC	Coupe, 01/09/02 ->, x 1, D.I.S.						470 581	C10	
Eng. G4GC-G	01/09/02 ->, Qty: 2						470 581	C10	
Eng. G4GC-G									360 385

2.0 GLS	Petrol	105	02/03-08/09	ENGINE G4GC, G4GC-G
----------------	--------	------------	-------------	--------------------------------------

Engine	Information	A10	A20	A40	A50	A70	C10 - C30	C20	E01
Eng. G4GC	Coupe, x 1, D.I.S.						470 581	C10	
Eng. G4GC-G	Qty: 2						470 581	C10	
Eng. G4GC-G									360 385

2.7 V6	Petrol	121	01/01-08/09	ENGINE G6BA-G
---------------	--------	------------	-------------	--------------------------------

Engine	Information	A10	A20	A40	A50	A70	C10 - C30	C20	E01
All engines									358 236

2.7 V6	Petrol	123	03/02-08/09	ENGINE G6BA-G
---------------	--------	------------	-------------	--------------------------------

Engine	Information	A10	A20	A40	A50	A70	C10 - C30	C20	E01
All engines									358 236

CRETA

1.6	Petrol	90	01/16->	ENGINE G4FG
------------	--------	-----------	---------	------------------------------

Engine	Information	A10	A20	A40	A50	A70	C10 - C30	C20	E01
All engines	x 4, COIL ON PLUG						470 543	C10	

1.6 4WD	Petrol	90	08/16->	ENGINE G4FG
----------------	--------	-----------	---------	------------------------------

Engine	Information	A10	A20	A40	A50	A70	C10 - C30	C20	E01
All engines	euro 5, x 4, COIL ON PLUG						470 543	C10	

ELANTRA I

1.5 i GL	Petrol	62	12/90-08/94	ENGINE G4DJ
-----------------	--------	-----------	-------------	------------------------------

Engine	Information	A10	A20	A40	A50	A70	C10 - C30	C20	E01
All engines	SOHC/OHC, version Mitsubishi			831 003/001	931 107				
All engines	DOHC								360 401

1.6i 16V	Petrol	84	12/90-05/95	ENGINE G4CR
-----------------	--------	-----------	-------------	------------------------------

Engine	Information	A10	A20	A40	A50	A70	C10 - C30	C20	E01
All engines									360 401

1.8i 16V	Petrol	93	06/92-12/95	ENGINE G4CN
-----------------	--------	-----------	-------------	------------------------------

Engine	Information	A10	A20	A40	A50	A70	C10 - C30	C20	E01
All engines									360 401

ELANTRA II

1.6i 16V	Petrol	84	06/95-05/00	ENGINE G4GR
-----------------	--------	-----------	-------------	------------------------------

Engine	Information	A10	A20	A40	A50	A70	C10 - C30	C20	E01
All engines									360 385

1.8i 16V	Petrol	93	05/95-05/00	ENGINE G4GM
-----------------	--------	-----------	-------------	------------------------------









Engine	Information	A10	A20	A40	A50	A70	C10 - C30	C20	E01
All engines									360 385

A10 CONDENSER	A20 CONTACT SET	A40 DISTRIBUTOR CAP	A50 ROTOR	A70 PICK-UP
C10 COIL	C20 IGNITION MODULE	C30 ELECTRONIC IGNITION KIT	E01 IGNITION CABLE SET	

Vehicle	alim.	kW	Date	Engine	FUNCTIONS ON THE VEHICLE									
					A10	A20	A40	A50	A70	C10 - C30	C20	E01		
ENGINE														
1.8 i 16V	Petrol	94	09/95-05/00	G4GM										
Engine	Information				A10	A20	A40	A50	A70	C10 - C30	C20	E01		
All engines													360 385	
ENGINE														
2.0 i 16V	Petrol	102	06/97-05/00	G4DF										
Engine	Information				A10	A20	A40	A50	A70	C10 - C30	C20	E01		
All engines													360 385	
ELANTRA III														
ENGINE														
1.6	Petrol	66	06/00-07/06	G4GR										
Engine	Information				A10	A20	A40	A50	A70	C10 - C30	C20	E01		
All engines	x 1, D.I.S.									470 586	C10			
All engines													358 111	
ENGINE														
1.6	Petrol	77	05/03-07/06	G4ED, G4ED-G										
Engine	Information				A10	A20	A40	A50	A70	C10 - C30	C20	E01		
Eng. G4ED-G										470 582, 470 584	C10		358 111	
Eng. G4ED	x 1, D.I.S.									470 586	C10			
Eng. G4ED-G	Kit									470 586	C10			
ENGINE														
1.6	Petrol	79	06/00-07/06	G4ED, G4ED-G										
Engine	Information				A10	A20	A40	A50	A70	C10 - C30	C20	E01		
Eng. G4ED-G										470 582, 470 584	C10		358 111	
Eng. G4ED	x 1, D.I.S.									470 586	C10			
Eng. G4ED-G	Kit									470 586	C10			
ENGINE														
1.6	Petrol	82	09/03-07/06	G4GA										
Engine	Information				A10	A20	A40	A50	A70	C10 - C30	C20	E01		
All engines										470 582, 470 584	C10		358 111	
All engines	Kit									470 586	C10			
All engines	x 1, D.I.S.									470 586	C10			
ENGINE														
1.8	Petrol	79	06/00-07/03	G4BB										
Engine	Information				A10	A20	A40	A50	A70	C10 - C30	C20	E01		
All engines	01/09/02 ->, Qty: 2									470 581	C10			
All engines	01/10/02 ->, x 1, D.I.S.									470 581	C10			
All engines													360 385	
ENGINE														
1.8	Petrol	97	06/00-07/06	G4BB, G4GB										
Engine	Information				A10	A20	A40	A50	A70	C10 - C30	C20	E01		
All engines	01/10/02 ->, x 1, D.I.S.									470 581	C10			
All engines													360 385	
ENGINE														
1.8	Petrol	98	11/02-07/06	G4GB										
Engine	Information				A10	A20	A40	A50	A70	C10 - C30	C20	E01		
All engines	Qty: 2									470 581	C10			
All engines													360 385	
ENGINE														
2.0	Petrol	102	06/00-07/06	G4GC, G4GC-G										
Engine	Information				A10	A20	A40	A50	A70	C10 - C30	C20	E01		
Eng. G4GC	01/10/02 ->, x 1, D.I.S.									470 581	C10			
Eng. G4GC-G	01/09/02 ->, Qty: 2									470 581	C10			
Eng. G4GC-G													360 385	
ENGINE														
2.0	Petrol	104	06/00-07/06	G4GC										
Engine	Information				A10	A20	A40	A50	A70	C10 - C30	C20	E01		
All engines	01/10/02 ->, x 1, D.I.S.									470 581	C10			
All engines													360 385	

A10 CONDENSER	A20 CONTACT SET	A40 DISTRIBUTOR CAP	A50 ROTOR	A70 PICK-UP
C10 COIL	C20 IGNITION MODULE	C30 ELECTRONIC IGNITION KIT	E01 IGNITION CABLE SET	

The present application list is a brief version. For the detailed information about the possibility of installation on a specific vehicle, please refer to our web-catalogue <http://catalogo.facet.eu/>

					FUNCTIONS ON THE VEHICLE							
Vehicle	alim.	kW	Date	Engine								
ELANTRA IV												
2.0	Petrol	105	10/03-07/06	ENGINE G4GC								
ENGINE												
Information					A10	A20	A40	A50	A70	C10 - C30	C20	E01
All engines										470 581	C10	
All engines												360 385
ELANTRA IV												
1.6 CVT	Petrol	90	06/06-06/11	ENGINE G4FC								
ENGINE												
Information					A10	A20	A40	A50	A70	C10 - C30	C20	E01
All engines										470 495	C10	
All engines												360 385
ELANTRA IV												
2.0 CVT	Petrol	103	06/06-05/10	ENGINE G4GC								
ENGINE												
Information					A10	A20	A40	A50	A70	C10 - C30	C20	E01
All engines										470 581	C10	
All engines												360 385
ELANTRA IV												
2.0 CVT	Petrol	105	06/06-06/11	ENGINE G4GC								
ENGINE												
Information					A10	A20	A40	A50	A70	C10 - C30	C20	E01
All engines										470 581	C10	
All engines										470 581	C10	
All engines												360 385
ELANTRA V												
1.6	Petrol	94	04/11->	ENGINE G4FG								
ENGINE												
Information					A10	A20	A40	A50	A70	C10 - C30	C20	E01
All engines										470 543	C10	
All engines										470 543	C10	
ELANTRA V												
1.6	Petrol	96	06/11-12/15	ENGINE G4FG								
ENGINE												
Information					A10	A20	A40	A50	A70	C10 - C30	C20	E01
All engines										470 543	C10	
ELANTRA V												
1.6	Petrol	97	06/11-12/15	ENGINE G4FG								
ENGINE												
Information					A10	A20	A40	A50	A70	C10 - C30	C20	E01
All engines										470 543	C10	
EQUUS / CENTENNIAL II												
3.8	Petrol	246	01/13->	ENGINE --								
ENGINE												
Information					A10	A20	A40	A50	A70	C10 - C30	C20	E01
All engines										470 492	C10	
EXCEL												
1.3	Petrol	51	09/89-07/91	ENGINE G4DG								
ENGINE												
Information					A10	A20	A40	A50	A70	C10 - C30	C20	E01
All engines							831 003/001	931 023				
EXCEL												
1.3 i 12V	Petrol	63	09/94-08/99	ENGINE G4EH								
ENGINE												
Information					A10	A20	A40	A50	A70	C10 - C30	C20	E01
All engines												358 119
EXCEL												
1.5 i 12V	Petrol	65	09/94-08/99	ENGINE G4EK								
ENGINE												
Information					A10	A20	A40	A50	A70	C10 - C30	C20	E01
All engines												358 119
EXCEL												
1.5 i 16V GT	Petrol	73	10/96-08/99	ENGINE G4ER								
ENGINE												
Information					A10	A20	A40	A50	A70	C10 - C30	C20	E01
All engines												358 111

A10 CONDENSER	A20 CONTACT SET	A40 DISTRIBUTOR CAP	A50 ROTOR	A70 PICK-UP
C10 COIL	C20 IGNITION MODULE	C30 ELECTRONIC IGNITION KIT	E01 IGNITION CABLE SET	

Vehicle	alim.	kW	Date	Engine	FUNCTIONS ON THE VEHICLE							
					A10	A20	A40	A50	A70	C10 - C30	C20	E01

GALLOPER

ENGINE
3.0 V6 Petrol 104 08/98-12/03 G6AT

Engine	Information	A10	A20	A40	A50	A70	C10 - C30	C20	E01
All engines				831 116					
All engines	version Mitsubishi			931 109					

GENESIS

ENGINE
2.0 Petrol 191 01/13-> G4KF

Engine	Information	A10	A20	A40	A50	A70	C10 - C30	C20	E01
All engines	x 4, COIL ON PLUG						470 556	C10	

ENGINE
2.0 CVVT Petrol 154 06/08-02/14 G4KF

Engine	Information	A10	A20	A40	A50	A70	C10 - C30	C20	E01
All engines	x 4, COIL ON PLUG						470 556	C10	

ENGINE
2.0 CVVT Petrol 184 02/13-02/14 G4KF

Engine	Information	A10	A20	A40	A50	A70	C10 - C30	C20	E01
All engines	x 4, COIL ON PLUG						470 556	C10	

ENGINE
2.0 T Petrol 157 01/08-12/12 G4KF

Engine	Information	A10	A20	A40	A50	A70	C10 - C30	C20	E01
All engines	x 4, COIL ON PLUG						470 556	C10	

ENGINE
2.0 T Petrol 202 11/11-12/14 G4KF

Engine	Information	A10	A20	A40	A50	A70	C10 - C30	C20	E01
All engines	x 4, COIL ON PLUG						470 556	C10	

ENGINE
2.0 TCI Petrol 191 01/11-> --

Engine	Information	A10	A20	A40	A50	A70	C10 - C30	C20	E01
All engines	Qty: 4						470 556	C10	

ENGINE
3.0 GDI Petrol 183 06/14-> G6DG

Engine	Information	A10	A20	A40	A50	A70	C10 - C30	C20	E01
All engines	x 6, COIL ON PLUG						470 492	C10	

ENGINE
3.0 GDI 4WD Petrol 183 06/14-> G6DG

Engine	Information	A10	A20	A40	A50	A70	C10 - C30	C20	E01
All engines	x 6, COIL ON PLUG						470 492	C10	

ENGINE
3.8 Petrol 228 09/09-> G6DA

Engine	Information	A10	A20	A40	A50	A70	C10 - C30	C20	E01
All engines	Qty: 6						470 492	C10	

ENGINE
3.8 GDI Petrol 232 06/14-> G6DJ

Engine	Information	A10	A20	A40	A50	A70	C10 - C30	C20	E01
All engines	x 6, COIL ON PLUG						470 492	C10	

ENGINE
3.8 GDI 4WD Petrol 232 06/14-> G6DJ

Engine	Information	A10	A20	A40	A50	A70	C10 - C30	C20	E01
All engines	x 6, COIL ON PLUG						470 492	C10	

ENGINE
3.8 V6 Petrol 213 01/08-12/14 G6DA









Engine	Information	A10	A20	A40	A50	A70	C10 - C30	C20	E01
All engines	x 6, COIL ON PLUG						470 492	C10	

ENGINE
3.8 V6 Petrol 223 01/08-02/14 G6DA

Engine	Information	A10	A20	A40	A50	A70	C10 - C30	C20	E01
All engines	x 6, COIL ON PLUG						470 492	C10	

A10 CONDENSER	A20 CONTACT SET	A40 DISTRIBUTOR CAP	A50 ROTOR	A70 PICK-UP
C10 COIL	C20 IGNITION MODULE	C30 ELECTRONIC IGNITION KIT	E01 IGNITION CABLE SET	

The present application list is a brief version. For the detailed information about the possibility of installation on a specific vehicle, please refer to our web-catalogue <http://catalogo.facet.eu/>

				FUNCTIONS ON THE VEHICLE								
Vehicle	alim.	kW	Date	Engine								
				ENGINE								
3.8 V6	Petrol	246	01/11-12/14	G6DJ								
Engine		Information			A10	A20	A40	A50	A70	C10 - C30	C20	E01
All engines		x 6, COIL ON PLUG								470 492	C10	
				ENGINE								
3.8 V6	Petrol	255	11/11-12/14	G6DJ								
Engine		Information			A10	A20	A40	A50	A70	C10 - C30	C20	E01
All engines		x 6, COIL ON PLUG								470 492	C10	
				ENGINE								
3.8 V6	Petrol	260	04/12->	G6DJ								
Engine		Information			A10	A20	A40	A50	A70	C10 - C30	C20	E01
All engines		Qty: 6								470 492	C10	
				ENGINE								
1.1	Petrol	46	09/02-09/05	G4HD								
Engine		Information			A10	A20	A40	A50	A70	C10 - C30	C20	E01
All engines		Fitting Position:for cylinder 1, Fitting Position:for cylinder 2, Fitting Position:for cylinder 3, Fitting Position:for cylinder 4, x 1, D.I.S.								470 587	C10	
All engines		15/04/03 ->										358 119
All engines		->year 15/04/03										358 235
				ENGINE								
1.1	Petrol	49	09/05-06/09	G4HD								
Engine		Information			A10	A20	A40	A50	A70	C10 - C30	C20	E01
All engines		Fitting Position:for cylinder 1-2, Fitting Position:for cylinder 3-4, x 1, D.I.S.								470 587	C10	
All engines												358 235
				ENGINE								
1.3	Petrol	61	09/04-06/09	G4EA								
Engine		Information			A10	A20	A40	A50	A70	C10 - C30	C20	E01
All engines										470 582, 470 583	C10	358 119
All engines		Kit								470 585	C10	
				ENGINE								
1.3	Petrol	63	09/03-09/05	G4EA								
Engine		Information			A10	A20	A40	A50	A70	C10 - C30	C20	E01
All engines		Fitting Position:for cylinder 1, Fitting Position:for cylinder 4, x 1, D.I.S.								470 582	C10	
All engines		Fitting Position:for cylinder 2, Fitting Position:for cylinder 3, x 1, D.I.S.								470 583	C10	
All engines												358 119
				ENGINE								
1.3 i	Petrol	60	09/02-03/04	G4EA								
Engine		Information			A10	A20	A40	A50	A70	C10 - C30	C20	E01
All engines		FP: right, x 1, D.I.S.								470 582	C10	
All engines		FP: Left, FP: Left Front, x 1, D.I.S.								470 583	C10	
All engines												358 119
				ENGINE								
1.4 i	Petrol	71	08/05-12/10	G4EE								
Engine		Information			A10	A20	A40	A50	A70	C10 - C30	C20	E01
All engines		Fitting Position:for cylinder 1, Fitting Position:for cylinder 4, x 1, D.I.S.								470 582	C10	
All engines		Fitting Position:for cylinder 2, Fitting Position:for cylinder 3, x 1, D.I.S.								470 584	C10	
All engines												358 111
				ENGINE								
1.6	Petrol	77	09/02-09/05	G4ED, G4ED-G								
Engine		Information			A10	A20	A40	A50	A70	C10 - C30	C20	E01
Eng. G4ED		Fitting Position:for cylinder 1, Fitting Position:for cylinder 4, x 1, D.I.S.								470 582	C10	
Eng. G4ED-G										470 582, 470 584	C10	358 111
Eng. G4ED		Fitting Position:for cylinder 2, Fitting Position:for cylinder 3, x 1, D.I.S.								470 584	C10	
Eng. G4ED-G		Kit								470 586	C10	

A10 CONDENSER	A20 CONTACT SET	A40 DISTRIBUTOR CAP	A50 ROTOR	A70 PICK-UP
C10 COIL	C20 IGNITION MODULE	C30 ELECTRONIC IGNITION KIT	E01 IGNITION CABLE SET	

Vehicle	alim.	kW	Date	Engine	FUNCTIONS ON THE VEHICLE									
					A10	A20	A40	A50	A70	C10 - C30	C20	E01		
ENGINE														
1.6	Petrol	78	06/05-06/09	G4ED, G4ED-G										
Engine	Information			A10	A20	A40	A50	A70	C10 - C30	C20	E01			
Eng. G4ED	Fitting Position:for cylinder 1, Fitting Position:for cylinder 4, x 1, D.I.S.								470 582	C10				
Eng. G4ED-G									470 582, 470 584	C10		358 111		
Eng. G4ED	Fitting Position:for cylinder 2, Fitting Position:for cylinder 3, x 1, D.I.S.								470 584	C10				
Eng. G4ED-G	Kit								470 586	C10				
GRAND SANTA FE														
ENGINE														
3.0 GDi Trazione integrale	Petrol	183	07/13->	G6DG										
Engine	Information			A10	A20	A40	A50	A70	C10 - C30	C20	E01			
All engines	x 6, COIL ON PLUG								470 492	C10				
ENGINE														
3.3	Petrol	183	01/14->	G6DF										
Engine	Information			A10	A20	A40	A50	A70	C10 - C30	C20	E01			
All engines	x 6, COIL ON PLUG								470 492	C10				
ENGINE														
3.3 Trazione integrale	Petrol	199	02/14->	G6DF										
Engine	Information			A10	A20	A40	A50	A70	C10 - C30	C20	E01			
All engines	x 6, COIL ON PLUG								470 492	C10				
GRANDEUR														
ENGINE														
2.4	Petrol	132	07/11->	G4KE										
Engine	Information			A10	A20	A40	A50	A70	C10 - C30	C20	E01			
All engines	Grandeur, x 4, COIL ON PLUG								470 556	C10				
ENGINE														
3.3	Petrol	173	04/05-12/10	G6DB										
Engine	Information			A10	A20	A40	A50	A70	C10 - C30	C20	E01			
All engines	Grandeur, x 6, COIL ON PLUG								470 492	C10				
ENGINE														
3.3	Petrol	191	11/10-12/11	G6DB										
Engine	Information			A10	A20	A40	A50	A70	C10 - C30	C20	E01			
All engines	Grandeur, x 6, COIL ON PLUG								470 492	C10				
H1														
ENGINE														
2.4 CVT	Petrol	127	01/10->	G4KC										
Engine	Information			A10	A20	A40	A50	A70	C10 - C30	C20	E01			
All engines	x 4, COIL ON PLUG								470 556	C10				
H-1 I														
ENGINE														
2.4	Petrol	101	02/03-04/04	G4JS										
Engine	Information			A10	A20	A40	A50	A70	C10 - C30	C20	E01			
All engines												358 241		
ENGINE														
2.4	Petrol	107	11/01-04/04	G4JS										
Engine	Information			A10	A20	A40	A50	A70	C10 - C30	C20	E01			
All engines												358 241		
ENGINE														
2.4	Petrol	82	06/97-04/04	G4CS										
Engine	Information			A10	A20	A40	A50	A70	C10 - C30	C20	E01			
All engines	version Mitsubishi					831 003/001	931 107							
ENGINE														
2.4 4WD	Petrol	82	02/98-04/04	G4CS										
Engine	Information			A10	A20	A40	A50	A70	C10 - C30	C20	E01			
All engines	version Mitsubishi					831 003/001	931 107							

A10 CONDENSER	A20 CONTACT SET	A40 DISTRIBUTOR CAP	A50 ROTOR	A70 PICK-UP
C10 COIL	C20 IGNITION MODULE	C30 ELECTRONIC IGNITION KIT	E01 IGNITION CABLE SET	

The present application list is a brief version. For the detailed information about the possibility of installation on a specific vehicle, please refer to our web-catalogue <http://catalogo.facet.eu/>

Vehicle	alim.	kW	Date	Engine	FUNCTIONS ON THE VEHICLE							
					A10	A20	A40	A50	A70	C10 - C30	C20	E01

H-1 II

2.4	Petrol	129	02/08->	ENGINE --, G4KC
-----	--------	-----	---------	--------------------

Engine	Information	A10	A20	A40	A50	A70	C10 - C30	C20	E01
Eng. --	Qty: 4						470 556	C10	
Eng. G4KC	x 4, COIL ON PLUG						470 556	C10	

2.4 i	Petrol	129	02/08->	ENGINE G4KC
-------	--------	-----	---------	----------------

Engine	Information	A10	A20	A40	A50	A70	C10 - C30	C20	E01
All engines	x 4, COIL ON PLUG						470 556	C10	

H100

2.4	Petrol	82	10/97-12/04	ENGINE G4CS
-----	--------	----	-------------	----------------

Engine	Information	A10	A20	A40	A50	A70	C10 - C30	C20	E01
All engines	->year 15/03/96, version Mitsubishi			831 003/001	931 107				

2.4	Petrol	84	05/96-03/00	ENGINE G4CS
-----	--------	----	-------------	----------------

Engine	Information	A10	A20	A40	A50	A70	C10 - C30	C20	E01
All engines	->year 15/03/96, version Mitsubishi			831 003/001	931 107				

2.4	Petrol	90	07/93-03/00	ENGINE G4CS
-----	--------	----	-------------	----------------

Engine	Information	A10	A20	A40	A50	A70	C10 - C30	C20	E01
All engines	->year 15/03/96, version Mitsubishi			831 003/001	931 107				

HIGHWAY VAN

2.0 16V	Petrol	100	03/00-03/04	ENGINE G4JP
---------	--------	-----	-------------	----------------

Engine	Information	A10	A20	A40	A50	A70	C10 - C30	C20	E01
All engines									358 241

I10 I

1.0	Petrol	51	01/11-12/17	ENGINE G3LA
-----	--------	----	-------------	----------------

Engine	Information	A10	A20	A40	A50	A70	C10 - C30	C20	E01
All engines	x 3, COIL ON PLUG						470 614	C10	

1.1	Petrol	48	12/07-12/13	ENGINE G4HG
-----	--------	----	-------------	----------------

Engine	Information	A10	A20	A40	A50	A70	C10 - C30	C20	E01
All engines	Fitting Position:for cylinder 1, Fitting Position:for cylinder 2, Fitting Position:for cylinder 3, Fitting Position:for cylinder 4, x 1, D.I.S.						470 496	C10	
All engines									358 235

1.1	Petrol	49	01/08-12/13	ENGINE G4HG
-----	--------	----	-------------	----------------

Engine	Information	A10	A20	A40	A50	A70	C10 - C30	C20	E01
All engines	Fitting Position:for cylinder 1, Fitting Position:for cylinder 2, Fitting Position:for cylinder 3, Fitting Position:for cylinder 4, x 1, D.I.S.						470 496	C10	
All engines									358 235

1.1	Petrol	50	11/08-12/13	ENGINE G4HG
-----	--------	----	-------------	----------------

Engine	Information	A10	A20	A40	A50	A70	C10 - C30	C20	E01
All engines	Fitting Position:for cylinder 1, Fitting Position:for cylinder 2, Fitting Position:for cylinder 3, Fitting Position:for cylinder 4, x 1, D.I.S.						470 496	C10	
All engines									358 235

1.1	Petrol	51	04/11-12/13	ENGINE G4HG
-----	--------	----	-------------	----------------





Engine	Information	A10	A20	A40	A50	A70	C10 - C30	C20	E01
All engines	Fitting Position:for cylinder 1, Fitting Position:for cylinder 2, Fitting Position:for cylinder 3, Fitting Position:for cylinder 4, x 1, D.I.S.						470 496	C10	
All engines									358 235

A10 CONDENSER	A20 CONTACT SET	A40 DISTRIBUTOR CAP	A50 ROTOR	A70 PICK-UP
C10 COIL	C20 IGNITION MODULE	C30 ELECTRONIC IGNITION KIT	E01 IGNITION CABLE SET	

Vehicle	alim.	kW	Date	Engine	FUNCTIONS ON THE VEHICLE							
					A10	A20	A40	A50	A70	C10 - C30	C20	E01
1.1 LPG	Petrol/ Liquified Petro- leum Gas (LPG)	48	01/09-12/13	G4HG								
ENGINE					A10	A20	A40	A50	A70	C10 - C30	C20	E01
All engines	Information Fitting Position:for cylinder 1, Fitting Position:for cylinder 2, Fitting Position:for cylinder 3, Fitting Position:for cylinder 4, x 1, D.I.S.									470 496	C10	
1.1 LPG	Petrol/ Liquified Petro- leum Gas (LPG)	51	04/11-12/13	G4HG								
ENGINE					A10	A20	A40	A50	A70	C10 - C30	C20	E01
All engines	Information Fitting Position:for cylinder 1-4, Fitting Position:for cylinder 2, Fitting Position:for cylinder 3, x 1, D.I.S., x 1, D.I.S.									470 496	C10	
1.2	Petrol	57	11/08-12/11	G4LA								
ENGINE					A10	A20	A40	A50	A70	C10 - C30	C20	E01
All engines	Information Fitting Position:for cylinder 1-2, Fitting Position:for cylinder 3-4, x 1, D.I.S.									470 579	C10	
All engines												358 255
1.2	Petrol	63	04/11-12/13	G4LA								
ENGINE					A10	A20	A40	A50	A70	C10 - C30	C20	E01
All engines	Information Fitting Position:for cylinder 1-2, Fitting Position:for cylinder 3-4, x 1, D.I.S.									470 579	C10	
All engines												358 255
1.2	Petrol	64	12/15->	G4LA								
ENGINE					A10	A20	A40	A50	A70	C10 - C30	C20	E01
All engines	Information Fitting Position:for cylinder 1-2, Fitting Position:for cylinder 3-4, x 1, D.I.S.									470 579	C10	
1.2 LPG	Petrol/ Liquified Petro- leum Gas (LPG)	57	01/10-12/13	G4LA								
ENGINE					A10	A20	A40	A50	A70	C10 - C30	C20	E01
All engines	Information Fitting Position:for cylinder 1-2, Fitting Position:for cylinder 2, Fitting Position:for cylinder 3, x 1, D.I.S., Fitting Position:for cylinder 4, x 1, D.I.S.									470 579	C10	
I10 II												
1.0	Petrol	49	08/13->	G3LA								
ENGINE					A10	A20	A40	A50	A70	C10 - C30	C20	E01
All engines	Information x 3, COIL ON PLUG									470 614	C10	
1.0 LPG	Petrol/ Liquified Petro- leum Gas (LPG)	49	02/14->	B3LA								
ENGINE					A10	A20	A40	A50	A70	C10 - C30	C20	E01
All engines	Information x 3, COIL ON PLUG									470 614	C10	
1.0 LPG	Petrol/ Liquified Petro- leum Gas (LPG)	51	07/14-08/16	B3LA								
ENGINE					A10	A20	A40	A50	A70	C10 - C30	C20	E01
All engines	Information x 3, COIL ON PLUG									470 614	C10	
1.2	Petrol	64	12/13->	G4LA								
ENGINE					A10	A20	A40	A50	A70	C10 - C30	C20	E01
All engines	Information x 1, COIL ON PLUG									470 579	C10	
All engines												358 255









A10 CONDENSER	A20 CONTACT SET	A40 DISTRIBUTOR CAP	A50 ROTOR	A70 PICK-UP
C10 COIL	C20 IGNITION MODULE	C30 ELECTRONIC IGNITION KIT	E01 IGNITION CABLE SET	

The present application list is a brief version. For the detailed information about the possibility of installation on a specific vehicle, please refer to our web-catalogue <http://catalogo.facet.eu/>

					FUNCTIONS ON THE VEHICLE									
Vehicle	alim.	kW	Date	Engine	 A10	 A20	 A40	 A50	 A70	 C10 - C30	 C20	 E01		
I20 I														
1.2	Petrol	56	12/08-08/14	ENGINE G4AG										
Engine					Information	A10	A20	A40	A50	A70	C10 - C30	C20	E01	
All engines					x 1, D.I.S.						470 579	C10		
1.2	Petrol	57	09/08-12/12	ENGINE G4LA										
Engine					Information	A10	A20	A40	A50	A70	C10 - C30	C20	E01	
All engines					x 1, D.I.S.						470 579	C10		
All engines					-start-stop function								358 255	
1.2	Petrol	63	03/12-12/15	ENGINE G4LA										
Engine					Information	A10	A20	A40	A50	A70	C10 - C30	C20	E01	
All engines					Fitting Position:for cylinder 1-2, Fitting Position:for cylinder 3-4, x 4, COIL ON PLUG, x 1, D.I.S., incl. spark plug connector						470 579	C10		
All engines					x 4, +start-stop function, COIL ON PLUG, incl. spark plug connector						470 612	C10		
All engines					-start-stop function								358 255	
1.2 LPG	Petrol/ Liquified Petro- leum Gas (LPG)	60	01/09-08/14	ENGINE G4LA										
Engine					Information	A10	A20	A40	A50	A70	C10 - C30	C20	E01	
All engines					Fitting Position:for cylinder 1-2, Fitting Position:for cylinder 3-4, x 1, D.I.S.						470 579	C10		
1.4	Petrol	74	09/08-12/15	ENGINE G4FA										
Engine					Information	A10	A20	A40	A50	A70	C10 - C30	C20	E01	
All engines					x 4, COIL ON PLUG						470 543	C10		
1.4 LPG	Petrol/ Liquified Petro- leum Gas (LPG)	75	12/08-12/12	ENGINE G4FA										
Engine					Information	A10	A20	A40	A50	A70	C10 - C30	C20	E01	
All engines					x 4, COIL ON PLUG						470 543	C10		
1.6	Petrol	93	09/08-12/12	ENGINE G4FC										
Engine					Information	A10	A20	A40	A50	A70	C10 - C30	C20	E01	
All engines					x 4, COIL ON PLUG						470 543	C10		
I20 II														
1.0 T-GDI	Petrol	74	09/15->	ENGINE G3LC										
Engine					Information	A10	A20	A40	A50	A70	C10 - C30	C20	E01	
All engines					x 3, COIL ON PLUG						470 638	C10		
1.0 T-GDI	Petrol	88	09/15->	ENGINE G3LC										
Engine					Information	A10	A20	A40	A50	A70	C10 - C30	C20	E01	
All engines					x 3, COIL ON PLUG						470 638	C10		
1.2	Petrol	55	11/14->	ENGINE G4LA										
Engine					Information	A10	A20	A40	A50	A70	C10 - C30	C20	E01	
All engines					x 4, Fitting Position:for cylinder 1-2, Fitting Position:for cylinder 3-4, -start-stop function, COIL ON PLUG, x 1, -start-stop function, D.I.S.						470 579	C10		
All engines					x 4, +start-stop function, COIL ON PLUG, incl. spark plug connector						470 612	C10		
All engines					-start-stop function								358 255	
1.2	Petrol	62	11/14->	ENGINE G4LA										
Engine					Information	A10	A20	A40	A50	A70	C10 - C30	C20	E01	
All engines					Qty: 2, -start-stop function						470 579	C10		
All engines					x 4, Fitting Position:for cylinder 1-2, Fitting Position:for cylinder 3-4, -start-stop function, COIL ON PLUG, x 1, -start-stop function, D.I.S.						470 579	C10		
All engines					+start-stop function, Qty: 4						470 612	C10		
A10	CONDENSER		A20	CONTACT SET		A40	DISTRIBUTOR CAP		A50	ROTOR		A70	PICK-UP	
C10	COIL		C20	IGNITION MODULE		C30	ELECTRONIC IGNITION KIT		E01	IGNITION CABLE SET				

Vehicle	alim.	kW	Date	Engine	FUNCTIONS ON THE VEHICLE									
					A10	A20	A40	A50	A70	C10 - C30	C20	E01		
ENGINE														
1.2	Petrol	62	11/14->	G4LA										
Engine	Information				A10	A20	A40	A50	A70	C10 - C30	C20	E01		
All engines	x 4, +start-stop function, COIL ON PLUG, incl. spark plug connector									470 612	C10			
All engines	-start-stop function												358 255	
ENGINE														
1.2 LPG	Petrol/ Liquified Petro- leum Gas (LPG)	55	01/19->	G4LA										
Engine	Information				A10	A20	A40	A50	A70	C10 - C30	C20	E01		
All engines	x 4, COIL ON PLUG, incl. spark plug connector									470 612	C10			
ENGINE														
1.2 LPGI	Petrol/ Liquified Petro- leum Gas (LPG)	61	11/14->	G4LA										
Engine	Information				A10	A20	A40	A50	A70	C10 - C30	C20	E01		
All engines	x 4, Fitting Position:for cylinder 1-2, Fitting Position:for cylinder 3-4, -start-stop function, COIL ON PLUG, x 1, -start-stop function, D.I.S.									470 579	C10			
All engines	x 4, +start-stop function, COIL ON PLUG, incl. spark plug connector									470 612	C10			
ENGINE														
1.2 MPI	Petrol	55	05/15->	G4LA										
Engine	Information				A10	A20	A40	A50	A70	C10 - C30	C20	E01		
All engines	x 4, Fitting Position:for cylinder 1-2, Fitting Position:for cylinder 3-4, -start-stop function, COIL ON PLUG, x 1, -start-stop function, D.I.S.									470 579	C10			
All engines	x 4, +start-stop function, COIL ON PLUG, incl. spark plug connector									470 612	C10			
ENGINE														
1.2 MPI	Petrol	62	05/15->	G4LA										
Engine	Information				A10	A20	A40	A50	A70	C10 - C30	C20	E01		
All engines	x 4, Fitting Position:for cylinder 1-2, Fitting Position:for cylinder 3-4, -start-stop function, COIL ON PLUG, x 1, -start-stop function, D.I.S.									470 579	C10			
All engines	x 4, +start-stop function, COIL ON PLUG, incl. spark plug connector									470 612	C10			
ENGINE														
1.4	Petrol	74	11/14->	G4LC										
Engine	Information				A10	A20	A40	A50	A70	C10 - C30	C20	E01		
All engines	x 4, COIL ON PLUG									470 622	C10			
ENGINE														
1.4 MPI	Petrol	74	05/15->	G4LC										
Engine	Information				A10	A20	A40	A50	A70	C10 - C30	C20	E01		
All engines	x 4, COIL ON PLUG									470 622	C10			
I30 I														
ENGINE														
1.4	Petrol	77	10/07-06/12	G4FA										
Engine	Information				A10	A20	A40	A50	A70	C10 - C30	C20	E01		
All engines	->year 01/11/08, MADE BY: (ROK), MADE BY: (CZ), x 4, COIL ON PLUG, x 4, COIL ON PLUG ----- MADE BY: (ROK), x 4, COIL ON PLUG									470 495	C10			
All engines	01/12/08 ->, MADE BY: (CZ), MADE BY: (CZ), x 4, COIL ON PLUG, x 4, COIL ON PLUG									470 543	C10			
ENGINE														
1.4	Petrol	80	10/07-06/12	G4FA										
Engine	Information				A10	A20	A40	A50	A70	C10 - C30	C20	E01		
All engines	->year 01/11/08, MADE BY: (ROK), MADE BY: (CZ), x 4, COIL ON PLUG, x 4, COIL ON PLUG ----- MADE BY: (ROK), x 4, COIL ON PLUG									470 495	C10			
All engines	01/12/08 ->, MADE BY: (CZ), MADE BY: (CZ), x 4, COIL ON PLUG, x 4, COIL ON PLUG									470 543	C10			









A10 CONDENSER	A20 CONTACT SET	A40 DISTRIBUTOR CAP	A50 ROTOR	A70 PICK-UP
C10 COIL	C20 IGNITION MODULE	C30 ELECTRONIC IGNITION KIT	E01 IGNITION CABLE SET	

					FUNCTIONS ON THE VEHICLE												
Vehicle	alim.	kW	Date	Engine													
ENGINE																	
1.4 LPG	Petrol/ Liquified Petro- leum Gas (LPG)	80	01/09-06/12	G4FA													
Engine	Information				A10	A20	A40	A50	A70	C10 - C30	C20	E01					
All engines	MADE BY: (ROK), x 4, COIL ON PLUG									470 495	C10						
All engines	MADE BY: (CZ), x 4, COIL ON PLUG									470 543	C10						
ENGINE																	
1.6	Petrol	85	10/07-06/12	G4FC													
Engine	Information				A10	A20	A40	A50	A70	C10 - C30	C20	E01					
All engines	->year 01/11/08, MADE BY: (CZ), x 4, COIL ON PLUG MADE BY: (ROK), x 4, COIL ON PLUG									470 495	C10						
All engines	01/12/08 ->, MADE BY: (CZ), x 4, COIL ON PLUG									470 543	C10						
ENGINE																	
1.6	Petrol	90	10/07-06/12	G4FC													
Engine	Information				A10	A20	A40	A50	A70	C10 - C30	C20	E01					
All engines	->year 01/11/08, MADE BY: (CZ), x 4, COIL ON PLUG MADE BY: (ROK), x 4, COIL ON PLUG									470 495	C10						
All engines	01/12/08 ->, MADE BY: (CZ), x 4, COIL ON PLUG									470 543	C10						
ENGINE																	
1.6	Petrol	93	02/08-06/12	G4FC													
Engine	Information				A10	A20	A40	A50	A70	C10 - C30	C20	E01					
All engines	->year 01/11/08, MADE BY: (CZ), x 4, COIL ON PLUG MADE BY: (ROK), x 4, COIL ON PLUG									470 495	C10						
All engines	01/12/08 ->, MADE BY: (CZ), x 4, COIL ON PLUG									470 543	C10						
ENGINE																	
2.0	Petrol	105	10/07-06/12	G4GC, G4GC-G													
Engine	Information				A10	A20	A40	A50	A70	C10 - C30	C20	E01					
Eng. G4GC	x 1, D.I.S.									470 581	C10						
Eng. G4GC-G	Qty: 2									470 581	C10						
All engines												360 385					
I30 II																	
ENGINE																	
1.4	Petrol	73	12/11->	G4FA													
Engine	Information				A10	A20	A40	A50	A70	C10 - C30	C20	E01					
All engines	x 4, COIL ON PLUG									470 543	C10						
ENGINE																	
1.4	Petrol	74	12/14->	G4LC													
Engine	Information				A10	A20	A40	A50	A70	C10 - C30	C20	E01					
All engines	->year 01/12/14, x 4, COIL ON PLUG									470 543	C10						
All engines	x 4, COIL ON PLUG, x 4, COIL ON PLUG									470 622	C10						
ENGINE																	
1.4 LPG	Petrol/ Liquified Petro- leum Gas (LPG)	73	01/13->	G4FA													
Engine	Information				A10	A20	A40	A50	A70	C10 - C30	C20	E01					
All engines	x 4, COIL ON PLUG									470 543	C10						
ENGINE																	
1.4 MPI	Petrol	74	05/15->	G4LC													
Engine	Information				A10	A20	A40	A50	A70	C10 - C30	C20	E01					
All engines	x 4, COIL ON PLUG									470 622	C10						
ENGINE																	
1.6	Petrol	88	01/12->	G4FC, G4FG													
Engine	Information				A10	A20	A40	A50	A70	C10 - C30	C20	E01					
All engines	x 4, COIL ON PLUG									470 543, 470 611	C10						
ENGINE																	
1.6	Petrol	95	12/11-12/15	G4FC, G4FD, G4FG													
Engine	Information				A10	A20	A40	A50	A70	C10 - C30	C20	E01					
Eng. G4FG	no specific info conc. application available, Qty: 4									470 543, 470 611	C10						
Eng. G4FC, G4FD	x 4, COIL ON PLUG									470 611	C10						
A10	CONDENSER	A20	CONTACT SET	A40	DISTRIBUTOR CAP	A50	ROTOR	A70	PICK-UP	C10	COIL	C20	IGNITION MODULE	C30	ELECTRONIC IGNITION KIT	E01	IGNITION CABLE SET

Vehicle	alim.	kW	Date	Engine	FUNCTIONS ON THE VEHICLE								
					A10	A20	A40	A50	A70	C10 - C30	C20	E01	
ENGINE													
1.6	Petrol	96	06/14->	G4FC									
Engine		Information			A10	A20	A40	A50	A70	C10 - C30	C20	E01	
All engines		x 4, COIL ON PLUG								470 543	C10		
ENGINE													
1.6 GDI	Petrol	99	12/11->	G4FD									
Engine		Information			A10	A20	A40	A50	A70	C10 - C30	C20	E01	
All engines		x 4, COIL ON PLUG								470 611	C10		
ENGINE													
1.6 MPI	Petrol	88	11/16->	G4FC									
Engine		Information			A10	A20	A40	A50	A70	C10 - C30	C20	E01	
All engines		x 4, COIL ON PLUG								470 543	C10		
ENGINE													
1.6 MPI	Petrol	96	06/14->	G4FC									
Engine		Information			A10	A20	A40	A50	A70	C10 - C30	C20	E01	
All engines		x 4, COIL ON PLUG								470 543	C10		
I30 III													
ENGINE													
1.0 T-GDi	Petrol	88	11/16->	G3LC									
Engine		Information			A10	A20	A40	A50	A70	C10 - C30	C20	E01	
All engines		x 3, COIL ON PLUG								470 638	C10		
ENGINE													
1.4 MPI	Petrol	73	05/17->	G4LC									
Engine		Information			A10	A20	A40	A50	A70	C10 - C30	C20	E01	
All engines		x 4, COIL ON PLUG								470 622	C10		
ENGINE													
1.4 MPI	Petrol	74	11/16->	G4LC									
Engine		Information			A10	A20	A40	A50	A70	C10 - C30	C20	E01	
All engines		x 4, COIL ON PLUG								470 622	C10		
I40													
ENGINE													
1.6 GDI	Petrol	99	07/11->	G4FD									
Engine		Information			A10	A20	A40	A50	A70	C10 - C30	C20	E01	
All engines		x 4, COIL ON PLUG								470 611	C10		
INNOVATION													
ENGINE													
3.0 V6	Petrol	104	05/00->	G6AT									
Engine		Information			A10	A20	A40	A50	A70	C10 - C30	C20	E01	
All engines		version Mitsubishi					831 116						
All engines							931 109						
IONIQ													
ENGINE													
1.6 GDI Hybrid	Petrol/ Electric	104	03/16->	G4LE									
Engine		Information			A10	A20	A40	A50	A70	C10 - C30	C20	E01	
All engines		x 4, COIL ON PLUG								470 647	C10		
ENGINE													
1.6 GDI Hybrid	Petrol/ Electric	77	03/16->	G4LE									
Engine		Information			A10	A20	A40	A50	A70	C10 - C30	C20	E01	
All engines		x 4, COIL ON PLUG								470 647	C10		
ENGINE													
1.6 GDI Plug-in Hybrid	Petrol/ Electric	77	03/16->	G4LE									
Engine		Information			A10	A20	A40	A50	A70	C10 - C30	C20	E01	
All engines		x 4, COIL ON PLUG								470 647	C10		
IX20													
ENGINE													
1.4	Petrol	66	11/10->	G4FA									
Engine		Information			A10	A20	A40	A50	A70	C10 - C30	C20	E01	
All engines		x 4, COIL ON PLUG								470 543	C10		

A10	CONDENSER	A20	CONTACT SET	A40	DISTRIBUTOR CAP	A50	ROTOR	A70	PICK-UP
C10	COIL	C20	IGNITION MODULE	C30	ELECTRONIC IGNITION KIT	E01	IGNITION CABLE SET		

The present application list is a brief version. For the detailed information about the possibility of installation on a specific vehicle, please refer to our web-catalogue <http://catalogo.facet.eu/>







					FUNCTIONS ON THE VEHICLE							
Vehicle	alim.	kW	Date	Engine	 A10	 A20	 A40	 A50	 A70	 C10 - C30	 C20	 E01
ENGINE												
1.4	Petrol	74	11/10->	G4FA								
Engine		Information			A10	A20	A40	A50	A70	C10 - C30	C20	E01
All engines		x 4, COIL ON PLUG								470 543	C10	
ENGINE												
1.4 LPG	Petrol/ Liquified Petro- leum Gas (LPG)	66	11/10->	G4FA								
Engine		Information			A10	A20	A40	A50	A70	C10 - C30	C20	E01
All engines		x 4, COIL ON PLUG								470 543	C10	
ENGINE												
1.6	Petrol	92	11/10->	G4FC								
Engine		Information			A10	A20	A40	A50	A70	C10 - C30	C20	E01
All engines		x 4, COIL ON PLUG								470 543	C10	
ENGINE												
1.6 LPG	Petrol/ Liquified Petro- leum Gas (LPG)	92	11/10->	G4FC								
Engine		Information			A10	A20	A40	A50	A70	C10 - C30	C20	E01
All engines		x 4, COIL ON PLUG								470 543	C10	
IX35												
ENGINE												
1.6	Petrol	99	11/10->	G4FD								
Engine		Information			A10	A20	A40	A50	A70	C10 - C30	C20	E01
All engines		x 4, COIL ON PLUG								470 611	C10	
ENGINE												
2.0	Petrol	120	01/10-07/13	G4KD								
Engine		Information			A10	A20	A40	A50	A70	C10 - C30	C20	E01
All engines		x 4, COIL ON PLUG								470 556	C10	
ENGINE												
2.0	Petrol	122	01/10->	G4KD								
Engine		Information			A10	A20	A40	A50	A70	C10 - C30	C20	E01
All engines		x 4, COIL ON PLUG								470 556	C10	
ENGINE												
2.0 4WD	Petrol	120	01/10->	G4KD								
Engine		Information			A10	A20	A40	A50	A70	C10 - C30	C20	E01
All engines		x 4, COIL ON PLUG								470 556	C10	
ENGINE												
2.0 CVT	Petrol	110	08/09-07/13	G4KD								
Engine		Information			A10	A20	A40	A50	A70	C10 - C30	C20	E01
All engines		x 4, COIL ON PLUG								470 556	C10	
ENGINE												
2.0 CVT AWD	Petrol	110	08/09-07/13	G4KD								
Engine		Information			A10	A20	A40	A50	A70	C10 - C30	C20	E01
All engines		x 4, COIL ON PLUG								470 556	C10	
ENGINE												
2.4 DCVVT-I 4WD	Petrol	128	07/10-12/13	G4KE								
Engine		Information			A10	A20	A40	A50	A70	C10 - C30	C20	E01
All engines		Qty: 4								470 556	C10	
ENGINE												
2.4 GDi 4WD	Petrol	136	01/13->	G4KJ								
Engine		Information			A10	A20	A40	A50	A70	C10 - C30	C20	E01
All engines		Qty: 4								470 556	C10	
ENGINE												
GDi	Petrol	99	05/15-12/15	G4FD								
Engine		Information			A10	A20	A40	A50	A70	C10 - C30	C20	E01
All engines		x 4, COIL ON PLUG								470 611	C10	

A10 CONDENSER	A20 CONTACT SET	A40 DISTRIBUTOR CAP	A50 ROTOR	A70 PICK-UP
C10 COIL	C20 IGNITION MODULE	C30 ELECTRONIC IGNITION KIT	E01 IGNITION CABLE SET	

Vehicle	alim.	kW	Date	Engine	FUNCTIONS ON THE VEHICLE							
					A10	A20	A40	A50	A70	C10 - C30	C20	E01
IX55												
3.8 V6	Petrol	194	01/11->	G6DA								
Engine Information					A10	A20	A40	A50	A70	C10 - C30	C20	E01
All engines Qty: 6										470 492	C10	
3.8 V6 4WD	Petrol	191	01/07->	G6DA								
Engine Information					A10	A20	A40	A50	A70	C10 - C30	C20	E01
All engines x 6, COIL ON PLUG										470 492	C10	
KONA												
1.0 T-GDi	Petrol	88	07/17->	G3LC								
Engine Information					A10	A20	A40	A50	A70	C10 - C30	C20	E01
All engines x 3, COIL ON PLUG										470 638	C10	
1.6 GDi Hybrid	Petrol/ Electric	77	06/19->	G4LE								
Engine Information					A10	A20	A40	A50	A70	C10 - C30	C20	E01
All engines x 4, COIL ON PLUG										470 647	C10	
LANTRA												
1.8	Petrol	97	06/00->	G4GB								
Engine Information					A10	A20	A40	A50	A70	C10 - C30	C20	E01
All engines 01/09/02 ->, Qty: 2										470 581	C10	
All engines												360 385
2.0	Petrol	102	06/00->	G4GC-G								
Engine Information					A10	A20	A40	A50	A70	C10 - C30	C20	E01
All engines 01/09/02 ->, Qty: 2										470 581	C10	
All engines												360 385
LANTRA I												
1.5	Petrol	53	10/90-04/95	G4DJ								
Engine Information					A10	A20	A40	A50	A70	C10 - C30	C20	E01
All engines version Mitsubishi							831 003/001	931 023				
1.5 i.e.	Petrol	63	10/90-11/95	G4DJ								
Engine Information					A10	A20	A40	A50	A70	C10 - C30	C20	E01
All engines SOHC/OHC, version Mitsubishi							831 003/001	931 107				
All engines DOHC												360 401
1.6 i.e. 16V	Petrol	78	10/90-11/95	G4CR								
Engine Information					A10	A20	A40	A50	A70	C10 - C30	C20	E01
All engines												360 401
1.6 i.e. 16V	Petrol	84	10/90-11/95	G4CR								
Engine Information					A10	A20	A40	A50	A70	C10 - C30	C20	E01
All engines												360 401
1.8 i.e. 16V	Petrol	93	10/90-11/95	G4CN								
Engine Information					A10	A20	A40	A50	A70	C10 - C30	C20	E01
All engines												360 401
LANTRA II												
1.5 12V	Petrol	65	12/96-10/00	G4EK								
Engine Information					A10	A20	A40	A50	A70	C10 - C30	C20	E01
All engines												358 119
1.6 16V	Petrol	84	11/95-10/00	4G61								
Engine Information					A10	A20	A40	A50	A70	C10 - C30	C20	E01
All engines												360 385

A10 CONDENSER	A20 CONTACT SET	A40 DISTRIBUTOR CAP	A50 ROTOR	A70 PICK-UP
C10 COIL	C20 IGNITION MODULE	C30 ELECTRONIC IGNITION KIT	E01 IGNITION CABLE SET	

The present application list is a brief version. For the detailed information about the possibility of installation on a specific vehicle, please refer to our web-catalogue <http://catalogo.facet.eu/>

				FUNCTIONS ON THE VEHICLE												
Vehicle	alim.	kW	Date	Engine												
				ENGINE												
1.6 i	Petrol	66	11/95-10/00	G4GR												
				ENGINE												
				G4GR												
Engine		Information		A10	A20	A40	A50	A70	C10 - C30	C20	E01					
All engines													360 385			
				ENGINE												
1.8 16V	Petrol	94	11/95-10/00	G4GM												
				ENGINE												
				G4GM												
Engine		Information		A10	A20	A40	A50	A70	C10 - C30	C20	E01					
All engines													360 385			
				ENGINE												
2.0 16V	Petrol	102	11/95-10/00	G4GF												
				ENGINE												
				G4GF												
Engine		Information		A10	A20	A40	A50	A70	C10 - C30	C20	E01					
All engines													360 385			
				MATRIX												
				ENGINE												
1.6	Petrol	66	01/02-12/05	G4ED-L												
				ENGINE												
				G4ED-L												
Engine		Information		A10	A20	A40	A50	A70	C10 - C30	C20	E01					
All engines									470 582, 470 584	C10			358 111			
All engines		Kit							470 586	C10						
				ENGINE												
1.6	Petrol	76	06/01-08/10	G4ED, G4ED-G												
				ENGINE												
				G4ED, G4ED-G												
Engine		Information		A10	A20	A40	A50	A70	C10 - C30	C20	E01					
Eng. G4ED		x 1, D.I.S.							470 582	C10						
Eng. G4ED-G									470 582, 470 584	C10			358 111			
Eng. G4ED-G		Kit							470 586	C10						
				ENGINE												
1.6 [TUR]	Petrol	76	04/08->	G4ED												
				ENGINE												
				G4ED												
Engine		Information		A10	A20	A40	A50	A70	C10 - C30	C20	E01					
All engines									470 582, 470 584	C10			358 111			
All engines		Kit							470 586	C10						
				ENGINE												
1.8	Petrol	90	06/01-08/10	G4GB, G4GB-G												
				ENGINE												
				G4GB, G4GB-G												
Engine		Information		A10	A20	A40	A50	A70	C10 - C30	C20	E01					
Eng. G4GB		01/10/02->, x 1, D.I.S.							470 581	C10						
Eng. G4GB-G		01/09/02->, Qty: 2							470 581	C10						
Eng. G4GB-G													360 385			
				ENGINE												
1.8 [TUR]	Petrol	90	04/08->	G4GB												
				ENGINE												
				G4GB												
Engine		Information		A10	A20	A40	A50	A70	C10 - C30	C20	E01					
All engines		Qty: 2							470 581	C10						
All engines													360 385			
				ENGINE												
				NF												
				ENGINE												
2.0 CVT	Petrol	111	05/05-12/10	G4BPE												
				ENGINE												
				G4BPE												
Engine		Information		A10	A20	A40	A50	A70	C10 - C30	C20	E01					
All engines		NF, ->year 01/12/07, x 4, COIL ON PLUG							470 492	C10						
All engines		NF, 01/01/08->, x 4, COIL ON PLUG							470 556	C10						
				ENGINE												
				PONY												
				ENGINE												
1.3	Petrol	43	10/89-01/95	G4DG												
				ENGINE												
				G4DG												
Engine		Information		A10	A20	A40	A50	A70	C10 - C30	C20	E01					
All engines		version Mitsubishi				831 003/001	931 023									
				ENGINE												
1.3	Petrol	49	10/89-01/95	G4DG												
				ENGINE												
				G4DG												
Engine		Information		A10	A20	A40	A50	A70	C10 - C30	C20	E01					
All engines		version Mitsubishi				831 003/001	931 023									
				ENGINE												
1.3	Petrol	50	10/85-09/89	G13B												
				ENGINE												
				G13B												
Engine		Information		A10	A20	A40	A50	A70	C10 - C30	C20	E01					
All engines		version Mitsubishi				831 003/001	931 023									

A10 CONDENSER	A20 CONTACT SET	A40 DISTRIBUTOR CAP	A50 ROTOR	A70 PICK-UP
C10 COIL	C20 IGNITION MODULE	C30 ELECTRONIC IGNITION KIT	E01 IGNITION CABLE SET	

Vehicle	alim.	kW	Date	Engine	FUNCTIONS ON THE VEHICLE									
					A10	A20	A40	A50	A70	C10 - C30	C20	E01		
ENGINE														
1.5	Petrol	53	10/85-01/95	G15B, G4DJ										
Engine		Information			A10	A20	A40	A50	A70	C10 - C30	C20	E01		
All engines		version Mitsubishi					831 003/001	931 023						
ENGINE														
1.5 i	Petrol	61	10/89-01/95	G15B, G4DJ										
Engine		Information			A10	A20	A40	A50	A70	C10 - C30	C20	E01		
All engines		version Mitsubishi					831 003/001	931 107						
ENGINE														
1.5 i	Petrol	62	10/89-01/95	G15B, G4DJ										
Engine		Information			A10	A20	A40	A50	A70	C10 - C30	C20	E01		
All engines		version Mitsubishi					831 003/001	931 107						
PONY / EXCEL														
ENGINE														
1.3	Petrol	48	12/92-09/94	G4DG										
Engine		Information			A10	A20	A40	A50	A70	C10 - C30	C20	E01		
All engines		version Mitsubishi					831 003/001	931 023						
ENGINE														
1.3	Petrol	49	01/90-01/95	G4DG										
Engine		Information			A10	A20	A40	A50	A70	C10 - C30	C20	E01		
All engines		version Mitsubishi					831 003/001	931 023						
ENGINE														
1.5	Petrol	53	01/90-01/95	G15B, G4DJ										
Engine		Information			A10	A20	A40	A50	A70	C10 - C30	C20	E01		
All engines		version Mitsubishi					831 003/001	931 023						
ENGINE														
1.5 i	Petrol	61	01/90-01/95	G15B, G4DJ										
Engine		Information			A10	A20	A40	A50	A70	C10 - C30	C20	E01		
All engines		version Mitsubishi					831 003/001	931 107						
ENGINE														
1.5 i	Petrol	62	01/90-01/95	G15B, G4DJ										
Engine		Information			A10	A20	A40	A50	A70	C10 - C30	C20	E01		
All engines		version Mitsubishi					831 003/001	931 107						
PORTER I														
ENGINE														
2.4	Petrol	82	03/96-04/04	G4CS										
Engine		Information			A10	A20	A40	A50	A70	C10 - C30	C20	E01		
All engines		version Mitsubishi					831 003/001	931 107						
PRECIS														
ENGINE														
1.5 i [USA]	Petrol	0	01/89->	G4DJ										
Engine		Information			A10	A20	A40	A50	A70	C10 - C30	C20	E01		
All engines		version Mitsubishi					831 003/001	931 107						
S COUPE														
ENGINE														
1.5 i	Petrol	62	02/90-05/96	G4DJ										
Engine		Information			A10	A20	A40	A50	A70	C10 - C30	C20	E01		
All engines		version Mitsubishi					831 003/001	931 107						
ENGINE														
1.5 i	Petrol	65	04/92-05/96	G4EK										
Engine		Information			A10	A20	A40	A50	A70	C10 - C30	C20	E01		
All engines		->year 01/04/94, version Bosch					806 124	906 121R	406 244					
All engines		01/04/94 ->											358 119	
ENGINE														
1.5 i Turbo	Petrol	85	04/91-05/96	G4EK-TC										
Engine		Information			A10	A20	A40	A50	A70	C10 - C30	C20	E01		
All engines		->year 01/04/94, version Bosch					806 124	906 121R	406 244					
All engines		01/04/94 ->											358 119	

A10 CONDENSER	A20 CONTACT SET	A40 DISTRIBUTOR CAP	A50 ROTOR	A70 PICK-UP
C10 COIL	C20 IGNITION MODULE	C30 ELECTRONIC IGNITION KIT	E01 IGNITION CABLE SET	

The present application list is a brief version. For the detailed information about the possibility of installation on a specific vehicle, please refer to our web-catalogue <http://catalogo.facet.eu/>

					FUNCTIONS ON THE VEHICLE							
Vehicle	alim.	kW	Date	Engine								
					A10	A20	A40	A50	A70	C10 - C30	C20	E01

SANTA FE I

				ENGINE								
2.0	Petrol	99	08/01-03/06	G4BP								
Engine	Information				A10	A20	A40	A50	A70	C10 - C30	C20	E01
All engines												358 241
2.4 16V	Petrol	100	02/01-03/06	G4JS-G								
Engine	Information				A10	A20	A40	A50	A70	C10 - C30	C20	E01
All engines												358 241
2.4 16V	Petrol	107	02/01-03/06	G4JS-G								
Engine	Information				A10	A20	A40	A50	A70	C10 - C30	C20	E01
All engines												358 241
2.4 16V 4x4	Petrol	100	02/01-03/06	G4JS-G								
Engine	Information				A10	A20	A40	A50	A70	C10 - C30	C20	E01
All engines												358 241
2.4 16V 4x4	Petrol	107	02/01-03/06	G4JS-G								
Engine	Information				A10	A20	A40	A50	A70	C10 - C30	C20	E01
All engines												358 241
2.7 4x4	Petrol	129	09/02-12/04	G6BA								
Engine	Information				A10	A20	A40	A50	A70	C10 - C30	C20	E01
All engines	FP: Centre, x 1, D.I.S.									470 580	C10	
All engines	FP: Left, FP: Left Front, x 1, D.I.S.									470 587	C10	
2.7 V6 4x4	Petrol	127	02/01-03/06	G6BA, G6BA-G								
Engine	Information				A10	A20	A40	A50	A70	C10 - C30	C20	E01
Eng. G6BA	->year 01/10/01, x 3, D.I.S.									470 579	C10	
Eng. G6BA-G	->year 15/11/01, Qty: 3									470 579	C10	
Eng. G6BA	01/11/01 ->, FP: Centre, x 1, D.I.S.									470 580	C10	
Eng. G6BA-G	15/11/01 ->, FP: Centre									470 580	C10	
Eng. G6BA	01/11/01 ->, FP: Left, FP: Left Front, x 1, D.I.S.									470 587	C10	
Eng. G6BA-G	15/11/01 ->, FP: Left, FP: Left Front									470 587	C10	
Eng. G6BA-G												358 236

SANTA FE II









				ENGINE								
2.4	Petrol	128	11/10-12/12	G4KE								
Engine	Information				A10	A20	A40	A50	A70	C10 - C30	C20	E01
All engines	x 4, COIL ON PLUG									470 556	C10	
2.4 4x4	Petrol	128	07/10-12/12	G4KE								
Engine	Information				A10	A20	A40	A50	A70	C10 - C30	C20	E01
All engines	x 4, COIL ON PLUG									470 556	C10	
3.3	Petrol	180	07/07-11/08	G6DB								
Engine	Information				A10	A20	A40	A50	A70	C10 - C30	C20	E01
All engines	Qty: 6									470 492	C10	
3.3 Dynamic 4x4	Petrol	173	03/06-12/12	G6DB								
Engine	Information				A10	A20	A40	A50	A70	C10 - C30	C20	E01
All engines	Qty: 6									470 492	C10	
3.5	Petrol	147	01/10->	--								
Engine	Information				A10	A20	A40	A50	A70	C10 - C30	C20	E01
All engines	Qty: 6									470 492	C10	
3.5 4x4	Petrol	203	08/11-12/12	G6DC								
Engine	Information				A10	A20	A40	A50	A70	C10 - C30	C20	E01
All engines	x 6, COIL ON PLUG									470 492	C10	

A10 CONDENSER	A20 CONTACT SET	A40 DISTRIBUTOR CAP	A50 ROTOR	A70 PICK-UP
C10 COIL	C20 IGNITION MODULE	C30 ELECTRONIC IGNITION KIT	E01 IGNITION CABLE SET	

Vehicle	alim.	kW	Date	Engine	FUNCTIONS ON THE VEHICLE									
					A10	A20	A40	A50	A70	C10 - C30	C20	E01		
ENGINE														
3.5 4x4	Petrol	204	08/11-12/12	G6DC										
Engine	Information				A10	A20	A40	A50	A70	C10 - C30	C20	E01		
All engines	x 6, COIL ON PLUG									470 492	C10			
SANTA FE III														
2.4	Petrol	141	09/12-12/15	G4KJ										
Engine	Information				A10	A20	A40	A50	A70	C10 - C30	C20	E01		
All engines	x 4, COIL ON PLUG									470 556	C10			
ENGINE														
2.4 4WD	Petrol	141	09/12->	G4KJ										
Engine	Information				A10	A20	A40	A50	A70	C10 - C30	C20	E01		
All engines	x 4, COIL ON PLUG									470 556	C10			
ENGINE														
2.4 CCVT	Petrol	126	07/18->	G4KE										
Engine	Information				A10	A20	A40	A50	A70	C10 - C30	C20	E01		
All engines	x 4, COIL ON PLUG									470 556	C10			
ENGINE														
2.4 CCVT	Petrol	129	09/12->	G4KE										
Engine	Information				A10	A20	A40	A50	A70	C10 - C30	C20	E01		
All engines	x 4, COIL ON PLUG									470 556	C10			
ENGINE														
2.4 CCVT AWD	Petrol	126	06/15->	G4KE										
Engine	Information				A10	A20	A40	A50	A70	C10 - C30	C20	E01		
All engines	x 4, COIL ON PLUG									470 556	C10			
ENGINE														
2.4 CCVT AWD	Petrol	129	09/12->	G4KE										
Engine	Information				A10	A20	A40	A50	A70	C10 - C30	C20	E01		
All engines	x 4, COIL ON PLUG									470 556	C10			
ENGINE														
2.4 GDI 4WD	Petrol	138	05/15->	G4KJ										
Engine	Information				A10	A20	A40	A50	A70	C10 - C30	C20	E01		
All engines	->year 01/01/17, euro 5, x 4, COIL ON PLUG									470 556	C10			
SANTA FE IV														
2.4 AWD	Petrol	127	07/18->	G4KE										
Engine	Information				A10	A20	A40	A50	A70	C10 - C30	C20	E01		
All engines	x 4, COIL ON PLUG									470 556	C10			
ENGINE														
2.4 GDI AWD	Petrol	138	07/18->	G4KJ										
Engine	Information				A10	A20	A40	A50	A70	C10 - C30	C20	E01		
All engines	x 4, COIL ON PLUG									470 556	C10			
ENGINE														
3.5 MPI AWD	Petrol	183	07/19->	G6DC										
Engine	Information				A10	A20	A40	A50	A70	C10 - C30	C20	E01		
All engines	x 6, COIL ON PLUG									470 492	C10			
SANTAMO														
2.0 16V	Petrol	102	05/99-12/02	G4JP										
Engine	Information				A10	A20	A40	A50	A70	C10 - C30	C20	E01		
All engines	SOHC/OHC, version Mitsubishi						831 003/001	931 107						
All engines	DOHC												360 401	
ENGINE														
2.0 16V 4x4	Petrol	102	05/99-12/02	G4CP-D										
Engine	Information				A10	A20	A40	A50	A70	C10 - C30	C20	E01		
All engines	SOHC/OHC, version Mitsubishi						831 003/001	931 107						
All engines	DOHC												360 401	

A10 CONDENSER	A20 CONTACT SET	A40 DISTRIBUTOR CAP	A50 ROTOR	A70 PICK-UP
C10 COIL	C20 IGNITION MODULE	C30 ELECTRONIC IGNITION KIT	E01 IGNITION CABLE SET	

The present application list is a brief version. For the detailed information about the possibility of installation on a specific vehicle, please refer to our web-catalogue <http://catalogo.facet.eu/>









					FUNCTIONS ON THE VEHICLE								
Vehicle	alim.	kW	Date	Engine	 A10	 A20	 A40	 A50	 A70	 C10 - C30	 C20	 E01	
SANTRO													
1.1	Petrol	0	01/03->	ENGINE G4HD									
Engine					Information	A10	A20	A40	A50	A70	C10 - C30	C20	E01
All engines					Qty: 2						470 496	C10	
All engines													358 119
SB 11													
1.4	Petrol	79	01/11->	ENGINE --									
Engine					Information	A10	A20	A40	A50	A70	C10 - C30	C20	E01
All engines					Qty: 4						470 543	C10	
ENGINE													
1.6	Petrol	90	01/11->	ENGINE --									
Engine					Information	A10	A20	A40	A50	A70	C10 - C30	C20	E01
All engines					Qty: 4						470 543	C10	
SOLARIS													
1.4	Petrol	74	01/17->	ENGINE G4LC									
Engine					Information	A10	A20	A40	A50	A70	C10 - C30	C20	E01
All engines					Solaris, x 4, COIL ON PLUG						470 622	C10	
ENGINE													
1.4 16V	Petrol	79	01/11->	ENGINE --									
Engine					Information	A10	A20	A40	A50	A70	C10 - C30	C20	E01
All engines					Qty: 4						470 543	C10	
ENGINE													
1.4 VVTi	Petrol	79	11/10->	ENGINE G4FA									
Engine					Information	A10	A20	A40	A50	A70	C10 - C30	C20	E01
All engines					Solaris, x 4, COIL ON PLUG						470 543	C10	
ENGINE													
1.6	Petrol	90	01/17->	ENGINE G4FG									
Engine					Information	A10	A20	A40	A50	A70	C10 - C30	C20	E01
All engines					Solaris, x 4, COIL ON PLUG						470 543	C10	
ENGINE													
1.6 16V	Petrol	90	01/11->	ENGINE --									
Engine					Information	A10	A20	A40	A50	A70	C10 - C30	C20	E01
All engines					Qty: 4						470 543	C10	
SONATA II													
2.0 i 16V	Petrol	96	01/91-10/93	ENGINE G4CP-D									
Engine					Information	A10	A20	A40	A50	A70	C10 - C30	C20	E01
All engines												360 401	
ENGINE													
2.4 i	Petrol	83	09/88-08/91	ENGINE G4CS									
Engine					Information	A10	A20	A40	A50	A70	C10 - C30	C20	E01
All engines					version Mitsubishi			831 003/001	931 107				
ENGINE													
3.0 i V6 [USA]	Petrol	106	01/88->	ENGINE G6AT									
Engine					Information	A10	A20	A40	A50	A70	C10 - C30	C20	E01
All engines					version Mitsubishi				931 109				
SONATA III													
1.8 GLS	Petrol	63	07/96-05/98	ENGINE G4DM									
Engine					Information	A10	A20	A40	A50	A70	C10 - C30	C20	E01
All engines					version Mitsubishi			831 003/001	931 107				
ENGINE													
1.8 i	Petrol	72	05/93-06/98	ENGINE G4CM									
Engine					Information	A10	A20	A40	A50	A70	C10 - C30	C20	E01
All engines					version Mitsubishi			831 003/001	931 107				

A10 CONDENSER	A20 CONTACT SET	A40 DISTRIBUTOR CAP	A50 ROTOR	A70 PICK-UP
C10 COIL	C20 IGNITION MODULE	C30 ELECTRONIC IGNITION KIT	E01 IGNITION CABLE SET	

Vehicle	alim.	kW	Date	Engine	FUNCTIONS ON THE VEHICLE									
					A10	A20	A40	A50	A70	C10 - C30	C20	E01		
ENGINE														
2.0 i	Petrol	70	08/96-06/98	G4EP										
Engine		Information			A10	A20	A40	A50	A70	C10 - C30	C20	E01		
All engines		version Mitsubishi					831 003/001	931 107						
ENGINE														
2.0 i	Petrol	77	06/94-08/96	G4CP										
Engine		Information			A10	A20	A40	A50	A70	C10 - C30	C20	E01		
All engines		version Mitsubishi					831 003/001	931 107						
ENGINE														
2.0 i 16V	Petrol	102	05/93-06/98	G4CP-D										
Engine		Information			A10	A20	A40	A50	A70	C10 - C30	C20	E01		
All engines													360 401	
ENGINE														
2.0 i 16V	Petrol	92	06/96-06/98	G4CP-DM										
Engine		Information			A10	A20	A40	A50	A70	C10 - C30	C20	E01		
All engines													360 401	
ENGINE														
3.0 i V6	Petrol	107	05/93-06/98	G6AT										
Engine		Information			A10	A20	A40	A50	A70	C10 - C30	C20	E01		
All engines		version Mitsubishi						931 109						
SONATA IV														
ENGINE														
2.0 16V	Petrol	100	06/98-10/01	G4JP-G										
Engine		Information			A10	A20	A40	A50	A70	C10 - C30	C20	E01		
All engines													358 241	
ENGINE														
2.0 16V	Petrol	96	10/01-11/04	G4JP-EG										
Engine		Information			A10	A20	A40	A50	A70	C10 - C30	C20	E01		
All engines													358 241	
ENGINE														
2.4 16V	Petrol	105	03/98-10/01	G4BS										
Engine		Information			A10	A20	A40	A50	A70	C10 - C30	C20	E01		
All engines													358 241	
SONATA V														
ENGINE														
2.0 [RUS]	Petrol	0	01/05-04/06	--										
Engine		Information			A10	A20	A40	A50	A70	C10 - C30	C20	E01		
All engines													358 241	
ENGINE														
2.0 GLSI	Petrol	119	07/08-12/10	G4KD										
Engine		Information			A10	A20	A40	A50	A70	C10 - C30	C20	E01		
All engines		x 4, COIL ON PLUG								470 556	C10			
ENGINE														
2.0 i [RUS]	Petrol	0	04/06-12/10	--										
Engine		Information			A10	A20	A40	A50	A70	C10 - C30	C20	E01		
All engines		Qty: 2								470 581	C10			
All engines													360 385	
ENGINE														
2.0 VVTi GLS	Petrol	106	05/05-12/10	G4KA										
Engine		Information			A10	A20	A40	A50	A70	C10 - C30	C20	E01		
All engines		->year 01/12/07, x 4, COIL ON PLUG								470 492	C10			
All engines		01/01/08 ->, x 4, COIL ON PLUG								470 556	C10			
ENGINE														
2.0 VVTi GLS	Petrol	121	01/08-12/10	G4KD										
Engine		Information			A10	A20	A40	A50	A70	C10 - C30	C20	E01		
All engines		x 4, COIL ON PLUG								470 556	C10			
ENGINE														
2.4	Petrol	119	01/05-12/10	G4KC										
Engine		Information			A10	A20	A40	A50	A70	C10 - C30	C20	E01		
All engines		->year 01/11/07, x 4, COIL ON PLUG								470 492	C10			
All engines		01/12/07 ->, x 4, COIL ON PLUG								470 556	C10			

A10 CONDENSER	A20 CONTACT SET	A40 DISTRIBUTOR CAP	A50 ROTOR	A70 PICK-UP
C10 COIL	C20 IGNITION MODULE	C30 ELECTRONIC IGNITION KIT	E01 IGNITION CABLE SET	

The present application list is a brief version. For the detailed information about the possibility of installation on a specific vehicle, please refer to our web-catalogue <http://catalogo.facet.eu/>

				FUNCTIONS ON THE VEHICLE								
Vehicle	alim.	kW	Date	Engine								
				ENGINE								
2.4	Petrol	125	06/08-12/09	G4KC								
		Engine Information			A10	A20	A40	A50	A70	C10 - C30	C20	E01
		All engines Qty: 4								470 492	C10	
				ENGINE								
2.4	Petrol	128	06/08-12/10	G4KE								
		Engine Information			A10	A20	A40	A50	A70	C10 - C30	C20	E01
		All engines Qty: 4								470 556	C10	
				ENGINE								
2.4	Petrol	132	11/07-12/10	G4KC								
		Engine Information			A10	A20	A40	A50	A70	C10 - C30	C20	E01
		All engines Qty: 4								470 492	C10	
				ENGINE								
3.3	Petrol	171	01/05-12/10	G6DB								
		Engine Information			A10	A20	A40	A50	A70	C10 - C30	C20	E01
		All engines x 6, COIL ON PLUG								470 492	C10	
				ENGINE								
3.3	Petrol	173	06/05-12/10	G6DB								
		Engine Information			A10	A20	A40	A50	A70	C10 - C30	C20	E01
		All engines x 6, COIL ON PLUG								470 492	C10	
				ENGINE								
3.3	Petrol	184	01/08-12/10	G6DB								
		Engine Information			A10	A20	A40	A50	A70	C10 - C30	C20	E01
		All engines x 6, COIL ON PLUG								470 492	C10	
				ENGINE								
3.3	Petrol	186	09/07-12/08	G6DB								
		Engine Information			A10	A20	A40	A50	A70	C10 - C30	C20	E01
		All engines x 6, COIL ON PLUG								470 492	C10	
				ENGINE								
				ENGINE								
2.0	Petrol	110	06/09-06/14	G4KD								
		Engine Information			A10	A20	A40	A50	A70	C10 - C30	C20	E01
		All engines x 4, COIL ON PLUG								470 556	C10	
				ENGINE								
2.0 i	Petrol	121	01/11-06/14	G4KD								
		Engine Information			A10	A20	A40	A50	A70	C10 - C30	C20	E01
		All engines Qty: 4								470 556	C10	
				ENGINE								
2.4	Petrol	128	06/09-11/10	G4KC								
		Engine Information			A10	A20	A40	A50	A70	C10 - C30	C20	E01
		All engines x 4, COIL ON PLUG								470 556	C10	
				ENGINE								
2.4	Petrol	131	11/10-12/15	G4KC								
		Engine Information			A10	A20	A40	A50	A70	C10 - C30	C20	E01
		All engines x 4, COIL ON PLUG								470 556	C10	
				ENGINE								
				ENGINE								
3.3 CVT	Petrol	186	03/09-12/10	G6DB								
		Engine Information			A10	A20	A40	A50	A70	C10 - C30	C20	E01
		Sonica, x 6, COIL ON PLUG								470 492	C10	
				ENGINE								
				ENGINE								
1.4	Petrol	50	10/83-08/86	4G33								
		Engine Information			A10	A20	A40	A50	A70	C10 - C30	C20	E01
		All engines version Mitsubishi				731 084	831 003/001	931 023				
				ENGINE								
1.6	Petrol	56	10/83-12/91	G32B								
		Engine Information			A10	A20	A40	A50	A70	C10 - C30	C20	E01
		All engines version Mitsubishi				731 084	831 003/001	931 023				

A10 CONDENSER	A20 CONTACT SET	A40 DISTRIBUTOR CAP	A50 ROTOR	A70 PICK-UP
C10 COIL	C20 IGNITION MODULE	C30 ELECTRONIC IGNITION KIT	E01 IGNITION CABLE SET	

Vehicle	alim.	kW	Date	Engine	FUNCTIONS ON THE VEHICLE							
					A10	A20	A40	A50	A70	C10 - C30	C20	E01

TIBURON

1.6 i 16V	Petrol	79	08/00->	ENGINE G4GL
-----------	--------	----	---------	----------------

Engine	Information	A10	A20	A40	A50	A70	C10 - C30	C20	E01
All engines									360 385

1.6 i 16V	Petrol	84	08/99->	ENGINE G4GR
-----------	--------	----	---------	----------------

Engine	Information	A10	A20	A40	A50	A70	C10 - C30	C20	E01
All engines									360 385

2.0 i 16V	Petrol	101	08/99->	ENGINE G4DF
-----------	--------	-----	---------	----------------

Engine	Information	A10	A20	A40	A50	A70	C10 - C30	C20	E01
All engines									360 385

TRAJET

2.0	Petrol	100	03/00-07/08	ENGINE G4JP-G
-----	--------	-----	-------------	------------------

Engine	Information	A10	A20	A40	A50	A70	C10 - C30	C20	E01
All engines	01/02/04 ->, Qty: 2						470 581	C10	
All engines	->year 01/02/04								358 241
All engines	01/02/04 ->								360 385

2.0	Petrol	103	01/04-07/08	ENGINE G4GC, G4GC-G
-----	--------	-----	-------------	------------------------

Engine	Information	A10	A20	A40	A50	A70	C10 - C30	C20	E01
Eng. G4GC	01/03/04 ->, x 1, D.I.S.						470 581	C10	
Eng. G4GC-G	01/02/04 ->, Qty: 2						470 581	C10	
Eng. G4GC-G	->year 01/02/04								358 241
Eng. G4GC-G	01/02/04 ->								360 385

2.0	Petrol	104	11/03-07/08	ENGINE G4GC
-----	--------	-----	-------------	----------------

Engine	Information	A10	A20	A40	A50	A70	C10 - C30	C20	E01
All engines	01/03/04 ->, x 1, D.I.S.						470 581	C10	
All engines	->year 01/02/04								358 241
All engines	01/02/04 ->								360 385

2.0 CRDi	Diesel	92	08/05-07/08	ENGINE D4EA
----------	--------	----	-------------	----------------

Engine	Information	A10	A20	A40	A50	A70	C10 - C30	C20	E01
All engines	01/02/04 ->, Qty: 2						470 581	C10	
All engines	->year 01/02/04								358 241
All engines	01/02/04 ->								360 385

CWT	Petrol	103	01/04-07/08	ENGINE G4GC
-----	--------	-----	-------------	----------------

Engine	Information	A10	A20	A40	A50	A70	C10 - C30	C20	E01
All engines	01/03/04 ->, x 1, D.I.S.						470 581	C10	

TUCSON

1.6 GDi	Petrol	97	06/15-09/20	ENGINE G4FD
---------	--------	----	-------------	----------------

Engine	Information	A10	A20	A40	A50	A70	C10 - C30	C20	E01
All engines	Tucson, x 4, COIL ON PLUG						470 611	C10	

2.0	Petrol	104	08/04->	ENGINE G4GC
-----	--------	-----	---------	----------------









Engine	Information	A10	A20	A40	A50	A70	C10 - C30	C20	E01
All engines	Tucson, x 1, D.I.S.						470 581	C10	
All engines									360 385

2.0	Petrol	105	01/07-01/12	ENGINE G4GC
-----	--------	-----	-------------	----------------

Engine	Information	A10	A20	A40	A50	A70	C10 - C30	C20	E01
All engines	Qty: 2						470 581	C10	
All engines									360 385

A10 CONDENSER	A20 CONTACT SET	A40 DISTRIBUTOR CAP	A50 ROTOR	A70 PICK-UP
C10 COIL	C20 IGNITION MODULE	C30 ELECTRONIC IGNITION KIT	E01 IGNITION CABLE SET	

The present application list is a brief version. For the detailed information about the possibility of installation on a specific vehicle, please refer to our web-catalogue <http://catalogo.facet.eu/>









					FUNCTIONS ON THE VEHICLE							
Vehicle	alim.	kW	Date	Engine	 A10	 A20	 A40	 A50	 A70	 C10 - C30	 C20	 E01
ENGINE												
2.0 LPG	Petrol/ Liquified Petro- leum Gas (LPG)	104	06/04-03/10	G4GC								
Engine	Information				A10	A20	A40	A50	A70	C10 - C30	C20	E01
All engines	Tucson, x 1, D.I.S.									470 581	C10	
ENGINE												
2.0 LPG Trazione integrale	Petrol/ Liquified Petro- leum Gas (LPG)	104	06/09-03/10	G4GC								
Engine	Information				A10	A20	A40	A50	A70	C10 - C30	C20	E01
All engines	Tucson, x 1, D.I.S.									470 581	C10	
ENGINE												
2.0 Trazione integrale	Petrol	104	08/04-03/10	G4GC								
Engine	Information				A10	A20	A40	A50	A70	C10 - C30	C20	E01
All engines	Tucson, x 1, D.I.S.									470 581	C10	
All engines												360 385
ENGINE												
2.0 Trazione integrale	Petrol	105	07/05-11/10	G4GC								
Engine	Information				A10	A20	A40	A50	A70	C10 - C30	C20	E01
All engines	Qty: 2									470 581	C10	
All engines												360 385
ENGINE												
2.7 Trazione integrale	Petrol	129	08/04-11/10	G6BA-G								
Engine	Information				A10	A20	A40	A50	A70	C10 - C30	C20	E01
All engines	31/10/06 ->											358 236
ENGINE												
CVVT	Petrol	104	06/04-03/10	G4GC								
Engine	Information				A10	A20	A40	A50	A70	C10 - C30	C20	E01
All engines	Tucson, x 1, D.I.S.									470 581	C10	
VELOSTER												
ENGINE												
1.6	Petrol	94	06/11->	G4FG								
Engine	Information				A10	A20	A40	A50	A70	C10 - C30	C20	E01
All engines	Qty: 4									470 543	C10	
ENGINE												
1.6 GDI	Petrol	103	03/11-12/17	G4FD								
Engine	Information				A10	A20	A40	A50	A70	C10 - C30	C20	E01
All engines	x 4, COIL ON PLUG									470 611	C10	
ENGINE												
1.6 GDi	Petrol	95	10/11-12/17	G4FD								
Engine	Information				A10	A20	A40	A50	A70	C10 - C30	C20	E01
All engines	x 4, COIL ON PLUG									470 611	C10	
ENGINE												
1.6 MPI	Petrol	97	04/11-12/17	G4FC								
Engine	Information				A10	A20	A40	A50	A70	C10 - C30	C20	E01
All engines	x 4, COIL ON PLUG									470 543	C10	
VERNA I												
ENGINE												
1.3	Petrol	63	09/99->	G4EA								
Engine	Information				A10	A20	A40	A50	A70	C10 - C30	C20	E01
All engines										470 582, 470 583	C10	358 119
All engines	Kit									470 585	C10	
ENGINE												
1.5	Petrol	66	09/99->	G4EB								
Engine	Information				A10	A20	A40	A50	A70	C10 - C30	C20	E01
All engines										470 582, 470 583	C10	358 119

A10 CONDENSER	A20 CONTACT SET	A40 DISTRIBUTOR CAP	A50 ROTOR	A70 PICK-UP
C10 COIL	C20 IGNITION MODULE	C30 ELECTRONIC IGNITION KIT	E01 IGNITION CABLE SET	

Vehicle	alim.	kW	Date	Engine	FUNCTIONS ON THE VEHICLE								
					A10	A20	A40	A50	A70	C10 - C30	C20	E01	
ENGINE													
1.5	Petrol	66	09/99->	G4EB									
ENGINE													
G4EB													
ENGINE													
G4EC-G													
1.5	Petrol	75	09/99->	G4EC-G									
ENGINE													
G4EC-G													
ENGINE													
G4ED-G													
1.6	Petrol	77	12/02->	G4ED-G									
ENGINE													
G4ED-G													
ENGINE													
G4ED-G													

A10	CONDENSER	A20	CONTACT SET	A40	DISTRIBUTOR CAP	A50	ROTOR	A70	PICK-UP
C10	COIL	C20	IGNITION MODULE	C30	ELECTRONIC IGNITION KIT	E01	IGNITION CABLE SET		

The present application list is a brief version. For the detailed information about the possibility of installation on a specific vehicle, please refer to our web-catalogue <http://catalogo.facet.eu/>









					FUNCTIONS ON THE VEHICLE							
Vehicle	alim.	kW	Date	Engine	 A10	 A20	 A40	 A50	 A70	 C10 - C30	 C20	 E01
EX35												
3.5 V6	Petrol	221	04/08->	ENGINE VQ35HR								
Engine	Information				A10	A20	A40	A50	A70	C10 - C30	C20	E01
All engines	Qty: 6									470 533	C10	
FX												
35	Petrol	205	07/08-10/09	ENGINE VQ35HR								
Engine	Information				A10	A20	A40	A50	A70	C10 - C30	C20	E01
All engines	FX35, x 6, COIL ON PLUG									470 533	C10	
35	Petrol	226	10/08-12/11	ENGINE VQ35HR								
Engine	Information				A10	A20	A40	A50	A70	C10 - C30	C20	E01
All engines	FX35, x 6, COIL ON PLUG									470 533	C10	
35 AWD	Petrol	205	07/08-05/09	ENGINE VQ35HR								
Engine	Information				A10	A20	A40	A50	A70	C10 - C30	C20	E01
All engines	FX35, x 6, COIL ON PLUG									470 533	C10	
35 AWD	Petrol	226	02/09-12/10	ENGINE VQ35HR								
Engine	Information				A10	A20	A40	A50	A70	C10 - C30	C20	E01
All engines	FX35, x 6, COIL ON PLUG									470 533	C10	
50 AWD	Petrol	287	10/08->	ENGINE VK50VE								
Engine	Information				A10	A20	A40	A50	A70	C10 - C30	C20	E01
All engines	FX50, ->year 01/12/10, x 8, COIL ON PLUG									470 552	C10	
50 AWD	Petrol	291	10/08->	ENGINE VK50VE								
Engine	Information				A10	A20	A40	A50	A70	C10 - C30	C20	E01
All engines	FX50, ->year 01/12/10, x 8, COIL ON PLUG									470 552	C10	
50 AWD	Petrol	309	06/13-07/13	ENGINE VK50VE								
Engine	Information				A10	A20	A40	A50	A70	C10 - C30	C20	E01
All engines	FX50, Fitting Position:for cylinder 1, Fitting Position:for cylinder 2, Fitting Position:for cylinder 3, Fitting Position:for cylinder 5, Fitting Position:for cylinder 6, Fitting Position:for cylinder 7, x 8, COIL ON PLUG									470 552	C10	
G												
25	Petrol	163	01/11->	ENGINE VQ25HR								
Engine	Information				A10	A20	A40	A50	A70	C10 - C30	C20	E01
All engines	G25, x 6, COIL ON PLUG									470 533	C10	
35 X	Petrol	228	01/07-12/08	ENGINE VQ35HR								
Engine	Information				A10	A20	A40	A50	A70	C10 - C30	C20	E01
All engines	G35, x 6, COIL ON PLUG									470 533	C10	
G SERIES												
3.5 V6	Petrol	228	12/06->	ENGINE VQ35HR								
Engine	Information				A10	A20	A40	A50	A70	C10 - C30	C20	E01
All engines	Qty: 6									470 533	C10	
G20												
2.0	Petrol	85	01/90-12/97	ENGINE SR20DE								
Engine	Information				A10	A20	A40	A50	A70	C10 - C30	C20	E01
All engines	->year 31/12/93, version Hitachi						822 073	922 085				
All engines	01/01/94 ->, version Mitsubishi						831 151	931 136				
JX												
3.5 AWD	Petrol	195	11/12-09/13	ENGINE VQ35DE								
Engine	Information				A10	A20	A40	A50	A70	C10 - C30	C20	E01
All engines	JX35, x 6, COIL ON PLUG									470 533	C10	

A10 CONDENSER	A20 CONTACT SET	A40 DISTRIBUTOR CAP	A50 ROTOR	A70 PICK-UP
C10 COIL	C20 IGNITION MODULE	C30 ELECTRONIC IGNITION KIT	E01 IGNITION CABLE SET	

Vehicle	alim.	kW	Date	Engine	FUNCTIONS ON THE VEHICLE									
					A10	A20	A40	A50	A70	C10 - C30	C20	E01		
M														
25	Petrol	163	07/10->	ENGINE VQ25HR										
Engine		Information			A10	A20	A40	A50	A70	C10 - C30	C20	E01		
All engines		M25, x 6, COIL ON PLUG								470 533	C10			
35h														
35h	Petrol/ Electric	225	04/11->	ENGINE VQ35HR										
Engine		Information			A10	A20	A40	A50	A70	C10 - C30	C20	E01		
All engines		M35h, x 6, COIL ON PLUG								470 533	C10			
56														
56	Petrol	300	03/10->	ENGINE VK56VD										
Engine		Information			A10	A20	A40	A50	A70	C10 - C30	C20	E01		
All engines		M56, Fitting Position:for cylinder 1-6, x 8, COIL ON PLUG								470 552	C10			
56 X														
56 X	Petrol	300	03/10->	ENGINE VK56VD										
Engine		Information			A10	A20	A40	A50	A70	C10 - C30	C20	E01		
All engines		M56, Fitting Position:for cylinder 1, Fitting Position:for cylinder 2, Fitting Position:for cylinder 3, Fitting Position:for cylinder 5, Fitting Position:for cylinder 6, Fitting Position:for cylinder 7, x 8, COIL ON PLUG								470 552	C10			
M35														
3.5	Petrol	226	09/08-12/10	ENGINE VQ35HR										
Engine		Information			A10	A20	A40	A50	A70	C10 - C30	C20	E01		
All engines		x 6, COIL ON PLUG								470 533	C10			
3.5 h														
3.5 h	Petrol/ Electric	268	01/10->	ENGINE VQ35HR										
Engine		Information			A10	A20	A40	A50	A70	C10 - C30	C20	E01		
All engines		M35h, x 6, COIL ON PLUG								470 533	C10			
3.5 X														
3.5 X	Petrol	226	09/08-12/10	ENGINE VQ35HR										
Engine		Information			A10	A20	A40	A50	A70	C10 - C30	C20	E01		
All engines		x 6, COIL ON PLUG								470 533	C10			
Q30														
2.0 T	Petrol	155	11/15->	ENGINE 270920										
Engine		Information			A10	A20	A40	A50	A70	C10 - C30	C20	E01		
All engines		x 4, COIL ON PLUG								470 626	C10			
2.0 T AWD														
2.0 T AWD	Petrol	155	11/15->	ENGINE 270920										
Engine		Information			A10	A20	A40	A50	A70	C10 - C30	C20	E01		
All engines		x 4, COIL ON PLUG								470 626	C10			
Q50														
2.0 T	Petrol	155	04/14->	ENGINE M 274										
Engine		Information			A10	A20	A40	A50	A70	C10 - C30	C20	E01		
All engines		x 4, COIL ON PLUG								470 626	C10			
50 Hybrid														
50 Hybrid	Petrol/ Electric	219	06/13->	ENGINE VQ35HR										
Engine		Information			A10	A20	A40	A50	A70	C10 - C30	C20	E01		
All engines		x 6, COIL ON PLUG								470 533	C10			
50 Hybrid														
50 Hybrid	Petrol/ Electric	225	04/13->	ENGINE VQ35HR										
Engine		Information			A10	A20	A40	A50	A70	C10 - C30	C20	E01		
All engines		x 6, COIL ON PLUG								470 533	C10			
50 Hybrid														
50 Hybrid	Petrol/ Electric	268	04/13->	ENGINE VQ35HR										
Engine		Information			A10	A20	A40	A50	A70	C10 - C30	C20	E01		
All engines		x 6, COIL ON PLUG								470 533	C10			

A10 CONDENSER	A20 CONTACT SET	A40 DISTRIBUTOR CAP	A50 ROTOR	A70 PICK-UP
C10 COIL	C20 IGNITION MODULE	C30 ELECTRONIC IGNITION KIT	E01 IGNITION CABLE SET	

The present application list is a brief version. For the detailed information about the possibility of installation on a specific vehicle, please refer to our web-catalogue <http://catalogo.facet.eu/>

					FUNCTIONS ON THE VEHICLE							
Vehicle	alim.	kW	Date	Engine								
QX70												
50 Hybrid AWD	Petrol/ Electric	219	06/13->	ENGINE VQ35HR								
Engine	Information				A10	A20	A40	A50	A70	C10 - C30	C20	E01
All engines	x 6, COIL ON PLUG									470 533	C10	
50 Hybrid AWD	Petrol/ Electric	225	04/13->	ENGINE VQ35HR								
Engine	Information				A10	A20	A40	A50	A70	C10 - C30	C20	E01
All engines	x 6, COIL ON PLUG									470 533	C10	
50 Hybrid AWD	Petrol/ Electric	268	04/13->	ENGINE VQ35HR								
Engine	Information				A10	A20	A40	A50	A70	C10 - C30	C20	E01
All engines	x 6, COIL ON PLUG									470 533	C10	
QX60												
2.0 T	Petrol	155	09/16->	ENGINE M 274								
Engine	Information				A10	A20	A40	A50	A70	C10 - C30	C20	E01
All engines	x 4, COIL ON PLUG									470 626	C10	
QX70												
2.5	Petrol	163	05/15->	ENGINE VQ25HR								
Engine	Information				A10	A20	A40	A50	A70	C10 - C30	C20	E01
All engines	x 6, COIL ON PLUG									470 533	C10	
3.5 Hybrid	Petrol/ Electric	225	03/13->	ENGINE VQ35HR								
Engine	Information				A10	A20	A40	A50	A70	C10 - C30	C20	E01
All engines	x 6, COIL ON PLUG									470 533	C10	
5.6 AWD	Petrol	300	01/15->	ENGINE VK56VD								
Engine	Information				A10	A20	A40	A50	A70	C10 - C30	C20	E01
All engines	Fitting Position:for cylinder 1, Fitting Position:for cylinder 2, Fitting Position:for cylinder 3, Fitting Position:for cylinder 5, Fitting Position:for cylinder 6, Fitting Position:for cylinder 7, x 6, COIL ON PLUG									470 552	C10	
QX30												
2.0 AWD	Petrol	155	09/16->	ENGINE 270920								
Engine	Information				A10	A20	A40	A50	A70	C10 - C30	C20	E01
All engines	x 4, COIL ON PLUG									470 626	C10	
QX50												
2.5 AWD	Petrol	163	02/14->	ENGINE VQ25HR								
Engine	Information				A10	A20	A40	A50	A70	C10 - C30	C20	E01
All engines	x 6, COIL ON PLUG									470 533	C10	
QX60												
3.5 AWD	Petrol	193	10/13->	ENGINE VQ35DE								
Engine	Information				A10	A20	A40	A50	A70	C10 - C30	C20	E01
All engines	x 6, COIL ON PLUG									470 533	C10	
QX70												
50 AWD	Petrol	287	08/13->	ENGINE VK50VE								
Engine	Information				A10	A20	A40	A50	A70	C10 - C30	C20	E01
All engines	x 8, COIL ON PLUG									470 552	C10	
50 AWD	Petrol	294	08/13->	ENGINE VK50VE								
Engine	Information				A10	A20	A40	A50	A70	C10 - C30	C20	E01
All engines	Fitting Position:for cylinder 1, Fitting Position:for cylinder 2, Fitting Position:for cylinder 3, Fitting Position:for cylinder 5, Fitting Position:for cylinder 6, Fitting Position:for cylinder 7, x 8, COIL ON PLUG									470 552	C10	

A10 CONDENSER	A20 CONTACT SET	A40 DISTRIBUTOR CAP	A50 ROTOR	A70 PICK-UP
C10 COIL	C20 IGNITION MODULE	C30 ELECTRONIC IGNITION KIT	E01 IGNITION CABLE SET	

Vehicle	alim.	kW	Date	Engine	FUNCTIONS ON THE VEHICLE							
					A10	A20	A40	A50	A70	C10 - C30	C20	E01

ELBA

				ENGINE
1.3	Petrol	49	08/91-12/96	146 A5.000

Engine	Information	A10	A20	A40	A50	A70	C10 - C30	C20	E01
All engines	version Marelli			830 101		430 176M			
All engines	no specific info conc. application available, version Marelli				930 047R, 930 060				
All engines							470 158	C10	465 020

				ENGINE
1.4 i.e.	Petrol	49	09/94-12/96	146 C5.000, 146 D5.000

Engine	Information	A10	A20	A40	A50	A70	C10 - C30	C20	E01
Eng. 146 C5.000	version Marelli			830 114	930 060				
Eng. 146 C5.000							470 148	C10	
Eng. 146 D5.000							470 188	C10	359 655

				ENGINE
1.5 i.e.	Petrol	55	08/92-09/94	149 C1.000

Engine	Information	A10	A20	A40	A50	A70	C10 - C30	C20	E01
All engines	->year 31/05/93, version Marelli			830 104					
All engines	01/06/93 ->, version Marelli			830 114					
All engines	version Marelli				930 059				
All engines							470 148	C10	

				ENGINE
1.6 i.e.	Petrol	55	09/94-12/96	146 C6.000, 146 D6.000

Engine	Information	A10	A20	A40	A50	A70	C10 - C30	C20	E01
Eng. 146 C6.000	version Marelli			830 115	930 059	430 177/1			
Eng. 146 C6.000							470 148	C10	
Eng. 146 D6.000							470 188	C10	359 655

MILLE

				ENGINE
1.0i	Petrol	35	02/93-02/98	146 C7.000

Engine	Information	A10	A20	A40	A50	A70	C10 - C30	C20	E01
All engines	Qty: 2						470 146	C10	

A10	CONDENSER	A20	CONTACT SET	A40	DISTRIBUTOR CAP	A50	ROTOR	A70	PICK-UP
C10	COIL	C20	IGNITION MODULE	C30	ELECTRONIC IGNITION KIT	E01	IGNITION CABLE SET		

The present application list is a brief version. For the detailed information about the possibility of installation on a specific vehicle, please refer to our web-catalogue <http://catalogo.facet.eu/>

Vehicle	alim.	kW	Date	Engine	FUNCTIONS ON THE VEHICLE							
					A10	A20	A40	A50	A70	C10 - C30	C20	E01

IMPULSE

1.6i [USA]	Petrol	0	01/90->	ENGINE RLK
------------	--------	---	---------	---------------

Engine	Information	A10	A20	A40	A50	A70	C10 - C30	C20	E01
All engines	version Delco Remy			812 075	912 098				

1.8i [USA]	Petrol	0	01/91->	ENGINE RLX
------------	--------	---	---------	---------------

Engine	Information	A10	A20	A40	A50	A70	C10 - C30	C20	E01
All engines	version Delco Remy			812 075	912 098				

PICK-UP

3.1i V6 [USA]	Petrol	0	01/90->	ENGINE LG 6
---------------	--------	---	---------	----------------

Engine	Information	A10	A20	A40	A50	A70	C10 - C30	C20	E01
All engines								465 025	

RODEO

3.1i V6 [USA]	Petrol	0	01/90-12/92	ENGINE LG 6
---------------	--------	---	-------------	----------------

Engine	Information	A10	A20	A40	A50	A70	C10 - C30	C20	E01
All engines								465 025	

STYLUS

1.6i DOHC [USA]	Petrol	0	01/90-12/91	ENGINE RLK
-----------------	--------	---	-------------	---------------

Engine	Information	A10	A20	A40	A50	A70	C10 - C30	C20	E01
All engines	version Delco Remy			812 075	912 098				

1.6i SOHC [USA]	Petrol	0	01/90->	ENGINE RLR
-----------------	--------	---	---------	---------------

Engine	Information	A10	A20	A40	A50	A70	C10 - C30	C20	E01
All engines	version Delco Remy			812 075	912 098				

1.8i DOHC [USA]	Petrol	0	01/91->	ENGINE RLX
-----------------	--------	---	---------	---------------

Engine	Information	A10	A20	A40	A50	A70	C10 - C30	C20	E01
All engines	version Delco Remy			812 075	912 098				

TROOPER

2.3	Petrol	66	11/85-12/91	ENGINE 4ZD1
-----	--------	----	-------------	----------------

Engine	Information	A10	A20	A40	A50	A70	C10 - C30	C20	E01
All engines							470 219	C10	

2.6 4WD	Petrol	85	11/86-07/91	ENGINE 4ZE1
---------	--------	----	-------------	----------------

Engine	Information	A10	A20	A40	A50	A70	C10 - C30	C20	E01
All engines	version Hitachi				922 069				

2.6 i	Petrol	85	10/87-12/91	ENGINE 4ZE1
-------	--------	----	-------------	----------------

Engine	Information	A10	A20	A40	A50	A70	C10 - C30	C20	E01
All engines	version Hitachi				922 069				

3.2i V6 [USA]	Petrol	0	01/88-12/91	ENGINE --
---------------	--------	---	-------------	--------------

Engine	Information	A10	A20	A40	A50	A70	C10 - C30	C20	E01
All engines								465 025	

A10 CONDENSER	A20 CONTACT SET	A40 DISTRIBUTOR CAP	A50 ROTOR	A70 PICK-UP
C10 COIL	C20 IGNITION MODULE	C30 ELECTRONIC IGNITION KIT	E01 IGNITION CABLE SET	

Vehicle	alim.	kW	Date	Engine	FUNCTIONS ON THE VEHICLE							
					A10	A20	A40	A50	A70	C10 - C30	C20	E01
DAILY												
2.8 CNG	CNG	78	07/99-12/06	ENGINE 8149.03								
Engine	Information				A10	A20	A40	A50	A70	C10 - C30	C20	E01
All engines	Daily 35C11, Daily 35C11P, Daily 35S11, Daily 35S11P, Daily 40C11, Daily 40C11P, Daily 60C11, Daily 65C11, Daily 65C11P, x 1, D.I.S.									470 345	C10	
3.0 CNG	CNG	100	06/06-02/14	ENGINE F1CE0441A								
Engine	Information				A10	A20	A40	A50	A70	C10 - C30	C20	E01
All engines	Daily 50C14, Daily 50C14P, Daily 60C14, x 4, COIL ON PLUG									470 442	C10	
3.0 CNG	CNG	103	09/09-08/11	ENGINE F1CE0441A								
Engine	Information				A10	A20	A40	A50	A70	C10 - C30	C20	E01
All engines	Daily 70C14, Daily 70C14P, x 4, COIL ON PLUG									470 442	C10	
DAILY II												
2.8 CNG	CNG	78	05/99-07/07	ENGINE 8149.03								
Engine	Information				A10	A20	A40	A50	A70	C10 - C30	C20	E01
All engines	Daily 35C11, x 1, D.I.S.									470 345	C10	
50 C 11 Natural Power	CNG	78	05/99-04/06	ENGINE 8149.03								
Engine	Information				A10	A20	A40	A50	A70	C10 - C30	C20	E01
All engines	Daily 50C11, x 1, D.I.S.									470 345	C10	
DAILY III												
50 C 11 Natural Power	CNG	78	05/02-05/06	ENGINE 8149.03								
Engine	Information				A10	A20	A40	A50	A70	C10 - C30	C20	E01
All engines	Daily 50C11, x 1, D.I.S.									470 345	C10	
DAILY IV												
35C14 G, 35C14 G/P, 35S14 G, 35S14 G/P, 35C14 GD,...	CNG	100	07/07-08/11	ENGINE F1CE0441A								
Engine	Information				A10	A20	A40	A50	A70	C10 - C30	C20	E01
All engines	Daily 35C14, x 4, COIL ON PLUG									470 442	C10	
35C14 GV, 35C14 GV/P, 35S14 GV, 35S14 GV/P	CNG	100	07/07-08/11	ENGINE F1CE0441A								
Engine	Information				A10	A20	A40	A50	A70	C10 - C30	C20	E01
All engines	Daily 35C14, x 4, COIL ON PLUG									470 442	C10	
40C14 G, 40C14 G/P	CNG	100	07/07-08/11	ENGINE F1CE0441A								
Engine	Information				A10	A20	A40	A50	A70	C10 - C30	C20	E01
All engines	Daily 40C14, x 4, COIL ON PLUG									470 442	C10	
40C14 GV, 40C14 GV/P	CNG	100	07/07-08/11	ENGINE F1CE0441A								
Engine	Information				A10	A20	A40	A50	A70	C10 - C30	C20	E01
All engines	Daily 40C14, x 4, COIL ON PLUG									470 442	C10	
50C14 G, 50C14 G/P, 50C14 GD, 50C14 GD/P	CNG	100	07/07-08/11	ENGINE F1CE0441A								
Engine	Information				A10	A20	A40	A50	A70	C10 - C30	C20	E01
All engines	Daily 50C14, x 4, COIL ON PLUG									470 442	C10	
50C14 GV, 50C14 GV/P	CNG	100	07/07-08/11	ENGINE F1CE0441A								
Engine	Information				A10	A20	A40	A50	A70	C10 - C30	C20	E01
All engines	Daily 50C14, x 4, COIL ON PLUG									470 442	C10	

A10 CONDENSER	A20 CONTACT SET	A40 DISTRIBUTOR CAP	A50 ROTOR	A70 PICK-UP
C10 COIL	C20 IGNITION MODULE	C30 ELECTRONIC IGNITION KIT	E01 IGNITION CABLE SET	

The present application list is a brief version. For the detailed information about the possibility of installation on a specific vehicle, please refer to our web-catalogue <http://catalogo.facet.eu/>

Vehicle	alim.	kW	Date	Engine	FUNCTIONS ON THE VEHICLE							
					A10	A20	A40	A50	A70	C10 - C30	C20	E01

ENGINE				
65C14 G, 65C14 G/P, 65C14 GD, 65C14 GD/P	CNG	100	07/07-08/11	F1CE0441A

Engine	Information	A10	A20	A40	A50	A70	C10 - C30	C20	E01
All engines	Daily 65C14, x 4, COIL ON PLUG						470 442	C10	

ENGINE				
Natural Power 35S14, 35C14, 40C14, 50C14, 65C14, 70C14	CNG	100	09/11-02/14	F1CE0441A

Engine	Information	A10	A20	A40	A50	A70	C10 - C30	C20	E01
All engines	Daily 35C14, x 4, COIL ON PLUG						470 442	C10	

ENGINE				
Natural Power 35S14, 35C14, 40C14, 50C14, 60C14, 65C14,...	CNG	100	09/11-02/14	F1CE0441A

Engine	Information	A10	A20	A40	A50	A70	C10 - C30	C20	E01
All engines	Daily 35C14, x 4, COIL ON PLUG						470 442	C10	

DAILY V

ENGINE				
Natural Power 35S14, 35C14, 40C14, 50C14, 60C14, 65C14,...	CNG	100	03/14->	F1CFA401A, F1CFA401B, F1CFA401C

Engine	Information	A10	A20	A40	A50	A70	C10 - C30	C20	E01
All engines	Daily 35C14, Daily 50C14, x 4, COIL ON PLUG						470 442	C10	

ENGINE				
Natural Power 40C14, 50C14, 60C14	CNG	100	03/14->	F1CFA401A, F1CFA401C

Engine	Information	A10	A20	A40	A50	A70	C10 - C30	C20	E01
All engines	Daily 50C14, x 4, COIL ON PLUG						470 442	C10	

A10	CONDENSER	A20	CONTACT SET	A40	DISTRIBUTOR CAP	A50	ROTOR	A70	PICK-UP
C10	COIL	C20	IGNITION MODULE	C30	ELECTRONIC IGNITION KIT	E01	IGNITION CABLE SET		

Vehicle	alim.	kW	Date	Engine	FUNCTIONS ON THE VEHICLE							
					A10	A20	A40	A50	A70	C10 - C30	C20	E01

E-TYPE

3.8	Petrol	195	04/61-07/64	ENGINE --, 7R
-----	--------	-----	-------------	------------------

Engine	Information	A10	A20	A40	A50	A70	C10 - C30	C20	E01
All engines					928 007				

4.2	Petrol	127	03/71-04/75	ENGINE --, 8L (85-87)
-----	--------	-----	-------------	--------------------------

Engine	Information	A10	A20	A40	A50	A70	C10 - C30	C20	E01
All engines					928 007				

4.2	Petrol	195	05/64-09/70	ENGINE XK 4.2 (82-87)
-----	--------	-----	-------------	--------------------------

Engine	Information	A10	A20	A40	A50	A70	C10 - C30	C20	E01
All engines			728 083MHV		928 007				

4.2	Petrol	198	07/68-05/71	ENGINE XK 4.2 (82-87)
-----	--------	-----	-------------	--------------------------

Engine	Information	A10	A20	A40	A50	A70	C10 - C30	C20	E01
All engines					928 007				

E-TYPE 2+2

4.2	Petrol	127	05/68-04/75	ENGINE --, 8LC
-----	--------	-----	-------------	-------------------

Engine	Information	A10	A20	A40	A50	A70	C10 - C30	C20	E01
All engines					928 007				

4.2	Petrol	195	06/66-09/68	ENGINE --, 7L
-----	--------	-----	-------------	------------------

Engine	Information	A10	A20	A40	A50	A70	C10 - C30	C20	E01
All engines					928 007				

S-TYPE

3.4	Petrol	150	05/63-08/68	ENGINE --
-----	--------	-----	-------------	--------------

Engine	Information	A10	A20	A40	A50	A70	C10 - C30	C20	E01
All engines					928 007				

3.8	Petrol	164	05/63-08/68	ENGINE --
-----	--------	-----	-------------	--------------

Engine	Information	A10	A20	A40	A50	A70	C10 - C30	C20	E01
All engines					928 007				

XJ

12 6.0	Petrol	229	09/94-09/97	ENGINE 8E
--------	--------	-----	-------------	--------------

Engine	Information	A10	A20	A40	A50	A70	C10 - C30	C20	E01
All engines	Qty: 2						470 170	C10	

2.8	Petrol	132	10/68-10/73	ENGINE --
-----	--------	-----	-------------	--------------

Engine	Information	A10	A20	A40	A50	A70	C10 - C30	C20	E01
All engines					928 007				

3.6	Petrol	136	10/86-08/89	ENGINE 9DPANA
-----	--------	-----	-------------	------------------

Engine	Information	A10	A20	A40	A50	A70	C10 - C30	C20	E01
All engines	version Lucas			828 098	928 027R				

3.6	Petrol	146	01/88-05/91	ENGINE 9DPALA, 9DPANA
-----	--------	-----	-------------	--------------------------

Engine	Information	A10	A20	A40	A50	A70	C10 - C30	C20	E01
All engines	version Lucas			828 098	928 027R				

4.0	Petrol	163	05/91-09/94	ENGINE 9EPCNA
-----	--------	-----	-------------	------------------

Engine	Information	A10	A20	A40	A50	A70	C10 - C30	C20	E01
All engines	version Lucas			828 098	928 027R				

4.0	Petrol	166	10/89-08/94	ENGINE 9EPCNA
-----	--------	-----	-------------	------------------

Engine	Information	A10	A20	A40	A50	A70	C10 - C30	C20	E01
All engines	version Lucas			828 098	928 027R				

A10 CONDENSER	A20 CONTACT SET	A40 DISTRIBUTOR CAP	A50 ROTOR	A70 PICK-UP
C10 COIL	C20 IGNITION MODULE	C30 ELECTRONIC IGNITION KIT	E01 IGNITION CABLE SET	



Vehicle	alim.	kW	Date	Engine	FUNCTIONS ON THE VEHICLE									
					A10	A20	A40	A50	A70	C10 - C30	C20	E01		
ENGINE														
4.0	Petrol	171	07/94-03/96	9LPFRB										
ENGINE														
Engine	Information				A10	A20	A40	A50	A70	C10 - C30	C20	E01		
All engines	version Lucas						828 098	928 027R						
ENGINE														
4.0	Petrol	187	10/89-08/94	9EPCNA										
ENGINE														
Engine	Information				A10	A20	A40	A50	A70	C10 - C30	C20	E01		
All engines	version Lucas						828 098	928 027R						
ENGINE														
5.3	Petrol	207	05/91-08/93	8S (92-93)										
ENGINE														
Engine	Information				A10	A20	A40	A50	A70	C10 - C30	C20	E01		
All engines	version Marelli						830 110	930 058						
ENGINE														
62.8	Petrol	110	09/68-10/75	--										
ENGINE														
Engine	Information				A10	A20	A40	A50	A70	C10 - C30	C20	E01		
All engines								928 007						
ENGINE														
6 3.2 24V	Petrol	146	09/90-11/94	9BPMNA										
ENGINE														
Engine	Information				A10	A20	A40	A50	A70	C10 - C30	C20	E01		
All engines	version Lucas						828 098	928 027R						
ENGINE														
6 3.6	Petrol	145	10/86-08/89	9DPANA										
ENGINE														
Engine	Information				A10	A20	A40	A50	A70	C10 - C30	C20	E01		
All engines	version Lucas						828 098	928 027R						
ENGINE														
6 3.6	Petrol	156	10/86-08/89	9DPANA, AJ 6 (3.6, 156KW)										
ENGINE														
Engine	Information				A10	A20	A40	A50	A70	C10 - C30	C20	E01		
All engines	version Lucas						828 098	928 027R						
ENGINE														
6 4.0	Petrol	163	09/89-11/94	9EPCNA										
ENGINE														
Engine	Information				A10	A20	A40	A50	A70	C10 - C30	C20	E01		
All engines	version Lucas						828 098	928 027R						
ENGINE														
6 4.2	Petrol	137	10/69-05/75	XK 4.2 (-79)										
ENGINE														
Engine	Information				A10	A20	A40	A50	A70	C10 - C30	C20	E01		
All engines								928 007						
ENGINE														
6.0	Petrol	222	05/93-03/96	8D										
ENGINE														
Engine	Information				A10	A20	A40	A50	A70	C10 - C30	C20	E01		
All engines	version Marelli						830 110	930 058						
ENGINE														
V12 6.0	Petrol	229	03/93-11/94	8C (92-94)										
ENGINE														
Engine	Information				A10	A20	A40	A50	A70	C10 - C30	C20	E01		
All engines	version Marelli						830 110	930 058						
XJSC														
ENGINE														
3.6	Petrol	136	08/87-05/91	9DPANA										
ENGINE														
Engine	Information				A10	A20	A40	A50	A70	C10 - C30	C20	E01		
All engines	version Lucas						828 098	928 027R						
ENGINE														
3.6	Petrol	146	10/87-02/91	9DPALA, 9DPANA										
ENGINE														
Engine	Information				A10	A20	A40	A50	A70	C10 - C30	C20	E01		
All engines	version Lucas						828 098	928 027R						
ENGINE														
4.0	Petrol	163	05/91-09/94	9EPCNA										
ENGINE														
Engine	Information				A10	A20	A40	A50	A70	C10 - C30	C20	E01		
All engines	version Lucas						828 098	928 027R						

A10 CONDENSER	A20 CONTACT SET	A40 DISTRIBUTOR CAP	A50 ROTOR	A70 PICK-UP
C10 COIL	C20 IGNITION MODULE	C30 ELECTRONIC IGNITION KIT	E01 IGNITION CABLE SET	

Vehicle	alim.	kW	Date	Engine	FUNCTIONS ON THE VEHICLE									
					A10	A20	A40	A50	A70	C10 - C30	C20	E01		
ENGINE														
4.0	Petrol	171	07/94-03/96	9LPFRB										
ENGINE														
All engines														
Information														
version Lucas														
828 098														
928 027R														
5.3	Petrol	207	05/91-08/93	85 (92-93)										
ENGINE														
All engines														
Information														
version Marelli														
830 110														
930 058														
6.0	Petrol	222	05/93-03/96	8D										
ENGINE														
All engines														
Information														
version Marelli														
830 110														
930 058														
XK														
120	Petrol	118	01/50-10/54	--										
ENGINE														
All engines														
Information														
928 007														
120	Petrol	134	01/50-10/54	--										
ENGINE														
All engines														
Information														
928 007														
120	Petrol	157	01/50-10/54	--										
ENGINE														
All engines														
Information														
928 007														
150	Petrol	187	09/57-10/60	--										
ENGINE														
All engines														
Information														
928 007														
150	Petrol	198	09/57-10/60	--										
ENGINE														
All engines														
Information														
928 007														
150 S	Petrol	164	09/57-10/60	--										
ENGINE														
All engines														
Information														
928 007														

A10 CONDENSER	A20 CONTACT SET	A40 DISTRIBUTOR CAP	A50 ROTOR	A70 PICK-UP
C10 COIL	C20 IGNITION MODULE	C30 ELECTRONIC IGNITION KIT	E01 IGNITION CABLE SET	

The present application list is a brief version. For the detailed information about the possibility of installation on a specific vehicle, please refer to our web-catalogue <http://catalogo.facet.eu/>

					FUNCTIONS ON THE VEHICLE							
Vehicle	alim.	kW	Date	Engine								
					A10	A20	A40	A50	A70	C10 - C30	C20	E01

CHEROKEE II

					ENGINE							
2.5	Petrol	90	10/86-09/90	EPE								
Engine		Information			A10	A20	A40	A50	A70	C10 - C30	C20	E01
All engines		petrol injection								470 107	C10	
2.5 4x4	Petrol	90	10/86-09/90	EPE								
Engine		Information			A10	A20	A40	A50	A70	C10 - C30	C20	E01
All engines		petrol injection								470 107	C10	
4.0 i	Petrol	127	07/98-09/01	--								
Engine		Information			A10	A20	A40	A50	A70	C10 - C30	C20	E01
All engines		version Ford					819 093	919 092				
4.0 i	Petrol	130	10/86-09/90	1Z7K								
Engine		Information			A10	A20	A40	A50	A70	C10 - C30	C20	E01
All engines		version Ford					819 093	919 092				
All engines										470 107	C10	
4.0 i	Petrol	135	12/91-09/01	MX								
Engine		Information			A10	A20	A40	A50	A70	C10 - C30	C20	E01
All engines		version Ford					819 093	919 092				
4.0 i	Petrol	136	01/88-09/01	ERH								
Engine		Information			A10	A20	A40	A50	A70	C10 - C30	C20	E01
All engines		version Ford					819 093	919 092				
All engines										470 107	C10	
4.0 i 4x4	Petrol	131	01/95-09/01	ERH								
Engine		Information			A10	A20	A40	A50	A70	C10 - C30	C20	E01
All engines		version Ford					819 093	919 092				

COMANCHE

					ENGINE							
2.5	Petrol	90	10/86-09/90	EPE								
Engine		Information			A10	A20	A40	A50	A70	C10 - C30	C20	E01
All engines		petrol injection								470 107	C10	
4.0 i	Petrol	130	10/87-09/90	1Z7K								
Engine		Information			A10	A20	A40	A50	A70	C10 - C30	C20	E01
All engines		version Ford					819 093	919 092				
All engines										470 107	C10	

COMPASS

					ENGINE							
1.4 MultiAir	Petrol	103	03/17->	EAQ(55263624)								
Engine		Information			A10	A20	A40	A50	A70	C10 - C30	C20	E01
All engines		x 4, PLUG ON PLUG								470 549	C10	
1.4 MultiAir Trazione integrale	Petrol	125	03/17->	EAQ(55263623)								
Engine		Information			A10	A20	A40	A50	A70	C10 - C30	C20	E01
All engines		x 4, COIL ON PLUG								470 549	C10	

GRAND CHEROKEE

					ENGINE							
4.0 Laredo	Petrol	131	10/96-09/98	ERH								
Engine		Information			A10	A20	A40	A50	A70	C10 - C30	C20	E01
All engines		version Ford					819 093					
5.2	Petrol	164	10/96-09/98	ELF								
Engine		Information			A10	A20	A40	A50	A70	C10 - C30	C20	E01
All engines												358 181

A10 CONDENSER	A20 CONTACT SET	A40 DISTRIBUTOR CAP	A50 ROTOR	A70 PICK-UP
C10 COIL	C20 IGNITION MODULE	C30 ELECTRONIC IGNITION KIT	E01 IGNITION CABLE SET	

Vehicle	alim.	kW	Date	Engine	FUNCTIONS ON THE VEHICLE							
					A10	A20	A40	A50	A70	C10 - C30	C20	E01
5.2 4x4												
ENGINE												
Petrol 164 10/96-09/98 ELF												
Engine	Information				A10	A20	A40	A50	A70	C10 - C30	C20	E01
All engines												358 181
GRAND WAGONEER												
4.0 i												
Petrol 130 10/86-09/90 1Z7K												
Engine	Information				A10	A20	A40	A50	A70	C10 - C30	C20	E01
All engines	version Ford						819 093	919 092				
All engines										470 107	C10	
RENEGADE												
1.4												
Petrol 100 01/16-> 552 63 624												
Engine	Information				A10	A20	A40	A50	A70	C10 - C30	C20	E01
All engines	->year 01/11/16, x 4, COIL ON PLUG ----- production date 2019 ->, x 4, COIL ON PLUG									470 549	C10	
ENGINE												
Petrol 103 07/14-> EAM, EAM(55263624)												
Engine	Information				A10	A20	A40	A50	A70	C10 - C30	C20	E01
Eng. EAM	Qty: 4									470 549	C10	
Eng. EAM(55263624)	->year 01/11/14, 01/12/14 ->, ->year 01/11/16, x 4, COIL ON PLUG, x 4, COIL ON PLUG ----- production date 2019 ->, x 4, COIL ON PLUG									470 549	C10	
ENGINE												
Petrol 125 07/14-> EAM, EAM(55263623)												
Engine	Information				A10	A20	A40	A50	A70	C10 - C30	C20	E01
Eng. EAM	Qty: 4									470 549	C10	
Eng. EAM(55263623)	->year 01/11/14, 01/12/14 ->, ->year 01/11/16, x 4, COIL ON PLUG, x 4, COIL ON PLUG ----- production date 2019 ->, x 4, COIL ON PLUG									470 549	C10	
WAGONEER												
2.5												
Petrol 90 10/86-09/90 EPE												
Engine	Information				A10	A20	A40	A50	A70	C10 - C30	C20	E01
All engines	petrol injection									470 107	C10	
ENGINE												
Petrol 130 10/86-09/90 1Z7K												
Engine	Information				A10	A20	A40	A50	A70	C10 - C30	C20	E01
All engines	version Ford						819 093	919 092				
All engines										470 107	C10	
WRANGLER												
2.5												
Petrol 89 12/91-08/96 EPE												
Engine	Information				A10	A20	A40	A50	A70	C10 - C30	C20	E01
All engines	version Ford							919 092				
ENGINE												
Petrol 130 10/86-09/90 1Z7K												
Engine	Information				A10	A20	A40	A50	A70	C10 - C30	C20	E01
All engines	version Ford						819 093	919 092				
All engines										470 107	C10	
ENGINE												
Petrol 131 10/90-09/96 1Z7K, ERH												
Engine	Information				A10	A20	A40	A50	A70	C10 - C30	C20	E01
All engines	version Ford						819 093					
Eng. ERH	version Ford							919 092				

A10 CONDENSER	A20 CONTACT SET	A40 DISTRIBUTOR CAP	A50 ROTOR	A70 PICK-UP
C10 COIL	C20 IGNITION MODULE	C30 ELECTRONIC IGNITION KIT	E01 IGNITION CABLE SET	

Vehicle	alim.	kW	Date	Engine	FUNCTIONS ON THE VEHICLE							
					A10	A20	A40	A50	A70	C10 - C30	C20	E01

GT

				ENGINE
2.0	Petrol	104	06/75-12/76	--

Engine	Information	A10	A20	A40	A50	A70	C10 - C30	C20	E01
All engines				828 075	928 006				

HEALEY

				ENGINE
2.0	Petrol	104	01/72-12/75	--

Engine	Information	A10	A20	A40	A50	A70	C10 - C30	C20	E01
All engines				828 075	928 006				

A10	CONDENSER	A20	CONTACT SET	A40	DISTRIBUTOR CAP	A50	ROTOR	A70	PICK-UP
C10	COIL	C20	IGNITION MODULE	C30	ELECTRONIC IGNITION KIT	E01	IGNITION CABLE SET		

Vehicle	alim.	kW	Date	Engine	FUNCTIONS ON THE VEHICLE							
					A10	A20	A40	A50	A70	C10 - C30	C20	E01

AVELLA

1.3	Petrol	55	11/95-12/01	ENGINE B3
-----	--------	----	-------------	--------------

Engine	Information	A10	A20	A40	A50	A70	C10 - C30	C20	E01
All engines	version Mitsubishi			831 121					

1.5	Petrol	55	02/97-12/01	ENGINE --
-----	--------	----	-------------	--------------

Engine	Information	A10	A20	A40	A50	A70	C10 - C30	C20	E01
All engines	version Mitsubishi			831 121					

BORREGO

3.8	Petrol	202	06/08-12/13	ENGINE --
-----	--------	-----	-------------	--------------

Engine	Information	A10	A20	A40	A50	A70	C10 - C30	C20	E01
All engines	Qty: 6						470 492	C10	

4.6	Petrol	250	09/08-12/11	ENGINE G8BA
-----	--------	-----	-------------	----------------

Engine	Information	A10	A20	A40	A50	A70	C10 - C30	C20	E01
All engines	Qty: 8						470 556	C10	

CADENZA

3.5 CVT	Petrol	213	01/10->	ENGINE G6DC
---------	--------	-----	---------	----------------

Engine	Information	A10	A20	A40	A50	A70	C10 - C30	C20	E01
All engines	Qty: 6						470 492	C10	

CARENS I

1.6	Petrol	77	07/02->	ENGINE GA6D
-----	--------	----	---------	----------------

Engine	Information	A10	A20	A40	A50	A70	C10 - C30	C20	E01
All engines									358 239

1.8	Petrol	93	07/02->	ENGINE TB
-----	--------	----	---------	--------------

Engine	Information	A10	A20	A40	A50	A70	C10 - C30	C20	E01
All engines									360 841

1.8 i	Petrol	81	11/00-07/02	ENGINE T8
-------	--------	----	-------------	--------------

Engine	Information	A10	A20	A40	A50	A70	C10 - C30	C20	E01
All engines									360 841

2.0 CVT	Petrol	102	08/04->	ENGINE G4GC
---------	--------	-----	---------	----------------

Engine	Information	A10	A20	A40	A50	A70	C10 - C30	C20	E01
All engines	x 1, D.I.S.						470 581	C10	
All engines									360 385

CARENS II

1.6 CVT	Petrol	93	10/10->	ENGINE G4FC
---------	--------	----	---------	----------------

Engine	Information	A10	A20	A40	A50	A70	C10 - C30	C20	E01
All engines	x 4, COIL ON PLUG						470 543	C10	

1.6 CVT	Petrol	97	08/09->	ENGINE G4FC
---------	--------	----	---------	----------------

Engine	Information	A10	A20	A40	A50	A70	C10 - C30	C20	E01
All engines	x 4, COIL ON PLUG						470 543	C10	

2.0 CVT	Petrol	106	09/06->	ENGINE G4KA
---------	--------	-----	---------	----------------

Engine	Information	A10	A20	A40	A50	A70	C10 - C30	C20	E01
All engines	x 4, COIL ON PLUG						470 492	C10	

CARENS III

1.6 GDi	Petrol	99	03/13->	ENGINE G4FD
---------	--------	----	---------	----------------

Engine	Information	A10	A20	A40	A50	A70	C10 - C30	C20	E01
All engines	x 4, COIL ON PLUG						470 611	C10	

A10 CONDENSER	A20 CONTACT SET	A40 DISTRIBUTOR CAP	A50 ROTOR	A70 PICK-UP
C10 COIL	C20 IGNITION MODULE	C30 ELECTRONIC IGNITION KIT	E01 IGNITION CABLE SET	

The present application list is a brief version. For the detailed information about the possibility of installation on a specific vehicle, please refer to our web-catalogue <http://catalogo.facet.eu/>

Vehicle	alim.	kW	Date	Engine	FUNCTIONS ON THE VEHICLE							
					A10	A20	A40	A50	A70	C10 - C30	C20	E01

CEED I				ENGINE
1.4	Petrol	77	12/06-12/12	G4FA

Engine	Information	A10	A20	A40	A50	A70	C10 - C30	C20	E01
All engines	->year 01/01/09, x 4, COIL ON PLUG						470 495	C10	
All engines	01/02/09->, x 4, COIL ON PLUG, x 4, COIL ON PLUG						470 543	C10	

CEED I				ENGINE
1.4	Petrol	80	12/06-12/12	G4FA

Engine	Information	A10	A20	A40	A50	A70	C10 - C30	C20	E01
All engines	->year 01/01/09, x 4, COIL ON PLUG						470 495	C10	
All engines	01/02/09->, x 4, COIL ON PLUG						470 543	C10	

CEED I				ENGINE
1.4 CVT	Petrol	66	07/09-12/12	G4FA, G4FA-L

Engine	Information	A10	A20	A40	A50	A70	C10 - C30	C20	E01
Eng. G4FA	x 4, COIL ON PLUG						470 543	C10	
Eng. G4FA-L	Qty: 4						470 543	C10	

CEED I				ENGINE
1.4 LPG	Petrol/ Liquified Petro- leum Gas (LPG)	64	06/11-04/12	G4FA

Engine	Information	A10	A20	A40	A50	A70	C10 - C30	C20	E01
All engines	x 4, COIL ON PLUG						470 543	C10	

CEED I				ENGINE
1.4 LPG	Petrol/ Liquified Petro- leum Gas (LPG)	80	01/09-12/10	G4FA

Engine	Information	A10	A20	A40	A50	A70	C10 - C30	C20	E01
All engines	x 4, COIL ON PLUG						470 543	C10	

CEED I				ENGINE
1.6	Petrol	85	09/07-12/12	G4FC

Engine	Information	A10	A20	A40	A50	A70	C10 - C30	C20	E01
All engines	->year 01/03/09, x 4, COIL ON PLUG						470 495	C10	
All engines	01/04/09->, x 4, COIL ON PLUG						470 543	C10	

CEED I				ENGINE
1.6	Petrol	90	12/06-12/12	G4FC

Engine	Information	A10	A20	A40	A50	A70	C10 - C30	C20	E01
All engines	x 4, COIL ON PLUG						470 543	C10	

CEED I				ENGINE
1.6	Petrol	93	09/07-12/12	G4FC

Engine	Information	A10	A20	A40	A50	A70	C10 - C30	C20	E01
All engines	x 4, COIL ON PLUG						470 543	C10	

CEED I				ENGINE
1.6 CVT	Petrol	92	06/09-12/12	G4FC

Engine	Information	A10	A20	A40	A50	A70	C10 - C30	C20	E01
All engines	x 4, COIL ON PLUG						470 543	C10	

CEED I				ENGINE
1.6 LPG	Petrol/ Liquified Petro- leum Gas (LPG)	87	06/11-12/11	G4FC

Engine	Information	A10	A20	A40	A50	A70	C10 - C30	C20	E01
All engines	x 4, COIL ON PLUG						470 543	C10	

CEED I				ENGINE
1.6 LPG	Petrol/ Liquified Petro- leum Gas (LPG)	91	06/07-09/12	G4FC

Engine	Information	A10	A20	A40	A50	A70	C10 - C30	C20	E01
All engines	->year 01/03/09, x 4, COIL ON PLUG						470 495	C10	
All engines	01/04/09->, x 4, COIL ON PLUG, x 4, COIL ON PLUG						470 543	C10	

A10 CONDENSER	A20 CONTACT SET	A40 DISTRIBUTOR CAP	A50 ROTOR	A70 PICK-UP
C10 COIL	C20 IGNITION MODULE	C30 ELECTRONIC IGNITION KIT	E01 IGNITION CABLE SET	

Vehicle	alim.	kW	Date	Engine	FUNCTIONS ON THE VEHICLE							
					A10	A20	A40	A50	A70	C10 - C30	C20	E01

				ENGINE
2.0	Petrol	105	12/06-12/12	G4GC

Engine	Information	A10	A20	A40	A50	A70	C10 - C30	C20	E01
All engines	x 1, D.I.S.						470 581	C10	
All engines									360 385

				ENGINE
1.0 T-GDI	Petrol	74	04/15-07/18	G3LC

Engine	Information	A10	A20	A40	A50	A70	C10 - C30	C20	E01
All engines	x 3, COIL ON PLUG						470 638	C10	

				ENGINE
1.0 T-GDI	Petrol	88	04/15-07/18	G3LC

Engine	Information	A10	A20	A40	A50	A70	C10 - C30	C20	E01
All engines	x 3, COIL ON PLUG						470 638	C10	

				ENGINE
1.4 CVVT	Petrol	66	05/12-07/18	G4FA, G4FA-L

Engine	Information	A10	A20	A40	A50	A70	C10 - C30	C20	E01
Eng. G4FA	x 4, COIL ON PLUG						470 543	C10	
Eng. G4FA-L	Qty: 4						470 543	C10	

				ENGINE
1.4 CVVT	Petrol	73	05/12-07/18	G4FA

Engine	Information	A10	A20	A40	A50	A70	C10 - C30	C20	E01
All engines	x 4, COIL ON PLUG						470 543	C10	

				ENGINE
1.4 LPG	Petrol/ Liquified Petro- leum Gas (LPG)	72	05/12-07/18	G4FA

Engine	Information	A10	A20	A40	A50	A70	C10 - C30	C20	E01
All engines	x 4, COIL ON PLUG						470 543	C10	

				ENGINE
1.4 MPI	Petrol	74	04/15-07/18	G4LC

Engine	Information	A10	A20	A40	A50	A70	C10 - C30	C20	E01
All engines	x 4, COIL ON PLUG						470 622	C10	

				ENGINE
1.6 CVVT	Petrol	92	05/12->	G4FC

Engine	Information	A10	A20	A40	A50	A70	C10 - C30	C20	E01
All engines	Qty: 4						470 543	C10	

				ENGINE
1.6 CVVT	Petrol	95	01/13-07/18	G4FC

Engine	Information	A10	A20	A40	A50	A70	C10 - C30	C20	E01
All engines	x 4, COIL ON PLUG						470 543	C10	

				ENGINE
1.6 CVVT	Petrol	96	11/14-07/18	G4FC

Engine	Information	A10	A20	A40	A50	A70	C10 - C30	C20	E01
All engines	x 4, COIL ON PLUG						470 543	C10	

				ENGINE
1.6 GDI	Petrol	99	05/12-07/18	G4FD

Engine	Information	A10	A20	A40	A50	A70	C10 - C30	C20	E01
All engines	x 4, COIL ON PLUG						470 611	C10	

				ENGINE
1.0 T-GDI	Petrol	74	09/19->	G3LC

Engine	Information	A10	A20	A40	A50	A70	C10 - C30	C20	E01
All engines	x 3, COIL ON PLUG						470 638	C10	

				ENGINE
1.0 T-GDI	Petrol	88	03/18->	G3LC

Engine	Information	A10	A20	A40	A50	A70	C10 - C30	C20	E01
All engines	x 3, COIL ON PLUG						470 638	C10	

A10	CONDENSER	A20	CONTACT SET	A40	DISTRIBUTOR CAP	A50	ROTOR	A70	PICK-UP
C10	COIL	C20	IGNITION MODULE	C30	ELECTRONIC IGNITION KIT	E01	IGNITION CABLE SET		

The present application list is a brief version. For the detailed information about the possibility of installation on a specific vehicle, please refer to our web-catalogue <http://catalogo.facet.eu/>

					FUNCTIONS ON THE VEHICLE							
Vehicle	alim.	kW	Date	Engine	A10	A20	A40	A50	A70	C10 - C30	C20	E01
ENGINE												
1.4	Petrol	73	03/18->	G4LC								
ENGINE												
Engine		Information			A10	A20	A40	A50	A70	C10 - C30	C20	E01
All engines		x 4, COIL ON PLUG								470 622	C10	
ENGINE												
1.4 LPG	Petrol/ Liquified Petro- leum Gas (LPG)	71	12/18->	G4LC								
ENGINE												
Engine		Information			A10	A20	A40	A50	A70	C10 - C30	C20	E01
All engines		x 4, COIL ON PLUG								470 622	C10	
ENGINE												
1.6	Petrol	94	03/18->	G4FG								
ENGINE												
Engine		Information			A10	A20	A40	A50	A70	C10 - C30	C20	E01
All engines		x 4, COIL ON PLUG								470 543	C10	
ENGINE												
1.6 GDI Hybrid	Petrol/ Electric	104	12/19->	G4LE								
ENGINE												
Engine		Information			A10	A20	A40	A50	A70	C10 - C30	C20	E01
All engines		x 4, COIL ON PLUG								470 647	C10	
ENGINE												
1.6 GDI Hybrid	Petrol/ Electric	77	12/19->	G4LE								
ENGINE												
Engine		Information			A10	A20	A40	A50	A70	C10 - C30	C20	E01
All engines		x 4, COIL ON PLUG								470 647	C10	
ENGINE												
GDI Hybrid	Petrol/ Electric	104	12/19->	G4LE								
ENGINE												
Engine		Information			A10	A20	A40	A50	A70	C10 - C30	C20	E01
All engines		x 4, COIL ON PLUG								470 647	C10	
ENGINE												
GDI Hybrid	Petrol/ Electric	77	12/19->	G4LE								
ENGINE												
Engine		Information			A10	A20	A40	A50	A70	C10 - C30	C20	E01
All engines		x 4, COIL ON PLUG								470 647	C10	
ENGINE												
T-GDI	Petrol	88	03/18->	G3LC								
ENGINE												
Engine		Information			A10	A20	A40	A50	A70	C10 - C30	C20	E01
All engines		x 3, COIL ON PLUG								470 638	C10	
ENGINE												
2.0 CVT	Petrol	110	07/09-02/14	G4KD								
ENGINE												
Engine		Information			A10	A20	A40	A50	A70	C10 - C30	C20	E01
All engines		x 4, COIL ON PLUG								470 556	C10	
ENGINE												
1.6	Petrol	77	04/04-12/09	G4ED								
ENGINE												
Engine		Information			A10	A20	A40	A50	A70	C10 - C30	C20	E01
All engines		01/11/06 ->, x 4, COIL ON PLUG								470 495	C10	
All engines		->year 01/10/06, x 1, D.I.S.								470 586	C10	
All engines												358 111
ENGINE												
1.6	Petrol	90	04/04->	G4FC, G4GR								
ENGINE												
Engine		Information			A10	A20	A40	A50	A70	C10 - C30	C20	E01
All engines		x 4, COIL ON PLUG								470 495	C10	
Eng. G4FC		->year 25/01/08, Qty: 4								470 495	C10	
Eng. G4FC		25/01/08 ->, Qty: 4								470 543	C10	
ENGINE												
2.0	Petrol	105	03/04-05/07	G4GC								
ENGINE												
Engine		Information			A10	A20	A40	A50	A70	C10 - C30	C20	E01
All engines		x 1, D.I.S.								470 581	C10	
All engines												360 385

A10 CONDENSER	A20 CONTACT SET	A40 DISTRIBUTOR CAP	A50 ROTOR	A70 PICK-UP
C10 COIL	C20 IGNITION MODULE	C30 ELECTRONIC IGNITION KIT	E01 IGNITION CABLE SET	

Vehicle	alim.	kW	Date	Engine	FUNCTIONS ON THE VEHICLE							
					A10	A20	A40	A50	A70	C10 - C30	C20	E01

CERATO II

1.6	Petrol	90	01/10->	ENGINE G4FC
-----	--------	----	---------	----------------

Engine	Information	A10	A20	A40	A50	A70	C10 - C30	C20	E01
All engines	x 4, COIL ON PLUG						470 556	C10	

1.6	Petrol	93	01/10-06/13	ENGINE G4FC
-----	--------	----	-------------	----------------

Engine	Information	A10	A20	A40	A50	A70	C10 - C30	C20	E01
All engines	x 4, COIL ON PLUG						470 543	C10	

1.6 CVVT	Petrol	91	02/09->	ENGINE G4FC
----------	--------	----	---------	----------------

Engine	Information	A10	A20	A40	A50	A70	C10 - C30	C20	E01
All engines	Qty: 4						470 543	C10	
All engines	x 4, COIL ON PLUG						470 543	C10	

1.6 CVVT	Petrol	93	01/10-06/13	ENGINE G4FC
----------	--------	----	-------------	----------------

Engine	Information	A10	A20	A40	A50	A70	C10 - C30	C20	E01
All engines	x 4, COIL ON PLUG						470 543	C10	

2.0	Petrol	115	01/09->	ENGINE G4KD
-----	--------	-----	---------	----------------

Engine	Information	A10	A20	A40	A50	A70	C10 - C30	C20	E01
All engines	x 4, COIL ON PLUG						470 556	C10	

2.0	Petrol	116	07/10->	ENGINE G4KD
-----	--------	-----	---------	----------------

Engine	Information	A10	A20	A40	A50	A70	C10 - C30	C20	E01
All engines	Qty: 4						470 556	C10	

2.0 CVVT	Petrol	110	07/09-06/13	ENGINE G4KD
----------	--------	-----	-------------	----------------

Engine	Information	A10	A20	A40	A50	A70	C10 - C30	C20	E01
All engines	x 4, COIL ON PLUG						470 556	C10	

2.0 CVVT	Petrol	115	01/09->	ENGINE --, G4KD
----------	--------	-----	---------	--------------------

Engine	Information	A10	A20	A40	A50	A70	C10 - C30	C20	E01
Eng. G4KD	x 4, COIL ON PLUG						470 556	C10	
Eng. --							470 581	C10	360 385

CERATO III

1.6	Petrol	91	07/12->	ENGINE --
-----	--------	----	---------	--------------

Engine	Information	A10	A20	A40	A50	A70	C10 - C30	C20	E01
All engines	no specific info conc. application available, Qty: 4						470 543	C10	

1.6 CVVT	Petrol	95	07/16->	ENGINE G4FC
----------	--------	----	---------	----------------

Engine	Information	A10	A20	A40	A50	A70	C10 - C30	C20	E01
All engines	x 4, COIL ON PLUG						470 543	C10	

1.6 MPi	Petrol	96	06/13->	ENGINE G4FG
---------	--------	----	---------	----------------

Engine	Information	A10	A20	A40	A50	A70	C10 - C30	C20	E01
All engines	x 4, COIL ON PLUG						470 543	C10	

CLARUS

1.8 i 16V	Petrol	85	07/96->	ENGINE T8
-----------	--------	----	---------	--------------









Engine	Information	A10	A20	A40	A50	A70	C10 - C30	C20	E01
All engines									360 841

2.0 i 16V	Petrol	98	07/96->	ENGINE FE (16V)
-----------	--------	----	---------	--------------------

Engine	Information	A10	A20	A40	A50	A70	C10 - C30	C20	E01
All engines	version Mitsubishi			831 121					

A10 CONDENSER	A20 CONTACT SET	A40 DISTRIBUTOR CAP	A50 ROTOR	A70 PICK-UP
C10 COIL	C20 IGNITION MODULE	C30 ELECTRONIC IGNITION KIT	E01 IGNITION CABLE SET	

The present application list is a brief version. For the detailed information about the possibility of installation on a specific vehicle, please refer to our web-catalogue <http://catalogo.facet.eu/>

					FUNCTIONS ON THE VEHICLE								
Vehicle	alim.	kW	Date	Engine	 A10	 A20	 A40	 A50	 A70	 C10 - C30	 C20	 E01	
FORTE													
1.6	Petrol	91	07/12->	ENGINE									
All engines					no specific info conc. application available, Qty: 4								
					A10	A20	A40	A50	A70	C10 - C30	C20	E01	
										470 543	C10		
JOICE													
2.0	Petrol	102	02/00->	ENGINE									
All engines													
					A10	A20	A40	A50	A70	C10 - C30	C20	E01	
												360 401	
2.0	Petrol	88	09/01->	ENGINE									
All engines													
					A10	A20	A40	A50	A70	C10 - C30	C20	E01	
												360 401	
MAGENTIS I													
2.0	Petrol	100	05/01-09/05	ENGINE									
All engines													
					A10	A20	A40	A50	A70	C10 - C30	C20	E01	
												358 241	
2.4 [USA]	Petrol	0	01/01-12/04	ENGINE									
All engines													
					A10	A20	A40	A50	A70	C10 - C30	C20	E01	
												358 241	
MAGENTIS II													
2.0	Petrol	100	09/06->	ENGINE									
All engines					Qty: 4								
					A10	A20	A40	A50	A70	C10 - C30	C20	E01	
										470 492	C10		
2.0	Petrol	106	11/05-12/10	ENGINE									
All engines					x 4, COIL ON PLUG								
					A10	A20	A40	A50	A70	C10 - C30	C20	E01	
										470 492	C10		
2.0	Petrol	121	09/09-12/10	ENGINE									
All engines					x 4, COIL ON PLUG								
					A10	A20	A40	A50	A70	C10 - C30	C20	E01	
										470 556	C10		
MOHAVE													
3.8	Petrol	202	12/08->	ENGINE									
All engines					Qty: 6								
					A10	A20	A40	A50	A70	C10 - C30	C20	E01	
										470 492	C10		
4.6	Petrol	251	09/08->	ENGINE									
All engines					Qty: 8								
					A10	A20	A40	A50	A70	C10 - C30	C20	E01	
										470 556	C10		
NIRO													
1.6 GDI Hybrid	Petrol/ Electric	104	09/16->	ENGINE									
All engines					x 4, COIL ON PLUG								
					A10	A20	A40	A50	A70	C10 - C30	C20	E01	
										470 647	C10		
1.6 GDI Hybrid	Petrol/ Electric	107	09/16->	ENGINE									
All engines					x 4, COIL ON PLUG								
					A10	A20	A40	A50	A70	C10 - C30	C20	E01	
										470 647	C10		
1.6 GDI Hybrid	Petrol/ Electric	77	09/16->	ENGINE									
All engines					x 4, COIL ON PLUG								
					A10	A20	A40	A50	A70	C10 - C30	C20	E01	
										470 647	C10		

A10 CONDENSER	A20 CONTACT SET	A40 DISTRIBUTOR CAP	A50 ROTOR	A70 PICK-UP
C10 COIL	C20 IGNITION MODULE	C30 ELECTRONIC IGNITION KIT	E01 IGNITION CABLE SET	

Vehicle	alim.	kW	Date	Engine	FUNCTIONS ON THE VEHICLE							
					A10	A20	A40	A50	A70	C10 - C30	C20	E01
GDI Hybrid												
	Petrol/ Electric	77	09/16->	ENGINE G4LE								
	Engine	Information			A10	A20	A40	A50	A70	C10 - C30	C20	E01
	All engines	x 4, COIL ON PLUG								470 647	C10	
OPIRUS												
3.8 V6	Petrol	196	10/06->	ENGINE G6DA								
	Engine	Information			A10	A20	A40	A50	A70	C10 - C30	C20	E01
	All engines	x 6, COIL ON PLUG								470 492	C10	
OPTIMA II												
2.0	Petrol	106	05/08->	ENGINE G4KA								
	Engine	Information			A10	A20	A40	A50	A70	C10 - C30	C20	E01
	All engines	Qty: 4								470 492	C10	
OPTIMA III												
2.0	Petrol	121	03/10->	ENGINE --								
	Engine	Information			A10	A20	A40	A50	A70	C10 - C30	C20	E01
	All engines	Qty: 4								470 556	C10	
2.0	Petrol	125	03/12->	ENGINE G4KD								
	Engine	Information			A10	A20	A40	A50	A70	C10 - C30	C20	E01
	All engines	Optima, x 4, COIL ON PLUG								470 556	C10	
2.0 CVVL	Petrol	121	03/12->	ENGINE G4KD								
	Engine	Information			A10	A20	A40	A50	A70	C10 - C30	C20	E01
	All engines	Optima, x 4, COIL ON PLUG								470 556	C10	
2.0 CVVT	Petrol	110	01/11-12/15	ENGINE G4KD								
	Engine	Information			A10	A20	A40	A50	A70	C10 - C30	C20	E01
	All engines	Optima, x 4, COIL ON PLUG								470 556	C10	
2.4	Petrol	129	06/10-12/15	ENGINE G4KC								
	Engine	Information			A10	A20	A40	A50	A70	C10 - C30	C20	E01
	All engines	Optima, x 4, COIL ON PLUG								470 556	C10	
2.4	Petrol	132	03/10->	ENGINE --, G4KE, G4KJ								
	Engine	Information			A10	A20	A40	A50	A70	C10 - C30	C20	E01
	Eng. --	Qty: 4								470 556	C10	
	Eng. G4KE, G4KJ	Optima, x 4, COIL ON PLUG								470 556	C10	
2.4	Petrol	149	09/10->	ENGINE G4KJ								
	Engine	Information			A10	A20	A40	A50	A70	C10 - C30	C20	E01
	All engines	Qty: 4								470 556	C10	
2.4 CVVT	Petrol	132	01/12->	ENGINE G4KE, G4KJ								
	Engine	Information			A10	A20	A40	A50	A70	C10 - C30	C20	E01
	All engines	Optima, x 4, COIL ON PLUG								470 556	C10	
2.4 Hybrid	Petrol/ Electric	154	09/11->	ENGINE G4KC								
	Engine	Information			A10	A20	A40	A50	A70	C10 - C30	C20	E01
	All engines	Qty: 4								470 556	C10	
OPTIMA IV												
2.4 MPi	Petrol	126	09/15->	ENGINE G4KE								
	Engine	Information			A10	A20	A40	A50	A70	C10 - C30	C20	E01
	All engines	Optima, x 4, COIL ON PLUG								470 556	C10	

A10	CONDENSER	A20	CONTACT SET	A40	DISTRIBUTOR CAP	A50	ROTOR	A70	PICK-UP
C10	COIL	C20	IGNITION MODULE	C30	ELECTRONIC IGNITION KIT	E01	IGNITION CABLE SET		

The present application list is a brief version. For the detailed information about the possibility of installation on a specific vehicle, please refer to our web-catalogue <http://catalogo.facet.eu/>

Vehicle	alim.	kW	Date	Engine	FUNCTIONS ON THE VEHICLE							
					A10	A20	A40	A50	A70	C10 - C30	C20	E01

PICANTO I

1.0	Petrol	45	04/04-04/11	ENGINE G4HE
-----	--------	----	-------------	----------------

Engine	Information	A10	A20	A40	A50	A70	C10 - C30	C20	E01
All engines	01/10/06 ->, Fitting Position:for cylinder 2, Fitting Position:for cylinder 3, x 1, D.I.S.						470 580	C10	
All engines	01/10/06 ->, Fitting Position:for cylinder 1, Fitting Position:for cylinder 4, x 1, D.I.S.						470 587	C10	
All engines	->year 01/09/06, Fitting Position:for cylinder 1-4, x 1, D.I.S.						470 589	C10	
All engines									358 119

1.0	Petrol	46	09/07-04/11	ENGINE G4HE
-----	--------	----	-------------	----------------

Engine	Information	A10	A20	A40	A50	A70	C10 - C30	C20	E01
All engines	Fitting Position:for cylinder 2, Fitting Position:for cylinder 3, x 1, D.I.S.						470 580	C10	
All engines	Fitting Position:for cylinder 1, Fitting Position:for cylinder 4, x 1, D.I.S.						470 587	C10	
All engines									358 235

1.0 LPG	Petrol/ Liquified Petro- leum Gas (LPG)	45	01/09-04/11	ENGINE G4HE
---------	---	----	-------------	----------------

Engine	Information	A10	A20	A40	A50	A70	C10 - C30	C20	E01
All engines	Fitting Position:for cylinder 2, Fitting Position:for cylinder 3, x 1, D.I.S.						470 580	C10	
All engines	Fitting Position:for cylinder 1, Fitting Position:for cylinder 4, x 1, D.I.S.						470 587	C10	

1.1	Petrol	48	04/04-09/11	ENGINE G4HG
-----	--------	----	-------------	----------------

Engine	Information	A10	A20	A40	A50	A70	C10 - C30	C20	E01
All engines	01/10/06 ->, Fitting Position:for cylinder 2, Fitting Position:for cylinder 3, x 1, D.I.S.						470 580	C10	
All engines	01/10/06 ->, Fitting Position:for cylinder 1, Fitting Position:for cylinder 4, x 1, D.I.S.						470 587	C10	
All engines	->year 01/09/06, Fitting Position:for cylinder 1-4, x 1, D.I.S.						470 589	C10	
All engines									358 119

1.1	Petrol	71	08/07->	ENGINE --
-----	--------	----	---------	--------------

Engine	Information	A10	A20	A40	A50	A70	C10 - C30	C20	E01
All engines	no specific info conc. application available						470 580, 470 587	C10	
All engines	Kit						470 589	C10	
All engines									358 235

1.1 LPG	Petrol/ Liquified Petro- leum Gas (LPG)	48	01/09-04/11	ENGINE G4HG
---------	---	----	-------------	----------------

Engine	Information	A10	A20	A40	A50	A70	C10 - C30	C20	E01
All engines	Fitting Position:for cylinder 2, Fitting Position:for cylinder 3, x 1, D.I.S.						470 580	C10	
All engines	Fitting Position:for cylinder 1, Fitting Position:for cylinder 4, x 1, D.I.S.						470 587	C10	

PICANTO II

1.0	Petrol	49	05/11-03/17	ENGINE G3LA
-----	--------	----	-------------	----------------









Engine	Information	A10	A20	A40	A50	A70	C10 - C30	C20	E01
All engines	x 3, COIL ON PLUG						470 614	C10	

1.0	Petrol	51	05/11-03/17	ENGINE G3LA
-----	--------	----	-------------	----------------

Engine	Information	A10	A20	A40	A50	A70	C10 - C30	C20	E01
All engines	x 3, COIL ON PLUG						470 614	C10	

A10 CONDENSER	A20 CONTACT SET	A40 DISTRIBUTOR CAP	A50 ROTOR	A70 PICK-UP
C10 COIL	C20 IGNITION MODULE	C30 ELECTRONIC IGNITION KIT	E01 IGNITION CABLE SET	

Vehicle	alim.	kW	Date	Engine	FUNCTIONS ON THE VEHICLE									
					A10	A20	A40	A50	A70	C10 - C30	C20	E01		
ENGINE														
1.0 Bi-Fuel	Petrol/ Liquified Petro- leum Gas (LPG)	60	05/11-10/14	B3LA										
Engine	Information				A10	A20	A40	A50	A70	C10 - C30	C20	E01		
All engines	x 3, COIL ON PLUG									470 614	C10			
ENGINE														
1.0 LPG	Petrol/ Liquified Petro- leum Gas (LPG)	49	08/13-03/17	B3LA										
Engine	Information				A10	A20	A40	A50	A70	C10 - C30	C20	E01		
All engines	x 3, COIL ON PLUG									470 614	C10			
ENGINE														
1.2	Petrol	63	09/11-03/17	G4LA										
Engine	Information				A10	A20	A40	A50	A70	C10 - C30	C20	E01		
All engines	x 1, -start-stop function, D.I.S.									470 579	C10			
All engines	x 4, +start-stop function, COIL ON PLUG									470 612	C10			
ENGINE														
1.2	Petrol	64	09/11-02/17	G4LA										
Engine	Information				A10	A20	A40	A50	A70	C10 - C30	C20	E01		
All engines	x 1, D.I.S.									470 579	C10			
All engines	x 4, +start-stop function, COIL ON PLUG									470 612	C10			
PICANTO III														
ENGINE														
1.0	Petrol	49	03/17->	G3LA, G3LD										
Engine	Information				A10	A20	A40	A50	A70	C10 - C30	C20	E01		
All engines	x 3, COIL ON PLUG									470 638	C10			
ENGINE														
1.0	Petrol	51	03/17->	G3LA										
Engine	Information				A10	A20	A40	A50	A70	C10 - C30	C20	E01		
All engines	x 3, COIL ON PLUG									470 638	C10			
ENGINE														
1.0 LPG	Petrol/ Liquified Petro- leum Gas (LPG)	48	11/18->	G3LA										
Engine	Information				A10	A20	A40	A50	A70	C10 - C30	C20	E01		
All engines	x 3, COIL ON PLUG									470 638	C10			
ENGINE														
1.0 T-GDi	Petrol	74	03/17->	G3LC										
Engine	Information				A10	A20	A40	A50	A70	C10 - C30	C20	E01		
All engines	x 3, COIL ON PLUG									470 638	C10			
ENGINE														
1.2	Petrol	62	03/17->	G4LA										
Engine	Information				A10	A20	A40	A50	A70	C10 - C30	C20	E01		
All engines	x 4, COIL ON PLUG									470 612	C10			
PRIDE														
ENGINE														
1.1 i	Petrol	38	01/91-10/00	B1										
Engine	Information				A10	A20	A40	A50	A70	C10 - C30	C20	E01		
All engines	version Mitsubishi						831 122	931 108						
All engines	alternatively												360 398	
ENGINE														
1.3	Petrol	44	01/90-10/00	B3										
Engine	Information				A10	A20	A40	A50	A70	C10 - C30	C20	E01		
All engines	version Mitsubishi						831 121							
All engines	alternatively												360 398	
ENGINE														
1.3	Petrol	47	10/96-05/01	B3, B3A5										
Engine	Information				A10	A20	A40	A50	A70	C10 - C30	C20	E01		
All engines	version Mitsubishi						831 121							
A10	CONDENSER		A20	CONTACT SET		A40	DISTRIBUTOR CAP		A50	ROTOR		A70	PICK-UP	
C10	COIL		C20	IGNITION MODULE		C30	ELECTRONIC IGNITION KIT		E01	IGNITION CABLE SET				

				FUNCTIONS ON THE VEHICLE								
Vehicle	alim.	kW	Date	Engine								
				ENGINE								
1.3	Petrol	47	10/96-05/01	B3, B3A5								
				ENGINE								
Engine		Information			A10	A20	A40	A50	A70	C10 - C30	C20	E01
All engines		alternatively										360 398
				ENGINE								
1.3	Petrol	53	01/90-09/01	B3								
				ENGINE								
Engine		Information			A10	A20	A40	A50	A70	C10 - C30	C20	E01
All engines		version Mitsubishi					831 121					
All engines		alternatively										360 398
				ENGINE								
1.3 i	Petrol	51	01/90-05/97	--								
				ENGINE								
Engine		Information			A10	A20	A40	A50	A70	C10 - C30	C20	E01
All engines		version Mitsubishi					831 122	931 108				
All engines		alternatively										360 398
				ENGINE								
1.4 CVT	Petrol	73	05/12-07/18	G4FA								
				ENGINE								
Engine		Information			A10	A20	A40	A50	A70	C10 - C30	C20	E01
All engines		x 4, COIL ON PLUG								470 543	C10	
				ENGINE								
1.6 GDI	Petrol	99	04/15-07/18	G4FD								
				ENGINE								
Engine		Information			A10	A20	A40	A50	A70	C10 - C30	C20	E01
All engines		x 4, COIL ON PLUG								470 611	C10	
				ENGINE								
1.4	Petrol	77	02/08-09/12	G4FA								
				ENGINE								
Engine		Information			A10	A20	A40	A50	A70	C10 - C30	C20	E01
All engines		->year 01/03/09, x 4, COIL ON PLUG								470 495	C10	
All engines		01/04/09 ->, x 4, COIL ON PLUG								470 543	C10	
				ENGINE								
1.4	Petrol	80	02/08-09/12	G4FA								
				ENGINE								
Engine		Information			A10	A20	A40	A50	A70	C10 - C30	C20	E01
All engines		x 4, COIL ON PLUG								470 543	C10	
				ENGINE								
1.4 CVT	Petrol	66	06/10-09/12	G4FA, G4FA-L								
				ENGINE								
Engine		Information			A10	A20	A40	A50	A70	C10 - C30	C20	E01
Eng. G4FA		x 4, COIL ON PLUG								470 543	C10	
Eng. G4FA-L		Qty: 4								470 543	C10	
				ENGINE								
1.6	Petrol	90	02/08-09/12	G4FC								
				ENGINE								
Engine		Information			A10	A20	A40	A50	A70	C10 - C30	C20	E01
All engines		->year 01/03/09, x 4, COIL ON PLUG								470 495	C10	
All engines		01/04/09 ->, x 4, COIL ON PLUG								470 543	C10	
				ENGINE								
1.6	Petrol	93	02/08-09/12	G4FC								
				ENGINE								
Engine		Information			A10	A20	A40	A50	A70	C10 - C30	C20	E01
All engines		x 4, COIL ON PLUG								470 543	C10	
				ENGINE								
1.6 CVT	Petrol	85	02/08-09/12	G4FC								
				ENGINE								
Engine		Information			A10	A20	A40	A50	A70	C10 - C30	C20	E01
All engines		->year 01/03/09, x 4, COIL ON PLUG								470 495	C10	
All engines		01/04/09 ->, x 4, COIL ON PLUG								470 543	C10	
				ENGINE								
1.6 CVT	Petrol	92	10/10-02/13	G4FC								
				ENGINE								
Engine		Information			A10	A20	A40	A50	A70	C10 - C30	C20	E01
All engines		x 4, COIL ON PLUG								470 543	C10	
				ENGINE								
2.0	Petrol	105	02/08-09/12	G4GC								
				ENGINE								
Engine		Information			A10	A20	A40	A50	A70	C10 - C30	C20	E01
All engines		x 1, D.I.S.								470 581	C10	
All engines												360 385

A10 CONDENSER	A20 CONTACT SET	A40 DISTRIBUTOR CAP	A50 ROTOR	A70 PICK-UP
C10 COIL	C20 IGNITION MODULE	C30 ELECTRONIC IGNITION KIT	E01 IGNITION CABLE SET	

Vehicle	alim.	kW	Date	Engine	FUNCTIONS ON THE VEHICLE							
					A10	A20	A40	A50	A70	C10 - C30	C20	E01

ENGINE				
2.0 LPG	Petrol/ Liquified Petro- leum Gas (LPG)	105	01/09-12/09	G4GC

Engine	Information	A10	A20	A40	A50	A70	C10 - C30	C20	E01
All engines	x 1, D.I.S.						470 581	C10	

PRO CEE'D II				
ENGINE				
1.0 T-GDI	Petrol	74	07/15-07/18	G3LC

Engine	Information	A10	A20	A40	A50	A70	C10 - C30	C20	E01
All engines	x 3, COIL ON PLUG						470 638	C10	

ENGINE				
1.0 T-GDI	Petrol	88	07/15-07/18	G3LC

Engine	Information	A10	A20	A40	A50	A70	C10 - C30	C20	E01
All engines	x 3, COIL ON PLUG						470 638	C10	

ENGINE				
1.4 CVT	Petrol	73	03/13-07/15	G4FA

Engine	Information	A10	A20	A40	A50	A70	C10 - C30	C20	E01
All engines	x 4, COIL ON PLUG						470 543	C10	

ENGINE				
1.4 CVT	Petrol	74	07/13-07/18	G4FA

Engine	Information	A10	A20	A40	A50	A70	C10 - C30	C20	E01
All engines	x 4, COIL ON PLUG						470 543	C10	

ENGINE				
1.4 MPI	Petrol	73	07/13-07/18	G4LC

Engine	Information	A10	A20	A40	A50	A70	C10 - C30	C20	E01
All engines	->year 01/05/15, x 4, COIL ON PLUG						470 543	C10	
All engines	01/06/15 ->, x 4, COIL ON PLUG						470 622	C10	

ENGINE				
1.4 MPI	Petrol	74	04/15-07/18	G4LC

Engine	Information	A10	A20	A40	A50	A70	C10 - C30	C20	E01
All engines	x 4, COIL ON PLUG						470 622	C10	

ENGINE				
1.6 CVT	Petrol	95	03/13-07/18	G4FC

Engine	Information	A10	A20	A40	A50	A70	C10 - C30	C20	E01
All engines	x 4, COIL ON PLUG						470 543	C10	

ENGINE				
1.6 GDI	Petrol	99	03/13-07/18	G4FD

Engine	Information	A10	A20	A40	A50	A70	C10 - C30	C20	E01
All engines	x 4, COIL ON PLUG						470 611	C10	

PROCEED				
---------	--	--	--	--

ENGINE				
1.0 T-GDI	Petrol	88	10/18->	G3LC

Engine	Information	A10	A20	A40	A50	A70	C10 - C30	C20	E01
All engines	x 3, COIL ON PLUG						470 638	C10	

QUORIS				
--------	--	--	--	--

ENGINE				
3.8	Petrol	213	01/13->	G6DK

Engine	Information	A10	A20	A40	A50	A70	C10 - C30	C20	E01
All engines	x 6, COIL ON PLUG						470 492	C10	

ENGINE				
3.8	Petrol	216	03/17->	G6DK





Engine	Information	A10	A20	A40	A50	A70	C10 - C30	C20	E01
All engines	x 6, COIL ON PLUG						470 492	C10	

ENGINE				
3.8 GDI	Petrol	246	04/15->	G6DJ

Engine	Information	A10	A20	A40	A50	A70	C10 - C30	C20	E01
All engines	x 6, COIL ON PLUG						470 492	C10	

A10	CONDENSER	A20	CONTACT SET	A40	DISTRIBUTOR CAP	A50	ROTOR	A70	PICK-UP
C10	COIL	C20	IGNITION MODULE	C30	ELECTRONIC IGNITION KIT	E01	IGNITION CABLE SET		

The present application list is a brief version. For the detailed information about the possibility of installation on a specific vehicle, please refer to our web-catalogue <http://catalogo.facet.eu/>

				FUNCTIONS ON THE VEHICLE								
Vehicle	alim.	kW	Date	Engine	 A10	 A20	 A40	 A50	 A70	 C10 - C30	 C20	 E01
				ENGINE								
5.0 GDI	Petrol	312	05/15->	G8BE								
Engine		Information			A10	A20	A40	A50	A70	C10 - C30	C20	E01
All engines		x 8, COIL ON PLUG								470 556	C10	
				ENGINE								
RIO I												
1.3	Petrol	55	08/00-02/05	A3E								
Engine		Information			A10	A20	A40	A50	A70	C10 - C30	C20	E01
All engines												360 851
				ENGINE								
1.3	Petrol	60	08/00-02/05	A3E								
Engine		Information			A10	A20	A40	A50	A70	C10 - C30	C20	E01
All engines												360 851
				ENGINE								
1.5 16V	Petrol	71	09/02-02/05	A5D								
Engine		Information			A10	A20	A40	A50	A70	C10 - C30	C20	E01
All engines												358 239
				ENGINE								
1.5 16V	Petrol	72	08/00-02/05	A5D								
Engine		Information			A10	A20	A40	A50	A70	C10 - C30	C20	E01
All engines												358 239
				ENGINE								
1.6 [CAN] [USA]	Petrol	0	06/00-02/05	--								
Engine		Information			A10	A20	A40	A50	A70	C10 - C30	C20	E01
All engines												358 239
				ENGINE								
RIO II												
1.4	Petrol	55	01/10-12/11	G4EE								
Engine		Information			A10	A20	A40	A50	A70	C10 - C30	C20	E01
All engines		Fitting Position:for cylinder 1, Fitting Position:for cylinder 4, x 1, D.I.S.								470 582	C10	
All engines		Fitting Position:for cylinder 2, Fitting Position:for cylinder 3, x 1, D.I.S.								470 584	C10	
				ENGINE								
1.4 16V	Petrol	71	03/05-12/11	G4EE								
Engine		Information			A10	A20	A40	A50	A70	C10 - C30	C20	E01
All engines		Fitting Position:for cylinder 1, Fitting Position:for cylinder 4, x 1, D.I.S.								470 582	C10	
All engines		Fitting Position:for cylinder 2, Fitting Position:for cylinder 3, x 1, D.I.S.								470 584	C10	
All engines												358 111
				ENGINE								
1.6 16V	Petrol	82	03/05-12/11	G4ED								
Engine		Information			A10	A20	A40	A50	A70	C10 - C30	C20	E01
All engines												358 111
				ENGINE								
1.6 CVT	Petrol	82	03/05-12/11	G4ED								
Engine		Information			A10	A20	A40	A50	A70	C10 - C30	C20	E01
All engines												358 111
				ENGINE								
RIO III												
1.2	Petrol	51	09/11-12/17	G4LA								
Engine		Information			A10	A20	A40	A50	A70	C10 - C30	C20	E01
All engines		x 1, D.I.S.								470 579	C10	
				ENGINE								
1.2 CVT	Petrol	62	11/14-12/17	G4LA								
Engine		Information			A10	A20	A40	A50	A70	C10 - C30	C20	E01
All engines		Fitting Position:for cylinder 1-2, Fitting Position:for cylinder 3-4, x 4, -start-stop function, x 1, COIL ON PLUG, D.I.S.								470 579	C10	
All engines		x 4, +start-stop function, COIL ON PLUG								470 612	C10	

A10 CONDENSER	A20 CONTACT SET	A40 DISTRIBUTOR CAP	A50 ROTOR	A70 PICK-UP
C10 COIL	C20 IGNITION MODULE	C30 ELECTRONIC IGNITION KIT	E01 IGNITION CABLE SET	

Vehicle	alim.	kW	Date	Engine	FUNCTIONS ON THE VEHICLE							
					A10	A20	A40	A50	A70	C10 - C30	C20	E01
ENGINE												
1.2 CVVT	Petrol	63	04/15-12/17	G4LA								
Engine	Information			A10	A20	A40	A50	A70	C10 - C30	C20	E01	
All engines	Fitting Position:for cylinder 1-2, Fitting Position:for cylinder 3-4, x 4, -start-stop function, x 1, COIL ON PLUG, -start-stop function, D.I.S.								470 579	C10		
All engines	x 4, +start-stop function, COIL ON PLUG								470 612	C10		
ENGINE												
1.2 CVVT	Petrol	64	11/14-12/17	G4LA								
Engine	Information			A10	A20	A40	A50	A70	C10 - C30	C20	E01	
All engines	x 1, x 4, D.I.S., -start-stop function, COIL ON PLUG								470 579	C10		
All engines	x 4, +start-stop function, COIL ON PLUG								470 612	C10		
ENGINE												
1.25 CVVT	Petrol	63	09/11-12/17	G4LA								
Engine	Information			A10	A20	A40	A50	A70	C10 - C30	C20	E01	
All engines	Fitting Position:for cylinder 1-2, Fitting Position:for cylinder 3-4, x 1, x 4, D.I.S., -start-stop function, x 1, COIL ON PLUG, D.I.S.								470 579	C10		
All engines	x 4, +start-stop function, COIL ON PLUG								470 612	C10		
ENGINE												
1.25 CVVT	Petrol	65	06/11-12/17	G4LA								
Engine	Information			A10	A20	A40	A50	A70	C10 - C30	C20	E01	
All engines	Fitting Position:for cylinder 1-2, Fitting Position:for cylinder 2, x 4, Fitting Position:for cylinder 3, -start-stop function, x 1, COIL ON PLUG, D.I.S., x 1, D.I.S.								470 579	C10		
All engines	Qty: 2, -start-stop function, without fastening clamp								470 579	C10		
All engines	+start-stop function, Qty: 4								470 612	C10		
All engines	x 4, +start-stop function, COIL ON PLUG								470 612	C10		
ENGINE												
1.25 LPG	Petrol/ Liquified Petro- leum Gas (LPG)	63	09/11-12/17	G4LA								
Engine	Information			A10	A20	A40	A50	A70	C10 - C30	C20	E01	
All engines	Fitting Position:for cylinder 1, Fitting Position:for cylinder 2, x 4, Fitting Position:for cylinder 3, Fitting Position:for cylinder 4, -start-stop function, COIL ON PLUG, x 1, -start-stop function, D.I.S.								470 579	C10		
All engines	x 4, +start-stop function, COIL ON PLUG								470 612	C10		
ENGINE												
1.4 CVVT	Petrol	78	10/11->	G4FA								
Engine	Information			A10	A20	A40	A50	A70	C10 - C30	C20	E01	
All engines	Qty: 4								470 543	C10		
ENGINE												
1.4 CVVT	Petrol	79	06/11-12/17	G4FA								
Engine	Information			A10	A20	A40	A50	A70	C10 - C30	C20	E01	
All engines	x 4, COIL ON PLUG								470 543	C10		
ENGINE												
1.4 CVVT	Petrol	80	09/11->	G4FA								
Engine	Information			A10	A20	A40	A50	A70	C10 - C30	C20	E01	
All engines	x 4, COIL ON PLUG								470 543	C10		
ENGINE												
1.6 CVVT	Petrol	90	06/12-12/17	G4FC								
Engine	Information			A10	A20	A40	A50	A70	C10 - C30	C20	E01	
All engines	x 4, COIL ON PLUG								470 543	C10		
RIO IV												
ENGINE												
1.0 T-GDI 100	Petrol	74	01/17->	G3LC, G3LE								
Engine	Information			A10	A20	A40	A50	A70	C10 - C30	C20	E01	
All engines	x 3, COIL ON PLUG								470 638	C10		
ENGINE												
1.0 T-GDI 100 Eco-Dynamics+	Petrol/ Electric	74	02/17->	G3LF								
Engine	Information			A10	A20	A40	A50	A70	C10 - C30	C20	E01	
All engines	x 3, COIL ON PLUG								470 638	C10		









A10 CONDENSER	A20 CONTACT SET	A40 DISTRIBUTOR CAP	A50 ROTOR	A70 PICK-UP
C10 COIL	C20 IGNITION MODULE	C30 ELECTRONIC IGNITION KIT	E01 IGNITION CABLE SET	

The present application list is a brief version. For the detailed information about the possibility of installation on a specific vehicle, please refer to our web-catalogue <http://catalogo.facet.eu/>

Vehicle	alim.	kW	Date	Engine	FUNCTIONS ON THE VEHICLE									
					A10	A20	A40	A50	A70	C10 - C30	C20	E01		
ENGINE														
1.0 T-GDI 120	Petrol	88	01/17->	G3LC										
Engine	Information				A10	A20	A40	A50	A70	C10 - C30	C20	E01		
All engines	x 3, COIL ON PLUG									470 638	C10			
ENGINE														
1.25	Petrol	62	01/17->	G4LA										
Engine	Information				A10	A20	A40	A50	A70	C10 - C30	C20	E01		
All engines	x 4, COIL ON PLUG									470 612	C10			
ENGINE														
1.4	Petrol	73	01/17->	G4LC										
Engine	Information				A10	A20	A40	A50	A70	C10 - C30	C20	E01		
All engines	x 4, COIL ON PLUG									470 622	C10			
ENGINE														
1.4	Petrol	74	01/17->	G4LC										
Engine	Information				A10	A20	A40	A50	A70	C10 - C30	C20	E01		
All engines	x 4, COIL ON PLUG									470 622	C10			
ENGINE														
1.6	Petrol	90	01/17->	G4FG										
Engine	Information				A10	A20	A40	A50	A70	C10 - C30	C20	E01		
All engines	euro 5, x 4, COIL ON PLUG, x 4, COIL ON PLUG									470 543	C10			
SEPHIA														
ENGINE														
1.5 i 16V	Petrol	0	09/97->	--										
Engine	Information				A10	A20	A40	A50	A70	C10 - C30	C20	E01		
All engines													360 841	
ENGINE														
1.6 i 16V	Petrol	0	07/00->	--										
Engine	Information				A10	A20	A40	A50	A70	C10 - C30	C20	E01		
All engines													358 239	
ENGINE														
1.8 i 16V	Petrol	0	09/97->	--										
Engine	Information				A10	A20	A40	A50	A70	C10 - C30	C20	E01		
All engines													360 841	
SEPHIA I														
ENGINE														
1.5 i	Petrol	59	02/96-10/97	B5										
Engine	Information				A10	A20	A40	A50	A70	C10 - C30	C20	E01		
All engines													360 841	
ENGINE														
1.6 i	Petrol	59	09/93-10/97	B6										
Engine	Information				A10	A20	A40	A50	A70	C10 - C30	C20	E01		
All engines	version Mitsubishi						831 121							
All engines													360 398	
ENGINE														
1.8 i 16V	Petrol	0	01/95-10/97	--										
Engine	Information				A10	A20	A40	A50	A70	C10 - C30	C20	E01		
All engines													360 841	
ENGINE														
1.8 i 16V	Petrol	82	01/95-10/97	OK24N, OK26Y										
Engine	Information				A10	A20	A40	A50	A70	C10 - C30	C20	E01		
All engines													360 841	
SHUMA I														
ENGINE														
1.5	Petrol	59	03/96-12/98	OK280										
Engine	Information				A10	A20	A40	A50	A70	C10 - C30	C20	E01		
All engines													360 841	
ENGINE														
1.5 i 16V	Petrol	65	10/97-10/01	BFD, ZY-VE										
Engine	Information				A10	A20	A40	A50	A70	C10 - C30	C20	E01		
All engines													360 841	

A10 CONDENSER	A20 CONTACT SET	A40 DISTRIBUTOR CAP	A50 ROTOR	A70 PICK-UP
C10 COIL	C20 IGNITION MODULE	C30 ELECTRONIC IGNITION KIT	E01 IGNITION CABLE SET	

Vehicle	alim.	kW	Date	Engine	FUNCTIONS ON THE VEHICLE									
					A10	A20	A40	A50	A70	C10 - C30	C20	E01		
ENGINE														
1.6	Petrol	75	01/01-12/01	GA6D										
ENGINE														
All engines														358 239
ENGINE														
1.8 i 16V	Petrol	81	10/97-03/01	T8										
ENGINE														
All engines														360 841
SHUMA II														
ENGINE														
1.6	Petrol	75	05/01-08/04	GA6D										
ENGINE														
All engines														358 239
ENGINE														
1.8	Petrol	81	05/01-06/04	T8										
ENGINE														
All engines														360 841
ENGINE														
1.8	Petrol	84	04/03-08/04	T8										
ENGINE														
All engines														360 841
SORENTO I														
ENGINE														
3.3 V6	Petrol	177	12/06->	--										
ENGINE														
All engines											470 492	C10		
ENGINE														
3.3 V6 4WD	Petrol	182	02/07-12/11	G6DB										
ENGINE														
All engines											470 492	C10		
SORENTO II														
ENGINE														
2.4 CVVT	Petrol	128	11/09-12/15	G4KE										
ENGINE														
All engines											470 556	C10		
ENGINE														
2.4 CVVT	Petrol	141	10/12-12/15	G4KJ										
ENGINE														
All engines											470 556	C10		
ENGINE														
2.4 CVVT 4WD	Petrol	128	11/09-12/15	G4KE										
ENGINE														
All engines											470 556	C10		
ENGINE														
2.4 CVVT 4WD	Petrol	141	10/12-12/15	G4KJ										
ENGINE														
All engines											470 556	C10		
ENGINE														
2.4 GDI	Petrol	141	10/12-12/15	G4KJ										
ENGINE														
All engines											470 556	C10		
ENGINE														
2.4 GDI 4WD	Petrol	141	10/12-12/15	G4KJ										
ENGINE														
All engines											470 556	C10		
ENGINE														
2.4 LPG	Petrol/ Liquified Petroleum Gas (LPG)	126	04/10-12/15	G4KE										
ENGINE														
All engines											470 556	C10		
ENGINE														
A10	CONDENSER		A20	CONTACT SET		A40	DISTRIBUTOR CAP		A50	ROTOR		A70	PICK-UP	
C10	COIL		C20	IGNITION MODULE		C30	ELECTRONIC IGNITION KIT		E01	IGNITION CABLE SET				

VEHICLE					FUNCTIONS ON THE VEHICLE								
Vehicle	alim.	kW	Date	Engine	 A10	 A20	 A40	 A50	 A70	 C10 - C30	 C20	 E01	
ENGINE													
2.4 LPG 4WD	Petrol/ Liquified Petroleum Gas (LPG)	126	04/10-12/15	G4KE									
Engine	Information				A10	A20	A40	A50	A70	C10 - C30	C20	E01	
All engines	x 4, COIL ON PLUG									470 556	C10		
ENGINE													
3.3 GDI	Petrol	0	10/12->	--									
Engine	Information				A10	A20	A40	A50	A70	C10 - C30	C20	E01	
All engines	Qty: 6									470 492	C10		
ENGINE													
3.5	Petrol	204	05/13-12/15	G6DC									
Engine	Information				A10	A20	A40	A50	A70	C10 - C30	C20	E01	
All engines	Qty: 6									470 492	C10		
ENGINE													
3.5	Petrol	207	11/09->	G6DC									
Engine	Information				A10	A20	A40	A50	A70	C10 - C30	C20	E01	
All engines	Qty: 6									470 492	C10		
ENGINE													
3.5 4WD	Petrol	203	11/09->	G6DC									
Engine	Information				A10	A20	A40	A50	A70	C10 - C30	C20	E01	
All engines	Qty: 6									470 492	C10		
ENGINE													
3.5 4WD	Petrol	204	05/13-12/15	G6DC									
Engine	Information				A10	A20	A40	A50	A70	C10 - C30	C20	E01	
All engines	Qty: 6									470 492	C10		
ENGINE													
CVVT	Petrol	128	06/09-12/15	G4KE									
Engine	Information				A10	A20	A40	A50	A70	C10 - C30	C20	E01	
All engines	x 4, COIL ON PLUG									470 556	C10		
ENGINE													
CVVT 4WD	Petrol	128	06/09-12/15	G4KE									
Engine	Information				A10	A20	A40	A50	A70	C10 - C30	C20	E01	
All engines	x 4, COIL ON PLUG									470 556	C10		
SORENTO III													
ENGINE													
3.5 D-CVVT	Petrol	183	12/18->	G6DC									
Engine	Information				A10	A20	A40	A50	A70	C10 - C30	C20	E01	
All engines	x 6, COIL ON PLUG									470 492	C10		
ENGINE													
3.5 D-CVVT 4WD	Petrol	183	12/18->	G6DC									
Engine	Information				A10	A20	A40	A50	A70	C10 - C30	C20	E01	
All engines	x 6, COIL ON PLUG									470 492	C10		
SOUL I													
ENGINE													
1.6	Petrol	91	09/09-12/14	G4FC									
Engine	Information				A10	A20	A40	A50	A70	C10 - C30	C20	E01	
All engines	x 4, COIL ON PLUG									470 543	C10		
ENGINE													
1.6 CVVT	Petrol	77	02/09-12/11	G4FC									
Engine	Information				A10	A20	A40	A50	A70	C10 - C30	C20	E01	
All engines	x 4, COIL ON PLUG									470 543	C10		
ENGINE													
1.6 CVVT	Petrol	93	02/09-12/11	G4FC									
Engine	Information				A10	A20	A40	A50	A70	C10 - C30	C20	E01	
All engines	x 4, COIL ON PLUG									470 543	C10		
ENGINE													
1.6 CVVT	Petrol	95	06/11-12/14	G4FC									
Engine	Information				A10	A20	A40	A50	A70	C10 - C30	C20	E01	
All engines	x 4, COIL ON PLUG									470 543	C10		

A10 CONDENSER	A20 CONTACT SET	A40 DISTRIBUTOR CAP	A50 ROTOR	A70 PICK-UP
C10 COIL	C20 IGNITION MODULE	C30 ELECTRONIC IGNITION KIT	E01 IGNITION CABLE SET	

Vehicle	alim.	kW	Date	Engine	FUNCTIONS ON THE VEHICLE								
					A10	A20	A40	A50	A70	C10 - C30	C20	E01	
ENGINE													
1.6 Flex	Flexfuel	94	01/11->	--									
Engine	Information												
All engines	Qty: 4, no specific info conc. application available									470 543, 470 611	C10		
ENGINE													
1.6 GDI	Petrol	103	06/11-12/14	G4FD									
Engine	Information												
All engines	x 4, COIL ON PLUG									470 611	C10		
ENGINE													
1.6 LPG	Petrol/ Liquified Petro- leum Gas (LPG)	87	06/11-12/14	G4FC									
Engine	Information												
All engines	x 4, COIL ON PLUG									470 543	C10		
ENGINE													
1.6 LPG	Petrol/ Liquified Petro- leum Gas (LPG)	92	02/09-12/11	G4FC									
Engine	Information												
All engines	x 4, COIL ON PLUG									470 543	C10		
SOUL II													
ENGINE													
1.6 CVT	Petrol	91	02/14->	G4FG									
Engine	Information												
All engines	x 4, COIL ON PLUG									470 543	C10		
ENGINE													
1.6 GDI	Petrol	97	02/14->	G4FD									
Engine	Information												
All engines	x 4, COIL ON PLUG									470 611	C10		
ENGINE													
1.6 LPG	Petrol/ Liquified Petro- leum Gas (LPG)	96	12/14->	G4FG									
Engine	Information												
All engines	x 4, COIL ON PLUG									470 543	C10		
SOUL III													
ENGINE													
1.6 MPi	Petrol	91	01/19->	G4FG									
Engine	Information												
All engines	x 4, COIL ON PLUG									470 543	C10		
SPECTRA													
ENGINE													
1.5 i	Petrol	0	09/97->	--									
Engine	Information												
All engines													360 841
ENGINE													
1.5 i 16V	Petrol	65	09/97->	--									
Engine	Information												
All engines													360 841
ENGINE													
1.6 i 16V	Petrol	75	07/00->	--									
Engine	Information												
All engines													358 239
ENGINE													
1.8 i 16V	Petrol	93	09/97->	--									
Engine	Information												
All engines													360 841

A10 CONDENSER	A20 CONTACT SET	A40 DISTRIBUTOR CAP	A50 ROTOR	A70 PICK-UP
C10 COIL	C20 IGNITION MODULE	C30 ELECTRONIC IGNITION KIT	E01 IGNITION CABLE SET	

The present application list is a brief version. For the detailed information about the possibility of installation on a specific vehicle, please refer to our web-catalogue <http://catalogo.facet.eu/>

Vehicle	alim.	kW	Date	Engine	FUNCTIONS ON THE VEHICLE							
					A10	A20	A40	A50	A70	C10 - C30	C20	E01

SPORTAGE I

2.0 4WD	Petrol	70	06/95-11/98	ENGINE FE (8V)
---------	--------	----	-------------	-------------------

Engine	Information	A10	A20	A40	A50	A70	C10 - C30	C20	E01
All engines	x 1, D.I.S., connector type, saw teeth						470 168	C10	

2.0 i 4WD	Petrol	70	04/94-08/99	ENGINE FE (8V)
-----------	--------	----	-------------	-------------------

Engine	Information	A10	A20	A40	A50	A70	C10 - C30	C20	E01
All engines	x 1, D.I.S., connector type, saw teeth						470 168	C10	

SPORTAGE II

2.0	Petrol	122	01/09-05/10	ENGINE G4KD
-----	--------	-----	-------------	----------------

Engine	Information	A10	A20	A40	A50	A70	C10 - C30	C20	E01
All engines	x 1, D.I.S.						470 581	C10	

2.0 16V 4WD	Petrol	104	09/04->	ENGINE G4GC
-------------	--------	-----	---------	----------------

Engine	Information	A10	A20	A40	A50	A70	C10 - C30	C20	E01
All engines	x 1, D.I.S.						470 581	C10	
All engines									360 385

2.0 i 16V	Petrol	104	09/04->	ENGINE G4GC
-----------	--------	-----	---------	----------------

Engine	Information	A10	A20	A40	A50	A70	C10 - C30	C20	E01
All engines	x 1, D.I.S.						470 581	C10	
All engines									360 385

2.0 LPG	Petrol/ Liquified Petro- leum Gas (LPG)	101	06/09-05/10	ENGINE G4GC
---------	---	-----	-------------	----------------

Engine	Information	A10	A20	A40	A50	A70	C10 - C30	C20	E01
All engines	x 1, D.I.S.						470 581	C10	

2.7 V6 4WD	Petrol	129	09/04->	ENGINE G6BA
------------	--------	-----	---------	----------------

Engine	Information	A10	A20	A40	A50	A70	C10 - C30	C20	E01
All engines									358 236

SPORTAGE III

1.6 GDI	Petrol	99	02/11->	ENGINE G4FD
---------	--------	----	---------	----------------

Engine	Information	A10	A20	A40	A50	A70	C10 - C30	C20	E01
All engines	x 4, COIL ON PLUG						470 611	C10	

1.6 LPG	Petrol/ Liquified Petro- leum Gas (LPG)	99	01/14-12/15	ENGINE G4FD
---------	---	----	-------------	----------------

Engine	Information	A10	A20	A40	A50	A70	C10 - C30	C20	E01
All engines	x 4, COIL ON PLUG						470 611	C10	

2.0 CVT	Petrol	110	06/10-12/13	ENGINE G4KD
---------	--------	-----	-------------	----------------

Engine	Information	A10	A20	A40	A50	A70	C10 - C30	C20	E01
All engines	x 4, COIL ON PLUG						470 556	C10	

2.0 CVT	Petrol	120	07/10->	ENGINE G4KD
---------	--------	-----	---------	----------------

Engine	Information	A10	A20	A40	A50	A70	C10 - C30	C20	E01
All engines	x 4, COIL ON PLUG						470 556	C10	

2.0 CVT	Petrol	122	07/10->	ENGINE G4KD
---------	--------	-----	---------	----------------

Engine	Information	A10	A20	A40	A50	A70	C10 - C30	C20	E01
All engines	x 4, COIL ON PLUG						470 556	C10	

A10 CONDENSER	A20 CONTACT SET	A40 DISTRIBUTOR CAP	A50 ROTOR	A70 PICK-UP
C10 COIL	C20 IGNITION MODULE	C30 ELECTRONIC IGNITION KIT	E01 IGNITION CABLE SET	

Vehicle	alim.	kW	Date	Engine	FUNCTIONS ON THE VEHICLE									
					A10	A20	A40	A50	A70	C10 - C30	C20	E01		
ENGINE														
2.0 CVVT AWD	Petrol	110	06/10-12/13	G4KD										
ENGINE														
All engines					x 4, COIL ON PLUG									
ENGINE														
2.0 CVVT AWD	Petrol	120	07/10->	G4KD										
ENGINE														
All engines					x 4, COIL ON PLUG									
ENGINE														
2.0 CVVT AWD	Petrol	122	07/10->	G4KD, G4NC										
ENGINE														
Eng. G4KD					x 4, COIL ON PLUG									
Eng. G4NC					Qty: 4									
ENGINE														
2.4 i 4WD	Petrol	130	08/10->	G4KE										
ENGINE														
All engines					Qty: 4									
SPORTAGE IV														
ENGINE														
1.6 GDI	Petrol	97	09/15->	G4FD										
ENGINE														
All engines					x 4, COIL ON PLUG									
ENGINE														
1.6 LPG	Petrol/ Liquified Petro- leum Gas (LPG)	93	07/20->	G4FD										
ENGINE														
All engines					x 4, COIL ON PLUG									
STONIC														
ENGINE														
1.0 T-GDi	Petrol	74	08/18->	G3LC										
ENGINE														
All engines					x 3, COIL ON PLUG									
ENGINE														
1.0 T-GDi	Petrol	88	07/17->	G3LC										
ENGINE														
All engines					x 3, COIL ON PLUG									
ENGINE														
1.2 CVVT	Petrol	62	07/17->	G4LA										
ENGINE														
All engines					x 4, COIL ON PLUG									
ENGINE														
1.4 CVVT	Petrol	73	07/17->	G4LC										
ENGINE														
All engines					x 4, COIL ON PLUG									
ENGINE														
1.4 LPG	Petrol/ Liquified Petro- leum Gas (LPG)	71	11/18->	G4LC										
ENGINE														
All engines					x 4, COIL ON PLUG									
TOWNER														
ENGINE														
0.8 Gasoline	Petrol	31	10/97->	--										
ENGINE														
All engines														

A10 CONDENSER	A20 CONTACT SET	A40 DISTRIBUTOR CAP	A50 ROTOR	A70 PICK-UP
C10 COIL	C20 IGNITION MODULE	C30 ELECTRONIC IGNITION KIT	E01 IGNITION CABLE SET	

The present application list is a brief version. For the detailed information about the possibility of installation on a specific vehicle, please refer to our web-catalogue <http://catalogo.facet.eu/>

Vehicle	alim.	kW	Date	Engine	FUNCTIONS ON THE VEHICLE							
					A10	A20	A40	A50	A70	C10 - C30	C20	E01

VENGA

1.4 CVT	Petrol	66	02/10->	ENGINE G4FA, G4FA-L
---------	--------	----	---------	------------------------

Engine	Information	A10	A20	A40	A50	A70	C10 - C30	C20	E01
Eng. G4FA	x 4, COIL ON PLUG						470 543	C10	
Eng. G4FA-L	Qty: 4						470 543	C10	

1.4 LPG	Petrol/ Liquified Petroleum Gas (LPG)	66	02/10->	ENGINE G4FA
---------	--	----	---------	----------------

Engine	Information	A10	A20	A40	A50	A70	C10 - C30	C20	E01
All engines	x 4, COIL ON PLUG						470 543	C10	

1.6 CVT	Petrol	92	02/10->	ENGINE G4FC
---------	--------	----	---------	----------------

Engine	Information	A10	A20	A40	A50	A70	C10 - C30	C20	E01
All engines	x 4, COIL ON PLUG						470 543	C10	

CVT	Petrol	66	04/15->	ENGINE G4FA
-----	--------	----	---------	----------------

Engine	Information	A10	A20	A40	A50	A70	C10 - C30	C20	E01
All engines	x 4, COIL ON PLUG						470 543	C10	

CVT	Petrol	92	02/15->	ENGINE G4FC
-----	--------	----	---------	----------------

Engine	Information	A10	A20	A40	A50	A70	C10 - C30	C20	E01
All engines	x 4, COIL ON PLUG						470 543	C10	

XCEED

1.0 T-GDI	Petrol	88	06/19->	ENGINE G3LC
-----------	--------	----	---------	----------------

Engine	Information	A10	A20	A40	A50	A70	C10 - C30	C20	E01
All engines	x 3, COIL ON PLUG						470 638	C10	

1.6 GDI Hybrid	Petrol/ Electric	104	12/19->	ENGINE G4LE
----------------	---------------------	-----	---------	----------------

Engine	Information	A10	A20	A40	A50	A70	C10 - C30	C20	E01
All engines	x 4, COIL ON PLUG						470 647	C10	

1.6 GDI Hybrid	Petrol/ Electric	77	12/19->	ENGINE G4LE
----------------	---------------------	----	---------	----------------

Engine	Information	A10	A20	A40	A50	A70	C10 - C30	C20	E01
All engines	x 4, COIL ON PLUG						470 647	C10	

A10 CONDENSER	A20 CONTACT SET	A40 DISTRIBUTOR CAP	A50 ROTOR	A70 PICK-UP
C10 COIL	C20 IGNITION MODULE	C30 ELECTRONIC IGNITION KIT	E01 IGNITION CABLE SET	

Vehicle	alim.	kW	Date	Engine	FUNCTIONS ON THE VEHICLE							
					A10	A20	A40	A50	A70	C10 - C30	C20	E01

LARGUS

1.6	Petrol	62	03/12->	ENGINE K7M
-----	--------	----	---------	---------------

Engine	Information	A10	A20	A40	A50	A70	C10 - C30	C20	E01
All engines	x 1, D.I.S.						470 596	C10	

1.6	Petrol	64	04/16->	ENGINE 11189
-----	--------	----	---------	-----------------

Engine	Information	A10	A20	A40	A50	A70	C10 - C30	C20	E01
All engines	x 1, D.I.S.						470 596	C10	

1.6	Petrol	75	04/16->	ENGINE K4M
-----	--------	----	---------	---------------

Engine	Information	A10	A20	A40	A50	A70	C10 - C30	C20	E01
All engines	x 4, COIL ON PLUG						470 432	C10	

1.6	Petrol	77	03/12->	ENGINE K4M
-----	--------	----	---------	---------------

Engine	Information	A10	A20	A40	A50	A70	C10 - C30	C20	E01
All engines	x 4, COIL ON PLUG						470 432	C10	

1.6	Petrol	78	09/17->	ENGINE 21129
-----	--------	----	---------	-----------------

Engine	Information	A10	A20	A40	A50	A70	C10 - C30	C20	E01
All engines	x 4, COIL ON PLUG						470 432	C10	

NIVA I

1600	Petrol	56	12/76-12/93	ENGINE BA3 2121
------	--------	----	-------------	--------------------

Engine	Information	A10	A20	A40	A50	A70	C10 - C30	C20	E01
All engines	version Russian distributor		746 070						
All engines	version Hungarian distributor		746 071						
All engines	version U.D.S.S.R.			847 025	946 014R				
All engines							470 101D	C10	359 511

RIVA

1.5	Petrol	55	01/85->	ENGINE --
-----	--------	----	---------	--------------

Engine	Information	A10	A20	A40	A50	A70	C10 - C30	C20	E01
All engines			746 070	847 025	946 014R				

1.6	Petrol	63	01/85->	ENGINE --
-----	--------	----	---------	--------------

Engine	Information	A10	A20	A40	A50	A70	C10 - C30	C20	E01
All engines			746 070	847 025	946 014R				

SAMARA

1.5	Petrol	52	01/97->	ENGINE --
-----	--------	----	---------	--------------

Engine	Information	A10	A20	A40	A50	A70	C10 - C30	C20	E01
All engines	version U.D.S.S.R.			847 027	946 016R				

1100	Petrol	39	02/88-12/94	ENGINE BA3 21081
------	--------	----	-------------	---------------------

Engine	Information	A10	A20	A40	A50	A70	C10 - C30	C20	E01
All engines	version U.D.S.S.R.			847 027	946 016R				

1300	Petrol	48	01/86-12/94	ENGINE BA3 2108
------	--------	----	-------------	--------------------

Engine	Information	A10	A20	A40	A50	A70	C10 - C30	C20	E01
All engines	version U.D.S.S.R.			847 027	946 016R				

1500	Petrol	53	09/87-12/96	ENGINE BA3 21083
------	--------	----	-------------	---------------------

Engine	Information	A10	A20	A40	A50	A70	C10 - C30	C20	E01
All engines	version U.D.S.S.R.			847 027	946 016R				

VESTA

1.6	Petrol	83	11/19->	ENGINE H4M
-----	--------	----	---------	---------------

Engine	Information	A10	A20	A40	A50	A70	C10 - C30	C20	E01
All engines	x 4, COIL ON PLUG						470 613	C10	

A10 CONDENSER	A20 CONTACT SET	A40 DISTRIBUTOR CAP	A50 ROTOR	A70 PICK-UP
C10 COIL	C20 IGNITION MODULE	C30 ELECTRONIC IGNITION KIT	E01 IGNITION CABLE SET	

The present application list is a brief version. For the detailed information about the possibility of installation on a specific vehicle, please refer to our web-catalogue <http://catalogo.facet.eu/>

Vehicle	alim.	kW	Date	Engine	FUNCTIONS ON THE VEHICLE							
					A10	A20	A40	A50	A70	C10 - C30	C20	E01

A 112

				ENGINE
0.9 Junior	Petrol	29	03/81-06/86	A112 A5.000

Engine	Information	A10	A20	A40	A50	A70	C10 - C30	C20	E01
All engines	version Ducellier	615 023	715 101	815 058	915 083R				
All engines							470 101D	C10	

				ENGINE
1.0 Abarth	Petrol	51	03/78-02/84	A112 A2.000

Engine	Information	A10	A20	A40	A50	A70	C10 - C30	C20	E01
All engines	version Marelli			830 093	930 054R	430 161/1			

BETA

				ENGINE
1600	Petrol	74	08/73-07/82	828 B.000

Engine	Information	A10	A20	A40	A50	A70	C10 - C30	C20	E01
All engines	version Bosch			806 079	906 025R				
All engines	version Marelli				930 054R	430 163/1			
All engines							470 103	C10	

DEDRA

				ENGINE
1.6	Petrol	66	10/94-07/99	159 B9.000

Engine	Information	A10	A20	A40	A50	A70	C10 - C30	C20	E01
All engines									359 888

				ENGINE
1.6 16V	Petrol	76	01/96-07/99	182 A4.000

Engine	Information	A10	A20	A40	A50	A70	C10 - C30	C20	E01
All engines							470 345	C10	360 503

				ENGINE
1.6 i.e.	Petrol	55	04/93-07/99	835 C1.000

Engine	Information	A10	A20	A40	A50	A70	C10 - C30	C20	E01
All engines							470 168	C10	359 655

				ENGINE
1.6 i.e.	Petrol	57	08/89-03/93	835 A1.046

Engine	Information	A10	A20	A40	A50	A70	C10 - C30	C20	E01
All engines	-> eng. 7852632, version Marelli			830 104					
All engines	eng. type 7852632 ->, version Marelli			830 115					
All engines	version Marelli, no specific info conc. application available				930 055R, 930 059				
All engines							470 148	C10	

				ENGINE
1.6 i.e.	Petrol	66	08/89-06/94	835 A1.000

Engine	Information	A10	A20	A40	A50	A70	C10 - C30	C20	E01
All engines	version Marelli			830 104					
All engines	version Marelli, no specific info conc. application available				930 055R, 930 059				
All engines							490 303	C30	

				ENGINE
1.6 LE Cat	Petrol	66	07/94-07/99	159 B9.000

Engine	Information	A10	A20	A40	A50	A70	C10 - C30	C20	E01
All engines									359 888

				ENGINE
1.8 i.e.	Petrol	66	08/93-07/99	835 C5.000

Engine	Information	A10	A20	A40	A50	A70	C10 - C30	C20	E01
All engines	version Marelli			830 115	930 060	430 177/1			
All engines							490 303	C30	359 692

				ENGINE
1.8 i.e.	Petrol	74	07/94-07/99	836 A5.000

Engine	Information	A10	A20	A40	A50	A70	C10 - C30	C20	E01
All engines	Qty: 2						470 146	C10	
All engines									359 889

				ENGINE
1.8 i.e.	Petrol	77	09/89-07/99	835 A2.046

Engine	Information	A10	A20	A40	A50	A70	C10 - C30	C20	E01
All engines	version Marelli			830 115	930 060	430 177/1			



A10 CONDENSER	A20 CONTACT SET	A40 DISTRIBUTOR CAP	A50 ROTOR	A70 PICK-UP
C10 COIL	C20 IGNITION MODULE	C30 ELECTRONIC IGNITION KIT	E01 IGNITION CABLE SET	

Vehicle	alim.	kW	Date	Engine	FUNCTIONS ON THE VEHICLE									
					A10	A20	A40	A50	A70	C10 - C30	C20	E01		
ENGINE														
1.8 i.e.	Petrol	77	09/89-07/99	835 A2.046										
Engine	Information				A10	A20	A40	A50	A70	C10 - C30	C20	E01		
All engines										490 303	C30		359 692	
ENGINE														
1.8 i.e.	Petrol	80	09/89-06/94	835 A2.000										
Engine	Information				A10	A20	A40	A50	A70	C10 - C30	C20	E01		
All engines	version Marelli						830 115	930 060	430 177/1					
All engines										490 303	C30		359 692	
ENGINE														
2.0 16V	Petrol	102	07/94-07/99	836 A3.000										
Engine	Information				A10	A20	A40	A50	A70	C10 - C30	C20	E01		
All engines	version Marelli						830 114	930 060	430 177/1					
All engines										490 303	C30		359 650	
ENGINE														
2.0 HF Integrale	Petrol	124	11/90-07/94	835 A7.046										
Engine	Information				A10	A20	A40	A50	A70	C10 - C30	C20	E01		
All engines	version Marelli						830 115	930 060	430 177/1					
All engines										490 303	C30		359 692	
ENGINE														
2.0 i.e.	Petrol	83	09/89-07/99	835 A5.046										
Engine	Information				A10	A20	A40	A50	A70	C10 - C30	C20	E01		
All engines	01/07/94 -> version Marelli, +automatic transmission, eng. type 1339290 ->						830 114							
All engines	version Marelli							930 060	430 177/1					
All engines										490 303	C30			
All engines	+automatic transmission, ->eng. 1303624												359 692	
ENGINE														
2.0 i.e.	Petrol	86	09/89-07/92	835 A5.000										
Engine	Information				A10	A20	A40	A50	A70	C10 - C30	C20	E01		
All engines	version Marelli						830 115	930 060	430 177/1					
All engines										490 303	C30		359 692	
ENGINE														
2.0 i.e. Turbo	Petrol	119	04/91-07/99	835 A8.046										
Engine	Information				A10	A20	A40	A50	A70	C10 - C30	C20	E01		
All engines	version Marelli						830 115	930 060	430 177/1					
All engines										490 303	C30		359 692	
ENGINE														
2.0 i.e. Turbo Integrale	Petrol	121	04/90-08/91	835 A7.000										
Engine	Information				A10	A20	A40	A50	A70	C10 - C30	C20	E01		
All engines	version Marelli						830 115	930 060	430 177/1					
All engines										490 303	C30		359 692	
ENGINE														
2.0 Integrale	Petrol	102	07/94-07/99	836 A3.000										
Engine	Information				A10	A20	A40	A50	A70	C10 - C30	C20	E01		
All engines	version Marelli						830 114	930 060	430 177/1					
All engines										490 303	C30		359 650	
ENGINE														
2.0 Turbo	Petrol	130	11/90-06/94	835 A8.000										
Engine	Information				A10	A20	A40	A50	A70	C10 - C30	C20	E01		
All engines	version Marelli						830 115	930 060	430 177/1					
All engines										490 303	C30		359 692	
DELTA I														
ENGINE														
1.1	Petrol	47	01/86-12/90	831 B8.000										
Engine	Information				A10	A20	A40	A50	A70	C10 - C30	C20	E01		
All engines	version Marelli						830 101	930 047R	430 176M					
All engines										470 158	C10	465 020	359 354	

A10	CONDENSER	A20	CONTACT SET	A40	DISTRIBUTOR CAP	A50	ROTOR	A70	PICK-UP
C10	COIL	C20	IGNITION MODULE	C30	ELECTRONIC IGNITION KIT	E01	IGNITION CABLE SET		

The present application list is a brief version. For the detailed information about the possibility of installation on a specific vehicle, please refer to our web-catalogue <http://catalogo.facet.eu/>

FUNCTIONS ON THE VEHICLE

Vehicle	alim.	kW	Date	Engine								
1.3	Petrol	55	09/79-08/92	ENGINE 831 A2.000, 831 B.000								
Engine	Information			A10	A20	A40	A50	A70	C10 - C30	C20	E01	
All engines	version Marelli, no specific info conc. application available					830 101, 830 104						
All engines	->eng. 6651557, version Marelli						930 047R					
All engines	eng. type 6651557 ->, version Marelli						930 060					
All engines	version Marelli							430 176M				
All engines									470 158	C10	465 020	359 354
1.3	Petrol	58	09/83-08/92	ENGINE 831 A2.000								
Engine	Information			A10	A20	A40	A50	A70	C10 - C30	C20	E01	
All engines	version Marelli, no specific info conc. application available					830 101						
All engines	->eng. 6651557, version Marelli						930 047R					
All engines	eng. type 6651557 ->, version Marelli						930 060					
All engines	version Marelli							430 176M				
All engines									470 158	C10	465 020	359 354
1.5	Petrol	63	09/79-12/92	ENGINE 831 A1.000, 831 B1.000								
Engine	Information			A10	A20	A40	A50	A70	C10 - C30	C20	E01	
All engines	version Marelli					830 104	930 055R					
All engines									470 103	C10		
All engines	VET. 6119941 ->, ->VET. 0626853											359 354
1.6 GT i.e.	Petrol	66	05/87-08/92	ENGINE 149 C2.000								
Engine	Information			A10	A20	A40	A50	A70	C10 - C30	C20	E01	
All engines	version Marelli					830 115		430 177/1				
All engines	version Marelli, no specific info conc. application available						930 057R, 930 060					
1.6 GT i.e.	Petrol	80	08/86-08/88	ENGINE 831 B7.000								
Engine	Information			A10	A20	A40	A50	A70	C10 - C30	C20	E01	
All engines	version Marelli					830 115		430 177/1				
All engines	version Marelli, no specific info conc. application available						930 057R, 930 060					
All engines	VET. 0651166 ->											359 398
1.6 HF Turbo	Petrol	103	08/86-08/88	ENGINE 831 B3.000								
Engine	Information			A10	A20	A40	A50	A70	C10 - C30	C20	E01	
All engines	version Marelli					830 115		430 177/1				
All engines	->eng. 957187, version Marelli						930 057R					
All engines	eng. type 957187 ->, version Marelli						930 060					
1.6 HF Turbo	Petrol	97	04/87-03/89	ENGINE 831 B7.046								
Engine	Information			A10	A20	A40	A50	A70	C10 - C30	C20	E01	
All engines	version Marelli					830 115		430 177/1				
All engines	->eng. 957187, version Marelli						930 057R					
All engines	eng. type 957187 ->, version Marelli						930 060					
2.0 16V HF Evo Integrale	Petrol	155	06/93-01/94	ENGINE 831 E5.000, 831 E5.046								
Engine	Information			A10	A20	A40	A50	A70	C10 - C30	C20	E01	
Eng. 831 E5.000	version Marelli					830 115	930 060	430 177/1				
Eng. 831 E5.046	Qty: 2								470 146	C10		
Eng. 831 E5.000												359 471
2.0 16V HF Integrale	Petrol	144	03/89-09/91	ENGINE 831 D5.000								
Engine	Information			A10	A20	A40	A50	A70	C10 - C30	C20	E01	
All engines	version Marelli					830 115	930 057R	430 177/1				
All engines									490 303	C30		359 471

A10 CONDENSER	A20 CONTACT SET	A40 DISTRIBUTOR CAP	A50 ROTOR	A70 PICK-UP
C10 COIL	C20 IGNITION MODULE	C30 ELECTRONIC IGNITION KIT	E01 IGNITION CABLE SET	

Vehicle	alim.	kW	Date	Engine	FUNCTIONS ON THE VEHICLE							
					A10	A20	A40	A50	A70	C10 - C30	C20	E01

ENGINE				
2.0 HF Integrale	Petrol	122	11/86-08/88	831 B5.000

Engine	Information	A10	A20	A40	A50	A70	C10 - C30	C20	E01
All engines	version Marelli			830 115	930 057R	430 177/1			

ENGINE				
2.0 HF Integrale	Petrol	130	12/86-12/92	831 C5.046

Engine	Information	A10	A20	A40	A50	A70	C10 - C30	C20	E01
All engines	version Marelli			830 115		430 177/1			
All engines	->year 30/06/91, version Marelli				930 057R				
All engines	01/07/91 ->, version Marelli				930 060				
All engines	->year 30/06/91						490 303	C30	359 471

ENGINE				
2.0 HF Integrale	Petrol	133	10/87-12/91	831 C5.000

Engine	Information	A10	A20	A40	A50	A70	C10 - C30	C20	E01
All engines	version Marelli			830 115	930 057R	430 177/1			

DELTA II

ENGINE				
1.4 i.e.	Petrol	51	10/94-08/99	160 A1.046, 836 A4.000

Engine	Information	A10	A20	A40	A50	A70	C10 - C30	C20	E01
Eng. 160 A1.046	version Marelli			830 115	930 059	430 177/1			
Eng. 160 A1.046							470 148	C10	
Eng. 836 A4.000							470 168	C10	359 655

ENGINE				
1.6 i.e.	Petrol	55	06/93-08/99	835 C1.000

Engine	Information	A10	A20	A40	A50	A70	C10 - C30	C20	E01
All engines							470 168	C10	359 655

ENGINE				
1.6 i.e.	Petrol	66	03/96-08/99	182 A6.000

Engine	Information	A10	A20	A40	A50	A70	C10 - C30	C20	E01
All engines							470 345	C10	360 503

ENGINE				
1.6 i.e. 16V	Petrol	76	01/96-08/99	182 A4.000

Engine	Information	A10	A20	A40	A50	A70	C10 - C30	C20	E01
All engines							470 345	C10	360 503

ENGINE				
1.8 i.e.	Petrol	66	07/94-08/99	835 C4.000, 836 A6.000, 836 C4.000

Engine	Information	A10	A20	A40	A50	A70	C10 - C30	C20	E01
All engines	Qty: 2						470 146	C10	
All engines	eng. type 1486839 ->								359 889

ENGINE				
1.8 i.e.	Petrol	74	02/96-08/99	836 A5.000

Engine	Information	A10	A20	A40	A50	A70	C10 - C30	C20	E01
All engines	Qty: 2						470 146	C10	
All engines	eng. type 1486839 ->								359 889

ENGINE				
1.8 i.e.	Petrol	76	06/93-08/99	835 C2.000

Engine	Information	A10	A20	A40	A50	A70	C10 - C30	C20	E01
All engines	Qty: 2						470 146	C10	
All engines	eng. type 1486839 ->								359 889

ENGINE				
1.8 i.e. 16V GT	Petrol	96	03/96-08/99	183 A1.000

Engine	Information	A10	A20	A40	A50	A70	C10 - C30	C20	E01
All engines	01/05/98 ->, Qty: 4						470 384	C10	

ENGINE				
2.0 16V	Petrol	102	06/93-08/99	836 A3.000

Engine	Information	A10	A20	A40	A50	A70	C10 - C30	C20	E01
All engines	version Marelli			830 114	930 060	430 177/1			
All engines							490 303	C30	359 650

A10 CONDENSER	A20 CONTACT SET	A40 DISTRIBUTOR CAP	A50 ROTOR	A70 PICK-UP
C10 COIL	C20 IGNITION MODULE	C30 ELECTRONIC IGNITION KIT	E01 IGNITION CABLE SET	

The present application list is a brief version. For the detailed information about the possibility of installation on a specific vehicle, please refer to our web-catalogue <http://catalogo.facet.eu/>

Vehicle	alim.	kW	Date	Engine	FUNCTIONS ON THE VEHICLE							
					A10	A20	A40	A50	A70	C10 - C30	C20	E01

2.0 16V Turbo					ENGINE
Petrol	137	06/93-08/99	836 A2.000		

Engine	Information	A10	A20	A40	A50	A70	C10 - C30	C20	E01
All engines	Qty: 2						470 146	C10	
All engines									359 456

2.0 16V Turbo					ENGINE
Petrol	142	07/96-08/99	175 A4.000		

Engine	Information	A10	A20	A40	A50	A70	C10 - C30	C20	E01
All engines	Qty: 2						470 146	C10	
All engines									359 456

DELTA III

1.4 16V					ENGINE
Petrol	103	07/10-08/14	198 A7.000		

Engine	Information	A10	A20	A40	A50	A70	C10 - C30	C20	E01
All engines	x 4, COIL ON PLUG						470 549	C10	

1.8					ENGINE
Petrol	147	01/09-08/14	939 B1.000		

Engine	Information	A10	A20	A40	A50	A70	C10 - C30	C20	E01
All engines	x 4, COIL ON PLUG						470 549	C10	

KAPPA

2.0 16V Turbo					ENGINE
Petrol	151	02/95-10/01	834 A4.000, 838 A4.000		

Engine	Information	A10	A20	A40	A50	A70	C10 - C30	C20	E01
All engines	x 1, D.I.S., connector type, saw teeth						470 168	C10	
Eng. 834 A4.000							470 168	C10	
All engines									359 700

2.0 20V					ENGINE
Petrol	107	10/94-10/01	838 A1.000		

Engine	Information	A10	A20	A40	A50	A70	C10 - C30	C20	E01
All engines	x 5, COIL ON PLUG, incl. spark plug connector						470 314	C10	

2.0 20V					ENGINE
Petrol	114	07/96-10/01	838 A6.000		

Engine	Information	A10	A20	A40	A50	A70	C10 - C30	C20	E01
All engines	->ch. 2092439, x 5, COIL ON PLUG, incl. spark plug connector						470 314	C10	

2.0 20V Turbo					ENGINE
Petrol	162	06/98-10/01	175 A3.000		

Engine	Information	A10	A20	A40	A50	A70	C10 - C30	C20	E01
All engines	x 5, COIL ON PLUG, incl. spark plug connector						470 314	C10	

2.4 20V					ENGINE
Petrol	129	08/94-10/01	838 A2.000, 838 A2.027		

Engine	Information	A10	A20	A40	A50	A70	C10 - C30	C20	E01
All engines	x 5, COIL ON PLUG, incl. spark plug connector						470 314	C10	

3.0 24V					ENGINE
Petrol	150	10/94-10/01	838 B.000		

Engine	Information	A10	A20	A40	A50	A70	C10 - C30	C20	E01
All engines	x 6, COIL ON PLUG						470 313	C10	

LYBRA

1.6					ENGINE
Petrol	76	10/00-10/05	182 B6.000		

Engine	Information	A10	A20	A40	A50	A70	C10 - C30	C20	E01
All engines	x 1, D.I.S., connector type, saw teeth						470 345	C10	
All engines									360 503

1.6 16V					ENGINE
Petrol	76	07/99-10/05	182 A4.000		

Engine	Information	A10	A20	A40	A50	A70	C10 - C30	C20	E01
All engines	x 1, D.I.S., connector type, saw teeth						470 345	C10	
All engines									360 503



A10 CONDENSER	A20 CONTACT SET	A40 DISTRIBUTOR CAP	A50 ROTOR	A70 PICK-UP
C10 COIL	C20 IGNITION MODULE	C30 ELECTRONIC IGNITION KIT	E01 IGNITION CABLE SET	

Vehicle	alim.	kW	Date	Engine	FUNCTIONS ON THE VEHICLE									
					A10	A20	A40	A50	A70	C10 - C30	C20	E01		
ENGINE														
1.8 16V	Petrol	96	07/99-10/05	839 A4.000, 839 A7.000, 839 A9.000										
Engine		Information			A10	A20	A40	A50	A70	C10 - C30	C20	E01		
All engines		x 4, COIL ON PLUG, incl. spark plug connector								470 384	C10			
MUSA														
ENGINE														
1.4	Petrol	57	09/05-09/12	350 A1.000										
Engine		Information			A10	A20	A40	A50	A70	C10 - C30	C20	E01		
All engines		x 1, D.I.S.								470 423	C10			
All engines												358 170		
ENGINE														
1.4	Petrol	66	10/07-09/12	192 B2.000										
Engine		Information			A10	A20	A40	A50	A70	C10 - C30	C20	E01		
All engines		x 4, COIL ON PLUG, incl. spark plug connector								470 442	C10			
ENGINE														
1.4	Petrol	70	10/04-09/12	843 A 1.000										
Engine		Information			A10	A20	A40	A50	A70	C10 - C30	C20	E01		
All engines		x 4, COIL ON PLUG, incl. spark plug connector								470 442	C10			
ENGINE														
1.4 16V	Petrol	70	01/11-12/12	--										
Engine		Information			A10	A20	A40	A50	A70	C10 - C30	C20	E01		
All engines		Qty: 4								470 442	C10			
ENGINE														
1.4 8V	Petrol	57	01/11-12/12	--										
Engine		Information			A10	A20	A40	A50	A70	C10 - C30	C20	E01		
All engines										470 423	C10	358 170		
ENGINE														
1.4 LPG	Petrol/ Liquified Petro- leum Gas (LPG)	57	11/10-09/12	350 A1.000										
Engine		Information			A10	A20	A40	A50	A70	C10 - C30	C20	E01		
All engines		x 1, D.I.S.								470 423	C10			
PHEDRA														
ENGINE														
2.0	Petrol	100	09/02-11/10	RFN, RFN (EW10J4)										
Engine		Information			A10	A20	A40	A50	A70	C10 - C30	C20	E01		
Eng. RFN		x 4, COIL ON PLUG								470 408	C10			
Eng. RFN (EW10J4)										470 408	C10			
PRISMA														
ENGINE														
1.3	Petrol	58	01/83-12/89	831 A2.000										
Engine		Information			A10	A20	A40	A50	A70	C10 - C30	C20	E01		
All engines		version Marelli					830 101		430 176M					
All engines		->year 28/02/88, version Marelli						930 047R						
All engines		01/03/88 ->, version Marelli						930 060						
All engines											465 020	359 354		
ENGINE														
1.5	Petrol	59	05/86-07/89	831 B1.000										
Engine		Information			A10	A20	A40	A50	A70	C10 - C30	C20	E01		
All engines		version Marelli					830 104	930 055R						
All engines										470 103	C10			
ENGINE														
1.5	Petrol	63	01/83-04/86	831 A1.000										
Engine		Information			A10	A20	A40	A50	A70	C10 - C30	C20	E01		
All engines		version Marelli					830 104	930 047R						
ENGINE														
1.6	Petrol	71	08/87-08/88	831 B6.000										
Engine		Information			A10	A20	A40	A50	A70	C10 - C30	C20	E01		
All engines		version Marelli					830 098	930 055R						
All engines										470 103	C10	359 398		

A10	CONDENSER	A20	CONTACT SET	A40	DISTRIBUTOR CAP	A50	ROTOR	A70	PICK-UP
C10	COIL	C20	IGNITION MODULE	C30	ELECTRONIC IGNITION KIT	E01	IGNITION CABLE SET		

The present application list is a brief version. For the detailed information about the possibility of installation on a specific vehicle, please refer to our web-catalogue <http://catalogo.facet.eu/>

FUNCTIONS ON THE VEHICLE

Vehicle	alim.	kW	Date	Engine								
---------	-------	----	------	--------	---	---	---	--	---	---	---	---

				ENGINE
1.6	Petrol	73	08/86-02/92	831 B6.000

Engine	Information	A10	A20	A40	A50	A70	C10 - C30	C20	E01
All engines	version Marelli			830 098	930 055R				
All engines							470 103	C10	359 398

				ENGINE
1.6 i.e.	Petrol	80	05/86-12/89	831 B7.000

Engine	Information	A10	A20	A40	A50	A70	C10 - C30	C20	E01
All engines	version Marelli			830 098	930 057R	430 177/1			

				ENGINE
2.0 i.e. Trazione integrale	Petrol	85	04/86-12/89	831 B4.000

Engine	Information	A10	A20	A40	A50	A70	C10 - C30	C20	E01
All engines	version Marelli			830 098	930 057R	430 177/1			

THEMA

				ENGINE
2000 16V	Petrol	112	05/92-07/94	834 F1.000

Engine	Information	A10	A20	A40	A50	A70	C10 - C30	C20	E01
All engines							470 168	C10	359 700

				ENGINE
2000 16V Turbo	Petrol	133	12/88-06/90	834 C1.000

Engine	Information	A10	A20	A40	A50	A70	C10 - C30	C20	E01
All engines	Qty: 2						470 146	C10	
All engines									359 456

				ENGINE
2000 16V Turbo	Petrol	148	10/92-07/94	834 F2.000

Engine	Information	A10	A20	A40	A50	A70	C10 - C30	C20	E01
All engines							470 168	C10	359 700

				ENGINE
2000 i.e.	Petrol	86	09/88-05/92	834 B1.000

Engine	Information	A10	A20	A40	A50	A70	C10 - C30	C20	E01
All engines	version Marelli			830 115					
All engines	->eng. 112486, version Marelli				930 055R				
All engines	eng. type 112486 ->, version Marelli				930 059				
All engines							470 148	C10	359 398

				ENGINE
2000 i.e.	Petrol	85	09/87-05/92	834 B.146

Engine	Information	A10	A20	A40	A50	A70	C10 - C30	C20	E01
All engines	version Marelli			830 115					
All engines	->eng. 112486, version Marelli				930 055R				
All engines	eng. type 112486 ->, version Marelli				930 059				
All engines							470 148	C10	359 398

				ENGINE
2000 i.e. 16V	Petrol	104	02/89-05/92	834 B2.246

Engine	Information	A10	A20	A40	A50	A70	C10 - C30	C20	E01
All engines	Qty: 2						470 146	C10	
All engines									359 456

				ENGINE
2000 i.e. 16V	Petrol	108	05/88-08/92	834 B2.000

Engine	Information	A10	A20	A40	A50	A70	C10 - C30	C20	E01
All engines	Qty: 2						470 146	C10	
All engines									359 456

				ENGINE
2000 i.e. 16V Turbo	Petrol	130	04/89-03/93	834 C1.246









Engine	Information	A10	A20	A40	A50	A70	C10 - C30	C20	E01
All engines	Qty: 2						470 146	C10	
All engines									359 456

				ENGINE
2000 i.e. 16V Turbo	Petrol	133	12/88-06/90	834 C1.000

Engine	Information	A10	A20	A40	A50	A70	C10 - C30	C20	E01
All engines	Qty: 2						470 146	C10	
All engines									359 456

A10 CONDENSER	A20 CONTACT SET	A40 DISTRIBUTOR CAP	A50 ROTOR	A70 PICK-UP
C10 COIL	C20 IGNITION MODULE	C30 ELECTRONIC IGNITION KIT	E01 IGNITION CABLE SET	

Vehicle	alim.	kW	Date	Engine	FUNCTIONS ON THE VEHICLE												
					A10	A20	A40	A50	A70	C10 - C30	C20	E01					
ENGINE																	
2000 i.e.Turbo	Petrol	110	07/86-05/90	834 C.146													
Engine	Information			A10	A20	A40	A50	A70	C10 - C30	C20	E01						
All engines	version Marelli					830 115											
All engines	->eng. 112486, version Marelli						930 055R										
All engines	eng. type 112486 ->, version Marelli						930 059										
All engines								470 148	C10		359 398						
ENGINE																	
2000 Turbo	Petrol	110	12/88-03/92	834 C.146													
Engine	Information			A10	A20	A40	A50	A70	C10 - C30	C20	E01						
All engines	version Marelli					830 115											
All engines	->eng. 112486, version Marelli						930 055R										
All engines	eng. type 112486 ->, version Marelli						930 059										
All engines								470 148	C10		359 398						
ENGINE																	
2000 Turbo 16V	Petrol	148	11/92-07/94	834 F2.000													
Engine	Information			A10	A20	A40	A50	A70	C10 - C30	C20	E01						
All engines									470 168	C10	359 700						
ENGINE																	
2850 V6 i.e.	Petrol	108	06/88-05/92	834 E.146													
Engine	Information			A10	A20	A40	A50	A70	C10 - C30	C20	E01						
All engines	version Bosch					806 236	906 119R										
All engines									470 126	C10							
ENGINE																	
2850 V6 i.e.	Petrol	110	11/84-09/88	834 E.000													
Engine	Information			A10	A20	A40	A50	A70	C10 - C30	C20	E01						
All engines	version Bosch						906 023R										
ENGINE																	
8.32	Petrol	151	10/87-05/92	F 105 L.046													
Engine	Information			A10	A20	A40	A50	A70	C10 - C30	C20	E01						
All engines	Qty: 2								490 303	C30							
ENGINE																	
8.32	Petrol	158	09/87-05/89	F 105 L													
Engine	Information			A10	A20	A40	A50	A70	C10 - C30	C20	E01						
All engines									470 126	C10							
All engines	Qty: 2								490 303	C30							
THESIS																	
ENGINE																	
3.0 V6	Petrol	158	07/02-07/09	841 A.000													
Engine	Information			A10	A20	A40	A50	A70	C10 - C30	C20	E01						
All engines	x 6, COIL ON PLUG								470 313	C10							
ENGINE																	
3.2 V6	Petrol	169	05/03-07/09	841 L.000													
Engine	Information			A10	A20	A40	A50	A70	C10 - C30	C20	E01						
All engines	x 6, COIL ON PLUG								470 313	C10							
Y I																	
ENGINE																	
1.1	Petrol	40	11/95-09/03	176 B2.000													
Engine	Information			A10	A20	A40	A50	A70	C10 - C30	C20	E01						
All engines	x 1, D.I.S., connector type DIN								470 146	C10							
All engines											359 616						
ENGINE																	
1.2	Petrol	44	03/96-09/03	188 A4.000, 840 A3.000													
Engine	Information			A10	A20	A40	A50	A70	C10 - C30	C20	E01						
All engines	x 1, D.I.S., connector type DIN								470 146	C10							
Eng. 840 A3.000											359 616						
Eng. 188 A4.000											360 451						
ENGINE																	
1.2 16V	Petrol	59	10/00-09/03	188 A5.000													
Engine	Information			A10	A20	A40	A50	A70	C10 - C30	C20	E01						
All engines	x 1, D.I.S., connector type, saw teeth								470 168	C10							
All engines											360 505						
A10	CONDENSER			A20	CONTACT SET			A40	DISTRIBUTOR CAP			A50	ROTOR		A70	PICK-UP	
C10	COIL			C20	IGNITION MODULE			C30	ELECTRONIC IGNITION KIT			E01	IGNITION CABLE SET				

					FUNCTIONS ON THE VEHICLE							
Vehicle	alim.	kW	Date	Engine								
ENGINE												
1.2 12V	Petrol	63	04/97-09/03	176 B9.000								
Engine	Information				A10	A20	A40	A50	A70	C10 - C30	C20	E01
All engines	->year 01/12/99, x 1, D.I.S., connector type DIN									470 146	C10	
All engines	01/01/00 ->, x 1, D.I.S., connector type, saw teeth									470 168	C10	
All engines												360 504
ENGINE												
1.4 12V	Petrol	55	03/96-09/03	840 A4.000								
Engine	Information				A10	A20	A40	A50	A70	C10 - C30	C20	E01
All engines	x 1, D.I.S., connector type, saw teeth									470 168	C10	
All engines												360 363
ENGINE												
1.4 12V	Petrol	59	10/96-09/03	840 A2.000								
Engine	Information				A10	A20	A40	A50	A70	C10 - C30	C20	E01
All engines	x 1, D.I.S., connector type, saw teeth									470 168	C10	
All engines												360 363
ENGINE												
Y10												
ENGINE												
1.0 Fire	Petrol	32	06/85-06/91	156 A2.100								
Engine	Information				A10	A20	A40	A50	A70	C10 - C30	C20	E01
All engines	version Marelli						830 109	930 060	430 180M			
All engines										470 108	C10	465 020 359 347
ENGINE												
1.0 Fire Catalytic-Conv	Petrol	33	10/87-02/92	156 A2.246								
Engine	Information				A10	A20	A40	A50	A70	C10 - C30	C20	E01
All engines	version Marelli						830 109	930 060	430 180M			
All engines										470 108	C10	465 020 359 347
ENGINE												
1.0 Fire Trazione integrale	Petrol	32	12/86-02/89	156 A2.100								
Engine	Information				A10	A20	A40	A50	A70	C10 - C30	C20	E01
All engines	version Ducellier						815 080	915 094				
All engines	version Marelli						830 109	930 060	430 180M			
All engines										470 108	C10	465 020 359 347
ENGINE												
1.0 Fire Trazione integrale	Petrol	33	12/87-02/92	156 A2.246								
Engine	Information				A10	A20	A40	A50	A70	C10 - C30	C20	E01
All engines	version Ducellier						815 080	915 094				
All engines	version Marelli						830 109	930 060	430 180M			
All engines										470 108	C10	465 020
ENGINE												
1.0 Fire Trazione integrale	Petrol	37	12/87-02/90	156 A2.000								
Engine	Information				A10	A20	A40	A50	A70	C10 - C30	C20	E01
All engines	version Ducellier						815 080	915 094			465 029	
All engines	version Marelli						830 109	930 060	430 180M		465 020	
All engines										470 108	C10	359 347
ENGINE												
1.1 Fire	Petrol	40	01/95-12/95	176 B2.000								
Engine	Information				A10	A20	A40	A50	A70	C10 - C30	C20	E01
All engines										470 168	C10	359 694
ENGINE												
1.1 Fire Trazione integrale	Petrol	40	01/95-12/95	176 B2.000								
Engine	Information				A10	A20	A40	A50	A70	C10 - C30	C20	E01
All engines										470 168	C10	359 694
ENGINE												
1.1 i.e Fire	Petrol	42	08/89-06/92	156 C.000								
Engine	Information				A10	A20	A40	A50	A70	C10 - C30	C20	E01
All engines	version Ducellier						815 080	915 094			465 029	
All engines	version Marelli						830 109	930 060	430 180M		465 020	

A10 CONDENSER	A20 CONTACT SET	A40 DISTRIBUTOR CAP	A50 ROTOR	A70 PICK-UP
C10 COIL	C20 IGNITION MODULE	C30 ELECTRONIC IGNITION KIT	E01 IGNITION CABLE SET	

Vehicle	alim.	kW	Date	Engine	FUNCTIONS ON THE VEHICLE							
					A10	A20	A40	A50	A70	C10 - C30	C20	E01
ENGINE												
1.1 i.e Fire	Petrol	42	08/89-06/92	156 C.000								
Engine	Information			A10	A20	A40	A50	A70	C10 - C30	C20	E01	
All engines									470 108	C10	359 347	
ENGINE												
1.1 i.e Fire Trazione integrale	Petrol	42	08/89-06/92	156 C.000								
Engine	Information			A10	A20	A40	A50	A70	C10 - C30	C20	E01	
All engines	version Ducellier					815 080	915 094			465 029		
All engines	version Marelli					830 109	930 060	430 180M		465 020		
All engines									470 108	C10		
ENGINE												
1.1 i.e. Fire	Petrol	37	07/89-09/95	156 C.046								
Engine	Information			A10	A20	A40	A50	A70	C10 - C30	C20	E01	
All engines	version Marelli					830 109	930 060	430 180M				
All engines									470 108	C10	465 020	
All engines											359 347	
ENGINE												
1.1 i.e. Fire Trazione integrale	Petrol	37	09/92-12/95	156 C.046								
Engine	Information			A10	A20	A40	A50	A70	C10 - C30	C20	E01	
All engines									470 168	C10	359 694	
ENGINE												
1.3 i.e.	Petrol	53	02/89-12/95	146 A 5.046, 156 B.000								
Engine	Information			A10	A20	A40	A50	A70	C10 - C30	C20	E01	
All engines	version Marelli					830 101						
All engines	version Marelli, version Marelli						930 055R					
All engines									470 148	C10		
ENGINE												
1.3 i.e.	Petrol	56	11/87-05/93	156 B.000								
Engine	Information			A10	A20	A40	A50	A70	C10 - C30	C20	E01	
All engines	version Marelli					830 101	930 055R					
All engines									470 148	C10		
YPSILON II												
ENGINE												
1.2	Petrol	44	10/03-12/11	188 A4.000								
Engine	Information			A10	A20	A40	A50	A70	C10 - C30	C20	E01	
All engines	euro 4 (D4), x 1, D.I.S., connector type DIN								470 146	C10		
All engines	euro 5, x 1, D.I.S.								470 423	C10		
All engines											360 451	
ENGINE												
1.2	Petrol	51	08/10-12/11	169 A4.000								
Engine	Information			A10	A20	A40	A50	A70	C10 - C30	C20	E01	
All engines	euro 4 (D4), x 1, D.I.S., connector type DIN								470 146	C10		
All engines	euro 5, x 1, D.I.S.								470 423	C10		
All engines											360 451	
ENGINE												
1.2	Petrol	59	10/03-12/11	188 A5.000								
Engine	Information			A10	A20	A40	A50	A70	C10 - C30	C20	E01	
All engines	x 4, COIL ON PLUG, incl. spark plug connector								470 442	C10		
ENGINE												
1.4	Petrol	57	02/06-12/11	350 A1.000								
Engine	Information			A10	A20	A40	A50	A70	C10 - C30	C20	E01	
All engines	x 1, D.I.S.								470 423	C10		
All engines											358 170	
ENGINE												
1.4 16V	Petrol	70	10/03-12/11	843 A 1.000								
Engine	Information			A10	A20	A40	A50	A70	C10 - C30	C20	E01	
All engines	x 4, COIL ON PLUG, incl. spark plug connector								470 442	C10		

A10	CONDENSER	A20	CONTACT SET	A40	DISTRIBUTOR CAP	A50	ROTOR	A70	PICK-UP
C10	COIL	C20	IGNITION MODULE	C30	ELECTRONIC IGNITION KIT	E01	IGNITION CABLE SET		

The present application list is a brief version. For the detailed information about the possibility of installation on a specific vehicle, please refer to our web-catalogue <http://catalogo.facet.eu/>

Vehicle	alim.	kW	Date	Engine	FUNCTIONS ON THE VEHICLE							
					A10	A20	A40	A50	A70	C10 - C30	C20	E01

ENGINE				
1.4 LPG	Petrol/ Liquified Petro- leum Gas (LPG)	57	11/10-12/11	350 A1.000

Engine	Information	A10	A20	A40	A50	A70	C10 - C30	C20	E01
All engines	x 1, D.I.S.						470 423	C10	
All engines									358 170

YPSILON III				
ENGINE				
1.2	Petrol	51	05/11->	169 A4.000

Engine	Information	A10	A20	A40	A50	A70	C10 - C30	C20	E01
All engines	x 1, D.I.S.						470 423	C10	
All engines									358 170

ENGINE				
1.2 Bi-fuel	Petrol/ Liquified Petro- leum Gas (LPG)	49	05/11->	169 A4.000

Engine	Information	A10	A20	A40	A50	A70	C10 - C30	C20	E01
All engines	x 1, D.I.S.						470 423	C10	
All engines									358 170

ENGINE				
1.2 Bi-fuel	Petrol/ Liquified Petro- leum Gas (LPG)	51	05/11->	169 A4.000

Engine	Information	A10	A20	A40	A50	A70	C10 - C30	C20	E01
All engines	x 1, D.I.S.						470 423	C10	
All engines									358 170

ZETA				
ENGINE				
2.0 Turbo	Petrol	108	05/95-09/02	RGX (XU10J2TE)

Engine	Information	A10	A20	A40	A50	A70	C10 - C30	C20	E01
All engines							470 188	C10	

A10 CONDENSER	A20 CONTACT SET	A40 DISTRIBUTOR CAP	A50 ROTOR	A70 PICK-UP
C10 COIL	C20 IGNITION MODULE	C30 ELECTRONIC IGNITION KIT	E01 IGNITION CABLE SET	

Vehicle	alim.	kW	Date	Engine	FUNCTIONS ON THE VEHICLE							
					A10	A20	A40	A50	A70	C10 - C30	C20	E01
110/127												
2.5 4x4	Petrol	61	10/85-07/90	17 H								
Engine	Information				A10	A20	A40	A50	A70	C10 - C30	C20	E01
All engines	version Ducellier				615 034		815 054	915 091				
All engines	version Lucas					728 089	828 078	928 012				
All engines									470 101D	C10		
88/109												
2.3 4x4	Petrol	51	09/61-12/86	10 H, 11H								
Engine	Information				A10	A20	A40	A50	A70	C10 - C30	C20	E01
All engines						728 083MHV	828 070, 828 075	928 006				
90												
2.5 4x4	Petrol	62	09/85-08/90	17 H								
Engine	Information				A10	A20	A40	A50	A70	C10 - C30	C20	E01
All engines	version Ducellier				615 034		815 054	915 091				
All engines	version Lucas					728 089	828 078	928 012				
All engines									470 101D	C10		
DEFENDER												
3.5 4x4	Petrol	100	09/90-12/98	15G, 21 G, 22 D								
Engine	Information				A10	A20	A40	A50	A70	C10 - C30	C20	E01
All engines	version Lucas						828 091	928 021, 928 022				
DISCOVERY I												
3.5 4x4	Petrol	113	06/89-06/94	22 D								
Engine	Information				A10	A20	A40	A50	A70	C10 - C30	C20	E01
All engines	version Lucas						828 091	928 022				
DISCOVERY II												
4.0 4x4	Petrol	134	09/93-10/98	35 D, 36 D								
Engine	Information				A10	A20	A40	A50	A70	C10 - C30	C20	E01
All engines	->ch. SA163099, SA501919, version Lucas						828 091	928 022				
DISCOVERY II												
4.0 V8 4x4	Petrol	136	11/98-06/04	35 D, 56 D, 94 D								
Engine	Information				A10	A20	A40	A50	A70	C10 - C30	C20	E01
Eng. 35 D, 94 D	Qty: 2									470 168	C10	
Eng. 56 D	x 1, D.I.S.									470 168	C10	
All engines												358 107
4.6 V8 [USA]												
4.6 V8 [USA]	Petrol	162	01/03-06/04	--								
Engine	Information				A10	A20	A40	A50	A70	C10 - C30	C20	E01
All engines	Qty: 2									470 168	C10	
All engines												358 107
FREELANDER												
1.8 16V 4x4	Petrol	86	04/98-10/06	18 K4F								
Engine	Information				A10	A20	A40	A50	A70	C10 - C30	C20	E01
All engines	->ch. YA999999, version Lucas						828 093	928 029R				
All engines	ch. 1A000001 ->, x 1, DISTRIBUTOR									470 374	C10	
All engines	ch. 1A000001 ->											360 889
All engines	->ch. YA999999											360 900
1.8 4x4												
1.8 4x4	Petrol	86	10/00-10/06	18 K4F								
Engine	Information				A10	A20	A40	A50	A70	C10 - C30	C20	E01
All engines	ch. 1A000001 ->, x 1, DISTRIBUTOR									470 374	C10	
1.8 i 16V 4x4												
1.8 i 16V 4x4	Petrol	88	02/98-10/06	18 K4F								
Engine	Information				A10	A20	A40	A50	A70	C10 - C30	C20	E01
All engines	->ch. YA999999, version Lucas						828 093	928 029R				

A10 CONDENSER	A20 CONTACT SET	A40 DISTRIBUTOR CAP	A50 ROTOR	A70 PICK-UP
C10 COIL	C20 IGNITION MODULE	C30 ELECTRONIC IGNITION KIT	E01 IGNITION CABLE SET	









The present application list is a brief version. For the detailed information about the possibility of installation on a specific vehicle, please refer to our web-catalogue <http://catalogo.facet.eu/>

Vehicle	alim.	kW	Date	Engine	FUNCTIONS ON THE VEHICLE												
					A10	A20	A40	A50	A70	C10 - C30	C20	E01					
ENGINE																	
1.8 i 16V 4x4	Petrol	88	02/98-10/06	18 K4F													
Engine	Information				A10	A20	A40	A50	A70	C10 - C30	C20	E01					
All engines	ch. 1A000001 ->, x 1, DISTRIBUTOR									470 374	C10						
All engines	ch. 1A000001 ->											360 889					
All engines	->ch. YA999999											360 900					
ENGINE																	
2.5 V6 4x4	Petrol	130	11/00-10/06	25KV6													
Engine	Information				A10	A20	A40	A50	A70	C10 - C30	C20	E01					
All engines	->ch. 3A224999, x 1, D.I.S.									470 352	C10						
All engines	->ch. 3A224999, x 6, COIL ON PLUG									470 413	C10						
RANGE ROVER I																	
ENGINE																	
3.5 4x4	Petrol	107	01/87-09/90	31 D													
Engine	Information				A10	A20	A40	A50	A70	C10 - C30	C20	E01					
All engines	version Lucas						828 091	928 022									
ENGINE																	
3.5 Vogue 4x4	Petrol	120	10/85-09/90	24 D, 25 D													
Engine	Information				A10	A20	A40	A50	A70	C10 - C30	C20	E01					
All engines	version Lucas						828 091	928 022									
ENGINE																	
3.5 Vogue 4x4	Petrol	93	08/81-09/90	11 D													
Engine	Information				A10	A20	A40	A50	A70	C10 - C30	C20	E01					
All engines	version Lucas						828 091										
ENGINE																	
3.9 4x4	Petrol	134	11/88-12/92	35 D													
Engine	Information				A10	A20	A40	A50	A70	C10 - C30	C20	E01					
All engines	version Lucas						828 091	928 022									
ENGINE																	
3.9 Cat 4x4	Petrol	127	11/88-07/94	37 D, 38 D													
Engine	Information				A10	A20	A40	A50	A70	C10 - C30	C20	E01					
All engines	version Lucas						828 091	928 022									
ENGINE																	
3.9 Vogue SEI 4x4	Petrol	134	11/88-07/94	35 D, 36 D													
Engine	Information				A10	A20	A40	A50	A70	C10 - C30	C20	E01					
All engines	version Lucas						828 091	928 022									
ENGINE																	
4.3 Vogue LSE 4x4	Petrol	149	09/92-07/94	40 D													
Engine	Information				A10	A20	A40	A50	A70	C10 - C30	C20	E01					
All engines	version Lucas						828 091	928 022									
RANGE ROVER II																	
ENGINE																	
3.9 4x4	Petrol	140	07/94-03/02	42 D													
Engine	Information				A10	A20	A40	A50	A70	C10 - C30	C20	E01					
All engines	ch. XA410482 ->, x 1, D.I.S.									470 168	C10						
All engines	ch. XA410482 ->											358 107					
ENGINE																	
4.0 4x4	Petrol	136	01/95-03/02	42 D, 46698710													
Engine	Information				A10	A20	A40	A50	A70	C10 - C30	C20	E01					
Eng. 42 D	ch. XA410482 ->, Qty: 2									470 168	C10						
Eng. 46698710	ch. XA410482 ->, x 1, D.I.S.									470 168	C10						
Eng. 42 D	ch. XA410482 ->											358 107					
ENGINE																	
4.6 4x4	Petrol	160	06/98-03/02	60 D													
Engine	Information				A10	A20	A40	A50	A70	C10 - C30	C20	E01					
All engines	ch. XA410482 ->, x 1, D.I.S.									470 168	C10						
ENGINE																	
4.6 4x4	Petrol	165	07/94-03/02	46 D, 48 D, 60 D													
Engine	Information				A10	A20	A40	A50	A70	C10 - C30	C20	E01					
Eng. 46 D	ch. XA410482 ->, Qty: 2									470 168	C10						
Eng. 48 D, 60 D	ch. XA410482 ->, x 1, D.I.S.									470 168	C10						
A10	CONDENSER	A20	CONTACT SET	A40	DISTRIBUTOR CAP	A50	ROTOR	A70	PICK-UP	C10	COIL	C20	IGNITION MODULE	C30	ELECTRONIC IGNITION KIT	E01	IGNITION CABLE SET

Vehicle	alim.	kW	Date	Engine	FUNCTIONS ON THE VEHICLE									
					A10	A20	A40	A50	A70	C10 - C30	C20	E01		
ENGINE														
4.6 4x4	Petrol	165	07/94-03/02	46 D, 48 D, 60 D										
Engine	Information				A10	A20	A40	A50	A70	C10 - C30	C20	E01		
Eng. 46 D	ch. XA410482 ->												358 107	
ENGINE														
4.6 4x4	Petrol	168	09/95-03/02	46 D										
Engine	Information				A10	A20	A40	A50	A70	C10 - C30	C20	E01		
All engines	ch. XA410482 ->, Qty: 2									470 168	C10			
All engines	ch. XA410482 ->												358 107	
RANGE ROVER III														
ENGINE														
4.4 4x4	Petrol	210	03/02-08/05	44SDEX, M62 B44										
Engine	Information				A10	A20	A40	A50	A70	C10 - C30	C20	E01		
Eng. 44SDEX	x 8, COIL ON PLUG									470 352	C10			
Eng. M62 B44	Qty: 8									470 352	C10			
ENGINE														
4.4 4x4	Petrol	220	08/04-08/12	448PN										
Engine	Information				A10	A20	A40	A50	A70	C10 - C30	C20	E01		
All engines	x 8, COIL ON PLUG									470 352	C10			

A10	CONDENSER	A20	CONTACT SET	A40	DISTRIBUTOR CAP	A50	ROTOR	A70	PICK-UP
C10	COIL	C20	IGNITION MODULE	C30	ELECTRONIC IGNITION KIT	E01	IGNITION CABLE SET		









The present application list is a brief version. For the detailed information about the possibility of installation on a specific vehicle, please refer to our web-catalogue <http://catalogo.facet.eu/>

					FUNCTIONS ON THE VEHICLE									
Vehicle	alim.	kW	Date	Engine	 A10	 A20	 A40	 A50	 A70	 C10 - C30	 C20	 E01		
CT														
200h	Petrol/ Electric	100	09/11->	2ZR-FXE										
Engine	Information				A10	A20	A40	A50	A70	C10 - C30	C20	E01		
All engines	CT 200h, x 4, COIL ON PLUG									470 536	C10			
200h	Petrol/ Electric	73	12/10->	2ZR-FXE										
Engine	Information				A10	A20	A40	A50	A70	C10 - C30	C20	E01		
All engines	CT 200h, x 4, COIL ON PLUG									470 536	C10			
ES														
200	Petrol	110	08/15->	6AR-FSE										
Engine	Information				A10	A20	A40	A50	A70	C10 - C30	C20	E01		
All engines	ES 200, x 4, COIL ON PLUG, FOR: (J)									470 537	C10			
250	Petrol	118	12/89-12/91	2VZ-FE										
Engine	Information				A10	A20	A40	A50	A70	C10 - C30	C20	E01		
All engines										470 202	C10			
250	Petrol	135	06/12-06/18	2AR-FE										
Engine	Information				A10	A20	A40	A50	A70	C10 - C30	C20	E01		
All engines	ES 250, x 4, COIL ON PLUG, FOR: (J)									470 537	C10			
3.5	Petrol	204	05/06-06/12	2GR-FE										
Engine	Information				A10	A20	A40	A50	A70	C10 - C30	C20	E01		
All engines	ES 350, x 6, COIL ON PLUG									470 538	C10			
300h	Petrol/ Electric	118	06/12-06/18	2AR-FXE										
Engine	Information				A10	A20	A40	A50	A70	C10 - C30	C20	E01		
All engines	ES 300h, x 4, COIL ON PLUG, FOR: (J)									470 537	C10			
350	Petrol	183	06/12-06/18	2GR-FE										
Engine	Information				A10	A20	A40	A50	A70	C10 - C30	C20	E01		
All engines	ES 350, x 6, COIL ON PLUG									470 538	C10			
350	Petrol	204	06/12-06/18	2GR-FE										
Engine	Information				A10	A20	A40	A50	A70	C10 - C30	C20	E01		
All engines	ES 350, x 6, COIL ON PLUG									470 538	C10			
GS														
250	Petrol	154	01/12->	4GR-FSE										
Engine	Information				A10	A20	A40	A50	A70	C10 - C30	C20	E01		
All engines	GS 250, x 6, COIL ON PLUG, FOR: (J)									470 537	C10			
3.5 450h	Petrol/ Electric	213	03/12-09/18	2GR-FXE										
Engine	Information				A10	A20	A40	A50	A70	C10 - C30	C20	E01		
All engines	GS 450h, x 6, COIL ON PLUG, FOR: (J)									470 537	C10			
3.5 VVTi	Petrol	223	04/05-12/12	2GR-FSE										
Engine	Information				A10	A20	A40	A50	A70	C10 - C30	C20	E01		
All engines	GS 350, x 6, COIL ON PLUG, FOR: (J)									470 537	C10			
300	Petrol	156	01/93-08/97	2JZ-GE										
Engine	Information				A10	A20	A40	A50	A70	C10 - C30	C20	E01		
All engines										470 203	C10			
300	Petrol	170	04/05-11/11	3GR-FE										
Engine	Information				A10	A20	A40	A50	A70	C10 - C30	C20	E01		
All engines	GS 300, x 6, COIL ON PLUG, FOR: (J)									470 537	C10			
A10	CONDENSER		A20	CONTACT SET		A40	DISTRIBUTOR CAP		A50	ROTOR		A70	PICK-UP	
C10	COIL		C20	IGNITION MODULE		C30	ELECTRONIC IGNITION KIT		E01	IGNITION CABLE SET				

Vehicle	alim.	kW	Date	Engine	FUNCTIONS ON THE VEHICLE									
					A10	A20	A40	A50	A70	C10 - C30	C20	E01		
ENGINE														
300	Petrol	183	04/05-11/11	3GR-FSE										
Engine Information					A10	A20	A40	A50	A70	C10 - C30	C20	E01		
All engines										470 537	C10			
ENGINE														
300h	Petrol/ Electric	133	10/13->	2AR-FSE										
Engine Information					A10	A20	A40	A50	A70	C10 - C30	C20	E01		
All engines										470 537	C10			
ENGINE														
350	Petrol	226	09/06-11/11	2GR-FSE										
Engine Information					A10	A20	A40	A50	A70	C10 - C30	C20	E01		
All engines										470 537	C10			
ENGINE														
350	Petrol	233	03/12->	2GR-FSE										
Engine Information					A10	A20	A40	A50	A70	C10 - C30	C20	E01		
All engines										470 537	C10			
ENGINE														
350	Petrol	234	01/12->	2GR-FSE										
Engine Information					A10	A20	A40	A50	A70	C10 - C30	C20	E01		
All engines										470 537	C10			
ENGINE														
350 AWD	Petrol	226	09/06-11/11	2GR-FSE										
Engine Information					A10	A20	A40	A50	A70	C10 - C30	C20	E01		
All engines										470 537	C10			
ENGINE														
350 AWD	Petrol	232	05/08-11/11	2GR-FSE										
Engine Information					A10	A20	A40	A50	A70	C10 - C30	C20	E01		
All engines										470 537	C10			
ENGINE														
350 AWD	Petrol	233	03/12->	2GR-FSE										
Engine Information					A10	A20	A40	A50	A70	C10 - C30	C20	E01		
All engines										470 537	C10			
ENGINE														
350 AWD	Petrol	234	12/11->	2GR-FKS, 2GR-FSE										
Engine Information					A10	A20	A40	A50	A70	C10 - C30	C20	E01		
All engines										470 537	C10			
ENGINE														
450h	Petrol/ Electric	215	01/12->	2GR-FXE										
Engine Information					A10	A20	A40	A50	A70	C10 - C30	C20	E01		
All engines										470 537	C10			
ENGINE														
450h	Petrol/ Electric	218	02/06-11/11	2GR-FSE										
Engine Information					A10	A20	A40	A50	A70	C10 - C30	C20	E01		
All engines										470 537	C10			
ENGINE														
450h	Petrol/ Electric	254	02/06-09/18	2GR-FSE, 2GR-FXE										
Engine Information					A10	A20	A40	A50	A70	C10 - C30	C20	E01		
All engines										470 537	C10			
ENGINE														
F	Petrol	351	09/15->	2UR-GSE										
Engine Information					A10	A20	A40	A50	A70	C10 - C30	C20	E01		
All engines										470 458	C10			
ENGINE														
GX														
460 4WD	Petrol	218	01/10->	1UR-FE										
Engine Information					A10	A20	A40	A50	A70	C10 - C30	C20	E01		
All engines										470 537	C10			

A10	CONDENSER	A20	CONTACT SET	A40	DISTRIBUTOR CAP	A50	ROTOR	A70	PICK-UP
C10	COIL	C20	IGNITION MODULE	C30	ELECTRONIC IGNITION KIT	E01	IGNITION CABLE SET		

The present application list is a brief version. For the detailed information about the possibility of installation on a specific vehicle, please refer to our web-catalogue <http://catalogo.facet.eu/>









					FUNCTIONS ON THE VEHICLE							
Vehicle	alim.	kW	Date	Engine								
460 4WD												
ENGINE												
Petrol 225 01/10-> 1UR-FE												
Engine	Information				A10	A20	A40	A50	A70	C10 - C30	C20	E01
All engines	GX 460, x 8, COIL ON PLUG, FOR: (J)									470 537	C10	
HS												
ENGINE												
Petrol/Electric 110 07/09-01/18 2AZ-FXE												
Engine	Information				A10	A20	A40	A50	A70	C10 - C30	C20	E01
All engines	HS 250h, x 4, COIL ON PLUG, FOR: (J)									470 466	C10	
IS II												
ENGINE												
Petrol 153 08/05-06/15 4GR-FSE												
Engine	Information				A10	A20	A40	A50	A70	C10 - C30	C20	E01
All engines	IS 250, IS 250 C, x 6, COIL ON PLUG, FOR: (J)									470 537	C10	
ENGINE												
Petrol 157 08/10-> 4GR-FSE												
Engine	Information				A10	A20	A40	A50	A70	C10 - C30	C20	E01
All engines	Qty: 6									470 537	C10	
ENGINE												
Petrol 158 11/10-03/13 4GR-FSE												
Engine	Information				A10	A20	A40	A50	A70	C10 - C30	C20	E01
All engines	Qty: 6									470 537	C10	
ENGINE												
Petrol 153 10/05-03/13 4GR-FSE												
Engine	Information				A10	A20	A40	A50	A70	C10 - C30	C20	E01
All engines	IS 250, x 6, COIL ON PLUG, FOR: (J)									470 537	C10	
ENGINE												
Petrol 158 11/10-03/13 4GR-FSE												
Engine	Information				A10	A20	A40	A50	A70	C10 - C30	C20	E01
All engines	Qty: 6									470 537	C10	
ENGINE												
Petrol 228 04/09-> 2GR-FSE												
Engine	Information				A10	A20	A40	A50	A70	C10 - C30	C20	E01
All engines	Qty: 6									470 537	C10	
ENGINE												
Petrol 234 01/08-> 2GR-FSE												
Engine	Information				A10	A20	A40	A50	A70	C10 - C30	C20	E01
All engines	Qty: 6									470 537	C10	
IS III												
ENGINE												
Petrol 153 04/13-> 4GR-FSE												
Engine	Information				A10	A20	A40	A50	A70	C10 - C30	C20	E01
All engines	IS 250, x 6, COIL ON PLUG, FOR: (J)									470 537	C10	
ENGINE												
Petrol/Electric 131 04/13-> 2AR-FSE												
Engine	Information				A10	A20	A40	A50	A70	C10 - C30	C20	E01
All engines	IS 300h, x 4, COIL ON PLUG, FOR: (J)									470 537	C10	
ENGINE												
Petrol/Electric 133 04/13-> 2AR-FSE												
Engine	Information				A10	A20	A40	A50	A70	C10 - C30	C20	E01
All engines	IS 300h, x 4, COIL ON PLUG, FOR: (J)									470 537	C10	
LC												
ENGINE												
Petrol 341 11/18-> 2UR-GSE												
Engine	Information				A10	A20	A40	A50	A70	C10 - C30	C20	E01
All engines	LC 500, x 8, COIL ON PLUG, FOR: (J)									470 458	C10	

A10 CONDENSER	A20 CONTACT SET	A40 DISTRIBUTOR CAP	A50 ROTOR	A70 PICK-UP
C10 COIL	C20 IGNITION MODULE	C30 ELECTRONIC IGNITION KIT	E01 IGNITION CABLE SET	

Vehicle	alim.	kW	Date	Engine	FUNCTIONS ON THE VEHICLE									
					A10	A20	A40	A50	A70	C10 - C30	C20	E01		
ENGINE														
500	Petrol	351	11/16->	2UR-GSE										
Engine		Information			A10	A20	A40	A50	A70	C10 - C30	C20	E01		
All engines		LC 500, x 8, COIL ON PLUG, FOR: (J)								470 458	C10			
LS I														
400	Petrol	180	12/89-12/95	1UZ-FE										
Engine		Information			A10	A20	A40	A50	A70	C10 - C30	C20	E01		
All engines		Qty: 2								470 203	C10			
LS II														
400	Petrol	194	12/94-08/97	1UZ-FE										
Engine		Information			A10	A20	A40	A50	A70	C10 - C30	C20	E01		
All engines		LS 400, x 1, DISTRIBUTOR								470 203	C10			
LS IV														
460	Petrol	255	08/06->	1UR-FE										
Engine		Information			A10	A20	A40	A50	A70	C10 - C30	C20	E01		
All engines		LS 460, x 8, COIL ON PLUG, FOR: (J)								470 537	C10			
ENGINE														
460	Petrol	280	04/06->	1UR-FE - E4, 1UR-FE - E5, 1UR-FSE, 1UR-FSE - E4, 1UR-FSE - E5										
Engine		Information			A10	A20	A40	A50	A70	C10 - C30	C20	E01		
Eng. 1UR-FE - E4, 1UR-FE - E5, 1UR-FSE - E4, 1UR-FSE - E5		Qty: 6								470 537	C10			
Eng. 1UR-FSE		LS 460, x 8, COIL ON PLUG, FOR: (J)								470 537	C10			
460	Petrol	285	09/12->	1UR-FSE										
Engine		Information			A10	A20	A40	A50	A70	C10 - C30	C20	E01		
All engines		LS 460, x 8, COIL ON PLUG, FOR: (J)								470 537	C10			
ENGINE														
460 4WD	Petrol	280	08/06->	1UR-FSE										
Engine		Information			A10	A20	A40	A50	A70	C10 - C30	C20	E01		
All engines		LS 460, x 8, COIL ON PLUG, FOR: (J)								470 537	C10			
ENGINE														
460 AWD	Petrol	270	12/08->	1UR-FE - E4, 1UR-FSE										
Engine		Information			A10	A20	A40	A50	A70	C10 - C30	C20	E01		
Eng. 1UR-FE - E4		Qty: 8								470 537	C10			
Eng. 1UR-FSE		LS 460, x 8, COIL ON PLUG, FOR: (J)								470 537	C10			
ENGINE														
460 AWD	Petrol	272	09/12->	1UR-FSE										
Engine		Information			A10	A20	A40	A50	A70	C10 - C30	C20	E01		
All engines		LS 460, x 8, COIL ON PLUG, FOR: (J)								470 537	C10			
ENGINE														
460 AWD	Petrol	283	10/09->	1UR-FSE										
Engine		Information			A10	A20	A40	A50	A70	C10 - C30	C20	E01		
All engines		LS 460, x 8, COIL ON PLUG, FOR: (J)								470 537	C10			
ENGINE														
600h AWD	Petrol/ Electric	272	07/12-07/17	2UR-FSE										
Engine		Information			A10	A20	A40	A50	A70	C10 - C30	C20	E01		
All engines		LS 600h, x 8, COIL ON PLUG, FOR: (J)								470 537	C10			
ENGINE														
600h AWD	Petrol/ Electric	290	04/07->	2UR-FSE, 2URFSE - E4, 2UR-FSE - E5										
Engine		Information			A10	A20	A40	A50	A70	C10 - C30	C20	E01		
Eng. 2UR-FSE		LS 600h, x 8, COIL ON PLUG, FOR: (J)								470 537	C10			
Eng. 2URFSE - E4, 2UR-FSE - E5		Qty: 6								470 537	C10			

A10	CONDENSER	A20	CONTACT SET	A40	DISTRIBUTOR CAP	A50	ROTOR	A70	PICK-UP
C10	COIL	C20	IGNITION MODULE	C30	ELECTRONIC IGNITION KIT	E01	IGNITION CABLE SET		

The present application list is a brief version. For the detailed information about the possibility of installation on a specific vehicle, please refer to our web-catalogue <http://catalogo.facet.eu/>

					FUNCTIONS ON THE VEHICLE							
Vehicle	alim.	kW	Date	Engine	 A10	 A20	 A40	 A50	 A70	 C10 - C30	 C20	 E01
600h AWD												
	Petrol/ Electric	327	09/07->	2UR-FSE								
ENGINE												
Engine	Information				A10	A20	A40	A50	A70	C10 - C30	C20	E01
All engines	LS 600h, x 8, COIL ON PLUG, FOR: (J)									470 537	C10	
LX												
570												
	Petrol	270	11/07->	3UR-FE								
ENGINE												
Engine	Information				A10	A20	A40	A50	A70	C10 - C30	C20	E01
All engines	LX 570, x 8, COIL ON PLUG, FOR: (J)									470 537	C10	
570												
	Petrol	282	11/07->	3UR-FE								
ENGINE												
Engine	Information				A10	A20	A40	A50	A70	C10 - C30	C20	E01
All engines	LX 570, x 8, COIL ON PLUG, FOR: (J)									470 537	C10	
570												
	Petrol	285	08/07->	3UR-FE								
ENGINE												
Engine	Information				A10	A20	A40	A50	A70	C10 - C30	C20	E01
All engines	LX 570, x 8, COIL ON PLUG, FOR: (J)									470 537	C10	
NX												
200												
	Petrol	110	11/14->	3ZR-FAE								
ENGINE												
Engine	Information				A10	A20	A40	A50	A70	C10 - C30	C20	E01
All engines	NX 200, x 4, COIL ON PLUG									470 536	C10	
200 AWD												
	Petrol	110	11/14->	3ZR-FAE								
ENGINE												
Engine	Information				A10	A20	A40	A50	A70	C10 - C30	C20	E01
All engines	NX 200, x 4, COIL ON PLUG									470 536	C10	
300h												
	Petrol/ Electric	114	07/14->	2AR-FXE								
ENGINE												
Engine	Information				A10	A20	A40	A50	A70	C10 - C30	C20	E01
All engines	NX 300h, x 4, COIL ON PLUG, FOR: (J)									470 537	C10	
300h												
	Petrol/ Electric	145	11/14->	2AR-FXE								
ENGINE												
Engine	Information				A10	A20	A40	A50	A70	C10 - C30	C20	E01
All engines	NX 300h, x 4, COIL ON PLUG, FOR: (J)									470 537	C10	
300h AWD												
	Petrol/ Electric	114	07/14->	2AR-FXE								
ENGINE												
Engine	Information				A10	A20	A40	A50	A70	C10 - C30	C20	E01
All engines	NX 300h, x 4, COIL ON PLUG, FOR: (J)									470 537	C10	
300h AWD												
	Petrol/ Electric	145	07/14->	2AR-FXE								
ENGINE												
Engine	Information				A10	A20	A40	A50	A70	C10 - C30	C20	E01
All engines	NX 300h, x 4, COIL ON PLUG, FOR: (J)									470 537	C10	
300h AWD												
	Petrol/ Electric	147	11/18->	2AR-FXE								
ENGINE												
Engine	Information				A10	A20	A40	A50	A70	C10 - C30	C20	E01
All engines	NX 300h, x 4, COIL ON PLUG, FOR: (J)									470 537	C10	
RC												
300h												
	Petrol/ Electric	133	09/14->	2AR-FSE								
ENGINE												
Engine	Information				A10	A20	A40	A50	A70	C10 - C30	C20	E01
All engines	RC 300h, x 4, COIL ON PLUG, FOR: (J)									470 537	C10	
350												
	Petrol	234	08/14->	2GR-FSE								
ENGINE												
Engine	Information				A10	A20	A40	A50	A70	C10 - C30	C20	E01
All engines	RC 350, x 6, COIL ON PLUG, FOR: (J)									470 537	C10	

A10 CONDENSER	A20 CONTACT SET	A40 DISTRIBUTOR CAP	A50 ROTOR	A70 PICK-UP
C10 COIL	C20 IGNITION MODULE	C30 ELECTRONIC IGNITION KIT	E01 IGNITION CABLE SET	

Vehicle	alim.	kW	Date	Engine	FUNCTIONS ON THE VEHICLE							
					A10	A20	A40	A50	A70	C10 - C30	C20	E01
ENGINE												
F	Petrol	330	08/14->	2UR-GSE								
Engine	Information			A10	A20	A40	A50	A70	C10 - C30	C20	E01	
All engines	RCF, x 8, COIL ON PLUG, FOR: (J)								470 458	C10		
ENGINE												
F	Petrol	341	03/18->	2UR-GSE								
Engine	Information			A10	A20	A40	A50	A70	C10 - C30	C20	E01	
All engines	RCF, x 8, COIL ON PLUG, FOR: (J)								470 458	C10		
ENGINE												
F	Petrol	344	08/14->	2UR-GSE								
Engine	Information			A10	A20	A40	A50	A70	C10 - C30	C20	E01	
All engines	RCF, x 8, COIL ON PLUG, FOR: (J)								470 458	C10		
ENGINE												
F	Petrol	351	08/14->	2UR-GSE								
Engine	Information			A10	A20	A40	A50	A70	C10 - C30	C20	E01	
All engines	RCF, x 8, COIL ON PLUG, FOR: (J)								470 458	C10		
RX II												
ENGINE												
350	Petrol	203	01/06-12/08	2GR-FE								
Engine	Information			A10	A20	A40	A50	A70	C10 - C30	C20	E01	
All engines	RX 350, x 6, COIL ON PLUG								470 538	C10		
ENGINE												
350 AWD	Petrol	203	02/06-12/08	2GR-FE, 2GRFE(276)								
Engine	Information			A10	A20	A40	A50	A70	C10 - C30	C20	E01	
Eng. 2GR-FE	RX 350, x 6, COIL ON PLUG								470 538	C10		
Eng. 2GRFE(276)	->year 01/12/08, 01/01/06 ->								470 538	C10		
RX III												
ENGINE												
270	Petrol	138	12/08-10/15	1AR-FE								
Engine	Information			A10	A20	A40	A50	A70	C10 - C30	C20	E01	
All engines	RX 270, x 4, COIL ON PLUG, FOR: (J)								470 537	C10		
ENGINE												
350	Petrol	202	01/09-09/15	2GR-FE								
Engine	Information			A10	A20	A40	A50	A70	C10 - C30	C20	E01	
All engines	RX 350, FOR: (J), FOR: (USA), FOR: (CDN), x 6, COIL ON PLUG, x 6, COIL ON PLUG								470 538	C10		
ENGINE												
350 AWD	Petrol	204	12/08-08/15	2GR-FE								
Engine	Information			A10	A20	A40	A50	A70	C10 - C30	C20	E01	
All engines	RX 350, FOR: (J), FOR: (USA), FOR: (CDN), x 6, COIL ON PLUG, x 6, COIL ON PLUG								470 538	C10		
ENGINE												
350 AWD	Petrol	206	03/09-02/12	2GR-FE								
Engine	Information			A10	A20	A40	A50	A70	C10 - C30	C20	E01	
All engines	Qty: 6								470 538	C10		
ENGINE												
450h	Petrol/ Electric	183	12/08-10/15	2GR-FXE								
Engine	Information			A10	A20	A40	A50	A70	C10 - C30	C20	E01	
All engines	RX 450h, x 6, COIL ON PLUG								470 538	C10		
ENGINE												
450h	Petrol/ Electric	220	12/08-10/15	2GR-FXE								
Engine	Information			A10	A20	A40	A50	A70	C10 - C30	C20	E01	
All engines	Qty: 6								470 538	C10		
ENGINE												
450h AWD	Petrol/ Electric	183	12/08-10/15	2GR-FXE, 2GRFXE(299H) - E4								
Engine	Information			A10	A20	A40	A50	A70	C10 - C30	C20	E01	
Eng. 2GRFXE(299H) - E4	Qty: 6								470 537	C10		
Eng. 2GR-FXE	RX 450h, x 6, COIL ON PLUG								470 538	C10		

A10	CONDENSER	A20	CONTACT SET	A40	DISTRIBUTOR CAP	A50	ROTOR	A70	PICK-UP
C10	COIL	C20	IGNITION MODULE	C30	ELECTRONIC IGNITION KIT	E01	IGNITION CABLE SET		

The present application list is a brief version. For the detailed information about the possibility of installation on a specific vehicle, please refer to our web-catalogue <http://catalogo.facet.eu/>

Vehicle	alim.	kW	Date	Engine	FUNCTIONS ON THE VEHICLE							
					A10	A20	A40	A50	A70	C10 - C30	C20	E01

				ENGINE
450h AWD	Petrol/ Electric	220	12/08-10/15	2GR-FXE

Engine	Information	A10	A20	A40	A50	A70	C10 - C30	C20	E01
All engines	Qty: 6						470 537	C10	

				ENGINE
4.0i	Petrol	0	01/91->	1UZFE

Engine	Information	A10	A20	A40	A50	A70	C10 - C30	C20	E01
All engines	Qty: 2						470 203	C10	

A10	CONDENSER	A20	CONTACT SET	A40	DISTRIBUTOR CAP	A50	ROTOR	A70	PICK-UP
C10	COIL	C20	IGNITION MODULE	C30	ELECTRONIC IGNITION KIT	E01	IGNITION CABLE SET		

Vehicle	alim.	kW	Date	Engine	FUNCTIONS ON THE VEHICLE							
					A10	A20	A40	A50	A70	C10 - C30	C20	E01
												

ECLAT

2.0	Petrol	119	10/75-05/80	ENGINE
				907

Engine	Information	A10	A20	A40	A50	A70	C10 - C30	C20	E01
All engines				828 075					

ELITE

2.0	Petrol	119	05/74-05/80	ENGINE
				907

Engine	Information	A10	A20	A40	A50	A70	C10 - C30	C20	E01
All engines				828 075					









ESPRIT

2.0	Petrol	119	10/75-05/80	ENGINE
				907

Engine	Information	A10	A20	A40	A50	A70	C10 - C30	C20	E01
All engines				828 075					

A10 CONDENSER	A20 CONTACT SET	A40 DISTRIBUTOR CAP	A50 ROTOR	A70 PICK-UP
C10 COIL	C20 IGNITION MODULE	C30 ELECTRONIC IGNITION KIT	E01 IGNITION CABLE SET	

The present application list is a brief version. For the detailed information about the possibility of installation on a specific vehicle, please refer to our web-catalogue <http://catalogo.facet.eu/>

					FUNCTIONS ON THE VEHICLE							
Vehicle	alim.	kW	Date	Engine	 A10	 A20	 A40	 A50	 A70	 C10 - C30	 C20	 E01
E2000												
E2000		170	05/00->	ENGINE E 2866 DF 01								
Engine	Information				A10	A20	A40	A50	A70	C10 - C30	C20	E01
All engines	->year 200209						806 081					
F2000												
F2000		170	09/96->	ENGINE E 2866 DF 01								
Engine	Information				A10	A20	A40	A50	A70	C10 - C30	C20	E01
All engines	->year 200112, ->year 200208						806 081					
LION'S CITY												
LION'S CITY		184	06/96->	ENGINE D 0826 LUH								
Engine	Information				A10	A20	A40	A50	A70	C10 - C30	C20	E01
All engines	200903 ->									470 417	C10	
LION'S CITY		228	05/07->	ENGINE E 2876 LUH 02								
Engine	Information				A10	A20	A40	A50	A70	C10 - C30	C20	E01
All engines										470 417	C10	
LION'S CITY		235	10/09->	ENGINE E 2876 LUH 03								
Engine	Information				A10	A20	A40	A50	A70	C10 - C30	C20	E01
All engines										470 417	C10	
NG												
NG		170	01/95-07/99	ENGINE E 2866 DUH 01								
Engine	Information				A10	A20	A40	A50	A70	C10 - C30	C20	E01
All engines							806 081, 806 258			470 417	C10	
NG		228	05/07-12/14	ENGINE E 2876 LUH 02								
Engine	Information				A10	A20	A40	A50	A70	C10 - C30	C20	E01
All engines										470 417	C10	
NL												
NL		170	05/93-06/00	ENGINE E 2866 DUH 01, E 2866 DUH 02								
Engine	Information				A10	A20	A40	A50	A70	C10 - C30	C20	E01
All engines	199404 ->						806 081, 806 258			470 417	C10	
NL		180	05/07-12/14	ENGINE E 2866 DUH 03								
Engine	Information				A10	A20	A40	A50	A70	C10 - C30	C20	E01
All engines										470 417	C10	
NL		228	04/99-12/14	ENGINE E 2866 LUH 02, E 2876 LUH 02								
Engine	Information				A10	A20	A40	A50	A70	C10 - C30	C20	E01
All engines										470 417	C10	

A10 CONDENSER	A20 CONTACT SET	A40 DISTRIBUTOR CAP	A50 ROTOR	A70 PICK-UP
C10 COIL	C20 IGNITION MODULE	C30 ELECTRONIC IGNITION KIT	E01 IGNITION CABLE SET	



Vehicle	alim.	kW	Date	Engine	FUNCTIONS ON THE VEHICLE							
					 A10	 A20	 A40	 A50	 A70	 C10 - C30	 C20	 E01

800				ENGINE
0.8	Petrol	26	01/91-12/06	F8B

Engine	Information	A10	A20	A40	A50	A70	C10 - C30	C20	E01
All engines	version Denso		713 011HV	813 107	913 030				

A10	CONDENSER	A20	CONTACT SET	A40	DISTRIBUTOR CAP	A50	ROTOR	A70	PICK-UP
C10	COIL	C20	IGNITION MODULE	C30	ELECTRONIC IGNITION KIT	E01	IGNITION CABLE SET		

The present application list is a brief version. For the detailed information about the possibility of installation on a specific vehicle, please refer to our web-catalogue <http://catalogo.facet.eu/>

					FUNCTIONS ON THE VEHICLE							
Vehicle	alim.	kW	Date	Engine								
					A10	A20	A40	A50	A70	C10 - C30	C20	E01

BITURBO				ENGINE
i	Petrol	136	07/85-04/87	AM 452

Engine	Information	A10	A20	A40	A50	A70	C10 - C30	C20	E01
All engines	version Marelli				930 054R				

A10	CONDENSER	A20	CONTACT SET	A40	DISTRIBUTOR CAP	A50	ROTOR	A70	PICK-UP
C10	COIL	C20	IGNITION MODULE	C30	ELECTRONIC IGNITION KIT	E01	IGNITION CABLE SET		

Vehicle	alim.	kW	Date	Engine	FUNCTIONS ON THE VEHICLE							
					A10	A20	A40	A50	A70	C10 - C30	C20	E01
121												
1.3	Petrol	37	07/96-10/02	1E03								
Engine	Information				A10	A20	A40	A50	A70	C10 - C30	C20	E01
All engines	x 1, DENSO, x 1, D.I.S., x 1, D.I.S.									470 532	C10	
1.3												
1.3	Petrol	44	01/96-05/97	1E04								
Engine	Information				A10	A20	A40	A50	A70	C10 - C30	C20	E01
All engines	x 1, D.I.S., DENSO, D.I.S.									470 532	C10	
121 I												
1.1	Petrol	42	10/87-10/90	B1, B116								
Engine	Information				A10	A20	A40	A50	A70	C10 - C30	C20	E01
Eng. B116	for manuf. exhaust norm US-83, version Mitsubishi						831 122					
Eng. B116	super unlead (95), version Mitsubshi						831 131					
All engines	version Mitsubishi						831 132					
All engines	for manuf. exhaust norm US-83, version Mitsubishi							931 108				
Eng. B116	super unlead (95), version Mitsubishi							931 119				
Eng. B116	super unlead (95)										465 073	
1.3												
1.3	Petrol	40	04/89-10/90	B3								
Engine	Information				A10	A20	A40	A50	A70	C10 - C30	C20	E01
All engines	version Mitsubishi						831 122					
All engines	version Mitsubshi						831 131					
All engines	version Mitsubishi, no specific info conc. application available							931 108, 931 119				
All engines											465 073	
1.3												
1.3	Petrol	44	10/87-06/91	B3								
Engine	Information				A10	A20	A40	A50	A70	C10 - C30	C20	E01
All engines	FOR: (S), FOR: (CH), version Mitsubishi						831 122					
All engines	FOR: (EU), NOT FOR: (S), NOT FOR: (CH), version Mitsubishi						831 132					
All engines	version Mitsubishi, no specific info conc. application available							931 108, 931 119				
121 II												
1.1	Petrol	40	11/90-10/93	B1								
Engine	Information				A10	A20	A40	A50	A70	C10 - C30	C20	E01
All engines	version Mitsubishi						831 131	931 119				
All engines											465 073	
1.3 16V												
1.3 16V	Petrol	39	11/90-03/96	B3 (16V)								
Engine	Information				A10	A20	A40	A50	A70	C10 - C30	C20	E01
All engines	version Hitachi						822 088	922 094				
1.3 i 16V												
1.3 i 16V	Petrol	53	11/90-03/96	B3 (16V)								
Engine	Information				A10	A20	A40	A50	A70	C10 - C30	C20	E01
All engines	version Hitachi						822 088	922 094				
121 III												
1.25	Petrol	55	03/96-04/03	1E05, DHF, DHG								
Engine	Information				A10	A20	A40	A50	A70	C10 - C30	C20	E01
Eng. 1E05	->year 01/05/98, 01/06/98 ->, ->year 01/11/00, x 1, D.I.S., x 1, D.I.S.									470 299	C10	
Eng. DHF, DHG										470 299, 470 312	C10	
Eng. 1E05	01/12/00 ->, x 1, D.I.S.									470 532	C10	
1.3												
1.3	Petrol	37	03/96-04/03	1E03, JJK, JJM								
Engine	Information				A10	A20	A40	A50	A70	C10 - C30	C20	E01
Eng. 1E03	x 1, DENSO, x 1, D.I.S., x 1, D.I.S.									470 532	C10	
Eng. JJK, JJM										470 532	C10	

A10 CONDENSER	A20 CONTACT SET	A40 DISTRIBUTOR CAP	A50 ROTOR	A70 PICK-UP
C10 COIL	C20 IGNITION MODULE	C30 ELECTRONIC IGNITION KIT	E01 IGNITION CABLE SET	

The present application list is a brief version. For the detailed information about the possibility of installation on a specific vehicle, please refer to our web-catalogue <http://catalogo.facet.eu/>

FUNCTIONS ON THE VEHICLE

Vehicle	alim.	kW	Date	Engine	A10	A20	A40	A50	A70	C10 - C30	C20	E01
				ENGINE								
1.3	Petrol	44	03/96-04/03	1E04, 1E09, J4R, J4T								
Engine					A10	A20	A40	A50	A70	C10 - C30	C20	E01
Information												
Eng. 1E04, 1E09										470 532	C10	
Eng. J4R, J4T										470 532	C10	
				ENGINE								
1.2	Petrol	55	02/03-06/07	FUJA								
Engine					A10	A20	A40	A50	A70	C10 - C30	C20	E01
Information												
All engines										470 481	C10	
All engines										470 532	C10	
All engines												358 242
				ENGINE								
1.25	Petrol	55	04/03-06/07	FUJA								
Engine					A10	A20	A40	A50	A70	C10 - C30	C20	E01
Information												
All engines										470 481	C10	
All engines										470 532	C10	
All engines												358 242
				ENGINE								
1.3 L	Petrol	67	04/03-06/07	ZJ-04								
Engine					A10	A20	A40	A50	A70	C10 - C30	C20	E01
Information												
All engines										470 481	C10	
All engines										470 532	C10	
All engines												358 242
				ENGINE								
1.4	Petrol	59	02/03-06/07	FXJA								
Engine					A10	A20	A40	A50	A70	C10 - C30	C20	E01
Information												
All engines										470 481	C10	
All engines										470 532	C10	
All engines												358 242
				ENGINE								
1.5	Petrol	82	04/03-06/07	ZY-VE								
Engine					A10	A20	A40	A50	A70	C10 - C30	C20	E01
Information												
All engines										470 481	C10	
All engines										470 532	C10	
All engines												358 242
				ENGINE								
1.6	Petrol	74	02/03-06/07	FYJA								
Engine					A10	A20	A40	A50	A70	C10 - C30	C20	E01
Information												
All engines										470 481	C10	
All engines										470 532	C10	
All engines												358 242
				ENGINE								
1.3	Petrol	55	10/07-06/15	ZJ-46, ZJ-VE								
Engine					A10	A20	A40	A50	A70	C10 - C30	C20	E01
Information												
Eng. ZJ-46										470 514	C10	
Eng. ZJ-46										470 516	C10	
Eng. ZJ-VE										470 516	C10	
				ENGINE								
1.3	Petrol	63	10/07-06/15	ZJ-46, ZJ-VE								
Engine					A10	A20	A40	A50	A70	C10 - C30	C20	E01
Information												
Eng. ZJ-46										470 514	C10	
Eng. ZJ-46										470 516	C10	
Eng. ZJ-VE										470 516	C10	
				ENGINE								
1.3	Petrol	67	07/07-11/14	ZJ-VE								
Engine					A10	A20	A40	A50	A70	C10 - C30	C20	E01
Information												
All engines										470 516	C10	

A10 CONDENSER	A20 CONTACT SET	A40 DISTRIBUTOR CAP	A50 ROTOR	A70 PICK-UP
C10 COIL	C20 IGNITION MODULE	C30 ELECTRONIC IGNITION KIT	E01 IGNITION CABLE SET	

Vehicle	alim.	kW	Date	Engine	FUNCTIONS ON THE VEHICLE									
					A10	A20	A40	A50	A70	C10 - C30	C20	E01		
ENGINE														
1.3 BiFuel	Petrol/ Liquified Petro- leum Gas (LPG)	55	05/11-11/14	ZJ-46										
Engine	Information				A10	A20	A40	A50	A70	C10 - C30	C20	E01		
All engines	x 4, version 2, COIL ON PLUG									470 514	C10			
All engines	x 4, version 1, COIL ON PLUG									470 516	C10			
ENGINE														
1.3 BiFuel	Petrol/ Liquified Petro- leum Gas (LPG)	62	05/11-11/14	ZJ-46										
Engine	Information				A10	A20	A40	A50	A70	C10 - C30	C20	E01		
All engines	x 4, COIL ON PLUG									470 516	C10			
ENGINE														
1.3 MZR	Petrol	62	01/10-06/15	ZJ-46, ZJ-VE										
Engine	Information				A10	A20	A40	A50	A70	C10 - C30	C20	E01		
Eng. ZJ-46	x 4, COIL ON PLUG									470 516	C10			
Eng. ZJ-VE	Qty: 4									470 516	C10			
ENGINE														
1.5	Petrol	76	07/07-06/15	ZY66, ZY-DE, ZY-VE										
Engine	Information				A10	A20	A40	A50	A70	C10 - C30	C20	E01		
Eng. ZY66	->year 01/11/09, x 4, COIL ON PLUG									470 514	C10			
Eng. ZY66	01/12/09 ->, x 4, COIL ON PLUG									470 516	C10			
Eng. ZY-DE, ZY-VE	Qty: 4									470 516	C10			
ENGINE														
1.5	Petrol	83	10/07-06/15	ZY06										
Engine	Information				A10	A20	A40	A50	A70	C10 - C30	C20	E01		
All engines	x 4, COIL ON PLUG									470 516	C10			
ENGINE														
1.5 i	Petrol	76	05/10-06/15	ZY-DE										
Engine	Information				A10	A20	A40	A50	A70	C10 - C30	C20	E01		
All engines	Qty: 4									470 516	C10			
ENGINE														
1.5 MZR	Petrol	75	06/11-06/15	ZY05, ZY66										
Engine	Information				A10	A20	A40	A50	A70	C10 - C30	C20	E01		
Eng. ZY05	Qty: 4									470 516	C10			
Eng. ZY66	x 4, COIL ON PLUG									470 516	C10			
2 III														
ENGINE														
1.5	Petrol	55	08/14-11/17	P5X0, P5X2, P5Y5, P5Y8, P5Z7, P5Z8, P5Z9										
Engine	Information				A10	A20	A40	A50	A70	C10 - C30	C20	E01		
All engines	x 4, COIL ON PLUG									470 627	C10			
ENGINE														
1.5	Petrol	79	11/14->	P5Y4										
Engine	Information				A10	A20	A40	A50	A70	C10 - C30	C20	E01		
All engines	+start-stop function, Qty: 4									470 627	C10			
All engines	x 4, +start-stop function, COIL ON PLUG									470 627	C10			
ENGINE														
1.5	Petrol	81	11/14->	P5Y4, P5Y6										
Engine	Information				A10	A20	A40	A50	A70	C10 - C30	C20	E01		
All engines	+start-stop function, Qty: 4									470 627	C10			
ENGINE														
1.5	Petrol	85	01/15->	P5Y5										
Engine	Information				A10	A20	A40	A50	A70	C10 - C30	C20	E01		
All engines	+start-stop function, Qty: 4									470 627	C10			

A10 CONDENSER	A20 CONTACT SET	A40 DISTRIBUTOR CAP	A50 ROTOR	A70 PICK-UP
C10 COIL	C20 IGNITION MODULE	C30 ELECTRONIC IGNITION KIT	E01 IGNITION CABLE SET	

The present application list is a brief version. For the detailed information about the possibility of installation on a specific vehicle, please refer to our web-catalogue <http://catalogo.facet.eu/>

				FUNCTIONS ON THE VEHICLE								
Vehicle	alim.	kW	Date	Engine	A10	A20	A40	A50	A70	C10 - C30	C20	E01
				ENGINE								
1.5 SKYACTIV-G	Petrol	66	08/14-11/17	P5X0, P5X2, P5Y5, P5Y6, P5Y8, P5Z2, P5Z3, P5Z7, P5Z8, P5Z9						470 627	C10	
				ENGINE								
1.5 SKYACTIV-G	Petrol	85	08/14->	P5X0, P5X2, P5Y5, P5Z3, P5Z7, P5Z8, P5Z9						470 627	C10	
				ENGINE								
2.0	Petrol	108	09/03-06/06	LF17						470 480	C10	
				ENGINE								
1.3	Petrol	62	10/03-06/09	ZJ07, ZJ30, ZJ-VE						470 514	C10	
				ENGINE								
1.4	Petrol	59	02/04-06/09	FXJA						470 514	C10	
				ENGINE								
1.6	Petrol	77	10/03-06/09	B6ZE, Z6, Z601, Z627						470 514	C10	
				ENGINE								
2.0	Petrol	104	10/03-06/06	LF17						470 480	C10	
				ENGINE								
2.0	Petrol	108	10/03-06/06	LF17						470 480	C10	
				ENGINE								
2.0	Petrol	110	10/03-12/09	LF17, LF50, LF72, LFN7, LFN8						470 480	C10	
				ENGINE								
1.6 MZR	Petrol	77	12/08-09/14	Z6, Z668, Z682, Z683						470 514	C10	
				ENGINE								
1.6 MZR	Petrol	79	01/10-12/13	Z6, Z682						470 514	C10	
				ENGINE								

A10	CONDENSER	A20	CONTACT SET	A40	DISTRIBUTOR CAP	A50	ROTOR	A70	PICK-UP
C10	COIL	C20	IGNITION MODULE	C30	ELECTRONIC IGNITION KIT	E01	IGNITION CABLE SET		

Vehicle	alim.	kW	Date	Engine	FUNCTIONS ON THE VEHICLE							
					A10	A20	A40	A50	A70	C10 - C30	C20	E01

3 III

1.5	Petrol	74	09/13->	ENGINE P5Y1, P5Y4, P5Y5, P5Z3
-----	--------	----	---------	----------------------------------

Engine	Information	A10	A20	A40	A50	A70	C10 - C30	C20	E01
All engines	x 4, COIL ON PLUG						470 627	C10	

1.5	Petrol	82	09/13->	ENGINE P5-VPS
-----	--------	----	---------	------------------

Engine	Information	A10	A20	A40	A50	A70	C10 - C30	C20	E01
All engines	Qty: 4						470 627	C10	

1.5	Petrol	88	10/13->	ENGINE P5Y1, P5Y4, P5Y5, P5Z3
-----	--------	----	---------	----------------------------------

Engine	Information	A10	A20	A40	A50	A70	C10 - C30	C20	E01
All engines	x 4, COIL ON PLUG						470 627	C10	

1.6	Petrol	77	09/13->	ENGINE Z6Y1, Z6Y3
-----	--------	----	---------	----------------------

Engine	Information	A10	A20	A40	A50	A70	C10 - C30	C20	E01
All engines	x 4, COIL ON PLUG						470 516	C10	

2.0	Petrol	110	11/13->	ENGINE PEY7
-----	--------	-----	---------	----------------

Engine	Information	A10	A20	A40	A50	A70	C10 - C30	C20	E01
All engines	x 4, COIL ON PLUG						470 627	C10	

2.0	Petrol	114	11/13->	ENGINE LFX
-----	--------	-----	---------	---------------

Engine	Information	A10	A20	A40	A50	A70	C10 - C30	C20	E01
All engines	Qty: 4						470 627	C10	

2.0	Petrol	121	07/13->	ENGINE PEX2, PEXL, PEY5, PEY7
-----	--------	-----	---------	----------------------------------

Engine	Information	A10	A20	A40	A50	A70	C10 - C30	C20	E01
All engines	x 4, COIL ON PLUG						470 627	C10	

2.0	Petrol	88	09/13->	ENGINE PEXL, PEY5, PEY7
-----	--------	----	---------	----------------------------

Engine	Information	A10	A20	A40	A50	A70	C10 - C30	C20	E01
All engines	x 4, COIL ON PLUG						470 627	C10	

2.0 Hybrid	Petrol/ Electric	60	10/14->	ENGINE --
------------	---------------------	----	---------	--------------

Engine	Information	A10	A20	A40	A50	A70	C10 - C30	C20	E01
All engines	Qty: 4						470 627	C10	

2.0 Hybrid	Petrol/ Electric	73	10/14->	ENGINE PE-VPH
------------	---------------------	----	---------	------------------

Engine	Information	A10	A20	A40	A50	A70	C10 - C30	C20	E01
All engines	Qty: 4						470 627	C10	

3 IV

1.5 SKYACTIV-G	Petrol	88	11/18->	ENGINE P5X4
----------------	--------	----	---------	----------------

Engine	Information	A10	A20	A40	A50	A70	C10 - C30	C20	E01
All engines	x 4, Vehicle Equipment:for vehicles with cylinder shut-down, Vehicle Equipment:for vehicles without cylinder shutdown, COIL ON PLUG						470 627	C10	

2.0 SKYACTIV-G	Petrol	110	11/18->	ENGINE PEXN, PEXP
----------------	--------	-----	---------	----------------------









Engine	Information	A10	A20	A40	A50	A70	C10 - C30	C20	E01
All engines	x 4, Vehicle Equipment:for vehicles with cylinder shut-down, Vehicle Equipment:for vehicles without cylinder shutdown, COIL ON PLUG						470 627	C10	

2.0 SKYACTIV-G M Hybrid	Petrol/ Electric	110	01/20->	ENGINE PEXN
-------------------------	---------------------	-----	---------	----------------

Engine	Information	A10	A20	A40	A50	A70	C10 - C30	C20	E01
All engines	x 4, COIL ON PLUG						470 627	C10	

A10 CONDENSER	A20 CONTACT SET	A40 DISTRIBUTOR CAP	A50 ROTOR	A70 PICK-UP
C10 COIL	C20 IGNITION MODULE	C30 ELECTRONIC IGNITION KIT	E01 IGNITION CABLE SET	

The present application list is a brief version. For the detailed information about the possibility of installation on a specific vehicle, please refer to our web-catalogue <http://catalogo.facet.eu/>

					FUNCTIONS ON THE VEHICLE									
Vehicle	alim.	kW	Date	Engine	 A10	 A20	 A40	 A50	 A70	 C10 - C30	 C20	 E01		
2.0 SKYACTIV-G M Hybrid					ENGINE									
Petrol/ Electric	90	11/18->		PEXN										
Engine	Information				A10	A20	A40	A50	A70	C10 - C30	C20	E01		
All engines	x 4, COIL ON PLUG									470 627	C10			
2.0 SKYACTIV-X M Hybrid					ENGINE									
Petrol/ Electric	137	02/21->		HFY7										
Engine	Information				A10	A20	A40	A50	A70	C10 - C30	C20	E01		
All engines	x 4, COIL ON PLUG									470 627	C10			
SKYACTIV-X M Hybrid					ENGINE									
Petrol/ Electric	137	02/21->		HFY7										
Engine	Information				A10	A20	A40	A50	A70	C10 - C30	C20	E01		
All engines	x 4, COIL ON PLUG									470 627	C10			
SKYACTIV-X M Hybrid AWD					ENGINE									
Petrol/ Electric	137	02/21->		HFY7										
Engine	Information				A10	A20	A40	A50	A70	C10 - C30	C20	E01		
All engines	x 4, COIL ON PLUG									470 627	C10			
323 IV					ENGINE									
1.1	Petrol	40	11/80-10/85	E1										
Engine	Information				A10	A20	A40	A50	A70	C10 - C30	C20	E01		
All engines	version Mitsubishi						831 109							
1.3	Petrol	44	09/81-10/85	E3										
Engine	Information				A10	A20	A40	A50	A70	C10 - C30	C20	E01		
All engines	version Mitsubishi						831 132	931 108						
323 V					ENGINE									
1.1	Petrol	40	09/85-10/89	E1										
Engine	Information				A10	A20	A40	A50	A70	C10 - C30	C20	E01		
All engines	version Mitsubishi						831 118							
1.3	Petrol	44	08/85-05/89	E3										
Engine	Information				A10	A20	A40	A50	A70	C10 - C30	C20	E01		
All engines	version Mitsubishi, no specific info conc. application available						831 118, 831 132	931 108						
1.3	Petrol	50	01/86-06/87	E393										
Engine	Information				A10	A20	A40	A50	A70	C10 - C30	C20	E01		
All engines	version Mitsubishi, no specific info conc. application available						831 118, 831 132	931 108						
1.3	Petrol	52	01/86-06/87	E391										
Engine	Information				A10	A20	A40	A50	A70	C10 - C30	C20	E01		
All engines	version Mitsubishi, no specific info conc. application available						831 118, 831 132	931 108						
1.3 i	Petrol	49	09/85-08/89	B3E										
Engine	Information				A10	A20	A40	A50	A70	C10 - C30	C20	E01		
All engines	version Mitsubishi, no specific info conc. application available						831 118, 831 132	931 108						
1.5	Petrol	54	01/87-10/89	B5, B50, B53										
Engine	Information				A10	A20	A40	A50	A70	C10 - C30	C20	E01		
All engines	version Mitsubishi, no specific info conc. application available						831 118, 831 132	931 108						
1.5	Petrol	55	08/85-05/89	B50, B53, E5										
Engine	Information				A10	A20	A40	A50	A70	C10 - C30	C20	E01		
All engines	version Mitsubishi, no specific info conc. application available						831 118, 831 132	931 108						
A10	CONDENSER		A20	CONTACT SET		A40	DISTRIBUTOR CAP		A50	ROTOR		A70	PICK-UP	
C10	COIL		C20	IGNITION MODULE		C30	ELECTRONIC IGNITION KIT		E01	IGNITION CABLE SET				

Vehicle	alim.	kW	Date	Engine	FUNCTIONS ON THE VEHICLE							
					A10	A20	A40	A50	A70	C10 - C30	C20	E01

ENGINE				
1.6	Petrol	63	09/86-10/95	93AF1006, B6E

Engine	Information	A10	A20	A40	A50	A70	C10 - C30	C20	E01
All engines	version Mitsubishi, no specific info conc. application available			831 122, 831 132					
All engines	version Hitachi				922 073				
All engines	version Mitsubishi				931 108				

ENGINE				
1.6 4x4	Petrol	63	05/90-03/93	B65M, B6E

Engine	Information	A10	A20	A40	A50	A70	C10 - C30	C20	E01
All engines	version Mitsubishi			831 122	931 108				

ENGINE				
1.6 GT	Petrol	63	11/86-10/89	93AF1006

Engine	Information	A10	A20	A40	A50	A70	C10 - C30	C20	E01
All engines	super unlead (95), version Mitsubishi			831 122	931 108				
All engines	Super (98), version Mitsubishi			831 125					
All engines	super unlead (95), version Hitachi				922 073				

ENGINE				
1.6 GT	Petrol	77	01/86-12/88	93AF1006

Engine	Information	A10	A20	A40	A50	A70	C10 - C30	C20	E01
All engines	super unlead (95), version Mitsubishi			831 122	931 108				
All engines	Super (98), version Mitsubishi			831 125					
All engines	super unlead (95), version Hitachi				922 073				

ENGINE				
1.6i	Petrol	54	06/86-07/87	B681, B682

Engine	Information	A10	A20	A40	A50	A70	C10 - C30	C20	E01
All engines	Super (98), version Mitsubishi			831 125					
All engines	super unlead (95), version Hitachi				922 073				

ENGINE				
1.6i 16v 4x4	Petrol	100	06/86-07/87	B595

Engine	Information	A10	A20	A40	A50	A70	C10 - C30	C20	E01
All engines	Super (98), version Mitsubishi			831 125					
All engines	super unlead (95), version Hitachi				922 073				

ENGINE				
1.6i 16v Formula 4	Petrol	110	08/87-05/89	B6F2

Engine	Information	A10	A20	A40	A50	A70	C10 - C30	C20	E01
All engines	super unlead (95), version Mitsubishi			831 122	931 108				
All engines	Super (98), version Mitsubishi			831 125					

323 VI

ENGINE				
1.3 16V	Petrol	55	06/89-03/91	B384, B386, B387

Engine	Information	A10	A20	A40	A50	A70	C10 - C30	C20	E01
All engines	version Mitsubishi			831 131	931 119				
All engines							470 233	C10	465 073

ENGINE				
1.8i 16v 4x4	Petrol	78	06/89-03/91	BP51

Engine	Information	A10	A20	A40	A50	A70	C10 - C30	C20	E01
All engines	version Mitsubishi			831 121					
All engines							470 233	C10	

ENGINE				
1.8i 16v GRSi	Petrol	103	06/89-03/91	BP22

Engine	Information	A10	A20	A40	A50	A70	C10 - C30	C20	E01
All engines	version Mitsubishi			831 121					
All engines							470 233	C10	

ENGINE				
1.8i 16v GT Formula 4	Petrol	122	04/91-04/94	BP55

Engine	Information	A10	A20	A40	A50	A70	C10 - C30	C20	E01
All engines	version Mitsubishi			831 121					
All engines							470 233	C10	

A10	CONDENSER	A20	CONTACT SET	A40	DISTRIBUTOR CAP	A50	ROTOR	A70	PICK-UP
C10	COIL	C20	IGNITION MODULE	C30	ELECTRONIC IGNITION KIT	E01	IGNITION CABLE SET		

Vehicle	alim.	kW	Date	Engine	FUNCTIONS ON THE VEHICLE									
					A10	A20	A40	A50	A70	C10 - C30	C20	E01		
ENGINE														
1.8i 16v GT-R Formula 4	Petrol	138	04/91-04/94	BP5J										
Engine	Information				A10	A20	A40	A50	A70	C10 - C30	C20	E01		
All engines	version Mitsubishi						831 121							
All engines										470 233	C10			
ENGINE														
1.8i 16v Turbo 4x4	Petrol	122	06/89-03/91	BP55										
Engine	Information				A10	A20	A40	A50	A70	C10 - C30	C20	E01		
All engines	version Mitsubishi						831 121							
All engines										470 233	C10			
323 VI C														
ENGINE														
1.3	Petrol	49	09/89-07/94	B3E										
Engine	Information				A10	A20	A40	A50	A70	C10 - C30	C20	E01		
All engines								931 113						
ENGINE														
1.6	Petrol	62	09/89-06/91	B6E										
Engine	Information				A10	A20	A40	A50	A70	C10 - C30	C20	E01		
All engines	version Mitsubishi						831 121							
All engines	version Mitsubishi, no specific info conc. application available							931 119						
All engines										470 233	C10	465 073		
ENGINE														
1.6 16V	Petrol	65	03/91-10/94	B6										
Engine	Information				A10	A20	A40	A50	A70	C10 - C30	C20	E01		
All engines	version Mitsubishi						831 121							
All engines										470 233	C10	465 073		
All engines	no specific info conc. application available												360 398	
ENGINE														
1.8 16V 4WD	Petrol	76	11/91-12/93	BP										
Engine	Information				A10	A20	A40	A50	A70	C10 - C30	C20	E01		
All engines								931 113						
ENGINE														
1.8 16V GT	Petrol	94	09/89-03/93	BP (DOHC)										
Engine	Information				A10	A20	A40	A50	A70	C10 - C30	C20	E01		
All engines								931 113						
ENGINE														
1.8 16V Turbo 4WD	Petrol	120	09/90-12/92	BP Turbo										
Engine	Information				A10	A20	A40	A50	A70	C10 - C30	C20	E01		
All engines								931 113						
323 VI F														
ENGINE														
1.6	Petrol	62	09/89-06/91	B6E										
Engine	Information				A10	A20	A40	A50	A70	C10 - C30	C20	E01		
All engines	version Mitsubishi						831 121							
All engines	version Mitsubishi, no specific info conc. application available							931 119						
All engines										470 233	C10	465 073		
ENGINE														
1.6 16V	Petrol	65	03/91-10/94	B6										
Engine	Information				A10	A20	A40	A50	A70	C10 - C30	C20	E01		
All engines	version Mitsubishi						831 121							
All engines										470 233	C10	465 073		
All engines	no specific info conc. application available												360 398	
ENGINE														
1.8 16V	Petrol	76	08/89-07/94	BP										
Engine	Information				A10	A20	A40	A50	A70	C10 - C30	C20	E01		
All engines	version Mitsubishi						831 121							
All engines										470 233	C10		360 398	

A10 CONDENSER	A20 CONTACT SET	A40 DISTRIBUTOR CAP	A50 ROTOR	A70 PICK-UP
C10 COIL	C20 IGNITION MODULE	C30 ELECTRONIC IGNITION KIT	E01 IGNITION CABLE SET	

Vehicle	alim.	kW	Date	Engine	FUNCTIONS ON THE VEHICLE							
					A10	A20	A40	A50	A70	C10 - C30	C20	E01

				ENGINE
1.8 16V GT	Petrol	94	08/89-07/94	BP (DOHC)

Engine	Information	A10	A20	A40	A50	A70	C10 - C30	C20	E01
All engines	version Mitsubishi			831 121					
All engines							470 233	C10	360 398

				ENGINE
1.8i 16v GRSi	Petrol	103	06/89-03/91	BP31

Engine	Information	A10	A20	A40	A50	A70	C10 - C30	C20	E01
All engines	version Mitsubishi			831 121					
All engines							470 233	C10	360 398

323 VI S

				ENGINE
1.3	Petrol	49	09/89-06/91	B383, B3E

Engine	Information	A10	A20	A40	A50	A70	C10 - C30	C20	E01
All engines	version Mitsubishi			831 131	931 119				
All engines								465 073	

				ENGINE
1.3 16V	Petrol	54	04/91-07/94	B3 (16V)

Engine	Information	A10	A20	A40	A50	A70	C10 - C30	C20	E01
All engines	version Mitsubishi			831 121, 831 131					
All engines	version Mitsubishi, no specific info conc. application available				931 119				
All engines							470 233	C10	360 398
All engines	->ch. 853897							465 073	

				ENGINE
1.6	Petrol	62	09/89-06/91	B6E

Engine	Information	A10	A20	A40	A50	A70	C10 - C30	C20	E01
All engines	version Mitsubishi			831 121					
All engines	version Mitsubishi, no specific info conc. application available				931 119				
All engines							470 233	C10	465 073

				ENGINE
1.6 16V	Petrol	65	08/89-10/96	B6

Engine	Information	A10	A20	A40	A50	A70	C10 - C30	C20	E01
All engines	version Mitsubishi			831 121, 831 131					
All engines	version Mitsubishi, no specific info conc. application available				931 119				
All engines							470 233	C10	360 398
All engines	->ch. 853897							465 073	

				ENGINE
1.8 16V	Petrol	76	08/89-07/94	BP52

Engine	Information	A10	A20	A40	A50	A70	C10 - C30	C20	E01
All engines	version Mitsubishi			831 121					
All engines							470 233	C10	360 398

				ENGINE
1.8 16V 4WD	Petrol	76	09/91-07/94	BP52

Engine	Information	A10	A20	A40	A50	A70	C10 - C30	C20	E01
All engines	version Mitsubishi			831 121					
All engines							470 233	C10	360 398

				ENGINE
1.8 16V Turbo 4WD	Petrol	120	01/91-07/94	BP Turbo

Engine	Information	A10	A20	A40	A50	A70	C10 - C30	C20	E01
All engines	version Mitsubishi			831 121					
All engines							470 233	C10	







323 VII

				ENGINE
1.5 16V	Petrol	65	07/94-09/98	Z5-DE

Engine	Information	A10	A20	A40	A50	A70	C10 - C30	C20	E01
All engines	version Mitsubishi			831 150	931 132				
All engines									360 738

A10 CONDENSER	A20 CONTACT SET	A40 DISTRIBUTOR CAP	A50 ROTOR	A70 PICK-UP
C10 COIL	C20 IGNITION MODULE	C30 ELECTRONIC IGNITION KIT	E01 IGNITION CABLE SET	

The present application list is a brief version. For the detailed information about the possibility of installation on a specific vehicle, please refer to our web-catalogue <http://catalogo.facet.eu/>









					FUNCTIONS ON THE VEHICLE							
Vehicle	alim.	kW	Date	Engine								
323 VIII F												
1.8 16V	Petrol	84	08/94-09/98	BP-ZE								
ENGINE												
Engine	Information				A10	A20	A40	A50	A70	C10 - C30	C20	E01
All engines	version Mitsubishi						831 150	931 132				
All engines												360 231
2.0 24V	Petrol	106	08/94-09/98	KF								
ENGINE												
Engine	Information				A10	A20	A40	A50	A70	C10 - C30	C20	E01
All engines	version Mitsubishi						831 149	931 134				
All engines												360 760
323 VII C												
1.3 16V	Petrol	54	08/94-09/98	B3 (16V)								
ENGINE												
Engine	Information				A10	A20	A40	A50	A70	C10 - C30	C20	E01
All engines	version Mitsubishi						831 154	931 132				
All engines												
1.5 16V	Petrol	65	08/94-09/98	Z5-DE								
ENGINE												
Engine	Information				A10	A20	A40	A50	A70	C10 - C30	C20	E01
All engines	version Mitsubishi						831 150	931 132				
All engines												360 738
1.8 16V	Petrol	84	08/94-09/98	BP-ZE								
ENGINE												
Engine	Information				A10	A20	A40	A50	A70	C10 - C30	C20	E01
All engines	version Mitsubishi						831 150	931 132				
All engines												360 231
323 VII P												
1.3 16V	Petrol	54	10/96-09/98	B3 (16V)								
ENGINE												
Engine	Information				A10	A20	A40	A50	A70	C10 - C30	C20	E01
All engines	version Mitsubishi						831 154	931 132				
All engines												
1.5 16V	Petrol	65	10/96-09/98	Z5-DE								
ENGINE												
Engine	Information				A10	A20	A40	A50	A70	C10 - C30	C20	E01
All engines	version Mitsubishi						831 150	931 132				
All engines												360 738
323 VIII F												
1.4	Petrol	53	01/01-05/04	B3 (16V)								
ENGINE												
Engine	Information				A10	A20	A40	A50	A70	C10 - C30	C20	E01
All engines	version Mitsubishi						831 154	931 132				
All engines												360 741
1.4 16V	Petrol	54	09/98-01/01	B3 ME								
ENGINE												
Engine	Information				A10	A20	A40	A50	A70	C10 - C30	C20	E01
All engines	version Mitsubishi						831 154	931 132				
All engines												360 741
1.5 16V	Petrol	65	09/98-01/01	ZL05, ZL06								
ENGINE												
Engine	Information				A10	A20	A40	A50	A70	C10 - C30	C20	E01
All engines												360 729
1.6	Petrol	70	01/01-05/04	ZM								
ENGINE												
Engine	Information				A10	A20	A40	A50	A70	C10 - C30	C20	E01
All engines												360 729
1.6	Petrol	72	01/01-05/04	ZM								
ENGINE												
Engine	Information				A10	A20	A40	A50	A70	C10 - C30	C20	E01
All engines												360 729

A10 CONDENSER	A20 CONTACT SET	A40 DISTRIBUTOR CAP	A50 ROTOR	A70 PICK-UP
C10 COIL	C20 IGNITION MODULE	C30 ELECTRONIC IGNITION KIT	E01 IGNITION CABLE SET	

Vehicle	alim.	kW	Date	Engine	FUNCTIONS ON THE VEHICLE									
					A10	A20	A40	A50	A70	C10 - C30	C20	E01		
ENGINE														
1.8 Astina	Petrol	92	09/98-05/04	BP (DOHC)										
Engine	Information				A10	A20	A40	A50	A70	C10 - C30	C20	E01		
All engines														360 767
ENGINE														
1.9 16V	Petrol	84	09/98-01/01	FP, FP55										
Engine	Information				A10	A20	A40	A50	A70	C10 - C30	C20	E01		
All engines														360 740
ENGINE														
2.0	Petrol	96	01/01-05/04	FS7E, FS7G										
Engine	Information				A10	A20	A40	A50	A70	C10 - C30	C20	E01		
All engines														360 767
ENGINE														
2.0	Petrol	98	02/00-09/04	FS										
Engine	Information				A10	A20	A40	A50	A70	C10 - C30	C20	E01		
All engines														360 767
323 VIII S														
ENGINE														
1.3	Petrol	53	01/01-05/04	B3 (16V)										
Engine	Information				A10	A20	A40	A50	A70	C10 - C30	C20	E01		
All engines	version Mitsubishi						831 154	931 132						
All engines														360 741
ENGINE														
1.3 16V	Petrol	54	08/94-01/01	B3 (16V), B3 ME										
Engine	Information				A10	A20	A40	A50	A70	C10 - C30	C20	E01		
All engines	version Mitsubishi						831 154	931 132						
Eng. B3 ME														360 741
ENGINE														
1.5 16V	Petrol	65	08/94-01/01	Z5-DE, ZL05, ZL06										
Engine	Information				A10	A20	A40	A50	A70	C10 - C30	C20	E01		
Eng. Z5-DE	version Mitsubishi						831 150	931 132						
Eng. ZL05, ZL06														360 729
Eng. Z5-DE														360 738
ENGINE														
1.6	Petrol	70	01/01-05/04	ZM										
Engine	Information				A10	A20	A40	A50	A70	C10 - C30	C20	E01		
All engines														360 729
ENGINE														
1.6	Petrol	72	01/01-05/04	ZM										
Engine	Information				A10	A20	A40	A50	A70	C10 - C30	C20	E01		
All engines														360 729
ENGINE														
1.8 16V	Petrol	84	08/94-09/98	BP-ZE										
Engine	Information				A10	A20	A40	A50	A70	C10 - C30	C20	E01		
All engines	version Mitsubishi						831 150	931 132						
All engines														360 231
ENGINE														
1.8 Protege	Petrol	92	05/98-05/04	BP (DOHC)										
Engine	Information				A10	A20	A40	A50	A70	C10 - C30	C20	E01		
All engines														360 767
ENGINE														
1.9 16V	Petrol	84	09/98-05/04	FP, FP55										
Engine	Information				A10	A20	A40	A50	A70	C10 - C30	C20	E01		
All engines														360 740
ENGINE														
2.0	Petrol	96	01/01-05/04	FS7E, FS7G										
Engine	Information				A10	A20	A40	A50	A70	C10 - C30	C20	E01		
All engines														360 767

A10 CONDENSER	A20 CONTACT SET	A40 DISTRIBUTOR CAP	A50 ROTOR	A70 PICK-UP
C10 COIL	C20 IGNITION MODULE	C30 ELECTRONIC IGNITION KIT	E01 IGNITION CABLE SET	









The present application list is a brief version. For the detailed information about the possibility of installation on a specific vehicle, please refer to our web-catalogue <http://catalogo.facet.eu/>

				FUNCTIONS ON THE VEHICLE								
Vehicle	alim.	kW	Date	Engine								
				ENGINE								
2.0	Petrol	98	02/00-05/04	FS								
Engine Information				A10	A20	A40	A50	A70	C10 - C30	C20	E01	
All engines												360 767
				ENGINE								
1.8	Petrol	88	08/02-08/07	L813, L823, L828								
Engine Information				A10	A20	A40	A50	A70	C10 - C30	C20	E01	
All engines FOR MODEL: 2002												358 245
				ENGINE								
2.0	Petrol	104	06/02-08/07	LF17, LF18								
Engine Information				A10	A20	A40	A50	A70	C10 - C30	C20	E01	
All engines												358 245
				ENGINE								
2.3	Petrol	122	01/02-02/08	L3C1								
Engine Information				A10	A20	A40	A50	A70	C10 - C30	C20	E01	
All engines												358 245
				ENGINE								
2.3 AWD	Petrol	119	11/02-08/07	L3C1								
Engine Information				A10	A20	A40	A50	A70	C10 - C30	C20	E01	
All engines												358 245
				ENGINE								
2.0	Petrol	107	01/13->	PEXB, PEXL, PEY5, PEY7								
Engine Information				A10	A20	A40	A50	A70	C10 - C30	C20	E01	
All engines x 4, COIL ON PLUG									470 627	C10		
				ENGINE								
2.0	Petrol	110	12/12->	PEXL, PEY5, PEY7								
Engine Information				A10	A20	A40	A50	A70	C10 - C30	C20	E01	
All engines x 4, COIL ON PLUG									470 627	C10		
				ENGINE								
2.0	Petrol	114	12/12->	PE-VPR, PEY5, PEY7								
Engine Information				A10	A20	A40	A50	A70	C10 - C30	C20	E01	
All engines Qty: 4									470 627	C10		
				ENGINE								
2.0	Petrol	121	01/13->	PEXB, PEXL, PEY5, PEY7								
Engine Information				A10	A20	A40	A50	A70	C10 - C30	C20	E01	
All engines x 4, COIL ON PLUG									470 627	C10		
				ENGINE								
2.5	Petrol	138	12/12->	PYY1								
Engine Information				A10	A20	A40	A50	A70	C10 - C30	C20	E01	
All engines Qty: 4									470 627	C10		
				ENGINE								
2.5	Petrol	140	03/18->	PYZC								
Engine Information				A10	A20	A40	A50	A70	C10 - C30	C20	E01	
All engines x 4, Vehicle Equipment:for vehicles with cylinder shutdown, Vehicle Equipment:for vehicles without cylinder shutdown, COIL ON PLUG									470 627	C10		
				ENGINE								
2.5	Petrol	141	12/12->	PYY1, PYY3, PY-Y8, PY-ZA								
Engine Information				A10	A20	A40	A50	A70	C10 - C30	C20	E01	
All engines x 4, COIL ON PLUG									470 627	C10		
				ENGINE								
2.5	Petrol	143	03/18->	PYZ8, PYZC								
Engine Information				A10	A20	A40	A50	A70	C10 - C30	C20	E01	
All engines x 4, +brake energy recovery, -brake energy recovery, COIL ON PLUG									470 627	C10		

A10 CONDENSER	A20 CONTACT SET	A40 DISTRIBUTOR CAP	A50 ROTOR	A70 PICK-UP
C10 COIL	C20 IGNITION MODULE	C30 ELECTRONIC IGNITION KIT	E01 IGNITION CABLE SET	

Vehicle	alim.	kW	Date	Engine	FUNCTIONS ON THE VEHICLE							
					A10	A20	A40	A50	A70	C10 - C30	C20	E01
ENGINE												
2.5	Petrol	170	03/18->	PYZ4								
ENGINE												
Engine	Information				A10	A20	A40	A50	A70	C10 - C30	C20	E01
All engines	LHD, x 4, Vehicle Equipment:for vehicles with cylinder shutdown, Vehicle Equipment:for vehicles without cylinder shutdown, COIL ON PLUG RHD, x 4, +brake energy recovery, -brake energy recovery, COIL ON PLUG									470 627	C10	
626 III												
ENGINE												
1.6	Petrol	59	11/82-09/87	F6								
ENGINE												
Engine	Information				A10	A20	A40	A50	A70	C10 - C30	C20	E01
All engines	version Mitsubishi						831 109					
ENGINE												
2.0	Petrol	68	01/85-01/90	FE (8V)								
ENGINE												
Engine	Information				A10	A20	A40	A50	A70	C10 - C30	C20	E01
All engines	version Mitsubishi						831 109					
ENGINE												
2.0	Petrol	74	03/83-09/87	FE (8V)								
ENGINE												
Engine	Information				A10	A20	A40	A50	A70	C10 - C30	C20	E01
All engines	version Mitsubishi						831 109					
ENGINE												
2.0	Petrol	88	01/86-09/87	FE (8V)								
ENGINE												
Engine	Information				A10	A20	A40	A50	A70	C10 - C30	C20	E01
All engines	version Mitsubishi						831 109					
626 IV												
ENGINE												
1.8	Petrol	65	09/87-05/92	F8 (12V)								
ENGINE												
Engine	Information				A10	A20	A40	A50	A70	C10 - C30	C20	E01
All engines	version Mitsubishi, no specific info conc. application available						831 125, 831 132	931 108				
ENGINE												
1.8	Petrol	69	11/87-05/92	F8 (12V)								
ENGINE												
Engine	Information				A10	A20	A40	A50	A70	C10 - C30	C20	E01
All engines	version Mitsubishi, no specific info conc. application available						831 125, 831 132	931 108				
ENGINE												
2.0	Petrol	66	09/87-10/90	FE (12V), FE (8V)								
ENGINE												
Engine	Information				A10	A20	A40	A50	A70	C10 - C30	C20	E01
All engines	-catalytic converter, version Mitsubishi						831 125					
All engines	+catalytic converter, version Mitsubishi						831 132	931 108				
ENGINE												
2.0 12V	Petrol	79	09/87-05/92	FE (12V)								
ENGINE												
Engine	Information				A10	A20	A40	A50	A70	C10 - C30	C20	E01
All engines	-catalytic converter, version Mitsubishi						831 125					
All engines	+catalytic converter, version Mitsubishi						831 132					
All engines	super unlead (95), version Mitsubishi							931 108				
ENGINE												
2.0 16V	Petrol	103	11/87-05/92	FE (16V)								
ENGINE												
Engine	Information				A10	A20	A40	A50	A70	C10 - C30	C20	E01
All engines	version Mitsubishi						831 121					
ENGINE												
2.0 16V	Petrol	109	06/87-09/89	FE (16V)								
ENGINE												
Engine	Information				A10	A20	A40	A50	A70	C10 - C30	C20	E01
All engines	version Mitsubishi						831 121					
ENGINE												
2.2 12V	Petrol	85	11/87-04/92	F2								
ENGINE												
Engine	Information				A10	A20	A40	A50	A70	C10 - C30	C20	E01
All engines	4WD, version Mitsubishi						831 121	931 108				
All engines	version Mitsubishi						831 125					
ENGINE												
2.2 12V 4WD	Petrol	85	11/87-07/90	F2								
ENGINE												
Engine	Information				A10	A20	A40	A50	A70	C10 - C30	C20	E01
All engines	4WD, version Mitsubishi						831 121	931 108				

A10 CONDENSER	A20 CONTACT SET	A40 DISTRIBUTOR CAP	A50 ROTOR	A70 PICK-UP
C10 COIL	C20 IGNITION MODULE	C30 ELECTRONIC IGNITION KIT	E01 IGNITION CABLE SET	

				FUNCTIONS ON THE VEHICLE								
Vehicle	alim.	kW	Date	Engine								
				ENGINE								
2.2 12V 4WD	Petrol	85	11/87-07/90	F2								
Engine	Information											
All engines	version Mitsubishi					831 125						
				ENGINE								
626 V				FP01LP								
1.8	Petrol	66	08/94-04/97	FP01LP								
Engine	Information											
All engines	version Hitachi, no specific info conc. application available					822 077, 822 092	922 094, 922 102					
All engines	version Mitsubishi, no specific info conc. application available						931 132, 931 137					
All engines												359 884
				ENGINE								
1.8	Petrol	77	08/91-04/97	FP								
Engine	Information											
All engines	version Hitachi, no specific info conc. application available					822 077, 822 092	922 094, 922 102					
All engines	version Mitsubishi, no specific info conc. application available						931 132, 931 137					
All engines												359 884
				ENGINE								
1.8 i	Petrol	66	08/94-04/97	--								
Engine	Information											
All engines	version Hitachi, no specific info conc. application available					822 077, 822 092	922 094, 922 102					
All engines	version Mitsubishi, no specific info conc. application available						931 132, 931 137					
All engines												359 884
				ENGINE								
1.8 i	Petrol	77	08/91-04/97	FP								
Engine	Information											
All engines	version Hitachi, no specific info conc. application available					822 077, 822 092	922 094, 922 102					
All engines	version Mitsubishi, no specific info conc. application available						931 132, 931 137					
All engines												359 884
				ENGINE								
1.8 i	Petrol	78	05/94-06/97	FP								
Engine	Information											
All engines	version Hitachi, no specific info conc. application available					822 077, 822 092	922 094, 922 102					
All engines	version Mitsubishi, no specific info conc. application available						931 132, 931 137					
All engines												359 884
				ENGINE								
2.0 i	Petrol	85	08/91-04/97	FS								
Engine	Information											
All engines	->year 30/04/94, version Hitachi					822 077	922 094					
All engines	01/05/94 ->, version Hitachi					822 092	922 102					
All engines	01/05/94 ->, version Mitsubishi						931 132					
All engines	->year 30/04/94, version Mitsubishi						931 137					
All engines												359 884
				ENGINE								
2.0 i 4WD	Petrol	85	04/92-04/97	FS								
Engine	Information											
All engines	->year 30/04/94, version Hitachi					822 077	922 094					
All engines	01/05/94 ->, version Hitachi					822 092	922 102					
All engines	01/05/94 ->, version Mitsubishi						931 132					
All engines	->year 30/04/94, version Mitsubishi						931 137					
All engines												359 884
				ENGINE								
2.5 24V	Petrol	120	08/94-04/97	KL								
Engine	Information											
All engines	version Mitsubishi					831 149	931 134					
All engines	->ch. 498325											360 760

A10 CONDENSER	A20 CONTACT SET	A40 DISTRIBUTOR CAP	A50 ROTOR	A70 PICK-UP
C10 COIL	C20 IGNITION MODULE	C30 ELECTRONIC IGNITION KIT	E01 IGNITION CABLE SET	

Vehicle	alim.	kW	Date	Engine	FUNCTIONS ON THE VEHICLE									
					A10	A20	A40	A50	A70	C10 - C30	C20	E01		
ENGINE														
2.5 24V	Petrol	121	01/92-04/97	KL										
ENGINE														
Engine	Information				A10	A20	A40	A50	A70	C10 - C30	C20	E01		
All engines	version Mitsubishi						831 137	931 133						
All engines													360 760	
626 VI														
ENGINE														
1.8	Petrol	66	05/97-01/00	FPY3										
ENGINE														
Engine	Information				A10	A20	A40	A50	A70	C10 - C30	C20	E01		
All engines										470 135	C10		360 739	
ENGINE														
1.8	Petrol	74	12/99-10/02	FP, FP9A										
ENGINE														
Engine	Information				A10	A20	A40	A50	A70	C10 - C30	C20	E01		
All engines										470 135	C10			
All engines	->ch. 211589												360 739	
ENGINE														
2.0	Petrol	100	04/98-10/02	FS2C										
ENGINE														
Engine	Information				A10	A20	A40	A50	A70	C10 - C30	C20	E01		
All engines	->ch. 211589												360 739	
ENGINE														
2.0	Petrol	85	05/97-10/02	FS										
ENGINE														
Engine	Information				A10	A20	A40	A50	A70	C10 - C30	C20	E01		
All engines										470 135, 470 312	C10			
All engines	->ch. 211589												360 739	
ENGINE														
2.0 H.P.	Petrol	100	02/98-10/02	FS2C										
ENGINE														
Engine	Information				A10	A20	A40	A50	A70	C10 - C30	C20	E01		
All engines	->ch. 211589												360 739	
929 I														
ENGINE														
2.0	Petrol	66	05/79-07/86	MA										
ENGINE														
Engine	Information				A10	A20	A40	A50	A70	C10 - C30	C20	E01		
All engines	version Mitsubishi					731 084	831 003/001	931 023						
929 II														
ENGINE														
2.0	Petrol	74	03/84-07/87	FE (8V)										
ENGINE														
Engine	Information				A10	A20	A40	A50	A70	C10 - C30	C20	E01		
All engines	version Mitsubishi						831 109	931 023						
929 III														
ENGINE														
2.0	Petrol	85	06/87-05/89	FE (8V), FEFA										
ENGINE														
Engine	Information				A10	A20	A40	A50	A70	C10 - C30	C20	E01		
All engines	version Mitsubishi						831 132	931 108						
ENGINE														
2.2 12V	Petrol	85	01/88-04/89	F2, F21, F2E										
ENGINE														
Engine	Information				A10	A20	A40	A50	A70	C10 - C30	C20	E01		
All engines	->ch. 102442, version Mitsubishi						831 117							
All engines	ch. 102442 ->, version Mitsubishi						831 132							
All engines	version Mitsubishi							931 108						
ENGINE														
2.2i	Petrol	100	05/87-12/88	F2-EG1										
ENGINE														
Engine	Information				A10	A20	A40	A50	A70	C10 - C30	C20	E01		
All engines	->ch. 102442, version Mitsubishi						831 117							
All engines	ch. 102442 ->, version Mitsubishi						831 132							
All engines	version Mitsubishi							931 108						
ENGINE														
2.2i 12v	Petrol	100	06/89-09/92	F2E6, F2E7										
ENGINE														
Engine	Information				A10	A20	A40	A50	A70	C10 - C30	C20	E01		
All engines	version Mitsubishi						831 132	931 108						

A10 CONDENSER	A20 CONTACT SET	A40 DISTRIBUTOR CAP	A50 ROTOR	A70 PICK-UP
C10 COIL	C20 IGNITION MODULE	C30 ELECTRONIC IGNITION KIT	E01 IGNITION CABLE SET	

The present application list is a brief version. For the detailed information about the possibility of installation on a specific vehicle, please refer to our web-catalogue <http://catalogo.facet.eu/>

Vehicle	alim.	kW	Date	Engine	FUNCTIONS ON THE VEHICLE							
					A10	A20	A40	A50	A70	C10 - C30	C20	E01

B-SERIE

2.2 4WD	Petrol	60	02/99-11/06	ENGINE R5A2
---------	--------	----	-------------	----------------

Engine	Information	A10	A20	A40	A50	A70	C10 - C30	C20	E01
All engines	version Mitsubishi			831 121					

BT-50

2.2	Petrol	73	10/06-06/13	ENGINE --
-----	--------	----	-------------	--------------

Engine	Information	A10	A20	A40	A50	A70	C10 - C30	C20	E01
All engines	version Mitsubishi			831 121					

2.2	Petrol	75	09/06->	ENGINE F2E
-----	--------	----	---------	---------------

Engine	Information	A10	A20	A40	A50	A70	C10 - C30	C20	E01
All engines	version Mitsubishi			831 121					

2.6	Petrol	90	10/06-06/13	ENGINE G6Y1
-----	--------	----	-------------	----------------

Engine	Information	A10	A20	A40	A50	A70	C10 - C30	C20	E01
All engines	version Mitsubishi			831 121					

2.6	Petrol	92	10/06-12/15	ENGINE G6Y1
-----	--------	----	-------------	----------------

Engine	Information	A10	A20	A40	A50	A70	C10 - C30	C20	E01
All engines	version Mitsubishi			831 121					

2.6	Petrol	99	09/06->	ENGINE G6
-----	--------	----	---------	--------------

Engine	Information	A10	A20	A40	A50	A70	C10 - C30	C20	E01
All engines	version Mitsubishi			831 121					

CX-3

2.0 SKYACTIV-G	Petrol	110	05/18->	ENGINE PEXB
----------------	--------	-----	---------	----------------

Engine	Information	A10	A20	A40	A50	A70	C10 - C30	C20	E01
All engines	x 4, COIL ON PLUG						470 627	C10	

2.0 SKYACTIV-G	Petrol	88	05/15->	ENGINE PEX3, PEXB
----------------	--------	----	---------	----------------------

Engine	Information	A10	A20	A40	A50	A70	C10 - C30	C20	E01
All engines	x 4, COIL ON PLUG						470 627	C10	

2.0 SKYACTIV-G	Petrol	89	02/18->	ENGINE PEXB, PEXT
----------------	--------	----	---------	----------------------

Engine	Information	A10	A20	A40	A50	A70	C10 - C30	C20	E01
All engines	x 4, COIL ON PLUG						470 627	C10	

2.0 SKYACTIV-G AWD	Petrol	110	05/15->	ENGINE PEX3, PEXB, PEXT
--------------------	--------	-----	---------	----------------------------

Engine	Information	A10	A20	A40	A50	A70	C10 - C30	C20	E01
All engines	x 4, COIL ON PLUG						470 627	C10	

CX-30

e-SKYACTIV-X M Hybrid	Petrol/ Electric	137	06/21->	ENGINE HFY7
-----------------------	---------------------	-----	---------	----------------

Engine	Information	A10	A20	A40	A50	A70	C10 - C30	C20	E01
All engines	x 4, Vehicle Equipment:for vehicles with cylinder shutdown, COIL ON PLUG						470 627	C10	

e-SKYACTIV-X M Hybrid AWD	Petrol/ Electric	137	06/21->	ENGINE HFY7
---------------------------	---------------------	-----	---------	----------------

Engine	Information	A10	A20	A40	A50	A70	C10 - C30	C20	E01
All engines	x 4, Vehicle Equipment:for vehicles with cylinder shutdown, COIL ON PLUG						470 627	C10	

SKYACTIV-G M Hybrid	Petrol/ Electric	110	01/20->	ENGINE PEXW
---------------------	---------------------	-----	---------	----------------

Engine	Information	A10	A20	A40	A50	A70	C10 - C30	C20	E01
All engines	x 4, COIL ON PLUG						470 627	C10	

A10 CONDENSER	A20 CONTACT SET	A40 DISTRIBUTOR CAP	A50 ROTOR	A70 PICK-UP
C10 COIL	C20 IGNITION MODULE	C30 ELECTRONIC IGNITION KIT	E01 IGNITION CABLE SET	









Vehicle	alim.	kW	Date	Engine	FUNCTIONS ON THE VEHICLE							
					A10	A20	A40	A50	A70	C10 - C30	C20	E01
ENGINE												
SKYACTIV-G M Hybrid	Petrol/ Electric	90	07/19->	PEXN								
Engine	Information				A10	A20	A40	A50	A70	C10 - C30	C20	E01
All engines	x 4, Vehicle Equipment:for vehicles with cylinder shutdown, COIL ON PLUG									470 627	C10	
ENGINE												
SKYACTIV-G M Hybrid AWD	Petrol/ Electric	110	01/20->	PEXW								
Engine	Information				A10	A20	A40	A50	A70	C10 - C30	C20	E01
All engines	x 4, COIL ON PLUG									470 627	C10	
ENGINE												
SKYACTIV-G M Hybrid AWD	Petrol/ Electric	90	07/19->	PEXN								
Engine	Information				A10	A20	A40	A50	A70	C10 - C30	C20	E01
All engines	x 4, Vehicle Equipment:for vehicles with cylinder shutdown, COIL ON PLUG									470 627	C10	
ENGINE												
SKYACTIV-X M Hybrid	Petrol/ Electric	132	07/19->	HFY1								
Engine	Information				A10	A20	A40	A50	A70	C10 - C30	C20	E01
All engines	x 4, Vehicle Equipment:for vehicles with cylinder shutdown, COIL ON PLUG									470 627	C10	
ENGINE												
SKYACTIV-X M Hybrid AWD	Petrol/ Electric	132	07/19->	HFY1								
Engine	Information				A10	A20	A40	A50	A70	C10 - C30	C20	E01
All engines	x 4, Vehicle Equipment:for vehicles with cylinder shutdown, COIL ON PLUG									470 627	C10	
CX-5												
2.0	Petrol	110	02/12->	PEXB, PEXP, PEYS								
Engine	Information				A10	A20	A40	A50	A70	C10 - C30	C20	E01
All engines	x 4, COIL ON PLUG									470 627	C10	
ENGINE												
2.0	Petrol	114	07/12->	PEY4, PEY5								
Engine	Information				A10	A20	A40	A50	A70	C10 - C30	C20	E01
All engines	Qty: 4									470 627	C10	
All engines	x 4, COIL ON PLUG									470 627	C10	
ENGINE												
2.0	Petrol	115	01/12->	PE-VPS, PEY7								
Engine	Information				A10	A20	A40	A50	A70	C10 - C30	C20	E01
Eng. PE-VPS	Qty: 4									470 627	C10	
Eng. PEY7	x 4, COIL ON PLUG									470 627	C10	
ENGINE												
2.0	Petrol	121	11/11->	PEX3, PEXB, PEXP, PEY6, PEY7								
Engine	Information				A10	A20	A40	A50	A70	C10 - C30	C20	E01
All engines	LHD, x 4, COIL ON PLUG, x 4, +brake energy recovery, -brake energy recovery, COIL ON PLUG ----- RHD, x 4, COIL ON PLUG									470 627	C10	
ENGINE												
2.0 AWD	Petrol	110	02/12->	PEXB, PEXP, PEYS								
Engine	Information				A10	A20	A40	A50	A70	C10 - C30	C20	E01
All engines	x 4, COIL ON PLUG									470 627	C10	
ENGINE												
2.0 AWD	Petrol	113	02/12->	PEY4, PEY5								
Engine	Information				A10	A20	A40	A50	A70	C10 - C30	C20	E01
All engines	Qty: 4									470 627	C10	
All engines	x 4, COIL ON PLUG									470 627	C10	
ENGINE												
2.0 AWD	Petrol	114	07/12->	PEY4, PEY5								
Engine	Information				A10	A20	A40	A50	A70	C10 - C30	C20	E01
All engines	Qty: 4									470 627	C10	

A10 CONDENSER	A20 CONTACT SET	A40 DISTRIBUTOR CAP	A50 ROTOR	A70 PICK-UP
C10 COIL	C20 IGNITION MODULE	C30 ELECTRONIC IGNITION KIT	E01 IGNITION CABLE SET	

The present application list is a brief version. For the detailed information about the possibility of installation on a specific vehicle, please refer to our web-catalogue <http://catalogo.facet.eu/>

Vehicle	alim.	kW	Date	Engine	FUNCTIONS ON THE VEHICLE							
					A10	A20	A40	A50	A70	C10 - C30	C20	E01
ENGINE												
2.0 AWD	Petrol	115	01/12->	PE-VPS, PEY7								
Engine	Information				A10	A20	A40	A50	A70	C10 - C30	C20	E01
Eng. PE-VPS	Qty: 4									470 627	C10	
Eng. PEY7	x 4, COIL ON PLUG									470 627	C10	
ENGINE												
2.0 AWD	Petrol	118	11/11->	PEX3, PEY6, PEY7								
Engine	Information				A10	A20	A40	A50	A70	C10 - C30	C20	E01
All engines	x 4, +brake energy recovery, -brake energy recovery, COIL ON PLUG, COIL ON PLUG									470 627	C10	
ENGINE												
2.0 AWD	Petrol	121	06/18->	PEXB, PEXP								
Engine	Information				A10	A20	A40	A50	A70	C10 - C30	C20	E01
All engines	x 4, COIL ON PLUG									470 627	C10	
ENGINE												
2.0 SKYACTIV-G	Petrol	120	03/18->	PEXB, PEXP								
Engine	Information				A10	A20	A40	A50	A70	C10 - C30	C20	E01
All engines	x 4, COIL ON PLUG									470 627	C10	
ENGINE												
2.0 SKYACTIV-G AWD	Petrol	120	03/18->	PEXB, PEXP								
Engine	Information				A10	A20	A40	A50	A70	C10 - C30	C20	E01
All engines	x 4, COIL ON PLUG									470 627	C10	
ENGINE												
2.5	Petrol	138	02/13->	PY-VPS								
Engine	Information				A10	A20	A40	A50	A70	C10 - C30	C20	E01
All engines	Qty: 4									470 627	C10	
ENGINE												
2.5	Petrol	141	03/15->	PYY1								
Engine	Information				A10	A20	A40	A50	A70	C10 - C30	C20	E01
All engines	Qty: 4									470 627	C10	
ENGINE												
2.5	Petrol	143	05/17->	PYZ8, PYZC								
Engine	Information				A10	A20	A40	A50	A70	C10 - C30	C20	E01
All engines	x 4, Vehicle Equipment:for vehicles with cylinder shut-down, Vehicle Equipment:for vehicles without cylinder shutdown, COIL ON PLUG									470 627	C10	
ENGINE												
2.5 4WD	Petrol	135	07/14->	PY-VPS								
Engine	Information				A10	A20	A40	A50	A70	C10 - C30	C20	E01
All engines	Qty: 4									470 627	C10	
ENGINE												
2.5 AWD	Petrol	141	02/15-02/17	PYY1								
Engine	Information				A10	A20	A40	A50	A70	C10 - C30	C20	E01
All engines	x 4, COIL ON PLUG									470 627	C10	
ENGINE												
2.5 AWD	Petrol	143	05/17->	PY-Y8, PYZ8, PY-ZA, PYZC								
Engine	Information				A10	A20	A40	A50	A70	C10 - C30	C20	E01
All engines	x 4, +brake energy recovery, -brake energy recovery, COIL ON PLUG									470 627	C10	
ENGINE												
SKYACTIV-G	Petrol	121	04/15-02/17	PEY7								
Engine	Information				A10	A20	A40	A50	A70	C10 - C30	C20	E01
All engines	x 4, COIL ON PLUG									470 627	C10	
ENGINE												
SKYACTIV-G AWD	Petrol	118	04/15-02/17	PEY7								
Engine	Information				A10	A20	A40	A50	A70	C10 - C30	C20	E01
All engines	x 4, COIL ON PLUG									470 627	C10	
ENGINE												
SKYACTIV-G AWD	Petrol	141	04/15-02/17	PYY1								
Engine	Information				A10	A20	A40	A50	A70	C10 - C30	C20	E01
All engines	x 4, COIL ON PLUG									470 627	C10	

A10 CONDENSER	A20 CONTACT SET	A40 DISTRIBUTOR CAP	A50 ROTOR	A70 PICK-UP
C10 COIL	C20 IGNITION MODULE	C30 ELECTRONIC IGNITION KIT	E01 IGNITION CABLE SET	

				FUNCTIONS ON THE VEHICLE								
Vehicle	alim.	kW	Date	Engine								
CX-9				ENGINE								
2.5 T AWD	Petrol	170	06/16->	PY24								
Engine Information					A10	A20	A40	A50	A70	C10 - C30	C20	E01
All engines				x 4, COIL ON PLUG						470 627	C10	
DEMIO				ENGINE								
1.3 16V	Petrol	46	08/98-07/03	B3 ME								
Engine Information					A10	A20	A40	A50	A70	C10 - C30	C20	E01
All engines				version Mitsubishi			831 150	931 132				
1.5 16V				ENGINE								
1.5 16V	Petrol	55	04/00-07/03	B5 E								
Engine Information					A10	A20	A40	A50	A70	C10 - C30	C20	E01
All engines				version Mitsubishi			831 150	931 132				
E				ENGINE								
E2000 4WD	Petrol	60	10/88-09/89	FEBN								
Engine Information					A10	A20	A40	A50	A70	C10 - C30	C20	E01
All engines				version Mitsubishi			831 132	931 108				
E2000				ENGINE								
2.0	Petrol	60	10/89-05/95	FEBN								
Engine Information					A10	A20	A40	A50	A70	C10 - C30	C20	E01
All engines				version Mitsubishi			831 132	931 108				
2.0i 12v				ENGINE								
2.0i 12v	Petrol	71	04/97->	FERW, FEY9								
Engine Information					A10	A20	A40	A50	A70	C10 - C30	C20	E01
All engines				version Mitsubishi			831 121					
All engines									470 3665	C10		
2.0i 12v 4x4				ENGINE								
2.0i 12v 4x4	Petrol	71	09/90-08/99	FEJM, FEY9								
Engine Information					A10	A20	A40	A50	A70	C10 - C30	C20	E01
All engines				version Mitsubishi			831 121					
All engines									470 3665	C10		
MIATA				ENGINE								
1.6i 16v	Petrol	85	03/90-08/93	CE16I								
Engine Information					A10	A20	A40	A50	A70	C10 - C30	C20	E01
All engines												360 745
1.6i 16v GT				ENGINE								
1.6i 16v GT	Petrol	95	11/90-08/93	CE16T								
Engine Information					A10	A20	A40	A50	A70	C10 - C30	C20	E01
All engines												360 745
1.8i [USA]				ENGINE								
1.8i [USA]	Petrol	0	01/94->	--								
Engine Information					A10	A20	A40	A50	A70	C10 - C30	C20	E01
All engines												360 745
MPV I				ENGINE								
3.0	Petrol	112	09/88-12/91	JE94								
Engine Information					A10	A20	A40	A50	A70	C10 - C30	C20	E01
All engines				version Mitsubishi				931 134				
3.0 i V6				ENGINE								
3.0 i V6	Petrol	109	11/89-09/99	JE94								
Engine Information					A10	A20	A40	A50	A70	C10 - C30	C20	E01
All engines				version Mitsubishi				931 134				
3.0 i V6				ENGINE								
3.0 i V6	Petrol	113	11/88-05/99	JE94								
Engine Information					A10	A20	A40	A50	A70	C10 - C30	C20	E01
All engines				version Mitsubishi				931 134				

A10 CONDENSER	A20 CONTACT SET	A40 DISTRIBUTOR CAP	A50 ROTOR	A70 PICK-UP
C10 COIL	C20 IGNITION MODULE	C30 ELECTRONIC IGNITION KIT	E01 IGNITION CABLE SET	

The present application list is a brief version. For the detailed information about the possibility of installation on a specific vehicle, please refer to our web-catalogue <http://catalogo.facet.eu/>

Vehicle	alim.	kW	Date	Engine	FUNCTIONS ON THE VEHICLE							
					A10	A20	A40	A50	A70	C10 - C30	C20	E01

MPV II

2.0	Petrol	90	09/99-08/00	ENGINE FS-DS
-----	--------	----	-------------	-----------------

Engine	Information	A10	A20	A40	A50	A70	C10 - C30	C20	E01
All engines									360 767

2.3	Petrol	104	07/02-02/06	ENGINE L3
-----	--------	-----	-------------	--------------

Engine	Information	A10	A20	A40	A50	A70	C10 - C30	C20	E01
All engines									358 245

MX-3

1.6	Petrol	66	05/91-10/93	ENGINE B69
-----	--------	----	-------------	---------------

Engine	Information	A10	A20	A40	A50	A70	C10 - C30	C20	E01
All engines	version Mitsubishi			831 121					
All engines							470 233	C10	

1.6 i	Petrol	79	11/93-09/98	ENGINE B6D
-------	--------	----	-------------	---------------

Engine	Information	A10	A20	A40	A50	A70	C10 - C30	C20	E01
All engines	version Mitsubishi			831 150	931 132				
All engines									360 231

1.8 i V6	Petrol	95	01/94-10/97	ENGINE K838
----------	--------	----	-------------	----------------

Engine	Information	A10	A20	A40	A50	A70	C10 - C30	C20	E01
All engines	version Mitsubishi			831 149	931 134				
All engines									360 760

1.8 i V6	Petrol	98	01/92-01/94	ENGINE K819
----------	--------	----	-------------	----------------

Engine	Information	A10	A20	A40	A50	A70	C10 - C30	C20	E01
All engines	version Mitsubishi			831 137	931 133				

1.8 i V6	Petrol	99	01/96-10/97	ENGINE K8-ZE
----------	--------	----	-------------	-----------------

Engine	Information	A10	A20	A40	A50	A70	C10 - C30	C20	E01
All engines	version Mitsubishi			831 149	931 134				
All engines									360 760

MX-5 I

1.6	Petrol	66	01/95-04/98	ENGINE 8AN1
-----	--------	----	-------------	----------------

Engine	Information	A10	A20	A40	A50	A70	C10 - C30	C20	E01
All engines									360 745

1.6	Petrol	85	05/90-01/94	ENGINE B64F
-----	--------	----	-------------	----------------

Engine	Information	A10	A20	A40	A50	A70	C10 - C30	C20	E01
All engines	ch. 118792 ->								360 745

1.8	Petrol	96	01/93-04/98	ENGINE BPF1
-----	--------	----	-------------	----------------

Engine	Information	A10	A20	A40	A50	A70	C10 - C30	C20	E01
All engines									360 745

MX-5 II

1.6 16V	Petrol	81	05/98-10/05	ENGINE B6D
---------	--------	----	-------------	---------------

Engine	Information	A10	A20	A40	A50	A70	C10 - C30	C20	E01
All engines									360 745

1.8	Petrol	103	01/98-07/02	ENGINE BPD
-----	--------	-----	-------------	---------------

Engine	Information	A10	A20	A40	A50	A70	C10 - C30	C20	E01
All engines									360 745

1.8	Petrol	107	08/02-10/05	ENGINE BP6J
-----	--------	-----	-------------	----------------

Engine	Information	A10	A20	A40	A50	A70	C10 - C30	C20	E01
All engines									360 745

A10 CONDENSER	A20 CONTACT SET	A40 DISTRIBUTOR CAP	A50 ROTOR	A70 PICK-UP
C10 COIL	C20 IGNITION MODULE	C30 ELECTRONIC IGNITION KIT	E01 IGNITION CABLE SET	

Vehicle	alim.	kW	Date	Engine	FUNCTIONS ON THE VEHICLE							
					A10	A20	A40	A50	A70	C10 - C30	C20	E01

ENGINE				
1.8 16V	Petrol	102	11/00-10/05	BPD

Engine	Information	A10	A20	A40	A50	A70	C10 - C30	C20	E01
All engines									360 745

ENGINE				
1.8 16V	Petrol	103	05/98-10/05	BP-ZE

Engine	Information	A10	A20	A40	A50	A70	C10 - C30	C20	E01
All engines									360 745

ENGINE				
1.8 16V	Petrol	107	11/00-10/05	BPD, BP-ZE

Engine	Information	A10	A20	A40	A50	A70	C10 - C30	C20	E01
All engines									360 745

MX-5 IV

ENGINE				
1.5	Petrol	96	06/15->	P5-VPR, P5Z1

Engine	Information	A10	A20	A40	A50	A70	C10 - C30	C20	E01
All engines	x 4, COIL ON PLUG						470 627	C10	

ENGINE				
1.5	Petrol	97	05/18->	P5X1

Engine	Information	A10	A20	A40	A50	A70	C10 - C30	C20	E01
All engines	x 4, COIL ON PLUG						470 627	C10	

ENGINE				
2.0	Petrol	118	06/15->	PEX4, PEX6

Engine	Information	A10	A20	A40	A50	A70	C10 - C30	C20	E01
All engines	x 4, COIL ON PLUG						470 627	C10	

ENGINE				
2.0	Petrol	135	05/18->	PEXF

Engine	Information	A10	A20	A40	A50	A70	C10 - C30	C20	E01
All engines	x 4, COIL ON PLUG						470 627	C10	

MX-6

ENGINE				
2.0	Petrol	85	02/92-02/97	FS

Engine	Information	A10	A20	A40	A50	A70	C10 - C30	C20	E01
All engines	->year 30/04/94, version Hitachi			822 077	922 094				
All engines	01/05/94 ->, version Hitachi			822 092	922 102				
All engines	01/05/94 ->, version Mitsubishi				931 132				
All engines									359 884

ENGINE				
2.5 24V	Petrol	121	02/92-09/97	KL

Engine	Information	A10	A20	A40	A50	A70	C10 - C30	C20	E01
All engines	->year 30/04/94, version Mitsubishi			831 137	931 133				
All engines	01/05/94 ->, version Mitsubishi			831 149	931 134				
All engines	->ch. 498325								360 760

ENGINE				
2.5 24V	Petrol	123	02/93-11/95	KL

Engine	Information	A10	A20	A40	A50	A70	C10 - C30	C20	E01
All engines	->year 30/04/94, version Mitsubishi			831 137	931 133				
All engines	01/05/94 ->, version Mitsubishi			831 149	931 134				
All engines	->ch. 498325								360 760

ENGINE				
2.5 i 24V	Petrol	120	08/94-02/97	KL

Engine	Information	A10	A20	A40	A50	A70	C10 - C30	C20	E01
All engines	version Mitsubishi			831 149	931 134				
All engines	->ch. 498325								360 760

NAVAJO

ENGINE				
4.0i [USA]	Petrol	0	01/91->	--

Engine	Information	A10	A20	A40	A50	A70	C10 - C30	C20	E01
All engines							470 289	C10	

A10 CONDENSER	A20 CONTACT SET	A40 DISTRIBUTOR CAP	A50 ROTOR	A70 PICK-UP
C10 COIL	C20 IGNITION MODULE	C30 ELECTRONIC IGNITION KIT	E01 IGNITION CABLE SET	

					FUNCTIONS ON THE VEHICLE							
Vehicle	alim.	kW	Date	Engine								

PREMACY

				ENGINE
1.9	Petrol	74	07/99-03/05	FP

Engine	Information	A10	A20	A40	A50	A70	C10 - C30	C20	E01
All engines									360 767

				ENGINE
1.9	Petrol	84	07/99-03/05	FP

Engine	Information	A10	A20	A40	A50	A70	C10 - C30	C20	E01
All engines									360 767

PROTEGE

				ENGINE
1.6i [USA]	Petrol	0	06/98->	--

Engine	Information	A10	A20	A40	A50	A70	C10 - C30	C20	E01
All engines									360 729

				ENGINE
1.8i [USA]	Petrol	0	06/98->	--

Engine	Information	A10	A20	A40	A50	A70	C10 - C30	C20	E01
All engines									360 740

				ENGINE
1.8i DOHC [USA]	Petrol	0	01/90->	--

Engine	Information	A10	A20	A40	A50	A70	C10 - C30	C20	E01
All engines	version Mitsubishi			831 121					
All engines							470 233	C10	

				ENGINE
1.8i OHC [USA]	Petrol	0	01/90->	--

Engine	Information	A10	A20	A40	A50	A70	C10 - C30	C20	E01
All engines	version Mitsubishi			831 121					
All engines							470 233	C10	360 398

TRIBUTE

				ENGINE
2.0	Petrol	91	03/00-05/08	0L65(396CUV8)

Engine	Information	A10	A20	A40	A50	A70	C10 - C30	C20	E01
All engines	x 1, D.I.S.						470 532	C10	

				ENGINE
2.0 4WD	Petrol	91	03/00-05/08	1L33(425CUV8)

Engine	Information	A10	A20	A40	A50	A70	C10 - C30	C20	E01
All engines	x 1, D.I.S.						470 532	C10	

				ENGINE
2.0i [USA]	Petrol	91	05/00->	B

Engine	Information	A10	A20	A40	A50	A70	C10 - C30	C20	E01
All engines							470 532	C10	

				ENGINE
2.0i 4x4 [USA]	Petrol	91	05/00->	B

Engine	Information	A10	A20	A40	A50	A70	C10 - C30	C20	E01
All engines							470 532	C10	

				ENGINE
2.3 AWD	Petrol	110	04/04-05/08	L3-VE

Engine	Information	A10	A20	A40	A50	A70	C10 - C30	C20	E01
All engines	x 4, COIL ON PLUG						470 480	C10	

				ENGINE
2.3 GX	Petrol	110	12/03-10/04	L3-VE

Engine	Information	A10	A20	A40	A50	A70	C10 - C30	C20	E01
All engines	x 4, COIL ON PLUG						470 480	C10	

XEDOS 6

				ENGINE
1.6 16V	Petrol	79	04/94-10/99	B6 (DOHC)









Engine	Information	A10	A20	A40	A50	A70	C10 - C30	C20	E01
All engines	->eng. 210758								360 231

A10 CONDENSER	A20 CONTACT SET	A40 DISTRIBUTOR CAP	A50 ROTOR	A70 PICK-UP
C10 COIL	C20 IGNITION MODULE	C30 ELECTRONIC IGNITION KIT	E01 IGNITION CABLE SET	

Vehicle	alim.	kW	Date	Engine	FUNCTIONS ON THE VEHICLE									
					A10	A20	A40	A50	A70	C10 - C30	C20	E01		
ENGINE														
1.6 16V	Petrol	83	01/92-03/94	B69										
ENGINE														
All engines														360 231
ENGINE														
2.0 V6	Petrol	103	06/94-10/99	KF1										
ENGINE														
All engines														360 760
ENGINE														
2.0 V6	Petrol	106	01/92-05/94	KF1										
ENGINE														
All engines														360 760
XEDOS 9														
ENGINE														
2.0	Petrol	118	08/98-08/00	KF										
ENGINE														
All engines							831 149	931 134						
All engines														360 760
ENGINE														
2.0 24V	Petrol	105	08/93-01/00	KF										
ENGINE														
All engines							831 149	931 134						
All engines														360 760
ENGINE														
2.5 24V	Petrol	123	07/93-07/00	KL										
ENGINE														
All engines							831 149	931 134						
All engines														360 760
ENGINE														
2.5 V6	Petrol	120	07/00-09/02	KL										
ENGINE														
All engines							831 149	931 134						

A10	CONDENSER	A20	CONTACT SET	A40	DISTRIBUTOR CAP	A50	ROTOR	A70	PICK-UP
C10	COIL	C20	IGNITION MODULE	C30	ELECTRONIC IGNITION KIT	E01	IGNITION CABLE SET		

The present application list is a brief version. For the detailed information about the possibility of installation on a specific vehicle, please refer to our web-catalogue <http://catalogo.facet.eu/>

				FUNCTIONS ON THE VEHICLE								
Vehicle	alim.	kW	Date	Engine	 A10	 A20	 A40	 A50	 A70	 C10 - C30	 C20	 E01
/8				ENGINE								
200	Petrol	70	01/68-01/77	M 115.923, M 115.926								
Engine	Information				A10	A20	A40	A50	A70	C10 - C30	C20	E01
All engines								906 021R				
230.6				ENGINE								
Petrol	88	01/68-11/76	M 180.954									
Engine	Information				A10	A20	A40	A50	A70	C10 - C30	C20	E01
All engines						706 029HV		906 018R				
250				ENGINE								
Petrol	85	01/68-08/72	M 114.920									
Engine	Information				A10	A20	A40	A50	A70	C10 - C30	C20	E01
All engines						706 029HV		906 018R				
250				ENGINE								
Petrol	96	07/68-08/72	M 114.920									
Engine	Information				A10	A20	A40	A50	A70	C10 - C30	C20	E01
All engines						706 029HV		906 018R				
250 2.8				ENGINE								
Petrol	96	06/72-11/76	M 130.923									
Engine	Information				A10	A20	A40	A50	A70	C10 - C30	C20	E01
All engines								906 018R				
250 C				ENGINE								
Petrol	96	04/69-06/72	M 114.920									
Engine	Information				A10	A20	A40	A50	A70	C10 - C30	C20	E01
All engines						706 029HV		906 018R				
250 C 2.8				ENGINE								
Petrol	96	06/72-11/76	M 130.923									
Engine	Information				A10	A20	A40	A50	A70	C10 - C30	C20	E01
All engines								906 018R				
250 CE				ENGINE								
Petrol	110	04/69-04/72	M 114.980									
Engine	Information				A10	A20	A40	A50	A70	C10 - C30	C20	E01
All engines						706 029HV						
280				ENGINE								
Petrol	118	06/72-11/76	M 110.921									
Engine	Information				A10	A20	A40	A50	A70	C10 - C30	C20	E01
All engines						706 029HV, 706 062						
280 C				ENGINE								
Petrol	118	06/72-02/77	M 110.921									
Engine	Information				A10	A20	A40	A50	A70	C10 - C30	C20	E01
All engines						706 029HV, 706 062						
280 CE				ENGINE								
Petrol	136	06/72-01/77	M 110.981									
Engine	Information				A10	A20	A40	A50	A70	C10 - C30	C20	E01
All engines						706 062						
280 E				ENGINE								
Petrol	136	06/72-11/76	M 110.981									
Engine	Information				A10	A20	A40	A50	A70	C10 - C30	C20	E01
All engines						706 062						
123				ENGINE								
280 CE	Petrol	136	03/77-11/85	M 110.988								
Engine	Information				A10	A20	A40	A50	A70	C10 - C30	C20	E01
All engines	version Bosch						806 123	906 060R				
All engines												360 323
124				ENGINE								
200 CE	Petrol	90	09/89-06/93	M 102.963								
Engine	Information				A10	A20	A40	A50	A70	C10 - C30	C20	E01
All engines	-catalytic converter, version Bosch						806 108	906 055R				

A10 CONDENSER	A20 CONTACT SET	A40 DISTRIBUTOR CAP	A50 ROTOR	A70 PICK-UP
C10 COIL	C20 IGNITION MODULE	C30 ELECTRONIC IGNITION KIT	E01 IGNITION CABLE SET	

Vehicle	alim.	kW	Date	Engine	FUNCTIONS ON THE VEHICLE							
					A10	A20	A40	A50	A70	C10 - C30	C20	E01

124

ENGINE				
200 CE	Petrol	90	09/89-06/93	M 102.963

Engine	Information	A10	A20	A40	A50	A70	C10 - C30	C20	E01
All engines	+catalytic converter, version Bosch			806 234	906 121R				
All engines	+catalytic converter						470 178	C10	
All engines	-catalytic converter						470 180	C10	
All engines									360 654

ENGINE				
220 CE	Petrol	110	10/92-05/93	M 111.960

Engine	Information	A10	A20	A40	A50	A70	C10 - C30	C20	E01
All engines	Qty: 2						470 317	C10	

ENGINE				
230 CE	Petrol	100	03/87-12/92	M 102.982

Engine	Information	A10	A20	A40	A50	A70	C10 - C30	C20	E01
All engines	-catalytic converter, version Bosch			806 108	906 055R				
All engines	+catalytic converter, version Bosch			806 234	906 121R				
All engines	+catalytic converter						470 178	C10	
All engines	-catalytic converter						470 180	C10	
All engines									360 654

ENGINE				
230 CE	Petrol	97	03/87-12/92	M 102.982

Engine	Information	A10	A20	A40	A50	A70	C10 - C30	C20	E01
All engines	-catalytic converter, version Bosch			806 108	906 055R				
All engines	+catalytic converter, version Bosch			806 234	906 121R				
All engines	+catalytic converter						470 178	C10	
All engines	-catalytic converter						470 180	C10	
All engines									360 654

ENGINE				
230 CE Cat	Petrol	97	06/89-12/92	M 102.982

Engine	Information	A10	A20	A40	A50	A70	C10 - C30	C20	E01
All engines	-catalytic converter, version Bosch			806 108	906 055R				
All engines	+catalytic converter, version Bosch			806 234	906 121R				
All engines	+catalytic converter						470 178	C10	
All engines	-catalytic converter						470 180	C10	
All engines									360 654

ENGINE				
300 CE	Petrol	132	03/87-05/93	M 103.983

Engine	Information	A10	A20	A40	A50	A70	C10 - C30	C20	E01
All engines	version Bosch			806 237	906 125R				
All engines							470 178	C10	360 657

ENGINE				
300 CE	Petrol	138	03/87-12/89	M 103.983

Engine	Information	A10	A20	A40	A50	A70	C10 - C30	C20	E01
All engines	version Bosch			806 237	906 125R				
All engines							470 178	C10	

ENGINE				
300 CE-24	Petrol	162	09/89-06/93	M 104.980

Engine	Information	A10	A20	A40	A50	A70	C10 - C30	C20	E01
All engines							470 179	C10	

ENGINE				
300 CE-24	Petrol	170	09/89-06/93	M 104.980

Engine	Information	A10	A20	A40	A50	A70	C10 - C30	C20	E01
All engines							470 179	C10	

ENGINE				
320 CE	Petrol	162	10/92-05/93	M 104.992

Engine	Information	A10	A20	A40	A50	A70	C10 - C30	C20	E01
All engines	Qty: 3, without spark plug connector						470 316	C10	
All engines	incl. spark plug connector, Qty: 3						470 316K	C10	

A10 CONDENSER	A20 CONTACT SET	A40 DISTRIBUTOR CAP	A50 ROTOR	A70 PICK-UP
C10 COIL	C20 IGNITION MODULE	C30 ELECTRONIC IGNITION KIT	E01 IGNITION CABLE SET	

The present application list is a brief version. For the detailed information about the possibility of installation on a specific vehicle, please refer to our web-catalogue <http://catalogo.facet.eu/>

FUNCTIONS ON THE VEHICLE







Vehicle	alim.	kW	Date	Engine	 A10	 A20	 A40	 A50	 A70	 C10 - C30	 C20	 E01
190												
ENGINE												
2.0	Petrol	66	10/82-10/84	M 102.921			806 108	906 055R		470 180	C10	
Engine	Information				A10	A20	A40	A50	A70	C10 - C30	C20	E01
All engines	version Bosch						806 108	906 055R				
All engines										470 180	C10	
ENGINE												
2.0	Petrol	75	01/86-05/90	M 102.924			806 108	906 055R				
Engine	Information				A10	A20	A40	A50	A70	C10 - C30	C20	E01
All engines	version Bosch						806 108	906 055R				
All engines	-catalytic converter, version Bosch							906 055R				
All engines	+catalytic converter, version Bosch							906 121R				
All engines	+catalytic converter								470 178	C10		
All engines	-catalytic converter								470 180	C10		
All engines												360 654
ENGINE												
2.0	Petrol	77	08/83-05/90	M 102.924			806 108	906 055R		470 178	C10	
Engine	Information				A10	A20	A40	A50	A70	C10 - C30	C20	E01
All engines	version Bosch						806 108	906 055R				
All engines	-catalytic converter, version Bosch							906 055R				
All engines	+catalytic converter, version Bosch							906 121R				
All engines	+catalytic converter								470 178	C10		
All engines	-catalytic converter								470 180	C10		
All engines												360 654
ENGINE												
2.3	Petrol	97	09/87-09/88	M 102.985			806 108	906 055R		470 178	C10	
Engine	Information				A10	A20	A40	A50	A70	C10 - C30	C20	E01
All engines	-catalytic converter, version Bosch						806 108	906 055R				
All engines	+catalytic converter, version Bosch						806 234	906 121R				
All engines	+catalytic converter								470 178	C10		
All engines	-catalytic converter								470 180	C10		
All engines												360 300
ENGINE												
2.3 E	Petrol	100	10/82-09/88	M 102.985			806 108	906 055R		470 178	C10	
Engine	Information				A10	A20	A40	A50	A70	C10 - C30	C20	E01
All engines	-catalytic converter, version Bosch						806 108	906 055R				
All engines	+catalytic converter, version Bosch						806 234	906 121R				
All engines	+catalytic converter								470 178	C10		
All engines	-catalytic converter								470 180	C10		
All engines												360 300
ENGINE												
2.6	Petrol	118	10/82-09/88	M 103.942			806 237	906 125R		470 178	C10	
Engine	Information				A10	A20	A40	A50	A70	C10 - C30	C20	E01
All engines	version Bosch						806 237	906 125R				
All engines									470 178	C10		
ENGINE												
E 1.8	Petrol	77	01/92-12/93	M 102.919			806 234	906 121R		470 178	C10	360 300
Engine	Information				A10	A20	A40	A50	A70	C10 - C30	C20	E01
All engines	version Bosch						806 234	906 121R				
All engines									470 178	C10		360 300
ENGINE												
E 1.8	Petrol	80	04/90-08/93	M 102.910			806 234	906 121R		470 178	C10	360 300
Engine	Information				A10	A20	A40	A50	A70	C10 - C30	C20	E01
All engines	version Bosch						806 234	906 121R				
All engines									470 178	C10		360 300
ENGINE												
E 2.0	Petrol	83	02/85-12/86	M 102.962			806 108	906 055R		470 178	C10	
Engine	Information				A10	A20	A40	A50	A70	C10 - C30	C20	E01
All engines	-catalytic converter, version Bosch						806 108	906 055R				
All engines	+catalytic converter, version Bosch						806 234	906 121R				
All engines	+catalytic converter								470 178	C10		
All engines	-catalytic converter								470 180	C10		

A10 CONDENSER	A20 CONTACT SET	A40 DISTRIBUTOR CAP	A50 ROTOR	A70 PICK-UP
C10 COIL	C20 IGNITION MODULE	C30 ELECTRONIC IGNITION KIT	E01 IGNITION CABLE SET	

Vehicle	alim.	kW	Date	Engine	FUNCTIONS ON THE VEHICLE									
					A10	A20	A40	A50	A70	C10 - C30	C20	E01		
ENGINE														
E 2.0	Petrol	83	02/85-12/86	M 102.962										
Engine	Information				A10	A20	A40	A50	A70	C10 - C30	C20	E01		
All engines	01/01/90 ->												360 300	
ENGINE														
E 2.0	Petrol	85	02/85-12/86	M 102.962										
Engine	Information				A10	A20	A40	A50	A70	C10 - C30	C20	E01		
All engines	-catalytic converter, version Bosch						806 108	906 055R						
All engines	+catalytic converter, version Bosch						806 234	906 121R						
All engines	+catalytic converter									470 178	C10			
All engines	-catalytic converter									470 180	C10			
All engines	01/01/90 ->												360 300	
ENGINE														
E 2.0	Petrol	87	01/85-08/93	M 102.962										
Engine	Information				A10	A20	A40	A50	A70	C10 - C30	C20	E01		
All engines	-catalytic converter, version Bosch						806 108	906 055R						
All engines	+catalytic converter, version Bosch						806 234	906 121R						
All engines	+catalytic converter									470 178	C10			
All engines	-catalytic converter									470 180	C10			
All engines	01/01/90 ->												360 300	
ENGINE														
E 2.0	Petrol	90	10/82-06/93	M 102.962										
Engine	Information				A10	A20	A40	A50	A70	C10 - C30	C20	E01		
All engines	-catalytic converter, version Bosch						806 108	906 055R						
All engines	+catalytic converter, version Bosch						806 234	906 121R						
All engines	+catalytic converter									470 178	C10			
All engines	-catalytic converter									470 180	C10			
All engines	01/01/90 ->												360 300	
ENGINE														
E 2.3	Petrol	100	10/86-08/93	M 102.985										
Engine	Information				A10	A20	A40	A50	A70	C10 - C30	C20	E01		
All engines	-catalytic converter, version Bosch						806 108	906 055R						
All engines	+catalytic converter, version Bosch						806 234	906 121R						
All engines	+catalytic converter									470 178	C10			
All engines	-catalytic converter									470 180	C10			
All engines	01/01/90 ->												360 300	
ENGINE														
E 2.3	Petrol	97	09/86-08/91	M 102.985										
Engine	Information				A10	A20	A40	A50	A70	C10 - C30	C20	E01		
All engines	-catalytic converter, version Bosch						806 108	906 055R						
All engines	+catalytic converter, version Bosch						806 234	906 121R						
All engines	+catalytic converter									470 178	C10			
All engines	-catalytic converter									470 180	C10			
All engines	01/01/90 ->												360 300	
ENGINE														
E 2.3-16	Petrol	125	09/85-12/87	M 102.983										
Engine	Information				A10	A20	A40	A50	A70	C10 - C30	C20	E01		
All engines	version Bosch						806 234	906 121R						
All engines										470 178	C10			
ENGINE														
E 2.3-16	Petrol	130	09/85-08/88	M 102.983										
Engine	Information				A10	A20	A40	A50	A70	C10 - C30	C20	E01		
All engines	version Bosch						806 234	906 121R						
All engines										470 178	C10			
ENGINE														
E 2.3-16	Petrol	136	04/84-01/87	M 102.983										
Engine	Information				A10	A20	A40	A50	A70	C10 - C30	C20	E01		
All engines	version Bosch						806 234	906 121R						
All engines										470 178	C10			









A10 CONDENSER	A20 CONTACT SET	A40 DISTRIBUTOR CAP	A50 ROTOR	A70 PICK-UP
C10 COIL	C20 IGNITION MODULE	C30 ELECTRONIC IGNITION KIT	E01 IGNITION CABLE SET	

The present application list is a brief version. For the detailed information about the possibility of installation on a specific vehicle, please refer to our web-catalogue <http://catalogo.facet.eu/>

				FUNCTIONS ON THE VEHICLE								
Vehicle	alim.	kW	Date	Engine								
				ENGINE								
E 2.5-16	Petrol	150	09/88-08/93	M 102.990								
Engine		Information			A10	A20	A40	A50	A70	C10 - C30	C20	E01
All engines		version Bosch					806 234	906 121R				
All engines										470 178	C10	
				ENGINE								
E 2.5-16 Evolution	Petrol	143	03/89-08/93	M 102.991								
Engine		Information			A10	A20	A40	A50	A70	C10 - C30	C20	E01
All engines		version Bosch					806 234	906 121R				
All engines										470 178	C10	
				ENGINE								
E 2.5-16 Evolution II	Petrol	173	05/90-08/93	M 102.992								
Engine		Information			A10	A20	A40	A50	A70	C10 - C30	C20	E01
All engines		version Bosch					806 234					
All engines										470 178	C10	
				ENGINE								
E 2.6	Petrol	118	09/86-08/93	M 103.942								
Engine		Information			A10	A20	A40	A50	A70	C10 - C30	C20	E01
All engines		version Bosch					806 237	906 125R				
All engines										470 178	C10	
				ENGINE								
E 2.6	Petrol	122	09/86-12/89	M 103.942								
Engine		Information			A10	A20	A40	A50	A70	C10 - C30	C20	E01
All engines		version Bosch					806 237	906 125R				
All engines										470 178	C10	
				ENGINE								
E 3.2 AMG	Petrol	132	01/88->	M 103.983								
Engine		Information			A10	A20	A40	A50	A70	C10 - C30	C20	E01
All engines		version Bosch					806 237	906 125R				
All engines										470 178	C10	
				CITAN								
112	Petrol	84	06/13-08/21	M 200.711								
Engine		Information			A10	A20	A40	A50	A70	C10 - C30	C20	E01
All engines		x 4, COIL ON PLUG								470 613	C10	
				CLASSE A II								
				ENGINE								
A 150	Petrol	70	09/04-06/12	M 266.920								
Engine		Information			A10	A20	A40	A50	A70	C10 - C30	C20	E01
All engines		x 2, COIL ON PLUG								470 417	C10	
All engines												358 234
				ENGINE								
A 160	Petrol	70	04/09-06/12	M 266.920								
Engine		Information			A10	A20	A40	A50	A70	C10 - C30	C20	E01
All engines		x 2, COIL ON PLUG								470 417	C10	
All engines												358 234
				ENGINE								
A 170	Petrol	85	09/04-06/12	M 266.940								
Engine		Information			A10	A20	A40	A50	A70	C10 - C30	C20	E01
All engines		x 2, COIL ON PLUG								470 417	C10	
All engines												358 234
				ENGINE								
A 180	Petrol	85	04/09-06/12	M 266.940								
Engine		Information			A10	A20	A40	A50	A70	C10 - C30	C20	E01
All engines		x 2, COIL ON PLUG								470 417	C10	
All engines												358 234
				ENGINE								
A 200	Petrol	100	09/04-06/12	M 266.960								
Engine		Information			A10	A20	A40	A50	A70	C10 - C30	C20	E01
All engines		x 2, COIL ON PLUG								470 417	C10	
All engines												358 234

A10 CONDENSER	A20 CONTACT SET	A40 DISTRIBUTOR CAP	A50 ROTOR	A70 PICK-UP
C10 COIL	C20 IGNITION MODULE	C30 ELECTRONIC IGNITION KIT	E01 IGNITION CABLE SET	

Vehicle	alim.	kW	Date	Engine	FUNCTIONS ON THE VEHICLE									
					A10	A20	A40	A50	A70	C10 - C30	C20	E01		
ENGINE														
A 200 TURBO	Petrol	142	09/05-06/12	M 266.980										
Engine	Information				A10	A20	A40	A50	A70	C10 - C30	C20	E01		
All engines	x 2, COIL ON PLUG									470 417	C10			
All engines													358 232	
CLASSE A III														
ENGINE														
A 160	Petrol	75	07/15-05/18	M 270.910										
Engine	Information				A10	A20	A40	A50	A70	C10 - C30	C20	E01		
All engines	x 4, without protection hose, COIL ON PLUG, FOR: (TJ)									470 626	C10			
ENGINE														
A 180	Petrol	90	09/12-05/18	M 270.910										
Engine	Information				A10	A20	A40	A50	A70	C10 - C30	C20	E01		
All engines	x 4, without protection hose, COIL ON PLUG, FOR: (TJ)									470 626	C10			
ENGINE														
A 200	Petrol	115	06/12-05/18	M 270.910										
Engine	Information				A10	A20	A40	A50	A70	C10 - C30	C20	E01		
All engines	x 4, without protection hose, COIL ON PLUG, FOR: (TJ)									470 626	C10			
ENGINE														
A 220 4-matic	Petrol	135	05/14-05/18	M 270.920										
Engine	Information				A10	A20	A40	A50	A70	C10 - C30	C20	E01		
All engines	x 4, version 1, without protection hose, COIL ON PLUG, DELPHI, FOR: (TJ), without protection hose, COIL ON PLUG									470 626	C10			
ENGINE														
A 250	Petrol	155	06/12-05/18	M 270.920										
Engine	Information				A10	A20	A40	A50	A70	C10 - C30	C20	E01		
All engines	x 4, version 1, without protection hose, COIL ON PLUG, DELPHI, FOR: (TJ), without protection hose, COIL ON PLUG									470 626	C10			
ENGINE														
A 250	Petrol	160	07/15-05/18	M 270.920										
Engine	Information				A10	A20	A40	A50	A70	C10 - C30	C20	E01		
All engines	x 4, version 1, without protection hose, COIL ON PLUG, DELPHI, FOR: (TJ), without protection hose, COIL ON PLUG									470 626	C10			
ENGINE														
A 250 4-matic	Petrol	155	06/13-05/18	M 270.920										
Engine	Information				A10	A20	A40	A50	A70	C10 - C30	C20	E01		
All engines	x 4, version 1, without protection hose, COIL ON PLUG, DELPHI, FOR: (TJ), without protection hose, COIL ON PLUG									470 626	C10			
ENGINE														
A 250 4-matic	Petrol	160	07/15-05/18	M 270.920										
Engine	Information				A10	A20	A40	A50	A70	C10 - C30	C20	E01		
All engines	x 4, version 1, without protection hose, COIL ON PLUG, DELPHI, FOR: (TJ), without protection hose, COIL ON PLUG									470 626	C10			
ENGINE														
A 45 AMG 4-matic	Petrol	265	06/13-05/18	M 133.980										
Engine	Information				A10	A20	A40	A50	A70	C10 - C30	C20	E01		
All engines	x 4, DELPHI, without protection hose, COIL ON PLUG									470 626	C10			
ENGINE														
AMG A 45 4-matic	Petrol	280	07/15-05/18	M 133.980										
Engine	Information				A10	A20	A40	A50	A70	C10 - C30	C20	E01		
All engines	x 4, DELPHI, without protection hose, COIL ON PLUG									470 626	C10			
CLASSE B I														
ENGINE														
B 150	Petrol	70	03/05-11/11	M 266.920										
Engine	Information				A10	A20	A40	A50	A70	C10 - C30	C20	E01		
All engines	x 2, COIL ON PLUG									470 417	C10			
All engines													358 234	
ENGINE														
B 160	Petrol	70	04/09-11/11	M 266.920										
Engine	Information				A10	A20	A40	A50	A70	C10 - C30	C20	E01		
All engines	x 2, COIL ON PLUG									470 417	C10			
All engines													358 234	
A10	CONDENSER		A20	CONTACT SET		A40	DISTRIBUTOR CAP		A50	ROTOR		A70	PICK-UP	
C10	COIL		C20	IGNITION MODULE		C30	ELECTRONIC IGNITION KIT		E01	IGNITION CABLE SET				

					FUNCTIONS ON THE VEHICLE												
Vehicle	alim.	kW	Date	Engine	 A10	 A20	 A40	 A50	 A70	 C10 - C30	 C20	 E01					
ENGINE																	
B 170	Petrol	85	03/05-11/11	M 266.940													
Engine	Information				A10	A20	A40	A50	A70	C10 - C30	C20	E01					
All engines	x 2, COIL ON PLUG									470 417	C10						
All engines												358 234					
ENGINE																	
B 170 NGT	Petrol/ Com- pressed Natural Gas (CNG)	85	04/08-11/11	M 266.960, M 266960NGT													
Engine	Information				A10	A20	A40	A50	A70	C10 - C30	C20	E01					
Eng. M 266.960	Qty: 2									470 417	C10						
Eng. M 266960NGT	x 2, COIL ON PLUG									470 417	C10						
Eng. M 266.960												358 234					
ENGINE																	
B 180	Petrol	85	04/09-11/11	M 266.940													
Engine	Information				A10	A20	A40	A50	A70	C10 - C30	C20	E01					
All engines	x 2, COIL ON PLUG									470 417	C10						
All engines												358 234					
ENGINE																	
B 180 NGT	Petrol/ Com- pressed Natural Gas (CNG)	85	04/08-11/11	M 266.960, M 266960NGT													
Engine	Information				A10	A20	A40	A50	A70	C10 - C30	C20	E01					
Eng. M 266.960	Qty: 2									470 417	C10						
Eng. M 266960NGT	x 2, COIL ON PLUG									470 417	C10						
Eng. M 266.960												358 234					
ENGINE																	
B 200	Petrol	100	03/05-11/11	M 266.960													
Engine	Information				A10	A20	A40	A50	A70	C10 - C30	C20	E01					
All engines	x 2, COIL ON PLUG									470 417	C10						
All engines												358 234					
ENGINE																	
B 200 TURBO	Petrol	142	03/05-11/11	M 266.980													
Engine	Information				A10	A20	A40	A50	A70	C10 - C30	C20	E01					
All engines	x 2, COIL ON PLUG									470 417	C10						
All engines												358 232					
CLASSE B II																	
ENGINE																	
B 160	Petrol	75	07/15-12/18	M 270.910													
Engine	Information				A10	A20	A40	A50	A70	C10 - C30	C20	E01					
All engines	SA A701, MADE BY: (TJ), x 4, without protection hose, COIL ON PLUG, FOR: (TJ)									470 626	C10						
ENGINE																	
B 180	Petrol	90	11/11-12/18	M 270.910													
Engine	Information				A10	A20	A40	A50	A70	C10 - C30	C20	E01					
All engines	MADE BY: (TJ), x 4, without protection hose, COIL ON PLUG, FOR: (TJ)									470 626	C10						
ENGINE																	
B 200	Petrol	115	11/11-12/18	M 270.910													
Engine	Information				A10	A20	A40	A50	A70	C10 - C30	C20	E01					
All engines	MADE BY: (TJ), x 4, without protection hose, COIL ON PLUG, FOR: (TJ)									470 626	C10						
ENGINE																	
B 200 Natural Gas Drive / B 200 c	Petrol/ Com- pressed Natural Gas (CNG)	115	11/12-12/17	M 270.920, M 270920NGT													
Engine	Information				A10	A20	A40	A50	A70	C10 - C30	C20	E01					
Eng. M 270.920	-protective sheath, Qty: 4									470 626	C10						
Eng. M 270920NGT	x 4, DELPHI, without protection hose, COIL ON PLUG									470 626	C10						
A10	CONDENSER	A20	CONTACT SET	A40	DISTRIBUTOR CAP	A50	ROTOR	A70	PICK-UP	C10	COIL	C20	IGNITION MODULE	C30	ELECTRONIC IGNITION KIT	E01	IGNITION CABLE SET

Vehicle	alim.	kW	Date	Engine	FUNCTIONS ON THE VEHICLE							
					A10	A20	A40	A50	A70	C10 - C30	C20	E01
B 220 4-matic Petrol 135 05/13-12/18 M 270.920					ENGINE							
All engines					A10	A20	A40	A50	A70	C10 - C30	C20	E01
Information					MADE BY: (TJ), x 4, DELPHI, x 4, without protection hose, COIL ON PLUG, FOR: (TJ)							
470 626										C10		
B 250 Petrol 155 05/12-12/18 M 270.920					ENGINE							
All engines					A10	A20	A40	A50	A70	C10 - C30	C20	E01
Information					x 4, DELPHI, without protection hose, COIL ON PLUG							
470 626										C10		
B 250 4-matic Petrol 155 08/14-12/18 M 270.920					ENGINE							
All engines					A10	A20	A40	A50	A70	C10 - C30	C20	E01
Information					x 4, DELPHI, without protection hose, COIL ON PLUG							
470 626										C10		
CLASSE C I					ENGINE							
C 180 Petrol 89 11/94-05/00 M 111.921					ENGINE							
All engines					A10	A20	A40	A50	A70	C10 - C30	C20	E01
Information					Qty: 2, without spark plug connector							
470 316										C10		
All engines					A10	A20	A40	A50	A70	C10 - C30	C20	E01
Information					incl. spark plug connector, Qty: 2							
470 316K										C10		
C 180 Petrol 90 03/93-05/00 M 111.920, M 111.921					ENGINE							
Eng. M 111.921					A10	A20	A40	A50	A70	C10 - C30	C20	E01
Information					Qty: 2, without spark plug connector							
470 316										C10		
Eng. M 111.921					A10	A20	A40	A50	A70	C10 - C30	C20	E01
Information					incl. spark plug connector, Qty: 2							
470 316K										C10		
Eng. M 111.920					A10	A20	A40	A50	A70	C10 - C30	C20	E01
Information					Qty: 2							
470 317										C10		
Eng. M 111.920					A10	A20	A40	A50	A70	C10 - C30	C20	E01
Information					Qty: 2							
360 305												
C 180 T Petrol 90 06/96-09/00 M 111.920, M 111.921					ENGINE							
Eng. M 111.921					A10	A20	A40	A50	A70	C10 - C30	C20	E01
Information					Qty: 2, without spark plug connector							
470 316										C10		
Eng. M 111.921					A10	A20	A40	A50	A70	C10 - C30	C20	E01
Information					incl. spark plug connector, Qty: 2							
470 316K										C10		
Eng. M 111.920					A10	A20	A40	A50	A70	C10 - C30	C20	E01
Information					Qty: 2							
470 317										C10		
Eng. M 111.920					A10	A20	A40	A50	A70	C10 - C30	C20	E01
Information					Qty: 2							
360 305												
C 200 Petrol 100 01/94-05/00 M 111.941, M 111.945					ENGINE							
Eng. M 111.945					A10	A20	A40	A50	A70	C10 - C30	C20	E01
Information					Qty: 2, without spark plug connector							
470 316										C10		
Eng. M 111.945					A10	A20	A40	A50	A70	C10 - C30	C20	E01
Information					incl. spark plug connector, Qty: 2							
470 316K										C10		
Eng. M 111.941					A10	A20	A40	A50	A70	C10 - C30	C20	E01
Information					Qty: 2							
470 317										C10		
Eng. M 111.941					A10	A20	A40	A50	A70	C10 - C30	C20	E01
Information					Qty: 2							
360 305												
C 200 Kompressor Petrol 132 10/95-05/00 M 111.944					ENGINE							
All engines					A10	A20	A40	A50	A70	C10 - C30	C20	E01
Information					Qty: 2, without spark plug connector							
470 316										C10		
All engines					A10	A20	A40	A50	A70	C10 - C30	C20	E01
Information					incl. spark plug connector, Qty: 2							
470 316K										C10		
C 200 Kompressor Petrol 141 11/96-05/00 M 111.944					ENGINE							
All engines					A10	A20	A40	A50	A70	C10 - C30	C20	E01
Information					Qty: 2, without spark plug connector							
470 316										C10		
All engines					A10	A20	A40	A50	A70	C10 - C30	C20	E01
Information					incl. spark plug connector, Qty: 2							
470 316K										C10		
C 200 T Petrol 100 06/96-03/01 M 111.941, M 111.945					ENGINE							
Eng. M 111.945					A10	A20	A40	A50	A70	C10 - C30	C20	E01
Information					Qty: 2, without spark plug connector							
470 316										C10		
Eng. M 111.945					A10	A20	A40	A50	A70	C10 - C30	C20	E01
Information					incl. spark plug connector, Qty: 2							
470 316K										C10		
Eng. M 111.941					A10	A20	A40	A50	A70	C10 - C30	C20	E01
Information					Qty: 2							
470 317										C10		
Eng. M 111.941					A10	A20	A40	A50	A70	C10 - C30	C20	E01
Information					Qty: 2							
360 305												
C 200 T Kompressor Petrol 141 11/96-03/01 M 111.944					ENGINE							
All engines					A10	A20	A40	A50	A70	C10 - C30	C20	E01
Information					Qty: 2, without spark plug connector							
470 316										C10		
All engines					A10	A20	A40	A50	A70	C10 - C30	C20	E01
Information					incl. spark plug connector, Qty: 2							
470 316K										C10		

A10 CONDENSER	A20 CONTACT SET	A40 DISTRIBUTOR CAP	A50 ROTOR	A70 PICK-UP
C10 COIL	C20 IGNITION MODULE	C30 ELECTRONIC IGNITION KIT	E01 IGNITION CABLE SET	

Vehicle	alim.	kW	Date	Engine	FUNCTIONS ON THE VEHICLE								
					A10	A20	A40	A50	A70	C10 - C30	C20	E01	
ENGINE													
C220	Petrol	110	03/93-05/00	M 111.961									
Engine	Information				A10	A20	A40	A50	A70	C10 - C30	C20	E01	
All engines	Qty: 2									470 317	C10		
ENGINE													
C230	Petrol	110	06/96-06/97	M 111.974									
Engine	Information				A10	A20	A40	A50	A70	C10 - C30	C20	E01	
All engines	Qty: 2, without spark plug connector									470 316	C10		
All engines	incl. spark plug connector, Qty: 2									470 316K	C10		
ENGINE													
C230 Kompressor	Petrol	142	10/95-05/00	M 111.975									
Engine	Information				A10	A20	A40	A50	A70	C10 - C30	C20	E01	
All engines	Qty: 2, without spark plug connector									470 316	C10		
All engines	incl. spark plug connector, Qty: 2									470 316K	C10		
ENGINE													
C230 T	Petrol	110	06/96-06/98	M 111.974									
Engine	Information				A10	A20	A40	A50	A70	C10 - C30	C20	E01	
All engines	Qty: 2, without spark plug connector									470 316	C10		
All engines	incl. spark plug connector, Qty: 2									470 316K	C10		
ENGINE													
C230 T Kompressor	Petrol	142	06/97-09/00	M 111.975									
Engine	Information				A10	A20	A40	A50	A70	C10 - C30	C20	E01	
All engines	Qty: 2, without spark plug connector									470 316	C10		
All engines	incl. spark plug connector, Qty: 2									470 316K	C10		
ENGINE													
C240	Petrol	125	06/97-05/00	M 112.910									
Engine	Information				A10	A20	A40	A50	A70	C10 - C30	C20	E01	
All engines	Qty: 6									470 417	C10		
All engines													360 649
ENGINE													
C240 T	Petrol	125	06/97-03/01	M 112.910, M 112.915									
Engine	Information				A10	A20	A40	A50	A70	C10 - C30	C20	E01	
All engines	Qty: 6									470 417	C10		
All engines													360 649
ENGINE													
C280	Petrol	142	05/93-05/00	M 104.941									
Engine	Information				A10	A20	A40	A50	A70	C10 - C30	C20	E01	
All engines	Qty: 3, without spark plug connector									470 316	C10		
All engines	incl. spark plug connector, Qty: 3									470 316K	C10		
ENGINE													
C280	Petrol	145	06/97-05/00	M 112.920									
Engine	Information				A10	A20	A40	A50	A70	C10 - C30	C20	E01	
All engines	Qty: 6									470 417	C10		
All engines													360 649
ENGINE													
C280 T	Petrol	145	06/97-03/01	M 112.920									
Engine	Information				A10	A20	A40	A50	A70	C10 - C30	C20	E01	
All engines	Qty: 6									470 417	C10		
All engines													360 649
ENGINE													
C36 AMG	Petrol	206	05/94-05/00	M 104.941 (AMG 3.6)									
Engine	Information				A10	A20	A40	A50	A70	C10 - C30	C20	E01	
All engines	Qty: 3, without spark plug connector									470 316	C10		
All engines	incl. spark plug connector, Qty: 3									470 316K	C10		
ENGINE													
C43 AMG	Petrol	225	08/97-03/01	M 113.944									
Engine	Information				A10	A20	A40	A50	A70	C10 - C30	C20	E01	
All engines	Qty: 8									470 417	C10		

A10 CONDENSER	A20 CONTACT SET	A40 DISTRIBUTOR CAP	A50 ROTOR	A70 PICK-UP
C10 COIL	C20 IGNITION MODULE	C30 ELECTRONIC IGNITION KIT	E01 IGNITION CABLE SET	

Vehicle	alim.	kW	Date	Engine	FUNCTIONS ON THE VEHICLE							
					A10	A20	A40	A50	A70	C10 - C30	C20	E01

CLASSE C II

				ENGINE
C 160 Kompressor	Petrol	90	05/02-05/08	M 271.921

Engine	Information	A10	A20	A40	A50	A70	C10 - C30	C20	E01
All engines	x 4, COIL ON PLUG						470 420	C10	

				ENGINE
C 180 Kompressor	Petrol	105	05/02-05/08	M 271.946

Engine	Information	A10	A20	A40	A50	A70	C10 - C30	C20	E01
All engines	->eng. 30853899 (+31019397), eng. type 30853900 (+30821903) ->, x 4, COIL ON PLUG, x 4, COIL ON PLUG						470 420	C10	

				ENGINE
C 200 CGI Kompressor	Petrol	125	03/03-05/08	M 271.942

Engine	Information	A10	A20	A40	A50	A70	C10 - C30	C20	E01
All engines	x 4, COIL ON PLUG						470 420	C10	

				ENGINE
C 200 Kompressor	Petrol	120	05/02-05/08	M 271.940

Engine	Information	A10	A20	A40	A50	A70	C10 - C30	C20	E01
All engines	x 4, COIL ON PLUG, x 4, COIL ON PLUG						470 420	C10	

				ENGINE
C 220	Petrol	120	05/02-05/08	M 271.948

Engine	Information	A10	A20	A40	A50	A70	C10 - C30	C20	E01
All engines	x 4, COIL ON PLUG						470 420	C10	

				ENGINE
C 230	Petrol	150	01/05-05/08	M 272.920

Engine	Information	A10	A20	A40	A50	A70	C10 - C30	C20	E01
All engines	x 6, COIL ON PLUG						470 487	C10	

				ENGINE
C 230 Kompressor	Petrol	141	05/02-05/08	M 271.948

Engine	Information	A10	A20	A40	A50	A70	C10 - C30	C20	E01
All engines	x 4, ->eng. 30853899, COIL ON PLUG, eng. type 30853900 ->, x 4, COIL ON PLUG, x 4, COIL ON PLUG						470 420	C10	

				ENGINE
C 240	Petrol	125	05/00-08/07	M 112.912

Engine	Information	A10	A20	A40	A50	A70	C10 - C30	C20	E01
All engines	x 6, COIL ON PLUG						470 417	C10	
All engines									360 649

				ENGINE
C 240 4-matic	Petrol	125	07/02-08/07	M 112.916

Engine	Information	A10	A20	A40	A50	A70	C10 - C30	C20	E01
All engines	x 6, COIL ON PLUG						470 417	C10	
All engines									360 649

				ENGINE
C 280	Petrol	170	01/05-08/07	M 272.940

Engine	Information	A10	A20	A40	A50	A70	C10 - C30	C20	E01
All engines	x 6, COIL ON PLUG						470 487	C10	

				ENGINE
C 280 4-matic	Petrol	170	01/05-08/07	M 272.941

Engine	Information	A10	A20	A40	A50	A70	C10 - C30	C20	E01
All engines	x 6, COIL ON PLUG						470 487	C10	

				ENGINE
C 32 AMG Kompressor	Petrol	260	02/01-08/07	M 112.961

Engine	Information	A10	A20	A40	A50	A70	C10 - C30	C20	E01
All engines	x 6, COIL ON PLUG						470 417	C10	
All engines									360 649

				ENGINE
C 320	Petrol	160	05/00-05/08	M 112.946

Engine	Information	A10	A20	A40	A50	A70	C10 - C30	C20	E01
All engines	x 6, COIL ON PLUG						470 417	C10	
All engines									360 649

A10 CONDENSER	A20 CONTACT SET	A40 DISTRIBUTOR CAP	A50 ROTOR	A70 PICK-UP
C10 COIL	C20 IGNITION MODULE	C30 ELECTRONIC IGNITION KIT	E01 IGNITION CABLE SET	

The present application list is a brief version. For the detailed information about the possibility of installation on a specific vehicle, please refer to our web-catalogue <http://catalogo.facet.eu/>

					FUNCTIONS ON THE VEHICLE							
Vehicle	alim.	kW	Date	Engine	A10	A20	A40	A50	A70	C10 - C30	C20	E01
C 320 4-matic												
Petrol												
		160	07/02-08/07	M 112.953								
ENGINE												
Engine	Information				A10	A20	A40	A50	A70	C10 - C30	C20	E01
All engines	x 6, COIL ON PLUG									470 417	C10	
All engines												360 649
C 350												
Petrol												
		200	01/05-05/08	M 272.960								
ENGINE												
Engine	Information				A10	A20	A40	A50	A70	C10 - C30	C20	E01
All engines	x 6, COIL ON PLUG									470 487	C10	
C 350 4-matic												
Petrol												
		200	01/05-08/07	M 272.970								
ENGINE												
Engine	Information				A10	A20	A40	A50	A70	C10 - C30	C20	E01
All engines	x 6, COIL ON PLUG									470 487	C10	
C 55 AMG												
Petrol												
		270	02/04-08/07	M 113.988								
ENGINE												
Engine	Information				A10	A20	A40	A50	A70	C10 - C30	C20	E01
All engines	x 8, COIL ON PLUG									470 417	C10	
CLASSE C III												
C 180												
Petrol												
		115	06/11->	M 271.820, M 274.910								
ENGINE												
Engine	Information				A10	A20	A40	A50	A70	C10 - C30	C20	E01
Eng. M 271.820	x 4, COIL ON PLUG									470 420	C10	
Eng. M 274.910	MADE BY: (TJ), x 4, DELPHI, without protection hose, x 4, COIL ON PLUG, without protection hose, COIL ON PLUG, FOR: (TJ), FOR: (TJ)									470 626	C10	
C 180 CGI												
Petrol												
		115	01/07-08/14	M 271.820, M 271.952, M 274.910								
ENGINE												
Engine	Information				A10	A20	A40	A50	A70	C10 - C30	C20	E01
Eng. M 271.820, M 271.952	x 4, COIL ON PLUG									470 420	C10	
Eng. M 274.910	MADE BY: (TJ), x 4, DELPHI, x 4, without protection hose, COIL ON PLUG, FOR: (TJ)									470 626	C10	
C 180 Kompressor												
Petrol												
		115	01/07-08/14	M 271.820, M 271.910, M 271.952								
ENGINE												
Engine	Information				A10	A20	A40	A50	A70	C10 - C30	C20	E01
All engines	x 4, COIL ON PLUG									470 420	C10	
C 200												
Petrol												
		137	05/11-01/14	M 271.820								
ENGINE												
Engine	Information				A10	A20	A40	A50	A70	C10 - C30	C20	E01
All engines	x 4, COIL ON PLUG									470 420	C10	
C 200 CGI												
Petrol												
		135	01/07->	M 271.820, M 271.860, M 271.950								
ENGINE												
Engine	Information				A10	A20	A40	A50	A70	C10 - C30	C20	E01
All engines	x 4, COIL ON PLUG									470 420	C10	
Eng. M 271.860	Qty: 4									470 420	C10	
C 200 Kompressor												
Petrol												
		135	01/07-08/14	M 271.820, M 271.860, M 271.950								
ENGINE												
Engine	Information				A10	A20	A40	A50	A70	C10 - C30	C20	E01
All engines	x 4, COIL ON PLUG									470 420	C10	
C 230												
Petrol												
		150	01/07-08/14	M 272.921								
ENGINE												
Engine	Information				A10	A20	A40	A50	A70	C10 - C30	C20	E01
All engines	x 6, COIL ON PLUG									470 487	C10	
C 230 4-matic												
Petrol												
		150	07/07-01/14	M 272.911								
ENGINE												
Engine	Information				A10	A20	A40	A50	A70	C10 - C30	C20	E01
All engines	x 6, COIL ON PLUG									470 487	C10	
C 250												
Petrol												
		150	01/07->	M 271.860, M 272.921								
ENGINE												
Engine	Information				A10	A20	A40	A50	A70	C10 - C30	C20	E01
Eng. M 271.860	x 4, COIL ON PLUG									470 420	C10	

A10 CONDENSER	A20 CONTACT SET	A40 DISTRIBUTOR CAP	A50 ROTOR	A70 PICK-UP
C10 COIL	C20 IGNITION MODULE	C30 ELECTRONIC IGNITION KIT	E01 IGNITION CABLE SET	

Vehicle	alim.	kW	Date	Engine	FUNCTIONS ON THE VEHICLE									
					A10	A20	A40	A50	A70	C10 - C30	C20	E01		
C250					ENGINE									
	Petrol	150	01/07->	M 271.860, M 272.921										
Engine	Information				A10	A20	A40	A50	A70	C10 - C30	C20	E01		
Eng. M 272.921	Qty: 6									470 487	C10			
Eng. M 272.921	x 6, COIL ON PLUG									470 487	C10			
C250 4-matic					ENGINE									
	Petrol	150	07/07->	M 272.911										
Engine	Information				A10	A20	A40	A50	A70	C10 - C30	C20	E01		
All engines	Qty: 6									470 487	C10			
C250 CGI					ENGINE									
	Petrol	150	07/09-08/14	M 271.860										
Engine	Information				A10	A20	A40	A50	A70	C10 - C30	C20	E01		
All engines	x 4, COIL ON PLUG									470 420	C10			
C280					ENGINE									
	Petrol	170	01/07-08/14	M 272.947										
Engine	Information				A10	A20	A40	A50	A70	C10 - C30	C20	E01		
All engines	x 6, COIL ON PLUG									470 487	C10			
C280 4-matic					ENGINE									
	Petrol	170	07/07-01/14	M 272.948										
Engine	Information				A10	A20	A40	A50	A70	C10 - C30	C20	E01		
All engines	x 6, COIL ON PLUG									470 487	C10			
C300					ENGINE									
	Petrol	170	08/07-08/14	M 272.947										
Engine	Information				A10	A20	A40	A50	A70	C10 - C30	C20	E01		
All engines	x 6, COIL ON PLUG									470 487	C10			
C300 4-matic					ENGINE									
	Petrol	170	07/07-01/14	M 272.948										
Engine	Information				A10	A20	A40	A50	A70	C10 - C30	C20	E01		
All engines	x 6, COIL ON PLUG									470 487	C10			
C350					ENGINE									
	Petrol	200	01/07-08/14	M 272.961										
Engine	Information				A10	A20	A40	A50	A70	C10 - C30	C20	E01		
All engines	x 6, COIL ON PLUG									470 487	C10			
C350 4-matic					ENGINE									
	Petrol	200	07/07-01/14	M 272.971										
Engine	Information				A10	A20	A40	A50	A70	C10 - C30	C20	E01		
All engines	x 6, COIL ON PLUG									470 487	C10			
CLASSE C IV					ENGINE									
C160					ENGINE									
	Petrol	95	04/15->	M 274.910										
Engine	Information				A10	A20	A40	A50	A70	C10 - C30	C20	E01		
All engines	SA A701, x 4, DELPHI, x 4, without protection hose, COIL ON PLUG, FOR: (TJ)									470 626	C10			
C180					ENGINE									
	Petrol	110	10/18->	M 274.910										
Engine	Information				A10	A20	A40	A50	A70	C10 - C30	C20	E01		
All engines	x 4, DELPHI, without protection hose, COIL ON PLUG, without protection hose, COIL ON PLUG, FOR: (TJ)									470 626	C10			
C180					ENGINE									
	Petrol	115	03/14->	M 274.910										
Engine	Information				A10	A20	A40	A50	A70	C10 - C30	C20	E01		
All engines	MADE BY: (TJ), SA A701, SA A701/784K, x 4, DELPHI, MADE BY: (TJ), x 4, without protection hose, x 4, COIL ON PLUG, without protection hose, COIL ON PLUG, FOR: (TJ), FOR: (TJ)									470 626	C10			
C200					ENGINE									
	Petrol	135	12/13-08/18	M 274.920										
Engine	Information				A10	A20	A40	A50	A70	C10 - C30	C20	E01		
All engines	MADE BY: (TJ), SA A701, x 4, DELPHI, MADE BY: (TJ), without protection hose, x 4, COIL ON PLUG, without protection hose, x 4, COIL ON PLUG, FOR: (TJ), without protection hose, COIL ON PLUG, FOR: (TJ), FOR: (TJ)									470 626	C10			

A10 CONDENSER	A20 CONTACT SET	A40 DISTRIBUTOR CAP	A50 ROTOR	A70 PICK-UP
C10 COIL	C20 IGNITION MODULE	C30 ELECTRONIC IGNITION KIT	E01 IGNITION CABLE SET	

The present application list is a brief version. For the detailed information about the possibility of installation on a specific vehicle, please refer to our web-catalogue <http://catalogo.facet.eu/>

Vehicle	alim.	kW	Date	Engine	FUNCTIONS ON THE VEHICLE							
					A10	A20	A40	A50	A70	C10 - C30	C20	E01

ENGINE				
C200 4-matic	Petrol	135	04/15-08/18	M 274.920

Engine	Information	A10	A20	A40	A50	A70	C10 - C30	C20	E01
All engines	SA A701/784K, x 4, DELPHI, MADE BY: (TJ), without protection hose, COIL ON PLUG, without protection hose, x 4, COIL ON PLUG, FOR: (TJ), without protection hose, COIL ON PLUG, FOR: (TJ)						470 626	C10	

ENGINE				
C250	Petrol	155	03/14-05/18	M 274.920

Engine	Information	A10	A20	A40	A50	A70	C10 - C30	C20	E01
All engines	MADE BY: (TJ), SA A701/784K, x 4, DELPHI, without protection hose, x 4, COIL ON PLUG, without protection hose, COIL ON PLUG, FOR: (TJ), FOR: (TJ)						470 626	C10	

ENGINE				
C300	Petrol	180	09/15-12/18	M 274.920

Engine	Information	A10	A20	A40	A50	A70	C10 - C30	C20	E01
All engines	SA A701/784K, x 4, DELPHI, without protection hose, x 4, COIL ON PLUG, without protection hose, COIL ON PLUG, FOR: (TJ), FOR: (TJ)						470 626	C10	

ENGINE				
C300 4-matic	Petrol	180	12/13-08/18	M 274.920

Engine	Information	A10	A20	A40	A50	A70	C10 - C30	C20	E01
All engines	SA A701/784K, x 4, DELPHI, MADE BY: (TJ), without protection hose, x 4, COIL ON PLUG, without protection hose, COIL ON PLUG, FOR: (TJ)						470 626	C10	

ENGINE				
C300 e	Petrol/ Electric	155	07/19->	M 274.920

Engine	Information	A10	A20	A40	A50	A70	C10 - C30	C20	E01
All engines	x 4, DELPHI, without protection hose, COIL ON PLUG, without protection hose, COIL ON PLUG, FOR: (TJ)						470 626	C10	

ENGINE				
C300 e	Petrol/ Electric	235	07/19->	M 274.920

Engine	Information	A10	A20	A40	A50	A70	C10 - C30	C20	E01
All engines	x 4, DELPHI, without protection hose, COIL ON PLUG, without protection hose, COIL ON PLUG, FOR: (TJ)						470 626	C10	

ENGINE				
C300 e 4-matic	Petrol/ Electric	155	07/19->	M 274.920

Engine	Information	A10	A20	A40	A50	A70	C10 - C30	C20	E01
All engines	x 4, DELPHI, without protection hose, COIL ON PLUG, without protection hose, COIL ON PLUG, FOR: (TJ)						470 626	C10	

ENGINE				
C350 e	Petrol/ Electric	155	02/15-08/18	M 274.920

Engine	Information	A10	A20	A40	A50	A70	C10 - C30	C20	E01
All engines	MADE BY: (TJ), x 4, DELPHI, x 4, without protection hose, COIL ON PLUG, FOR: (TJ)						470 626	C10	

ENGINE				
C350 e	Petrol/ Electric	205	02/15-08/18	M 274.920

Engine	Information	A10	A20	A40	A50	A70	C10 - C30	C20	E01
All engines	MADE BY: (TJ), x 4, DELPHI, x 4, without protection hose, COIL ON PLUG, FOR: (TJ)						470 626	C10	

ENGINE				
AMG CLA 45 4-matic	Petrol	280	07/15-03/19	M 133.980

Engine	Information	A10	A20	A40	A50	A70	C10 - C30	C20	E01
All engines	x 4, DELPHI, without protection hose, COIL ON PLUG						470 626	C10	

ENGINE				
CLA 180	Petrol	90	01/13-03/19	M 270.910

Engine	Information	A10	A20	A40	A50	A70	C10 - C30	C20	E01
All engines	MADE BY: (TJ), x 4, without protection hose, COIL ON PLUG, FOR: (TJ)						470 626	C10	

ENGINE				
CLA 200	Petrol	110	07/18-03/19	M 270.910

Engine	Information	A10	A20	A40	A50	A70	C10 - C30	C20	E01
All engines	x 4, without protection hose, COIL ON PLUG, FOR: (TJ)						470 626	C10	

A10 CONDENSER	A20 CONTACT SET	A40 DISTRIBUTOR CAP	A50 ROTOR	A70 PICK-UP
C10 COIL	C20 IGNITION MODULE	C30 ELECTRONIC IGNITION KIT	E01 IGNITION CABLE SET	

Vehicle	alim.	kW	Date	Engine	FUNCTIONS ON THE VEHICLE									
					A10	A20	A40	A50	A70	C10 - C30	C20	E01		
ENGINE														
CLA 200	Petrol	115	01/13-03/19	M 270.910										
Engine	Information				A10	A20	A40	A50	A70	C10 - C30	C20	E01		
All engines	MADE BY: (TJ), x 4, without protection hose, x 4, COIL ON PLUG, without protection hose, COIL ON PLUG, FOR: (TJ), FOR: (TJ)									470 626	C10			
ENGINE														
CLA 220 4-matic	Petrol	135	01/15->	M 270.910, M 270.920										
Engine	Information				A10	A20	A40	A50	A70	C10 - C30	C20	E01		
Eng. M 270.910	MADE BY: (TJ), Qty: 4									470 626	C10			
Eng. M 270.920	SA A701, x 4, DELPHI, without protection hose, x 4, COIL ON PLUG, without protection hose, COIL ON PLUG, FOR: (TJ), FOR: (TJ)									470 626	C10			
ENGINE														
CLA 250	Petrol	155	01/13-03/19	M 270.920										
Engine	Information				A10	A20	A40	A50	A70	C10 - C30	C20	E01		
All engines	x 4, DELPHI, without protection hose, COIL ON PLUG									470 626	C10			
ENGINE														
CLA 250	Petrol	160	07/15-03/19	M 270.920										
Engine	Information				A10	A20	A40	A50	A70	C10 - C30	C20	E01		
All engines	x 4, DELPHI, without protection hose, COIL ON PLUG									470 626	C10			
ENGINE														
CLA 250 4-matic	Petrol	155	07/13-03/19	M 270.920										
Engine	Information				A10	A20	A40	A50	A70	C10 - C30	C20	E01		
All engines	x 4, DELPHI, without protection hose, COIL ON PLUG									470 626	C10			
ENGINE														
CLA 250 4-matic	Petrol	160	07/15-03/19	M 270.920										
Engine	Information				A10	A20	A40	A50	A70	C10 - C30	C20	E01		
All engines	x 4, DELPHI, without protection hose, COIL ON PLUG									470 626	C10			
ENGINE														
CLA 45 AMG 4-matic	Petrol	265	07/13-03/19	M 133.980										
Engine	Information				A10	A20	A40	A50	A70	C10 - C30	C20	E01		
All engines	x 4, DELPHI, without protection hose, COIL ON PLUG									470 626	C10			
CLASSE CLC														
ENGINE														
CLC 160	Petrol	95	02/09-06/11	M 271.911, M 271.921										
Engine	Information				A10	A20	A40	A50	A70	C10 - C30	C20	E01		
Eng. M 271.911	x 4, COIL ON PLUG									470 420	C10			
Eng. M 271.921	Qty: 4									470 420	C10			
ENGINE														
CLC 180 Kompressor	Petrol	0	05/08-06/11	M 271.940										
Engine	Information				A10	A20	A40	A50	A70	C10 - C30	C20	E01		
All engines	Qty: 4									470 420	C10			
ENGINE														
CLC 180 Kompressor	Petrol	105	05/08-06/11	M 271.946										
Engine	Information				A10	A20	A40	A50	A70	C10 - C30	C20	E01		
All engines	x 4, COIL ON PLUG									470 420	C10			
ENGINE														
CLC 200 Kompressor	Petrol	135	05/08-06/11	M 271.957										
Engine	Information				A10	A20	A40	A50	A70	C10 - C30	C20	E01		
All engines	x 4, COIL ON PLUG									470 420	C10			
ENGINE														
CLC 230	Petrol	150	05/08-06/11	M 272.920										
Engine	Information				A10	A20	A40	A50	A70	C10 - C30	C20	E01		
All engines	x 6, COIL ON PLUG									470 487	C10			
ENGINE														
CLC 250	Petrol	150	06/09-06/11	M 272.920										
Engine	Information				A10	A20	A40	A50	A70	C10 - C30	C20	E01		
All engines	x 6, COIL ON PLUG									470 487	C10			
ENGINE														
CLC 350	Petrol	200	05/08-06/11	M 272.960										
Engine	Information				A10	A20	A40	A50	A70	C10 - C30	C20	E01		
All engines	x 6, COIL ON PLUG									470 487	C10			
ENGINE														
A10	CONDENSER		A20	CONTACT SET		A40	DISTRIBUTOR CAP		A50	ROTOR		A70	PICK-UP	
C10	COIL		C20	IGNITION MODULE		C30	ELECTRONIC IGNITION KIT		E01	IGNITION CABLE SET				

Vehicle	alim.	kW	Date	Engine	FUNCTIONS ON THE VEHICLE							
					A10	A20	A40	A50	A70	C10 - C30	C20	E01

CLASSE CLK I

				ENGINE
200	Petrol	100	06/97-06/02	M 111.945

Engine	Information	A10	A20	A40	A50	A70	C10 - C30	C20	E01
All engines	x 2, SEMI-DIRECT, Dia: 4 mm, connector type, saw teeth						470 316	C10	

				ENGINE
200 Kompressor	Petrol	141	06/97-06/00	M 111.944

Engine	Information	A10	A20	A40	A50	A70	C10 - C30	C20	E01
All engines	x 2, SEMI-DIRECT, Dia: 4 mm, connector type, saw teeth						470 316	C10	

				ENGINE
230 Kompressor	Petrol	142	06/97-06/00	M 111.975

Engine	Information	A10	A20	A40	A50	A70	C10 - C30	C20	E01
All engines	x 2, SEMI-DIRECT, Dia: 4 mm, connector type, saw teeth						470 316	C10	

				ENGINE
320	Petrol	160	06/97-06/02	M 112.940

Engine	Information	A10	A20	A40	A50	A70	C10 - C30	C20	E01
All engines	x 6, COIL ON PLUG						470 417	C10	
All engines									360 649

				ENGINE
430	Petrol	205	07/98-06/02	M 113.943

Engine	Information	A10	A20	A40	A50	A70	C10 - C30	C20	E01
All engines	x 8, COIL ON PLUG						470 417	C10	

				ENGINE
55 AMG	Petrol	255	08/99-12/03	M 113.984

Engine	Information	A10	A20	A40	A50	A70	C10 - C30	C20	E01
All engines	x 8, COIL ON PLUG						470 417	C10	

CLASSE CLK II

				ENGINE
200 CGI	Petrol	125	07/03-05/09	M 271.942

Engine	Information	A10	A20	A40	A50	A70	C10 - C30	C20	E01
All engines	x 4, COIL ON PLUG						470 420	C10	

				ENGINE
200 Kompressor	Petrol	120	09/02-05/09	M 271.940

Engine	Information	A10	A20	A40	A50	A70	C10 - C30	C20	E01
All engines	x 4, COIL ON PLUG						470 420	C10	

				ENGINE
200 Kompressor	Petrol	135	10/06-05/09	M 271.955

Engine	Information	A10	A20	A40	A50	A70	C10 - C30	C20	E01
All engines	x 4, COIL ON PLUG						470 420	C10	

				ENGINE
240	Petrol	120	06/02-05/09	M 112.912

Engine	Information	A10	A20	A40	A50	A70	C10 - C30	C20	E01
All engines	x 6, COIL ON PLUG						470 417	C10	
All engines									360 649

				ENGINE
240	Petrol	125	06/02-05/09	M 112.912

Engine	Information	A10	A20	A40	A50	A70	C10 - C30	C20	E01
All engines	x 6, COIL ON PLUG						470 417	C10	
All engines									360 649

				ENGINE
280	Petrol	170	01/05-05/09	M 272.940

Engine	Information	A10	A20	A40	A50	A70	C10 - C30	C20	E01
All engines	x 6, COIL ON PLUG						470 487	C10	

				ENGINE
320	Petrol	160	06/02-05/09	M 112.955

Engine	Information	A10	A20	A40	A50	A70	C10 - C30	C20	E01
All engines	x 6, COIL ON PLUG						470 417	C10	
All engines									360 649

A10	CONDENSER	A20	CONTACT SET	A40	DISTRIBUTOR CAP	A50	ROTOR	A70	PICK-UP
C10	COIL	C20	IGNITION MODULE	C30	ELECTRONIC IGNITION KIT	E01	IGNITION CABLE SET		

Vehicle	alim.	kW	Date	Engine	FUNCTIONS ON THE VEHICLE									
					A10	A20	A40	A50	A70	C10 - C30	C20	E01		
ENGINE														
350	Petrol	200	01/05-05/09	M 272.960										
ENGINE														
Engine Information					A10	A20	A40	A50	A70	C10 - C30	C20	E01		
All engines x 6, COIL ON PLUG										470 487	C10			
500	Petrol	225	06/02-05/09	M 113.968										
ENGINE														
Engine Information					A10	A20	A40	A50	A70	C10 - C30	C20	E01		
All engines x 8, COIL ON PLUG										470 417	C10			
500	Petrol	285	06/06->	M 273.967										
ENGINE														
Engine Information					A10	A20	A40	A50	A70	C10 - C30	C20	E01		
All engines Qty: 8										470 487	C10			
All engines x 8, COIL ON PLUG										470 487	C10			
55 AMG	Petrol	270	09/02-05/09	M 113.987										
ENGINE														
Engine Information					A10	A20	A40	A50	A70	C10 - C30	C20	E01		
All engines x 8, COIL ON PLUG										470 417	C10			
550	Petrol	285	06/06->	M 273.967										
ENGINE														
Engine Information					A10	A20	A40	A50	A70	C10 - C30	C20	E01		
All engines Qty: 8										470 487	C10			
CLK 200 CGI	Petrol	125	07/03-03/10	M 271.942										
ENGINE														
Engine Information					A10	A20	A40	A50	A70	C10 - C30	C20	E01		
All engines ->eng. 30853899, eng. type 30853900 ->, x 4, COIL ON PLUG										470 420	C10			
CLK 200 Kompressor	Petrol	120	02/03-03/10	M 271.940										
ENGINE														
Engine Information					A10	A20	A40	A50	A70	C10 - C30	C20	E01		
All engines x 4, COIL ON PLUG										470 420	C10			
CLK 200 Kompressor	Petrol	135	10/06-03/10	M 271.955										
ENGINE														
Engine Information					A10	A20	A40	A50	A70	C10 - C30	C20	E01		
All engines x 4, COIL ON PLUG										470 420	C10			
CLK 240	Petrol	125	02/03-03/10	M 112.912										
ENGINE														
Engine Information					A10	A20	A40	A50	A70	C10 - C30	C20	E01		
All engines x 6, COIL ON PLUG										470 417	C10			
All engines													360 649	
CLK 280	Petrol	170	01/05-03/10	M 272.940										
ENGINE														
Engine Information					A10	A20	A40	A50	A70	C10 - C30	C20	E01		
All engines x 6, COIL ON PLUG										470 487	C10			
CLK 320	Petrol	160	02/03-03/10	M 112.955										
ENGINE														
Engine Information					A10	A20	A40	A50	A70	C10 - C30	C20	E01		
All engines x 6, COIL ON PLUG										470 417	C10			
All engines													360 649	
CLK 350	Petrol	200	01/05-03/10	M 272.960										
ENGINE														
Engine Information					A10	A20	A40	A50	A70	C10 - C30	C20	E01		
All engines x 6, COIL ON PLUG										470 487	C10			
CLK 500	Petrol	225	02/03-03/10	M 113.968										
ENGINE														
Engine Information					A10	A20	A40	A50	A70	C10 - C30	C20	E01		
All engines x 8, COIL ON PLUG										470 417	C10			
CLK 500	Petrol	285	06/06-03/10	M 273.967										
ENGINE														
Engine Information					A10	A20	A40	A50	A70	C10 - C30	C20	E01		
All engines x 8, COIL ON PLUG										470 487	C10			

A10 CONDENSER	A20 CONTACT SET	A40 DISTRIBUTOR CAP	A50 ROTOR	A70 PICK-UP
C10 COIL	C20 IGNITION MODULE	C30 ELECTRONIC IGNITION KIT	E01 IGNITION CABLE SET	

The present application list is a brief version. For the detailed information about the possibility of installation on a specific vehicle, please refer to our web-catalogue <http://catalogo.facet.eu/>

Vehicle	alim.	kW	Date	Engine	FUNCTIONS ON THE VEHICLE								
					A10	A20	A40	A50	A70	C10 - C30	C20	E01	
CLASSE CLK													
CLK 55 AMG	Petrol	270	06/02-03/10	ENGINE M 113.987									
Engine	Information				A10	A20	A40	A50	A70	C10 - C30	C20	E01	
All engines	x 8, COIL ON PLUG									470 417	C10		
CLASSE CLS I													
CLS 280	Petrol	170	07/08-12/10	ENGINE M 272.943									
Engine	Information				A10	A20	A40	A50	A70	C10 - C30	C20	E01	
All engines	x 6, COIL ON PLUG									470 487	C10		
CLS 300	Petrol	170	04/09-12/10	ENGINE M 272.943									
Engine	Information				A10	A20	A40	A50	A70	C10 - C30	C20	E01	
All engines	x 6, COIL ON PLUG									470 487	C10		
CLS 350	Petrol	200	10/04-12/10	ENGINE M 272.964									
Engine	Information				A10	A20	A40	A50	A70	C10 - C30	C20	E01	
All engines	x 6, COIL ON PLUG									470 487	C10		
CLS 500	Petrol	225	10/04-12/10	ENGINE M 113.967									
Engine	Information				A10	A20	A40	A50	A70	C10 - C30	C20	E01	
All engines	x 8, COIL ON PLUG									470 417	C10		
CLS 500	Petrol	285	04/06-12/10	ENGINE M 273.960									
Engine	Information				A10	A20	A40	A50	A70	C10 - C30	C20	E01	
All engines	x 8, COIL ON PLUG									470 487	C10		
CLS 55 AMG	Petrol	350	01/05-12/10	ENGINE M 113.990									
Engine	Information				A10	A20	A40	A50	A70	C10 - C30	C20	E01	
All engines	x 8, COIL ON PLUG									470 417	C10		
CLS 550	Petrol	285	04/06-02/11	ENGINE M 273.960									
Engine	Information				A10	A20	A40	A50	A70	C10 - C30	C20	E01	
All engines	Qty: 8									470 487	C10		
CLASSE CLS II													
CLS 250	Petrol	0	05/14->	ENGINE M 274.920									
Engine	Information				A10	A20	A40	A50	A70	C10 - C30	C20	E01	
All engines	Qty: 4, version Delphi									470 626	C10		
CLASSE E													
E 280	Petrol	150	07/99-11/02	ENGINE M 112.921									
Engine	Information				A10	A20	A40	A50	A70	C10 - C30	C20	E01	
All engines	x 6, COIL ON PLUG									470 417	C10		
CLASSE E I													
E 200	Petrol	100	06/93-03/98	ENGINE M 111.940									
Engine	Information				A10	A20	A40	A50	A70	C10 - C30	C20	E01	
All engines	Qty: 2									470 317	C10		
E 200 T	Petrol	100	06/93-06/96	ENGINE M 111.940									
Engine	Information				A10	A20	A40	A50	A70	C10 - C30	C20	E01	
All engines	Qty: 2									470 317	C10		
E 220	Petrol	110	06/93-03/98	ENGINE M 111.960									
Engine	Information				A10	A20	A40	A50	A70	C10 - C30	C20	E01	
All engines	Qty: 2									470 317	C10		
E 220 T	Petrol	110	06/93-06/96	ENGINE M 111.960									
Engine	Information				A10	A20	A40	A50	A70	C10 - C30	C20	E01	
All engines	Qty: 2									470 317	C10		

A10 CONDENSER	A20 CONTACT SET	A40 DISTRIBUTOR CAP	A50 ROTOR	A70 PICK-UP
C10 COIL	C20 IGNITION MODULE	C30 ELECTRONIC IGNITION KIT	E01 IGNITION CABLE SET	

Vehicle	alim.	kW	Date	Engine	FUNCTIONS ON THE VEHICLE								
					A10	A20	A40	A50	A70	C10 - C30	C20	E01	
ENGINE													
E 280	Petrol	142	06/93-06/95	M 104.942									
Engine	Information				A10	A20	A40	A50	A70	C10 - C30	C20	E01	
All engines	Qty: 3, without spark plug connector									470 316	C10		
All engines	incl. spark plug connector, Qty: 3									470 316K	C10		
ENGINE													
E 280	Petrol	145	06/93-06/95	M 104.942									
Engine	Information				A10	A20	A40	A50	A70	C10 - C30	C20	E01	
All engines	Qty: 3, without spark plug connector									470 316	C10		
All engines	incl. spark plug connector, Qty: 3									470 316K	C10		
ENGINE													
E 280 T	Petrol	142	06/93-06/96	M 104.942									
Engine	Information				A10	A20	A40	A50	A70	C10 - C30	C20	E01	
All engines	Qty: 3, without spark plug connector									470 316	C10		
All engines	incl. spark plug connector, Qty: 3									470 316K	C10		
ENGINE													
E 280 T	Petrol	145	06/93-06/96	M 104.942									
Engine	Information				A10	A20	A40	A50	A70	C10 - C30	C20	E01	
All engines	Qty: 3, without spark plug connector									470 316	C10		
All engines	incl. spark plug connector, Qty: 3									470 316K	C10		
ENGINE													
E 300 4-matic	Petrol	132	06/93-06/95	M 103.985									
Engine	Information				A10	A20	A40	A50	A70	C10 - C30	C20	E01	
All engines	version Bosch						806 237	906 125R					
All engines										470 178	C10		360 657
ENGINE													
E 300 T 4-matic	Petrol	132	06/93-06/96	M 103.985									
Engine	Information				A10	A20	A40	A50	A70	C10 - C30	C20	E01	
All engines	version Bosch						806 237	906 125R					
All engines										470 178	C10		360 657
ENGINE													
E 320	Petrol	162	06/93-03/98	M 104.992									
Engine	Information				A10	A20	A40	A50	A70	C10 - C30	C20	E01	
All engines	Qty: 3, without spark plug connector									470 316	C10		
All engines	incl. spark plug connector, Qty: 3									470 316K	C10		
ENGINE													
E 320 T	Petrol	162	06/93-06/96	M 104.992									
Engine	Information				A10	A20	A40	A50	A70	C10 - C30	C20	E01	
All engines	Qty: 3, without spark plug connector									470 316	C10		
All engines	incl. spark plug connector, Qty: 3									470 316K	C10		
ENGINE													
E 36 AMG	Petrol	195	06/93-04/95	M 104.992 (AMG 3.6)									
Engine	Information				A10	A20	A40	A50	A70	C10 - C30	C20	E01	
All engines	Qty: 3, without spark plug connector									470 316	C10		
All engines	incl. spark plug connector, Qty: 3									470 316K	C10		
ENGINE													
E 36 AMG	Petrol	200	05/94-03/98	M 104.992 (AMG 3.6)									
Engine	Information				A10	A20	A40	A50	A70	C10 - C30	C20	E01	
All engines	Qty: 3, without spark plug connector									470 316	C10		
All engines	incl. spark plug connector, Qty: 3									470 316K	C10		
ENGINE													
E 36 T AMG	Petrol	200	05/94-06/96	M 104.992 (AMG 3.6)									
Engine	Information				A10	A20	A40	A50	A70	C10 - C30	C20	E01	
All engines	Qty: 3, without spark plug connector									470 316	C10		
All engines	incl. spark plug connector, Qty: 3									470 316K	C10		
ENGINE													
E 420	Petrol	205	06/93-06/95	M 119.975									
Engine	Information				A10	A20	A40	A50	A70	C10 - C30	C20	E01	
All engines	Qty: 2, version Bosch							906 146R					
All engines	-> ch. B 568955, Qty: 2									470 178	C10		
All engines	ch. B 568956 ->									470 179	C10		

A10 CONDENSER	A20 CONTACT SET	A40 DISTRIBUTOR CAP	A50 ROTOR	A70 PICK-UP
C10 COIL	C20 IGNITION MODULE	C30 ELECTRONIC IGNITION KIT	E01 IGNITION CABLE SET	

Vehicle	alim.	kW	Date	Engine	FUNCTIONS ON THE VEHICLE								
					A10	A20	A40	A50	A70	C10 - C30	C20	E01	
ENGINE													
E 500	Petrol	235	06/93-06/95	M 119.974									
Engine	Information				A10	A20	A40	A50	A70	C10 - C30	C20	E01	
All engines	Qty: 2, version Bosch							906 146R					
All engines	->ch. B 568955, Qty: 2									470 178	C10		
All engines	ch. B 568956 ->									470 179	C10		
ENGINE													
E 60 AMG	Petrol	280	05/94-06/95	M 119.974 (AMG 6.0)									
Engine	Information				A10	A20	A40	A50	A70	C10 - C30	C20	E01	
All engines	Qty: 2, version Bosch							906 146R					
All engines	->ch. B 568955, Qty: 2									470 178	C10		
All engines	ch. B 568956 ->									470 179	C10		
CLASSE E II													
ENGINE													
E 200	Petrol	100	06/95-08/00	M 111.942									
Engine	Information				A10	A20	A40	A50	A70	C10 - C30	C20	E01	
All engines	x 2, SEMI-DIRECT, Dia: 4 mm, connector type, saw teeth									470 316	C10		
ENGINE													
E 200 Kompressor	Petrol	137	06/97-03/02	M 111.947									
Engine	Information				A10	A20	A40	A50	A70	C10 - C30	C20	E01	
All engines	x 2, SEMI-DIRECT, Dia: 4 mm, connector type, saw teeth									470 316	C10		
ENGINE													
E 200 T	Petrol	100	06/96-08/00	M 111.942									
Engine	Information				A10	A20	A40	A50	A70	C10 - C30	C20	E01	
All engines	x 2, SEMI-DIRECT, Dia: 4 mm, connector type, saw teeth									470 316	C10		
ENGINE													
E 200 T Kompressor	Petrol	137	06/97-03/03	M 111.947									
Engine	Information				A10	A20	A40	A50	A70	C10 - C30	C20	E01	
All engines	x 2, SEMI-DIRECT, Dia: 4 mm, connector type, saw teeth									470 316	C10		
ENGINE													
E 230	Petrol	110	06/95-06/97	M 111.970									
Engine	Information				A10	A20	A40	A50	A70	C10 - C30	C20	E01	
All engines	x 2, SEMI-DIRECT, Dia: 4 mm, connector type, saw teeth									470 316	C10		
ENGINE													
E 230 T	Petrol	110	06/96-06/97	M 111.970									
Engine	Information				A10	A20	A40	A50	A70	C10 - C30	C20	E01	
All engines	x 2, SEMI-DIRECT, Dia: 4 mm, connector type, saw teeth									470 316	C10		
ENGINE													
E 240	Petrol	125	06/97-03/02	M 112.911, M 112.914									
Engine	Information				A10	A20	A40	A50	A70	C10 - C30	C20	E01	
All engines	x 6, COIL ON PLUG									470 417	C10		
All engines												360 649	
ENGINE													
E 240 T	Petrol	125	06/97-03/03	M 112.911, M 112.914									
Engine	Information				A10	A20	A40	A50	A70	C10 - C30	C20	E01	
All engines	x 6, COIL ON PLUG									470 417	C10		
All engines												360 649	
ENGINE													
E 280	Petrol	142	01/96-06/97	M 104.945									
Engine	Information				A10	A20	A40	A50	A70	C10 - C30	C20	E01	
All engines	x 3, SEMI-DIRECT, Dia: 4 mm, connector type, saw teeth									470 316	C10		
ENGINE													
E 280	Petrol	150	12/96-03/02	M 112.921									
Engine	Information				A10	A20	A40	A50	A70	C10 - C30	C20	E01	
All engines	x 6, COIL ON PLUG									470 417	C10		
All engines												360 649	
ENGINE													
E 280 4-matic	Petrol	150	12/96-03/02	M 112.921									
Engine	Information				A10	A20	A40	A50	A70	C10 - C30	C20	E01	
All engines	x 6, COIL ON PLUG									470 417	C10		
All engines												360 649	

A10 CONDENSER	A20 CONTACT SET	A40 DISTRIBUTOR CAP	A50 ROTOR	A70 PICK-UP
C10 COIL	C20 IGNITION MODULE	C30 ELECTRONIC IGNITION KIT	E01 IGNITION CABLE SET	

Vehicle	alim.	kW	Date	Engine	FUNCTIONS ON THE VEHICLE									
					A10	A20	A40	A50	A70	C10 - C30	C20	E01		
E 280 T					ENGINE									
	Petrol	150	12/96-03/03	M 112.921										
Engine	Information				A10	A20	A40	A50	A70	C10 - C30	C20	E01		
All engines	x 6, COIL ON PLUG									470 417	C10			
All engines													360 649	
E 280 T 4-matic					ENGINE									
	Petrol	150	12/96-03/03	M 112.921										
Engine	Information				A10	A20	A40	A50	A70	C10 - C30	C20	E01		
All engines	x 6, COIL ON PLUG									470 417	C10			
All engines													360 649	
E 320					ENGINE									
	Petrol	162	06/95-06/97	M 104.995										
Engine	Information				A10	A20	A40	A50	A70	C10 - C30	C20	E01		
All engines	x 3, SEMI-DIRECT, Dia: 4 mm, connector type, saw teeth									470 316	C10			
All engines														
E 320					ENGINE									
	Petrol	165	06/97-03/02	M 112.941										
Engine	Information				A10	A20	A40	A50	A70	C10 - C30	C20	E01		
All engines	x 6, COIL ON PLUG									470 417	C10			
All engines													360 649	
E 320 4-matic					ENGINE									
	Petrol	165	06/97-03/02	M 112.941										
Engine	Information				A10	A20	A40	A50	A70	C10 - C30	C20	E01		
All engines	x 6, COIL ON PLUG									470 417	C10			
All engines													360 649	
E 320 T					ENGINE									
	Petrol	165	12/96-03/03	M 112.941										
Engine	Information				A10	A20	A40	A50	A70	C10 - C30	C20	E01		
All engines	x 6, COIL ON PLUG									470 417	C10			
All engines													360 649	
E 320 T 4-matic					ENGINE									
	Petrol	165	12/96-03/03	M 112.941										
Engine	Information				A10	A20	A40	A50	A70	C10 - C30	C20	E01		
All engines	x 6, COIL ON PLUG									470 417	C10			
All engines													360 649	
E 36 AMG					ENGINE									
	Petrol	200	04/96-01/98	M 104995AMG										
Engine	Information				A10	A20	A40	A50	A70	C10 - C30	C20	E01		
All engines	x 3, SEMI-DIRECT, Dia: 4 mm, connector type, saw teeth									470 316	C10			
All engines														
E 430					ENGINE									
	Petrol	205	06/97-03/02	M 113.940										
Engine	Information				A10	A20	A40	A50	A70	C10 - C30	C20	E01		
All engines	x 8, COIL ON PLUG									470 417	C10			
All engines														
E 430 4-matic					ENGINE									
	Petrol	205	05/99-03/02	M 113.940										
Engine	Information				A10	A20	A40	A50	A70	C10 - C30	C20	E01		
All engines	x 8, COIL ON PLUG									470 417	C10			
All engines														
E 430 T					ENGINE									
	Petrol	205	06/97-03/03	M 113.940										
Engine	Information				A10	A20	A40	A50	A70	C10 - C30	C20	E01		
All engines	x 8, COIL ON PLUG									470 417	C10			
All engines														
E 430 T 4-matic					ENGINE									
	Petrol	205	05/99-03/03	M 113.940										
Engine	Information				A10	A20	A40	A50	A70	C10 - C30	C20	E01		
All engines	x 8, COIL ON PLUG									470 417	C10			
All engines														
E 55 AMG					ENGINE									
	Petrol	260	08/97-03/02	M 113.980										
Engine	Information				A10	A20	A40	A50	A70	C10 - C30	C20	E01		
All engines	x 8, COIL ON PLUG									470 417	C10			
All engines														

A10	CONDENSER	A20	CONTACT SET	A40	DISTRIBUTOR CAP	A50	ROTOR	A70	PICK-UP
C10	COIL	C20	IGNITION MODULE	C30	ELECTRONIC IGNITION KIT	E01	IGNITION CABLE SET		

The present application list is a brief version. For the detailed information about the possibility of installation on a specific vehicle, please refer to our web-catalogue <http://catalogo.facet.eu/>

					FUNCTIONS ON THE VEHICLE							
Vehicle	alim.	kW	Date	Engine	A10	A20	A40	A50	A70	C10 - C30	C20	E01
CLASSE E III												
E 55 T AMG												
	Petrol	260	08/97-03/03	ENGINE M 113.980								
Engine	Information				A10	A20	A40	A50	A70	C10 - C30	C20	E01
All engines	x 8, COIL ON PLUG									470 417	C10	
CLASSE E III												
350 CGI												
	Petrol	215	05/06-07/09	ENGINE M 272.985								
Engine	Information				A10	A20	A40	A50	A70	C10 - C30	C20	E01
All engines	->year 01/09/06, x 6, COIL ON PLUG									470 487	C10	
E 200 Kompressor												
	Petrol	120	11/02-12/08	ENGINE M 271.941								
Engine	Information				A10	A20	A40	A50	A70	C10 - C30	C20	E01
All engines	x 4, COIL ON PLUG									470 420	C10	
E 200 Kompressor												
	Petrol	135	04/06-07/09	ENGINE M 271.956								
Engine	Information				A10	A20	A40	A50	A70	C10 - C30	C20	E01
All engines	->eng. 30853899, x 4, COIL ON PLUG									470 420	C10	
E 200 NGT												
	Petrol/ Compressed Natural Gas (CNG)	120	03/04-12/08	ENGINE M 271.941, M 271941NGT								
Engine	Information				A10	A20	A40	A50	A70	C10 - C30	C20	E01
Eng. M 271.941	Qty: 4									470 420	C10	
Eng. M 271941NGT	->eng. 30853899, x 4, COIL ON PLUG									470 420	C10	
E 200 T Kompressor												
	Petrol	120	03/03-07/09	ENGINE M 271.941								
Engine	Information				A10	A20	A40	A50	A70	C10 - C30	C20	E01
All engines	x 4, COIL ON PLUG									470 420	C10	
E 230												
	Petrol	150	09/07-12/08	ENGINE M 272.922								
Engine	Information				A10	A20	A40	A50	A70	C10 - C30	C20	E01
All engines	x 6, COIL ON PLUG									470 487	C10	
E 230 T												
	Petrol	150	05/07-07/09	ENGINE M 272.922								
Engine	Information				A10	A20	A40	A50	A70	C10 - C30	C20	E01
All engines	x 6, COIL ON PLUG									470 487	C10	
E 240												
	Petrol	130	03/02-12/08	ENGINE M 112.913								
Engine	Information				A10	A20	A40	A50	A70	C10 - C30	C20	E01
All engines	x 6, COIL ON PLUG									470 417	C10	
All engines												360 649
E 240 4-matic												
	Petrol	130	03/03-12/08	ENGINE M 112.917								
Engine	Information				A10	A20	A40	A50	A70	C10 - C30	C20	E01
All engines	x 6, COIL ON PLUG									470 417	C10	
All engines												360 649
E 240 T												
	Petrol	130	03/03-07/09	ENGINE M 112.913								
Engine	Information				A10	A20	A40	A50	A70	C10 - C30	C20	E01
All engines	x 6, COIL ON PLUG									470 417	C10	
All engines												360 649
E 240 T 4-matic												
	Petrol	130	07/03-07/09	ENGINE M 112.917								
Engine	Information				A10	A20	A40	A50	A70	C10 - C30	C20	E01
All engines	x 6, COIL ON PLUG									470 417	C10	
All engines												360 649
E 250												
	Petrol	150	09/07-12/08	ENGINE M 272.922								
Engine	Information				A10	A20	A40	A50	A70	C10 - C30	C20	E01
All engines	Qty: 6									470 487	C10	

A10 CONDENSER	A20 CONTACT SET	A40 DISTRIBUTOR CAP	A50 ROTOR	A70 PICK-UP
C10 COIL	C20 IGNITION MODULE	C30 ELECTRONIC IGNITION KIT	E01 IGNITION CABLE SET	

Vehicle	alim.	kW	Date	Engine	FUNCTIONS ON THE VEHICLE									
					A10	A20	A40	A50	A70	C10 - C30	C20	E01		
E 280					ENGINE									
	Petrol	170	03/05-12/08	M 272.943										
Engine	Information				A10	A20	A40	A50	A70	C10 - C30	C20	E01		
All engines	x 6, COIL ON PLUG									470 487	C10			
E 280 4-matic					ENGINE									
	Petrol	170	03/05-12/08	9930.61, M 272944										
Engine	Information				A10	A20	A40	A50	A70	C10 - C30	C20	E01		
Eng. 9930.61	Qty: 6									470 487	C10			
Eng. M 272944	x 6, COIL ON PLUG									470 487	C10			
E 280 T					ENGINE									
	Petrol	170	03/05-07/09	M 272.943										
Engine	Information				A10	A20	A40	A50	A70	C10 - C30	C20	E01		
All engines	x 6, COIL ON PLUG									470 487	C10			
E 280 T 4-matic					ENGINE									
	Petrol	170	03/05-07/09	9930.61, M 272944										
Engine	Information				A10	A20	A40	A50	A70	C10 - C30	C20	E01		
Eng. 9930.61	Qty: 6									470 487	C10			
Eng. M 272944	x 6, COIL ON PLUG									470 487	C10			
E 300					ENGINE									
	Petrol	170	03/05-12/08	M 272.943										
Engine	Information				A10	A20	A40	A50	A70	C10 - C30	C20	E01		
All engines	Qty: 6									470 487	C10			
E 300 T 4-matic					ENGINE									
	Petrol	170	03/05-07/09	9930.61										
Engine	Information				A10	A20	A40	A50	A70	C10 - C30	C20	E01		
All engines	Qty: 6									470 487	C10			
E 320					ENGINE									
	Petrol	165	03/02-12/08	M 112.949										
Engine	Information				A10	A20	A40	A50	A70	C10 - C30	C20	E01		
All engines	x 6, COIL ON PLUG									470 417	C10			
All engines													360 649	
E 320 4-matic					ENGINE									
	Petrol	165	03/03-12/08	M 112.954										
Engine	Information				A10	A20	A40	A50	A70	C10 - C30	C20	E01		
All engines	x 6, COIL ON PLUG									470 417	C10			
All engines													360 649	
E 320 T					ENGINE									
	Petrol	165	03/03-07/09	M 112.949										
Engine	Information				A10	A20	A40	A50	A70	C10 - C30	C20	E01		
All engines	x 6, COIL ON PLUG									470 417	C10			
All engines													360 649	
E 320 T 4-matic					ENGINE									
	Petrol	165	07/03-07/09	M 112.954										
Engine	Information				A10	A20	A40	A50	A70	C10 - C30	C20	E01		
All engines	x 6, COIL ON PLUG									470 417	C10			
All engines													360 649	
E 350					ENGINE									
	Petrol	200	03/05-12/08	M 272.964										
Engine	Information				A10	A20	A40	A50	A70	C10 - C30	C20	E01		
All engines	x 6, COIL ON PLUG									470 487	C10			
E 350 4-matic					ENGINE									
	Petrol	200	03/05-12/08	M 272.972										
Engine	Information				A10	A20	A40	A50	A70	C10 - C30	C20	E01		
All engines	x 6, COIL ON PLUG									470 487	C10			
E 350 4-matic					ENGINE									
	Petrol	205	08/04-08/06	M 272.972										
Engine	Information				A10	A20	A40	A50	A70	C10 - C30	C20	E01		
All engines	Qty: 6									470 487	C10			

A10 CONDENSER	A20 CONTACT SET	A40 DISTRIBUTOR CAP	A50 ROTOR	A70 PICK-UP
C10 COIL	C20 IGNITION MODULE	C30 ELECTRONIC IGNITION KIT	E01 IGNITION CABLE SET	

The present application list is a brief version. For the detailed information about the possibility of installation on a specific vehicle, please refer to our web-catalogue <http://catalogo.facet.eu/>

Vehicle	alim.	kW	Date	Engine	FUNCTIONS ON THE VEHICLE									
					A10	A20	A40	A50	A70	C10 - C30	C20	E01		
ENGINE														
E 350 CGI	Petrol	215	09/07-12/08	M 272.985										
Engine	Information				A10	A20	A40	A50	A70	C10 - C30	C20	E01		
All engines	->year 01/09/06, ->eng. 30417696, x6, COIL ON PLUG									470 487	C10			
ENGINE														
E 350 T	Petrol	200	03/05-07/09	M 272.964										
Engine	Information				A10	A20	A40	A50	A70	C10 - C30	C20	E01		
All engines	x 6, COIL ON PLUG									470 487	C10			
ENGINE														
E 350 T 4-matic	Petrol	200	03/05-07/09	M 272.972										
Engine	Information				A10	A20	A40	A50	A70	C10 - C30	C20	E01		
All engines	x 6, COIL ON PLUG									470 487	C10			
ENGINE														
E 500	Petrol	225	03/02-12/08	M 113.967										
Engine	Information				A10	A20	A40	A50	A70	C10 - C30	C20	E01		
All engines	x 8, COIL ON PLUG									470 417	C10			
ENGINE														
E 500	Petrol	285	04/06-12/08	M 273.960										
Engine	Information				A10	A20	A40	A50	A70	C10 - C30	C20	E01		
All engines	x 8, COIL ON PLUG									470 487	C10			
ENGINE														
E 500 4-matic	Petrol	225	10/03-12/08	M 113.969										
Engine	Information				A10	A20	A40	A50	A70	C10 - C30	C20	E01		
All engines	x 8, COIL ON PLUG									470 417	C10			
ENGINE														
E 500 4-matic	Petrol	285	04/06-12/08	M 273.962										
Engine	Information				A10	A20	A40	A50	A70	C10 - C30	C20	E01		
All engines	x 8, COIL ON PLUG									470 487	C10			
ENGINE														
E 500 T	Petrol	225	10/03-07/09	M 113.967										
Engine	Information				A10	A20	A40	A50	A70	C10 - C30	C20	E01		
All engines	x 8, COIL ON PLUG									470 417	C10			
ENGINE														
E 500 T	Petrol	285	04/06-07/09	M 273.960										
Engine	Information				A10	A20	A40	A50	A70	C10 - C30	C20	E01		
All engines	x 8, COIL ON PLUG									470 487	C10			
ENGINE														
E 500 T 4-matic	Petrol	225	10/03-07/09	M 113.969										
Engine	Information				A10	A20	A40	A50	A70	C10 - C30	C20	E01		
All engines	x 8, COIL ON PLUG									470 417	C10			
ENGINE														
E 500 T 4-matic	Petrol	285	04/06-07/09	M 273.962										
Engine	Information				A10	A20	A40	A50	A70	C10 - C30	C20	E01		
All engines	x 8, COIL ON PLUG									470 487	C10			
ENGINE														
E 55 AMG Kompressor	Petrol	350	10/02-12/08	M 113.990										
Engine	Information				A10	A20	A40	A50	A70	C10 - C30	C20	E01		
All engines	x 8, COIL ON PLUG									470 417	C10			
ENGINE														
E 55 T AMG Kompressor	Petrol	350	07/03-07/09	M 113.990										
Engine	Information				A10	A20	A40	A50	A70	C10 - C30	C20	E01		
All engines	x 8, COIL ON PLUG									470 417	C10			
ENGINE														
E 550 4-matic	Petrol	285	04/06-12/08	M 273.962										
Engine	Information				A10	A20	A40	A50	A70	C10 - C30	C20	E01		
All engines	Qty: 8									470 487	C10			
ENGINE														
E 550 T 4-matic	Petrol	285	04/06-07/09	M 273.962										
Engine	Information				A10	A20	A40	A50	A70	C10 - C30	C20	E01		
All engines	Qty: 8									470 487	C10			
ENGINE														
A10	CONDENSER		A20	CONTACT SET		A40	DISTRIBUTOR CAP		A50	ROTOR		A70	PICK-UP	
C10	COIL		C20	IGNITION MODULE		C30	ELECTRONIC IGNITION KIT		E01	IGNITION CABLE SET				

Vehicle	alim.	kW	Date	Engine	FUNCTIONS ON THE VEHICLE							
					A10	A20	A40	A50	A70	C10 - C30	C20	E01

CLASSE E IV

				ENGINE
E 180	Petrol	115	12/12->	M 274.910

Engine	Information	A10	A20	A40	A50	A70	C10 - C30	C20	E01
All engines	MADE BY: (TJ), x 4, DELPHI, x 4, without protection hose, COIL ON PLUG, FOR: (TJ)						470 626	C10	
All engines	Qty: 4						470 626	C10	

				ENGINE
E 200	Petrol	135	11/12-12/16	M 274.920

Engine	Information	A10	A20	A40	A50	A70	C10 - C30	C20	E01
All engines	MADE BY: (TJ), MADE BY: (USA), x 4, DELPHI, x 4, without protection hose, COIL ON PLUG, FOR: (TJ)						470 626	C10	

				ENGINE
E 200 CGI	Petrol	135	08/09-12/16	M 271.820, M 271.860

Engine	Information	A10	A20	A40	A50	A70	C10 - C30	C20	E01
All engines	x 4, COIL ON PLUG						470 420	C10	

				ENGINE
E 200 NGT	Petrol/ Com- pressed Natural Gas (CNG)	115	07/13-12/15	M 274.920, M 274920NGT

Engine	Information	A10	A20	A40	A50	A70	C10 - C30	C20	E01
Eng. M 274.920	Qty: 4						470 626	C10	
Eng. M 274920NGT	MADE BY: (TJ), x 4, DELPHI, x 4, without protection hose, COIL ON PLUG, FOR: (TJ)						470 626	C10	

				ENGINE
E 200 NGT	Petrol/ Com- pressed Natural Gas (CNG)	120	03/11-12/15	M 271.958, M 271958NGT

Engine	Information	A10	A20	A40	A50	A70	C10 - C30	C20	E01
Eng. M 271.958	Qty: 4						470 420	C10	
Eng. M 271958NGT	x 4, COIL ON PLUG						470 420	C10	

				ENGINE
E 250	Petrol	150	01/10->	M 272.923

Engine	Information	A10	A20	A40	A50	A70	C10 - C30	C20	E01
All engines	Qty: 6						470 487	C10	

				ENGINE
E 250	Petrol	155	11/12-12/16	M 274.920

Engine	Information	A10	A20	A40	A50	A70	C10 - C30	C20	E01
All engines	MADE BY: (TJ), x 4, DELPHI, x 4, without protection hose, COIL ON PLUG, FOR: (TJ)						470 626	C10	

				ENGINE
E 250 CGI	Petrol	150	01/09-12/16	M 271.860

Engine	Information	A10	A20	A40	A50	A70	C10 - C30	C20	E01
All engines	x 4, COIL ON PLUG						470 420	C10	

				ENGINE
E 300	Petrol	170	01/09-12/13	M 272.952

Engine	Information	A10	A20	A40	A50	A70	C10 - C30	C20	E01
All engines	x 6, COIL ON PLUG						470 487	C10	

				ENGINE
E 300	Petrol	200	01/10->	M 272.980

Engine	Information	A10	A20	A40	A50	A70	C10 - C30	C20	E01
All engines	Qty: 6						470 487	C10	









				ENGINE
E 350	Petrol	200	01/09->	M 272.961, M 272.980, M 272.988

Engine	Information	A10	A20	A40	A50	A70	C10 - C30	C20	E01
All engines	x 6, COIL ON PLUG						470 487	C10	
Eng. M 272.961	Qty: 6						470 487	C10	

				ENGINE
E 350 4-matic	Petrol	200	01/09-12/11	M 272.977

Engine	Information	A10	A20	A40	A50	A70	C10 - C30	C20	E01
All engines	x 6, COIL ON PLUG						470 487	C10	

A10 CONDENSER	A20 CONTACT SET	A40 DISTRIBUTOR CAP	A50 ROTOR	A70 PICK-UP
C10 COIL	C20 IGNITION MODULE	C30 ELECTRONIC IGNITION KIT	E01 IGNITION CABLE SET	

					FUNCTIONS ON THE VEHICLE							
Vehicle	alim.	kW	Date	Engine	 A10	 A20	 A40	 A50	 A70	 C10 - C30	 C20	 E01
ENGINE												
E 500	Petrol	285	01/09-12/16	M 273.966, M 273.971								
ENGINE												
Engine		Information			A10	A20	A40	A50	A70	C10 - C30	C20	E01
All engines		x 8, COIL ON PLUG								470 487	C10	
ENGINE												
E 500 4-matic	Petrol	285	01/09-12/11	M 273.970								
ENGINE												
Engine		Information			A10	A20	A40	A50	A70	C10 - C30	C20	E01
All engines		x 8, COIL ON PLUG								470 487	C10	
ENGINE												
E 550 [USA]	Petrol	295	01/09->	M 273.966								
ENGINE												
Engine		Information			A10	A20	A40	A50	A70	C10 - C30	C20	E01
All engines		Qty: 8								470 487	C10	
ENGINE												
E 550 [USA] [CAN] [JPN]	Petrol	295	01/09->	M 273.971								
ENGINE												
Engine		Information			A10	A20	A40	A50	A70	C10 - C30	C20	E01
All engines		Qty: 8								470 487	C10	
ENGINE												
E 550 4-matic [USA] [CAN]	Petrol	295	01/09->	M 273.970								
ENGINE												
Engine		Information			A10	A20	A40	A50	A70	C10 - C30	C20	E01
All engines		Qty: 8								470 487	C10	
CLASSE E V												
ENGINE												
E 180	Petrol	115	01/17->	M 274.910								
ENGINE												
Engine		Information			A10	A20	A40	A50	A70	C10 - C30	C20	E01
All engines		->year 01/06/21, x 4, DELPHI, x 4, without protection hose, COIL ON PLUG, FOR: (TJ)								470 626	C10	
ENGINE												
E 200	Petrol	135	01/16->	M 274.920								
ENGINE												
Engine		Information			A10	A20	A40	A50	A70	C10 - C30	C20	E01
All engines		SA A701/784K, x 4, DELPHI, without protection hose, x 4, COIL ON PLUG, without protection hose, COIL ON PLUG, FOR: (TJ), FOR: (TJ)								470 626	C10	
ENGINE												
E 200 4-matic	Petrol	135	07/16->	M 274.920								
ENGINE												
Engine		Information			A10	A20	A40	A50	A70	C10 - C30	C20	E01
All engines		x 4, DELPHI, without protection hose, COIL ON PLUG, without protection hose, COIL ON PLUG, FOR: (TJ)								470 626	C10	
ENGINE												
E 250	Petrol	155	07/16->	M 274.920								
ENGINE												
Engine		Information			A10	A20	A40	A50	A70	C10 - C30	C20	E01
All engines		SA A701/784K, x 4, DELPHI, x 4, without protection hose, COIL ON PLUG, FOR: (TJ)								470 626	C10	
ENGINE												
E 300	Petrol	180	07/16->	M 274.920								
ENGINE												
Engine		Information			A10	A20	A40	A50	A70	C10 - C30	C20	E01
All engines		x 4, DELPHI, without protection hose, COIL ON PLUG, without protection hose, COIL ON PLUG, FOR: (TJ)								470 626	C10	
ENGINE												
E 300 e	Petrol/ Electric	155	11/18->	M 274.920								
ENGINE												
Engine		Information			A10	A20	A40	A50	A70	C10 - C30	C20	E01
All engines		x 4, DELPHI, without protection hose, COIL ON PLUG, without protection hose, COIL ON PLUG, FOR: (TJ)								470 626	C10	
ENGINE												
E 300 e	Petrol/ Electric	235	11/18->	M 274.920								
ENGINE												
Engine		Information			A10	A20	A40	A50	A70	C10 - C30	C20	E01
All engines		x 4, DELPHI, without protection hose, COIL ON PLUG, without protection hose, COIL ON PLUG, FOR: (TJ)								470 626	C10	
ENGINE												
E 300 e 4-matic	Petrol/ Electric	155	07/20->	M 274.920								
ENGINE												
Engine		Information			A10	A20	A40	A50	A70	C10 - C30	C20	E01
All engines		x 4, DELPHI, without protection hose, COIL ON PLUG, without protection hose, COIL ON PLUG, FOR: (TJ)								470 626	C10	
A10	CONDENSER	A20	CONTACT SET	A40	DISTRIBUTOR CAP	A50	ROTOR	A70	PICK-UP			
C10	COIL	C20	IGNITION MODULE	C30	ELECTRONIC IGNITION KIT	E01	IGNITION CABLE SET					

Vehicle	alim.	kW	Date	Engine	FUNCTIONS ON THE VEHICLE									
					A10	A20	A40	A50	A70	C10 - C30	C20	E01		
ENGINE														
E 300 e 4-matic	Petrol/ Electric	235	07/20->	M 274.920										
Engine	Information			A10	A20	A40	A50	A70	C10 - C30	C20	E01			
All engines	x 4, DELPHI, without protection hose, COIL ON PLUG, without protection hose, COIL ON PLUG, FOR: (TJ)								470 626	C10				
ENGINE														
E 350 e	Petrol/ Electric	155	07/16->	M 274.920										
Engine	Information			A10	A20	A40	A50	A70	C10 - C30	C20	E01			
All engines	x 4, DELPHI, without protection hose, COIL ON PLUG, without protection hose, COIL ON PLUG, FOR: (TJ)								470 626	C10				
ENGINE														
E 350 e	Petrol/ Electric	210	07/16->	M 274.920										
Engine	Information			A10	A20	A40	A50	A70	C10 - C30	C20	E01			
All engines	x 4, DELPHI, without protection hose, COIL ON PLUG, without protection hose, COIL ON PLUG, FOR: (TJ)								470 626	C10				
ENGINE														
E 350 e	Petrol/ Electric	235	11/19->	M 274.920										
Engine	Information			A10	A20	A40	A50	A70	C10 - C30	C20	E01			
All engines	x 4, DELPHI, without protection hose, COIL ON PLUG, without protection hose, COIL ON PLUG, FOR: (TJ)								470 626	C10				
CLASSE G I														
ENGINE														
200 GE	Petrol	80	02/80-08/92	M 102.964										
Engine	Information			A10	A20	A40	A50	A70	C10 - C30	C20	E01			
All engines	version Bosch					806 108	906 055R							
All engines									470 180	C10	360 654			
ENGINE														
230 G	Petrol	66	03/79-07/93	M 115.973										
Engine	Information			A10	A20	A40	A50	A70	C10 - C30	C20	E01			
All engines	version Bosch				706 034HVS	806 108								
ENGINE														
230 G	Petrol	75	02/80-07/87	M 115.973										
Engine	Information			A10	A20	A40	A50	A70	C10 - C30	C20	E01			
All engines	version Bosch				706 034HVS	806 108								
ENGINE														
230 GE	Petrol	90	05/87-08/92	M 102.987										
Engine	Information			A10	A20	A40	A50	A70	C10 - C30	C20	E01			
All engines	version Bosch					806 108	906 055R							
All engines									470 180	C10	360 654			
ENGINE														
230 GE	Petrol	92	04/82-08/92	M 102.981, M 102.987										
Engine	Information			A10	A20	A40	A50	A70	C10 - C30	C20	E01			
All engines	version Bosch					806 108	906 055R							
All engines									470 180	C10	360 654			
ENGINE														
280 GE	Petrol	110	08/84-08/89	M 110.994										
Engine	Information			A10	A20	A40	A50	A70	C10 - C30	C20	E01			
All engines	version Bosch				706 034HVS									
All engines	->eng. 004203, 001498, version Bosch					806 092								
All engines	eng. type 004204, 001499 ->, version Bosch					806 123	906 060R							
All engines	eng. type 002294, 000115 ->, ->eng. 004203, 001498, version Bosch						906 024R							
All engines	->eng. 002293, 000114, version Bosch						906 034R							
All engines	ch. 034825, 901172 ->								470 180	C10				
ENGINE														
280 GE	Petrol	115	11/79-08/89	M 110.994										
Engine	Information			A10	A20	A40	A50	A70	C10 - C30	C20	E01			
All engines	version Bosch				706 034HVS									
All engines	->eng. 004203, 001498, version Bosch					806 092								
All engines	eng. type 004204, 001499 ->, version Bosch					806 123	906 060R							
All engines	eng. type 002294, 000115 ->, ->eng. 004203, 001498, version Bosch						906 024R							
All engines	->eng. 002293, 000114, version Bosch						906 034R							
ENGINE														
A10	CONDENSER		A20	CONTACT SET		A40	DISTRIBUTOR CAP		A50	ROTOR		A70	PICK-UP	
C10	COIL		C20	IGNITION MODULE		C30	ELECTRONIC IGNITION KIT		E01	IGNITION CABLE SET				

					FUNCTIONS ON THE VEHICLE							
Vehicle	alim.	kW	Date	Engine	A10	A20	A40	A50	A70	C10 - C30	C20	E01
ENGINE												
280 GE	Petrol	115	11/79-08/89	M 110.994								
ENGINE												
Engine	Information				A10	A20	A40	A50	A70	C10 - C30	C20	E01
All engines	ch. 034825, 901172 ->									470 180	C10	
CLASSE G II												
ENGINE												
200 GE	Petrol	80	01/90-07/93	M 102.965								
ENGINE												
Engine	Information				A10	A20	A40	A50	A70	C10 - C30	C20	E01
All engines	version Bosch						806 234	906 121R				
All engines										470 178	C10	
ENGINE												
200 GE	Petrol	85	01/90-07/93	M 102.965								
ENGINE												
Engine	Information				A10	A20	A40	A50	A70	C10 - C30	C20	E01
All engines	version Bosch						806 234	906 121R				
All engines										470 178	C10	
ENGINE												
230 G	Petrol	74	04/92->	M 102.958								
ENGINE												
Engine	Information				A10	A20	A40	A50	A70	C10 - C30	C20	E01
All engines	version Bosch						806 234	906 055R				
ENGINE												
230 GE	Petrol	90	09/89-07/96	M 102.979								
ENGINE												
Engine	Information				A10	A20	A40	A50	A70	C10 - C30	C20	E01
All engines	version Bosch						806 234	906 121R				
All engines										470 178	C10	
ENGINE												
230 GE	Petrol	92	04/92->	M 102.981, M 102.996, M 102.997								
ENGINE												
Engine	Information				A10	A20	A40	A50	A70	C10 - C30	C20	E01
Eng. M 102.981	version Bosch						806 108					
Eng. M 102.996, M 102.997	version Bosch						806 234					
All engines	version Bosch							906 055R				
Eng. M 102.996, M 102.997										470 178	C10	
Eng. M 102.981												360 654
ENGINE												
230 GE	Petrol	93	06/90-06/93	M 102.989								
ENGINE												
Engine	Information				A10	A20	A40	A50	A70	C10 - C30	C20	E01
All engines	version Bosch						806 234	906 121R				
All engines										470 178	C10	
ENGINE												
280 GE	Petrol	110	04/92->	M 110.994								
ENGINE												
Engine	Information				A10	A20	A40	A50	A70	C10 - C30	C20	E01
All engines	->eng. 004203, 001498, version Bosch						806 092					
All engines	eng. type 004204, 001499 ->, version Bosch						806 123	906 060R				
All engines	eng. type 002294, 000115 ->, ->eng. 004203, 001498, version Bosch							906 024R				
All engines	->eng. 002293, 000114, version Bosch							906 034R				
ENGINE												
300 GE	Petrol	125	09/89-09/97	M 103.987								
ENGINE												
Engine	Information				A10	A20	A40	A50	A70	C10 - C30	C20	E01
All engines	version Bosch						806 237	906 125R				
All engines										470 178	C10	360 657
ENGINE												
300 GE	Petrol	128	06/90-08/97	M 103.987								
ENGINE												
Engine	Information				A10	A20	A40	A50	A70	C10 - C30	C20	E01
All engines	version Bosch						806 237	906 125R				
All engines										470 178	C10	360 657
ENGINE												
320 GE	Petrol	155	09/94-11/97	M 104.996								
ENGINE												
Engine	Information				A10	A20	A40	A50	A70	C10 - C30	C20	E01
All engines	Qty: 3, without spark plug connector									470 316	C10	
All engines	incl. spark plug connector, Qty: 3									470 316K	C10	

A10 CONDENSER	A20 CONTACT SET	A40 DISTRIBUTOR CAP	A50 ROTOR	A70 PICK-UP
C10 COIL	C20 IGNITION MODULE	C30 ELECTRONIC IGNITION KIT	E01 IGNITION CABLE SET	

Vehicle	alim.	kW	Date	Engine	FUNCTIONS ON THE VEHICLE									
					A10	A20	A40	A50	A70	C10 - C30	C20	E01		
ENGINE														
500 GE	Petrol	177	09/93-12/94	M 117.965										
Engine	Information				A10	A20	A40	A50	A70	C10 - C30	C20	E01		
All engines	version Bosch						806 239	906 126R						
All engines										470 179	C10			
ENGINE														
G 320	Petrol	154	06/97-11/97	M 112.945										
Engine	Information				A10	A20	A40	A50	A70	C10 - C30	C20	E01		
All engines	Qty: 6									470 417	C10			
All engines													360 649	
ENGINE														
G 320	Petrol	155	09/94-12/97	M 104.996										
Engine	Information				A10	A20	A40	A50	A70	C10 - C30	C20	E01		
All engines	Qty: 3, without spark plug connector									470 316	C10			
All engines	incl. spark plug connector, Qty: 3									470 316K	C10			
ENGINE														
G 320	Petrol	158	07/97-08/04	M 112.945										
Engine	Information				A10	A20	A40	A50	A70	C10 - C30	C20	E01		
All engines	Qty: 6									470 417	C10			
All engines													360 649	
ENGINE														
G 36 AMG	Petrol	200	01/95-07/98	M 104.996 (AMG 3.6)										
Engine	Information				A10	A20	A40	A50	A70	C10 - C30	C20	E01		
All engines	Qty: 3, without spark plug connector									470 316	C10			
All engines	incl. spark plug connector, Qty: 3									470 316K	C10			
ENGINE														
G 500	Petrol	218	04/98->	M 113.962										
Engine	Information				A10	A20	A40	A50	A70	C10 - C30	C20	E01		
All engines	Qty: 8									470 417	C10			
ENGINE														
G 500	Petrol	285	01/07->	M 273.963, M 273.969										
Engine	Information				A10	A20	A40	A50	A70	C10 - C30	C20	E01		
All engines	Qty: 8									470 487	C10			
ENGINE														
G 500 GUARD	Petrol	0	06/10->	M 273.963										
Engine	Information				A10	A20	A40	A50	A70	C10 - C30	C20	E01		
All engines	Qty: 8									470 487	C10			
ENGINE														
G 55 AMG	Petrol	218	04/98->	M 113.962										
Engine	Information				A10	A20	A40	A50	A70	C10 - C30	C20	E01		
All engines	Qty: 8									470 417	C10			
ENGINE														
G 55 AMG	Petrol	260	04/99->	M 113.982										
Engine	Information				A10	A20	A40	A50	A70	C10 - C30	C20	E01		
All engines	Qty: 8									470 417	C10			
ENGINE														
G 55 AMG	Petrol	350	06/04->	M 113.993										
Engine	Information				A10	A20	A40	A50	A70	C10 - C30	C20	E01		
All engines	Qty: 8									470 417	C10			
ENGINE														
G 55 AMG	Petrol	368	08/06-12/12	M 113.993										
Engine	Information				A10	A20	A40	A50	A70	C10 - C30	C20	E01		
All engines	Qty: 8									470 417	C10			
ENGINE														
G 55 AMG	Petrol	373	08/08->	M 113.993										
Engine	Information				A10	A20	A40	A50	A70	C10 - C30	C20	E01		
All engines	Qty: 8									470 417	C10			
ENGINE														
G 550	Petrol	0	06/10->	M 273.963, M 273.969										
Engine	Information				A10	A20	A40	A50	A70	C10 - C30	C20	E01		
All engines	Qty: 8									470 487	C10			

A10 CONDENSER	A20 CONTACT SET	A40 DISTRIBUTOR CAP	A50 ROTOR	A70 PICK-UP
C10 COIL	C20 IGNITION MODULE	C30 ELECTRONIC IGNITION KIT	E01 IGNITION CABLE SET	

The present application list is a brief version. For the detailed information about the possibility of installation on a specific vehicle, please refer to our web-catalogue <http://catalogo.facet.eu/>

Vehicle	alim.	kW	Date	Engine	FUNCTIONS ON THE VEHICLE							
					A10	A20	A40	A50	A70	C10 - C30	C20	E01

CLASSE GL I

				ENGINE
GL 450 4-matic	Petrol	250	09/06-08/12	M 273.923

Engine	Information	A10	A20	A40	A50	A70	C10 - C30	C20	E01
All engines	x 8, COIL ON PLUG						470 487	C10	

				ENGINE
GL 500 4-matic	Petrol	285	09/06-12/12	M 273.963

Engine	Information	A10	A20	A40	A50	A70	C10 - C30	C20	E01
All engines	x 8, COIL ON PLUG						470 487	C10	

				ENGINE
GL 550 4-matic	Petrol	285	09/06->	M 273.963

Engine	Information	A10	A20	A40	A50	A70	C10 - C30	C20	E01
All engines	Qty: 8						470 487	C10	

CLASSE GLA

				ENGINE
AMG GLA 45 4-matic	Petrol	280	07/15->	M 133.980

Engine	Information	A10	A20	A40	A50	A70	C10 - C30	C20	E01
All engines	x 4, DELPHI, without protection hose, COIL ON PLUG						470 626	C10	

				ENGINE
GLA 180	Petrol	90	02/15->	M 270.910

Engine	Information	A10	A20	A40	A50	A70	C10 - C30	C20	E01
All engines	SA A701, MADE BY: (TJ), x 4, without protection hose, COIL ON PLUG, FOR: (TJ)						470 626	C10	

				ENGINE
GLA 200	Petrol	110	07/18->	M 270.910

Engine	Information	A10	A20	A40	A50	A70	C10 - C30	C20	E01
All engines	x 4, without protection hose, COIL ON PLUG, FOR: (TJ)						470 626	C10	

				ENGINE
GLA 200	Petrol	115	12/13->	M 270.910

Engine	Information	A10	A20	A40	A50	A70	C10 - C30	C20	E01
All engines	MADE BY: (TJ), x 4, without protection hose, COIL ON PLUG, FOR: (TJ)						470 626	C10	

				ENGINE
GLA 220 4-matic	Petrol	135	01/17->	M 270.920

Engine	Information	A10	A20	A40	A50	A70	C10 - C30	C20	E01
All engines	x 4, DELPHI, without protection hose, COIL ON PLUG, without protection hose, COIL ON PLUG, FOR: (TJ)						470 626	C10	

				ENGINE
GLA 250	Petrol	155	12/13->	M 270.920

Engine	Information	A10	A20	A40	A50	A70	C10 - C30	C20	E01
All engines	MADE BY: (TJ), x 4, DELPHI, x 4, without protection hose, COIL ON PLUG, FOR: (TJ)						470 626	C10	

				ENGINE
GLA 250 4-matic	Petrol	155	12/13->	M 270.920

Engine	Information	A10	A20	A40	A50	A70	C10 - C30	C20	E01
All engines	MADE BY: (TJ), x 4, DELPHI, x 4, without protection hose, COIL ON PLUG, FOR: (TJ)						470 626	C10	

				ENGINE
GLA 250 Flex	Petrol/ Ethanol	155	01/15->	M 270.920

Engine	Information	A10	A20	A40	A50	A70	C10 - C30	C20	E01
All engines	x 4, DELPHI, without protection hose, COIL ON PLUG						470 626	C10	

				ENGINE
GLA 45 AMG 4-matic	Petrol	265	05/14->	M 133.980

Engine	Information	A10	A20	A40	A50	A70	C10 - C30	C20	E01
All engines	x 4, DELPHI, without protection hose, COIL ON PLUG						470 626	C10	

CLASSE GLC

				ENGINE
250 4-matic	Petrol	155	06/15-04/19	M 274.920

Engine	Information	A10	A20	A40	A50	A70	C10 - C30	C20	E01
All engines	SA A701/784K, x 4, DELPHI, without protection hose, x 4, COIL ON PLUG, without protection hose, COIL ON PLUG, FOR: (TJ), FOR: (TJ)						470 626	C10	

A10 CONDENSER	A20 CONTACT SET	A40 DISTRIBUTOR CAP	A50 ROTOR	A70 PICK-UP
C10 COIL	C20 IGNITION MODULE	C30 ELECTRONIC IGNITION KIT	E01 IGNITION CABLE SET	

Vehicle	alim.	kW	Date	Engine	FUNCTIONS ON THE VEHICLE									
					A10	A20	A40	A50	A70	C10 - C30	C20	E01		
ENGINE														
300 4-matic	Petrol	180	07/15-04/19	M 274.920										
Engine	Information				A10	A20	A40	A50	A70	C10 - C30	C20	E01		
All engines	MADE BY: (TJ), SA A701, x 4, DELPHI, MADE BY: (TJ), x 4, without protection hose, x 4, COIL ON PLUG, without protection hose, COIL ON PLUG, FOR: (TJ), FOR: (TJ)									470 626	C10			
ENGINE														
300 e 4-matic	Petrol/ Electric	155	11/19->	M 274.920										
Engine	Information				A10	A20	A40	A50	A70	C10 - C30	C20	E01		
All engines	x 4, DELPHI, without protection hose, COIL ON PLUG, without protection hose, COIL ON PLUG, FOR: (TJ)									470 626	C10			
ENGINE														
300 e 4-matic	Petrol/ Electric	235	11/19->	M 274.920										
Engine	Information				A10	A20	A40	A50	A70	C10 - C30	C20	E01		
All engines	x 4, DELPHI, without protection hose, COIL ON PLUG, without protection hose, COIL ON PLUG, FOR: (TJ)									470 626	C10			
ENGINE														
350 e 4-matic	Petrol/ Electric	155	01/16-04/19	M 274.920										
Engine	Information				A10	A20	A40	A50	A70	C10 - C30	C20	E01		
All engines	SA A701, SA A701/784K, x 4, DELPHI, MADE BY: (TJ), x 4, DELPHI, without protection hose, x 4, COIL ON PLUG, without protection hose, COIL ON PLUG, FOR: (TJ), FOR: (TJ) ----- x 4, without protection hose, COIL ON PLUG, FOR: (TJ)									470 626	C10			
ENGINE														
350 e 4-matic	Petrol/ Electric	235	01/16-04/19	M 274.920										
Engine	Information				A10	A20	A40	A50	A70	C10 - C30	C20	E01		
All engines	SA A701, SA A701/784K, x 4, DELPHI, MADE BY: (TJ), x 4, DELPHI, without protection hose, x 4, COIL ON PLUG, without protection hose, COIL ON PLUG, FOR: (TJ), FOR: (TJ) ----- x 4, without protection hose, COIL ON PLUG, FOR: (TJ)									470 626	C10			
CLASSE GLK														
ENGINE														
200	Petrol	135	08/13-06/15	M 274.920										
Engine	Information				A10	A20	A40	A50	A70	C10 - C30	C20	E01		
All engines	MADE BY: (TJ), x 4, DELPHI, x 4, without protection hose, COIL ON PLUG, FOR: (TJ)									470 626	C10			
ENGINE														
250	Petrol	155	08/13-06/15	M 274.920										
Engine	Information				A10	A20	A40	A50	A70	C10 - C30	C20	E01		
All engines	MADE BY: (TJ), x 4, DELPHI, x 4, without protection hose, COIL ON PLUG, FOR: (TJ)									470 626	C10			
ENGINE														
250 4-matic	Petrol	155	08/13-06/15	M 274.920										
Engine	Information				A10	A20	A40	A50	A70	C10 - C30	C20	E01		
All engines	MADE BY: (USA), x 4, DELPHI, x 4, without protection hose, COIL ON PLUG, FOR: (TJ)									470 626	C10			
ENGINE														
280 4-matic	Petrol	170	06/08-06/09	M 272.948										
Engine	Information				A10	A20	A40	A50	A70	C10 - C30	C20	E01		
All engines	x 6, COIL ON PLUG									470 487	C10			
ENGINE														
300 4-matic	Petrol	170	07/09-12/15	M 272.948										
Engine	Information				A10	A20	A40	A50	A70	C10 - C30	C20	E01		
All engines	x 6, COIL ON PLUG									470 487	C10			
ENGINE														
350	Petrol	200	04/09-06/15	M 272.991										
Engine	Information				A10	A20	A40	A50	A70	C10 - C30	C20	E01		
All engines	x 6, COIL ON PLUG									470 487	C10			
ENGINE														
350 4-matic	Petrol	200	06/08-04/11	M 272.971										
Engine	Information				A10	A20	A40	A50	A70	C10 - C30	C20	E01		
All engines	x 6, COIL ON PLUG									470 487	C10			

A10 CONDENSER	A20 CONTACT SET	A40 DISTRIBUTOR CAP	A50 ROTOR	A70 PICK-UP
C10 COIL	C20 IGNITION MODULE	C30 ELECTRONIC IGNITION KIT	E01 IGNITION CABLE SET	

The present application list is a brief version. For the detailed information about the possibility of installation on a specific vehicle, please refer to our web-catalogue <http://catalogo.facet.eu/>

Vehicle	alim.	kW	Date	Engine	FUNCTIONS ON THE VEHICLE							
					A10	A20	A40	A50	A70	C10 - C30	C20	E01

CLASSE M I

				ENGINE
ML 230	Petrol	110	02/98-06/05	M 111.977

Engine	Information	A10	A20	A40	A50	A70	C10 - C30	C20	E01
All engines	x 2, SEMI-DIRECT, Dia: 4 mm, connector type, saw teeth						470 316	C10	

				ENGINE
ML 320	Petrol	160	02/98-08/02	M 112.942

Engine	Information	A10	A20	A40	A50	A70	C10 - C30	C20	E01
All engines	x 6, COIL ON PLUG						470 417	C10	
All engines									360 649

				ENGINE
ML 350	Petrol	173	02/03-06/05	M 112.970

Engine	Information	A10	A20	A40	A50	A70	C10 - C30	C20	E01
All engines	x 6, COIL ON PLUG						470 417	C10	
All engines									360 649

				ENGINE
ML 350	Petrol	180	08/02-06/05	M 112.970

Engine	Information	A10	A20	A40	A50	A70	C10 - C30	C20	E01
All engines	x 6, COIL ON PLUG						470 417	C10	
All engines									360 649

				ENGINE
ML 430	Petrol	200	02/98-06/05	M 113.942

Engine	Information	A10	A20	A40	A50	A70	C10 - C30	C20	E01
All engines	x 8, COIL ON PLUG						470 417	C10	

				ENGINE
ML 500	Petrol	215	09/01-06/05	M 113.965

Engine	Information	A10	A20	A40	A50	A70	C10 - C30	C20	E01
All engines	x 8, COIL ON PLUG						470 417	C10	

				ENGINE
ML 55 AMG	Petrol	255	02/00-06/05	M 113.981

Engine	Information	A10	A20	A40	A50	A70	C10 - C30	C20	E01
All engines	x 8, COIL ON PLUG						470 417	C10	

CLASSE M II

				ENGINE
ML 300	Petrol	0	07/09->	M 272.945

Engine	Information	A10	A20	A40	A50	A70	C10 - C30	C20	E01
All engines	Qty: 6						470 487	C10	

				ENGINE
ML 300 4-matic	Petrol	170	03/10-12/11	M 272.945

Engine	Information	A10	A20	A40	A50	A70	C10 - C30	C20	E01
All engines	x 6, COIL ON PLUG						470 487	C10	

				ENGINE
ML 350	Petrol	200	07/05->	M 272.967

Engine	Information	A10	A20	A40	A50	A70	C10 - C30	C20	E01
All engines	Qty: 6						470 487	C10	

				ENGINE
ML 350 4-matic	Petrol	200	02/05-12/11	M 272.967

Engine	Information	A10	A20	A40	A50	A70	C10 - C30	C20	E01
All engines	x 6, COIL ON PLUG						470 487	C10	

				ENGINE
ML 500 4-matic	Petrol	225	07/05-12/11	M 113.964

Engine	Information	A10	A20	A40	A50	A70	C10 - C30	C20	E01
All engines	x 8, COIL ON PLUG						470 417	C10	

				ENGINE
ML 500 4-matic	Petrol	285	12/07-12/11	M 273.963

Engine	Information	A10	A20	A40	A50	A70	C10 - C30	C20	E01
All engines	x 8, COIL ON PLUG						470 487	C10	

				ENGINE
ML 550 4-matic	Petrol	285	12/07->	M 273.963

Engine	Information	A10	A20	A40	A50	A70	C10 - C30	C20	E01
All engines	Qty: 8						470 487	C10	

A10 CONDENSER	A20 CONTACT SET	A40 DISTRIBUTOR CAP	A50 ROTOR	A70 PICK-UP
C10 COIL	C20 IGNITION MODULE	C30 ELECTRONIC IGNITION KIT	E01 IGNITION CABLE SET	

Vehicle	alim.	kW	Date	Engine	FUNCTIONS ON THE VEHICLE									
					A10	A20	A40	A50	A70	C10 - C30	C20	E01		
CLASSE R														
R 280	Petrol	170	01/07-12/14	M 272.945										
Engine	Information				A10	A20	A40	A50	A70	C10 - C30	C20	E01		
All engines	x 6, COIL ON PLUG									470 487	C10			
R 280 4-matic	Petrol	170	05/07-12/11	M 272.945										
Engine	Information				A10	A20	A40	A50	A70	C10 - C30	C20	E01		
All engines	x 6, COIL ON PLUG									470 487	C10			
R 300	Petrol	170	07/09-12/14	M 272.945										
Engine	Information				A10	A20	A40	A50	A70	C10 - C30	C20	E01		
All engines	x 6, COIL ON PLUG									470 487	C10			
R 300 4-matic	Petrol	170	07/09->	M 272.945										
Engine	Information				A10	A20	A40	A50	A70	C10 - C30	C20	E01		
All engines	Qty: 6									470 487	C10			
All engines	x 6, COIL ON PLUG									470 487	C10			
R 350	Petrol	200	01/07-12/12	M 272.967										
Engine	Information				A10	A20	A40	A50	A70	C10 - C30	C20	E01		
All engines	x 6, COIL ON PLUG									470 487	C10			
R 350 4-matic	Petrol	200	08/05-12/12	M 272.967										
Engine	Information				A10	A20	A40	A50	A70	C10 - C30	C20	E01		
All engines	x 6, COIL ON PLUG									470 487	C10			
R 500 4-matic	Petrol	225	08/05-12/14	M 113.971										
Engine	Information				A10	A20	A40	A50	A70	C10 - C30	C20	E01		
All engines	x 8, COIL ON PLUG									470 417	C10			
R 500 4-matic	Petrol	285	05/07-12/14	M 273.963										
Engine	Information				A10	A20	A40	A50	A70	C10 - C30	C20	E01		
All engines	x 8, COIL ON PLUG									470 487	C10			
R 550 4-matic	Petrol	285	01/07->	M 273.963										
Engine	Information				A10	A20	A40	A50	A70	C10 - C30	C20	E01		
All engines	Qty: 8									470 487	C10			
CLASSE S I														
250 S	Petrol	96	01/66-12/69	M 108.920										
Engine	Information				A10	A20	A40	A50	A70	C10 - C30	C20	E01		
All engines								906 018R						
250 SE	Petrol	110	01/66-12/67	M 129.980										
Engine	Information				A10	A20	A40	A50	A70	C10 - C30	C20	E01		
All engines						706 021		906 018R						
280 S	Petrol	103	10/67-07/72	M 130.920										
Engine	Information				A10	A20	A40	A50	A70	C10 - C30	C20	E01		
All engines								906 018R						
280 S	Petrol	118	08/72-07/80	M 110.922										
Engine	Information				A10	A20	A40	A50	A70	C10 - C30	C20	E01		
All engines						706 029HV								
280 SE, SEL	Petrol	118	01/68-08/72	M 130.980										
Engine	Information				A10	A20	A40	A50	A70	C10 - C30	C20	E01		
All engines								906 018R						

A10 CONDENSER	A20 CONTACT SET	A40 DISTRIBUTOR CAP	A50 ROTOR	A70 PICK-UP
C10 COIL	C20 IGNITION MODULE	C30 ELECTRONIC IGNITION KIT	E01 IGNITION CABLE SET	

The present application list is a brief version. For the detailed information about the possibility of installation on a specific vehicle, please refer to our web-catalogue <http://catalogo.facet.eu/>

Vehicle	alim.	kW	Date	Engine	FUNCTIONS ON THE VEHICLE							
					A10	A20	A40	A50	A70	C10 - C30	C20	E01

CLASSE S II

				ENGINE
260 SE	Petrol	118	09/85-06/91	M 103.941

Engine	Information	A10	A20	A40	A50	A70	C10 - C30	C20	E01
All engines	version Bosch			806 237	906 125R				
All engines							470 178	C10	

				ENGINE
260 SE	Petrol	122	09/85-06/91	M 103.941

Engine	Information	A10	A20	A40	A50	A70	C10 - C30	C20	E01
All engines	version Bosch			806 237	906 125R				
All engines							470 178	C10	

				ENGINE
280 S	Petrol	115	12/79-07/85	M 110.924

Engine	Information	A10	A20	A40	A50	A70	C10 - C30	C20	E01
All engines	version Bosch			806 092	906 034R				

				ENGINE
280 SE, SEL	Petrol	136	10/79-07/85	M 110.989

Engine	Information	A10	A20	A40	A50	A70	C10 - C30	C20	E01
All engines	version Bosch			806 123	906 060R				
All engines									360 323

				ENGINE
300 SE, SEL	Petrol	132	01/86-06/91	M 103.981

Engine	Information	A10	A20	A40	A50	A70	C10 - C30	C20	E01
All engines	version Bosch			806 237	906 125R				
All engines							470 178	C10	

				ENGINE
300 SE, SEL	Petrol	138	09/85-12/89	M 103.981

Engine	Information	A10	A20	A40	A50	A70	C10 - C30	C20	E01
All engines	version Bosch			806 237	906 125R				
All engines							470 178	C10	

				ENGINE
380 SE, SEL	Petrol	150	10/81-08/85	M 116.963

Engine	Information	A10	A20	A40	A50	A70	C10 - C30	C20	E01
All engines	version Bosch			806 090	906 049R				
All engines							470 178	C10	

				ENGINE
380 SE, SEL	Petrol	160	09/80-10/81	M 116.961

Engine	Information	A10	A20	A40	A50	A70	C10 - C30	C20	E01
All engines	version Bosch			806 090					
All engines	eng. type 01396 ->, version Bosch				906 023R				

				ENGINE
380 SEC	Petrol	150	10/81-07/85	M 116.963

Engine	Information	A10	A20	A40	A50	A70	C10 - C30	C20	E01
All engines	version Bosch			806 090	906 049R				
All engines							470 178	C10	

				ENGINE
420 SE, SEL	Petrol	150	10/85-06/91	M 116.965

Engine	Information	A10	A20	A40	A50	A70	C10 - C30	C20	E01
All engines	version Bosch			806 239	906 126R				
All engines							470 179	C10	

				ENGINE
420 SE, SEL	Petrol	160	10/85-12/87	M 116.965

Engine	Information	A10	A20	A40	A50	A70	C10 - C30	C20	E01
All engines	version Bosch			806 239	906 126R				
All engines							470 179	C10	

				ENGINE
420 SE, SEL	Petrol	165	10/85-06/91	M 116.965







Engine	Information	A10	A20	A40	A50	A70	C10 - C30	C20	E01
All engines	version Bosch			806 239	906 126R				
All engines							470 179	C10	

A10 CONDENSER	A20 CONTACT SET	A40 DISTRIBUTOR CAP	A50 ROTOR	A70 PICK-UP
C10 COIL	C20 IGNITION MODULE	C30 ELECTRONIC IGNITION KIT	E01 IGNITION CABLE SET	

Vehicle	alim.	kW	Date	Engine	FUNCTIONS ON THE VEHICLE								
					A10	A20	A40	A50	A70	C10 - C30	C20	E01	
ENGINE													
420 SE, SEL	Petrol	170	10/85-12/87	M 116.965									
Engine	Information				A10	A20	A40	A50	A70	C10 - C30	C20	E01	
All engines	version Bosch						806 239	906 126R					
All engines										470 179	C10		
ENGINE													
420 SEC	Petrol	150	10/85-06/91	M 116.965									
Engine	Information				A10	A20	A40	A50	A70	C10 - C30	C20	E01	
All engines	version Bosch						806 239	906 126R					
All engines										470 179	C10		
ENGINE													
420 SEC	Petrol	160	10/85-12/87	M 116.965									
Engine	Information				A10	A20	A40	A50	A70	C10 - C30	C20	E01	
All engines	version Bosch						806 239	906 126R					
All engines										470 179	C10		
ENGINE													
420 SEC	Petrol	165	10/85-06/91	M 116.965									
Engine	Information				A10	A20	A40	A50	A70	C10 - C30	C20	E01	
All engines	version Bosch						806 239	906 126R					
All engines										470 179	C10		
ENGINE													
500 SE, SEL	Petrol	164	09/85-06/91	M 117.965									
Engine	Information				A10	A20	A40	A50	A70	C10 - C30	C20	E01	
All engines	version Bosch						806 239	906 126R					
All engines										470 179	C10		
ENGINE													
500 SE, SEL	Petrol	170	12/79-08/85	M 117.961, M 117.963									
Engine	Information				A10	A20	A40	A50	A70	C10 - C30	C20	E01	
All engines	version Bosch						806 090						
Eng. M 117.961	version Bosch							906 023R					
Eng. M 117.963	version Bosch							906 049R					
All engines										470 178	C10		
ENGINE													
500 SE, SEL	Petrol	177	12/79-08/85	M 117.961, M 117.963									
Engine	Information				A10	A20	A40	A50	A70	C10 - C30	C20	E01	
All engines	version Bosch						806 090						
Eng. M 117.961	version Bosch							906 023R					
Eng. M 117.963	version Bosch							906 049R					
All engines										470 178	C10		
ENGINE													
500 SE, SEL	Petrol	180	09/85-06/91	M 117.965									
Engine	Information				A10	A20	A40	A50	A70	C10 - C30	C20	E01	
All engines	version Bosch						806 239	906 126R					
All engines										470 179	C10		
ENGINE													
500 SE, SEL	Petrol	185	09/87-06/91	M 117.965									
Engine	Information				A10	A20	A40	A50	A70	C10 - C30	C20	E01	
All engines	version Bosch						806 239	906 126R					
All engines										470 179	C10		
ENGINE													
500 SE, SEL	Petrol	195	09/87-06/91	M 117.965									
Engine	Information				A10	A20	A40	A50	A70	C10 - C30	C20	E01	
All engines	version Bosch						806 239	906 126R					
All engines										470 179	C10		
ENGINE													
500 SE, SEL Cat	Petrol	185	06/89-06/91	M 117.965									
Engine	Information				A10	A20	A40	A50	A70	C10 - C30	C20	E01	
All engines	version Bosch						806 239	906 126R					
All engines										470 179	C10		

A10	CONDENSER	A20	CONTACT SET	A40	DISTRIBUTOR CAP	A50	ROTOR	A70	PICK-UP
C10	COIL	C20	IGNITION MODULE	C30	ELECTRONIC IGNITION KIT	E01	IGNITION CABLE SET		

The present application list is a brief version. For the detailed information about the possibility of installation on a specific vehicle, please refer to our web-catalogue <http://catalogo.facet.eu/>

				FUNCTIONS ON THE VEHICLE								
Vehicle	alim.	kW	Date	Engine								
				ENGINE								
500 SEC	Petrol	164	10/85-06/91	M 117.965								
Engine	Information			A10	A20	A40	A50	A70	C10 - C30	C20	E01	
All engines	version Bosch					806 239	906 126R					
All engines									470 179	C10		
				ENGINE								
500 SEC	Petrol	170	10/81-08/85	M 117.963								
Engine	Information			A10	A20	A40	A50	A70	C10 - C30	C20	E01	
All engines	version Bosch					806 090	906 049R					
All engines									470 178	C10		
				ENGINE								
500 SEC	Petrol	177	08/80-08/85	M 117.963								
Engine	Information			A10	A20	A40	A50	A70	C10 - C30	C20	E01	
All engines	version Bosch					806 090	906 049R					
All engines									470 178	C10		
				ENGINE								
500 SEC	Petrol	180	09/85-06/91	M 117.965								
Engine	Information			A10	A20	A40	A50	A70	C10 - C30	C20	E01	
All engines	version Bosch					806 239	906 126R					
All engines									470 179	C10		
				ENGINE								
500 SEC	Petrol	185	08/87-06/91	M 117.965								
Engine	Information			A10	A20	A40	A50	A70	C10 - C30	C20	E01	
All engines	version Bosch					806 239	906 126R					
All engines									470 179	C10		
				ENGINE								
500 SEC Cat	Petrol	185	06/89-06/91	M 117.965								
Engine	Information			A10	A20	A40	A50	A70	C10 - C30	C20	E01	
All engines	version Bosch					806 239	906 126R					
All engines									470 179	C10		
				ENGINE								
560 SE, SEL	Petrol	178	10/85-06/91	M 117.968								
Engine	Information			A10	A20	A40	A50	A70	C10 - C30	C20	E01	
All engines	version Bosch					806 239	906 126R					
All engines									470 179	C10		
				ENGINE								
560 SE, SEL	Petrol	200	10/85-12/87	M 117.968								
Engine	Information			A10	A20	A40	A50	A70	C10 - C30	C20	E01	
All engines	version Bosch					806 239	906 126R					
All engines									470 179	C10		
				ENGINE								
560 SE, SEL	Petrol	205	08/87-06/91	M 117.968								
Engine	Information			A10	A20	A40	A50	A70	C10 - C30	C20	E01	
All engines	version Bosch					806 239	906 126R					
All engines									470 179	C10		
				ENGINE								
560 SE, SEL	Petrol	220	10/85-06/91	M 117.968								
Engine	Information			A10	A20	A40	A50	A70	C10 - C30	C20	E01	
All engines	version Bosch					806 239	906 126R					
All engines									470 179	C10		
				ENGINE								
560 SEC	Petrol	178	10/85-06/91	M 117.968								
Engine	Information			A10	A20	A40	A50	A70	C10 - C30	C20	E01	
All engines	version Bosch					806 239	906 126R					
All engines									470 179	C10		

A10 CONDENSER	A20 CONTACT SET	A40 DISTRIBUTOR CAP	A50 ROTOR	A70 PICK-UP
C10 COIL	C20 IGNITION MODULE	C30 ELECTRONIC IGNITION KIT	E01 IGNITION CABLE SET	

Vehicle	alim.	kW	Date	Engine	FUNCTIONS ON THE VEHICLE									
					A10	A20	A40	A50	A70	C10 - C30	C20	E01		
ENGINE														
560 SEC	Petrol	200	10/85-12/87	M 117.968										
Engine	Information				A10	A20	A40	A50	A70	C10 - C30	C20	E01		
All engines	version Bosch						806 239	906 126R						
All engines										470 179	C10			
ENGINE														
560 SEC	Petrol	205	10/85-06/91	M 117.968										
Engine	Information				A10	A20	A40	A50	A70	C10 - C30	C20	E01		
All engines	version Bosch						806 239	906 126R						
All engines										470 179	C10			
ENGINE														
560 SEC	Petrol	220	10/85-12/89	M 117.968										
Engine	Information				A10	A20	A40	A50	A70	C10 - C30	C20	E01		
All engines	version Bosch						806 239	906 126R						
All engines										470 179	C10			
CLASSE S III														
ENGINE														
300 SE 2.8	Petrol	145	01/93-10/98	M 104.944										
Engine	Information				A10	A20	A40	A50	A70	C10 - C30	C20	E01		
All engines	Qty: 3, without spark plug connector									470 316	C10			
All engines	incl. spark plug connector, Qty: 3									470 316K	C10			
ENGINE														
300 SE, SEL/S320	Petrol	170	03/91-10/98	M 104.994										
Engine	Information				A10	A20	A40	A50	A70	C10 - C30	C20	E01		
All engines	Qty: 3, without spark plug connector									470 316	C10			
All engines	incl. spark plug connector, Qty: 3									470 316K	C10			
ENGINE														
400 SE, SEL/S420	Petrol	210	02/91-10/98	M 119.971										
Engine	Information				A10	A20	A40	A50	A70	C10 - C30	C20	E01		
All engines	Qty: 2, version Bosch							906 146R						
All engines	->ch. A 006502, Qty: 2, NOT FOR: (USA)									470 178	C10			
ENGINE														
500 SE, SEL	Petrol	240	02/91-10/98	M 119.970										
Engine	Information				A10	A20	A40	A50	A70	C10 - C30	C20	E01		
All engines	Qty: 2, version Bosch							906 146R						
All engines	->ch. A 006502, Qty: 2, NOT FOR: (USA)									470 178	C10			
ENGINE														
500 SEC / CL 500	Petrol	235	10/92-12/99	M 119.970										
Engine	Information				A10	A20	A40	A50	A70	C10 - C30	C20	E01		
All engines	Qty: 2, version Bosch							906 146R						
All engines	->ch. A 006502, Qty: 2, NOT FOR: (USA)									470 178	C10			
ENGINE														
600 SE, SEL	Petrol	300	04/91-12/92	M 120.980										
Engine	Information				A10	A20	A40	A50	A70	C10 - C30	C20	E01		
All engines	FP: right									470 179	C10			
ENGINE														
S 280	Petrol	142	02/93-10/98	M 104.944										
Engine	Information				A10	A20	A40	A50	A70	C10 - C30	C20	E01		
All engines	Qty: 3, without spark plug connector									470 316	C10			
All engines	incl. spark plug connector, Qty: 3									470 316K	C10			
ENGINE														
S 420	Petrol	205	01/93-10/98	M 119.971										
Engine	Information				A10	A20	A40	A50	A70	C10 - C30	C20	E01		
All engines	Qty: 2, version Bosch							906 146R						
All engines	->ch. A 006502, Qty: 2, NOT FOR: (USA)									470 178	C10			
ENGINE														
S 500	Petrol	235	01/93-10/98	M 119.970										
Engine	Information				A10	A20	A40	A50	A70	C10 - C30	C20	E01		
All engines	Qty: 2, version Bosch							906 146R						
All engines	->ch. A 006502, Qty: 2, NOT FOR: (USA)									470 178	C10			

A10	CONDENSER	A20	CONTACT SET	A40	DISTRIBUTOR CAP	A50	ROTOR	A70	PICK-UP
C10	COIL	C20	IGNITION MODULE	C30	ELECTRONIC IGNITION KIT	E01	IGNITION CABLE SET		

The present application list is a brief version. For the detailed information about the possibility of installation on a specific vehicle, please refer to our web-catalogue <http://catalogo.facet.eu/>

Vehicle	alim.	kW	Date	Engine	FUNCTIONS ON THE VEHICLE								
					A10	A20	A40	A50	A70	C10 - C30	C20	E01	
ENGINE													
S 600	Petrol	290	01/93-10/98	M 120.980									
Engine		Information			A10	A20	A40	A50	A70	C10 - C30	C20	E01	
All engines		FP: right								470 179	C10		
ENGINE													
SEC/CL 420	Petrol	205	10/94-02/99	M 119.971									
Engine		Information			A10	A20	A40	A50	A70	C10 - C30	C20	E01	
All engines		Qty: 2, version Bosch						906 146R					
All engines		->ch. A 006502, Qty: 2, NOT FOR: (USA)								470 178	C10		
ENGINE													
SEC/CL 600	Petrol	290	09/92-02/99	M 120.980									
Engine		Information			A10	A20	A40	A50	A70	C10 - C30	C20	E01	
All engines		FP: right								470 179	C10		
CLASSE S IV													
ENGINE													
S 280	Petrol	150	10/98-08/05	M 112.922									
Engine		Information			A10	A20	A40	A50	A70	C10 - C30	C20	E01	
All engines		x 6, COIL ON PLUG								470 417	C10		
All engines													360 649
ENGINE													
S 320	Petrol	165	10/98-08/05	M 112.944									
Engine		Information			A10	A20	A40	A50	A70	C10 - C30	C20	E01	
All engines		x 6, COIL ON PLUG								470 417	C10		
All engines													360 649
ENGINE													
S 350	Petrol	180	09/02-08/05	M 112.972									
Engine		Information			A10	A20	A40	A50	A70	C10 - C30	C20	E01	
All engines		x 6, COIL ON PLUG								470 417	C10		
All engines													360 649
ENGINE													
S 350 4-matic	Petrol	180	06/03-08/05	M 112.975									
Engine		Information			A10	A20	A40	A50	A70	C10 - C30	C20	E01	
All engines		x 6, COIL ON PLUG								470 417	C10		
All engines													360 649
ENGINE													
S 430	Petrol	205	10/98-08/05	M 113.941									
Engine		Information			A10	A20	A40	A50	A70	C10 - C30	C20	E01	
All engines		x 8, COIL ON PLUG								470 417	C10		
ENGINE													
S 430 4-matic	Petrol	205	09/02-08/05	M 113.948									
Engine		Information			A10	A20	A40	A50	A70	C10 - C30	C20	E01	
All engines		x 8, COIL ON PLUG								470 417	C10		
ENGINE													
S 500	Petrol	220	10/98-12/03	M 113.960									
Engine		Information			A10	A20	A40	A50	A70	C10 - C30	C20	E01	
All engines		x 8, COIL ON PLUG								470 417	C10		
ENGINE													
S 500	Petrol	225	10/98-08/05	M 113.960									
Engine		Information			A10	A20	A40	A50	A70	C10 - C30	C20	E01	
All engines		x 8, COIL ON PLUG								470 417	C10		
ENGINE													
S 500 4-matic	Petrol	225	09/02-08/05	M 113.966									
Engine		Information			A10	A20	A40	A50	A70	C10 - C30	C20	E01	
All engines		x 8, COIL ON PLUG								470 417	C10		
ENGINE													
S 55 AMG	Petrol	265	04/99-08/05	M 113.986									
Engine		Information			A10	A20	A40	A50	A70	C10 - C30	C20	E01	
All engines		x 8, COIL ON PLUG								470 417	C10		

A10 CONDENSER	A20 CONTACT SET	A40 DISTRIBUTOR CAP	A50 ROTOR	A70 PICK-UP
C10 COIL	C20 IGNITION MODULE	C30 ELECTRONIC IGNITION KIT	E01 IGNITION CABLE SET	

Vehicle	alim.	kW	Date	Engine	FUNCTIONS ON THE VEHICLE								
					A10	A20	A40	A50	A70	C10 - C30	C20	E01	
S 55 AMG Kompressor Petrol 368 06/02-08/05 M 113.991					ENGINE								
Engine Information					A10	A20	A40	A50	A70	C10 - C30	C20	E01	
All engines x 8, COIL ON PLUG										470 417	C10		
CLASSE S V					ENGINE								
CL 550 [JPN] Petrol 285 06/06-> M 273.961					ENGINE								
Engine Information					A10	A20	A40	A50	A70	C10 - C30	C20	E01	
All engines Qty: 8										470 487	C10		
CL 550 [USA] Petrol 285 06/06-> M 273.961					ENGINE								
Engine Information					A10	A20	A40	A50	A70	C10 - C30	C20	E01	
All engines Qty: 8										470 487	C10		
CL 550 4-matic [JPN] Petrol 285 02/08-> M 273.968					ENGINE								
Engine Information					A10	A20	A40	A50	A70	C10 - C30	C20	E01	
All engines Qty: 8										470 487	C10		
CL 550 4-matic [USA] Petrol 285 02/08-> M 273.968					ENGINE								
Engine Information					A10	A20	A40	A50	A70	C10 - C30	C20	E01	
All engines Qty: 8										470 487	C10		
S 280 Petrol 170 08/06-12/13 M 272.946					ENGINE								
Engine Information					A10	A20	A40	A50	A70	C10 - C30	C20	E01	
All engines x 6, COIL ON PLUG										470 487	C10		
S 300 Petrol 170 08/06-12/13 M 272.946					ENGINE								
Engine Information					A10	A20	A40	A50	A70	C10 - C30	C20	E01	
All engines x 6, COIL ON PLUG										470 487	C10		
S 350 Petrol 200 10/05-12/13 M 272.965					ENGINE								
Engine Information					A10	A20	A40	A50	A70	C10 - C30	C20	E01	
All engines x 6, COIL ON PLUG										470 487	C10		
S 350 4-matic Petrol 200 02/08-12/13 M 272.975					ENGINE								
Engine Information					A10	A20	A40	A50	A70	C10 - C30	C20	E01	
All engines x 6, COIL ON PLUG										470 487	C10		
S 400 Hybrid Petrol/ Electric 205 01/09-12/13 M 272.974					ENGINE								
Engine Information					A10	A20	A40	A50	A70	C10 - C30	C20	E01	
All engines x 6, COIL ON PLUG										470 487	C10		
S 450 Petrol 250 12/05-12/13 M 273.922					ENGINE								
Engine Information					A10	A20	A40	A50	A70	C10 - C30	C20	E01	
All engines x 8, COIL ON PLUG										470 487	C10		
S 450 4-matic Petrol 250 12/05-12/13 M 273.924					ENGINE								
Engine Information					A10	A20	A40	A50	A70	C10 - C30	C20	E01	
All engines x 8, COIL ON PLUG										470 487	C10		
S 500 Petrol 285 10/05-12/13 M 273.961					ENGINE								
Engine Information					A10	A20	A40	A50	A70	C10 - C30	C20	E01	
All engines x 8, COIL ON PLUG										470 487	C10		
S 500 4-matic Petrol 285 10/05-12/13 M 273.968					ENGINE								
Engine Information					A10	A20	A40	A50	A70	C10 - C30	C20	E01	
All engines x 8, COIL ON PLUG										470 487	C10		

A10 CONDENSER	A20 CONTACT SET	A40 DISTRIBUTOR CAP	A50 ROTOR	A70 PICK-UP
C10 COIL	C20 IGNITION MODULE	C30 ELECTRONIC IGNITION KIT	E01 IGNITION CABLE SET	

The present application list is a brief version. For the detailed information about the possibility of installation on a specific vehicle, please refer to our web-catalogue <http://catalogo.facet.eu/>

Vehicle	alim.	kW	Date	Engine	FUNCTIONS ON THE VEHICLE							
					A10	A20	A40	A50	A70	C10 - C30	C20	E01

ENGINE				
S 550 [JPN]	Petrol	285	10/05->	M 273.961

Engine	Information	A10	A20	A40	A50	A70	C10 - C30	C20	E01
All engines	Qty: 8						470 487	C10	

ENGINE				
S 550 [USA]	Petrol	285	10/05->	M 273.961

Engine	Information	A10	A20	A40	A50	A70	C10 - C30	C20	E01
All engines	Qty: 8						470 487	C10	

ENGINE				
S 550 4-matic [JPN]	Petrol	285	10/05->	M 273.968

Engine	Information	A10	A20	A40	A50	A70	C10 - C30	C20	E01
All engines	Qty: 8						470 487	C10	

ENGINE				
S 550 4-matic [USA]	Petrol	285	10/05->	M 273.968

Engine	Information	A10	A20	A40	A50	A70	C10 - C30	C20	E01
All engines	Qty: 8						470 487	C10	

CLASSE SL I

ENGINE				
190 SL	Petrol	77	01/55-12/63	M 121.921, M 121.928

Engine	Information	A10	A20	A40	A50	A70	C10 - C30	C20	E01
All engines			706 029HV	806 062	906 018R				

CLASSE SL III

ENGINE				
280 SL	Petrol	130	06/76-09/81	M 110.986

Engine	Information	A10	A20	A40	A50	A70	C10 - C30	C20	E01
All engines	version Bosch			806 092	906 034R				

ENGINE				
280 SLC	Petrol	130	06/76-09/81	M 110.986

Engine	Information	A10	A20	A40	A50	A70	C10 - C30	C20	E01
All engines	version Bosch			806 092	906 034R				

ENGINE				
300 SL	Petrol	132	09/85-08/89	M 103.982

Engine	Information	A10	A20	A40	A50	A70	C10 - C30	C20	E01
All engines			706 021				470 178	C10	360 657
All engines	version Bosch			806 237	906 125R				

ENGINE				
300 SL	Petrol	138	09/85-08/89	M 103.982

Engine	Information	A10	A20	A40	A50	A70	C10 - C30	C20	E01
All engines			706 021				470 178	C10	360 657
All engines	version Bosch			806 237	906 125R				

ENGINE				
380 SL	Petrol	150	09/80-08/85	M 116.962

Engine	Information	A10	A20	A40	A50	A70	C10 - C30	C20	E01
All engines	version Bosch			806 090	906 049R				

ENGINE				
380 SL	Petrol	160	09/80-08/81	M 116.960

Engine	Information	A10	A20	A40	A50	A70	C10 - C30	C20	E01
All engines	version Bosch			806 090					
All engines	eng. type 00016 ->, version Bosch				906 023R				

ENGINE				
420 SL	Petrol	150	01/86-08/89	M 116.964

Engine	Information	A10	A20	A40	A50	A70	C10 - C30	C20	E01
All engines	version Bosch			806 239	906 126R				

ENGINE				
420 SL	Petrol	160	01/86-08/89	M 116.964

Engine	Information	A10	A20	A40	A50	A70	C10 - C30	C20	E01
All engines	version Bosch			806 239	906 126R				

ENGINE				
500 SL	Petrol	164	01/86-08/89	M 117.964

Engine	Information	A10	A20	A40	A50	A70	C10 - C30	C20	E01
All engines	version Bosch			806 239	906 126R				

A10 CONDENSER	A20 CONTACT SET	A40 DISTRIBUTOR CAP	A50 ROTOR	A70 PICK-UP
C10 COIL	C20 IGNITION MODULE	C30 ELECTRONIC IGNITION KIT	E01 IGNITION CABLE SET	

Vehicle	alim.	kW	Date	Engine	FUNCTIONS ON THE VEHICLE									
					A10	A20	A40	A50	A70	C10 - C30	C20	E01		
ENGINE														
500 SL	Petrol	180	01/86-08/89	M 117.964										
Engine		Information			A10	A20	A40	A50	A70	C10 - C30	C20	E01		
All engines		version Bosch					806 239	906 126R						
ENGINE														
560 SL	Petrol	169	09/85-12/89	M 117.967										
Engine		Information			A10	A20	A40	A50	A70	C10 - C30	C20	E01		
All engines		version Bosch					806 239	906 126R						
CLASSE SL IV														
ENGINE														
280	Petrol	142	08/93-10/01	M 104.943										
Engine		Information			A10	A20	A40	A50	A70	C10 - C30	C20	E01		
All engines		Qty: 3, without spark plug connector								470 316	C10			
All engines		incl. spark plug connector, Qty: 3								470 316K	C10			
ENGINE														
280	Petrol	150	05/98-10/01	M 112.923										
Engine		Information			A10	A20	A40	A50	A70	C10 - C30	C20	E01		
All engines		Qty: 6								470 417	C10			
All engines													360 649	
ENGINE														
300 SL	Petrol	140	03/89-08/93	M 103.984										
Engine		Information			A10	A20	A40	A50	A70	C10 - C30	C20	E01		
All engines		version Bosch					806 237	906 125R						
All engines										470 178	C10		360 657	
ENGINE														
320	Petrol	165	05/98-10/01	M 112.943										
Engine		Information			A10	A20	A40	A50	A70	C10 - C30	C20	E01		
All engines		Qty: 6								470 417	C10			
All engines													360 649	
ENGINE														
320	Petrol	170	09/93-10/01	M 104.991										
Engine		Information			A10	A20	A40	A50	A70	C10 - C30	C20	E01		
All engines		Qty: 3, without spark plug connector								470 316	C10			
All engines		incl. spark plug connector, Qty: 3								470 316K	C10			
ENGINE														
500	Petrol	225	05/98-10/01	M 113.961										
Engine		Information			A10	A20	A40	A50	A70	C10 - C30	C20	E01		
All engines		Qty: 8								470 417	C10			
ENGINE														
500	Petrol	235	09/92-10/01	M 119.972										
Engine		Information			A10	A20	A40	A50	A70	C10 - C30	C20	E01		
All engines		Qty: 2, version Bosch						906 146R						
All engines										470 179	C10			
ENGINE														
500 SL	Petrol	240	09/89-08/92	M 119.960										
Engine		Information			A10	A20	A40	A50	A70	C10 - C30	C20	E01		
All engines		Qty: 2, version Bosch						906 146R						
All engines		Qty: 2								470 178	C10			
ENGINE														
600	Petrol	290	07/92-10/01	M 120.981										
Engine		Information			A10	A20	A40	A50	A70	C10 - C30	C20	E01		
All engines										470 179	C10			
ENGINE														
600 SL	Petrol	300	02/92-08/94	M 120.981										
Engine		Information			A10	A20	A40	A50	A70	C10 - C30	C20	E01		
All engines										470 179	C10			
CLASSE SL V														
ENGINE														
280	Petrol	170	03/08-01/12	M 272.949										
Engine		Information			A10	A20	A40	A50	A70	C10 - C30	C20	E01		
All engines		x 6, COIL ON PLUG								470 487	C10			

A10	CONDENSER	A20	CONTACT SET	A40	DISTRIBUTOR CAP	A50	ROTOR	A70	PICK-UP
C10	COIL	C20	IGNITION MODULE	C30	ELECTRONIC IGNITION KIT	E01	IGNITION CABLE SET		

The present application list is a brief version. For the detailed information about the possibility of installation on a specific vehicle, please refer to our web-catalogue <http://catalogo.facet.eu/>

Vehicle	alim.	kW	Date	Engine	FUNCTIONS ON THE VEHICLE							
					A10	A20	A40	A50	A70	C10 - C30	C20	E01

300	Petrol	170	04/09-01/12	ENGINE M 272.949
------------	--------	------------	-------------	-----------------------------------

Engine	Information	A10	A20	A40	A50	A70	C10 - C30	C20	E01
All engines	x 6, COIL ON PLUG						470 487	C10	

350	Petrol	180	03/03-01/12	ENGINE M 112.973
------------	--------	------------	-------------	-----------------------------------

Engine	Information	A10	A20	A40	A50	A70	C10 - C30	C20	E01
All engines	x 6, COIL ON PLUG						470 417	C10	
All engines									360 649

350	Petrol	200	03/06-01/12	ENGINE M 272.966
------------	--------	------------	-------------	-----------------------------------

Engine	Information	A10	A20	A40	A50	A70	C10 - C30	C20	E01
All engines	x 6, COIL ON PLUG						470 487	C10	

350	Petrol	232	04/08-01/12	ENGINE M 272.968
------------	--------	------------	-------------	-----------------------------------

Engine	Information	A10	A20	A40	A50	A70	C10 - C30	C20	E01
All engines	x 6, COIL ON PLUG						470 487	C10	

500	Petrol	225	10/01-01/12	ENGINE M 113.963
------------	--------	------------	-------------	-----------------------------------

Engine	Information	A10	A20	A40	A50	A70	C10 - C30	C20	E01
All engines	x 8, COIL ON PLUG						470 417	C10	

500	Petrol	285	03/06-01/12	ENGINE M 273.965
------------	--------	------------	-------------	-----------------------------------

Engine	Information	A10	A20	A40	A50	A70	C10 - C30	C20	E01
All engines	x 8, COIL ON PLUG						470 487	C10	

55 AMG	Petrol	350	10/01-06/02	ENGINE M 113.992
---------------	--------	------------	-------------	-----------------------------------

Engine	Information	A10	A20	A40	A50	A70	C10 - C30	C20	E01
All engines	x 8, COIL ON PLUG						470 417	C10	

55 AMG	Petrol	380	03/06-01/12	ENGINE M 113.995
---------------	--------	------------	-------------	-----------------------------------

Engine	Information	A10	A20	A40	A50	A70	C10 - C30	C20	E01
All engines	x 8, COIL ON PLUG						470 417	C10	

55 AMG Kompressor	Petrol	368	06/02-01/12	ENGINE M 113.992
--------------------------	--------	------------	-------------	-----------------------------------

Engine	Information	A10	A20	A40	A50	A70	C10 - C30	C20	E01
All engines	x 8, COIL ON PLUG						470 417	C10	

550	Petrol	285	03/06-01/12	ENGINE M 273.965
------------	--------	------------	-------------	-----------------------------------

Engine	Information	A10	A20	A40	A50	A70	C10 - C30	C20	E01
All engines	Qty: 8						470 487	C10	

CLASSE SLC

180	Petrol	115	01/16->	ENGINE M 274.910
------------	--------	------------	---------	-----------------------------------

Engine	Information	A10	A20	A40	A50	A70	C10 - C30	C20	E01
All engines	SA A701, x 4, DELPHI, MADE BY: (TJ), without protection hose, x 4, COIL ON PLUG, without protection hose, COIL ON PLUG, FOR: (TJ)						470 626	C10	

200	Petrol	135	01/16->	ENGINE M 274.920
------------	--------	------------	---------	-----------------------------------

Engine	Information	A10	A20	A40	A50	A70	C10 - C30	C20	E01
All engines	SA A701/784K, x 4, DELPHI, MADE BY: (TJ), without protection hose, x 4, COIL ON PLUG, without protection hose, COIL ON PLUG, FOR: (TJ)						470 626	C10	

300	Petrol	180	01/16->	ENGINE M 274.920
------------	--------	------------	---------	-----------------------------------

Engine	Information	A10	A20	A40	A50	A70	C10 - C30	C20	E01
All engines	SA A701/784K, x 4, DELPHI, MADE BY: (TJ), without protection hose, x 4, COIL ON PLUG, without protection hose, COIL ON PLUG, FOR: (TJ)						470 626	C10	

A10 CONDENSER	A20 CONTACT SET	A40 DISTRIBUTOR CAP	A50 ROTOR	A70 PICK-UP
C10 COIL	C20 IGNITION MODULE	C30 ELECTRONIC IGNITION KIT	E01 IGNITION CABLE SET	

Vehicle	alim.	kW	Date	Engine	FUNCTIONS ON THE VEHICLE							
					A10	A20	A40	A50	A70	C10 - C30	C20	E01

CLASSE SLK I

				ENGINE
200	Petrol	100	09/96-03/00	M 111.946

Engine	Information	A10	A20	A40	A50	A70	C10 - C30	C20	E01
All engines	x 2, SEMI-DIRECT, Dia: 4 mm, connector type, saw teeth						470 316	C10	

				ENGINE
200 Kompressor	Petrol	141	10/96-03/00	M 111.943

Engine	Information	A10	A20	A40	A50	A70	C10 - C30	C20	E01
All engines	x 2, SEMI-DIRECT, Dia: 4 mm, connector type, saw teeth						470 316	C10	

				ENGINE
230 Kompressor	Petrol	142	09/96-03/00	M 111.973

Engine	Information	A10	A20	A40	A50	A70	C10 - C30	C20	E01
All engines	x 2, SEMI-DIRECT, Dia: 4 mm, connector type, saw teeth						470 316	C10	

				ENGINE
32 AMG Kompressor	Petrol	260	03/01-04/04	M 112.960

Engine	Information	A10	A20	A40	A50	A70	C10 - C30	C20	E01
All engines	x 6, COIL ON PLUG						470 417	C10	
All engines									360 649

				ENGINE
320	Petrol	160	03/00-04/04	M 112.947

Engine	Information	A10	A20	A40	A50	A70	C10 - C30	C20	E01
All engines	x 6, COIL ON PLUG						470 417	C10	
All engines									360 649

CLASSE SLK II

				ENGINE
200 Kompressor	Petrol	120	03/04-02/11	M 271.944

Engine	Information	A10	A20	A40	A50	A70	C10 - C30	C20	E01
All engines	->eng. 30853899, eng. type 30853900 ->, x 4, COIL ON PLUG						470 420	C10	

				ENGINE
200 Kompressor	Petrol	135	01/08-02/11	M 271.954

Engine	Information	A10	A20	A40	A50	A70	C10 - C30	C20	E01
All engines	x 4, COIL ON PLUG						470 420	C10	

				ENGINE
280	Petrol	170	01/05-02/11	M 272.942

Engine	Information	A10	A20	A40	A50	A70	C10 - C30	C20	E01
All engines	x 6, COIL ON PLUG						470 487	C10	

				ENGINE
300	Petrol	170	04/09-02/11	M 272.942

Engine	Information	A10	A20	A40	A50	A70	C10 - C30	C20	E01
All engines	x 6, COIL ON PLUG						470 487	C10	

				ENGINE
350	Petrol	200	06/04-02/11	M 272.963

Engine	Information	A10	A20	A40	A50	A70	C10 - C30	C20	E01
All engines	x 6, COIL ON PLUG						470 487	C10	

				ENGINE
350	Petrol	224	01/08-02/11	M 272.969

Engine	Information	A10	A20	A40	A50	A70	C10 - C30	C20	E01
All engines	x 6, COIL ON PLUG						470 487	C10	

				ENGINE
55 AMG	Petrol	265	06/04-12/11	M 113.989

Engine	Information	A10	A20	A40	A50	A70	C10 - C30	C20	E01
All engines	x 8, COIL ON PLUG						470 417	C10	

				ENGINE
55 AMG	Petrol	294	06/06-02/11	M 113.989









Engine	Information	A10	A20	A40	A50	A70	C10 - C30	C20	E01
All engines	x 8, COIL ON PLUG						470 417	C10	

CLASSE SLK III

				ENGINE
200	Petrol	135	02/11->	M 271.861, M 274.920

Engine	Information	A10	A20	A40	A50	A70	C10 - C30	C20	E01
Eng. M 271.861	x 4, COIL ON PLUG						470 420	C10	

A10 CONDENSER	A20 CONTACT SET	A40 DISTRIBUTOR CAP	A50 ROTOR	A70 PICK-UP
C10 COIL	C20 IGNITION MODULE	C30 ELECTRONIC IGNITION KIT	E01 IGNITION CABLE SET	

					FUNCTIONS ON THE VEHICLE												
Vehicle	alim.	kW	Date	Engine													
CLASSE SLK III																	
200	Petrol	135	02/11->	ENGINE M 271.861, M 274.920													
Engine	Information			A10	A20	A40	A50	A70	C10 - C30	C20	E01						
Eng. M 274.920	SA A701/784K, x 4, DELPHI, MADE BY: (TJ), without protection hose, x 4, COIL ON PLUG, without protection hose, COIL ON PLUG, FOR: (TJ)								470 626	C10							
250	Petrol	150	02/11->	ENGINE M 271.861													
Engine	Information			A10	A20	A40	A50	A70	C10 - C30	C20	E01						
All engines	x 4, COIL ON PLUG								470 420	C10							
300	Petrol	180	07/15->	ENGINE M 274.920													
Engine	Information			A10	A20	A40	A50	A70	C10 - C30	C20	E01						
All engines	x 4, DELPHI, without protection hose, COIL ON PLUG, without protection hose, COIL ON PLUG, FOR: (TJ)								470 626	C10							
CLASSE V																	
V 200	Petrol	95	02/97-07/03	ENGINE M 111.948, M 111.950													
Engine	Information			A10	A20	A40	A50	A70	C10 - C30	C20	E01						
All engines	x 2, SEMI-DIRECT, Dia: 4 mm, connector type, saw teeth								470 316	C10							
V 230	Petrol	105	10/96-07/03	ENGINE M 111.978, M 111.980													
Engine	Information			A10	A20	A40	A50	A70	C10 - C30	C20	E01						
All engines	x 2, SEMI-DIRECT, Dia: 4 mm, connector type, saw teeth								470 316	C10							
COUPE																	
220 SEB	Petrol	88	01/61-12/65	ENGINE M 127.984													
Engine	Information			A10	A20	A40	A50	A70	C10 - C30	C20	E01						
All engines							906 018R										
250 SE	Petrol	110	01/65-12/67	ENGINE M 129.980, M 129.981													
Engine	Information			A10	A20	A40	A50	A70	C10 - C30	C20	E01						
All engines					706 021		906 018R										
280 SE	Petrol	118	01/67-12/71	ENGINE M 130.980, M 130.984													
Engine	Information			A10	A20	A40	A50	A70	C10 - C30	C20	E01						
All engines					706 021		906 021R										
GLE																	
GLE 350 e 4-matic	Petrol/ Electric	155	06/20->	ENGINE M 274.920													
Engine	Information			A10	A20	A40	A50	A70	C10 - C30	C20	E01						
All engines	SA A701/784K, x 4, DELPHI, x 4, without protection hose, COIL ON PLUG, FOR: (TJ)								470 626	C10							
GLE 350 e 4-matic	Petrol/ Electric	245	06/20->	ENGINE M 274.920													
Engine	Information			A10	A20	A40	A50	A70	C10 - C30	C20	E01						
All engines	SA A701/784K, x 4, DELPHI, x 4, without protection hose, COIL ON PLUG, FOR: (TJ)								470 626	C10							
HECKFLOSSE																	
190 C	Petrol	59	04/61-08/65	ENGINE M 121.924													
Engine	Information			A10	A20	A40	A50	A70	C10 - C30	C20	E01						
All engines					706 029HV		906 018R										
200	Petrol	61	07/65-02/68	ENGINE M 121.940													
Engine	Information			A10	A20	A40	A50	A70	C10 - C30	C20	E01						
All engines					706 021, 706 029HV		906 018R										
200	Petrol	70	07/65-02/68	ENGINE M 115.926													
Engine	Information			A10	A20	A40	A50	A70	C10 - C30	C20	E01						
All engines							906 018R										
A10	CONDENSER	A20	CONTACT SET	A40	DISTRIBUTOR CAP	A50	ROTOR	A70	PICK-UP	C10	COIL	C20	IGNITION MODULE	C30	ELECTRONIC IGNITION KIT	E01	IGNITION CABLE SET

Vehicle	alim.	kW	Date	Engine	FUNCTIONS ON THE VEHICLE									
					A10	A20	A40	A50	A70	C10 - C30	C20	E01		
ENGINE														
220 B	Petrol	70	08/59-08/65	M 180.940										
Engine	Information				A10	A20	A40	A50	A70	C10 - C30	C20	E01		
All engines								906 018R						
ENGINE														
220 SB	Petrol	81	08/59-08/65	M 180.941										
Engine	Information				A10	A20	A40	A50	A70	C10 - C30	C20	E01		
All engines								906 018R						
ENGINE														
220 SEB	Petrol	88	08/59-08/65	M 127.982										
Engine	Information				A10	A20	A40	A50	A70	C10 - C30	C20	E01		
All engines								906 018R						
ENGINE														
230	Petrol	77	07/65-02/68	M 180.945, M 180.949										
Engine	Information				A10	A20	A40	A50	A70	C10 - C30	C20	E01		
All engines								906 018R						
ENGINE														
230	Petrol	88	06/66-12/67	M 180.950										
Engine	Information				A10	A20	A40	A50	A70	C10 - C30	C20	E01		
All engines								906 018R						
ENGINE														
230 S	Petrol	88	07/65-01/68	M 180.947, M 180.950										
Engine	Information				A10	A20	A40	A50	A70	C10 - C30	C20	E01		
All engines								906 018R						
KOMBI I														
ENGINE														
200 T	Petrol	74	11/80-11/85	M 102.939										
Engine	Information				A10	A20	A40	A50	A70	C10 - C30	C20	E01		
All engines	version Bosch						806 108	906 055R						
All engines										470 180	C10			
ENGINE														
200 T	Petrol	80	11/80-11/85	M 102.920										
Engine	Information				A10	A20	A40	A50	A70	C10 - C30	C20	E01		
All engines	version Bosch						806 108	906 055R						
All engines										470 180	C10			
KOMBI II														
ENGINE														
200 T	Petrol	77	01/86-05/90	M 102.922										
Engine	Information				A10	A20	A40	A50	A70	C10 - C30	C20	E01		
All engines	-catalytic converter, version Bosch						806 108	906 055R						
All engines	+catalytic converter, version Bosch						806 234	906 121R						
All engines	+catalytic converter									470 178	C10			
All engines	-catalytic converter									470 180	C10			
All engines													360 654	
ENGINE														
200 T	Petrol	80	09/85-08/89	M 102.922										
Engine	Information				A10	A20	A40	A50	A70	C10 - C30	C20	E01		
All engines	-catalytic converter, version Bosch						806 108	906 055R						
All engines	+catalytic converter, version Bosch						806 234	906 121R						
All engines	+catalytic converter									470 178	C10			
All engines	-catalytic converter									470 180	C10			
All engines													360 654	
ENGINE														
200 TE	Petrol	100	05/86-06/93	M 111.940										
Engine	Information				A10	A20	A40	A50	A70	C10 - C30	C20	E01		
All engines	Qty: 2									470 317	C10			
ENGINE														
200 TE	Petrol	87	09/88-08/92	M 102.963										
Engine	Information				A10	A20	A40	A50	A70	C10 - C30	C20	E01		
All engines	-catalytic converter, version Bosch						806 108	906 055R						
All engines	+catalytic converter, version Bosch						806 234	906 121R						
All engines	+catalytic converter									470 178	C10			

A10	CONDENSER	A20	CONTACT SET	A40	DISTRIBUTOR CAP	A50	ROTOR	A70	PICK-UP
C10	COIL	C20	IGNITION MODULE	C30	ELECTRONIC IGNITION KIT	E01	IGNITION CABLE SET		

Vehicle	alim.	kW	Date	Engine	FUNCTIONS ON THE VEHICLE							
					A10	A20	A40	A50	A70	C10 - C30	C20	E01

ENGINE				
200 TE	Petrol	87	09/88-08/92	M 102.963

Engine	Information	A10	A20	A40	A50	A70	C10 - C30	C20	E01
All engines	-catalytic converter						470 180	C10	
All engines									360 654

ENGINE				
200 TE	Petrol	90	09/88-12/89	M 102.962

Engine	Information	A10	A20	A40	A50	A70	C10 - C30	C20	E01
All engines	-catalytic converter, version Bosch			806 108	906 055R				
All engines	+catalytic converter, version Bosch			806 234	906 121R				
All engines	+catalytic converter						470 178	C10	
All engines	-catalytic converter						470 180	C10	
All engines	01/01/90 ->								360 300

ENGINE				
220 TE	Petrol	110	10/92-05/93	M 111.960

Engine	Information	A10	A20	A40	A50	A70	C10 - C30	C20	E01
All engines	Qty: 2						470 317	C10	

ENGINE				
230 E Chassis	Petrol	97	09/86-06/93	M 102.982

Engine	Information	A10	A20	A40	A50	A70	C10 - C30	C20	E01
All engines	-catalytic converter, version Bosch			806 108	906 055R				
All engines	+catalytic converter, version Bosch			806 234	906 121R				
All engines	+catalytic converter						470 178	C10	
All engines	-catalytic converter						470 180	C10	
All engines									360 654

ENGINE				
230 TE	Petrol	100	09/85-08/92	M 102.982

Engine	Information	A10	A20	A40	A50	A70	C10 - C30	C20	E01
All engines	-catalytic converter, version Bosch			806 108	906 055R				
All engines	+catalytic converter, version Bosch			806 234	906 121R				
All engines	+catalytic converter						470 178	C10	
All engines	-catalytic converter						470 180	C10	
All engines									360 654

ENGINE				
230 TE	Petrol	97	09/85-08/92	M 102.982

Engine	Information	A10	A20	A40	A50	A70	C10 - C30	C20	E01
All engines	-catalytic converter, version Bosch			806 108	906 055R				
All engines	+catalytic converter, version Bosch			806 234	906 121R				
All engines	+catalytic converter						470 178	C10	
All engines	-catalytic converter						470 180	C10	
All engines									360 654

ENGINE				
230 TE Cat	Petrol	97	06/89-08/92	M 102.982

Engine	Information	A10	A20	A40	A50	A70	C10 - C30	C20	E01
All engines	-catalytic converter, version Bosch			806 108	906 055R				
All engines	+catalytic converter, version Bosch			806 234	906 121R				
All engines	+catalytic converter						470 178	C10	
All engines	-catalytic converter						470 180	C10	
All engines									360 654

ENGINE				
260 TE FGST.	Petrol	118	09/89-08/92	M 103.940

Engine	Information	A10	A20	A40	A50	A70	C10 - C30	C20	E01
All engines	version Bosch			806 237	906 125R				
All engines							470 178	C10	

ENGINE				
280 TE	Petrol	145	10/92-06/93	M 104.942









Engine	Information	A10	A20	A40	A50	A70	C10 - C30	C20	E01
All engines	Qty: 3, without spark plug connector						470 316	C10	
All engines	incl. spark plug connector, Qty: 3						470 316K	C10	

A10 CONDENSER	A20 CONTACT SET	A40 DISTRIBUTOR CAP	A50 ROTOR	A70 PICK-UP
C10 COIL	C20 IGNITION MODULE	C30 ELECTRONIC IGNITION KIT	E01 IGNITION CABLE SET	

Vehicle	alim.	kW	Date	Engine	FUNCTIONS ON THE VEHICLE									
					A10	A20	A40	A50	A70	C10 - C30	C20	E01		
ENGINE														
300 TE	Petrol	132	01/86-08/92	M 103.983										
Engine	Information				A10	A20	A40	A50	A70	C10 - C30	C20	E01		
All engines	version Bosch						806 237	906 125R						
All engines										470 178	C10		360 657	
ENGINE														
300 TE 4-matic	Petrol	132	09/86-06/93	M 103.985										
Engine	Information				A10	A20	A40	A50	A70	C10 - C30	C20	E01		
All engines	version Bosch						806 237	906 125R						
All engines										470 178	C10		360 657	
ENGINE														
300 TE-24	Petrol	162	09/89-08/92	M 104.980										
Engine	Information				A10	A20	A40	A50	A70	C10 - C30	C20	E01		
All engines										470 179	C10			
ENGINE														
300 TE-24	Petrol	170	09/89-08/92	M 104.980										
Engine	Information				A10	A20	A40	A50	A70	C10 - C30	C20	E01		
All engines										470 179	C10			
ENGINE														
320 TE	Petrol	162	10/92-06/93	M 104.992										
Engine	Information				A10	A20	A40	A50	A70	C10 - C30	C20	E01		
All engines	Qty: 3, without spark plug connector									470 316	C10			
All engines	incl. spark plug connector, Qty: 3									470 316K	C10			
O 309														
ENGINE														
O 309		63	01/68-02/89	M 115.921										
Engine	Information				A10	A20	A40	A50	A70	C10 - C30	C20	E01		
All engines	->year 197212									470 101D	C10			
ENGINE														
O 309		66	01/68-02/89	M 115.952										
Engine	Information				A10	A20	A40	A50	A70	C10 - C30	C20	E01		
All engines	->year 198208						806 079	906 025R		470 101D	C10			
ENGINE														
O 309		70	01/68-02/89	M 102.943										
Engine	Information				A10	A20	A40	A50	A70	C10 - C30	C20	E01		
All engines							806 108	906 055R		470 180	C10			
PAGODE														
ENGINE														
230 SL	Petrol	110	01/63-01/67	M 127.981										
Engine	Information				A10	A20	A40	A50	A70	C10 - C30	C20	E01		
All engines								906 018R						
ENGINE														
250 SL	Petrol	110	01/66-01/68	M 129.982										
Engine	Information				A10	A20	A40	A50	A70	C10 - C30	C20	E01		
All engines						706 021		906 018R						
ENGINE														
280 SL	Petrol	125	01/68-03/71	M 130.983										
Engine	Information				A10	A20	A40	A50	A70	C10 - C30	C20	E01		
All engines								906 018R						
PONTON														
ENGINE														
190 b	Petrol	59	06/59-12/61	M 121.920										
Engine	Information				A10	A20	A40	A50	A70	C10 - C30	C20	E01		
All engines						706 029HV								
ENGINE														
220	Petrol	63	01/54-12/56	M 180.921										
Engine	Information				A10	A20	A40	A50	A70	C10 - C30	C20	E01		
All engines								906 018R						

A10	CONDENSER	A20	CONTACT SET	A40	DISTRIBUTOR CAP	A50	ROTOR	A70	PICK-UP
C10	COIL	C20	IGNITION MODULE	C30	ELECTRONIC IGNITION KIT	E01	IGNITION CABLE SET		

The present application list is a brief version. For the detailed information about the possibility of installation on a specific vehicle, please refer to our web-catalogue <http://catalogo.facet.eu/>

					FUNCTIONS ON THE VEHICLE							
Vehicle	alim.	kW	Date	Engine	 A10	 A20	 A40	 A50	 A70	 C10 - C30	 C20	 E01
220 S					ENGINE							
Petrol	78	01/56-12/59	M 180.924									
Engine Information					A10	A20	A40	A50	A70	C10 - C30	C20	E01
All engines								906 018R				
SLR MCLAREN					ENGINE							
Petrol	460	04/04->	M 155.980									
Engine Information					A10	A20	A40	A50	A70	C10 - C30	C20	E01
All engines										470 417	C10	
5.4					ENGINE							
Petrol	478	10/06->	M 155.980									
Engine Information					A10	A20	A40	A50	A70	C10 - C30	C20	E01
All engines										470 417	C10	
5.4 722 Edition					ENGINE							
Petrol	478	10/06->	M 155.980									
Engine Information					A10	A20	A40	A50	A70	C10 - C30	C20	E01
All engines										470 417	C10	
5.5					ENGINE							
Petrol	460	09/04->	M 155.980									
Engine Information					A10	A20	A40	A50	A70	C10 - C30	C20	E01
All engines										470 417	C10	
5.5 SLR McLaren					ENGINE							
Petrol	460	04/07-12/09	M 155.980									
Engine Information					A10	A20	A40	A50	A70	C10 - C30	C20	E01
All engines										470 417	C10	
SPRINTER I					ENGINE							
Petrol	105	02/95-05/06	M 111.979, M 111.984									
Engine Information					A10	A20	A40	A50	A70	C10 - C30	C20	E01
All engines										470 316	C10	
214 NGT					ENGINE							
Petrol/Compressed Natural Gas (CNG)	95	02/95-05/06	M 111.984, M 111979NGT, M 111984NGT									
Engine Information					A10	A20	A40	A50	A70	C10 - C30	C20	E01
Eng. M 111.984										470 316	C10	
Eng. M 111979NGT, M 111984NGT										470 316	C10	
Eng. M 111.984										470 316K	C10	
314					ENGINE							
Petrol	105	02/95-05/06	M 111.979, M 111.984									
Engine Information					A10	A20	A40	A50	A70	C10 - C30	C20	E01
All engines										470 316	C10	
314 4x4					ENGINE							
Petrol	105	08/02-05/06	M 111.984									
Engine Information					A10	A20	A40	A50	A70	C10 - C30	C20	E01
All engines										470 316	C10	
314 NGT					ENGINE							
Petrol/Compressed Natural Gas (CNG)	95	02/95-05/06	M 111.984, M 111979NGT, M 111984NGT									
Engine Information					A10	A20	A40	A50	A70	C10 - C30	C20	E01
Eng. M 111.984										470 316	C10	
Eng. M 111979NGT, M 111984NGT										470 316	C10	
Eng. M 111.984										470 316K	C10	
414					ENGINE							
Petrol	105	02/95-05/06	M 111.979, M 111.984									
Engine Information					A10	A20	A40	A50	A70	C10 - C30	C20	E01
All engines										470 316	C10	

A10 CONDENSER	A20 CONTACT SET	A40 DISTRIBUTOR CAP	A50 ROTOR	A70 PICK-UP
C10 COIL	C20 IGNITION MODULE	C30 ELECTRONIC IGNITION KIT	E01 IGNITION CABLE SET	

Vehicle	alim.	kW	Date	Engine	FUNCTIONS ON THE VEHICLE									
					A10	A20	A40	A50	A70	C10 - C30	C20	E01		
ENGINE														
414	Petrol	105	02/95-05/06	M 111.979, M 111.984										
Engine	Information				A10	A20	A40	A50	A70	C10 - C30	C20	E01		
Eng. M 111.979	Qty: 2, without spark plug connector									470 316	C10			
Eng. M 111.979	incl. spark plug connector, Qty: 2									470 316K	C10			
ENGINE														
414 4x4	Petrol	105	05/97-05/06	M 111.979, M 111.984										
Engine	Information				A10	A20	A40	A50	A70	C10 - C30	C20	E01		
Eng. M 111.979	Qty: 2, without spark plug connector									470 316	C10			
Eng. M 111.984	x 2, SEMI-DIRECT, Dia: 4 mm, connector type, saw teeth									470 316	C10			
Eng. M 111.979	incl. spark plug connector, Qty: 2									470 316K	C10			
ENGINE														
414 NGT	Petrol/ Com- pressed Natural Gas (CNG)	95	02/95-05/06	M 111.979, M 111.984, M 111.979NGT, M 111.984NGT										
Engine	Information				A10	A20	A40	A50	A70	C10 - C30	C20	E01		
All engines	x 2, SEMI-DIRECT, Dia: 4 mm, connector type, saw teeth									470 316	C10			
SPRINTER II														
ENGINE														
216	Petrol	115	09/08->	M 271.951										
Engine	Information				A10	A20	A40	A50	A70	C10 - C30	C20	E01		
All engines	x 4, COIL ON PLUG									470 420	C10			
ENGINE														
224	Petrol	190	06/06->	M 272.979										
Engine	Information				A10	A20	A40	A50	A70	C10 - C30	C20	E01		
All engines	x 6, COIL ON PLUG									470 487	C10			
ENGINE														
316	Petrol	115	09/08->	M 271.951										
Engine	Information				A10	A20	A40	A50	A70	C10 - C30	C20	E01		
All engines	x 4, COIL ON PLUG									470 420	C10			
ENGINE														
316 LGT	Petrol/ Liquified Petro- leum Gas (LPG)	115	09/08->	271951										
Engine	Information				A10	A20	A40	A50	A70	C10 - C30	C20	E01		
All engines	x 4, COIL ON PLUG									470 420	C10			
ENGINE														
316 NGT	Petrol/ Com- pressed Natural Gas (CNG)	115	09/08->	M 271.951, M 271951NGT										
Engine	Information				A10	A20	A40	A50	A70	C10 - C30	C20	E01		
Eng. M 271.951	Qty: 4									470 420	C10			
Eng. M 271951NGT	x 4, COIL ON PLUG									470 420	C10			
ENGINE														
324	Petrol	190	06/06-12/13	M 272.979										
Engine	Information				A10	A20	A40	A50	A70	C10 - C30	C20	E01		
All engines	x 6, COIL ON PLUG									470 487	C10			
ENGINE														
424	Petrol	190	06/06-12/13	M 272.979										
Engine	Information				A10	A20	A40	A50	A70	C10 - C30	C20	E01		
All engines	x 6, COIL ON PLUG									470 487	C10			
ENGINE														
516	Petrol	115	09/08->	M 271.951										
Engine	Information				A10	A20	A40	A50	A70	C10 - C30	C20	E01		
All engines	x 4, COIL ON PLUG									470 420	C10			

A10	CONDENSER	A20	CONTACT SET	A40	DISTRIBUTOR CAP	A50	ROTOR	A70	PICK-UP
C10	COIL	C20	IGNITION MODULE	C30	ELECTRONIC IGNITION KIT	E01	IGNITION CABLE SET		

The present application list is a brief version. For the detailed information about the possibility of installation on a specific vehicle, please refer to our web-catalogue <http://catalogo.facet.eu/>

Vehicle	alim.	kW	Date	Engine	FUNCTIONS ON THE VEHICLE							
					A10	A20	A40	A50	A70	C10 - C30	C20	E01

ENGINE				
516 NGT	Petrol/ Compressed Natural Gas (CNG)	115	09/08->	M 271.951, M 271951NGT

Engine	Information	A10	A20	A40	A50	A70	C10 - C30	C20	E01
Eng. M 271.951	Qty: 4						470 420	C10	
Eng. M 271951NGT	x 4, COIL ON PLUG						470 420	C10	

ENGINE				
524	Petrol	190	06/06-12/13	M 272.979

Engine	Information	A10	A20	A40	A50	A70	C10 - C30	C20	E01
All engines	x 6, COIL ON PLUG						470 487	C10	

ENGINE				
210 2.3	Petrol	70	04/77-02/96	M 102.942

Engine	Information	A10	A20	A40	A50	A70	C10 - C30	C20	E01
All engines	version Bosch			806 108	906 055R				
All engines	ch. 240088 ->						470 180	C10	
All engines									360 654

ENGINE				
210 2.3	Petrol	77	05/89-02/96	M 102.945

Engine	Information	A10	A20	A40	A50	A70	C10 - C30	C20	E01
All engines	version Bosch			806 108	906 055R				
All engines	ch. 240088 ->						470 180	C10	
All engines									360 654

ENGINE				
310 2.3	Petrol	70	08/82-02/96	M 102.942

Engine	Information	A10	A20	A40	A50	A70	C10 - C30	C20	E01
All engines	version Bosch			806 108	906 055R				
All engines	ch. 240088 ->						470 180	C10	
All engines									360 654

ENGINE				
310 2.3	Petrol	77	10/87-12/95	M 102.945

Engine	Information	A10	A20	A40	A50	A70	C10 - C30	C20	E01
All engines	version Bosch			806 108	906 055R				
All engines	ch. 240088 ->						470 180	C10	
All engines									360 654

ENGINE				
410 2.3	Petrol	70	08/82-06/95	M 102.942

Engine	Information	A10	A20	A40	A50	A70	C10 - C30	C20	E01
All engines	version Bosch			806 108	906 055R				
All engines							470 180	C10	360 654

ENGINE				
410 2.3	Petrol	77	10/87-06/95	M 102.945

Engine	Information	A10	A20	A40	A50	A70	C10 - C30	C20	E01
All engines	version Bosch			806 108	906 055R				
All engines							470 180	C10	360 654

ENGINE				
510	Petrol	70	04/86-12/94	M 102.946

Engine	Information	A10	A20	A40	A50	A70	C10 - C30	C20	E01
All engines	version Bosch			806 108	906 055R				
All engines							470 180	C10	360 654

ENGINE				
510	Petrol	77	04/86-12/94	M 102.946

Engine	Information	A10	A20	A40	A50	A70	C10 - C30	C20	E01
All engines	version Bosch			806 108	906 055R				
All engines							470 180	C10	360 654

A10 CONDENSER	A20 CONTACT SET	A40 DISTRIBUTOR CAP	A50 ROTOR	A70 PICK-UP
C10 COIL	C20 IGNITION MODULE	C30 ELECTRONIC IGNITION KIT	E01 IGNITION CABLE SET	

Vehicle	alim.	kW	Date	Engine	FUNCTIONS ON THE VEHICLE							
					A10	A20	A40	A50	A70	C10 - C30	C20	E01

TRE VOLUMI I

				ENGINE
280 E	Petrol	136	02/76-11/85	M 110.984, M 110.988

Engine	Information	A10	A20	A40	A50	A70	C10 - C30	C20	E01
Eng. M 110.984	version Bosch			806 092					
Eng. M 110.988	version Bosch			806 123	906 060R				
Eng. M 110.984	eng. type 026112, 084886 ->, version Bosch				906 024R				
Eng. M 110.984	->eng. 026111, 084885, version Bosch				906 034R				
All engines	ext. thread M6 - M5 mm						470 180	C10	
Eng. M 110.988									360 323

TRE VOLUMI II

				ENGINE
200	Petrol	75	01/86-05/90	M 102.922

Engine	Information	A10	A20	A40	A50	A70	C10 - C30	C20	E01
All engines	-catalytic converter, version Bosch			806 108	906 055R				
All engines	+catalytic converter, version Bosch			806 234	906 121R				
All engines	+catalytic converter						470 178	C10	
All engines	-catalytic converter						470 180	C10	
All engines									360 654

				ENGINE
200	Petrol	77	01/86-10/92	M 102.922

Engine	Information	A10	A20	A40	A50	A70	C10 - C30	C20	E01
All engines	-catalytic converter, version Bosch			806 108	906 055R				
All engines	+catalytic converter, version Bosch			806 234	906 121R				
All engines	+catalytic converter						470 178	C10	
All engines	-catalytic converter						470 180	C10	
All engines									360 654

				ENGINE
200	Petrol	80	12/85-05/90	M 102.922

Engine	Information	A10	A20	A40	A50	A70	C10 - C30	C20	E01
All engines	-catalytic converter, version Bosch			806 108	906 055R				
All engines	+catalytic converter, version Bosch			806 234	906 121R				
All engines	+catalytic converter						470 178	C10	
All engines	-catalytic converter						470 180	C10	
All engines									360 654

				ENGINE
200 E	Petrol	100	10/92-06/93	M 111.940

Engine	Information	A10	A20	A40	A50	A70	C10 - C30	C20	E01
All engines	Qty: 2						470 317	C10	

				ENGINE
200 E	Petrol	87	09/88-08/93	M 102.963

Engine	Information	A10	A20	A40	A50	A70	C10 - C30	C20	E01
All engines	-catalytic converter, version Bosch			806 108	906 055R				
All engines	+catalytic converter, version Bosch			806 234	906 121R				
All engines	+catalytic converter						470 178	C10	
All engines	-catalytic converter						470 180	C10	
All engines									360 654

				ENGINE
200 E	Petrol	90	09/88-12/89	M 102.963

Engine	Information	A10	A20	A40	A50	A70	C10 - C30	C20	E01
All engines	-catalytic converter, version Bosch			806 108	906 055R				
All engines	+catalytic converter, version Bosch			806 234	906 121R				
All engines	+catalytic converter						470 178	C10	
All engines	-catalytic converter						470 180	C10	
All engines									360 654

				ENGINE
220 E	Petrol	110	10/92-06/93	M 111.960

Engine	Information	A10	A20	A40	A50	A70	C10 - C30	C20	E01
All engines	Qty: 2						470 317	C10	

				ENGINE
230 E	Petrol	100	01/85-06/93	M 102.982

Engine	Information	A10	A20	A40	A50	A70	C10 - C30	C20	E01
All engines	-catalytic converter, version Bosch			806 108	906 055R				

A10	CONDENSER	A20	CONTACT SET	A40	DISTRIBUTOR CAP	A50	ROTOR	A70	PICK-UP
C10	COIL	C20	IGNITION MODULE	C30	ELECTRONIC IGNITION KIT	E01	IGNITION CABLE SET		

					FUNCTIONS ON THE VEHICLE							
Vehicle	alim.	kW	Date	Engine								
ENGINE												
230 E	Petrol	100	01/85-06/93	M 102.982								
Engine	Information			A10	A20	A40	A50	A70	C10 - C30	C20	E01	
All engines	+catalytic converter, version Bosch					806 234	906 121R					
All engines	+catalytic converter								470 178	C10		
All engines	-catalytic converter								470 180	C10		
All engines												360 654
ENGINE												
230 E	Petrol	97	12/84-03/92	M 102.982								
Engine	Information			A10	A20	A40	A50	A70	C10 - C30	C20	E01	
All engines	-catalytic converter, version Bosch					806 108	906 055R					
All engines	+catalytic converter, version Bosch					806 234	906 121R					
All engines	+catalytic converter								470 178	C10		
All engines	-catalytic converter								470 180	C10		
All engines												360 654
ENGINE												
230 E Cat	Petrol	97	06/89-06/93	M 102.982								
Engine	Information			A10	A20	A40	A50	A70	C10 - C30	C20	E01	
All engines	-catalytic converter, version Bosch					806 108	906 055R					
All engines	+catalytic converter, version Bosch					806 234	906 121R					
All engines	+catalytic converter								470 178	C10		
All engines	-catalytic converter								470 180	C10		
All engines												360 654
ENGINE												
260 E	Petrol	118	09/85-08/92	M 103.940								
Engine	Information			A10	A20	A40	A50	A70	C10 - C30	C20	E01	
All engines	version Bosch					806 237	906 125R					
All engines									470 178	C10		360 657
ENGINE												
260 E	Petrol	122	09/85-12/89	M 103.940								
Engine	Information			A10	A20	A40	A50	A70	C10 - C30	C20	E01	
All engines	version Bosch					806 237	906 125R					
All engines									470 178	C10		360 657
ENGINE												
260 E 4-matic	Petrol	118	09/86-08/92	M 103.943								
Engine	Information			A10	A20	A40	A50	A70	C10 - C30	C20	E01	
All engines	version Bosch					806 237	906 125R					
All engines									470 178	C10		360 657
ENGINE												
280 E	Petrol	145	10/92-06/93	M 104.942								
Engine	Information			A10	A20	A40	A50	A70	C10 - C30	C20	E01	
All engines	Qty: 3, without spark plug connector								470 316	C10		
All engines	incl. spark plug connector, Qty: 3								470 316K	C10		
ENGINE												
300 E	Petrol	132	08/85-08/92	M 103.983								
Engine	Information			A10	A20	A40	A50	A70	C10 - C30	C20	E01	
All engines	version Bosch					806 237	906 125R					
All engines									470 178	C10		360 657
ENGINE												
300 E	Petrol	138	06/85-08/92	M 103.983								
Engine	Information			A10	A20	A40	A50	A70	C10 - C30	C20	E01	
All engines	version Bosch					806 237	906 125R					
All engines									470 178	C10		
ENGINE												
300 E 4-matic	Petrol	118	01/86-12/93	M 103.943								
Engine	Information			A10	A20	A40	A50	A70	C10 - C30	C20	E01	
All engines	version Bosch					806 237	906 125R					
All engines									470 178	C10		
ENGINE												
300 E 4-matic	Petrol	132	09/86-06/93	M 103.985								
Engine	Information			A10	A20	A40	A50	A70	C10 - C30	C20	E01	
All engines	version Bosch					806 237	906 125R					
All engines									470 178	C10		

A10 CONDENSER	A20 CONTACT SET	A40 DISTRIBUTOR CAP	A50 ROTOR	A70 PICK-UP
C10 COIL	C20 IGNITION MODULE	C30 ELECTRONIC IGNITION KIT	E01 IGNITION CABLE SET	

Vehicle	alim.	kW	Date	Engine	FUNCTIONS ON THE VEHICLE									
					A10	A20	A40	A50	A70	C10 - C30	C20	E01		
ENGINE														
300 E 4-matic	Petrol	132	09/86-06/93	M 103.985										
Engine	Information				A10	A20	A40	A50	A70	C10 - C30	C20	E01		
All engines										470 178	C10		360 657	
ENGINE														
300 E 4-matic	Petrol	138	09/86-02/92	M 103.983										
Engine	Information				A10	A20	A40	A50	A70	C10 - C30	C20	E01		
All engines	version Bosch						806 237	906 125R						
All engines										470 178	C10		360 657	
ENGINE														
300 E-24	Petrol	162	09/88-08/92	M 104.980										
Engine	Information				A10	A20	A40	A50	A70	C10 - C30	C20	E01		
All engines										470 179	C10			
ENGINE														
300 E-24	Petrol	170	09/88-08/92	M 104.980										
Engine	Information				A10	A20	A40	A50	A70	C10 - C30	C20	E01		
All engines										470 179	C10			
ENGINE														
320 E	Petrol	162	10/92-06/93	M 104.992										
Engine	Information				A10	A20	A40	A50	A70	C10 - C30	C20	E01		
All engines	Qty: 3, without spark plug connector									470 316	C10			
All engines	incl. spark plug connector, Qty: 3									470 316K	C10			
ENGINE														
400 E 4.2	Petrol	205	10/92-06/93	M 119.975										
Engine	Information				A10	A20	A40	A50	A70	C10 - C30	C20	E01		
All engines	Qty: 2, version Bosch							906 146R						
All engines	->ch. B 568955, Qty: 2									470 178	C10			
All engines	ch. B 568956 ->									470 179	C10			
ENGINE														
500 E	Petrol	240	01/91-06/93	M 119.974										
Engine	Information				A10	A20	A40	A50	A70	C10 - C30	C20	E01		
All engines	Qty: 2, version Bosch							906 146R						
All engines	->ch. B 568955, Qty: 2									470 178	C10			
All engines	ch. B 568956 ->									470 179	C10			
ENGINE														
500 E AMG 6.0	Petrol	275	01/92-06/93	M 119.974 (AMG 6.0)										
Engine	Information				A10	A20	A40	A50	A70	C10 - C30	C20	E01		
All engines	Qty: 2, version Bosch							906 146R						
All engines	->ch. B 568955, Qty: 2									470 178	C10			
All engines	ch. B 568956 ->									470 179	C10			
VIANO														
ENGINE														
3.2	Petrol	140	09/03->	M 112.951										
Engine	Information				A10	A20	A40	A50	A70	C10 - C30	C20	E01		
All engines	x 6, COIL ON PLUG									470 417	C10			
All engines													360 649	
ENGINE														
3.2	Petrol	160	09/03->	M 112.951										
Engine	Information				A10	A20	A40	A50	A70	C10 - C30	C20	E01		
All engines	x 6, COIL ON PLUG									470 417	C10			
All engines													360 649	
ENGINE														
3.5	Petrol	190	09/07->	M 272.978										
Engine	Information				A10	A20	A40	A50	A70	C10 - C30	C20	E01		
All engines	x 6, COIL ON PLUG									470 487	C10			
ENGINE														
3.7	Petrol	165	06/04-07/07	M 112.976										
Engine	Information				A10	A20	A40	A50	A70	C10 - C30	C20	E01		
All engines	x 6, COIL ON PLUG									470 487	C10			

A10	CONDENSER	A20	CONTACT SET	A40	DISTRIBUTOR CAP	A50	ROTOR	A70	PICK-UP
C10	COIL	C20	IGNITION MODULE	C30	ELECTRONIC IGNITION KIT	E01	IGNITION CABLE SET		

The present application list is a brief version. For the detailed information about the possibility of installation on a specific vehicle, please refer to our web-catalogue <http://catalogo.facet.eu/>

FUNCTIONS ON THE VEHICLE

Vehicle	alim.	kW	Date	Engine								
---------	-------	----	------	--------	---	---	---	--	---	---	---	---

				ENGINE
3.7	Petrol	170	06/04->	M 112.976

Engine	Information	A10	A20	A40	A50	A70	C10 - C30	C20	E01
All engines	x 6, COIL ON PLUG						470 417	C10	
All engines									360 649

				ENGINE
113 2.0	Petrol	95	02/96-07/03	M 111.948, M 111.950

Engine	Information	A10	A20	A40	A50	A70	C10 - C30	C20	E01
All engines	x 2, SEMI-DIRECT, Dia: 4 mm, connector type, saw teeth						470 316	C10	

				ENGINE
114 2.3	Petrol	105	12/96-07/03	M 111.978

Engine	Information	A10	A20	A40	A50	A70	C10 - C30	C20	E01
All engines	x 2, SEMI-DIRECT, Dia: 4 mm, connector type, saw teeth						470 316	C10	

				ENGINE
119	Petrol	140	09/03->	M 112.951

Engine	Information	A10	A20	A40	A50	A70	C10 - C30	C20	E01
All engines	x 6, COIL ON PLUG						470 417	C10	
All engines									360 649

				ENGINE
122	Petrol	160	09/03->	M 112.951

Engine	Information	A10	A20	A40	A50	A70	C10 - C30	C20	E01
All engines	x 6, COIL ON PLUG						470 417	C10	
All engines									360 649

				ENGINE
123	Petrol	165	06/04-07/08	M 112.976

Engine	Information	A10	A20	A40	A50	A70	C10 - C30	C20	E01
All engines	x 6, COIL ON PLUG						470 487	C10	
All engines									360 649

				ENGINE
123	Petrol	170	06/04-07/08	M 112.976

Engine	Information	A10	A20	A40	A50	A70	C10 - C30	C20	E01
All engines	x 6, COIL ON PLUG						470 417, 470 487	C10	
All engines									360 649

				ENGINE
126	Petrol	190	09/07->	M 272.978







Engine	Information	A10	A20	A40	A50	A70	C10 - C30	C20	E01
All engines	x 6, COIL ON PLUG						470 487	C10	

A10 CONDENSER	A20 CONTACT SET	A40 DISTRIBUTOR CAP	A50 ROTOR	A70 PICK-UP
C10 COIL	C20 IGNITION MODULE	C30 ELECTRONIC IGNITION KIT	E01 IGNITION CABLE SET	

Vehicle	alim.	kW	Date	Engine	FUNCTIONS ON THE VEHICLE							
					A10	A20	A40	A50	A70	C10 - C30	C20	E01
1300 MK.II												
1300	Petrol	52	09/67-09/70	ENGINE --								
Engine Information					A10	A20	A40	A50	A70	C10 - C30	C20	E01
All engines							828 075	928 006				
EXPRESS												
1.4	Petrol	76	03/03-05/05	ENGINE 14 K4F								
Engine Information					A10	A20	A40	A50	A70	C10 - C30	C20	E01
All engines										470 374	C10	
MAGNETTE												
1.5	Petrol	45	01/53-05/56	ENGINE --								
Engine Information					A10	A20	A40	A50	A70	C10 - C30	C20	E01
All engines								928 006				
1.5	Petrol	48	05/56-04/58	ENGINE --								
Engine Information					A10	A20	A40	A50	A70	C10 - C30	C20	E01
All engines								928 006				
1.6	Petrol	51	03/61-09/68	ENGINE --								
Engine Information					A10	A20	A40	A50	A70	C10 - C30	C20	E01
All engines						728 083MHV	828 075	928 006				
MG TF												
115	Petrol	85	03/02-12/09	ENGINE 16 K4F								
Engine Information					A10	A20	A40	A50	A70	C10 - C30	C20	E01
All engines							828 093	928 029R				
All engines										470 374	C10	
All engines												360 888
All engines												360 889
120	Petrol	88	03/02-12/09	ENGINE 18 K4F								
Engine Information					A10	A20	A40	A50	A70	C10 - C30	C20	E01
All engines							828 093	928 029R				
All engines												360 888
All engines												360 889
135	Petrol	100	03/02-12/09	ENGINE 18 K4F								
Engine Information					A10	A20	A40	A50	A70	C10 - C30	C20	E01
All engines							828 093	928 029R				
All engines										470 374	C10	
All engines												360 888
All engines												360 889
160	Petrol	118	03/02-12/09	ENGINE 18 K4K								
Engine Information					A10	A20	A40	A50	A70	C10 - C30	C20	E01
All engines										470 374	C10	
MG ZR												
105	Petrol	76	06/01-04/05	ENGINE 14 K4F								
Engine Information					A10	A20	A40	A50	A70	C10 - C30	C20	E01
All engines							828 093	928 029R				
All engines										470 374	C10	
All engines												360 888
All engines												360 889
120	Petrol	86	06/01-04/05	ENGINE 18 K4F								
Engine Information					A10	A20	A40	A50	A70	C10 - C30	C20	E01
All engines							828 093	928 029R				
All engines										470 374	C10	
All engines												360 888

A10 CONDENSER	A20 CONTACT SET	A40 DISTRIBUTOR CAP	A50 ROTOR	A70 PICK-UP
C10 COIL	C20 IGNITION MODULE	C30 ELECTRONIC IGNITION KIT	E01 IGNITION CABLE SET	

The present application list is a brief version. For the detailed information about the possibility of installation on a specific vehicle, please refer to our web-catalogue <http://catalogo.facet.eu/>

				FUNCTIONS ON THE VEHICLE								
Vehicle	alim.	kW	Date	Engine								
				ENGINE								
120	Petrol	86	06/01-04/05	18 K4F								
Engine Information				A10	A20	A40	A50	A70	C10 - C30	C20	E01	
All engines				ch.YD471565 ->								360 889
				ENGINE								
MG ZS												
120	Petrol	86	07/01-10/05	18 K4F								
Engine Information				A10	A20	A40	A50	A70	C10 - C30	C20	E01	
All engines												360 889
				ENGINE								
180	Petrol	130	07/01-10/05	25 K4F								
Engine Information				A10	A20	A40	A50	A70	C10 - C30	C20	E01	
All engines				x 1, LONG, SHORT, BREMI, D.I.S.					470 413	C10		
				ENGINE								
MGA												
1.5	Petrol	51	05/55-04/60	--								
Engine Information				A10	A20	A40	A50	A70	C10 - C30	C20	E01	
All engines							928 006					
				ENGINE								
1.6	Petrol	58	01/58-04/60	--								
Engine Information				A10	A20	A40	A50	A70	C10 - C30	C20	E01	
All engines							928 006					
				ENGINE								
1.6	Petrol	70	05/60-07/62	--								
Engine Information				A10	A20	A40	A50	A70	C10 - C30	C20	E01	
All engines							928 006					
				ENGINE								
1.6	Petrol	81	01/58-05/60	--								
Engine Information				A10	A20	A40	A50	A70	C10 - C30	C20	E01	
All engines							928 006					
				ENGINE								
MGB												
1.8	Petrol	68	05/62-12/80	--								
Engine Information				A10	A20	A40	A50	A70	C10 - C30	C20	E01	
All engines					728 083MHV	828 075	928 006					
				ENGINE								
1.8	Petrol	70	05/62-12/80	--								
Engine Information				A10	A20	A40	A50	A70	C10 - C30	C20	E01	
All engines					728 083MHV	828 075	928 006					
				ENGINE								
MGB GT												
1.8	Petrol	68	07/65-11/80	--, 18G								
Engine Information				A10	A20	A40	A50	A70	C10 - C30	C20	E01	
All engines					728 083MHV	828 075	928 006					
				ENGINE								
1.8	Petrol	70	07/65-11/80	--, 18G								
Engine Information				A10	A20	A40	A50	A70	C10 - C30	C20	E01	
All engines					728 083MHV	828 075	928 006					
				ENGINE								
MGC												
3.0	Petrol	108	01/67-09/69	--								
Engine Information				A10	A20	A40	A50	A70	C10 - C30	C20	E01	
All engines							928 007					
				ENGINE								
MGC GT												
3.0	Petrol	108	01/67-09/69	--								
Engine Information				A10	A20	A40	A50	A70	C10 - C30	C20	E01	
All engines							928 007					

A10 CONDENSER	A20 CONTACT SET	A40 DISTRIBUTOR CAP	A50 ROTOR	A70 PICK-UP
C10 COIL	C20 IGNITION MODULE	C30 ELECTRONIC IGNITION KIT	E01 IGNITION CABLE SET	

Vehicle	alim.	kW	Date	Engine	FUNCTIONS ON THE VEHICLE							
					A10	A20	A40	A50	A70	C10 - C30	C20	E01

MGF

				ENGINE
1.8 i 16V	Petrol	88	03/95-03/02	18 K4F

Engine	Information	A10	A20	A40	A50	A70	C10 - C30	C20	E01
All engines	->ch. YD522572, version Lucas			828 093	928 029R				
All engines	->ch. YD522572								360 888
All engines	ch. YD522573 ->								360 889

MGY

				ENGINE
1.3	Petrol	34	01/50-12/51	--

Engine	Information	A10	A20	A40	A50	A70	C10 - C30	C20	E01
All engines					928 006				

				ENGINE
1.3	Petrol	40	01/50-12/51	--

Engine	Information	A10	A20	A40	A50	A70	C10 - C30	C20	E01
All engines					928 006				

MIDGET

				ENGINE
1.1	Petrol	41	01/64-12/66	--

Engine	Information	A10	A20	A40	A50	A70	C10 - C30	C20	E01
All engines					928 006				

				ENGINE
1.3	Petrol	48	01/67-09/74	--

Engine	Information	A10	A20	A40	A50	A70	C10 - C30	C20	E01
All engines					928 006				

A10	CONDENSER	A20	CONTACT SET	A40	DISTRIBUTOR CAP	A50	ROTOR	A70	PICK-UP
C10	COIL	C20	IGNITION MODULE	C30	ELECTRONIC IGNITION KIT	E01	IGNITION CABLE SET		

The present application list is a brief version. For the detailed information about the possibility of installation on a specific vehicle, please refer to our web-catalogue <http://catalogo.facet.eu/>

FUNCTIONS ON THE VEHICLE

Vehicle	alim.	kW	Date	Engine								
					A10	A20	A40	A50	A70	C10 - C30	C20	E01

MINI I

Cooper	Petrol	85	06/01-07/08	ENGINE W10 B16 A
--------	--------	----	-------------	---------------------

Engine	Information	A10	A20	A40	A50	A70	C10 - C30	C20	E01
All engines									360 719

Cooper S	Petrol	120	03/02-11/07	ENGINE W11 B16 A
----------	--------	-----	-------------	---------------------

Engine	Information	A10	A20	A40	A50	A70	C10 - C30	C20	E01
All engines									360 719

Cooper S	Petrol	125	07/04-11/07	ENGINE W11 B16 A
----------	--------	-----	-------------	---------------------

Engine	Information	A10	A20	A40	A50	A70	C10 - C30	C20	E01
All engines									360 719

John Cooper Works	Petrol	155	07/04-11/07	ENGINE W11 B16 A
-------------------	--------	-----	-------------	---------------------

Engine	Information	A10	A20	A40	A50	A70	C10 - C30	C20	E01
All engines									360 719

One	Petrol	55	04/03-09/06	ENGINE W10 B14 A
-----	--------	----	-------------	---------------------

Engine	Information	A10	A20	A40	A50	A70	C10 - C30	C20	E01
All engines									360 719

One	Petrol	66	06/01-11/07	ENGINE W10 B16 A
-----	--------	----	-------------	---------------------

Engine	Information	A10	A20	A40	A50	A70	C10 - C30	C20	E01
All engines									360 719

Works	Petrol	155	11/03-09/06	ENGINE W11 B16 A
-------	--------	-----	-------------	---------------------

Engine	Information	A10	A20	A40	A50	A70	C10 - C30	C20	E01
All engines									360 719

MINI II

Cooper	Diesel	88	03/09-06/15	ENGINE N12 B16 BA
--------	--------	----	-------------	----------------------

Engine	Information	A10	A20	A40	A50	A70	C10 - C30	C20	E01
All engines	Qty: 4						470 475 C10		

Cooper	Petrol	85	09/06-10/16	ENGINE N12 B16 A, N16 B16 A
--------	--------	----	-------------	--------------------------------

Engine	Information	A10	A20	A40	A50	A70	C10 - C30	C20	E01
All engines	x 4, DELPHI, x 4, COIL ON PLUG, DELPHI, ELDOR, COIL ON PLUG						470 475 C10		

Cooper	Petrol	88	10/06-10/16	ENGINE N12 B16 A, N16 B16 A
--------	--------	----	-------------	--------------------------------

Engine	Information	A10	A20	A40	A50	A70	C10 - C30	C20	E01
All engines	x 4, DELPHI, ELDOR, COIL ON PLUG						470 475 C10		

Cooper	Petrol	90	09/09-10/16	ENGINE N12 B16 A, N16 B16 A
--------	--------	----	-------------	--------------------------------

Engine	Information	A10	A20	A40	A50	A70	C10 - C30	C20	E01
Eng. N12 B16 A	Qty: 4						470 475 C10		
Eng. N16 B16 A	x 4, DELPHI, COIL ON PLUG						470 475 C10		

Cooper ALL4	Petrol	85	07/13-09/16	ENGINE N16 B16 A
-------------	--------	----	-------------	---------------------

Engine	Information	A10	A20	A40	A50	A70	C10 - C30	C20	E01
All engines	x 4, DELPHI, COIL ON PLUG						470 475 C10		

Cooper ALL4	Petrol	90	11/12-10/16	ENGINE N16 B16 A, N18 B16 A
-------------	--------	----	-------------	--------------------------------

Engine	Information	A10	A20	A40	A50	A70	C10 - C30	C20	E01
All engines	x 4, DELPHI, COIL ON PLUG						470 475 C10		

Cooper S	Petrol	120	10/07-10/16	ENGINE N14 B16 A, N14 B16 AB, N18 B16 A
----------	--------	-----	-------------	--

Engine	Information	A10	A20	A40	A50	A70	C10 - C30	C20	E01
All engines	x 4, DELPHI, COIL ON PLUG						470 475 C10		

A10 CONDENSER	A20 CONTACT SET	A40 DISTRIBUTOR CAP	A50 ROTOR	A70 PICK-UP
C10 COIL	C20 IGNITION MODULE	C30 ELECTRONIC IGNITION KIT	E01 IGNITION CABLE SET	

Vehicle	alim.	kW	Date	Engine	FUNCTIONS ON THE VEHICLE									
					A10	A20	A40	A50	A70	C10 - C30	C20	E01		
ENGINE														
Cooper S	Petrol	128	10/06-07/10	N14 B16 A, N14 B16 AB										
Engine	Information				A10	A20	A40	A50	A70	C10 - C30	C20	E01		
All engines	x 4, DELPHI, COIL ON PLUG									470 475	C10			
Eng. N14 B16 A	Qty: 4									470 475	C10			
ENGINE														
Cooper S	Petrol	135	02/10-10/16	N18 B16 A										
Engine	Information				A10	A20	A40	A50	A70	C10 - C30	C20	E01		
All engines	x 4, DELPHI, COIL ON PLUG									470 475	C10			
ENGINE														
Cooper S	Petrol	140	07/14-10/16	N18 B16 A										
Engine	Information				A10	A20	A40	A50	A70	C10 - C30	C20	E01		
All engines	x 4, DELPHI, COIL ON PLUG									470 475	C10			
ENGINE														
Cooper S	Petrol	141	04/08-07/10	N14 B16 AB										
Engine	Information				A10	A20	A40	A50	A70	C10 - C30	C20	E01		
All engines	x 4, DELPHI, COIL ON PLUG									470 475	C10			
ENGINE														
Cooper S	Petrol	147	02/10-10/16	N18 B16 A										
Engine	Information				A10	A20	A40	A50	A70	C10 - C30	C20	E01		
All engines	x 4, DELPHI, COIL ON PLUG									470 475	C10			
ENGINE														
Cooper S ALL4	Petrol	120	08/10-10/16	N18 B16 A										
Engine	Information				A10	A20	A40	A50	A70	C10 - C30	C20	E01		
All engines	x 4, DELPHI, COIL ON PLUG									470 475	C10			
ENGINE														
Cooper S ALL4	Petrol	135	08/10-10/16	N18 B16 A										
Engine	Information				A10	A20	A40	A50	A70	C10 - C30	C20	E01		
All engines	x 4, DELPHI, COIL ON PLUG									470 475	C10			
ENGINE														
Cooper S ALL4	Petrol	140	03/12-10/16	N18 B16 A										
Engine	Information				A10	A20	A40	A50	A70	C10 - C30	C20	E01		
All engines	x 4, DELPHI, COIL ON PLUG									470 475	C10			
ENGINE														
Cooper S JCW	Petrol	147	12/10-04/15	N18 B16 A										
Engine	Information				A10	A20	A40	A50	A70	C10 - C30	C20	E01		
All engines	x 4, DELPHI, COIL ON PLUG									470 475	C10			
ENGINE														
Cooper S John Cooper Works	Petrol	141	11/06-02/10	N14 B16 AB, N14 B16 C										
Engine	Information				A10	A20	A40	A50	A70	C10 - C30	C20	E01		
Eng. N14 B16 AB	x 4, DELPHI, COIL ON PLUG									470 475	C10			
Eng. N14 B16 C	Qty: 4									470 475	C10			
ENGINE														
Cooper S John Cooper Works	Petrol	147	01/12-11/13	N18 B16 A										
Engine	Information				A10	A20	A40	A50	A70	C10 - C30	C20	E01		
All engines	x 4, DELPHI, COIL ON PLUG									470 475	C10			
ENGINE														
John Cooper Works	Petrol	155	11/07-05/15	N14 B16 C, N18 B16 C										
Engine	Information				A10	A20	A40	A50	A70	C10 - C30	C20	E01		
All engines	x 4, DELPHI, COIL ON PLUG									470 475	C10			
ENGINE														
John Cooper Works ALL4	Petrol	160	11/12-10/16	N18 B16 C										
Engine	Information				A10	A20	A40	A50	A70	C10 - C30	C20	E01		
All engines	x 4, DELPHI, COIL ON PLUG									470 475	C10			
ENGINE														
John Cooper Works GP	Petrol	160	09/12-11/13	N14 B16 C, N18 B16 C										
Engine	Information				A10	A20	A40	A50	A70	C10 - C30	C20	E01		
All engines	x 4, DELPHI, COIL ON PLUG									470 475	C10			
ENGINE														
A10	CONDENSER		A20	CONTACT SET		A40	DISTRIBUTOR CAP		A50	ROTOR		A70	PICK-UP	
C10	COIL		C20	IGNITION MODULE		C30	ELECTRONIC IGNITION KIT		E01	IGNITION CABLE SET				

					FUNCTIONS ON THE VEHICLE							
Vehicle	alim.	kW	Date	Engine	A10	A20	A40	A50	A70	C10 - C30	C20	E01
ENGINE												
John Cooper Works ALL4	Petrol	160	11/12->	N18 B16 C								
Engine	Information											
All engines	Qty: 4									470 475	C10	
ENGINE												
One	Petrol	55	03/09-11/13	N12 B14 A, N16 B16 A								
Engine	Information											
All engines	x 4, DELPHI, ELDOR, COIL ON PLUG									470 475	C10	
ENGINE												
One	Petrol	70	11/06-03/10	N12 B14 A								
Engine	Information											
All engines	x 4, DELPHI, ELDOR, COIL ON PLUG									470 475	C10	
ENGINE												
One	Petrol	72	09/09-10/16	N16 B16 A								
Engine	Information											
All engines	x 4, DELPHI, COIL ON PLUG									470 475	C10	
ENGINE												
One LPG	Petrol/ Liquified Petro- leum Gas (LPG)	55	03/09-03/10	N12 B14 A								
Engine	Information											
All engines	x 4, DELPHI, ELDOR, COIL ON PLUG									470 475	C10	
MINI III												
ENGINE												
Cooper	Petrol	100	09/13->	B36 A15 A, B38 A15 A, B38 A15 F								
Engine	Information											
All engines	x 3, COIL ON PLUG									470 632	C10	
Eng. B36 A15 A	Qty: 3									470 632	C10	
ENGINE												
Cooper ALL4	Petrol	100	10/16->	B38 A15 A, B38 A15 F								
Engine	Information											
All engines	x 3, COIL ON PLUG									470 632	C10	
ENGINE												
Cooper S	Petrol	120	09/13->	B46 A20 A, B48 A20 A, B48 A20 F								
Engine	Information											
All engines	x 4, COIL ON PLUG									470 632	C10	
ENGINE												
Cooper S	Petrol	131	07/20->	B46 A20 A, B48 A20 A, B48 A20 F								
Engine	Information											
All engines	x 4, COIL ON PLUG, x 4, COIL ON PLUG									470 632	C10	
ENGINE												
Cooper S	Petrol	141	09/13->	B46 A20 A, B48 A20 A, B48 A20 F								
Engine	Information											
All engines	x 4, COIL ON PLUG									470 632	C10	
ENGINE												
Cooper S ALL4	Petrol	120	04/15->	B46 A20 A, B48 A20 A								
Engine	Information											
All engines	x 4, COIL ON PLUG									470 632	C10	
ENGINE												
Cooper S ALL4	Petrol	131	07/20->	B46 A20 A, B48 A20 A, B48 A20 F								
Engine	Information											
All engines	x 4, COIL ON PLUG									470 632	C10	
ENGINE												
Cooper S ALL4	Petrol	141	04/15->	B46 A20 A, B48 A20 A								
Engine	Information											
All engines	x 4, COIL ON PLUG									470 632	C10	

A10 CONDENSER	A20 CONTACT SET	A40 DISTRIBUTOR CAP	A50 ROTOR	A70 PICK-UP
C10 COIL	C20 IGNITION MODULE	C30 ELECTRONIC IGNITION KIT	E01 IGNITION CABLE SET	

Vehicle	alim.	kW	Date	Engine	FUNCTIONS ON THE VEHICLE									
					A10	A20	A40	A50	A70	C10 - C30	C20	E01		
ENGINE														
Cooper SJCW	Petrol	155	09/13->	B46 A20 A, B48 A20 A, B48 A20 F										
Engine	Information				A10	A20	A40	A50	A70	C10 - C30	C20	E01		
All engines	x 4, COIL ON PLUG									470 632	C10			
ENGINE														
Cooper SJCW ALL4	Petrol	155	11/14->	B48 A20 A										
Engine	Information				A10	A20	A40	A50	A70	C10 - C30	C20	E01		
All engines	x 4, COIL ON PLUG									470 632	C10			
ENGINE														
Cooper SE ALL4	Petrol/ Electric	100	01/17->	B38 A15 A										
Engine	Information				A10	A20	A40	A50	A70	C10 - C30	C20	E01		
All engines	x 3, COIL ON PLUG									470 632	C10			
ENGINE														
Cooper SE ALL4	Petrol/ Electric	162	07/20->	B38 A15 A										
Engine	Information				A10	A20	A40	A50	A70	C10 - C30	C20	E01		
All engines	x 3, COIL ON PLUG									470 632	C10			
ENGINE														
Cooper SE ALL4	Petrol/ Electric	165	01/17->	B38 A15 A										
Engine	Information				A10	A20	A40	A50	A70	C10 - C30	C20	E01		
All engines	x 3, COIL ON PLUG									470 632	C10			
ENGINE														
Cooper SE ALL4	Petrol/ Electric	92	07/20->	B38 A15 A										
Engine	Information				A10	A20	A40	A50	A70	C10 - C30	C20	E01		
All engines	x 3, COIL ON PLUG									470 632	C10			
ENGINE														
John Cooper Works	Petrol	170	03/15->	B46 A20 B, B48 A20 B										
Engine	Information				A10	A20	A40	A50	A70	C10 - C30	C20	E01		
All engines	x 4, COIL ON PLUG									470 632	C10			
ENGINE														
John Cooper Works	Petrol	225	07/19->	B48 A20 E										
Engine	Information				A10	A20	A40	A50	A70	C10 - C30	C20	E01		
All engines	x 4, COIL ON PLUG									470 632	C10			
ENGINE														
John Cooper Works ALL4	Petrol	170	03/17-06/19	B48 A20 B										
Engine	Information				A10	A20	A40	A50	A70	C10 - C30	C20	E01		
All engines	x 4, COIL ON PLUG									470 632	C10			
ENGINE														
John Cooper Works ALL4	Petrol	225	07/19->	B48 A20 E										
Engine	Information				A10	A20	A40	A50	A70	C10 - C30	C20	E01		
All engines	x 4, COIL ON PLUG									470 632	C10			
ENGINE														
John Cooper Works GP	Petrol	225	03/20->	B48 A20 E										
Engine	Information				A10	A20	A40	A50	A70	C10 - C30	C20	E01		
All engines	x 4, COIL ON PLUG									470 632	C10			
ENGINE														
One	Petrol	75	04/14->	B38 A12 A, B38 A15 A										
Engine	Information				A10	A20	A40	A50	A70	C10 - C30	C20	E01		
All engines	x 3, COIL ON PLUG									470 632	C10			
ENGINE														
One First	Petrol	55	06/14->	B38 A12 A, B38 A15 A										
Engine	Information				A10	A20	A40	A50	A70	C10 - C30	C20	E01		
All engines	x 3, COIL ON PLUG									470 632	C10			

A10 CONDENSER	A20 CONTACT SET	A40 DISTRIBUTOR CAP	A50 ROTOR	A70 PICK-UP
C10 COIL	C20 IGNITION MODULE	C30 ELECTRONIC IGNITION KIT	E01 IGNITION CABLE SET	

The present application list is a brief version. For the detailed information about the possibility of installation on a specific vehicle, please refer to our web-catalogue <http://catalogo.facet.eu/>

Vehicle	alim.	kW	Date	Engine	FUNCTIONS ON THE VEHICLE							
					A10	A20	A40	A50	A70	C10 - C30	C20	E01

ASX

				ENGINE
1.6 LPG	Petrol/ Liquified Petroleum Gas (LPG)	86	06/10->	4A92

Engine	Information	A10	A20	A40	A50	A70	C10 - C30	C20	E01
All engines	x 4, COIL ON PLUG						470 505	C10	

				ENGINE
1.6 MIVEC	Petrol	85	05/10->	4A92

Engine	Information	A10	A20	A40	A50	A70	C10 - C30	C20	E01
All engines	x 4, COIL ON PLUG						470 505	C10	

				ENGINE
1.6 MIVEC	Petrol	86	06/10->	4A92

Engine	Information	A10	A20	A40	A50	A70	C10 - C30	C20	E01
All engines	x 4, COIL ON PLUG						470 505	C10	

				ENGINE
1.8	Petrol	102	02/10->	4B10

Engine	Information	A10	A20	A40	A50	A70	C10 - C30	C20	E01
All engines	x 4, COIL ON PLUG						470 497	C10	

				ENGINE
1.8 4WD	Petrol	102	02/10->	6B4204T30

Engine	Information	A10	A20	A40	A50	A70	C10 - C30	C20	E01
All engines	Qty: 4						470 497	C10	

				ENGINE
2.0 i	Petrol	118	06/10->	4B11

Engine	Information	A10	A20	A40	A50	A70	C10 - C30	C20	E01
All engines	Qty: 4						470 497	C10	

				ENGINE
2.0 i 4WD	Petrol	112	01/10->	4B11

Engine	Information	A10	A20	A40	A50	A70	C10 - C30	C20	E01
All engines	Qty: 4						470 497	C10	

				ENGINE
2.0 i 4WD	Petrol	114	01/10->	4B11

Engine	Information	A10	A20	A40	A50	A70	C10 - C30	C20	E01
All engines	Qty: 4						470 497	C10	

				ENGINE
2.0 i 4WD	Petrol	118	06/10->	4B11

Engine	Information	A10	A20	A40	A50	A70	C10 - C30	C20	E01
All engines	Qty: 4						470 497	C10	

				ENGINE
2.0 MIVEC	Petrol	110	06/10->	4B11, 4J11

Engine	Information	A10	A20	A40	A50	A70	C10 - C30	C20	E01
All engines	x 4, COIL ON PLUG						470 497	C10	

				ENGINE
2.0 MIVEC 4WD	Petrol	110	06/10->	4B11, 4J11

Engine	Information	A10	A20	A40	A50	A70	C10 - C30	C20	E01
All engines	x 4, COIL ON PLUG						470 497	C10	

CARISMA

				ENGINE
1.3 16V	Petrol	60	09/00-10/04	4G13 (16V)

Engine	Information	A10	A20	A40	A50	A70	C10 - C30	C20	E01
All engines									360 883

				ENGINE
1.6	Petrol	66	07/95-06/06	4G92 (SOHC 16V)

Engine	Information	A10	A20	A40	A50	A70	C10 - C30	C20	E01
All engines	->year 30/04/96, version Mitsubishi			831 169	931 136				
All engines	01/05/96 ->								360 764

A10 CONDENSER	A20 CONTACT SET	A40 DISTRIBUTOR CAP	A50 ROTOR	A70 PICK-UP
C10 COIL	C20 IGNITION MODULE	C30 ELECTRONIC IGNITION KIT	E01 IGNITION CABLE SET	

Vehicle	alim.	kW	Date	Engine	FUNCTIONS ON THE VEHICLE									
					A10	A20	A40	A50	A70	C10 - C30	C20	E01		
ENGINE														
1.6	Petrol	70	12/98-06/06	4G92 (SOHC 16V)										
Engine		Information			A10	A20	A40	A50	A70	C10 - C30	C20	E01		
All engines													360 764	
ENGINE														
1.6	Petrol	73	05/97-06/06	4G92 (SOHC 16V)										
Engine		Information			A10	A20	A40	A50	A70	C10 - C30	C20	E01		
All engines		01/05/96 ->											360 764	
ENGINE														
1.6	Petrol	76	09/00-06/06	4G92 (SOHC 16V)										
Engine		Information			A10	A20	A40	A50	A70	C10 - C30	C20	E01		
All engines													360 764	
ENGINE														
1.8	Petrol	85	07/95-09/97	4G93 (SOHC 16V)										
Engine		Information			A10	A20	A40	A50	A70	C10 - C30	C20	E01		
All engines		->year 30/04/96, version Mitsubishi					831 169	931 136						
All engines		01/05/96 ->											360 764	
COLT I														
ENGINE														
1.2 GL	Petrol	40	12/78-01/84	4G11										
Engine		Information			A10	A20	A40	A50	A70	C10 - C30	C20	E01		
All engines		version Mitsubishi				731 085	831 003/001	931 023						
COLT II														
ENGINE														
1.3 EL, GL	Petrol	49	06/86-04/88	G13B										
Engine		Information			A10	A20	A40	A50	A70	C10 - C30	C20	E01		
All engines		version Mitsubishi					831 003/001	931 023						
COLT III														
ENGINE														
1.3 12V	Petrol	55	04/88-05/92	4G13 (12V)										
Engine		Information			A10	A20	A40	A50	A70	C10 - C30	C20	E01		
All engines		version Mitsubishi					831 158	931 119						
ENGINE														
1.3 GL	Petrol	44	04/88-12/90	4G13 (8V)										
Engine		Information			A10	A20	A40	A50	A70	C10 - C30	C20	E01		
All engines		->year 31/05/90, version Mitsubishi					831 003/001	931 023						
All engines		01/06/90 ->, version Mitsubishi					831 158	931 119						
ENGINE														
1.5 Cat	Petrol	66	07/90-05/92	4G15 (12V)										
Engine		Information			A10	A20	A40	A50	A70	C10 - C30	C20	E01		
All engines		version Mitsubishi					831 134							
ENGINE														
1.5 GLXi	Petrol	62	04/88-05/92	4G15 (8V)										
Engine		Information			A10	A20	A40	A50	A70	C10 - C30	C20	E01		
All engines		version Mitsubishi					831 003/001	931 107						
ENGINE														
1.6 GTi 16V	Petrol	91	04/88-05/90	4G61										
Engine		Information			A10	A20	A40	A50	A70	C10 - C30	C20	E01		
All engines													360 401	
ENGINE														
1.8 GTi 16V Cat	Petrol	100	06/90-05/92	4G67										
Engine		Information			A10	A20	A40	A50	A70	C10 - C30	C20	E01		
All engines													360 401	
COLT IV														
ENGINE														
1.3 GLi 12V	Petrol	55	04/92-04/96	4G13 (12V)										
Engine		Information			A10	A20	A40	A50	A70	C10 - C30	C20	E01		
All engines		version Mitsubishi					831 134							

A10	CONDENSER	A20	CONTACT SET	A40	DISTRIBUTOR CAP	A50	ROTOR	A70	PICK-UP
C10	COIL	C20	IGNITION MODULE	C30	ELECTRONIC IGNITION KIT	E01	IGNITION CABLE SET		







The present application list is a brief version. For the detailed information about the possibility of installation on a specific vehicle, please refer to our web-catalogue <http://catalogo.facet.eu/>

				FUNCTIONS ON THE VEHICLE										
Vehicle	alim.	kW	Date	Engine										
				ENGINE										
1.5	Petrol	60	04/92-04/96	4G15										
Engine	Information				A10	A20	A40	A50	A70	C10 - C30	C20	E01		
All engines	version Mitsubishi, no specific info conc. application available						831 134, 831 138	931 119						
				ENGINE										
1.6 4WD	Petrol	84	08/93-08/95	4G92 (SOHC 16V)										
Engine	Information				A10	A20	A40	A50	A70	C10 - C30	C20	E01		
All engines	version Mitsubishi						831 138							
All engines	version Mitsubishi, no specific info conc. application available						931 136, 931 137							
All engines												360 278		
				ENGINE										
1.6 GLXi 16V	Petrol	83	04/92-04/96	4G92 (SOHC 16V)										
Engine	Information				A10	A20	A40	A50	A70	C10 - C30	C20	E01		
All engines	version Mitsubishi						831 138							
All engines	version Mitsubishi, no specific info conc. application available						931 136, 931 137							
All engines												360 278		
COLT V														
				ENGINE										
1.3	Petrol	66	08/02-09/03	4G19										
Engine	Information				A10	A20	A40	A50	A70	C10 - C30	C20	E01		
All engines												360 883		
				ENGINE										
1.5	Petrol	81	09/95-09/03	301353C										
Engine	Information				A10	A20	A40	A50	A70	C10 - C30	C20	E01		
All engines	version Mitsubishi						831 158	931 119						
All engines												360 753		
				ENGINE										
1.5 16V	Petrol	69	10/99-09/03	301353C										
Engine	Information				A10	A20	A40	A50	A70	C10 - C30	C20	E01		
All engines	version Mitsubishi						831 158	931 119						
All engines												360 753		
				ENGINE										
1300	Petrol	60	06/00-09/03	4G13 (16V)										
Engine	Information				A10	A20	A40	A50	A70	C10 - C30	C20	E01		
All engines												360 883		
				ENGINE										
1300 GL, GLX	Petrol	55	05/96-06/00	4G13 (12V)										
Engine	Information				A10	A20	A40	A50	A70	C10 - C30	C20	E01		
All engines	->year 31/05/00, version Mitsubishi						831 168	931 136						
All engines	->year 31/05/00											360 753		
All engines	01/06/00 ->											360 883		
				ENGINE										
1600	Petrol	76	09/00-09/03	4G92 (SOHC 16V)										
Engine	Information				A10	A20	A40	A50	A70	C10 - C30	C20	E01		
All engines												360 764		
				ENGINE										
1600 GLX	Petrol	66	05/96-09/00	4G92 (SOHC 16V)										
Engine	Information				A10	A20	A40	A50	A70	C10 - C30	C20	E01		
All engines												360 764		
COLT VI														
				ENGINE										
1.1	Petrol	55	10/04-06/12	3A91										
Engine	Information				A10	A20	A40	A50	A70	C10 - C30	C20	E01		
All engines	01/07/10 ->, x 3, COIL ON PLUG									470 505	C10			
				ENGINE										
1.1 LPG	Petrol/ Liquified Petro- leum Gas (LPG)	55	10/04-06/12	3A91										
Engine	Information				A10	A20	A40	A50	A70	C10 - C30	C20	E01		
All engines	01/07/10 ->, x 3, COIL ON PLUG									470 505	C10			
A10	CONDENSER		A20	CONTACT SET		A40	DISTRIBUTOR CAP		A50	ROTOR		A70	PICK-UP	
C10	COIL		C20	IGNITION MODULE		C30	ELECTRONIC IGNITION KIT		E01	IGNITION CABLE SET				

Vehicle	alim.	kW	Date	Engine	FUNCTIONS ON THE VEHICLE									
					A10	A20	A40	A50	A70	C10 - C30	C20	E01		
ENGINE														
1.3	Petrol	68	08/04->	4A90										
Engine					A10	A20	A40	A50	A70	C10 - C30	C20	E01		
Information										470 505	C10			
All engines														
ENGINE														
1.3	Petrol	70	06/04-06/12	4A90										
Engine					A10	A20	A40	A50	A70	C10 - C30	C20	E01		
Information										470 505	C10			
All engines														
ENGINE														
1.3 4WD	Petrol	67	08/04->	4A90										
Engine					A10	A20	A40	A50	A70	C10 - C30	C20	E01		
Information										470 505	C10			
All engines														
ENGINE														
1.3 LPG	Petrol/ Liquified Petroleum Gas (LPG)	70	06/04-06/12	4A90										
Engine					A10	A20	A40	A50	A70	C10 - C30	C20	E01		
Information										470 505	C10			
All engines														
ENGINE														
CORDIA														
ENGINE														
1.8 [USA]	Petrol	0	01/82-12/88	G62B										
Engine					A10	A20	A40	A50	A70	C10 - C30	C20	E01		
Information						731 085	831 003/001	931 023						
All engines														
ENGINE														
1.8 Turbo [USA]	Petrol	0	01/82-12/88	G62B										
Engine					A10	A20	A40	A50	A70	C10 - C30	C20	E01		
Information						731 085	831 003/001	931 023						
All engines														
ENGINE														
DELICA D5														
ENGINE														
2.4 4WD	Petrol	125	06/07->	4B12										
Engine					A10	A20	A40	A50	A70	C10 - C30	C20	E01		
Information										470 497	C10			
All engines														
ENGINE														
ECLIPSE I														
ENGINE														
1.8	Petrol	68	12/89-03/94	4G37										
Engine					A10	A20	A40	A50	A70	C10 - C30	C20	E01		
Information							831 135							
All engines														
ENGINE														
2.0 i 16V	Petrol	110	04/91-11/95	4G63 (DOHC 16V)										
Engine					A10	A20	A40	A50	A70	C10 - C30	C20	E01		
Information												360 401		
All engines														
ENGINE														
2.0 i 16V 4WD	Petrol	110	04/91-11/95	4G63 (DOHC 16V)										
Engine					A10	A20	A40	A50	A70	C10 - C30	C20	E01		
Information												360 401		
All engines														
ENGINE														
2.0 Turbo	Petrol	147	12/89-03/94	4G63-T (DOHC 16V)										
Engine					A10	A20	A40	A50	A70	C10 - C30	C20	E01		
Information												360 401		
All engines														
ENGINE														
2.0 Turbo 4WD	Petrol	157	12/89-03/94	4G63-T (DOHC 16V)										
Engine					A10	A20	A40	A50	A70	C10 - C30	C20	E01		
Information												360 401		
All engines														
ENGINE														
GALANT IV														
ENGINE														
1.6 GLX	Petrol	55	09/80-05/84	4G32										
Engine					A10	A20	A40	A50	A70	C10 - C30	C20	E01		
Information								931 107						
All engines														

A10	CONDENSER	A20	CONTACT SET	A40	DISTRIBUTOR CAP	A50	ROTOR	A70	PICK-UP
C10	COIL	C20	IGNITION MODULE	C30	ELECTRONIC IGNITION KIT	E01	IGNITION CABLE SET		

The present application list is a brief version. For the detailed information about the possibility of installation on a specific vehicle, please refer to our web-catalogue <http://catalogo.facet.eu/>



					FUNCTIONS ON THE VEHICLE							
Vehicle	alim.	kW	Date	Engine	 A10	 A20	 A40	 A50	 A70	 C10 - C30	 C20	 E01
GALANT VI												
1.6	Petrol	55	01/88-10/92	4G32								
Engine	Information				A10	A20	A40	A50	A70	C10 - C30	C20	E01
All engines	version Mitsubishi						831 003/001	931 023				
1.8												
Petrol	63	11/87-10/92	4G37									
Engine	Information				A10	A20	A40	A50	A70	C10 - C30	C20	E01
All engines	fuel formation: carburettor, version Mitsubishi						831 003/001	931 023				
All engines	11/05/90 ->, Multi Point Injection (MPI), version Mitsubishi						831 135					
1.8												
Petrol	66	11/87-10/92	4G37									
Engine	Information				A10	A20	A40	A50	A70	C10 - C30	C20	E01
All engines	fuel formation: carburettor, version Mitsubishi						831 003/001	931 023				
All engines	11/05/90 ->, Multi Point Injection (MPI), version Mitsubishi						831 135					
2.0												
Petrol	77	05/89-12/92	4G63 (SOHC 8V)									
Engine	Information				A10	A20	A40	A50	A70	C10 - C30	C20	E01
All engines	->year 31/05/90, version Mitsubishi						831 003/001	931 107				
All engines	01/06/90 ->, version Mitsubishi						831 131	931 131				
2.0												
Petrol	80	11/87-10/92	4G63 (SOHC 8V)									
Engine	Information				A10	A20	A40	A50	A70	C10 - C30	C20	E01
All engines	->year 31/05/90, version Mitsubishi						831 003/001	931 107				
All engines	01/06/90 ->, version Mitsubishi						831 131	931 131				
2.0 4WD												
Petrol	80	12/88-10/92	4G63 (SOHC 8V)									
Engine	Information				A10	A20	A40	A50	A70	C10 - C30	C20	E01
All engines	->year 31/05/90, version Mitsubishi						831 003/001	931 107				
All engines	01/06/90 ->, version Mitsubishi						831 131	931 131				
2.0 GTi 16V												
Petrol	106	11/87-10/92	4G63 (DOHC 16V)									
Engine	Information				A10	A20	A40	A50	A70	C10 - C30	C20	E01
All engines												360 401
2.0 GTI 16V												
Petrol	107	11/88-10/92	4G63 (DOHC 16V)									
Engine	Information				A10	A20	A40	A50	A70	C10 - C30	C20	E01
All engines												360 401
2.0 GTi 16V 4WD												
Petrol	106	06/88-10/92	4G63 (DOHC 16V)									
Engine	Information				A10	A20	A40	A50	A70	C10 - C30	C20	E01
All engines	->year 31/05/91											360 401
2.0 GTI 16V 4x4												
Petrol	106	07/89-12/92	4G63 (DOHC 16V)									
Engine	Information				A10	A20	A40	A50	A70	C10 - C30	C20	E01
All engines	->year 31/05/91											360 401
2.0 GTI 16V Cat 4WD												
Petrol	110	09/91-10/92	4G63 (DOHC 16V)									
Engine	Information				A10	A20	A40	A50	A70	C10 - C30	C20	E01
All engines	->year 31/05/91											360 401
GALANT VII												
1.8	Petrol	85	02/94-08/96	4G93 (SOHC 16V)								
Engine	Information				A10	A20	A40	A50	A70	C10 - C30	C20	E01
All engines												360 278
1.8 GLSI												
Petrol	93	11/92-08/96	4G93 (SOHC 16V)									
Engine	Information				A10	A20	A40	A50	A70	C10 - C30	C20	E01
All engines	version Mitsubishi						831 147	931 137				
All engines												360 278

A10 CONDENSER	A20 CONTACT SET	A40 DISTRIBUTOR CAP	A50 ROTOR	A70 PICK-UP
C10 COIL	C20 IGNITION MODULE	C30 ELECTRONIC IGNITION KIT	E01 IGNITION CABLE SET	

Vehicle	alim.	kW	Date	Engine	FUNCTIONS ON THE VEHICLE							
					A10	A20	A40	A50	A70	C10 - C30	C20	E01
2.0 GLSI												
Petrol 101 11/92-08/96 ENGINE 4G63 (SOHC 16V)												
Engine	Information				A10	A20	A40	A50	A70	C10 - C30	C20	E01
All engines	version Mitsubishi						831 147	931 137				
All engines												360 278
2.0 GLSI 4WD												
Petrol 101 11/92-08/96 ENGINE 4G63 (SOHC 16V)												
Engine	Information				A10	A20	A40	A50	A70	C10 - C30	C20	E01
All engines	version Mitsubishi						831 147	931 137				
All engines												360 278
GALANT VIII												
2.0												
Petrol 100 09/96-09/00 ENGINE 4G63 (SOHC 16V)												
Engine	Information				A10	A20	A40	A50	A70	C10 - C30	C20	E01
All engines												360 764
2.0												
Petrol 98 09/00-10/04 ENGINE 4G63 (SOHC 16V)												
Engine	Information				A10	A20	A40	A50	A70	C10 - C30	C20	E01
All engines												360 764
2.5 V6 24V												
Petrol 118 09/00-10/04 ENGINE 6A13												
Engine	Information				A10	A20	A40	A50	A70	C10 - C30	C20	E01
All engines	version Mitsubishi							931 134				
2.5 V6 24V												
Petrol 120 09/96-09/00 ENGINE 6A13												
Engine	Information				A10	A20	A40	A50	A70	C10 - C30	C20	E01
All engines	version Mitsubishi							931 134				
GRANDIS												
2.0												
Petrol 77 04/04-> ENGINE 4G63 (SOHC 8V)												
Engine	Information				A10	A20	A40	A50	A70	C10 - C30	C20	E01
All engines												360 764
I												
0.7												
Petrol 38 02/07-> ENGINE 3B20												
Engine	Information				A10	A20	A40	A50	A70	C10 - C30	C20	E01
All engines	x 3, COIL ON PLUG									470 503	C10	
L200 II												
1.6												
Petrol 60 04/87-10/96 ENGINE 4G32												
Engine	Information				A10	A20	A40	A50	A70	C10 - C30	C20	E01
All engines	version Mitsubishi						831 003/001	931 023				
2.4												
Petrol 82 06/90-10/96 ENGINE 4G64 (12V)												
Engine	Information				A10	A20	A40	A50	A70	C10 - C30	C20	E01
All engines	version Mitsubishi						831 003/001	931 107				
2.4 4WD												
Petrol 82 06/94-10/96 ENGINE 4G64 (12V)												
Engine	Information				A10	A20	A40	A50	A70	C10 - C30	C20	E01
All engines	version Mitsubishi							931 107				
2.6 4WD												
Petrol 76 11/89-05/95 ENGINE G54B												
Engine	Information				A10	A20	A40	A50	A70	C10 - C30	C20	E01
All engines	version Mitsubishi						831 003/001	931 023				
L200 III												
2.0												
Petrol 90 06/96-12/07 ENGINE 4G63 (SOHC 16V)												
Engine	Information				A10	A20	A40	A50	A70	C10 - C30	C20	E01
All engines	version Mitsubishi							931 131				

A10 CONDENSER	A20 CONTACT SET	A40 DISTRIBUTOR CAP	A50 ROTOR	A70 PICK-UP
C10 COIL	C20 IGNITION MODULE	C30 ELECTRONIC IGNITION KIT	E01 IGNITION CABLE SET	









The present application list is a brief version. For the detailed information about the possibility of installation on a specific vehicle, please refer to our web-catalogue <http://catalogo.facet.eu/>

					FUNCTIONS ON THE VEHICLE											
Vehicle	alim.	kW	Date	Engine												
2.4 4WD																
Petrol 97 06/96-12/07 ENGINE 4G64 (16V)																
Engine Information					A10	A20	A40	A50	A70	C10 - C30	C20	E01				
All engines -->year 30/06/01, version Mitsubishi								931 131								
L200 IV																
2.4 i																
Petrol 94 11/05-12/15 ENGINE 4G64 (16V)																
Engine Information					A10	A20	A40	A50	A70	C10 - C30	C20	E01				
All engines -->year 30/06/01, version Mitsubishi								931 131								
L400																
2.0																
Petrol 83 12/94-10/02 ENGINE 4G63 (SOHC 16V)																
Engine Information					A10	A20	A40	A50	A70	C10 - C30	C20	E01				
All engines version Mitsubishi								931 119								
All engines version Mitsubishi, Multi Point Injection (MPI)								931 131								
2.0																
Petrol 85 06/96-03/01 ENGINE 4G63 (SOHC 16V)																
Engine Information					A10	A20	A40	A50	A70	C10 - C30	C20	E01				
All engines version Mitsubishi								931 119								
All engines version Mitsubishi, Multi Point Injection (MPI)								931 131								
2.4																
Petrol 97 05/95-02/06 ENGINE 4G64 (16V)																
Engine Information					A10	A20	A40	A50	A70	C10 - C30	C20	E01				
All engines version Mitsubishi								931 131								
2.4 i 4WD																
Petrol 97 05/95-05/00 ENGINE 4G64 (16V)																
Engine Information					A10	A20	A40	A50	A70	C10 - C30	C20	E01				
All engines version Mitsubishi								931 131								
LANCER																
1.8 i																
Petrol 0 10/07-> ENGINE --																
Engine Information					A10	A20	A40	A50	A70	C10 - C30	C20	E01				
All engines pole nr. 4										470 497	C10					
LANCER III/IV																
1.2																
Petrol 44 08/86-04/88 ENGINE 4G16																
Engine Information					A10	A20	A40	A50	A70	C10 - C30	C20	E01				
All engines version Mitsubishi							831 003/001	931 023								
LANCER IX																
1.5																
Petrol 80 06/08-> ENGINE 4A91																
Engine Information					A10	A20	A40	A50	A70	C10 - C30	C20	E01				
All engines x 4, COIL ON PLUG										470 505	C10					
1.5 Bifuel																
Petrol/Liquified Petroleum Gas (LPG) 80 02/10-> ENGINE 4A91																
Engine Information					A10	A20	A40	A50	A70	C10 - C30	C20	E01				
All engines x 4, COIL ON PLUG										470 505	C10					
1.6 MIVEC																
Petrol 86 05/10-> ENGINE 4A92																
Engine Information					A10	A20	A40	A50	A70	C10 - C30	C20	E01				
All engines x 4, COIL ON PLUG										470 505	C10					
1.8																
Petrol 103 05/10-> ENGINE 4B10, 4J10																
Engine Information					A10	A20	A40	A50	A70	C10 - C30	C20	E01				
All engines x 4, COIL ON PLUG										470 497	C10					
1.8																
Petrol 105 02/08-> ENGINE 4B10																
Engine Information					A10	A20	A40	A50	A70	C10 - C30	C20	E01				
All engines x 4, COIL ON PLUG										470 497	C10					
A10 CONDENSER					A20 CONTACT SET					A40 DISTRIBUTOR CAP			A50 ROTOR		A70 PICK-UP	
C10 COIL					C20 IGNITION MODULE					C30 ELECTRONIC IGNITION KIT			E01 IGNITION CABLE SET			

Vehicle	alim.	kW	Date	Engine	FUNCTIONS ON THE VEHICLE									
					A10	A20	A40	A50	A70	C10 - C30	C20	E01		
ENGINE														
1.8 Bifuel	Petrol/ Liquified Petroleum Gas (LPG)	105	01/10->	4B10										
Engine	Information				A10	A20	A40	A50	A70	C10 - C30	C20	E01		
All engines	x 4, COIL ON PLUG									470 497	C10			
ENGINE														
1.8 Flex	Petrol/ Ethanol	103	03/09->	4B10										
Engine	Information				A10	A20	A40	A50	A70	C10 - C30	C20	E01		
All engines	x 4, COIL ON PLUG									470 497	C10			
ENGINE														
1.8 Flexfuel	Petrol/ Ethanol	103	03/09->	6B4204T30										
Engine	Information				A10	A20	A40	A50	A70	C10 - C30	C20	E01		
All engines	Qty: 4									470 497	C10			
ENGINE														
1.8 Flexfuel	Petrol/ Ethanol	105	01/10->	4B10										
Engine	Information				A10	A20	A40	A50	A70	C10 - C30	C20	E01		
All engines	x 4, COIL ON PLUG									470 497	C10			
ENGINE														
1.8 MIVEC	Petrol	103	03/09->	4B10, 4J10										
Engine	Information				A10	A20	A40	A50	A70	C10 - C30	C20	E01		
All engines	x 4, COIL ON PLUG									470 497	C10			
ENGINE														
1.8 Mivec	Petrol	110	11/09->	4B10										
Engine	Information				A10	A20	A40	A50	A70	C10 - C30	C20	E01		
All engines	x 4, COIL ON PLUG									470 497	C10			
ENGINE														
2.0	Petrol	108	01/09->	4B11										
Engine	Information				A10	A20	A40	A50	A70	C10 - C30	C20	E01		
All engines	x 4, COIL ON PLUG									470 497	C10			
ENGINE														
2.0	Petrol	110	01/13->	4B11										
Engine	Information				A10	A20	A40	A50	A70	C10 - C30	C20	E01		
All engines	no specific info conc. application available, pole nr. 4									470 497	C10			
ENGINE														
2.0	Petrol	115	04/08->	4B11										
Engine	Information				A10	A20	A40	A50	A70	C10 - C30	C20	E01		
All engines	no specific info conc. application available, pole nr. 4									470 497	C10			
ENGINE														
2.0 i	Petrol	113	04/07->	4B11										
Engine	Information				A10	A20	A40	A50	A70	C10 - C30	C20	E01		
All engines	no specific info conc. application available, Qty: 4									470 497	C10			
All engines	x 4, COIL ON PLUG									470 497	C10			
ENGINE														
2.0 i	Petrol	118	10/09->	4B11										
Engine	Information				A10	A20	A40	A50	A70	C10 - C30	C20	E01		
All engines	no specific info conc. application available, Qty: 4									470 497	C10			
ENGINE														
2.0 i 4WD	Petrol	113	03/07->	4B11										
Engine	Information				A10	A20	A40	A50	A70	C10 - C30	C20	E01		
All engines	x 4, COIL ON PLUG									470 497	C10			
LANCER V														
ENGINE														
1.2 GL	Petrol	44	05/88-08/92	4G16										
Engine	Information				A10	A20	A40	A50	A70	C10 - C30	C20	E01		
All engines	version Mitsubishi						831 003/001	931 023						

A10	CONDENSER	A20	CONTACT SET	A40	DISTRIBUTOR CAP	A50	ROTOR	A70	PICK-UP
C10	COIL	C20	IGNITION MODULE	C30	ELECTRONIC IGNITION KIT	E01	IGNITION CABLE SET		

The present application list is a brief version. For the detailed information about the possibility of installation on a specific vehicle, please refer to our web-catalogue <http://catalogo.facet.eu/>









				FUNCTIONS ON THE VEHICLE								
Vehicle	alim.	kW	Date	Engine	 A10	 A20	 A40	 A50	 A70	 C10 - C30	 C20	 E01
ENGINE												
1.3	Petrol	44	04/88-05/92	4G13 (8V)								
Engine	Information				A10	A20	A40	A50	A70	C10 - C30	C20	E01
All engines	->year 31/05/90, version Mitsubishi						831 003/001	931 023				
All engines	01/06/90 ->, version Mitsubishi						831 158	931 119				
ENGINE												
1.3	Petrol	51	08/88-05/92	4G13 (8V), G13B								
Engine	Information				A10	A20	A40	A50	A70	C10 - C30	C20	E01
All engines	->year 31/05/90, version Mitsubishi						831 003/001	931 023				
All engines	01/06/90 ->, version Mitsubishi						831 158	931 119				
ENGINE												
1.3 12V	Petrol	44	07/90-07/93	4G13 (12V)								
Engine	Information				A10	A20	A40	A50	A70	C10 - C30	C20	E01
All engines	version Mitsubishi						831 158	931 119				
ENGINE												
1.3 12V	Petrol	55	07/90-05/94	4G13 (12V)								
Engine	Information				A10	A20	A40	A50	A70	C10 - C30	C20	E01
All engines	version Mitsubishi						831 134					
ENGINE												
1.3 GL	Petrol	50	05/88-06/90	G13B								
Engine	Information				A10	A20	A40	A50	A70	C10 - C30	C20	E01
All engines	version Mitsubishi						831 003/001	931 023				
ENGINE												
1.3 GL	Petrol	55	07/90-08/92	4G13 (12V)								
Engine	Information				A10	A20	A40	A50	A70	C10 - C30	C20	E01
All engines	version Mitsubishi						831 134					
ENGINE												
1.5	Petrol	56	09/88-08/90	4G15 (12V)								
Engine	Information				A10	A20	A40	A50	A70	C10 - C30	C20	E01
All engines	->year 31/05/90, version Mitsubishi						831 003/001	931 107				
All engines	01/06/90 ->, version Mitsubishi						831 134					
ENGINE												
1.5	Petrol	61	04/89-08/90	4G15 (12V)								
Engine	Information				A10	A20	A40	A50	A70	C10 - C30	C20	E01
All engines	->year 31/05/90, version Mitsubishi						831 003/001	931 107				
All engines	01/06/90 ->, version Mitsubishi						831 134					
ENGINE												
1.5	Petrol	62	04/88-05/92	4G15 (12V), 4G15 (8V)								
Engine	Information				A10	A20	A40	A50	A70	C10 - C30	C20	E01
All engines	->year 31/05/90, version Mitsubishi						831 003/001	931 023				
All engines	01/06/90 ->, version Mitsubishi						831 158	931 119				
ENGINE												
1.5	Petrol	65	09/90-09/92	4G15 (12V)								
Engine	Information				A10	A20	A40	A50	A70	C10 - C30	C20	E01
All engines	version Mitsubishi						831 134					
ENGINE												
1.5 12V	Petrol	66	05/89-05/92	4G15 (12V)								
Engine	Information				A10	A20	A40	A50	A70	C10 - C30	C20	E01
All engines	->year 31/05/90, version Mitsubishi						831 003/001	931 107				
All engines	01/06/90 ->, version Mitsubishi						831 134					
ENGINE												
1.5 GLS	Petrol	63	08/89-08/92	4G15 (12V)								
Engine	Information				A10	A20	A40	A50	A70	C10 - C30	C20	E01
All engines	->year 31/05/90, version Mitsubishi						831 003/001	931 107				
All engines	01/06/90 ->, version Mitsubishi						831 134					
ENGINE												
1.6 16V	Petrol	83	06/92-05/94	4G92 (SOHC 16V)								
Engine	Information				A10	A20	A40	A50	A70	C10 - C30	C20	E01
All engines	version Mitsubishi						831 138	931 137				
All engines												360 278

A10 CONDENSER	A20 CONTACT SET	A40 DISTRIBUTOR CAP	A50 ROTOR	A70 PICK-UP
C10 COIL	C20 IGNITION MODULE	C30 ELECTRONIC IGNITION KIT	E01 IGNITION CABLE SET	

Vehicle	alim.	kW	Date	Engine	FUNCTIONS ON THE VEHICLE									
					A10	A20	A40	A50	A70	C10 - C30	C20	E01		
ENGINE														
1.6 4WD	Petrol	84	06/92-11/93	4G92 (SOHC 16V)										
Engine	Information				A10	A20	A40	A50	A70	C10 - C30	C20	E01		
All engines	version Mitsubishi						831 138	931 137						
All engines													360 278	
ENGINE														
1.6 GTi	Petrol	91	05/88-05/90	4G61										
Engine	Information				A10	A20	A40	A50	A70	C10 - C30	C20	E01		
All engines													360 401	
ENGINE														
1.8 4WD	Petrol	63	03/89-12/90	4G37										
Engine	Information				A10	A20	A40	A50	A70	C10 - C30	C20	E01		
All engines	->year 31/05/90, version Mitsubishi						831 003/001	931 023						
All engines	01/06/90 ->, version Mitsubishi						831 131	931 131						
ENGINE														
1.8 4WD	Petrol	69	08/90-06/92	4G37										
Engine	Information				A10	A20	A40	A50	A70	C10 - C30	C20	E01		
All engines	version Mitsubishi						831 131	931 131						
ENGINE														
1.8 4WD	Petrol	71	09/89-06/92	4G37										
Engine	Information				A10	A20	A40	A50	A70	C10 - C30	C20	E01		
All engines	->year 31/05/90, version Mitsubishi						831 003/001	931 107						
All engines	01/06/90 ->, version Mitsubishi						831 131	931 131						
ENGINE														
1.8 GTi	Petrol	70	06/92-07/93	4G37										
Engine	Information				A10	A20	A40	A50	A70	C10 - C30	C20	E01		
All engines	version Mitsubishi						831 131	931 131						
ENGINE														
1.8 GTi 16V	Petrol	100	11/89-05/92	4G67										
Engine	Information				A10	A20	A40	A50	A70	C10 - C30	C20	E01		
All engines													360 401	
LANCER VI														
ENGINE														
1.5	Petrol	65	09/92-07/96	4G15 (12V)										
Engine	Information				A10	A20	A40	A50	A70	C10 - C30	C20	E01		
All engines	version Mitsubishi						831 158	931 119						
ENGINE														
1.6	Petrol	66	02/94-12/96	4G92 (SOHC 16V)										
Engine	Information				A10	A20	A40	A50	A70	C10 - C30	C20	E01		
All engines													360 278	
ENGINE														
1.6 16V	Petrol	83	06/92-10/03	4G92 (SOHC 16V)										
Engine	Information				A10	A20	A40	A50	A70	C10 - C30	C20	E01		
All engines	version Mitsubishi, no specific info conc. application available						831 138, 831 168	931 136, 931 137						
All engines													360 278	
ENGINE														
1.6 16V 4WD	Petrol	83	06/92-10/03	4G92 (SOHC 16V)										
Engine	Information				A10	A20	A40	A50	A70	C10 - C30	C20	E01		
All engines	version Mitsubishi, no specific info conc. application available						831 138, 831 168	931 136, 931 137						
All engines													360 278	
ENGINE														
1.6 i	Petrol	71	09/92-07/96	4G92 (SOHC 16V)										
Engine	Information				A10	A20	A40	A50	A70	C10 - C30	C20	E01		
All engines													360 278	
ENGINE														
1.8 GTi	Petrol	70	06/92-07/93	4G37										
Engine	Information				A10	A20	A40	A50	A70	C10 - C30	C20	E01		
All engines	version Mitsubishi						831 131	931 131						

A10	CONDENSER	A20	CONTACT SET	A40	DISTRIBUTOR CAP	A50	ROTOR	A70	PICK-UP
C10	COIL	C20	IGNITION MODULE	C30	ELECTRONIC IGNITION KIT	E01	IGNITION CABLE SET		

The present application list is a brief version. For the detailed information about the possibility of installation on a specific vehicle, please refer to our web-catalogue <http://catalogo.facet.eu/>





					FUNCTIONS ON THE VEHICLE							
Vehicle	alim.	kW	Date	Engine								
LANCER VII												
1.3 12V	Petrol	55	12/95-08/03	4G13 (12V)								
Engine	Information				A10	A20	A40	A50	A70	C10 - C30	C20	E01
All engines	version Mitsubishi						831 168	931 136				
All engines												360 753
1.5												
Petrol	74	06/00-08/03	301353C									
Engine	Information				A10	A20	A40	A50	A70	C10 - C30	C20	E01
All engines	version Mitsubishi						831 158	931 119				
All engines												360 753
1.5 16V												
Petrol	69	10/99-08/03	301353C									
Engine	Information				A10	A20	A40	A50	A70	C10 - C30	C20	E01
All engines	version Mitsubishi						831 158	931 119				
All engines												360 753
1.6 16V												
Petrol	66	12/95-08/03	4G92 (SOHC 16V)									
Engine	Information				A10	A20	A40	A50	A70	C10 - C30	C20	E01
All engines												360 764
2.0 16V EVO IV												
Petrol	199	08/96-06/97	4G63 Turbo									
Engine	Information				A10	A20	A40	A50	A70	C10 - C30	C20	E01
All engines												358 251
EVO V												
Petrol	206	01/98-12/98	4G63 Turbo									
Engine	Information				A10	A20	A40	A50	A70	C10 - C30	C20	E01
All engines												358 251
EVO VI												
Petrol	207	01/99-02/01	4G63 Turbo									
Engine	Information				A10	A20	A40	A50	A70	C10 - C30	C20	E01
All engines												358 251
LANCER VIII												
1.3	Petrol	60	09/03-12/13	4G13 (16V)								
Engine	Information				A10	A20	A40	A50	A70	C10 - C30	C20	E01
All engines												360 883
1.6												
Petrol	72	09/03-12/13	4G18									
Engine	Information				A10	A20	A40	A50	A70	C10 - C30	C20	E01
All engines												360 883
1.8 SEi Limited												
Petrol	91	09/03-03/07	4G93 (GDI)									
Engine	Information				A10	A20	A40	A50	A70	C10 - C30	C20	E01
All engines	Qty: 4									470 497	C10	
2.0												
Petrol	85	09/03->	4G63 (DOHC 16V)									
Engine	Information				A10	A20	A40	A50	A70	C10 - C30	C20	E01
All engines												358 251
2.0												
Petrol	99	09/03-12/13	4G63 (DOHC 16V), 4G63-7									
Engine	Information				A10	A20	A40	A50	A70	C10 - C30	C20	E01
All engines												358 251
MIRAGE III												
1.5	Petrol	62	05/88-06/90	4G15 (12V)								
Engine	Information				A10	A20	A40	A50	A70	C10 - C30	C20	E01
All engines	version Mitsubishi						831 134					

A10 CONDENSER	A20 CONTACT SET	A40 DISTRIBUTOR CAP	A50 ROTOR	A70 PICK-UP
C10 COIL	C20 IGNITION MODULE	C30 ELECTRONIC IGNITION KIT	E01 IGNITION CABLE SET	

Vehicle	alim.	kW	Date	Engine	FUNCTIONS ON THE VEHICLE									
					A10	A20	A40	A50	A70	C10 - C30	C20	E01		
ENGINE														
1.5 12V	Petrol	60	05/88-06/90	4G15 (12V)										
Engine	Information				A10	A20	A40	A50	A70	C10 - C30	C20	E01		
All engines	version Mitsubishi						831 134							
ENGINE														
1.5 12V	Petrol	62	05/88-06/90	4G15 (12V)										
Engine	Information				A10	A20	A40	A50	A70	C10 - C30	C20	E01		
All engines	version Mitsubishi						831 134							
MONTERO														
ENGINE														
2.4 16V	Petrol	100	04/91->	4G64 (12V)										
Engine	Information				A10	A20	A40	A50	A70	C10 - C30	C20	E01		
All engines	version Mitsubishi						831 003/001	931 107						
ENGINE														
2.6i [USA]	Petrol	76	01/83-12/90	4G54										
Engine	Information				A10	A20	A40	A50	A70	C10 - C30	C20	E01		
All engines	version Mitsubishi						831 003/001	931 023						
MONTERO IO														
ENGINE														
1.8 GDI	Petrol	88	08/99->	4G93 (SOHC 16V)										
Engine	Information				A10	A20	A40	A50	A70	C10 - C30	C20	E01		
All engines												360 764		
MONTERO SPORT														
ENGINE														
3.0 V6	Petrol	130	11/98->	6G72										
Engine	Information				A10	A20	A40	A50	A70	C10 - C30	C20	E01		
All engines												360 344		
OUTLANDER I														
ENGINE														
2.0	Petrol	100	05/03-10/06	4G63 (DOHC 16V)										
Engine	Information				A10	A20	A40	A50	A70	C10 - C30	C20	E01		
All engines												358 251		
ENGINE														
2.0 4WD	Petrol	100	05/03-10/06	4G63 (DOHC 16V)										
Engine	Information				A10	A20	A40	A50	A70	C10 - C30	C20	E01		
All engines												358 251		
ENGINE														
2.0 4WD	Petrol	93	05/03-10/06	4G63 (DOHC 16V)										
Engine	Information				A10	A20	A40	A50	A70	C10 - C30	C20	E01		
All engines												358 251		
ENGINE														
2.0 Turbo 4WD	Petrol	148	04/04-10/06	4G63-T (DOHC 16V)										
Engine	Information				A10	A20	A40	A50	A70	C10 - C30	C20	E01		
All engines												358 251		
ENGINE														
2.0 Turbo-R 4WD	Petrol	177	01/02-10/06	4G63 Turbo										
Engine	Information				A10	A20	A40	A50	A70	C10 - C30	C20	E01		
All engines												358 251		
ENGINE														
2.4 4WD	Petrol	102	05/03-10/06	4G64 (16V)										
Engine	Information				A10	A20	A40	A50	A70	C10 - C30	C20	E01		
All engines	Qty: 4, no specific info conc. application available									470 497	C10			
ENGINE														
2.4 HDD Mivec	Petrol	118	03/01-12/06	4G69										
Engine	Information				A10	A20	A40	A50	A70	C10 - C30	C20	E01		
All engines	Qty: 4, no specific info conc. application available									470 497	C10			
OUTLANDER II														
ENGINE														
2.0	Petrol	108	11/06-11/12	4B11										
Engine	Information				A10	A20	A40	A50	A70	C10 - C30	C20	E01		
All engines	x 4, COIL ON PLUG									470 497	C10			

A10 CONDENSER	A20 CONTACT SET	A40 DISTRIBUTOR CAP	A50 ROTOR	A70 PICK-UP
C10 COIL	C20 IGNITION MODULE	C30 ELECTRONIC IGNITION KIT	E01 IGNITION CABLE SET	

The present application list is a brief version. For the detailed information about the possibility of installation on a specific vehicle, please refer to our web-catalogue <http://catalogo.facet.eu/>

					FUNCTIONS ON THE VEHICLE							
Vehicle	alim.	kW	Date	Engine	 A10	 A20	 A40	 A50	 A70	 C10 - C30	 C20	 E01
ENGINE												
2.0	Petrol	118	06/09-11/12	4B11								
ENGINE												
Engine		Information			A10	A20	A40	A50	A70	C10 - C30	C20	E01
All engines		Qty: 4								470 497	C10	
ENGINE												
2.0 4WD	Petrol	108	11/06-11/12	4B11								
ENGINE												
Engine		Information			A10	A20	A40	A50	A70	C10 - C30	C20	E01
All engines		x 4, COIL ON PLUG								470 497	C10	
ENGINE												
2.4	Petrol	125	11/06-11/12	4B12								
ENGINE												
Engine		Information			A10	A20	A40	A50	A70	C10 - C30	C20	E01
All engines		x 4, COIL ON PLUG								470 497	C10	
ENGINE												
2.4 4WD	Petrol	125	09/07-11/12	4B12								
ENGINE												
Engine		Information			A10	A20	A40	A50	A70	C10 - C30	C20	E01
All engines		x 4, COIL ON PLUG								470 497	C10	
ENGINE												
2.4 Flex 4WD	Petrol/ Ethanol	125	09/07-11/12	4B12								
ENGINE												
Engine		Information			A10	A20	A40	A50	A70	C10 - C30	C20	E01
All engines		x 4, COIL ON PLUG								470 497	C10	
ENGINE												
3.0 4WD	Petrol	162	11/06-11/12	6B31								
ENGINE												
Engine		Information			A10	A20	A40	A50	A70	C10 - C30	C20	E01
All engines		x 6, COIL ON PLUG								470 497	C10	
ENGINE												
3.0 4WD	Petrol	169	09/10-12/12	6B31								
ENGINE												
Engine		Information			A10	A20	A40	A50	A70	C10 - C30	C20	E01
All engines		x 6, COIL ON PLUG								470 497	C10	
ENGINE												
3.0 4WD	Petrol	177	10/09-11/12	6B31								
ENGINE												
Engine		Information			A10	A20	A40	A50	A70	C10 - C30	C20	E01
All engines		Qty: 6								470 497	C10	
ENGINE												
3.0 AWD	Petrol	164	11/06-12/10	6B31								
ENGINE												
Engine		Information			A10	A20	A40	A50	A70	C10 - C30	C20	E01
All engines		x 6, COIL ON PLUG								470 497	C10	
ENGINE												
3.0 FWD	Petrol	162	11/06-11/12	6B31								
ENGINE												
Engine		Information			A10	A20	A40	A50	A70	C10 - C30	C20	E01
All engines		Qty: 6								470 497	C10	
ENGINE												
OUTLANDER III												
3.0	Petrol	0	08/12->	6B31								
ENGINE												
Engine		Information			A10	A20	A40	A50	A70	C10 - C30	C20	E01
All engines		Qty: 6								470 497	C10	
ENGINE												
3.0 4WD	Petrol	165	03/14->	6B31								
ENGINE												
Engine		Information			A10	A20	A40	A50	A70	C10 - C30	C20	E01
All engines		x 6, COIL ON PLUG								470 497	C10	
ENGINE												
3.0 4WD	Petrol	169	03/14->	6B31								
ENGINE												
Engine		Information			A10	A20	A40	A50	A70	C10 - C30	C20	E01
All engines		x 6, COIL ON PLUG								470 497	C10	
ENGINE												
3.0 GT 4WD	Petrol	167	08/12->	6B31								
ENGINE												
Engine		Information			A10	A20	A40	A50	A70	C10 - C30	C20	E01
All engines		x 6, COIL ON PLUG								470 497	C10	

A10 CONDENSER	A20 CONTACT SET	A40 DISTRIBUTOR CAP	A50 ROTOR	A70 PICK-UP
C10 COIL	C20 IGNITION MODULE	C30 ELECTRONIC IGNITION KIT	E01 IGNITION CABLE SET	

Vehicle	alim.	kW	Date	Engine	FUNCTIONS ON THE VEHICLE								
					A10	A20	A40	A50	A70	C10 - C30	C20	E01	
PAJERO I													
2.6	Petrol	76	01/83-11/90	4G54									
Engine	Information				A10	A20	A40	A50	A70	C10 - C30	C20	E01	
All engines	->year 31/08/84, version Mitsubishi					731 085							
All engines	version Mitsubishi						831 003/001	931 023					
2.6 4WD	Petrol	76	01/83-09/87	4G54									
Engine	Information				A10	A20	A40	A50	A70	C10 - C30	C20	E01	
All engines	->year 31/08/84, version Mitsubishi					731 085							
All engines	version Mitsubishi						831 003/001	931 023					
2.6 4WD	Petrol	79	10/86-05/91	4G54									
Engine	Information				A10	A20	A40	A50	A70	C10 - C30	C20	E01	
All engines	version Mitsubishi					731 085	831 003/001	931 023					
3.0 i 4WD	Petrol	105	05/88-05/91	6G72 (SOHC 12V)									
Engine	Information				A10	A20	A40	A50	A70	C10 - C30	C20	E01	
All engines	version Mitsubishi						831 116	931 109					
3.0 V6	Petrol	104	11/88-11/90	6G72 (SOHC 12V)									
Engine	Information				A10	A20	A40	A50	A70	C10 - C30	C20	E01	
All engines	version Mitsubishi						831 116	931 109					
PAJERO II													
2.4	Petrol	82	04/91-04/00	4G64 (12V)									
Engine	Information				A10	A20	A40	A50	A70	C10 - C30	C20	E01	
All engines	version Mitsubishi						831 003/001	931 107					
2.6 4WD	Petrol	76	03/91-10/97	4G54									
Engine	Information				A10	A20	A40	A50	A70	C10 - C30	C20	E01	
All engines	version Mitsubishi						831 003/001	931 023					
3.0 V6	Petrol	110	12/90-12/95	6G72 (SOHC 12V)									
Engine	Information				A10	A20	A40	A50	A70	C10 - C30	C20	E01	
All engines	version Mitsubishi						831 116	931 109					
3.0 V6 24V	Petrol	130	06/97-10/99	6G72 (SOHC 24V)									
Engine	Information				A10	A20	A40	A50	A70	C10 - C30	C20	E01	
All engines	version Mitsubishi											360 344	
3.0 V6 24V	Petrol	133	06/94-04/00	6G72 (SOHC 24V)									
Engine	Information				A10	A20	A40	A50	A70	C10 - C30	C20	E01	
All engines	01/06/97 ->											360 344	
3.0 V6 4WD	Petrol	110	12/90-12/95	6G72 (SOHC 12V)									
Engine	Information				A10	A20	A40	A50	A70	C10 - C30	C20	E01	
All engines	version Mitsubishi						831 116	931 109					
3.5 V6 24V	Petrol	143	07/97-10/99	6G74 (DOHC 24V), 6G74 (SOHC 24V)									
Engine	Information				A10	A20	A40	A50	A70	C10 - C30	C20	E01	
All engines	01/06/97 ->											360 344	
3.5 V6 24V	Petrol	153	06/94-10/99	6G74 (DOHC 24V), 6G74 (SOHC 24V)									
Engine	Information				A10	A20	A40	A50	A70	C10 - C30	C20	E01	
All engines	01/06/97 ->											360 344	

A10	CONDENSER	A20	CONTACT SET	A40	DISTRIBUTOR CAP	A50	ROTOR	A70	PICK-UP
C10	COIL	C20	IGNITION MODULE	C30	ELECTRONIC IGNITION KIT	E01	IGNITION CABLE SET		

The present application list is a brief version. For the detailed information about the possibility of installation on a specific vehicle, please refer to our web-catalogue <http://catalogo.facet.eu/>

					FUNCTIONS ON THE VEHICLE							
Vehicle	alim.	kW	Date	Engine	 A10	 A20	 A40	 A50	 A70	 C10 - C30	 C20	 E01
PAJERO III												
2.4	Petrol	82	10/01-08/06	ENGINE 4G64 (12V)								
Engine	Information				A10	A20	A40	A50	A70	C10 - C30	C20	E01
All engines	version Mitsubishi						831 003/001	931 107				
2.4 4x4	Petrol	82	10/01-12/06	ENGINE 4G64 (12V)								
Engine	Information				A10	A20	A40	A50	A70	C10 - C30	C20	E01
All engines	version Mitsubishi						831 003/001	931 107				
3.0	Petrol	125	10/01-12/06	ENGINE 6G72 (SOHC 24V)								
Engine	Information				A10	A20	A40	A50	A70	C10 - C30	C20	E01
All engines												360 344
3.0 ZR	Petrol	132	08/03->	ENGINE 6G72 (DOHC 24V)								
Engine	Information				A10	A20	A40	A50	A70	C10 - C30	C20	E01
All engines												360 344
3.5	Petrol	149	04/00-01/07	ENGINE 6G74 (DOHC 24V)								
Engine	Information				A10	A20	A40	A50	A70	C10 - C30	C20	E01
All engines	01/06/97 ->											360 344
3.5 i	Petrol	160	09/03-10/06	ENGINE 6G74 (DOHC 24V), 6G74 (SOHC 24V)								
Engine	Information				A10	A20	A40	A50	A70	C10 - C30	C20	E01
All engines	01/06/97 ->											360 344
3.5 V6 GDI	Petrol	149	04/00-12/06	ENGINE 6G74 (GDI)								
Engine	Information				A10	A20	A40	A50	A70	C10 - C30	C20	E01
All engines	01/06/97 ->											360 344
PAJERO PININ												
1.8	Petrol	84	11/01-06/07	ENGINE 4G93 (SOHC 16V)								
Engine	Information				A10	A20	A40	A50	A70	C10 - C30	C20	E01
All engines												360 764
1.8 GDI	Petrol	88	10/99-10/01	ENGINE 4G93 (GDI)								
Engine	Information				A10	A20	A40	A50	A70	C10 - C30	C20	E01
All engines												360 764
PAJERO SPORT I												
3.0 4WD	Petrol	129	09/96-12/01	ENGINE 6G72 (SOHC 24V)								
Engine	Information				A10	A20	A40	A50	A70	C10 - C30	C20	E01
All engines												360 344
3.0 V6	Petrol	125	06/00->	ENGINE 6G72 (SOHC 24V)								
Engine	Information				A10	A20	A40	A50	A70	C10 - C30	C20	E01
All engines												360 344
3.0 V6	Petrol	130	11/98-10/00	ENGINE 6G72 (SOHC 24V)								
Engine	Information				A10	A20	A40	A50	A70	C10 - C30	C20	E01
All engines												360 344
3.0 V6 4WD	Petrol	123	03/03->	ENGINE 6G72 (DOHC 24V)								
Engine	Information				A10	A20	A40	A50	A70	C10 - C30	C20	E01
All engines												360 344
PAJERO SPORT II												
2.4	Petrol	94	07/08->	ENGINE 4G64 (16V)								
Engine	Information				A10	A20	A40	A50	A70	C10 - C30	C20	E01
All engines	version Mitsubishi						831 003/001	931 107				

A10 CONDENSER	A20 CONTACT SET	A40 DISTRIBUTOR CAP	A50 ROTOR	A70 PICK-UP
C10 COIL	C20 IGNITION MODULE	C30 ELECTRONIC IGNITION KIT	E01 IGNITION CABLE SET	

Vehicle	alim.	kW	Date	Engine	FUNCTIONS ON THE VEHICLE							
					A10	A20	A40	A50	A70	C10 - C30	C20	E01

ENGINE				
3.0	Petrol	162	09/08->	6B31

Engine	Information	A10	A20	A40	A50	A70	C10 - C30	C20	E01
All engines	Qty: 6						470 497	C10	

ENGINE				
3.0 4WD	Petrol	162	09/08->	6B31

Engine	Information	A10	A20	A40	A50	A70	C10 - C30	C20	E01
All engines	x 6, COIL ON PLUG						470 497	C10	

ENGINE			
--------	--	--	--

ENGINE				
1.5 i [USA]	Petrol	0	01/89-12/94	G4DJ

Engine	Information	A10	A20	A40	A50	A70	C10 - C30	C20	E01
All engines	version Mitsubishi			831 003/001	931 107				

ENGINE			
--------	--	--	--

ENGINE				
1.2.6 4x4	Petrol	76	01/84-02/91	4G54

Engine	Information	A10	A20	A40	A50	A70	C10 - C30	C20	E01
All engines	->year 31/08/84, version Mitsubishi		731 085						
All engines	version Mitsubishi, version Mitsubishi			831 003/001					
All engines	version Mitsubishi				931 023				

ENGINE			
--------	--	--	--

ENGINE				
3.0	Petrol	125	06/92-10/96	6G72 (SOHC 12V)

Engine	Information	A10	A20	A40	A50	A70	C10 - C30	C20	E01
All engines				831 143					

ENGINE			
--------	--	--	--

ENGINE				
3.0 V6	Petrol	130	12/90-07/96	6G72 (SOHC 12V)

Engine	Information	A10	A20	A40	A50	A70	C10 - C30	C20	E01
All engines				831 143					

ENGINE			
--------	--	--	--

ENGINE				
2.0 16V	Petrol	83	08/96-05/00	4G63 (DOHC 16V)

Engine	Information	A10	A20	A40	A50	A70	C10 - C30	C20	E01
All engines	version Mitsubishi				931 119				
All engines	version Mitsubishi, Multi Point Injection (MPI)				931 131				

ENGINE			
--------	--	--	--

ENGINE				
2.4 i	Petrol	97	05/95-05/00	4G64 (16V)

Engine	Information	A10	A20	A40	A50	A70	C10 - C30	C20	E01
All engines	version Mitsubishi				931 131				

ENGINE			
--------	--	--	--

ENGINE				
1.8	Petrol	85	06/96-08/99	4G93 (SOHC 16V)

Engine	Information	A10	A20	A40	A50	A70	C10 - C30	C20	E01
All engines	->year 31/05/96, version Mitsubishi			831 138	931 137				
All engines	01/06/96 ->, version Mitsubishi				931 136				
All engines									360 278

ENGINE			
--------	--	--	--

ENGINE				
1.8	Petrol	90	10/91-08/99	4G93 (SOHC 16V)

Engine	Information	A10	A20	A40	A50	A70	C10 - C30	C20	E01
All engines	->year 31/05/96, version Mitsubishi			831 138	931 137				
All engines	01/06/96 ->, version Mitsubishi				931 136				
All engines									360 278

ENGINE			
--------	--	--	--

ENGINE				
1.8 4WD	Petrol	85	06/96-08/99	4G93 (SOHC 16V)

Engine	Information	A10	A20	A40	A50	A70	C10 - C30	C20	E01
All engines	version Mitsubishi			831 138					
All engines	01/06/96 ->, version Mitsubishi				931 136				
All engines	->year 31/05/96, version Mitsubishi				931 137				
All engines									360 278

A10 CONDENSER	A20 CONTACT SET	A40 DISTRIBUTOR CAP	A50 ROTOR	A70 PICK-UP
C10 COIL	C20 IGNITION MODULE	C30 ELECTRONIC IGNITION KIT	E01 IGNITION CABLE SET	

Vehicle	alim.	kW	Date	Engine	FUNCTIONS ON THE VEHICLE								
					A10	A20	A40	A50	A70	C10 - C30	C20	E01	
ENGINE													
1.8 4WD	Petrol	90	10/91-08/99	4G93 (SOHC 16V)									
Engine	Information				A10	A20	A40	A50	A70	C10 - C30	C20	E01	
All engines	version Mitsubishi						831 138	931 136					
All engines	01/06/96 ->, version Mitsubishi							931 136					
All engines	->year 31/05/96, version Mitsubishi							931 137					
All engines													360 278
ENGINE													
2.0	Petrol	100	08/99-08/02	4G63 (SOHC 16V)									
Engine	Information				A10	A20	A40	A50	A70	C10 - C30	C20	E01	
All engines													360 764
ENGINE													
2.0	Petrol	98	05/00-08/02	4G63 (SOHC 16V)									
Engine	Information				A10	A20	A40	A50	A70	C10 - C30	C20	E01	
All engines													360 764
SPACE STAR													
ENGINE													
1.3 16V	Petrol	60	09/00-12/04	4G13 (16V)									
Engine	Information				A10	A20	A40	A50	A70	C10 - C30	C20	E01	
All engines	->year 31/05/00, version Mitsubishi						831 168	931 136					
All engines	->year 31/05/00												360 882
All engines	01/06/00 ->												360 883
ENGINE													
1.3 16V	Petrol	61	12/98-12/04	4G13 (16V)									
Engine	Information				A10	A20	A40	A50	A70	C10 - C30	C20	E01	
All engines	->year 31/05/00, version Mitsubishi						831 168	931 136					
All engines	->year 31/05/00												360 882
All engines	01/06/00 ->												360 883
ENGINE													
1.3 16V	Petrol	63	06/98-12/04	4G13 (16V)									
Engine	Information				A10	A20	A40	A50	A70	C10 - C30	C20	E01	
All engines	->year 31/05/00, version Mitsubishi						831 168	931 136					
All engines	->year 31/05/00												360 882
All engines	01/06/00 ->												360 883
ENGINE													
1.6 16V	Petrol	72	01/01-12/04	4G18									
Engine	Information				A10	A20	A40	A50	A70	C10 - C30	C20	E01	
All engines													360 883
ENGINE													
1.8 GDI	Petrol	87	06/98-12/04	4G93 (GDI)									
Engine	Information				A10	A20	A40	A50	A70	C10 - C30	C20	E01	
All engines													360 764
ENGINE													
1.8 GDI	Petrol	90	06/98-12/04	4G93 (GDI)									
Engine	Information				A10	A20	A40	A50	A70	C10 - C30	C20	E01	
All engines													360 764
ENGINE													
1.8 MPI	Petrol	82	10/02-12/04	4G93 (DOHC 16V)									
Engine	Information				A10	A20	A40	A50	A70	C10 - C30	C20	E01	
All engines													360 764
SPACE WAGON													
ENGINE													
1.8	Petrol	90	10/91-10/98	4G93 (SOHC 16V)									
Engine	Information				A10	A20	A40	A50	A70	C10 - C30	C20	E01	
All engines	version Mitsubishi						831 138	931 137					
All engines													360 278
ENGINE													
1.8 4WD	Petrol	90	10/91-10/98	4G93 (SOHC 16V)									
Engine	Information				A10	A20	A40	A50	A70	C10 - C30	C20	E01	
All engines	version Mitsubishi						831 138	931 137					
All engines													360 278

A10 CONDENSER	A20 CONTACT SET	A40 DISTRIBUTOR CAP	A50 ROTOR	A70 PICK-UP
C10 COIL	C20 IGNITION MODULE	C30 ELECTRONIC IGNITION KIT	E01 IGNITION CABLE SET	

Vehicle	alim.	kW	Date	Engine	FUNCTIONS ON THE VEHICLE									
					A10	A20	A40	A50	A70	C10 - C30	C20	E01		
ENGINE														
2.0	Petrol	98	10/92-10/98	4G63 (SOHC 16V)										
Engine		Information			A10	A20	A40	A50	A70	C10 - C30	C20	E01		
All engines		version Mitsubishi					831 138	931 137						
All engines													360 278	
ENGINE														
2.0 16V	Petrol	98	06/00->	4G63 (DOHC 16V)										
Engine		Information			A10	A20	A40	A50	A70	C10 - C30	C20	E01		
All engines													360 764	
ENGINE														
2.0 4WD	Petrol	98	10/92-10/98	4G63 (SOHC 16V)										
Engine		Information			A10	A20	A40	A50	A70	C10 - C30	C20	E01		
All engines		version Mitsubishi					831 138	931 137						
All engines													360 278	
ENGINE														
2.4 GDI	Petrol	110	07/98->	4G64 (GDI)										
Engine		Information			A10	A20	A40	A50	A70	C10 - C30	C20	E01		
All engines													360 764	
ENGINE														
2.4 GDi GLX	Petrol	108	08/00-05/03	4G64 (GDI)										
Engine		Information			A10	A20	A40	A50	A70	C10 - C30	C20	E01		
All engines													360 764	
ENGINE														
2.4 GDi GLX	Petrol	110	11/97-07/00	4G64 (GDI)										
Engine		Information			A10	A20	A40	A50	A70	C10 - C30	C20	E01		
All engines													360 764	
STARION														
ENGINE														
2.0 Turbo ECI	Petrol	125	06/82-12/85	4G63-T (ECI)										
Engine		Information			A10	A20	A40	A50	A70	C10 - C30	C20	E01		
All engines		01/06/84 ->, version Mitsubishi					831 003/001	931 023						
ENGINE														
2.0 Turbo ECI	Petrol	132	05/85-08/87	4G63-T/C										
Engine		Information			A10	A20	A40	A50	A70	C10 - C30	C20	E01		
All engines		01/06/84 ->, version Mitsubishi					831 003/001	931 023						
VALLEY														
ENGINE														
2.0	Petrol	75	09/92-10/94	4G63-T										
Engine		Information			A10	A20	A40	A50	A70	C10 - C30	C20	E01		
All engines		version Denso					813 117	913 030						

A10	CONDENSER	A20	CONTACT SET	A40	DISTRIBUTOR CAP	A50	ROTOR	A70	PICK-UP
C10	COIL	C20	IGNITION MODULE	C30	ELECTRONIC IGNITION KIT	E01	IGNITION CABLE SET		

The present application list is a brief version. For the detailed information about the possibility of installation on a specific vehicle, please refer to our web-catalogue <http://catalogo.facet.eu/>

Vehicle	alim.	kW	Date	Engine	FUNCTIONS ON THE VEHICLE							
					A10	A20	A40	A50	A70	C10 - C30	C20	E01

MARINA

1.8	Petrol	59	04/71-12/79	--	ENGINE							
------------	--------	-----------	-------------	----	---------------	--	--	--	--	--	--	--

Engine	Information	A10	A20	A40	A50	A70	C10 - C30	C20	E01
All engines			728 083MHV	828 075	928 006				

1.8 TC	Petrol	68	04/71-09/75	--	ENGINE							
---------------	--------	-----------	-------------	----	---------------	--	--	--	--	--	--	--

Engine	Information	A10	A20	A40	A50	A70	C10 - C30	C20	E01
All engines			728 083MHV	828 075	928 006				

1300	Petrol	42	04/71-06/80	--	ENGINE							
-------------	--------	-----------	-------------	----	---------------	--	--	--	--	--	--	--

Engine	Information	A10	A20	A40	A50	A70	C10 - C30	C20	E01
All engines			728 083MHV	828 075	928 006				

1300	Petrol	44	04/71-06/75	--	ENGINE							
-------------	--------	-----------	-------------	----	---------------	--	--	--	--	--	--	--

Engine	Information	A10	A20	A40	A50	A70	C10 - C30	C20	E01
All engines			728 083MHV	828 075	928 006				

1800	Petrol	53	04/71-12/75	--	ENGINE							
-------------	--------	-----------	-------------	----	---------------	--	--	--	--	--	--	--

Engine	Information	A10	A20	A40	A50	A70	C10 - C30	C20	E01
All engines			728 083MHV	828 075	928 006				

1800	Petrol	57	04/71-10/75	--	ENGINE							
-------------	--------	-----------	-------------	----	---------------	--	--	--	--	--	--	--

Engine	Information	A10	A20	A40	A50	A70	C10 - C30	C20	E01
All engines			728 083MHV	828 075	928 006				

1800 TC	Petrol	70	04/71-12/75	--	ENGINE							
----------------	--------	-----------	-------------	----	---------------	--	--	--	--	--	--	--

Engine	Information	A10	A20	A40	A50	A70	C10 - C30	C20	E01
All engines			728 083MHV	828 075	928 006				

MINOR

0.9	Petrol	28	11/55-12/62	--	ENGINE							
------------	--------	-----------	-------------	----	---------------	--	--	--	--	--	--	--

Engine	Information	A10	A20	A40	A50	A70	C10 - C30	C20	E01
All engines					928 006				

1.1	Petrol	37	01/62-10/71	--	ENGINE							
------------	--------	-----------	-------------	----	---------------	--	--	--	--	--	--	--

Engine	Information	A10	A20	A40	A50	A70	C10 - C30	C20	E01
All engines				828 075	928 006				

OXFORD

1.5	Petrol	44	11/59-09/62	--	ENGINE							
------------	--------	-----------	-------------	----	---------------	--	--	--	--	--	--	--

Engine	Information	A10	A20	A40	A50	A70	C10 - C30	C20	E01
All engines					928 006				

1.7	Petrol	63	05/62-04/70	--	ENGINE							
------------	--------	-----------	-------------	----	---------------	--	--	--	--	--	--	--

Engine	Information	A10	A20	A40	A50	A70	C10 - C30	C20	E01
All engines				828 075	928 006				

A10 CONDENSER	A20 CONTACT SET	A40 DISTRIBUTOR CAP	A50 ROTOR	A70 PICK-UP
C10 COIL	C20 IGNITION MODULE	C30 ELECTRONIC IGNITION KIT	E01 IGNITION CABLE SET	

Vehicle	alim.	kW	Date	Engine	FUNCTIONS ON THE VEHICLE							
					A10	A20	A40	A50	A70	C10 - C30	C20	E01

100NX

				ENGINE
1.6	Petrol	66	03/90-10/94	GA16DS

Engine	Information	A10	A20	A40	A50	A70	C10 - C30	C20	E01
All engines	FOR: (D), FOR: (NL), FOR: (CH), FOR: (A), FOR: (S), FOR: (SF), FOR: (N), FOR: (DK), version Hitachi			822 046	922 070				
All engines	FOR: (F), FOR: (B), FOR: (I), FOR: (E), FOR: (P), FOR: (GR), version Lucas			828 101					
All engines	FOR: (F), FOR: (B), FOR: (I), FOR: (E), FOR: (P), FOR: (GR), version Hitachi				922 086				

				ENGINE
1.6 SR	Petrol	75	09/93-10/94	GA16DE

Engine	Information	A10	A20	A40	A50	A70	C10 - C30	C20	E01
All engines									360 399

				ENGINE
2.0	Petrol	110	10/90-10/94	SR20DE

Engine	Information	A10	A20	A40	A50	A70	C10 - C30	C20	E01
All engines	version Hitachi			822 073	922 085				

				ENGINE
2.0 GTI	Petrol	105	03/91-10/94	SR20DE

Engine	Information	A10	A20	A40	A50	A70	C10 - C30	C20	E01
All engines	version Hitachi			822 073	922 085				

200 SX

				ENGINE
1.8i Turbo	Petrol	0	01/87->	CA18ET

Engine	Information	A10	A20	A40	A50	A70	C10 - C30	C20	E01
All engines	version Hitachi			822 040	922 066				

240SX

				ENGINE
2.4	Petrol	112	05/94-08/97	KA24DE

Engine	Information	A10	A20	A40	A50	A70	C10 - C30	C20	E01
All engines	01/01/95 ->, version Mitsubishi			831 152	931 136				

				ENGINE
2.4	Petrol	115	04/93-09/94	KA24DE

Engine	Information	A10	A20	A40	A50	A70	C10 - C30	C20	E01
All engines	->year 31/12/94, version Mitsubishi				931 118				

ALMERA

				ENGINE
1.6	Petrol	75	11/12->	K4M

Engine	Information	A10	A20	A40	A50	A70	C10 - C30	C20	E01
All engines	Qty: 4						470 432	C10	

ALMERA I

				ENGINE
1.4	Petrol	64	09/95-07/00	GA14DE

Engine	Information	A10	A20	A40	A50	A70	C10 - C30	C20	E01
All engines	->year 31/01/98, version Hitachi			822 089					
All engines	version Hitachi				922 102				
All engines									360 399

				ENGINE
1.4 GX, LX	Petrol	55	09/95-07/00	GA14DE

Engine	Information	A10	A20	A40	A50	A70	C10 - C30	C20	E01
All engines	->year 31/01/98, version Hitachi			822 089					
All engines	version Hitachi				922 102				
All engines									360 399







				ENGINE
1.4 S, GX, LX	Petrol	55	09/95-03/00	GA14DE

Engine	Information	A10	A20	A40	A50	A70	C10 - C30	C20	E01
All engines	->year 31/01/98, version Hitachi			822 089					
All engines	version Hitachi				922 102				
All engines									360 399

				ENGINE
1.6	Petrol	73	09/95-07/00	GA16DE

Engine	Information	A10	A20	A40	A50	A70	C10 - C30	C20	E01
All engines	->year 31/01/98, version Hitachi			822 089					

A10	CONDENSER	A20	CONTACT SET	A40	DISTRIBUTOR CAP	A50	ROTOR	A70	PICK-UP
C10	COIL	C20	IGNITION MODULE	C30	ELECTRONIC IGNITION KIT	E01	IGNITION CABLE SET		









					FUNCTIONS ON THE VEHICLE							
Vehicle	alim.	kW	Date	Engine	 A10	 A20	 A40	 A50	 A70	 C10 - C30	 C20	 E01
ENGINE												
1.6	Petrol	73	09/95-07/00	GA16DE				922 102				
ENGINE												
1.6	Petrol	75	07/95-03/00	GA16DE			822 089	922 102				360 399
ENGINE												
1.6	Petrol	86	09/95-07/00	GA16DE			822 089	922 102				360 399
ENGINE												
1.6 SLX	Petrol	66	09/95-07/00	GA16DE			822 089	922 102				360 399
ENGINE												
1.6 SR, SLX	Petrol	66	09/95-03/00	GA16DE			822 089	922 102				360 399
ENGINE												
1.8	Petrol	84	07/95-05/00	QG18DE						470 557	C10	
ENGINE												
2.0 GTi	Petrol	105	07/96-03/00	SR20DE				931 136				360 411
ALMERA II												
ENGINE												
1.5	Petrol	66	03/00-11/06	QG15DE						470 557	C10	
ENGINE												
1.5	Petrol	72	10/02-09/06	QG15DE						470 557	C10	
ENGINE												
1.5	Petrol	77	03/01->	QG15DE						470 557	C10	
ENGINE												
1.5 XL	Petrol	77	03/01->	QG15DE						470 557	C10	
ENGINE												
1.8	Petrol	84	01/00-11/02	QG18DE						470 557	C10	
ENGINE												
1.8	Petrol	84	01/00-11/02	QG18DE						470 557	C10	

A10 CONDENSER	A20 CONTACT SET	A40 DISTRIBUTOR CAP	A50 ROTOR	A70 PICK-UP
C10 COIL	C20 IGNITION MODULE	C30 ELECTRONIC IGNITION KIT	E01 IGNITION CABLE SET	

Vehicle	alim.	kW	Date	Engine	FUNCTIONS ON THE VEHICLE									
					A10	A20	A40	A50	A70	C10 - C30	C20	E01		
ENGINE														
1.8	Petrol	85	10/02-09/06	QG18DE										
Engine					A10	A20	A40	A50	A70	C10 - C30	C20	E01		
Information										470 557	C10			
All engines														
Almera, x 4, COIL ON PLUG														
ENGINE														
1.8	Petrol	94	01/02->	QG18DE										
Engine					A10	A20	A40	A50	A70	C10 - C30	C20	E01		
Information										470 557	C10			
All engines														
01/03/01 ->, Qty: 4														
ALMERA III														
ENGINE														
1.2 i	Petrol	58	09/11->	HR12DE										
Engine					A10	A20	A40	A50	A70	C10 - C30	C20	E01		
Information										470 552	C10			
All engines														
Qty: 3														
ENGINE														
1.5	Petrol	0	01/06->	QG15DE										
Engine					A10	A20	A40	A50	A70	C10 - C30	C20	E01		
Information										470 557	C10			
All engines														
Qty: 4														
ENGINE														
1.6	Petrol	79	01/06->	QG16										
Engine					A10	A20	A40	A50	A70	C10 - C30	C20	E01		
Information										470 557	C10			
All engines														
Qty: 4														
ENGINE														
1.6 16V	Petrol	79	03/06->	QG16, QG16DE										
Engine					A10	A20	A40	A50	A70	C10 - C30	C20	E01		
Information										470 557	C10			
Eng. QG16														
x 4, COIL ON PLUG														
Eng. QG16DE										470 557	C10			
Qty: 4														
ALMERA TINO														
ENGINE														
1.8	Petrol	84	08/00-02/06	QG18DE										
Engine					A10	A20	A40	A50	A70	C10 - C30	C20	E01		
Information										470 557	C10			
All engines														
01/12/00 ->, x 4, COIL ON PLUG														
ENGINE														
1.8	Petrol	85	12/02-02/06	QG18DE										
Engine					A10	A20	A40	A50	A70	C10 - C30	C20	E01		
Information										470 557	C10			
All engines														
x 4, COIL ON PLUG														
ENGINE														
1.8	Petrol	88	12/98-02/03	QG18DE										
Engine					A10	A20	A40	A50	A70	C10 - C30	C20	E01		
Information										470 557	C10			
All engines														
01/03/01 ->, Qty: 4														
ENGINE														
2.0	Petrol	100	08/00-01/03	SR20DE										
Engine					A10	A20	A40	A50	A70	C10 - C30	C20	E01		
Information								931 136						
All engines														
->year 30/11/00, version Mitsubishi														
All engines														
360 411														
ALTIMA														
ENGINE														
2.4	Petrol	112	06/93-09/01	KA24DE										
Engine					A10	A20	A40	A50	A70	C10 - C30	C20	E01		
Information										470 296	C10			
All engines														
BLUEBIRD														
ENGINE														
1.6	Petrol	61	03/86-06/90	CA16S										
Engine					A10	A20	A40	A50	A70	C10 - C30	C20	E01		
Information							822 063							
All engines														
version Hitachi														
ENGINE														
1.6	Petrol	66	12/85-02/90	CA16S										
Engine					A10	A20	A40	A50	A70	C10 - C30	C20	E01		
Information							822 063							
All engines														
version Hitachi														

A10	CONDENSER	A20	CONTACT SET	A40	DISTRIBUTOR CAP	A50	ROTOR	A70	PICK-UP
C10	COIL	C20	IGNITION MODULE	C30	ELECTRONIC IGNITION KIT	E01	IGNITION CABLE SET		

The present application list is a brief version. For the detailed information about the possibility of installation on a specific vehicle, please refer to our web-catalogue <http://catalogo.facet.eu/>

					FUNCTIONS ON THE VEHICLE							
Vehicle	alim.	kW	Date	Engine	 A10	 A20	 A40	 A50	 A70	 C10 - C30	 C20	 E01
ENGINE												
1.6 DX	Petrol	61	11/83-02/88	CA16S								
Engine		Information			A10	A20	A40	A50	A70	C10 - C30	C20	E01
All engines		version Hitachi					822 063					
ENGINE												
1.8 Turbo	Petrol	99	04/84-11/92	CA18T								
Engine		Information			A10	A20	A40	A50	A70	C10 - C30	C20	E01
All engines		version Hitachi					822 046	922 070				
ENGINE												
2.0	Petrol	75	12/85-09/90	CA20S								
Engine		Information			A10	A20	A40	A50	A70	C10 - C30	C20	E01
All engines		version Hitachi					822 063					
ENGINE												
2.0 i	Petrol	77	04/84-12/90	CA20E								
Engine		Information			A10	A20	A40	A50	A70	C10 - C30	C20	E01
All engines		-catalytic converter, version Hitachi					822 046	922 070				
All engines		+catalytic converter, version Hitachi						922 066				
ENGINE												
2.0 i	Petrol	85	09/88-09/90	CA20E								
Engine		Information			A10	A20	A40	A50	A70	C10 - C30	C20	E01
All engines		-catalytic converter, version Hitachi					822 046	922 070				
All engines		+catalytic converter, version Hitachi						922 066				
CABSTAR II												
2.0	Petrol	66	07/92-05/94	--, Z20S								
Engine		Information			A10	A20	A40	A50	A70	C10 - C30	C20	E01
All engines		version Mitsubishi					831 136					
CUBE												
1.6 16V	Petrol	81	08/09->	HR16DE								
Engine		Information			A10	A20	A40	A50	A70	C10 - C30	C20	E01
All engines		x 4, COIL ON PLUG								470 552	C10	
FRONTIER												
2.5 i	Petrol	0	11/14->	QR25DE								
Engine		Information			A10	A20	A40	A50	A70	C10 - C30	C20	E01
All engines		pole nr. 4								470 552	C10	
JUKE I												
1.2 DIG-T	Petrol	85	05/14->	HR12DDT, HRA2DDT								
Engine		Information			A10	A20	A40	A50	A70	C10 - C30	C20	E01
Eng. HR12DDT		Qty: 4								470 613	C10	
Eng. HRA2DDT		x 4, COIL ON PLUG								470 613	C10	
ENGINE												
1.5	Petrol	84	10/13->	HR15DE								
Engine		Information			A10	A20	A40	A50	A70	C10 - C30	C20	E01
All engines		Qty: 4								470 552	C10	
ENGINE												
1.6	Petrol	140	03/13->	MR16DDT								
Engine		Information			A10	A20	A40	A50	A70	C10 - C30	C20	E01
All engines		x 4, COIL ON PLUG								470 551	C10	
ENGINE												
1.6	Petrol	69	01/13->	HR16DE								
Engine		Information			A10	A20	A40	A50	A70	C10 - C30	C20	E01
All engines		x 4, COIL ON PLUG								470 552	C10	
ENGINE												
1.6	Petrol	83	07/18->	HR16DE								
Engine		Information			A10	A20	A40	A50	A70	C10 - C30	C20	E01
All engines		x 4, COIL ON PLUG								470 552	C10	

A10 CONDENSER	A20 CONTACT SET	A40 DISTRIBUTOR CAP	A50 ROTOR	A70 PICK-UP
C10 COIL	C20 IGNITION MODULE	C30 ELECTRONIC IGNITION KIT	E01 IGNITION CABLE SET	

Vehicle	alim.	kW	Date	Engine	FUNCTIONS ON THE VEHICLE									
					A10	A20	A40	A50	A70	C10 - C30	C20	E01		
ENGINE														
1.6	Petrol	86	06/10->	HR16DE										
ENGINE														
Engine Information					A10	A20	A40	A50	A70	C10 - C30	C20	E01		
All engines x 4, COIL ON PLUG										470 552	C10			
1.6 CVTC	Petrol	72	08/14->	HR16DE										
ENGINE														
Engine Information					A10	A20	A40	A50	A70	C10 - C30	C20	E01		
All engines x 4, COIL ON PLUG										470 552	C10			
1.6 DIG-T	Petrol	140	06/10->	MR16DDT										
ENGINE														
Engine Information					A10	A20	A40	A50	A70	C10 - C30	C20	E01		
All engines x 4, COIL ON PLUG										470 551	C10			
1.6 DIG-T 4x4	Petrol	140	06/10->	MR16DDT										
ENGINE														
Engine Information					A10	A20	A40	A50	A70	C10 - C30	C20	E01		
All engines x 4, COIL ON PLUG										470 551	C10			
1.6 DIG-T NISMO	Petrol	147	03/13-07/14	MR16DDT										
ENGINE														
Engine Information					A10	A20	A40	A50	A70	C10 - C30	C20	E01		
All engines x 4, COIL ON PLUG										470 551	C10			
1.6 DIG-T NISMO 4x4	Petrol	147	02/13-07/14	MR16DDT										
ENGINE														
Engine Information					A10	A20	A40	A50	A70	C10 - C30	C20	E01		
All engines x 4, COIL ON PLUG										470 551	C10			
1.6 DIG-T NISMO RS	Petrol	160	08/14->	MR16DDT										
ENGINE														
Engine Information					A10	A20	A40	A50	A70	C10 - C30	C20	E01		
All engines x 4, COIL ON PLUG										470 551	C10			
1.6 DIG-T NISMO RS 4x4	Petrol	157	08/14->	MR16DDT										
ENGINE														
Engine Information					A10	A20	A40	A50	A70	C10 - C30	C20	E01		
All engines x 4, COIL ON PLUG										470 551	C10			
1.6 LPG	Petrol/ Liquified Petroleum Gas (LPG)	80	09/18->	HR16DE										
ENGINE														
Engine Information					A10	A20	A40	A50	A70	C10 - C30	C20	E01		
All engines x 4, COIL ON PLUG										470 552	C10			
1.6 LPG	Petrol/ Liquified Petroleum Gas (LPG)	85	01/12->	HR16DE										
ENGINE														
Engine Information					A10	A20	A40	A50	A70	C10 - C30	C20	E01		
All engines x 4, COIL ON PLUG										470 552	C10			
CVTC	Petrol	86	03/13->	HR16DE										
ENGINE														
Engine Information					A10	A20	A40	A50	A70	C10 - C30	C20	E01		
All engines x 4, COIL ON PLUG										470 552	C10			
KUBISTAR														
1.2	Petrol	44	08/03->	D7F 726, D7F 744, D7F 764, D7F726										
ENGINE														
Engine Information					A10	A20	A40	A50	A70	C10 - C30	C20	E01		
Eng. D7F 726, D7F 744, D7F 764										470 596	C10		358 230	
Eng. D7F726 x 1, VALEO, D.I.S.										470 596	C10			
1.2 16V	Petrol	55	04/06->	D4F 712, D4F 730										
ENGINE														
Engine Information					A10	A20	A40	A50	A70	C10 - C30	C20	E01		
Eng. D4F 712 x 4, COIL ON PLUG										470 419	C10			
A10	CONDENSER	A20	CONTACT SET	A40	DISTRIBUTOR CAP	A50	ROTOR	A70	PICK-UP					
C10	COIL	C20	IGNITION MODULE	C30	ELECTRONIC IGNITION KIT	E01	IGNITION CABLE SET							

					FUNCTIONS ON THE VEHICLE							
Vehicle	alim.	kW	Date	Engine	A10	A20	A40	A50	A70	C10 - C30	C20	E01
ENGINE												
1.2 16V	Petrol	55	04/06->	D4F 712, D4F 730								
Engine	Information				A10	A20	A40	A50	A70	C10 - C30	C20	E01
Eng. D4F 730	x 4, COIL ON PLUG									470 518	C10	
Eng. D4F 712												358 246
ENGINE												
1.2 LPG	LPG	44	10/03-08/05	D7F 764								
Engine	Information				A10	A20	A40	A50	A70	C10 - C30	C20	E01
All engines	x 1, VALEO, D.I.S.									470 596	C10	
ENGINE												
1.4	Petrol	55	08/03-10/09	K7J 700, K7J701								
Engine	Information				A10	A20	A40	A50	A70	C10 - C30	C20	E01
All engines	x 1, VALEO, D.I.S.									470 596	C10	
Eng. K7J 700												358 244
ENGINE												
1.6 16V	Petrol	70	08/03->	K4M 750, K4M 752, K4M 753, K4M753								
Engine	Information				A10	A20	A40	A50	A70	C10 - C30	C20	E01
Eng. K4M 750, K4M 753	Qty: 4									470 432	C10	
Eng. K4M 752, K4M753	x 4, BERU, ELDOR, COIL ON PLUG									470 432	C10	
Eng. K4M 752, K4M753	x 1, VALEO, D.I.S.									470 596	C10	
ENGINE												
2.0 GL	Petrol	75	11/84-12/85	CA20S								
Engine	Information				A10	A20	A40	A50	A70	C10 - C30	C20	E01
All engines	version Hitachi						822 057					
ENGINE												
1.4 16V	Petrol	65	08/05->	CR14DE								
Engine	Information				A10	A20	A40	A50	A70	C10 - C30	C20	E01
All engines	x 4, COIL ON PLUG									470 602	C10	
ENGINE												
1.6 160 SR	Petrol	81	08/05->	HR16DE								
Engine	Information				A10	A20	A40	A50	A70	C10 - C30	C20	E01
All engines	x 4, COIL ON PLUG									470 489	C10	
ENGINE												
1.0 i 16V	Petrol	40	08/92-07/00	CG10DE								
Engine	Information				A10	A20	A40	A50	A70	C10 - C30	C20	E01
All engines	->year 28/02/00, version Lucas						828 104	928 030				
All engines	->year 31/07/00, 01/03/00 ->, version Hitachi						922 102					
All engines												359 608
ENGINE												
1.3 i 16V	Petrol	55	08/92-09/00	CG13DE								
Engine	Information				A10	A20	A40	A50	A70	C10 - C30	C20	E01
All engines	->year 28/02/00, version Lucas						828 104, 828 105	928 030				
All engines	01/03/00 ->, version Hitachi						922 102					
All engines												359 608
ENGINE												
1.0 16V	Petrol	48	01/03-06/10	CG10DE								
Engine	Information				A10	A20	A40	A50	A70	C10 - C30	C20	E01
All engines	x 4, COIL ON PLUG									470 602	C10	
ENGINE												
1.2	Petrol	66	01/07-06/10	CR12DE								
Engine	Information				A10	A20	A40	A50	A70	C10 - C30	C20	E01
All engines	Qty: 4									470 602	C10	
ENGINE												
1.2	Petrol	80	10/03-07/05	CR12DE								
Engine	Information				A10	A20	A40	A50	A70	C10 - C30	C20	E01
All engines	Qty: 4									470 602	C10	

A10 CONDENSER	A20 CONTACT SET	A40 DISTRIBUTOR CAP	A50 ROTOR	A70 PICK-UP
C10 COIL	C20 IGNITION MODULE	C30 ELECTRONIC IGNITION KIT	E01 IGNITION CABLE SET	

Vehicle	alim.	kW	Date	Engine	FUNCTIONS ON THE VEHICLE									
					A10	A20	A40	A50	A70	C10 - C30	C20	E01		
ENGINE														
1.2	Petrol	81	08/05-06/10	CR12DE										
ENGINE														
All engines					Qty: 4						470 602	C10		
ENGINE														
1.2 16V	Petrol	48	01/03-06/10	CG12DE, CR12DE										
ENGINE														
All engines					x 4, COIL ON PLUG						470 602	C10		
ENGINE														
1.2 16V	Petrol	59	01/03-06/10	CG12DE, CR12DE										
ENGINE														
All engines					x 4, COIL ON PLUG						470 602	C10		
ENGINE														
1.2 LPG	Petrol/ Liquified Petro- leum Gas (LPG)	59	10/02-06/10	CG12DELPG, CR12DE										
ENGINE														
All engines					x 4, COIL ON PLUG						470 602	C10		
ENGINE														
1.3	Petrol	60	08/04->	CGA3DE										
ENGINE														
All engines					Qty: 4						470 602	C10		
ENGINE														
1.4 16V	Petrol	65	01/03-06/10	CR14DE										
ENGINE														
All engines					x 4, COIL ON PLUG						470 602	C10		
ENGINE														
160 SR	Petrol	81	05/05-06/10	HR16DE										
ENGINE														
All engines					x 4, COIL ON PLUG						470 489	C10		
MICRA IV														
ENGINE														
1.2	Petrol	56	05/10->	HR12DE										
ENGINE														
All engines					no specific info conc. application available, Qty: 3, no specific info conc. application available						470 552	C10		
All engines					x 3, COIL ON PLUG						470 552	C10		
ENGINE														
1.2	Petrol	58	05/10->	HR12DE										
ENGINE														
All engines					no specific info conc. application available, Qty: 3, no specific info conc. application available						470 552	C10		
ENGINE														
1.2	Petrol	59	05/10->	HR12DE										
ENGINE														
All engines					->year 01/11/13, 01/12/13 ->, K13K, x 3, EUR/C, COIL ON PLUG ----- K13KK, x 3, EUR/C, COIL ON PLUG						470 552	C10		
ENGINE														
1.2 4WD	Petrol	59	05/10->	HR12DE										
ENGINE														
All engines					no specific info conc. application available, Qty: 3, no specific info conc. application available						470 552	C10		
ENGINE														
1.2 LPG	Petrol/ Liquified Petro- leum Gas (LPG)	59	05/10-09/15	HR12DE										
ENGINE														
All engines					x 3, GROUP C, COIL ON PLUG						470 552	C10		

A10 CONDENSER	A20 CONTACT SET	A40 DISTRIBUTOR CAP	A50 ROTOR	A70 PICK-UP
C10 COIL	C20 IGNITION MODULE	C30 ELECTRONIC IGNITION KIT	E01 IGNITION CABLE SET	

The present application list is a brief version. For the detailed information about the possibility of installation on a specific vehicle, please refer to our web-catalogue <http://catalogo.facet.eu/>

Vehicle	alim.	kW	Date	Engine	FUNCTIONS ON THE VEHICLE							
					A10	A20	A40	A50	A70	C10 - C30	C20	E01

MICRA V

				ENGINE
0.9 IG-T	Petrol	66	12/16->	HR09DET

Engine	Information	A10	A20	A40	A50	A70	C10 - C30	C20	E01
All engines	x 3, COIL ON PLUG						470 613	C10	

				ENGINE
0.9 LPG	Petrol/ Liquified Petro- leum Gas (LPG)	64	03/19->	HR09DET

Engine	Information	A10	A20	A40	A50	A70	C10 - C30	C20	E01
All engines	x 3, COIL ON PLUG						470 613	C10	

MURANO

				ENGINE
3.5 CVTc4x4	Petrol	188	03/13-09/14	VQ35DE

Engine	Information	A10	A20	A40	A50	A70	C10 - C30	C20	E01
All engines	x 6, COIL ON PLUG						470 533	C10	

MURANO II

				ENGINE
3.5	Petrol	191	01/11-09/14	VQ35DE

Engine	Information	A10	A20	A40	A50	A70	C10 - C30	C20	E01
All engines	Qty: 6						470 533	C10	

				ENGINE
3.5	Petrol	195	11/07-09/14	VQ35DE

Engine	Information	A10	A20	A40	A50	A70	C10 - C30	C20	E01
All engines	Qty: 6						470 533	C10	
All engines	x 6, COIL ON PLUG						470 533	C10	

				ENGINE
3.5 4x4	Petrol	183	12/10-09/14	VQ35DE

Engine	Information	A10	A20	A40	A50	A70	C10 - C30	C20	E01
All engines	x 6, COIL ON PLUG						470 533	C10	

				ENGINE
3.5 4x4	Petrol	188	10/08-09/14	VQ35DE

Engine	Information	A10	A20	A40	A50	A70	C10 - C30	C20	E01
All engines	x 6, COIL ON PLUG						470 533	C10	

				ENGINE
3.5 4x4	Petrol	191	12/09-09/14	VQ35DE

Engine	Information	A10	A20	A40	A50	A70	C10 - C30	C20	E01
All engines	x 6, COIL ON PLUG						470 533	C10	

				ENGINE
3.5 4x4	Petrol	195	11/07-09/14	VQ35DE

Engine	Information	A10	A20	A40	A50	A70	C10 - C30	C20	E01
All engines	Qty: 6						470 533	C10	
All engines	x 6, COIL ON PLUG						470 533	C10	

				ENGINE
3.5 4x4	Petrol	198	09/08-12/10	VQ35DE

Engine	Information	A10	A20	A40	A50	A70	C10 - C30	C20	E01
All engines	Qty: 6						470 533	C10	

MURANO III

				ENGINE
2.5 HEV ALL MODE 4x4-i	Petrol/ Electric	172	01/16->	QR25DER

Engine	Information	A10	A20	A40	A50	A70	C10 - C30	C20	E01
All engines	x 4, COIL ON PLUG						470 552	C10	

				ENGINE
3.5 V6	Petrol	183	01/16->	VQ35DE



Engine	Information	A10	A20	A40	A50	A70	C10 - C30	C20	E01
All engines	x 6, COIL ON PLUG						470 533	C10	

A10 CONDENSER	A20 CONTACT SET	A40 DISTRIBUTOR CAP	A50 ROTOR	A70 PICK-UP
C10 COIL	C20 IGNITION MODULE	C30 ELECTRONIC IGNITION KIT	E01 IGNITION CABLE SET	

Vehicle	alim.	kW	Date	Engine	FUNCTIONS ON THE VEHICLE								
					A10	A20	A40	A50	A70	C10 - C30	C20	E01	
ENGINE													
3.5 V6 ALL MODE 4x4-i	Petrol	183	01/16->	VQ35DE									
Engine	Information				A10	A20	A40	A50	A70	C10 - C30	C20	E01	
All engines	x 6, COIL ON PLUG									470 533	C10		
ENGINE													
3.5 V6 ALL MODE 4x4-i	Petrol	188	10/14->	VQ35DE									
Engine	Information				A10	A20	A40	A50	A70	C10 - C30	C20	E01	
All engines	Qty: 6									470 533	C10		
ENGINE													
3.5 V6 ALL MODE 4x4-i	Petrol	191	01/16->	VQ35DE									
Engine	Information				A10	A20	A40	A50	A70	C10 - C30	C20	E01	
All engines	Qty: 6									470 533	C10		
NAVARA I													
2.4	Petrol	91	06/92-02/97	Z24i									
Engine	Information				A10	A20	A40	A50	A70	C10 - C30	C20	E01	
All engines	version Mitsubishi						831 114	931 030					
NAVARA III													
2.5	Petrol	122	01/15->	QR25DE									
Engine	Information				A10	A20	A40	A50	A70	C10 - C30	C20	E01	
All engines	Qty: 4									470 552	C10		
ENGINE													
2.5	Petrol	124	07/14->	QR25DE									
Engine	Information				A10	A20	A40	A50	A70	C10 - C30	C20	E01	
All engines	Qty: 4									470 552	C10		
ENGINE													
2.5 DDTi	Diesel	120	01/15->	YD25DDTi									
Engine	Information				A10	A20	A40	A50	A70	C10 - C30	C20	E01	
All engines	Qty: 4									470 552	C10		
NOTE I													
1.4	Petrol	65	03/06-06/12	CR14DE									
Engine	Information				A10	A20	A40	A50	A70	C10 - C30	C20	E01	
All engines	x 4, COIL ON PLUG									470 602	C10		
ENGINE													
1.4 LPG	Petrol/ Liquified Petroleum Gas (LPG)	65	01/06-08/13	CR14DE									
Engine	Information				A10	A20	A40	A50	A70	C10 - C30	C20	E01	
All engines	x 4, COIL ON PLUG									470 602	C10		
ENGINE													
1.6	Petrol	81	03/06-06/12	HR16DE									
Engine	Information				A10	A20	A40	A50	A70	C10 - C30	C20	E01	
All engines	x 4, COIL ON PLUG									470 489	C10		
NOTE II													
1.2	Petrol	58	06/13->	HR12DE									
Engine	Information				A10	A20	A40	A50	A70	C10 - C30	C20	E01	
All engines	Qty: 3									470 552	C10		
ENGINE													
1.2	Petrol	59	06/13->	HR12DE									
Engine	Information				A10	A20	A40	A50	A70	C10 - C30	C20	E01	
All engines	x 3, COIL ON PLUG									470 552	C10		
ENGINE													
1.2 4WD	Petrol	59	06/13->	HR12DE									
Engine	Information				A10	A20	A40	A50	A70	C10 - C30	C20	E01	
All engines	Qty: 3									470 552	C10		

A10 CONDENSER	A20 CONTACT SET	A40 DISTRIBUTOR CAP	A50 ROTOR	A70 PICK-UP
C10 COIL	C20 IGNITION MODULE	C30 ELECTRONIC IGNITION KIT	E01 IGNITION CABLE SET	

The present application list is a brief version. For the detailed information about the possibility of installation on a specific vehicle, please refer to our web-catalogue <http://catalogo.facet.eu/>

					FUNCTIONS ON THE VEHICLE							
Vehicle	alim.	kW	Date	Engine								
NP300												
1.2 LPG	LPG	56	03/15->	ENGINE HR12DE								
Engine		Information			A10	A20	A40	A50	A70	C10 - C30	C20	E01
All engines		x 3, COIL ON PLUG								470 552	C10	
NP300												
2.5i	Petrol	0	06/14->	ENGINE QR25DE								
Engine		Information			A10	A20	A40	A50	A70	C10 - C30	C20	E01
All engines		Qty: 4								470 552	C10	
NV200 / EVALIA												
2.0	Petrol	101	07/10->	ENGINE MR20DE								
Engine		Information			A10	A20	A40	A50	A70	C10 - C30	C20	E01
All engines		->year 15/12/13, Qty: 4								470 552	C10	
NX1600												
1.6 [USA]	Petrol	0	01/87-12/90	ENGINE E16								
Engine		Information			A10	A20	A40	A50	A70	C10 - C30	C20	E01
All engines		version Mitsubishi					831 114	931 110				
NX1600												
1.6i [USA]	Petrol	0	01/88-12/92	ENGINE GA16, GA16DE								
Engine		Information			A10	A20	A40	A50	A70	C10 - C30	C20	E01
All engines		version Hitachi					822 046	922 070				
PATHFINDER IV												
2.5 Hybrid	Petrol/ Electric	188	10/13->	ENGINE QR25DER								
Engine		Information			A10	A20	A40	A50	A70	C10 - C30	C20	E01
All engines		Qty: 4								470 552	C10	
PATHFINDER IV												
2.5 Hybrid 4WD	Petrol/ Electric	172	11/14->	ENGINE QR25DER								
Engine		Information			A10	A20	A40	A50	A70	C10 - C30	C20	E01
All engines		x 4, COIL ON PLUG								470 552	C10	
PATHFINDER IV												
2.5 Hybrid 4WD	Petrol/ Electric	188	10/13->	ENGINE QR25DER								
Engine		Information			A10	A20	A40	A50	A70	C10 - C30	C20	E01
All engines		Qty: 4								470 552	C10	
All engines		x 4, COIL ON PLUG								470 552	C10	
PATROL GR I												
4.2 Cat	Petrol	121	11/88-02/98	ENGINE TB42E								
Engine		Information			A10	A20	A40	A50	A70	C10 - C30	C20	E01
All engines		version Mitsubishi					831 126					
PATROL III												
2.8	Petrol	88	07/80-08/88	ENGINE L28								
Engine		Information			A10	A20	A40	A50	A70	C10 - C30	C20	E01
All engines		version Hitachi				722 056HV						
PATROL III												
2.8	Petrol	89	07/80-08/88	ENGINE L28								
Engine		Information			A10	A20	A40	A50	A70	C10 - C30	C20	E01
All engines		version Hitachi				722 056HV						

A10 CONDENSER	A20 CONTACT SET	A40 DISTRIBUTOR CAP	A50 ROTOR	A70 PICK-UP
C10 COIL	C20 IGNITION MODULE	C30 ELECTRONIC IGNITION KIT	E01 IGNITION CABLE SET	

Vehicle	alim.	kW	Date	Engine	FUNCTIONS ON THE VEHICLE							
					A10	A20	A40	A50	A70	C10 - C30	C20	E01

PICK UP I

2.4 [USA]	Petrol	0	01/85-12/89	ENGINE
				Z24i

Engine	Information	A10	A20	A40	A50	A70	C10 - C30	C20	E01
All engines	version Hitachi			822 040	922 066				

2.4 i [USA]	Petrol	0	01/89->	ENGINE
				KA24E

Engine	Information	A10	A20	A40	A50	A70	C10 - C30	C20	E01
All engines	version Hitachi			822 046	922 070				
All engines	version Mitsubishi			831 114	931 110				

2.4 i 12V	Petrol	91	04/92-02/98	ENGINE
				KA24E

Engine	Information	A10	A20	A40	A50	A70	C10 - C30	C20	E01
All engines	version HITACHI, ->year 01/10/95			822 046	922 070				
All engines	version HITACHI, 01/10/95 ->			822 089					
All engines	version MITSUBISHI, ->year 01/10/95			831 114	931 110				

2.4 i 12V 4WD	Petrol	93	04/92-02/98	ENGINE
				KA24E

Engine	Information	A10	A20	A40	A50	A70	C10 - C30	C20	E01
All engines	version HITACHI, ->year 01/10/95			822 046	922 070				
All engines	version HITACHI, 01/10/95 ->			822 089					
All engines	version MITSUBISHI, ->year 01/10/95			831 114	931 110				

PICK UP II

2.4 i	Petrol	88	02/98-04/05	ENGINE
				KA24E

Engine	Information	A10	A20	A40	A50	A70	C10 - C30	C20	E01
All engines	version Hitachi			822 089					
All engines									360 789

2.4 i 4WD	Petrol	88	02/98-04/05	ENGINE
				KA24E

Engine	Information	A10	A20	A40	A50	A70	C10 - C30	C20	E01
All engines	version Hitachi			822 089					
All engines									360 789

PRAIRIE PRO

2.4 i	Petrol	98	01/90-07/94	ENGINE
				KA24E

Engine	Information	A10	A20	A40	A50	A70	C10 - C30	C20	E01
All engines	version Hitachi				922 085				

2.4 i 4x4	Petrol	98	04/92-07/94	ENGINE
				KA24E

Engine	Information	A10	A20	A40	A50	A70	C10 - C30	C20	E01
All engines	version Hitachi				922 085				

PRIMASTAR

2.0	Petrol	86	04/06->	ENGINE
				F4R 820

Engine	Information	A10	A20	A40	A50	A70	C10 - C30	C20	E01
All engines	x 4, BERU, COIL ON PLUG						470 432	C10	

2.0	Petrol	88	03/01->	ENGINE
				F4R 720, F4R 722, F4R726

Engine	Information	A10	A20	A40	A50	A70	C10 - C30	C20	E01
All engines	x 4, BERU, COIL ON PLUG						470 432	C10	

PRIMERA

1.6 LPG	LPG	73	09/96-07/02	ENGINE
				QG16DE

Engine	Information	A10	A20	A40	A50	A70	C10 - C30	C20	E01
All engines	x 4, COIL ON PLUG						470 557	C10	

1.8 LPG	LPG	84	08/99-07/02	ENGINE
				QG18DE

Engine	Information	A10	A20	A40	A50	A70	C10 - C30	C20	E01
All engines	01/10/00 ->, x 4, COIL ON PLUG						470 557	C10	

A10 CONDENSER	A20 CONTACT SET	A40 DISTRIBUTOR CAP	A50 ROTOR	A70 PICK-UP
C10 COIL	C20 IGNITION MODULE	C30 ELECTRONIC IGNITION KIT	E01 IGNITION CABLE SET	

Vehicle	alim.	kW	Date	Engine	FUNCTIONS ON THE VEHICLE							
					A10	A20	A40	A50	A70	C10 - C30	C20	E01

PRIMERA I

				ENGINE
1.6	Petrol	66	06/90-01/96	GA16DS

Engine	Information	A10	A20	A40	A50	A70	C10 - C30	C20	E01
All engines	-catalytic converter, version Lucas			828 101					
All engines	+catalytic converter, version Lucas			828 103					
All engines	+catalytic converter, version Hitachi				922 070				
All engines	-catalytic converter, version Hitachi				922 086				
All engines	->year 31/03/91								359 609

				ENGINE
1.6	Petrol	71	06/90-01/96	GA16DS

Engine	Information	A10	A20	A40	A50	A70	C10 - C30	C20	E01
All engines	-catalytic converter, version Lucas			828 101					
All engines	+catalytic converter, version Lucas			828 103					
All engines	+catalytic converter, version Hitachi				922 070				
All engines	-catalytic converter, version Hitachi				922 086				
All engines	->year 31/03/91								359 609

				ENGINE
1.6	Petrol	75	06/93-01/96	GA16DE

Engine	Information	A10	A20	A40	A50	A70	C10 - C30	C20	E01
All engines	version Lucas			828 105					
All engines	->year 30/09/94								360 658

				ENGINE
1.6 i	Petrol	66	07/90-03/98	GA16DS

Engine	Information	A10	A20	A40	A50	A70	C10 - C30	C20	E01
All engines	version Hitachi			822 046	922 070				
All engines	FOR: (F), FOR: (B), FOR: (I), FOR: (E), FOR: (P), FOR: (GR), version Lucas			828 101					
All engines	FOR: (F), FOR: (B), FOR: (I), FOR: (E), FOR: (P), FOR: (GR), version Hitachi				922 086				

				ENGINE
1.6 i	Petrol	75	02/91-03/98	GA16DE

Engine	Information	A10	A20	A40	A50	A70	C10 - C30	C20	E01
All engines	->year 30/04/96, version Hitachi			822 079					
All engines	01/05/96 ->, version Hitachi			822 089					
All engines									360 399

				ENGINE
2.0	Petrol	105	06/90-04/93	SR20DE

Engine	Information	A10	A20	A40	A50	A70	C10 - C30	C20	E01
All engines	version Lucas			828 102					
All engines	version Hitachi				922 085				

				ENGINE
2.0	Petrol	110	07/94-01/98	SR20DE

Engine	Information	A10	A20	A40	A50	A70	C10 - C30	C20	E01
All engines	->year 30/04/96, version Mitsubishi			831 151					
All engines	01/04/96 ->, version Mitsubishi				931 136				
All engines	01/04/96 ->								360 411

				ENGINE
2.0 16V	Petrol	85	06/90-01/96	SR20DI

Engine	Information	A10	A20	A40	A50	A70	C10 - C30	C20	E01
All engines	version Lucas			828 102					
All engines	version Hitachi				922 085				

				ENGINE
2.0 16V 4x4	Petrol	85	04/91-06/96	SR20DI

Engine	Information	A10	A20	A40	A50	A70	C10 - C30	C20	E01
All engines	version Lucas			828 102					
All engines	version Hitachi				922 085				

				ENGINE
2.0 GT	Petrol	110	06/90-01/96	SR20DE









Engine	Information	A10	A20	A40	A50	A70	C10 - C30	C20	E01
All engines	version Lucas			828 102					
All engines	version Hitachi				922 085				

A10	CONDENSER	A20	CONTACT SET	A40	DISTRIBUTOR CAP	A50	ROTOR	A70	PICK-UP
C10	COIL	C20	IGNITION MODULE	C30	ELECTRONIC IGNITION KIT	E01	IGNITION CABLE SET		

Vehicle	alim.	kW	Date	Engine	FUNCTIONS ON THE VEHICLE									
					A10	A20	A40	A50	A70	C10 - C30	C20	E01		
ENGINE														
2.0 GT 4x4	Petrol	105	03/91-04/93	SR20DE										
Engine	Information				A10	A20	A40	A50	A70	C10 - C30	C20	E01		
All engines	version Lucas						828 102							
All engines	version Hitachi							922 085						
ENGINE														
2.0 i	Petrol	85	07/90-03/98	SR20DI										
Engine	Information				A10	A20	A40	A50	A70	C10 - C30	C20	E01		
All engines	version Hitachi						822 073	922 085						
ENGINE														
2.0 i	Petrol	92	01/95-06/96	SR20DE										
Engine	Information				A10	A20	A40	A50	A70	C10 - C30	C20	E01		
All engines	version Lucas						828 102							
All engines	version Hitachi							922 085						
PRIMERA II														
ENGINE														
1.6 16V	Petrol	66	09/96-07/02	GA16DE										
Engine	Information				A10	A20	A40	A50	A70	C10 - C30	C20	E01		
All engines	version Lucas						828 105	928 030						
All engines													360 658	
ENGINE														
1.6 16V	Petrol	73	09/96-07/02	GA16DE, QG16DE										
Engine	Information				A10	A20	A40	A50	A70	C10 - C30	C20	E01		
Eng. GA16DE	version Lucas						828 105	928 030						
Eng. QG16DE	x 4, COIL ON PLUG									470 557	C10			
Eng. GA16DE													360 658	
ENGINE														
1.6 16V	Petrol	78	06/96-07/02	QG16DE										
Engine	Information				A10	A20	A40	A50	A70	C10 - C30	C20	E01		
All engines	x 4, COIL ON PLUG									470 557	C10			
ENGINE														
1.6 16V	Petrol	81	04/98-01/02	GA16DE										
Engine	Information				A10	A20	A40	A50	A70	C10 - C30	C20	E01		
All engines	version Lucas						828 105	928 030						
All engines													360 658	
ENGINE														
1.6 16V LPG	Petrol/ Liquified Petro- leum Gas (LPG)	78	09/00-07/02	QG16DE										
Engine	Information				A10	A20	A40	A50	A70	C10 - C30	C20	E01		
All engines	x 4, COIL ON PLUG									470 557	C10			
ENGINE														
1.8 16V	Petrol	84	08/99-07/02	QG18DE										
Engine	Information				A10	A20	A40	A50	A70	C10 - C30	C20	E01		
All engines	01/10/00 ->, x 4, COIL ON PLUG									470 557	C10			
ENGINE														
1.8 16V LPG	Petrol/ Liquified Petro- leum Gas (LPG)	84	08/99-12/01	QG18DE										
Engine	Information				A10	A20	A40	A50	A70	C10 - C30	C20	E01		
All engines	01/10/00 ->, x 4, COIL ON PLUG									470 557	C10			
ENGINE														
2.0 16V	Petrol	103	08/99-07/02	SR20DE										
Engine	Information				A10	A20	A40	A50	A70	C10 - C30	C20	E01		
All engines	version Lucas						828 102							
All engines	version Hitachi							922 085						
All engines	->year 30/09/00, version Mitsubishi							931 136						
All engines													360 411	

A10 CONDENSER	A20 CONTACT SET	A40 DISTRIBUTOR CAP	A50 ROTOR	A70 PICK-UP
C10 COIL	C20 IGNITION MODULE	C30 ELECTRONIC IGNITION KIT	E01 IGNITION CABLE SET	

The present application list is a brief version. For the detailed information about the possibility of installation on a specific vehicle, please refer to our web-catalogue <http://catalogo.facet.eu/>









					FUNCTIONS ON THE VEHICLE								
Vehicle	alim.	kW	Date	Engine									
2.0 16V					Petrol	110	09/96-07/02	ENGINE SR20DE					
Engine	Information				A10	A20	A40	A50	A70	C10 - C30	C20	E01	
All engines	->year 30/09/00, version Mitsubishi							931 136					
All engines												360 411	
2.0 16V					Petrol	85	06/96-07/02	ENGINE SR20De					
Engine	Information				A10	A20	A40	A50	A70	C10 - C30	C20	E01	
All engines	->year 30/09/00, version Mitsubishi							931 136					
All engines												360 411	
2.0 16V					Petrol	96	09/96-07/02	ENGINE SR20DE					
Engine	Information				A10	A20	A40	A50	A70	C10 - C30	C20	E01	
All engines	->year 30/09/00, version Mitsubishi							931 136					
All engines												360 411	
PRIMERA III													
1.6					Petrol	78	03/02-08/08	ENGINE QG16DE					
Engine	Information				A10	A20	A40	A50	A70	C10 - C30	C20	E01	
All engines	x 4, COIL ON PLUG									470 557	C10		
1.6					Petrol	80	01/02-04/06	ENGINE QG16DE					
Engine	Information				A10	A20	A40	A50	A70	C10 - C30	C20	E01	
All engines	x 4, COIL ON PLUG									470 557	C10		
1.6 Visia					Petrol	80	01/02-04/06	ENGINE QG16DE					
Engine	Information				A10	A20	A40	A50	A70	C10 - C30	C20	E01	
All engines	x 4, COIL ON PLUG									470 557	C10		
1.8					Petrol	85	03/02-10/08	ENGINE QG18DE					
Engine	Information				A10	A20	A40	A50	A70	C10 - C30	C20	E01	
All engines	x 4, COIL ON PLUG									470 557	C10		
1.8 LPG					Petrol/ Liquified Petro- leum Gas (LPG)	85	03/02->	ENGINE QG18DE					
Engine	Information				A10	A20	A40	A50	A70	C10 - C30	C20	E01	
All engines	x 4, COIL ON PLUG									470 557	C10		
PULSAR													
1.2 DIG-T					Petrol	85	10/14->	ENGINE HRA2DDT					
Engine	Information				A10	A20	A40	A50	A70	C10 - C30	C20	E01	
All engines	Pulsar, x 4, COIL ON PLUG									470 613	C10		
1.6					Petrol	0	01/84-12/86	ENGINE E16					
Engine	Information				A10	A20	A40	A50	A70	C10 - C30	C20	E01	
All engines	version Hitachi						822 057	922 052					
1.6 [USA]					Petrol	0	01/82-12/83	ENGINE E16					
Engine	Information				A10	A20	A40	A50	A70	C10 - C30	C20	E01	
All engines	version Hitachi						822 057	922 052					
1.6 DIG-T					Petrol	140	02/15->	ENGINE MR16DDT					
Engine	Information				A10	A20	A40	A50	A70	C10 - C30	C20	E01	
All engines	Pulsar, x 4, COIL ON PLUG									470 551	C10		
PULSAR NX													
1.6 [USA]					Petrol	0	01/86->	ENGINE E16					
Engine	Information				A10	A20	A40	A50	A70	C10 - C30	C20	E01	
All engines	version Mitsubishi						831 114	931 110					

A10 CONDENSER	A20 CONTACT SET	A40 DISTRIBUTOR CAP	A50 ROTOR	A70 PICK-UP
C10 COIL	C20 IGNITION MODULE	C30 ELECTRONIC IGNITION KIT	E01 IGNITION CABLE SET	

Vehicle	alim.	kW	Date	Engine	FUNCTIONS ON THE VEHICLE									
					A10	A20	A40	A50	A70	C10 - C30	C20	E01		
QASHQAI / QASHQAI +2														
1.6 CVTC	Petrol	86	03/13-04/14	HR16DE										
Engine		Information			A10	A20	A40	A50	A70	C10 - C30	C20	E01		
All engines		x 4, COIL ON PLUG								470 489	C10			
2.0	Petrol	104	03/13-04/14	MR20DE										
Engine		Information			A10	A20	A40	A50	A70	C10 - C30	C20	E01		
All engines		x 4, COIL ON PLUG								470 552	C10			
2.0 Trazione integrale	Petrol	104	03/13-04/14	MR20DE										
Engine		Information			A10	A20	A40	A50	A70	C10 - C30	C20	E01		
All engines		x 4, COIL ON PLUG								470 552	C10			
QASHQAI I														
1.6	Petrol	84	02/07-12/13	HR16DE										
Engine		Information			A10	A20	A40	A50	A70	C10 - C30	C20	E01		
All engines		x 4, COIL ON PLUG								470 489	C10			
1.6	Petrol	86	11/10-12/13	HR16DE										
Engine		Information			A10	A20	A40	A50	A70	C10 - C30	C20	E01		
All engines		x 4, COIL ON PLUG								470 489	C10			
1.6 LPG	Petrol/ Liquified Petroleum Gas (LPG)	86	11/10-12/13	HR16DE										
Engine		Information			A10	A20	A40	A50	A70	C10 - C30	C20	E01		
All engines		x 4, -start-stop function, COIL ON PLUG								470 489	C10			
All engines		x 4, +start-stop function, COIL ON PLUG								470 552	C10			
2.0	Petrol	102	02/07-12/13	MR20DE										
Engine		Information			A10	A20	A40	A50	A70	C10 - C30	C20	E01		
All engines		Qty: 4								470 552	C10			
2.0	Petrol	103	01/10-04/14	MR20DE										
Engine		Information			A10	A20	A40	A50	A70	C10 - C30	C20	E01		
All engines		x 4, COIL ON PLUG								470 552	C10			
2.0	Petrol	104	02/07-12/13	MR20DE										
Engine		Information			A10	A20	A40	A50	A70	C10 - C30	C20	E01		
All engines		->year 01/03/07, x 4, COIL ON PLUG								470 489	C10			
All engines		01/04/07 ->, x 4, COIL ON PLUG ----- x 4, COIL ON PLUG								470 552	C10			
2.0 Trazione integrale	Petrol	102	02/07-12/13	MR20DE										
Engine		Information			A10	A20	A40	A50	A70	C10 - C30	C20	E01		
All engines		Qty: 4								470 552	C10			
2.0 Trazione integrale	Petrol	103	01/10-04/14	MR20DE										
Engine		Information			A10	A20	A40	A50	A70	C10 - C30	C20	E01		
All engines		x 4, COIL ON PLUG								470 552	C10			
2.0 Trazione integrale	Petrol	104	02/07-12/13	MR20DE										
Engine		Information			A10	A20	A40	A50	A70	C10 - C30	C20	E01		
All engines		->year 01/03/07, x 4, COIL ON PLUG								470 489	C10			
All engines		01/04/07 ->, x 4, COIL ON PLUG ----- x 4, COIL ON PLUG								470 552	C10			

A10 CONDENSER	A20 CONTACT SET	A40 DISTRIBUTOR CAP	A50 ROTOR	A70 PICK-UP
C10 COIL	C20 IGNITION MODULE	C30 ELECTRONIC IGNITION KIT	E01 IGNITION CABLE SET	

The present application list is a brief version. For the detailed information about the possibility of installation on a specific vehicle, please refer to our web-catalogue <http://catalogo.facet.eu/>

					FUNCTIONS ON THE VEHICLE							
Vehicle	alim.	kW	Date	Engine								
QASHQAI II												
1.2 DIG-T	Petrol	85	11/13->	ENGINE HR12DDT, HRA2DDT								
Engine	Information				A10	A20	A40	A50	A70	C10 - C30	C20	E01
Eng. HR12DDT	Qty: 4									470 613	C10	
Eng. HRA2DDT	x 4, COIL ON PLUG									470 613	C10	
1.6 DIG-T	Petrol	120	10/14->	ENGINE MR16DDT								
Engine	Information				A10	A20	A40	A50	A70	C10 - C30	C20	E01
All engines	x 4, COIL ON PLUG									470 551	C10	
2.0	Petrol	106	06/14->	ENGINE MR20DD								
Engine	Information				A10	A20	A40	A50	A70	C10 - C30	C20	E01
All engines	x 4, COIL ON PLUG									470 551	C10	
2.0 ALL MODE 4x4-i	Petrol	106	10/15->	ENGINE MR20DD								
Engine	Information				A10	A20	A40	A50	A70	C10 - C30	C20	E01
All engines	x 4, COIL ON PLUG									470 551	C10	
SENTRA III												
1.6i [USA]	Petrol	0	01/90-12/92	ENGINE GA16DE								
Engine	Information				A10	A20	A40	A50	A70	C10 - C30	C20	E01
All engines	version Hitachi						822 046	922 070				
2.0i [USA]	Petrol	0	01/90->	ENGINE SR20DE								
Engine	Information				A10	A20	A40	A50	A70	C10 - C30	C20	E01
All engines	version Hitachi						822 073	922 085				
SENTRA IV												
1.6i	Petrol	79	01/95-12/97	ENGINE GA16DE								
Engine	Information				A10	A20	A40	A50	A70	C10 - C30	C20	E01
All engines	version Hitachi						822 089					
SENTRA VII												
1.6 DIG-T	Petrol	0	07/12->	ENGINE MR16DDT								
Engine	Information				A10	A20	A40	A50	A70	C10 - C30	C20	E01
All engines	Qty: 4									470 551	C10	
1.8	Petrol	96	08/12->	ENGINE MRA8DE								
Engine	Information				A10	A20	A40	A50	A70	C10 - C30	C20	E01
All engines	Qty: 4									470 552	C10	
1.8 [TWN]	Petrol	0	08/13->	ENGINE MRA8DE								
Engine	Information				A10	A20	A40	A50	A70	C10 - C30	C20	E01
All engines	Qty: 4									470 552	C10	
1.8 i	Petrol	0	07/12->	ENGINE MRA8DE								
Engine	Information				A10	A20	A40	A50	A70	C10 - C30	C20	E01
All engines	B17T, B17Z, Qty: 4									470 552	C10	
SERENA												
1.6	Petrol	71	02/93-09/01	ENGINE GA16DE								
Engine	Information				A10	A20	A40	A50	A70	C10 - C30	C20	E01
All engines	version Mitsubishi							931 118				
1.6	Petrol	75	09/94-08/00	ENGINE GA16DE								
Engine	Information				A10	A20	A40	A50	A70	C10 - C30	C20	E01
All engines	version Mitsubishi							931 118				

A10 CONDENSER	A20 CONTACT SET	A40 DISTRIBUTOR CAP	A50 ROTOR	A70 PICK-UP
C10 COIL	C20 IGNITION MODULE	C30 ELECTRONIC IGNITION KIT	E01 IGNITION CABLE SET	

Vehicle	alim.	kW	Date	Engine	FUNCTIONS ON THE VEHICLE									
					A10	A20	A40	A50	A70	C10 - C30	C20	E01		
ENGINE														
2.0	Petrol	93	11/92-09/01	SR20DE										
Engine					A10	A20	A40	A50	A70	C10 - C30	C20	E01		
All engines								931 118						
STANZA														
ENGINE														
2.4i [USA]	Petrol	0	01/92->	KA24DE										
Engine					A10	A20	A40	A50	A70	C10 - C30	C20	E01		
All engines										470 296	C10			
SUNNY II														
ENGINE														
1.0L	Petrol	37	07/86-09/90	E10S										
Engine					A10	A20	A40	A50	A70	C10 - C30	C20	E01		
All engines							822 046							
All engines							822 057							
All engines								922 086						
ENGINE														
1.3	Petrol	44	06/86-10/91	E13S										
Engine					A10	A20	A40	A50	A70	C10 - C30	C20	E01		
All engines							822 057							
All engines								922 086						
ENGINE														
1.4 LX	Petrol	55	10/88-08/91	GA14S										
Engine					A10	A20	A40	A50	A70	C10 - C30	C20	E01		
All engines							828 101							
All engines							831 136	931 030						
All engines								922 086						
ENGINE														
1.5	Petrol	52	06/86-10/88	E15S										
Engine					A10	A20	A40	A50	A70	C10 - C30	C20	E01		
All engines							822 057							
All engines								922 086						
ENGINE														
1.6	Petrol	62	06/86-10/88	E16S										
Engine					A10	A20	A40	A50	A70	C10 - C30	C20	E01		
All engines							822 057							
All engines								922 086						
ENGINE														
1.6 i	Petrol	54	06/86-10/90	E16i										
Engine					A10	A20	A40	A50	A70	C10 - C30	C20	E01		
All engines							831 114							
All engines								931 110						
ENGINE														
1.6 i 12V	Petrol	66	06/86-06/91	GA16i										
Engine					A10	A20	A40	A50	A70	C10 - C30	C20	E01		
All engines							822 046	922 070						
All engines							831 114	931 110						
ENGINE														
1.6 i 4x4	Petrol	54	06/86-10/90	E16i										
Engine					A10	A20	A40	A50	A70	C10 - C30	C20	E01		
All engines							831 114							
All engines								931 110						
SUNNY III														
ENGINE														
1.4	Petrol	60	10/90-06/95	GA14DS										
Engine					A10	A20	A40	A50	A70	C10 - C30	C20	E01		
All engines							828 101							
All engines							831 114	931 110						
All engines							831 155	931 131						
All engines								922 086						

A10	CONDENSER	A20	CONTACT SET	A40	DISTRIBUTOR CAP	A50	ROTOR	A70	PICK-UP
C10	COIL	C20	IGNITION MODULE	C30	ELECTRONIC IGNITION KIT	E01	IGNITION CABLE SET		

The present application list is a brief version. For the detailed information about the possibility of installation on a specific vehicle, please refer to our web-catalogue <http://catalogo.facet.eu/>

Vehicle	alim.	kW	Date	Engine	FUNCTIONS ON THE VEHICLE							
					A10	A20	A40	A50	A70	C10 - C30	C20	E01

ENGINE				
1.4 i	Petrol	55	10/90-05/95	GA14DE, GA14DS

Engine	Information	A10	A20	A40	A50	A70	C10 - C30	C20	E01
Eng. GA14DE	version Hitachi			822 079					
Eng. GA14DS	01/10/92 ->, version Lucas			828 101					
Eng. GA14DS	->year 01/10/92, version Mitsubishi			831 114	931 110				
Eng. GA14DS	01/10/92 ->, version Mitsubishi			831 155	931 131				
Eng. GA14DS	01/10/92 ->, version Hitachi				922 086				

ENGINE				
1.4 i 16V	Petrol	64	10/90-06/95	GA14DE

Engine	Information	A10	A20	A40	A50	A70	C10 - C30	C20	E01
All engines	version Hitachi			822 079					

ENGINE				
1.6 16V 4x4	Petrol	66	11/90-05/95	GA16DS

Engine	Information	A10	A20	A40	A50	A70	C10 - C30	C20	E01
All engines	version Hitachi			822 046					
All engines	version Lucas			828 101					
All engines	version Hitachi, no specific info conc. application available				922 070, 922 086				

ENGINE				
1.6 i	Petrol	66	10/90-03/00	GA16DE, GA16DS

Engine	Information	A10	A20	A40	A50	A70	C10 - C30	C20	E01
All engines	->year 01/10/92, version Hitachi			822 046	922 070				
Eng. GA16DE	version Hitachi			822 079					
Eng. GA16DE	->year 30/04/98, Traveller, version Hitachi			822 089					
All engines	01/10/92 ->, version Lucas			828 101					
All engines	01/10/92 ->, version Mitsubishi			831 155	931 131				
All engines	01/10/92 ->, version Hitachi				922 086				
Eng. GA16DE									360 399

ENGINE				
1.6 i	Petrol	82	10/90-05/95	GA16DE

Engine	Information	A10	A20	A40	A50	A70	C10 - C30	C20	E01
All engines	version Hitachi			822 079					
All engines									360 399

ENGINE				
1.6 i 16V	Petrol	75	10/92-05/95	GA16DE

Engine	Information	A10	A20	A40	A50	A70	C10 - C30	C20	E01
All engines	version Hitachi			822 079					
All engines									360 399

ENGINE				
1.6 i 16V 4WD	Petrol	66	10/90-05/95	GA16DS

Engine	Information	A10	A20	A40	A50	A70	C10 - C30	C20	E01
All engines	version Hitachi			822 046					
All engines	version Hitachi, no specific info conc. application available				922 070, 922 086				

ENGINE				
1.6 i 16V 4WD	Petrol	75	10/92-06/95	GA16DE

Engine	Information	A10	A20	A40	A50	A70	C10 - C30	C20	E01
All engines	version Hitachi			822 046					
All engines	version Hitachi, no specific info conc. application available				922 070, 922 086				

ENGINE				
1.6 i 16V 4x4	Petrol	75	10/92-03/00	GA16DE

Engine	Information	A10	A20	A40	A50	A70	C10 - C30	C20	E01
All engines	version Hitachi			822 046					
All engines	version Hitachi, no specific info conc. application available				922 070, 922 086				

ENGINE				
2.0 GTI 16V	Petrol	105	10/90-05/95	SR20DE









Engine	Information	A10	A20	A40	A50	A70	C10 - C30	C20	E01
All engines	version Hitachi			822 073	922 085				

A10	CONDENSER	A20	CONTACT SET	A40	DISTRIBUTOR CAP	A50	ROTOR	A70	PICK-UP
C10	COIL	C20	IGNITION MODULE	C30	ELECTRONIC IGNITION KIT	E01	IGNITION CABLE SET		

Vehicle	alim.	kW	Date	Engine	FUNCTIONS ON THE VEHICLE									
					A10	A20	A40	A50	A70	C10 - C30	C20	E01		
ENGINE														
2.0 GTI-R 4x4	Petrol	162	10/90-05/95	SR20DET										
Engine	Information				A10	A20	A40	A50	A70	C10 - C30	C20	E01		
All engines	version Hitachi						822 073	922 085						
SYLPHY III														
1.6 DIG-T	Petrol	0	07/12->	MR16DDT										
Engine	Information				A10	A20	A40	A50	A70	C10 - C30	C20	E01		
All engines	Qty: 4									470 551	C10			
ENGINE														
1.8	Petrol	96	08/12->	MRA8DE										
Engine	Information				A10	A20	A40	A50	A70	C10 - C30	C20	E01		
All engines	Qty: 4									470 552	C10			
TEANA II														
2.5	Petrol	134	07/08-09/13	VQ25DE										
Engine	Information				A10	A20	A40	A50	A70	C10 - C30	C20	E01		
All engines	x 6, COIL ON PLUG									470 533	C10			
ENGINE														
2.5 FOUR Trazione integrale	Petrol	123	06/08-12/12	QR25DE										
Engine	Information				A10	A20	A40	A50	A70	C10 - C30	C20	E01		
All engines	x 4, COIL ON PLUG									470 552	C10			
ENGINE														
3.5	Petrol	183	07/08-09/13	VQ35DE										
Engine	Information				A10	A20	A40	A50	A70	C10 - C30	C20	E01		
All engines	x 6, COIL ON PLUG									470 533	C10			
TEANA III														
2.5	Petrol	127	09/13->	QR25DE										
Engine	Information				A10	A20	A40	A50	A70	C10 - C30	C20	E01		
All engines	x 4, COIL ON PLUG									470 552	C10			
ENGINE														
3.5	Petrol	0	01/14->	VQ35DE										
Engine	Information				A10	A20	A40	A50	A70	C10 - C30	C20	E01		
All engines	Qty: 6									470 533	C10			
ENGINE														
3.5 CVTC	Petrol	183	01/14->	VQ35DE										
Engine	Information				A10	A20	A40	A50	A70	C10 - C30	C20	E01		
All engines	x 6, COIL ON PLUG									470 533	C10			
TERRANO I														
2.4 i 4WD	Petrol	76	10/87-02/93	Z24i										
Engine	Information				A10	A20	A40	A50	A70	C10 - C30	C20	E01		
All engines	version Hitachi						822 040	922 066						
TERRANO II														
2.4 4WD	Petrol	85	05/96-01/02	KA24E										
Engine	Information				A10	A20	A40	A50	A70	C10 - C30	C20	E01		
All engines	->year 01/05/96, version Hitachi						822 046							
All engines	01/05/96 ->, version Hitachi						822 089							
All engines	no specific info conc. application available, version Hitachi							922 070, 922 102						
All engines	01/05/96 ->												360 789	
ENGINE														
2.4 4WD	Petrol	87	05/96-09/07	KA24E										
Engine	Information				A10	A20	A40	A50	A70	C10 - C30	C20	E01		
All engines	->year 01/05/96, version Hitachi						822 046							
All engines	01/05/96 ->, version Hitachi						822 089							
All engines	01/10/99 ->, ->year 01/02/02, version Hitachi							922 070						
All engines	01/03/02 ->, version Hitachi							922 102						
All engines	01/05/96 ->												360 789	

A10 CONDENSER	A20 CONTACT SET	A40 DISTRIBUTOR CAP	A50 ROTOR	A70 PICK-UP
C10 COIL	C20 IGNITION MODULE	C30 ELECTRONIC IGNITION KIT	E01 IGNITION CABLE SET	

The present application list is a brief version. For the detailed information about the possibility of installation on a specific vehicle, please refer to our web-catalogue <http://catalogo.facet.eu/>

				FUNCTIONS ON THE VEHICLE								
Vehicle	alim.	kW	Date	Engine								
				ENGINE								
2.4 i 12V 4WD	Petrol	91	02/93-12/97	KA24E								
Engine	Information			A10	A20	A40	A50	A70	C10 - C30	C20	E01	
All engines	->year 01/05/96, version Hitachi					822 046						
All engines	01/05/96 ->, version Hitachi					822 089						
All engines	->year 01/05/96, 01/10/99 ->, ->year 01/02/02, version Hitachi						922 070					
All engines	01/03/02 ->, version Hitachi						922 102					
All engines	01/05/96 ->											360 789
TERRANO III				ENGINE								
1.6	Petrol	75	03/14->	K4M606, K4M690								
Engine	Information			A10	A20	A40	A50	A70	C10 - C30	C20	E01	
All engines	x 4, COIL ON PLUG								470 432	C10		
1.6	Petrol	77	09/13->	K4M								
Engine	Information			A10	A20	A40	A50	A70	C10 - C30	C20	E01	
All engines									470 432	C10		
1.6	Petrol	84	12/15->	H4M								
Engine	Information			A10	A20	A40	A50	A70	C10 - C30	C20	E01	
All engines	x 4, COIL ON PLUG								470 613	C10		
1.6 4x4	Petrol	75	03/14->	K4M606, K4M690								
Engine	Information			A10	A20	A40	A50	A70	C10 - C30	C20	E01	
All engines	x 4, COIL ON PLUG								470 432	C10		
1.6 4x4	Petrol	84	12/15->	H4M								
Engine	Information			A10	A20	A40	A50	A70	C10 - C30	C20	E01	
All engines	x 4, COIL ON PLUG								470 613	C10		
2.0	Petrol	0	09/13->	F4R								
Engine	Information			A10	A20	A40	A50	A70	C10 - C30	C20	E01	
All engines	Qty: 4								470 432	C10		
2.0	Petrol	98	03/14->	F4R								
Engine	Information			A10	A20	A40	A50	A70	C10 - C30	C20	E01	
All engines	x 4, BERU, COIL ON PLUG								470 432	C10		
2.0 4x4	Petrol	105	12/15->	F4R								
Engine	Information			A10	A20	A40	A50	A70	C10 - C30	C20	E01	
All engines	x 4, BERU, COIL ON PLUG								470 432	C10		
2.0 4x4	Petrol	98	03/14->	F4R								
Engine	Information			A10	A20	A40	A50	A70	C10 - C30	C20	E01	
All engines	x 4, BERU, COIL ON PLUG								470 432	C10		
TIIDA I				ENGINE								
1.6	Petrol	81	09/07-12/12	HR16DE								
Engine	Information			A10	A20	A40	A50	A70	C10 - C30	C20	E01	
All engines	x 4, COIL ON PLUG								470 489	C10		
1.8	Petrol	78	01/07-06/11	MR18DE								
Engine	Information			A10	A20	A40	A50	A70	C10 - C30	C20	E01	
All engines	Qty: 4								470 489	C10		
All engines	x 4, COIL ON PLUG								470 489	C10		
1.8	Petrol	93	05/04-12/12	MR18DE								
Engine	Information			A10	A20	A40	A50	A70	C10 - C30	C20	E01	
All engines	Qty: 4								470 489	C10		
All engines	x 4, COIL ON PLUG								470 489	C10		

A10 CONDENSER	A20 CONTACT SET	A40 DISTRIBUTOR CAP	A50 ROTOR	A70 PICK-UP
C10 COIL	C20 IGNITION MODULE	C30 ELECTRONIC IGNITION KIT	E01 IGNITION CABLE SET	

Vehicle	alim.	kW	Date	Engine	FUNCTIONS ON THE VEHICLE							
					A10	A20	A40	A50	A70	C10 - C30	C20	E01

TIIDA II

1.6	Petrol	140	02/13->	ENGINE MR16DDT
-----	--------	-----	---------	-------------------

Engine	Information	A10	A20	A40	A50	A70	C10 - C30	C20	E01
All engines	Qty: 4						470 551	C10	

1.6 [RUS]	Petrol	0	01/15->	ENGINE HR16DE
-----------	--------	---	---------	------------------

Engine	Information	A10	A20	A40	A50	A70	C10 - C30	C20	E01
All engines	Qty: 4						470 552	C10	

1.6 CVTC	Petrol	86	08/12->	ENGINE HR16DE
----------	--------	----	---------	------------------

Engine	Information	A10	A20	A40	A50	A70	C10 - C30	C20	E01
All engines	x 4, COIL ON PLUG						470 552	C10	

1.6 DIG-T	Petrol	0	08/11->	ENGINE MR16DDT
-----------	--------	---	---------	-------------------

Engine	Information	A10	A20	A40	A50	A70	C10 - C30	C20	E01
All engines	Qty: 4						470 551	C10	

1.8	Petrol	96	08/12->	ENGINE MRA8DE
-----	--------	----	---------	------------------

Engine	Information	A10	A20	A40	A50	A70	C10 - C30	C20	E01
All engines	Qty: 4						470 552	C10	

URVAN III

2.0	Petrol	64	05/87-05/97	ENGINE Z20
-----	--------	----	-------------	---------------

Engine	Information	A10	A20	A40	A50	A70	C10 - C30	C20	E01
All engines	version Mitsubishi		731 085	831 003/001	931 023				

2.4 i	Petrol	74	05/89-09/93	ENGINE Z24i
-------	--------	----	-------------	----------------

Engine	Information	A10	A20	A40	A50	A70	C10 - C30	C20	E01
All engines	version Hitachi			822 040	922 066				

VAN

2.4 [USA]	Petrol	0	01/86-12/89	ENGINE Z24i
-----------	--------	---	-------------	----------------

Engine	Information	A10	A20	A40	A50	A70	C10 - C30	C20	E01
All engines	version Hitachi			822 040	922 066				

VANETTE II

1.5	Petrol	55	04/87-11/94	ENGINE A15
-----	--------	----	-------------	---------------

Engine	Information	A10	A20	A40	A50	A70	C10 - C30	C20	E01
All engines	version Mitsubishi		731 085	831 120	931 023				
All engines	version Hitachi			822 003					

2.0	Petrol	66	07/87-08/94	ENGINE Z20S
-----	--------	----	-------------	----------------

Engine	Information	A10	A20	A40	A50	A70	C10 - C30	C20	E01
All engines	version Mitsubishi	631 131	731 085	831 114	931 030				
All engines	version Hitachi			822 040	922 066				

X-TRAIL

2.0	Petrol	106	12/14->	ENGINE MR20DD
-----	--------	-----	---------	------------------

Engine	Information	A10	A20	A40	A50	A70	C10 - C30	C20	E01
All engines	x 4, COIL ON PLUG						470 551	C10	

2.0 ALL MODE 4x4-i	Petrol	106	12/14->	ENGINE MR20DD
--------------------	--------	-----	---------	------------------

Engine	Information	A10	A20	A40	A50	A70	C10 - C30	C20	E01
All engines	x 4, COIL ON PLUG						470 551	C10	

2.5 ALL MODE 4x4-i	Petrol	126	04/16->	ENGINE QR25DE
--------------------	--------	-----	---------	------------------

Engine	Information	A10	A20	A40	A50	A70	C10 - C30	C20	E01
All engines	x 4, COIL ON PLUG						470 552	C10	

A10 CONDENSER	A20 CONTACT SET	A40 DISTRIBUTOR CAP	A50 ROTOR	A70 PICK-UP
C10 COIL	C20 IGNITION MODULE	C30 ELECTRONIC IGNITION KIT	E01 IGNITION CABLE SET	

The present application list is a brief version. For the detailed information about the possibility of installation on a specific vehicle, please refer to our web-catalogue <http://catalogo.facet.eu/>

Vehicle	alim.	kW	Date	Engine	FUNCTIONS ON THE VEHICLE							
					A10	A20	A40	A50	A70	C10 - C30	C20	E01

X-TRAIL II

2.0	Petrol	102	06/08-02/14	ENGINE MR20DE
-----	--------	-----	-------------	------------------

Engine	Information	A10	A20	A40	A50	A70	C10 - C30	C20	E01
All engines	Qty: 4						470 489	C10	

2.0 4x4	Petrol	101	06/07-11/13	ENGINE MR20DE
---------	--------	-----	-------------	------------------

Engine	Information	A10	A20	A40	A50	A70	C10 - C30	C20	E01
All engines	Qty: 4						470 489	C10	

2.0 4x4	Petrol	103	06/08-11/13	ENGINE MR20DE
---------	--------	-----	-------------	------------------

Engine	Information	A10	A20	A40	A50	A70	C10 - C30	C20	E01
All engines	x 4, COIL ON PLUG						470 489	C10	

2.0 4x4	Petrol	104	06/07-11/13	ENGINE MR20DE
---------	--------	-----	-------------	------------------

Engine	Information	A10	A20	A40	A50	A70	C10 - C30	C20	E01
All engines	x 4, COIL ON PLUG						470 489	C10	

2.0 FWD	Petrol	103	06/08-11/13	ENGINE MR20DE
---------	--------	-----	-------------	------------------

Engine	Information	A10	A20	A40	A50	A70	C10 - C30	C20	E01
All engines	x 4, COIL ON PLUG						470 489	C10	

2.0 FWD	Petrol	104	03/07-11/13	ENGINE MR20DE
---------	--------	-----	-------------	------------------

Engine	Information	A10	A20	A40	A50	A70	C10 - C30	C20	E01
All engines	x 4, COIL ON PLUG						470 489	C10	

2.5	Petrol	124	09/07-11/13	ENGINE QR25DE
-----	--------	-----	-------------	------------------

Engine	Information	A10	A20	A40	A50	A70	C10 - C30	C20	E01
All engines	Qty: 4						470 552	C10	

2.5 4x4	Petrol	124	06/07-11/13	ENGINE QR25DE
---------	--------	-----	-------------	------------------

Engine	Information	A10	A20	A40	A50	A70	C10 - C30	C20	E01
All engines	x 4, COIL ON PLUG						470 552	C10	

2.5 4x4	Petrol	132	09/07-07/14	ENGINE QR25DE
---------	--------	-----	-------------	------------------

Engine	Information	A10	A20	A40	A50	A70	C10 - C30	C20	E01
All engines	Qty: 4						470 552	C10	

X-TRAIL III

1.6 DIG-T	Petrol	120	06/15->	ENGINE MR16DDT
-----------	--------	-----	---------	-------------------

Engine	Information	A10	A20	A40	A50	A70	C10 - C30	C20	E01
All engines	x 4, COIL ON PLUG						470 551	C10	

2.0	Petrol	106	09/14->	ENGINE MR20DD
-----	--------	-----	---------	------------------

Engine	Information	A10	A20	A40	A50	A70	C10 - C30	C20	E01
All engines	x 4, COIL ON PLUG						470 551	C10	

2.0 ALL MODE 4x4-i	Petrol	106	09/14->	ENGINE MR20DD
--------------------	--------	-----	---------	------------------

Engine	Information	A10	A20	A40	A50	A70	C10 - C30	C20	E01
All engines	x 4, COIL ON PLUG						470 551	C10	

2.5	Petrol	126	12/13->	ENGINE QR25DE
-----	--------	-----	---------	------------------

Engine	Information	A10	A20	A40	A50	A70	C10 - C30	C20	E01
All engines	Qty: 4						470 552	C10	

2.5 ALL MODE 4x4-i	Petrol	126	12/13->	ENGINE QR25DE
--------------------	--------	-----	---------	------------------

Engine	Information	A10	A20	A40	A50	A70	C10 - C30	C20	E01
All engines	x 4, COIL ON PLUG						470 552	C10	

A10 CONDENSER	A20 CONTACT SET	A40 DISTRIBUTOR CAP	A50 ROTOR	A70 PICK-UP
C10 COIL	C20 IGNITION MODULE	C30 ELECTRONIC IGNITION KIT	E01 IGNITION CABLE SET	





Vehicle	alim.	kW	Date	Engine	FUNCTIONS ON THE VEHICLE							
					 A10	 A20	 A40	 A50	 A70	 C10 - C30	 C20	 E01

1000				ENGINE
C	Petrol	29	08/63-12/72	--

Engine	Information	A10	A20	A40	A50	A70	C10 - C30	C20	E01
All engines					906 021R				

A10	CONDENSER	A20	CONTACT SET	A40	DISTRIBUTOR CAP	A50	ROTOR	A70	PICK-UP
C10	COIL	C20	IGNITION MODULE	C30	ELECTRONIC IGNITION KIT	E01	IGNITION CABLE SET		

The present application list is a brief version. For the detailed information about the possibility of installation on a specific vehicle, please refer to our web-catalogue <http://catalogo.facet.eu/>

					FUNCTIONS ON THE VEHICLE							
Vehicle	alim.	kW	Date	Engine								
					A10	A20	A40	A50	A70	C10 - C30	C20	E01

ADAM

				ENGINE
1.0	Petrol	66	07/14-11/18	B 10 XFL, D 10 XFL

Engine	Information	A10	A20	A40	A50	A70	C10 - C30	C20	E01
All engines	x 3, COIL ON PLUG						470 631	C10	

				ENGINE
1.0	Petrol	85	07/14-11/18	B 10 XFT, D 10 XFT

Engine	Information	A10	A20	A40	A50	A70	C10 - C30	C20	E01
All engines	x 3, COIL ON PLUG						470 631	C10	

				ENGINE
1.2	Petrol	51	10/12-02/19	A 12 XEL, B 12 XEL, D 12 XEL

Engine	Information	A10	A20	A40	A50	A70	C10 - C30	C20	E01
All engines	x 1, COIL ON RAIL						470 547	C10	

				ENGINE
1.4	Petrol	64	10/12-02/19	A 14 XEL, B 14 XEL, D 14 XEL

Engine	Information	A10	A20	A40	A50	A70	C10 - C30	C20	E01
All engines	x 1, COIL ON RAIL						470 547	C10	

				ENGINE
1.4	Petrol	74	10/12-02/19	A 14 XER, B 14 XER, D 14 XER

Engine	Information	A10	A20	A40	A50	A70	C10 - C30	C20	E01
All engines	x 1, COIL ON RAIL						470 547	C10	

				ENGINE
1.4 LPG	Petrol/ Liquified Petroleum Gas (LPG)	64	07/13-11/18	A 14 XEL, B 14 XEL, D 14 XEL

Engine	Information	A10	A20	A40	A50	A70	C10 - C30	C20	E01
All engines	x 1, COIL ON RAIL						470 547	C10	

				ENGINE
1.4 S	Petrol	110	11/14-01/19	B 14 NEH, D 14 NEH

Engine	Information	A10	A20	A40	A50	A70	C10 - C30	C20	E01
All engines	x 1, COIL ON RAIL						470 547	C10	

ADMIRAL

				ENGINE
2.6 S	Petrol	74	04/64-09/65	26 S

Engine	Information	A10	A20	A40	A50	A70	C10 - C30	C20	E01
All engines			706 029HV						

AGILA A

				ENGINE
1.0	Petrol	44	08/03-12/07	Z 10 XEP

Engine	Information	A10	A20	A40	A50	A70	C10 - C30	C20	E01
All engines	x 3, BOSCH, COIL ON PLUG, 12 Volt, Dia: 55 mm, for pre-resistance						470 398	C10	

				ENGINE
1.0 12V	Petrol	43	09/00-12/07	Z10XE

Engine	Information	A10	A20	A40	A50	A70	C10 - C30	C20	E01
All engines	x 3, BOSCH, COIL ON PLUG						470 398	C10	

				ENGINE
1.2 16V	Petrol	55	09/00-12/07	Z 12 XE

Engine	Information	A10	A20	A40	A50	A70	C10 - C30	C20	E01
All engines	x 4, BOSCH, COIL ON PLUG						470 400	C10	

				ENGINE
1.2 16V Twinport	Petrol	59	07/04-12/07	Z 12 XEP

Engine	Information	A10	A20	A40	A50	A70	C10 - C30	C20	E01
All engines	x 1, BOSCH, COIL ON PLUG, incl. spark plug connector						470 400	C10	

AMPERA

				ENGINE
EV 150	Petrol/ Electric	111	11/11-03/15	A 14 XFL

Engine	Information	A10	A20	A40	A50	A70	C10 - C30	C20	E01
All engines	x 1, COIL ON RAIL						470 547	C10	

A10 CONDENSER	A20 CONTACT SET	A40 DISTRIBUTOR CAP	A50 ROTOR	A70 PICK-UP
C10 COIL	C20 IGNITION MODULE	C30 ELECTRONIC IGNITION KIT	E01 IGNITION CABLE SET	

Vehicle	alim.	kW	Date	Engine	FUNCTIONS ON THE VEHICLE							
					A10	A20	A40	A50	A70	C10 - C30	C20	E01

ASCONA B

				ENGINE
2.0 N	Petrol	66	08/77-08/81	20 N

Engine	Information	A10	A20	A40	A50	A70	C10 - C30	C20	E01
All engines					912 093R				

ASCONA C

				ENGINE
1.3 N	Petrol	44	09/81-08/86	13 N

Engine	Information	A10	A20	A40	A50	A70	C10 - C30	C20	E01
All engines	version Bosch		706 034HVS	806 080	906 026R				
All engines	version Delco Remy			812 073	912 096	412 011			
All engines	eng. type 879422 ->						470 111	C10	
All engines									359 514

				ENGINE
1.3 S	Petrol	55	09/81-08/88	13 S

Engine	Information	A10	A20	A40	A50	A70	C10 - C30	C20	E01
All engines	eng. type 885919 ->						470 111	C10	
All engines									359 514

				ENGINE
1.6	Petrol	55	09/81-08/88	16 N

Engine	Information	A10	A20	A40	A50	A70	C10 - C30	C20	E01
All engines	version Bosch			806 080	906 056R				
All engines							470 109	C10	

				ENGINE
1.6	Petrol	60	09/86-08/88	16 SV

Engine	Information	A10	A20	A40	A50	A70	C10 - C30	C20	E01
All engines	prod. nr. 4J24 ->, version Delco Remy			812 073					
All engines	->prod. nr. 4J23, version Delco Remy			812 074					
All engines	version Delco Remy				912 097	412 011			
All engines							470 111	C10	359 514

				ENGINE
1.6 i	Petrol	55	09/87-08/88	E 16 NZ

Engine	Information	A10	A20	A40	A50	A70	C10 - C30	C20	E01
All engines									360 942

				ENGINE
1.6 i Cat	Petrol	55	09/86-08/88	C 16 LZ, C 16 NZ

Engine	Information	A10	A20	A40	A50	A70	C10 - C30	C20	E01
All engines	version Delco Remy			812 073	912 097	412 010			
All engines							470 111	C10	465 025
All engines									360 942

				ENGINE
1.6 S	Petrol	66	09/81-08/86	16 SH

Engine	Information	A10	A20	A40	A50	A70	C10 - C30	C20	E01
All engines	version Bosch			806 080	906 056R				
All engines							470 109	C10	

				ENGINE
1.8	Petrol	62	09/87-08/88	E 18 NV

Engine	Information	A10	A20	A40	A50	A70	C10 - C30	C20	E01
All engines	version Bosch			806 240	906 127R				
All engines							470 194	C10	

				ENGINE
1.8	Petrol	85	09/81-08/88	18 SE

Engine	Information	A10	A20	A40	A50	A70	C10 - C30	C20	E01
All engines	version Bosch			806 240	906 127R				

				ENGINE
1.8 E	Petrol	74	01/85-08/86	C 18 NE, S 18 NV

Engine	Information	A10	A20	A40	A50	A70	C10 - C30	C20	E01
Eng. C 18 NE	version Bosch			806 080	906 056R				
Eng. S 18 NV	version Bosch			806 240	906 127R				
Eng. S 18 NV							470 194	C10	

A10	CONDENSER	A20	CONTACT SET	A40	DISTRIBUTOR CAP	A50	ROTOR	A70	PICK-UP
C10	COIL	C20	IGNITION MODULE	C30	ELECTRONIC IGNITION KIT	E01	IGNITION CABLE SET		

Vehicle	alim.	kW	Date	Engine	FUNCTIONS ON THE VEHICLE							
					A10	A20	A40	A50	A70	C10 - C30	C20	E01

ENGINE				
1.8 i	Petrol	85	09/82-08/86	18 E

Engine	Information	A10	A20	A40	A50	A70	C10 - C30	C20	E01
All engines	version Bosch			806 080	906 056R				
All engines							470 109	C10	

ENGINE				
2.0 i	Petrol	85	09/86-08/88	20 NE

Engine	Information	A10	A20	A40	A50	A70	C10 - C30	C20	E01
All engines	version Bosch			806 240	906 127R				
All engines							470 194	C10	

ENGINE				
2.0 i Cat	Petrol	85	09/86-08/88	C 20 NE

Engine	Information	A10	A20	A40	A50	A70	C10 - C30	C20	E01
All engines	version Bosch			806 240	906 127R				
All engines							470 194	C10	

ENGINE				
2.0 i GT	Petrol	95	03/87-08/88	20 SEH

Engine	Information	A10	A20	A40	A50	A70	C10 - C30	C20	E01
All engines	version Bosch			806 240	906 127R				
All engines							470 194	C10	

ASTRA F

ENGINE				
1.4	Petrol	55	09/91-09/93	14 NV

Engine	Information	A10	A20	A40	A50	A70	C10 - C30	C20	E01
All engines	version Bosch			806 256	906 056R				
All engines								465 005	
All engines	->eng. 02BF1476, 19241623								360 237
All engines	eng. type 02BF1477, 19241624 ->								360 529

ENGINE				
1.4	Petrol	60	09/92-09/98	14 SE

Engine	Information	A10	A20	A40	A50	A70	C10 - C30	C20	E01
All engines	version Lucas			828 100	928 028R				
All engines							470 140	C10	465 036
All engines	eng. type 02T14053, 02BD1413 ->								359 634
All engines	->eng. 02T14052, 19880550								360 237
All engines	eng. type 02BD1413, 19280317 ->								360 531

ENGINE				
1.4 i	Petrol	44	09/91-01/05	C 14 NZ, X 14 NZ

Engine	Information	A10	A20	A40	A50	A70	C10 - C30	C20	E01
All engines	connector type SAE, version Bosch			806 249					
All engines	connector type M4, version Bosch			806 256					
All engines	version Bosch				906 121R				
All engines	version Lucas				928 028R	428 202			
All engines							470 140	C10	465 036
All engines	->eng. 02BF1476, 19241623								360 237
All engines	eng. type 02BF1477, 19241624 ->								360 529

ENGINE				
1.4 i 16V	Petrol	66	01/96-03/01	X 14 XE

Engine	Information	A10	A20	A40	A50	A70	C10 - C30	C20	E01
All engines									360 559

ENGINE				
1.4 Si	Petrol	60	03/92-03/01	C 14 SE

Engine	Information	A10	A20	A40	A50	A70	C10 - C30	C20	E01
All engines	version Lucas			828 100	928 028R				
All engines							470 140	C10	465 036
All engines	eng. type 02T14053, 02BD1413 ->								359 634
All engines	->eng. 02T14052, 19880550								360 237
All engines	eng. type 02BD1413, 19280317 ->								360 531

ENGINE				
1.6	Petrol	55	09/95-09/98	16 LZ2, 16 NZR

Engine	Information	A10	A20	A40	A50	A70	C10 - C30	C20	E01
Eng. 16 LZ2	version Ducellier			815 084	915 103R				

A10 CONDENSER	A20 CONTACT SET	A40 DISTRIBUTOR CAP	A50 ROTOR	A70 PICK-UP
C10 COIL	C20 IGNITION MODULE	C30 ELECTRONIC IGNITION KIT	E01 IGNITION CABLE SET	

Vehicle	alim.	kW	Date	Engine	FUNCTIONS ON THE VEHICLE								
					A10	A20	A40	A50	A70	C10 - C30	C20	E01	
1.6	Petrol	55	09/95-09/98	ENGINE 16 LZ2, 16 NZR									
Engine	Information				A10	A20	A40	A50	A70	C10 - C30	C20	E01	
Eng. 16 LZ2										470 140	C10 465 036		
Eng. 16 LZ2	FOR: (ZA)									470 192	C10		
Eng. 16 NZR	->eng. 02BE6166												359 634
Eng. 16 NZR	eng. type 02BE6167 ->												360 531
1.6 i	Petrol	52	02/93-08/96	ENGINE X 16 SZ									
Engine	Information				A10	A20	A40	A50	A70	C10 - C30	C20	E01	
All engines	->eng. 02BE6166												359 634
All engines	eng. type 02BE6167 ->												360 531
1.6 i	Petrol	55	09/91-01/05	ENGINE C 16 NZ, X 16 SZR									
Engine	Information				A10	A20	A40	A50	A70	C10 - C30	C20	E01	
Eng. C 16 NZ	version Delco Remy						812 073	912 100	412 010				
Eng. C 16 NZ										470 341	C10 465 025		
Eng. C 16 NZ	->eng. 02V65825												359 514
Eng. X 16 SZR	->eng. 02BE6166												359 634
Eng. X 16 SZR	eng. type 02BE6167 ->												360 531
1.6 i 16V	Petrol	74	08/94-01/05	ENGINE X 16 XEL									
Engine	Information				A10	A20	A40	A50	A70	C10 - C30	C20	E01	
All engines	->eng. 20C17332												359 688
All engines	eng. type 20C17333 ->												360 559
1.6 Si	Petrol	74	03/92-12/94	ENGINE C 16 SE									
Engine	Information				A10	A20	A40	A50	A70	C10 - C30	C20	E01	
All engines	->eng. 02BD0920												359 634
All engines	eng. type 02BD0921 ->												360 531
1.8	Petrol	81	02/03-07/04	ENGINE Z 18 XEL									
Engine	Information				A10	A20	A40	A50	A70	C10 - C30	C20	E01	
All engines										470 272	C10		360 562
1.8 i	Petrol	66	09/91-09/98	ENGINE C 18 NZ									
Engine	Information				A10	A20	A40	A50	A70	C10 - C30	C20	E01	
All engines	version Bosch						806 257	906 127R					
All engines	version Duellier						815 084	915 103R					
All engines										470 140	C10 465 036		
All engines	FOR: (ZA)									470 192	C10		
All engines	eng. type 14349312 ->												359 689
1.8 i	Petrol	85	03/98-08/00	ENGINE X 18 XE1									
Engine	Information				A10	A20	A40	A50	A70	C10 - C30	C20	E01	
All engines										470 508	C10		
1.8 i 16V	Petrol	82	09/95-09/96	ENGINE 18 SE									
Engine	Information				A10	A20	A40	A50	A70	C10 - C30	C20	E01	
All engines										470 192	C10		
1.8 i 16V	Petrol	85	07/94-03/01	ENGINE C 18 SEL, C 18 XEL, X 18 XE									
Engine	Information				A10	A20	A40	A50	A70	C10 - C30	C20	E01	
All engines										470 272	C10		
All engines	ch. W2000000 ->, ch. W5000000 ->, ch. W8000000 ->												360 506
All engines	->ch. V29999999, ->ch. V59999999, ->ch. V89999999												360 562
1.8 i 16V	Petrol	92	06/93-01/98	ENGINE C 18 XE									
Engine	Information				A10	A20	A40	A50	A70	C10 - C30	C20	E01	
All engines										470 272	C10		
All engines	ch. W2000000 ->, ch. W5000000 ->, ch. W8000000 ->												360 506

A10 CONDENSER	A20 CONTACT SET	A40 DISTRIBUTOR CAP	A50 ROTOR	A70 PICK-UP
C10 COIL	C20 IGNITION MODULE	C30 ELECTRONIC IGNITION KIT	E01 IGNITION CABLE SET	

The present application list is a brief version. For the detailed information about the possibility of installation on a specific vehicle, please refer to our web-catalogue <http://catalogo.facet.eu/>

Vehicle	alim.	kW	Date	Engine	FUNCTIONS ON THE VEHICLE							
					A10	A20	A40	A50	A70	C10 - C30	C20	E01

ENGINE				
1.8 i 16V	Petrol	92	06/93-01/98	C 18 XE

Engine	Information	A10	A20	A40	A50	A70	C10 - C30	C20	E01
All engines	->ch. V2999999, ->ch. V5999999, ->ch. V8999999								360 562

ENGINE				
2.0 GSI 16V	Petrol	110	09/91-01/98	C 20 XE

Engine	Information	A10	A20	A40	A50	A70	C10 - C30	C20	E01
All engines	->eng. 14137012, version Bosch			806 257	906 121R				
All engines	eng. type 14137013 ->						470 273	C10	
All engines	eng. type 14002935 ->								359 688

ENGINE				
2.0 i	Petrol	85	09/91-09/98	C 20 NE

Engine	Information	A10	A20	A40	A50	A70	C10 - C30	C20	E01
All engines	version Bosch			806 257	906 127R				
All engines	version Ducellier			815 084	915 103R				
All engines							470 192	C10	
All engines	eng. type 14672354 ->, ->ch. R2999999, ->ch. R3999999, ->ch. R4999999, ->ch. R5999999, ->ch. R6999999, ->ch. R8999999								359 689

ENGINE				
2.0 i 16V	Petrol	100	02/95-08/00	X 20 XEV

Engine	Information	A10	A20	A40	A50	A70	C10 - C30	C20	E01
All engines							470 272	C10	
All engines	ch. W2000000 ->, ch. W5000000 ->, ch. W8000000 ->								360 506
All engines	->ch. V2999999, ->ch. V5999999, ->ch. V8999999								360 562

ENGINE				
2.0 i 16V	Petrol	110	03/93-01/98	C 20 XE

Engine	Information	A10	A20	A40	A50	A70	C10 - C30	C20	E01
All engines	->eng. 14137012, version Bosch			806 257	906 121R				
All engines	eng. type 14137013 ->						470 273	C10	
All engines	eng. type 14002935 ->								359 688

ENGINE				
2.0 i 16V	Petrol	118	10/99-08/00	X 20 XER

Engine	Information	A10	A20	A40	A50	A70	C10 - C30	C20	E01
All engines							470 272	C10	360 562

ASTRA G

ENGINE				
1.2	Petrol	48	09/98-08/00	X 12 XE

Engine	Information	A10	A20	A40	A50	A70	C10 - C30	C20	E01
All engines	x 4, BOSCH, COIL ON PLUG						470 400	C10	

ENGINE				
1.2 16V	Petrol	48	02/98-09/00	X 12 XE

Engine	Information	A10	A20	A40	A50	A70	C10 - C30	C20	E01
All engines	x 4, BOSCH, COIL ON PLUG						470 400	C10	

ENGINE				
1.2 16V	Petrol	55	09/00-01/05	Z 12 XE

Engine	Information	A10	A20	A40	A50	A70	C10 - C30	C20	E01
All engines	->ch. 38999999, ch. 39000000 ->, x 1, x 4, BOSCH, COIL ON PLUG, incl. spark plug connector						470 400	C10	

ENGINE				
1.4	Petrol	66	09/98-12/09	X 14 XE, Z 14 XE, Z 14 XEP

Engine	Information	A10	A20	A40	A50	A70	C10 - C30	C20	E01
Eng. X 14 XE, Z 14 XE	x 4, COIL ON PLUG, incl. spark plug connector						470 399	C10	
Eng. Z 14 XEP	x 1, BOSCH, COIL ON PLUG, incl. spark plug connector						470 400	C10	

ENGINE				
1.4 16V	Petrol	66	02/98-01/05	X 14 XE, Z 14 XE

Engine	Information	A10	A20	A40	A50	A70	C10 - C30	C20	E01
All engines	x 4, COIL ON PLUG, incl. spark plug connector						470 399	C10	

A10	CONDENSER	A20	CONTACT SET	A40	DISTRIBUTOR CAP	A50	ROTOR	A70	PICK-UP
C10	COIL	C20	IGNITION MODULE	C30	ELECTRONIC IGNITION KIT	E01	IGNITION CABLE SET		

Vehicle	alim.	kW	Date	Engine	FUNCTIONS ON THE VEHICLE								
					A10	A20	A40	A50	A70	C10 - C30	C20	E01	
1.4 LPG	Petrol/ Liquified Petro- leum Gas (LPG)	66	02/98-01/05	ENGINE									
				X 14 XE, Z 14 XE									
Engine					A10	A20	A40	A50	A70	C10 - C30	C20	E01	
All engines										470 399	C10		
1.6	Petrol	55	02/98-09/00	ENGINE									
				X 16 SZR									
Engine					A10	A20	A40	A50	A70	C10 - C30	C20	E01	
All engines												360 904	
1.6	Petrol	62	09/00-04/05	ENGINE									
				Z 16 SE									
Engine					A10	A20	A40	A50	A70	C10 - C30	C20	E01	
All engines												360 904	
1.6	Petrol	74	09/98-01/04	ENGINE									
				C 16 SEL, Z 16 XE									
Engine					A10	A20	A40	A50	A70	C10 - C30	C20	E01	
All engines										470 399	C10		
1.6	Petrol	76	11/02-12/09	ENGINE									
				Z 16 XEP									
Engine					A10	A20	A40	A50	A70	C10 - C30	C20	E01	
All engines										470 399	C10		
All engines										470 450	C10		
1.6 16V	Petrol	74	02/98-10/05	ENGINE									
				X 16 XEL, Z 16 XE									
Engine					A10	A20	A40	A50	A70	C10 - C30	C20	E01	
All engines										470 399	C10		
1.6 16V	Petrol	76	03/00-05/05	ENGINE									
				Z 16 XEP									
Engine					A10	A20	A40	A50	A70	C10 - C30	C20	E01	
All engines										470 450	C10		
1.6 CNG	Petrol/ Com- pressed Natural Gas (CNG)	71	03/03-07/04	ENGINE									
				Z 16 YNG									
Engine					A10	A20	A40	A50	A70	C10 - C30	C20	E01	
All engines										470 399	C10		
1.6 LPG	Petrol/ Liquified Petro- leum Gas (LPG)	74	03/98-01/05	ENGINE									
				X 16 XEL, Z 16 XE									
Engine					A10	A20	A40	A50	A70	C10 - C30	C20	E01	
All engines										470 399	C10		
1.6 LPG	Petrol/ Liquified Petro- leum Gas (LPG)	76	06/02-06/07	ENGINE									
				Z 16 XEP									
Engine					A10	A20	A40	A50	A70	C10 - C30	C20	E01	
All engines										470 450	C10		
1.8	Petrol	81	02/03-07/04	ENGINE									
				Z 18 XEL									
Engine					A10	A20	A40	A50	A70	C10 - C30	C20	E01	
All engines										470 508	C10		
1.8 16V	Petrol	85	02/98-10/00	ENGINE									
				X 18 XE1									
Engine					A10	A20	A40	A50	A70	C10 - C30	C20	E01	
All engines										470 508	C10		

A10	CONDENSER	A20	CONTACT SET	A40	DISTRIBUTOR CAP	A50	ROTOR	A70	PICK-UP
C10	COIL	C20	IGNITION MODULE	C30	ELECTRONIC IGNITION KIT	E01	IGNITION CABLE SET		

The present application list is a brief version. For the detailed information about the possibility of installation on a specific vehicle, please refer to our web-catalogue <http://catalogo.facet.eu/>

Vehicle	alim.	kW	Date	Engine	FUNCTIONS ON THE VEHICLE							
					A10	A20	A40	A50	A70	C10 - C30	C20	E01

ENGINE												
1.8 16V	Petrol	92	06/00-10/05	Z 18 XE	A10	A20	A40	A50	A70	C10 - C30	C20	E01
Engine	Information											
All engines	x 1, COIL ON PLUG, incl. spark plug connector									470 508	C10	

ENGINE												
2.0 16V	Petrol	100	02/98-01/05	X 20 XEV	A10	A20	A40	A50	A70	C10 - C30	C20	E01
Engine	Information											
All engines	x 1, D.I.S.									470 272	C10	
All engines												360 562

ENGINE												
2.0 16V OPC	Petrol	118	11/99-09/02	X 20 XER	A10	A20	A40	A50	A70	C10 - C30	C20	E01
Engine	Information											
All engines	x 1, D.I.S.									470 272	C10	
All engines												360 562

ENGINE												
2.0 16V Turbo	Petrol	140	09/00-08/01	Z 20 LET	A10	A20	A40	A50	A70	C10 - C30	C20	E01
Engine	Information											
All engines	x 1, COIL ON PLUG									470 507	C10	

ENGINE												
2.0 16V Turbo	Petrol	141	08/01-05/05	Z 20 LET	A10	A20	A40	A50	A70	C10 - C30	C20	E01
Engine	Information											
All engines	x 1, COIL ON PLUG									470 507	C10	

ENGINE												
2.0 16V Turbo	Petrol	147	11/02-10/05	Z 20 LET	A10	A20	A40	A50	A70	C10 - C30	C20	E01
Engine	Information											
All engines	x 1, COIL ON PLUG									470 507	C10	

ENGINE												
2.0 OPC	Petrol	141	03/02-10/05	Z 20 LET	A10	A20	A40	A50	A70	C10 - C30	C20	E01
Engine	Information											
All engines	x 1, COIL ON PLUG									470 507	C10	

ENGINE												
2.0 OPC	Petrol	147	11/02-01/05	Z 20 LET	A10	A20	A40	A50	A70	C10 - C30	C20	E01
Engine	Information											
All engines	x 1, COIL ON PLUG									470 507	C10	

ASTRA H

ENGINE												
1.2	Petrol	59	08/05-10/10	Z 12 XEP	A10	A20	A40	A50	A70	C10 - C30	C20	E01
Engine	Information											
All engines	x 1, BOSCH, COIL ON PLUG, incl. spark plug connector									470 400	C10	
All engines										470 400	C10	

ENGINE												
1.4	Petrol	55	04/04-10/10	Z 14 XEL	A10	A20	A40	A50	A70	C10 - C30	C20	E01
Engine	Information											
All engines	x 1, BOSCH, COIL ON PLUG, incl. spark plug connector									470 400	C10	

ENGINE												
1.4	Petrol	59	04/04-10/04	Z 14 XEL	A10	A20	A40	A50	A70	C10 - C30	C20	E01
Engine	Information											
All engines										470 400	C10	









ENGINE												
1.4	Petrol	66	03/04-10/10	Z 14 XEP	A10	A20	A40	A50	A70	C10 - C30	C20	E01
Engine	Information											
All engines	x 1, BOSCH, COIL ON PLUG, incl. spark plug connector									470 400	C10	

ENGINE												
1.4 16V	Petrol	66	05/04-07/09	Z 14 XE	A10	A20	A40	A50	A70	C10 - C30	C20	E01
Engine	Information											
All engines	x 4, COIL ON PLUG, incl. spark plug connector									470 399	C10	

ENGINE												
1.4 EcoTec	Petrol	66	12/04-12/12	Z 14 XEP	A10	A20	A40	A50	A70	C10 - C30	C20	E01
Engine	Information											
All engines	x 1, BOSCH, COIL ON PLUG, incl. spark plug connector									470 400	C10	

A10 CONDENSER	A20 CONTACT SET	A40 DISTRIBUTOR CAP	A50 ROTOR	A70 PICK-UP
C10 COIL	C20 IGNITION MODULE	C30 ELECTRONIC IGNITION KIT	E01 IGNITION CABLE SET	

Vehicle	alim.	kW	Date	Engine	FUNCTIONS ON THE VEHICLE												
					A10	A20	A40	A50	A70	C10 - C30	C20	E01					
1.4 LPG	Petrol/ Liquified Petro- leum Gas (LPG)	66	08/09-10/10	Z 14 XEP													
ENGINE																	
All engines					x 1, BOSCH, COIL ON PLUG, incl. spark plug connector						470 400	C10					
1.6	Petrol	74	06/04-02/06	Z 16 XE													
ENGINE																	
All engines					x 4, COIL ON PLUG, incl. spark plug connector						470 399	C10					
1.6	Petrol	76	02/06-07/09	Z 16 XEP													
ENGINE																	
All engines					x 1, DELPHI, COIL ON PLUG, incl. spark plug connector						470 450	C10					
1.6	Petrol	77	03/04-10/10	Z 16 XE1, Z 16 XEP													
ENGINE																	
All engines					x 1, DELPHI, COIL ON PLUG, incl. spark plug connector						470 450	C10					
1.6	Petrol	85	12/06-05/14	A 16 XER, Z 16 XER													
ENGINE																	
All engines					x 1, DELPHI, COIL ON PLUG, incl. spark plug connector						470 450	C10					
1.6 16V	Petrol	74	03/04-01/08	Z 16 XE													
ENGINE																	
All engines					x 4, COIL ON PLUG, incl. spark plug connector						470 399	C10					
1.6 EcoTec	Petrol	76	02/04-11/04	Z 16 XEP													
ENGINE																	
All engines					x 1, DELPHI, COIL ON PLUG, incl. spark plug connector						470 450	C10					
1.6 EcoTec	Petrol	85	10/06-12/10	Z 16 XER													
ENGINE																	
All engines					x 1, DELPHI, COIL ON PLUG, incl. spark plug connector						470 450	C10					
1.6 LPG	Petrol/ Liquified Petro- leum Gas (LPG)	85	08/09-10/10	Z 16 XER													
ENGINE																	
All engines					x 1, DELPHI, COIL ON PLUG, incl. spark plug connector						470 450	C10					
1.6 Turbo	Petrol	132	02/07-10/10	A 16 LET, Z 16 LET													
ENGINE																	
All engines					x 1, DELPHI, COIL ON PLUG, incl. spark plug connector						470 450	C10					
1.8	Petrol	103	08/05-05/14	A 18 XER, Z 18 XER													
ENGINE																	
All engines					x 1, DELPHI, COIL ON PLUG, incl. spark plug connector						470 450	C10					
1.8	Petrol	92	01/04-10/10	Z 18 XE													
ENGINE																	
All engines					x 1, COIL ON PLUG, incl. spark plug connector						470 508	C10					
2.0 Turbo	Petrol	125	03/04-10/10	Z 20 LEL													
ENGINE																	
All engines					x 1, COIL ON PLUG						470 507	C10					
2.0 Turbo	Petrol	147	09/04-10/10	Z 20 LER													
ENGINE																	
All engines					x 1, COIL ON PLUG						470 507	C10					
A10	CONDENSER			A20	CONTACT SET			A40	DISTRIBUTOR CAP			A50	ROTOR		A70	PICK-UP	
C10	COIL			C20	IGNITION MODULE			C30	ELECTRONIC IGNITION KIT			E01	IGNITION CABLE SET				

					FUNCTIONS ON THE VEHICLE							
Vehicle	alim.	kW	Date	Engine								
2.0 Turbo												
	Petrol	177	03/05-10/10	ENGINE Z 20 LEH								
Engine		Information			A10	A20	A40	A50	A70	C10 - C30	C20	E01
All engines		x 1, COIL ON PLUG								470 507	C10	
ASTRA J												
1.4												
	Petrol	103	10/11->	ENGINE A 14 NET, B 14 NET								
Engine		Information			A10	A20	A40	A50	A70	C10 - C30	C20	E01
All engines		x 1, COIL ON RAIL								470 547	C10	
1.4												
	Petrol	64	12/09-10/15	ENGINE A 14 XEL								
Engine		Information			A10	A20	A40	A50	A70	C10 - C30	C20	E01
All engines		x 1, COIL ON RAIL								470 547	C10	
1.4												
	Petrol	66	01/09->	ENGINE Z 14 XEP								
Engine		Information			A10	A20	A40	A50	A70	C10 - C30	C20	E01
All engines		x 1, BOSCH, COIL ON PLUG, incl. spark plug connector								470 400	C10	
1.4												
	Petrol	74	12/09-10/15	ENGINE A 14 XER, B 14 XER								
Engine		Information			A10	A20	A40	A50	A70	C10 - C30	C20	E01
All engines		x 1, COIL ON RAIL								470 547	C10	
1.4												
	Petrol	88	10/11->	ENGINE A 14 NEL, B 14 NEL								
Engine		Information			A10	A20	A40	A50	A70	C10 - C30	C20	E01
All engines		x 1, COIL ON RAIL								470 547	C10	
1.4 LPG												
	Petrol/ Liquified Petro- leum Gas (LPG)	103	12/11->	ENGINE A 14 NET								
Engine		Information			A10	A20	A40	A50	A70	C10 - C30	C20	E01
All engines		x 1, COIL ON RAIL								470 547	C10	
1.4 Turbo												
	Petrol	103	12/09->	ENGINE A 14 NET, B 14 NET								
Engine		Information			A10	A20	A40	A50	A70	C10 - C30	C20	E01
All engines		x 1, COIL ON RAIL								470 547	C10	
1.4 Turbo												
	Petrol	88	10/10-10/15	ENGINE A 14 NEL, B 14 NEL								
Engine		Information			A10	A20	A40	A50	A70	C10 - C30	C20	E01
All engines		x 1, COIL ON RAIL								470 547	C10	
1.6												
	Petrol	132	10/11->	ENGINE A 16 LET								
Engine		Information			A10	A20	A40	A50	A70	C10 - C30	C20	E01
All engines		x 1, COIL ON PLUG								470 545	C10	
1.6												
	Petrol	85	12/06->	ENGINE A 16 XER, B 16 XER, Z 16 XER								
Engine		Information			A10	A20	A40	A50	A70	C10 - C30	C20	E01
Eng. Z 16 XER		x 1, DELPHI, COIL ON PLUG, incl. spark plug connector								470 450	C10	
Eng. A 16 XER, B 16 XER		x 1, COIL ON PLUG, COIL RAILS								470 545	C10	
1.6 LPG												
	Petrol/ Liquified Petro- leum Gas (LPG)	84	10/12-10/15	ENGINE A 16 XER								
Engine		Information			A10	A20	A40	A50	A70	C10 - C30	C20	E01
All engines										470 545	C10	
1.6 Turbo												
	Petrol	132	12/09->	ENGINE A 16 LET								
Engine		Information			A10	A20	A40	A50	A70	C10 - C30	C20	E01
All engines		x 1, COIL ON PLUG								470 545	C10	

A10 CONDENSER	A20 CONTACT SET	A40 DISTRIBUTOR CAP	A50 ROTOR	A70 PICK-UP
C10 COIL	C20 IGNITION MODULE	C30 ELECTRONIC IGNITION KIT	E01 IGNITION CABLE SET	

Vehicle	alim.	kW	Date	Engine	FUNCTIONS ON THE VEHICLE									
					A10	A20	A40	A50	A70	C10 - C30	C20	E01		
ENGINE														
1.8	Petrol	103	02/07->	A 18 XER, Z 18 XER										
Engine					A10	A20	A40	A50	A70	C10 - C30	C20	E01		
Eng. Z 18 XER										470 450	C10			
Eng. A 18 XER										470 545	C10			
ASTRA K														
ENGINE														
1.0	Petrol	77	05/18->	D 10 XFL										
Engine					A10	A20	A40	A50	A70	C10 - C30	C20	E01		
All engines										470 631	C10			
ENGINE														
1.0 Turbo	Petrol	66	06/18->	D 10 XFL										
Engine					A10	A20	A40	A50	A70	C10 - C30	C20	E01		
All engines										470 631	C10			
ENGINE														
1.0 Turbo	Petrol	77	06/15->	B 10 XFL, D 10 XFL										
Engine					A10	A20	A40	A50	A70	C10 - C30	C20	E01		
All engines										470 631	C10			
ENGINE														
1.4	Petrol	110	06/18->	D 14 XFT										
Engine					A10	A20	A40	A50	A70	C10 - C30	C20	E01		
All engines										470 631	C10			
ENGINE														
1.4 CNG	Petrol/ Com- pressed Natural Gas (CNG)	81	10/17->	B 14 XNT										
Engine					A10	A20	A40	A50	A70	C10 - C30	C20	E01		
All engines										470 631	C10			
ENGINE														
1.4 Turbo	Petrol	110	06/15->	B 14 XFT, D 14 XFT										
Engine					A10	A20	A40	A50	A70	C10 - C30	C20	E01		
All engines										470 631	C10			
ENGINE														
1.4 Turbo	Petrol	92	06/15->	B 14 XFL, D14XFL										
Engine					A10	A20	A40	A50	A70	C10 - C30	C20	E01		
All engines										470 631	C10			
CALIBRA A														
ENGINE														
2.0 i	Petrol	85	08/89-12/96	C 20 NE										
Engine					A10	A20	A40	A50	A70	C10 - C30	C20	E01		
All engines							806 257	906 127R						
All engines							815 084	915 103R						
All engines										470 191	C10			
All engines										470 192	C10			
All engines													359 689	
ENGINE														
2.0 i 16V	Petrol	100	02/94-07/97	X 20 XEV										
Engine					A10	A20	A40	A50	A70	C10 - C30	C20	E01		
All engines										470 272	C10			
All engines													360 506	
All engines													360 562	
ENGINE														
2.0 i 16V	Petrol	110	06/90-02/94	C 20 XE										
Engine					A10	A20	A40	A50	A70	C10 - C30	C20	E01		
All engines							806 251	906 121R						
All engines										470 273	C10		359 688	
ENGINE														
2.0 i 16V 4x4	Petrol	100	02/94-07/97	X 20 XEV										
Engine					A10	A20	A40	A50	A70	C10 - C30	C20	E01		
All engines										470 272	C10			
A10	CONDENSER		A20	CONTACT SET		A40	DISTRIBUTOR CAP		A50	ROTOR		A70	PICK-UP	
C10	COIL		C20	IGNITION MODULE		C30	ELECTRONIC IGNITION KIT		E01	IGNITION CABLE SET				

					FUNCTIONS ON THE VEHICLE							
Vehicle	alim.	kW	Date	Engine	A10	A20	A40	A50	A70	C10 - C30	C20	E01
ENGINE												
2.0 i 16V 4x4	Petrol	100	02/94-07/97	X 20 XEV								
Engine	Information				A10	A20	A40	A50	A70	C10 - C30	C20	E01
All engines	ch. 14195307 ->											360 506
All engines	->ch. 14195306											360 562
ENGINE												
2.0 i 16V 4x4	Petrol	110	06/90-02/94	C 20 XE								
Engine	Information				A10	A20	A40	A50	A70	C10 - C30	C20	E01
All engines	version Bosch						806 251	906 121R				
All engines	ch. P1000001, P9000001 ->									470 273	C10	359 688
ENGINE												
2.0 i 4x4	Petrol	85	06/90-07/97	C 20 NE								
Engine	Information				A10	A20	A40	A50	A70	C10 - C30	C20	E01
All engines	version Bosch						806 257	906 127R				
All engines	version Ducellier						815 084	915 103R				
All engines	->eng. 14180385, info WY									470 191	C10	
All engines	eng. type 14180386 ->, info WE									470 192	C10	
All engines	eng. type 14672353 ->, ->ch. R1..., R9..., no specific info conc. application available											359 689
ENGINE												
2.0 i Turbo 4x4	Petrol	150	08/91-07/97	C 20 LET								
Engine	Information				A10	A20	A40	A50	A70	C10 - C30	C20	E01
All engines	version Bosch						806 257	906 121R				
CAMPO												
ENGINE												
2.3	Petrol	72	08/94-09/96	23 P								
Engine	Information				A10	A20	A40	A50	A70	C10 - C30	C20	E01
All engines	version Denso						813 254					
All engines	version Hitachi						822 060					
All engines	01/07/94 ->, version Hitachi							922 069				
CASCADE												
ENGINE												
1.4	Petrol	88	03/13->	A 14 NEL, B 14 NEL								
Engine	Information				A10	A20	A40	A50	A70	C10 - C30	C20	E01
All engines	x 1, COIL ON RAIL									470 547	C10	
Eng. B 14 NEL										470 547	C10	
ENGINE												
1.4 Turbo	Petrol	103	03/13->	A 14 NET, B 14 NET								
Engine	Information				A10	A20	A40	A50	A70	C10 - C30	C20	E01
All engines	x 1, COIL ON RAIL									470 547	C10	
Eng. B 14 NET										470 547	C10	
COMBO B												
ENGINE												
1.2	Petrol	33	07/94-10/01	C 12 NZ, X 12 SZ								
Engine	Information				A10	A20	A40	A50	A70	C10 - C30	C20	E01
Eng. C 12 NZ	version Bosch						806 256	906 121R				
Eng. C 12 NZ	version Lucas						828 100	928 028R				
Eng. C 12 NZ										470 140	C10	465 036
All engines	ch. 19019894 ->, ->ch. 19334654											358 195
All engines	ch. 19334657 ->											358 199
All engines	->ch. 19019893											360 237
ENGINE												
1.4	Petrol	44	07/94-10/01	C 14 NZ, X 14 SZ								
Engine	Information				A10	A20	A40	A50	A70	C10 - C30	C20	E01
Eng. C 14 NZ	version Bosch						806 256	906 121R				
Eng. C 14 NZ	version Lucas						828 100	928 028R				
Eng. C 14 NZ										470 140	C10	465 036
Eng. C 14 NZ	->ch. 02BF1475, 19241622											358 195
Eng. C 14 NZ	ch. 02BF1476, 19241623 ->, -air conditioning											358 199
Eng. C 14 NZ	ch. 02BF1476, 19241623 ->, +air conditioning											360 529
Eng. X 14 SZ	ch. 02HY3580 ->											360 904

A10 CONDENSER	A20 CONTACT SET	A40 DISTRIBUTOR CAP	A50 ROTOR	A70 PICK-UP
C10 COIL	C20 IGNITION MODULE	C30 ELECTRONIC IGNITION KIT	E01 IGNITION CABLE SET	

Vehicle	alim.	kW	Date	Engine	FUNCTIONS ON THE VEHICLE							
					A10	A20	A40	A50	A70	C10 - C30	C20	E01

				ENGINE
1.4	Petrol	60	07/94-10/01	C 14 SE

Engine	Information	A10	A20	A40	A50	A70	C10 - C30	C20	E01
All engines	->ch. 02BD1412, 19262000								359 634
All engines	ch. 02HY3580 ->								360 904

				ENGINE
1.4 16V	Petrol	66	08/99-10/01	X 14 XE

Engine	Information	A10	A20	A40	A50	A70	C10 - C30	C20	E01
All engines	->ch. 20C17331								359 688
All engines	ch. 20C17332 ->								360 559

COMBO C

				ENGINE
1.4	Petrol	66	10/04-12/11	Z 14 XEP

Engine	Information	A10	A20	A40	A50	A70	C10 - C30	C20	E01
All engines	x 1, BOSCH, COIL ON PLUG, incl. spark plug connector						470 400	C10	

				ENGINE
1.4 16V	Petrol	66	08/05->	Z 14 XEP

Engine	Information	A10	A20	A40	A50	A70	C10 - C30	C20	E01
All engines	x 1, BOSCH, COIL ON PLUG, incl. spark plug connector						470 400	C10	

				ENGINE
1.6	Petrol	64	10/01->	Z 16 SE

Engine	Information	A10	A20	A40	A50	A70	C10 - C30	C20	E01
All engines									360 904

				ENGINE
1.6 CNG	Petrol/ Com- pressed Natural Gas (CNG)	69	06/06-12/11	Y 16 YNG, Z 16 YNG

Engine	Information	A10	A20	A40	A50	A70	C10 - C30	C20	E01
All engines	x 4, COIL ON PLUG, incl. spark plug connector						470 399	C10	

				ENGINE
1.6 CNG	Petrol/ Com- pressed Natural Gas (CNG)	71	04/05-01/11	Z 16 YNG

Engine	Information	A10	A20	A40	A50	A70	C10 - C30	C20	E01
All engines	x 4, COIL ON PLUG, incl. spark plug connector						470 399	C10	

				ENGINE
1.6 CNG 16V	Petrol/ Com- pressed Natural Gas (CNG)	69	06/06->	Y 16 YNG, Z 16 YNG

Engine	Information	A10	A20	A40	A50	A70	C10 - C30	C20	E01
All engines	x 4, COIL ON PLUG, incl. spark plug connector						470 399	C10	

				ENGINE
1.6 CNG 16V	Petrol/ Com- pressed Natural Gas (CNG)	71	04/05->	Z 16 YNG

Engine	Information	A10	A20	A40	A50	A70	C10 - C30	C20	E01
All engines	x 4, COIL ON PLUG, incl. spark plug connector						470 399	C10	

COMBO D

				ENGINE
1.4	Petrol	70	02/12->	A 14 FP

Engine	Information	A10	A20	A40	A50	A70	C10 - C30	C20	E01
All engines	x 4, COIL ON PLUG						470 442	C10	

CORSA A

				ENGINE
1.0	Petrol	33	09/82-03/93	10 S

Engine	Information	A10	A20	A40	A50	A70	C10 - C30	C20	E01
All engines	version Bosch	606 212	706 034HVS	806 080	906 012R				

A10	CONDENSER	A20	CONTACT SET	A40	DISTRIBUTOR CAP	A50	ROTOR	A70	PICK-UP
C10	COIL	C20	IGNITION MODULE	C30	ELECTRONIC IGNITION KIT	E01	IGNITION CABLE SET		

Vehicle	alim.	kW	Date	Engine	FUNCTIONS ON THE VEHICLE							
					A10	A20	A40	A50	A70	C10 - C30	C20	E01

CORSA A

1.0	Petrol	33	09/82-03/93	ENGINE
				10 S

Engine	Information	A10	A20	A40	A50	A70	C10 - C30	C20	E01
All engines	version Delco Remy		712 055HVS	812 066	912 095R				
All engines					912 093R				359 509

1.2	Petrol	33	09/82-08/90	ENGINE
				12 N, 12 NC, E 12 GV

Engine	Information	A10	A20	A40	A50	A70	C10 - C30	C20	E01
Eng. 12 N, 12 NC	version Bosch	606 212	706 034HVS		906 012R				
All engines	->eng. 0106700, version Bosch			806 080					
Eng. 12 NC, E 12 GV	eng. type 0106701 ->, version Bosch			806 256					
Eng. E 12 GV	version Bosch				906 061R				
Eng. 12 NC, E 12 GV								465 005	
All engines	->ch. J4999999								359 509

1.2	Petrol	40	02/86-04/89	ENGINE
				12 ST

Engine	Information	A10	A20	A40	A50	A70	C10 - C30	C20	E01
All engines	version Delco Remy			812 073	912 096	412 011			
All engines	FOR: (S), ch. F4178159 ->, FOR: (CH), version Delco Remy				912 100				
All engines							470 341	C10	

1.2	Petrol	44	09/82-08/90	ENGINE
				12 S

Engine	Information	A10	A20	A40	A50	A70	C10 - C30	C20	E01
All engines	version Delco Remy			812 073	912 096	412 011			
All engines	FOR: (S), ->year 23/09/84, FOR: (CH), version Delco Remy			812 074					
All engines	FOR: (S), ch. F4178159 ->, FOR: (CH), version Delco Remy				912 100				
All engines							470 341	C10	

1.2 i	Petrol	33	09/89-03/93	ENGINE
				C 12 NZ

Engine	Information	A10	A20	A40	A50	A70	C10 - C30	C20	E01
All engines	version Bosch			806 256	906 121R				
All engines	version Lucas			828 100	928 028R	428 202			
All engines							470 140	C10	465 036
									360 237

1.2 N	Petrol	33	01/85-10/87	ENGINE
				12 NC, E 12 GV

Engine	Information	A10	A20	A40	A50	A70	C10 - C30	C20	E01
Eng. 12 NC	version Bosch	606 212	706 034HVS		906 012R				
All engines	->eng. 0106700, version Bosch			806 080					
All engines	eng. type 0106701 ->, version Bosch			806 256					
Eng. E 12 GV	version Bosch				906 061R				
All engines								465 005	
All engines	->ch. J4999999								359 509

1.2 N	Petrol	38	01/90-03/93	ENGINE
				12 NV

Engine	Information	A10	A20	A40	A50	A70	C10 - C30	C20	E01
All engines	version Delco Remy			812 073	912 096	412 011			
All engines	FOR: (S), ch. F4178159 ->, FOR: (CH), version Delco Remy				912 100				
All engines							470 341	C10	

1.2 S	Petrol	40	09/82-03/93	ENGINE
				12 ST

Engine	Information	A10	A20	A40	A50	A70	C10 - C30	C20	E01
All engines	version Delco Remy			812 073	912 096	412 011			
All engines	FOR: (S), ch. F4178159 ->, FOR: (CH), version Delco Remy				912 100				
All engines							470 341	C10	

1.2 S	Petrol	43	09/82-10/87	ENGINE
				12 S

Engine	Information	A10	A20	A40	A50	A70	C10 - C30	C20	E01
All engines	version Delco Remy			812 073	912 096	412 011			
All engines	FOR: (S), ->year 23/09/84, FOR: (CH), version Delco Remy			812 074					

A10 CONDENSER	A20 CONTACT SET	A40 DISTRIBUTOR CAP	A50 ROTOR	A70 PICK-UP
C10 COIL	C20 IGNITION MODULE	C30 ELECTRONIC IGNITION KIT	E01 IGNITION CABLE SET	

Vehicle	alim.	kW	Date	Engine	FUNCTIONS ON THE VEHICLE									
					A10	A20	A40	A50	A70	C10 - C30	C20	E01		
ENGINE														
1.2 S	Petrol	43	09/82-10/87	12 S										
Engine	Information				A10	A20	A40	A50	A70	C10 - C30	C20	E01		
All engines	FOR: (S), ch. F4178159 ->, FOR: (CH), version Delco Remy							912 100						
All engines										470 341	C10			
ENGINE														
1.3	Petrol	44	09/85-10/89	13 NB, C13 N										
Engine	Information				A10	A20	A40	A50	A70	C10 - C30	C20	E01		
Eng. 13 NB	24/09/84 ->, version Delco Remy						812 073							
Eng. 13 NB	->year 23/09/84, version Delco Remy						812 074							
Eng. 13 NB	version Delco Remy							912 100	412 011					
Eng. C13 N	version Delco Remy								412 010					
All engines										470 341	C10			
Eng. C13 N												465 025		
ENGINE														
1.3	Petrol	51	02/86-04/89	13 SB										
Engine	Information				A10	A20	A40	A50	A70	C10 - C30	C20	E01		
All engines	version Delco Remy						812 073	912 096	412 011					
All engines										470 341	C10			
ENGINE														
1.3 GL	Petrol	55	09/82-03/93	13 S										
Engine	Information				A10	A20	A40	A50	A70	C10 - C30	C20	E01		
All engines	version Delco Remy						812 073	912 096	412 011					
All engines										470 341	C10			
ENGINE														
1.3 i	Petrol	44	09/86-09/90	C13 N										
Engine	Information				A10	A20	A40	A50	A70	C10 - C30	C20	E01		
All engines	version Delco Remy								412 010					
All engines										470 341	C10	465 025		
ENGINE														
1.3 S	Petrol	51	09/82-10/89	13 SB										
Engine	Information				A10	A20	A40	A50	A70	C10 - C30	C20	E01		
All engines	version Delco Remy						812 073	912 096	412 011					
All engines										470 341	C10			
ENGINE														
1.4 i	Petrol	40	01/85-03/93	C14 NZ										
Engine	Information				A10	A20	A40	A50	A70	C10 - C30	C20	E01		
All engines	version Bosch						806 249	906 121R						
All engines										470 140	C10	465 036	360 237	
ENGINE														
1.4 i	Petrol	44	10/89-03/93	C14 NZ										
Engine	Information				A10	A20	A40	A50	A70	C10 - C30	C20	E01		
All engines	version Bosch						806 249	906 121R						
All engines										470 140	C10	465 036	360 237	
ENGINE														
1.4 S	Petrol	53	09/89-03/93	14 NV										
Engine	Information				A10	A20	A40	A50	A70	C10 - C30	C20	E01		
All engines	version Bosch						806 256	906 056R						
All engines											465 005	360 237		
ENGINE														
1.4 Si	Petrol	60	09/91-03/93	C14 SE										
Engine	Information				A10	A20	A40	A50	A70	C10 - C30	C20	E01		
All engines	->eng. 02T14052, version Lucas						828 100	928 028R						
All engines	->eng. 02T14052									470 140	C10	465 036	360 237	
All engines	eng. type 02T14053 ->												359 634	
ENGINE														
1.6 GSI	Petrol	55	08/88-09/92	C16 NZ										
Engine	Information				A10	A20	A40	A50	A70	C10 - C30	C20	E01		
All engines	version Delco Remy								412 010					
All engines										470 341	C10		359 514	

A10	CONDENSER	A20	CONTACT SET	A40	DISTRIBUTOR CAP	A50	ROTOR	A70	PICK-UP
C10	COIL	C20	IGNITION MODULE	C30	ELECTRONIC IGNITION KIT	E01	IGNITION CABLE SET		

The present application list is a brief version. For the detailed information about the possibility of installation on a specific vehicle, please refer to our web-catalogue <http://catalogo.facet.eu/>

Vehicle	alim.	kW	Date	Engine	FUNCTIONS ON THE VEHICLE							
					A10	A20	A40	A50	A70	C10 - C30	C20	E01

				ENGINE
1.6 GSI	Petrol	74	05/88-03/92	E 16 SE

Engine	Information	A10	A20	A40	A50	A70	C10 - C30	C20	E01
All engines	distr. num. 0 237 506 012, version Bosch			806 080	906 056R				
All engines	distr. num. 0 237 521 024, version Bosch, connector type SAE			806 249					
All engines	distr. num. 0 237 521 024, version Bosch, connector type M4			806 256					
All engines	version Lucas			828 100	928 028R	428 202			
All engines	distr. num. 0 237 521 024, version Bosch				906 121R				
All engines	ch. L4000001 ->						470 140	C10	465 036

				ENGINE
1.0 i 12V	Petrol	40	11/96-09/00	X 10 XE

Engine	Information	A10	A20	A40	A50	A70	C10 - C30	C20	E01
All engines							470 398	C10	

				ENGINE
1.2 i	Petrol	33	03/93-09/00	12 NZ, C 12 NZ, X 12 SZ

Engine	Information	A10	A20	A40	A50	A70	C10 - C30	C20	E01
Eng. 12 NZ, C 12 NZ	version Bosch			806 256	906 121R				
Eng. 12 NZ, C 12 NZ	version Lucas			828 100	928 028R				
Eng. 12 NZ, C 12 NZ							470 140	C10	465 036
All engines	ch. 19019894 ->, ->ch. 19334654								358 195
All engines	ch. 19334657 ->								358 199
All engines	->ch. 19019893								360 237

				ENGINE
1.2 i 16V	Petrol	48	03/98-09/00	X 12 XE

Engine	Information	A10	A20	A40	A50	A70	C10 - C30	C20	E01
All engines							470 400	C10	

				ENGINE
1.4	Petrol	54	04/93-08/94	C 14 SE

Engine	Information	A10	A20	A40	A50	A70	C10 - C30	C20	E01
All engines	->ch. 02BD1412, 19262000								359 634
All engines	ch. 02HY3580 ->								360 904

				ENGINE
1.4 i	Petrol	40	03/93-09/00	C 14 NZ, X 14 SZ

Engine	Information	A10	A20	A40	A50	A70	C10 - C30	C20	E01
Eng. C 14 NZ	version Bosch			806 256	906 121R				
Eng. C 14 NZ	version Lucas			828 100	928 028R				
Eng. C 14 NZ							470 140	C10	465 036
Eng. C 14 NZ	->ch. 02BF1475, 19241622								358 195
Eng. C 14 NZ	ch. 02BF1476, 19241623 ->, -air conditioning								358 199
Eng. C 14 NZ	ch. 02BF1476, 19241623 ->, +air conditioning								360 529
Eng. X 14 SZ	ch. 02HY3580 ->								360 904

				ENGINE
1.4 i	Petrol	44	03/93-09/00	C 14 NZ, X 14 SZ

Engine	Information	A10	A20	A40	A50	A70	C10 - C30	C20	E01
Eng. C 14 NZ	version Bosch			806 256	906 121R				
Eng. C 14 NZ	version Lucas			828 100	928 028R				
Eng. C 14 NZ							470 140	C10	465 036
Eng. C 14 NZ	->ch. 02BF1475, 19241622								358 195
Eng. C 14 NZ	ch. 02BF1476, 19241623 ->, -air conditioning								358 199
Eng. C 14 NZ	ch. 02BF1476, 19241623 ->, +air conditioning								360 529
Eng. X 14 SZ	ch. 02HY3580 ->								360 904

				ENGINE
1.4 i 16V	Petrol	63	08/97-09/00	C 14 SEL

Engine	Information	A10	A20	A40	A50	A70	C10 - C30	C20	E01
All engines	->ch. 20C17331								359 688
All engines	ch. 20C17332 ->								360 559

				ENGINE
1.4 i 16V	Petrol	66	09/94-12/02	X 14 XE









Engine	Information	A10	A20	A40	A50	A70	C10 - C30	C20	E01
All engines	->ch. 20C17331								359 688
All engines	ch. 20C17332 ->								360 559

A10 CONDENSER	A20 CONTACT SET	A40 DISTRIBUTOR CAP	A50 ROTOR	A70 PICK-UP
C10 COIL	C20 IGNITION MODULE	C30 ELECTRONIC IGNITION KIT	E01 IGNITION CABLE SET	

Vehicle	alim.	kW	Date	Engine	FUNCTIONS ON THE VEHICLE									
					A10	A20	A40	A50	A70	C10 - C30	C20	E01		
ENGINE														
1.4 i 16V	Petrol	67	09/94-09/00	X 14 XE										
Engine	Information				A10	A20	A40	A50	A70	C10 - C30	C20	E01		
All engines	->ch. 20C17331												359 688	
All engines	ch. 20C17332 ->												360 559	
ENGINE														
1.4 Si	Petrol	60	03/93-09/00	C 14 SE										
Engine	Information				A10	A20	A40	A50	A70	C10 - C30	C20	E01		
All engines	->ch. 02BD1412, 19262000												359 634	
All engines	ch. 02HY3580 ->												360 904	
ENGINE														
1.6 GSI 16V	Petrol	80	03/93-09/00	C 16 XE										
Engine	Information				A10	A20	A40	A50	A70	C10 - C30	C20	E01		
All engines	->ch. 20C17331												359 688	
All engines	ch. 20C17332 ->												360 559	
ENGINE														
1.6 i 16V	Petrol	74	08/97-09/00	C 16 SEL										
Engine	Information				A10	A20	A40	A50	A70	C10 - C30	C20	E01		
All engines	->ch. 20C17331												359 688	
All engines	ch. 20C17332 ->												360 559	
ENGINE														
1.6 i 16V	Petrol	78	09/94-09/00	X 16 XE										
Engine	Information				A10	A20	A40	A50	A70	C10 - C30	C20	E01		
All engines	->ch. 20C17331												359 688	
All engines	ch. 20C17332 ->												360 559	
CORSA C														
ENGINE														
1.0	Petrol	43	09/00-06/03	1K10CT										
Engine	Information				A10	A20	A40	A50	A70	C10 - C30	C20	E01		
All engines	x 3, BOSCH, COIL ON PLUG									470 398	C10			
ENGINE														
1.0	Petrol	44	06/03-12/09	Z 10 XEP										
Engine	Information				A10	A20	A40	A50	A70	C10 - C30	C20	E01		
All engines	x 3, BOSCH, COIL ON PLUG, 12 Volt, Dia: 55 mm, for pre-resistance									470 398	C10			
ENGINE														
1.2	Petrol	55	09/00-12/09	Z 12 XE										
Engine	Information				A10	A20	A40	A50	A70	C10 - C30	C20	E01		
All engines	->ch. 36999999, ch. 37000000 ->, x 1, x 4, BOSCH, COIL ON PLUG, incl. spark plug connector									470 400	C10			
ENGINE														
1.2	Petrol	59	07/05-06/06	Z 12 XEP										
Engine	Information				A10	A20	A40	A50	A70	C10 - C30	C20	E01		
All engines	x 1, BOSCH, COIL ON PLUG, incl. spark plug connector									470 400	C10			
ENGINE														
1.2 16V	Petrol	55	09/00-07/03	Z 12 XE										
Engine	Information				A10	A20	A40	A50	A70	C10 - C30	C20	E01		
All engines	->ch. 36999999, ch. 37000000 ->, x 1, x 4, BOSCH, COIL ON PLUG, incl. spark plug connector									470 400	C10			
ENGINE														
1.2 Twinport	Petrol	59	07/04-12/09	Z 12 XEP										
Engine	Information				A10	A20	A40	A50	A70	C10 - C30	C20	E01		
All engines	x 1, BOSCH, COIL ON PLUG, incl. spark plug connector									470 400	C10			
ENGINE														
1.4	Petrol	66	09/00-06/12	Z 14 XE, Z 14 XEP										
Engine	Information				A10	A20	A40	A50	A70	C10 - C30	C20	E01		
Eng. Z 14 XE	x 4, COIL ON PLUG, incl. spark plug connector									470 399	C10			
Eng. Z 14 XEP	x 1, BOSCH, COIL ON PLUG, incl. spark plug connector									470 400	C10			
ENGINE														
1.4 Twinport	Petrol	66	06/03-12/09	Z 14 XEP										
Engine	Information				A10	A20	A40	A50	A70	C10 - C30	C20	E01		
All engines	x 1, BOSCH, COIL ON PLUG, incl. spark plug connector									470 400	C10			

A10	CONDENSER	A20	CONTACT SET	A40	DISTRIBUTOR CAP	A50	ROTOR	A70	PICK-UP
C10	COIL	C20	IGNITION MODULE	C30	ELECTRONIC IGNITION KIT	E01	IGNITION CABLE SET		

The present application list is a brief version. For the detailed information about the possibility of installation on a specific vehicle, please refer to our web-catalogue <http://catalogo.facet.eu/>









					FUNCTIONS ON THE VEHICLE								
Vehicle	alim.	kW	Date	Engine									
ENGINE													
1.6	Petrol	62	09/00->	Z 16 SE									
ENGINE													
All engines												360 904	
ENGINE													
1.6 CNG	CNG	69	05/03-12/09	Y 16 YNG									
ENGINE													
All engines										470 399	C10		
ENGINE													
1.6 X	Petrol	71	08/05->	Z 16 YNG									
ENGINE													
All engines										470 399	C10		
ENGINE													
1.8	Petrol	92	09/00-12/09	Z 18 XE									
ENGINE													
All engines					x 1, COIL ON PLUG, incl. spark plug connector						470 508	C10	
CORSA D													
ENGINE													
1.0	Petrol	44	07/06-08/14	Z 10 XEP									
ENGINE													
All engines					x 3, BOSCH, COIL ON PLUG, 12 Volt, Dia: 55 mm, for pre-resistance						470 398	C10	
ENGINE													
1.2	Petrol	51	12/09-08/14	A 12 XEL									
ENGINE													
All engines					x 1, COIL ON RAIL						470 547	C10	
ENGINE													
1.2	Petrol	59	07/06-08/14	Z 12 XEP									
ENGINE													
All engines					x 1, BOSCH, COIL ON PLUG, incl. spark plug connector						470 400	C10	
ENGINE													
1.2	Petrol	63	12/09-08/14	A 12 XER									
ENGINE													
All engines					x 1, COIL ON RAIL						470 547	C10	
ENGINE													
1.2 LPG	Petrol/ Liquified Petro- leum Gas (LPG)	55	09/09-12/11	Z 12 XEP									
ENGINE													
All engines					x 1, BOSCH, COIL ON PLUG, incl. spark plug connector						470 400	C10	
ENGINE													
1.2 LPG	Petrol/ Liquified Petro- leum Gas (LPG)	59	08/06-08/14	Z 12 XEP									
ENGINE													
All engines					x 1, BOSCH, COIL ON PLUG, incl. spark plug connector						470 400	C10	
ENGINE													
1.2 LPG	Petrol/ Liquified Petro- leum Gas (LPG)	61	06/11-08/14	A 12 XER									
ENGINE													
All engines					x 1, COIL ON RAIL						470 547	C10	
ENGINE													
1.2 LPG	Petrol/ Liquified Petro- leum Gas (LPG)	63	06/11-08/14	A 12 XER									
ENGINE													
All engines					x 1, COIL ON RAIL						470 547	C10	

A10 CONDENSER	A20 CONTACT SET	A40 DISTRIBUTOR CAP	A50 ROTOR	A70 PICK-UP
C10 COIL	C20 IGNITION MODULE	C30 ELECTRONIC IGNITION KIT	E01 IGNITION CABLE SET	

Vehicle	alim.	kW	Date	Engine	FUNCTIONS ON THE VEHICLE									
					A10	A20	A40	A50	A70	C10 - C30	C20	E01		
ENGINE														
1.4	Petrol	64	09/09-08/14	A 14 XEL										
ENGINE														
All engines					x 1, COIL ON RAIL						470 547	C10		
ENGINE														
1.4	Petrol	66	07/06-08/14	Z 14 XEP										
ENGINE														
All engines					x 1, BOSCH, COIL ON PLUG, incl. spark plug connector						470 400	C10		
ENGINE														
1.4	Petrol	74	12/09-08/14	A 14 XER										
ENGINE														
All engines					x 1, COIL ON RAIL						470 547	C10		
ENGINE														
1.4	Petrol	88	07/12-08/14	A 14 NEL										
ENGINE														
All engines					x 1, COIL ON RAIL						470 547	C10		
ENGINE														
1.4 LPG	Petrol/ Liquified Petro- leum Gas (LPG)	64	09/09-08/14	A 14 XEL										
ENGINE														
All engines					x 1, COIL ON RAIL						470 547	C10		
ENGINE														
1.4 LPG	Petrol/ Liquified Petro- leum Gas (LPG)	66	08/06-12/11	Z 14 XEP										
ENGINE														
All engines					x 1, BOSCH, COIL ON PLUG, incl. spark plug connector						470 400	C10		
ENGINE														
1.6	Petrol	141	07/12-08/14	Z 16 LER										
ENGINE														
All engines					x 1, DELPHI, COIL ON PLUG, incl. spark plug connector						470 450	C10		
ENGINE														
1.6 Turbo	Petrol	110	05/07-08/14	A 16 LEL, Z 16 LEL										
ENGINE														
All engines					x 1, DELPHI, COIL ON PLUG, incl. spark plug connector						470 450	C10		
ENGINE														
1.6 Turbo	Petrol	141	11/06-08/14	A 16 LER, B 16 LER, Z 16 LER										
ENGINE														
All engines					x 1, DELPHI, COIL ON PLUG, incl. spark plug connector						470 450	C10		
ENGINE														
1.6 Turbo	Petrol	155	06/11-08/14	A 16 LES										
ENGINE														
All engines					x 1, DELPHI, COIL ON PLUG, incl. spark plug connector						470 450	C10		
CORSA E														
ENGINE														
1.0	Petrol	66	09/14->	B 10 XFL, D 10 XFL, F 10 XFL										
ENGINE														
All engines					x 3, COIL ON PLUG						470 631	C10		
ENGINE														
1.0	Petrol	85	09/14->	B 10 XFT										
ENGINE														
All engines					x 3, COIL ON PLUG						470 631	C10		
ENGINE														
1.2	Petrol	51	09/14->	B 12 XEL										
ENGINE														
All engines					x 1, COIL ON RAIL						470 547	C10		

A10 CONDENSER	A20 CONTACT SET	A40 DISTRIBUTOR CAP	A50 ROTOR	A70 PICK-UP
C10 COIL	C20 IGNITION MODULE	C30 ELECTRONIC IGNITION KIT	E01 IGNITION CABLE SET	

The present application list is a brief version. For the detailed information about the possibility of installation on a specific vehicle, please refer to our web-catalogue <http://catalogo.facet.eu/>

					FUNCTIONS ON THE VEHICLE												
Vehicle	alim.	kW	Date	Engine													
ENGINE																	
1.4	Petrol	55	09/14->	B 14 XEJ													
ENGINE																	
All engines										470 547	C10						
ENGINE																	
1.4	Petrol	66	09/14->	B 14 XEL, D 14 XEL													
ENGINE																	
All engines										470 547	C10						
ENGINE																	
1.4 LPG	Petrol/ Liquified Petro- leum Gas (LPG)	64	11/15->	B 14 XEL													
ENGINE																	
All engines										470 547	C10						
ENGINE																	
1.4 LPG	Petrol/ Liquified Petro- leum Gas (LPG)	66	03/15->	B 14 XEL													
ENGINE																	
All engines										470 547	C10						
ENGINE																	
1.4 Turbo	Petrol	110	03/15->	B 14 NEH, D 14 NEH													
ENGINE																	
All engines										470 547	C10						
ENGINE																	
1.4 Turbo	Petrol	74	09/14-06/19	B 14 NEJ, D 14 NEJ													
ENGINE																	
All engines										470 547	C10						
ENGINE																	
1.6 Turbo	Petrol	152	03/15->	B 16 LER, B 16 LES													
ENGINE																	
All engines										470 545	C10						
CORSA F																	
ENGINE																	
1.2	Petrol	55	07/19->	F 12 XEL (EB2FAD)													
ENGINE																	
All engines										470 609	C10						
CROSSLAND X																	
ENGINE																	
1.2	Petrol	61	07/19->	F 12 XE (EB2FA)													
ENGINE																	
All engines										470 609	C10						
FRONTERA A																	
ENGINE																	
2.0 i	Petrol	85	03/92-10/98	C 20 NE, X 20 SE													
ENGINE																	
Eng. C 20 NE							806 257	906 127R									
Eng. C 20 NE							815 084	915 103R									
Eng. C 20 NE									470 192	C10							
Eng. X 20 SE									470 273	C10		360 947					
Eng. C 20 NE												359 527					
Eng. C 20 NE												359 689					
ENGINE																	
2.2 i	Petrol	100	03/95-10/98	X 22 XE													
ENGINE																	
All engines										470 273	C10						
ENGINE																	
2.4 i	Petrol	92	03/92-10/98	C 24 NE													
ENGINE																	
All engines							806 256	906 121R									
All engines									470 192	C10							
A10	CONDENSER	A20	CONTACT SET	A40	DISTRIBUTOR CAP	A50	ROTOR	A70	PICK-UP	C10	COIL	C20	IGNITION MODULE	C30	ELECTRONIC IGNITION KIT	E01	IGNITION CABLE SET

Vehicle	alim.	kW	Date	Engine	FUNCTIONS ON THE VEHICLE							
					A10	A20	A40	A50	A70	C10 - C30	C20	E01

GRANDLAND / GRANDLAND X

				ENGINE
1.2	Petrol	96	06/17->	B 12 XHT (EB2DTS)

Engine	Information	A10	A20	A40	A50	A70	C10 - C30	C20	E01
All engines	x 3, COIL ON PLUG						470 620	C10	

				ENGINE
1.6 Turbo	Petrol	110	12/19->	A 16 XHL (EP6FDTMD)

Engine	Information	A10	A20	A40	A50	A70	C10 - C30	C20	E01
All engines	x 4, COIL ON PLUG						470 475	C10	

				ENGINE
1.6 Turbo	Petrol	133	09/18->	D 16 XHT (EP6FADTXD)

Engine	Information	A10	A20	A40	A50	A70	C10 - C30	C20	E01
All engines	x 4, COIL ON PLUG						470 475	C10	

				ENGINE
1.6 Turbo Hybrid	Petrol/ Electric	133	12/19->	F 16 XHR (EP6FADTXD)

Engine	Information	A10	A20	A40	A50	A70	C10 - C30	C20	E01
All engines	x 4, COIL ON PLUG						470 475	C10	

				ENGINE
1.6 Turbo Hybrid	Petrol/ Electric	165	12/19->	F 16 XHR (EP6FADTXD)

Engine	Information	A10	A20	A40	A50	A70	C10 - C30	C20	E01
All engines	x 4, COIL ON PLUG						470 475	C10	

				ENGINE
1.6 Turbo Hybrid4	Petrol/ Electric	147	06/19->	F 16 XHR (EP6FADTXD)

Engine	Information	A10	A20	A40	A50	A70	C10 - C30	C20	E01
All engines	x 4, COIL ON PLUG						470 475	C10	

				ENGINE
1.6 Turbo Hybrid4	Petrol/ Electric	221	06/19->	F 16 XHR (EP6FADTXD)

Engine	Information	A10	A20	A40	A50	A70	C10 - C30	C20	E01
All engines	x 4, COIL ON PLUG						470 475	C10	

GT

				ENGINE
1.1	Petrol	44	09/68-12/70	11 SR

Engine	Information	A10	A20	A40	A50	A70	C10 - C30	C20	E01
All engines				806 062					
All engines	version BOSCH			806 076					

				ENGINE
1.9	Petrol	66	09/68-08/73	19 S

Engine	Information	A10	A20	A40	A50	A70	C10 - C30	C20	E01
All engines	version BOSCH			806 076					

INSIGNIA A

				ENGINE
1.4	Petrol	103	04/11->	A 14 NET, B 14 NET, B 18 XER

Engine	Information	A10	A20	A40	A50	A70	C10 - C30	C20	E01
Eng. B 18 XER							470 545	C10	
Eng. A 14 NET, B 14 NET	x 1, COIL ON RAIL						470 547	C10	

				ENGINE
1.4 LPG	Petrol/ Liquified Petro- leum Gas (LPG)	103	07/12-03/17	A 14 NET, B 14 NET

Engine	Information	A10	A20	A40	A50	A70	C10 - C30	C20	E01
All engines	x 1, COIL ON RAIL						470 547	C10	

				ENGINE
1.6	Petrol	85	07/08-03/17	A 16 XER

Engine	Information	A10	A20	A40	A50	A70	C10 - C30	C20	E01
All engines	x 1, COIL ON PLUG						470 545	C10	

A10	CONDENSER	A20	CONTACT SET	A40	DISTRIBUTOR CAP	A50	ROTOR	A70	PICK-UP
C10	COIL	C20	IGNITION MODULE	C30	ELECTRONIC IGNITION KIT	E01	IGNITION CABLE SET		

Vehicle	alim.	kW	Date	Engine	FUNCTIONS ON THE VEHICLE							
					A10	A20	A40	A50	A70	C10 - C30	C20	E01

ENGINE
1.6 Turbo Petrol 132 07/08-03/17 A 16 LET

Engine	Information	A10	A20	A40	A50	A70	C10 - C30	C20	E01
All engines	x 1, DELPHI, COIL ON PLUG, incl. spark plug connector						470 450	C10	

ENGINE
1.8 Petrol 103 07/08-03/17 A 18 XER, B 18 XER

Engine	Information	A10	A20	A40	A50	A70	C10 - C30	C20	E01
All engines	x 1, COIL ON PLUG						470 545	C10	

INSIGNIA B ENGINE
1.5 Petrol 103 03/17-> B 15 SFL, D 15 SFL

Engine	Information	A10	A20	A40	A50	A70	C10 - C30	C20	E01
All engines	x 4, COIL ON PLUG						470 631	C10	

ENGINE
1.5 Petrol 121 03/17-> B 15 SFT, D 15 SFT

Engine	Information	A10	A20	A40	A50	A70	C10 - C30	C20	E01
All engines	x 4, COIL ON PLUG						470 631	C10	

KADETT B ENGINE

1.1 Petrol 37 08/71-08/73 11 N

Engine	Information	A10	A20	A40	A50	A70	C10 - C30	C20	E01
All engines	version Bosch	606 212	706 034HVS	806 080	906 012R				
All engines	version Delco Remy		712 055HVS	812 066	912 093				

KADETT C ENGINE

1.2 Petrol 38 05/75-04/77 12 N

Engine	Information	A10	A20	A40	A50	A70	C10 - C30	C20	E01
All engines					912 093R				

ENGINE
1.2 Petrol 40 07/76-07/79 12 N

Engine	Information	A10	A20	A40	A50	A70	C10 - C30	C20	E01
All engines					912 093R				

ENGINE
1.2 S Petrol 44 08/73-07/79 12 S

Engine	Information	A10	A20	A40	A50	A70	C10 - C30	C20	E01
All engines					912 093R				

ENGINE
1.6 S Petrol 55 09/76-07/79 16 S

Engine	Information	A10	A20	A40	A50	A70	C10 - C30	C20	E01
All engines					912 093R				

KADETT D ENGINE

1.0 Petrol 30 09/79-08/82 10 N

Engine	Information	A10	A20	A40	A50	A70	C10 - C30	C20	E01
All engines	version Bosch	606 212	706 034HVS	806 080	906 012R				
All engines	version Delco Remy		712 055HVS	812 066	912 093				

ENGINE
1.2 Petrol 40 08/82-08/84 12 ST

Engine	Information	A10	A20	A40	A50	A70	C10 - C30	C20	E01
All engines	version Delco Remy			812 073	912 096	412 011			
All engines							470 341	C10	359 514

ENGINE
1.3 S Petrol 55 08/79-08/84 13 S

Engine	Information	A10	A20	A40	A50	A70	C10 - C30	C20	E01
All engines	version Bosch		706 049HDVS	806 099	906 026R				

KADETT E ENGINE

1.2 Petrol 40 09/84-08/88 12 SC, 12 ST

Engine	Information	A10	A20	A40	A50	A70	C10 - C30	C20	E01
Eng. 12 SC	version Bosch	606 212	706 034HVS	806 080	906 012R				
Eng. 12 SC	version Delco Remy		712 055HVS	812 066	912 095R				
Eng. 12 SC					912 093R				359 509

A10 CONDENSER	A20 CONTACT SET	A40 DISTRIBUTOR CAP	A50 ROTOR	A70 PICK-UP
C10 COIL	C20 IGNITION MODULE	C30 ELECTRONIC IGNITION KIT	E01 IGNITION CABLE SET	

Vehicle	alim.	kW	Date	Engine	FUNCTIONS ON THE VEHICLE							
					A10	A20	A40	A50	A70	C10 - C30	C20	E01

KADETT E

				ENGINE
1.2	Petrol	40	09/84-08/88	12 SC, 12 ST

Engine	Information	A10	A20	A40	A50	A70	C10 - C30	C20	E01
Eng. 12 ST									359 514

				ENGINE
1.3 i Cat	Petrol	44	09/85-08/91	C 13 N

Engine	Information	A10	A20	A40	A50	A70	C10 - C30	C20	E01
All engines	version Delco Remy			812 073	912 100	412 010			
All engines							470 341	C10	465 025
									359 514

				ENGINE
1.3 N	Petrol	44	09/84-08/91	13 N, 13 NB

Engine	Information	A10	A20	A40	A50	A70	C10 - C30	C20	E01
All engines	version Delco Remy			812 073	912 096	412 011			
All engines	FOR: (S), FOR: (CH), version Delco Remy			812 074	912 100				
All engines							470 341	C10	359 514

				ENGINE
1.3 S	Petrol	55	09/84-02/93	13 S

Engine	Information	A10	A20	A40	A50	A70	C10 - C30	C20	E01
All engines	version Delco Remy			812 073	912 096	412 011			
All engines	FOR: (S), FOR: (CH), version Delco Remy			812 074	912 100				
All engines							470 341	C10	359 514

				ENGINE
1.4 i	Petrol	44	01/90-07/94	C 14 NZ

Engine	Information	A10	A20	A40	A50	A70	C10 - C30	C20	E01
All engines	connector type SAE, version Bosch			806 249					
All engines	connector type M4, version Bosch			806 256					
All engines	version Lucas			828 100	928 028R				
All engines	version Bosch				906 121R				
All engines							470 140	C10	465 036
									360 237

				ENGINE
1.4 S	Petrol	55	07/89-02/93	14 NV

Engine	Information	A10	A20	A40	A50	A70	C10 - C30	C20	E01
All engines	version Bosch			806 256	906 056R				
All engines								465 005	360 237

				ENGINE
1.6	Petrol	60	09/86-12/91	16 SV

Engine	Information	A10	A20	A40	A50	A70	C10 - C30	C20	E01
All engines	->ch. K2500000, ->ch. K5000000, ->ch. KE299999, version Bosch			806 249					
All engines	ch. L2500001 ->, ch. L5000001 ->, ch. LE100001 ->, version Bosch			806 256					
All engines	24/09/84 ->, version Delco Remy			812 073					
All engines	->year 23/09/84, version Delco Remy			812 074					
All engines	->ch. K2500000, ->ch. K5000000, ->ch. KE299999, version Lucas			828 099					
All engines	ch. L2500001 ->, ch. L5000001 ->, ch. LE100001 ->, version Lucas			828 100					
All engines	version Bosch				906 121R			465 036	
All engines	version Delco Remy				912 100	412 011			
All engines	version Lucas				928 028R				
All engines	info XE						470 140	C10	
All engines	info XF						470 341	C10	
All engines	->eng. 02E85672								359 514
All engines	eng. type 02N39786 ->								360 237

				ENGINE
1.6 i	Petrol	55	09/86-07/94	C 16 NZ, E 16 NZ

Engine	Information	A10	A20	A40	A50	A70	C10 - C30	C20	E01
All engines	version Delco Remy			812 073	912 100	412 010			
All engines							470 341	C10	465 025
All engines	ch. J2508724, J5008434 ->, ->eng. 02V65825								359 514
All engines	->ch. J2508723, J5008433								360 942

A10	CONDENSER	A20	CONTACT SET	A40	DISTRIBUTOR CAP	A50	ROTOR	A70	PICK-UP
C10	COIL	C20	IGNITION MODULE	C30	ELECTRONIC IGNITION KIT	E01	IGNITION CABLE SET		

The present application list is a brief version. For the detailed information about the possibility of installation on a specific vehicle, please refer to our web-catalogue <http://catalogo.facet.eu/>

Vehicle	alim.	kW	Date	Engine	FUNCTIONS ON THE VEHICLE							
					A10	A20	A40	A50	A70	C10 - C30	C20	E01

ENGINE				
1.6 i	Petrol	60	07/89-02/93	16 SV

Engine	Information	A10	A20	A40	A50	A70	C10 - C30	C20	E01
All engines	->ch. K2500000, ->ch. K5000000, ->ch. KE299999, version Bosch			806 249					
All engines	ch. L2500001 ->, ch. L5000001 ->, ch. LE100001 ->, version Bosch			806 256					
All engines	24/09/84 ->, version Delco Remy			812 073					
All engines	->year 23/09/84, version Delco Remy			812 074					
All engines	->ch. K2500000, ->ch. K5000000, ->ch. KE299999, version Lucas			828 099					
All engines	ch. L2500001 ->, ch. L5000001 ->, ch. LE100001 ->, version Lucas			828 100					
All engines	version Bosch				906 121R			465 036	
All engines	version Delco Remy				912 100	412 011			
All engines	version Lucas				928 028R				
All engines	info XE						470 140	C10	
All engines	info XF						470 341	C10	
All engines	->eng. 02E85672								359 514
All engines	eng. type 02N39786 ->								360 237

ENGINE				
1.6 i Cat	Petrol	55	09/86-02/93	C 16 LZ, C 16 NZ

Engine	Information	A10	A20	A40	A50	A70	C10 - C30	C20	E01
All engines	version Delco Remy			812 073	912 100	412 010			
All engines							470 341	C10	465 025
All engines	ch. J2508724, J5008434 ->, ->eng. 02V65825								359 514
All engines	->ch. J2508723, J5008433								360 942

ENGINE				
1.6 S	Petrol	60	09/86-08/91	16 SV

Engine	Information	A10	A20	A40	A50	A70	C10 - C30	C20	E01
All engines	->ch. K2500000, ->ch. K5000000, ->ch. KE299999, version Bosch			806 249					
All engines	ch. L2500001 ->, ch. L5000001 ->, ch. LE100001 ->, version Bosch			806 256					
All engines	24/09/84 ->, version Delco Remy			812 073					
All engines	->year 23/09/84, version Delco Remy			812 074					
All engines	->ch. K2500000, ->ch. K5000000, ->ch. KE299999, version Lucas			828 099					
All engines	ch. L2500001 ->, ch. L5000001 ->, ch. LE100001 ->, version Lucas			828 100					
All engines	version Bosch				906 121R			465 036	
All engines	version Delco Remy				912 100	412 011			
All engines	version Lucas				928 028R				
All engines	info XE						470 140	C10	
All engines	info XF						470 341	C10	
All engines	->eng. 02E85672								359 514
All engines	eng. type 02N39786 ->								360 237

ENGINE				
1.6 S	Petrol	66	09/84-08/86	16 S

Engine	Information	A10	A20	A40	A50	A70	C10 - C30	C20	E01
All engines	version Bosch			806 080	906 056R				
All engines	info XE						470 140	C10	
All engines	info XF						470 341	C10	
All engines									465 004
All engines	FOR: (S), FOR: (CH)								465 034

ENGINE				
1.8	Petrol	82	01/86-08/91	18 SE

Engine	Information	A10	A20	A40	A50	A70	C10 - C30	C20	E01
All engines	->eng. 14258179, version Bosch			806 240					
All engines	eng. type 14258180 ->, version Bosch			806 257					
All engines	version Duellier			815 084	915 103R				
All engines	version Bosch				906 127R				
All engines	->ch. KE299999, ->ch. L2500000, ->ch. L5000000, ->ch. LB523999, eng. type 14258180 ->						470 140	C10	
All engines									465 004
All engines	FOR: (S), FOR: (CH)								465 034

A10 CONDENSER	A20 CONTACT SET	A40 DISTRIBUTOR CAP	A50 ROTOR	A70 PICK-UP
C10 COIL	C20 IGNITION MODULE	C30 ELECTRONIC IGNITION KIT	E01 IGNITION CABLE SET	

Vehicle	alim.	kW	Date	Engine	FUNCTIONS ON THE VEHICLE									
					A10	A20	A40	A50	A70	C10 - C30	C20	E01		
1.8 E	Petrol	74	10/85-08/86	ENGINE C 18 NE										
Engine	Information				A10	A20	A40	A50	A70	C10 - C30	C20	E01		
All engines	version Bosch						806 080	906 056R						
1.8 GSI	Petrol	85	09/84-08/86	ENGINE 18 E										
Engine	Information				A10	A20	A40	A50	A70	C10 - C30	C20	E01		
All engines	version Bosch						806 080	906 056R						
All engines											465 004			
All engines	FOR: (S), FOR: (CH)										465 034			
1.8 i	Petrol	66	08/84-09/92	ENGINE C 18 NT, C 18 NZ, S 18 NV										
Engine	Information				A10	A20	A40	A50	A70	C10 - C30	C20	E01		
Eng. C 18 NT	version Bosch						806 080	906 056R						
Eng. S 18 NV	->eng. 14258179, version Bosch						806 240							
Eng. C 18 NZ, S 18 NV	eng. type 14258180 ->, version Bosch						806 257							
Eng. C 18 NZ, S 18 NV	version Duellier						815 084	915 103R						
Eng. C 18 NZ, S 18 NV	version Bosch							906 127R						
Eng. C 18 NZ										470 140	C10			
Eng. S 18 NV	ch. J2791968 ->, ch. J5273428 ->, ch. JE215466 ->, ->eng. 14258179, info WY									470 191	C10			
Eng. S 18 NV	eng. type 14258180 ->, info WE									470 192	C10			
Eng. S 18 NV	->ch. J2791967, ->ch. J5273427, ->ch. JE215465									470 194	C10			
Eng. S 18 NV	eng. type 14275382 ->												359 689	
1.8 i	Petrol	74	10/85-08/86	ENGINE C 18 NE										
Engine	Information				A10	A20	A40	A50	A70	C10 - C30	C20	E01		
All engines	version Bosch						806 080	906 056R						
1.8 i	Petrol	85	09/84-08/86	ENGINE 18 E										
Engine	Information				A10	A20	A40	A50	A70	C10 - C30	C20	E01		
All engines	version Bosch						806 080	906 056R						
All engines										470 109	C10	465 004		
All engines	FOR: (S), FOR: (CH)										465 034			
1.8 S	Petrol	62	09/87-08/91	ENGINE E 18 NV										
Engine	Information				A10	A20	A40	A50	A70	C10 - C30	C20	E01		
All engines	->eng. 14258179, version Bosch						806 240							
All engines	eng. type 14258180 ->, version Bosch						806 257							
All engines	version Bosch							906 127R						
All engines	ch. J2791968 ->, ch. J5273428 ->, ch. JE215466 ->, ->eng. 14258179, ->eng. 14258179, info WY									470 191	C10			
All engines	eng. type 14258180 ->, info WE									470 192	C10			
All engines	->ch. J2791967, ->ch. J5273427, ->ch. JE215465									470 194	C10			
All engines	eng. type 14275382 ->												359 689	
2.0 GSI	Petrol	85	09/86-08/91	ENGINE 20 NE										
Engine	Information				A10	A20	A40	A50	A70	C10 - C30	C20	E01		
All engines	->eng. 14180385, version Bosch						806 240							
All engines	eng. type 14180386 ->, version Bosch						806 257							
All engines	version Duellier						815 084	915 103R						
All engines	version Bosch							906 127R						
All engines	ch. J2791968 ->, ch. J5273428 ->, ch. JE215466 ->, ->eng. 14180385, info WY									470 191	C10			
All engines	eng. type 14180386 ->, info WE									470 192	C10			
All engines	->ch. J2791967, ->ch. J5273427, ->ch. JE215465									470 194	C10			
All engines	eng. type 14672353 ->												359 689	
2.0 GSI	Petrol	95	09/86-08/91	ENGINE 20 SEH										
Engine	Information				A10	A20	A40	A50	A70	C10 - C30	C20	E01		
All engines	->eng. 14180385, version Bosch						806 240							
All engines	eng. type 14180386 ->, version Bosch						806 257							
All engines	version Duellier						815 084	915 103R						
All engines	version Bosch							906 127R						
All engines	ch. J2791968 ->, ch. J5273428 ->, ch. JE215466 ->, ->eng. 14180385, info WY									470 191	C10			
All engines	eng. type 14180386 ->, info WE									470 192	C10			
All engines	->ch. J2791967, ->ch. J5273427, ->ch. JE215465									470 194	C10			
All engines	eng. type 14672353 ->												359 689	
2.0 GSI	Petrol	95	09/86-08/91	ENGINE 20 SEH										
Engine	Information				A10	A20	A40	A50	A70	C10 - C30	C20	E01		
All engines	->eng. 14180385, version Bosch						806 240							
All engines	eng. type 14180386 ->, version Bosch						806 257							
All engines	version Duellier						815 084	915 103R						
All engines	version Bosch							906 127R						

A10 CONDENSER	A20 CONTACT SET	A40 DISTRIBUTOR CAP	A50 ROTOR	A70 PICK-UP
C10 COIL	C20 IGNITION MODULE	C30 ELECTRONIC IGNITION KIT	E01 IGNITION CABLE SET	

The present application list is a brief version. For the detailed information about the possibility of installation on a specific vehicle, please refer to our web-catalogue <http://catalogue.facet.eu/>

FUNCTIONS ON THE VEHICLE

Vehicle	alim.	kW	Date	Engine								
---------	-------	----	------	--------	---	---	---	--	---	---	---	---

				ENGINE
2.0 GSI	Petrol	95	09/86-08/91	20 SEH

Engine	Information	A10	A20	A40	A50	A70	C10 - C30	C20	E01
All engines	ch. J2791968 ->, ch. J5273428 ->, ch. JE215466 ->, ->eng. 14180385, info WY						470 191	C10	
All engines	eng. type 14180386 ->, info WE						470 192	C10	
All engines	->ch. J2791967, ->ch. J5273427, ->ch. JE215465						470 194	C10	

				ENGINE
2.0 GSI 16V	Petrol	115	12/87-08/91	20 XE

Engine	Information	A10	A20	A40	A50	A70	C10 - C30	C20	E01
All engines	->eng. 14180385, version Bosch			806 251					
All engines	eng. type 14180386 ->, version Bosch			806 257					
All engines	version Bosch				906 121R				

				ENGINE
2.0 GSI 16V Cat	Petrol	110	03/88-08/91	C 20 XE

Engine	Information	A10	A20	A40	A50	A70	C10 - C30	C20	E01
All engines	->eng. 14180385, version Bosch			806 251					
All engines	eng. type 14180386 ->, version Bosch			806 257					
All engines	version Bosch				906 121R				

				ENGINE
2.0 GSI Cat	Petrol	85	09/86-08/91	C 20 NE

Engine	Information	A10	A20	A40	A50	A70	C10 - C30	C20	E01
All engines	->eng. 14180385, version Bosch			806 240					
All engines	eng. type 14180386 ->, version Bosch			806 257					
All engines	version Ducellier			815 084	915 103R				
All engines	version Bosch				906 127R				
All engines	ch. J2791968 ->, ch. J5273428 ->, ch. JE215466 ->, ->eng. 14180385, info WY						470 191	C10	
All engines	eng. type 14180386 ->, info WE						470 192	C10	
All engines	->ch. J2791967, ->ch. J5273427, ->ch. JE215465						470 194	C10	
All engines	eng. type 14672353 ->								359 689

				ENGINE
2.0 i	Petrol	85	10/86-02/93	20 NE

Engine	Information	A10	A20	A40	A50	A70	C10 - C30	C20	E01
All engines	->eng. 14180385, version Bosch			806 240					
All engines	eng. type 14180386 ->, version Bosch			806 257					
All engines	version Ducellier			815 084	915 103R				
All engines	version Bosch				906 127R				
All engines	ch. J2791968 ->, ch. J5273428 ->, ch. JE215466 ->, ->eng. 14180385, info WY						470 191	C10	
All engines	eng. type 14180386 ->, info WE						470 192	C10	
All engines	->ch. J2791967, ->ch. J5273427, ->ch. JE215465						470 194	C10	
All engines	eng. type 14672353 ->								359 689

				ENGINE
2.0 i Cat	Petrol	85	10/86-02/93	C 20 NE

Engine	Information	A10	A20	A40	A50	A70	C10 - C30	C20	E01
All engines	->eng. 14180385, version Bosch			806 240					
All engines	eng. type 14180386 ->, version Bosch			806 257					
All engines	version Ducellier			815 084	915 103R				
All engines	version Bosch				906 127R				
All engines	ch. J2791968 ->, ch. J5273428 ->, ch. JE215466 ->, ->eng. 14180385, info WY						470 191	C10	
All engines	eng. type 14180386 ->, info WE						470 192	C10	
All engines	->ch. J2791967, ->ch. J5273427, ->ch. JE215465						470 194	C10	
All engines	eng. type 14672353 ->								359 689

MANTA B

				ENGINE
1.2 S	Petrol	44	09/75-02/79	12 S

Engine	Information	A10	A20	A40	A50	A70	C10 - C30	C20	E01
All engines					912 093R				

				ENGINE
1.3 N	Petrol	44	03/79-12/80	13 N

Engine	Information	A10	A20	A40	A50	A70	C10 - C30	C20	E01
All engines	version Bosch		706 034HVS	806 080	906 012R				

A10 CONDENSER	A20 CONTACT SET	A40 DISTRIBUTOR CAP	A50 ROTOR	A70 PICK-UP
C10 COIL	C20 IGNITION MODULE	C30 ELECTRONIC IGNITION KIT	E01 IGNITION CABLE SET	

Vehicle	alim.	kW	Date	Engine	FUNCTIONS ON THE VEHICLE									
					A10	A20	A40	A50	A70	C10 - C30	C20	E01		
ENGINE														
1.3 S	Petrol	55	08/81-08/86	13 S										
ENGINE														
Engine		Information			A10	A20	A40	A50	A70	C10 - C30	C20	E01		
All engines		version Bosch					806 080	906 055R						
All engines		version Delco Remy					812 073	912 096						
1.6 S	Petrol	55	09/75-12/81	16 S										
ENGINE														
Engine		Information			A10	A20	A40	A50	A70	C10 - C30	C20	E01		
All engines		version Bosch				706 034HVS	806 080	906 012R						
1.9 N	Petrol	55	08/76-12/81	19 N										
ENGINE														
Engine		Information			A10	A20	A40	A50	A70	C10 - C30	C20	E01		
All engines		version Bosch				706 034HVS	806 080	906 012R						
All engines								912 093R						
2.0	Petrol	66	08/77-12/80	20 N										
ENGINE														
Engine		Information			A10	A20	A40	A50	A70	C10 - C30	C20	E01		
All engines		version Bosch				706 034HVS	806 080	906 012R						
MERIVA														
1.4 ECOTEC	Petrol	74	01/13-03/17	A 14 XER										
ENGINE														
Engine		Information			A10	A20	A40	A50	A70	C10 - C30	C20	E01		
All engines		x 1, COIL ON RAIL								470 547	C10			
MERIVA A														
1.4 16V Twinport	Petrol	66	07/04-05/10	Z 14 XEP										
ENGINE														
Engine		Information			A10	A20	A40	A50	A70	C10 - C30	C20	E01		
All engines		x 1, BOSCH, COIL ON PLUG, incl. spark plug connector								470 400	C10			
1.4 16V Twinport LPG	Petrol/ Liquified Petroleum Gas (LPG)	66	07/04-05/10	Z 14 XEP										
ENGINE														
Engine		Information			A10	A20	A40	A50	A70	C10 - C30	C20	E01		
All engines		x 1, BOSCH, COIL ON PLUG, incl. spark plug connector								470 400	C10			
1.6	Petrol	64	05/03-05/10	Z 16 SE										
ENGINE														
Engine		Information			A10	A20	A40	A50	A70	C10 - C30	C20	E01		
All engines												360 904		
1.6	Petrol	77	01/06-05/10	Z 16 XEP										
ENGINE														
Engine		Information			A10	A20	A40	A50	A70	C10 - C30	C20	E01		
All engines		x 1, DELPHI, COIL ON PLUG, incl. spark plug connector								470 450	C10			
1.6 16V	Petrol	74	05/03-01/06	Z 16 XE										
ENGINE														
Engine		Information			A10	A20	A40	A50	A70	C10 - C30	C20	E01		
All engines		x 4, COIL ON PLUG, incl. spark plug connector								470 399	C10			
1.6 Turbo	Petrol	132	09/05-05/10	Z 16 LET										
ENGINE														
Engine		Information			A10	A20	A40	A50	A70	C10 - C30	C20	E01		
All engines		x 1, DELPHI, COIL ON PLUG, incl. spark plug connector								470 450	C10			
1.8	Petrol	92	05/03-05/10	Z 18 XE										
ENGINE														
Engine		Information			A10	A20	A40	A50	A70	C10 - C30	C20	E01		
All engines		x 1, COIL ON PLUG, incl. spark plug connector								470 508	C10			
MERIVA B														
1.4	Petrol	103	06/10-03/17	A 14 NET, B 14 NET										
ENGINE														
Engine		Information			A10	A20	A40	A50	A70	C10 - C30	C20	E01		
All engines		x 1, COIL ON RAIL								470 547	C10			

A10 CONDENSER	A20 CONTACT SET	A40 DISTRIBUTOR CAP	A50 ROTOR	A70 PICK-UP
C10 COIL	C20 IGNITION MODULE	C30 ELECTRONIC IGNITION KIT	E01 IGNITION CABLE SET	

The present application list is a brief version. For the detailed information about the possibility of installation on a specific vehicle, please refer to our web-catalogue <http://catalogo.facet.eu/>

Vehicle	alim.	kW	Date	Engine	FUNCTIONS ON THE VEHICLE							
					A10	A20	A40	A50	A70	C10 - C30	C20	E01

ENGINE				
1.4	Petrol	74	06/10-03/17	A 14 XER, B 14 XER

Engine	Information	A10	A20	A40	A50	A70	C10 - C30	C20	E01
All engines	x 1, COIL ON RAIL						470 547	C10	

ENGINE				
1.4	Petrol	88	06/10-03/17	A 14 NEL, B 14 NEL

Engine	Information	A10	A20	A40	A50	A70	C10 - C30	C20	E01
All engines	x 1, COIL ON RAIL						470 547	C10	

ENGINE				
1.4 LPG	Petrol/ Liquified Petro- leum Gas (LPG)	88	06/11-03/17	A 14 NEL, B 14 NEL

Engine	Information	A10	A20	A40	A50	A70	C10 - C30	C20	E01
All engines	x 1, COIL ON RAIL						470 547	C10	

MIDI

ENGINE				
2.0 i	Petrol	62	09/92-08/94	20PET

Engine	Information	A10	A20	A40	A50	A70	C10 - C30	C20	E01
All engines	version Denso			813 093	913 030				
All engines	for emission-controlled vehicles						470 219	C10	

ENGINE				
2.0 i 4x4	Petrol	62	09/92-08/94	20PET

Engine	Information	A10	A20	A40	A50	A70	C10 - C30	C20	E01
All engines	version Denso			813 093	913 030				
All engines	for emission-controlled vehicles						470 219	C10	

MOKKA

ENGINE				
1.4	Petrol	103	04/13->	A 14 NET, B 14 NET, D 14 NET

Engine	Information	A10	A20	A40	A50	A70	C10 - C30	C20	E01
All engines	x 1, COIL ON RAIL						470 547	C10	

ENGINE				
1.4 4x4	Petrol	103	06/12->	A 14 NET, B 14 NET, D 14 NET

Engine	Information	A10	A20	A40	A50	A70	C10 - C30	C20	E01
All engines	x 1, COIL ON RAIL						470 547	C10	

ENGINE				
1.4 4x4	Petrol	112	06/16->	B 14 XFT

Engine	Information	A10	A20	A40	A50	A70	C10 - C30	C20	E01
All engines	x 4, COIL ON PLUG						470 631	C10	

ENGINE				
1.4 LPG	Petrol/ Liquified Petro- leum Gas (LPG)	103	04/13->	A 14 NET, B 14 NET, D 14 NET

Engine	Information	A10	A20	A40	A50	A70	C10 - C30	C20	E01
All engines	x 1, COIL ON RAIL						470 547	C10	

ENGINE				
1.6	Petrol	85	06/12->	A 16 XER, B 16 XER, D 16 XER

Engine	Information	A10	A20	A40	A50	A70	C10 - C30	C20	E01
All engines	x 1, COIL RAILS						470 545	C10	

ENGINE				
1.8	Petrol	103	01/13->	A 18 XER

Engine	Information	A10	A20	A40	A50	A70	C10 - C30	C20	E01
All engines	x 1, COIL ON PLUG						470 545	C10	

ENGINE				
1.8 4x4	Petrol	103	01/13->	A 18 XER

Engine	Information	A10	A20	A40	A50	A70	C10 - C30	C20	E01
All engines	x 1, COIL ON PLUG						470 545	C10	

A10 CONDENSER	A20 CONTACT SET	A40 DISTRIBUTOR CAP	A50 ROTOR	A70 PICK-UP
C10 COIL	C20 IGNITION MODULE	C30 ELECTRONIC IGNITION KIT	E01 IGNITION CABLE SET	

Vehicle	alim.	kW	Date	Engine	FUNCTIONS ON THE VEHICLE							
					A10	A20	A40	A50	A70	C10 - C30	C20	E01

OMEGA A

1.8	Petrol	60	09/86-03/94	ENGINE S 18 NV
-----	--------	----	-------------	-------------------

Engine	Information	A10	A20	A40	A50	A70	C10 - C30	C20	E01
All engines	->ch. K1999999, version Bosch			806 240					
All engines	ch. L1000001 ->, version Bosch			806 257					
All engines	version Ducellier			815 084	915 103R				
All engines	version Bosch				906 127R				
All engines	->eng. 14258179, ch. K1000099 ->						470 191	C10	
All engines	eng. type 14258180 ->						470 192	C10	
All engines	->ch. K1000098						470 194	C10	
All engines	eng. type 14258180 ->, ->ch. L1204907								359 527
All engines	ch. L1204908 ->								359 689

1.8	Petrol	65	09/87-03/94	ENGINE E 18 NVR
-----	--------	----	-------------	--------------------

Engine	Information	A10	A20	A40	A50	A70	C10 - C30	C20	E01
All engines	->ch. K1999999, version Bosch			806 240					
All engines	ch. L1000001 ->, version Bosch			806 257					
All engines	version Ducellier			815 084	915 103R				
All engines	version Bosch				906 127R				
All engines	->eng. 14258179, ch. K1000099 ->						470 191	C10	
All engines	eng. type 14258180 ->						470 192	C10	
All engines	->ch. K1000098						470 194	C10	
All engines	eng. type 14258180 ->, ->ch. L1204907								359 527
All engines	ch. L1204908 ->								359 689

1.8	Petrol	85	09/86-03/94	ENGINE 18 SEH
-----	--------	----	-------------	------------------

Engine	Information	A10	A20	A40	A50	A70	C10 - C30	C20	E01
All engines	->ch. K1999999, version Bosch			806 240					
All engines	ch. L1000001 ->, version Bosch			806 257					
All engines	version Ducellier			815 084	915 103R				
All engines	version Bosch				906 127R				
All engines	eng. type 1019854 ->, ->eng. 14258180						470 140	C10	
All engines	eng. type 14258180 ->, ->ch. L1204907								359 527
All engines	ch. L1204908 ->								359 689

1.8 N	Petrol	60	09/86-08/87	ENGINE 18 NV
-------	--------	----	-------------	-----------------

Engine	Information	A10	A20	A40	A50	A70	C10 - C30	C20	E01
All engines	->ch. K1999999, version Bosch			806 240					
All engines	ch. L1000001 ->, version Bosch			806 257					
All engines	version Ducellier			815 084	915 103R				
All engines	version Bosch				906 127R				
All engines	->eng. 14258179, ch. K1000099 ->						470 191	C10	
All engines	eng. type 14258180 ->						470 192	C10	
All engines	->ch. K1000098						470 194	C10	
All engines	eng. type 14258180 ->, ->ch. L1204907								359 527
All engines	ch. L1204908 ->								359 689

1.8 S	Petrol	66	09/86-03/94	ENGINE 18 SV
-------	--------	----	-------------	-----------------

Engine	Information	A10	A20	A40	A50	A70	C10 - C30	C20	E01
All engines	->ch. K1999999, version Bosch			806 240					
All engines	ch. L1000001 ->, version Bosch			806 257					
All engines	version Ducellier			815 084	915 103R				
All engines	version Bosch				906 127R				
All engines	eng. type 14258180 ->						470 140	C10	
All engines	ch. L1019855 ->							465 036	
All engines	eng. type 14258180 ->, ->ch. L1204907								359 527
All engines	ch. L1204908 ->								359 689

2.0	Petrol	85	09/87-04/94	ENGINE C 20 NE
-----	--------	----	-------------	-------------------

Engine	Information	A10	A20	A40	A50	A70	C10 - C30	C20	E01
All engines	->ch. K1999999, version Bosch			806 240					
All engines	ch. L1000001 ->, version Bosch			806 257					

A10 CONDENSER	A20 CONTACT SET	A40 DISTRIBUTOR CAP	A50 ROTOR	A70 PICK-UP
C10 COIL	C20 IGNITION MODULE	C30 ELECTRONIC IGNITION KIT	E01 IGNITION CABLE SET	

The present application list is a brief version. For the detailed information about the possibility of installation on a specific vehicle, please refer to our web-catalogue <http://catalogo.facet.eu/>

Vehicle	alim.	kW	Date	Engine	FUNCTIONS ON THE VEHICLE							
					A10	A20	A40	A50	A70	C10 - C30	C20	E01

ENGINE				
2.0	Petrol	85	09/87-04/94	C20 NE

Engine	Information	A10	A20	A40	A50	A70	C10 - C30	C20	E01
All engines	version Ducellier			815 084	915 103R				
All engines	version Bosch				906 127R				
All engines	->eng. 14180385, ch. K1000099 ->						470 191	C10	
All engines	eng. type 14180386 ->						470 192	C10	
All engines	->ch. K1000098						470 194	C10	
All engines	->eng. 14672352, eng. type 14180386 ->								359 527
All engines	eng. type 14672353 ->								359 689

ENGINE				
2.0	Petrol	90	09/86-03/94	20 SE

Engine	Information	A10	A20	A40	A50	A70	C10 - C30	C20	E01
All engines	->ch. K1999999, version Bosch			806 240					
All engines	ch. L1000001 ->, version Bosch			806 257					
All engines	version Ducellier			815 084	915 103R				
All engines	version Bosch				906 127R				
All engines	->eng. 14180385, ch. K1000099 ->						470 191	C10	
All engines	eng. type 14180386 ->						470 192	C10	
All engines	->ch. K1000098						470 194	C10	
All engines	->eng. 14312950, eng. type 14180386 ->								359 527
All engines	eng. type 14312951 ->								359 689

ENGINE				
2.0 i	Petrol	85	09/86-04/94	C20 NE

Engine	Information	A10	A20	A40	A50	A70	C10 - C30	C20	E01
All engines	->ch. K1999999, version Bosch			806 240					
All engines	ch. L1000001 ->, version Bosch			806 257					
All engines	version Ducellier			815 084	915 103R				
All engines	version Bosch				906 127R				
All engines	->eng. 14180385, ch. K1000099 ->						470 191	C10	
All engines	eng. type 14180386 ->						470 192	C10	
All engines	->ch. K1000098						470 194	C10	
All engines	->eng. 14672352, eng. type 14180386 ->								359 527
All engines	eng. type 14672353 ->								359 689

ENGINE				
2.4 i	Petrol	92	09/88-03/94	C24 NE

Engine	Information	A10	A20	A40	A50	A70	C10 - C30	C20	E01
All engines	oe Bosch 1 235 522 409			806 080					
All engines	oe Bosch 1 235 522 437			806 256					
All engines	version Bosch				906 121R				
All engines	->ch. K1999999						470 191	C10	
All engines	ch. L1000001 ->						470 192	C10	

ENGINE				
2.6 i	Petrol	110	09/90-03/94	C26 NE

Engine	Information	A10	A20	A40	A50	A70	C10 - C30	C20	E01
All engines	version Bosch			806 258	906 056R				
All engines							470 192	C10	

ENGINE				
3.0	Petrol	115	03/87-03/94	C30 LE

Engine	Information	A10	A20	A40	A50	A70	C10 - C30	C20	E01
All engines	->ch. K1999999, version Bosch			806 081					
All engines	ch. L1000001 ->, version Bosch			806 258					
All engines	version Bosch				906 056R				
All engines	->ch. K1999999, ch. K1000099 ->						470 191	C10	
All engines	ch. L1000001 ->						470 192	C10	
All engines	->ch. K1000098						470 194	C10	

ENGINE				
3.0	Petrol	130	03/87-03/94	30 NE, C30 NE

Engine	Information	A10	A20	A40	A50	A70	C10 - C30	C20	E01
All engines	->ch. K1999999, version Bosch			806 081					
All engines	ch. L1000001 ->, version Bosch			806 258					
All engines	version Bosch				906 056R				
Eng. C30 NE	->ch. K1999999, ch. K1000099 ->						470 191	C10	

A10 CONDENSER	A20 CONTACT SET	A40 DISTRIBUTOR CAP	A50 ROTOR	A70 PICK-UP
C10 COIL	C20 IGNITION MODULE	C30 ELECTRONIC IGNITION KIT	E01 IGNITION CABLE SET	

Vehicle	alim.	kW	Date	Engine	FUNCTIONS ON THE VEHICLE							
					A10	A20	A40	A50	A70	C10 - C30	C20	E01

ENGINE				
3.0	Petrol	130	03/87-03/94	30 NE, C30 NE

Engine	Information	A10	A20	A40	A50	A70	C10 - C30	C20	E01
Eng. C30 NE	ch. L1000001 ->						470 192	C10	
Eng. C30 NE	->ch. K1000098						470 194	C10	
Eng. 30 NE								465 034	

ENGINE				
3.0 24V	Petrol	150	09/89-03/94	C30 SE

Engine	Information	A10	A20	A40	A50	A70	C10 - C30	C20	E01
All engines	version Bosch			806 258	906 056R				
All engines							470 192	C10	

ENGINE				
3.0 24V Omega 3000	Petrol	150	09/88-04/94	C30 SE

Engine	Information	A10	A20	A40	A50	A70	C10 - C30	C20	E01
All engines	version Bosch			806 258	906 056R				
All engines							470 192	C10	

ENGINE				
3.0 Cat	Petrol	130	03/87-03/94	C30 NE

Engine	Information	A10	A20	A40	A50	A70	C10 - C30	C20	E01
All engines	->ch. K1999999, version Bosch			806 081					
All engines	ch. L1000001 ->, version Bosch			806 258					
All engines	version Bosch				906 056R				
All engines	->ch. K1999999, ch. K1000099 ->						470 191	C10	
All engines	ch. L1000001 ->						470 192	C10	
All engines	->ch. K1000098						470 194	C10	

OMEGA B

ENGINE				
2.0	Petrol	85	03/94-12/00	20 SE, X20 SE

Engine	Information	A10	A20	A40	A50	A70	C10 - C30	C20	E01
Eng. 20 SE	->ch. K1999999, version Bosch			806 240					
Eng. 20 SE	ch. L1000001 ->, version Bosch			806 257					
Eng. 20 SE	version Ducellier			815 084	915 103R				
Eng. 20 SE	version Bosch				906 127R				
Eng. 20 SE	->eng. 14180385, ch. K1000099 ->						470 191	C10	
Eng. 20 SE	eng. type 14180386 ->						470 192	C10	
Eng. 20 SE	->ch. K1000098						470 194	C10	
Eng. X20 SE							470 273	C10	
Eng. 20 SE	->eng. 14312950, eng. type 14180386 ->								359 527
Eng. 20 SE	eng. type 14312951 ->								359 689

ENGINE				
2.0 16V	Petrol	100	03/94-09/99	X20 XEV

Engine	Information	A10	A20	A40	A50	A70	C10 - C30	C20	E01
All engines							470 272	C10	360 562

REKORD D

ENGINE				
1.7	Petrol	44	03/75-08/77	17 N

Engine	Information	A10	A20	A40	A50	A70	C10 - C30	C20	E01
All engines					912 093R				

REKORD E

ENGINE				
1.7	Petrol	44	09/77-10/82	17 N

Engine	Information	A10	A20	A40	A50	A70	C10 - C30	C20	E01
All engines					906 067R				

ENGINE				
1.9	Petrol	55	09/77-10/82	19 N

Engine	Information	A10	A20	A40	A50	A70	C10 - C30	C20	E01
All engines					906 067R				

ENGINE				
2.0	Petrol	66	09/77-10/82	20 N

Engine	Information	A10	A20	A40	A50	A70	C10 - C30	C20	E01
All engines					906 067R				

A10 CONDENSER	A20 CONTACT SET	A40 DISTRIBUTOR CAP	A50 ROTOR	A70 PICK-UP
C10 COIL	C20 IGNITION MODULE	C30 ELECTRONIC IGNITION KIT	E01 IGNITION CABLE SET	

The present application list is a brief version. For the detailed information about the possibility of installation on a specific vehicle, please refer to our web-catalogue <http://catalogo.facet.eu/>

Vehicle	alim.	kW	Date	Engine	FUNCTIONS ON THE VEHICLE							
					A10	A20	A40	A50	A70	C10 - C30	C20	E01

SENATOR B

				ENGINE
2.5 i	Petrol	103	09/90-09/93	25 NE

Engine	Information	A10	A20	A40	A50	A70	C10 - C30	C20	E01
All engines	->eng. 055888, version Bosch			806 081					
All engines	eng. type 055889 ->, version Bosch			806 258					
All engines	version Bosch				906 056R				

				ENGINE
3.0	Petrol	115	09/87-09/93	C 30 LE

Engine	Information	A10	A20	A40	A50	A70	C10 - C30	C20	E01
All engines	->eng. 018097, version Bosch			806 081					
All engines	eng. type 018098 ->, version Bosch			806 258					
All engines	version Bosch				906 056R				
All engines	ch. K1000099 ->, ->ch. L1000000						470 191	C10	
All engines	ch. L1000001 ->						470 192	C10	
All engines	->ch. K1000098						470 194	C10	

				ENGINE
3.0	Petrol	130	01/88-09/90	30 NE

Engine	Information	A10	A20	A40	A50	A70	C10 - C30	C20	E01
All engines	->eng. 115025, version Bosch			806 081					
All engines	eng. type 115026 ->, version Bosch			806 258					
All engines	version Bosch				906 056R				

				ENGINE
3.0 24V	Petrol	150	09/89-09/93	C 30 SE

Engine	Information	A10	A20	A40	A50	A70	C10 - C30	C20	E01
All engines	version Bosch			806 258	906 056R				
All engines							470 192	C10	

				ENGINE
3.0 i Cat	Petrol	130	01/88-09/93	C 30 NE

Engine	Information	A10	A20	A40	A50	A70	C10 - C30	C20	E01
All engines	->eng. 115025, version Bosch			806 081					
All engines	eng. type 115026 ->, version Bosch			806 258					
All engines	version Bosch				906 056R				
All engines	ch. K1000099 ->, ->ch. L1000000						470 191	C10	
All engines	ch. L1000001 ->						470 192	C10	
All engines	->ch. K1000098						470 194	C10	

SIGNUM

				ENGINE
1.8	Petrol	103	09/05-12/08	Z 18 XER

Engine	Information	A10	A20	A40	A50	A70	C10 - C30	C20	E01
All engines	x 1, DELPHI, COIL ON PLUG, incl. spark plug connector						470 450	C10	

				ENGINE
1.8	Petrol	90	05/03-07/05	Z 18 XE

Engine	Information	A10	A20	A40	A50	A70	C10 - C30	C20	E01
All engines	x 1, COIL ON PLUG, incl. spark plug connector						470 508	C10	

SINTRA

				ENGINE
2.2 i 16V	Petrol	104	11/96-04/99	X 22 XE

Engine	Information	A10	A20	A40	A50	A70	C10 - C30	C20	E01
All engines	x 1, D.I.S.						470 389	C10	
All engines									360 562

SPEEDSTER

				ENGINE
2.0	Petrol	162	10/03-08/06	Z 20 LET

Engine	Information	A10	A20	A40	A50	A70	C10 - C30	C20	E01
All engines							470 507	C10	

				ENGINE
2.0 Turbo	Petrol	147	08/02-08/06	Z 20 LET

Engine	Information	A10	A20	A40	A50	A70	C10 - C30	C20	E01
All engines	x 1, COIL ON PLUG						470 507	C10	

A10 CONDENSER	A20 CONTACT SET	A40 DISTRIBUTOR CAP	A50 ROTOR	A70 PICK-UP
C10 COIL	C20 IGNITION MODULE	C30 ELECTRONIC IGNITION KIT	E01 IGNITION CABLE SET	

Vehicle	alim.	kW	Date	Engine	FUNCTIONS ON THE VEHICLE							
					A10	A20	A40	A50	A70	C10 - C30	C20	E01

TIGRA A

1.4 16V	Petrol	63	08/97-12/00	ENGINE X 14 XE
---------	--------	----	-------------	-------------------

Engine	Information	A10	A20	A40	A50	A70	C10 - C30	C20	E01
All engines	->ch. 20C17331								359 688
All engines	ch. 20C17332 ->								360 559

1.4 16V	Petrol	66	07/94-12/00	ENGINE X 14 XE
---------	--------	----	-------------	-------------------

Engine	Information	A10	A20	A40	A50	A70	C10 - C30	C20	E01
All engines	->ch. 20C17331								359 688
All engines	ch. 20C17332 ->								360 559

1.6 16V	Petrol	74	08/97-08/98	ENGINE C 16 SEL
---------	--------	----	-------------	--------------------

Engine	Information	A10	A20	A40	A50	A70	C10 - C30	C20	E01
All engines	->ch. 20C17331								359 688
All engines	ch. 20C17332 ->								360 559

1.6 16V	Petrol	78	07/94-08/98	ENGINE X 16 XE
---------	--------	----	-------------	-------------------

Engine	Information	A10	A20	A40	A50	A70	C10 - C30	C20	E01
All engines	->ch. 20C17331								359 688
All engines	ch. 20C17332 ->								360 559

TIGRA B

1.4	Petrol	66	06/04-12/10	ENGINE Z 14 XEP
-----	--------	----	-------------	--------------------

Engine	Information	A10	A20	A40	A50	A70	C10 - C30	C20	E01
All engines	x 1, BOSCH, COIL ON PLUG, incl. spark plug connector						470 400	C10	

1.8	Petrol	92	06/04-12/10	ENGINE Z 18 XE
-----	--------	----	-------------	-------------------

Engine	Information	A10	A20	A40	A50	A70	C10 - C30	C20	E01
All engines	x 1, COIL ON PLUG, incl. spark plug connector						470 508	C10	

VECTRA

2.0	Petrol	85	10/95-04/02	ENGINE C 20 SEL
-----	--------	----	-------------	--------------------

Engine	Information	A10	A20	A40	A50	A70	C10 - C30	C20	E01
All engines	x 1, D.I.S.						470 272	C10	

VECTRA A

1.4 S	Petrol	55	04/88-06/92	ENGINE 14 NV
-------	--------	----	-------------	-----------------

Engine	Information	A10	A20	A40	A50	A70	C10 - C30	C20	E01
All engines	->ch. K1999999, ->ch. K5999999, ->ch. KV999999, version Bosch			806 080					
All engines	ch. L1000001 ->, ch. L5000001 ->, ch. LV100001 ->, version Bosch			806 256					
All engines	version Bosch			906 056R				465 005	
All engines	eng. type 02J22350 ->								359 956
All engines	eng. type 19S85416 ->								360 237

1.6	Petrol	51	08/92-07/93	ENGINE C 16 LZ2
-----	--------	----	-------------	--------------------

Engine	Information	A10	A20	A40	A50	A70	C10 - C30	C20	E01
All engines	version Ducellier			815 084	915 103R				
All engines							470 140	C10	465 036

1.6	Petrol	60	09/88-05/93	ENGINE 16 SV
-----	--------	----	-------------	-----------------

Engine	Information	A10	A20	A40	A50	A70	C10 - C30	C20	E01
All engines	->ch. K1999999, ->ch. K5999999, ->ch. KV999999, version Bosch			806 249					
All engines	ch. L1000001 ->, ch. L5000001 ->, ch. LV100001 ->, version Bosch			806 256					
All engines	->ch. K1999999, ->ch. K5999999, ->ch. KV999999, version Lucas			828 099					
All engines	ch. L1000001 ->, ch. L5000001 ->, ch. LV100001 ->, version Lucas			828 100					
All engines	version Bosch				906 121R				
All engines	version Lucas				928 028R				
All engines	ch. L1000001 ->, ch. L5000001 ->, ch. LV100001 ->						470 140	C10	

A10 CONDENSER	A20 CONTACT SET	A40 DISTRIBUTOR CAP	A50 ROTOR	A70 PICK-UP
C10 COIL	C20 IGNITION MODULE	C30 ELECTRONIC IGNITION KIT	E01 IGNITION CABLE SET	

Vehicle	alim.	kW	Date	Engine	FUNCTIONS ON THE VEHICLE							
					A10	A20	A40	A50	A70	C10 - C30	C20	E01

ENGINE				
1.6	Petrol	60	09/88-05/93	16 SV

Engine	Information	A10	A20	A40	A50	A70	C10 - C30	C20	E01
All engines								465 036	
All engines	->eng. 02E85672								359 514
All engines	eng. type 02N39786 ->								360 237

ENGINE				
1.6i	Petrol	52	09/93-11/95	X 16 SZ

Engine	Information	A10	A20	A40	A50	A70	C10 - C30	C20	E01
All engines	version Delco Remy			812 073	912 100	412 010			
All engines								465 025	
All engines	->ch. P1999999, ->ch. P5999999, ->ch. P7999999								359 634
All engines	ch. R1000001 ->, ch. R5000001 ->, ch. R7500001 ->								360 531

ENGINE				
1.6i	Petrol	55	09/88-11/95	C 16 NZ, C 16 NZ2, E 16 NZ

Engine	Information	A10	A20	A40	A50	A70	C10 - C30	C20	E01
Eng. C 16 NZ, E 16 NZ	version Delco Remy			812 073	912 100	412 010			
Eng. C 16 NZ2	version Ducellier			815 084	915 103R				
Eng. C 16 NZ2							470 140	C10	465 036
Eng. C 16 NZ, E 16 NZ							470 341	C10	465 025
Eng. C 16 NZ, E 16 NZ	->eng. 02V65825								359 513
Eng. C 16 NZ, E 16 NZ	ch. R1000001 ->, ch. R5000001 ->, ch. R7500001 ->								360 237

ENGINE				
1.6i Cat	Petrol	55	09/88-11/95	C 16 NZ, C 16 NZ2

Engine	Information	A10	A20	A40	A50	A70	C10 - C30	C20	E01
Eng. C 16 NZ	version Delco Remy			812 073	912 100	412 010			
Eng. C 16 NZ2	version Ducellier			815 084	915 103R				
Eng. C 16 NZ2							470 140	C10	465 036
Eng. C 16 NZ							470 341	C10	465 025
Eng. C 16 NZ	->eng. 02V65825								359 513
Eng. C 16 NZ	ch. R1000001 ->, ch. R5000001 ->, ch. R7500001 ->								360 237

ENGINE				
1.6 S	Petrol	60	09/88-05/93	16 SV

Engine	Information	A10	A20	A40	A50	A70	C10 - C30	C20	E01
All engines	->ch. K1999999, ->ch. K5999999, ->ch. KV999999, version Bosch			806 249					
All engines	ch. L1000001 ->, ch. L5000001 ->, ch. LV100001 ->, version Bosch			806 256					
All engines	->ch. K1999999, ->ch. K5999999, ->ch. KV999999, version Lucas			828 099					
All engines	ch. L1000001 ->, ch. L5000001 ->, ch. LV100001 ->, version Lucas			828 100					
All engines	version Bosch				906 121R				
All engines	version Lucas				928 028R				
All engines	ch. L1000001 ->, ch. L5000001 ->, ch. LV100001 ->					470 140	C10		
All engines								465 036	
All engines	->eng. 02E85672								359 514
All engines	eng. type 02N39786 ->								360 237

ENGINE				
1.8i	Petrol	66	09/88-10/90	18 SV









Engine	Information	A10	A20	A40	A50	A70	C10 - C30	C20	E01
All engines	->ch. K1999999, ->ch. K5999999, ->ch. KV999999, version Bosch			806 240					
All engines	ch. L1000001 ->, ch. L5000001 ->, ch. LV100001 ->, version Bosch			806 257					
All engines	version Ducellier			815 084	915 103R				
All engines	version Bosch				906 127R				
All engines							470 140	C10	465 036
All engines	->eng. 14279654, eng. type 14275382 ->								359 689

ENGINE				
1.8i Cat	Petrol	66	03/90-11/95	C 18 NZ

Engine	Information	A10	A20	A40	A50	A70	C10 - C30	C20	E01
All engines	version Bosch			806 257	906 127R				
All engines	version Ducellier			815 084	915 103R				
All engines							470 140	C10	465 036
All engines	->eng. 14432540, eng. type 14349311 ->								359 689

A10 CONDENSER	A20 CONTACT SET	A40 DISTRIBUTOR CAP	A50 ROTOR	A70 PICK-UP
C10 COIL	C20 IGNITION MODULE	C30 ELECTRONIC IGNITION KIT	E01 IGNITION CABLE SET	

Vehicle	alim.	kW	Date	Engine	FUNCTIONS ON THE VEHICLE								
					A10	A20	A40	A50	A70	C10 - C30	C20	E01	
1.8 S	Petrol	65	09/88-07/89	ENGINE E 18 NVR									
Engine	Information	A10	A20	A40	A50	A70	C10 - C30	C20	E01				
All engines	->ch. K1999999, ->ch. K5999999, ->ch. KV999999, version Bosch			806 240									
All engines	ch. L1000001 ->, ch. L5000001 ->, ch. LV100001 ->, version Bosch			806 257									
All engines	version Ducellier			815 084	915 103R								
All engines	version Bosch				906 127R								
All engines	->eng. 14258179, info WY						470 191	C10					
All engines	eng. type 14258180 ->, info WE						470 192	C10					
All engines	->eng. 14279654, eng. type 14275382 ->								359 689				
1.8 S	Petrol	66	09/89-10/90	ENGINE 18 SV									
Engine	Information	A10	A20	A40	A50	A70	C10 - C30	C20	E01				
All engines	->ch. K1999999, ->ch. K5999999, ->ch. KV999999, version Bosch			806 240									
All engines	ch. L1000001 ->, ch. L5000001 ->, ch. LV100001 ->, version Bosch			806 257									
All engines	version Ducellier			815 084	915 103R								
All engines	version Bosch				906 127R								
All engines	->eng. 14258179, info WY						470 140	C10	465 036				
All engines	eng. type 14279654, eng. type 14275382 ->								359 689				
1.8 S 4x4	Petrol	65	01/89-07/89	ENGINE E 18 NVR									
Engine	Information	A10	A20	A40	A50	A70	C10 - C30	C20	E01				
All engines	->ch. K1999999, ->ch. K5999999, ->ch. KV999999, version Bosch			806 240									
All engines	ch. L1000001 ->, ch. L5000001 ->, ch. LV100001 ->, version Bosch			806 257									
All engines	version Ducellier			815 084	915 103R								
All engines	version Bosch				906 127R								
All engines	->eng. 14258179, info WY						470 191	C10					
All engines	eng. type 14258180 ->, info WE						470 192	C10					
All engines	->eng. 14279654, eng. type 14275382 ->								359 689				
2.0 i	Petrol	85	09/88-10/90	ENGINE 20 NE									
Engine	Information	A10	A20	A40	A50	A70	C10 - C30	C20	E01				
All engines	->ch. K1999999, ->ch. K5999999, ->ch. KV999999, version Bosch			806 240									
All engines	ch. L1000001 ->, ch. L5000001 ->, ch. LV100001 ->, version Bosch			806 257									
All engines	version Ducellier			815 084	915 103R								
All engines	version Bosch				906 127R								
All engines	->eng. 14180385, info WY						470 191	C10					
All engines	eng. type 14180386 ->, info WE						470 192	C10					
All engines	->eng. 14841581, eng. type 14672353 ->								359 689				
2.0 i	Petrol	95	09/88-09/92	ENGINE 20 SEH									
Engine	Information	A10	A20	A40	A50	A70	C10 - C30	C20	E01				
All engines	->ch. K1999999, ->ch. K5999999, ->ch. KV999999, version Bosch			806 240									
All engines	ch. L1000001 ->, ch. L5000001 ->, ch. LV100001 ->, version Bosch			806 257									
All engines	version Ducellier			815 084	915 103R								
All engines	version Bosch				906 127R								
All engines	->eng. 14180385, info WY						470 191	C10					
All engines	eng. type 14180386 ->, info WE						470 192	C10					
All engines	eng. type 14672353 ->								359 689				
2.0 i 16V	Petrol	100	08/92-08/95	ENGINE X 20 XEV									
Engine	Information	A10	A20	A40	A50	A70	C10 - C30	C20	E01				
All engines	->ch. K1999999, ->ch. K5999999, ->ch. KV999999, version Bosch			806 240									
All engines	ch. L1000001 ->, ch. L5000001 ->, ch. LV100001 ->, version Bosch			806 257									
All engines	version Ducellier			815 084	915 103R								
All engines	version Bosch				906 127R								
All engines	->eng. 14180385, info WY						470 191	C10					
All engines	eng. type 14180386 ->, info WE						470 192	C10					
All engines	eng. type 14672353 ->								359 689				
2.0 i 16V	Petrol	110	02/89-10/90	ENGINE 20 XEJ									
Engine	Information	A10	A20	A40	A50	A70	C10 - C30	C20	E01				
All engines	->eng. 14180385, version Bosch			806 251									
All engines	eng. type 14180386 ->, version Bosch			806 257									
All engines	version Bosch				906 121R								
A10	CONDENSER	A20	CONTACT SET	A40	DISTRIBUTOR CAP	A50	ROTOR	A70	PICK-UP				
C10	COIL	C20	IGNITION MODULE	C30	ELECTRONIC IGNITION KIT	E01	IGNITION CABLE SET						

				FUNCTIONS ON THE VEHICLE								
Vehicle	alim.	kW	Date	Engine								
				ENGINE								
2.0 i 16V	Petrol	110	02/89-10/90	20 XEJ								
Engine	Information				A10	A20	A40	A50	A70	C10 - C30	C20	E01
All engines	ch. P1000001 ->, ch. P5000001 ->, ch. P7500001 ->											359 688
				ENGINE								
2.0 i 16V 4x4	Petrol	100	06/94-11/95	X 20 XEV								
Engine	Information				A10	A20	A40	A50	A70	C10 - C30	C20	E01
All engines										470 272 C10		360 562
				ENGINE								
2.0 i 16V 4x4	Petrol	110	08/89-08/95	C 20 XE								
Engine	Information				A10	A20	A40	A50	A70	C10 - C30	C20	E01
All engines	->eng. 14180385, version Bosch						806 251					
All engines	eng. type 14180386 ->, version Bosch						806 257					
All engines	version Bosch						906 121R					
All engines	ch. P1000001 ->, ch. P5000001 ->, ch. P7500001 ->											359 688
				ENGINE								
2.0 i 16V Cat	Petrol	110	02/90-11/95	C 20 XE								
Engine	Information				A10	A20	A40	A50	A70	C10 - C30	C20	E01
All engines	->eng. 14180385, version Bosch						806 251					
All engines	eng. type 14180386 ->, version Bosch						806 257					
All engines	version Bosch						906 121R					
All engines	ch. P1000001 ->, ch. P5000001 ->, ch. P7500001 ->											359 688
				ENGINE								
2.0 i 4x4	Petrol	85	01/89-10/90	20 NE								
Engine	Information				A10	A20	A40	A50	A70	C10 - C30	C20	E01
All engines	->ch. K1999999, ->ch. K5999999, ->ch. KV999999, version Bosch						806 240					
All engines	ch. L1000001 ->, ch. L5000001 ->, ch. LV100001 ->, version Bosch						806 257					
All engines	version Ducellier						815 084	915 103R				
All engines	version Bosch						906 127R					
All engines	->eng. 14180385, info WY								470 191	C10		
All engines	eng. type 14180386 ->, info WE								470 192	C10		
All engines	->eng. 14841581, eng. type 14672353 ->											359 689
				ENGINE								
2.0 i 4x4	Petrol	95	08/89-07/92	20 SEH								
Engine	Information				A10	A20	A40	A50	A70	C10 - C30	C20	E01
All engines	->ch. K1999999, ->ch. K5999999, ->ch. KV999999, version Bosch						806 240					
All engines	ch. L1000001 ->, ch. L5000001 ->, ch. LV100001 ->, version Bosch						806 257					
All engines	version Ducellier						815 084	915 103R				
All engines	version Bosch						906 127R					
All engines	->eng. 14180385, info WY								470 191	C10		
All engines	eng. type 14180386 ->, info WE								470 192	C10		
All engines	eng. type 14672353 ->											359 689
				ENGINE								
2.0 i Cat	Petrol	85	09/88-11/95	C 20 NE								
Engine	Information				A10	A20	A40	A50	A70	C10 - C30	C20	E01
All engines	->ch. K1999999, ->ch. K5999999, ->ch. KV999999, version Bosch						806 240					
All engines	ch. L1000001 ->, ch. L5000001 ->, ch. LV100001 ->, version Bosch						806 257					
All engines	version Ducellier						815 084	915 103R				
All engines	version Bosch						906 127R					
All engines	->eng. 14180385, info WY								470 191	C10		
All engines	eng. type 14180386 ->, info WE								470 192	C10		
All engines	->eng. 14841581, eng. type 14672353 ->											359 689
				ENGINE								
2.0 i Cat 4x4	Petrol	85	01/89-11/95	C 20 NE								
Engine	Information				A10	A20	A40	A50	A70	C10 - C30	C20	E01
All engines	->ch. K1999999, ->ch. K5999999, ->ch. KV999999, version Bosch						806 240					
All engines	ch. L1000001 ->, ch. L5000001 ->, ch. LV100001 ->, version Bosch						806 257					
All engines	version Ducellier						815 084	915 103R				
All engines	version Bosch						906 127R					

A10 CONDENSER	A20 CONTACT SET	A40 DISTRIBUTOR CAP	A50 ROTOR	A70 PICK-UP
C10 COIL	C20 IGNITION MODULE	C30 ELECTRONIC IGNITION KIT	E01 IGNITION CABLE SET	

Vehicle	alim.	kW	Date	Engine	FUNCTIONS ON THE VEHICLE							
					A10	A20	A40	A50	A70	C10 - C30	C20	E01

				ENGINE
2.0 i Cat 4x4	Petrol	85	01/89-11/95	C 20 NE

Engine	Information	A10	A20	A40	A50	A70	C10 - C30	C20	E01
All engines	->eng. 14180385, info WY						470 191	C10	
All engines	eng. type 14180386 ->, info WE						470 192	C10	
All engines	->eng. 14841581, eng. type 14672353 ->								359 689

				ENGINE
2.0 i GT	Petrol	95	09/88-11/95	20 SEH

Engine	Information	A10	A20	A40	A50	A70	C10 - C30	C20	E01
All engines	->ch. K1999999, ->ch. K5999999, ->ch. KV999999, version Bosch			806 240					
All engines	ch. L1000001 ->, ch. L5000001 ->, ch. LV100001 ->, version Bosch			806 257					
All engines	version Ducellier			815 084	915 103R				
All engines	version Bosch				906 127R				
All engines	->eng. 14180385, info WY						470 191	C10	
All engines	eng. type 14180386 ->, info WE						470 192	C10	
All engines	eng. type 14672353 ->								359 689

				ENGINE
2.0 i Turbo 4x4	Petrol	150	06/94-11/95	C 20 LET

Engine	Information	A10	A20	A40	A50	A70	C10 - C30	C20	E01
All engines	version Bosch			806 257	906 121R				

				ENGINE
2000 16V 4x4	Petrol	110	01/89-10/90	20 XEJ

Engine	Information	A10	A20	A40	A50	A70	C10 - C30	C20	E01
All engines	->eng. 14180385, version Bosch			806 251					
All engines	eng. type 14180386 ->, version Bosch			806 257					
All engines	version Bosch				906 121R				
All engines	ch. P1000001 ->, ch. P5000001 ->, ch. P7500001 ->								359 688

				ENGINE
2000/GT 16V	Petrol	110	01/89-06/94	20 XEJ

Engine	Information	A10	A20	A40	A50	A70	C10 - C30	C20	E01
All engines	->eng. 14180385, version Bosch			806 251					
All engines	eng. type 14180386 ->, version Bosch			806 257					
All engines	version Bosch				906 121R				
All engines	ch. P1000001 ->, ch. P5000001 ->, ch. P7500001 ->								359 688

				ENGINE
2000/GT 16V Cat	Petrol	110	02/90-11/95	C 20 XE

Engine	Information	A10	A20	A40	A50	A70	C10 - C30	C20	E01
All engines	->eng. 14180385, version Bosch			806 251					
All engines	eng. type 14180386 ->, version Bosch			806 257					
All engines	version Bosch				906 121R				
All engines	ch. P1000001 ->, ch. P5000001 ->, ch. P7500001 ->								359 688

				ENGINE
2000/GT 16V Cat 4x4	Petrol	110	02/90-11/95	C 20 XE

Engine	Information	A10	A20	A40	A50	A70	C10 - C30	C20	E01
All engines	->eng. 14180385, version Bosch			806 251					
All engines	eng. type 14180386 ->, version Bosch			806 257					
All engines	version Bosch				906 121R				
All engines	ch. P1000001 ->, ch. P5000001 ->, ch. P7500001 ->								359 688

VECTRA B

				ENGINE
1.6 i	Petrol	55	10/95-07/03	16 LZ2, X 16 SZR

Engine	Information	A10	A20	A40	A50	A70	C10 - C30	C20	E01
Eng. 16 LZ2	version Ducellier			815 084	915 103R				
Eng. 16 LZ2	x 1, SAGEM, DISTRIBUTOR, connector type, saw teeth						470 140	C10	
Eng. 16 LZ2								465 036	
Eng. X 16 SZR	->eng. 02HP7704								360 531
Eng. X 16 SZR	eng. type 02HP7705 ->								360 904

A10 CONDENSER	A20 CONTACT SET	A40 DISTRIBUTOR CAP	A50 ROTOR	A70 PICK-UP
C10 COIL	C20 IGNITION MODULE	C30 ELECTRONIC IGNITION KIT	E01 IGNITION CABLE SET	

The present application list is a brief version. For the detailed information about the possibility of installation on a specific vehicle, please refer to our web-catalogue <http://catalogo.facet.eu/>

Vehicle	alim.	kW	Date	Engine	FUNCTIONS ON THE VEHICLE							
					A10	A20	A40	A50	A70	C10 - C30	C20	E01

ENGINE				
1.6 i 16V	Petrol	74	10/95-07/02	X 16 XEL, Y 16 XE, Z 16 XE

Engine	Information	A10	A20	A40	A50	A70	C10 - C30	C20	E01
All engines	ch. W1285447 ->, x 4, ch. W5276826 ->, COIL ON PLUG, ch. W7154259 ->, incl. spark plug connector, ch. WL000002 ->, ch. WP000002 ->, ch. W5000002 ->, x 4, COIL ON PLUG, x 4, COIL ON PLUG, incl. spark plug connector, incl. spark plug connector						470 399	C10	
Eng. X 16 XEL	->ch. W1285449, ->ch. W5276825, ->ch. W7154258								359 688

ENGINE				
1.8 FlexFuel	Petrol/ Liquified Petro- leum Gas (LPG)	85	01/99-09/00	X 18 XE

Engine	Information	A10	A20	A40	A50	A70	C10 - C30	C20	E01
All engines	x 1, D.I.S.						470 272	C10	

ENGINE				
1.8 i 16V	Petrol	85	10/95-09/00	X 18 XE, X 18 XE1, Z 18 XEL

Engine	Information	A10	A20	A40	A50	A70	C10 - C30	C20	E01
Eng. X 18 XE	x 1, D.I.S.						470 272	C10	
Eng. X 18 XE1, Z 18 XEL	x 1, COIL ON PLUG, incl. spark plug connector						470 508	C10	
Eng. X 18 XE	no specific info conc. application available								360 506, 360 562

ENGINE				
1.8 i 16V	Petrol	92	09/00-07/03	Z 18 XE

Engine	Information	A10	A20	A40	A50	A70	C10 - C30	C20	E01
All engines	x 1, COIL ON PLUG, incl. spark plug connector						470 508	C10	

ENGINE				
2.0 i	Petrol	82	10/95-04/02	20 NEJ

Engine	Information	A10	A20	A40	A50	A70	C10 - C30	C20	E01
All engines	x 1, BOSCH, D.I.S., connector type, saw teeth						470 273	C10	

ENGINE				
2.0 i 16V	Petrol	100	09/95-06/00	C 20 SEL, X 20 XEV

Engine	Information	A10	A20	A40	A50	A70	C10 - C30	C20	E01
All engines	x 1, D.I.S.						470 272	C10	
All engines	no specific info conc. application available								360 506, 360 562

ENGINE				
2.0 i 16V	Petrol	85	07/00-07/03	C 20 SEL

Engine	Information	A10	A20	A40	A50	A70	C10 - C30	C20	E01
All engines	x 1, D.I.S.						470 272	C10	

ENGINE				
2.2 i 16V	Petrol	102	07/00-07/02	C 22 SEL

Engine	Information	A10	A20	A40	A50	A70	C10 - C30	C20	E01
All engines	x 1, D.I.S.						470 272	C10	

VECTRA C

ENGINE				
1.6	Petrol	74	08/05-08/08	Z 16 XE

Engine	Information	A10	A20	A40	A50	A70	C10 - C30	C20	E01
All engines	x 1, COIL ON PLUG, incl. spark plug connector						470 399	C10	

ENGINE				
1.6	Petrol	77	08/05-08/08	Z 16 XEP

Engine	Information	A10	A20	A40	A50	A70	C10 - C30	C20	E01
All engines	x 1, DELPHI, COIL ON PLUG, incl. spark plug connector						470 450	C10	

ENGINE				
1.6 i 16V	Petrol	74	06/04-10/05	Z 16 XE

Engine	Information	A10	A20	A40	A50	A70	C10 - C30	C20	E01
All engines	x 1, COIL ON PLUG, incl. spark plug connector						470 399	C10	

ENGINE				
1.8	Petrol	103	08/05-08/08	Z 18 XER









Engine	Information	A10	A20	A40	A50	A70	C10 - C30	C20	E01
All engines	x 1, DELPHI, COIL ON PLUG, incl. spark plug connector						470 450	C10	

A10 CONDENSER	A20 CONTACT SET	A40 DISTRIBUTOR CAP	A50 ROTOR	A70 PICK-UP
C10 COIL	C20 IGNITION MODULE	C30 ELECTRONIC IGNITION KIT	E01 IGNITION CABLE SET	

Vehicle	alim.	kW	Date	Engine	FUNCTIONS ON THE VEHICLE									
					A10	A20	A40	A50	A70	C10 - C30	C20	E01		
ENGINE														
1.8	Petrol	81	04/02-07/08	Z 18 XEL										
ENGINE														
Engine	Information				A10	A20	A40	A50	A70	C10 - C30	C20	E01		
All engines	x 1, COIL ON PLUG, incl. spark plug connector									470 508	C10			
1.8	Petrol	90	10/03-09/06	Z 18 XE										
ENGINE														
Engine	Information				A10	A20	A40	A50	A70	C10 - C30	C20	E01		
All engines	x 1, COIL ON PLUG, incl. spark plug connector									470 508	C10			
1.8 16V	Petrol	81	08/02-12/06	Z 18 XEL										
ENGINE														
Engine	Information				A10	A20	A40	A50	A70	C10 - C30	C20	E01		
All engines	x 1, COIL ON PLUG, incl. spark plug connector									470 508	C10			
1.8 16V	Petrol	90	04/02-09/08	Z 18 XE										
ENGINE														
Engine	Information				A10	A20	A40	A50	A70	C10 - C30	C20	E01		
All engines	x 1, COIL ON PLUG, incl. spark plug connector									470 508	C10			
VIVARO A														
2.0 16V	Petrol	88	08/01-07/06	F4R 720										
ENGINE														
Engine	Information				A10	A20	A40	A50	A70	C10 - C30	C20	E01		
All engines	x 4, COIL ON PLUG									470 432	C10			
2.0 ECOTEC	Petrol	86	08/06-07/14	F4R 820										
ENGINE														
Engine	Information				A10	A20	A40	A50	A70	C10 - C30	C20	E01		
All engines	x 4, COIL ON PLUG									470 432	C10			
ZAFIRA A														
1.6	Petrol	76	10/03-06/05	Z 16 XEP										
ENGINE														
Engine	Information				A10	A20	A40	A50	A70	C10 - C30	C20	E01		
All engines	x 1, DELPHI, COIL ON PLUG, incl. spark plug connector									470 450	C10			
1.6 16V	Bi-Fuel	70	09/02-06/05	Z 16 YNG										
ENGINE														
Engine	Information				A10	A20	A40	A50	A70	C10 - C30	C20	E01		
All engines										470 399	C10			
1.6 16V	Petrol	74	04/99-06/05	X 16 XEL, Z 16 XE										
ENGINE														
Engine	Information				A10	A20	A40	A50	A70	C10 - C30	C20	E01		
All engines	x 4, COIL ON PLUG, incl. spark plug connector									470 399	C10			
1.6 16V	Petrol	76	10/03-06/05	Z 16 XEP										
ENGINE														
Engine	Information				A10	A20	A40	A50	A70	C10 - C30	C20	E01		
All engines										470 450	C10			
1.6 CNG	Petrol/ Com- pressed Natural Gas (CNG)	71	09/01-06/05	Z 16 YNG										
ENGINE														
Engine	Information				A10	A20	A40	A50	A70	C10 - C30	C20	E01		
All engines	x 4, COIL ON PLUG, incl. spark plug connector									470 399	C10			
1.6 LPG	Petrol/ Liquified Petro- leum Gas (LPG)	74	04/99-06/05	X 16 XEL, Z 16 XE										
ENGINE														
Engine	Information				A10	A20	A40	A50	A70	C10 - C30	C20	E01		
All engines	x 4, COIL ON PLUG, incl. spark plug connector									470 399	C10			

A10 CONDENSER	A20 CONTACT SET	A40 DISTRIBUTOR CAP	A50 ROTOR	A70 PICK-UP
C10 COIL	C20 IGNITION MODULE	C30 ELECTRONIC IGNITION KIT	E01 IGNITION CABLE SET	

The present application list is a brief version. For the detailed information about the possibility of installation on a specific vehicle, please refer to our web-catalogue <http://catalogo.facet.eu/>









					FUNCTIONS ON THE VEHICLE							
Vehicle	alim.	kW	Date	Engine								
ENGINE												
1.6 LPG	Petrol/ Liquified Petro- leum Gas (LPG)	76	10/03-06/05	Z 16 XE								
Engine	Information				A10	A20	A40	A50	A70	C10 - C30	C20	E01
All engines	x 1, COIL ON PLUG, incl. spark plug connector									470 399	C10	
ENGINE												
1.8	Petrol	81	02/03-06/05	Z 18 XEL								
Engine	Information				A10	A20	A40	A50	A70	C10 - C30	C20	E01
All engines										470 508	C10	
ENGINE												
1.8 16V	Petrol	85	04/99-09/00	X 18 XE1								
Engine	Information				A10	A20	A40	A50	A70	C10 - C30	C20	E01
All engines	x 1, COIL ON PLUG, incl. spark plug connector									470 508	C10	
ENGINE												
1.8 16V	Petrol	92	09/00-06/05	Z 18 XE								
Engine	Information				A10	A20	A40	A50	A70	C10 - C30	C20	E01
All engines	x 1, COIL ON PLUG, incl. spark plug connector									470 508	C10	
ENGINE												
2.0 OPC	Petrol	141	09/01-06/05	Z 20 LET								
Engine	Information				A10	A20	A40	A50	A70	C10 - C30	C20	E01
All engines	x 1, COIL ON PLUG									470 507	C10	
ENGINE												
2.0 OPC	Petrol	147	11/02-06/05	Z 20 LET								
Engine	Information				A10	A20	A40	A50	A70	C10 - C30	C20	E01
All engines	x 1, COIL ON PLUG									470 507	C10	
ZAFIRA B												
ENGINE												
1.6	Petrol	77	07/05-09/12	Z 16 XE1, Z 16 XEP								
Engine	Information				A10	A20	A40	A50	A70	C10 - C30	C20	E01
All engines	x 1, DELPHI, COIL ON PLUG, incl. spark plug connector									470 450	C10	
ENGINE												
1.6	Petrol	85	01/08-04/15	A 16 XER, Z 16 XER								
Engine	Information				A10	A20	A40	A50	A70	C10 - C30	C20	E01
All engines	x 1, DELPHI, COIL ON PLUG, incl. spark plug connector									470 450	C10	
ENGINE												
1.6 CNG	Petrol/ Com- pressed Natural Gas (CNG)	69	07/05-04/15	Z 16 YNG								
Engine	Information				A10	A20	A40	A50	A70	C10 - C30	C20	E01
All engines	x 4, COIL ON PLUG, incl. spark plug connector									470 399	C10	
ENGINE												
1.6 CNG Turbo	Petrol/ Com- pressed Natural Gas (CNG)	110	04/10-04/15	A 16 XNT, Z16XNT								
Engine	Information				A10	A20	A40	A50	A70	C10 - C30	C20	E01
All engines	x 1, DELPHI, COIL ON PLUG, incl. spark plug connector									470 450	C10	
ENGINE												
1.6 CNG Turbo VAN	Petrol/ Com- pressed Natural Gas (CNG)	110	02/09-04/15	A 16 XNT, Z16XNT								
Engine	Information				A10	A20	A40	A50	A70	C10 - C30	C20	E01
All engines	x 1, DELPHI, COIL ON PLUG, incl. spark plug connector									470 450	C10	

A10 CONDENSER	A20 CONTACT SET	A40 DISTRIBUTOR CAP	A50 ROTOR	A70 PICK-UP
C10 COIL	C20 IGNITION MODULE	C30 ELECTRONIC IGNITION KIT	E01 IGNITION CABLE SET	

Vehicle	alim.	kW	Date	Engine	FUNCTIONS ON THE VEHICLE									
					A10	A20	A40	A50	A70	C10 - C30	C20	E01		
ENGINE														
1.6 CNG VAN	Petrol/ Compressed Natural Gas (CNG)	69	07/05-04/15	Z 16 YNG										
Engine	Information				A10	A20	A40	A50	A70	C10 - C30	C20	E01		
All engines	x 4, COIL ON PLUG, incl. spark plug connector									470 399	C10			
ENGINE														
1.6 FlexFuel	Petrol/ Ethanol	85	08/08-12/12	Z 16 XER										
Engine	Information				A10	A20	A40	A50	A70	C10 - C30	C20	E01		
All engines	x 1, DELPHI, COIL ON PLUG, incl. spark plug connector									470 450	C10			
ENGINE														
1.8	Petrol	103	07/05-04/15	A 18 XER, Z 18 XER										
Engine	Information				A10	A20	A40	A50	A70	C10 - C30	C20	E01		
All engines	x 1, DELPHI, COIL ON PLUG, incl. spark plug connector									470 450	C10			
ENGINE														
1.8	Petrol	88	06/13-04/15	A 18 XEL										
Engine	Information				A10	A20	A40	A50	A70	C10 - C30	C20	E01		
All engines	x 1, COIL ON PLUG									470 545	C10			
ENGINE														
1.8 LPG	Petrol/ Liquified Petro- leum Gas (LPG)	103	07/09-04/15	Z 18 XER										
Engine	Information				A10	A20	A40	A50	A70	C10 - C30	C20	E01		
All engines	x 1, DELPHI, COIL ON PLUG, incl. spark plug connector									470 450	C10			
ENGINE														
1.8 VAN	Petrol	103	07/05-04/15	A 18 XER, Z 18 XER										
Engine	Information				A10	A20	A40	A50	A70	C10 - C30	C20	E01		
All engines	x 1, DELPHI, COIL ON PLUG, incl. spark plug connector									470 450	C10			
ENGINE														
2.0	Petrol	147	07/05-12/10	Z 20 LER										
Engine	Information				A10	A20	A40	A50	A70	C10 - C30	C20	E01		
All engines	x 1, COIL ON PLUG									470 507	C10			
ENGINE														
2.0	Petrol	177	01/06-12/10	Z 20 LEH										
Engine	Information				A10	A20	A40	A50	A70	C10 - C30	C20	E01		
All engines	x 1, COIL ON PLUG									470 507	C10			
ENGINE														
2.0 VAN	Petrol	147	07/05-12/10	Z 20 LER										
Engine	Information				A10	A20	A40	A50	A70	C10 - C30	C20	E01		
All engines	x 1, COIL ON PLUG									470 507	C10			
ZAFIRA TOURER														
ENGINE														
1.4	Petrol	103	10/11->	A 14 NET, B 14 NET										
Engine	Information				A10	A20	A40	A50	A70	C10 - C30	C20	E01		
All engines	x 1, COIL ON RAIL									470 547	C10			
ENGINE														
1.4	Petrol	88	10/11->	A 14 NEL, B 14 NEL										
Engine	Information				A10	A20	A40	A50	A70	C10 - C30	C20	E01		
All engines	x 1, COIL ON RAIL									470 547	C10			
ENGINE														
1.4 LPG	Petrol/ Liquified Petro- leum Gas (LPG)	103	10/11->	A 14 NET, B 14 NET										
Engine	Information				A10	A20	A40	A50	A70	C10 - C30	C20	E01		
All engines	x 1, COIL ON RAIL									470 547	C10			

A10	CONDENSER	A20	CONTACT SET	A40	DISTRIBUTOR CAP	A50	ROTOR	A70	PICK-UP
C10	COIL	C20	IGNITION MODULE	C30	ELECTRONIC IGNITION KIT	E01	IGNITION CABLE SET		

The present application list is a brief version. For the detailed information about the possibility of installation on a specific vehicle, please refer to our web-catalogue <http://catalogo.facet.eu/>





					FUNCTIONS ON THE VEHICLE							
Vehicle	alim.	kW	Date	Engine								
					ENGINE							
1.6 CNG	Petrol/ Compressed Natural Gas (CNG)	110	10/11->	A 16 XNT, B 16 XNT								
Engine					A10	A20	A40	A50	A70	C10 - C30	C20	E01
All engines										470 450	C10	
					ENGINE							
1.8	Petrol	103	10/11->	A 18 XER								
Engine					A10	A20	A40	A50	A70	C10 - C30	C20	E01
All engines										470 545	C10	
					ENGINE							
1.8	Petrol	85	10/11->	A 18 XEL								
Engine					A10	A20	A40	A50	A70	C10 - C30	C20	E01
All engines										470 545	C10	
					ENGINE							
1.8	Petrol	88	10/11->	A 18 XEL								
Engine					A10	A20	A40	A50	A70	C10 - C30	C20	E01
All engines										470 545	C10	
					ENGINE							
1.8 LPG	Petrol/ Liquified Petro- leum Gas (LPG)	101	10/11->	A 18 XER								
Engine					A10	A20	A40	A50	A70	C10 - C30	C20	E01
All engines										470 545	C10	

A10 CONDENSER	A20 CONTACT SET	A40 DISTRIBUTOR CAP	A50 ROTOR	A70 PICK-UP
C10 COIL	C20 IGNITION MODULE	C30 ELECTRONIC IGNITION KIT	E01 IGNITION CABLE SET	

Vehicle	alim.	kW	Date	Engine	FUNCTIONS ON THE VEHICLE									
					A10	A20	A40	A50	A70	C10 - C30	C20	E01		
1007														
1.4	Petrol	54	04/05->	ENGINE KFV (TU3A), KFV (TU3JP)										
Engine	Information				A10	A20	A40	A50	A70	C10 - C30	C20	E01		
All engines										470 405	C10			
1.4 16V														
1.4 16V	Petrol	65	10/05->	ENGINE KFU (ET3J4)										
Engine	Information				A10	A20	A40	A50	A70	C10 - C30	C20	E01		
All engines	x 1, COIL ON PLUG									470 483	C10			
1.6 16V														
1.6 16V	Petrol	80	04/05->	ENGINE NFU (TU5JP4)										
Engine	Information				A10	A20	A40	A50	A70	C10 - C30	C20	E01		
All engines	x 1, COIL ON PLUG									470 407	C10			
104														
0.9	Petrol	33	09/73-10/83	ENGINE 108 (XV3), 108 (XV5)										
Engine	Information				A10	A20	A40	A50	A70	C10 - C30	C20	E01		
Eng. 108 (XV5)	version Ducellier				615 034	715 103	815 058	915 088						
All engines						715 076								
0.9														
0.9	Petrol	34	10/72-10/79	ENGINE 108 (XV3)										
Engine	Information				A10	A20	A40	A50	A70	C10 - C30	C20	E01		
All engines						715 076								
1.0														
1.0	Petrol	32	09/83-06/88	ENGINE 108C (XV8)										
Engine	Information				A10	A20	A40	A50	A70	C10 - C30	C20	E01		
All engines	version Bosch						806 124	906 056R						
All engines											465 005			
1.1														
1.1	Petrol	42	07/76-06/83	ENGINE 109 (XW3)										
Engine	Information				A10	A20	A40	A50	A70	C10 - C30	C20	E01		
All engines						715 076								
106 I														
1.0	Petrol	33	09/91-03/01	ENGINE CDY (TU9M), TU9										
Engine	Information				A10	A20	A40	A50	A70	C10 - C30	C20	E01		
Eng. TU9	version Bosch						806 241	906 056R						
Eng. TU9	version Ducellier						815 074	915 102R	415 019					
Eng. TU9	version Marelli							930 060						
Eng. TU9										470 155	C10		359 780	
All engines	x 1, D.I.S., connector type, saw teeth									470 188	C10			
Eng. CDY (TU9M)										470 189	C10		360 374	
1.0														
1.0	Petrol	37	09/91-04/96	ENGINE CDZ (TU9M)										
Engine	Information				A10	A20	A40	A50	A70	C10 - C30	C20	E01		
All engines										470 189	C10		360 374	
1.1														
1.1	Petrol	44	08/91-04/96	ENGINE H1B (TU1), HDZ (TU1M)										
Engine	Information				A10	A20	A40	A50	A70	C10 - C30	C20	E01		
All engines	version Bosch, ->year 01/07/92						806 241							
All engines	version Ducellier, ->year 01/07/92						815 074	915 102R	415 019					
Eng. HDZ (TU1M)	version Bosch, ->year 01/07/92							906 026R						
Eng. H1B (TU1)	version Bosch							906 056R						
Eng. H1B (TU1)	version Marelli							930 060						
All engines	->year 01/07/92									470 155	C10		359 780	
Eng. HDZ (TU1M)	01/07/92 ->									470 189	C10		360 374	
1.3														
1.3	Petrol	72	10/93-04/96	ENGINE TU2J2										
Engine	Information				A10	A20	A40	A50	A70	C10 - C30	C20	E01		
All engines										470 189	C10		360 374	

A10 CONDENSER	A20 CONTACT SET	A40 DISTRIBUTOR CAP	A50 ROTOR	A70 PICK-UP
C10 COIL	C20 IGNITION MODULE	C30 ELECTRONIC IGNITION KIT	E01 IGNITION CABLE SET	

The present application list is a brief version. For the detailed information about the possibility of installation on a specific vehicle, please refer to our web-catalogue <http://catalogo.facet.eu/>

				FUNCTIONS ON THE VEHICLE								
Vehicle	alim.	kW	Date	Engine								
				ENGINE								
1.4	Petrol	51	08/91-03/96	K5A (TU3)								
				ENGINE								
Engine	Information			A10	A20	A40	A50	A70	C10 - C30	C20	E01	
All engines	version Bosch					806 241	906 026R					
All engines	version Ducellier					815 074	915 102R	415 019				
All engines									470 155	C10		359 780
				ENGINE								
1.4	Petrol	55	09/91-04/96	KDX (TU3MC), KDY (TU3M)								
				ENGINE								
Engine	Information			A10	A20	A40	A50	A70	C10 - C30	C20	E01	
Eng. KDY (TU3M)	version Bosch					806 241	906 056R					
Eng. KDY (TU3M)	version Ducellier					815 074	915 102R	415 019				
Eng. KDY (TU3M)									470 155	C10		359 780
Eng. KDX (TU3MC)									470 189	C10		360 374
				ENGINE								
1.4 i	Petrol	55	01/92-12/96	TU3FMC								
				ENGINE								
Engine	Information			A10	A20	A40	A50	A70	C10 - C30	C20	E01	
All engines									470 189	C10		360 025
				ENGINE								
1.4 i	Petrol	69	01/91-12/96	TU3FJ								
				ENGINE								
Engine	Information			A10	A20	A40	A50	A70	C10 - C30	C20	E01	
All engines									470 189	C10		360 025
				ENGINE								
1.4 i XSI	Petrol	72	09/91-03/96	TU3J								
				ENGINE								
Engine	Information			A10	A20	A40	A50	A70	C10 - C30	C20	E01	
All engines									470 189	C10		360 374
				ENGINE								
1.4 Le Mans	Petrol	69	09/91-11/94	KFZ (TU3J2/Z)								
				ENGINE								
Engine	Information			A10	A20	A40	A50	A70	C10 - C30	C20	E01	
All engines									470 189	C10		360 374
				ENGINE								
1.6	Petrol	65	06/93-04/96	NFZ (TU5JP)								
				ENGINE								
Engine	Information			A10	A20	A40	A50	A70	C10 - C30	C20	E01	
All engines									470 189	C10		360 374
				ENGINE								
1.6	Petrol	76	11/94-04/96	NFY (TU5J2)								
				ENGINE								
Engine	Information			A10	A20	A40	A50	A70	C10 - C30	C20	E01	
All engines									470 189	C10		360 374
				ENGINE								
106 II				ENGINE								
1.0 i	Petrol	33	05/96-10/99	CDY (TU9M)								
				ENGINE								
Engine	Information			A10	A20	A40	A50	A70	C10 - C30	C20	E01	
All engines	x 1, D.I.S., connector type, saw teeth								470 188	C10		
All engines												360 374
				ENGINE								
1.0 i	Petrol	37	04/96-03/01	CDZ (TU9M)								
				ENGINE								
Engine	Information			A10	A20	A40	A50	A70	C10 - C30	C20	E01	
All engines	x 1, D.I.S., connector type, saw teeth								470 188	C10		
All engines												360 374
				ENGINE								
1.1	Petrol	40	04/96->	H1B (TU1)								
				ENGINE								
Engine	Information			A10	A20	A40	A50	A70	C10 - C30	C20	E01	
All engines	version Ducellier					815 074	915 102R	415 019				
All engines									470 155	C10		359 780
				ENGINE								
1.1 BiFuel	Petrol/ Liquified Petro- leum Gas (LPG)	44	04/96-03/01	HDZ (TU1M+)								
				ENGINE								
Engine	Information			A10	A20	A40	A50	A70	C10 - C30	C20	E01	
All engines	x 1, D.I.S., connector type, saw teeth								470 188	C10		









A10 CONDENSER	A20 CONTACT SET	A40 DISTRIBUTOR CAP	A50 ROTOR	A70 PICK-UP
C10 COIL	C20 IGNITION MODULE	C30 ELECTRONIC IGNITION KIT	E01 IGNITION CABLE SET	

Vehicle	alim.	kW	Date	Engine	FUNCTIONS ON THE VEHICLE									
					A10	A20	A40	A50	A70	C10 - C30	C20	E01		
ENGINE														
1.1 i	Petrol	40	01/97-03/01	HDY (TU1M), HDY (TU1M+)										
Engine	Information				A10	A20	A40	A50	A70	C10 - C30	C20	E01		
Eng. HDY (TU1M+)	x 1, D.I.S., connector type, saw teeth									470 188	C10			
Eng. HDY (TU1M)													360 374	
ENGINE														
1.1 i	Petrol	44	05/96-07/04	HDZ (TU1M), HFX (TU1JP)										
Engine	Information				A10	A20	A40	A50	A70	C10 - C30	C20	E01		
Eng. HDZ (TU1M)										470 188	C10		360 374	
Eng. HFX (TU1JP)										470 405	C10			
ENGINE														
1.4 i	Petrol	55	05/96-07/04	KFW (TU3JP), KFX (TU3JP)										
Engine	Information				A10	A20	A40	A50	A70	C10 - C30	C20	E01		
All engines	x 1, D.I.S., connector type, saw teeth									470 188	C10			
All engines	euro 2, x 4, Electricfil, COIL ON PLUG									470 403	C10			
All engines	euro 3, x 1, COIL ON PLUG									470 405	C10			
All engines	->year 04/01/98, man., aut.												360 374	
ENGINE														
1.6 i	Petrol	65	05/96-10/99	NFZ (TU5JP)										
Engine	Information				A10	A20	A40	A50	A70	C10 - C30	C20	E01		
All engines	x 1, D.I.S., connector type, saw teeth									470 188	C10			
All engines													360 374	
ENGINE														
1.6 i	Petrol	74	05/96-01/01	NFW (TU5J2), NFY (TU5J2)										
Engine	Information				A10	A20	A40	A50	A70	C10 - C30	C20	E01		
All engines	x 1, D.I.S.									470 189	C10			
All engines													360 374	
107														
ENGINE														
1.0	Petrol	50	06/05-05/14	1KR (384 F), CFA (384F), CFB (1KR)										
Engine	Information				A10	A20	A40	A50	A70	C10 - C30	C20	E01		
Eng. 1KR (384 F)	Qty: 3									470 461	C10			
Eng. CFA (384F), CFB (1KR)	x 3, COIL ON PLUG									470 461	C10			
108														
ENGINE														
1.0 VTi	Petrol	51	05/14->	1KR-FE, CFB (1KR)										
Engine	Information				A10	A20	A40	A50	A70	C10 - C30	C20	E01		
Eng. 1KR-FE	Qty: 3									470 459	C10			
Eng. CFB (1KR)	euro5/euro6, x 3, COIL ON PLUG									470 459	C10			
ENGINE														
1.0 VTi 72	Petrol	53	05/18->	CFB (1KR)										
Engine	Information				A10	A20	A40	A50	A70	C10 - C30	C20	E01		
All engines	euro5/euro6, x 3, COIL ON PLUG									470 459	C10			
ENGINE														
1.2	Petrol	60	05/14->	HMT (EB2D), HMZ (EB2), HMZ (EB2F)										
Engine	Information				A10	A20	A40	A50	A70	C10 - C30	C20	E01		
All engines	x 3, COIL ON PLUG									470 609	C10			
ENGINE														
1.2 VTi	Petrol	60	05/14->	HMZ (EB2)										
Engine	Information				A10	A20	A40	A50	A70	C10 - C30	C20	E01		
All engines	Qty: 3									470 609	C10			
ENGINE														
108 1.2	Petrol	60	05/14->	HMZ (EB2F)										
Engine	Information				A10	A20	A40	A50	A70	C10 - C30	C20	E01		
All engines	Qty: 3									470 609	C10			

A10 CONDENSER	A20 CONTACT SET	A40 DISTRIBUTOR CAP	A50 ROTOR	A70 PICK-UP
C10 COIL	C20 IGNITION MODULE	C30 ELECTRONIC IGNITION KIT	E01 IGNITION CABLE SET	

The present application list is a brief version. For the detailed information about the possibility of installation on a specific vehicle, please refer to our web-catalogue <http://catalogo.facet.eu/>

					FUNCTIONS ON THE VEHICLE									
Vehicle	alim.	kW	Date	Engine	A10	A20	A40	A50	A70	C10 - C30	C20	E01		
2008 I														
1.2 PureTech 82	Petrol	61	01/18-12/19	ENGINE HMR (EB2FA)										
Engine	Information				A10	A20	A40	A50	A70	C10 - C30	C20	E01		
All engines	x 3, COIL ON PLUG									470 609	C10			
1.2 THP 130 / PureTech 130	Petrol	96	01/15->	ENGINE HNS (EB2ADTS), HNY (EB2DTS)										
Engine	Information				A10	A20	A40	A50	A70	C10 - C30	C20	E01		
All engines	x 3, COIL ON PLUG									470 620	C10			
1.2 VTi	Petrol	60	03/13->	ENGINE HMZ (EB2), HMZ (EB2F)										
Engine	Information				A10	A20	A40	A50	A70	C10 - C30	C20	E01		
All engines	x 3, COIL ON PLUG									470 609	C10			
Eng. HMZ (EB2)	Qty: 3									470 609	C10			
1.6 VTi	Petrol	85	05/13->	ENGINE 5FS (EP6C)										
Engine	Information				A10	A20	A40	A50	A70	C10 - C30	C20	E01		
All engines	x 4, COIL ON PLUG									470 475	C10			
1.6 VTi	Petrol	88	03/13->	ENGINE 5FS (EP6C)										
Engine	Information				A10	A20	A40	A50	A70	C10 - C30	C20	E01		
All engines	x 4, COIL ON PLUG									470 475	C10			
PureTech 130	Petrol	96	01/18->	ENGINE HNS (EB2ADTS), HNY (EB2DTS)										
Engine	Information				A10	A20	A40	A50	A70	C10 - C30	C20	E01		
All engines	x 3, COIL ON PLUG									470 620	C10			
204														
1.1	Petrol	39	10/65-07/69	ENGINE XK										
Engine	Information				A10	A20	A40	A50	A70	C10 - C30	C20	E01		
All engines						715 111U		906 014R						
1.1	Petrol	40	05/69-07/77	ENGINE XK4										
Engine	Information				A10	A20	A40	A50	A70	C10 - C30	C20	E01		
All engines						715 111U		906 014R						
1.1	Petrol	43	09/75-07/77	ENGINE XK5										
Engine	Information				A10	A20	A40	A50	A70	C10 - C30	C20	E01		
All engines						715 111U		906 014R						
1.1 Grand Luxe	Petrol	40	05/69-10/77	ENGINE XK4										
Engine	Information				A10	A20	A40	A50	A70	C10 - C30	C20	E01		
All engines						715 111U		906 014R						
205 I														
1.0	Petrol	33	02/83-12/90	ENGINE 108C (XV8)										
Engine	Information				A10	A20	A40	A50	A70	C10 - C30	C20	E01		
All engines	version Bosch						806 124	906 056R						
All engines	version Ducellier, distr. num. 2525569 A						815 058							
All engines	version Ducellier, distr. num. 2525569 B						815 067							
All engines	version Ducellier							915 094						
All engines											465 005			
1.1	Petrol	36	02/83-10/87	ENGINE 109N (XW7)										
Engine	Information				A10	A20	A40	A50	A70	C10 - C30	C20	E01		
All engines	version Ducellier, distr. num. 525 483 A, distr. num. 525 512 A, distr. num. 525 512 B, distr. num. 525 480 A, 2 525 574 A						815 058							
All engines	version Ducellier, distr. num. 525 512 C, 2 525 574 B						815 067							
All engines	version Ducellier							915 094						
All engines											465 005	359 846		
A10	CONDENSER		A20	CONTACT SET		A40	DISTRIBUTOR CAP		A50	ROTOR		A70	PICK-UP	
C10	COIL		C20	IGNITION MODULE		C30	ELECTRONIC IGNITION KIT		E01	IGNITION CABLE SET				

				FUNCTIONS ON THE VEHICLE								
Vehicle	alim.	kW	Date	Engine	 A10	 A20	 A40	 A50	 A70	 C10 - C30	 C20	 E01
				ENGINE								
1.1	Petrol	37	02/83-10/87	109F (XW7)								
	Engine	Information			A10	A20	A40	A50	A70	C10 - C30	C20	E01
	All engines	version Ducellier, distr. num. 525 483 A, distr. num. 525 512 A, distr. num. 525 512 B, distr. num. 525 480 A, 2 525 574 A					815 058					
	All engines	version Ducellier, distr. num. 525 512 C, 2 525 574 B					815 067					
	All engines	version Ducellier						915 094				
	All engines										465 005	359 846
				ENGINE								
1.3	Petrol	47	02/84-10/87	G1A								
	Engine	Information			A10	A20	A40	A50	A70	C10 - C30	C20	E01
	All engines	version Bosch					806 124	906 061R				
	All engines	version Ducellier					815 058	915 094				
	All engines	01/01/89 ->								470 106	C10	
	All engines										465 005	
				ENGINE								
1.4	Petrol	44	02/83-10/87	150D (XY7), 150G (XY7)								
	Engine	Information			A10	A20	A40	A50	A70	C10 - C30	C20	E01
	Eng. 150G (XY7)	version Bosch					806 124	906 056R				
	All engines	version Ducellier, distr. num. 525 520 A/B, distr. num. 525 490 A, 525 475 A					815 058					
	All engines	distr. num. 2 525 20 C, version Ducellier, distr. num. 525 490 B/C					815 067					
	All engines	version Ducellier						915 094				
	All engines										465 005	359 846
				ENGINE								
1.4	Petrol	53	02/83-10/87	150 (XY6B)								
	Engine	Information			A10	A20	A40	A50	A70	C10 - C30	C20	E01
	All engines	version Ducellier, distr. num. 525 520 A/B					815 058					
	All engines	distr. num. 2 525 20 C, version Ducellier					815 067					
	All engines	version Ducellier						915 094				
	All engines										465 005	359 846
				ENGINE								
1.4	Petrol	58	10/85-10/87	150H (XY8)								
	Engine	Information			A10	A20	A40	A50	A70	C10 - C30	C20	E01
	All engines	version Bosch					806 124	906 056R				
	All engines	version Ducellier					815 058	915 094				
	All engines										465 005	359 846
				ENGINE								
1.4	Petrol	59	02/83-10/87	150B (XY8)								
	Engine	Information			A10	A20	A40	A50	A70	C10 - C30	C20	E01
	All engines	version Bosch					806 124	906 056R				
	All engines	version Ducellier					815 058	915 094				
	All engines										465 005	359 846
				ENGINE								
1.5	Petrol	63	02/84-10/87	Y2/K								
	Engine	Information			A10	A20	A40	A50	A70	C10 - C30	C20	E01
	All engines	version Bosch					806 124	906 025R				
	All engines	version Ducellier					815 058	915 094				
	All engines	01/01/89 ->								470 106	C10	
	All engines										465 005	
				ENGINE								
1.6	Petrol	53	03/87-10/87	B1E (XU51C)								
	Engine	Information			A10	A20	A40	A50	A70	C10 - C30	C20	E01
	All engines	version Bosch					806 124	906 056R				
	All engines	version Ducellier, distr. num. 2 525 626 A					815 058					
	All engines	version Ducellier, distr. num. 2 525 626 B/C					815 067					
	All engines	version Ducellier, distr. num. 2 525 663 A					815 074	915 102R	415 019			
	All engines	version Ducellier, distr. num. 2 525 626 A/B/C						915 094				
	All engines	version Ducellier, distr. num. 2 525 640 B/C							415 017			
	All engines										465 005	
	All engines	ch. 7330001 ->, ->year 01/01/90										359 747
	All engines	01/01/90 ->										359 748

A10	CONDENSER	A20	CONTACT SET	A40	DISTRIBUTOR CAP	A50	ROTOR	A70	PICK-UP
C10	COIL	C20	IGNITION MODULE	C30	ELECTRONIC IGNITION KIT	E01	IGNITION CABLE SET		

The present application list is a brief version. For the detailed information about the possibility of installation on a specific vehicle, please refer to our web-catalogue <http://catalogo.facet.eu/>

Vehicle	alim.	kW	Date	Engine	FUNCTIONS ON THE VEHICLE							
					A10	A20	A40	A50	A70	C10 - C30	C20	E01

ENGINE				
1.6	Petrol	55	08/86-10/87	B1A (XU51C), BAZ (XU5CP)

Engine	Information	A10	A20	A40	A50	A70	C10 - C30	C20	E01
All engines	version Bosch			806 124	906 056R				
All engines	version Ducellier, distr. num. 2 525 626 A			815 058					
All engines	version Ducellier, distr. num. 2 525 626 B/C, distr. num. 2 525 683 A/B			815 067					
Eng. B1A (XU51C)	version Ducellier, distr. num. 2 525 663 A			815 074	915 102R	415 019			
All engines	version Ducellier, distr. num. 2 525 626 A/B/C				915 094				
All engines	version Ducellier, distr. num. 2 525 640 B/C, distr. num. 2 525 626 B/C, distr. num. 2 525 683 A/B					415 017			
All engines								465 005	
All engines	ch. 7330001 ->, ->year 01/01/90								359 747
Eng. B1A (XU51C)	01/01/90 ->								359 748

ENGINE				
1.6 GTI	Petrol	76	12/84-10/87	180A (XU5J)

Engine	Information	A10	A20	A40	A50	A70	C10 - C30	C20	E01
All engines	version Bosch			806 124	906 056R				
All engines								465 005	
All engines	ch. 7330001 ->								359 747

ENGINE				
1.6 GTI	Petrol	85	02/83-07/87	B6D (XU5JA)

Engine	Information	A10	A20	A40	A50	A70	C10 - C30	C20	E01
All engines	version Bosch			806 124	906 056R				
All engines								465 005	
All engines	01/01/90 ->								359 491
All engines	ch. 7330001 ->, ->year 01/01/90								359 747

ENGINE				
1.9 GTI	Petrol	75	03/87-10/87	DFZ (XU9J1)

Engine	Information	A10	A20	A40	A50	A70	C10 - C30	C20	E01
All engines	version Bosch			806 124	906 056R				
All engines	version Ducellier			815 067	915 094	415 017			
All engines								465 005	
All engines	ch. 7330001 ->								359 747

ENGINE				
1.9 GTI	Petrol	94	10/86-10/87	D6B (XU9JA)

Engine	Information	A10	A20	A40	A50	A70	C10 - C30	C20	E01
All engines	version Bosch			806 241	906 056R				
All engines							470 105	C10	465 005

205 II

ENGINE				
1.0	Petrol	33	10/87-09/98	TU9

Engine	Information	A10	A20	A40	A50	A70	C10 - C30	C20	E01
All engines	version Bosch			806 241	906 056R				
All engines	version Ducellier			815 074	915 102R	415 019			
All engines	version Marelli				930 060				
All engines	See connection type						470 105, 470 155	C10	
All engines									359 780

ENGINE				
1.0	Petrol	37	08/92-05/97	CDZ (TU9M)

Engine	Information	A10	A20	A40	A50	A70	C10 - C30	C20	E01
All engines							470 189	C10	

ENGINE				
1.1	Petrol	36	10/87-10/90	109N (XW7)

Engine	Information	A10	A20	A40	A50	A70	C10 - C30	C20	E01
All engines	version Ducellier, distr. num. 525 483 A, distr. num. 525 512 A, distr. num. 525 512 B, distr. num. 525 480 A, 2 525 574 A			815 058					
All engines	version Ducellier, distr. num. 525 512 C, 2 525 574 B			815 067					
All engines	version Ducellier				915 094				
All engines								465 005	

A10 CONDENSER	A20 CONTACT SET	A40 DISTRIBUTOR CAP	A50 ROTOR	A70 PICK-UP
C10 COIL	C20 IGNITION MODULE	C30 ELECTRONIC IGNITION KIT	E01 IGNITION CABLE SET	

Vehicle	alim.	kW	Date	Engine	FUNCTIONS ON THE VEHICLE									
					A10	A20	A40	A50	A70	C10 - C30	C20	E01		
ENGINE														
1.1	Petrol	40	10/87-12/94	H1B (TU1)										
Engine	Information			A10	A20	A40	A50	A70	C10 - C30	C20	E01			
All engines	version Bosch					806 241	906 056R							
All engines	version Ducellier					815 074	915 102R	415 019						
All engines	See connection type								470 105, 470 155	C10				
All engines													359 780	
ENGINE														
1.1	Petrol	44	07/89-09/98	HDZ (TU1M)										
Engine	Information			A10	A20	A40	A50	A70	C10 - C30	C20	E01			
All engines	version Bosch					806 241	906 026R							
All engines	version Ducellier					815 074	915 102R	415 019						
All engines	->ch. 2490280								470 105	C10				
All engines	ch. 2490281 ->								470 189	C10				
All engines	->ch. 24902800												359 780	
ENGINE														
1.1 CJ	Petrol	44	10/89-12/94	HDZ (TU1M)										
Engine	Information			A10	A20	A40	A50	A70	C10 - C30	C20	E01			
All engines	version Bosch					806 241	906 056R							
All engines	version Ducellier					815 074	915 102R	415 019						
All engines									470 105	C10				
All engines													359 780	
ENGINE														
1.1 XA	Petrol	40	07/87-10/88	E1										
Engine	Information			A10	A20	A40	A50	A70	C10 - C30	C20	E01			
All engines	version Bosch					806 124	906 061R							
All engines	version Ducellier					815 058	915 094							
All engines	01/01/89 ->								470 106	C10				
All engines												465 005		
ENGINE														
1.2	Petrol	47	01/87-12/90	F1										
Engine	Information			A10	A20	A40	A50	A70	C10 - C30	C20	E01			
All engines	version Bosch					806 124	906 061R							
All engines	version Ducellier					815 058	915 094							
All engines	01/01/89 ->								470 106	C10				
All engines												465 005		
ENGINE														
1.3	Petrol	47	08/90-07/92	G1A										
Engine	Information			A10	A20	A40	A50	A70	C10 - C30	C20	E01			
All engines	version Bosch					806 124	906 061R							
All engines	version Ducellier					815 058	915 094							
All engines									470 106	C10		465 005		
ENGINE														
1.3	Petrol	74	01/91-12/94	TU24										
Engine	Information			A10	A20	A40	A50	A70	C10 - C30	C20	E01			
All engines	version Bosch					806 241								
All engines									470 105	C10				
ENGINE														
1.3 Rallye	Petrol	74	10/87-10/90	TU24										
Engine	Information			A10	A20	A40	A50	A70	C10 - C30	C20	E01			
All engines	version Bosch					806 241								
All engines									470 105	C10				
ENGINE														
1.4	Petrol	44	10/87-05/89	150D (XY7), 150G (XY7)										
Engine	Information			A10	A20	A40	A50	A70	C10 - C30	C20	E01			
Eng. 150G (XY7)	version Bosch					806 124	906 056R							
Eng. 150G (XY7)	version Ducellier, distr. num. 525 490 A, 525 475 A					815 058								
All engines	version Ducellier, distr. num. 525 490 B/C					815 067								
All engines	version Ducellier						915 094							
All engines												465 005		
Eng. 150G (XY7)													359 846	

A10	CONDENSER	A20	CONTACT SET	A40	DISTRIBUTOR CAP	A50	ROTOR	A70	PICK-UP
C10	COIL	C20	IGNITION MODULE	C30	ELECTRONIC IGNITION KIT	E01	IGNITION CABLE SET		

The present application list is a brief version. For the detailed information about the possibility of installation on a specific vehicle, please refer to our web-catalogue <http://catalogo.facet.eu/>

				FUNCTIONS ON THE VEHICLE								
Vehicle	alim.	kW	Date	Engine								
1.4	Petrol	49	10/87-10/90	ENGINE K1D (TU3A)								
Engine	Information			A10	A20	A40	A50	A70	C10 - C30	C20	E01	
All engines	version Bosch					806 241	906 056R					
All engines	version Ducellier					815 074	915 102R	415 019				
All engines									470 105	C10		359 780
1.4	Petrol	53	01/87-07/88	ENGINE 150 (XY6B)								
Engine	Information			A10	A20	A40	A50	A70	C10 - C30	C20	E01	
All engines	version Ducellier					815 067	915 094					
All engines										465 005		
1.4	Petrol	55	07/88-09/98	ENGINE KDX (TU3MC), KDY (TU3M), KDZ (TU3M)								
Engine	Information			A10	A20	A40	A50	A70	C10 - C30	C20	E01	
Eng. KDY (TU3M), KDZ (TU3M)	version Bosch					806 241						
Eng. KDY (TU3M), KDZ (TU3M)	version Ducellier					815 074	915 102R	415 019				
Eng. KDY (TU3M), KDZ (TU3M)	version Bosch, distr. num. 0 237 009 624						906 026R					
Eng. KDY (TU3M), KDZ (TU3M)									470 105	C10		359 780
Eng. KDX (TU3MC)									470 189	C10		
1.4	Petrol	58	07/88-05/89	ENGINE 150B (XY8), 150H (XY8)								
Engine	Information			A10	A20	A40	A50	A70	C10 - C30	C20	E01	
All engines	version Bosch					806 124	906 056R					
All engines	version Ducellier, distr. num. 2 525 585 A					815 058						
Eng. 150B (XY8)	version Ducellier, distr. num. 2 525 585 B, 2 525 567 A					815 067						
All engines	version Ducellier						915 094					
All engines										465 005		
Eng. 150H (XY8)												359 846
1.4	Petrol	62	06/87-12/89	ENGINE K2B (TU3S)								
Engine	Information			A10	A20	A40	A50	A70	C10 - C30	C20	E01	
All engines	version Bosch					806 241	906 056R					
All engines	version Ducellier					815 074	915 102R	415 019				
All engines									470 105	C10		359 780
1.4 Cat	Petrol	44	08/87-09/93	ENGINE KAY (TU3CP)								
Engine	Information			A10	A20	A40	A50	A70	C10 - C30	C20	E01	
All engines	version Bosch					806 241	906 056R					
All engines									470 105	C10		359 780
1.4 CJ	Petrol	44	03/88-05/89	ENGINE 150D (XY7), 150G (XY7)								
Engine	Information			A10	A20	A40	A50	A70	C10 - C30	C20	E01	
Eng. 150G (XY7)	version Bosch					806 124	906 056R					
All engines	version Ducellier, distr. num. 525 490 A, 525 475 A, distr. num. 525 520 A/B					815 058						
All engines	version Ducellier, distr. num. 2 525 20 C, distr. num. 525 490 B/C					815 067						
All engines	version Ducellier						915 094					
All engines										465 005		359 846
1.4 CJ	Petrol	49	03/89-12/94	ENGINE K1D (TU3A)								
Engine	Information			A10	A20	A40	A50	A70	C10 - C30	C20	E01	
All engines	version Bosch					806 241	906 056R					
All engines	version Ducellier					815 074	915 102R	415 019				
All engines									470 105	C10		359 780
1.4 CJ	Petrol	55	05/91-12/94	ENGINE KDY (TU3M), KDZ (TU3M)								
Engine	Information			A10	A20	A40	A50	A70	C10 - C30	C20	E01	
All engines	version Bosch					806 241						
Eng. KDY (TU3M)	version Ducellier					815 074	915 102R	415 019				
All engines	version Bosch, distr. num. 0 237 009 624						906 026R					
All engines									470 105	C10		359 780

A10 CONDENSER	A20 CONTACT SET	A40 DISTRIBUTOR CAP	A50 ROTOR	A70 PICK-UP
C10 COIL	C20 IGNITION MODULE	C30 ELECTRONIC IGNITION KIT	E01 IGNITION CABLE SET	

Vehicle	alim.	kW	Date	Engine	FUNCTIONS ON THE VEHICLE									
					A10	A20	A40	A50	A70	C10 - C30	C20	E01		
ENGINE														
1.4 CJ Cat	Petrol	44	01/89-09/93	KAY (TU3CP)										
Engine	Information				A10	A20	A40	A50	A70	C10 - C30	C20	E01		
All engines	version Bosch						806 241	906 056R						
All engines										470 105	C10		359 780	
ENGINE														
1.4 CT	Petrol	58	04/86-12/88	150B (XY8), 150H (XY8)										
Engine	Information				A10	A20	A40	A50	A70	C10 - C30	C20	E01		
All engines	version Bosch						806 124	906 056R						
All engines	version Ducellier						815 058	915 094						
All engines											465 005		359 846	
ENGINE														
1.6	Petrol	53	10/87-09/98	B1E (XU51C)										
Engine	Information				A10	A20	A40	A50	A70	C10 - C30	C20	E01		
All engines	version Bosch						806 124	906 056R						
All engines	version Ducellier, distr. num. 2 525 626 A						815 058							
All engines	version Ducellier, distr. num. 2 525 626 B/C						815 067							
All engines	version Ducellier, distr. num. 2 525 663 A						815 074	915 102R	415 019					
All engines	version Ducellier, distr. num. 2 525 626 A/B/C							915 094						
All engines	version Ducellier, distr. num. 2 525 640 B/C								415 017					
All engines											465 005			
All engines	ch. 7330001 ->, ->year 01/01/90												359 747	
All engines	01/01/90 ->												359 748	
ENGINE														
1.6	Petrol	55	10/87-09/98	B1A (XU51C), BAZ (XU5CP)										
Engine	Information				A10	A20	A40	A50	A70	C10 - C30	C20	E01		
All engines	version Bosch						806 124	906 056R						
All engines	version Ducellier, distr. num. 2 525 626 A						815 058							
All engines	version Ducellier, distr. num. 2 525 626 B/C, distr. num. 2 525 683 A/B						815 067							
Eng. B1A (XU51C)	version Ducellier, distr. num. 2 525 663 A						815 074	915 102R	415 019					
All engines	version Ducellier, distr. num. 2 525 626 A/B/C							915 094						
All engines	version Ducellier, distr. num. 2 525 640 B/C, distr. num. 2 525 683 A/B								415 017					
All engines											465 005			
All engines	ch. 7330001 ->, ->year 01/01/90												359 747	
Eng. B1A (XU51C)	01/01/90 ->												359 748	
ENGINE														
1.6 CTI	Petrol	76	03/86-10/90	180A (XU5J), 180Z (XU5J)										
Engine	Information				A10	A20	A40	A50	A70	C10 - C30	C20	E01		
All engines	version Bosch						806 124	906 056R						
All engines											465 005			
All engines	ch. 7330001 ->												359 747	
ENGINE														
1.6 GTI	Petrol	76	10/87-12/89	180A (XU5J), 180Z (XU5J)										
Engine	Information				A10	A20	A40	A50	A70	C10 - C30	C20	E01		
All engines	version Bosch						806 124	906 056R						
All engines											465 005			
All engines	ch. 7330001 ->												359 747	
ENGINE														
1.6 i	Petrol	0	01/91-12/94	BDZ (XU5M)										
Engine	Information				A10	A20	A40	A50	A70	C10 - C30	C20	E01		
All engines										470 188	C10		359 674	
ENGINE														
1.9 CTI	Petrol	75	10/87-12/94	DFZ (XU9J1)										
Engine	Information				A10	A20	A40	A50	A70	C10 - C30	C20	E01		
All engines	version Bosch						806 124	906 056R						
All engines	version Ducellier						815 067	915 094	415 017					
All engines	01/03/91 ->									470 105	C10			
All engines											465 005			
All engines	->year 01/03/91												359 747	

A10	CONDENSER	A20	CONTACT SET	A40	DISTRIBUTOR CAP	A50	ROTOR	A70	PICK-UP
C10	COIL	C20	IGNITION MODULE	C30	ELECTRONIC IGNITION KIT	E01	IGNITION CABLE SET		

The present application list is a brief version. For the detailed information about the possibility of installation on a specific vehicle, please refer to our web-catalogue <http://catalogo.facet.eu/>

FUNCTIONS ON THE VEHICLE

Vehicle	alim.	kW	Date	Engine								
---------	-------	----	------	--------	---	---	---	--	---	---	---	---

				ENGINE
1.9 GTI	Petrol	88	10/87-10/94	DKZ (XU9JAZ)

Engine	Information	A10	A20	A40	A50	A70	C10 - C30	C20	E01
All engines	version Ducellier			815 074	915 102R				
All engines	01/01/90 ->						470 105	C10	359 491
All engines								465 005	

				ENGINE
1.9 GTI	Petrol	94	10/87-09/98	D6B (XU9JA)

Engine	Information	A10	A20	A40	A50	A70	C10 - C30	C20	E01
All engines	version Bosch			806 241	906 056R				
All engines							470 105	C10	465 005
All engines									359 491

				ENGINE
1.9 GTI Cat	Petrol	75	10/87-07/94	DFZ (XU9J1)

Engine	Information	A10	A20	A40	A50	A70	C10 - C30	C20	E01
All engines	version Bosch			806 124	906 056R				
All engines	version Ducellier			815 067	915 094	415 017			
All engines	01/03/91 ->						470 105	C10	
All engines									465 005
All engines	->year 01/03/91								359 747

				ENGINE
206				

				ENGINE
1.1	Petrol	40	08/98-07/00	HFY (TU1JP)

Engine	Information	A10	A20	A40	A50	A70	C10 - C30	C20	E01
All engines	euro 2, x 4, Electricfil, COIL ON PLUG						470 403	C10	
All engines	euro 3, x 1, COIL ON PLUG						470 405	C10	

				ENGINE
1.1	Petrol	44	07/02-02/07	HFX (TU1JP), HFZ (TU1JP)

Engine	Information	A10	A20	A40	A50	A70	C10 - C30	C20	E01
All engines	euro 2, x 4, Electricfil, COIL ON PLUG						470 403	C10	
All engines	euro 3, x 1, COIL ON PLUG						470 405	C10	

				ENGINE
1.1 i	Petrol	44	09/98-02/07	HFX (TU1JP), HFZ (TU1JP)

Engine	Information	A10	A20	A40	A50	A70	C10 - C30	C20	E01
All engines	euro 2, x 4, Electricfil, COIL ON PLUG						470 403	C10	
All engines	euro 3, x 1, COIL ON PLUG						470 405	C10	

				ENGINE
1.4	Petrol	55	07/02->	KFV (TU3A), KFW (TU3JP)

Engine	Information	A10	A20	A40	A50	A70	C10 - C30	C20	E01
All engines							470 405	C10	
All engines	x 4, COIL ON PLUG						470 405	C10	

				ENGINE
1.4 16V	Petrol	65	10/03->	KFU (ET3J4)

Engine	Information	A10	A20	A40	A50	A70	C10 - C30	C20	E01
All engines	x 1, COIL ON PLUG						470 483	C10	

				ENGINE
1.4 CNG	Petrol/ Compressed Natural Gas (CNG)	55	05/06-09/07	KFW (TU3A)









Engine	Information	A10	A20	A40	A50	A70	C10 - C30	C20	E01
All engines	x 4, COIL ON PLUG						470 405	C10	

				ENGINE
1.4 i	Petrol	55	09/98->	K6C (TU3JP), K6D (TU3A), K6D (TU3JP), KFW (TU3A), KFW (TU3JP), KFX (TU3JP), TU3AF

Engine	Information	A10	A20	A40	A50	A70	C10 - C30	C20	E01
Eng. K6C (TU3JP), KFX (TU3JP)							470 403	C10	

A10 CONDENSER	A20 CONTACT SET	A40 DISTRIBUTOR CAP	A50 ROTOR	A70 PICK-UP
C10 COIL	C20 IGNITION MODULE	C30 ELECTRONIC IGNITION KIT	E01 IGNITION CABLE SET	

Vehicle	alim.	kW	Date	Engine	FUNCTIONS ON THE VEHICLE												
					A10	A20	A40	A50	A70	C10 - C30	C20	E01					
1.4 i	Petrol	55	09/98->	ENGINE K6C (TU3JP), K6D (TU3A), K6D (TU3JP), KFW (TU3A), KFW (TU3JP), KFX (TU3JP), TU3AF													
				Eng. K6D (TU3A), K6D (TU3JP), KFW (TU3A), KFW (TU3JP), TU3AF							470 405	C10					
1.4 LPG	Petrol/ Liquified Petro- leum Gas (LPG)	55	07/02-09/07	ENGINE KfV (TU3JP), KfW (TU3JP)													
				All engines							470 405	C10					
1.6	Petrol	81	09/01-12/08	ENGINE NFU (TU5JP4)													
				All engines							470 407	C10					
1.6 16V	Petrol	79	06/01-04/09	ENGINE NFU (TU5JP4)													
				All engines							470 407	C10					
1.6 16V	Petrol	80	07/00->	ENGINE N6A (TU5JP4), NFU (TU5JP4)													
				Eng. N6A (TU5JP4)							470 407	C10					
				Eng. NFU (TU5JP4)													
				x 1, COIL ON PLUG							470 407	C10					
1.6 8V	Petrol	66	05/99-10/03	ENGINE NFZ (TU5JP)													
				All engines							470 403	C10					
1.6 BiFuel	Petrol/ Liquified Petro- leum Gas (LPG)	80	07/00-04/09	ENGINE NFU (TU5JP4)													
				All engines							470 407	C10					
1.6 i	Petrol	65	09/98-12/00	ENGINE NFZ (TU5JP)													
				All engines							470 403	C10					
1.6 LPG	Bi-Fuel	80	07/02->	ENGINE NFU (TU5JP4)													
				All engines							470 407	C10					
				x 1, COIL ON PLUG							470 407	C10					
2.0 16V	Petrol	100	07/02-02/07	ENGINE RFN (EW10J4)													
				All engines							470 408	C10					
2.0 RC	Petrol	130	07/03-12/07	ENGINE RFK (EW10J4S)													
				All engines							470 509	C10					
2.0 S16	Petrol	100	06/99-12/07	ENGINE RFN (EW10J4), RFR (DEW10J4)													
				Eng. RFN (EW10J4)							470 408	C10					
				Eng. RFR (DEW10J4)							470 408	C10					
				x 4, COIL ON PLUG							470 408	C10					
A10	CONDENSER	A20	CONTACT SET	A40	DISTRIBUTOR CAP	A50	ROTOR	A70	PICK-UP	C10	COIL	C20	IGNITION MODULE	C30	ELECTRONIC IGNITION KIT	E01	IGNITION CABLE SET









					FUNCTIONS ON THE VEHICLE							
Vehicle	alim.	kW	Date	Engine	 A10	 A20	 A40	 A50	 A70	 C10 - C30	 C20	 E01
2.0 S16												
Petrol 99 04/99-10/00					ENGINE RFR (DEW10J4), RFR (EW10J4)							
Engine Information					A10	A20	A40	A50	A70	C10 - C30	C20	E01
Eng. RFR (DEW10J4)										470 408	C10	
Eng. RFR (EW10J4)										470 408	C10	
206+												
1.1					ENGINE HFX (TU1A)							
Petrol 44 01/09-06/13												
Engine Information					A10	A20	A40	A50	A70	C10 - C30	C20	E01
All engines										470 405	C10	
1.1 LPG					ENGINE HFX (TU1A), HFX (TU1JP)							
Petrol/Liquified Petroleum Gas (LPG) 44 04/09-06/13												
Engine Information					A10	A20	A40	A50	A70	C10 - C30	C20	E01
All engines										470 405	C10	
1.4 i					ENGINE KFT (TU3AE5)							
Petrol 54 09/10-06/13												
Engine Information					A10	A20	A40	A50	A70	C10 - C30	C20	E01
All engines										470 405	C10	
1.4 i					ENGINE K6D (TU3A), KFW (TU3A), TU3AE5							
Petrol 55 01/09->												
Engine Information					A10	A20	A40	A50	A70	C10 - C30	C20	E01
Eng. K6D (TU3A), TU3AE5										470 405	C10	
Eng. KFW (TU3A)										470 405	C10	
1.6 16V					ENGINE NFU (TU5JP4)							
Petrol 80 07/10->												
Engine Information					A10	A20	A40	A50	A70	C10 - C30	C20	E01
All engines										470 407	C10	
207												
1.4					ENGINE KFT (TU3A), KFT (TU3AE5), KFU (TU3A)							
Petrol 53 02/06-10/13												
Engine Information					A10	A20	A40	A50	A70	C10 - C30	C20	E01
All engines										470 405	C10	
1.4					ENGINE KFT (TU3A), KFT (TU3AE5), KFU (TU3A)							
Petrol 54 04/06-10/13												
Engine Information					A10	A20	A40	A50	A70	C10 - C30	C20	E01
All engines										470 405	C10	
1.4					ENGINE KFV (TU3A), KFW (TU3A)							
Petrol 55 08/08-12/15												
Engine Information					A10	A20	A40	A50	A70	C10 - C30	C20	E01
All engines										470 405	C10	
1.4 16V					ENGINE KFU (ET3J4)							
Petrol 65 02/06-10/13												
Engine Information					A10	A20	A40	A50	A70	C10 - C30	C20	E01
All engines										470 483	C10	
1.4 16V					ENGINE 8FS (EP3), EP3, EP3C							
Petrol 70 06/07-10/13												
Engine Information					A10	A20	A40	A50	A70	C10 - C30	C20	E01
All engines										470 475	C10	
1.4 16V					ENGINE 8FR (EP3)							
Petrol 72 10/09-12/12												
Engine Information					A10	A20	A40	A50	A70	C10 - C30	C20	E01
All engines										470 475	C10	

A10 CONDENSER	A20 CONTACT SET	A40 DISTRIBUTOR CAP	A50 ROTOR	A70 PICK-UP
C10 COIL	C20 IGNITION MODULE	C30 ELECTRONIC IGNITION KIT	E01 IGNITION CABLE SET	

Vehicle	alim.	kW	Date	Engine	FUNCTIONS ON THE VEHICLE									
					A10	A20	A40	A50	A70	C10 - C30	C20	E01		
ENGINE														
1.4 BiFuel	Petrol/ Liquified Petroleum Gas (LPG)	54	08/07-12/13	KFV (TU3A)										
Engine		Information			A10	A20	A40	A50	A70	C10 - C30	C20	E01		
All engines		x 4, COIL ON PLUG								470 405	C10			
ENGINE														
1.4 Flex	Petrol/ Ethanol	60	11/08-12/14	KFW (TU3A)										
Engine		Information			A10	A20	A40	A50	A70	C10 - C30	C20	E01		
All engines										470 405	C10			
ENGINE														
1.4 LPG	Petrol/ Liquified Petroleum Gas (LPG)	54	08/07-12/12	KFV (TU3A)										
Engine		Information			A10	A20	A40	A50	A70	C10 - C30	C20	E01		
All engines		x 4, COIL ON PLUG								470 405	C10			
ENGINE														
1.6	Petrol	78	01/10->	NFU (TU5JP4)										
Engine		Information			A10	A20	A40	A50	A70	C10 - C30	C20	E01		
All engines										470 407	C10			
ENGINE														
1.6	Petrol	81	08/08-12/13	N6A (TU5JP4)										
Engine		Information			A10	A20	A40	A50	A70	C10 - C30	C20	E01		
All engines										470 407	C10			
ENGINE														
1.6 16V	Petrol	80	02/06-10/13	NFU (TU5JP4)										
Engine		Information			A10	A20	A40	A50	A70	C10 - C30	C20	E01		
All engines		x 1, COIL ON PLUG								470 407	C10			
ENGINE														
1.6 16V	Petrol	88	06/07-10/13	5FS (EP6C), 5FW (EP6), EP6										
Engine		Information			A10	A20	A40	A50	A70	C10 - C30	C20	E01		
All engines		x 4, COIL ON PLUG								470 475	C10			
ENGINE														
1.6 16V RC	Petrol	128	02/07-12/12	5FY (EP6DTS)										
Engine		Information			A10	A20	A40	A50	A70	C10 - C30	C20	E01		
All engines		x 4, COIL ON PLUG								470 475	C10			
ENGINE														
1.6 16V Turbo	Petrol	110	02/06-10/13	5FX (EP6DT)										
Engine		Information			A10	A20	A40	A50	A70	C10 - C30	C20	E01		
All engines		x 4, COIL ON PLUG								470 475	C10			
ENGINE														
1.6 16V Turbo	Petrol	115	10/09-12/12	5FR (EP6DT)										
Engine		Information			A10	A20	A40	A50	A70	C10 - C30	C20	E01		
All engines		x 4, COIL ON PLUG								470 475	C10			
ENGINE														
1.6 16V VTi	Petrol	81	09/08-12/12	EP6										
Engine		Information			A10	A20	A40	A50	A70	C10 - C30	C20	E01		
All engines		x 4, COIL ON PLUG								470 475	C10			
ENGINE														
1.6 16V VTi	Petrol	88	02/07-12/12	5FS (EP6C), 5FW (EP6), EP6										
Engine		Information			A10	A20	A40	A50	A70	C10 - C30	C20	E01		
All engines		x 4, COIL ON PLUG								470 475	C10			
ENGINE														
1.6 Bioflex	Petrol/ Ethanol	83	01/08-12/13	N6A (TU5JP4)										
Engine		Information			A10	A20	A40	A50	A70	C10 - C30	C20	E01		
All engines										470 407	C10			

A10 CONDENSER	A20 CONTACT SET	A40 DISTRIBUTOR CAP	A50 ROTOR	A70 PICK-UP
C10 COIL	C20 IGNITION MODULE	C30 ELECTRONIC IGNITION KIT	E01 IGNITION CABLE SET	

The present application list is a brief version. For the detailed information about the possibility of installation on a specific vehicle, please refer to our web-catalogue <http://catalogo.facet.eu/>









					FUNCTIONS ON THE VEHICLE							
Vehicle	alim.	kW	Date	Engine								
ENGINE												
1.6 VTi	Petrol	88	03/07-12/12	5FW (EP6)								
Engine		Information			A10	A20	A40	A50	A70	C10 - C30	C20	E01
All engines		x 4, COIL ON PLUG								470 475	C10	
207 CC												
ENGINE												
1.6 16V	Petrol	88	02/07-10/13	5FS (EP6C), 5FW (EP6), EP6								
Engine		Information			A10	A20	A40	A50	A70	C10 - C30	C20	E01
All engines		x 4, COIL ON PLUG								470 475	C10	
ENGINE												
1.6 16V Turbo	Petrol	110	02/07-12/12	5FX (EP6DT)								
Engine		Information			A10	A20	A40	A50	A70	C10 - C30	C20	E01
All engines		x 4, COIL ON PLUG								470 475	C10	
ENGINE												
1.6 16V Turbo	Petrol	115	10/09-12/13	5FR (EP6DT), 5FV (EP6CDT)								
Engine		Information			A10	A20	A40	A50	A70	C10 - C30	C20	E01
All engines		x 4, COIL ON PLUG								470 475	C10	
208 I												
ENGINE												
1.0	Petrol	50	03/12->	ZMZ (EB0)								
Engine		Information			A10	A20	A40	A50	A70	C10 - C30	C20	E01
All engines		x 3, COIL ON PLUG								470 609	C10	
ENGINE												
1.2 GPL	Petrol/ Liquified Petro- leum Gas (LPG)	60	06/15->	HMZ (EB2F)								
Engine		Information			A10	A20	A40	A50	A70	C10 - C30	C20	E01
All engines		x 3, COIL ON PLUG								470 609	C10	
ENGINE												
1.2 PureTech 82	Petrol	61	03/18->	HMR (EB2FA), HMZ (EB2F)								
Engine		Information			A10	A20	A40	A50	A70	C10 - C30	C20	E01
All engines		x 3, COIL ON PLUG								470 609	C10	
ENGINE												
1.2 VTi	Petrol	60	09/13->	HMZ (EB2)								
Engine		Information			A10	A20	A40	A50	A70	C10 - C30	C20	E01
All engines		Qty: 3								470 609	C10	
ENGINE												
1.2 VTi 68 / PureTech 68	Petrol	50	06/15->	HMM (EB2FAD), HMP (EB2FB)								
Engine		Information			A10	A20	A40	A50	A70	C10 - C30	C20	E01
All engines		x 3, COIL ON PLUG								470 609	C10	
ENGINE												
1.2 VTi 82	Petrol	60	03/12->	HMZ (EB2), HMZ (EB2F)								
Engine		Information			A10	A20	A40	A50	A70	C10 - C30	C20	E01
All engines		x 3, COIL ON PLUG								470 609	C10	
ENGINE												
1.2 VTi 82 / PureTech 82	Petrol	60	06/15->	HMR (EB2FA), HMZ (EB2), HMZ (EB2F)								
Engine		Information			A10	A20	A40	A50	A70	C10 - C30	C20	E01
All engines		x 3, COIL ON PLUG								470 609	C10	
ENGINE												
1.4 GPL	Petrol/ Liquified Petro- leum Gas (LPG)	70	10/13->	EP3C								
Engine		Information			A10	A20	A40	A50	A70	C10 - C30	C20	E01
All engines		x 4, COIL ON PLUG								470 475	C10	

A10 CONDENSER	A20 CONTACT SET	A40 DISTRIBUTOR CAP	A50 ROTOR	A70 PICK-UP
C10 COIL	C20 IGNITION MODULE	C30 ELECTRONIC IGNITION KIT	E01 IGNITION CABLE SET	

Vehicle	alim.	kW	Date	Engine	FUNCTIONS ON THE VEHICLE									
					A10	A20	A40	A50	A70	C10 - C30	C20	E01		
ENGINE														
1.4 VTi	Petrol	70	03/12->	8FS (EP3), EP3C										
ENGINE														
All engines														
Information														
x 4, COIL ON PLUG														
x 4, COIL ON PLUG														
Qty: 4														
470 475														
C10														
ENGINE														
1.6	Petrol	115	03/12->	5FV (EP6CDT), 5FV (EP6DT)										
ENGINE														
All engines														
Information														
x 4, COIL ON PLUG														
Qty: 4														
470 475														
C10														
470 475														
C10														
ENGINE														
1.6	Petrol	121	02/12->	5GZ (EP6FDT)										
ENGINE														
All engines														
Information														
Qty: 4														
470 475														
C10														
ENGINE														
1.6	Petrol	88	03/12->	5FS (EP6C)										
ENGINE														
All engines														
Information														
x 4, COIL ON PLUG														
470 475														
C10														
ENGINE														
1.6	Petrol	89	09/16->	5FS (EP6C)										
ENGINE														
All engines														
Information														
x 4, COIL ON PLUG														
470 475														
C10														
ENGINE														
1.6 GTi	Petrol	147	08/12->	5FU (EP6CDTX)										
ENGINE														
All engines														
Information														
x 4, COIL ON PLUG														
470 475														
C10														
ENGINE														
1.6 GTi	Petrol	153	10/14->	9H92										
ENGINE														
All engines														
Information														
x 4, COIL ON PLUG														
470 475														
C10														
ENGINE														
1.6 THP 165	Petrol	121	03/15->	5GZ (EP6FDT)										
ENGINE														
All engines														
Information														
x 4, COIL ON PLUG														
470 475														
C10														
ENGINE														
1.6 THP 210	Petrol	155	04/15->	5GM (EP6FDTX)										
ENGINE														
All engines														
Information														
Qty: 4														
470 475														
C10														
ENGINE														
208 II														
1.2 PureTech 75	Petrol	55	06/19->	HMH (EB2FAD)										
ENGINE														
All engines														
Information														
x 3, COIL ON PLUG														
470 609														
C10														
ENGINE														
3008 I														
1.2	Petrol	96	01/15-08/16	HNY (EB2DTS)										
ENGINE														
All engines														
Information														
x 3, COIL ON PLUG														
470 620														
C10														
ENGINE														
1.6 THP	Petrol	110	06/09->	5FE (EP6CDTM), 5FE (EP6CDTMD), 5FX (EP6DT), EP6CDT M										
ENGINE														
All engines														
Information														
x 4, COIL ON PLUG														
Qty: 4														
470 475														
C10														
470 475														
C10														
ENGINE														
1.6 THP	Petrol	115	06/09->	5FV (EP6CDT), 5FV (EP6DT)										
ENGINE														
All engines														
Information														
Qty: 4														
470 475														
C10														
470 475														
C10														

A10 CONDENSER	A20 CONTACT SET	A40 DISTRIBUTOR CAP	A50 ROTOR	A70 PICK-UP
C10 COIL	C20 IGNITION MODULE	C30 ELECTRONIC IGNITION KIT	E01 IGNITION CABLE SET	

The present application list is a brief version. For the detailed information about the possibility of installation on a specific vehicle, please refer to our web-catalogue <http://catalogo.facet.eu/>

					FUNCTIONS ON THE VEHICLE							
Vehicle	alim.	kW	Date	Engine	 A10	 A20	 A40	 A50	 A70	 C10 - C30	 C20	 E01
ENGINE												
1.6 THP	Petrol	120	09/10->	5FM (EP6CDTM), EP6CDT MD								
Engine	Information				A10	A20	A40	A50	A70	C10 - C30	C20	E01
Eng. 5FM (EP6CDTM)	x 4, COIL ON PLUG									470 475	C10	
Eng. EP6CDT MD	Qty: 4									470 475	C10	
ENGINE												
1.6 VTi	Petrol	88	06/09-08/16	EP6								
Engine	Information				A10	A20	A40	A50	A70	C10 - C30	C20	E01
All engines	x 4, COIL ON PLUG									470 475	C10	
3008 II												
ENGINE												
1.2 THP/ PureTech 130	Petrol	96	05/16->	HNS (EB2ADTS), HNY (EB2DTS)								
Engine	Information				A10	A20	A40	A50	A70	C10 - C30	C20	E01
All engines	x 3, COIL ON PLUG									470 620	C10	
ENGINE												
1.6 PureTech 180	Petrol	133	07/18->	5GF (EP6FADTXD)								
Engine	Information				A10	A20	A40	A50	A70	C10 - C30	C20	E01
All engines	x 4, COIL ON PLUG									470 475	C10	
ENGINE												
1.6 THP 150	Petrol	110	11/17->	5GX (EP6FDTMD)								
Engine	Information				A10	A20	A40	A50	A70	C10 - C30	C20	E01
All engines	x 4, COIL ON PLUG									470 475	C10	
ENGINE												
1.6 THP 165	Petrol	121	05/16->	5GY (EP6FDTM), 5GZ (EP6FDT)								
Engine	Information				A10	A20	A40	A50	A70	C10 - C30	C20	E01
All engines	x 4, COIL ON PLUG									470 475	C10	
ENGINE												
Hybrid	Petrol/ Electric	133	10/19->	5GQ (EP6FADTXHPD)								
Engine	Information				A10	A20	A40	A50	A70	C10 - C30	C20	E01
All engines	x 4, COIL ON PLUG									470 475	C10	
ENGINE												
Hybrid4	Petrol/ Electric	147	10/19->	5GB (EP6FADTXHPA)								
Engine	Information				A10	A20	A40	A50	A70	C10 - C30	C20	E01
All engines	x 4, COIL ON PLUG									470 475	C10	
ENGINE												
PureTech 130	Petrol	96	05/16->	HNY (EB2DTS)								
Engine	Information				A10	A20	A40	A50	A70	C10 - C30	C20	E01
All engines	x 3, COIL ON PLUG									470 620	C10	
301												
ENGINE												
1.2	Petrol	60	11/12->	HMZ (EB2F)								
Engine	Information				A10	A20	A40	A50	A70	C10 - C30	C20	E01
All engines	Qty: 3									470 609	C10	
ENGINE												
1.2 PureTech 82	Petrol	61	02/18->	HMR (EB2FA)								
Engine	Information				A10	A20	A40	A50	A70	C10 - C30	C20	E01
All engines	x 3, COIL ON PLUG									470 609	C10	
ENGINE												
1.2 VTi 72	Petrol	53	11/12->	HMY (EB2M)								
Engine	Information				A10	A20	A40	A50	A70	C10 - C30	C20	E01
All engines	x 3, COIL ON PLUG									470 609	C10	
ENGINE												
1.2 VTi 82	Petrol	60	12/14->	HMZ (EB2F)								
Engine	Information				A10	A20	A40	A50	A70	C10 - C30	C20	E01
All engines	x 3, COIL ON PLUG									470 609	C10	

A10 CONDENSER	A20 CONTACT SET	A40 DISTRIBUTOR CAP	A50 ROTOR	A70 PICK-UP
C10 COIL	C20 IGNITION MODULE	C30 ELECTRONIC IGNITION KIT	E01 IGNITION CABLE SET	

Vehicle	alim.	kW	Date	Engine	FUNCTIONS ON THE VEHICLE							
					A10	A20	A40	A50	A70	C10 - C30	C20	E01

304

1.1	Petrol	43	10/76-10/80	ENGINE XK5
-----	--------	----	-------------	---------------

Engine	Information	A10	A20	A40	A50	A70	C10 - C30	C20	E01
All engines					906 014R				

1.3	Petrol	48	03/70-10/80	ENGINE XL3, XL5
-----	--------	----	-------------	--------------------

Engine	Information	A10	A20	A40	A50	A70	C10 - C30	C20	E01
All engines					906 014R				

1.3	Petrol	55	03/72-07/76	ENGINE XL3S
-----	--------	----	-------------	----------------

Engine	Information	A10	A20	A40	A50	A70	C10 - C30	C20	E01
All engines					906 014R				

1.3 GL	Petrol	48	09/72-10/79	ENGINE XL5
--------	--------	----	-------------	---------------

Engine	Information	A10	A20	A40	A50	A70	C10 - C30	C20	E01
All engines					906 014R				

1.3 GT	Petrol	48	10/69-09/75	ENGINE XL3
--------	--------	----	-------------	---------------

Engine	Information	A10	A20	A40	A50	A70	C10 - C30	C20	E01
All engines					906 014R				

305

1.5	Petrol	65	05/80-09/82	ENGINE 117 (XR5S)
-----	--------	----	-------------	----------------------

Engine	Information	A10	A20	A40	A50	A70	C10 - C30	C20	E01
All engines	01/01/83 ->, version Ducellier	615 034							
All engines	->year 01/01/83, version Ducellier		715 102						
All engines	->year 01/01/83, version Marelli		730 146M						
All engines	version Ducellier			815 049	915 091				
All engines	version Marelli			830 101	930 047R				
All engines	->year 01/01/83						470 101D	C10	
All engines									465 005

306

1.1	Petrol	44	05/93-05/01	ENGINE HDZ (TU1M)
-----	--------	----	-------------	----------------------

Engine	Information	A10	A20	A40	A50	A70	C10 - C30	C20	E01
All engines							470 189	C10	360 025

1.4	Petrol	55	04/93-04/02	ENGINE KDX (TU3MC), KFW (TU3JP), KFX (TU3JP)
-----	--------	----	-------------	---

Engine	Information	A10	A20	A40	A50	A70	C10 - C30	C20	E01
Eng. KFW (TU3JP), KFX (TU3JP)	->year 31/05/98						470 188	C10	360 374
Eng. KDX (TU3MC)							470 189	C10	360 025
Eng. KFW (TU3JP), KFX (TU3JP)	01/06/98 ->, Colour:Black						470 403	C10	
Eng. KFW (TU3JP), KFX (TU3JP)	01/06/98 ->, Colour:Grey						470 405	C10	

1.4 SL	Petrol	55	06/94-05/01	ENGINE KDX (TU3MC), KFW (TU3JP), KFX (TU3JP)
--------	--------	----	-------------	---

Engine	Information	A10	A20	A40	A50	A70	C10 - C30	C20	E01
Eng. KFW (TU3JP), KFX (TU3JP)	->year 31/05/98						470 188	C10	360 374
Eng. KDX (TU3MC)							470 189	C10	360 025
Eng. KFW (TU3JP), KFX (TU3JP)	01/06/98 ->, Colour:Black						470 403	C10	
Eng. KFW (TU3JP), KFX (TU3JP)	01/06/98 ->, Colour:Grey						470 405	C10	

1.6	Petrol	65	05/93-10/00	ENGINE NFZ (TU5JP)
-----	--------	----	-------------	-----------------------

Engine	Information	A10	A20	A40	A50	A70	C10 - C30	C20	E01
All engines	01/05/97 ->, ->year 31/05/98						470 188	C10	
All engines	->year 30/04/97						470 189	C10	360 025
All engines	01/06/98 ->						470 403	C10	
All engines	->year 31/05/98, 01/05/97 ->								360 374

A10 CONDENSER	A20 CONTACT SET	A40 DISTRIBUTOR CAP	A50 ROTOR	A70 PICK-UP
C10 COIL	C20 IGNITION MODULE	C30 ELECTRONIC IGNITION KIT	E01 IGNITION CABLE SET	

The present application list is a brief version. For the detailed information about the possibility of installation on a specific vehicle, please refer to our web-catalogue <http://catalogo.facet.eu/>









Vehicle	alim.	kW	Date	Engine	FUNCTIONS ON THE VEHICLE								
					A10	A20	A40	A50	A70	C10 - C30	C20	E01	
ENGINE													
1.6	Petrol	72	10/00-04/02	NFT (TU5JP)									
Engine	Information				A10	A20	A40	A50	A70	C10 - C30	C20	E01	
All engines										470 405	C10		
ENGINE													
1.6 SR	Petrol	65	06/94-10/00	NFZ (TU5JP)									
Engine	Information				A10	A20	A40	A50	A70	C10 - C30	C20	E01	
All engines	01/05/97 ->, ->year 31/05/98									470 188	C10		
All engines	->year 30/04/97									470 189	C10		360 025
All engines	01/06/98 ->									470 403	C10		
All engines	->year 31/05/98, 01/05/97 ->												360 374
ENGINE													
1.8	Petrol	74	05/93-04/02	--, LFZ (XU7JP)									
Engine	Information				A10	A20	A40	A50	A70	C10 - C30	C20	E01	
All engines										470 188	C10		359 674
ENGINE													
1.8 ST	Petrol	74	06/94-05/01	LFZ (XU7JP)									
Engine	Information				A10	A20	A40	A50	A70	C10 - C30	C20	E01	
All engines										470 188	C10		359 674
ENGINE													
2.0	Petrol	89	03/94-04/02	RFX (XU10J2)									
Engine	Information				A10	A20	A40	A50	A70	C10 - C30	C20	E01	
All engines										470 188	C10		359 494
ENGINE													
2.0 ST	Petrol	89	07/94-05/01	RFX (XU10J2)									
Engine	Information				A10	A20	A40	A50	A70	C10 - C30	C20	E01	
All engines										470 188	C10		359 494
ENGINE													
2.0 XSi	Petrol	89	05/93-05/01	RFX (XU10J2)									
Engine	Information				A10	A20	A40	A50	A70	C10 - C30	C20	E01	
All engines										470 188	C10		359 494
307													
ENGINE													
1.4	Petrol	55	08/00-09/03	KFW (TU3JP)									
Engine	Information				A10	A20	A40	A50	A70	C10 - C30	C20	E01	
All engines	x 1, COIL ON PLUG									470 405	C10		
ENGINE													
1.4 16V	Petrol	65	11/03-07/07	KFU (ET3J4)									
Engine	Information				A10	A20	A40	A50	A70	C10 - C30	C20	E01	
All engines	x 1, COIL ON PLUG									470 483	C10		
ENGINE													
1.6	Petrol	81	07/06-04/12	NFU (TU5JP4)									
Engine	Information				A10	A20	A40	A50	A70	C10 - C30	C20	E01	
All engines	x 1, COIL ON PLUG									470 407	C10		
ENGINE													
1.6 16V	Petrol	80	08/00->	N6A (TU5JP4), NFU (TU5JP4)									
Engine	Information				A10	A20	A40	A50	A70	C10 - C30	C20	E01	
Eng. N6A (TU5JP4)										470 407	C10		
Eng. NFU (TU5JP4)	x 1, COIL ON PLUG									470 407	C10		
ENGINE													
1.6 BioFlex	Flexfuel	81	07/06->	--									
Engine	Information				A10	A20	A40	A50	A70	C10 - C30	C20	E01	
All engines										470 407	C10		
ENGINE													
1.6 BioFlex	Petrol	80	07/06->	N6A (TU5JP4)									
Engine	Information				A10	A20	A40	A50	A70	C10 - C30	C20	E01	
All engines										470 407	C10		
All engines	x 1, COIL ON PLUG									470 407	C10		

A10 CONDENSER	A20 CONTACT SET	A40 DISTRIBUTOR CAP	A50 ROTOR	A70 PICK-UP
C10 COIL	C20 IGNITION MODULE	C30 ELECTRONIC IGNITION KIT	E01 IGNITION CABLE SET	

Vehicle	alim.	kW	Date	Engine	FUNCTIONS ON THE VEHICLE								
					A10	A20	A40	A50	A70	C10 - C30	C20	E01	
ENGINE													
2.0	Petrol	100	03/02-06/05	RFN (EW10J4)									
ENGINE													
Engine Information					A10	A20	A40	A50	A70	C10 - C30	C20	E01	
All engines x 4, COIL ON PLUG										470 408	C10		
2.0 16V	Petrol	100	08/00-06/05	RFN (EW10J4)									
ENGINE													
Engine Information					A10	A20	A40	A50	A70	C10 - C30	C20	E01	
All engines x 4, COIL ON PLUG										470 408	C10		
2.0 16V	Petrol	103	12/04-04/09	RFJ (EW10A), RFN (EW10J4)									
ENGINE													
Engine Information					A10	A20	A40	A50	A70	C10 - C30	C20	E01	
Eng. RFN (EW10J4)										470 408	C10		
Eng. RFJ (EW10A)										470 476	C10		
2.0 16V	Petrol	130	10/03-04/09	RFK (EW10J4S)									
ENGINE													
Engine Information					A10	A20	A40	A50	A70	C10 - C30	C20	E01	
All engines ->year 01/08/05, x 1, COIL ON PLUG										470 476	C10		
All engines 01/09/05 ->, x 4, COIL ON PLUG, x 1, COIL ON PLUG										470 509	C10		
308 I													
1.4 16V	Petrol	70	09/07-10/14	8FS (EP3), EP3									
ENGINE													
Engine Information					A10	A20	A40	A50	A70	C10 - C30	C20	E01	
All engines x 4, COIL ON PLUG										470 475	C10		
1.4 16V	Petrol	72	12/09->	8FR (EP3), EP3C									
ENGINE													
Engine Information					A10	A20	A40	A50	A70	C10 - C30	C20	E01	
Eng. 8FR (EP3)										470 475	C10		
Eng. EP3C										470 475	C10		
Qty: 4													
1.6 16V	Petrol	103	09/07-12/14	5FT (EP6DT)									
ENGINE													
Engine Information					A10	A20	A40	A50	A70	C10 - C30	C20	E01	
All engines x 4, COIL ON PLUG										470 475	C10		
1.6 16V	Petrol	110	09/07-12/14	5FX (EP6DT)									
ENGINE													
Engine Information					A10	A20	A40	A50	A70	C10 - C30	C20	E01	
All engines x 4, COIL ON PLUG										470 475	C10		
1.6 16V	Petrol	115	06/09-12/14	5FV (EP6CDT)									
ENGINE													
Engine Information					A10	A20	A40	A50	A70	C10 - C30	C20	E01	
All engines x 4, COIL ON PLUG										470 475	C10		
1.6 16V	Petrol	128	03/08-10/14	5FY (EP6DTS)									
ENGINE													
Engine Information					A10	A20	A40	A50	A70	C10 - C30	C20	E01	
All engines x 4, COIL ON PLUG										470 475	C10		
1.6 16V	Petrol	80	07/08->	N6A (TU5JP4)									
ENGINE													
Engine Information					A10	A20	A40	A50	A70	C10 - C30	C20	E01	
All engines										470 407	C10		
1.6 16V	Petrol	88	09/07->	5FS (EP6C), 5FW (EP6), EP6, EP6C									
ENGINE													
Engine Information					A10	A20	A40	A50	A70	C10 - C30	C20	E01	
Eng. 5FS (EP6C), 5FW (EP6), EP6										470 475	C10		
Eng. EP6C										470 475	C10		
Qty: 4													
1.6 BioFlex	Petrol	80	07/08->	N6A (TU5JP4)									
ENGINE													
Engine Information					A10	A20	A40	A50	A70	C10 - C30	C20	E01	
All engines										470 407	C10		
All engines x 1, COIL ON PLUG										470 407	C10		

A10 CONDENSER	A20 CONTACT SET	A40 DISTRIBUTOR CAP	A50 ROTOR	A70 PICK-UP
C10 COIL	C20 IGNITION MODULE	C30 ELECTRONIC IGNITION KIT	E01 IGNITION CABLE SET	

The present application list is a brief version. For the detailed information about the possibility of installation on a specific vehicle, please refer to our web-catalogue <http://catalogo.facet.eu/>





					FUNCTIONS ON THE VEHICLE							
Vehicle	alim.	kW	Date	Engine								
ENGINE												
1.6 Bioflex	Petrol/ Ethanol	82	03/09-10/14	NFU (TU5JP4)								
Engine	Information				A10	A20	A40	A50	A70	C10 - C30	C20	E01
All engines	x 1, COIL ON PLUG									470 407	C10	
ENGINE												
1.6 GTi	Petrol	147	07/10-10/14	EP6CDTX								
Engine	Information				A10	A20	A40	A50	A70	C10 - C30	C20	E01
All engines	x 4, COIL ON PLUG									470 475	C10	
ENGINE												
1.6 THP	Petrol	110	01/11->	EP6CDT M								
Engine	Information				A10	A20	A40	A50	A70	C10 - C30	C20	E01
All engines	Qty: 4									470 475	C10	
ENGINE												
1.6 THP	Petrol	120	01/11->	EP6CDT MD								
Engine	Information				A10	A20	A40	A50	A70	C10 - C30	C20	E01
All engines	Qty: 4									470 475	C10	
ENGINE												
1.6 THP	Petrol	147	10/10-12/14	EP6CDTX								
Engine	Information				A10	A20	A40	A50	A70	C10 - C30	C20	E01
All engines	x 4, COIL ON PLUG									470 475	C10	
ENGINE												
1.6 THP 16V	Petrol	115	10/09-10/14	5FV (EP6CDT)								
Engine	Information				A10	A20	A40	A50	A70	C10 - C30	C20	E01
All engines	x 4, COIL ON PLUG									470 475	C10	
ENGINE												
2.0 Bioflex	Petrol/ Ethanol	103	01/08-12/12	RFJ (EW10A)								
Engine	Information				A10	A20	A40	A50	A70	C10 - C30	C20	E01
All engines	x 1, COIL ON PLUG									470 476	C10	
ENGINE												
2.0 CVT	Petrol	103	07/09-12/14	RFJ (EW10A)								
Engine	Information				A10	A20	A40	A50	A70	C10 - C30	C20	E01
All engines	x 1, COIL ON PLUG									470 476	C10	
308 II												
ENGINE												
1.2 THP 130	Petrol	96	03/14-06/21	HNY (EB2DTS)								
Engine	Information				A10	A20	A40	A50	A70	C10 - C30	C20	E01
All engines	x 3, COIL ON PLUG									470 620	C10	
ENGINE												
1.2 VTi 72	Petrol	60	09/13->	HMZ (EB2), HMZ (EB2F)								
Engine	Information				A10	A20	A40	A50	A70	C10 - C30	C20	E01
Eng. HMZ (EB2)	Qty: 3									470 609	C10	
Eng. HMZ (EB2F)	x 3, COIL ON PLUG									470 609	C10	
ENGINE												
1.6	Petrol	120	01/12->	5GZ (EP6FDT)								
Engine	Information				A10	A20	A40	A50	A70	C10 - C30	C20	E01
All engines	Qty: 4									470 475	C10	
ENGINE												
1.6 GT 205	Petrol	151	06/14-06/21	3AC								
Engine	Information				A10	A20	A40	A50	A70	C10 - C30	C20	E01
All engines	x 4, COIL ON PLUG									470 475	C10	
ENGINE												
1.6 GTi	Petrol	184	08/15-06/21	6AAS								
Engine	Information				A10	A20	A40	A50	A70	C10 - C30	C20	E01
All engines	x 4, COIL ON PLUG									470 475	C10	
ENGINE												
1.6 GTi	Petrol	200	06/15-06/21	5GN (EP6FDTR)								
Engine	Information				A10	A20	A40	A50	A70	C10 - C30	C20	E01
All engines	x 4, COIL ON PLUG									470 475	C10	

A10 CONDENSER	A20 CONTACT SET	A40 DISTRIBUTOR CAP	A50 ROTOR	A70 PICK-UP
C10 COIL	C20 IGNITION MODULE	C30 ELECTRONIC IGNITION KIT	E01 IGNITION CABLE SET	

Vehicle	alim.	kW	Date	Engine	FUNCTIONS ON THE VEHICLE								
					A10	A20	A40	A50	A70	C10 - C30	C20	E01	
ENGINE													
1.6 GTi PureTech 263	Petrol	193	07/18-06/21	EGX (EP6FADTR)									
Engine	Information				A10	A20	A40	A50	A70	C10 - C30	C20	E01	
All engines	x 4, COIL ON PLUG									470 475	C10		
ENGINE													
1.6 PureTech 225	Petrol	165	01/18-06/21	5GG (EP6FADTX), GGR (EP6FADTX)									
Engine	Information				A10	A20	A40	A50	A70	C10 - C30	C20	E01	
All engines	x 4, COIL ON PLUG									470 475	C10		
ENGINE													
1.6 THP	Petrol	112	09/13-06/21	5GX (EP6FTMD)									
Engine	Information				A10	A20	A40	A50	A70	C10 - C30	C20	E01	
All engines	x 4, COIL ON PLUG									470 475	C10		
ENGINE													
1.6 THP	Petrol	115	09/13-06/21	5FV (EP6CDT), 5FV (EP6DT)									
Engine	Information				A10	A20	A40	A50	A70	C10 - C30	C20	E01	
Eng. 5FV (EP6CDT)	x 4, COIL ON PLUG									470 475	C10		
Eng. 5FV (EP6DT)	Qty: 4									470 475	C10		
ENGINE													
1.6 THP 125	Petrol	92	09/13-06/21	5FA (EP6CDT)									
Engine	Information				A10	A20	A40	A50	A70	C10 - C30	C20	E01	
All engines	x 4, COIL ON PLUG									470 475	C10		
ENGINE													
1.6 THP 150	Petrol	110	03/14-06/21	5GX (EP6FTMD)									
Engine	Information				A10	A20	A40	A50	A70	C10 - C30	C20	E01	
All engines	x 4, COIL ON PLUG									470 475	C10		
ENGINE													
1.6 THP 155	Petrol	115	03/14-06/21	5FV (EP6CDT), 5FV (EP6DT)									
Engine	Information				A10	A20	A40	A50	A70	C10 - C30	C20	E01	
Eng. 5FV (EP6CDT)	x 4, COIL ON PLUG									470 475	C10		
Eng. 5FV (EP6DT)	Qty: 4									470 475	C10		
ENGINE													
1.6 THP 163	Petrol	120	06/14-06/21	5FM (EP6CDTM)									
Engine	Information				A10	A20	A40	A50	A70	C10 - C30	C20	E01	
All engines	x 4, COIL ON PLUG									470 475	C10		
ENGINE													
1.6 THP 210	Petrol	155	04/15->	5GM (EP6FDTX)									
Engine	Information				A10	A20	A40	A50	A70	C10 - C30	C20	E01	
All engines	Qty: 4									470 475	C10		
ENGINE													
309 I													
1.1	Petrol	40	10/85-07/89	E1									
Engine	Information				A10	A20	A40	A50	A70	C10 - C30	C20	E01	
All engines	version Bosch						806 124	906 061R					
All engines	version Duellier						815 058	915 094					
All engines	01/01/89 ->									470 106	C10		
All engines											465 005		
ENGINE													
1.3	Petrol	47	10/85-07/89	G1A									
Engine	Information				A10	A20	A40	A50	A70	C10 - C30	C20	E01	
All engines	version Bosch						806 124	906 061R					
All engines	version Duellier						815 058	915 094					
All engines	version Bosch, distr. num. 0 237 002 114								406 153				
All engines	01/01/89 ->									470 106	C10		
All engines											465 005		
ENGINE													
1.3 XL	Petrol	52	09/86-08/89	--									
Engine	Information				A10	A20	A40	A50	A70	C10 - C30	C20	E01	
All engines	version Duellier						815 058	915 094					
All engines	01/01/89 ->									470 106	C10		

A10	CONDENSER	A20	CONTACT SET	A40	DISTRIBUTOR CAP	A50	ROTOR	A70	PICK-UP
C10	COIL	C20	IGNITION MODULE	C30	ELECTRONIC IGNITION KIT	E01	IGNITION CABLE SET		

The present application list is a brief version. For the detailed information about the possibility of installation on a specific vehicle, please refer to our web-catalogue <http://catalogo.facet.eu/>

					FUNCTIONS ON THE VEHICLE							
Vehicle	alim.	kW	Date	Engine	 A10	 A20	 A40	 A50	 A70	 C10 - C30	 C20	 E01
ENGINE												
1.3 XL	Petrol	52	09/86-08/89	--								
ENGINE												
Engine	Information				A10	A20	A40	A50	A70	C10 - C30	C20	E01
All engines											465 005	
ENGINE												
1.4	Petrol	49	03/89-07/89	K1D (TU3A)								
ENGINE												
Engine	Information				A10	A20	A40	A50	A70	C10 - C30	C20	E01
All engines	version Bosch						806 241	906 056R				
All engines	version Ducellier						815 074	915 102R	415 019			
All engines										470 105	C10	359 780
ENGINE												
1.4	Petrol	55	03/89-07/89	KDY (TU3M), KDZ (TU3M)								
ENGINE												
Engine	Information				A10	A20	A40	A50	A70	C10 - C30	C20	E01
All engines	version Bosch						806 241	906 026R				
All engines	version Ducellier						815 074	915 102R	415 019			
All engines										470 105	C10	359 780
ENGINE												
1.4	Petrol	62	08/88-08/89	K2B (TU3S)								
ENGINE												
Engine	Information				A10	A20	A40	A50	A70	C10 - C30	C20	E01
All engines	version Ducellier						815 074	915 102R	415 019			
All engines										470 105	C10	359 780
ENGINE												
1.5	Petrol	63	06/87-12/89	Y2/K								
ENGINE												
Engine	Information				A10	A20	A40	A50	A70	C10 - C30	C20	E01
All engines	version Bosch						806 124	906 025R				
All engines	version Ducellier						815 058	915 094				
All engines	01/01/89 ->									470 106	C10	
All engines											465 005	
ENGINE												
1.6	Petrol	53	08/87-07/89	B1E (XU51C)								
ENGINE												
Engine	Information				A10	A20	A40	A50	A70	C10 - C30	C20	E01
All engines	version Bosch						806 124	906 056R				
All engines	version Ducellier, distr. num. 2525640 A						815 058					
All engines	version Ducellier, distr. num. 2525640 B/C						815 067		415 017			
All engines	version Ducellier							915 094				
All engines											465 005	
ENGINE												
1.6	Petrol	55	10/85-07/89	B1A (XU51C)								
ENGINE												
Engine	Information				A10	A20	A40	A50	A70	C10 - C30	C20	E01
All engines	version Bosch						806 124	906 056R				
All engines	version Ducellier, distr. num. 2525640 A						815 058					
All engines	version Ducellier, distr. num. 2525640 B/C						815 067		415 017			
All engines	version Ducellier							915 094				
All engines											465 005	
ENGINE												
1.6	Petrol	59	10/85-07/89	B1A (XU51C), B1D (XU51C)								
ENGINE												
Engine	Information				A10	A20	A40	A50	A70	C10 - C30	C20	E01
All engines	version Bosch						806 124	906 056R				
All engines	version Ducellier, distr. num. 2525640 A						815 058					
All engines	version Ducellier, distr. num. 2525640 B/C						815 067		415 017			
All engines	version Ducellier							915 094				
All engines											465 005	
ENGINE												
1.6	Petrol	69	01/86-07/89	--								
ENGINE												
Engine	Information				A10	A20	A40	A50	A70	C10 - C30	C20	E01
All engines	version Bosch						806 124	906 061R				
All engines	01/01/89 ->									470 106	C10	
All engines											465 005	

A10 CONDENSER	A20 CONTACT SET	A40 DISTRIBUTOR CAP	A50 ROTOR	A70 PICK-UP
C10 COIL	C20 IGNITION MODULE	C30 ELECTRONIC IGNITION KIT	E01 IGNITION CABLE SET	

Vehicle	alim.	kW	Date	Engine	FUNCTIONS ON THE VEHICLE							
					A10	A20	A40	A50	A70	C10 - C30	C20	E01

ENGINE				
1.6	Petrol	76	11/85-09/88	180Z (XU5J), B6B (XU5J)

Engine	Information	A10	A20	A40	A50	A70	C10 - C30	C20	E01
All engines	version Bosch			806 124	906 056R				
All engines								465 005	
All engines	01/01/88 ->								359 747

ENGINE				
1.6	Petrol	83	07/86-06/89	--

Engine	Information	A10	A20	A40	A50	A70	C10 - C30	C20	E01
All engines	version Bosch			806 124	906 056R				
All engines								465 005	
All engines	01/01/88 ->								359 747

ENGINE				
1.6 Cat	Petrol	55	09/86-12/89	BAZ (XU5CP)

Engine	Information	A10	A20	A40	A50	A70	C10 - C30	C20	E01
All engines	version Bosch			806 124	906 056R				
All engines	distr. num. 2525626 A, version Ducellier			815 058					
All engines	distr. num. 2525626 B/C, version Ducellier, distr. num. 2525683 A/B			815 067		415 017			
All engines	version Ducellier				915 094				
All engines								465 005	359 747

ENGINE				
1.9	Petrol	72	03/86-07/89	DFZ (XU9J1)

Engine	Information	A10	A20	A40	A50	A70	C10 - C30	C20	E01
All engines	version Bosch			806 124	906 056R				
All engines	version Ducellier			815 067	915 094	415 017			
All engines								465 005	
All engines	01/01/88 ->, -> ch. 10561562								359 747

ENGINE				
1.9	Petrol	75	10/85-07/89	D2B (XU9S)

Engine	Information	A10	A20	A40	A50	A70	C10 - C30	C20	E01
All engines	version Bosch			806 124	906 056R				
All engines	version Ducellier			815 067	915 094	415 017			
All engines								465 005	
All engines	01/01/88 ->								359 747

ENGINE				
1.9 GTI	Petrol	94	10/86-07/89	D6B (XU9JA)

Engine	Information	A10	A20	A40	A50	A70	C10 - C30	C20	E01
All engines	version Bosch			806 241	906 056R				
All engines								465 005	

309 II

ENGINE				
1.1	Petrol	40	09/89-10/93	H1B (TU1)

Engine	Information	A10	A20	A40	A50	A70	C10 - C30	C20	E01
All engines	version Bosch			806 241	906 056R				
All engines	version Ducellier			815 074	915 102R	415 019			
All engines	version Marelli				930 060				
All engines							470 105	C10	359 780

ENGINE				
1.1	Petrol	44	08/90-12/93	HDZ (TU1M)

Engine	Information	A10	A20	A40	A50	A70	C10 - C30	C20	E01
All engines	version Bosch			806 241	906 026R				
All engines	version Ducellier			815 074	915 102R	415 019			
All engines							470 105	C10	359 780

ENGINE				
1.4	Petrol	55	07/89-12/93	KDZ (TU3M)

Engine	Information	A10	A20	A40	A50	A70	C10 - C30	C20	E01
All engines	version Bosch			806 241	906 026R				
All engines	version Ducellier			815 074	915 102R	415 019			
All engines							470 105	C10	359 780

A10 CONDENSER	A20 CONTACT SET	A40 DISTRIBUTOR CAP	A50 ROTOR	A70 PICK-UP
C10 COIL	C20 IGNITION MODULE	C30 ELECTRONIC IGNITION KIT	E01 IGNITION CABLE SET	

The present application list is a brief version. For the detailed information about the possibility of installation on a specific vehicle, please refer to our web-catalogue <http://catalogo.facet.eu/>

FUNCTIONS ON THE VEHICLE

Vehicle	alim.	kW	Date	Engine	A10	A20	A40	A50	A70	C10 - C30	C20	E01					
ENGINE																	
1.6	Petrol	65	07/89-12/93	BDZ (XU5M)													
Engine	Information																
All engines	version Ducellier					815 074	915 102R	415 019									
All engines	->year 31/12/91									470 106	C10	359 748					
All engines	01/01/92->									470 188	C10	359 674					
ENGINE																	
1.6	Petrol	68	07/89-12/93	18EM													
Engine	Information																
All engines	version Ducellier					815 074	915 102R	415 019									
All engines										470 106	C10	359 748					
ENGINE																	
1.6	Petrol	69	07/89-12/93	18EM													
Engine	Information																
All engines	version Bosch					806 124	906 061R										
All engines	01/01/91->									470 106	C10						
All engines											465 005						
ENGINE																	
1.6 GTi	Petrol	85	09/89-10/93	--													
Engine	Information																
All engines	->year 31/12/90, version Bosch					806 124	906 056R										
All engines	01/01/91->, version Bosch					806 241	906 026R										
All engines	01/01/91->									470 105	C10	359 491					
All engines											465 005						
All engines	->year 31/12/90, 01/01/88->											359 747					
ENGINE																	
1.9	Petrol	80	10/90-12/93	DDZ (XU9M)													
Engine	Information																
All engines	version Ducellier					815 074	915 102R	415 019									
ENGINE																	
1.9 GTI	Petrol	88	07/89-12/93	DKZ (XU9JAZ)													
Engine	Information																
All engines	version Ducellier					815 074	915 102R										
All engines	01/01/91->									470 105	C10	359 491					
All engines											465 005						
ENGINE																	
1.9 GTI 16V	Petrol	116	08/89-07/90	D6C (XU9JA)													
Engine	Information																
All engines	version Ducellier					815 077	915 104										
All engines	Kit, version Ducellier					815 078											
All engines										470 106	C10	465 005					
4007																	
ENGINE																	
2.0	Petrol	108	11/10-03/13	4B11													
Engine	Information																
All engines	x 4, COIL ON PLUG									470 497	C10						
ENGINE																	
2.0 4x4	Petrol	108	11/10-03/13	4B11													
Engine	Information																
All engines	x 4, COIL ON PLUG									470 497	C10						
ENGINE																	
2.4 16V	Petrol	125	02/07-03/13	SFY (4B12-MMC), SFZ (4B12-MMC)													
Engine	Information																
All engines	x 4, COIL ON PLUG									470 497	C10						
4008																	
ENGINE																	
1.6	Petrol	84	05/12->	MMC													
Engine	Information																
All engines	Qty: 4									470 505	C10						
A10	CONDENSER	A20	CONTACT SET	A40	DISTRIBUTOR CAP	A50	ROTOR	A70	PICK-UP	C10	COIL	C20	IGNITION MODULE	C30	ELECTRONIC IGNITION KIT	E01	IGNITION CABLE SET

Vehicle	alim.	kW	Date	Engine	FUNCTIONS ON THE VEHICLE									
					A10	A20	A40	A50	A70	C10 - C30	C20	E01		
1.6	Petrol	86	05/12->	ENGINE --, 4A92										
Engine	Information				A10	A20	A40	A50	A70	C10 - C30	C20	E01		
Eng. --	Qty: 4									470 505	C10			
Eng. 4A92	x 4, COIL ON PLUG									470 505	C10			
2.0	Petrol	110	05/13->	ENGINE 4B11										
Engine	Information				A10	A20	A40	A50	A70	C10 - C30	C20	E01		
All engines	Qty: 4									470 497	C10			
All engines	x 4, COIL ON PLUG									470 497	C10			
2.0 AWC	Petrol	110	05/12->	ENGINE 4B11										
Engine	Information				A10	A20	A40	A50	A70	C10 - C30	C20	E01		
All engines	x 4, COIL ON PLUG									470 497	C10			
404														
1.6	Petrol	48	04/63-12/71	ENGINE XC6										
Engine	Information				A10	A20	A40	A50	A70	C10 - C30	C20	E01		
All engines						706 040		906 014R						
1.6	Petrol	54	11/67-12/71	ENGINE XC6										
Engine	Information				A10	A20	A40	A50	A70	C10 - C30	C20	E01		
All engines						706 040		906 014R						
1.6	Petrol	59	04/63-12/68	ENGINE XC6										
Engine	Information				A10	A20	A40	A50	A70	C10 - C30	C20	E01		
All engines								906 014R						
1.6 GT	Petrol	50	07/71-12/71	ENGINE XC6										
Engine	Information				A10	A20	A40	A50	A70	C10 - C30	C20	E01		
All engines								906 014R						
405 I														
1.4	Petrol	47	01/87-07/92	ENGINE K5A (TU3)										
Engine	Information				A10	A20	A40	A50	A70	C10 - C30	C20	E01		
All engines	version Bosch						806 241	906 056R						
All engines	version Ducellier						815 074	915 102R	415 019					
All engines										470 105	C10		359 780	
1.6	Petrol	53	07/87-12/92	ENGINE B1E (XU51C)										
Engine	Information				A10	A20	A40	A50	A70	C10 - C30	C20	E01		
All engines	version Ducellier						815 074	915 102R	415 019					
All engines										470 106	C10	465 005	359 748	
1.6	Petrol	55	07/87-06/88	ENGINE B1E (XU51C)										
Engine	Information				A10	A20	A40	A50	A70	C10 - C30	C20	E01		
All engines	version Ducellier						815 074	915 102R	415 019					
All engines										470 106	C10	465 005	359 748	
1.6	Petrol	65	07/87-12/92	ENGINE BDY (XU5M2Z), BDY (XU5M3Z), BDZ (XU5M)										
Engine	Information				A10	A20	A40	A50	A70	C10 - C30	C20	E01		
Eng. BDZ (XU5M)	version Ducellier						815 074	915 102R						
Eng. BDZ (XU5M)										470 106	C10	465 005	359 748	
Eng. BDY (XU5M2Z), BDY (XU5M3Z)													359 674	
1.6	Petrol	66	10/88-12/92	ENGINE BDZ (XU5M)										
Engine	Information				A10	A20	A40	A50	A70	C10 - C30	C20	E01		
All engines	version Ducellier						815 074	915 102R						
All engines										470 106	C10	465 005	359 748	

A10	CONDENSER	A20	CONTACT SET	A40	DISTRIBUTOR CAP	A50	ROTOR	A70	PICK-UP
C10	COIL	C20	IGNITION MODULE	C30	ELECTRONIC IGNITION KIT	E01	IGNITION CABLE SET		

The present application list is a brief version. For the detailed information about the possibility of installation on a specific vehicle, please refer to our web-catalogue <http://catalogo.facet.eu/>

Vehicle	alim.	kW	Date	Engine	FUNCTIONS ON THE VEHICLE									
					A10	A20	A40	A50	A70	C10 - C30	C20	E01		
1.6	Petrol	69	01/87-12/92	ENGINE --, 18EM										
Engine	Information				A10	A20	A40	A50	A70	C10 - C30	C20	E01		
All engines	version Bosch						806 241	906 056R						
All engines	version Ducellier						815 074	915 102R	415 019					
All engines										470 106	C10		359 748	
1.6 4x4	Petrol	65	04/88-07/92	ENGINE BDZ (XU5M)										
Engine	Information				A10	A20	A40	A50	A70	C10 - C30	C20	E01		
All engines	version Ducellier						815 074	915 102R						
All engines										470 106	C10	465 005	359 748	
1.6 Sri 4x4	Petrol	65	04/88-07/92	ENGINE BDZ (XU5M)										
Engine	Information				A10	A20	A40	A50	A70	C10 - C30	C20	E01		
All engines	version Ducellier						815 074	915 102R						
All engines										470 106	C10	465 005	359 748	
1.9	Petrol	116	06/87-07/92	ENGINE D6C (XU9J4)										
Engine	Information				A10	A20	A40	A50	A70	C10 - C30	C20	E01		
All engines	version Ducellier						815 077	915 104						
All engines	Kit, version Ducellier						815 078							
All engines										470 106	C10	465 005		
1.9	Petrol	70	07/87-12/92	ENGINE D2C (XU92C)										
Engine	Information				A10	A20	A40	A50	A70	C10 - C30	C20	E01		
All engines	version Bosch						806 241	906 026R						
All engines	version Ducellier						815 074	915 102R	415 019					
All engines										470 106	C10		359 748	
1.9	Petrol	72	05/88-07/92	ENGINE DFZ (XU9J1)										
Engine	Information				A10	A20	A40	A50	A70	C10 - C30	C20	E01		
All engines	version Bosch						806 124	906 056R						
All engines	version Ducellier						815 067	915 102R	415 017					
All engines											465 005		359 747	
1.9	Petrol	77	10/88-08/92	ENGINE DFZ (XU9J1)										
Engine	Information				A10	A20	A40	A50	A70	C10 - C30	C20	E01		
All engines	version Bosch						806 124	906 056R						
All engines	version Ducellier						815 067	915 102R	415 017					
All engines											465 005		359 747	
1.9	Petrol	80	06/87-08/92	ENGINE DDZ (XU9M)										
Engine	Information				A10	A20	A40	A50	A70	C10 - C30	C20	E01		
All engines	version Ducellier						815 074	915 102R						
1.9	Petrol	88	06/87-08/92	ENGINE DKZ (XU9JAZ)										
Engine	Information				A10	A20	A40	A50	A70	C10 - C30	C20	E01		
All engines	version Ducellier						815 074	915 102R						
All engines	ch. 8819069 ->									470 105	C10			
All engines											465 005			
1.9	Petrol	90	01/89-12/92	ENGINE D6A (XU9J2)										
Engine	Information				A10	A20	A40	A50	A70	C10 - C30	C20	E01		
All engines	version Bosch						806 241	906 056R						
All engines										470 106	C10			
1.9	Petrol	93	07/87-12/93	ENGINE D6A (XU9J2)										
Engine	Information				A10	A20	A40	A50	A70	C10 - C30	C20	E01		
All engines	version Bosch						806 241	906 056R						
All engines										470 106	C10			

A10	CONDENSER	A20	CONTACT SET	A40	DISTRIBUTOR CAP	A50	ROTOR	A70	PICK-UP
C10	COIL	C20	IGNITION MODULE	C30	ELECTRONIC IGNITION KIT	E01	IGNITION CABLE SET		

Vehicle	alim.	kW	Date	Engine	FUNCTIONS ON THE VEHICLE									
					A10	A20	A40	A50	A70	C10 - C30	C20	E01		
ENGINE														
1.9 4x4	Petrol	116	06/87-07/92	D6C (XU9J4)										
Engine	Information				A10	A20	A40	A50	A70	C10 - C30	C20	E01		
All engines	version Ducellier						815 077	915 104						
All engines	Kit, version Ducellier						815 078							
All engines										470 106	C10	465 005		
ENGINE														
1.9 4x4	Petrol	80	07/88-12/92	DDZ (XU9M)										
Engine	Information				A10	A20	A40	A50	A70	C10 - C30	C20	E01		
All engines	version Ducellier						815 074	915 102R						
ENGINE														
1.9 4x4	Petrol	88	06/87-07/92	DKZ (XU9JAZ)										
Engine	Information				A10	A20	A40	A50	A70	C10 - C30	C20	E01		
All engines	version Ducellier						815 074	915 102R						
All engines	ch. 8819069 ->									470 105	C10			
All engines											465 005			
ENGINE														
1.9 Injection	Petrol	77	07/87-12/92	DFZ (XU9J1)										
Engine	Information				A10	A20	A40	A50	A70	C10 - C30	C20	E01		
All engines	version Bosch						806 124	906 056R						
All engines	version Ducellier						815 067	915 102R	415 017					
All engines											465 005	359 747		
ENGINE														
1.9 Sport MI-16	Petrol	108	06/87-07/92	DFW (XU9J4Z)										
Engine	Information				A10	A20	A40	A50	A70	C10 - C30	C20	E01		
All engines	version Ducellier						815 077	915 104						
All engines	Kit, version Ducellier						815 078							
All engines										470 106	C10	465 005		
ENGINE														
1.9 Sport MI-16	Petrol	116	07/87-11/92	D6C (XU9J4)										
Engine	Information				A10	A20	A40	A50	A70	C10 - C30	C20	E01		
All engines	version Ducellier						815 077	915 104						
All engines	Kit, version Ducellier						815 078							
All engines										470 106	C10	465 005		
ENGINE														
1.9 Sport MI-16 4x4	Petrol	108	06/87-07/92	DFW (XU9J4Z)										
Engine	Information				A10	A20	A40	A50	A70	C10 - C30	C20	E01		
All engines	version Ducellier						815 077	915 104						
All engines	Kit, version Ducellier						815 078							
All engines										470 106	C10	465 005		
ENGINE														
1.9 Trazione integrale	Petrol	116	06/87-07/92	D6C (XU9J4)										
Engine	Information				A10	A20	A40	A50	A70	C10 - C30	C20	E01		
All engines	version Ducellier						815 077	915 104						
All engines	Kit, version Ducellier						815 078							
All engines										470 106	C10	465 005		
ENGINE														
1.9 Trazione integrale	Petrol	77	09/88-07/92	DFZ (XU9J1)										
Engine	Information				A10	A20	A40	A50	A70	C10 - C30	C20	E01		
All engines	version Bosch						806 124	906 056R						
All engines	version Ducellier						815 067	915 102R	415 017					
All engines											465 005	359 747		
405 II														
ENGINE														
1.6	Petrol	65	08/92-10/96	BDY (XU5M2Z), BDY (XU5M3Z), BDZ (XU5M), BFZ (XU5JP)										
Engine	Information				A10	A20	A40	A50	A70	C10 - C30	C20	E01		
All engines										470 188	C10	359 674		

A10	CONDENSER	A20	CONTACT SET	A40	DISTRIBUTOR CAP	A50	ROTOR	A70	PICK-UP
C10	COIL	C20	IGNITION MODULE	C30	ELECTRONIC IGNITION KIT	E01	IGNITION CABLE SET		

The present application list is a brief version. For the detailed information about the possibility of installation on a specific vehicle, please refer to our web-catalogue <http://catalogo.facet.eu/>









					FUNCTIONS ON THE VEHICLE							
Vehicle	alim.	kW	Date	Engine	 A10	 A20	 A40	 A50	 A70	 C10 - C30	 C20	 E01
ENGINE												
1.6	Petrol	66	08/92-05/97	18EM, BFZ (XU5JP)								
Engine	Information											
Eng. 18EM	version Bosch					806 241	906 056R					
Eng. 18EM	version Ducellier					815 074	915 102R	415 019				
Eng. 18EM									470 106	C10		359 748
Eng. BFZ (XU5JP)									470 188	C10		359 674
ENGINE												
1.6	Petrol	68	08/92-08/94	18EM, BDZ (XU5M), BFZ (XU5JP)								
Engine	Information											
Eng. 18EM	version Bosch					806 241	906 056R					
Eng. 18EM	version Ducellier					815 074	915 102R	415 019				
Eng. 18EM									470 106	C10		359 748
Eng. BDZ (XU5M), BFZ (XU5JP)									470 188	C10		359 674
ENGINE												
1.8	Petrol	74	08/92-10/96	LFZ (XU7JP)								
Engine	Information											
All engines									470 188	C10		359 674
ENGINE												
2.0	Petrol	89	08/92-10/96	RFX (XU10J2)								
Engine	Information											
All engines									470 188	C10		359 494
ENGINE												
2.0 4x4	Petrol	89	08/92-10/96	RFX (XU10J2)								
Engine	Information											
All engines									470 188	C10		359 494
ENGINE												
2.0 X4	Petrol	89	08/92-10/95	RFX (XU10J2)								
Engine	Information											
All engines									470 188	C10		359 494
406												
ENGINE												
1.6	Petrol	65	11/95-05/04	BFZ (XU5JP)								
Engine	Information											
All engines	x 1, D.I.S., connector type, saw teeth								470 188	C10		
All engines												359 674
ENGINE												
1.8	Petrol	66	05/97-10/04	LFZ (XU7JB)								
Engine	Information											
All engines	x 1, D.I.S., connector type, saw teeth								470 188	C10		
All engines												359 674
ENGINE												
1.8	Petrol	74	10/96-03/99	L6A (XU7JP), LFZ (XU7JP)								
Engine	Information											
Eng. LFZ (XU7JP)									470 188	C10		359 674
All engines	x 1, D.I.S., connector type, saw teeth								470 188	C10		
ENGINE												
1.8 16V	Petrol	85	10/00-10/04	6FZ (EW7J4)								
Engine	Information											
All engines	x 4, COIL ON PLUG								470 408	C10		
ENGINE												
1.8 BiFuel	Petrol/ Liquified Petro- leum Gas (LPG)	85	09/00-05/04	6FZ (EW7J4)								
Engine	Information											
All engines	x 4, COIL ON PLUG								470 408	C10		

A10 CONDENSER	A20 CONTACT SET	A40 DISTRIBUTOR CAP	A50 ROTOR	A70 PICK-UP
C10 COIL	C20 IGNITION MODULE	C30 ELECTRONIC IGNITION KIT	E01 IGNITION CABLE SET	

Vehicle	alim.	kW	Date	Engine	FUNCTIONS ON THE VEHICLE									
					A10	A20	A40	A50	A70	C10 - C30	C20	E01		
ENGINE														
2.0 16V	Petrol	100	08/00-12/04	RFN (EW10J4), RFV (XU10J4R)										
Engine	Information				A10	A20	A40	A50	A70	C10 - C30	C20	E01		
All engines	x 4, COIL ON PLUG									470 408	C10			
ENGINE														
2.0 16V	Petrol	99	01/99-10/00	RFR (DEW10J4), RFR (EW10J4)										
Engine	Information				A10	A20	A40	A50	A70	C10 - C30	C20	E01		
Eng. RFR (DEW10J4)	incl. spark plug connector									470 408	C10			
Eng. RFR (EW10J4)	x 4, COIL ON PLUG									470 408	C10			
ENGINE														
2.0 Turbo	Petrol	108	04/96-10/04	RGX (XU10J2TE)										
Engine	Information				A10	A20	A40	A50	A70	C10 - C30	C20	E01		
All engines	x 1, D.I.S., connector type, saw teeth									470 188	C10			
All engines													359 494	
ENGINE														
2.2	Petrol	116	07/00-12/04	3FZ (EW12J4)										
Engine	Information				A10	A20	A40	A50	A70	C10 - C30	C20	E01		
All engines	x 4, COIL ON PLUG									470 509	C10			
407														
ENGINE														
1.8	Petrol	85	03/04-07/05	6FZ (EW7J4)										
Engine	Information				A10	A20	A40	A50	A70	C10 - C30	C20	E01		
All engines	x 4, COIL ON PLUG									470 408	C10			
ENGINE														
1.8 16V	Petrol	92	08/05-12/10	6FY (EW7A)										
Engine	Information				A10	A20	A40	A50	A70	C10 - C30	C20	E01		
All engines	x 4, COIL ON PLUG									470 408	C10			
ENGINE														
2.0	Petrol	100	03/04-07/05	RFN (EW10J4)										
Engine	Information				A10	A20	A40	A50	A70	C10 - C30	C20	E01		
All engines	x 4, COIL ON PLUG									470 408	C10			
ENGINE														
2.0 16V	Petrol	103	08/05-12/10	RFJ (EW10A)										
Engine	Information				A10	A20	A40	A50	A70	C10 - C30	C20	E01		
All engines	x 1, COIL ON PLUG									470 476	C10			
ENGINE														
2.0 Bioflex	Petrol/ Ethanol	103	09/07-02/11	RFJ (EW10A)										
Engine	Information				A10	A20	A40	A50	A70	C10 - C30	C20	E01		
All engines	x 1, COIL ON PLUG									470 476	C10			
ENGINE														
2.0 Flex	Petrol/ Ethanol	103	10/05-02/11	RFJ (EW10A)										
Engine	Information				A10	A20	A40	A50	A70	C10 - C30	C20	E01		
All engines	x 1, COIL ON PLUG									470 476	C10			
ENGINE														
2.2	Petrol	116	03/04-10/06	3FZ (EW12J4)										
Engine	Information				A10	A20	A40	A50	A70	C10 - C30	C20	E01		
All engines	x 4, COIL ON PLUG									470 509	C10			
ENGINE														
2.2 16V	Petrol	120	08/05->	3FY (EW12J4)										
Engine	Information				A10	A20	A40	A50	A70	C10 - C30	C20	E01		
All engines	x 4, COIL ON PLUG									470 509	C10			
5008 I														
ENGINE														
1.2	Petrol	96	01/15-03/17	HNY (EB2DTS)										
Engine	Information				A10	A20	A40	A50	A70	C10 - C30	C20	E01		
All engines	x 3, COIL ON PLUG									470 620	C10			

A10	CONDENSER	A20	CONTACT SET	A40	DISTRIBUTOR CAP	A50	ROTOR	A70	PICK-UP
C10	COIL	C20	IGNITION MODULE	C30	ELECTRONIC IGNITION KIT	E01	IGNITION CABLE SET		









The present application list is a brief version. For the detailed information about the possibility of installation on a specific vehicle, please refer to our web-catalogue <http://catalogo.facet.eu/>

				FUNCTIONS ON THE VEHICLE															
Vehicle	alim.	kW	Date	Engine	 A10	 A20	 A40	 A50	 A70	 C10 - C30	 C20	 E01							
				ENGINE															
1.6 16V	Petrol	115	09/09-03/17	5FV (EP6CDT)															
Engine		Information			A10	A20	A40	A50	A70	C10 - C30	C20	E01							
All engines		x 4, COIL ON PLUG								470 475	C10								
				ENGINE															
1.6 16V	Petrol	88	09/09-03/17	5F5 (EP6C), 5FW (EP6), EP6															
Engine		Information			A10	A20	A40	A50	A70	C10 - C30	C20	E01							
All engines		x 4, COIL ON PLUG								470 475	C10								
				ENGINE															
1.6 THP 150	Petrol	110	02/12-03/17	5FX (EP6DT)															
Engine		Information			A10	A20	A40	A50	A70	C10 - C30	C20	E01							
All engines		x 4, COIL ON PLUG								470 475	C10								
				ENGINE															
1.6 THP 163	Petrol	120	02/12-03/17	5GZ (EP6FDT)															
Engine		Information			A10	A20	A40	A50	A70	C10 - C30	C20	E01							
All engines		x 4, COIL ON PLUG								470 475	C10								
				ENGINE															
1.6 THP 165	Petrol	121	02/12-03/17	5GZ (EP6FDT)															
Engine		Information			A10	A20	A40	A50	A70	C10 - C30	C20	E01							
All engines		x 4, COIL ON PLUG								470 475	C10								
				ENGINE															
5008 II				ENGINE															
1.6	Petrol	110	07/18->	5GX (EP6FDTMD)															
Engine		Information			A10	A20	A40	A50	A70	C10 - C30	C20	E01							
All engines		x 4, COIL ON PLUG								470 475	C10								
				ENGINE															
1.6 PureTech 180	Petrol	133	07/18->	5GF (EP6FADTXD)															
Engine		Information			A10	A20	A40	A50	A70	C10 - C30	C20	E01							
All engines		x 4, COIL ON PLUG								470 475	C10								
				ENGINE															
1.6 THP 165	Petrol	121	12/16->	5GY (EP6FDTM), 5GZ (EP6FDT)															
Engine		Information			A10	A20	A40	A50	A70	C10 - C30	C20	E01							
All engines		x 4, COIL ON PLUG								470 475	C10								
				ENGINE															
504				ENGINE															
1.8	Petrol	54	04/71-07/86	XM7															
Engine		Information			A10	A20	A40	A50	A70	C10 - C30	C20	E01							
All engines						706 040, 715 111U		906 014R											
				ENGINE															
1.8	Petrol	55	09/79-08/82	XM7															
Engine		Information			A10	A20	A40	A50	A70	C10 - C30	C20	E01							
All engines		version Ducellier					815 058	915 091											
				ENGINE															
1.8	Petrol	58	01/71-06/83	XM7															
Engine		Information			A10	A20	A40	A50	A70	C10 - C30	C20	E01							
All engines						706 040, 715 111U		906 014R											
All engines		version Ducellier					815 058	915 091											
				ENGINE															
1.8 Injection	Petrol	71	07/68-02/71	KF5, KF6															
Engine		Information			A10	A20	A40	A50	A70	C10 - C30	C20	E01							
All engines		version Ducellier			615 023	715 055	815 054	915 091											
				ENGINE															
2.0	Petrol	68	04/71-07/86	XN1															
Engine		Information			A10	A20	A40	A50	A70	C10 - C30	C20	E01							
All engines						706 040		906 014R											
				ENGINE															
2.0	Petrol	71	03/71-06/86	106 (XN1)															
Engine		Information			A10	A20	A40	A50	A70	C10 - C30	C20	E01							
All engines						706 040		906 014R											
A10		CONDENSER		A20		CONTACT SET		A40		DISTRIBUTOR CAP		A50		ROTOR		A70		PICK-UP	
C10		COIL		C20		IGNITION MODULE		C30		ELECTRONIC IGNITION KIT		E01		IGNITION CABLE SET					

Vehicle	alim.	kW	Date	Engine	FUNCTIONS ON THE VEHICLE									
					A10	A20	A40	A50	A70	C10 - C30	C20	E01		
ENGINE														
2.0	Petrol	78	08/82-08/84	107 (XN2)										
ENGINE														
Engine	Information				A10	A20	A40	A50	A70	C10 - C30	C20	E01		
All engines						706 040								
ENGINE														
2.0 TI	Petrol	78	01/71-06/83	107 (XN2)										
ENGINE														
Engine	Information				A10	A20	A40	A50	A70	C10 - C30	C20	E01		
All engines						706 040								
ENGINE														
505														
1.8	Petrol	55	06/81-10/85	105 (XM7)										
ENGINE														
Engine	Information				A10	A20	A40	A50	A70	C10 - C30	C20	E01		
All engines	version Ducellier				615 034	715 105	815 054	915 091						
All engines						706 040		906 014R		470 101D	C10			
ENGINE														
1.8	Petrol	60	01/82-10/85	105 (XM7)										
ENGINE														
Engine	Information				A10	A20	A40	A50	A70	C10 - C30	C20	E01		
All engines	version Ducellier				615 034	715 105	815 054	915 091						
All engines						706 040				470 101D	C10			
ENGINE														
1.8	Petrol	62	09/85-10/86	105C (XM7A)										
ENGINE														
Engine	Information				A10	A20	A40	A50	A70	C10 - C30	C20	E01		
All engines	version Ducellier				615 034		815 054	915 091						
ENGINE														
2.0	Petrol	60	04/82-11/87	--										
ENGINE														
Engine	Information				A10	A20	A40	A50	A70	C10 - C30	C20	E01		
All engines						706 040								
ENGINE														
2.0	Petrol	69	08/83-12/85	106 (XN1)										
ENGINE														
Engine	Information				A10	A20	A40	A50	A70	C10 - C30	C20	E01		
All engines						706 040		906 014R						
ENGINE														
2.0	Petrol	71	11/80-12/85	106 (XN1)										
ENGINE														
Engine	Information				A10	A20	A40	A50	A70	C10 - C30	C20	E01		
All engines						706 040		906 014R						
ENGINE														
2.0	Petrol	72	09/85-09/95	106E (XN1A)										
ENGINE														
Engine	Information				A10	A20	A40	A50	A70	C10 - C30	C20	E01		
All engines	version Bosch						806 079	906 055R						
All engines	version Ducellier						815 054	915 094						
All engines	version Marelli						830 098	930 047R	430 178M					
All engines											465 005			
ENGINE														
2.0 TI, STI	Petrol	81	08/79-10/86	829 (ZEJ)										
ENGINE														
Engine	Information				A10	A20	A40	A50	A70	C10 - C30	C20	E01		
All engines	version Bosch						806 079	906 056R	406 153					
All engines	version Ducellier						815 059	915 091						
All engines	->year 31/12/85										465 005			
ENGINE														
2.2	Petrol	84	01/86-12/93	851X (ZDJL)										
ENGINE														
Engine	Information				A10	A20	A40	A50	A70	C10 - C30	C20	E01		
All engines	version Bosch						806 079	906 055R						
All engines	version Bosch, distr. num. 0 237 035 001								406 159					
All engines											465 005			
ENGINE														
2.2	Petrol	85	05/81-10/84	851 (ZDJ)										
ENGINE														
Engine	Information				A10	A20	A40	A50	A70	C10 - C30	C20	E01		
All engines	version Bosch						806 079	906 055R						
All engines	version Bosch, distr. num. 0 237 035 001								406 159					
All engines											465 005			

A10	CONDENSER	A20	CONTACT SET	A40	DISTRIBUTOR CAP	A50	ROTOR	A70	PICK-UP
C10	COIL	C20	IGNITION MODULE	C30	ELECTRONIC IGNITION KIT	E01	IGNITION CABLE SET		

The present application list is a brief version. For the detailed information about the possibility of installation on a specific vehicle, please refer to our web-catalogue <http://catalogo.facet.eu/>







				FUNCTIONS ON THE VEHICLE								
Vehicle	alim.	kW	Date	Engine	 A10	 A20	 A40	 A50	 A70	 C10 - C30	 C20	 E01
				ENGINE								
2.2 GTI	Petrol	90	08/83-12/93	851B (ZDJL)								
Engine	Information											
All engines	version Bosch					806 079	906 055R					
All engines	version Bosch, distr. num. 0 237 035 001							406 159				
All engines											465 005	
				ENGINE								
508 I				ENGINE								
1.6	Petrol	121	02/12-12/18	5GZ (EP6FDT)								
Engine	Information											
All engines	x 4, COIL ON PLUG									470 475	C10	
				ENGINE								
1.6 THP	Petrol	110	11/10-12/18	5FE (EP6CDTM), 5FN (EP6CDT)								
Engine	Information											
All engines	x 4, COIL ON PLUG									470 475	C10	
				ENGINE								
1.6 THP	Petrol	115	11/10-12/18	5FV (EP6CDT)								
Engine	Information											
All engines	x 4, COIL ON PLUG									470 475	C10	
				ENGINE								
1.6 THP	Petrol	120	05/11->	5GZ (EP6FDT), EP6CDT M								
Engine	Information											
Eng. 5GZ (EP6FDT)	x 4, COIL ON PLUG									470 475	C10	
Eng. EP6CDT M	Qty: 4									470 475	C10	
				ENGINE								
1.6 THP	Petrol	121	09/11-12/18	5GZ (EP6FDT)								
Engine	Information											
All engines	x 4, COIL ON PLUG									470 475	C10	
				ENGINE								
1.6 Vti	Petrol	85	11/10-12/18	5FH (EP6C)								
Engine	Information											
All engines	x 4, COIL ON PLUG									470 475	C10	
				ENGINE								
1.6 Vti	Petrol	88	11/10-12/18	5FS (EP6C)								
Engine	Information											
All engines	x 4, COIL ON PLUG									470 475	C10	
				ENGINE								
				ENGINE								
508 II				ENGINE								
1.6 PureTech 180	Petrol	133	09/18->	5GF (EP6FADTXD), GFR (EP6FADTXD)								
Engine	Information											
All engines	x 4, COIL ON PLUG									470 475	C10	
				ENGINE								
1.6 PureTech 225	Petrol	165	09/18->	5GG (EP6FADTX), GCR (EP6FADTX)								
Engine	Information											
All engines	x 4, COIL ON PLUG									470 475	C10	
				ENGINE								
1.6 THP 150	Petrol	110	09/18->	5GX (EP6FTMD)								
Engine	Information											
All engines	x 4, COIL ON PLUG									470 475	C10	
				ENGINE								
1.6 THP 165	Petrol	121	09/18->	5GY (EP6FTM)								
Engine	Information											
All engines	x 4, COIL ON PLUG									470 475	C10	
				ENGINE								
Hybrid 224	Petrol/ Electric	133	08/19->	5GQ (EP6FADTXHPD)								
Engine	Information											
All engines	x 4, COIL ON PLUG									470 475	C10	

A10 CONDENSER	A20 CONTACT SET	A40 DISTRIBUTOR CAP	A50 ROTOR	A70 PICK-UP
C10 COIL	C20 IGNITION MODULE	C30 ELECTRONIC IGNITION KIT	E01 IGNITION CABLE SET	

Vehicle	alim.	kW	Date	Engine	FUNCTIONS ON THE VEHICLE								
					A10	A20	A40	A50	A70	C10 - C30	C20	E01	
ENGINE													
Hybrid 224	Petrol/ Electric	165	08/19->	5GQ (EP6FADTXHPD)									
Engine	Information												
All engines	x 4, COIL ON PLUG									470 475	C10		E01
ENGINE													
Hybrid 225	Petrol/ Electric	133	08/19->	5GQ (EP6FADTXHPD)									
Engine	Information												
All engines	x 4, COIL ON PLUG									470 475	C10		E01
ENGINE													
Hybrid 225	Petrol/ Electric	165	08/19->	5GQ (EP6FADTXHPD)									
Engine	Information												
All engines	x 4, COIL ON PLUG									470 475	C10		E01
604													
ENGINE													
2.0 i	Petrol	0	01/85-12/86	XN6									
Engine	Information												
All engines	version Ducellier					815 079	915 094						
ENGINE													
2.7 SL	Petrol	100	08/77-05/83	112 (ZM)									
Engine	Information												
All engines	version Bosch						906 049R						
ENGINE													
2.7 TI, STI	Petrol	106	08/77-05/83	140 (ZMJ)									
Engine	Information												
All engines	version Bosch						906 049R						
605													
ENGINE													
2.0	Petrol	79	02/90-09/99	--									
Engine	Information												
All engines	version Ducellier					815 074	915 102R						
ENGINE													
2.0	Petrol	84	06/89-09/99	R5A (XU102C)									
Engine	Information												
All engines	version Ducellier					815 074	915 102R	415 019					
ENGINE													
2.0	Petrol	89	06/89-09/99	RFZ (XU10J2Z)									
Engine	Information												
All engines										470 188	C10		359 494
ENGINE													
2.0 Turbo	Petrol	104	07/92-09/99	RGY (XU10J2TE)									
Engine	Information												
All engines										470 188	C10		359 494
ENGINE													
2.0 Turbo	Petrol	108	07/91-09/99	RGX (XU10J2TE)									
Engine	Information												
All engines										470 188	C10		359 494
ENGINE													
3.0	Petrol	123	08/89-09/99	UFZ (ZPJ)									
Engine	Information												
All engines	version Bosch					806 252	906 119R						
All engines												465 034	
ENGINE													
3.0	Petrol	147	08/89-06/94	UKZ (ZPJ4/Z)									
Engine	Information												
All engines	version Bosch					806 252	906 119R						
All engines												465 034	

A10	CONDENSER	A20	CONTACT SET	A40	DISTRIBUTOR CAP	A50	ROTOR	A70	PICK-UP
C10	COIL	C20	IGNITION MODULE	C30	ELECTRONIC IGNITION KIT	E01	IGNITION CABLE SET		

The present application list is a brief version. For the detailed information about the possibility of installation on a specific vehicle, please refer to our web-catalogue <http://catalogo.facet.eu/>









					FUNCTIONS ON THE VEHICLE							
Vehicle	alim.	kW	Date	Engine								
3.0 SV 24												
	Petrol	147	08/89-09/99	ENGINE UKZ (ZPJ4/Z)								
Engine	Information				A10	A20	A40	A50	A70	C10 - C30	C20	E01
All engines	version Bosch						806 252	906 119R				
All engines											465 034	
607												
2.0												
	Petrol	100	02/00-08/05	ENGINE RFN (EW10J4)								
Engine	Information				A10	A20	A40	A50	A70	C10 - C30	C20	E01
All engines	x 4, COIL ON PLUG									470 408	C10	
2.2 16V												
	Petrol	116	02/00-08/05	ENGINE 3FZ (EW12J4)								
Engine	Information				A10	A20	A40	A50	A70	C10 - C30	C20	E01
All engines	euro 4 (D4), x 4, COIL ON PLUG									470 476	C10	
All engines	euro 3, x 4, COIL ON PLUG									470 509	C10	
2.2 16V												
	Petrol	120	09/05-06/10	ENGINE 3FY (EW12J4)								
Engine	Information				A10	A20	A40	A50	A70	C10 - C30	C20	E01
All engines	euro 4 (D4), x 4, COIL ON PLUG									470 476	C10	
All engines	euro 3, x 4, COIL ON PLUG									470 509	C10	
806												
1.8												
	Petrol	73	07/95-08/02	ENGINE LFW (XU7JP)								
Engine	Information				A10	A20	A40	A50	A70	C10 - C30	C20	E01
All engines	x 1, D.I.S., connector type, saw teeth									470 188	C10	
All engines												359 674
2.0												
	Petrol	100	05/00-02/03	ENGINE RFN (EW10J4)								
Engine	Information				A10	A20	A40	A50	A70	C10 - C30	C20	E01
All engines	x 4, COIL ON PLUG									470 408	C10	
2.0												
	Petrol	108	02/97-05/00	ENGINE RGX (XU10J2TE)								
Engine	Information				A10	A20	A40	A50	A70	C10 - C30	C20	E01
All engines	x 1, D.I.S., connector type, saw teeth									470 188	C10	
2.0												
	Petrol	89	06/94-08/02	ENGINE RFU (XU10J2)								
Engine	Information				A10	A20	A40	A50	A70	C10 - C30	C20	E01
All engines	x 1, D.I.S., connector type, saw teeth									470 188	C10	
All engines												359 494
2.0 16V												
	Petrol	100	09/00-08/02	ENGINE RFN (EW10J4)								
Engine	Information				A10	A20	A40	A50	A70	C10 - C30	C20	E01
All engines	x 4, COIL ON PLUG									470 408	C10	
2.0 Turbo												
	Petrol	108	06/94-08/02	ENGINE RGX (XU10J2TE)								
Engine	Information				A10	A20	A40	A50	A70	C10 - C30	C20	E01
All engines	x 1, D.I.S., connector type, saw teeth									470 188	C10	
All engines												359 494
807												
2.0												
	Petrol	100	06/02->	ENGINE RFN (EW10J4)								
Engine	Information				A10	A20	A40	A50	A70	C10 - C30	C20	E01
All engines	x 4, COIL ON PLUG									470 408	C10	
2.0 16V												
	Petrol	103	09/05->	ENGINE RFJ (EW10A)								
Engine	Information				A10	A20	A40	A50	A70	C10 - C30	C20	E01
All engines	x 1, COIL ON PLUG									470 476	C10	
2.2												
	Petrol	116	06/02->	ENGINE 3FZ (EW12J4)								
Engine	Information				A10	A20	A40	A50	A70	C10 - C30	C20	E01
All engines	x 4, COIL ON PLUG									470 509	C10	

A10 CONDENSER	A20 CONTACT SET	A40 DISTRIBUTOR CAP	A50 ROTOR	A70 PICK-UP
C10 COIL	C20 IGNITION MODULE	C30 ELECTRONIC IGNITION KIT	E01 IGNITION CABLE SET	

Vehicle	alim.	kW	Date	Engine	FUNCTIONS ON THE VEHICLE									
					A10	A20	A40	A50	A70	C10 - C30	C20	E01		
BIPPER														
1.4	Petrol	54	02/08->	ENGINE KFV (TU3A)										
Engine		Information			A10	A20	A40	A50	A70	C10 - C30	C20	E01		
All engines		x 4, COIL ON PLUG								470 405	C10			
BIPPER TEPEE														
1.4	Petrol	54	04/08->	ENGINE KFV (TU3A)										
Engine		Information			A10	A20	A40	A50	A70	C10 - C30	C20	E01		
All engines		x 4, COIL ON PLUG								470 405	C10			
BOXER I														
2.0	Petrol	81	12/01->	ENGINE RFL (XU10J2U)										
Engine		Information			A10	A20	A40	A50	A70	C10 - C30	C20	E01		
All engines		x 1, D.I.S., connector type, saw teeth								470 188	C10			
All engines													359 674	
2.0 4x4														
2.0 4x4	Petrol	80	03/96-09/98	ENGINE --										
Engine		Information			A10	A20	A40	A50	A70	C10 - C30	C20	E01		
All engines										470 188	C10		359 674	
2.0 i														
2.0 i	Petrol	80	03/94-04/02	ENGINE RFW (XU10J2)										
Engine		Information			A10	A20	A40	A50	A70	C10 - C30	C20	E01		
All engines										470 188	C10		359 674	
2.0 i 4x4														
2.0 i 4x4	Petrol	80	08/96-04/02	ENGINE RFW (XU10J2)										
Engine		Information			A10	A20	A40	A50	A70	C10 - C30	C20	E01		
All engines										470 188	C10		359 674	
EXPERT I														
1.6	Petrol	58	02/96-09/00	ENGINE 222A2 (1580 SPI)										
Engine		Information			A10	A20	A40	A50	A70	C10 - C30	C20	E01		
All engines		x 1, D.I.S., connector type, saw teeth								470 168	C10			
All engines													359 655	
1.8														
1.8	Petrol	74	10/96-09/00	ENGINE LFZ (XU7JP)										
Engine		Information			A10	A20	A40	A50	A70	C10 - C30	C20	E01		
All engines		x 1, D.I.S., connector type, saw teeth								470 188	C10			
All engines													359 674	
2.0														
2.0	Petrol	100	07/00-12/06	ENGINE RFN (EW10J4)										
Engine		Information			A10	A20	A40	A50	A70	C10 - C30	C20	E01		
All engines		x 4, COIL ON PLUG								470 408	C10			
EXPERT II														
2.0 16V	Petrol	103	01/07->	ENGINE RFH (EW10A), RFJ (EW10A)										
Engine		Information			A10	A20	A40	A50	A70	C10 - C30	C20	E01		
All engines		x 1, COIL ON PLUG								470 476	C10			
EXPERT II TEPEE														
2.0 16V	Petrol	103	01/07-03/16	ENGINE RFH (EW10A), RFJ (EW10A)										
Engine		Information			A10	A20	A40	A50	A70	C10 - C30	C20	E01		
All engines		x 1, COIL ON PLUG								470 476	C10			
J5														
1.8	Petrol	51	01/83-11/88	ENGINE 169B (XM7T)										
Engine		Information			A10	A20	A40	A50	A70	C10 - C30	C20	E01		
All engines		version Ducellier					815 054	915 094						
All engines													465 005	

A10 CONDENSER	A20 CONTACT SET	A40 DISTRIBUTOR CAP	A50 ROTOR	A70 PICK-UP
C10 COIL	C20 IGNITION MODULE	C30 ELECTRONIC IGNITION KIT	E01 IGNITION CABLE SET	

The present application list is a brief version. For the detailed information about the possibility of installation on a specific vehicle, please refer to our web-catalogue <http://catalogo.facet.eu/>

					FUNCTIONS ON THE VEHICLE							
Vehicle	alim.	kW	Date	Engine	 A10	 A20	 A40	 A50	 A70	 C10 - C30	 C20	 E01
J9												
1.6	Petrol	44	03/80-06/87	XC7P	ENGINE							
Engine Information					A10	A20	A40	A50	A70	C10 - C30	C20	E01
All engines version Ducellier					615 034	715 105	815 054	915 091				
2.0	Petrol	57	03/80-06/87	XN1P	ENGINE							
Engine Information					A10	A20	A40	A50	A70	C10 - C30	C20	E01
All engines version Ducellier							815 054	915 094				
All engines											465 005	
PARTNER I												
1.1	Petrol	44	06/96->	HDY (TU1M), HDZ (TU1M), HFX (TU1JP)	ENGINE							
Engine Information					A10	A20	A40	A50	A70	C10 - C30	C20	E01
Eng. HDY (TU1M), HDZ (TU1M)										470 188	C10	360 374
Eng. HDZ (TU1M), HFX (TU1JP) x 1, COIL ON PLUG										470 405	C10	
1.4	Petrol	54	11/02-10/06	KFW (TU3JP)	ENGINE							
Engine Information					A10	A20	A40	A50	A70	C10 - C30	C20	E01
All engines x 1, COIL ON PLUG										470 405	C10	
1.4	Petrol	55	06/96-12/15	KFX (TU3JP), TU32	ENGINE							
Engine Information					A10	A20	A40	A50	A70	C10 - C30	C20	E01
Eng. TU32 x 1, DISTRIBUTOR, connector type SAE										470 155	C10	
Eng. KFX (TU3JP) ->year 31/05/98										470 188	C10	
All engines ->year 31/05/98												360 374
1.4 BiFuel	Petrol/ Com- pressed Natural Gas (CNG)	55	04/03-10/06	KFW (TU3JP)	ENGINE							
Engine Information					A10	A20	A40	A50	A70	C10 - C30	C20	E01
All engines x 1, COIL ON PLUG										470 405	C10	
1.6	Petrol	80	09/00->	N6A (TU5JP4), NFU (TU5JP4)	ENGINE							
Engine Information					A10	A20	A40	A50	A70	C10 - C30	C20	E01
Eng. N6A (TU5JP4)										470 407	C10	
Eng. NFU (TU5JP4) x 1, COIL ON PLUG										470 407	C10	
1.6 16V	Petrol	80	07/01-03/08	NFU (TU5JP4)	ENGINE							
Engine Information					A10	A20	A40	A50	A70	C10 - C30	C20	E01
All engines x 1, COIL ON PLUG										470 407	C10	
1.6 Bioflex	Petrol/ Ethanol	80	09/00-10/02	NFU (TU5JP4)	ENGINE							
Engine Information					A10	A20	A40	A50	A70	C10 - C30	C20	E01
All engines x 1, COIL ON PLUG										470 407	C10	
1.6 Flexfuel	Petrol/ Ethanol	80	09/00-10/02	NFU (TU5JP4)	ENGINE							
Engine Information					A10	A20	A40	A50	A70	C10 - C30	C20	E01
All engines x 1, COIL ON PLUG										470 407	C10	
1.8	Petrol	66	03/97-12/02	LFX (XU7JB)	ENGINE							
Engine Information					A10	A20	A40	A50	A70	C10 - C30	C20	E01
All engines										470 188	C10	359 674
All engines x 1, D.I.S., connector type, saw teeth										470 188	C10	

A10 CONDENSER	A20 CONTACT SET	A40 DISTRIBUTOR CAP	A50 ROTOR	A70 PICK-UP
C10 COIL	C20 IGNITION MODULE	C30 ELECTRONIC IGNITION KIT	E01 IGNITION CABLE SET	

Vehicle	alim.	kW	Date	Engine	FUNCTIONS ON THE VEHICLE							
					A10	A20	A40	A50	A70	C10 - C30	C20	E01

PARTNER II

1.2 THP	Petrol	81	02/16->	ENGINE HNZ (EB2DT)
---------	--------	----	---------	-----------------------

Engine	Information	A10	A20	A40	A50	A70	C10 - C30	C20	E01
All engines	x 3, COIL ON PLUG						470 620	C10	

1.6	Petrol	66	04/08->	ENGINE NFR (TU5JP4B)
-----	--------	----	---------	-------------------------

Engine	Information	A10	A20	A40	A50	A70	C10 - C30	C20	E01
All engines	x 1, COIL ON PLUG						470 407	C10	

1.6	Petrol	72	11/10->	ENGINE 5FK (EP6CB)
-----	--------	----	---------	-----------------------

Engine	Information	A10	A20	A40	A50	A70	C10 - C30	C20	E01
All engines	x 4, COIL ON PLUG						470 475	C10	

1.6	Petrol	80	04/08->	ENGINE NFU (TU5JP4)
-----	--------	----	---------	------------------------

Engine	Information	A10	A20	A40	A50	A70	C10 - C30	C20	E01
All engines	x 1, COIL ON PLUG						470 407	C10	

1.6	Petrol	88	04/10->	ENGINE 5FS (EP6C)
-----	--------	----	---------	----------------------

Engine	Information	A10	A20	A40	A50	A70	C10 - C30	C20	E01
All engines	x 4, COIL ON PLUG						470 475	C10	

PARTNER II TEPEE

1.2 THP	Petrol	81	02/16->	ENGINE HNV (EB2DTM), HNZ (EB2DT)
---------	--------	----	---------	-------------------------------------

Engine	Information	A10	A20	A40	A50	A70	C10 - C30	C20	E01
All engines	x 3, COIL ON PLUG						470 620	C10	

1.6 VTi	Petrol	66	04/08->	ENGINE NFR (TU5JP4B)
---------	--------	----	---------	-------------------------

Engine	Information	A10	A20	A40	A50	A70	C10 - C30	C20	E01
All engines	x 1, COIL ON PLUG						470 407	C10	

1.6 VTi	Petrol	72	08/10->	ENGINE 5FK (EP6CB)
---------	--------	----	---------	-----------------------

Engine	Information	A10	A20	A40	A50	A70	C10 - C30	C20	E01
All engines	x 4, COIL ON PLUG						470 475	C10	

1.6 VTi	Petrol	80	04/08->	ENGINE NFU (TU5JP4)
---------	--------	----	---------	------------------------

Engine	Information	A10	A20	A40	A50	A70	C10 - C30	C20	E01
All engines	x 1, COIL ON PLUG						470 407	C10	

1.6 VTi	Petrol	81	09/08->	ENGINE NFU (TU5JP4)
---------	--------	----	---------	------------------------

Engine	Information	A10	A20	A40	A50	A70	C10 - C30	C20	E01
All engines							470 407	C10	

1.6 VTi	Petrol	88	09/09-04/16	ENGINE 5FS (EP6C)
---------	--------	----	-------------	----------------------

Engine	Information	A10	A20	A40	A50	A70	C10 - C30	C20	E01
All engines	x 4, COIL ON PLUG						470 475	C10	

PARTNER ORIGIN

1.4	Petrol	55	07/08-12/15	ENGINE KFW (TU3JP)
-----	--------	----	-------------	-----------------------

Engine	Information	A10	A20	A40	A50	A70	C10 - C30	C20	E01
All engines	x 1, COIL ON PLUG						470 405	C10	

1.6	Petrol	81	09/11-12/15	ENGINE NFU (TU5JP4)
-----	--------	----	-------------	------------------------

Engine	Information	A10	A20	A40	A50	A70	C10 - C30	C20	E01
All engines	x 1, COIL ON PLUG						470 407	C10	

1.6 16V	Petrol	81	09/11-12/13	ENGINE NFU (TU5JP4)
---------	--------	----	-------------	------------------------

Engine	Information	A10	A20	A40	A50	A70	C10 - C30	C20	E01
All engines	x 1, COIL ON PLUG						470 407	C10	

A10 CONDENSER	A20 CONTACT SET	A40 DISTRIBUTOR CAP	A50 ROTOR	A70 PICK-UP
C10 COIL	C20 IGNITION MODULE	C30 ELECTRONIC IGNITION KIT	E01 IGNITION CABLE SET	

The present application list is a brief version. For the detailed information about the possibility of installation on a specific vehicle, please refer to our web-catalogue <http://catalogo.facet.eu/>

Vehicle	alim.	kW	Date	Engine	FUNCTIONS ON THE VEHICLE							
					A10	A20	A40	A50	A70	C10 - C30	C20	E01

RANCH

1.1	Petrol	44	06/96->	ENGINE HDY (TU1M), HDZ (TU1M), HFX (TU1JP)
-----	--------	----	---------	---

Engine	Information	A10	A20	A40	A50	A70	C10 - C30	C20	E01
Eng. HDY (TU1M), HDZ (TU1M)							470 188	C10	360 374
Eng. HFX (TU1JP)							470 405	C10	

1.4	Petrol	55	06/96->	ENGINE KFW (TU3JP), KFX (TU3JP)
-----	--------	----	---------	------------------------------------

Engine	Information	A10	A20	A40	A50	A70	C10 - C30	C20	E01
Eng. KFX (TU3JP)	->year 31/05/98						470 188	C10	360 374
Eng. KFX (TU3JP)	01/06/98 ->						470 403	C10	
Eng. KFW (TU3JP)							470 405	C10	

1.4 BiFuel	Petrol	55	04/03->	ENGINE KFW (TU3JP)
------------	--------	----	---------	-----------------------

Engine	Information	A10	A20	A40	A50	A70	C10 - C30	C20	E01
All engines							470 405	C10	

1.6 16V	Petrol	80	07/01->	ENGINE N6A (TU5JP4), NFU (TU5JP4)
---------	--------	----	---------	--------------------------------------

Engine	Information	A10	A20	A40	A50	A70	C10 - C30	C20	E01
All engines							470 407	C10	

1.8	Petrol	66	05/97->	ENGINE LFX (XU7JB)
-----	--------	----	---------	-----------------------

Engine	Information	A10	A20	A40	A50	A70	C10 - C30	C20	E01
All engines							470 188	C10	359 674

RCZ

1.6 16V	Petrol	115	03/10-12/15	ENGINE 5FV (EP6CDT)
---------	--------	-----	-------------	------------------------

Engine	Information	A10	A20	A40	A50	A70	C10 - C30	C20	E01
All engines	x 4, COIL ON PLUG						470 475	C10	

1.6 16V	Petrol	121	01/11-12/15	ENGINE 5FM (EP6CDTM)
---------	--------	-----	-------------	-------------------------

Engine	Information	A10	A20	A40	A50	A70	C10 - C30	C20	E01
All engines	Qty: 4						470 475	C10	

1.6 16V	Petrol	147	06/10-12/15	ENGINE EP6CDTX
---------	--------	-----	-------------	-------------------

Engine	Information	A10	A20	A40	A50	A70	C10 - C30	C20	E01
All engines	x 4, COIL ON PLUG						470 475	C10	

1.6 16V	Petrol	150	06/10-12/15	ENGINE EP6CDTX
---------	--------	-----	-------------	-------------------

Engine	Information	A10	A20	A40	A50	A70	C10 - C30	C20	E01
All engines	Qty: 4						470 475	C10	

1.6 THP 150	Petrol	110	03/11-12/15	ENGINE 5FE (EP6CDTMD)
-------------	--------	-----	-------------	--------------------------

Engine	Information	A10	A20	A40	A50	A70	C10 - C30	C20	E01
All engines	x 4, COIL ON PLUG						470 475	C10	

1.6 THP 270	Petrol	199	06/13-12/15	ENGINE 5FG (EP6CDTR)
-------------	--------	-----	-------------	-------------------------

Engine	Information	A10	A20	A40	A50	A70	C10 - C30	C20	E01
All engines	x 4, COIL ON PLUG						470 475	C10	

A10 CONDENSER	A20 CONTACT SET	A40 DISTRIBUTOR CAP	A50 ROTOR	A70 PICK-UP
C10 COIL	C20 IGNITION MODULE	C30 ELECTRONIC IGNITION KIT	E01 IGNITION CABLE SET	







					FUNCTIONS ON THE VEHICLE							
Vehicle	alim.	kW	Date	Engine								
					A10	A20	A40	A50	A70	C10 - C30	C20	E01

PORTER				ENGINE
1.0	Petrol	33	02/93-06/94	CB41

Engine	Information	A10	A20	A40	A50	A70	C10 - C30	C20	E01
All engines	version Denso				913 030				

A10	CONDENSER	A20	CONTACT SET	A40	DISTRIBUTOR CAP	A50	ROTOR	A70	PICK-UP
C10	COIL	C20	IGNITION MODULE	C30	ELECTRONIC IGNITION KIT	E01	IGNITION CABLE SET		

The present application list is a brief version. For the detailed information about the possibility of installation on a specific vehicle, please refer to our web-catalogue <http://catalogo.facet.eu/>

				FUNCTIONS ON THE VEHICLE													
Vehicle	alim.	kW	Date	Engine	 A10	 A20	 A40	 A50	 A70	 C10 - C30	 C20	 E01					
356																	
A 1600	Petrol	44	01/55-12/59	ENGINE --													
Engine	Information			A10	A20	A40	A50	A70	C10 - C30	C20	E01						
All engines					706 047		906 021R										
A 1600 GS Carrera																	
Petrol	85	01/55-12/61	ENGINE --														
Engine	Information			A10	A20	A40	A50	A70	C10 - C30	C20	E01						
All engines					706 047												
A 1600 S																	
Petrol	55	01/55-12/59	ENGINE 616.15														
Engine	Information			A10	A20	A40	A50	A70	C10 - C30	C20	E01						
All engines					706 047		906 021R										
All engines	version BOSCH					806 076											
A 1600 Super																	
Petrol	55	01/55-12/59	ENGINE 616.15														
Engine	Information			A10	A20	A40	A50	A70	C10 - C30	C20	E01						
All engines					706 047		906 021R										
All engines	version BOSCH					806 076											
B 1600																	
Petrol	44	09/59-08/63	ENGINE --														
Engine	Information			A10	A20	A40	A50	A70	C10 - C30	C20	E01						
All engines					706 047		906 021R										
B 1600 Super 75																	
Petrol	55	01/59-12/63	ENGINE 616.15														
Engine	Information			A10	A20	A40	A50	A70	C10 - C30	C20	E01						
All engines					706 047		906 021R										
B 1600 Super 90																	
Petrol	66	01/59-12/63	ENGINE --														
Engine	Information			A10	A20	A40	A50	A70	C10 - C30	C20	E01						
All engines					706 047		906 021R										
C 1600																	
Petrol	55	01/63-12/65	ENGINE 616.15														
Engine	Information			A10	A20	A40	A50	A70	C10 - C30	C20	E01						
All engines					706 047												
C 1600 SC																	
Petrol	70	01/63-12/65	ENGINE --														
Engine	Information			A10	A20	A40	A50	A70	C10 - C30	C20	E01						
All engines					706 047		906 018R, 906 021R										
911 I																	
2.0 L	Petrol	110	08/67-11/68	ENGINE --													
Engine	Information			A10	A20	A40	A50	A70	C10 - C30	C20	E01						
All engines					706 047												
2.0 L																	
Petrol	96	01/67-12/68	ENGINE 901.01, 901.05														
Engine	Information			A10	A20	A40	A50	A70	C10 - C30	C20	E01						
All engines	version Bosch					806 072											
2.0 S																	
Petrol	118	07/66-11/68	ENGINE 901.02, 901.08														
Engine	Information			A10	A20	A40	A50	A70	C10 - C30	C20	E01						
All engines					706 047												
2.0 S																	
Petrol	125	07/66-02/72	ENGINE 901.10														
Engine	Information			A10	A20	A40	A50	A70	C10 - C30	C20	E01						
All engines					706 047												
2.7																	
Petrol	110	09/73-08/75	ENGINE 911.41, 911.46, 911.92, 911.97														
Engine	Information			A10	A20	A40	A50	A70	C10 - C30	C20	E01						
All engines					706 062												
A10	CONDENSER	A20	CONTACT SET	A40	DISTRIBUTOR CAP	A50	ROTOR	A70	PICK-UP	C10	COIL	C20	IGNITION MODULE	C30	ELECTRONIC IGNITION KIT	E01	IGNITION CABLE SET

Vehicle	alim.	kW	Date	Engine	FUNCTIONS ON THE VEHICLE									
					A10	A20	A40	A50	A70	C10 - C30	C20	E01		
ENGINE														
2.7	Petrol	121	09/75-06/77	911.43, 911.48, 911.81, 911.82, 911.84, 911.85, 911.86, 911.89, 911.90, 911.94, 911.99		706 062								
ENGINE														
2.7 S	Petrol	129	08/73-01/76	911.42, 911.47, 911.93, 911.98		706 062								
ENGINE														
2.7 S Carrera	Petrol	129	08/73-01/76	911.42, 911.47, 911.93, 911.98		706 062								
ENGINE														
2.7 SC Carrera RS	Petrol	154	08/72-01/79	911.83		706 062								
ENGINE														
3.2 SC Carrera	Petrol	170	08/83-08/89	930.20			806 123	906 113R						
ENGINE														
911 II														
ENGINE														
3.3 Turbo	Petrol	235	08/90-09/93	M 30.69				906 113R						
ENGINE														
3.3 Turbo S	Petrol	261	06/91-12/92	M 30.69S				906 113R						
ENGINE														
3.6 Carrera	Petrol	184	12/88-05/94	M 64.01, M 64.02				906 113R					465 034	
ENGINE														
3.6 Carrera 4	Petrol	184	12/88-05/94	M 64.01				906 113R					465 034	
ENGINE														
3.6 Carrera RS	Petrol	191	06/91-09/93	M 64.03				906 113R					465 034	
ENGINE														
3.6 Turbo	Petrol	265	01/93-09/93	M 64.50				906 113R						
ENGINE														
911 III														
ENGINE														
3.6 Carrera	Petrol	200	10/93-08/95	M 64.05, M 64.06, M 64.07, M 64.08				906 113R						
ENGINE														

A10	CONDENSER	A20	CONTACT SET	A40	DISTRIBUTOR CAP	A50	ROTOR	A70	PICK-UP
C10	COIL	C20	IGNITION MODULE	C30	ELECTRONIC IGNITION KIT	E01	IGNITION CABLE SET		

The present application list is a brief version. For the detailed information about the possibility of installation on a specific vehicle, please refer to our web-catalogue <http://catalogo.facet.eu/>

				FUNCTIONS ON THE VEHICLE								
Vehicle	alim.	kW	Date	Engine	 A10	 A20	 A40	 A50	 A70	 C10 - C30	 C20	 E01
				ENGINE								
3.6 Carrera	Petrol	210	08/95-09/97	M 64.21, M 64.22, M 64.23, M 64.24								
Engine		Information			A10	A20	A40	A50	A70	C10 - C30	C20	E01
All engines		Qty: 2, version Bosch						906 113R				
				ENGINE								
3.6 Carrera 4	Petrol	200	07/94-08/95	M 64.05, M 64.07								
Engine		Information			A10	A20	A40	A50	A70	C10 - C30	C20	E01
All engines		Qty: 2, version Bosch						906 113R				
				ENGINE								
3.6 Carrera 4	Petrol	210	08/95-09/97	M 64.21, M 64.23								
Engine		Information			A10	A20	A40	A50	A70	C10 - C30	C20	E01
All engines		Qty: 2, version Bosch						906 113R				
				ENGINE								
3.6 Turbo 4	Petrol	300	03/95-09/97	M 64.60								
Engine		Information			A10	A20	A40	A50	A70	C10 - C30	C20	E01
All engines		version Bosch					806 123	906 113R				
				ENGINE								
3.6 Turbo GT2	Petrol	316	03/95-09/97	M 64.60R								
Engine		Information			A10	A20	A40	A50	A70	C10 - C30	C20	E01
All engines		version Bosch					806 123	906 113R				
				ENGINE								
3.6 Turbo GT2 4	Petrol	316	08/95-09/97	M 64.60R								
Engine		Information			A10	A20	A40	A50	A70	C10 - C30	C20	E01
All engines		version Bosch					806 123	906 113R				
				ENGINE								
3.6 Turbo GT2 4	Petrol	331	06/97-09/97	M 64.60RS								
Engine		Information			A10	A20	A40	A50	A70	C10 - C30	C20	E01
All engines		version Bosch					806 123	906 113R				
				ENGINE								
3.8 Carrera	Petrol	210	06/95-09/97	M 64.05S, M 64.06S								
Engine		Information			A10	A20	A40	A50	A70	C10 - C30	C20	E01
All engines		Qty: 2, version Bosch						906 113R				
				ENGINE								
3.8 Carrera	Petrol	221	08/95-09/97	M 64.21S								
Engine		Information			A10	A20	A40	A50	A70	C10 - C30	C20	E01
All engines		Qty: 2, version Bosch						906 113R				
				ENGINE								
3.8 Carrera 4	Petrol	210	06/95-09/97	M 64.05S, M 64.06S								
Engine		Information			A10	A20	A40	A50	A70	C10 - C30	C20	E01
All engines		Qty: 2, version Bosch						906 113R				
				ENGINE								
3.8 Carrera 4	Petrol	221	08/95-09/97	M 64.21S								
Engine		Information			A10	A20	A40	A50	A70	C10 - C30	C20	E01
All engines		Qty: 2, version Bosch						906 113R				
				ENGINE								
3.8 Carrera RS	Petrol	221	06/95-09/97	M 64.20								
Engine		Information			A10	A20	A40	A50	A70	C10 - C30	C20	E01
All engines		Qty: 2, version Bosch						906 113R				
				ENGINE								
				912								
1.6	Petrol	66	01/65-02/70	616.36, 616.39, 616.40								
Engine		Information			A10	A20	A40	A50	A70	C10 - C30	C20	E01
All engines						706 047						
All engines		version BOSCH					806 076					
				ENGINE								
				924								
2.0 Turbo	Petrol	130	06/80-10/86	M 31.03								
Engine		Information			A10	A20	A40	A50	A70	C10 - C30	C20	E01
All engines		version Bosch					806 079	906 025R				

A10 CONDENSER	A20 CONTACT SET	A40 DISTRIBUTOR CAP	A50 ROTOR	A70 PICK-UP
C10 COIL	C20 IGNITION MODULE	C30 ELECTRONIC IGNITION KIT	E01 IGNITION CABLE SET	

Vehicle	alim.	kW	Date	Engine	FUNCTIONS ON THE VEHICLE									
					A10	A20	A40	A50	A70	C10 - C30	C20	E01		
2.5 S					ENGINE									
	Petrol	110	09/85-07/87	M 44.07										
Engine		Information			A10	A20	A40	A50	A70	C10 - C30	C20	E01		
All engines		version Bosch					806 117	906 070R						
928					ENGINE									
4.7 S														
	Petrol	221	09/79-07/83	M 28.11, M 28.12										
Engine		Information			A10	A20	A40	A50	A70	C10 - C30	C20	E01		
All engines		version Bosch					806 090							
All engines		FOR: (CH), FOR: (AUS), version Bosch					806 117	906 070R						
4.7 S					ENGINE									
	Petrol	228	08/83-07/86	M 28.21, M 28.22										
Engine		Information			A10	A20	A40	A50	A70	C10 - C30	C20	E01		
All engines		Qty: 2, version Bosch					806 128							
5.4 GTS					ENGINE									
	Petrol	257	08/91-11/95	M 28.49, M 28.50										
Engine		Information			A10	A20	A40	A50	A70	C10 - C30	C20	E01		
All engines		Qty: 2, version Bosch					806 128							
All engines		Qty: 2									465 034			
968					ENGINE									
3.0														
	Petrol	176	06/91-11/95	M 44.43, M 44.44										
Engine		Information			A10	A20	A40	A50	A70	C10 - C30	C20	E01		
All engines		version Bosch					806 128							
CAYENNE					ENGINE									
3.0 S Plug-in Hybrid Supercharged														
	Diesel/Electro	245	01/15->	MCG.EA, MCG.FA										
Engine		Information			A10	A20	A40	A50	A70	C10 - C30	C20	E01		
All engines		x 6, COIL ON PLUG								470 427	C10			
CAYENNE I					ENGINE									
3.2														
	Petrol	177	08/03-09/07	M02.2Y										
Engine		Information			A10	A20	A40	A50	A70	C10 - C30	C20	E01		
All engines		x 6, COIL ON PLUG								470 434	C10			
3.2					ENGINE									
	Petrol	184	10/03-09/07	M02.2Y										
Engine		Information			A10	A20	A40	A50	A70	C10 - C30	C20	E01		
All engines		x 6, COIL ON PLUG								470 434	C10			
3.6					ENGINE									
	Petrol	213	02/07-09/10	M 55.01										
Engine		Information			A10	A20	A40	A50	A70	C10 - C30	C20	E01		
All engines		x 6, COIL ON PLUG								470 434	C10			
CAYENNE II					ENGINE									
3.0 S E-Hybrid														
	Petrol/Electric	306	10/14->	M 06.EC, MCG.EA, MCG.FA										
Engine		Information			A10	A20	A40	A50	A70	C10 - C30	C20	E01		
Eng. M 06.EC		Qty: 6								470 427	C10			
Eng. MCG.EA, MCG.FA		x 6, COIL ON PLUG								470 427	C10			
3.6					ENGINE									
	Petrol	220	06/10->	M 55.02, MCE.YA										
Engine		Information			A10	A20	A40	A50	A70	C10 - C30	C20	E01		
All engines		x 6, COIL ON PLUG								470 434	C10			
CAYENNE III					ENGINE									
2.9 SAWD														
	Petrol	324	05/17->	DCAB, MDC.AB										
Engine		Information			A10	A20	A40	A50	A70	C10 - C30	C20	E01		
All engines		x 6, COIL ON PLUG								470 636	C10			

A10 CONDENSER	A20 CONTACT SET	A40 DISTRIBUTOR CAP	A50 ROTOR	A70 PICK-UP
C10 COIL	C20 IGNITION MODULE	C30 ELECTRONIC IGNITION KIT	E01 IGNITION CABLE SET	

The present application list is a brief version. For the detailed information about the possibility of installation on a specific vehicle, please refer to our web-catalogue <http://catalogo.facet.eu/>

					FUNCTIONS ON THE VEHICLE							
Vehicle	alim.	kW	Date	Engine	A10	A20	A40	A50	A70	C10 - C30	C20	E01
ENGINE												
3.0 AWD	Petrol	250	05/17->	DCBE, MDC.BE								
Engine	Information				A10	A20	A40	A50	A70	C10 - C30	C20	E01
All engines	x 6, COIL ON PLUG									470 636	C10	
ENGINE												
3.0 E-Hybrid AWD	Petrol/ Electric	250	05/17->	DCBE, MDC.BE								
Engine	Information				A10	A20	A40	A50	A70	C10 - C30	C20	E01
All engines	x 6, COIL ON PLUG									470 636	C10	
ENGINE												
3.0 E-Hybrid AWD	Petrol/ Electric	339	01/19->	DCBE, MDC.BE								
Engine	Information				A10	A20	A40	A50	A70	C10 - C30	C20	E01
All engines	x 6, COIL ON PLUG									470 636	C10	
ENGINE												
3.0 E-Hybrid AWD	Petrol/ Electric	340	01/19->	DCBE, MDC.BE								
Engine	Information				A10	A20	A40	A50	A70	C10 - C30	C20	E01
All engines	x 6, COIL ON PLUG									470 636	C10	
ENGINE												
4.0 Turbo AWD	Petrol	404	05/17->	DCUA, MDC.UA								
Engine	Information				A10	A20	A40	A50	A70	C10 - C30	C20	E01
All engines	x 8, COIL ON PLUG									470 636	C10	
ENGINE												
4.0 Turbo GT AWD	Petrol	471	06/21->	DWNA								
Engine	Information				A10	A20	A40	A50	A70	C10 - C30	C20	E01
All engines	x 8, version 9A7905110, COIL ON PLUG									470 636	C10	
ENGINE												
4.0 Turbo S E-Hybrid AWD	Petrol/ Electric	500	10/19->	DCUA								
Engine	Information				A10	A20	A40	A50	A70	C10 - C30	C20	E01
All engines	x 8, COIL ON PLUG									470 636	C10	
MACAN												
ENGINE												
2.0	Petrol	174	07/14->	MCN.CC, MCY.NA								
Engine	Information				A10	A20	A40	A50	A70	C10 - C30	C20	E01
Eng. MCN.CC	x 4, COIL ON PLUG									470 636	C10	
Eng. MCY.NA	Qty: 4									470 636	C10	
ENGINE												
2.0	Petrol	180	05/18->	DKNA								
Engine	Information				A10	A20	A40	A50	A70	C10 - C30	C20	E01
All engines	x 4, COIL ON PLUG									470 636	C10	
ENGINE												
2.0	Petrol	185	05/15->	DLHB, MCY.PA								
Engine	Information				A10	A20	A40	A50	A70	C10 - C30	C20	E01
All engines	x 4, COIL ON PLUG									470 636	C10	
ENGINE												
2.9 Turbo AWD	Petrol	324	05/18->	DGRC								
Engine	Information				A10	A20	A40	A50	A70	C10 - C30	C20	E01
All engines	x 6, COIL ON PLUG									470 636	C10	
ENGINE												
3.0 S	Petrol	260	05/18->	DLZB								
Engine	Information				A10	A20	A40	A50	A70	C10 - C30	C20	E01
All engines	x 6, COIL ON PLUG									470 636	C10	
PANAMERA												
ENGINE												
2.94	Petrol	243	05/16->	MDG.PA								
Engine	Information				A10	A20	A40	A50	A70	C10 - C30	C20	E01
All engines	x 6, COIL ON PLUG									470 636	C10	

A10 CONDENSER	A20 CONTACT SET	A40 DISTRIBUTOR CAP	A50 ROTOR	A70 PICK-UP
C10 COIL	C20 IGNITION MODULE	C30 ELECTRONIC IGNITION KIT	E01 IGNITION CABLE SET	

Vehicle	alim.	kW	Date	Engine	FUNCTIONS ON THE VEHICLE									
					A10	A20	A40	A50	A70	C10 - C30	C20	E01		
ENGINE														
2.9 4 E-Hybrid	Petrol/ Electric	243	05/16->	DGPA, MDG.PA										
Engine	Information				A10	A20	A40	A50	A70	C10 - C30	C20	E01		
All engines	x 6, COIL ON PLUG									470 636	C10			
ENGINE														
2.9 4 E-Hybrid	Petrol/ Electric	340	05/16->	DGPA, MDG.PA										
Engine	Information				A10	A20	A40	A50	A70	C10 - C30	C20	E01		
All engines	x 6, COIL ON PLUG									470 636	C10			
ENGINE														
2.9 4S	Petrol	324	05/16->	MCS.ZA										
Engine	Information				A10	A20	A40	A50	A70	C10 - C30	C20	E01		
All engines	x 6, COIL ON PLUG									470 636	C10			
ENGINE														
2.9 4S E-Hybrid	Petrol/ Electric	324	08/20->	CSZA										
Engine	Information				A10	A20	A40	A50	A70	C10 - C30	C20	E01		
All engines	x 6, COIL ON PLUG									470 636	C10			
ENGINE														
2.9 4S E-Hybrid	Petrol/ Electric	412	08/20->	DGPA										
Engine	Information				A10	A20	A40	A50	A70	C10 - C30	C20	E01		
All engines	x 6, COIL ON PLUG									470 636	C10			
ENGINE														
3.0	Petrol	243	05/16->	MCX.TA										
Engine	Information				A10	A20	A40	A50	A70	C10 - C30	C20	E01		
All engines	x 6, COIL ON PLUG									470 636	C10			
ENGINE														
3.0 4	Petrol	243	05/16->	MCX.TA										
Engine	Information				A10	A20	A40	A50	A70	C10 - C30	C20	E01		
All engines	x 6, COIL ON PLUG									470 636	C10			
ENGINE														
3.0 S E-Hybrid	Petrol/ Electric	245	03/11-07/13	MCG.EA, MCG.FA										
Engine	Information				A10	A20	A40	A50	A70	C10 - C30	C20	E01		
All engines	x 6, COIL ON PLUG									470 427	C10			
ENGINE														
3.0 S E-Hybrid	Petrol/ Electric	279	03/11-07/13	MCG.EA, MCG.FA										
Engine	Information				A10	A20	A40	A50	A70	C10 - C30	C20	E01		
All engines	x 6, COIL ON PLUG									470 427	C10			
ENGINE														
3.0 S E-Hybrid	Petrol/ Electric	306	07/13-10/16	MCG.EA, MCG.FA										
Engine	Information				A10	A20	A40	A50	A70	C10 - C30	C20	E01		
All engines	x 6, COIL ON PLUG									470 427	C10			
ENGINE														
4.0 GTS	Petrol	338	01/18->	CVDD										
Engine	Information				A10	A20	A40	A50	A70	C10 - C30	C20	E01		
All engines	x 8, COIL ON PLUG									470 636	C10			
ENGINE														
4.0 Turbo	Petrol	404	05/16->	MCV.DA										
Engine	Information				A10	A20	A40	A50	A70	C10 - C30	C20	E01		
All engines	x 8, COIL ON PLUG									470 636	C10			
ENGINE														
4.0 Turbo S E-Hybrid	Petrol	515	05/20->	CVDA										
Engine	Information				A10	A20	A40	A50	A70	C10 - C30	C20	E01		
All engines	x 8, COIL ON PLUG									470 636	C10			
ENGINE														
4.0 Turbo S E-Hybrid	Petrol/ Electric	404	05/17->	MCV.DA										
Engine	Information				A10	A20	A40	A50	A70	C10 - C30	C20	E01		
All engines	x 8, COIL ON PLUG									470 636	C10			
ENGINE														
A10	CONDENSER		A20	CONTACT SET		A40	DISTRIBUTOR CAP		A50	ROTOR		A70	PICK-UP	
C10	COIL		C20	IGNITION MODULE		C30	ELECTRONIC IGNITION KIT		E01	IGNITION CABLE SET				

Vehicle	alim.	kW	Date	Engine	FUNCTIONS ON THE VEHICLE							
					A10	A20	A40	A50	A70	C10 - C30	C20	E01

ENGINE				
4.0 Turbo S E-Hybrid	Petrol/ Electric	500	05/17->	MCV.DA

Engine	Information	A10	A20	A40	A50	A70	C10 - C30	C20	E01
All engines	x 8, COIL ON PLUG						470 636	C10	

ENGINE				
4.0 Turbo S E-Hybrid	Petrol/ Electric	515	05/20->	CVDA

Engine	Information	A10	A20	A40	A50	A70	C10 - C30	C20	E01
All engines	x 8, COIL ON PLUG						470 636	C10	

A10	CONDENSER	A20	CONTACT SET	A40	DISTRIBUTOR CAP	A50	ROTOR	A70	PICK-UP
C10	COIL	C20	IGNITION MODULE	C30	ELECTRONIC IGNITION KIT	E01	IGNITION CABLE SET		

Vehicle	alim.	kW	Date	Engine	FUNCTIONS ON THE VEHICLE							
					A10	A20	A40	A50	A70	C10 - C30	C20	E01

G-MODELL

				ENGINE
230 GE	Petrol	92	03/79-07/00	M 102.981, M 102.987, M 102.996

Engine	Information	A10	A20	A40	A50	A70	C10 - C30	C20	E01
Eng. M 102.981, M 102.987	version Bosch			806 108					
Eng. M 102.996	version Bosch			806 234					
All engines	version Bosch				906 055R				
Eng. M 102.996							470 178	C10	
Eng. M 102.981, M 102.987							470 180	C10	360 654

				ENGINE
230 GE	Petrol	93	07/89-08/93	M 102.989

Engine	Information	A10	A20	A40	A50	A70	C10 - C30	C20	E01
All engines	version Bosch			806 234	906 121R				
All engines							470 178	C10	

				ENGINE
280 GE	Petrol	110	01/86-12/91	M 110.994

Engine	Information	A10	A20	A40	A50	A70	C10 - C30	C20	E01
All engines	version Bosch		706 034HV5						
All engines	->eng. 004203, 001498, version Bosch			806 092					
All engines	eng. type 004205, 001499 ->, version Bosch			806 123					
All engines	eng. type 002294, 000115 ->, ->eng. 004203, 001498, version Bosch				906 024R				
All engines	->eng. 002293, 000114, version Bosch				906 034R				
All engines	eng. type 004204, 001499 ->, version Bosch				906 060R				
All engines	ch. 034825, 901172 ->						470 180	C10	

				ENGINE
300 GE	Petrol	125	06/89-08/93	M 103.987

Engine	Information	A10	A20	A40	A50	A70	C10 - C30	C20	E01
All engines	version Bosch			806 237	906 125R				
All engines							470 178	C10	360 657

				ENGINE
G 320	Petrol	155	02/94-12/97	M 104.996

Engine	Information	A10	A20	A40	A50	A70	C10 - C30	C20	E01
All engines	Qty: 3, without spark plug connector						470 316	C10	
All engines	incl. spark plug connector, Qty: 3						470 316K	C10	

				ENGINE
G 36 AMG	Petrol	200	01/95-04/98	M 104.952 (AMG 3, 6)

Engine	Information	A10	A20	A40	A50	A70	C10 - C30	C20	E01
All engines	Qty: 3, without spark plug connector						470 316	C10	
All engines	incl. spark plug connector, Qty: 3						470 316K	C10	

				ENGINE
G 500	Petrol	218	12/97-11/00	M 113.962

Engine	Information	A10	A20	A40	A50	A70	C10 - C30	C20	E01
All engines	Qty: 8						470 417	C10	

				ENGINE
G 55 AMG	Petrol	260	04/99-03/01	M 113.982

Engine	Information	A10	A20	A40	A50	A70	C10 - C30	C20	E01
All engines	Qty: 8						470 417	C10	

A10 CONDENSER	A20 CONTACT SET	A40 DISTRIBUTOR CAP	A50 ROTOR	A70 PICK-UP
C10 COIL	C20 IGNITION MODULE	C30 ELECTRONIC IGNITION KIT	E01 IGNITION CABLE SET	

Vehicle	alim.	kW	Date	Engine	FUNCTIONS ON THE VEHICLE							
					 A10	 A20	 A40	 A50	 A70	 C10 - C30	 C20	 E01

REBEL

700	Petrol	23	01/68-08/71	ENGINE								
-----	--------	----	-------------	--------	--	--	--	--	--	--	--	--

Engine	Information	A10	A20	A40	A50	A70	C10 - C30	C20	E01
All engines				828 075	928 006				

750	Petrol	24	08/71-12/73	ENGINE								
-----	--------	----	-------------	--------	--	--	--	--	--	--	--	--

Engine	Information	A10	A20	A40	A50	A70	C10 - C30	C20	E01
All engines				828 075	928 006				

ROBIN

850	Petrol	29	11/73-10/02	ENGINE								
-----	--------	----	-------------	--------	--	--	--	--	--	--	--	--

Engine	Information	A10	A20	A40	A50	A70	C10 - C30	C20	E01
All engines				828 075	928 006				

A10	CONDENSER	A20	CONTACT SET	A40	DISTRIBUTOR CAP	A50	ROTOR	A70	PICK-UP
C10	COIL	C20	IGNITION MODULE	C30	ELECTRONIC IGNITION KIT	E01	IGNITION CABLE SET		

Vehicle	alim.	kW	Date	Engine	FUNCTIONS ON THE VEHICLE							
					A10	A20	A40	A50	A70	C10 - C30	C20	E01

11

ENGINE				
1.1	Petrol	35	03/83-06/86	C1E 715, C1E 720

Engine	Information	A10	A20	A40	A50	A70	C10 - C30	C20	E01
All engines	version Ducellier		715 126	815 054	915 091				
All engines	version Marelli			830 101	930 047R		470 101D	C10	

ENGINE				
1.2	Petrol	40	10/84-12/88	C1G 700, C1G 710

Engine	Information	A10	A20	A40	A50	A70	C10 - C30	C20	E01
All engines	version Ducellier		715 126	815 059	915 094				
All engines	version Femsas		717 026		917 058				
All engines							470 101D	C10	359 839

ENGINE				
1.4	Petrol	43	07/86-10/87	C2J 720

Engine	Information	A10	A20	A40	A50	A70	C10 - C30	C20	E01
All engines	version Ducellier			815 059					
All engines	version Femsas			817 023	917 058				
All engines	distr. num. 525 352 A/B, version Ducellier				915 088				
All engines	distr. num. 525 352 C/D, version Ducellier				915 094				
All engines									359 839

ENGINE				
1.4	Petrol	49	03/83-12/88	C2J 720, C2J 766, C2J 767, C2J 768

Engine	Information	A10	A20	A40	A50	A70	C10 - C30	C20	E01
All engines	version Ducellier			815 059					
All engines	version Femsas			817 023	917 058				
All engines	distr. num. 525 352 A/B, version Ducellier				915 088				
All engines	distr. num. 525 352 C/D, version Ducellier				915 094				
All engines									359 839

ENGINE				
1.7	Petrol	54	10/86-12/88	F2N 730

Engine	Information	A10	A20	A40	A50	A70	C10 - C30	C20	E01
All engines				815 062					

ENGINE				
1.7	Petrol	55	10/84-12/88	F3N 718

Engine	Information	A10	A20	A40	A50	A70	C10 - C30	C20	E01
All engines				815 062					

ENGINE				
1.7	Petrol	59	10/83-12/87	F2N 700, F2N 704

Engine	Information	A10	A20	A40	A50	A70	C10 - C30	C20	E01
Eng. F2N 700	version Femsas		717 026	817 023	917 058				
Eng. F2N 700	version Marelli		730 148M		930 047R				
All engines				815 062					
Eng. F2N 700	version Ducellier			815 063	915 097				
Eng. F2N 700	Kit, version Ducellier			815 073					

ENGINE				
1.7	Petrol	64	06/87-12/88	F2N 732, F2N 742

Engine	Information	A10	A20	A40	A50	A70	C10 - C30	C20	E01
All engines				815 062					

ENGINE				
1.7	Petrol	65	10/86-12/88	F2N 708, F2N 710, F2N 798

Engine	Information	A10	A20	A40	A50	A70	C10 - C30	C20	E01
All engines				815 062					









12

ENGINE				
1.3	Petrol	37	07/75-04/80	810.02

Engine	Information	A10	A20	A40	A50	A70	C10 - C30	C20	E01
All engines			706 040		906 014R				

A10	CONDENSER	A20	CONTACT SET	A40	DISTRIBUTOR CAP	A50	ROTOR	A70	PICK-UP
C10	COIL	C20	IGNITION MODULE	C30	ELECTRONIC IGNITION KIT	E01	IGNITION CABLE SET		

The present application list is a brief version. For the detailed information about the possibility of installation on a specific vehicle, please refer to our web-catalogue <http://catalogo.facet.eu/>









				FUNCTIONS ON THE VEHICLE								
Vehicle	alim.	kW	Date	Engine								
				ENGINE								
1.3	Petrol	40	10/69-08/80	810-02/97								
Engine Information					A10	A20	A40	A50	A70	C10 - C30	C20	E01
All engines						706 040		906 014R				
				ENGINE								
1.3	Petrol	44	08/73-08/80	810.05, 810.06								
Engine Information					A10	A20	A40	A50	A70	C10 - C30	C20	E01
All engines						706 040						
				ENGINE								
1.3 TS	Petrol	44	08/72-08/80	810.05, 810.06								
Engine Information					A10	A20	A40	A50	A70	C10 - C30	C20	E01
All engines						706 040						
				ENGINE								
14												
1.4	Petrol	52	09/79-06/83	150								
Engine Information					A10	A20	A40	A50	A70	C10 - C30	C20	E01
All engines					version Ducellier	615 034		915 088				
All engines					version Marelli		830 098	930 047R				
				ENGINE								
18												
1.4	Petrol	47	04/78-07/86	847 720, 847 722								
Engine Information					A10	A20	A40	A50	A70	C10 - C30	C20	E01
All engines						706 040						
All engines					version Ducellier		815 059					
All engines					version Femsa		817 023	917 058				
All engines					distr. num. 525 352 A/B, version Ducellier			915 088				
All engines					distr. num. 525 352 C/D, version Ducellier			915 094				
All engines					01/01/85 ->				470 107	C10		
				ENGINE								
1.6 TS	Petrol	71	05/82-07/86	A6M 725, A6M 726								
Engine Information					A10	A20	A40	A50	A70	C10 - C30	C20	E01
All engines					version Ducellier		815 059					
All engines					distr. num. 525 352 A/B, version Ducellier			915 088				
All engines					distr. num. 525 352 C/D, version Ducellier			915 094				
All engines					01/01/85 ->				470 107	C10		
				ENGINE								
2.0	Petrol	77	05/82-07/86	J6R 716								
Engine Information					A10	A20	A40	A50	A70	C10 - C30	C20	E01
All engines					-air conditioning, version Ducellier		815 059					
All engines					+air conditioning, version Ducellier		815 079					
All engines					version Ducellier			915 094				
All engines					01/01/85 ->				470 107	C10		
				ENGINE								
19 I												
1.2	Petrol	40	01/88-12/92	C1G 730								
Engine Information					A10	A20	A40	A50	A70	C10 - C30	C20	E01
All engines					version Ducellier		815 059					
All engines					version Femsa		817 023	917 058				
All engines					distr. num. 525 352 A/B, version Ducellier			915 088				
All engines					distr. num. 525 352 C/D, version Ducellier			915 094				
All engines									470 107	C10	359 543	
				ENGINE								
1.2i	Petrol	0	01/89-12/92	E7F								
Engine Information					A10	A20	A40	A50	A70	C10 - C30	C20	E01
All engines					version Ducellier		815 081	915 101				
All engines					version Marelli		830 111	930 059				
All engines									470 107	C10	359 801	
				ENGINE								
1.4	Petrol	43	07/88-05/93	C2J 772, C3J 710								
Engine Information					A10	A20	A40	A50	A70	C10 - C30	C20	E01
All engines					version Ducellier		815 059					
All engines					version Femsa		817 023	917 058				

A10 CONDENSER	A20 CONTACT SET	A40 DISTRIBUTOR CAP	A50 ROTOR	A70 PICK-UP
C10 COIL	C20 IGNITION MODULE	C30 ELECTRONIC IGNITION KIT	E01 IGNITION CABLE SET	

Vehicle	alim.	kW	Date	Engine	FUNCTIONS ON THE VEHICLE								
					A10	A20	A40	A50	A70	C10 - C30	C20	E01	
1.4	Petrol	43	07/88-05/93	ENGINE C2J 772, C3J 710									
Engine	Information			A10	A20	A40	A50	A70	C10 - C30	C20	E01		
All engines	distr. num. 525 352 A/B, version Ducellier						915 088						
All engines	distr. num. 525 352 C/D, version Ducellier						915 094						
All engines									470 107	C10			
1.4	Petrol	50	09/88-09/92	ENGINE C2J 776									
Engine	Information			A10	A20	A40	A50	A70	C10 - C30	C20	E01		
All engines	version Ducellier					815 059							
All engines	version Femsa					817 023	917 058						
All engines	distr. num. 525 352 A/B, version Ducellier						915 088						
All engines	distr. num. 525 352 C/D, version Ducellier						915 094						
All engines									470 107	C10			
1.4	Petrol	55	09/90-04/92	ENGINE E7J 700									
Engine	Information			A10	A20	A40	A50	A70	C10 - C30	C20	E01		
All engines	version Ducellier					815 081	915 101						
All engines	version Marelli					830 111	930 059						
All engines									470 107	C10		359 801	
1.4	Petrol	57	07/88-08/90	ENGINE E6J 700, E6J 701									
Engine	Information			A10	A20	A40	A50	A70	C10 - C30	C20	E01		
All engines	version Ducellier					815 081	915 101						
All engines	version Marelli					830 111	930 059						
All engines									470 107	C10		359 801	
1.4	Petrol	58	06/89-08/90	ENGINE E6J 700									
Engine	Information			A10	A20	A40	A50	A70	C10 - C30	C20	E01		
All engines	version Ducellier					815 081	915 101						
All engines	version Marelli					830 111	930 059						
All engines									470 107	C10		359 801	
1.4	Petrol	59	01/88-12/92	ENGINE E6J 700, E6J 701									
Engine	Information			A10	A20	A40	A50	A70	C10 - C30	C20	E01		
All engines	version Ducellier					815 081	915 101						
All engines	version Marelli					830 111	930 059						
All engines									470 107	C10		359 801	
1.4 Cat	Petrol	43	01/89-04/92	ENGINE C3J 710									
Engine	Information			A10	A20	A40	A50	A70	C10 - C30	C20	E01		
All engines	version Ducellier					815 059							
All engines	version Femsa					817 023	917 058						
All engines	distr. num. 525 352 A/B, version Ducellier						915 088						
All engines	distr. num. 525 352 C/D, version Ducellier						915 094						
All engines									470 107	C10			
1.7	Petrol	54	09/88-04/92	ENGINE F3N 740, F3N 741									
Engine	Information			A10	A20	A40	A50	A70	C10 - C30	C20	E01		
All engines	version Ducellier					815 069	915 097						
All engines	Kit, version Ducellier					815 072							
All engines									470 107	C10			
1.7	Petrol	55	09/88-12/92	ENGINE F2N 724									
Engine	Information			A10	A20	A40	A50	A70	C10 - C30	C20	E01		
All engines	version Ducellier					815 069	915 097						
All engines	Kit, version Ducellier					815 072							
All engines									470 107	C10			

A10	CONDENSER	A20	CONTACT SET	A40	DISTRIBUTOR CAP	A50	ROTOR	A70	PICK-UP
C10	COIL	C20	IGNITION MODULE	C30	ELECTRONIC IGNITION KIT	E01	IGNITION CABLE SET		

The present application list is a brief version. For the detailed information about the possibility of installation on a specific vehicle, please refer to our web-catalogue <http://catalogo.facet.eu/>

				FUNCTIONS ON THE VEHICLE									
Vehicle	alim.	kW	Date	Engine									
				ENGINE									
1.7	Petrol	66	07/88-04/92	F2N 722, F3N 742, F3N 743			815 069	915 097					
Engine					Information	A10	A20	A40	A50	A70	C10 - C30	C20	E01
All engines					version Ducellier			815 069	915 097				
All engines					Kit, version Ducellier			815 072					
All engines										470 107	C10		
				ENGINE									
1.7	Petrol	68	09/88-12/92	F2N 720, F2N 721			815 069	915 097					
Engine					Information	A10	A20	A40	A50	A70	C10 - C30	C20	E01
All engines					version Ducellier			815 069	915 097				
All engines					Kit, version Ducellier			815 072					
All engines										470 107	C10		
				ENGINE									
1.7	Petrol	69	09/90-04/92	F2N 721			815 069	915 097					
Engine					Information	A10	A20	A40	A50	A70	C10 - C30	C20	E01
All engines					version Ducellier			815 069	915 097				
All engines					Kit, version Ducellier			815 072					
All engines										470 107	C10		
				ENGINE									
1.7	Petrol	70	07/91-04/92	F3N 742, F3N 743			815 069	915 097					
Engine					Information	A10	A20	A40	A50	A70	C10 - C30	C20	E01
All engines					version Ducellier			815 069	915 097				
All engines					Kit, version Ducellier			815 072					
All engines										470 107	C10		
				ENGINE									
1.7	Petrol	79	08/88-12/92	F3N 746			815 069	915 097					
Engine					Information	A10	A20	A40	A50	A70	C10 - C30	C20	E01
All engines					version Ducellier			815 069	915 097				
All engines					Kit, version Ducellier			815 072					
All engines										470 107	C10	359 415	
				ENGINE									
1.8 16V	Petrol	101	06/89-04/92	F7P 700, F7P 704			815 081	915 101					
Engine					Information	A10	A20	A40	A50	A70	C10 - C30	C20	E01
All engines					version Ducellier			815 081	915 101				
All engines										470 107	C10	359 802	
				ENGINE									
1.8 16V	Petrol	103	06/89-09/92	F7P 700			815 081	915 101					
Engine					Information	A10	A20	A40	A50	A70	C10 - C30	C20	E01
All engines					version Ducellier			815 081	915 101				
All engines										470 107	C10	359 802	
				ENGINE									
1.8 16V	Petrol	99	06/89-04/92	F7P 704			815 081	915 101					
Engine					Information	A10	A20	A40	A50	A70	C10 - C30	C20	E01
All engines					version Ducellier			815 081	915 101				
All engines										470 107	C10	359 802	
				ENGINE									
19 II				ENGINE									
1.2	Petrol	44	05/92-09/94	E7F 730			815 081	915 101					
Engine					Information	A10	A20	A40	A50	A70	C10 - C30	C20	E01
All engines					version Ducellier			815 081	915 101				
All engines					version Marelli			830 111	930 059				
All engines										470 107	C10	359 801	
				ENGINE									
1.4	Petrol	43	04/92-12/95	C3J 710			815 059						
Engine					Information	A10	A20	A40	A50	A70	C10 - C30	C20	E01
All engines					version Ducellier			815 059					
All engines					version Femsa			817 023	917 058				
All engines					distr. num. 525 352 A/B, version Ducellier				915 088				
All engines					distr. num. 525 352 C/D, version Ducellier				915 094				
All engines										470 107	C10		

A10 CONDENSER	A20 CONTACT SET	A40 DISTRIBUTOR CAP	A50 ROTOR	A70 PICK-UP
C10 COIL	C20 IGNITION MODULE	C30 ELECTRONIC IGNITION KIT	E01 IGNITION CABLE SET	

Vehicle	alim.	kW	Date	Engine	FUNCTIONS ON THE VEHICLE							
					A10	A20	A40	A50	A70	C10 - C30	C20	E01

ENGINE				
1.4	Petrol	44	05/92-09/94	C3J 710

Engine	Information	A10	A20	A40	A50	A70	C10 - C30	C20	E01
All engines	version Ducellier			815 059					
All engines	version Femsa			817 023	917 058				
All engines	distr. num. 525 352 A/B, version Ducellier				915 088				
All engines	distr. num. 525 352 C/D, version Ducellier				915 094				
All engines							470 107	C10	

ENGINE				
1.4	Petrol	55	01/92-12/95	E7J 707, E7J 742, E7J 745

Engine	Information	A10	A20	A40	A50	A70	C10 - C30	C20	E01
All engines	version Ducellier			815 081	915 101				
All engines	version Marelli			830 111	930 059				
Eng. E7J 742, E7J 745							470 107	C10	
All engines									359 801

ENGINE				
1.4	Petrol	58	05/92-12/95	E6J 706

Engine	Information	A10	A20	A40	A50	A70	C10 - C30	C20	E01
All engines	version Ducellier			815 081	915 101				
All engines	version Marelli			830 111	930 059				
All engines							470 107	C10	359 801

ENGINE				
1.4	Petrol	59	01/92-12/95	E7J 706

Engine	Information	A10	A20	A40	A50	A70	C10 - C30	C20	E01
All engines	version Ducellier			815 081	915 101				
All engines	version Marelli			830 111	930 059				
All engines							470 107	C10	359 801

ENGINE				
1.7	Petrol	54	04/92-12/95	F3N 740, F3N 741

Engine	Information	A10	A20	A40	A50	A70	C10 - C30	C20	E01
All engines	version Ducellier			815 069	915 097				
All engines	Kit, version Ducellier			815 072					
All engines							470 107	C10	

ENGINE				
1.7	Petrol	55	05/92-11/95	F3N 740, F3N 741

Engine	Information	A10	A20	A40	A50	A70	C10 - C30	C20	E01
All engines	version Ducellier			815 069	915 097				
All engines	Kit, version Ducellier			815 072					
All engines							470 107	C10	

ENGINE				
1.7	Petrol	66	04/92-12/95	F3N 742, F3N 743

Engine	Information	A10	A20	A40	A50	A70	C10 - C30	C20	E01
All engines	version Ducellier			815 069	915 097				
All engines	Kit, version Ducellier			815 072					
All engines							470 107	C10	
Eng. F3N 743									359 415

ENGINE				
1.7	Petrol	68	09/90-12/95	F2N 720, F2N 721, F2N 726, F2N 727

Engine	Information	A10	A20	A40	A50	A70	C10 - C30	C20	E01
All engines	version Ducellier			815 069	915 097				
All engines	Kit, version Ducellier			815 072					
All engines							470 107	C10	

ENGINE				
1.7	Petrol	79	05/92-09/94	F3N 746

Engine	Information	A10	A20	A40	A50	A70	C10 - C30	C20	E01
All engines	version Ducellier			815 069	915 097				
All engines	Kit, version Ducellier			815 072					
All engines							470 107	C10	359 415

A10	CONDENSER	A20	CONTACT SET	A40	DISTRIBUTOR CAP	A50	ROTOR	A70	PICK-UP
C10	COIL	C20	IGNITION MODULE	C30	ELECTRONIC IGNITION KIT	E01	IGNITION CABLE SET		

The present application list is a brief version. For the detailed information about the possibility of installation on a specific vehicle, please refer to our web-catalogue <http://catalogo.facet.eu/>

					FUNCTIONS ON THE VEHICLE							
Vehicle	alim.	kW	Date	Engine								
ENGINE												
1.8	Petrol	65	04/92-06/96	8NA20S, F3P 704, F3P 705, F3P 706, F3P 707, F3P 708			815 069	915 097		470 107	C10	
ENGINE												
1.8	Petrol	66	04/92-06/96	8NA20S, F3P 706			815 069	915 097		470 107	C10	
ENGINE												
1.8	Petrol	67	05/92-09/94	F3P 765			815 069	915 097				
ENGINE												
1.8	Petrol	79	05/92-06/96	5F 140 FE, F3P 682, F3P 764, F3P 765			815 069	915 097				
ENGINE												
1.8	Petrol	81	04/92-05/94	5F 140 FE			815 069	915 097				
ENGINE												
1.8 16V	Petrol	101	05/92-04/94	F7P 704			815 081	915 101		470 107	C10	359 802
ENGINE												
1.8 16V	Petrol	99	04/92-06/96	F7P 704			815 081	915 101		470 107	C10	359 802
ENGINE												
2.0	Petrol	76	10/80-12/83	829 702, 829 703			615 023	715 086	815 054	915 091		
ENGINE												
2.0	Petrol	80	10/77-10/80	829 700, 829 701, 829.01			615 023	715 086	815 054	915 091		
ENGINE												
2.0	Petrol	80	10/77-10/80	829 700, 829 701, 829.01			615 023	715 086	815 054	915 091		
ENGINE												
21	Petrol	0	06/90-12/91	C2L 717			815 059	915 088				
ENGINE												
1.4	Petrol	0	06/90-12/91	C2L 717			815 059	915 088		470 107	C10	

A10 CONDENSER	A20 CONTACT SET	A40 DISTRIBUTOR CAP	A50 ROTOR	A70 PICK-UP
C10 COIL	C20 IGNITION MODULE	C30 ELECTRONIC IGNITION KIT	E01 IGNITION CABLE SET	

Vehicle	alim.	kW	Date	Engine	FUNCTIONS ON THE VEHICLE								
					A10	A20	A40	A50	A70	C10 - C30	C20	E01	
1.4	Petrol	51	06/88-12/95	ENGINE C2J 770, C2L 714									
Engine	Information			A10	A20	A40	A50	A70	C10 - C30	C20	E01		
Eng. C2J 770	version Ducellier					815 059	915 088						
Eng. C2L 714	version Ducellier					815 091							
All engines									470 107	C10			
1.7	Petrol	54	06/86-12/95	ENGINE F2N 750, F2N 758, F2N 786, F3N 726									
Engine	Information			A10	A20	A40	A50	A70	C10 - C30	C20	E01		
All engines	version Ducellier					815 069	915 097						
All engines	Kit, version Ducellier					815 072							
All engines									470 107	C10			
1.7	Petrol	55	03/86-05/93	ENGINE F2N 712, F3N 726									
Engine	Information			A10	A20	A40	A50	A70	C10 - C30	C20	E01		
All engines	version Ducellier					815 069	915 097						
All engines	Kit, version Ducellier					815 072							
All engines									470 107	C10			
1.7	Petrol	64	06/87-04/89	ENGINE F2N 752									
Engine	Information			A10	A20	A40	A50	A70	C10 - C30	C20	E01		
All engines	version Ducellier					815 069	915 097						
All engines	Kit, version Ducellier					815 072							
All engines									470 107	C10			
1.7	Petrol	65	03/86-04/95	ENGINE F2N 710, F2N 711, F2N 754									
Engine	Information			A10	A20	A40	A50	A70	C10 - C30	C20	E01		
All engines	version Ducellier					815 069	915 097						
All engines	Kit, version Ducellier					815 072							
All engines									470 107	C10			
1.7	Petrol	66	09/89-06/94	ENGINE F3N 722, F3N 723									
Engine	Information			A10	A20	A40	A50	A70	C10 - C30	C20	E01		
All engines	version Ducellier					815 069	915 097						
All engines	Kit, version Ducellier					815 072							
All engines									470 107	C10			
1.7	Petrol	69	03/86-02/94	ENGINE F2N 722, F3N 722, F3N 723									
Engine	Information			A10	A20	A40	A50	A70	C10 - C30	C20	E01		
All engines	version Ducellier					815 069	915 097						
All engines	Kit, version Ducellier					815 072							
All engines									470 107	C10			
1.7	Petrol	70	04/86-06/89	ENGINE F3N 722, F3N 723									
Engine	Information			A10	A20	A40	A50	A70	C10 - C30	C20	E01		
All engines	version Ducellier					815 069	915 097						
All engines	Kit, version Ducellier					815 072							
All engines									470 107	C10			
1.7 Cat	Petrol	54	05/88-06/93	ENGINE F3N 726									
Engine	Information			A10	A20	A40	A50	A70	C10 - C30	C20	E01		
All engines	version Ducellier					815 069	915 097						
All engines	Kit, version Ducellier					815 072							
All engines									470 107	C10			
2.0	Petrol	66	09/89-12/91	ENGINE F2R 702									
Engine	Information			A10	A20	A40	A50	A70	C10 - C30	C20	E01		
All engines	version Ducellier					815 069	915 097						
All engines	Kit, version Ducellier					815 072							
All engines									470 107	C10			
A10	CONDENSER	A20	CONTACT SET	A40	DISTRIBUTOR CAP	A50	ROTOR	A70	PICK-UP				
C10	COIL	C20	IGNITION MODULE	C30	ELECTRONIC IGNITION KIT	E01	IGNITION CABLE SET						







					FUNCTIONS ON THE VEHICLE							
Vehicle	alim.	kW	Date	Engine	 A10	 A20	 A40	 A50	 A70	 C10 - C30	 C20	 E01
ENGINE												
2.0	Petrol	75	03/86-10/93	8CPD, J6R 758, J6R 759, J6R 793								
ENGINE												
2.0												
ENGINE												
2.0												
ENGINE												
2.0												
ENGINE												
2.0	Petrol	76	04/88-06/89	8CPD, J6R 793								
ENGINE												
2.0												
ENGINE												
2.0												
ENGINE												
2.0	Petrol	78	05/91-10/93	J6R 758								
ENGINE												
2.0												
ENGINE												
2.0												
ENGINE												
2.0	Petrol	85	03/86-12/88	J7R 750, J7R 751								
ENGINE												
2.0												
ENGINE												
2.0												
ENGINE												
2.0	Petrol	86	04/86-06/92	J7R 750, J7R 751								
ENGINE												
2.0												
ENGINE												
2.0												
ENGINE												
2.0	Petrol	88	03/86-12/93	14ZR, J7R 747								
ENGINE												
2.0												
ENGINE												
2.0												
ENGINE												
2.0	Petrol	99	02/90-06/94	J7R 740								
ENGINE												
2.0												
ENGINE												
2.0												
ENGINE												
2.0 4x4	Petrol	88	03/89-12/93	14ZR, J7R 747								
ENGINE												
2.0 4x4												
ENGINE												
2.0 4x4												
ENGINE												
2.0 4x4	Petrol	99	12/89-02/94	J7R 740								
ENGINE												
2.0 4x4												
ENGINE												
2.0 4x4												
ENGINE												
2.0 Turbo	Petrol	119	02/90-10/92	J7R 756								
ENGINE												
2.0 Turbo												
ENGINE												
2.0 Turbo												
ENGINE												
2.0 Turbo	Petrol	129	04/87-03/90	J7R 752								
ENGINE												
2.0 Turbo												
ENGINE												
2.0 Turbo												

A10 CONDENSER	A20 CONTACT SET	A40 DISTRIBUTOR CAP	A50 ROTOR	A70 PICK-UP
C10 COIL	C20 IGNITION MODULE	C30 ELECTRONIC IGNITION KIT	E01 IGNITION CABLE SET	

Vehicle	alim.	kW	Date	Engine	FUNCTIONS ON THE VEHICLE							
					A10	A20	A40	A50	A70	C10 - C30	C20	E01
ENGINE												
2.0 Turbo	Petrol	129	04/87-03/90	J7R 752								
Engine	Information			A10	A20	A40	A50	A70	C10 - C30	C20	E01	
All engines	Kit, version Ducellier					815 083						
All engines									470 107	C10		
All engines	->eng. F140627										359 539	
ENGINE												
2.0 Turbo 4x4	Petrol	119	02/90-10/92	J7R 756								
Engine	Information			A10	A20	A40	A50	A70	C10 - C30	C20	E01	
All engines	version Ducellier					815 082	915 101					
All engines	Kit, version Ducellier					815 083						
All engines	->year 30/06/91								470 107	C10		
All engines	01/07/91 ->, info A-K								470 275	C10		
All engines	01/07/91 ->, info B-K								470 276	C10		
ENGINE												
2.0 Turbo 4x4	Petrol	129	08/89-10/93	J7R 752								
Engine	Information			A10	A20	A40	A50	A70	C10 - C30	C20	E01	
All engines	version Ducellier					815 082	915 101					
All engines	Kit, version Ducellier					815 083						
All engines									470 107	C10		
All engines	->eng. F140627										359 539	
ENGINE												
2.0 Txi	Petrol	100	07/89-05/93	1SCRMP10U1, J7R 740								
Engine	Information			A10	A20	A40	A50	A70	C10 - C30	C20	E01	
All engines	version Ducellier					815 082	915 101					
All engines	Kit, version Ducellier					815 083						
All engines									470 107	C10		
ENGINE												
2.2	Petrol	79	06/86-12/95	J7T 754, J7T 755, J7T 756								
Engine	Information			A10	A20	A40	A50	A70	C10 - C30	C20	E01	
Eng. J7T 754, J7T 755						815 065						
All engines	version Ducellier					815 066						
All engines									470 107	C10	359 539	
ENGINE												
2.2	Petrol	81	04/86-05/93	J7T 755								
Engine	Information			A10	A20	A40	A50	A70	C10 - C30	C20	E01	
All engines						815 065			470 107	C10	359 539	
All engines	version Ducellier					815 066						
ENGINE												
2.2	Petrol	85	03/86-12/95	J6T 790, J6T 791								
Engine	Information			A10	A20	A40	A50	A70	C10 - C30	C20	E01	
All engines	version Ducellier					815 066						
All engines									470 107	C10	359 539	
ENGINE												
2.2 4x4	Petrol	79	06/86-06/94	J7T 754, J7T 755								
Engine	Information			A10	A20	A40	A50	A70	C10 - C30	C20	E01	
All engines						815 065			470 107	C10	359 539	
All engines	version Ducellier					815 066						
25												
ENGINE												
2.0	Petrol	74	04/84-12/92	08A, J6R 706, J6R 707, J6R 763								
Engine	Information			A10	A20	A40	A50	A70	C10 - C30	C20	E01	
Eng. J6R 706, J6R 707	version Ducellier					815 059	915 094					
Eng. 08A, J6R 763	version Ducellier					815 091						
All engines									470 107	C10		
ENGINE												
2.0	Petrol	88	03/87-12/93	J7R 722, J7R 723								
Engine	Information			A10	A20	A40	A50	A70	C10 - C30	C20	E01	
All engines	version Ducellier					815 091						
All engines									470 107	C10	359 539	

A10 CONDENSER	A20 CONTACT SET	A40 DISTRIBUTOR CAP	A50 ROTOR	A70 PICK-UP
C10 COIL	C20 IGNITION MODULE	C30 ELECTRONIC IGNITION KIT	E01 IGNITION CABLE SET	

The present application list is a brief version. For the detailed information about the possibility of installation on a specific vehicle, please refer to our web-catalogue <http://catalogo.facet.eu/>







					FUNCTIONS ON THE VEHICLE							
Vehicle	alim.	kW	Date	Engine	 A10	 A20	 A40	 A50	 A70	 C10 - C30	 C20	 E01
ENGINE												
2.0 12V	Petrol	103	06/88-12/93	7CYQD80D-E3, J7R 721								
Engine	Information			A10	A20	A40	A50	A70	C10 - C30	C20	E01	
All engines	01/07/88 ->, version Ducellier					815 081	915 101					
All engines	01/07/88 ->, Kit, version Ducellier					815 083						
All engines	->year 30/06/88, version Ducellier					815 091	915 094					
All engines									470 107	C10		
All engines	->year 30/06/88											359 539
ENGINE												
2.0 12V	Petrol	99	06/89-12/92	74AR-FXE								
Engine	Information			A10	A20	A40	A50	A70	C10 - C30	C20	E01	
All engines	01/07/88 ->, version Ducellier					815 081	915 101					
All engines	01/07/88 ->, Kit, version Ducellier					815 083						
All engines	->year 30/06/88, version Ducellier					815 091	915 094					
All engines									470 107	C10		
ENGINE												
2.2	Petrol	76	11/85-03/89	J7T 708, J7T 732								
Engine	Information			A10	A20	A40	A50	A70	C10 - C30	C20	E01	
All engines	version Ducellier					815 091						
All engines									470 107	C10		359 539
ENGINE												
2.2	Petrol	79	09/86-12/92	04TNV88-C, J7T 708, J7T 732								
Engine	Information			A10	A20	A40	A50	A70	C10 - C30	C20	E01	
All engines	version Ducellier					815 091						
All engines									470 107	C10		359 539
ENGINE												
2.2	Petrol	89	04/84-12/89	74G69-S4M, J7T 706, J7T 707, J7T 715								
Engine	Information			A10	A20	A40	A50	A70	C10 - C30	C20	E01	
Eng. J7T 706, J7T 707	version Ducellier					815 059	915 094					
Eng. 74G69-S4M, J7T 715	version Ducellier					815 091						
All engines									470 107	C10		359 539
ENGINE												
2.2	Petrol	91	04/84-12/89	J7T 730, J7T 731								
Engine	Information			A10	A20	A40	A50	A70	C10 - C30	C20	E01	
All engines	version Ducellier					815 091						
All engines									470 107	C10		359 539
ENGINE												
2.4 V6 Turbo	Petrol	133	10/84-05/90	Z7U 702								
Engine	Information			A10	A20	A40	A50	A70	C10 - C30	C20	E01	
All engines	version Bosch					806 236	906 119R					
All engines									470 107	C10		
ENGINE												
2.5 V6 Turbo	Petrol	151	01/90-12/92	Z7U 700								
Engine	Information			A10	A20	A40	A50	A70	C10 - C30	C20	E01	
All engines	version Bosch					806 236	906 119R					
All engines									470 107	C10		
ENGINE												
2.7 V6 Injection	Petrol	104	04/84-08/89	Z7V 708, Z7V 709, Z7V 711								
Engine	Information			A10	A20	A40	A50	A70	C10 - C30	C20	E01	
All engines	version Bosch						906 023R					
ENGINE												
2.8 V6	Petrol	115	06/87-02/90	Z7W 700, Z7W 701								
Engine	Information			A10	A20	A40	A50	A70	C10 - C30	C20	E01	
All engines	version Bosch					806 236	906 119R					
All engines									470 107	C10		
ENGINE												
2.8 V6 Injection	Petrol	100	06/86-02/88	Z7W 702								
Engine	Information			A10	A20	A40	A50	A70	C10 - C30	C20	E01	
All engines	version Bosch						906 023R					

A10 CONDENSER	A20 CONTACT SET	A40 DISTRIBUTOR CAP	A50 ROTOR	A70 PICK-UP
C10 COIL	C20 IGNITION MODULE	C30 ELECTRONIC IGNITION KIT	E01 IGNITION CABLE SET	

Vehicle	alim.	kW	Date	Engine	FUNCTIONS ON THE VEHICLE									
					A10	A20	A40	A50	A70	C10 - C30	C20	E01		
ENGINE														
2.8 V6 Injection	Petrol	110	06/87-12/92	Z7W 706, Z7W 707, Z7W 709										
Engine	Information				A10	A20	A40	A50	A70	C10 - C30	C20	E01		
All engines	version Bosch						806 236	906 119R						
All engines										470 107	C10			
4														
ENGINE														
0.8	Petrol	19	10/62-09/83	800, 800 705										
Engine	Information				A10	A20	A40	A50	A70	C10 - C30	C20	E01		
All engines	version DUCELLIER						815 041							
ENGINE														
0.8	Petrol	21	10/83-10/88	800 705										
Engine	Information				A10	A20	A40	A50	A70	C10 - C30	C20	E01		
All engines	version Ducellier				615 023	715 055	815 054	915 091						
All engines	version Sev				642 056	742 054	842 043							
ENGINE														
0.8	Petrol	25	09/71-12/88	800 01										
Engine	Information				A10	A20	A40	A50	A70	C10 - C30	C20	E01		
All engines	version Ducellier				615 023	715 061								
All engines	version Femsas				617 097	717 024	817 023	917 058						
All engines								915 081		470 101D	C10			
ENGINE														
1.1	Petrol	25	06/78-06/90	688 712, C1E 714, C1E 719										
Engine	Information				A10	A20	A40	A50	A70	C10 - C30	C20	E01		
All engines						706 040								
Eng. 688 712	version Femsas					717 026	817 023	917 058						
Eng. 688 712	version Marelli						830 101	930 047R						
ENGINE														
1.1	Petrol	33	02/78-03/84	688 712										
Engine	Information				A10	A20	A40	A50	A70	C10 - C30	C20	E01		
All engines	version Femsas					717 026	817 023	917 058						
All engines	version Marelli						830 101	930 047R						
5														
ENGINE														
1.0	Petrol	32	01/72-12/85	689 710										
Engine	Information				A10	A20	A40	A50	A70	C10 - C30	C20	E01		
All engines						706 040								
ENGINE														
1.3	Petrol	31	09/76-09/79	810 726										
Engine	Information				A10	A20	A40	A50	A70	C10 - C30	C20	E01		
All engines	version Ducellier				615 023	715 086		915 091						
All engines						706 040				470 101D	C10			
ENGINE														
1.3	Petrol	33	06/79-09/84	810 719										
Engine	Information				A10	A20	A40	A50	A70	C10 - C30	C20	E01		
All engines	version Ducellier				615 023	715 061								
All engines										470 101D	C10			
ENGINE														
1.3	Petrol	47	09/75-09/84	810 725										
Engine	Information				A10	A20	A40	A50	A70	C10 - C30	C20	E01		
All engines						706 040								
ENGINE														
1.4	Petrol	46	01/82-12/85	847 725, C2J 713										
Engine	Information				A10	A20	A40	A50	A70	C10 - C30	C20	E01		
All engines						706 040								
Eng. 847 725	version Femsas						817 023	917 058						
ENGINE														
1.4 Alpine A5	Petrol	68	09/77-09/81	840 725										
Engine	Information				A10	A20	A40	A50	A70	C10 - C30	C20	E01		
All engines	version Ducellier				615 034		815 054	915 091						

A10	CONDENSER	A20	CONTACT SET	A40	DISTRIBUTOR CAP	A50	ROTOR	A70	PICK-UP
C10	COIL	C20	IGNITION MODULE	C30	ELECTRONIC IGNITION KIT	E01	IGNITION CABLE SET		

The present application list is a brief version. For the detailed information about the possibility of installation on a specific vehicle, please refer to our web-catalogue <http://catalogo.facet.eu/>

					FUNCTIONS ON THE VEHICLE							
Vehicle	alim.	kW	Date	Engine	 A10	 A20	 A40	 A50	 A70	 C10 - C30	 C20	 E01
ENGINE												
1.4 Alpine A5	Petrol	68	09/77-09/81	840 725								
Engine	Information				A10	A20	A40	A50	A70	C10 - C30	C20	E01
All engines										470 101D	C10	
ENGINE												
1.4 Alpine Turbo	Petrol	79	10/81-01/85	840 726								
Engine	Information				A10	A20	A40	A50	A70	C10 - C30	C20	E01
All engines	version Ducellier						815 059					
All engines	distr. num. 525352A/B, version Ducellier							915 088				
All engines	distr. num. 525352C, version Ducellier							915 094				
ENGINE												
1.4 Automatik	Petrol	43	06/82-09/84	847 712								
Engine	Information				A10	A20	A40	A50	A70	C10 - C30	C20	E01
All engines						706 040						
9												
ENGINE												
1.1	Petrol	35	09/81-05/87	C1E 715								
Engine	Information				A10	A20	A40	A50	A70	C10 - C30	C20	E01
All engines	version Ducellier					715 126	815 054	915 091				
All engines	version Marelli						830 101	930 047R				
ENGINE												
1.2	Petrol	40	09/85-12/88	C1G 700, C1G 710								
Engine	Information				A10	A20	A40	A50	A70	C10 - C30	C20	E01
All engines	version Ducellier					715 126	815 059	915 094				
All engines	version Femsa					717 026		917 058				
All engines										470 101D	C10	359 839
ENGINE												
1.7	Petrol	54	10/86-12/88	F3N 718								
Engine	Information				A10	A20	A40	A50	A70	C10 - C30	C20	E01
All engines							815 062					
ENGINE												
1.7	Petrol	55	10/86-12/88	F2N 730								
Engine	Information				A10	A20	A40	A50	A70	C10 - C30	C20	E01
All engines							815 062					
ENGINE												
1.7	Petrol	59	09/84-12/89	F2N 700, F2N 704								
Engine	Information				A10	A20	A40	A50	A70	C10 - C30	C20	E01
All engines							815 062					
ENGINE												
1.7	Petrol	65	10/86-12/88	F2N 708, F2N 710, F2N 798								
Engine	Information				A10	A20	A40	A50	A70	C10 - C30	C20	E01
All engines							815 062					
ENGINE												
1.7	Petrol	69	06/87-12/88	F3N 708								
Engine	Information				A10	A20	A40	A50	A70	C10 - C30	C20	E01
All engines							815 062					
AVANTIME												
ENGINE												
2.0 16V Turbo	Petrol	120	11/01-05/03	F4R 760, F4R 761								
Engine	Information				A10	A20	A40	A50	A70	C10 - C30	C20	E01
All engines	x 4, SAGEM, COIL ON PLUG									470 432	C10	
CAPTUR												
ENGINE												
0.9 TCe 90	Petrol	66	06/13->	H4B 400, H4B 408								
Engine	Information				A10	A20	A40	A50	A70	C10 - C30	C20	E01
All engines	x 3, COIL ON PLUG									470 613	C10	
Eng. H4B 408	Qty: 3									470 613	C10	



A10 CONDENSER	A20 CONTACT SET	A40 DISTRIBUTOR CAP	A50 ROTOR	A70 PICK-UP
C10 COIL	C20 IGNITION MODULE	C30 ELECTRONIC IGNITION KIT	E01 IGNITION CABLE SET	

Vehicle	alim.	kW	Date	Engine	FUNCTIONS ON THE VEHICLE									
					A10	A20	A40	A50	A70	C10 - C30	C20	E01		
ENGINE														
1.0 TCe 90 ECO-G	Petrol/ Liquified Petroleum Gas (LPG)	67	01/21->	H4D470										
Engine					A10	A20	A40	A50	A70	C10 - C30	C20	E01		
All engines										470 552	C10			
ENGINE														
1.2 T	Petrol	83	06/13->	HSF 403										
Engine					A10	A20	A40	A50	A70	C10 - C30	C20	E01		
All engines										470 613	C10			
ENGINE														
1.2 T	Petrol	85	06/15->	HSF 403										
Engine					A10	A20	A40	A50	A70	C10 - C30	C20	E01		
All engines										470 613	C10			
ENGINE														
1.2 TCe	Petrol	97	02/18->	HSF 408										
Engine					A10	A20	A40	A50	A70	C10 - C30	C20	E01		
All engines										470 613	C10			
ENGINE														
1.2 TCe 120	Petrol	87	01/16->	HSF 408, HSF 412										
Engine					A10	A20	A40	A50	A70	C10 - C30	C20	E01		
All engines										470 613	C10			
ENGINE														
1.2 TCe 120	Petrol	88	06/13->	HSF 403										
Engine					A10	A20	A40	A50	A70	C10 - C30	C20	E01		
All engines										470 613	C10			
ENGINE														
LPG	Petrol/ Liquified Petroleum Gas (LPG)	74	01/20->	H4D 460										
Engine					A10	A20	A40	A50	A70	C10 - C30	C20	E01		
All engines										470 552	C10			
ENGINE														
TCe 100	Petrol	74	01/20->	H4D 450										
Engine					A10	A20	A40	A50	A70	C10 - C30	C20	E01		
All engines										470 552	C10			
ENGINE														
TCe 90	Petrol	67	09/20->	H4D470										
Engine					A10	A20	A40	A50	A70	C10 - C30	C20	E01		
All engines										470 552	C10			
CLIO														
ENGINE														
1.2	Petrol	47	11/12->	D4F 740										
Engine					A10	A20	A40	A50	A70	C10 - C30	C20	E01		
All engines										470 518	C10			
ENGINE														
1.2	Petrol	48	08/98-05/01	D4F 728										
Engine					A10	A20	A40	A50	A70	C10 - C30	C20	E01		
All engines										470 518	C10			
ENGINE														
1.2 BiFuel	LPG	44	03/98-10/01	D7F 722										
Engine					A10	A20	A40	A50	A70	C10 - C30	C20	E01		
All engines										470 596	C10			
ENGINE														
1.6	Petrol	58	07/00-10/03	K4M 734										
Engine					A10	A20	A40	A50	A70	C10 - C30	C20	E01		
All engines										470 432	C10			

A10 CONDENSER	A20 CONTACT SET	A40 DISTRIBUTOR CAP	A50 ROTOR	A70 PICK-UP
C10 COIL	C20 IGNITION MODULE	C30 ELECTRONIC IGNITION KIT	E01 IGNITION CABLE SET	

The present application list is a brief version. For the detailed information about the possibility of installation on a specific vehicle, please refer to our web-catalogue <http://catalogo.facet.eu/>

FUNCTIONS ON THE VEHICLE

Vehicle	alim.	kW	Date	Engine	 A10	 A20	 A40	 A50	 A70	 C10 - C30	 C20	 E01
---------	-------	----	------	--------	---	---	---	--	---	---	---	---

CLIO I					ENGINE							
1.1	Petrol	34	01/91-09/98	C1E 700	A10	A20	A40	A50	A70	C10 - C30	C20	E01
Engine Information					A10	A20	A40	A50	A70	C10 - C30	C20	E01
All engines version Ducellier						715 126	815 054	915 091				
CLIO I					ENGINE							
1.1	Petrol	36	04/92-08/92	C1E 700	A10	A20	A40	A50	A70	C10 - C30	C20	E01
Engine Information					A10	A20	A40	A50	A70	C10 - C30	C20	E01
All engines version Ducellier						715 126	815 054	915 091				
CLIO I					ENGINE							
1.2	Petrol	40	06/90-09/98	C3G 720, D7F 730, E5F 716, E7F 706	A10	A20	A40	A50	A70	C10 - C30	C20	E01
Engine Information					A10	A20	A40	A50	A70	C10 - C30	C20	E01
Eng. C3G 720 version Ducellier							815 059					
Eng. E5F 716, E7F 706 version Ducellier							815 081	915 101				
Eng. E5F 716, E7F 706 version Marelli							830 111	930 059				
Eng. C3G 720 distr. num. 525352A, version Ducellier								915 088				
Eng. C3G 720 distr. num. 525352E, version Ducellier								915 094				
Eng. E5F 716, E7F 706									470 107	C10		359 801
Eng. C3G 720									470 228	C10		360 497
Eng. D7F 730									470 365	C10		360 447
CLIO I					ENGINE							
1.2	Petrol	43	05/90-09/98	D7F 730, E7F 700, E7F 708, E7F 750	A10	A20	A40	A50	A70	C10 - C30	C20	E01
Engine Information					A10	A20	A40	A50	A70	C10 - C30	C20	E01
Eng. E7F 700, E7F 708, E7F 750 version Ducellier							815 081	915 101				
Eng. E7F 700, E7F 708, E7F 750 version Marelli							830 111	930 059				
Eng. E7F 700, E7F 708, E7F 750									470 107	C10		359 801
Eng. D7F 730									470 365	C10		360 447
CLIO I					ENGINE							
1.2	Petrol	44	05/90-09/98	ESF 710, E7F 750	A10	A20	A40	A50	A70	C10 - C30	C20	E01
Engine Information					A10	A20	A40	A50	A70	C10 - C30	C20	E01
All engines version Ducellier							815 081	915 101				
All engines version Marelli							830 111	930 059				
All engines									470 107	C10		359 801
CLIO I					ENGINE							
1.4	Petrol	55	06/90-09/98	E6J 718, E7J 756, E7J 757	A10	A20	A40	A50	A70	C10 - C30	C20	E01
Engine Information					A10	A20	A40	A50	A70	C10 - C30	C20	E01
All engines version Ducellier							815 081	915 101				
All engines version Marelli							830 111	930 059				
All engines									470 107	C10		359 801
CLIO I					ENGINE							
1.4	Petrol	57	05/90-02/98	E6J 712, E6J 713	A10	A20	A40	A50	A70	C10 - C30	C20	E01
Engine Information					A10	A20	A40	A50	A70	C10 - C30	C20	E01
All engines version Ducellier							815 081	915 101				
All engines version Marelli							830 111	930 059				
All engines									470 107	C10		359 801
CLIO I					ENGINE							
1.4	Petrol	58	01/91-09/98	E7J 601, E7J 718, E7J 719, E7J 754	A10	A20	A40	A50	A70	C10 - C30	C20	E01
Engine Information					A10	A20	A40	A50	A70	C10 - C30	C20	E01
All engines version Ducellier							815 081	915 101				
All engines version Marelli							830 111	930 059				
All engines									470 107	C10		359 801
CLIO I					ENGINE							
1.4	Petrol	59	01/91-09/98	E7J 710, E7J 711	A10	A20	A40	A50	A70	C10 - C30	C20	E01
Engine Information					A10	A20	A40	A50	A70	C10 - C30	C20	E01
All engines version Ducellier							815 081	915 101				
All engines version Marelli							830 111	930 059				
All engines									470 107	C10		359 801

A10	CONDENSER	A20	CONTACT SET	A40	DISTRIBUTOR CAP	A50	ROTOR	A70	PICK-UP
C10	COIL	C20	IGNITION MODULE	C30	ELECTRONIC IGNITION KIT	E01	IGNITION CABLE SET		

Vehicle	alim.	kW	Date	Engine	FUNCTIONS ON THE VEHICLE									
					A10	A20	A40	A50	A70	C10 - C30	C20	E01		
1.7	Petrol	68	01/91-12/93	ENGINE F2N 770										
Engine	Information			A10	A20	A40	A50	A70	C10 - C30	C20	E01			
All engines	version Ducellier					815 069	915 097							
All engines	Kit, version Ducellier					815 072								
All engines									470 107	C10			359 415	
1.8	Petrol	65	01/91-09/98	ENGINE F3P 710, F3P 714										
Engine	Information			A10	A20	A40	A50	A70	C10 - C30	C20	E01			
All engines	version Ducellier					815 069	915 097							
All engines	spacer, version Ducellier					815 070								
All engines	Kit, version Ducellier					815 072								
All engines									470 107	C10				
1.8	Petrol	66	08/90-09/98	ENGINE OHR10DE, F3P 754										
Engine	Information			A10	A20	A40	A50	A70	C10 - C30	C20	E01			
Eng. F3P 754	version Ducellier					815 069								
Eng. F3P 754	spacer, version Ducellier					815 070								
Eng. F3P 754	Kit, version Ducellier					815 072								
Eng. OHR10DE	version Ducellier					815 085								
Eng. OHR10DE	Kit, version Ducellier					815 086								
All engines	version Ducellier						915 097							
All engines									470 107	C10				
1.8	Petrol	70	01/91-09/98	ENGINE F3P 710										
Engine	Information			A10	A20	A40	A50	A70	C10 - C30	C20	E01			
All engines	version Ducellier					815 069	915 097							
All engines	spacer, version Ducellier					815 070								
All engines	Kit, version Ducellier					815 072								
All engines									470 107	C10				
1.8 16V	Petrol	100	02/91-10/92	ENGINE F7P 720										
Engine	Information			A10	A20	A40	A50	A70	C10 - C30	C20	E01			
All engines	distr. num. 525646, version Ducellier					815 081								
All engines	distr. num. 525645, version Ducellier					815 082								
All engines	distr. num. 525645, Kit, version Ducellier					815 083								
All engines	version Ducellier						915 101							
All engines									470 107	C10			359 802	
1.8 16V	Petrol	99	01/91-03/96	ENGINE F7P 722										
Engine	Information			A10	A20	A40	A50	A70	C10 - C30	C20	E01			
All engines	distr. num. 525646, version Ducellier					815 081								
All engines	distr. num. 525645, version Ducellier					815 082								
All engines	distr. num. 525645, Kit, version Ducellier					815 083								
All engines	version Ducellier						915 101							
All engines									470 107	C10			359 802	
1.8 Rsi	Petrol	79	08/95-09/98	ENGINE F3P 758										
Engine	Information			A10	A20	A40	A50	A70	C10 - C30	C20	E01			
All engines	version Ducellier					815 069	915 097							
All engines	Kit, version Ducellier					815 072								
All engines									470 107	C10				
1.8 Rsi	Petrol	80	01/93-08/95	ENGINE F3P 712										
Engine	Information			A10	A20	A40	A50	A70	C10 - C30	C20	E01			
All engines	version Ducellier					815 069	915 097							
All engines	Kit, version Ducellier					815 072								
All engines									470 107	C10				
Williams	Petrol	108	01/94-09/98	ENGINE F7R 700										
Engine	Information			A10	A20	A40	A50	A70	C10 - C30	C20	E01			
All engines	distr. num. 525646, version Ducellier					815 081								

A10	CONDENSER	A20	CONTACT SET	A40	DISTRIBUTOR CAP	A50	ROTOR	A70	PICK-UP
C10	COIL	C20	IGNITION MODULE	C30	ELECTRONIC IGNITION KIT	E01	IGNITION CABLE SET		

The present application list is a brief version. For the detailed information about the possibility of installation on a specific vehicle, please refer to our web-catalogue <http://catalogo.facet.eu/>

Vehicle	alim.	kW	Date	Engine	FUNCTIONS ON THE VEHICLE							
					A10	A20	A40	A50	A70	C10 - C30	C20	E01

ENGINE				
Williams	Petrol	108	01/94-09/98	F7R 700

Engine	Information	A10	A20	A40	A50	A70	C10 - C30	C20	E01
All engines	distr. num. 525645, version Ducellier			815 082					
All engines	distr. num. 525645, Kit, version Ducellier			815 083					
All engines	version Ducellier				915 101				
All engines							470 107	C10	359 802

CLIO II				
ENGINE				
1.0	Petrol	40	02/00-05/01	D7D 760

Engine	Information	A10	A20	A40	A50	A70	C10 - C30	C20	E01
All engines	x 1, D.I.S.						470 596	C10	
All engines									360 681

ENGINE				
1.0 16V	Petrol	51	01/01->	D4D 700

Engine	Information	A10	A20	A40	A50	A70	C10 - C30	C20	E01
All engines							470 419	C10	

ENGINE				
1.2	Petrol	43	03/98->	D7F 710, D7F 720, D7F 722, D7F 726, D7F 744, D7F 746, D7F 764, D7F 766

Engine	Information	A10	A20	A40	A50	A70	C10 - C30	C20	E01
Eng. D7F 710, D7F 722	->year 21/10/98						470 365	C10	
Eng. D7F 720, D7F 726	->year 01/10/98, x 1, D.I.S., x 1, D.I.S.						470 365	C10	
Eng. D7F 710, D7F 722, D7F 744, D7F 764	21/10/98 ->						470 596	C10	
Eng. D7F 720, D7F 726, D7F 746, D7F 764, D7F 766	01/11/98 ->, x 1, D.I.S., x 1, D.I.S. ----- x 1, D.I.S.						470 596	C10	
Eng. D7F 710, D7F 720, D7F 722, D7F 726, D7F 766	->year 20/10/99								360 447
All engines	20/10/99 ->								360 681

ENGINE				
1.2	Petrol	44	03/99-10/03	D7F 726, D7F 746

Engine	Information	A10	A20	A40	A50	A70	C10 - C30	C20	E01
Eng. D7F 726	->year 21/10/98						470 365	C10	
Eng. D7F 726	21/10/98 ->						470 596	C10	
Eng. D7F 746	x 1, D.I.S.						470 596	C10	
Eng. D7F 726	->year 20/10/99								360 447
All engines	20/10/99 ->								360 681

ENGINE				
1.2 16V	Petrol	55	06/01-08/16	D4F 706, D4F 712, D4F 714, D4F 722, D4F 728

Engine	Information	A10	A20	A40	A50	A70	C10 - C30	C20	E01
Eng. D4F 706, D4F 712, D4F 714	x 1, with cable, D.I.S.						470 419	C10	
Eng. D4F 722, D4F 728	x 1, D.I.S.						470 518	C10	
Eng. D4F 722, D4F 728									358 246

ENGINE				
1.2 LPG	Petrol/ Liquified Petro- leum Gas (LPG)	43	09/98-06/09	D7F 744, D7F 764, D7F 766

Engine	Information	A10	A20	A40	A50	A70	C10 - C30	C20	E01
All engines	x 1, D.I.S.						470 596	C10	
Eng. D7F 766	->year 20/10/99								360 447
Eng. D7F 764, D7F 766	20/10/99 ->								360 681

ENGINE				
1.2 LPG	Petrol/ Liquified Petro- leum Gas (LPG)	44	03/99-05/01	D7F 722

Engine	Information	A10	A20	A40	A50	A70	C10 - C30	C20	E01
All engines	->year 01/10/98, x 1, D.I.S.						470 365	C10	
All engines	->year 20/10/99								360 447
All engines	20/10/99 ->								360 681

A10 CONDENSER	A20 CONTACT SET	A40 DISTRIBUTOR CAP	A50 ROTOR	A70 PICK-UP
C10 COIL	C20 IGNITION MODULE	C30 ELECTRONIC IGNITION KIT	E01 IGNITION CABLE SET	

Vehicle	alim.	kW	Date	Engine	FUNCTIONS ON THE VEHICLE									
					A10	A20	A40	A50	A70	C10 - C30	C20	E01		
1.4	Petrol	55	09/98-05/05	ENGINE E7J 634, E7J 635, E7J 780, K7J 700										
Engine	Information				A10	A20	A40	A50	A70	C10 - C30	C20	E01		
Eng. E7J 780	x 1, Colour:Black, D.I.S., connector type, saw teeth									470 376	C10			
Eng. E7J 780	x 1, Colour:Grey, D.I.S., connector type, saw teeth									470 378	C10			
Eng. E7J 634, E7J 635, K7J 700	x 1, D.I.S.									470 596	C10			
Eng. E7J 634, K7J 700													358 244	
Eng. E7J 780													360 443	
1.4 16V	Petrol	70	10/99-09/04	ENGINE K4J 712, K4J 713										
Engine	Information				A10	A20	A40	A50	A70	C10 - C30	C20	E01		
All engines	x 4, SAGEM, COIL ON PLUG									470 432	C10			
1.4 16V	Petrol	72	02/00->	ENGINE K4J 700, K4J 710, K4J 711, K4J 712, K4J 713, K4J 715										
Engine	Information				A10	A20	A40	A50	A70	C10 - C30	C20	E01		
Eng. K4J 700	Qty: 4									470 432	C10			
Eng. K4J 710, K4J 711, K4J 712, K4J 713, K4J 715	x 4, SAGEM, COIL ON PLUG									470 432	C10			
1.6	Petrol	66	09/98-05/05	ENGINE K7M 744, K7M 745, K7M 746										
Engine	Information				A10	A20	A40	A50	A70	C10 - C30	C20	E01		
Eng. K7M 744, K7M 745	x 1, Colour:Black, D.I.S., connector type, saw teeth									470 376	C10			
Eng. K7M 744, K7M 745	x 1, Colour:Grey, D.I.S., connector type, saw teeth									470 378	C10			
Eng. K7M 746	x 1, D.I.S.									470 596	C10			
Eng. K7M 744, K7M 745													360 443	
1.6	Petrol	79	11/03->	ENGINE K4M 746										
Engine	Information				A10	A20	A40	A50	A70	C10 - C30	C20	E01		
All engines	x 4, SAGEM, COIL ON PLUG									470 432	C10			
1.6 16V	Petrol	66	10/99->	ENGINE K4M 734										
Engine	Information				A10	A20	A40	A50	A70	C10 - C30	C20	E01		
All engines	Qty: 4									470 432	C10			
1.6 16V	Petrol	79	09/98-04/05	ENGINE K4M 708, K4M 740, K4M 742, K4M 743, K4M 744, K4M 745, K4M 746, K4M 748										
Engine	Information				A10	A20	A40	A50	A70	C10 - C30	C20	E01		
All engines	x 4, SAGEM, COIL ON PLUG									470 432	C10			
1.6 16V	Petrol	82	03/99-12/08	ENGINE K4M 708										
Engine	Information				A10	A20	A40	A50	A70	C10 - C30	C20	E01		
All engines	x 4, SAGEM, COIL ON PLUG									470 432	C10			
1.6 Hi-Flex	Petrol/ Ethanol	86	01/05-02/10	ENGINE K4M 748										
Engine	Information				A10	A20	A40	A50	A70	C10 - C30	C20	E01		
All engines	x 4, SAGEM, COIL ON PLUG									470 432	C10			
1.6i	Petrol	66	11/04->	ENGINE K4M 736										
Engine	Information				A10	A20	A40	A50	A70	C10 - C30	C20	E01		
All engines	Qty: 4									470 432	C10			
2.0 16V	Petrol	124	06/01->	ENGINE F4R 732										
Engine	Information				A10	A20	A40	A50	A70	C10 - C30	C20	E01		
All engines	Qty: 4									470 432	C10			

A10 CONDENSER	A20 CONTACT SET	A40 DISTRIBUTOR CAP	A50 ROTOR	A70 PICK-UP
C10 COIL	C20 IGNITION MODULE	C30 ELECTRONIC IGNITION KIT	E01 IGNITION CABLE SET	

The present application list is a brief version. For the detailed information about the possibility of installation on a specific vehicle, please refer to our web-catalogue <http://catalogo.facet.eu/>

					FUNCTIONS ON THE VEHICLE							
Vehicle	alim.	kW	Date	Engine	A10	A20	A40	A50	A70	C10 - C30	C20	E01
ENGINE												
2.0 16V Sport	Petrol	124	02/00-06/09	F4R 730, F4R 732, F4R 736								
Engine	Information				A10	A20	A40	A50	A70	C10 - C30	C20	E01
All engines	x 1, D.I.S.									470 365	C10	
ENGINE												
2.0 16V Sport	Petrol	132	01/04-04/05	F4R 738								
Engine	Information				A10	A20	A40	A50	A70	C10 - C30	C20	E01
All engines	x 1, D.I.S.									470 365	C10	
CLIO III												
ENGINE												
1.2	Petrol	55	11/05-12/14	D4F 740								
Engine	Information				A10	A20	A40	A50	A70	C10 - C30	C20	E01
All engines	x 1, D.I.S.									470 518	C10	
ENGINE												
1.2	Petrol	57	10/05-12/12	D4F 764								
Engine	Information				A10	A20	A40	A50	A70	C10 - C30	C20	E01
All engines	x 1, D.I.S.									470 518	C10	
All engines												358 246
ENGINE												
1.2	Petrol	74	11/07-12/11	D4F 784								
Engine	Information				A10	A20	A40	A50	A70	C10 - C30	C20	E01
All engines	x 1, D.I.S.									470 596	C10	
ENGINE												
1.2 16V	Petrol	43	06/06-08/10	D4F 764								
Engine	Information				A10	A20	A40	A50	A70	C10 - C30	C20	E01
All engines	x 1, D.I.S.									470 518	C10	
All engines												358 246
ENGINE												
1.2 16V	Petrol	48	06/05-12/14	D4F 740								
Engine	Information				A10	A20	A40	A50	A70	C10 - C30	C20	E01
All engines	x 1, D.I.S.									470 518	C10	
All engines												358 246
ENGINE												
1.2 16V	Petrol	55	06/05-12/14	D4F 706, D4F 740, D4F 764								
Engine	Information				A10	A20	A40	A50	A70	C10 - C30	C20	E01
Eng. D4F 706										470 419	C10	
Eng. D4F 740	x 1, D.I.S.									470 518	C10	
Eng. D4F 764										470 518	C10	
Eng. D4F 740, D4F 764												358 246
ENGINE												
1.2 16V	Petrol	58	06/05-12/14	D4F 764								
Engine	Information				A10	A20	A40	A50	A70	C10 - C30	C20	E01
All engines	x 1, D.I.S.									470 518	C10	
All engines												358 246
ENGINE												
1.2 16V	Petrol	74	05/07-12/14	D4F 784								
Engine	Information				A10	A20	A40	A50	A70	C10 - C30	C20	E01
All engines	x 1, D.I.S.									470 596	C10	
All engines												358 229
ENGINE												
1.2 16V	Petrol	76	03/10-12/14	D4F 786								
Engine	Information				A10	A20	A40	A50	A70	C10 - C30	C20	E01
All engines	x 1, D.I.S.									470 596	C10	
All engines												358 229
ENGINE												
1.2 16V Hi-Flex	Petrol/ Ethanol	55	07/08-12/14	D4F 740, D4F 744								
Engine	Information				A10	A20	A40	A50	A70	C10 - C30	C20	E01
Eng. D4F 740										470 518	C10	358 246
Eng. D4F 744	x 1, D.I.S.									470 518	C10	

A10 CONDENSER	A20 CONTACT SET	A40 DISTRIBUTOR CAP	A50 ROTOR	A70 PICK-UP
C10 COIL	C20 IGNITION MODULE	C30 ELECTRONIC IGNITION KIT	E01 IGNITION CABLE SET	

Vehicle	alim.	kW	Date	Engine	FUNCTIONS ON THE VEHICLE									
					A10	A20	A40	A50	A70	C10 - C30	C20	E01		
ENGINE														
1.2 16V Hi-Flex	Petrol/ Ethanol	58	11/07-12/12	D4F 742										
Engine	Information				A10	A20	A40	A50	A70	C10 - C30	C20	E01		
All engines	x 1, D.I.S.									470 518	C10			
ENGINE														
1.2 16V Hi-Flex	Petrol/ Liquified Petro- leum Gas (LPG)	55	07/08-12/14	D4F 740, D4F 742										
Engine	Information				A10	A20	A40	A50	A70	C10 - C30	C20	E01		
Eng. D4F 740										470 518	C10			
Eng. D4F 742	x 1, D.I.S.									470 518	C10			
All engines													358 246	
ENGINE														
1.2 Ethanol	Petrol/ Ethanol	55	07/08-12/12	D4F 742										
Engine	Information				A10	A20	A40	A50	A70	C10 - C30	C20	E01		
All engines	x 1, D.I.S.									470 518	C10			
ENGINE														
1.2 Hi-Flex	Petrol/ Ethanol	58	11/07-12/09	D4F 742										
Engine	Information				A10	A20	A40	A50	A70	C10 - C30	C20	E01		
All engines	x 1, D.I.S.									470 518	C10			
ENGINE														
1.4 16V	Petrol	72	06/05-12/12	K4J 780										
Engine	Information				A10	A20	A40	A50	A70	C10 - C30	C20	E01		
All engines	x 4, SAGEM, COIL ON PLUG									470 432	C10			
ENGINE														
1.6 16V	Petrol	65	06/05-10/07	K4M 804										
Engine	Information				A10	A20	A40	A50	A70	C10 - C30	C20	E01		
All engines	x 4, SAGEM, COIL ON PLUG									470 432	C10			
ENGINE														
1.6 16V	Petrol	80	11/07-12/12	K4M 804										
Engine	Information				A10	A20	A40	A50	A70	C10 - C30	C20	E01		
All engines	x 4, SAGEM, COIL ON PLUG									470 432	C10			
ENGINE														
1.6 16V	Petrol	82	06/05-12/14	K4M 800, K4M 801										
Engine	Information				A10	A20	A40	A50	A70	C10 - C30	C20	E01		
All engines	x 4, SAGEM, COIL ON PLUG									470 432	C10			
ENGINE														
1.6 16V	Petrol	94	11/07-12/12	K4M 862										
Engine	Information				A10	A20	A40	A50	A70	C10 - C30	C20	E01		
All engines	x 4, SAGEM, COIL ON PLUG									470 432	C10			
ENGINE														
1.6 16V GT	Petrol	94	06/09-12/14	K4M 862										
Engine	Information				A10	A20	A40	A50	A70	C10 - C30	C20	E01		
All engines	x 4, SAGEM, COIL ON PLUG									470 432	C10			
ENGINE														
2.0 16V	Petrol	102	09/06-12/14	M4R 700, M4R 701										
Engine	Information				A10	A20	A40	A50	A70	C10 - C30	C20	E01		
All engines	x 4, COIL ON PLUG									470 489	C10			
ENGINE														
2.0 16V Sport	Petrol	145	02/06-12/12	F4R 830										
Engine	Information				A10	A20	A40	A50	A70	C10 - C30	C20	E01		
All engines	x 4, SAGEM, COIL ON PLUG									470 432	C10			
ENGINE														
2.0 16V Sport	Petrol	148	09/08->	--, F4R 830, F4R 832										
Engine	Information				A10	A20	A40	A50	A70	C10 - C30	C20	E01		
Eng. --, F4R 830	Qty: 4									470 432	C10			
Eng. F4R 832	x 4, SAGEM, COIL ON PLUG									470 432	C10			

A10 CONDENSER	A20 CONTACT SET	A40 DISTRIBUTOR CAP	A50 ROTOR	A70 PICK-UP
C10 COIL	C20 IGNITION MODULE	C30 ELECTRONIC IGNITION KIT	E01 IGNITION CABLE SET	

The present application list is a brief version. For the detailed information about the possibility of installation on a specific vehicle, please refer to our web-catalogue <http://catalogo.facet.eu/>

Vehicle	alim.	kW	Date	Engine	FUNCTIONS ON THE VEHICLE							
					A10	A20	A40	A50	A70	C10 - C30	C20	E01

CLIO IV

				ENGINE
0.9 TCe 75	Petrol	56	05/18->	H4B 408

Engine	Information	A10	A20	A40	A50	A70	C10 - C30	C20	E01
All engines	x 3, COIL ON PLUG						470 613	C10	

				ENGINE
0.9 TCe 90	Petrol	66	11/12->	H4B 400, H4B 408

Engine	Information	A10	A20	A40	A50	A70	C10 - C30	C20	E01
All engines	x 3, COIL ON PLUG						470 613	C10	
Eng. H4B 408	Qty: 3						470 613	C10	

				ENGINE
0.9 TCe 90 LPG	Petrol/ Liquified Petro- leum Gas (LPG)	66	08/15->	H4B 410

Engine	Information	A10	A20	A40	A50	A70	C10 - C30	C20	E01
All engines	x 3, COIL ON PLUG						470 613	C10	

				ENGINE
1.2 16V	Petrol	54	11/12->	D4F 740, D4F 744

Engine	Information	A10	A20	A40	A50	A70	C10 - C30	C20	E01
Eng. D4F 744							470 518	C10	358 246
Eng. D4F 740	x 1, D.I.S.						470 518	C10	

				ENGINE
1.2 16V	Petrol	55	06/15->	D4F 740

Engine	Information	A10	A20	A40	A50	A70	C10 - C30	C20	E01
All engines	x 1, D.I.S.						470 518	C10	

				ENGINE
1.2 16V LPG	Petrol/ Liquified Petro- leum Gas (LPG)	53	01/14->	D4F 744

Engine	Information	A10	A20	A40	A50	A70	C10 - C30	C20	E01
All engines	x 1, D.I.S.						470 518	C10	

				ENGINE
1.2 LPG	Petrol/ Liquified Petro- leum Gas (LPG)	53	01/14->	D4F 744

Engine	Information	A10	A20	A40	A50	A70	C10 - C30	C20	E01
All engines	x 1, D.I.S.						470 518	C10	

				ENGINE
1.2 LPG 16V	Petrol/ Liquified Petro- leum Gas (LPG)	54	11/12-06/15	D4F 744

Engine	Information	A10	A20	A40	A50	A70	C10 - C30	C20	E01
All engines	x 1, D.I.S.						470 518	C10	

				ENGINE
1.2 TCe 120	Petrol	87	01/16->	H5F 408, H5F 412

Engine	Information	A10	A20	A40	A50	A70	C10 - C30	C20	E01
All engines	x 4, COIL ON PLUG						470 613	C10	

				ENGINE
1.2 TCe 120	Petrol	88	03/13->	H5F 403, H5F 412

Engine	Information	A10	A20	A40	A50	A70	C10 - C30	C20	E01
All engines	x 4, COIL ON PLUG						470 613	C10	

				ENGINE
1.6 RS	Petrol	147	03/13->	M5M 400, M5M 401

Engine	Information	A10	A20	A40	A50	A70	C10 - C30	C20	E01
All engines	x 4, COIL ON PLUG						470 551	C10	

				ENGINE
1.6 RS Trophy	Petrol	162	03/15->	M5M 401

Engine	Information	A10	A20	A40	A50	A70	C10 - C30	C20	E01
All engines	x 4, COIL ON PLUG						470 551	C10	

A10 CONDENSER	A20 CONTACT SET	A40 DISTRIBUTOR CAP	A50 ROTOR	A70 PICK-UP
C10 COIL	C20 IGNITION MODULE	C30 ELECTRONIC IGNITION KIT	E01 IGNITION CABLE SET	

Vehicle	alim.	kW	Date	Engine	FUNCTIONS ON THE VEHICLE							
					A10	A20	A40	A50	A70	C10 - C30	C20	E01

CLIO V

				ENGINE
1.0 LPG	Petrol/ Liquified Petroleum Gas (LPG)	74	06/19->	H4D 450, H4D 452, H4D 460

Engine	Information	A10	A20	A40	A50	A70	C10 - C30	C20	E01
All engines	x 3, COIL ON PLUG						470 552	C10	

				ENGINE
1.0 TCe 100	Petrol	74	06/19->	H4D 450, H4D 452, H4D 460

Engine	Information	A10	A20	A40	A50	A70	C10 - C30	C20	E01
All engines	x 3, COIL ON PLUG						470 552	C10	

				ENGINE
TCe 90	Petrol	67	08/20->	H4D 450, H4D 470

Engine	Information	A10	A20	A40	A50	A70	C10 - C30	C20	E01
All engines	x 3, COIL ON PLUG						470 552	C10	

DOKKER

				ENGINE
1.6	Petrol	59	12/13->	K7M 812

Engine	Information	A10	A20	A40	A50	A70	C10 - C30	C20	E01
All engines	x 1, D.I.S.						470 596	C10	

DUSTER

				ENGINE
1.6 16V	Petrol	75	02/12->	K4M 616

Engine	Information	A10	A20	A40	A50	A70	C10 - C30	C20	E01
All engines	x 4, SAGEM, COIL ON PLUG						470 432	C10	

				ENGINE
1.6 16V	Petrol	84	06/15->	H4M 438

Engine	Information	A10	A20	A40	A50	A70	C10 - C30	C20	E01
All engines	x 4, COIL ON PLUG						470 613	C10	

				ENGINE
1.6 16V 4x4	Petrol	75	06/11-05/15	K4M 490, K4M 606, K4M 646, K4M 690

Engine	Information	A10	A20	A40	A50	A70	C10 - C30	C20	E01
All engines	x 4, SAGEM, COIL ON PLUG						470 432	C10	

				ENGINE
1.6 16V 4x4	Petrol	84	06/15->	H4M 430

Engine	Information	A10	A20	A40	A50	A70	C10 - C30	C20	E01
All engines	x 4, COIL ON PLUG						470 613	C10	

				ENGINE
2.0	Petrol	98	02/12->	F4R 403, F4R 405

Engine	Information	A10	A20	A40	A50	A70	C10 - C30	C20	E01
All engines	x 4, SAGEM, COIL ON PLUG						470 432	C10	

				ENGINE
2.0 4x4	Petrol	105	10/11->	F4R 410, F4R 412

Engine	Information	A10	A20	A40	A50	A70	C10 - C30	C20	E01
All engines	x 4, SAGEM, COIL ON PLUG						470 432	C10	

				ENGINE
2.0 4x4	Petrol	99	02/12->	F4R 400, F4R 402, F4R 401

Engine	Information	A10	A20	A40	A50	A70	C10 - C30	C20	E01
All engines	x 4, SAGEM, COIL ON PLUG						470 432	C10	

SPACE I

				ENGINE
2.0	Petrol	74	01/88-12/90	53AZ-FXE

Engine	Information	A10	A20	A40	A50	A70	C10 - C30	C20	E01
All engines	version Ducellier			815 079	915 094				
All engines	info S100600201, info S100600243, info S100620001, info S100940201, info S100940220, info S100948002, info S101910201, info S101910220, info S101910243, info S102020001, info S102030002						470 107	C10	

A10 CONDENSER	A20 CONTACT SET	A40 DISTRIBUTOR CAP	A50 ROTOR	A70 PICK-UP
C10 COIL	C20 IGNITION MODULE	C30 ELECTRONIC IGNITION KIT	E01 IGNITION CABLE SET	

Vehicle	alim.	kW	Date	Engine	FUNCTIONS ON THE VEHICLE							
					A10	A20	A40	A50	A70	C10 - C30	C20	E01

2.0	Petrol	80	07/84-12/90	ENGINE J6R 234, J6R 236
------------	--------	-----------	-------------	-----------------------------------

Engine	Information	A10	A20	A40	A50	A70	C10 - C30	C20	E01
All engines	version Ducellier			815 079	915 094				
All engines							470 107	C10	

2.0 i	Petrol	87	01/89-12/90	ENGINE J7R 760
--------------	--------	-----------	-------------	--------------------------

Engine	Information	A10	A20	A40	A50	A70	C10 - C30	C20	E01
All engines	Kit, version Ducellier			815 088					
All engines							470 107	C10	359 539

2.0 i Quadra	Petrol	87	03/88-12/92	ENGINE J7R 760
---------------------	--------	-----------	-------------	--------------------------

Engine	Information	A10	A20	A40	A50	A70	C10 - C30	C20	E01
All engines	Kit, version Ducellier			815 088					
All engines							470 107	C10	359 539

2.2	Petrol	79	07/86-12/90	ENGINE 2QG15DE
------------	--------	-----------	-------------	--------------------------

Engine	Information	A10	A20	A40	A50	A70	C10 - C30	C20	E01
All engines	Kit, version Ducellier			815 088					
All engines									359 539

2.2 Quadra	Petrol	79	01/88-12/90	ENGINE 2QG15DE
-------------------	--------	-----------	-------------	--------------------------

Engine	Information	A10	A20	A40	A50	A70	C10 - C30	C20	E01
All engines	Kit, version Ducellier			815 088					
All engines									359 539

ESPACE II

2.0	Petrol	76	01/91-10/96	ENGINE J7R 768
------------	--------	-----------	-------------	--------------------------

Engine	Information	A10	A20	A40	A50	A70	C10 - C30	C20	E01
All engines				815 065			470 107	C10	359 539
All engines	version Ducellier			815 066	915 094				

2.2	Petrol	79	01/91-10/96	ENGINE J7T 772, J7T 773, J7T 776
------------	--------	-----------	-------------	--

Engine	Information	A10	A20	A40	A50	A70	C10 - C30	C20	E01
Eng. J7T 772	version Ducellier			815 059	915 094				
All engines				815 065			470 107	C10	
Eng. J7T 776	version Ducellier			815 066					
Eng. J7T 773, J7T 776									359 539

2.2 4x4	Petrol	79	03/91-12/96	ENGINE J7T 772, J7T 773
----------------	--------	-----------	-------------	-----------------------------------

Engine	Information	A10	A20	A40	A50	A70	C10 - C30	C20	E01
Eng. J7T 772	version Ducellier			815 059	915 094				
All engines							470 107	C10	
Eng. J7T 773									359 539

2.8 V6	Petrol	110	01/91-10/96	ENGINE Z7W 712, Z7W 713, Z7W 717
---------------	--------	------------	-------------	--

Engine	Information	A10	A20	A40	A50	A70	C10 - C30	C20	E01
All engines	version Bosch			806 236	906 119R				
All engines							470 107	C10	

ESPACE III

2.0	Petrol	102	09/01-10/02	ENGINE F4R 700, F4R 701
------------	--------	------------	-------------	-----------------------------------

Engine	Information	A10	A20	A40	A50	A70	C10 - C30	C20	E01
All engines	x 4, SAGEM, COIL ON PLUG						470 432	C10	

2.0	Petrol	84	11/96-10/00	ENGINE F3R 728, F3R 729, F3R 742, F3R 768, F3R 769
------------	--------	-----------	-------------	--









Engine	Information	A10	A20	A40	A50	A70	C10 - C30	C20	E01
All engines	01/05/97 ->, x 1, D.I.S., connector type, saw teeth						470 196	C10	
Eng. F3R 728, F3R 729, F3R 768, F3R 769	->year 01/04/97, x 1, D.I.S.						470 275	C10	

A10 CONDENSER	A20 CONTACT SET	A40 DISTRIBUTOR CAP	A50 ROTOR	A70 PICK-UP
C10 COIL	C20 IGNITION MODULE	C30 ELECTRONIC IGNITION KIT	E01 IGNITION CABLE SET	

Vehicle	alim.	kW	Date	Engine	FUNCTIONS ON THE VEHICLE									
					A10	A20	A40	A50	A70	C10 - C30	C20	E01		
ENGINE														
2.0	Petrol	84	11/96-10/00	F3R 728, F3R 729, F3R 742, F3R 768, F3R 769										
Engine Information					A10	A20	A40	A50	A70	C10 - C30	C20	E01		
All engines													360 492	
Eng. F3R 728, F3R 768, F3R 769													360 501	
ENGINE														
2.0 16V	Petrol	103	10/98-10/02	F4R 700, F4R 701										
Engine Information					A10	A20	A40	A50	A70	C10 - C30	C20	E01		
All engines										470 432	C10			
ENGINE														
3.0	Petrol	123	11/96-10/98	Z7X 775										
Engine Information					A10	A20	A40	A50	A70	C10 - C30	C20	E01		
All engines										470 275	C10			
All engines										470 276	C10			
ESPACE IV														
ENGINE														
2.0	Petrol	100	11/02-01/15	F4R 792										
Engine Information					A10	A20	A40	A50	A70	C10 - C30	C20	E01		
All engines										470 432	C10			
ENGINE														
2.0	Petrol	125	04/05->	F4R 794, F4R 795, F4R 796, F4R 797, F4R 896, F4R 897										
Engine Information					A10	A20	A40	A50	A70	C10 - C30	C20	E01		
All engines										470 432	C10			
ENGINE														
2.0	Petrol	98	11/02-12/15	F4R 790										
Engine Information					A10	A20	A40	A50	A70	C10 - C30	C20	E01		
All engines										470 432	C10			
ENGINE														
2.0 Turbo	Petrol	120	11/02->	F4R 794, F4R 795, F4R 796, F4R 797										
Engine Information					A10	A20	A40	A50	A70	C10 - C30	C20	E01		
All engines										470 432	C10			
ESPACE V														
ENGINE														
1.6 TCe 200	Petrol	147	02/15->	M5M 450										
Engine Information					A10	A20	A40	A50	A70	C10 - C30	C20	E01		
All engines										470 551	C10			
ENGINE														
1.8 TCe 225	Petrol	165	10/16->	5T2175X15DYA, M5P 403										
Engine Information					A10	A20	A40	A50	A70	C10 - C30	C20	E01		
All engines										470 551	C10			
EXPRESS														
ENGINE														
1.2	Petrol	40	07/95-10/99	C3G 710, C3G 712										
Engine Information					A10	A20	A40	A50	A70	C10 - C30	C20	E01		
All engines										470 228	C10			
ENGINE														
1.4i	Petrol	0	01/85-10/90	C3G/C3J										
Engine Information					A10	A20	A40	A50	A70	C10 - C30	C20	E01		
All engines							815 059							
All engines								915 088						
All engines								915 094						
All engines										470 228	C10		359 543	
FLUENCE														
ENGINE														
1.6	Petrol	86	01/13->	H4M 729										
Engine Information					A10	A20	A40	A50	A70	C10 - C30	C20	E01		
All engines										470 552	C10			

A10	CONDENSER	A20	CONTACT SET	A40	DISTRIBUTOR CAP	A50	ROTOR	A70	PICK-UP
C10	COIL	C20	IGNITION MODULE	C30	ELECTRONIC IGNITION KIT	E01	IGNITION CABLE SET		

The present application list is a brief version. For the detailed information about the possibility of installation on a specific vehicle, please refer to our web-catalogue <http://catalogo.facet.eu/>

					FUNCTIONS ON THE VEHICLE								
Vehicle	alim.	kW	Date	Engine									
ENGINE													
1.6 16V	Petrol	78	02/10->	K4M 838									
ENGINE													
All engines					x 4, SAGEM, COIL ON PLUG						470 432	C10	
1.6 16V	Petrol	81	02/10->	K4M 838, K4M 839									
ENGINE													
All engines					x 4, SAGEM, COIL ON PLUG						470 432	C10	
1.6 LPG 16V	Petrol/ Liquified Petro- leum Gas (LPG)	81	01/12->	K4M 839									
ENGINE													
All engines					x 4, SAGEM, COIL ON PLUG						470 432	C10	
ENGINE													
1.6 [USA] R1368	Petrol	0	01/82-12/84	A7L 752									
ENGINE													
All engines					version Bosch			806 094	906 012R				
All engines					version Ducellier			815 054	915 091				
ENGINE													
1.6	Petrol	77	06/06-11/08	K4M 788									
ENGINE													
All engines					x 4, SAGEM, COIL ON PLUG						470 432	C10	
1.6	Petrol	82	06/06-11/08	K4M 812, K4M 813									
ENGINE													
All engines					x 4, SAGEM, COIL ON PLUG						470 432	C10	
1.6	Petrol	83	04/04-08/06	K4M 761, K4M 764, K4M 782, K4M 812, K4M 813									
ENGINE													
All engines					x 4, SAGEM, COIL ON PLUG						470 432	C10	
1.6 Flex	Petrol/ Ethanol	82	06/06-06/09	K4M 766									
ENGINE													
All engines					x 4, SAGEM, COIL ON PLUG						470 432	C10	
2.0	Petrol	120	04/04-06/09	F4R 776									
ENGINE													
All engines					x 4, SAGEM, COIL ON PLUG						470 432	C10	
2.0	Petrol	99	04/04-06/09	F4R 770, F4R 771									
ENGINE													
All engines					x 4, SAGEM, COIL ON PLUG						470 432	C10	
ENGINE													
1.2 TCe	Petrol	85	04/12->	H5F 400, H5F 408									
ENGINE													
All engines					x 4, COIL ON PLUG						470 613	C10	
1.2 TCe	Petrol	96	07/14->	H5F 408									
ENGINE													
All engines					x 4, COIL ON PLUG						470 613	C10	
1.2 TCe	Petrol	97	01/13->	H5F 404, H5F 408									
ENGINE													
All engines					x 4, COIL ON PLUG						470 613	C10	

A10 CONDENSER	A20 CONTACT SET	A40 DISTRIBUTOR CAP	A50 ROTOR	A70 PICK-UP
C10 COIL	C20 IGNITION MODULE	C30 ELECTRONIC IGNITION KIT	E01 IGNITION CABLE SET	

Vehicle	alim.	kW	Date	Engine	FUNCTIONS ON THE VEHICLE								
					A10	A20	A40	A50	A70	C10 - C30	C20	E01	
ENGINE													
1.6 16V	Petrol	81	02/09->	K4M 858									
Engine		Information			A10	A20	A40	A50	A70	C10 - C30	C20	E01	
All engines		x 4, SAGEM, COIL ON PLUG								470 432	C10		
ENGINE													
1.6 16V Bifuel	Petrol/ Liquified Petroleum Gas (LPG)	79	04/12->	K4M 866									
Engine		Information			A10	A20	A40	A50	A70	C10 - C30	C20	E01	
All engines		x 4, SAGEM, COIL ON PLUG								470 432	C10		
ENGINE													
1.6 16V Bifuel	Petrol/ Liquified Petroleum Gas (LPG)	81	02/09->	K4M 866									
Engine		Information			A10	A20	A40	A50	A70	C10 - C30	C20	E01	
All engines		x 4, SAGEM, COIL ON PLUG								470 432	C10		
ENGINE													
1.6 E85	Petrol/ Ethanol	81	02/09->	K4M 866									
Engine		Information			A10	A20	A40	A50	A70	C10 - C30	C20	E01	
All engines		x 4, SAGEM, COIL ON PLUG								470 432	C10		
GRAND SCÉNIC IV													
ENGINE													
1.2 TCe 115	Petrol	85	09/16->	H5F 408									
Engine		Information			A10	A20	A40	A50	A70	C10 - C30	C20	E01	
All engines		x 4, COIL ON PLUG								470 613	C10		
ENGINE													
1.2 TCe 130	Petrol	96	09/16->	H5F 408									
Engine		Information			A10	A20	A40	A50	A70	C10 - C30	C20	E01	
All engines		x 4, COIL ON PLUG								470 613	C10		
KADJAR													
ENGINE													
1.2 TCe 130	Petrol	96	06/15->	H5F 408									
Engine		Information			A10	A20	A40	A50	A70	C10 - C30	C20	E01	
All engines		x 4, COIL ON PLUG								470 613	C10		
ENGINE													
1.6 TCe 165	Petrol	120	11/16->	M5M460									
Engine		Information			A10	A20	A40	A50	A70	C10 - C30	C20	E01	
All engines		x 4, COIL ON PLUG								470 551	C10		
KANGOO													
ENGINE													
1.2	Petrol	43	07/01-10/03	D4F 712, D4F 714									
Engine		Information			A10	A20	A40	A50	A70	C10 - C30	C20	E01	
All engines		x 1, with cable, D.I.S.								470 419	C10		
ENGINE													
1.2	Petrol	44	12/01-06/03	D7F 746									
Engine		Information			A10	A20	A40	A50	A70	C10 - C30	C20	E01	
All engines		x 1, D.I.S.								470 596	C10		
ENGINE													
1.2 BiFuel	LPG	44	06/97-06/03	D7F 710, D7F 722, D7F 744, D7F 764, D7F 766									
Engine		Information			A10	A20	A40	A50	A70	C10 - C30	C20	E01	
All engines		->year 01/10/98, x 1, D.I.S.								470 365	C10		
All engines		01/11/98 ->, x 1, D.I.S.								470 596	C10		
ENGINE													
1.6	Petrol	74	03/13->	K4M 836									
Engine		Information			A10	A20	A40	A50	A70	C10 - C30	C20	E01	
All engines		x 4, SAGEM, COIL ON PLUG								470 432	C10		

A10 CONDENSER	A20 CONTACT SET	A40 DISTRIBUTOR CAP	A50 ROTOR	A70 PICK-UP
C10 COIL	C20 IGNITION MODULE	C30 ELECTRONIC IGNITION KIT	E01 IGNITION CABLE SET	

The present application list is a brief version. For the detailed information about the possibility of installation on a specific vehicle, please refer to our web-catalogue <http://catalogo.facet.eu/>









					FUNCTIONS ON THE VEHICLE							
Vehicle	alim.	kW	Date	Engine	A10	A20	A40	A50	A70	C10 - C30	C20	E01
ENGINE												
1.6 BiFuel	LPG	60	06/05-06/08	K4M 750								
Engine	Information				A10	A20	A40	A50	A70	C10 - C30	C20	E01
All engines	x 4, SAGEM, COIL ON PLUG									470 432	C10	
ENGINE												
1.6 CNG	CNG	78	10/07->	K4M 830								
Engine	Information				A10	A20	A40	A50	A70	C10 - C30	C20	E01
All engines	x 4, SAGEM, COIL ON PLUG									470 432	C10	
KANGOO I												
ENGINE												
1.0	Petrol	40	07/03->	D7D 700								
Engine	Information				A10	A20	A40	A50	A70	C10 - C30	C20	E01
All engines										470 596	C10	360 681
ENGINE												
1.0	Petrol	43	01/02-01/07	D7D 700								
Engine	Information				A10	A20	A40	A50	A70	C10 - C30	C20	E01
All engines	x 1, D.I.S.									470 596	C10	
ENGINE												
1.0	Petrol	50	01/02-01/07	D4D 700, D4D 720								
Engine	Information				A10	A20	A40	A50	A70	C10 - C30	C20	E01
All engines	x 1, with cable, D.I.S.									470 419	C10	
ENGINE												
1.0 16V	Petrol	51	03/98->	59CH23N17, D4D 700								
Engine	Information				A10	A20	A40	A50	A70	C10 - C30	C20	E01
All engines										470 419	C10	
ENGINE												
1.0 RN	Petrol	43	01/02-01/07	D7D 700, D7D 760								
Engine	Information				A10	A20	A40	A50	A70	C10 - C30	C20	E01
All engines	x 1, D.I.S.									470 596	C10	
ENGINE												
1.2	Petrol	43	08/97->	D7F 710, D7F 720, D7F 722, D7F 726, D7F 744, D7F 746								
Engine	Information				A10	A20	A40	A50	A70	C10 - C30	C20	E01
Eng. D7F 710, D7F 722, D7F 744	->year 21/10/98									470 365	C10	
Eng. D7F 720, D7F 726, D7F 746	->year 01/10/98, x 1, D.I.S.									470 365	C10	
Eng. D7F 710, D7F 722, D7F 744	21/10/98 ->									470 596	C10	
Eng. D7F 720, D7F 726, D7F 746	01/11/98 ->, x 1, D.I.S.									470 596	C10	
All engines	->year 02/10/99											360 447
All engines	02/10/99 ->											360 681
ENGINE												
1.2	Petrol	44	07/98-07/01	D7F 710, D7F 722, D7F 744, D7F 764, D7F 766								
Engine	Information				A10	A20	A40	A50	A70	C10 - C30	C20	E01
All engines	->year 01/10/98, x 1, D.I.S.									470 365	C10	
All engines	01/11/98 ->, x 1, D.I.S.									470 596	C10	
ENGINE												
1.2 16V	Petrol	55	06/01->	D4F 712, D4F 714, D4F 716, D4F 730								
Engine	Information				A10	A20	A40	A50	A70	C10 - C30	C20	E01
Eng. D4F 712, D4F 714, D4F 716	x 1, with cable, x 1, D.I.S., with cable, D.I.S.									470 419	C10	
Eng. D4F 730	x 1, D.I.S.									470 518	C10	
ENGINE												
1.2 BiFuel	Petrol/ Liquified Petro- leum Gas (LPG)	43	07/98-07/01	D7F 710, D7F 744								
Engine	Information				A10	A20	A40	A50	A70	C10 - C30	C20	E01
All engines	->year 01/10/98, x 1, D.I.S.									470 365	C10	
All engines	01/11/98 ->, x 1, D.I.S.									470 596	C10	

A10 CONDENSER	A20 CONTACT SET	A40 DISTRIBUTOR CAP	A50 ROTOR	A70 PICK-UP
C10 COIL	C20 IGNITION MODULE	C30 ELECTRONIC IGNITION KIT	E01 IGNITION CABLE SET	

Vehicle	alim.	kW	Date	Engine	FUNCTIONS ON THE VEHICLE									
					A10	A20	A40	A50	A70	C10 - C30	C20	E01		
ENGINE														
1.4	Petrol	55	08/97->	E7J 634, E7J 635, E7J 780, K7J 700, K7J 701										
Engine	Information				A10	A20	A40	A50	A70	C10 - C30	C20	E01		
Eng. E7J 780	Kangoo Rapid, x 1, Colour:Black, x 1, Colour:Black, D.I.S., connector type, saw teeth, D.I.S., connector type, saw teeth									470 376	C10			
Eng. E7J 780	Kangoo Rapid, x 1, Colour:Grey, x 1, Colour:Grey, D.I.S., connector type, saw teeth, D.I.S., connector type, saw teeth									470 378	C10			
Eng. E7J 634, E7J 635, K7J 700, K7J 701	x 1, D.I.S. ----- x 1, D.I.S., Kangoo Rapid, x 1, D.I.S.									470 596	C10			
Eng. E7J 634, E7J 635, K7J 700, K7J 701												358 244		
Eng. E7J 780												360 443		
ENGINE														
1.6	Petrol	66	09/99-06/01	K7M 746										
Engine	Information				A10	A20	A40	A50	A70	C10 - C30	C20	E01		
All engines	x 1, D.I.S.									470 596	C10			
All engines												358 244		
ENGINE														
1.6 16V	Petrol	70	06/01->	K4M 708, K4M 730, K4M 732, K4M 750, K4M 752, K4M 753, K4M 754										
Engine	Information				A10	A20	A40	A50	A70	C10 - C30	C20	E01		
All engines	Kangoo Rapid, x 4, SAGEM, x 4, COIL ON PLUG, SAGEM, COIL ON PLUG									470 432	C10			
ENGINE														
1.6 16V 4x4	Petrol	70	02/01->	K4M 708, K4M 750, K4M 752, K4M 753, K4M 754										
Engine	Information				A10	A20	A40	A50	A70	C10 - C30	C20	E01		
Eng. K4M 708, K4M 752, K4M 753	Qty: 4									470 432	C10			
Eng. K4M 750, K4M 752, K4M 753, K4M 754	Kangoo Rapid, x 4, SAGEM, x 4, COIL ON PLUG, SAGEM, COIL ON PLUG									470 432	C10			
ENGINE														
1.6 16V bivalent	Petrol/ Com- pressed Natural Gas (CNG)	60	06/05->	K4M850CNG										
Engine	Information				A10	A20	A40	A50	A70	C10 - C30	C20	E01		
All engines	Kangoo Rapid, x 4, SAGEM, x 4, COIL ON PLUG, SAGEM, COIL ON PLUG									470 432	C10			
ENGINE														
1.6 Flex	Petrol/ Ethanol	72	03/07-12/18	K4M 850										
Engine	Information				A10	A20	A40	A50	A70	C10 - C30	C20	E01		
All engines	x 4, SAGEM, COIL ON PLUG									470 432	C10			
KANGOO II														
ENGINE														
1.2 Tce 115	Petrol	84	07/13->	H5F 400, H5F 408, H5F 412										
Engine	Information				A10	A20	A40	A50	A70	C10 - C30	C20	E01		
All engines	x 4, COIL ON PLUG									470 613	C10			
ENGINE														
1.6	Petrol	64	02/08->	K7M 750										
Engine	Information				A10	A20	A40	A50	A70	C10 - C30	C20	E01		
All engines	x 1, D.I.S.									470 596	C10			
All engines												358 252		
ENGINE														
1.6	Petrol	78	02/09-12/12	K4M 830, K4M 831										
Engine	Information				A10	A20	A40	A50	A70	C10 - C30	C20	E01		
All engines	x 4, SAGEM, COIL ON PLUG									470 432	C10			
ENGINE														
1.6 16V	Petrol	78	02/08->	K4M 830, K4M 831, K4M 834, K4M 835, K4M 836										
Engine	Information				A10	A20	A40	A50	A70	C10 - C30	C20	E01		
All engines	x 4, SAGEM, COIL ON PLUG									470 432	C10			

A10	CONDENSER	A20	CONTACT SET	A40	DISTRIBUTOR CAP	A50	ROTOR	A70	PICK-UP
C10	COIL	C20	IGNITION MODULE	C30	ELECTRONIC IGNITION KIT	E01	IGNITION CABLE SET		

The present application list is a brief version. For the detailed information about the possibility of installation on a specific vehicle, please refer to our web-catalogue <http://catalogo.facet.eu/>

					FUNCTIONS ON THE VEHICLE							
Vehicle	alim.	kW	Date	Engine								
ENGINE												
1.6 16V FLEX	Petrol/ Ethanol	78	02/08->	K4M 834								
Engine	Information				A10	A20	A40	A50	A70	C10 - C30	C20	E01
All engines	x 4, SAGEM, COIL ON PLUG									470 432	C10	
ENGINE												
1.6 16V LPG	Petrol/ Liquified Petroleum Gas (LPG)	78	02/08->	K4M 834, K4M 835, K4M 836								
Engine	Information				A10	A20	A40	A50	A70	C10 - C30	C20	E01
All engines	x 4, SAGEM, COIL ON PLUG									470 432	C10	
KAPTUR												
ENGINE												
1.6	Petrol	84	03/16->	H4M 429, H4M 438								
Engine	Information				A10	A20	A40	A50	A70	C10 - C30	C20	E01
All engines	x 4, COIL ON PLUG									470 613	C10	
ENGINE												
2.0 4WD	Petrol	105	03/16->	F4R 410								
Engine	Information				A10	A20	A40	A50	A70	C10 - C30	C20	E01
All engines	x 4, SAGEM, COIL ON PLUG									470 432	C10	
KOLEOS												
ENGINE												
2.0 Tce	Petrol	107	08/16->	M5R 402								
Engine	Information				A10	A20	A40	A50	A70	C10 - C30	C20	E01
All engines	x 4, COIL ON PLUG									470 551	C10	
ENGINE												
2.5	Petrol	126	09/08->	2TR 700, 2TR 701, 2TR 703, 2TR 705, 2TR702								
Engine	Information				A10	A20	A40	A50	A70	C10 - C30	C20	E01
Eng. 2TR 700, 2TR 703, 2TR 705, 2TR702	x 4, COIL ON PLUG									470 552	C10	
Eng. 2TR 701, 2TR 705	Qty: 4									470 552	C10	
ENGINE												
2.5 4x4	Petrol	126	09/08->	2TR 700, 2TR 701, 2TR 703, 2TR 705, 2TR702								
Engine	Information				A10	A20	A40	A50	A70	C10 - C30	C20	E01
Eng. 2TR 700, 2TR 703, 2TR 705, 2TR702	x 4, COIL ON PLUG									470 552	C10	
Eng. 2TR 701	Qty: 4									470 552	C10	
ENGINE												
2.5 Sce 4WD	Petrol	126	08/16->	2TR707								
Engine	Information				A10	A20	A40	A50	A70	C10 - C30	C20	E01
All engines	x 4, COIL ON PLUG									470 552	C10	
LAGUNA I												
ENGINE												
1.6 16V	Petrol	79	11/97-03/01	K4M 720, K4M 724								
Engine	Information				A10	A20	A40	A50	A70	C10 - C30	C20	E01
All engines	Qty: 4									470 432	C10	
ENGINE												
1.8	Petrol	66	11/93-03/01	F3P 670, F3P 678, F3P 720, F3P 724								
Engine	Information				A10	A20	A40	A50	A70	C10 - C30	C20	E01
Eng. F3P 678, F3P 720, F3P 724	version Ducellier						815 085	915 097				
Eng. F3P 678, F3P 720, F3P 724	Kit, version Ducellier						815 086					
Eng. F3P 678, F3P 720, F3P 724										470 107	C10	
Eng. F3P 670	02/04/97 ->, Qty: 2									470 196	C10	
Eng. F3P 670	->year 02/04/97, Qty: 2									470 275	C10	
Eng. F3P 678, F3P 720, F3P 724	->year 02/05/95											359 920
Eng. F3P 670	02/04/97 ->											360 492
Eng. F3P 678, F3P 720, F3P 724	02/05/95 ->											360 499
Eng. F3P 670	->year 02/04/97											360 501

A10 CONDENSER	A20 CONTACT SET	A40 DISTRIBUTOR CAP	A50 ROTOR	A70 PICK-UP
C10 COIL	C20 IGNITION MODULE	C30 ELECTRONIC IGNITION KIT	E01 IGNITION CABLE SET	

Vehicle	alim.	kW	Date	Engine	FUNCTIONS ON THE VEHICLE							
					A10	A20	A40	A50	A70	C10 - C30	C20	E01

1.8	Petrol	69	06/95-03/01	ENGINE F3P 674, F3P 720, F3P 724
-----	--------	----	-------------	--

Engine	Information	A10	A20	A40	A50	A70	C10 - C30	C20	E01
Eng. F3P 720, F3P 724	version Ducellier			815 085	915 097				
Eng. F3P 720, F3P 724	Kit, version Ducellier			815 086					
Eng. F3P 720, F3P 724							470 107	C10	
Eng. F3P 674	02/04/97 ->, Qty: 2						470 196	C10	
Eng. F3P 674	->year 02/04/97, Qty: 2						470 275	C10	
Eng. F3P 720, F3P 724	->year 02/05/95								359 920
Eng. F3P 674	02/04/97 ->								360 492
Eng. F3P 720, F3P 724	02/05/95 ->								360 499
Eng. F3P 674	->year 02/04/97								360 501

1.8	Petrol	70	06/95-06/98	ENGINE F3P 676, F3P 678
-----	--------	----	-------------	-----------------------------------

Engine	Information	A10	A20	A40	A50	A70	C10 - C30	C20	E01
All engines	02/04/97 ->, Qty: 2						470 196	C10	
All engines	->year 02/04/97, Qty: 2						470 275	C10	
All engines	02/04/97 ->								360 492
All engines	->year 02/04/97								360 501

1.8 16V	Petrol	88	04/98-03/01	ENGINE F4P 760
---------	--------	----	-------------	--------------------------

Engine	Information	A10	A20	A40	A50	A70	C10 - C30	C20	E01
All engines	Qty: 4						470 432	C10	

2.0	Petrol	102	09/99-02/01	ENGINE F4R 780
-----	--------	-----	-------------	--------------------------

Engine	Information	A10	A20	A40	A50	A70	C10 - C30	C20	E01
All engines	Qty: 4						470 432	C10	

2.0	Petrol	103	06/95-02/01	ENGINE N7Q 700, N7Q 704
-----	--------	-----	-------------	-----------------------------------

Engine	Information	A10	A20	A40	A50	A70	C10 - C30	C20	E01
All engines	Colour:Black						470 355	C10	
All engines	Colour:Grey						470 356	C10	
All engines									358 061

2.0	Petrol	70	11/93-03/01	ENGINE --, F3R 769
-----	--------	----	-------------	------------------------------

Engine	Information	A10	A20	A40	A50	A70	C10 - C30	C20	E01
Eng. --	02/04/97 ->, Qty: 2						470 196	C10	
Eng. --	->year 02/04/97, Qty: 2						470 275	C10	
All engines	02/04/97 ->								360 492
All engines	->year 02/04/97								360 501

2.0	Petrol	80	03/99-03/01	ENGINE F3R 611
-----	--------	----	-------------	--------------------------

Engine	Information	A10	A20	A40	A50	A70	C10 - C30	C20	E01
All engines	02/04/97 ->, Qty: 2						470 196	C10	
All engines	->year 02/04/97, Qty: 2						470 275	C10	
All engines									360 492

2.0	Petrol	83	11/93-03/01	ENGINE 6Z7U 730, F3R 722, F3R 729
-----	--------	----	-------------	---

Engine	Information	A10	A20	A40	A50	A70	C10 - C30	C20	E01
Eng. 6Z7U 730, F3R 722	version Ducellier			815 085	915 097				
Eng. 6Z7U 730, F3R 722	Kit, version Ducellier			815 086					
Eng. 6Z7U 730, F3R 722							470 107	C10	
Eng. F3R 729	02/04/97 ->, Qty: 2						470 196	C10	
Eng. F3R 729	->year 02/04/97, Qty: 2						470 275	C10	
Eng. 6Z7U 730, F3R 722	->year 02/05/95								359 920
Eng. F3R 729	02/04/97 ->								360 492
Eng. 6Z7U 730, F3R 722	02/05/95 ->								360 499
Eng. F3R 729	->year 02/04/97								360 501

A10 CONDENSER	A20 CONTACT SET	A40 DISTRIBUTOR CAP	A50 ROTOR	A70 PICK-UP
C10 COIL	C20 IGNITION MODULE	C30 ELECTRONIC IGNITION KIT	E01 IGNITION CABLE SET	

The present application list is a brief version. For the detailed information about the possibility of installation on a specific vehicle, please refer to our web-catalogue <http://catalogo.facet.eu/>

Vehicle	alim.	kW	Date	Engine	FUNCTIONS ON THE VEHICLE							
					A10	A20	A40	A50	A70	C10 - C30	C20	E01

ENGINE				
2.0	Petrol	84	06/95-02/01	F3R 722, F3R 728, F3R 768

Engine	Information	A10	A20	A40	A50	A70	C10 - C30	C20	E01
Eng. F3R 722	version Ducellier			815 085	915 097				
Eng. F3R 722	Kit, version Ducellier			815 086					
Eng. F3R 722							470 107	C10	
Eng. F3R 728, F3R 768	02/04/97 ->, Qty: 2						470 196	C10	
Eng. F3R 728, F3R 768	->year 02/04/97, Qty: 2						470 275	C10	
Eng. F3R 722	->year 02/05/95								359 920
Eng. F3R 728, F3R 768	02/04/97 ->								360 492
Eng. F3R 722	02/05/95 ->								360 499
Eng. F3R 728, F3R 768	->year 02/04/97								360 501

ENGINE				
2.0 16V	Petrol	102	06/95-03/01	N7Q 700, N7Q 704

Engine	Information	A10	A20	A40	A50	A70	C10 - C30	C20	E01
All engines	Colour:Black						470 355	C10	
All engines	Colour:Grey						470 356	C10	
All engines									358 061

ENGINE				
2.0 16V	Petrol	103	09/99-03/01	F4R 780

Engine	Information	A10	A20	A40	A50	A70	C10 - C30	C20	E01
All engines	Qty: 4						470 432	C10	

ENGINE				
3.0	Petrol	123	11/93-03/01	Z7X 760, Z7X 765

Engine	Information	A10	A20	A40	A50	A70	C10 - C30	C20	E01
All engines	info A-K						470 275	C10	
All engines	info B-K						470 276	C10	

LAGUNA II

ENGINE				
1.6	Petrol	76	03/01-10/05	K4M 710

Engine	Information	A10	A20	A40	A50	A70	C10 - C30	C20	E01
All engines	x 4, SAGEM, COIL ON PLUG						470 432	C10	

ENGINE				
1.6 16V	Petrol	79	03/01-12/07	K4M 710, K4M 714

Engine	Information	A10	A20	A40	A50	A70	C10 - C30	C20	E01
Eng. K4M 710	x 4, SAGEM, COIL ON PLUG						470 432	C10	
Eng. K4M 714	Qty: 4						470 432	C10	

ENGINE				
1.6 16V	Petrol	82	02/05-08/07	K4M 716

Engine	Information	A10	A20	A40	A50	A70	C10 - C30	C20	E01
All engines	x 4, SAGEM, COIL ON PLUG						470 432	C10	

ENGINE				
1.6 Bifuel	Petrol/ Liquified Petro- leum Gas (LPG)	79	06/05-12/07	K4M 714

Engine	Information	A10	A20	A40	A50	A70	C10 - C30	C20	E01
All engines	x 4, SAGEM, COIL ON PLUG						470 432	C10	

ENGINE				
1.6 LPG	Bi-Fuel	79	03/01-05/05	K4M 714







Engine	Information	A10	A20	A40	A50	A70	C10 - C30	C20	E01
All engines	Qty: 4						470 432	C10	
All engines	x 4, SAGEM, COIL ON PLUG						470 432	C10	

ENGINE				
1.8 16V	Petrol	85	03/01-12/07	F4P 770, F4P 771, F4P 773, F4P 774, F4P 775

Engine	Information	A10	A20	A40	A50	A70	C10 - C30	C20	E01
Eng. F4P 770	Qty: 4						470 432	C10	
Eng. F4P 771, F4P 773, F4P 774, F4P 775	x 4, SAGEM, COIL ON PLUG						470 432	C10	

A10	CONDENSER	A20	CONTACT SET	A40	DISTRIBUTOR CAP	A50	ROTOR	A70	PICK-UP
C10	COIL	C20	IGNITION MODULE	C30	ELECTRONIC IGNITION KIT	E01	IGNITION CABLE SET		

Vehicle	alim.	kW	Date	Engine	FUNCTIONS ON THE VEHICLE									
					A10	A20	A40	A50	A70	C10 - C30	C20	E01		
ENGINE														
1.8 16V	Petrol	86	03/01-05/05	F4P 770, F4P 774										
Engine	Information				A10	A20	A40	A50	A70	C10 - C30	C20	E01		
Eng. F4P 770	Qty: 4									470 432	C10			
Eng. F4P 774	x 4, SAGEM, COIL ON PLUG									470 432	C10			
ENGINE														
1.8 16V	Petrol	88	03/01->	F4P 770, F4P 772										
Engine	Information				A10	A20	A40	A50	A70	C10 - C30	C20	E01		
Eng. F4P 770	x 4, SAGEM, COIL ON PLUG									470 432	C10			
Eng. F4P 772	Qty: 4									470 432	C10			
ENGINE														
1.8 16V	Petrol	89	03/01-05/05	F4P 770, F4P 772, F4P 774										
Engine	Information				A10	A20	A40	A50	A70	C10 - C30	C20	E01		
Eng. F4P 770, F4P 772	x 4, SAGEM, COIL ON PLUG									470 432	C10			
Eng. F4P 774	Qty: 4									470 432	C10			
ENGINE														
2.0 16V	LPG	95	09/02-05/05	F4R 713										
Engine	Information				A10	A20	A40	A50	A70	C10 - C30	C20	E01		
All engines	Qty: 4									470 432	C10			
ENGINE														
2.0 16V	LPG	97	09/02-05/05	F4R 713										
Engine	Information				A10	A20	A40	A50	A70	C10 - C30	C20	E01		
All engines	Qty: 4									470 432	C10			
ENGINE														
2.0 16V	Petrol	125	01/05-09/07	F4R 784, F4R 786, F4R 787										
Engine	Information				A10	A20	A40	A50	A70	C10 - C30	C20	E01		
All engines	x 4, SAGEM, COIL ON PLUG									470 432	C10			
ENGINE														
2.0 16V	Petrol	150	01/05-09/07	F4R 886, F4R 887										
Engine	Information				A10	A20	A40	A50	A70	C10 - C30	C20	E01		
All engines	x 4, SAGEM, COIL ON PLUG									470 432	C10			
ENGINE														
2.0 16V	Petrol	98	08/02-09/07	F4R 712, F4R 713, F4R 714, F4R 715										
Engine	Information				A10	A20	A40	A50	A70	C10 - C30	C20	E01		
All engines	x 4, SAGEM, COIL ON PLUG									470 432	C10			
ENGINE														
2.0 16V	Petrol	99	08/02-12/07	F4R 712, F4R 713, F4R 714, F4R 715										
Engine	Information				A10	A20	A40	A50	A70	C10 - C30	C20	E01		
All engines	x 4, SAGEM, COIL ON PLUG									470 432	C10			
ENGINE														
2.0 16V IDE	Petrol	103	04/01-09/07	F5R 700, F5R 701										
Engine	Information				A10	A20	A40	A50	A70	C10 - C30	C20	E01		
All engines	x 1, D.I.S.									470 365	C10			
Eng. F5R 700													358 049	
ENGINE														
2.0 16V Turbo	Petrol	120	01/03-08/05	F4R 764, F4R 765, F4R 786, F4R 787										
Engine	Information				A10	A20	A40	A50	A70	C10 - C30	C20	E01		
Eng. F4R 764, F4R 765	x 4, SAGEM, COIL ON PLUG									470 432	C10			
Eng. F4R 786, F4R 787	Qty: 4									470 432	C10			
LAGUNA III														
ENGINE														
1.6 16V	Petrol	81	10/07-12/15	K4M 824										
Engine	Information				A10	A20	A40	A50	A70	C10 - C30	C20	E01		
All engines	x 4, SAGEM, COIL ON PLUG									470 432	C10			
ENGINE														
2.0 16V	Petrol	103	10/07-12/15	M4R 704										
Engine	Information				A10	A20	A40	A50	A70	C10 - C30	C20	E01		
All engines	x 4, COIL ON PLUG									470 489	C10			
A10	CONDENSER		A20	CONTACT SET		A40	DISTRIBUTOR CAP		A50	ROTOR		A70	PICK-UP	
C10	COIL		C20	IGNITION MODULE		C30	ELECTRONIC IGNITION KIT		E01	IGNITION CABLE SET				

					FUNCTIONS ON THE VEHICLE							
Vehicle	alim.	kW	Date	Engine								
ENGINE												
2.0 16V Hi-Flex	Petrol/ Ethanol	103	10/07-12/15	M4R 704, M4R 726								
Engine	Information				A10	A20	A40	A50	A70	C10 - C30	C20	E01
Eng. M4R 704	Qty: 4									470 489	C10	
Eng. M4R 726	BT05/BT0F/BT0W, x 4, COIL ON PLUG									470 489	C10	
ENGINE												
2.0 16V Turbo	Petrol	125	10/07-12/15	F4R 811, F4R 813								
Engine	Information				A10	A20	A40	A50	A70	C10 - C30	C20	E01
All engines	x 4, SAGEM, COIL ON PLUG									470 432	C10	
ENGINE												
2.0 GT	Petrol	150	03/08-12/15	F4R 800, F4R802								
Engine	Information				A10	A20	A40	A50	A70	C10 - C30	C20	E01
All engines	x 4, SAGEM, COIL ON PLUG									470 432	C10	
ENGINE												
3.5 V6	Petrol	175	04/08-12/15	8TZ150XSG15, V4Y713								
Engine	Information				A10	A20	A40	A50	A70	C10 - C30	C20	E01
All engines	x 6, COIL ON PLUG									470 533	C10	
LATITUDE												
ENGINE												
1.6 RS	Petrol	132	04/14->	M5M 400								
Engine	Information				A10	A20	A40	A50	A70	C10 - C30	C20	E01
All engines	x 4, COIL ON PLUG									470 551	C10	
ENGINE												
2.5 V6	Petrol	130	05/11->	2ZV 604								
Engine	Information				A10	A20	A40	A50	A70	C10 - C30	C20	E01
All engines	x 6, COIL ON PLUG									470 533	C10	
ENGINE												
3.5	Petrol	171	05/11->	5ZV 604								
Engine	Information				A10	A20	A40	A50	A70	C10 - C30	C20	E01
All engines	Qty: 6									470 533	C10	
LODGY												
ENGINE												
1.6	Petrol	59	07/13->	K7M 812, K7M828								
Engine	Information				A10	A20	A40	A50	A70	C10 - C30	C20	E01
All engines	x 1, D.I.S.									470 596	C10	
LOGAN												
ENGINE												
1.2 16V	Petrol	54	12/13->	D4F 732, D4F 734								
Engine	Information				A10	A20	A40	A50	A70	C10 - C30	C20	E01
All engines	x 1, D.I.S.									470 518	C10	
ENGINE												
1.2 16V	Petrol	55	02/06->	D4F 732								
Engine	Information				A10	A20	A40	A50	A70	C10 - C30	C20	E01
All engines										470 518	C10	358 246
ENGINE												
1.2 16V LPG	Petrol/ Liquified Petro- leum Gas (LPG)	53	12/13->	D4F 732, D4F 734								
Engine	Information				A10	A20	A40	A50	A70	C10 - C30	C20	E01
All engines	x 1, D.I.S.									470 518	C10	
ENGINE												
1.4	Petrol	55	09/04->	K7J 710								
Engine	Information				A10	A20	A40	A50	A70	C10 - C30	C20	E01
All engines	x 1, D.I.S.									470 596	C10	
All engines	->year 18/03/05											358 244
All engines												358 252
All engines	18/03/05 ->											358 252

A10 CONDENSER	A20 CONTACT SET	A40 DISTRIBUTOR CAP	A50 ROTOR	A70 PICK-UP
C10 COIL	C20 IGNITION MODULE	C30 ELECTRONIC IGNITION KIT	E01 IGNITION CABLE SET	

Vehicle	alim.	kW	Date	Engine	FUNCTIONS ON THE VEHICLE									
					A10	A20	A40	A50	A70	C10 - C30	C20	E01		
ENGINE														
1.4 LPG	Petrol/ Liquified Petro- leum Gas (LPG)	53	02/08-10/13	K7J 714										
Engine					A10	A20	A40	A50	A70	C10 - C30	C20	E01		
All engines										470 596	C10			
ENGINE														
1.6	Petrol	59	12/13->	K7M 812										
Engine					A10	A20	A40	A50	A70	C10 - C30	C20	E01		
All engines										470 596	C10			
ENGINE														
1.6	Petrol	64	09/04->	K7M 710										
Engine					A10	A20	A40	A50	A70	C10 - C30	C20	E01		
All engines										470 596	C10			
All engines														358 244
All engines														358 252
All engines														358 252
ENGINE														
1.6	Petrol	65	09/04->	K7M 714										
Engine					A10	A20	A40	A50	A70	C10 - C30	C20	E01		
All engines										470 596	C10			358 252
ENGINE														
1.6	Petrol	77	04/07->	K4M 690, K4M 694, K4M 696, K4M 697										
Engine					A10	A20	A40	A50	A70	C10 - C30	C20	E01		
All engines										470 432	C10			
ENGINE														
1.6	Petrol	78	12/13->	K4M 845										
Engine					A10	A20	A40	A50	A70	C10 - C30	C20	E01		
All engines										470 432	C10			
ENGINE														
1.6 16V	Petrol	77	12/05->	K4M 694, K4M 696										
Engine					A10	A20	A40	A50	A70	C10 - C30	C20	E01		
All engines										470 432	C10			
LOGAN EXPRESS														
ENGINE														
1.6	Petrol	64	04/07->	K7M 710										
Engine					A10	A20	A40	A50	A70	C10 - C30	C20	E01		
All engines										470 596	C10			
LOGAN/STEPWAY														
ENGINE														
1.2	Petrol	55	11/13->	D4F 732, D4F 734										
Engine					A10	A20	A40	A50	A70	C10 - C30	C20	E01		
All engines										470 518	C10			
ENGINE														
1.2 16V LPG	Petrol/ Liquified Petro- leum Gas (LPG)	53	11/13->	D4F 732, D4F 734										
Engine					A10	A20	A40	A50	A70	C10 - C30	C20	E01		
All engines										470 518	C10			
ENGINE														
1.6	Petrol	59	11/13->	K7M 812										
Engine					A10	A20	A40	A50	A70	C10 - C30	C20	E01		
All engines										470 596	C10			
ENGINE														
1.6	Petrol	60	04/14->	K7M 812										
Engine					A10	A20	A40	A50	A70	C10 - C30	C20	E01		
All engines										470 596	C10			
L8JB/L8ME/L8MV, x 1, D.I.S.														

A10 CONDENSER	A20 CONTACT SET	A40 DISTRIBUTOR CAP	A50 ROTOR	A70 PICK-UP
C10 COIL	C20 IGNITION MODULE	C30 ELECTRONIC IGNITION KIT	E01 IGNITION CABLE SET	

The present application list is a brief version. For the detailed information about the possibility of installation on a specific vehicle, please refer to our web-catalogue <http://catalogo.facet.eu/>

				FUNCTIONS ON THE VEHICLE								
Vehicle	alim.	kW	Date	Engine	A10	A20	A40	A50	A70	C10 - C30	C20	E01
				ENGINE								
1.6	Petrol	75	04/14->	K4M 842, K4M 845								
				ENGINE								
Engine		Information			A10	A20	A40	A50	A70	C10 - C30	C20	E01
All engines		x 4, SAGEM, COIL ON PLUG								470 432	C10	
1.6	Petrol	83	09/16->	H4M 429, H4M 438								
				ENGINE								
Engine		Information			A10	A20	A40	A50	A70	C10 - C30	C20	E01
All engines		x 4, COIL ON PLUG								470 613	C10	
				MASTER I								
2.0	Petrol	59	07/80-06/85	829 731								
				ENGINE								
Engine		Information			A10	A20	A40	A50	A70	C10 - C30	C20	E01
All engines		version Ducellier					815 054	915 091				
2.0	Petrol	60	06/85-12/95	J5R 718, J5R 728								
				ENGINE								
Engine		Information			A10	A20	A40	A50	A70	C10 - C30	C20	E01
All engines		version Ducellier					815 079	915 094				
All engines										470 107	C10	
2.2	Petrol	71	08/93-02/98	J7T 788								
				ENGINE								
Engine		Information			A10	A20	A40	A50	A70	C10 - C30	C20	E01
All engines		version Ducellier					815 079	915 094				
All engines										470 107	C10	
28-35 2.0	Petrol	58	10/86-07/98	J5R 718, J5R 728								
				ENGINE								
Engine		Information			A10	A20	A40	A50	A70	C10 - C30	C20	E01
All engines		version Ducellier					815 079	915 094				
All engines										470 107	C10	
28-35 2.0	Petrol	59	08/80-10/86	829 731								
				ENGINE								
Engine		Information			A10	A20	A40	A50	A70	C10 - C30	C20	E01
All engines		version Ducellier					815 054	915 091				
30 2.2	Petrol	67	08/80-07/98	J7T 782, J7T 788								
				ENGINE								
Engine		Information			A10	A20	A40	A50	A70	C10 - C30	C20	E01
All engines		version Ducellier					815 079	915 094				
All engines										470 107	C10	
				MEGANE								
1.4	Petrol	70	04/01-07/03	K4J 714, K4J750								
				ENGINE								
Engine		Information			A10	A20	A40	A50	A70	C10 - C30	C20	E01
All engines		x 4, SAGEM, COIL ON PLUG								470 432	C10	
1.6	Petrol	79	04/01-07/03	K4M 701, K4M 708, K4M 709, K4M700								
				ENGINE								
Engine		Information			A10	A20	A40	A50	A70	C10 - C30	C20	E01
All engines		x 4, SAGEM, COIL ON PLUG								470 432	C10	
1.6 BiFuel	LPG	66	10/96-10/99	K7M 702								
				ENGINE								
Engine		Information			A10	A20	A40	A50	A70	C10 - C30	C20	E01
All engines		->year 01/03/97, x 1, Colour:Black, D.I.S.								470 355	C10	
All engines		->year 01/03/97, x 1, Colour:Grey, D.I.S.								470 356	C10	
All engines		01/04/97 ->, ->year 01/06/98, x 1, Colour:Black, D.I.S., connector type, saw teeth								470 376	C10	
All engines		01/04/97 ->, ->year 01/06/98, x 1, Colour:Grey, D.I.S., connector type, saw teeth								470 378	C10	
All engines		01/07/98 ->, x 1, D.I.S.								470 596	C10	

A10 CONDENSER	A20 CONTACT SET	A40 DISTRIBUTOR CAP	A50 ROTOR	A70 PICK-UP
C10 COIL	C20 IGNITION MODULE	C30 ELECTRONIC IGNITION KIT	E01 IGNITION CABLE SET	

Vehicle	alim.	kW	Date	Engine	FUNCTIONS ON THE VEHICLE								
					A10	A20	A40	A50	A70	C10 - C30	C20	E01	
ENGINE													
1.6 BiFuel	Petrol/ Liquified Petro- leum Gas (LPG)	79	04/01-07/03	K4M 712									
Engine	Information				A10	A20	A40	A50	A70	C10 - C30	C20	E01	
All engines	x 4, SAGEM, COIL ON PLUG									470 432	C10		
ENGINE													
1.6 BiFuel	Petrol/ Liquified Petro- leum Gas (LPG)	80	04/01-07/03	K4M 704									
Engine	Information				A10	A20	A40	A50	A70	C10 - C30	C20	E01	
All engines	x 4, SAGEM, COIL ON PLUG									470 432	C10		
ENGINE													
1.8	Petrol	85	04/01-07/03	F4P 722									
Engine	Information				A10	A20	A40	A50	A70	C10 - C30	C20	E01	
All engines	x 4, SAGEM, COIL ON PLUG									470 432	C10		
ENGINE													
2.0	Petrol	55	08/95-02/99	F4R 740, F4R 746									
Engine	Information				A10	A20	A40	A50	A70	C10 - C30	C20	E01	
All engines	x 4, SAGEM, COIL ON PLUG									470 432	C10		
MEGANE CC													
ENGINE													
1.2 TcE	Petrol	85	09/12-08/15	H5F 400									
Engine	Information				A10	A20	A40	A50	A70	C10 - C30	C20	E01	
All engines	x 4, COIL ON PLUG									470 613	C10		
ENGINE													
1.2 TcE	Petrol	97	01/13->	H5F 404									
Engine	Information				A10	A20	A40	A50	A70	C10 - C30	C20	E01	
All engines	x 4, COIL ON PLUG									470 613	C10		
ENGINE													
1.6 16V	Petrol	81	06/10->	K4M 858									
Engine	Information				A10	A20	A40	A50	A70	C10 - C30	C20	E01	
All engines	x 4, SAGEM, COIL ON PLUG									470 432	C10		
ENGINE													
1.6 16V Hi-Flex	Petrol/ Ethanol	81	06/10->	K4M 866									
Engine	Information				A10	A20	A40	A50	A70	C10 - C30	C20	E01	
All engines	x 4, SAGEM, COIL ON PLUG									470 432	C10		
ENGINE													
2.0 TcE	Petrol	132	06/10->	8XTDM10, F4R 872									
Engine	Information				A10	A20	A40	A50	A70	C10 - C30	C20	E01	
Eng. 8XTDM10	Qty: 4									470 432	C10		
Eng. F4R 872	x 4, SAGEM, COIL ON PLUG									470 432	C10		
ENGINE													
2.0 Turbo	Petrol	195	10/11->	8AR90212									
Engine	Information				A10	A20	A40	A50	A70	C10 - C30	C20	E01	
All engines	Qty: 4									470 432	C10		
MEGANE I													
ENGINE													
1.4	Petrol	55	09/96-08/03	E7J 626, E7J 764									
Engine	Information				A10	A20	A40	A50	A70	C10 - C30	C20	E01	
Eng. E7J 764	version Ducellier						815 081	915 101					
Eng. E7J 764	version Marelli						830 111	930 059					
Eng. E7J 764	x 1, SIEMENS, DISTRIBUTOR, Dia: 4 mm, connector type SAE									470 107	C10		
Eng. E7J 626	x 1, D.I.S.									470 596	C10		
Eng. E7J 626												358 244	
Eng. E7J 764												359 801	

A10	CONDENSER	A20	CONTACT SET	A40	DISTRIBUTOR CAP	A50	ROTOR	A70	PICK-UP
C10	COIL	C20	IGNITION MODULE	C30	ELECTRONIC IGNITION KIT	E01	IGNITION CABLE SET		

The present application list is a brief version. For the detailed information about the possibility of installation on a specific vehicle, please refer to our web-catalogue <http://catalogo.facet.eu/>

					FUNCTIONS ON THE VEHICLE							
Vehicle	alim.	kW	Date	Engine	A10	A20	A40	A50	A70	C10 - C30	C20	E01
ENGINE												
1.4 16V	Petrol	70	03/99-08/03	K4J 700, K4J 714, K4J750								
ENGINE												
All engines					A10	A20	A40	A50	A70	C10 - C30	C20	E01
Information					x 4, SAGEM, COIL ON PLUG							
1.4 16V	Petrol	71	05/99-11/02	K4J 710, K4J 711, K4J 712, K4J 713								
ENGINE												
All engines					A10	A20	A40	A50	A70	C10 - C30	C20	E01
Information					Qty: 4							
1.4 16V	Petrol	72	11/00-08/03	K4J 732								
ENGINE												
All engines					A10	A20	A40	A50	A70	C10 - C30	C20	E01
Information					Qty: 4							
1.4 e	Petrol	55	01/96-08/03	E7J 626, E7J 764								
ENGINE												
Eng. E7J 764					A10	A20	A40	A50	A70	C10 - C30	C20	E01
Information					version Ducellier							
Eng. E7J 764							815 081	915 101				
Information					version Marelli							
Eng. E7J 764							830 111	930 059				
Information					x 1, ignition mod. IGN. MODULE(-), SIEMENS, DISTRIBUTOR, Dia: 4 mm, connector type SAE							
Eng. E7J 626										470 107	C10	
Information					x 1, D.I.S., x 1, ignition mod. IGN. MODULE(-), D.I.S.							
Eng. E7J 626										470 596	C10	
Eng. E7J 764												358 244
Eng. E7J 764												359 801
1.4 Eco	Petrol	52	01/96-03/99	E7J 624								
ENGINE												
All engines					A10	A20	A40	A50	A70	C10 - C30	C20	E01
Information					version Ducellier							
All engines							815 081	915 101				
Information					version Marelli							
All engines							830 111	930 059				
Information					x 1, ignition mod. IGN. MODULE(-), SIEMENS, DISTRIBUTOR, Dia: 4 mm, connector type SAE							
All engines										470 107	C10	
All engines												359 801
1.6	Petrol	64	02/00-09/00	K7M 704								
ENGINE												
All engines					A10	A20	A40	A50	A70	C10 - C30	C20	E01
Information					x 1, D.I.S.							
All engines										470 596	C10	358 244
All engines										470 596	C10	
1.6 16V	Petrol	0	11/97->	K4M 743								
ENGINE												
All engines					A10	A20	A40	A50	A70	C10 - C30	C20	E01
Information					Qty: 4							
All engines										470 432	C10	
1.6 16V	Petrol	66	11/97->	K4M 734, K4M 740, K4M 742, K4M 744, K4M 745								
ENGINE												
All engines					A10	A20	A40	A50	A70	C10 - C30	C20	E01
Information					Qty: 4							
All engines										470 432	C10	
1.6 16V	Petrol	70	06/01->	K4M 750, K4M 752, K4M 753								
ENGINE												
All engines					A10	A20	A40	A50	A70	C10 - C30	C20	E01
Information					Qty: 4							
All engines										470 432	C10	
1.6 16V	Petrol	79	11/97->	K4M 701, K4M 704, K4M 706, K4M 708, K4M 709, K4M 710, K4M 712, K4M 714, K4M 720, K4M 724, K4M 730, K4M 748, K4M700								
ENGINE												
Eng. K4M 701, K4M 706, K4M 708, K4M 709, K4M700					A10	A20	A40	A50	A70	C10 - C30	C20	E01
Information					x 4, SAGEM, COIL ON PLUG							
Eng. K4M 704, K4M 706, K4M 709, K4M 710, K4M 712, K4M 714, K4M 720, K4M 724, K4M 730, K4M 748										470 432	C10	
Information					Qty: 4							
All engines										470 432	C10	

A10 CONDENSER	A20 CONTACT SET	A40 DISTRIBUTOR CAP	A50 ROTOR	A70 PICK-UP
C10 COIL	C20 IGNITION MODULE	C30 ELECTRONIC IGNITION KIT	E01 IGNITION CABLE SET	

Vehicle	alim.	kW	Date	Engine	FUNCTIONS ON THE VEHICLE							
					A10	A20	A40	A50	A70	C10 - C30	C20	E01

ENGINE				
1.6 16V	Petrol	83	11/00->	K4M 761, K4M 764

Engine	Information	A10	A20	A40	A50	A70	C10 - C30	C20	E01
All engines	Qty: 4						470 432	C10	

ENGINE				
1.6 Bifuel	Petrol/ Liquified Petroleum Gas (LPG)	80	03/99-09/00	K4M 712

Engine	Information	A10	A20	A40	A50	A70	C10 - C30	C20	E01
All engines	x 4, SAGEM, COIL ON PLUG						470 432	C10	

ENGINE				
1.6 e	Petrol	66	01/96-08/03	K7M 702, K7M 703, K7M 790

Engine	Information	A10	A20	A40	A50	A70	C10 - C30	C20	E01
All engines	->year 10/03/97, Colour:Black						470 355	C10	
Eng. K7M 702, K7M 703	->year 01/03/97, x 1, Colour:Black, D.I.S.						470 355	C10	
All engines	->year 10/03/97, Colour:Grey						470 356	C10	
Eng. K7M 702, K7M 703	->year 01/03/97, x 1, Colour:Grey, D.I.S.						470 356	C10	
All engines	->year 08/07/98, 10/03/97 ->, Colour:Black						470 376	C10	
Eng. K7M 702, K7M 703	01/04/97 ->, ->year 01/06/98, x 1, Colour:Black, D.I.S., connector type, saw teeth						470 376	C10	
All engines	->year 08/07/98, 10/03/97 ->, Colour:Grey						470 378	C10	
Eng. K7M 702, K7M 703	01/04/97 ->, ->year 01/06/98, x 1, Colour:Grey, D.I.S., connector type, saw teeth						470 378	C10	
All engines	08/07/98 ->						470 596	C10	
Eng. K7M 702, K7M 703	01/07/98 ->, x 1, D.I.S., x 1, D.I.S.						470 596	C10	
Eng. K7M 702, K7M 703	08/07/98 ->								358 244
Eng. K7M 702, K7M 703	->year 08/07/98, 10/03/97 ->								360 443
All engines	->year 10/03/97								360 446

ENGINE				
1.6 i	Petrol	55	01/96-03/99	K7M 720, K7M 790

Engine	Information	A10	A20	A40	A50	A70	C10 - C30	C20	E01
All engines	->year 01/03/97, x 1, Colour:Black, x 1, Colour:Black, D.I.S., D.I.S.						470 355	C10	
All engines	->year 01/03/97, x 1, Colour:Grey, x 1, Colour:Grey, D.I.S., D.I.S.						470 356	C10	
Eng. K7M 720	01/04/97 ->, ->year 01/06/98, x 1, Colour:Black, D.I.S., connector type, saw teeth						470 376	C10	
Eng. K7M 720	01/04/97 ->, ->year 01/06/98, x 1, Colour:Grey, D.I.S., connector type, saw teeth						470 378	C10	
Eng. K7M 720	01/07/98 ->, x 1, D.I.S.						470 596	C10	
Eng. K7M 720	08/07/98 ->								358 244
Eng. K7M 720	->year 08/07/98, 10/03/97 ->								360 443
Eng. K7M 720	->year 10/03/97								360 446

ENGINE				
1.6 LPG	Petrol/ Liquified Petroleum Gas (LPG)	66	08/95-03/99	K7M 702

Engine	Information	A10	A20	A40	A50	A70	C10 - C30	C20	E01
All engines	->year 01/03/97, x 1, Colour:Black, D.I.S.						470 355	C10	
All engines	->year 01/03/97, x 1, Colour:Grey, D.I.S.						470 356	C10	
All engines	01/04/97 ->, ->year 01/06/98, x 1, Colour:Black, D.I.S., connector type, saw teeth						470 376	C10	
All engines	01/04/97 ->, ->year 01/06/98, x 1, Colour:Grey, D.I.S., connector type, saw teeth						470 378	C10	
All engines	01/07/98 ->, x 1, D.I.S.						470 596	C10	

ENGINE				
1.6 LPG	Petrol/ Liquified Petroleum Gas (LPG)	80	10/00-08/02	K4M 704, K4M 712

Engine	Information	A10	A20	A40	A50	A70	C10 - C30	C20	E01
All engines	x 4, SAGEM, COIL ON PLUG						470 432	C10	

A10 CONDENSER	A20 CONTACT SET	A40 DISTRIBUTOR CAP	A50 ROTOR	A70 PICK-UP
C10 COIL	C20 IGNITION MODULE	C30 ELECTRONIC IGNITION KIT	E01 IGNITION CABLE SET	

					FUNCTIONS ON THE VEHICLE							
Vehicle	alim.	kW	Date	Engine	A10	A20	A40	A50	A70	C10 - C30	C20	E01
ENGINE												
1.8 16V	Petrol	85	01/99-08/03	F4P 720, F4P 722, F4P 772, F4P 774, F4P 775								
Engine	Information				A10	A20	A40	A50	A70	C10 - C30	C20	E01
Eng. F4P 720, F4P 722	x 4, SAGEM, COIL ON PLUG									470 432	C10	
Eng. F4P 772, F4P 774, F4P 775	Qty: 4									470 432	C10	
ENGINE												
1.8 16V	Petrol	88	07/00-10/02	F4P 760, F4P 770								
Engine	Information				A10	A20	A40	A50	A70	C10 - C30	C20	E01
All engines	Qty: 4									470 432	C10	
ENGINE												
1.8 16V	Petrol	89	01/99-11/02	F4P 771								
Engine	Information				A10	A20	A40	A50	A70	C10 - C30	C20	E01
All engines	Qty: 4									470 432	C10	
ENGINE												
2.0	Petrol	0	01/97-02/99	F3R 262, F3R 264								
Engine	Information				A10	A20	A40	A50	A70	C10 - C30	C20	E01
All engines	02/04/97 ->, Qty: 2									470 196	C10	
All engines	->year 02/04/97, Qty: 2									470 275	C10	
All engines												360 501
ENGINE												
2.0	Petrol	84	04/97-08/03	F3R 750, F3R 791, F3R 796								
Engine	Information				A10	A20	A40	A50	A70	C10 - C30	C20	E01
Eng. F3R 750	02/04/97 ->, Qty: 2									470 196	C10	
Eng. F3R 791	x 1, D.I.S., connector type, saw teeth									470 196	C10	
Eng. F3R 750	->year 02/04/97, Qty: 2									470 275	C10	
Eng. F3R 796	x 1, D.I.S.									470 275	C10	
Eng. F3R 750	02/04/97 ->											360 492
Eng. F3R 750	->year 02/04/97											360 501
ENGINE												
2.0	Petrol	85	05/98-05/01	F3R 750, F3R 751, F3R 752, F3R 791, F3R 796, F3R 797, F3R 798								
Engine	Information				A10	A20	A40	A50	A70	C10 - C30	C20	E01
Eng. F3R 791	x 1, D.I.S., connector type, saw teeth									470 196	C10	
Eng. F3R 750, F3R 751, F3R 752, F3R 796, F3R 797, F3R 798	->year 01/04/97, x 1, D.I.S., x 1, D.I.S.									470 275	C10	
All engines	02/04/97 ->											360 492
Eng. F3R 750, F3R 751, F3R 752, F3R 791, F3R 797, F3R 798	->year 02/04/97											360 501
ENGINE												
2.0 16V	Petrol	0	01/99-11/02	F4R 276, F4R 712, F4R 713, F4R 790, F4R 794, F4R 795								
Engine	Information				A10	A20	A40	A50	A70	C10 - C30	C20	E01
All engines	Qty: 4									470 432	C10	
ENGINE												
2.0 16V	Petrol	102	01/02-08/03	F4R 746, F4R 770, F5R 740								
Engine	Information				A10	A20	A40	A50	A70	C10 - C30	C20	E01
Eng. F4R 746	x 1, D.I.S.									470 365	C10	
Eng. F4R 746, F4R 770	Qty: 4									470 432	C10	
Eng. F5R 740	->year 01/10/00, x 1, D.I.S.									470 596	C10	
ENGINE												
2.0 16V	Petrol	103	09/99->	F4R 700, F4R 701, F4R 746, F4R 780								
Engine	Information				A10	A20	A40	A50	A70	C10 - C30	C20	E01
All engines	Qty: 4									470 432	C10	
ENGINE												
2.0 16V	Petrol	120	07/99->	F4R 760, F4R 761, F4R 762, F4R 763, F4R 767								
Engine	Information				A10	A20	A40	A50	A70	C10 - C30	C20	E01
All engines	Qty: 4									470 432	C10	

A10 CONDENSER	A20 CONTACT SET	A40 DISTRIBUTOR CAP	A50 ROTOR	A70 PICK-UP
C10 COIL	C20 IGNITION MODULE	C30 ELECTRONIC IGNITION KIT	E01 IGNITION CABLE SET	

Vehicle	alim.	kW	Date	Engine	FUNCTIONS ON THE VEHICLE							
					A10	A20	A40	A50	A70	C10 - C30	C20	E01

ENGINE				
2.0 16V	Petrol	124	05/00->	F4R 730, F4R 732, F4R 736

Engine	Information	A10	A20	A40	A50	A70	C10 - C30	C20	E01
All engines	Qty: 4						470 432	C10	

ENGINE				
2.0 16V	Petrol	88	05/00->	F4R 720

Engine	Information	A10	A20	A40	A50	A70	C10 - C30	C20	E01
All engines	Qty: 4						470 432	C10	

ENGINE				
2.0 16V	Petrol	99	11/00->	F4R 771

Engine	Information	A10	A20	A40	A50	A70	C10 - C30	C20	E01
All engines	Qty: 4						470 432	C10	

ENGINE				
2.0 16V IDE	Petrol	103	11/99-08/03	F4R 746, F5R 740

Engine	Information	A10	A20	A40	A50	A70	C10 - C30	C20	E01
All engines	01/11/00 ->, x 1, D.I.S.						470 365	C10	
All engines	->year 01/10/00, x 1, D.I.S.						470 596	C10	
Eng. F5R 740									358 049

ENGINE				
2.0 i	Petrol	80	03/99-08/03	F3R 750, F3R 751, F3R 752, F3R 791, F3R 796, F3R 797, F3R 798

Engine	Information	A10	A20	A40	A50	A70	C10 - C30	C20	E01
All engines	->eng. C017557, -eng. F3R752, x 1, D.I.S., x 1, connector type, saw teeth, D.I.S., connector type, saw teeth						470 196	C10	
All engines	eng. type I009203 ->, x 1, D.I.S.						470 275	C10	
All engines	02/04/97 ->								360 492
Eng. F3R 750, F3R 751, F3R 752, F3R 791, F3R 797, F3R 798	->year 02/04/97								360 501

ENGINE				
2.0 i	Petrol	84	01/96-08/03	F3R 750, F3R 751, F3R 752, F3R 791, F3R 796, F3R 797, F3R 798

Engine	Information	A10	A20	A40	A50	A70	C10 - C30	C20	E01
Eng. F3R 750, F3R 751, F3R 791, F3R 796, F3R 797, F3R 798	01/04/97 ->, 01/05/97 ->, x 1, D.I.S., connector type, saw teeth, x 1, D.I.S., connector type, saw teeth						470 196	C10	
Eng. F3R 750, F3R 751, F3R 752, F3R 796, F3R 797, F3R 798	->year 01/03/97, ->year 01/04/97, x 1, D.I.S., x 1, D.I.S.						470 275	C10	
All engines	02/04/97 ->								360 492
Eng. F3R 750, F3R 751, F3R 752, F3R 791, F3R 797, F3R 798	->year 02/04/97								360 501

ENGINE				
2.0 RT	Petrol	103	03/01-08/03	F4R 740, F4R 741, F4R 746, F4R 747

Engine	Information	A10	A20	A40	A50	A70	C10 - C30	C20	E01
All engines	x 4, SAGEM, COIL ON PLUG						470 432	C10	
Eng. F4R 747	Qty: 4						470 432	C10	

ENGINE				
2.0 RT	Petrol	112	10/96-02/99	F3R 750, F3R 751, F3R 752, F3R 791, F3R 796, F3R 797, F3R 798

Engine	Information	A10	A20	A40	A50	A70	C10 - C30	C20	E01
All engines	-eng. F3R752, x 1, D.I.S., connector type, saw teeth						470 196	C10	
Eng. F3R 752	x 1, D.I.S.						470 275	C10	

MEGANE II

ENGINE				
1.4	Petrol	60	09/03->	K4J 732









Engine	Information	A10	A20	A40	A50	A70	C10 - C30	C20	E01
All engines	x 4, SAGEM, COIL ON PLUG						470 432	C10	

ENGINE				
1.4	Petrol	72	08/03->	K4J 730, K4J 740

Engine	Information	A10	A20	A40	A50	A70	C10 - C30	C20	E01
All engines	x 4, SAGEM, COIL ON PLUG						470 432	C10	









A10 CONDENSER	A20 CONTACT SET	A40 DISTRIBUTOR CAP	A50 ROTOR	A70 PICK-UP
C10 COIL	C20 IGNITION MODULE	C30 ELECTRONIC IGNITION KIT	E01 IGNITION CABLE SET	

The present application list is a brief version. For the detailed information about the possibility of installation on a specific vehicle, please refer to our web-catalogue <http://catalogo.facet.eu/>

					FUNCTIONS ON THE VEHICLE							
Vehicle	alim.	kW	Date	Engine								
ENGINE												
1.4 16V	Petrol	60	10/03-02/08	K4J 732								
ENGINE												
Engine		Information			A10	A20	A40	A50	A70	C10 - C30	C20	E01
All engines		x 4, SAGEM, COIL ON PLUG								470 432	C10	
1.4 16V	Petrol	72	11/02-02/08	K4J 730, K4J 740								
ENGINE												
Engine		Information			A10	A20	A40	A50	A70	C10 - C30	C20	E01
All engines		x 4, SAGEM, COIL ON PLUG								470 432	C10	
1.6	Petrol	75	09/03->	K4M 768								
ENGINE												
Engine		Information			A10	A20	A40	A50	A70	C10 - C30	C20	E01
All engines		Qty: 4								470 432	C10	
1.6	Petrol	77	05/05->	K4M 760, K4M 761, K4M 762, K4M 788, K4M 812, K4M 813, K4M680								
ENGINE												
Engine		Information			A10	A20	A40	A50	A70	C10 - C30	C20	E01
Eng. K4M 760, K4M 761, K4M 762, K4M 812, K4M 813, K4M680		x 4, SAGEM, COIL ON PLUG								470 432	C10	
Eng. K4M 788		Qty: 4								470 432	C10	
1.6	Petrol	81	09/03-11/08	K4M 760, K4M 761								
ENGINE												
Engine		Information			A10	A20	A40	A50	A70	C10 - C30	C20	E01
All engines		Qty: 4								470 432	C10	
1.6	Petrol	82	10/03-01/08	K4M 760								
ENGINE												
Engine		Information			A10	A20	A40	A50	A70	C10 - C30	C20	E01
All engines		x 4, SAGEM, COIL ON PLUG								470 432	C10	
1.6	Petrol	83	08/03->	K4M 760, K4M 761, K4M 812, K4M 813								
ENGINE												
Engine		Information			A10	A20	A40	A50	A70	C10 - C30	C20	E01
All engines		x 4, SAGEM, COIL ON PLUG								470 432	C10	
1.6 16V	Petrol	75	05/05-07/09	K4M 768								
ENGINE												
Engine		Information			A10	A20	A40	A50	A70	C10 - C30	C20	E01
All engines		x 4, SAGEM, COIL ON PLUG								470 432	C10	
1.6 16V	Petrol	77	05/05-07/09	K4M 762								
ENGINE												
Engine		Information			A10	A20	A40	A50	A70	C10 - C30	C20	E01
All engines		x 4, SAGEM, COIL ON PLUG								470 432	C10	
1.6 16V	Petrol	82	01/06->	K4M 760, K4M 761, K4M 812, K4M 813								
ENGINE												
Engine		Information			A10	A20	A40	A50	A70	C10 - C30	C20	E01
All engines		x 4, SAGEM, COIL ON PLUG								470 432	C10	
Eng. K4M 761, K4M 812, K4M 813		Qty: 4								470 432	C10	
1.6 16V	Petrol	83	11/02->	K4M 760, K4M 761, K4M 764, K4M 812, K4M 813, K4M 856								
ENGINE												
Engine		Information			A10	A20	A40	A50	A70	C10 - C30	C20	E01
Eng. K4M 760, K4M 761, K4M 764, K4M 812, K4M 813		x 4, SAGEM, COIL ON PLUG								470 432	C10	
Eng. K4M 761, K4M 764, K4M 856		Qty: 4								470 432	C10	
1.6 16V Hi-Flex	Petrol/ Ethanol	77	02/08-07/09	K4M 856								
ENGINE												
Engine		Information			A10	A20	A40	A50	A70	C10 - C30	C20	E01
All engines		x 4, SAGEM, COIL ON PLUG								470 432	C10	

A10 CONDENSER	A20 CONTACT SET	A40 DISTRIBUTOR CAP	A50 ROTOR	A70 PICK-UP
C10 COIL	C20 IGNITION MODULE	C30 ELECTRONIC IGNITION KIT	E01 IGNITION CABLE SET	

Vehicle	alim.	kW	Date	Engine	FUNCTIONS ON THE VEHICLE									
					A10	A20	A40	A50	A70	C10 - C30	C20	E01		
ENGINE														
1.6 Bifuel	Petrol/ Liquified Petroleum Gas (LPG)	77	06/05-02/08	K4M 788										
Engine	Information				A10	A20	A40	A50	A70	C10 - C30	C20	E01		
All engines	x 4, SAGEM, COIL ON PLUG									470 432	C10			
ENGINE														
1.6 Flex-Fuel	Petrol/ Ethanol	77	01/07-02/08	K4M 856										
Engine	Information				A10	A20	A40	A50	A70	C10 - C30	C20	E01		
All engines	x 4, SAGEM, COIL ON PLUG									470 432	C10			
ENGINE														
1.6 LPG 16V	Petrol/ Liquified Petroleum Gas (LPG)	82	01/06-08/09	K4M 760										
Engine	Information				A10	A20	A40	A50	A70	C10 - C30	C20	E01		
All engines	x 4, SAGEM, COIL ON PLUG									470 432	C10			
ENGINE														
2.0	Petrol	101	04/06-11/10	F4R 770, F4R 771										
Engine	Information				A10	A20	A40	A50	A70	C10 - C30	C20	E01		
All engines	x 4, SAGEM, COIL ON PLUG									470 432	C10			
ENGINE														
2.0	Petrol	102	09/03-01/11	F4R 770										
Engine	Information				A10	A20	A40	A50	A70	C10 - C30	C20	E01		
All engines	Qty: 4									470 432	C10			
All engines	x 4, SAGEM, COIL ON PLUG									470 432	C10			
ENGINE														
2.0	Petrol	169	08/06-02/08	F4R 774										
Engine	Information				A10	A20	A40	A50	A70	C10 - C30	C20	E01		
All engines	x 4, SAGEM, COIL ON PLUG									470 432	C10			
ENGINE														
2.0	Petrol	99	08/03->	F4R 770, F4R 771										
Engine	Information				A10	A20	A40	A50	A70	C10 - C30	C20	E01		
All engines	x 4, SAGEM, COIL ON PLUG									470 432	C10			
ENGINE														
2.0 16V	Petrol	99	11/02-02/08	F4R 770, F4R 771										
Engine	Information				A10	A20	A40	A50	A70	C10 - C30	C20	E01		
All engines	x 4, SAGEM, COIL ON PLUG									470 432	C10			
ENGINE														
2.0 16V Turbo	Petrol	120	05/04-03/09	F4R 776										
Engine	Information				A10	A20	A40	A50	A70	C10 - C30	C20	E01		
All engines	x 4, SAGEM, COIL ON PLUG									470 432	C10			
ENGINE														
2.0 Renault Sport	Petrol	165	05/04-10/09	F4R 774, F4Rt 774										
Engine	Information				A10	A20	A40	A50	A70	C10 - C30	C20	E01		
Eng. F4R 774	x 4, SAGEM, COIL ON PLUG									470 432	C10			
Eng. F4Rt 774	Qty: 4									470 432	C10			
MEGANE III														
ENGINE														
1.2 Tce	Petrol	85	03/12->	HSF 400, HSF 408										
Engine	Information				A10	A20	A40	A50	A70	C10 - C30	C20	E01		
All engines	x 4, COIL ON PLUG									470 613	C10			
ENGINE														
1.2 Tce	Petrol	97	01/13->	HSF 404, HSF 405, HSF 412										
Engine	Information				A10	A20	A40	A50	A70	C10 - C30	C20	E01		
All engines	x 4, COIL ON PLUG									470 613	C10			
ENGINE														
1.6 16V	Petrol	74	11/08->	K4M 848										
Engine	Information				A10	A20	A40	A50	A70	C10 - C30	C20	E01		
All engines	x 4, SAGEM, COIL ON PLUG									470 432	C10			
A10	CONDENSER	A20	CONTACT SET	A40	DISTRIBUTOR CAP	A50	ROTOR	A70	PICK-UP					
C10	COIL	C20	IGNITION MODULE	C30	ELECTRONIC IGNITION KIT	E01	IGNITION CABLE SET							

					FUNCTIONS ON THE VEHICLE							
Vehicle	alim.	kW	Date	Engine								
ENGINE												
1.6 16V	Petrol	78	01/10-08/15	K4M 848								
ENGINE												
All engines					x 4, SAGEM, COIL ON PLUG					470 432	C10	
1.6 16V	Petrol	81	11/08->	K4M 858, K4M 866								
ENGINE												
All engines					x 4, SAGEM, COIL ON PLUG					470 432	C10	
1.6 16V	Petrol	82	11/08->	K4M 858, K4M 866								
ENGINE												
All engines					x 4, SAGEM, COIL ON PLUG					470 432	C10	
1.6 16V	Petrol	85	01/13->	K4M 858								
ENGINE												
All engines					x 4, SAGEM, COIL ON PLUG					470 432	C10	
1.6 16V Bifuel	Petrol/ Liquified Petroleum Gas (LPG)	81	11/08->	K4M 858, K4M 866								
ENGINE												
All engines					x 4, SAGEM, COIL ON PLUG					470 432	C10	
1.6 16V Hi-Flex	Petrol/ Ethanol	81	11/08-08/15	K4M 866								
ENGINE												
All engines					x 4, SAGEM, COIL ON PLUG					470 432	C10	
1.6 BiFuel	Petrol/ Liquified Petroleum Gas (LPG)	81	11/08->	K4M 866								
ENGINE												
All engines					x 4, SAGEM, COIL ON PLUG					470 432	C10	
2.0 R.S.	Petrol	195	11/08->	F4R874								
ENGINE												
All engines					x 4, SAGEM, COIL ON PLUG					470 432	C10	
2.0 R.S.	Petrol	201	07/14->	F4R874								
ENGINE												
All engines					x 4, SAGEM, COIL ON PLUG					470 432	C10	
2.0 TCe	Petrol	132	11/08->	F4R 872, F4R870								
ENGINE												
All engines					x 4, SAGEM, COIL ON PLUG					470 432	C10	
2.0 TCe	Petrol	140	06/12->	F4R 872								
ENGINE												
All engines					x 4, SAGEM, COIL ON PLUG					470 432	C10	
2.0 TCe	Petrol	162	09/12->	F4R874								
ENGINE												
All engines					x 4, SAGEM, COIL ON PLUG					470 432	C10	
2.0 TCe	Petrol	184	05/09->	F4R874								
ENGINE												
All engines					x 4, SAGEM, COIL ON PLUG					470 432	C10	

A10 CONDENSER	A20 CONTACT SET	A40 DISTRIBUTOR CAP	A50 ROTOR	A70 PICK-UP
C10 COIL	C20 IGNITION MODULE	C30 ELECTRONIC IGNITION KIT	E01 IGNITION CABLE SET	

Vehicle	alim.	kW	Date	Engine	FUNCTIONS ON THE VEHICLE									
					A10	A20	A40	A50	A70	C10 - C30	C20	E01		
ENGINE														
2.0 TCe 220	Petrol	162	11/13->	F4R874										
Engine	Information				A10	A20	A40	A50	A70	C10 - C30	C20	E01		
All engines	x 4, SAGEM, COIL ON PLUG									470 432	C10			
MEGANE IV														
ENGINE														
1.2 TCe 100	Petrol	74	11/15->	H5F 408										
Engine	Information				A10	A20	A40	A50	A70	C10 - C30	C20	E01		
All engines	x 4, COIL ON PLUG									470 613	C10			
ENGINE														
1.2 TCe 130	Petrol	97	11/15->	H5F 408										
Engine	Information				A10	A20	A40	A50	A70	C10 - C30	C20	E01		
All engines	x 4, COIL ON PLUG									470 613	C10			
ENGINE														
1.6 16V	Petrol	84	11/15->	H4M 738, H4M 750										
Engine	Information				A10	A20	A40	A50	A70	C10 - C30	C20	E01		
All engines	x 4, COIL ON PLUG, x 4, COIL ON PLUG									470 613	C10			
ENGINE														
1.6 SCe	Petrol	84	10/16->	H4M 738, H4M 750										
Engine	Information				A10	A20	A40	A50	A70	C10 - C30	C20	E01		
All engines	x 4, COIL ON PLUG									470 613	C10			
ENGINE														
1.6 TCe 165	Petrol	121	07/17->	MSM 450										
Engine	Information				A10	A20	A40	A50	A70	C10 - C30	C20	E01		
All engines	x 4, COIL ON PLUG									470 551	C10			
ENGINE														
1.6 TCe 205	Petrol	151	11/15->	MSM 450										
Engine	Information				A10	A20	A40	A50	A70	C10 - C30	C20	E01		
All engines	x 4, COIL ON PLUG									470 551	C10			
ENGINE														
1.8 RS 300	Petrol	221	09/18->	M5P 404										
Engine	Information				A10	A20	A40	A50	A70	C10 - C30	C20	E01		
All engines	x 4, COIL ON PLUG									470 551	C10			
ENGINE														
1.8 RS TCe 280	Petrol	205	10/17->	M5P 402, M5P 404										
Engine	Information				A10	A20	A40	A50	A70	C10 - C30	C20	E01		
All engines	x 4, COIL ON PLUG									470 551	C10			
MEGANE SCÉNIC I														
ENGINE														
1.4 i	Petrol	55	01/97-09/99	E7J 764										
Engine	Information				A10	A20	A40	A50	A70	C10 - C30	C20	E01		
All engines	version Ducellier						815 081	915 101						
All engines	version Marelli						830 111	930 059						
All engines	x 1, SIEMENS, DISTRIBUTOR, Dia: 4 mm, connector type SAE									470 107	C10			
All engines													359 801	
ENGINE														
1.6 16V	Petrol	79	04/98-10/99	K4M 701, K4M 704, K4M 708, K4M700										
Engine	Information				A10	A20	A40	A50	A70	C10 - C30	C20	E01		
Eng. K4M 701, K4M700	x 4, SAGEM, COIL ON PLUG									470 432	C10			
Eng. K4M 704, K4M 708	Qty: 4									470 432	C10			
ENGINE														
1.6 e	Petrol	66	10/96-10/99	K7M 702, K7M 703										
Engine	Information				A10	A20	A40	A50	A70	C10 - C30	C20	E01		
All engines	->year 01/03/97, x 1, Colour:Black, D.I.S.									470 355	C10			
All engines	->year 01/03/97, x 1, Colour:Grey, D.I.S.									470 356	C10			
All engines	01/04/97 ->, ->year 01/06/98, x 1, Colour:Black, D.I.S., connector type, saw teeth									470 376	C10			
All engines	01/04/97 ->, ->year 01/06/98, x 1, Colour:Grey, D.I.S., connector type, saw teeth									470 378	C10			
All engines	01/07/98 ->, x 1, D.I.S.									470 596	C10			
All engines	08/07/98 ->												358 244	
All engines	->year 08/07/98, 10/03/97 ->												360 443	
A10	CONDENSER		A20	CONTACT SET		A40	DISTRIBUTOR CAP		A50	ROTOR		A70	PICK-UP	
C10	COIL		C20	IGNITION MODULE		C30	ELECTRONIC IGNITION KIT		E01	IGNITION CABLE SET				

Vehicle	alim.	kW	Date	Engine	FUNCTIONS ON THE VEHICLE							
					A10	A20	A40	A50	A70	C10 - C30	C20	E01

ENGINE				
1.6 e	Petrol	66	10/96-10/99	K7M 702, K7M 703

Engine	Information	A10	A20	A40	A50	A70	C10 - C30	C20	E01
All engines	->year 10/03/97								360 446

ENGINE				
1.6 i	Petrol	55	01/97-09/99	K7M 720

Engine	Information	A10	A20	A40	A50	A70	C10 - C30	C20	E01
All engines	->year 01/03/97, x 1, Colour:Black, D.I.S.						470 355	C10	
All engines	->year 01/03/97, x 1, Colour:Grey, D.I.S.						470 356	C10	
All engines	01/04/97 ->, ->year 01/06/98, x 1, Colour:Black, D.I.S., connector type, saw teeth						470 376	C10	
All engines	01/04/97 ->, ->year 01/06/98, x 1, Colour:Grey, D.I.S., connector type, saw teeth						470 378	C10	
All engines	01/07/98 ->, x 1, D.I.S.						470 596	C10	
All engines	08/07/98 ->								358 244
All engines	->year 08/07/98, 10/03/97 ->								360 443
All engines	->year 10/03/97								360 446

ENGINE				
2.0 i	Petrol	80	01/99-09/99	F3R 750, F3R 751, F3R 791, F3R 796, F3R 797, F3R 798

Engine	Information	A10	A20	A40	A50	A70	C10 - C30	C20	E01
All engines	x 1, D.I.S., connector type, saw teeth						470 196	C10	
Eng. F3R 796									360 492

ENGINE				
2.0 i	Petrol	84	01/97-09/99	F3R 750, F3R 751, F3R 791, F3R 796, F3R 797, F3R 798

Engine	Information	A10	A20	A40	A50	A70	C10 - C30	C20	E01
All engines	x 1, D.I.S., connector type, saw teeth						470 196	C10	
Eng. F3R 750, F3R 751	02/04/97 ->								360 492
Eng. F3R 750, F3R 751	->year 02/04/97								360 501

ENGINE				
2.0 RXE 4x4	Petrol	84	05/97-10/99	F3R 750

Engine	Information	A10	A20	A40	A50	A70	C10 - C30	C20	E01
All engines	02/04/97 ->, Qty: 2						470 196	C10	
All engines	->year 02/04/97, Qty: 2						470 275	C10	
All engines	02/04/97 ->								360 492
All engines	->year 02/04/97								360 501

MODUS / GRAND MODUS

ENGINE				
1.2	Petrol	48	05/05->	D4F 740

Engine	Information	A10	A20	A40	A50	A70	C10 - C30	C20	E01
All engines	x 1, D.I.S.						470 518	C10	
All engines									358 246

ENGINE				
1.2	Petrol	55	12/04->	D4F 740, D4F 742, D4F 744

Engine	Information	A10	A20	A40	A50	A70	C10 - C30	C20	E01
Eng. D4F 740, D4F 744	x 1, D.I.S.						470 518	C10	
Eng. D4F 742							470 518	C10	
Eng. D4F 740, D4F 742									358 246

ENGINE				
1.2	Petrol	58	12/04->	D4F 764

Engine	Information	A10	A20	A40	A50	A70	C10 - C30	C20	E01
All engines	x 1, D.I.S.						470 518	C10	
All engines									358 246

ENGINE				
1.2	Petrol	76	04/11->	D4F 786

Engine	Information	A10	A20	A40	A50	A70	C10 - C30	C20	E01
All engines	x 1, D.I.S.						470 596	C10	
All engines									358 229

A10 CONDENSER	A20 CONTACT SET	A40 DISTRIBUTOR CAP	A50 ROTOR	A70 PICK-UP
C10 COIL	C20 IGNITION MODULE	C30 ELECTRONIC IGNITION KIT	E01 IGNITION CABLE SET	

Vehicle	alim.	kW	Date	Engine	FUNCTIONS ON THE VEHICLE									
					A10	A20	A40	A50	A70	C10 - C30	C20	E01		
ENGINE														
1.2 16V	Petrol	74	05/07->	D4F 784										
Engine	Information				A10	A20	A40	A50	A70	C10 - C30	C20	E01		
All engines	x 1, D.I.S.									470 596	C10			
All engines													358 229	
ENGINE														
1.2 16V Hi-Flex	Petrol/ Ethanol	55	10/08->	D4F 740, D4F 742										
Engine	Information				A10	A20	A40	A50	A70	C10 - C30	C20	E01		
Eng. D4F 742	x 1, D.I.S.									470 518	C10			
Eng. D4F 740													358 246	
ENGINE														
1.2 GPL	Petrol/ Liquified Petroleum Gas (LPG)	55	05/08-12/12	D4F 744										
Engine	Information				A10	A20	A40	A50	A70	C10 - C30	C20	E01		
All engines	x 1, D.I.S.									470 518	C10			
ENGINE														
1.4	Petrol	72	12/04->	K4J 770, K4J 780										
Engine	Information				A10	A20	A40	A50	A70	C10 - C30	C20	E01		
All engines	x 4, SAGEM, COIL ON PLUG									470 432	C10			
ENGINE														
1.6	Petrol	65	12/04->	K4M 792, K4M 794										
Engine	Information				A10	A20	A40	A50	A70	C10 - C30	C20	E01		
Eng. K4M 792	Qty: 4									470 432	C10			
Eng. K4M 794	x 4, SAGEM, COIL ON PLUG									470 432	C10			
ENGINE														
1.6	Petrol	82	12/04->	K4M 790, K4M 791, K4M 800, K4M 801										
Engine	Information				A10	A20	A40	A50	A70	C10 - C30	C20	E01		
All engines	x 4, SAGEM, COIL ON PLUG									470 432	C10			
RAPID														
ENGINE														
1.0	Petrol	27	02/86-05/92	C1C 706										
Engine	Information				A10	A20	A40	A50	A70	C10 - C30	C20	E01		
All engines	version Ducellier						815 054	915 091						
All engines													359 839	
ENGINE														
1.0	Petrol	31	09/85-08/91	C1C 706										
Engine	Information				A10	A20	A40	A50	A70	C10 - C30	C20	E01		
All engines	version Ducellier						815 054	915 091						
All engines													359 839	
ENGINE														
1.1	Petrol	33	07/85-04/95	C1E 750, C1E 752, C1E 754, C1E 756, C1E 760, C1E 762, C1E 792										
Engine	Information				A10	A20	A40	A50	A70	C10 - C30	C20	E01		
Eng. C1E 750, C1E 752, C1E 754, C1E 756, C1E 760, C1E 762	version Ducellier						815 054	915 091						
Eng. C1E 750, C1E 760	version Femsá						817 023	917 058						
Eng. C1E 750, C1E 760	version Marelli						830 101	930 047R						
All engines													359 839	
ENGINE														
1.1	Petrol	34	09/85-08/91	C1E 750										
Engine	Information				A10	A20	A40	A50	A70	C10 - C30	C20	E01		
All engines	version Ducellier						815 054	915 091						
All engines	version Femsá						817 023	917 058						
All engines	version Marelli						830 101	930 047R						
All engines													359 839	
ENGINE														
1.1	Petrol	35	09/93-04/95	C1E 762										
Engine	Information				A10	A20	A40	A50	A70	C10 - C30	C20	E01		
All engines	version Ducellier						815 054	915 091						

A10 CONDENSER	A20 CONTACT SET	A40 DISTRIBUTOR CAP	A50 ROTOR	A70 PICK-UP
C10 COIL	C20 IGNITION MODULE	C30 ELECTRONIC IGNITION KIT	E01 IGNITION CABLE SET	

The present application list is a brief version. For the detailed information about the possibility of installation on a specific vehicle, please refer to our web-catalogue <http://catalogue.facet.eu/>

Vehicle	alim.	kW	Date	Engine	FUNCTIONS ON THE VEHICLE							
					A10	A20	A40	A50	A70	C10 - C30	C20	E01

ENGINE				
1.1	Petrol	35	09/93-04/95	C1E 762

Engine	Information	A10	A20	A40	A50	A70	C10 - C30	C20	E01
All engines									359 839

ENGINE				
1.1	Petrol	36	09/91-10/97	C1E 764

Engine	Information	A10	A20	A40	A50	A70	C10 - C30	C20	E01
All engines	version Ducellier			815 054	915 091				
All engines									359 839

ENGINE				
1.2	Petrol	40	09/91-03/98	C1G 726, C3G 710, C3G 712

Engine	Information	A10	A20	A40	A50	A70	C10 - C30	C20	E01
All engines	distr. num. 525352A, version Ducellier			815 091					
Eng. C1G 726							470 107	C10	
Eng. C3G 710, C3G 712							470 228	C10	

ENGINE				
1.4	Petrol	43	07/85-09/97	C1J 768, C1J 780, E6J 738

Engine	Information	A10	A20	A40	A50	A70	C10 - C30	C20	E01
Eng. E6J 738	version Ducellier			815 081	915 101				
Eng. C1J 768, C1J 780	distr. num. 525352A, version Ducellier			815 091					
Eng. E6J 738	version Marelli			830 111	930 059				
All engines							470 107	C10	
Eng. E6J 738									359 801

ENGINE				
1.4	Petrol	44	03/86-08/91	C2J 784

Engine	Information	A10	A20	A40	A50	A70	C10 - C30	C20	E01
All engines	distr. num. 525352A, version Ducellier			815 091					
All engines							470 107	C10	

ENGINE				
1.4	Petrol	55	09/91-03/98	E7J 720, E7J 724, E7J 726, E7J 773

Engine	Information	A10	A20	A40	A50	A70	C10 - C30	C20	E01
All engines	version Ducellier			815 081	915 101				
All engines	version Marelli			830 111	930 059				
All engines							470 107	C10	359 801

ENGINE				
1.4	Petrol	58	01/94-03/98	E7J 728

Engine	Information	A10	A20	A40	A50	A70	C10 - C30	C20	E01
All engines	version Ducellier			815 081	915 101				
All engines	version Marelli			830 111	930 059				
All engines							470 107	C10	359 801

ENGINE				
1.4	Petrol	59	05/95-08/97	E7J 726, E7J 773

Engine	Information	A10	A20	A40	A50	A70	C10 - C30	C20	E01
All engines	x 1, ignition mod. IGN. MODULE(-), SIEMENS, DISTRIBUTOR, Dia: 4 mm, connector type SAE						470 107	C10	

ENGINE				
1.4 Cat	Petrol	43	08/88-03/98	C3J 700, C3J 702, C3J 760, C3J 762

Engine	Information	A10	A20	A40	A50	A70	C10 - C30	C20	E01
All engines	distr. num. 525352A, version Ducellier			815 091					
Eng. C3J 702, C3J 760, C3J 762							470 107	C10	

ENGINE				
1.4 RN	Petrol	44	09/91-08/93	E6J 734

Engine	Information	A10	A20	A40	A50	A70	C10 - C30	C20	E01
All engines	version Ducellier			815 081	915 101				
All engines	version Marelli			830 111	930 059				
All engines							470 107	C10	359 801

A10 CONDENSER	A20 CONTACT SET	A40 DISTRIBUTOR CAP	A50 ROTOR	A70 PICK-UP
C10 COIL	C20 IGNITION MODULE	C30 ELECTRONIC IGNITION KIT	E01 IGNITION CABLE SET	

Vehicle	alim.	kW	Date	Engine	FUNCTIONS ON THE VEHICLE							
					A10	A20	A40	A50	A70	C10 - C30	C20	E01

SAFRANE I

				ENGINE
2.0	Petrol	77	11/92-07/96	OLJY, J7R 732

Engine	Information	A10	A20	A40	A50	A70	C10 - C30	C20	E01
All engines	distr. num. 525646, version Ducellier			815 081					
All engines	distr. num. 525703, version Ducellier			815 082					
All engines	distr. num. 525703, Kit, version Ducellier			815 083					
All engines	version Ducellier				915 101				
All engines							470 107	C10	

				ENGINE
2.0	Petrol	97	08/92-09/96	J7R 738, J7R 739

Engine	Information	A10	A20	A40	A50	A70	C10 - C30	C20	E01
All engines	distr. num. 525646, version Ducellier			815 081					
All engines	distr. num. 525703, version Ducellier			815 082					
All engines	distr. num. 525703, Kit, version Ducellier			815 083					
All engines	version Ducellier				915 101				
All engines							470 107	C10	

				ENGINE
2.0 12V	Petrol	97	04/92-07/96	J7R 734, J7R 735

Engine	Information	A10	A20	A40	A50	A70	C10 - C30	C20	E01
All engines	distr. num. 525646, version Ducellier			815 081					
All engines	distr. num. 525704, version Ducellier			815 082					
All engines	distr. num. 525704, Kit, version Ducellier			815 083					
All engines	version Ducellier				915 101				
All engines							470 107	C10	

				ENGINE
2.2	Petrol	101	04/92-07/96	1MR479QB, J7T 761

Engine	Information	A10	A20	A40	A50	A70	C10 - C30	C20	E01
All engines	distr. num. 525646, version Ducellier			815 081					
All engines	distr. num. 525703, version Ducellier			815 082					
All engines	distr. num. 525703, Kit, version Ducellier			815 083					
All engines	version Ducellier				915 101				
All engines							470 107	C10	

				ENGINE
2.2	Petrol	79	04/92-07/96	J7T 762

Engine	Information	A10	A20	A40	A50	A70	C10 - C30	C20	E01
All engines	distr. num. 525646, version Ducellier			815 081					
All engines	distr. num. 525703, version Ducellier			815 082					
All engines	distr. num. 525703, Kit, version Ducellier			815 083					
All engines	version Ducellier				915 101				
All engines							470 107	C10	

				ENGINE
3.0	Petrol	125	02/93-06/96	Z7X 723

Engine	Information	A10	A20	A40	A50	A70	C10 - C30	C20	E01
All engines	version Bosch			806 236	906 119R				
All engines							470 107	C10	

				ENGINE
3.0 Biturbo 4x4	Petrol	193	02/93-07/96	Z7X 726

Engine	Information	A10	A20	A40	A50	A70	C10 - C30	C20	E01
All engines	version Bosch			806 236	906 119R				
All engines							470 107	C10	

				ENGINE
3.0 V6	Petrol	123	12/92-07/96	Z7X 721, Z7X 722, Z7X 723, Z7X 753

Engine	Information	A10	A20	A40	A50	A70	C10 - C30	C20	E01
All engines	version Bosch			806 236	906 119R				
All engines							470 107	C10	

				ENGINE
3.0 V6 4x4	Petrol	123	12/92-07/96	Z7X 721, Z7X 722, Z7X 723

Engine	Information	A10	A20	A40	A50	A70	C10 - C30	C20	E01
All engines	version Bosch			806 236	906 119R				
All engines							470 107	C10	

A10	CONDENSER	A20	CONTACT SET	A40	DISTRIBUTOR CAP	A50	ROTOR	A70	PICK-UP
C10	COIL	C20	IGNITION MODULE	C30	ELECTRONIC IGNITION KIT	E01	IGNITION CABLE SET		

Vehicle	alim.	kW	Date	Engine	FUNCTIONS ON THE VEHICLE							
					A10	A20	A40	A50	A70	C10 - C30	C20	E01

SAFRANE II

2.0 16V	Petrol	100	07/96-12/00	ENGINE N7Q 710, N7Q 711
---------	--------	-----	-------------	----------------------------

Engine	Information	A10	A20	A40	A50	A70	C10 - C30	C20	E01
All engines	Fitting Position:for cylinder 1, Fitting Position:for cylinder 4, x 1, Colour:Black, D.I.S.						470 355	C10	
All engines	Fitting Position:for cylinder 2, Fitting Position:for cylinder 3, x 1, Colour:Grey, D.I.S.						470 356	C10	
All engines									358 061

2.5 20V	Petrol	121	07/96-12/00	ENGINE N7U 700, N7U 701
---------	--------	-----	-------------	----------------------------

Engine	Information	A10	A20	A40	A50	A70	C10 - C30	C20	E01
All engines	version Bosch			806 260	906 147R				
All engines							490 423	C30	358 064

2.9 24V	Petrol	140	03/99-12/00	ENGINE L7X 713
---------	--------	-----	-------------	-------------------

Engine	Information	A10	A20	A40	A50	A70	C10 - C30	C20	E01
All engines	version Bosch			806 236	906 119R				

3.0 V6	Petrol	123	07/96-12/00	ENGINE Z7X 755
--------	--------	-----	-------------	-------------------

Engine	Information	A10	A20	A40	A50	A70	C10 - C30	C20	E01
All engines	x 1, ignition mod. IGN. MODULE(-), SIEMENS, DISTRIBUTOR, Dia: 4 mm, connector type SAE						470 107	C10	

SANDERO I

1.2 16V	Petrol	55	11/08->	ENGINE D4F 732
---------	--------	----	---------	-------------------

Engine	Information	A10	A20	A40	A50	A70	C10 - C30	C20	E01
All engines							470 518	C10	358 246

1.4	Petrol	55	02/09->	ENGINE K7J 710
-----	--------	----	---------	-------------------

Engine	Information	A10	A20	A40	A50	A70	C10 - C30	C20	E01
All engines	x 1, D.I.S.						470 596	C10	
All engines	->year 18/03/05								358 244
All engines	18/03/05 ->								358 252

1.4 LPG	Petrol/ Liquified Petroleum Gas (LPG)	53	02/09->	ENGINE K7J 714
---------	--	----	---------	-------------------

Engine	Information	A10	A20	A40	A50	A70	C10 - C30	C20	E01
All engines	x 1, D.I.S.						470 596	C10	

1.6	Petrol	62	11/10->	ENGINE K7M 710
-----	--------	----	---------	-------------------

Engine	Information	A10	A20	A40	A50	A70	C10 - C30	C20	E01
All engines	x 1, D.I.S.						470 596	C10	

1.6	Petrol	64	02/09->	ENGINE K7M 710
-----	--------	----	---------	-------------------

Engine	Information	A10	A20	A40	A50	A70	C10 - C30	C20	E01
All engines	x 1, D.I.S.						470 596	C10	
All engines	->year 18/03/05								358 244
All engines	18/03/05 ->								358 252

1.6	Petrol	66	05/09->	ENGINE K7M 710
-----	--------	----	---------	-------------------

Engine	Information	A10	A20	A40	A50	A70	C10 - C30	C20	E01
All engines							470 596	C10	
All engines	->year 18/03/05								358 244
All engines	18/03/05 ->								358 252

1.6	Petrol	75	12/07->	ENGINE K7M 710
-----	--------	----	---------	-------------------









Engine	Information	A10	A20	A40	A50	A70	C10 - C30	C20	E01
All engines	x 1, D.I.S.						470 596	C10	
All engines									358 252

A10 CONDENSER	A20 CONTACT SET	A40 DISTRIBUTOR CAP	A50 ROTOR	A70 PICK-UP
C10 COIL	C20 IGNITION MODULE	C30 ELECTRONIC IGNITION KIT	E01 IGNITION CABLE SET	

Vehicle	alim.	kW	Date	Engine	FUNCTIONS ON THE VEHICLE								
					A10	A20	A40	A50	A70	C10 - C30	C20	E01	
ENGINE													
1.6	Petrol	76	12/07-07/13	K4M 697									
Engine Information					A10	A20	A40	A50	A70	C10 - C30	C20	E01	
All engines										470 432	C10		
ENGINE													
1.6	Petrol	77	12/12->	K4M 697									
Engine Information					A10	A20	A40	A50	A70	C10 - C30	C20	E01	
All engines										470 432	C10		
SANDERO II													
ENGINE													
1.2 16V	Petrol	54	12/13->	D4F 732, D4F 734									
Engine Information					A10	A20	A40	A50	A70	C10 - C30	C20	E01	
All engines										470 518	C10		
ENGINE													
1.2 16V	Petrol	55	04/15->	D4F 732									
Engine Information					A10	A20	A40	A50	A70	C10 - C30	C20	E01	
All engines										470 518	C10		
ENGINE													
1.2 16V LPG	Petrol/ Liquified Petroleum Gas (LPG)	53	12/13->	D4F 734									
Engine Information					A10	A20	A40	A50	A70	C10 - C30	C20	E01	
All engines										470 518	C10		
ENGINE													
1.6	Petrol	59	11/13->	K7M 812									
Engine Information					A10	A20	A40	A50	A70	C10 - C30	C20	E01	
All engines										470 596	C10		
ENGINE													
1.6	Petrol	60	11/13->	K7M 812									
Engine Information					A10	A20	A40	A50	A70	C10 - C30	C20	E01	
All engines										470 596	C10		
ENGINE													
1.6	Petrol	61	11/13->	K7M 812									
Engine Information					A10	A20	A40	A50	A70	C10 - C30	C20	E01	
All engines										470 596	C10		
ENGINE													
1.6	Petrol	83	09/16->	H4M 429, H4M 438									
Engine Information					A10	A20	A40	A50	A70	C10 - C30	C20	E01	
All engines										470 613	C10		
ENGINE													
1.6 16V	Petrol	75	04/14->	K4M 842, K4M 845									
Engine Information					A10	A20	A40	A50	A70	C10 - C30	C20	E01	
All engines										470 432	C10		
ENGINE													
TCe 90	Petrol	66	09/15->	H4B 400, H4B 408, H4B 410, H4B411									
Engine Information					A10	A20	A40	A50	A70	C10 - C30	C20	E01	
All engines										470 613	C10		
SCÉNIC													
ENGINE													
1.6 VVT	Petrol	81	01/13->	K4M 858									
Engine Information					A10	A20	A40	A50	A70	C10 - C30	C20	E01	
All engines										470 432	C10		
SCÉNIC I													
ENGINE													
1.4 16V	Petrol	70	09/99-08/03	K4J 714, K4J750									
Engine Information					A10	A20	A40	A50	A70	C10 - C30	C20	E01	
All engines										470 432	C10		





A10	CONDENSER	A20	CONTACT SET	A40	DISTRIBUTOR CAP	A50	ROTOR	A70	PICK-UP
C10	COIL	C20	IGNITION MODULE	C30	ELECTRONIC IGNITION KIT	E01	IGNITION CABLE SET		

The present application list is a brief version. For the detailed information about the possibility of installation on a specific vehicle, please refer to our web-catalogue <http://catalogo.facet.eu/>

					FUNCTIONS ON THE VEHICLE							
Vehicle	alim.	kW	Date	Engine								
1.6	Petrol	75	03/01-08/03	ENGINE K4M 701, K4M 708, K4M 709, K4M700								
Engine					A10	A20	A40	A50	A70	C10 - C30	C20	E01
Information All engines					x 4, SAGEM, COIL ON PLUG					470 432	C10	
1.6	Petrol	79	09/99-09/03	ENGINE K4M 706, K4M 707, K4M 776, K4M700								
Engine					A10	A20	A40	A50	A70	C10 - C30	C20	E01
Information All engines					x 4, SAGEM, COIL ON PLUG					470 432	C10	
1.6	Petrol	81	06/01-09/03	ENGINE K4M 708								
Engine					A10	A20	A40	A50	A70	C10 - C30	C20	E01
Information All engines					Qty: 4					470 432	C10	
1.6 16V	Petrol	107	05/00-08/03	ENGINE K4M 712								
Engine					A10	A20	A40	A50	A70	C10 - C30	C20	E01
Information All engines					Qty: 4					470 432	C10	
1.6 BiFuel	Petrol/ Liquified Petroleum Gas (LPG)	75	03/01-08/03	ENGINE K4M 712								
Engine					A10	A20	A40	A50	A70	C10 - C30	C20	E01
Information All engines					x 4, SAGEM, COIL ON PLUG					470 432	C10	
1.6 BiFuel	Petrol/ Liquified Petroleum Gas (LPG)	79	09/99-04/01	ENGINE K4M 704								
Engine					A10	A20	A40	A50	A70	C10 - C30	C20	E01
Information All engines					x 4, SAGEM, COIL ON PLUG					470 432	C10	
1.8 16V	Petrol	85	01/01-08/03	ENGINE F4P 720, F4P 722								
Engine					A10	A20	A40	A50	A70	C10 - C30	C20	E01
Information All engines					x 4, SAGEM, COIL ON PLUG					470 432	C10	
1.8 4x4	Petrol	85	07/00-04/01	ENGINE F4P 722								
Engine					A10	A20	A40	A50	A70	C10 - C30	C20	E01
Information All engines					x 4, SAGEM, COIL ON PLUG					470 432	C10	
2.0	Petrol	84	09/99-08/03	ENGINE F3R 791, F3R 797, F3R 798								
Engine					A10	A20	A40	A50	A70	C10 - C30	C20	E01
Information All engines					02/04/97 ->, Qty: 2					470 196	C10	
Information All engines					->year 02/04/97, Qty: 2					470 275	C10	
Information All engines					02/04/97 ->							360 492
Information All engines					->year 02/04/97							360 501
2.0 16V	Petrol	102	07/00-08/03	ENGINE F4R 740, F4R 741, F4R 744, F4R 746, F4R 747								
Engine					A10	A20	A40	A50	A70	C10 - C30	C20	E01
Information Eng. F4R 740, F4R 741, F4R 744, F4R 747					x 4, SAGEM, COIL ON PLUG					470 432	C10	
Information Eng. F4R 746					Qty: 4					470 432	C10	
2.0 16V	Petrol	103	09/99-08/03	ENGINE F4R 740, F4R 741, F4R 744, F4R 746, F4R 747								
Engine					A10	A20	A40	A50	A70	C10 - C30	C20	E01
Information Eng. F4R 740, F4R 741, F4R 746, F4R 747					x 4, SAGEM, COIL ON PLUG					470 432	C10	
Information Eng. F4R 744					Qty: 4					470 432	C10	

A10 CONDENSER	A20 CONTACT SET	A40 DISTRIBUTOR CAP	A50 ROTOR	A70 PICK-UP
C10 COIL	C20 IGNITION MODULE	C30 ELECTRONIC IGNITION KIT	E01 IGNITION CABLE SET	

Vehicle	alim.	kW	Date	Engine	FUNCTIONS ON THE VEHICLE									
					A10	A20	A40	A50	A70	C10 - C30	C20	E01		
ENGINE														
2.0 16V RX4	Petrol	102	06/00-08/03	F4R 744, F4R 746										
Engine	Information				A10	A20	A40	A50	A70	C10 - C30	C20	E01		
Eng. F4R 744	x 4, SAGEM, COIL ON PLUG									470 432	C10			
Eng. F4R 746	Qty: 4									470 432	C10			
SCÉNIC II														
ENGINE														
1.4	Petrol	72	06/03-11/08	K4J 730, K4J 740										
Engine	Information				A10	A20	A40	A50	A70	C10 - C30	C20	E01		
All engines	x 4, SAGEM, COIL ON PLUG									470 432	C10			
ENGINE														
1.6	Petrol	77	06/06-11/08	K4M 788										
Engine	Information				A10	A20	A40	A50	A70	C10 - C30	C20	E01		
All engines	x 4, SAGEM, COIL ON PLUG									470 432	C10			
ENGINE														
1.6	Petrol	83	06/03-10/06	K4M 761, K4M 782, K4M 812, K4M 813										
Engine	Information				A10	A20	A40	A50	A70	C10 - C30	C20	E01		
All engines	x 4, SAGEM, COIL ON PLUG									470 432	C10			
ENGINE														
1.6 16V	Petrol	82	10/05-11/08	K4M 766, K4M 812, K4M 813										
Engine	Information				A10	A20	A40	A50	A70	C10 - C30	C20	E01		
Eng. K4M 766	Qty: 4									470 432	C10			
Eng. K4M 812, K4M 813	x 4, SAGEM, COIL ON PLUG									470 432	C10			
ENGINE														
1.6 16V	Petrol	83	05/03->	K4M 764										
Engine	Information				A10	A20	A40	A50	A70	C10 - C30	C20	E01		
All engines	Qty: 4									470 432	C10			
ENGINE														
1.6 BiFuel	Petrol/ Liquified Petro- leum Gas (LPG)	83	08/03-05/06	K4M 764										
Engine	Information				A10	A20	A40	A50	A70	C10 - C30	C20	E01		
All engines	x 4, SAGEM, COIL ON PLUG									470 432	C10			
ENGINE														
1.6 Hi-Flex	Petrol/ Ethanol	81	03/05-07/10	K4M 766										
Engine	Information				A10	A20	A40	A50	A70	C10 - C30	C20	E01		
All engines	x 4, SAGEM, COIL ON PLUG									470 432	C10			
ENGINE														
2.0	Petrol	101	02/08-04/09	F4R 770, F4R 771										
Engine	Information				A10	A20	A40	A50	A70	C10 - C30	C20	E01		
Eng. F4R 770	Qty: 4									470 432	C10			
Eng. F4R 771	x 4, SAGEM, COIL ON PLUG									470 432	C10			
ENGINE														
2.0	Petrol	103	06/03-07/10	F4R 770										
Engine	Information				A10	A20	A40	A50	A70	C10 - C30	C20	E01		
All engines	Qty: 4									470 432	C10			
ENGINE														
2.0	Petrol	99	06/03-06/09	F4R 770, F4R 771										
Engine	Information				A10	A20	A40	A50	A70	C10 - C30	C20	E01		
All engines	x 4, SAGEM, COIL ON PLUG									470 432	C10			
ENGINE														
2.0 16V Turbo	Petrol	120	05/04-11/08	F4R 776										
Engine	Information				A10	A20	A40	A50	A70	C10 - C30	C20	E01		
All engines	x 4, SAGEM, COIL ON PLUG									470 432	C10			
SCÉNIC III														
ENGINE														
1.2 Tce	Petrol	85	04/12->	H5F 400, H5F 408										
Engine	Information				A10	A20	A40	A50	A70	C10 - C30	C20	E01		
All engines	x 4, COIL ON PLUG									470 613	C10			
A10	CONDENSER		A20	CONTACT SET		A40	DISTRIBUTOR CAP		A50	ROTOR		A70	PICK-UP	
C10	COIL		C20	IGNITION MODULE		C30	ELECTRONIC IGNITION KIT		E01	IGNITION CABLE SET				









					FUNCTIONS ON THE VEHICLE							
Vehicle	alim.	kW	Date	Engine								
ENGINE												
1.2 TCe	Petrol	96	07/14->	HSF 408								
Engine	Information				A10	A20	A40	A50	A70	C10 - C30	C20	E01
All engines	x 4, COIL ON PLUG									470 613	C10	
ENGINE												
1.2 TCe	Petrol	97	01/13->	HSF 404, HSF 408								
Engine	Information				A10	A20	A40	A50	A70	C10 - C30	C20	E01
All engines	x 4, COIL ON PLUG									470 613	C10	
ENGINE												
1.6 16V	Petrol	81	02/09->	K4M 858								
Engine	Information				A10	A20	A40	A50	A70	C10 - C30	C20	E01
All engines	x 4, SAGEM, COIL ON PLUG									470 432	C10	
ENGINE												
1.6 16V Bifuel	Petrol/ Liquified Petro- leum Gas (LPG)	79	04/12-12/13	K4M 866								
Engine	Information				A10	A20	A40	A50	A70	C10 - C30	C20	E01
All engines	x 4, SAGEM, COIL ON PLUG									470 432	C10	
ENGINE												
1.6 16V Bifuel	Petrol/ Liquified Petro- leum Gas (LPG)	81	02/09->	K4M 866								
Engine	Information				A10	A20	A40	A50	A70	C10 - C30	C20	E01
All engines	x 4, SAGEM, COIL ON PLUG									470 432	C10	
ENGINE												
1.6 E85	Petrol/ Ethanol	81	02/09->	K4M 866								
Engine	Information				A10	A20	A40	A50	A70	C10 - C30	C20	E01
All engines	x 4, SAGEM, COIL ON PLUG									470 432	C10	
SCÉNIC IV												
ENGINE												
1.2 TCe 115	Petrol	85	09/16->	HSF 408								
Engine	Information				A10	A20	A40	A50	A70	C10 - C30	C20	E01
All engines	x 4, COIL ON PLUG									470 613	C10	
ENGINE												
1.2 TCe 130	Petrol	96	09/16->	HSF 408								
Engine	Information				A10	A20	A40	A50	A70	C10 - C30	C20	E01
All engines	x 4, COIL ON PLUG									470 613	C10	
SUPER 5												
ENGINE												
1.0	Petrol	30	10/84-10/88	C1C700								
Engine	Information				A10	A20	A40	A50	A70	C10 - C30	C20	E01
All engines	version Femsá						817 023	917 058				
All engines	version Marelli						830 101	930 047R				
All engines	-air conditioning											359 839
ENGINE												
1.1	Petrol	33	01/86-03/95	C1E 750, C1E 752, C1E 756, C1E 760								
Engine	Information				A10	A20	A40	A50	A70	C10 - C30	C20	E01
Eng. C1E 752, C1E 756, C1E 760	version Ducellier						815 054	915 091				
All engines	-air conditioning											359 839
ENGINE												
1.1	Petrol	34	10/84-12/96	C1E 750, C1E 752, C1E 754								
Engine	Information				A10	A20	A40	A50	A70	C10 - C30	C20	E01
Eng. C1E 752, C1E 754	version Ducellier						815 054	915 091				
All engines	-air conditioning											359 839

A10 CONDENSER	A20 CONTACT SET	A40 DISTRIBUTOR CAP	A50 ROTOR	A70 PICK-UP
C10 COIL	C20 IGNITION MODULE	C30 ELECTRONIC IGNITION KIT	E01 IGNITION CABLE SET	

Vehicle	alim.	kW	Date	Engine	FUNCTIONS ON THE VEHICLE									
					A10	A20	A40	A50	A70	C10 - C30	C20	E01		
1.2	Petrol	40	01/87-08/90	ENGINE C1G 702, C1G 720, C1G 722										
Engine	Information			A10	A20	A40	A50	A70	C10 - C30	C20	E01			
Eng. C1G 702	version Ducellier					815 059								
Eng. C1G 720, C1G 722	distr. num. 525352A, version Ducellier					815 091								
Eng. C1G 702	distr. num. 525352A, version Ducellier						915 088							
Eng. C1G 702	distr. num. 525352E, version Ducellier						915 094							
All engines									470 107	C10				
1.2	Petrol	44	01/87-12/96	ENGINE C1G 702										
Engine	Information			A10	A20	A40	A50	A70	C10 - C30	C20	E01			
All engines	version Ducellier					815 059								
All engines	distr. num. 525352A, version Ducellier						915 088							
All engines	distr. num. 525352E, version Ducellier						915 094							
All engines									470 107	C10				
1.4	Petrol	43	10/84-06/88	ENGINE C1J 768, C1J 780										
Engine	Information			A10	A20	A40	A50	A70	C10 - C30	C20	E01			
All engines	distr. num. 525352A, version Ducellier					815 091								
All engines									470 107	C10				
1.4	Petrol	44	09/85-08/90	ENGINE C2J 784, C3J 700										
Engine	Information			A10	A20	A40	A50	A70	C10 - C30	C20	E01			
All engines	distr. num. 525352A, version Ducellier					815 091								
All engines									470 107	C10				
1.4	Petrol	49	06/87-07/89	ENGINE C2J 782										
Engine	Information			A10	A20	A40	A50	A70	C10 - C30	C20	E01			
All engines	distr. num. 525352A, version Ducellier					815 091								
All engines									470 107	C10				
1.4	Petrol	52	10/84-07/89	ENGINE C2J 700, C2J 780, C2J 781, C2J 788, C2J 789, C2J 798										
Engine	Information			A10	A20	A40	A50	A70	C10 - C30	C20	E01			
Eng. C2J 798	version Ducellier					815 059								
Eng. C2J 700, C2J 780, C2J 781, C2J 788, C2J 789	distr. num. 525352A, version Ducellier					815 091								
Eng. C2J 798	distr. num. 525352A, version Ducellier						915 088							
Eng. C2J 798	distr. num. 525352E, version Ducellier						915 094							
All engines									470 107	C10				
1.4	Petrol	85	04/85-10/87	ENGINE C1J 788										
Engine	Information			A10	A20	A40	A50	A70	C10 - C30	C20	E01			
All engines	distr. num. 525352A, version Ducellier					815 091								
All engines									470 107	C10				
1.4 Cat	Petrol	43	10/85-12/96	ENGINE C3J 700, C3J 702, C3J 760										
Engine	Information			A10	A20	A40	A50	A70	C10 - C30	C20	E01			
All engines	distr. num. 525352A, version Ducellier					815 091								
All engines									470 107	C10				
1.4 Turbo	Petrol	85	08/85-06/89	ENGINE C1J 788										
Engine	Information			A10	A20	A40	A50	A70	C10 - C30	C20	E01			
All engines	distr. num. 525352A, version Ducellier					815 091								
All engines									470 107	C10				
1.4 Turbo	Petrol	88	04/85-08/90	ENGINE C1J 782, C1J 784, C1J 788										
Engine	Information			A10	A20	A40	A50	A70	C10 - C30	C20	E01			
Eng. C1J 784	version Ducellier					815 059								
Eng. C1J 782, C1J 788	distr. num. 525352A, version Ducellier					815 091								

A10	CONDENSER	A20	CONTACT SET	A40	DISTRIBUTOR CAP	A50	ROTOR	A70	PICK-UP
C10	COIL	C20	IGNITION MODULE	C30	ELECTRONIC IGNITION KIT	E01	IGNITION CABLE SET		

The present application list is a brief version. For the detailed information about the possibility of installation on a specific vehicle, please refer to our web-catalogue <http://catalogo.facet.eu/>

					FUNCTIONS ON THE VEHICLE							
Vehicle	alim.	kW	Date	Engine								

				ENGINE
1.4 Turbo	Petrol	88	04/85-08/90	C1J 782, C1J 784, C1J 788

Engine	Information	A10	A20	A40	A50	A70	C10 - C30	C20	E01
Eng. C1J 784	distr. num. 525352A, version Ducellier				915 088				
Eng. C1J 784	distr. num. 525352E, version Ducellier				915 094				
All engines							470 107	C10	

				ENGINE
1.7	Petrol	54	10/86-03/95	F3N 716, F3N 717

Engine	Information	A10	A20	A40	A50	A70	C10 - C30	C20	E01
All engines	version Ducellier			815 069	915 097				
All engines	Kit, version Ducellier			815 072					
All engines							470 107	C10	

				ENGINE
1.7	Petrol	64	06/87-03/95	F2N 740, F2N 742

Engine	Information	A10	A20	A40	A50	A70	C10 - C30	C20	E01
All engines	version Ducellier			815 069	915 097				
All engines	Kit, version Ducellier			815 072					
All engines							470 107	C10	

				ENGINE
1.7	Petrol	66	09/88-09/90	F2N 740

Engine	Information	A10	A20	A40	A50	A70	C10 - C30	C20	E01
All engines	version Ducellier			815 069	915 097				
All engines	Kit, version Ducellier			815 072					
All engines							470 107	C10	

				ENGINE
1.7 i	Petrol	69	10/86-08/91	F3N 702

Engine	Information	A10	A20	A40	A50	A70	C10 - C30	C20	E01
All engines	version Ducellier			815 069	915 097				
All engines	Kit, version Ducellier			815 072					
All engines							470 107	C10	

TALISMAN

				ENGINE
1.6 TCe 150	Petrol	110	11/15->	M5M 450

Engine	Information	A10	A20	A40	A50	A70	C10 - C30	C20	E01
All engines	x 4, COIL ON PLUG						470 551	C10	

				ENGINE
1.6 TCe 200	Petrol	147	11/15->	M5M 450

Engine	Information	A10	A20	A40	A50	A70	C10 - C30	C20	E01
All engines	x 4, COIL ON PLUG						470 551	C10	

				ENGINE
1.8 TCe 225	Petrol	165	09/18->	M5P 403

Engine	Information	A10	A20	A40	A50	A70	C10 - C30	C20	E01
All engines	x 4, COIL ON PLUG						470 551	C10	

THALIA I

				ENGINE
1.2i 16V	Petrol	55	04/04->	D4F 728

Engine	Information	A10	A20	A40	A50	A70	C10 - C30	C20	E01
All engines							470 518	C10	358 246

				ENGINE
1.4	Petrol	55	08/00->	K7J 700

Engine	Information	A10	A20	A40	A50	A70	C10 - C30	C20	E01
All engines									358 252

				ENGINE
1.4	Petrol	72	05/00-02/09	K7J 700, K7J718

Engine	Information	A10	A20	A40	A50	A70	C10 - C30	C20	E01
Eng. K7J718	x 1, D.I.S.						470 596	C10	
Eng. K7J 700									358 252

				ENGINE
1.4 16V	Petrol	72	08/00->	K4J 713

Engine	Information	A10	A20	A40	A50	A70	C10 - C30	C20	E01
All engines	Qty: 4						470 432	C10	

A10 CONDENSER	A20 CONTACT SET	A40 DISTRIBUTOR CAP	A50 ROTOR	A70 PICK-UP
C10 COIL	C20 IGNITION MODULE	C30 ELECTRONIC IGNITION KIT	E01 IGNITION CABLE SET	

Vehicle	alim.	kW	Date	Engine	FUNCTIONS ON THE VEHICLE									
					A10	A20	A40	A50	A70	C10 - C30	C20	E01		
ENGINE														
1.6	Petrol	79	01/01->	K4M 745										
ENGINE														
Engine Information					A10	A20	A40	A50	A70	C10 - C30	C20	E01		
All engines Qty: 4										470 432	C10			
THALIA II														
ENGINE														
1.2 16V	Petrol	55	09/08-06/14	D4F 728, D4F736										
ENGINE														
Engine Information					A10	A20	A40	A50	A70	C10 - C30	C20	E01		
All engines x 1, D.I.S.										470 518	C10			
ENGINE														
1.4	Petrol	55	09/08-06/14	K7J 700										
ENGINE														
Engine Information					A10	A20	A40	A50	A70	C10 - C30	C20	E01		
All engines x 1, D.I.S.										470 596	C10			
All engines													358 252	
ENGINE														
1.4	Petrol	72	01/09-12/11	K4J 712, K4J 713										
ENGINE														
Engine Information					A10	A20	A40	A50	A70	C10 - C30	C20	E01		
All engines x 4, SAGEM, COIL ON PLUG										470 432	C10			
ENGINE														
1.6 16V	Petrol	77	09/08->	K4M 670, K4M 674, K4M 744										
ENGINE														
Engine Information					A10	A20	A40	A50	A70	C10 - C30	C20	E01		
Eng. K4M 670, K4M 674 x 4, SAGEM, COIL ON PLUG										470 432	C10			
Eng. K4M 744 Qty: 4										470 432	C10			
TRAFIC I														
ENGINE														
1.4	Petrol	35	03/80-06/91	C1J 700										
ENGINE														
Engine Information					A10	A20	A40	A50	A70	C10 - C30	C20	E01		
All engines version Ducellier							815 054							
All engines ->year 30/09/90, version Ducellier								915 091						
All engines 01/10/90 ->, version Ducellier								915 094						
ENGINE														
1.7	Petrol	50	05/89-08/94	F1N 720, F1N 722, F1N 724										
ENGINE														
Engine Information					A10	A20	A40	A50	A70	C10 - C30	C20	E01		
All engines version Ducellier							815 069	915 097						
All engines Kit, version Ducellier							815 072							
All engines										470 107	C10			
ENGINE														
2.0	Petrol	59	05/89-08/90	J5R 716, J5R 726										
ENGINE														
Engine Information					A10	A20	A40	A50	A70	C10 - C30	C20	E01		
Eng. J5R 716 version Ducellier							815 079	915 094						
Eng. J5R 726 version Ducellier							815 081	915 101						
All engines										470 107	C10			
ENGINE														
2.0 RWD	Petrol	59	05/89-10/97	J5R 726										
ENGINE														
Engine Information					A10	A20	A40	A50	A70	C10 - C30	C20	E01		
All engines version Ducellier							815 081	915 101						
All engines										470 107	C10			
ENGINE														
2.2	Petrol	70	05/89-06/94	J7T 780										
ENGINE														
Engine Information					A10	A20	A40	A50	A70	C10 - C30	C20	E01		
All engines							815 065			470 107	C10		359 539	
All engines version Ducellier							815 066	915 094						
ENGINE														
2.2	Petrol	74	06/94-04/98	J7T 600										
ENGINE														
Engine Information					A10	A20	A40	A50	A70	C10 - C30	C20	E01		
All engines							815 065			470 107	C10		359 539	
All engines version Ducellier							815 066	915 094						

A10 CONDENSER	A20 CONTACT SET	A40 DISTRIBUTOR CAP	A50 ROTOR	A70 PICK-UP
C10 COIL	C20 IGNITION MODULE	C30 ELECTRONIC IGNITION KIT	E01 IGNITION CABLE SET	

The present application list is a brief version. For the detailed information about the possibility of installation on a specific vehicle, please refer to our web-catalogue <http://catalogo.facet.eu/>

Vehicle	alim.	kW	Date	Engine	FUNCTIONS ON THE VEHICLE							
					A10	A20	A40	A50	A70	C10 - C30	C20	E01

2.2 4x4	Petrol	70	05/89-06/94	ENGINE J7T 780
----------------	--------	-----------	-------------	---------------------------------

Engine	Information	A10	A20	A40	A50	A70	C10 - C30	C20	E01
All engines				815 065			470 107	C10	359 539
All engines	version Ducellier			815 066	915 094				

2.2 4x4	Petrol	74	06/94-04/98	ENGINE J7T 600
----------------	--------	-----------	-------------	---------------------------------

Engine	Information	A10	A20	A40	A50	A70	C10 - C30	C20	E01
All engines				815 065			470 107	C10	359 539
All engines	version Ducellier			815 066	915 094				

TRAFIC II

2.0	Petrol	88	03/01->	ENGINE F4R 720, F4R 722
------------	--------	-----------	---------	--

Engine	Information	A10	A20	A40	A50	A70	C10 - C30	C20	E01
Eng. F4R 720	x 4, SAGEM, COIL ON PLUG						470 432	C10	
Eng. F4R 722	Qty: 4						470 432	C10	

2.0 16V	Petrol	86	08/06->	ENGINE F4R 820
----------------	--------	-----------	---------	---------------------------------

Engine	Information	A10	A20	A40	A50	A70	C10 - C30	C20	E01
All engines	x 4, SAGEM, COIL ON PLUG						470 432	C10	

TWINGO I

1.0 16V	Petrol	51	01/01->	ENGINE D4D 712
----------------	--------	-----------	---------	---------------------------------

Engine	Information	A10	A20	A40	A50	A70	C10 - C30	C20	E01
All engines							470 419	C10	

1.2	Petrol	40	03/93-03/07	ENGINE C3G 700, C3G 702, D7F 700, D7F 701
------------	--------	-----------	-------------	--

Engine	Information	A10	A20	A40	A50	A70	C10 - C30	C20	E01
Eng. C3G 700, C3G 702	version Ducellier			815 059	915 088				
Eng. C3G 700, C3G 702							470 228	C10	360 332
Eng. D7F 700, D7F 701	->year 21/10/98						470 365	C10	
Eng. D7F 700, D7F 701	21/10/98 ->						470 596	C10	
Eng. D7F 700, D7F 701	->year 08/10/99								360 447
Eng. D7F 700, D7F 701	08/10/99 ->								360 681

1.2	Petrol	43	05/96-06/07	ENGINE D7F 700, D7F 701, D7F 702, D7F 703, D7F 704, D7F 706
------------	--------	-----------	-------------	--

Engine	Information	A10	A20	A40	A50	A70	C10 - C30	C20	E01
All engines	->year 21/10/98						470 365	C10	
All engines	21/10/98 ->						470 596	C10	
All engines	->year 08/10/99								360 447
All engines	08/10/99 ->								360 681

1.2	Petrol	44	09/98-08/00	ENGINE D7F 702, D7F 703, D7F 704
------------	--------	-----------	-------------	---

Engine	Information	A10	A20	A40	A50	A70	C10 - C30	C20	E01
All engines	->year 21/10/98						470 365	C10	
All engines	21/10/98 ->						470 596	C10	
All engines	->year 08/10/99								360 447
All engines	08/10/99 ->								360 681

1.2 16V	Petrol	44	08/04-06/07	ENGINE D4F 708
----------------	--------	-----------	-------------	---------------------------------

Engine	Information	A10	A20	A40	A50	A70	C10 - C30	C20	E01
All engines							470 518	C10	358 246

1.2 16V	Petrol	55	01/01-06/07	ENGINE D4F 702
----------------	--------	-----------	-------------	---------------------------------

Engine	Information	A10	A20	A40	A50	A70	C10 - C30	C20	E01
All engines							470 419	C10	

A10 CONDENSER	A20 CONTACT SET	A40 DISTRIBUTOR CAP	A50 ROTOR	A70 PICK-UP
C10 COIL	C20 IGNITION MODULE	C30 ELECTRONIC IGNITION KIT	E01 IGNITION CABLE SET	

Vehicle	alim.	kW	Date	Engine	FUNCTIONS ON THE VEHICLE									
					A10	A20	A40	A50	A70	C10 - C30	C20	E01		
TWINGO II														
1.2	Petrol	43	03/07-09/14	ENGINE D7F 800										
Engine	Information				A10	A20	A40	A50	A70	C10 - C30	C20	E01		
All engines	x 1, D.I.S.									470 596	C10			
All engines													358 230	
1.2	Petrol	55	09/10-09/14	ENGINE D4F 770										
Engine	Information				A10	A20	A40	A50	A70	C10 - C30	C20	E01		
All engines	x 1, D.I.S.									470 518	C10			
1.2 16V	Petrol	55	03/07->	ENGINE D4F 764, D4F 770, D4F 772										
Engine	Information				A10	A20	A40	A50	A70	C10 - C30	C20	E01		
Eng. D4F 764										470 518	C10			
Eng. D4F 770, D4F 772	x 1, D.I.S.									470 518	C10			
All engines													358 246	
1.2 16V	Petrol	56	03/07->	ENGINE D4F 772										
Engine	Information				A10	A20	A40	A50	A70	C10 - C30	C20	E01		
All engines	x 1, D.I.S.									470 518	C10			
All engines													358 246	
1.2 TCe 100	Petrol	75	02/11->	ENGINE D4F 780, D4F 782										
Engine	Information				A10	A20	A40	A50	A70	C10 - C30	C20	E01		
Eng. D4F 780	x 1, D.I.S.									470 596	C10			
Eng. D4F 782										470 596	C10			
All engines													358 229	
1.2 Turbo	Petrol	74	03/07-09/14	ENGINE D4F 780, D4F 782										
Engine	Information				A10	A20	A40	A50	A70	C10 - C30	C20	E01		
All engines	x 1, D.I.S.									470 596	C10			
All engines													358 229	
1.6 RS	Petrol	98	05/08-09/14	ENGINE K4M 854										
Engine	Information				A10	A20	A40	A50	A70	C10 - C30	C20	E01		
All engines	x 4, SAGEM, COIL ON PLUG									470 432	C10			
TWINGO III														
0.9 TCe 110	Petrol	80	11/16->	ENGINE H4B 401										
Engine	Information				A10	A20	A40	A50	A70	C10 - C30	C20	E01		
All engines	x 3, COIL ON PLUG									470 613	C10			
0.9 TCe 90	Petrol	66	09/14->	ENGINE H4B 401										
Engine	Information				A10	A20	A40	A50	A70	C10 - C30	C20	E01		
All engines	x 3, COIL ON PLUG									470 613	C10			
0.9 TCe 90 LPG	Petrol/ Liquified Petro- leum Gas (LPG)	66	08/18->	ENGINE H4B 451										
Engine	Information				A10	A20	A40	A50	A70	C10 - C30	C20	E01		
All engines	x 3, COIL ON PLUG									470 613	C10			
0.9 TCe 95	Petrol	68	03/19->	ENGINE H4B 453										
Engine	Information				A10	A20	A40	A50	A70	C10 - C30	C20	E01		
All engines	x 3, COIL ON PLUG									470 552	C10			
1.0 SSc 70	Petrol	51	09/15->	ENGINE H4D 400										
Engine	Information				A10	A20	A40	A50	A70	C10 - C30	C20	E01		
All engines	x 3, COIL ON PLUG									470 613	C10			

A10 CONDENSER	A20 CONTACT SET	A40 DISTRIBUTOR CAP	A50 ROTOR	A70 PICK-UP
C10 COIL	C20 IGNITION MODULE	C30 ELECTRONIC IGNITION KIT	E01 IGNITION CABLE SET	

The present application list is a brief version. For the detailed information about the possibility of installation on a specific vehicle, please refer to our web-catalogue <http://catalogo.facet.eu/>

Vehicle	alim.	kW	Date	Engine	FUNCTIONS ON THE VEHICLE							
					A10	A20	A40	A50	A70	C10 - C30	C20	E01
1.0 SCe 70												
Petrol 52 09/14->												
ENGINE												
H4D 400												
Engine												
All engines					x 3, COIL ON PLUG							
					A10	A20	A40	A50	A70	C10 - C30	C20	E01
										470 613	C10	
VEL SATIS												
2.0 16 V Turbo												
Petrol 125 04/04->												
ENGINE												
F4R 766, F4R 767												
Engine												
All engines					x 4, SAGEM, COIL ON PLUG							
					A10	A20	A40	A50	A70	C10 - C30	C20	E01
										470 432	C10	
2.0 16V Turbo												
Petrol 120 06/02-08/09												
ENGINE												
F4R 762, F4R 763												
Engine												
All engines					x 4, SAGEM, COIL ON PLUG							
					A10	A20	A40	A50	A70	C10 - C30	C20	E01
										470 432	C10	
2.0 Turbo												
Petrol 108 04/05->												
ENGINE												
F4R 767, F4R 867												
Engine												
All engines					x 4, SAGEM, COIL ON PLUG							
					A10	A20	A40	A50	A70	C10 - C30	C20	E01
										470 432	C10	
WIND												
1.2												
Petrol 74 07/10->												
ENGINE												
D4F 782												
Engine												
All engines					x 1, D.I.S.							
					A10	A20	A40	A50	A70	C10 - C30	C20	E01
										470 596	C10	
												358 229
1.2 TCe 100												
Petrol 75 02/11->												
ENGINE												
D4F 782												
Engine												
All engines					->year 01/11/11, x 1, D.I.S. 01/12/11->, x 1, D.I.S.							
					A10	A20	A40	A50	A70	C10 - C30	C20	E01
										470 596	C10	
1.6												
Petrol 98 07/10->												
ENGINE												
K4M 854												
Engine												
All engines					x 4, SAGEM, COIL ON PLUG							
					A10	A20	A40	A50	A70	C10 - C30	C20	E01
										470 432	C10	

A10 CONDENSER	A20 CONTACT SET	A40 DISTRIBUTOR CAP	A50 ROTOR	A70 PICK-UP
C10 COIL	C20 IGNITION MODULE	C30 ELECTRONIC IGNITION KIT	E01 IGNITION CABLE SET	

Vehicle	alim.	kW	Date	Engine	FUNCTIONS ON THE VEHICLE							
					A10	A20	A40	A50	A70	C10 - C30	C20	E01

4/72

				ENGINE
1.7	Petrol	51	03/61-10/68	--

Engine	Information	A10	A20	A40	A50	A70	C10 - C30	C20	E01
All engines				828 075	928 006				

ELF

				ENGINE
1.0	Petrol	28	03/63-10/68	--

Engine	Information	A10	A20	A40	A50	A70	C10 - C30	C20	E01
All engines				828 075	928 006				

KESTREL

				ENGINE
1100	Petrol	40	03/65-04/67	--, 10 H









Engine	Information	A10	A20	A40	A50	A70	C10 - C30	C20	E01
All engines					928 006				

				ENGINE
1300	Petrol	52	03/67-12/69	12 H

Engine	Information	A10	A20	A40	A50	A70	C10 - C30	C20	E01
All engines				828 075	928 006				

A10	CONDENSER	A20	CONTACT SET	A40	DISTRIBUTOR CAP	A50	ROTOR	A70	PICK-UP
C10	COIL	C20	IGNITION MODULE	C30	ELECTRONIC IGNITION KIT	E01	IGNITION CABLE SET		

The present application list is a brief version. For the detailed information about the possibility of installation on a specific vehicle, please refer to our web-catalogue <http://catalogo.facet.eu/>







					FUNCTIONS ON THE VEHICLE								
Vehicle	alim.	kW	Date	Engine	 A10	 A20	 A40	 A50	 A70	 C10 - C30	 C20	 E01	
CULLINAN													
V12	Petrol	420	08/18->	ENGINE N74 B68 A									
Engine	Information				A10	A20	A40	A50	A70	C10 - C30	C20	E01	
All engines	x 12, DELPHI, COIL ON PLUG									470 475	C10		
V12	Petrol	441	08/19->	ENGINE N74 B68 A									
Engine	Information				A10	A20	A40	A50	A70	C10 - C30	C20	E01	
All engines	x 12, DELPHI, COIL ON PLUG									470 475	C10		
DAWN													
V12	Petrol	420	02/16->	ENGINE N74 B66 A									
Engine	Information				A10	A20	A40	A50	A70	C10 - C30	C20	E01	
All engines	x 12, DELPHI, COIL ON PLUG									470 475	C10		
V12	Petrol	442	07/17->	ENGINE N74 B66 A									
Engine	Information				A10	A20	A40	A50	A70	C10 - C30	C20	E01	
All engines	x 12, DELPHI, COIL ON PLUG									470 475	C10		
GHOST													
V12	Petrol	420	12/09->	ENGINE N74 B66 A, N74 B68 A									
Engine	Information				A10	A20	A40	A50	A70	C10 - C30	C20	E01	
All engines	x 12, DELPHI, COIL ON PLUG									470 475	C10		
V12	Petrol	450	03/16-03/20	ENGINE N74 B66 A									
Engine	Information				A10	A20	A40	A50	A70	C10 - C30	C20	E01	
All engines	x 12, DELPHI, COIL ON PLUG									470 475	C10		
V-Specification	Petrol	442	01/14-06/14	ENGINE N74 B66 A									
Engine	Information				A10	A20	A40	A50	A70	C10 - C30	C20	E01	
All engines	x 12, DELPHI, COIL ON PLUG									470 475	C10		
PHANTOM													
6.75 V12	Petrol	338	06/07-07/17	ENGINE N73 B68 A									
Engine	Information				A10	A20	A40	A50	A70	C10 - C30	C20	E01	
All engines	x 12, COIL ON PLUG, DELPHI, ELDOR, COIL ON PLUG									470 475	C10		
V12	Petrol	338	01/03-07/17	ENGINE N73 B68 A									
Engine	Information				A10	A20	A40	A50	A70	C10 - C30	C20	E01	
All engines	x 12, COIL ON PLUG, DELPHI, ELDOR, COIL ON PLUG									470 475	C10		
V12, V12 EWB	Petrol	420	09/17->	ENGINE N74 B68 A									
Engine	Information				A10	A20	A40	A50	A70	C10 - C30	C20	E01	
All engines	x 12, DELPHI, COIL ON PLUG									470 475	C10		
WRAITH													
V12	Petrol	441	07/19->	ENGINE N74 B66 A									
Engine	Information				A10	A20	A40	A50	A70	C10 - C30	C20	E01	
All engines	x 12, DELPHI, COIL ON PLUG									470 475	C10		
V12	Petrol	465	08/13->	ENGINE N74 B66 A									
Engine	Information				A10	A20	A40	A50	A70	C10 - C30	C20	E01	
All engines	x 12, DELPHI, COIL ON PLUG									470 475	C10		

A10 CONDENSER	A20 CONTACT SET	A40 DISTRIBUTOR CAP	A50 ROTOR	A70 PICK-UP
C10 COIL	C20 IGNITION MODULE	C30 ELECTRONIC IGNITION KIT	E01 IGNITION CABLE SET	

Vehicle	alim.	kW	Date	Engine	FUNCTIONS ON THE VEHICLE							
					A10	A20	A40	A50	A70	C10 - C30	C20	E01
100												
111	Petrol	44	04/94-10/97	11 K2D								
Engine	Information			A10	A20	A40	A50	A70	C10 - C30	C20	E01	
All engines	version Lucas					828 093	928 029R					
114												
114	Petrol	55	04/94-10/97	14 K2A, 14 K2D								
Engine	Information			A10	A20	A40	A50	A70	C10 - C30	C20	E01	
Eng. 14 K2D	version Lucas					828 093	928 029R					
Eng. 14 K2A	version Lucas					828 094	928 025					
100 / METRO												
111 C/L/S	Petrol	44	03/90-12/98	11 K2A, 11 K2D								
Engine	Information			A10	A20	A40	A50	A70	C10 - C30	C20	E01	
Eng. 11 K2D	version Lucas					828 093	928 029R					
Eng. 11 K2A	version Lucas					828 094	928 025					
114 GSi												
114 GSi	Petrol	76	10/94-10/95	14 K4F								
Engine	Information			A10	A20	A40	A50	A70	C10 - C30	C20	E01	
All engines	version Lucas					828 093	928 029R					
114 GTI 16V												
114 GTI 16V	Petrol	69	03/90-08/91	14 K4C, 14 K4D								
Engine	Information			A10	A20	A40	A50	A70	C10 - C30	C20	E01	
All engines	version Lucas					828 093	928 029R					
114 GTI 16V												
114 GTI 16V	Petrol	76	08/91-12/98	14 K4F								
Engine	Information			A10	A20	A40	A50	A70	C10 - C30	C20	E01	
All engines	version Lucas					828 093	928 029R					
114 GTI/GT 16V Cat												
114 GTI/GT 16V Cat	Petrol	66	03/90-12/98	14 K4C, 14 K4D								
Engine	Information			A10	A20	A40	A50	A70	C10 - C30	C20	E01	
All engines	version Lucas					828 093	928 029R					
114 S/L/GTA												
114 S/L/GTA	Petrol	55	03/90-12/98	14 K2A, 14 K2D								
Engine	Information			A10	A20	A40	A50	A70	C10 - C30	C20	E01	
Eng. 14 K2D	version Lucas					828 093	928 029R					
Eng. 14 K2A	version Lucas					828 094	928 025					
200 I												
213 S	Petrol	54	09/85-09/89	EV 2								
Engine	Information			A10	A20	A40	A50	A70	C10 - C30	C20	E01	
All engines	version Mitsubishi					822 022	922 056					
200 II												
214	Petrol	55	09/93-12/95	14 K2A, 14 K2D								
Engine	Information			A10	A20	A40	A50	A70	C10 - C30	C20	E01	
All engines	version Lucas					828 093						
All engines							928 029R					
214 1.4												
214 1.4	Petrol	66	01/92-11/99	14 K4C, 14 K4D								
Engine	Information			A10	A20	A40	A50	A70	C10 - C30	C20	E01	
All engines	version Lucas					828 093	928 029R					
214 1.4i 16V												
214 1.4i 16V	Petrol	76	01/93-11/99	14 K4F								
Engine	Information			A10	A20	A40	A50	A70	C10 - C30	C20	E01	
All engines	version Lucas					828 093	928 029R					
214 GSi/Si												
214 GSi/Si	Petrol	70	01/90-10/95	14 K4C								
Engine	Information			A10	A20	A40	A50	A70	C10 - C30	C20	E01	
All engines	version Lucas					828 093	928 029R					
All engines	01/01/95 ->								470 374	C10		

A10 CONDENSER	A20 CONTACT SET	A40 DISTRIBUTOR CAP	A50 ROTOR	A70 PICK-UP
C10 COIL	C20 IGNITION MODULE	C30 ELECTRONIC IGNITION KIT	E01 IGNITION CABLE SET	

The present application list is a brief version. For the detailed information about the possibility of installation on a specific vehicle, please refer to our web-catalogue <http://catalogo.facet.eu/>

				FUNCTIONS ON THE VEHICLE								
Vehicle	alim.	kW	Date	Engine								
				ENGINE								
214 GSi/Si	Petrol	76	12/92-10/95	14 K4F								
				ENGINE								
Engine	Information				A10	A20	A40	A50	A70	C10 - C30	C20	E01
All engines	version Lucas						828 093	928 029R				
214 Si/Gsi	Petrol	66	10/89-10/95	14 K4C, 14 K4D								
				ENGINE								
Engine	Information				A10	A20	A40	A50	A70	C10 - C30	C20	E01
All engines	version Lucas						828 093	928 029R				
216	Petrol	82	01/96-12/97	16 K4F								
				ENGINE								
Engine	Information				A10	A20	A40	A50	A70	C10 - C30	C20	E01
All engines	version Lucas						828 093					
All engines							928 029R					360 888
216	Petrol	90	10/92-06/99	D 16 A8								
				ENGINE								
Engine	Information				A10	A20	A40	A50	A70	C10 - C30	C20	E01
All engines										470 213	C10	465 052
216 1.6i	Petrol	90	01/92-11/99	D 16 A8								
				ENGINE								
Engine	Information				A10	A20	A40	A50	A70	C10 - C30	C20	E01
All engines										470 213	C10	465 052
216 1.6i 16V	Petrol	82	01/96-11/99	16 K4F								
				ENGINE								
Engine	Information				A10	A20	A40	A50	A70	C10 - C30	C20	E01
All engines	version Lucas						828 093					
All engines							928 029R					360 888
All engines	x 1, DISTRIBUTOR								470 374	C10		
216 GSi	Petrol	82	01/90-12/95	1GH5E-180								
				ENGINE								
Engine	Information				A10	A20	A40	A50	A70	C10 - C30	C20	E01
All engines	->eng. E100000, version Hitachi						822 069					
All engines	eng. type E100001 ->, version Hitachi						922 082					
All engines									470 213	C10	465 052	
216 GSi	Petrol	85	10/89-10/95	D 16 A7								
				ENGINE								
Engine	Information				A10	A20	A40	A50	A70	C10 - C30	C20	E01
All engines	->eng. E100000, version Hitachi						822 069					
All engines	eng. type E100001 ->, version Hitachi						922 082					
All engines									470 213	C10		
216 GTi	Petrol	90	01/90-10/95	D 16 A8								
				ENGINE								
Engine	Information				A10	A20	A40	A50	A70	C10 - C30	C20	E01
All engines	->eng. E100000, version Hitachi						822 069	922 082				
All engines									470 213	C10	465 052	
216 GTi	Petrol	96	09/90-10/95	D 16 A9								
				ENGINE								
Engine	Information				A10	A20	A40	A50	A70	C10 - C30	C20	E01
All engines	->eng. E100000, version Hitachi						822 069	922 082				
All engines									470 213	C10		
220 GSi	Petrol	100	05/94-06/99	1CA4GA15-01								
				ENGINE								
Engine	Information				A10	A20	A40	A50	A70	C10 - C30	C20	E01
All engines	version Lucas						828 093					
All engines							928 029R					
220 GTi	Petrol	100	01/93-10/95	1CA4GA15-01								
				ENGINE								
Engine	Information				A10	A20	A40	A50	A70	C10 - C30	C20	E01
All engines	version Lucas						828 093					
All engines							928 029R					

A10 CONDENSER	A20 CONTACT SET	A40 DISTRIBUTOR CAP	A50 ROTOR	A70 PICK-UP
C10 COIL	C20 IGNITION MODULE	C30 ELECTRONIC IGNITION KIT	E01 IGNITION CABLE SET	

Vehicle	alim.	kW	Date	Engine	FUNCTIONS ON THE VEHICLE								
					A10	A20	A40	A50	A70	C10 - C30	C20	E01	
220 GTi					ENGINE								
Petrol	103	09/91-10/95	20 M4F										
Engine	Information				A10	A20	A40	A50	A70	C10 - C30	C20	E01	
All engines	version Lucas						828 093						
All engines	->year 31/01/92, version Lucas							928 024R					
All engines	01/02/92 ->, version Lucas							928 029R					
220 Turbo					ENGINE								
Petrol	147	10/92-06/99	20 T4G										
Engine	Information				A10	A20	A40	A50	A70	C10 - C30	C20	E01	
All engines	version Lucas						828 093						
All engines								928 029R					
200 III					ENGINE								
1.4	Petrol	66	01/96-12/97	14 K4D									
Engine	Information				A10	A20	A40	A50	A70	C10 - C30	C20	E01	
All engines	x 1, DISTRIBUTOR									470 374	C10		
211					ENGINE								
Petrol	44	01/98-03/00	11 K2D										
Engine	Information				A10	A20	A40	A50	A70	C10 - C30	C20	E01	
All engines	version Lucas						828 093	928 029R					
All engines	x 1, DISTRIBUTOR									470 374	C10		
All engines												360 914	
214 i					ENGINE								
Petrol	55	11/95-03/00	14 K2F										
Engine	Information				A10	A20	A40	A50	A70	C10 - C30	C20	E01	
All engines	version Lucas						828 093	928 029R					
All engines	x 1, DISTRIBUTOR									470 374	C10		
All engines												360 914	
214 Si					ENGINE								
Petrol	76	11/95-03/00	14 K4F										
Engine	Information				A10	A20	A40	A50	A70	C10 - C30	C20	E01	
All engines	->ch. YD471564, version Lucas						828 093	928 029R					
All engines	x 1, DISTRIBUTOR									470 374	C10		
All engines	->ch. YD471564											360 888	
All engines	ch. YD471565 ->											360 889	
216 Si					ENGINE								
Petrol	82	11/95-06/99	16 K4F										
Engine	Information				A10	A20	A40	A50	A70	C10 - C30	C20	E01	
All engines	->ch. YD471564, version Lucas						828 093	928 029R					
All engines	->ch. 471564, x 1, DISTRIBUTOR									470 374	C10		
All engines	->ch. YD471564											360 888	
All engines	ch. YD471565 ->											360 889	
2000-3500					ENGINE								
2000	Petrol	74	10/82-10/86	--									
Engine	Information				A10	A20	A40	A50	A70	C10 - C30	C20	E01	
All engines	version Lucas						828 094	928 026R					
2200					ENGINE								
Petrol	83	10/73-05/76	--										
Engine	Information				A10	A20	A40	A50	A70	C10 - C30	C20	E01	
All engines						728 083MHV	828 075						
25					ENGINE								
1.1	Petrol	44	11/99-05/05	11K2F									
Engine	Information				A10	A20	A40	A50	A70	C10 - C30	C20	E01	
All engines	x 1, DISTRIBUTOR									470 374	C10		
1.1					ENGINE								
Petrol	55	09/99-06/01	11 K4F										
Engine	Information				A10	A20	A40	A50	A70	C10 - C30	C20	E01	
All engines	x 1, DISTRIBUTOR									470 374	C10		









A10 CONDENSER	A20 CONTACT SET	A40 DISTRIBUTOR CAP	A50 ROTOR	A70 PICK-UP
C10 COIL	C20 IGNITION MODULE	C30 ELECTRONIC IGNITION KIT	E01 IGNITION CABLE SET	

The present application list is a brief version. For the detailed information about the possibility of installation on a specific vehicle, please refer to our web-catalogue <http://catalogo.facet.eu/>

				FUNCTIONS ON THE VEHICLE								
Vehicle	alim.	kW	Date	Engine								
				ENGINE								
1.1 16V	Petrol	55	01/04-05/05	11 K4F								
				ENGINE								
Engine		Information			A10	A20	A40	A50	A70	C10 - C30	C20	E01
All engines		x 1, DISTRIBUTOR								470 374	C10	
1.4	Petrol	62	01/03-12/05	14 K4M								
				ENGINE								
Engine		Information			A10	A20	A40	A50	A70	C10 - C30	C20	E01
All engines		->ch. 471564, x 1, DISTRIBUTOR								470 374	C10	
1.4 16V	Petrol	62	10/99-05/05	14 K4M								
				ENGINE								
Engine		Information			A10	A20	A40	A50	A70	C10 - C30	C20	E01
All engines		->ch. YD471564, version Lucas					828 093	928 029R				
All engines		->ch. 471564, x 1, DISTRIBUTOR								470 374	C10	
All engines		->ch. YD471564										360 888
All engines		ch. YD471565 ->										360 889
1.4 16V	Petrol	76	10/99-05/05	14 K4F								
				ENGINE								
Engine		Information			A10	A20	A40	A50	A70	C10 - C30	C20	E01
All engines		->ch. YD471564, version Lucas					828 093	928 029R				
All engines		->ch. 471564, x 1, DISTRIBUTOR								470 374	C10	
All engines		->ch. YD471564										360 888
All engines		ch. YD471565 ->										360 889
1.6 16V	Petrol	80	10/99-05/05	16 K4F								
				ENGINE								
Engine		Information			A10	A20	A40	A50	A70	C10 - C30	C20	E01
All engines		->ch. YD471564, version Lucas					828 093	928 029R				
All engines		->ch. 471564, x 1, DISTRIBUTOR								470 374	C10	
All engines		->ch. YD471564										360 888
All engines		ch. YD471565 ->										360 889
1.6 16V	Petrol	80	10/99-05/05	16 K4F								
				ENGINE								
Engine		Information			A10	A20	A40	A50	A70	C10 - C30	C20	E01
All engines		->ch. YD471564, version Lucas					828 093	928 029R				
All engines		->ch. 471564, x 1, DISTRIBUTOR								470 374	C10	
All engines		->ch. YD471564										360 888
All engines		ch. YD471565 ->										360 889
1.8 16V	Petrol	85	10/99-05/05	18 K4F								
				ENGINE								
Engine		Information			A10	A20	A40	A50	A70	C10 - C30	C20	E01
All engines		->ch. YD471564, version Lucas					828 093	928 029R				
All engines		->ch. 471564, x 1, DISTRIBUTOR								470 374	C10	
All engines		->ch. YD471564										360 888
All engines		ch. YD471565 ->										360 889
400 I												
				ENGINE								
1.6 i	Petrol	82	05/94-11/98	16 K4F								
				ENGINE								
Engine		Information			A10	A20	A40	A50	A70	C10 - C30	C20	E01
All engines		version Lucas					828 093					
All engines								928 029R		470 374	C10	360 888
1.6 i	Petrol	90	05/94-11/98	D 16 A8								
				ENGINE								
Engine		Information			A10	A20	A40	A50	A70	C10 - C30	C20	E01
All engines		version Lucas					828 093					
All engines								928 029R		470 374	C10	360 888
2.0 i	Petrol	100	05/94-11/98	1CA4GA15-01								
				ENGINE								
Engine		Information			A10	A20	A40	A50	A70	C10 - C30	C20	E01
All engines										470 189	C10	
414	Petrol	70	01/93-04/95	14 K4C								
				ENGINE								
Engine		Information			A10	A20	A40	A50	A70	C10 - C30	C20	E01
All engines		version Lucas					828 093	928 029R				
All engines		01/01/95 ->								470 374	C10	
414 GSI/SI	Petrol	66	04/90-04/95	14 K4C, 14 K4D								
				ENGINE								
Engine		Information			A10	A20	A40	A50	A70	C10 - C30	C20	E01
All engines		version Lucas					828 093	928 029R				

A10 CONDENSER	A20 CONTACT SET	A40 DISTRIBUTOR CAP	A50 ROTOR	A70 PICK-UP
C10 COIL	C20 IGNITION MODULE	C30 ELECTRONIC IGNITION KIT	E01 IGNITION CABLE SET	

Vehicle	alim.	kW	Date	Engine	FUNCTIONS ON THE VEHICLE									
					A10	A20	A40	A50	A70	C10 - C30	C20	E01		
ENGINE														
414 GSI/SI Cat	Petrol	76	10/92-04/95	14 K4F										
Engine	Information				A10	A20	A40	A50	A70	C10 - C30	C20	E01		
All engines	version Lucas						828 093	928 029R						
ENGINE														
416 GSI	Petrol	82	04/90-04/95	1GH5E-180										
Engine	Information				A10	A20	A40	A50	A70	C10 - C30	C20	E01		
All engines										470 213	C10	465 052		
ENGINE														
416 GSI/GSE	Petrol	85	04/90-04/95	D 16 A7										
Engine	Information				A10	A20	A40	A50	A70	C10 - C30	C20	E01		
All engines										470 213	C10	465 052		
ENGINE														
416 GTI	Petrol	90	04/90-04/95	D 16 A8										
Engine	Information				A10	A20	A40	A50	A70	C10 - C30	C20	E01		
All engines										470 213	C10	465 052		
ENGINE														
416 GTI/GTE	Petrol	96	04/90-04/95	D 16 A9										
Engine	Information				A10	A20	A40	A50	A70	C10 - C30	C20	E01		
All engines	->eng. E100000, version Hitachi						822 069	922 082						
All engines										470 213	C10			
ENGINE														
420 GSI/SLI/GTI/Vite	Petrol	100	01/93-04/95	1CA4GA15-01										
Engine	Information				A10	A20	A40	A50	A70	C10 - C30	C20	E01		
All engines	version Lucas						828 093							
All engines								928 029R						
ENGINE														
420 GTI/GSI/Vitesse	Petrol	103	02/92-04/95	20 M4F										
Engine	Information				A10	A20	A40	A50	A70	C10 - C30	C20	E01		
All engines	version Lucas						828 093							
All engines	->year 31/01/92, version Lucas							928 024R						
All engines	01/02/92 ->, version Lucas							928 029R						
ENGINE														
420 Turbo	Petrol	147	01/93-04/95	20 T4G										
Engine	Information				A10	A20	A40	A50	A70	C10 - C30	C20	E01		
All engines	version Lucas						828 093							
All engines								928 029R						
400 II														
ENGINE														
414	Petrol	55	03/96-12/99	14 K2F										
Engine	Information				A10	A20	A40	A50	A70	C10 - C30	C20	E01		
All engines	x 1, DISTRIBUTOR									470 374	C10			
ENGINE														
414 Si	Petrol	76	05/95-03/00	14 K4F										
Engine	Information				A10	A20	A40	A50	A70	C10 - C30	C20	E01		
All engines	version Lucas						828 093	928 029R						
All engines	x 1, DISTRIBUTOR									470 374	C10			
All engines												360 888		
ENGINE														
416 Si	Petrol	82	05/95-03/00	16 K4F										
Engine	Information				A10	A20	A40	A50	A70	C10 - C30	C20	E01		
All engines	version Lucas						828 093	928 029R						
All engines	ch. 74465 ->, x 1, DISTRIBUTOR									470 347	C10			
All engines	->ch. 74464, x 1, DISTRIBUTOR									470 374	C10			
All engines												360 888		
ENGINE														
416 Si	Petrol	83	03/95-03/00	D 16 Y2, D 16 Y3										
Engine	Information				A10	A20	A40	A50	A70	C10 - C30	C20	E01		
Eng. D 16 Y2	+automatic transmission, ->ch. AD074464, version Hitachi						822 068	922 095						
Eng. D 16 Y2	+automatic transmission, ->ch. AD250028, ch. AD074465 ->, version Hitachi						822 082	922 098						
Eng. D 16 Y2	+manual transmission, version Lucas						828 093							
A10	CONDENSER		A20	CONTACT SET		A40	DISTRIBUTOR CAP		A50	ROTOR		A70	PICK-UP	
C10	COIL		C20	IGNITION MODULE		C30	ELECTRONIC IGNITION KIT		E01	IGNITION CABLE SET				

				FUNCTIONS ON THE VEHICLE								
Vehicle	alim.	kW	Date	Engine	 A10	 A20	 A40	 A50	 A70	 C10 - C30	 C20	 E01
				ENGINE								
416 Si	Petrol	83	03/95-03/00	D 16 Y2, D 16 Y3								
Engine	Information			A10	A20	A40	A50	A70	C10 - C30	C20	E01	
Eng. D 16 Y2	+automatic transmission, ch. WD250029 ->, version Lucas					828 106						
Eng. D 16 Y2	+automatic transmission, ch. WD250029 ->, version Hitachi						922 102					
Eng. D 16 Y2	+manual transmission						928 029R		470 374	C10		360 888
Eng. D 16 Y2	+automatic transmission, ->ch. AD074464								470 214	C10		
Eng. D 16 Y3	->ch. 74464, x 1, DISTRIBUTOR								470 214	C10		
Eng. D 16 Y2	+automatic transmission, ->ch. AD250028, ch. AD074465 ->								470 347	C10		
Eng. D 16 Y3	ch. 74465 ->, x 1, DISTRIBUTOR								470 347	C10		
				ENGINE								
416 Si	Petrol	85	05/95-03/00	D16B2								
Engine	Information			A10	A20	A40	A50	A70	C10 - C30	C20	E01	
All engines	->ch. 74464, x 1, DISTRIBUTOR								470 214	C10		
All engines	ch. 74465 ->, x 1, DISTRIBUTOR								470 347	C10		
				ENGINE								
420 Si Lux	Petrol	100	12/95-03/00	1CA4GA15-01, 20 M4F								
Engine	Information			A10	A20	A40	A50	A70	C10 - C30	C20	E01	
Eng. 1CA4GA15-01									470 189	C10		
Eng. 20 M4F	x 1, D.I.S.								470 189	C10		
				ENGINE								
45												
				ENGINE								
1.4	Petrol	76	02/00-05/05	14 K4F								
Engine	Information			A10	A20	A40	A50	A70	C10 - C30	C20	E01	
All engines												360 889
				ENGINE								
1.6	Petrol	80	02/00-05/05	16 K4F								
Engine	Information			A10	A20	A40	A50	A70	C10 - C30	C20	E01	
All engines												360 889
				ENGINE								
1.8	Petrol	86	02/00-05/05	18 K4F								
Engine	Information			A10	A20	A40	A50	A70	C10 - C30	C20	E01	
All engines												360 889
				ENGINE								
2.0 V6	Petrol	110	02/00-05/05	20 K4F								
Engine	Information			A10	A20	A40	A50	A70	C10 - C30	C20	E01	
All engines	x 1, LONG, SHORT, BREMI, D.I.S.								470 413	C10		
				ENGINE								
600												
				ENGINE								
618 i/Si	Petrol	85	03/96-02/99	F 18 A3								
Engine	Information			A10	A20	A40	A50	A70	C10 - C30	C20	E01	
All engines	->ch. AM246796, version Hitachi					822 068	922 095					
All engines	ch. BM246797 ->, version Hitachi					822 082	922 098					
All engines	->ch. AM246796								470 214	C10	465 052	
All engines	ch. BM246797 ->								470 347	C10		
All engines												360 711
				ENGINE								
620 i	Petrol	85	08/93-06/96	F 20 Z2								
Engine	Information			A10	A20	A40	A50	A70	C10 - C30	C20	E01	
All engines	->ch. 246796, version Hitachi					822 068	922 095					
All engines	ch. 246797 ->, version Hitachi					822 082	922 098					
All engines	->ch. 246796								470 214	C10	465 052	
All engines	ch. 246797 ->								470 347	C10		
All engines												360 711
				ENGINE								
620 Si	Petrol	96	08/93-02/99	F 20 Z1								
Engine	Information			A10	A20	A40	A50	A70	C10 - C30	C20	E01	
All engines	->ch. 246796, version Hitachi					822 068	922 095					
All engines	ch. 246797 ->, version Hitachi					822 082	922 098					
All engines	->ch. 246796								470 214	C10	465 052	
All engines	ch. 246797 ->								470 347	C10		
All engines												360 711

A10 CONDENSER	A20 CONTACT SET	A40 DISTRIBUTOR CAP	A50 ROTOR	A70 PICK-UP
C10 COIL	C20 IGNITION MODULE	C30 ELECTRONIC IGNITION KIT	E01 IGNITION CABLE SET	

Vehicle	alim.	kW	Date	Engine	FUNCTIONS ON THE VEHICLE									
					A10	A20	A40	A50	A70	C10 - C30	C20	E01		
ENGINE														
620 Si	Petrol	96	08/93-02/99	F 20 Z1										
Engine	Information				A10	A20	A40	A50	A70	C10 - C30	C20	E01		
All engines													360 711	
ENGINE														
620 Ti Vitesse	Petrol	147	05/94-08/98	20 T4G										
Engine	Information				A10	A20	A40	A50	A70	C10 - C30	C20	E01		
All engines	->ch. AM246796, version Lucas						828 093	928 029R						
All engines	ch. BM246797 ->									470 189	C10			
ENGINE														
623 Si	Petrol	116	08/93-06/99	H 23 A3										
Engine	Information				A10	A20	A40	A50	A70	C10 - C30	C20	E01		
All engines	version Hitachi						822 068	922 095						
All engines										470 214	C10	465 052		
75														
ENGINE														
1.8	Petrol	88	02/99-05/05	K 1.8										
Engine	Information				A10	A20	A40	A50	A70	C10 - C30	C20	E01		
All engines													360 889	
ENGINE														
1.8 Turbo	Petrol	110	05/03-05/05	--										
Engine	Information				A10	A20	A40	A50	A70	C10 - C30	C20	E01		
All engines													360 889	
800														
ENGINE														
820	Petrol	74	10/88-10/91	--										
Engine	Information				A10	A20	A40	A50	A70	C10 - C30	C20	E01		
All engines	version Lucas						828 093	928 024R						
ENGINE														
820 16V Turbo	Petrol	132	11/91-02/99	T 16										
Engine	Information				A10	A20	A40	A50	A70	C10 - C30	C20	E01		
All engines	version Lucas						828 093	928 029R						
ENGINE														
820 I/SI	Petrol	100	01/91-02/99	1CA4GA15-01										
Engine	Information				A10	A20	A40	A50	A70	C10 - C30	C20	E01		
All engines	->ch. 230966, version Lucas						828 093	928 029R						
All engines	ch. 230967 ->									470 189	C10			
ENGINE														
820 i/Si	Petrol	103	10/88-12/91	20 HD										
Engine	Information				A10	A20	A40	A50	A70	C10 - C30	C20	E01		
All engines	version Lucas						828 093	928 024R						
ENGINE														
820 SI	Petrol	98	10/88-12/91	20 HD M 16										
Engine	Information				A10	A20	A40	A50	A70	C10 - C30	C20	E01		
All engines	version Lucas						828 093	928 024R						
ENGINE														
820 Sport	Petrol	145	04/94-03/96	20 T4G										
Engine	Information				A10	A20	A40	A50	A70	C10 - C30	C20	E01		
All engines	version Lucas						828 093	928 029R						
ENGINE														
827 24V	Petrol	124	08/92-02/99	C 27 A1										
Engine	Information				A10	A20	A40	A50	A70	C10 - C30	C20	E01		
All engines	+manual transmission									470 211	C10			
ENGINE														
827 24V I/SI Cat	Petrol	124	01/92-02/99	C 27 A1										
Engine	Information				A10	A20	A40	A50	A70	C10 - C30	C20	E01		
All engines	+manual transmission									470 211	C10			
ENGINE														
827 SI/Sterling	Petrol	130	02/88-12/91	82RZ-FE										
Engine	Information				A10	A20	A40	A50	A70	C10 - C30	C20	E01		
All engines	->eng. 5100000, ->eng. 6300000, ->eng. 6450000, ->eng. 6900000									470 211	C10			
ENGINE														
A10	CONDENSER		A20	CONTACT SET		A40	DISTRIBUTOR CAP		A50	ROTOR		A70	PICK-UP	
C10	COIL		C20	IGNITION MODULE		C30	ELECTRONIC IGNITION KIT		E01	IGNITION CABLE SET				

FUNCTIONS ON THE VEHICLE

Vehicle	alim.	kW	Date	Engine								
---------	-------	----	------	--------	---	---	---	--	---	---	---	---

ENGINE				
827 SI/Sterling Catalytic-Conv	Petrol	124	02/88-02/99	C27 A1

Engine	Information	A10	A20	A40	A50	A70	C10 - C30	C20	E01
All engines	+manual transmission						470 211	C10	

ENGINE				
827 Vitesse Catalytic-Conv	Petrol	124	10/88-12/91	C27 A1

Engine	Information	A10	A20	A40	A50	A70	C10 - C30	C20	E01
All engines	+manual transmission						470 211	C10	

ENGINE				
827 Vitesse/SLI	Petrol	130	10/88-12/91	82RZ-FE

Engine	Information	A10	A20	A40	A50	A70	C10 - C30	C20	E01
All engines	->eng. 5100000, ->eng. 6300000, ->eng. 6450000, ->eng. 6900000						470 211	C10	

A60 CAMBRIDGE

ENGINE				
1.7	Petrol	46	01/62-10/69	--

Engine	Information	A10	A20	A40	A50	A70	C10 - C30	C20	E01
All engines			728 083MHV	828 075	928 006				

COUPE

ENGINE				
1.6 16 V	Petrol	82	03/96-11/99	16 K4F

Engine	Information	A10	A20	A40	A50	A70	C10 - C30	C20	E01
All engines	version Lucas				928 029R				
All engines									360 888

MAESTRO

ENGINE				
1.3	Petrol	49	09/90-01/95	12 HE

Engine	Information	A10	A20	A40	A50	A70	C10 - C30	C20	E01
All engines	version Lucas			828 094	928 025				

ENGINE				
1.3	Petrol	51	09/90-01/95	12 HE

Engine	Information	A10	A20	A40	A50	A70	C10 - C30	C20	E01
All engines	version Lucas			828 094	928 025				

ENGINE				
1.6	Petrol	63	09/90-01/95	16 H

Engine	Information	A10	A20	A40	A50	A70	C10 - C30	C20	E01
All engines	version Lucas			828 093	928 024R				

MINI

ENGINE				
1.3i Cooper	Petrol	0	01/85->	--

Engine	Information	A10	A20	A40	A50	A70	C10 - C30	C20	E01
All engines	version Lucas			828 094	928 025				

ENGINE				
1.3i Turbo	Petrol	0	01/85->	--

Engine	Information	A10	A20	A40	A50	A70	C10 - C30	C20	E01
All engines	version Lucas			828 094	928 025				

ENGINE				
1300	Petrol	37	10/92-11/00	12 A2B

Engine	Information	A10	A20	A40	A50	A70	C10 - C30	C20	E01
All engines	version Lucas			828 094	928 025				
All engines	ch. BD134455 ->						470 189	C10	

ENGINE				
1300	Petrol	39	01/92-04/95	12 A2D

Engine	Information	A10	A20	A40	A50	A70	C10 - C30	C20	E01
All engines	version Lucas			828 094	928 025				
All engines	ch. BD134455 ->						470 189	C10	

ENGINE				
1300	Petrol	45	01/91-12/91	12 A2A









Engine	Information	A10	A20	A40	A50	A70	C10 - C30	C20	E01
All engines	version Lucas			828 094	928 025				
All engines	ch. BD134455 ->						470 189	C10	

A10 CONDENSER	A20 CONTACT SET	A40 DISTRIBUTOR CAP	A50 ROTOR	A70 PICK-UP
C10 COIL	C20 IGNITION MODULE	C30 ELECTRONIC IGNITION KIT	E01 IGNITION CABLE SET	

Vehicle	alim.	kW	Date	Engine	FUNCTIONS ON THE VEHICLE									
					A10	A20	A40	A50	A70	C10 - C30	C20	E01		
1300														
	Petrol	46	01/92-11/00	ENGINE 12 A2E, 12 A2L										
Engine	Information				A10	A20	A40	A50	A70	C10 - C30	C20	E01		
All engines	version Lucas						828 094	928 025						
All engines	ch. BD134455 ->									470 189	C10			
MONTEGO														
1.3														
	Petrol	50	10/84-10/88	ENGINE 12 HL										
Engine	Information				A10	A20	A40	A50	A70	C10 - C30	C20	E01		
All engines	version Lucas						828 094	928 025						
2.0 GTi														
	Petrol	86	02/85-10/91	ENGINE 20 H										
Engine	Information				A10	A20	A40	A50	A70	C10 - C30	C20	E01		
All engines	version Lucas						828 093	928 024R						
STREETWISE														
1.4														
	Petrol	62	08/03-05/05	ENGINE 14 K4M										
Engine	Information				A10	A20	A40	A50	A70	C10 - C30	C20	E01		
All engines	->ch. 471564, x 1, DISTRIBUTOR									470 374	C10			
1.4														
	Petrol	76	08/03-05/05	ENGINE 14 K4F										
Engine	Information				A10	A20	A40	A50	A70	C10 - C30	C20	E01		
All engines	->ch. 471564, x 1, DISTRIBUTOR									470 374	C10			
1.6														
	Petrol	80	01/04-05/05	ENGINE 16 K4F										
Engine	Information				A10	A20	A40	A50	A70	C10 - C30	C20	E01		
All engines	->ch. 471564, x 1, DISTRIBUTOR									470 374	C10			

A10	CONDENSER	A20	CONTACT SET	A40	DISTRIBUTOR CAP	A50	ROTOR	A70	PICK-UP
C10	COIL	C20	IGNITION MODULE	C30	ELECTRONIC IGNITION KIT	E01	IGNITION CABLE SET		

The present application list is a brief version. For the detailed information about the possibility of installation on a specific vehicle, please refer to our web-catalogue <http://catalogo.facet.eu/>









				FUNCTIONS ON THE VEHICLE								
Vehicle	alim.	kW	Date	Engine	 A10	 A20	 A40	 A50	 A70	 C10 - C30	 C20	 E01
90												
2.0	Petrol	74	08/84-08/87	B 20 I								
Engine	Information				A10	A20	A40	A50	A70	C10 - C30	C20	E01
All engines	version Bosch						806 079	906 026R				
All engines	MODEL FROM: 1986										465 004	
All engines												360 140
900 I												
2.0-16	Petrol	92	01/86-12/88	B202XI								
Engine	Information				A10	A20	A40	A50	A70	C10 - C30	C20	E01
All engines	version Bosch						806 079	906 123R				
All engines	FOR MODEL: 1988										465 004	
All engines												360 138
2.0-16	Petrol	93	01/89-06/94	5B 6304 GS								
Engine	Information				A10	A20	A40	A50	A70	C10 - C30	C20	E01
All engines	version Bosch						806 079	906 123R				
All engines	FOR MODEL: 1989										465 007	360 138
All engines	MODEL FROM: 1990										465 034	
2.0 c	Petrol	74	09/79-12/88	B201XC								
Engine	Information				A10	A20	A40	A50	A70	C10 - C30	C20	E01
All engines	version Bosch						806 079	906 026R				
All engines	FOR MODEL: 1988, version Bosch								406 193			
All engines											465 004	360 140
2.0 i	Petrol	81	09/85-08/90	OTLE4G15								
Engine	Information				A10	A20	A40	A50	A70	C10 - C30	C20	E01
All engines	version Bosch						806 079	906 026R				
All engines	MODEL FROM: 1988, version Bosch								406 193			
All engines	MODEL FROM: 1986, MODEL TO: 1988										465 004	
All engines	MODEL FROM: 1989										465 007	
All engines												360 140
2.0 i	Petrol	85	11/80-08/90	B201XI								
Engine	Information				A10	A20	A40	A50	A70	C10 - C30	C20	E01
All engines	version Bosch						806 079	906 026R				
All engines	MODEL FROM: 1988, version Bosch								406 193			
All engines	MODEL FROM: 1986, MODEL TO: 1988										465 004	
All engines	MODEL FROM: 1989										465 007	
All engines												360 140
2.0 S Turbo-16	Petrol	104	07/91-06/94	B202S								
Engine	Information				A10	A20	A40	A50	A70	C10 - C30	C20	E01
All engines	version Bosch						806 079					
All engines	distr. num. 88 57 617, version Bosch								406 244			
All engines											465 007	
2.0 S Turbo-16	Petrol	107	01/92-12/93	B202S								
Engine	Information				A10	A20	A40	A50	A70	C10 - C30	C20	E01
All engines	version Bosch						806 079					
All engines	distr. num. 88 57 617, version Bosch								406 244			
All engines											465 007	
2.0 Turbo	Petrol	103	10/86-12/91	B201XL								
Engine	Information				A10	A20	A40	A50	A70	C10 - C30	C20	E01
All engines	version Bosch						806 079	906 026R				
All engines								906 021R				360 140
All engines	MODEL FROM: 1988, version Bosch								406 193			
All engines	MODEL TO: 1988										465 004	
All engines	MODEL FROM: 1989										465 007	

A10 CONDENSER	A20 CONTACT SET	A40 DISTRIBUTOR CAP	A50 ROTOR	A70 PICK-UP
C10 COIL	C20 IGNITION MODULE	C30 ELECTRONIC IGNITION KIT	E01 IGNITION CABLE SET	

Vehicle	alim.	kW	Date	Engine	FUNCTIONS ON THE VEHICLE							
					A10	A20	A40	A50	A70	C10 - C30	C20	E01
ENGINE												
2.0 Turbo	Petrol	110	01/86-12/88	B201XL								
Engine	Information			A10	A20	A40	A50	A70	C10 - C30	C20	E01	
All engines	version Bosch					806 079	906 026R					
All engines							906 021R				360 140	
All engines	MODEL FROM: 1988, version Bosch							406 193				
All engines	MODEL TO: 1988									465 004		
All engines	MODEL FROM: 1989									465 007		
ENGINE												
2.0 Turbo-16	Petrol	118	11/85-06/94	B202XL								
Engine	Information			A10	A20	A40	A50	A70	C10 - C30	C20	E01	
All engines	version Bosch					806 079						
All engines	MODEL TO: 1989, version Bosch						906 123R					
All engines	distr. num. 88 57 617, version Bosch							406 244				
All engines	MODEL TO: 1988									465 004		
All engines	MODEL FROM: 1989									465 007		
All engines	FOR MODEL: 1989										360 138	
ENGINE												
2.0 Turbo-16	Petrol	132	01/93-06/94	B202L								
Engine	Information			A10	A20	A40	A50	A70	C10 - C30	C20	E01	
All engines	version Bosch					806 079						
All engines	distr. num. 88 57 617, version Bosch							406 244				
All engines	MODEL TO: 1988									465 004		
All engines	MODEL FROM: 1989									465 007		
All engines	FOR MODEL: 1989										360 138	
ENGINE												
2.0 Turbo-16 S	Petrol	129	01/84-06/94	B202XL								
Engine	Information			A10	A20	A40	A50	A70	C10 - C30	C20	E01	
All engines	version Bosch					806 079						
All engines	MODEL TO: 1989, version Bosch						906 123R					
All engines	distr. num. 88 57 617, version Bosch							406 244				
All engines	MODEL TO: 1988									465 004		
All engines	MODEL FROM: 1989									465 007		
All engines	FOR MODEL: 1989										360 138	
ENGINE												
2.0 Turbo-16 S Cat	Petrol	125	01/89-12/93	B202XL								
Engine	Information			A10	A20	A40	A50	A70	C10 - C30	C20	E01	
All engines	version Bosch					806 079						
All engines	FOR MODEL: 1989, version Bosch						906 123R					
All engines	distr. num. 88 57 617, version Bosch							406 244				
All engines	MODEL TO: 1988									465 004		
All engines	MODEL FROM: 1989									465 007		
All engines	FOR MODEL: 1989										360 138	
ENGINE												
2.0 Turbo-16 S Cat	Petrol	129	01/89-12/93	B202XL								
Engine	Information			A10	A20	A40	A50	A70	C10 - C30	C20	E01	
All engines	version Bosch					806 079						
All engines	FOR MODEL: 1989, version Bosch						906 123R					
All engines	distr. num. 88 57 617, version Bosch							406 244				
All engines	MODEL TO: 1988									465 004		
All engines	MODEL FROM: 1989									465 007		
ENGINE												
2.1 -16	Petrol	100	08/90-06/94	B212I								
Engine	Information			A10	A20	A40	A50	A70	C10 - C30	C20	E01	
All engines	version Bosch					806 079	906 123R					
900 II												
ENGINE												
2.0 i	Petrol	96	12/93-02/98	B204I								
Engine	Information			A10	A20	A40	A50	A70	C10 - C30	C20	E01	
All engines	version Bosch					806 124	906 121R					
All engines									470 192	C10		

A10 CONDENSER	A20 CONTACT SET	A40 DISTRIBUTOR CAP	A50 ROTOR	A70 PICK-UP
C10 COIL	C20 IGNITION MODULE	C30 ELECTRONIC IGNITION KIT	E01 IGNITION CABLE SET	

The present application list is a brief version. For the detailed information about the possibility of installation on a specific vehicle, please refer to our web-catalogue <http://catalogo.facet.eu/>

				FUNCTIONS ON THE VEHICLE								
Vehicle	alim.	kW	Date	Engine								
				ENGINE								
2.0 i	Petrol	98	07/93-07/94	B206I								
				ENGINE								
Engine		Information		A10	A20	A40	A50	A70	C10 - C30	C20	E01	
All engines		version Bosch				806 124	906 121R					
All engines									470 192	C10		
2.3 -16	Petrol	110	07/93-02/98	B234I								
				ENGINE								
Engine		Information		A10	A20	A40	A50	A70	C10 - C30	C20	E01	
All engines		version Bosch				806 124	906 121R					
All engines									470 192	C10		
9000												
				ENGINE								
2.0 -16	Petrol	92	12/85-12/88	B202XI								
				ENGINE								
Engine		Information		A10	A20	A40	A50	A70	C10 - C30	C20	E01	
All engines		version Bosch				806 079	906 123R					
All engines		EZK								465 034	360 138	
2.0 -16	Petrol	94	12/85-01/93	5B 6304 GS, B202XI								
				ENGINE								
Engine		Information		A10	A20	A40	A50	A70	C10 - C30	C20	E01	
All engines		EZK, version Bosch				806 079	906 123R					
All engines		EZK								465 034	360 138	
2.0 -16 CS	Petrol	94	01/89-12/98	5B 6304 GS								
				ENGINE								
Engine		Information		A10	A20	A40	A50	A70	C10 - C30	C20	E01	
All engines		EZK, version Bosch				806 079	906 123R					
All engines		EZK								465 034	360 138	
2.0 -16 Turbo	Petrol	118	09/84-08/93	B202XL								
				ENGINE								
Engine		Information		A10	A20	A40	A50	A70	C10 - C30	C20	E01	
All engines		version Bosch				806 079						
All engines		distr. num. 75 00 507, version Bosch					906 055R					
All engines		distr. num. 75 61 806, 75 61 814, version Bosch					906 123R					
All engines										465 004	360 138	
2.0 -16 Turbo	Petrol	120	05/88-08/93	B202XL								
				ENGINE								
Engine		Information		A10	A20	A40	A50	A70	C10 - C30	C20	E01	
All engines		version Bosch				806 079						
All engines		distr. num. 75 00 507, version Bosch					906 055R					
All engines		distr. num. 75 61 806, 75 61 814, version Bosch					906 123R					
All engines										465 004	360 138	
2.0 -16 Turbo	Petrol	129	09/84-12/91	B202XL								
				ENGINE								
Engine		Information		A10	A20	A40	A50	A70	C10 - C30	C20	E01	
All engines		version Bosch				806 079						
All engines		distr. num. 75 00 507, version Bosch					906 055R					
All engines		distr. num. 75 61 806, 75 61 814, version Bosch					906 123R					
All engines										465 004	360 138	
2.0 -16 Turbo CD	Petrol	120	09/88-08/93	B202XL								
				ENGINE								
Engine		Information		A10	A20	A40	A50	A70	C10 - C30	C20	E01	
All engines		version Bosch				806 079						
All engines		distr. num. 75 00 507, version Bosch					906 055R					
All engines		distr. num. 75 61 806, 75 61 814, version Bosch					906 123R					
All engines										465 004	360 138	
2.3 -16 CD	Petrol	107	08/89-12/98	B234I								
				ENGINE								
Engine		Information		A10	A20	A40	A50	A70	C10 - C30	C20	E01	
All engines		EZK, version Bosch				806 079	906 123R					
All engines		EZK								465 034	360 138	

A10 CONDENSER	A20 CONTACT SET	A40 DISTRIBUTOR CAP	A50 ROTOR	A70 PICK-UP
C10 COIL	C20 IGNITION MODULE	C30 ELECTRONIC IGNITION KIT	E01 IGNITION CABLE SET	

Vehicle	alim.	kW	Date	Engine	FUNCTIONS ON THE VEHICLE									
					A10	A20	A40	A50	A70	C10 - C30	C20	E01		
ENGINE														
2.3-16 CS	Petrol	107	09/89-12/98	B234I										
Engine	Information				A10	A20	A40	A50	A70	C10 - C30	C20	E01		
All engines	EZK, version Bosch						806 079	906 123R						
All engines	EZK										465 034	360 138		
ENGINE														
9-3														
1.8 i	Petrol	90	01/04-02/15	Z 18 XE										
Engine	Information				A10	A20	A40	A50	A70	C10 - C30	C20	E01		
All engines	x 1, x 4, COIL ON PLUG, incl. spark plug connector									470 508	C10			
ENGINE														
2.0 i	Petrol	96	02/98-08/03	B204I										
Engine	Information				A10	A20	A40	A50	A70	C10 - C30	C20	E01		
All engines	version Bosch						806 124	906 121R						
All engines	x 1, Colour:Yellow, DISTRIBUTOR, 12 Volt, Dia: 55 mm, L: 148, 5 mm, connector type, saw teeth									470 192	C10			
ENGINE														
2.0 SE Turbo	Petrol	147	02/98-08/03	B204R										
Engine	Information				A10	A20	A40	A50	A70	C10 - C30	C20	E01		
All engines	fuel formation: motronic, x 1, Colour:Yellow, x 1, Colour:Yellow, DISTRIBUTOR, 12 Volt, DISTRIBUTOR, 12 Volt, Dia: 55 mm, Dia: 55 mm, L: 148, 5 mm, connector type, saw teeth, L: 148, 5 mm, connector type, saw teeth									470 192	C10			
ENGINE														
2.0 Turbo	Petrol	110	03/99-08/03	B204E, B205E										
Engine	Information				A10	A20	A40	A50	A70	C10 - C30	C20	E01		
All engines	x 1, Colour:Yellow, DISTRIBUTOR, 12 Volt, Dia: 55 mm, L: 148, 5 mm, connector type, saw teeth									470 192	C10			
ENGINE														
2.0 Turbo	Petrol	113	10/98-08/03	B204E										
Engine	Information				A10	A20	A40	A50	A70	C10 - C30	C20	E01		
All engines	x 1, Colour:Yellow, DISTRIBUTOR, 12 Volt, Dia: 55 mm, L: 148, 5 mm, connector type, saw teeth									470 192	C10			
ENGINE														
2.0 Turbo	Petrol	136	02/98-08/03	B204L, B205L										
Engine	Information				A10	A20	A40	A50	A70	C10 - C30	C20	E01		
All engines	x 1, Colour:Yellow, DISTRIBUTOR, 12 Volt, Dia: 55 mm, L: 148, 5 mm, connector type, saw teeth									470 192	C10			
ENGINE														
2.0 Turbo	Petrol	151	10/99-08/03	B205R										
Engine	Information				A10	A20	A40	A50	A70	C10 - C30	C20	E01		
All engines	x 1, Colour:Yellow, DISTRIBUTOR, 12 Volt, Dia: 55 mm, L: 148, 5 mm, connector type, saw teeth									470 192	C10			
ENGINE														
2.3	Petrol	169	09/99-01/02	B235R										
Engine	Information				A10	A20	A40	A50	A70	C10 - C30	C20	E01		
All engines	x 1, Colour:Yellow, DISTRIBUTOR, 12 Volt, Dia: 55 mm, L: 148, 5 mm, connector type, saw teeth									470 192	C10			
ENGINE														
2.3 i	Petrol	110	02/98-08/03	B234I										
Engine	Information				A10	A20	A40	A50	A70	C10 - C30	C20	E01		
All engines	version Bosch						806 124	906 121R						
All engines	x 1, Colour:Yellow, DISTRIBUTOR, 12 Volt, Dia: 55 mm, L: 148, 5 mm, connector type, saw teeth									470 192	C10			
ENGINE														
9-5														
1.6 Turbo	Petrol	132	05/10-01/12	A 16 LET										
Engine	Information				A10	A20	A40	A50	A70	C10 - C30	C20	E01		
All engines	x 4, COIL ON PLUG									470 450	C10			

A10 CONDENSER	A20 CONTACT SET	A40 DISTRIBUTOR CAP	A50 ROTOR	A70 PICK-UP
C10 COIL	C20 IGNITION MODULE	C30 ELECTRONIC IGNITION KIT	E01 IGNITION CABLE SET	

The present application list is a brief version. For the detailed information about the possibility of installation on a specific vehicle, please refer to our web-catalogue <http://catalogo.facet.eu/>

Vehicle	alim.	kW	Date	Engine	FUNCTIONS ON THE VEHICLE							
					A10	A20	A40	A50	A70	C10 - C30	C20	E01

ALHAMBRA I / II

				ENGINE
1.8 T 20V	Petrol	110	10/97-03/10	AJH, AWC

Engine	Information	A10	A20	A40	A50	A70	C10 - C30	C20	E01
Eng. AJH	x 4, COIL ON PLUG						470 354S	C10	
Eng. AWC	x 4, COIL ON PLUG, incl. spark plug connector						470 44S	C10	
Eng. AJH								465 076	

				ENGINE
2.0	Petrol	85	03/96-03/10	ADY, ATM

Engine	Information	A10	A20	A40	A50	A70	C10 - C30	C20	E01
Eng. ADY							490 414	C30	
Eng. ATM							490 420	C30	

				ENGINE
2.0 i	Petrol	85	04/96-03/10	ADY, ATM

Engine	Information	A10	A20	A40	A50	A70	C10 - C30	C20	E01
Eng. ADY	version Bosch			806 266	906 121R	406 223			
Eng. ADY							490 414	C30	360 667
Eng. ATM							490 420	C30	360 585

				ENGINE
2.8 V6	Petrol	150	06/00-03/10	AUE, AYL

Engine	Information	A10	A20	A40	A50	A70	C10 - C30	C20	E01
All engines	x 6, COIL ON PLUG						470 435	C10	

				ENGINE
2.8 V6 4motion	Petrol	150	06/00-03/10	AUE, AYL

Engine	Information	A10	A20	A40	A50	A70	C10 - C30	C20	E01
All engines	x 6, COIL ON PLUG						470 435	C10	

ALHAMBRA III

				ENGINE
1.4 TSI	Petrol	110	06/10->	CAVA, CTHA, CZDA, DJKA

Engine	Information	A10	A20	A40	A50	A70	C10 - C30	C20	E01
Eng. CAVA, CTHA	x 4, COIL ON PLUG, incl. spark plug connector						470 474	C10	
Eng. CZDA, DJKA	x 4, BERU, ELDOR, COIL ON PLUG, incl. spark plug connector, Number of pins:4, incl. spark plug connector						470 599	C10	

				ENGINE
1.8 TSI	Petrol	118	11/12->	CDA

Engine	Information	A10	A20	A40	A50	A70	C10 - C30	C20	E01
All engines	x 4, ELDOR, Housing Colour:Black, COIL ON PLUG, incl. spark plug connector						470 426	C10	

				ENGINE
2.0 TFSI	Petrol	147	11/10-05/12	CCZA

Engine	Information	A10	A20	A40	A50	A70	C10 - C30	C20	E01
All engines	x 4, ELDOR, Housing Colour:Black, COIL ON PLUG, incl. spark plug connector						470 426	C10	

				ENGINE
TSI	Petrol	110	05/15->	CZDA

Engine	Information	A10	A20	A40	A50	A70	C10 - C30	C20	E01
All engines	x 4, BERU, ELDOR, COIL ON PLUG, incl. spark plug connector, Number of pins:4, incl. spark plug connector						470 599	C10	

ALTEA

				ENGINE
1.2 TSI	Petrol	77	04/10->	CBZB

Engine	Information	A10	A20	A40	A50	A70	C10 - C30	C20	E01
All engines							490 420	C30	358 248

				ENGINE
1.4 16V	Petrol	63	05/06->	BXW, CGGB

Engine	Information	A10	A20	A40	A50	A70	C10 - C30	C20	E01
All engines	x 4, COIL ON PLUG, incl. spark plug connector						470 474	C10	

				ENGINE
1.4 TFSI	Petrol	92	05/10-04/11	CAXC









Engine	Information	A10	A20	A40	A50	A70	C10 - C30	C20	E01
All engines	x 4, COIL ON PLUG, incl. spark plug connector						470 474	C10	

A10 CONDENSER	A20 CONTACT SET	A40 DISTRIBUTOR CAP	A50 ROTOR	A70 PICK-UP
C10 COIL	C20 IGNITION MODULE	C30 ELECTRONIC IGNITION KIT	E01 IGNITION CABLE SET	

Vehicle	alim.	kW	Date	Engine	FUNCTIONS ON THE VEHICLE									
					A10	A20	A40	A50	A70	C10 - C30	C20	E01		
ENGINE														
1.4 TSI	Petrol	92	11/07->	CAXC										
ENGINE														
ENGINE														
All engines											470 474	C10		
ENGINE														
1.6	Petrol	75	03/04->	BGU, BSE, BSF, CCSA, CMXA										
ENGINE														
All engines											490 420	C30		360 585
ENGINE														
1.6 LPG	Petrol/ Liquified Petro- leum Gas (LPG)	75	09/09->	CHGA										
ENGINE														
All engines											490 420	C30		360 585
ENGINE														
1.6 Multifuel	Petrol/ Metha- nol	75	11/10-05/11	CMXA										
ENGINE														
All engines											490 420	C30		
ENGINE														
1.8 TFSI	Petrol	118	01/07->	BYT, BZB, CDAA										
ENGINE														
All engines											470 426	C10		
ENGINE														
2.0 FSI	Petrol	110	05/04-03/09	BLR, BLY, BVY, BVZ										
ENGINE														
All engines											470 426	C10		
ENGINE														
2.0 TFSI	Petrol	147	04/06-05/09	BWA										
ENGINE														
All engines											470 426	C10		
ALTEA XL														
ENGINE														
1.2 TSI	Petrol	77	04/10->	CBZB										
ENGINE														
All engines											490 420	C30		358 248
ENGINE														
1.4 16V	Petrol	63	10/06->	BXW, CGGB										
ENGINE														
All engines											470 474	C10		
ENGINE														
1.4 TSI	Petrol	92	11/07->	CAXC										
ENGINE														
All engines											470 474	C10		
ENGINE														
1.6	Petrol	75	10/06->	BGU, BSE, BSF, CCSA, CMXA										
ENGINE														
All engines											490 420	C30		360 585
ENGINE														
1.6 LPG	Petrol/ Liquified Petro- leum Gas (LPG)	75	09/09->	CHGA										
ENGINE														
All engines											490 420	C30		360 585

A10 CONDENSER	A20 CONTACT SET	A40 DISTRIBUTOR CAP	A50 ROTOR	A70 PICK-UP
C10 COIL	C20 IGNITION MODULE	C30 ELECTRONIC IGNITION KIT	E01 IGNITION CABLE SET	

The present application list is a brief version. For the detailed information about the possibility of installation on a specific vehicle, please refer to our web-catalogue <http://catalogo.facet.eu/>

					FUNCTIONS ON THE VEHICLE							
Vehicle	alim.	kW	Date	Engine	 A10	 A20	 A40	 A50	 A70	 C10 - C30	 C20	 E01
ENGINE												
1.6 Multifuel	Petrol/ Ethanol	75	10/06-11/10	BSE, BSF, CCSA, CMXA								
Engine	Information				A10	A20	A40	A50	A70	C10 - C30	C20	E01
All engines										490 420	C30	
Eng. CCSA												360 585
ENGINE												
1.8 TFSI	Petrol	118	01/07->	BYT, BZB, CDA								
Engine	Information				A10	A20	A40	A50	A70	C10 - C30	C20	E01
All engines	x 4, ELDOR, Housing Colour:Black, COIL ON PLUG, incl. spark plug connector									470 426	C10	
ENGINE												
2.0 FSI	Petrol	110	10/06-03/09	BVY, BVZ								
Engine	Information				A10	A20	A40	A50	A70	C10 - C30	C20	E01
All engines	x 4, ELDOR, Housing Colour:Black, COIL ON PLUG, incl. spark plug connector									470 426	C10	
ENGINE												
2.0 TFSI	Petrol	147	10/06-05/09	BWA								
Engine	Information				A10	A20	A40	A50	A70	C10 - C30	C20	E01
All engines	x 4, ELDOR, Housing Colour:Black, COIL ON PLUG, incl. spark plug connector									470 426	C10	
ENGINE												
2.0 TFSI	Petrol	155	05/09->	CCZB								
Engine	Information				A10	A20	A40	A50	A70	C10 - C30	C20	E01
All engines	x 4, ELDOR, Housing Colour:Black, COIL ON PLUG, incl. spark plug connector									470 426	C10	
ENGINE												
2.0 TFSI 4x4	Petrol	147	06/07-05/09	BWA								
Engine	Information				A10	A20	A40	A50	A70	C10 - C30	C20	E01
All engines	x 4, ELDOR, Housing Colour:Black, COIL ON PLUG, incl. spark plug connector									470 426	C10	
ENGINE												
2.0 TFSI 4x4	Petrol	155	05/09->	CCZB								
Engine	Information				A10	A20	A40	A50	A70	C10 - C30	C20	E01
All engines	x 4, ELDOR, Housing Colour:Black, COIL ON PLUG, incl. spark plug connector									470 426	C10	
ARONA												
ENGINE												
1.0 TGI	Petrol/ Compressed Natural Gas (CNG)	66	11/18->	DBYA								
Engine	Information				A10	A20	A40	A50	A70	C10 - C30	C20	E01
All engines	x 3, BERU, ELDOR, COIL ON PLUG, incl. spark plug connector, Number of pins:4, incl. spark plug connector									470 599	C10	
ENGINE												
1.0 TSI	Petrol	70	07/17->	CHZL, DKLA								
Engine	Information				A10	A20	A40	A50	A70	C10 - C30	C20	E01
All engines	x 3, BERU, ELDOR, COIL ON PLUG, incl. spark plug connector, Number of pins:4, incl. spark plug connector									470 599	C10	
ENGINE												
1.0 TSI	Petrol	81	06/20->	DLAA								
Engine	Information				A10	A20	A40	A50	A70	C10 - C30	C20	E01
All engines	x 3, ELDOR, HITACHI, COIL ON PLUG, incl. spark plug connector, Number of pins:4, incl. spark plug connector									470 599	C10	
ENGINE												
1.0 TSI	Petrol	85	07/17->	CHZJ, DKJA, DKRF								
Engine	Information				A10	A20	A40	A50	A70	C10 - C30	C20	E01
All engines	x 3, BERU, ELDOR, COIL ON PLUG, incl. spark plug connector, Number of pins:4, incl. spark plug connector									470 599	C10	
ENGINE												
1.6 SRE	Petrol	81	07/17->	CWVA								
Engine	Information				A10	A20	A40	A50	A70	C10 - C30	C20	E01
All engines	x 4, BERU, ELDOR, COIL ON PLUG, incl. spark plug connector, Number of pins:4, incl. spark plug connector									470 599	C10	

A10 CONDENSER	A20 CONTACT SET	A40 DISTRIBUTOR CAP	A50 ROTOR	A70 PICK-UP
C10 COIL	C20 IGNITION MODULE	C30 ELECTRONIC IGNITION KIT	E01 IGNITION CABLE SET	

Vehicle	alim.	kW	Date	Engine	FUNCTIONS ON THE VEHICLE							
					A10	A20	A40	A50	A70	C10 - C30	C20	E01

AROSA				
				ENGINE
1.0	Petrol	37	05/97-06/04	AER, ALD, ALL, ANV, AUC

Engine	Information	A10	A20	A40	A50	A70	C10 - C30	C20	E01
Eng. AER, ALL	version Bosch			806 094	906 121R	406 223			
Eng. AER, ALL	version Marelli			830 116	930 057R				
Eng. AER, ALL							490 414	C30	
Eng. ALD, ANV, AUC							490 420	C30	
Eng. ALL									360 569
Eng. ALD, ANV									360 595
Eng. AUC									360 601
Eng. AER									360 641

AROSA				
				ENGINE
1.4	Petrol	44	05/97-06/04	4A 20 NFT, AEX, AKK, AKV, ANW, APQ, AUD

Engine	Information	A10	A20	A40	A50	A70	C10 - C30	C20	E01
Eng. AEX, AKV, APQ	version Bosch			806 094	906 121R	406 223			
Eng. AEX, AKV, APQ	version Marelli			830 116	930 057R				
Eng. AEX, AKV, APQ							490 414	C30	360 641
Eng. AKK, ANW, AUD							490 420	C30	
Eng. 4A 20 NFT									360 595
Eng. AUD									360 601

AROSA				
				ENGINE
1.4 16V	Petrol	74	01/00-06/04	0P11C-VF, AFK, AQQ, AUB

Engine	Information	A10	A20	A40	A50	A70	C10 - C30	C20	E01
Eng. AFK, AQQ, AUB							490 420	C30	
Eng. 0P11C-VF, AQQ, AUB									360 575

ATECA				
				ENGINE
1.0 TSI	Petrol	85	05/16->	CHZJ, DKRF

Engine	Information	A10	A20	A40	A50	A70	C10 - C30	C20	E01
All engines	x 3, BERU, ELDOR, COIL ON PLUG, incl. spark plug connector, Number of pins:4, incl. spark plug connector						470 599	C10	

ATECA				
				ENGINE
1.4 TSI	Petrol	110	06/16->	CZEA

Engine	Information	A10	A20	A40	A50	A70	C10 - C30	C20	E01
All engines	x 4, BERU, ELDOR, COIL ON PLUG, incl. spark plug connector, Number of pins:4, incl. spark plug connector						470 599	C10	

ATECA				
				ENGINE
1.4 TSI 4Drive	Petrol	110	06/16->	CZEA

Engine	Information	A10	A20	A40	A50	A70	C10 - C30	C20	E01
All engines	x 4, BERU, ELDOR, COIL ON PLUG, incl. spark plug connector, Number of pins:4, incl. spark plug connector						470 599	C10	

CORDOBA I				
				ENGINE
1.0 16V	Petrol	51	05/00-10/02	AST, AVZ

Engine	Information	A10	A20	A40	A50	A70	C10 - C30	C20	E01
All engines	without cover, version Bosch			806 094					
All engines	with cover, version Bosch			806 266					
All engines	version Bosch				906 121R	406 233			
All engines							490 414	C30	

CORDOBA I				
				ENGINE
1.0 CL	Petrol	33	02/93-06/96	AAU









Engine	Information	A10	A20	A40	A50	A70	C10 - C30	C20	E01
All engines	version Bosch			806 266	906 121R				
All engines							490 414	C30	

CORDOBA I				
				ENGINE
1.0 i	Petrol	37	09/96-10/02	AER

Engine	Information	A10	A20	A40	A50	A70	C10 - C30	C20	E01
All engines	version Bosch			806 094	906 121R	406 223			
All engines	version Marelli			830 116	930 057R	430 182			
All engines							490 414	C30	360 640

A10	CONDENSER	A20	CONTACT SET	A40	DISTRIBUTOR CAP	A50	ROTOR	A70	PICK-UP
C10	COIL	C20	IGNITION MODULE	C30	ELECTRONIC IGNITION KIT	E01	IGNITION CABLE SET		

The present application list is a brief version. For the detailed information about the possibility of installation on a specific vehicle, please refer to our web-catalogue <http://catalogo.facet.eu/>

					FUNCTIONS ON THE VEHICLE							
Vehicle	alim.	kW	Date	Engine	 A10	 A20	 A40	 A50	 A70	 C10 - C30	 C20	 E01
ENGINE												
1.3	Petrol	40	02/93-08/94	8C20HD0D, AAV								
Engine	Information				A10	A20	A40	A50	A70	C10 - C30	C20	E01
Eng. AAV	version Bosch						806 266	906 121R				
Eng. AAV										490 414	C30	
Eng. 8C20HD0D										490 416	C30	
ENGINE												
1.4	Petrol	40	12/97-04/99	ANX								
Engine	Information				A10	A20	A40	A50	A70	C10 - C30	C20	E01
All engines	version Bosch						806 094	906 121R	406 223			
All engines	version Marelli						830 116	930 057R	430 182			
All engines										490 414	C30	360 640
ENGINE												
1.4 16V	Petrol	55	06/99-12/02	2CJXE, AUA								
Engine	Information				A10	A20	A40	A50	A70	C10 - C30	C20	E01
All engines										490 420	C30	360 575
ENGINE												
1.4 i	Petrol	44	06/94-12/02	ABD, AEX, AKV, APQ								
Engine	Information				A10	A20	A40	A50	A70	C10 - C30	C20	E01
All engines	version Bosch						806 094	906 121R				
Eng. AKV, APQ	version Marelli						830 116	930 057R	430 182			
Eng. AEX, AKV, APQ	version Bosch								406 223			
All engines										490 414	C30	
Eng. ABD												360 364
Eng. AEX, AKV, APQ												360 640
ENGINE												
1.4 i 16V	Petrol	74	09/96-10/02	AFH								
Engine	Information				A10	A20	A40	A50	A70	C10 - C30	C20	E01
All engines	version Bosch						806 094	906 121R	406 223			
All engines	version Marelli						830 116	930 057R	430 182			
All engines										490 414	C30	
ENGINE												
1.6 i	Petrol	55	02/93-12/02	1F, ABU, AEE, ALM								
Engine	Information				A10	A20	A40	A50	A70	C10 - C30	C20	E01
Eng. ALM	version Bosch						806 079					
Eng. 1F, ABU, AEE	version Bosch						806 094					
Eng. 1F	version Ducellier						815 068	915 099R				
Eng. AEE, ALM	version Marelli						830 116	930 057R	430 182			
All engines	version Bosch							906 121R				
Eng. 1F, AEE, ALM	version Bosch								406 223			
All engines										490 414	C30	
Eng. ABU	->ch. 6K-ZR010 000, ->ch. 6K-ZR510 000											359 736
Eng. 1F												359 965
Eng. ABU	ch. 6K-ZR010 000 ->, ch. 6K-ZR510 000 ->											360 364
Eng. AEE, ALM												360 640
ENGINE												
1.6 i	Petrol	74	07/96-12/02	AFT, AKL								
Engine	Information				A10	A20	A40	A50	A70	C10 - C30	C20	E01
Eng. AFT	version Bosch						806 094	906 121R	406 223			
Eng. AFT										490 414	C30	360 932
Eng. AKL										490 420	C30	360 484
ENGINE												
1.8 i	Petrol	66	02/93-09/02	ABS, ACC, ADZ								
Engine	Information				A10	A20	A40	A50	A70	C10 - C30	C20	E01
All engines	version Bosch						806 094	906 121R	406 223			
All engines	version Ducellier						815 068	915 099R				
All engines										490 414	C30	
All engines	01/07/96 ->											359 965
Eng. ACC	->year 30/06/96											360 549

A10 CONDENSER	A20 CONTACT SET	A40 DISTRIBUTOR CAP	A50 ROTOR	A70 PICK-UP
C10 COIL	C20 IGNITION MODULE	C30 ELECTRONIC IGNITION KIT	E01 IGNITION CABLE SET	

Vehicle	alim.	kW	Date	Engine	FUNCTIONS ON THE VEHICLE									
					A10	A20	A40	A50	A70	C10 - C30	C20	E01		
ENGINE														
1.8 i 16V	Petrol	95	10/93-08/96	148 D										
Engine	Information				A10	A20	A40	A50	A70	C10 - C30	C20	E01		
All engines	version Bosch						806 094	906 121R	406 223					
All engines										490 414	C30			
ENGINE														
1.8 T 20V Cupra	Petrol	115	07/00-10/02	AQX										
Engine	Information				A10	A20	A40	A50	A70	C10 - C30	C20	E01		
All engines	Qty: 4									470 445	C10			
ENGINE														
2.0 i	Petrol	85	02/93-06/99	2E, AGG										
Engine	Information				A10	A20	A40	A50	A70	C10 - C30	C20	E01		
Eng. 2E	version Bosch						806 094							
Eng. AGG	version Bosch						806 266		406 223					
All engines	version Bosch							906 121R						
All engines	ch. 6K-ZR132 109 ->, ch. 6K-ZR672 417 ->									490 414	C30			
All engines													359 965	
ENGINE														
2.0 i 16V	Petrol	110	08/96-06/99	ABF										
Engine	Information				A10	A20	A40	A50	A70	C10 - C30	C20	E01		
All engines	version Bosch						806 263	906 121R						
All engines										490 414	C30			
CORDOBA II														
ENGINE														
1.2	Petrol	47	10/02-06/06	AZQ, BME										
Engine	Information				A10	A20	A40	A50	A70	C10 - C30	C20	E01		
All engines	x 3, COIL ON PLUG, incl. spark plug connector									470 474	C10			
ENGINE														
1.2 12V	Petrol	51	05/06-11/09	BXV										
Engine	Information				A10	A20	A40	A50	A70	C10 - C30	C20	E01		
All engines	x 3, COIL ON PLUG, incl. spark plug connector									470 474	C10			
ENGINE														
1.4 16V	Petrol	55	09/02-12/07	BBY, BKY										
Engine	Information				A10	A20	A40	A50	A70	C10 - C30	C20	E01		
All engines	x 4, COIL ON PLUG, incl. spark plug connector									470 474	C10			
ENGINE														
1.4 16V	Petrol	59	05/06->	BUD										
Engine	Information				A10	A20	A40	A50	A70	C10 - C30	C20	E01		
All engines	Qty: 4									470 474	C10			
ENGINE														
1.4 16V	Petrol	63	05/06-11/09	BXW										
Engine	Information				A10	A20	A40	A50	A70	C10 - C30	C20	E01		
All engines	x 4, COIL ON PLUG, incl. spark plug connector									470 474	C10			
ENGINE														
1.4 16V	Petrol	74	10/02-11/09	BBZ										
Engine	Information				A10	A20	A40	A50	A70	C10 - C30	C20	E01		
All engines	x 4, COIL ON PLUG, incl. spark plug connector									470 474	C10			
ENGINE														
1.6	Petrol	74	04/03-11/09	BAH										
Engine	Information				A10	A20	A40	A50	A70	C10 - C30	C20	E01		
All engines										490 420	C30		360 723	
ENGINE														
1.6 16V	Petrol	77	11/06-11/09	BTS										
Engine	Information				A10	A20	A40	A50	A70	C10 - C30	C20	E01		
All engines	x 4, COIL ON PLUG, incl. spark plug connector									470 474	C10			
ENGINE														
2.0	Petrol	85	09/02-11/09	AZL, BBX										
Engine	Information				A10	A20	A40	A50	A70	C10 - C30	C20	E01		
All engines										490 420	C30		360 585	

A10 CONDENSER	A20 CONTACT SET	A40 DISTRIBUTOR CAP	A50 ROTOR	A70 PICK-UP
C10 COIL	C20 IGNITION MODULE	C30 ELECTRONIC IGNITION KIT	E01 IGNITION CABLE SET	

The present application list is a brief version. For the detailed information about the possibility of installation on a specific vehicle, please refer to our web-catalogue <http://catalogo.facet.eu/>

Vehicle	alim.	kW	Date	Engine	FUNCTIONS ON THE VEHICLE							
					A10	A20	A40	A50	A70	C10 - C30	C20	E01

EXEO

1.6	Petrol	75	03/09-09/10	ENGINE ALZ
-----	--------	----	-------------	---------------

Engine	Information	A10	A20	A40	A50	A70	C10 - C30	C20	E01
All engines	x 4, COIL ON PLUG, incl. spark plug connector						470 429	C10	
All engines							490 420	C30	360 585

1.8 T	Petrol	110	12/08-05/10	ENGINE CFMA
-------	--------	-----	-------------	----------------

Engine	Information	A10	A20	A40	A50	A70	C10 - C30	C20	E01
All engines	x 4, COIL ON PLUG, incl. spark plug connector						470 429	C10	
All engines							490 420	C30	

1.8 TSI	Petrol	118	05/10-05/13	ENGINE CDHB
---------	--------	-----	-------------	----------------

Engine	Information	A10	A20	A40	A50	A70	C10 - C30	C20	E01
All engines	x 4, ELDOR, Housing Colour:Black, COIL ON PLUG, incl. spark plug connector						470 426	C10	

1.8 TSI	Petrol	88	09/10-05/13	ENGINE CDHA
---------	--------	----	-------------	----------------

Engine	Information	A10	A20	A40	A50	A70	C10 - C30	C20	E01
All engines	x 4, ELDOR, Housing Colour:Black, COIL ON PLUG, incl. spark plug connector						470 426	C10	

2.0 TFSI	Petrol	147	03/09-05/13	ENGINE BWE
----------	--------	-----	-------------	---------------

Engine	Information	A10	A20	A40	A50	A70	C10 - C30	C20	E01
All engines	x 4, ELDOR, Housing Colour:Black, COIL ON PLUG, incl. spark plug connector						470 426	C10	

2.0 TFSI	Petrol	155	05/10-05/13	ENGINE CDND
----------	--------	-----	-------------	----------------

Engine	Information	A10	A20	A40	A50	A70	C10 - C30	C20	E01
All engines	x 4, ELDOR, Housing Colour:Black, COIL ON PLUG, incl. spark plug connector						470 426	C10	

FURA

0.9	Petrol	33	01/82-06/86	ENGINE 100 GL 3000
-----	--------	----	-------------	-----------------------

Engine	Information	A10	A20	A40	A50	A70	C10 - C30	C20	E01
All engines	version Ducellier	615 039		815 058	915 083R				
All engines	version Marelli	630 117	730 142		930 042R				
All engines	version Femsa		717 020	817 016	917 052R				
All engines							470 101D	C10	

IBIZA

1.0 SRE	Petrol	55	05/15-12/16	ENGINE CHYB
---------	--------	----	-------------	----------------

Engine	Information	A10	A20	A40	A50	A70	C10 - C30	C20	E01
All engines	x 3, BERU, ELDOR, COIL ON PLUG, incl. spark plug connector, Number of pins:4, incl. spark plug connector						470 599	C10	

1.2	Petrol	44	07/09-05/15	ENGINE CGPB
-----	--------	----	-------------	----------------

Engine	Information	A10	A20	A40	A50	A70	C10 - C30	C20	E01
All engines	x 3, COIL ON PLUG, incl. spark plug connector						470 474	C10	

1.2	Petrol	51	04/08-05/15	ENGINE BZG, CGPA
-----	--------	----	-------------	---------------------

Engine	Information	A10	A20	A40	A50	A70	C10 - C30	C20	E01
All engines	x 3, COIL ON PLUG, incl. spark plug connector						470 474	C10	

1.4	Petrol	63	07/08-05/15	ENGINE BXW, CGGB
-----	--------	----	-------------	---------------------

Engine	Information	A10	A20	A40	A50	A70	C10 - C30	C20	E01
All engines	x 4, COIL ON PLUG, incl. spark plug connector						470 474	C10	

1.6	Petrol	77	07/08-05/15	ENGINE BTS
-----	--------	----	-------------	---------------

Engine	Information	A10	A20	A40	A50	A70	C10 - C30	C20	E01
All engines	x 4, COIL ON PLUG, incl. spark plug connector						470 474	C10	

A10 CONDENSER	A20 CONTACT SET	A40 DISTRIBUTOR CAP	A50 ROTOR	A70 PICK-UP
C10 COIL	C20 IGNITION MODULE	C30 ELECTRONIC IGNITION KIT	E01 IGNITION CABLE SET	

Vehicle	alim.	kW	Date	Engine	FUNCTIONS ON THE VEHICLE							
					A10	A20	A40	A50	A70	C10 - C30	C20	E01

ENGINE				
1.6 SRE	Petrol	81	07/15-12/16	CWVA

Engine	Information	A10	A20	A40	A50	A70	C10 - C30	C20	E01
All engines	x 4, BERU, ELDOR, COIL ON PLUG, incl. spark plug connector, Number of pins:4, incl. spark plug connector						470 599	C10	

IBIZA I

ENGINE				
0.9	Petrol	29	08/90-05/93	09 NCA, 146 A 000

Engine	Information	A10	A20	A40	A50	A70	C10 - C30	C20	E01
Eng. 146 A 000	version Ducellier	615 039		815 058	915 091				
Eng. 146 A 000	version Marelli	630 128	730 146M	830 098	930 047R				
Eng. 146 A 000	version Femsas		730 132	817 014	917 052R				
Eng. 09 NCA	version MARELLI			830 076					
All engines					930 037				
Eng. 146 A 000							470 101D	C10	

ENGINE				
0.9	Petrol	32	08/86-05/93	146 A 000

Engine	Information	A10	A20	A40	A50	A70	C10 - C30	C20	E01
All engines	version Ducellier	615 039		815 058	915 091				
All engines	version Marelli	630 128	730 146M	830 098	930 047R				
All engines	version Femsas		730 132	817 014	917 052R				
All engines							470 101D	C10	

ENGINE				
1.2	Petrol	46	11/84-12/93	021 A 1000

Engine	Information	A10	A20	A40	A50	A70	C10 - C30	C20	E01
All engines	version Bosch			806 079	906 056R	406 193			
All engines	version Marelli			830 101	930 047R				
All engines									359 612

ENGINE				
1.2 i	Petrol	52	01/89-05/93	021 C.1000

Engine	Information	A10	A20	A40	A50	A70	C10 - C30	C20	E01
All engines	version Bosch			806 079	906 121R				
All engines									359 612

ENGINE				
1.5 i	Petrol	74	10/86-05/93	021 B.2000

Engine	Information	A10	A20	A40	A50	A70	C10 - C30	C20	E01
All engines	version Bosch			806 079	906 121R				
All engines									359 612

IBIZA II

ENGINE				
1.0	Petrol	33	03/93-09/96	AAU

Engine	Information	A10	A20	A40	A50	A70	C10 - C30	C20	E01
All engines	version Bosch			806 094	906 121R				
All engines							490 414	C30	359 725

ENGINE				
1.0 16V	Petrol	51	10/99-02/02	AST, AVZ

Engine	Information	A10	A20	A40	A50	A70	C10 - C30	C20	E01
All engines				806 266			490 414	C30	
All engines	version Bosch				906 121R	406 233			

ENGINE				
1.0 i	Petrol	37	09/96-02/02	AER, AUC

Engine	Information	A10	A20	A40	A50	A70	C10 - C30	C20	E01
Eng. AER	version Bosch			806 094	906 121R	406 223			
Eng. AER	version Marelli			830 116	930 057R				
Eng. AER							490 414	C30	360 640
Eng. AUC							490 420	C30	360 601

ENGINE				
1.3 i	Petrol	40	03/93-08/99	8C20HD0D, AAV

Engine	Information	A10	A20	A40	A50	A70	C10 - C30	C20	E01
Eng. AAV	version Bosch			806 094	906 121R				
Eng. 8C20HD0D	version Bosch			806 266	906 056R	406 234			
Eng. AAV							490 414	C30	359 725
Eng. 8C20HD0D							490 416	C30	

A10 CONDENSER	A20 CONTACT SET	A40 DISTRIBUTOR CAP	A50 ROTOR	A70 PICK-UP
C10 COIL	C20 IGNITION MODULE	C30 ELECTRONIC IGNITION KIT	E01 IGNITION CABLE SET	

FUNCTIONS ON THE VEHICLE

Vehicle	alim.	kW	Date	Engine								
---------	-------	----	------	--------	---	---	---	--	---	---	---	---

				ENGINE
1.4	Petrol	40	12/97-04/99	ANX

Engine	Information	A10	A20	A40	A50	A70	C10 - C30	C20	E01
All engines	version Bosch			806 094	906 121R	406 223			
All engines	version Marelli			830 116	930 057R				
All engines									360 640

				ENGINE
1.4 16V	Petrol	55	05/00-02/02	2CJXE, AUA

Engine	Information	A10	A20	A40	A50	A70	C10 - C30	C20	E01
All engines							490 420	C30	360 575

				ENGINE
1.4 i	Petrol	44	09/93-02/02	ABD, AEX, AKV, APQ, AUD

Engine	Information	A10	A20	A40	A50	A70	C10 - C30	C20	E01
Eng. ABD, AEX, AKV, APQ	version Bosch			806 094	906 121R	406 223			
Eng. ABD, AEX, AKV, APQ	version Marelli			830 116					
Eng. ABD, AEX, AKV, APQ	version Marelli, version Marelli				930 057R				
Eng. ABD, AEX							490 414	C30	
Eng. AUD							490 420	C30	360 601
Eng. ABD									360 364
Eng. AEX, AKV, APQ									360 640

				ENGINE
1.4 i 16V	Petrol	74	06/97-02/02	AFH, AQQ

Engine	Information	A10	A20	A40	A50	A70	C10 - C30	C20	E01
Eng. AFH	version Bosch			806 094	906 121R	406 223			
Eng. AFH	version Marelli			830 116	930 057R				
Eng. AFH							490 414	C30	
Eng. AQQ							490 420	C30	360 575

				ENGINE
1.6 i	Petrol	55	03/93-02/02	1F, ABU, AEE, ALM

Engine	Information	A10	A20	A40	A50	A70	C10 - C30	C20	E01
All engines	version Bosch			806 094	906 121R				
Eng. 1F	version Ducellier			815 068	915 099R				
Eng. AEE, ALM	version Marelli, version Marelli			830 116	930 057R				
Eng. 1F, AEE, ALM	version Bosch					406 223			
All engines							490 414	C30	
Eng. 1F									359 965
Eng. ABU	ch. 6K-ZR010 000 ->, ch. 6K-ZR510 000 ->								360 364
Eng. AEE, ALM									360 640

				ENGINE
1.6 i	Petrol	74	04/96-02/02	AFT, AKL

Engine	Information	A10	A20	A40	A50	A70	C10 - C30	C20	E01
Eng. AFT	version Bosch			806 094	906 121R	406 223			
Eng. AFT							490 414	C30	360 932
Eng. AKL							490 420	C30	360 484

				ENGINE
1.8 i	Petrol	66	03/93-08/99	ABS, ACC, ADZ

Engine	Information	A10	A20	A40	A50	A70	C10 - C30	C20	E01
All engines	version Bosch			806 094	906 121R				
All engines	version Ducellier			815 068	915 099R				
Eng. ABS, ADZ	version Bosch					406 223			
Eng. ADZ							470 159	C10	
All engines							490 414	C30	359 965

				ENGINE
1.8 i 16V	Petrol	95	11/93-08/96	148 D

Engine	Information	A10	A20	A40	A50	A70	C10 - C30	C20	E01
All engines	version Bosch			806 094	906 121R	406 223			
All engines							490 414	C30	

				ENGINE
1.8 T 20V Cupra	Petrol	115	07/00-02/02	AQX, AYP





Engine	Information	A10	A20	A40	A50	A70	C10 - C30	C20	E01
Eng. AYP	Qty: 4						470 429	C10	
Eng. AQX	Qty: 4						470 445	C10	

A10 CONDENSER	A20 CONTACT SET	A40 DISTRIBUTOR CAP	A50 ROTOR	A70 PICK-UP
C10 COIL	C20 IGNITION MODULE	C30 ELECTRONIC IGNITION KIT	E01 IGNITION CABLE SET	

Vehicle	alim.	kW	Date	Engine	FUNCTIONS ON THE VEHICLE									
					A10	A20	A40	A50	A70	C10 - C30	C20	E01		
ENGINE														
2.0 i	Petrol	85	03/93-08/99	2E, AGG										
Engine	Information				A10	A20	A40	A50	A70	C10 - C30	C20	E01		
All engines	version Bosch						806 094	906 121R						
Eng. AGG	version Bosch								406 223					
Eng. 2E	->ch. 6K-ZR132 108, ->ch. 6K-ZR672 416									470 159	C10			
All engines	ch. 6K-ZR132 109 ->, ch. 6K-ZR672 417 ->									490 414	C30			
All engines													359 965	
ENGINE														
2.0 i 16V	Petrol	110	08/96-08/99	ABF										
Engine	Information				A10	A20	A40	A50	A70	C10 - C30	C20	E01		
All engines	version Bosch						806 263	906 121R						
All engines										490 414	C30			
IBIZA III														
ENGINE														
1.2	Petrol	44	06/07-05/08	BBM										
Engine	Information				A10	A20	A40	A50	A70	C10 - C30	C20	E01		
All engines	x 3, COIL ON PLUG, incl. spark plug connector									470 431	C10			
ENGINE														
1.2	Petrol	47	02/02-06/06	AZQ, BME										
Engine	Information				A10	A20	A40	A50	A70	C10 - C30	C20	E01		
All engines	x 3, COIL ON PLUG, incl. spark plug connector									470 474	C10			
ENGINE														
1.2 12V	Petrol	51	05/06-11/09	BXV										
Engine	Information				A10	A20	A40	A50	A70	C10 - C30	C20	E01		
All engines	x 3, COIL ON PLUG, incl. spark plug connector									470 474	C10			
ENGINE														
1.4 16V	Petrol	55	02/02-12/07	BBY, BKY										
Engine	Information				A10	A20	A40	A50	A70	C10 - C30	C20	E01		
All engines	x 4, COIL ON PLUG, incl. spark plug connector									470 474	C10			
ENGINE														
1.4 16V	Petrol	63	05/06-11/09	BXW										
Engine	Information				A10	A20	A40	A50	A70	C10 - C30	C20	E01		
All engines	x 4, COIL ON PLUG, incl. spark plug connector									470 474	C10			
ENGINE														
1.4 16V	Petrol	74	02/02-11/09	AUB, BBZ										
Engine	Information				A10	A20	A40	A50	A70	C10 - C30	C20	E01		
All engines	ch. 6L2012770 ->, x 4, COIL ON PLUG, incl. spark plug connector									470 474	C10			
Eng. AUB										490 420	C30		360 575	
ENGINE														
1.6	Petrol	74	02/03-11/09	BAH										
Engine	Information				A10	A20	A40	A50	A70	C10 - C30	C20	E01		
All engines										490 420	C30		360 723	
ENGINE														
1.6 16V	Petrol	77	11/06-11/09	BTS										
Engine	Information				A10	A20	A40	A50	A70	C10 - C30	C20	E01		
All engines	x 4, COIL ON PLUG, incl. spark plug connector									470 474	C10			
ENGINE														
1.8 T Cupra R	Petrol	132	01/04-02/08	BBU, BLZ										
Engine	Information				A10	A20	A40	A50	A70	C10 - C30	C20	E01		
All engines	x 4, COIL ON PLUG, incl. spark plug connector									470 429	C10			
ENGINE														
1.8 T FR	Petrol	110	12/03-05/08	BJX, BKV										
Engine	Information				A10	A20	A40	A50	A70	C10 - C30	C20	E01		
All engines	x 4, COIL ON PLUG, incl. spark plug connector									470 429	C10			
ENGINE														
2.0	Petrol	85	04/02-11/09	AZL, BBX										
Engine	Information				A10	A20	A40	A50	A70	C10 - C30	C20	E01		
All engines										490 420	C30		360 585	

A10 CONDENSER	A20 CONTACT SET	A40 DISTRIBUTOR CAP	A50 ROTOR	A70 PICK-UP
C10 COIL	C20 IGNITION MODULE	C30 ELECTRONIC IGNITION KIT	E01 IGNITION CABLE SET	

The present application list is a brief version. For the detailed information about the possibility of installation on a specific vehicle, please refer to our web-catalogue <http://catalogo.facet.eu/>

					FUNCTIONS ON THE VEHICLE							
Vehicle	alim.	kW	Date	Engine								

IBIZA IV

				ENGINE
1.0	Petrol	55	05/15-06/17	CHYB

Engine	Information	A10	A20	A40	A50	A70	C10 - C30	C20	E01
All engines	x 3, BERU, ELDOR, COIL ON PLUG, incl. spark plug connector, Number of pins:4, incl. spark plug connector						470 599	C10	

				ENGINE
1.0 TSI	Petrol	70	05/15-06/17	CHZB

Engine	Information	A10	A20	A40	A50	A70	C10 - C30	C20	E01
All engines	x 3, BERU, ELDOR, COIL ON PLUG, incl. spark plug connector, Number of pins:4, incl. spark plug connector						470 599	C10	

				ENGINE
1.0 TSI	Petrol	81	05/15-06/17	CHZC

Engine	Information	A10	A20	A40	A50	A70	C10 - C30	C20	E01
All engines	x 3, BERU, ELDOR, COIL ON PLUG, incl. spark plug connector, Number of pins:4, incl. spark plug connector						470 599	C10	

				ENGINE
1.2	Petrol	44	07/09-05/15	CGPB

Engine	Information	A10	A20	A40	A50	A70	C10 - C30	C20	E01
All engines	x 3, COIL ON PLUG, incl. spark plug connector						470 474	C10	

				ENGINE
1.2	Petrol	51	03/08-05/15	BZG, CGPA, CJLB

Engine	Information	A10	A20	A40	A50	A70	C10 - C30	C20	E01
All engines	x 3, COIL ON PLUG, incl. spark plug connector						470 474	C10	

				ENGINE
1.2 LPG	Petrol/ Liquified Petroleum Gas (LPG)	51	03/08-05/11	BZG

Engine	Information	A10	A20	A40	A50	A70	C10 - C30	C20	E01
All engines	x 3, COIL ON PLUG, incl. spark plug connector						470 474	C10	

				ENGINE
1.2 TSI	Petrol	63	08/12-05/15	CBZA

Engine	Information	A10	A20	A40	A50	A70	C10 - C30	C20	E01
All engines							490 420	C30	358 248

				ENGINE
1.2 TSI	Petrol	66	05/15-06/17	CJZC

Engine	Information	A10	A20	A40	A50	A70	C10 - C30	C20	E01
All engines	x 4, BERU, ELDOR, COIL ON PLUG, incl. spark plug connector, Number of pins:4, incl. spark plug connector						470 599	C10	

				ENGINE
1.2 TSI	Petrol	77	09/10-05/15	CBZB

Engine	Information	A10	A20	A40	A50	A70	C10 - C30	C20	E01
All engines							490 420	C30	358 248

				ENGINE
1.2 TSI	Petrol	81	09/15-06/17	CJZD

Engine	Information	A10	A20	A40	A50	A70	C10 - C30	C20	E01
All engines	x 4, BERU, ELDOR, COIL ON PLUG, incl. spark plug connector, Number of pins:4, incl. spark plug connector						470 599	C10	

				ENGINE
1.4	Petrol	63	03/08-05/15	BXW, CGGB

Engine	Information	A10	A20	A40	A50	A70	C10 - C30	C20	E01
All engines	x 4, COIL ON PLUG, incl. spark plug connector						470 474	C10	

				ENGINE
1.4 LPG	Petrol/ Liquified Petroleum Gas (LPG)	63	03/08-05/11	BXW

Engine	Information	A10	A20	A40	A50	A70	C10 - C30	C20	E01
All engines	x 4, COIL ON PLUG, incl. spark plug connector						470 474	C10	

				ENGINE
1.4 TSI	Petrol	103	10/13-05/15	CPTA









Engine	Information	A10	A20	A40	A50	A70	C10 - C30	C20	E01
All engines	x 4, BERU, ELDOR, COIL ON PLUG, incl. spark plug connector, Number of pins:4, incl. spark plug connector						470 599	C10	

A10 CONDENSER	A20 CONTACT SET	A40 DISTRIBUTOR CAP	A50 ROTOR	A70 PICK-UP
C10 COIL	C20 IGNITION MODULE	C30 ELECTRONIC IGNITION KIT	E01 IGNITION CABLE SET	

Vehicle	alim.	kW	Date	Engine	FUNCTIONS ON THE VEHICLE												
					A10	A20	A40	A50	A70	C10 - C30	C20	E01					
1.4 TSI	Petrol	110	01/09-06/17	ENGINE CAVF, CNUB, CTHF, CTJB, CZEA													
Engine	Information				A10	A20	A40	A50	A70	C10 - C30	C20	E01					
Eng. CAVF, CNUB, CTHF, CTJB	x 4, COIL ON PLUG, incl. spark plug connector									470 474	C10						
Eng. CZEA	x 4, BERU, ELDOR, COIL ON PLUG, incl. spark plug connector, Number of pins:4, incl. spark plug connector									470 599	C10						
1.4 TSI Cupra	Petrol	132	06/09-05/15	ENGINE CAVE, CTHE, CTJC													
Engine	Information				A10	A20	A40	A50	A70	C10 - C30	C20	E01					
All engines	x 4, COIL ON PLUG, incl. spark plug connector									470 474	C10						
1.6	Petrol	77	05/08-05/15	ENGINE BTS													
Engine	Information				A10	A20	A40	A50	A70	C10 - C30	C20	E01					
All engines	x 4, COIL ON PLUG, incl. spark plug connector									470 474	C10						
1.6	Petrol	81	07/15-06/17	ENGINE CWVA													
Engine	Information				A10	A20	A40	A50	A70	C10 - C30	C20	E01					
All engines	x 4, BERU, ELDOR, COIL ON PLUG, incl. spark plug connector, Number of pins:4, incl. spark plug connector									470 599	C10						
1.6 LPG	Petrol/ Liquified Petro- leum Gas (LPG)	60	05/11-05/15	ENGINE CNKA													
Engine	Information				A10	A20	A40	A50	A70	C10 - C30	C20	E01					
All engines	x 4, COIL ON PLUG, incl. spark plug connector									470 474	C10						
1.6 SRE	Petrol	66	07/15->	ENGINE CWVB													
Engine	Information				A10	A20	A40	A50	A70	C10 - C30	C20	E01					
All engines	Qty: 4									470 599	C10						
1.6 SRE	Petrol	81	07/15->	ENGINE CWVA													
Engine	Information				A10	A20	A40	A50	A70	C10 - C30	C20	E01					
All engines	Qty: 4									470 599	C10						
1.8 TSI Cupra	Petrol	141	11/15-12/16	ENGINE DAJA													
Engine	Information				A10	A20	A40	A50	A70	C10 - C30	C20	E01					
All engines	x 4, BERU, ELDOR, COIL ON PLUG, incl. spark plug connector, Number of pins:4, incl. spark plug connector									470 599	C10						
2.0	Petrol	85	10/08-05/15	ENGINE CEKA													
Engine	Information				A10	A20	A40	A50	A70	C10 - C30	C20	E01					
All engines										490 420	C30		360 585				
IBIZA V																	
1.0	Petrol	48	07/17->	ENGINE CHYC													
Engine	Information				A10	A20	A40	A50	A70	C10 - C30	C20	E01					
All engines	x 3, BERU, x 3, COIL ON PLUG, ELDOR, COIL ON PLUG, incl. spark plug connector, incl. spark plug connector, Number of pins:4, incl. spark plug connector									470 599	C10						
1.0	Petrol	55	01/17->	ENGINE CHYB													
Engine	Information				A10	A20	A40	A50	A70	C10 - C30	C20	E01					
All engines	x 3, BERU, x 3, COIL ON PLUG, ELDOR, COIL ON PLUG, incl. spark plug connector, incl. spark plug connector, Number of pins:4, incl. spark plug connector									470 599	C10						
1.0 TGI	Petrol/ Com- pressed Natural Gas (CNG)	66	11/17->	ENGINE DBYA													
Engine	Information				A10	A20	A40	A50	A70	C10 - C30	C20	E01					
All engines	x 3, BERU, x 3, COIL ON PLUG, ELDOR, COIL ON PLUG, incl. spark plug connector, incl. spark plug connector, Number of pins:4, incl. spark plug connector									470 599	C10						
A10	CONDENSER	A20	CONTACT SET	A40	DISTRIBUTOR CAP	A50	ROTOR	A70	PICK-UP	C10	COIL	C20	IGNITION MODULE	C30	ELECTRONIC IGNITION KIT	E01	IGNITION CABLE SET

Vehicle	alim.	kW	Date	Engine	FUNCTIONS ON THE VEHICLE							
					A10	A20	A40	A50	A70	C10 - C30	C20	E01
ENGINE												
1.0 TSI	Petrol	70	01/17->	CHZL, DKLA, DLAC								
Engine	Information			A10	A20	A40	A50	A70	C10 - C30	C20	E01	
All engines	x 3, BERU, x 3, COIL ON PLUG, ELDOR, COIL ON PLUG, incl. spark plug connector, incl. spark plug connector, Number of pins:4, incl. spark plug connector								470 599	C10		
ENGINE												
1.0 TSI	Petrol	81	06/20->	DLAA								
Engine	Information			A10	A20	A40	A50	A70	C10 - C30	C20	E01	
All engines	x 3, HITACHI, x 3, COIL ON PLUG, ELDOR, COIL ON PLUG, incl. spark plug connector, incl. spark plug connector, Number of pins:4, incl. spark plug connector								470 599	C10		
ENGINE												
1.0 TSI	Petrol	85	01/17->	CHZJ, DKJA, DKRF								
Engine	Information			A10	A20	A40	A50	A70	C10 - C30	C20	E01	
All engines	x 3, BERU, x 3, COIL ON PLUG, ELDOR, COIL ON PLUG, incl. spark plug connector, incl. spark plug connector, Number of pins:4, incl. spark plug connector								470 599	C10		
ENGINE												
1.6	Petrol	81	05/17->	CWVA								
Engine	Information			A10	A20	A40	A50	A70	C10 - C30	C20	E01	
All engines	x 4, BERU, x 4, COIL ON PLUG, ELDOR, COIL ON PLUG, incl. spark plug connector, incl. spark plug connector, Number of pins:4, incl. spark plug connector								470 599	C10		
INCA												
ENGINE												
1.4 16V	Petrol	55	04/00-06/03	AUA								
Engine	Information			A10	A20	A40	A50	A70	C10 - C30	C20	E01	
All engines									490 420	C30	360 575	
ENGINE												
1.4 i	Petrol	44	11/95-06/03	AEX, AKV, APQ, AUD								
Engine	Information			A10	A20	A40	A50	A70	C10 - C30	C20	E01	
Eng. AEX, AKV, APQ	version Bosch, without cover					806 094						
Eng. AEX, AKV, APQ	version Bosch, with cover					806 266						
Eng. AEX, AKV, APQ	version Ducellier					815 068	915 099R					
Eng. AEX, AKV, APQ	version Marelli					830 116	930 057R					
Eng. AEX, AKV, APQ	version Bosch						906 121R	406 223				
Eng. AEX, AKV, APQ									490 414	C30	360 660	
Eng. AUD									490 420	C30	360 601	
ENGINE												
1.6 i	Petrol	55	11/95-09/00	1F, AEE								
Engine	Information			A10	A20	A40	A50	A70	C10 - C30	C20	E01	
All engines	version Bosch, without cover					806 094						
All engines	version Bosch, with cover					806 266						
All engines	version Ducellier					815 068	915 099R					
All engines	version Marelli					830 116	930 057R					
All engines	version Bosch						906 121R	406 223				
All engines									490 414	C30		
Eng. 1F											359 965	
Eng. AEE											360 660	
LEON I												
ENGINE												
1.4 16V	Petrol	55	11/99-06/06	2CJXE, AHW, AXP, BCA								
Engine	Information			A10	A20	A40	A50	A70	C10 - C30	C20	E01	
Eng. BCA	x 4, COIL ON PLUG, incl. spark plug connector								470 474	C10		
Eng. 2CJXE, AHW, AXP									490 420	C30	360 575	
ENGINE												
1.6	Petrol	74	11/99-06/06	AEH, AKL								
Engine	Information			A10	A20	A40	A50	A70	C10 - C30	C20	E01	
All engines									490 420	C30	360 484	
ENGINE												
1.6	Petrol	75	10/05-06/06	BFQ								
Engine	Information			A10	A20	A40	A50	A70	C10 - C30	C20	E01	
All engines									490 420	C30	360 585	
A10	CONDENSER	A20	CONTACT SET	A40	DISTRIBUTOR CAP	A50	ROTOR	A70	PICK-UP			
C10	COIL	C20	IGNITION MODULE	C30	ELECTRONIC IGNITION KIT	E01	IGNITION CABLE SET					

Vehicle	alim.	kW	Date	Engine	FUNCTIONS ON THE VEHICLE												
					A10	A20	A40	A50	A70	C10 - C30	C20	E01					
ENGINE																	
1.6 16 V	Petrol	77	09/00-06/06	AUS, AZD, BCB													
Engine	Information				A10	A20	A40	A50	A70	C10 - C30	C20	E01					
Eng. AZD, BCB	x 4, COIL ON PLUG, incl. spark plug connector									470 474	C10						
Eng. AUS										490 420	C30		360 575				
ENGINE																	
1.8 20V	Petrol	92	11/99-06/06	AGN, APG													
Engine	Information				A10	A20	A40	A50	A70	C10 - C30	C20	E01					
All engines										490 420	C30		360 489				
ENGINE																	
1.8 20V T	Petrol	132	11/99-06/06	APP, AUQ													
Engine	Information				A10	A20	A40	A50	A70	C10 - C30	C20	E01					
Eng. AUQ	x 4, COIL ON PLUG, incl. spark plug connector									470 429	C10						
Eng. APP	x 4, COIL ON PLUG, incl. spark plug connector									470 445	C10						
Eng. APP											465 076						
ENGINE																	
1.8 20V T 4	Petrol	132	11/99-06/06	AJQ, ARY													
Engine	Information				A10	A20	A40	A50	A70	C10 - C30	C20	E01					
Eng. ARY	x 4, COIL ON PLUG, incl. spark plug connector									470 429	C10						
Eng. AJQ	x 4, COIL ON PLUG, incl. spark plug connector									470 445	C10						
ENGINE																	
1.8 T Cupra R	Petrol	154	02/02-06/06	AMK													
Engine	Information				A10	A20	A40	A50	A70	C10 - C30	C20	E01					
All engines	x 4, COIL ON PLUG, incl. spark plug connector									470 429	C10						
ENGINE																	
1.8 T Cupra R	Petrol	165	07/03-06/06	BAM													
Engine	Information				A10	A20	A40	A50	A70	C10 - C30	C20	E01					
All engines	x 4, COIL ON PLUG, incl. spark plug connector									470 429	C10						
ENGINE																	
1.8 Turbo 4x4	Petrol	154	05/02-05/03	AMK													
Engine	Information				A10	A20	A40	A50	A70	C10 - C30	C20	E01					
All engines	Qty: 4									470 429	C10						
ENGINE																	
2.3 V5	Petrol	110	10/98-11/00	AGZ													
Engine	Information				A10	A20	A40	A50	A70	C10 - C30	C20	E01					
All engines											465 074						
ENGINE																	
2.3 VR5	Petrol	125	09/00-11/03	AQN													
Engine	Information				A10	A20	A40	A50	A70	C10 - C30	C20	E01					
All engines	Qty: 5									470 435	C10						
ENGINE																	
2.8	Petrol	150	05/02-06/04	BDE													
Engine	Information				A10	A20	A40	A50	A70	C10 - C30	C20	E01					
All engines	x 6, COIL ON PLUG, incl. spark plug connector									470 434	C10						
ENGINE																	
2.8 Cupra 4	Petrol	150	02/01-06/06	AUE, BDE													
Engine	Information				A10	A20	A40	A50	A70	C10 - C30	C20	E01					
All engines	x 6, COIL ON PLUG, incl. spark plug connector									470 434	C10						
LEON II																	
ENGINE																	
1.2 TSI	Petrol	77	02/10-12/12	CBZB													
Engine	Information				A10	A20	A40	A50	A70	C10 - C30	C20	E01					
All engines										490 420	C30		358 248				
ENGINE																	
1.4 16V	Petrol	63	06/06-12/12	BXW													
Engine	Information				A10	A20	A40	A50	A70	C10 - C30	C20	E01					
All engines	x 4, COIL ON PLUG, incl. spark plug connector									470 474	C10						
ENGINE																	
1.4 TSI	Petrol	92	11/07-12/12	CAXC													
Engine	Information				A10	A20	A40	A50	A70	C10 - C30	C20	E01					
All engines	x 4, COIL ON PLUG, incl. spark plug connector									470 474	C10						
A10	CONDENSER	A20	CONTACT SET	A40	DISTRIBUTOR CAP	A50	ROTOR	A70	PICK-UP	C10	COIL	C20	IGNITION MODULE	C30	ELECTRONIC IGNITION KIT	E01	IGNITION CABLE SET

					FUNCTIONS ON THE VEHICLE									
Vehicle	alim.	kW	Date	Engine	 A10	 A20	 A40	 A50	 A70	 C10 - C30	 C20	 E01		
ENGINE														
1.6	Petrol	75	07/05-12/12	BSE, BSF, CCSA, CMXA										
ENGINE														
Engine					Information									
Eng. BSE, BSF, CCSA											490 420	C30		
All engines													360 585	
ENGINE														
1.6 LPG	Petrol/ Liquified Petro- leum Gas (LPG)	75	12/09-12/12	CHGA										
ENGINE														
Engine					Information									
All engines											490 420	C30	360 585	
ENGINE														
1.6 MultiFuel	Petrol/ Ethanol	75	07/05-08/13	BSE, CCSA, CMXA										
ENGINE														
Engine					Information									
All engines											490 420	C30		
Eng. BSE, CMXA													360 585	
ENGINE														
1.8 TSI	Petrol	118	06/07-12/12	BZB, CDA										
ENGINE														
Engine					Information									
All engines					x 4, ELDOR, Housing Colour:Black, COIL ON PLUG, incl. spark plug connector							470 426	C10	
ENGINE														
2.0 Cupra R	Petrol	195	09/09-12/12	CDLA										
ENGINE														
Engine					Information									
All engines					x 4, ELDOR, Housing Colour:Black, COIL ON PLUG, incl. spark plug connector							470 426	C10	
ENGINE														
2.0 TFSI	Petrol	110	07/05-05/10	BLR, BLY, BVY, BVZ										
ENGINE														
Engine					Information									
All engines					x 4, ELDOR, Housing Colour:Black, COIL ON PLUG, incl. spark plug connector							470 426	C10	
ENGINE														
2.0 TFSI	Petrol	136	09/05-05/06	BWA										
ENGINE														
Engine					Information									
All engines					x 4, ELDOR, Housing Colour:Black, COIL ON PLUG, incl. spark plug connector							470 426	C10	
ENGINE														
2.0 TFSI	Petrol	147	05/05-03/09	BWA										
ENGINE														
Engine					Information									
All engines					x 4, ELDOR, Housing Colour:Black, COIL ON PLUG, incl. spark plug connector							470 426	C10	
ENGINE														
2.0 TFSI	Petrol	155	06/09-12/12	CCZB										
ENGINE														
Engine					Information									
All engines					x 4, COIL ON PLUG, incl. spark plug connector							470 474	C10	
ENGINE														
2.0 TFSI	Petrol	177	11/06-05/11	BWJ, CDLD										
ENGINE														
Engine					Information									
All engines					x 4, ELDOR, Housing Colour:Black, COIL ON PLUG, incl. spark plug connector							470 426	C10	
ENGINE														
LEON III														
ENGINE														
1.0 TSi	Petrol	63	09/18->	DKLB										
ENGINE														
Engine					Information									
All engines					x 3, BERU, ELDOR, COIL ON PLUG, incl. spark plug connector, Number of pins:4, incl. spark plug connector							470 599	C10	
ENGINE														
1.0 TSi	Petrol	85	05/15->	CHZD										
ENGINE														
Engine					Information									
All engines					x 3, BERU, ELDOR, x 3, BERU, COIL ON PLUG, ELDOR, COIL ON PLUG, incl. spark plug connector, Number of pins:4, incl. spark plug connector, Number of pins:4, incl. spark plug connector							470 599	C10	

A10 CONDENSER	A20 CONTACT SET	A40 DISTRIBUTOR CAP	A50 ROTOR	A70 PICK-UP
C10 COIL	C20 IGNITION MODULE	C30 ELECTRONIC IGNITION KIT	E01 IGNITION CABLE SET	

Vehicle	alim.	kW	Date	Engine	FUNCTIONS ON THE VEHICLE							
					A10	A20	A40	A50	A70	C10 - C30	C20	E01
ENGINE												
1.2 TSI	Petrol	63	12/12->	CJZB, CYVA								
Engine	Information			A10	A20	A40	A50	A70	C10 - C30	C20	E01	
All engines	x 4, BERU, ELDOR, COIL ON PLUG, incl. spark plug connector, Number of pins:4, incl. spark plug connector								470 599	C10		
ENGINE												
1.2 TSI	Petrol	77	01/13->	CJZA								
Engine	Information			A10	A20	A40	A50	A70	C10 - C30	C20	E01	
All engines	x 4, BERU, ELDOR, COIL ON PLUG, incl. spark plug connector, Number of pins:4, incl. spark plug connector								470 599	C10		
ENGINE												
1.2 TSI	Petrol	81	04/14->	CVVB								
Engine	Information			A10	A20	A40	A50	A70	C10 - C30	C20	E01	
All engines	x 4, BERU, ELDOR, COIL ON PLUG, incl. spark plug connector, Number of pins:4, incl. spark plug connector								470 599	C10		
ENGINE												
1.4 TGI	Petrol/ Compressed Natural Gas (CNG)	81	02/13->	CPWA								
Engine	Information			A10	A20	A40	A50	A70	C10 - C30	C20	E01	
All engines	x 4, BERU, ELDOR, COIL ON PLUG, incl. spark plug connector, Number of pins:4, incl. spark plug connector								470 599	C10		
ENGINE												
1.4 TSI	Petrol	103	09/12->	CHPA								
Engine	Information			A10	A20	A40	A50	A70	C10 - C30	C20	E01	
All engines	x 4, BERU, ELDOR, COIL ON PLUG, incl. spark plug connector, Number of pins:4, incl. spark plug connector								470 599	C10		
ENGINE												
1.4 TSI	Petrol	110	05/14->	CZDA, CZEA								
Engine	Information			A10	A20	A40	A50	A70	C10 - C30	C20	E01	
All engines	x 4, BERU, ELDOR, x 4, BERU, COIL ON PLUG, ELDOR, COIL ON PLUG, incl. spark plug connector, Number of pins:4, incl. spark plug connector, Number of pins:4, incl. spark plug connector								470 599	C10		
Eng. CZDA	Qty: 4								470 599	C10		
ENGINE												
1.4 TSI	Petrol	90	09/12->	CMBA, CXSA								
Engine	Information			A10	A20	A40	A50	A70	C10 - C30	C20	E01	
All engines	x 4, BERU, ELDOR, COIL ON PLUG, incl. spark plug connector, Number of pins:4, incl. spark plug connector								470 599	C10		
ENGINE												
1.4 TSI	Petrol	92	05/14->	CZCA								
Engine	Information			A10	A20	A40	A50	A70	C10 - C30	C20	E01	
All engines	x 4, BERU, ELDOR, COIL ON PLUG, incl. spark plug connector, Number of pins:4, incl. spark plug connector								470 599	C10		
ENGINE												
1.6 TSI	Petrol	81	05/15->	CWVA								
Engine	Information			A10	A20	A40	A50	A70	C10 - C30	C20	E01	
All engines	Qty: 4								470 599	C10		
ENGINE												
1.8 TFSI	Petrol	132	02/13->	CJSA								
Engine	Information			A10	A20	A40	A50	A70	C10 - C30	C20	E01	
All engines	->year 01/09/18, x 4, HITACHI, COIL ON PLUG, incl. spark plug connector								470 636	C10		
ENGINE												
1.8 TSI	Petrol	132	02/13->	CJSA								
Engine	Information			A10	A20	A40	A50	A70	C10 - C30	C20	E01	
All engines	->year 01/09/18, x 4, HITACHI, x 4, COIL ON PLUG, HITACHI, COIL ON PLUG, incl. spark plug connector, incl. spark plug connector								470 636	C10		
ENGINE												
1.8 TSI 4Drive	Petrol	132	11/14->	CJSA, CJSB								
Engine	Information			A10	A20	A40	A50	A70	C10 - C30	C20	E01	
All engines	->year 01/09/18, x 4, HITACHI, COIL ON PLUG, incl. spark plug connector								470 636	C10		

A10 CONDENSER	A20 CONTACT SET	A40 DISTRIBUTOR CAP	A50 ROTOR	A70 PICK-UP
C10 COIL	C20 IGNITION MODULE	C30 ELECTRONIC IGNITION KIT	E01 IGNITION CABLE SET	

The present application list is a brief version. For the detailed information about the possibility of installation on a specific vehicle, please refer to our web-catalogue <http://catalogo.facet.eu/>

Vehicle	alim.	kW	Date	Engine	FUNCTIONS ON THE VEHICLE							
					A10	A20	A40	A50	A70	C10 - C30	C20	E01

ENGINE				
2.0 TSI	Petrol	140	09/18->	DKZA

Engine	Information	A10	A20	A40	A50	A70	C10 - C30	C20	E01
All engines	01/10/18 ->, x 4, HITACHI, COIL ON PLUG, incl. spark plug connector						470 636	C10	

ENGINE				
2.0 TSI 4Drive	Petrol	140	09/18->	DKZA

Engine	Information	A10	A20	A40	A50	A70	C10 - C30	C20	E01
All engines	01/10/18 ->, x 4, HITACHI, COIL ON PLUG, incl. spark plug connector						470 636	C10	

LEON IV

ENGINE				
1.0 TSI	Petrol	66	03/20->	DLAB

Engine	Information	A10	A20	A40	A50	A70	C10 - C30	C20	E01
All engines	x 3, ELDOR, HITACHI, COIL ON PLUG, incl. spark plug connector, Number of pins:4, incl. spark plug connector						470 599	C10	

ENGINE				
1.0 TSI	Petrol	81	03/20->	DLAA

Engine	Information	A10	A20	A40	A50	A70	C10 - C30	C20	E01
All engines	x 3, ELDOR, HITACHI, COIL ON PLUG, incl. spark plug connector, Number of pins:4, incl. spark plug connector						470 599	C10	

ENGINE				
1.0 TSI Mild Hybrid	Petrol/ Electric	81	08/20->	DLAA

Engine	Information	A10	A20	A40	A50	A70	C10 - C30	C20	E01
All engines	x 3, ELDOR, HITACHI, x 3, x 4, COIL ON PLUG, ELDOR, COIL ON PLUG, incl. spark plug connector, incl. spark plug connector, Number of pins:4, incl. spark plug connector						470 599	C10	

ENGINE				
1.4 TSI e-Hybrid	Petrol/ Electric	110	05/20->	DGEA

Engine	Information	A10	A20	A40	A50	A70	C10 - C30	C20	E01
All engines	x 4, ELDOR, COIL ON PLUG, Number of pins:4, incl. spark plug connector						470 599	C10	

ENGINE				
1.4 TSI e-Hybrid	Petrol/ Electric	150	05/20->	DGEA

Engine	Information	A10	A20	A40	A50	A70	C10 - C30	C20	E01
All engines	x 4, ELDOR, COIL ON PLUG, Number of pins:4, incl. spark plug connector						470 599	C10	

ENGINE				
2.0 TFSI	Petrol	140	03/21->	DNNA

Engine	Information	A10	A20	A40	A50	A70	C10 - C30	C20	E01
All engines	x 4, HITACHI, COIL ON PLUG, incl. spark plug connector						470 636	C10	

MALAGA

ENGINE				
1.2	Petrol	44	05/85-12/93	021 A 1000

Engine	Information	A10	A20	A40	A50	A70	C10 - C30	C20	E01
All engines	version Bosch			806 079	906 056R	406 193			
All engines	version Marelli			830 101	930 047R				
All engines									359 612

ENGINE				
1.5	Petrol	63	05/85-12/93	021 A 2000

Engine	Information	A10	A20	A40	A50	A70	C10 - C30	C20	E01
All engines	version Bosch			806 079	906 056R	406 193			
All engines	version Marelli			830 101	930 047R				
All engines									359 612

ENGINE				
1.5 i	Petrol	74	01/87-12/93	021 B.2000

Engine	Information	A10	A20	A40	A50	A70	C10 - C30	C20	E01
All engines	version Bosch			806 079	906 121R				

MARBELLA

ENGINE				
0.8	Petrol	25	08/86-12/93	5K9K 718

Engine	Information	A10	A20	A40	A50	A70	C10 - C30	C20	E01
All engines	version Femsa		717 020	817 016, 817 029	917 052R				
All engines	version Marelli		730 142		930 042R				

A10 CONDENSER	A20 CONTACT SET	A40 DISTRIBUTOR CAP	A50 ROTOR	A70 PICK-UP
C10 COIL	C20 IGNITION MODULE	C30 ELECTRONIC IGNITION KIT	E01 IGNITION CABLE SET	

Vehicle	alim.	kW	Date	Engine	FUNCTIONS ON THE VEHICLE									
					A10	A20	A40	A50	A70	C10 - C30	C20	E01		
MARBELLA														
0.8	Petrol	25	08/86-12/93	ENGINE 5K9K 718										
Engine		Information			A10	A20	A40	A50	A70	C10 - C30	C20	E01		
All engines										470 101D	C10			
0.9	Petrol	29	01/87-12/93	ENGINE 09 NCA, 100 GL 7000										
Engine		Information			A10	A20	A40	A50	A70	C10 - C30	C20	E01		
Eng. 09 NCA		version Marelli			630 128	730 146M	830 098	930 047R						
Eng. 09 NCA		version Femsa				730 132	817 014	917 052R						
Eng. 100 GL 7000		version MARELLI					830 076							
All engines								930 037						
Eng. 09 NCA										470 101D	C10			
0.9	Petrol	32	07/97-10/98	ENGINE 08 NCB										
Engine		Information			A10	A20	A40	A50	A70	C10 - C30	C20	E01		
All engines		version MARELLI					830 076							
0.9 Cat	Petrol	29	01/87-11/96	ENGINE 09 NCB, 100 GL 7000										
Engine		Information			A10	A20	A40	A50	A70	C10 - C30	C20	E01		
All engines		version MARELLI					830 076							
0.9 Cat	Petrol	30	11/96-10/98	ENGINE 08 NCB										
Engine		Information			A10	A20	A40	A50	A70	C10 - C30	C20	E01		
All engines		version MARELLI					830 076							
All engines		Qty: 2								470 196	C10			
MII														
1.0	Petrol	44	10/11-07/19	ENGINE CHYA										
Engine		Information			A10	A20	A40	A50	A70	C10 - C30	C20	E01		
All engines		x 3, x 4, BERU, ELDOR, HITACHI, COIL ON PLUG, incl. spark plug connector, Number of pins:4, incl. spark plug connector								470 599	C10			
1.0	Petrol	55	10/11-07/19	ENGINE CHYB										
Engine		Information			A10	A20	A40	A50	A70	C10 - C30	C20	E01		
All engines		x 3, x 4, BERU, ELDOR, HITACHI, COIL ON PLUG, incl. spark plug connector, Number of pins:4, incl. spark plug connector								470 599	C10			
1.0 EcoFuel	Petrol/ Com- pressed Natural Gas (CNG)	50	10/12-07/19	ENGINE CPGA										
Engine		Information			A10	A20	A40	A50	A70	C10 - C30	C20	E01		
All engines		x 3, x 4, BERU, ELDOR, HITACHI, COIL ON PLUG, incl. spark plug connector, Number of pins:4, incl. spark plug connector								470 599	C10			
PANDA														
0.9	Petrol	31	10/80-12/86	ENGINE 100 GL 3000										
Engine		Information			A10	A20	A40	A50	A70	C10 - C30	C20	E01		
All engines		version Femsa				730 132	817 014	917 052R						
All engines										470 101D	C10			
RONDA														
1.2	Petrol	47	08/83-05/85	ENGINE 021 A 1000										
Engine		Information			A10	A20	A40	A50	A70	C10 - C30	C20	E01		
All engines		version Femsa						917 052						
All engines		version Marelli						930 054R						
1.6	Petrol	68	08/83-09/85	ENGINE 138 AR6.000										
Engine		Information			A10	A20	A40	A50	A70	C10 - C30	C20	E01		
All engines		version Femsa						917 052						

A10 CONDENSER	A20 CONTACT SET	A40 DISTRIBUTOR CAP	A50 ROTOR	A70 PICK-UP
C10 COIL	C20 IGNITION MODULE	C30 ELECTRONIC IGNITION KIT	E01 IGNITION CABLE SET	

The present application list is a brief version. For the detailed information about the possibility of installation on a specific vehicle, please refer to our web-catalogue <http://catalogo.facet.eu/>

Vehicle	alim.	kW	Date	Engine	FUNCTIONS ON THE VEHICLE							
					A10	A20	A40	A50	A70	C10 - C30	C20	E01

TARRACO

				ENGINE
1.4 e-HYBRID	Petrol/ Electric	180	02/21->	DGEA

Engine	Information	A10	A20	A40	A50	A70	C10 - C30	C20	E01
All engines	x 4, ELDOR, COIL ON PLUG, incl. spark plug connector, Number of pins:4, incl. spark plug connector						470 599	C10	

				ENGINE
1.4 TSI Plug in Hybrid	Petrol/ Electric	110	02/21->	DGEA

Engine	Information	A10	A20	A40	A50	A70	C10 - C30	C20	E01
All engines	x 4, ELDOR, COIL ON PLUG, incl. spark plug connector, Number of pins:4, incl. spark plug connector						470 599	C10	

				ENGINE
2.0 TFSI 4Drive	Petrol	180	01/21->	DNPA

Engine	Information	A10	A20	A40	A50	A70	C10 - C30	C20	E01
All engines	x 4, HITACHI, COIL ON PLUG, incl. spark plug connector						470 636	C10	

				ENGINE
2.0 TSI 4Drive	Petrol	140	11/18->	DKZA

Engine	Information	A10	A20	A40	A50	A70	C10 - C30	C20	E01
All engines	x 4, HITACHI, COIL ON PLUG, incl. spark plug connector						470 636	C10	

TERRA

				ENGINE
0.9	Petrol	29	02/87-12/96	09 NCA

Engine	Information	A10	A20	A40	A50	A70	C10 - C30	C20	E01
All engines	version Marelli	630 128	730 146M	830 098	930 047R				
All engines	version Fems		730 132	817 014	917 052R				
All engines							470 101D	C10	

				ENGINE
0.9 Cat	Petrol	29	02/92-12/94	09 NCB

Engine	Information	A10	A20	A40	A50	A70	C10 - C30	C20	E01
All engines	Qty: 2						470 196	C10	

TOLEDO I

				ENGINE
1.6 i	Petrol	52	05/91-12/93	1F

Engine	Information	A10	A20	A40	A50	A70	C10 - C30	C20	E01
All engines	version Bosch, distr. num. 050 905 205 AH			806 094	906 121R	406 223			
All engines	version Bosch, distr. num. 051 905 205			806 266	906 055R	406 159			
All engines	->ch. 1L-ZR001 000						470 159	C10	465 007
All engines	ch. 1L-ZR001 001 ->						490 414	C30	
All engines									359 965

				ENGINE
1.6 i	Petrol	54	05/91-03/99	1F, ABN, EZ

Engine	Information	A10	A20	A40	A50	A70	C10 - C30	C20	E01
All engines	version Bosch, distr. num. 050 905 205 AH			806 094					
Eng. 1F	version Bosch, distr. num. 051 905 205			806 266		406 159			
All engines	version Bosch, distr. num. 051 905 205				906 055R				
Eng. 1F	version Bosch, distr. num. 050 905 205 AH				906 121R	406 223			
All engines	->ch. 1L-ZR001 000						470 159	C10	
All engines	ch. 1L-ZR001 001 ->						490 414	C30	
Eng. 1F	->ch. 1L-ZR001 000								465 007
Eng. ABN, EZ	->ch. 1L-ZD304 850								359 725
All engines	ch. 1L-ZD304 851 ->								359 965

				ENGINE
1.6 i	Petrol	55	01/93-03/99	1F

Engine	Information	A10	A20	A40	A50	A70	C10 - C30	C20	E01
All engines	version Bosch, distr. num. 050 905 205 AH			806 094	906 121R	406 223			
All engines	version Bosch, distr. num. 051 905 205			806 266	906 055R	406 159			
All engines	->ch. 1L-ZR001 000						470 159	C10	465 007
All engines	ch. 1L-ZR001 001 ->						490 414	C30	
All engines									359 965

A10 CONDENSER	A20 CONTACT SET	A40 DISTRIBUTOR CAP	A50 ROTOR	A70 PICK-UP
C10 COIL	C20 IGNITION MODULE	C30 ELECTRONIC IGNITION KIT	E01 IGNITION CABLE SET	

Vehicle	alim.	kW	Date	Engine	FUNCTIONS ON THE VEHICLE							
					A10	A20	A40	A50	A70	C10 - C30	C20	E01

				ENGINE
1.6 i	Petrol	74	11/96-03/99	AFT

Engine	Information	A10	A20	A40	A50	A70	C10 - C30	C20	E01
All engines	version Bosch			806 266	906 121R	406 223			
All engines							490 414	C30	360 937

				ENGINE
1.8 16V	Petrol	92	05/91-03/99	PL

Engine	Information	A10	A20	A40	A50	A70	C10 - C30	C20	E01
All engines	version Bosch			806 094	906 121R	406 233			
All engines							470 125	C10	465 007

				ENGINE
1.8 16V	Petrol	98	05/91-03/99	KR

Engine	Information	A10	A20	A40	A50	A70	C10 - C30	C20	E01
All engines	version Bosch			806 094	906 121R	406 233			
All engines							470 125	C10	

				ENGINE
1.8 GT	Petrol	102	05/91-11/92	KR

Engine	Information	A10	A20	A40	A50	A70	C10 - C30	C20	E01
All engines	version Bosch			806 094	906 121R	406 233			
All engines							470 125	C10	

				ENGINE
1.8 i	Petrol	65	05/91-12/96	RP

Engine	Information	A10	A20	A40	A50	A70	C10 - C30	C20	E01
All engines	version Bosch, distr. num. 050 905 205 AH			806 094	906 121R	406 223			
All engines	version Bosch, distr. num. 050 905 205 A			806 266	906 055R	406 159			
All engines							470 125	C10	465 007
All engines	->ch. 1L-ZD304 850								359 725
All engines	ch. 1L-ZD304 851 ->								359 965

				ENGINE
1.8 i	Petrol	66	11/93-12/96	ABS, ADZ

Engine	Information	A10	A20	A40	A50	A70	C10 - C30	C20	E01
Eng. ABS	version Bosch			806 094		406 223			
Eng. ADZ	version Bosch			806 266					
Eng. ADZ	version Ducellier			815 068	915 099R				
All engines	version Bosch				906 121R				
Eng. ABS							470 159	C10	
All engines	resist. 3700 ohm						490 414	C30	
Eng. ADZ	resist. 3300 ohm						490 416	C30	
All engines	->ch. 1L-ZD304 850								359 725
Eng. ABS	ch. 1L-ZD304 851 ->								359 965

				ENGINE
2.0 i	Petrol	85	05/91-03/99	2E, AGG

Engine	Information	A10	A20	A40	A50	A70	C10 - C30	C20	E01
Eng. 2E	version Bosch			806 094					
Eng. AGG	version Bosch			806 266		406 223			
All engines	version Bosch				906 121R				
Eng. 2E							470 159	C10	
All engines	resist. 3700 ohm						490 414	C30	
Eng. AGG	resist. 3300 ohm						490 416	C30	
Eng. 2E	->ch. 1L-ZD304 850								359 725
All engines	ch. 1L-ZD304 851 ->								359 965

				ENGINE
2.0 i 16V	Petrol	110	11/93-03/99	ABF









Engine	Information	A10	A20	A40	A50	A70	C10 - C30	C20	E01
All engines	version Bosch			806 263		406 223			
All engines							470 159, 490 414	C10, C30	

TOLEDO II

				ENGINE
1.4 16V	Petrol	55	01/00-05/02	2CJXE, AHW, AXP, BCA

Engine	Information	A10	A20	A40	A50	A70	C10 - C30	C20	E01
Eng. BCA	x 4, COIL ON PLUG, incl. spark plug connector						470 474	C10	
Eng. 2CJXE, AHW, AXP							490 420	C30	360 575

A10 CONDENSER	A20 CONTACT SET	A40 DISTRIBUTOR CAP	A50 ROTOR	A70 PICK-UP
C10 COIL	C20 IGNITION MODULE	C30 ELECTRONIC IGNITION KIT	E01 IGNITION CABLE SET	

				FUNCTIONS ON THE VEHICLE								
Vehicle	alim.	kW	Date	Engine	 A10	 A20	 A40	 A50	 A70	 C10 - C30	 C20	 E01
ENGINE												
1.6	Petrol	74	10/98-07/04	AEH, AKL, APF								
Engine	Information				A10	A20	A40	A50	A70	C10 - C30	C20	E01
All engines										490 420	C30	360 484
ENGINE												
1.6 16V	Petrol	77	06/00-05/06	AUS, AZD, BCB								
Engine	Information				A10	A20	A40	A50	A70	C10 - C30	C20	E01
Eng. AZD, BCB	x 4, COIL ON PLUG, incl. spark plug connector									470 474	C10	
Eng. AUS										490 420	C30	360 575
ENGINE												
1.8 20V	Petrol	92	10/98-07/04	AGN, APG								
Engine	Information				A10	A20	A40	A50	A70	C10 - C30	C20	E01
All engines										490 420	C30	360 489
ENGINE												
1.8 20VT	Petrol	132	09/00-07/04	APP, AUQ								
Engine	Information				A10	A20	A40	A50	A70	C10 - C30	C20	E01
Eng. APP	x 4, COIL ON PLUG, incl. spark plug connector									470 429	C10	
Eng. AUQ	x 4, COIL ON PLUG, incl. spark plug connector									470 445	C10	
ENGINE												
1.8 4x4	Petrol	132	05/01-04/04	AJQ								
Engine	Information				A10	A20	A40	A50	A70	C10 - C30	C20	E01
All engines	Qty: 4									470 445	C10	
ENGINE												
2.3 V5	Petrol	110	10/98-11/00	AGZ								
Engine	Information				A10	A20	A40	A50	A70	C10 - C30	C20	E01
All engines											465 074	
ENGINE												
2.3 V5 20V	Petrol	125	09/00-11/03	AQN								
Engine	Information				A10	A20	A40	A50	A70	C10 - C30	C20	E01
All engines	x 5, COIL ON PLUG									470 435	C10	
TOLEDO III												
ENGINE												
1.4 16V	Petrol	63	05/06-05/09	BXW								
Engine	Information				A10	A20	A40	A50	A70	C10 - C30	C20	E01
All engines	x 4, COIL ON PLUG, incl. spark plug connector									470 474	C10	
ENGINE												
1.6	Petrol	75	10/04-05/09	BGU, BSE, BSF, CCSA								
Engine	Information				A10	A20	A40	A50	A70	C10 - C30	C20	E01
All engines										490 420	C30	
Eng. BGU, BSE, BSF												360 585
ENGINE												
1.8 TFSI	Petrol	118	01/07-05/09	BYT, BZB, CDAA								
Engine	Information				A10	A20	A40	A50	A70	C10 - C30	C20	E01
All engines	x 4, ELDOR, Housing Colour:Black, COIL ON PLUG, incl. spark plug connector									470 426	C10	
ENGINE												
2.0 FSI	Petrol	110	10/04-05/09	BLR, BLY, BVY, BVZ								
Engine	Information				A10	A20	A40	A50	A70	C10 - C30	C20	E01
All engines	x 4, ELDOR, Housing Colour:Black, COIL ON PLUG, incl. spark plug connector									470 426	C10	
ENGINE												
2.0 TFSI	Petrol	147	11/05-05/09	BWA								
Engine	Information				A10	A20	A40	A50	A70	C10 - C30	C20	E01
All engines	x 4, ELDOR, Housing Colour:Black, COIL ON PLUG, incl. spark plug connector									470 426	C10	
TOLEDO IV												
ENGINE												
1.0 TSI	Petrol	70	05/17-04/19	CHZB, DKLD								
Engine	Information				A10	A20	A40	A50	A70	C10 - C30	C20	E01
All engines	x 3, BERU, ELDOR, COIL ON PLUG, incl. spark plug connector, Number of pins:4, incl. spark plug connector									470 599	C10	

A10 CONDENSER	A20 CONTACT SET	A40 DISTRIBUTOR CAP	A50 ROTOR	A70 PICK-UP
C10 COIL	C20 IGNITION MODULE	C30 ELECTRONIC IGNITION KIT	E01 IGNITION CABLE SET	

Vehicle	alim.	kW	Date	Engine	FUNCTIONS ON THE VEHICLE								
					A10	A20	A40	A50	A70	C10 - C30	C20	E01	
1.0 TSI	Petrol	81	05/17-04/19	ENGINE CHZC, DKRC									
Engine	Information				A10	A20	A40	A50	A70	C10 - C30	C20	E01	
All engines	x 3, BERU, ELDOR, COIL ON PLUG, incl. spark plug connector, Number of pins:4, incl. spark plug connector									470 599	C10		
1.2	Petrol	55	07/12-06/15	ENGINE CGPC									
Engine	Information				A10	A20	A40	A50	A70	C10 - C30	C20	E01	
All engines	x 3, COIL ON PLUG, incl. spark plug connector									470 474	C10		
1.2 TSI	Petrol	63	07/12-06/15	ENGINE CBZA									
Engine	Information				A10	A20	A40	A50	A70	C10 - C30	C20	E01	
All engines										490 420	C30	358 248	
1.2 TSI	Petrol	66	05/15-05/17	ENGINE CJZC									
Engine	Information				A10	A20	A40	A50	A70	C10 - C30	C20	E01	
All engines	x 4, BERU, ELDOR, COIL ON PLUG, incl. spark plug connector, Number of pins:4, incl. spark plug connector									470 599	C10		
1.2 TSI	Petrol	77	07/12-06/15	ENGINE CBZB									
Engine	Information				A10	A20	A40	A50	A70	C10 - C30	C20	E01	
All engines										490 420	C30	358 248	
1.2 TSI	Petrol	81	05/15-05/17	ENGINE CJZD									
Engine	Information				A10	A20	A40	A50	A70	C10 - C30	C20	E01	
All engines	x 4, BERU, ELDOR, COIL ON PLUG, incl. spark plug connector, Number of pins:4, incl. spark plug connector									470 599	C10		
1.4 TSI	Petrol	90	07/12-06/15	ENGINE CAXA									
Engine	Information				A10	A20	A40	A50	A70	C10 - C30	C20	E01	
All engines	x 4, COIL ON PLUG, incl. spark plug connector									470 474	C10		
1.4 TSI	Petrol	92	05/15-04/19	ENGINE CZCA									
Engine	Information				A10	A20	A40	A50	A70	C10 - C30	C20	E01	
All engines	x 4, BERU, ELDOR, COIL ON PLUG, incl. spark plug connector, Number of pins:4, incl. spark plug connector									470 599	C10		
1.6	Petrol	77	07/13-06/15	ENGINE CFNA									
Engine	Information				A10	A20	A40	A50	A70	C10 - C30	C20	E01	
All engines	x 4, COIL ON PLUG, incl. spark plug connector									470 474	C10		
1.6	Petrol	81	05/15-04/19	ENGINE CWVA									
Engine	Information				A10	A20	A40	A50	A70	C10 - C30	C20	E01	
All engines	x 4, BERU, ELDOR, COIL ON PLUG, incl. spark plug connector, Number of pins:4, incl. spark plug connector									470 599	C10		

A10 CONDENSER	A20 CONTACT SET	A40 DISTRIBUTOR CAP	A50 ROTOR	A70 PICK-UP
C10 COIL	C20 IGNITION MODULE	C30 ELECTRONIC IGNITION KIT	E01 IGNITION CABLE SET	

The present application list is a brief version. For the detailed information about the possibility of installation on a specific vehicle, please refer to our web-catalogue <http://catalogo.facet.eu/>

Vehicle	alim.	kW	Date	Engine	FUNCTIONS ON THE VEHICLE							
					A10	A20	A40	A50	A70	C10 - C30	C20	E01

105,120

1.0 105 S, L	Petrol	32	02/88-12/90	ENGINE	742.10
--------------	--------	----	-------------	--------	--------

Engine	Information	A10	A20	A40	A50	A70	C10 - C30	C20	E01
All engines	01/08/83 ->, version PAL		736 045	838 242	938 262R				

1.0 105 S, L	Petrol	34	08/76-12/90	ENGINE	742.10
--------------	--------	----	-------------	--------	--------

Engine	Information	A10	A20	A40	A50	A70	C10 - C30	C20	E01
All engines	01/08/83 ->, version PAL		736 045	838 242	938 262R				

1.0 105 S, L, GL	Petrol	33	08/76-08/83	ENGINE	742.10
------------------	--------	----	-------------	--------	--------

Engine	Information	A10	A20	A40	A50	A70	C10 - C30	C20	E01
All engines	01/08/83 ->, version PAL		736 045	838 242	938 262R				

1.0 105 S, L, LS	Petrol	33	10/83-12/90	ENGINE	742.10
------------------	--------	----	-------------	--------	--------

Engine	Information	A10	A20	A40	A50	A70	C10 - C30	C20	E01
All engines	01/08/83 ->, version PAL		736 045	838 242	938 262R				

1.2 120 GLS	Petrol	43	02/83-12/90	ENGINE	742.12X
-------------	--------	----	-------------	--------	---------

Engine	Information	A10	A20	A40	A50	A70	C10 - C30	C20	E01
All engines	01/08/83 ->, version PAL		736 045	838 242	938 262R				

1.2 120 L	Petrol	35	08/87-12/90	ENGINE	742.12
-----------	--------	----	-------------	--------	--------

Engine	Information	A10	A20	A40	A50	A70	C10 - C30	C20	E01
All engines	01/08/83 ->, version PAL		736 045	838 242	938 262R				

1.2 120 L	Petrol	38	08/76-12/90	ENGINE	742.12, 742.12X
-----------	--------	----	-------------	--------	-----------------

Engine	Information	A10	A20	A40	A50	A70	C10 - C30	C20	E01
All engines	01/08/83 ->, version PAL		736 045	838 242	938 262R				

1.2 120 LS	Petrol	43	08/76-12/90	ENGINE	742.12X
------------	--------	----	-------------	--------	---------

Engine	Information	A10	A20	A40	A50	A70	C10 - C30	C20	E01
All engines	01/08/83 ->, version PAL		736 045	838 242	938 262R				

CITIGO

1.0	Petrol	44	10/11-08/19	ENGINE	CHYA
-----	--------	----	-------------	--------	------

Engine	Information	A10	A20	A40	A50	A70	C10 - C30	C20	E01
All engines	x 3, BERU, ELDOR, HITACHI, COIL ON PLUG, incl. spark plug connector, Number of pins:4, incl. spark plug connector						470 599	C10	

1.0	Petrol	55	10/11-08/19	ENGINE	CHYB
-----	--------	----	-------------	--------	------

Engine	Information	A10	A20	A40	A50	A70	C10 - C30	C20	E01
All engines	x 3, BERU, ELDOR, HITACHI, COIL ON PLUG, incl. spark plug connector, Number of pins:4, incl. spark plug connector						470 599	C10	

1.0 CNG	CNG	50	11/12-08/19	ENGINE	CPGA
---------	-----	----	-------------	--------	------

Engine	Information	A10	A20	A40	A50	A70	C10 - C30	C20	E01
All engines	x 3, x 4, BERU, ELDOR, HITACHI, COIL ON PLUG, incl. spark plug connector, Number of pins:4, incl. spark plug connector						470 599	C10	

FABIA

1.0 TSI	Petrol	70	06/21->	ENGINE	DLAC
---------	--------	----	---------	--------	------

Engine	Information	A10	A20	A40	A50	A70	C10 - C30	C20	E01
All engines	x 3, version 1, version 2, ELDOR, COIL ON PLUG, incl. spark plug connector						470 599	C10	

1.0 TSI	Petrol	81	06/21->	ENGINE	DLAA
---------	--------	----	---------	--------	------

Engine	Information	A10	A20	A40	A50	A70	C10 - C30	C20	E01
All engines	x 3, version 1, version 2, ELDOR, COIL ON PLUG, incl. spark plug connector						470 599	C10	

A10 CONDENSER	A20 CONTACT SET	A40 DISTRIBUTOR CAP	A50 ROTOR	A70 PICK-UP
C10 COIL	C20 IGNITION MODULE	C30 ELECTRONIC IGNITION KIT	E01 IGNITION CABLE SET	

Vehicle	alim.	kW	Date	Engine	FUNCTIONS ON THE VEHICLE							
					A10	A20	A40	A50	A70	C10 - C30	C20	E01

FABIA I









				ENGINE									
1.2	Petrol	40	07/01-12/07	AWY, BMD									
Engine	Information			A10	A20	A40	A50	A70	C10 - C30	C20	E01		
All engines	x 3, COIL ON PLUG, incl. spark plug connector								470 431	C10			
1.2	Petrol	47	01/03-03/08	AZQ, BME									
Engine	Information			A10	A20	A40	A50	A70	C10 - C30	C20	E01		
All engines	x 3, COIL ON PLUG, incl. spark plug connector								470 474	C10			
1.4	Petrol	55	05/04-12/07	BKY									
Engine	Information			A10	A20	A40	A50	A70	C10 - C30	C20	E01		
All engines	x 4, COIL ON PLUG, incl. spark plug connector								470 474	C10			
1.4 16V	Petrol	55	10/99-03/08	AUA, BBY, BKY									
Engine	Information			A10	A20	A40	A50	A70	C10 - C30	C20	E01		
Eng. BBY, BKY	ch. 6Y2535495 ->, x 4, COIL ON PLUG, incl. spark plug connector								470 474	C10			
Eng. AUA, BBY									490 420	C30			
Eng. AUA, BBY	->year 30/04/02											360 575	
1.4 16V	Petrol	59	04/06-12/07	BUD									
Engine	Information			A10	A20	A40	A50	A70	C10 - C30	C20	E01		
All engines	x 4, COIL ON PLUG, incl. spark plug connector								470 474	C10			
1.4 16V	Petrol	74	12/99-03/08	AUB, BBZ									
Engine	Information			A10	A20	A40	A50	A70	C10 - C30	C20	E01		
All engines	01/05/02 -> ch. 6Y2535495 ->, x 4, COIL ON PLUG, x 4, COIL ON PLUG, incl. spark plug connector, incl. spark plug connector								470 474	C10			
All engines									490 420	C30			
All engines	->year 30/04/02											360 575	
2.0	Petrol	85	12/99-03/08	AZL									
Engine	Information			A10	A20	A40	A50	A70	C10 - C30	C20	E01		
All engines									490 420	C30		360 585	
				FABIA II									
1.2	Petrol	44	12/06-12/14	BBM, CHFA									
Engine	Information			A10	A20	A40	A50	A70	C10 - C30	C20	E01		
All engines	x 3, COIL ON PLUG, incl. spark plug connector								470 431	C10			
1.2	Petrol	51	01/07-12/14	BZG, CEVA, CGPA, CHTA									
Engine	Information			A10	A20	A40	A50	A70	C10 - C30	C20	E01		
All engines	x 3, COIL ON PLUG, incl. spark plug connector								470 474	C10			
1.2 [IND]	Petrol	55	09/10->	CJLA									
Engine	Information			A10	A20	A40	A50	A70	C10 - C30	C20	E01		
All engines	Qty: 3								470 474	C10			
1.2 12V	Petrol	44	11/11-12/14	CGPB									
Engine	Information			A10	A20	A40	A50	A70	C10 - C30	C20	E01		
All engines	x 3, COIL ON PLUG, incl. spark plug connector								470 474	C10			
1.2 LPG	Petrol/ Liquified Petroleum Gas (LPG)	44	03/09-11/11	CHFA									
Engine	Information			A10	A20	A40	A50	A70	C10 - C30	C20	E01		
All engines	x 3, COIL ON PLUG, incl. spark plug connector								470 431	C10			

A10 CONDENSER	A20 CONTACT SET	A40 DISTRIBUTOR CAP	A50 ROTOR	A70 PICK-UP
C10 COIL	C20 IGNITION MODULE	C30 ELECTRONIC IGNITION KIT	E01 IGNITION CABLE SET	

The present application list is a brief version. For the detailed information about the possibility of installation on a specific vehicle, please refer to our web-catalogue <http://catalogo.facet.eu/>

Vehicle					FUNCTIONS ON THE VEHICLE								
Vehicle	alim.	kW	Date	Engine	A10	A20	A40	A50	A70	C10 - C30	C20	E01	
ENGINE													
1.2 LPG	Petrol/ Liquified Petro- leum Gas (LPG)	51	07/07-11/14	CGPA									
Engine	Information				A10	A20	A40	A50	A70	C10 - C30	C20	E01	
All engines	x 3, COIL ON PLUG, incl. spark plug connector									470 474	C10		
ENGINE													
1.2 TSI	Petrol	63	03/10-12/14	CBZA									
Engine	Information				A10	A20	A40	A50	A70	C10 - C30	C20	E01	
All engines										490 420	C30	358 248	
ENGINE													
1.2 TSI	Petrol	77	03/10-12/14	CBZB									
Engine	Information				A10	A20	A40	A50	A70	C10 - C30	C20	E01	
All engines										490 420	C30	358 248	
ENGINE													
1.4	Petrol	63	01/07-12/14	BXW, CGGB									
Engine	Information				A10	A20	A40	A50	A70	C10 - C30	C20	E01	
All engines	x 4, COIL ON PLUG, incl. spark plug connector									470 474	C10		
ENGINE													
1.4 [CHN]	Petrol	63	12/08->	CLPA									
Engine	Information				A10	A20	A40	A50	A70	C10 - C30	C20	E01	
All engines	Qty: 4									470 474	C10		
ENGINE													
1.4 LPG	Petrol/ Liquified Petro- leum Gas (LPG)	63	01/07-11/14	BXW, CGGB									
Engine	Information				A10	A20	A40	A50	A70	C10 - C30	C20	E01	
All engines	x 4, COIL ON PLUG, incl. spark plug connector									470 474	C10		
ENGINE													
1.4 TSI RS	Petrol	132	05/10-12/14	CAVE, CTHE									
Engine	Information				A10	A20	A40	A50	A70	C10 - C30	C20	E01	
All engines	x 4, COIL ON PLUG, incl. spark plug connector									470 474	C10		
ENGINE													
1.6	Petrol	77	04/07-12/14	BTS, CFNA, CLSA									
Engine	Information				A10	A20	A40	A50	A70	C10 - C30	C20	E01	
Eng. BTS, CFNA	x 4, COIL ON PLUG, incl. spark plug connector									470 474	C10		
Eng. CLSA	Qty: 4									470 474	C10		
FABIA III													
ENGINE													
1.0	Petrol	44	08/14->	CHYA, CHYE									
Engine	Information				A10	A20	A40	A50	A70	C10 - C30	C20	E01	
All engines	x 3, BERU, x 3, COIL ON PLUG, ELDOR, COIL ON PLUG, incl. spark plug connector, incl. spark plug connector, Number of pins:4, incl. spark plug connector									470 599	C10		
ENGINE													
1.0	Petrol	55	08/14->	CHYB									
Engine	Information				A10	A20	A40	A50	A70	C10 - C30	C20	E01	
All engines	x 3, BERU, x 3, COIL ON PLUG, ELDOR, COIL ON PLUG, incl. spark plug connector, incl. spark plug connector, Number of pins:4, incl. spark plug connector									470 599	C10		
ENGINE													
1.0 TSI	Petrol	70	08/14->	CHZB, DKLD									
Engine	Information				A10	A20	A40	A50	A70	C10 - C30	C20	E01	
All engines	x 3, BERU, x 3, COIL ON PLUG, ELDOR, COIL ON PLUG, incl. spark plug connector, incl. spark plug connector, Number of pins:4, incl. spark plug connector									470 599	C10		
ENGINE													
1.0 TSI	Petrol	81	08/14->	CHZC, DKRC									
Engine	Information				A10	A20	A40	A50	A70	C10 - C30	C20	E01	
All engines	x 3, BERU, x 3, COIL ON PLUG, ELDOR, COIL ON PLUG, incl. spark plug connector, incl. spark plug connector, Number of pins:4, incl. spark plug connector									470 599	C10		
FUNCTIONS ON THE VEHICLE													
A10	CONDENSER	A20	CONTACT SET	A40	DISTRIBUTOR CAP	A50	ROTOR	A70	PICK-UP				
C10	COIL	C20	IGNITION MODULE	C30	ELECTRONIC IGNITION KIT	E01	IGNITION CABLE SET						

Vehicle	alim.	kW	Date	Engine	FUNCTIONS ON THE VEHICLE									
					A10	A20	A40	A50	A70	C10 - C30	C20	E01		
ENGINE														
1.2 TSI	Petrol	66	08/14->	CJZC										
Engine	Information			A10	A20	A40	A50	A70	C10 - C30	C20	E01			
All engines	x 4, BERU, x 4, COIL ON PLUG, ELDOR, COIL ON PLUG, incl. spark plug connector, incl. spark plug connector, Number of pins:4, incl. spark plug connector								470 599	C10				
ENGINE														
1.2 TSI	Petrol	81	08/14->	CJZD										
Engine	Information			A10	A20	A40	A50	A70	C10 - C30	C20	E01			
All engines	x 4, BERU, x 4, COIL ON PLUG, ELDOR, COIL ON PLUG, incl. spark plug connector, incl. spark plug connector, Number of pins:4, incl. spark plug connector								470 599	C10				
ENGINE														
1.4 TSI R5	Petrol	92	02/18->	CZCA										
Engine	Information			A10	A20	A40	A50	A70	C10 - C30	C20	E01			
All engines	x 4, BERU, x 4, COIL ON PLUG, ELDOR, COIL ON PLUG, incl. spark plug connector, incl. spark plug connector, Number of pins:4, incl. spark plug connector								470 599	C10				
ENGINE														
1.6	Petrol	66	01/15->	CWVB										
Engine	Information			A10	A20	A40	A50	A70	C10 - C30	C20	E01			
All engines	Qty: 4, version BERU, version ELDOR, Qty: 4								470 599	C10				
ENGINE														
1.6	Petrol	81	01/15->	CWVA										
Engine	Information			A10	A20	A40	A50	A70	C10 - C30	C20	E01			
All engines	x 4, BERU, x 4, COIL ON PLUG, ELDOR, COIL ON PLUG, incl. spark plug connector, incl. spark plug connector, Number of pins:4, incl. spark plug connector								470 599	C10				
FAVORIT														
ENGINE														
1.3	Petrol	40	09/91-06/97	135B, 781.135E										
Engine	Information			A10	A20	A40	A50	A70	C10 - C30	C20	E01			
All engines	version PAL					838 242	938 263R							
All engines									490 414	C30				
ENGINE														
1.3	Petrol	42	12/92-06/97	781.135										
Engine	Information			A10	A20	A40	A50	A70	C10 - C30	C20	E01			
All engines	version PAL					838 242	938 262R, 938 263R							
ENGINE														
1.3	Petrol	44	12/91-06/95	781.135										
Engine	Information			A10	A20	A40	A50	A70	C10 - C30	C20	E01			
All engines	version PAL					838 242	938 262R, 938 263R							
ENGINE														
1.3	Petrol	45	08/91-06/95	OHC										
Engine	Information			A10	A20	A40	A50	A70	C10 - C30	C20	E01			
All engines	version PAL					838 242	938 262R, 938 263R							
ENGINE														
1.3	Petrol	50	12/92-06/97	136B										
Engine	Information			A10	A20	A40	A50	A70	C10 - C30	C20	E01			
All engines	version PAL					838 242	938 263R							
All engines									490 414	C30				
ENGINE														
1.3 135	Petrol	42	12/91-09/94	781.135										
Engine	Information			A10	A20	A40	A50	A70	C10 - C30	C20	E01			
All engines	version PAL					838 242	938 262R, 938 263R							
ENGINE														
1.3 135	Petrol	43	12/91-09/94	781.135										
Engine	Information			A10	A20	A40	A50	A70	C10 - C30	C20	E01			
All engines	version PAL					838 242	938 262R, 938 263R							
ENGINE														
1.3 135	Petrol	44	10/90-09/94	781.135										
Engine	Information			A10	A20	A40	A50	A70	C10 - C30	C20	E01			
All engines	version PAL					838 242	938 262R, 938 263R							
FUNCTIONS ON THE VEHICLE														
A10	CONDENSER		A20	CONTACT SET		A40	DISTRIBUTOR CAP		A50	ROTOR		A70	PICK-UP	
C10	COIL		C20	IGNITION MODULE		C30	ELECTRONIC IGNITION KIT		E01	IGNITION CABLE SET				

					FUNCTIONS ON THE VEHICLE								
Vehicle	alim.	kW	Date	Engine									
ENGINE													
1.3 135 X, LX, GLX	Petrol	40	01/90-09/94	781.135E									
Engine	Information				A10	A20	A40	A50	A70	C10 - C30	C20	E01	
All engines	version PAL						838 242	938 263R					
All engines									490 414	C30			
ENGINE													
1.3 135L	Petrol	43	05/89-09/94	781.135									
Engine	Information				A10	A20	A40	A50	A70	C10 - C30	C20	E01	
All engines	version PAL						838 242	938 262R, 938 263R					
ENGINE													
1.3 136	Petrol	45	10/90-09/94	136 L									
Engine	Information				A10	A20	A40	A50	A70	C10 - C30	C20	E01	
All engines	version PAL						838 242	938 262R, 938 263R					
FELICIA													
ENGINE													
1.3	Petrol	40	10/94-04/02	135, 135I									
Engine	Information				A10	A20	A40	A50	A70	C10 - C30	C20	E01	
All engines										490 414	C30		
ENGINE													
1.3	Petrol	43	10/94-03/98	135L									
Engine	Information				A10	A20	A40	A50	A70	C10 - C30	C20	E01	
All engines	version Pal						838 243	938 262R					
All engines												360 373	
ENGINE													
1.3	Petrol	50	10/94-04/02	136 I, 136B									
Engine	Information				A10	A20	A40	A50	A70	C10 - C30	C20	E01	
All engines										490 414	C30		
ENGINE													
1.3 LXI	Petrol	50	08/95-03/98	136 I									
Engine	Information				A10	A20	A40	A50	A70	C10 - C30	C20	E01	
All engines										490 414	C30		
ENGINE													
1.6	Petrol	55	06/97-04/02	6A 16 XHT, AEE									
Engine	Information				A10	A20	A40	A50	A70	C10 - C30	C20	E01	
Eng. 6A 16 XHT	version Bosch						806 094	906 121R	406 223				
Eng. 6A 16 XHT	version Marelli						830 116	930 057R					
Eng. AEE										490 414	C30		
Eng. 6A 16 XHT												360 569	
ENGINE													
1.6 GLX	Petrol	55	08/95-03/98	6A 16 XHT, AEE									
Engine	Information				A10	A20	A40	A50	A70	C10 - C30	C20	E01	
Eng. 6A 16 XHT	version Bosch						806 094	906 121R	406 223				
Eng. 6A 16 XHT	version Marelli						830 116	930 057R					
Eng. AEE										490 414	C30		
Eng. 6A 16 XHT												360 569	
ENGINE													
1.6 LX	Petrol	55	08/95-03/98	6A 16 XHT, AEE									
Engine	Information				A10	A20	A40	A50	A70	C10 - C30	C20	E01	
Eng. 6A 16 XHT	version Bosch						806 094	906 121R	406 223				
Eng. 6A 16 XHT	version Marelli						830 116	930 057R					
Eng. AEE										490 414	C30		
Eng. 6A 16 XHT												360 569	
KAMIQ													
ENGINE													
1.0 TGI CNG	Petrol/ Com- pressed Natural Gas (CNG)	66	11/19->	DBYA									
Engine	Information				A10	A20	A40	A50	A70	C10 - C30	C20	E01	
All engines	x 3, BERU, ELDOR, COIL ON PLUG, incl. spark plug connector, Number of pins:4, incl. spark plug connector									470 599	C10		
A10	CONDENSER	A20	CONTACT SET	A40	DISTRIBUTOR CAP	A50	ROTOR	A70	PICK-UP	C10	COIL	C20	IGNITION MODULE
A40	DISTRIBUTOR CAP	A50	ROTOR	A70	PICK-UP	C10	COIL	C20	IGNITION MODULE	C30	ELECTRONIC IGNITION KIT	E01	IGNITION CABLE SET

Vehicle	alim.	kW	Date	Engine	FUNCTIONS ON THE VEHICLE							
					A10	A20	A40	A50	A70	C10 - C30	C20	E01
ENGINE												
1.0 TSI	Petrol	70	07/19->	DKLA								
Engine	Information				A10	A20	A40	A50	A70	C10 - C30	C20	E01
All engines	x 3, BERU, ELDOR, COIL ON PLUG, incl. spark plug connector, Number of pins:4, incl. spark plug connector									470 599	C10	
ENGINE												
1.0 TSI	Petrol	85	07/19->	DKJA, DKRF								
Engine	Information				A10	A20	A40	A50	A70	C10 - C30	C20	E01
All engines	x 3, BERU, ELDOR, COIL ON PLUG, incl. spark plug connector, Number of pins:4, incl. spark plug connector									470 599	C10	
ENGINE												
1.6 SRE	Petrol	81	07/19->	CWVA								
Engine	Information				A10	A20	A40	A50	A70	C10 - C30	C20	E01
All engines	x 4, BERU, ELDOR, COIL ON PLUG, incl. spark plug connector, Number of pins:4, incl. spark plug connector									470 599	C10	
KAROQ												
ENGINE												
1.0 TSI	Petrol	85	07/17->	CHZJ, DKRF								
Engine	Information				A10	A20	A40	A50	A70	C10 - C30	C20	E01
All engines	x 3, BERU, ELDOR, COIL ON PLUG, incl. spark plug connector, Number of pins:4, incl. spark plug connector									470 599	C10	
ENGINE												
1.4 TSI	Petrol	110	07/17->	CZEA, DJKA								
Engine	Information				A10	A20	A40	A50	A70	C10 - C30	C20	E01
All engines	x 4, BERU, ELDOR, COIL ON PLUG, incl. spark plug connector, Number of pins:4, incl. spark plug connector									470 599	C10	
ENGINE												
2.0 TSI 4x4	Petrol	140	04/19->	DKZA, DNNA								
Engine	Information				A10	A20	A40	A50	A70	C10 - C30	C20	E01
All engines	x 4, ELDOR, HITACHI, COIL ON PLUG, Colour:Black, COIL ON PLUG, incl. spark plug connector, incl. spark plug connector									470 636	C10	
KODIAQ												
ENGINE												
1.4 TSI	Petrol	110	10/16->	CZDA, CZEA								
Engine	Information				A10	A20	A40	A50	A70	C10 - C30	C20	E01
All engines	x 4, BERU, ELDOR, COIL ON PLUG, incl. spark plug connector, Number of pins:4, incl. spark plug connector									470 599	C10	
ENGINE												
1.4 TSI	Petrol	92	10/16->	CZCA								
Engine	Information				A10	A20	A40	A50	A70	C10 - C30	C20	E01
All engines	x 4, BERU, ELDOR, COIL ON PLUG, incl. spark plug connector, Number of pins:4, incl. spark plug connector									470 599	C10	
ENGINE												
1.4 TSI 4x4	Petrol	110	10/16->	CZDA, CZEA								
Engine	Information				A10	A20	A40	A50	A70	C10 - C30	C20	E01
All engines	x 4, BERU, ELDOR, COIL ON PLUG, incl. spark plug connector, Number of pins:4, incl. spark plug connector									470 599	C10	
ENGINE												
2.0 TSI 4x4	Petrol	132	10/16->	CZPA								
Engine	Information				A10	A20	A40	A50	A70	C10 - C30	C20	E01
All engines	x 4, ELDOR, Colour:Black, COIL ON PLUG, incl. spark plug connector									470 636	C10	
ENGINE												
2.0 TSI 4x4	Petrol	140	02/19->	DKZA, DNNA								
Engine	Information				A10	A20	A40	A50	A70	C10 - C30	C20	E01
All engines	x 4, ELDOR, Colour:Black, COIL ON PLUG, incl. spark plug connector									470 636	C10	
OCTAVIA I												
ENGINE												
1.4 16V	Petrol	55	08/00-12/10	AXP, BCA								
Engine	Information				A10	A20	A40	A50	A70	C10 - C30	C20	E01
Eng. BCA	x 4, COIL ON PLUG, incl. spark plug connector									470 474	C10	
Eng. AXP										490 420	C30	
All engines												360 575
ENGINE												
1.6	Petrol	55	09/96-09/04	6A 16 XHT, AEE								
Engine	Information				A10	A20	A40	A50	A70	C10 - C30	C20	E01
Eng. 6A 16 XHT	version Bosch						806 094	906 121R	406 223			
A10	CONDENSER	A20	CONTACT SET	A40	DISTRIBUTOR CAP	A50	ROTOR	A70	PICK-UP			
C10	COIL	C20	IGNITION MODULE	C30	ELECTRONIC IGNITION KIT	E01	IGNITION CABLE SET					

Vehicle	alim.	kW	Date	Engine	FUNCTIONS ON THE VEHICLE							
					A10	A20	A40	A50	A70	C10 - C30	C20	E01

ENGINE				
1.6	Petrol	55	09/96-09/04	6A 16 XHT, AEE

Engine	Information	A10	A20	A40	A50	A70	C10 - C30	C20	E01
Eng. 6A 16 XHT	version Marelli			830 116	930 057R				
Eng. AEE							490 414	C30	
Eng. 6A 16 XHT									360 609

ENGINE				
1.6	Petrol	74	02/97-12/07	AEH, AKL

Engine	Information	A10	A20	A40	A50	A70	C10 - C30	C20	E01
All engines							490 420	C30	
All engines	ch. 1U-V-005 001 ->, ->ch. 1U-W-060 000								360 479
All engines	ch. 1U-W-060 001 ->								360 484

ENGINE				
1.6	Petrol	75	09/00-12/10	AVU, BFQ

Engine	Information	A10	A20	A40	A50	A70	C10 - C30	C20	E01
All engines							490 420	C30	360 585

ENGINE				
1.8	Petrol	92	09/96-07/00	AGN

Engine	Information	A10	A20	A40	A50	A70	C10 - C30	C20	E01
All engines							490 420	C30	
All engines	ch. 1U-V-026 001 ->								360 489

ENGINE				
1.8 20V	Petrol	92	07/98-07/00	AGN

Engine	Information	A10	A20	A40	A50	A70	C10 - C30	C20	E01
All engines							490 420	C30	
All engines	ch. 1U-V-026 001 ->								360 489

ENGINE				
1.8 T	Petrol	110	08/97-12/10	AGU, ARX, ARZ, AUM

Engine	Information	A10	A20	A40	A50	A70	C10 - C30	C20	E01
Eng. AGU	x 4, COIL ON PLUG						470 354S	C10	
Eng. ARZ	x 4, COIL ON PLUG, incl. spark plug connector						470 429	C10	
Eng. ARX, AUM	x 4, COIL ON PLUG, incl. spark plug connector						470 445	C10	
Eng. AGU, ARX, AUM									465 076

ENGINE				
1.8 T 4x4	Petrol	110	05/01-05/06	ARX

Engine	Information	A10	A20	A40	A50	A70	C10 - C30	C20	E01
All engines	x 4, COIL ON PLUG, incl. spark plug connector						470 429	C10	
All engines									465 076

ENGINE				
2.0	Petrol	85	04/99-05/07	AEG, APK, AQY, AZH, AZJ

Engine	Information	A10	A20	A40	A50	A70	C10 - C30	C20	E01
Eng. AEG, APK, AQY							490 420	C30	
Eng. AZJ									358 223
Eng. AEG, APK, AQY, AZH									360 585

ENGINE				
2.0 4x4	Petrol	85	08/00-09/04	AZH, AZJ

Engine	Information	A10	A20	A40	A50	A70	C10 - C30	C20	E01
Eng. AZH							490 420	C30	360 585
Eng. AZJ									358 223

ENGINE				
RS 1.8 T	Petrol	132	05/01-01/06	AUQ

Engine	Information	A10	A20	A40	A50	A70	C10 - C30	C20	E01
All engines	x 4, COIL ON PLUG, incl. spark plug connector						470 429	C10	
All engines									465 076

OCTAVIA II

ENGINE				
1.2 TSI	Petrol	77	02/10-06/13	CBZB

Engine	Information	A10	A20	A40	A50	A70	C10 - C30	C20	E01
All engines							490 420	C30	358 248

A10 CONDENSER	A20 CONTACT SET	A40 DISTRIBUTOR CAP	A50 ROTOR	A70 PICK-UP
C10 COIL	C20 IGNITION MODULE	C30 ELECTRONIC IGNITION KIT	E01 IGNITION CABLE SET	

Vehicle	alim.	kW	Date	Engine	FUNCTIONS ON THE VEHICLE								
					A10	A20	A40	A50	A70	C10 - C30	C20	E01	
ENGINE													
1.4	Petrol	55	05/04-05/06	BCA									
ENGINE													
All engines					x 4, COIL ON PLUG, incl. spark plug connector	A10	A20	A40	A50	A70	C10 - C30	C20	E01
										470 474	C10		
1.4	Petrol	59	06/04-06/13	BUD, CGGA									
ENGINE													
All engines					x 4, COIL ON PLUG, incl. spark plug connector	A10	A20	A40	A50	A70	C10 - C30	C20	E01
										470 474	C10		
1.4 [CHN]	Petrol	96	03/10->	CFBA.									
ENGINE													
All engines					Qty: 4	A10	A20	A40	A50	A70	C10 - C30	C20	E01
										470 474	C10		
1.4 TSI	Petrol	90	11/08-06/13	CAXA									
ENGINE													
All engines					x 4, COIL ON PLUG, incl. spark plug connector	A10	A20	A40	A50	A70	C10 - C30	C20	E01
										470 474	C10		
1.6	Petrol	75	06/04-06/13	BGU, BSE, BSF, CCSA, CMXA									
ENGINE													
All engines						A10	A20	A40	A50	A70	C10 - C30	C20	E01
										490 420	C30		360 585
1.6 [CHN]	Petrol	77	09/07->	CDFA, CLRA, CPJA									
ENGINE													
All engines					Qty: 4	A10	A20	A40	A50	A70	C10 - C30	C20	E01
										470 474	C10		
1.6 FSI	Petrol	85	02/04-10/08	BLF									
ENGINE													
All engines					x 4, COIL ON PLUG, incl. spark plug connector	A10	A20	A40	A50	A70	C10 - C30	C20	E01
										470 474	C10		
1.6 LPG	Petrol/ Liquified Petro- leum Gas (LPG)	75	08/09-11/12	BSE, CHGA									
ENGINE													
All engines						A10	A20	A40	A50	A70	C10 - C30	C20	E01
				Eng. CHGA							490 420	C30	
													360 585
1.6 MultiFuel	Petrol/ Ethanol	75	01/08-06/13	CCSA, CMXA									
ENGINE													
Eng. CCSA						A10	A20	A40	A50	A70	C10 - C30	C20	E01
				All engines							490 420	C30	
													360 585
1.8 TSI	Petrol	112	03/09-06/13	CDAB									
ENGINE													
All engines					x 4, ELDOR, Housing Colour:Black, COIL ON PLUG, incl. spark plug connector	A10	A20	A40	A50	A70	C10 - C30	C20	E01
											470 426	C10	
1.8 TSI	Petrol	118	06/07-04/13	BZB, CDAA									
ENGINE													
All engines					x 4, ELDOR, Housing Colour:Black, COIL ON PLUG, incl. spark plug connector	A10	A20	A40	A50	A70	C10 - C30	C20	E01
											470 426	C10	
1.8 TSI 4x4	Petrol	112	03/09-02/13	CDAB									
ENGINE													
All engines					x 4, ELDOR, Housing Colour:Black, COIL ON PLUG, incl. spark plug connector	A10	A20	A40	A50	A70	C10 - C30	C20	E01
											470 426	C10	
1.8 TSI 4x4	Petrol	118	11/08-02/13	CDAA									
ENGINE													
All engines					x 4, ELDOR, Housing Colour:Black, COIL ON PLUG, incl. spark plug connector	A10	A20	A40	A50	A70	C10 - C30	C20	E01
											470 426	C10	









A10 CONDENSER	A20 CONTACT SET	A40 DISTRIBUTOR CAP	A50 ROTOR	A70 PICK-UP
C10 COIL	C20 IGNITION MODULE	C30 ELECTRONIC IGNITION KIT	E01 IGNITION CABLE SET	

The present application list is a brief version. For the detailed information about the possibility of installation on a specific vehicle, please refer to our web-catalogue <http://catalogo.facet.eu/>

Vehicle	alim.	kW	Date	Engine	FUNCTIONS ON THE VEHICLE							
					A10	A20	A40	A50	A70	C10 - C30	C20	E01
ENGINE												
2.0 [CHN]	Petrol	85	04/07->	BXX.								
Engine	Information				A10	A20	A40	A50	A70	C10 - C30	C20	E01
All engines										490 420	C30	360 585
ENGINE												
2.0 [CHN]	Petrol	88	06/08->	CGZA.								
Engine	Information				A10	A20	A40	A50	A70	C10 - C30	C20	E01
All engines										490 420	C30	360 585
ENGINE												
2.0 4x4	Petrol	147	11/08->	CCZA								
Engine	Information				A10	A20	A40	A50	A70	C10 - C30	C20	E01
All engines	Qty: 4									470 426	C10	
ENGINE												
2.0 FSI	Petrol	110	11/04-10/08	BLR, BLY, BVY, BVZ								
Engine	Information				A10	A20	A40	A50	A70	C10 - C30	C20	E01
All engines	x 4, ELDOR, Housing Colour:Black, COIL ON PLUG, incl. spark plug connector									470 426	C10	
ENGINE												
2.0 FSI 4x4	Petrol	110	11/04-04/09	BLX, BLY, BVX								
Engine	Information				A10	A20	A40	A50	A70	C10 - C30	C20	E01
All engines	x 4, ELDOR, Housing Colour:Black, COIL ON PLUG, incl. spark plug connector									470 426	C10	
ENGINE												
2.0 TFSI	Petrol	147	10/05-02/13	BWA, CCZA								
Engine	Information				A10	A20	A40	A50	A70	C10 - C30	C20	E01
All engines	x 4, ELDOR, Housing Colour:Black, COIL ON PLUG, incl. spark plug connector									470 426	C10	
OCTAVIA III												
ENGINE												
1.0 TSI	Petrol	85	05/16->	CHZD, DKRA, DKRF								
Engine	Information				A10	A20	A40	A50	A70	C10 - C30	C20	E01
All engines	x 3, BERU, ELDOR, COIL ON PLUG, incl. spark plug connector, Number of pins:4, incl. spark plug connector									470 599	C10	
ENGINE												
1.2 TSI	Petrol	63	11/12->	CJZB, CYVA								
Engine	Information				A10	A20	A40	A50	A70	C10 - C30	C20	E01
All engines	x 4, BERU, ELDOR, COIL ON PLUG, incl. spark plug connector, Number of pins:4, incl. spark plug connector									470 599	C10	
Eng. CYVA	Qty: 4									470 599	C10	
ENGINE												
1.2 TSI	Petrol	77	11/12->	CJZA								
Engine	Information				A10	A20	A40	A50	A70	C10 - C30	C20	E01
All engines	x 4, BERU, ELDOR, COIL ON PLUG, incl. spark plug connector, Number of pins:4, incl. spark plug connector									470 599	C10	
ENGINE												
1.2 TSI	Petrol	81	05/15-02/17	CYVB								
Engine	Information				A10	A20	A40	A50	A70	C10 - C30	C20	E01
All engines	x 4, BERU, ELDOR, COIL ON PLUG, incl. spark plug connector, Number of pins:4, incl. spark plug connector									470 599	C10	
ENGINE												
1.4 TSI	Petrol	103	11/12->	CHPA								
Engine	Information				A10	A20	A40	A50	A70	C10 - C30	C20	E01
All engines	x 4, BERU, ELDOR, COIL ON PLUG, incl. spark plug connector, Number of pins:4, incl. spark plug connector									470 599	C10	
ENGINE												
1.4 TSI	Petrol	110	08/14-10/20	CHPB, CZDA								
Engine	Information				A10	A20	A40	A50	A70	C10 - C30	C20	E01
All engines	x 4, BERU, x 4, COIL ON PLUG, ELDOR, COIL ON PLUG, incl. spark plug connector, Number of pins:4, incl. spark plug connector									470 599	C10	

A10 CONDENSER	A20 CONTACT SET	A40 DISTRIBUTOR CAP	A50 ROTOR	A70 PICK-UP
C10 COIL	C20 IGNITION MODULE	C30 ELECTRONIC IGNITION KIT	E01 IGNITION CABLE SET	

Vehicle	alim.	kW	Date	Engine	FUNCTIONS ON THE VEHICLE							
					A10	A20	A40	A50	A70	C10 - C30	C20	E01
ENGINE												
1.4 TSI G-TEC	Petrol/ Compressed Natural Gas (CNG)	81	11/13->	CPWA								
Engine	Information			A10	A20	A40	A50	A70	C10 - C30	C20	E01	
All engines	x 4, BERU, ELDOR, COIL ON PLUG, incl. spark plug connector, Number of pins:4, incl. spark plug connector								470 599	C10		
ENGINE												
1.6	Petrol	81	01/14->	CWVA								
Engine	Information			A10	A20	A40	A50	A70	C10 - C30	C20	E01	
All engines	x 4, BERU, ELDOR, COIL ON PLUG, incl. spark plug connector, Number of pins:4, incl. spark plug connector								470 599	C10		
ENGINE												
1.8 TSI	Petrol	132	11/12->	CJSA, CJSB								
Engine	Information			A10	A20	A40	A50	A70	C10 - C30	C20	E01	
All engines	x 4, HITACHI, COIL ON PLUG, incl. spark plug connector								470 636	C10		
ENGINE												
1.8 TSI 4x4	Petrol	132	11/12->	CJSA, CJSB								
Engine	Information			A10	A20	A40	A50	A70	C10 - C30	C20	E01	
Eng. CJSA	Qty: 4, Qty: 4								470 636	C10		
Eng. CJSB	x 4, HITACHI, COIL ON PLUG, incl. spark plug connector								470 636	C10		
ENGINE												
2.0 TSI	Petrol	140	02/17->	DKZA								
Engine	Information			A10	A20	A40	A50	A70	C10 - C30	C20	E01	
All engines	x 4, ELDOR, Colour:Black, COIL ON PLUG, incl. spark plug connector								470 636	C10		
ENGINE												
2.0 TSI 4x4	Petrol	140	02/19->	DKZA								
Engine	Information			A10	A20	A40	A50	A70	C10 - C30	C20	E01	
All engines	x 4, ELDOR, Colour:Black, COIL ON PLUG, incl. spark plug connector								470 636	C10		
OCTAVIA IV												
ENGINE												
1.0 TSI	Petrol	81	06/20->	DLAA								
Engine	Information			A10	A20	A40	A50	A70	C10 - C30	C20	E01	
All engines	x 3, ELDOR, HITACHI, COIL ON PLUG, incl. spark plug connector, Number of pins:4, incl. spark plug connector								470 599	C10		
ENGINE												
1.0 TSI e-TEC	Petrol/ Electric	81	06/20->	DLAA								
Engine	Information			A10	A20	A40	A50	A70	C10 - C30	C20	E01	
All engines	x 3, ELDOR, HITACHI, COIL ON PLUG, incl. spark plug connector, Number of pins:4, incl. spark plug connector								470 599	C10		
RAPID												
ENGINE												
1.0 TSI	Petrol	70	06/17-12/19	CHZB, DKLD								
Engine	Information			A10	A20	A40	A50	A70	C10 - C30	C20	E01	
All engines	x 3, BERU, ELDOR, COIL ON PLUG, incl. spark plug connector, Number of pins:4, incl. spark plug connector								470 599	C10		
ENGINE												
1.0 TSI	Petrol	81	06/17-12/19	CHZC								
Engine	Information			A10	A20	A40	A50	A70	C10 - C30	C20	E01	
All engines	x 3, BERU, ELDOR, COIL ON PLUG, incl. spark plug connector, Number of pins:4, incl. spark plug connector								470 599	C10		
ENGINE												
1.2	Petrol	55	07/12-06/15	CGPC								
Engine	Information			A10	A20	A40	A50	A70	C10 - C30	C20	E01	
All engines	x 3, COIL ON PLUG, incl. spark plug connector								470 474	C10		
ENGINE												
1.2 LPG	Petrol/ Liquified Petroleum Gas (LPG)	55	07/12-06/15	CGPC								
Engine	Information			A10	A20	A40	A50	A70	C10 - C30	C20	E01	
All engines	x 3, COIL ON PLUG, incl. spark plug connector								470 474	C10		
FUNCTIONS ON THE VEHICLE												
A10	CONDENSER	A20	CONTACT SET	A40	DISTRIBUTOR CAP	A50	ROTOR	A70	PICK-UP			
C10	COIL	C20	IGNITION MODULE	C30	ELECTRONIC IGNITION KIT	E01	IGNITION CABLE SET					









					FUNCTIONS ON THE VEHICLE							
Vehicle	alim.	kW	Date	Engine								
ENGINE												
1.2 LPG	Petrol/ Liquified Petroleum Gas (LPG)	63	07/12-05/15	CBZA								
Engine	Information				A10	A20	A40	A50	A70	C10 - C30	C20	E01
All engines										490 420	C30	
ENGINE												
1.2 TSI	Petrol	63	07/12-05/15	CBZA								
Engine	Information				A10	A20	A40	A50	A70	C10 - C30	C20	E01
All engines										490 420	C30	
ENGINE												
1.2 TSI	Petrol	66	05/15-12/19	CJZC								
Engine	Information				A10	A20	A40	A50	A70	C10 - C30	C20	E01
All engines	x 4, BERU, ELDOR, COIL ON PLUG, incl. spark plug connector, Number of pins:4, incl. spark plug connector									470 599	C10	
ENGINE												
1.2 TSI	Petrol	77	07/12-05/15	CBZB								
Engine	Information				A10	A20	A40	A50	A70	C10 - C30	C20	E01
All engines										490 420	C30	
ENGINE												
1.2 TSI	Petrol	81	05/15-12/19	CJZD								
Engine	Information				A10	A20	A40	A50	A70	C10 - C30	C20	E01
All engines	x 4, BERU, ELDOR, COIL ON PLUG, incl. spark plug connector, Number of pins:4, incl. spark plug connector									470 599	C10	
ENGINE												
1.4 TSI	Petrol	90	07/12-06/15	CAXA								
Engine	Information				A10	A20	A40	A50	A70	C10 - C30	C20	E01
All engines	x 4, COIL ON PLUG, incl. spark plug connector									470 474	C10	
ENGINE												
1.4 TSI	Petrol	92	05/15->	CZCA								
Engine	Information				A10	A20	A40	A50	A70	C10 - C30	C20	E01
All engines	x 4, BERU, ELDOR, COIL ON PLUG, incl. spark plug connector, Number of pins:4, incl. spark plug connector									470 599	C10	
ENGINE												
1.6	Petrol	77	07/12-06/15	CFNA								
Engine	Information				A10	A20	A40	A50	A70	C10 - C30	C20	E01
All engines	x 4, COIL ON PLUG, incl. spark plug connector									470 474	C10	
ENGINE												
1.6	Petrol	81	05/15->	CWVA								
Engine	Information				A10	A20	A40	A50	A70	C10 - C30	C20	E01
All engines	x 4, BERU, ELDOR, COIL ON PLUG, incl. spark plug connector, Number of pins:4, incl. spark plug connector									470 599	C10	
ENGINE												
1.6 SRE	Petrol	66	06/15->	CWVB								
Engine	Information				A10	A20	A40	A50	A70	C10 - C30	C20	E01
All engines	x 4, BERU, ELDOR, COIL ON PLUG, incl. spark plug connector, Number of pins:4, incl. spark plug connector									470 599	C10	
ENGINE												
1.6 SRE	Petrol	81	05/15-12/19	CWVA								
Engine	Information				A10	A20	A40	A50	A70	C10 - C30	C20	E01
All engines	x 4, BERU, ELDOR, COIL ON PLUG, incl. spark plug connector, Number of pins:4, incl. spark plug connector									470 599	C10	
ROOMSTER												
ENGINE												
1.2	Petrol	47	05/06-01/07	BME								
Engine	Information				A10	A20	A40	A50	A70	C10 - C30	C20	E01
All engines	x 3, COIL ON PLUG, incl. spark plug connector									470 474	C10	
ENGINE												
1.2	Petrol	51	01/07-05/15	BZG, CGPA								
Engine	Information				A10	A20	A40	A50	A70	C10 - C30	C20	E01
All engines	x 3, COIL ON PLUG, incl. spark plug connector									470 474	C10	

A10 CONDENSER	A20 CONTACT SET	A40 DISTRIBUTOR CAP	A50 ROTOR	A70 PICK-UP
C10 COIL	C20 IGNITION MODULE	C30 ELECTRONIC IGNITION KIT	E01 IGNITION CABLE SET	

Vehicle	alim.	kW	Date	Engine	FUNCTIONS ON THE VEHICLE									
					A10	A20	A40	A50	A70	C10 - C30	C20	E01		
ENGINE														
1.2 LPG	Petrol/ Liquified Petro- leum Gas (LPG)	51	03/09-05/15	CGPA										
ENGINE														
Engine		Information			A10	A20	A40	A50	A70	C10 - C30	C20	E01		
All engines		x 3, COIL ON PLUG, incl. spark plug connector								470 474	C10			
ENGINE														
1.2 TSI	Petrol	63	03/10-05/15	CBZA										
ENGINE														
Engine		Information			A10	A20	A40	A50	A70	C10 - C30	C20	E01		
All engines										490 420	C30			
ENGINE														
1.2 TSI	Petrol	77	03/10-05/15	CBZB										
ENGINE														
Engine		Information			A10	A20	A40	A50	A70	C10 - C30	C20	E01		
All engines										490 420	C30			
ENGINE														
1.4	Petrol	63	09/06-05/15	BXW, CGGB										
ENGINE														
Engine		Information			A10	A20	A40	A50	A70	C10 - C30	C20	E01		
All engines		x 4, COIL ON PLUG, incl. spark plug connector								470 474	C10			
ENGINE														
1.4 LPG	Petrol/ Liquified Petro- leum Gas (LPG)	63	03/10-05/15	BXW, CGGB										
ENGINE														
Engine		Information			A10	A20	A40	A50	A70	C10 - C30	C20	E01		
All engines		x 4, COIL ON PLUG, incl. spark plug connector								470 474	C10			
ENGINE														
1.6	Petrol	77	09/06-05/15	BTS, CFNA										
ENGINE														
Engine		Information			A10	A20	A40	A50	A70	C10 - C30	C20	E01		
All engines		x 4, COIL ON PLUG, incl. spark plug connector								470 474	C10			
ENGINE														
1.6 LPG	Petrol/ Liquified Petro- leum Gas (LPG)	77	06/06-07/10	BTS										
ENGINE														
Engine		Information			A10	A20	A40	A50	A70	C10 - C30	C20	E01		
All engines		x 4, COIL ON PLUG, incl. spark plug connector								470 474	C10			
SCALA														
ENGINE														
1.0 TGI CNG	Petrol/ Com- pressed Natural Gas (CNG)	66	11/19->	DBYA										
ENGINE														
Engine		Information			A10	A20	A40	A50	A70	C10 - C30	C20	E01		
All engines		x 3, BERU, ELDOR, COIL ON PLUG, incl. spark plug connector, Number of pins:4, incl. spark plug connector								470 599	C10			
ENGINE														
1.0 TSI	Petrol	70	02/19->	DKLA, DLAC										
ENGINE														
Engine		Information			A10	A20	A40	A50	A70	C10 - C30	C20	E01		
All engines		x 3, BERU, ELDOR, COIL ON PLUG, incl. spark plug connector, Number of pins:4, incl. spark plug connector								470 599	C10			
ENGINE														
1.0 TSI	Petrol	81	08/20->	DLAA										
ENGINE														
Engine		Information			A10	A20	A40	A50	A70	C10 - C30	C20	E01		
All engines		x 3, HITACHI, COIL ON PLUG, incl. spark plug connector								470 599	C10			
ENGINE														
1.0 TSI	Petrol	85	02/19->	DKJA, DKRF										
ENGINE														
Engine		Information			A10	A20	A40	A50	A70	C10 - C30	C20	E01		
All engines		x 3, BERU, ELDOR, COIL ON PLUG, incl. spark plug connector, Number of pins:4, incl. spark plug connector								470 599	C10			

A10 CONDENSER	A20 CONTACT SET	A40 DISTRIBUTOR CAP	A50 ROTOR	A70 PICK-UP
C10 COIL	C20 IGNITION MODULE	C30 ELECTRONIC IGNITION KIT	E01 IGNITION CABLE SET	

The present application list is a brief version. For the detailed information about the possibility of installation on a specific vehicle, please refer to our web-catalogue <http://catalogo.facet.eu/>

					FUNCTIONS ON THE VEHICLE							
Vehicle	alim.	kW	Date	Engine								
SUPERB I												
1.6 SRE	Petrol	81	02/19->	ENGINE CWVA								
Engine	Information				A10	A20	A40	A50	A70	C10 - C30	C20	E01
All engines	x 4, BERU, x 4, COIL ON PLUG, ELDOR, COIL ON PLUG, incl. spark plug connector, incl. spark plug connector, Number of pins:4, incl. spark plug connector									470 599	C10	
SUPERB II												
1.8 T	Petrol	110	12/01-03/08	ENGINE AWT								
Engine	Information				A10	A20	A40	A50	A70	C10 - C30	C20	E01
All engines	x 4, COIL ON PLUG, incl. spark plug connector									470 429	C10	
2.0	Petrol	85	12/01-03/08	ENGINE AZM								
Engine	Information				A10	A20	A40	A50	A70	C10 - C30	C20	E01
All engines										490 420	C30	360 585
SUPERB II												
1.4 [CHN]	Petrol	96	03/10->	ENGINE CFBA.								
Engine	Information				A10	A20	A40	A50	A70	C10 - C30	C20	E01
All engines	Qty: 4									470 474	C10	
1.4 TSI	Petrol	92	07/08-05/15	ENGINE CAXC								
Engine	Information				A10	A20	A40	A50	A70	C10 - C30	C20	E01
All engines	x 4, COIL ON PLUG, incl. spark plug connector									470 474	C10	
1.8 TSI	Petrol	112	03/09-05/15	ENGINE CDAB								
Engine	Information				A10	A20	A40	A50	A70	C10 - C30	C20	E01
All engines	x 4, ELDOR, Housing Colour:Black, COIL ON PLUG, incl. spark plug connector									470 426	C10	
1.8 TSI	Petrol	118	03/08-05/15	ENGINE BZB, CDAA								
Engine	Information				A10	A20	A40	A50	A70	C10 - C30	C20	E01
All engines	x 4, ELDOR, Housing Colour:Black, COIL ON PLUG, incl. spark plug connector									470 426	C10	
1.8 TSI 4x4	Petrol	112	03/09-05/15	ENGINE CDAB								
Engine	Information				A10	A20	A40	A50	A70	C10 - C30	C20	E01
All engines	x 4, ELDOR, Housing Colour:Black, COIL ON PLUG, incl. spark plug connector									470 426	C10	
1.8 TSI 4x4	Petrol	118	11/08-05/15	ENGINE CDAA								
Engine	Information				A10	A20	A40	A50	A70	C10 - C30	C20	E01
All engines	x 4, ELDOR, Housing Colour:Black, COIL ON PLUG, incl. spark plug connector									470 426	C10	
2.0 TFSI	Petrol	147	05/10-05/15	ENGINE CCZA								
Engine	Information				A10	A20	A40	A50	A70	C10 - C30	C20	E01
All engines	x 4, ELDOR, Housing Colour:Black, COIL ON PLUG, incl. spark plug connector									470 426	C10	
SUPERB III												
1.4 TSI	Petrol	110	03/15->	ENGINE CZDA, CZEA								
Engine	Information				A10	A20	A40	A50	A70	C10 - C30	C20	E01
All engines	x 4, BERU, x 4, COIL ON PLUG, ELDOR, COIL ON PLUG, incl. spark plug connector, incl. spark plug connector, Number of pins:4, incl. spark plug connector									470 599	C10	
1.4 TSI	Petrol	92	03/15->	ENGINE CZCA								
Engine	Information				A10	A20	A40	A50	A70	C10 - C30	C20	E01
All engines	x 4, BERU, ELDOR, COIL ON PLUG, incl. spark plug connector, Number of pins:4, incl. spark plug connector									470 599	C10	
1.4 TSI 4x4	Petrol	110	03/15->	ENGINE CZDA, CZEA								
Engine	Information				A10	A20	A40	A50	A70	C10 - C30	C20	E01
Eng. CZDA	Qty: 4, version BERU, version ELDOR, Qty: 4									470 599	C10	
Eng. CZEA	x 4, BERU, x 4, COIL ON PLUG, ELDOR, COIL ON PLUG, incl. spark plug connector, incl. spark plug connector, Number of pins:4, incl. spark plug connector									470 599	C10	

A10 CONDENSER	A20 CONTACT SET	A40 DISTRIBUTOR CAP	A50 ROTOR	A70 PICK-UP
C10 COIL	C20 IGNITION MODULE	C30 ELECTRONIC IGNITION KIT	E01 IGNITION CABLE SET	

Vehicle	alim.	kW	Date	Engine	FUNCTIONS ON THE VEHICLE							
					A10	A20	A40	A50	A70	C10 - C30	C20	E01
ENGINE												
1.4 TSI iV	Petrol/ Electric	115	08/19->	DGEB								
Engine	Information			A10	A20	A40	A50	A70	C10 - C30	C20	E01	
All engines	x 4, BERU, COIL ON PLUG, incl. spark plug connector								470 599	C10		
ENGINE												
1.4 TSI iV	Petrol/ Electric	160	08/19->	DGEB								
Engine	Information			A10	A20	A40	A50	A70	C10 - C30	C20	E01	
All engines	x 4, BERU, COIL ON PLUG, incl. spark plug connector								470 599	C10		
ENGINE												
1.8 TSI	Petrol	132	03/15->	CJSA, CJSC								
Engine	Information			A10	A20	A40	A50	A70	C10 - C30	C20	E01	
All engines	x 4, HITACHI, COIL ON PLUG, incl. spark plug connector								470 636	C10		
YETI												
ENGINE												
1.2 TSI	Petrol	77	09/09-05/15	CBZB								
Engine	Information			A10	A20	A40	A50	A70	C10 - C30	C20	E01	
All engines	x 4, ELDOR, Housing Colour:Black, COIL ON PLUG, incl. spark plug connector								470 426	C10		
All engines									490 420	C30	358 248	
ENGINE												
1.2 TSI	Petrol	81	05/15-12/17	CVVB								
Engine	Information			A10	A20	A40	A50	A70	C10 - C30	C20	E01	
All engines	x 4, BERU, ELDOR, COIL ON PLUG, incl. spark plug connector, Number of pins:4, incl. spark plug connector								470 599	C10		
ENGINE												
1.4 TSI	Petrol	90	06/10-05/15	CAXA								
Engine	Information			A10	A20	A40	A50	A70	C10 - C30	C20	E01	
All engines	x 4, COIL ON PLUG, incl. spark plug connector								470 474	C10		
ENGINE												
1.4 TSI	Petrol	92	05/15-12/17	CZCA								
Engine	Information			A10	A20	A40	A50	A70	C10 - C30	C20	E01	
All engines	x 4, ELDOR, COIL ON PLUG, Number of pins:4, incl. spark plug connector								470 599	C10		
ENGINE												
1.4 TSI 4x4	Petrol	110	05/15-12/17	CZDA								
Engine	Information			A10	A20	A40	A50	A70	C10 - C30	C20	E01	
All engines	x 4, ELDOR, COIL ON PLUG, Number of pins:4, incl. spark plug connector								470 599	C10		
ENGINE												
1.6	Petrol	81	04/14-12/17	CWVA								
Engine	Information			A10	A20	A40	A50	A70	C10 - C30	C20	E01	
All engines	x 4, BERU, ELDOR, COIL ON PLUG, incl. spark plug connector, Number of pins:4, incl. spark plug connector								470 599	C10		
ENGINE												
1.8	Petrol	112	02/11->	CDAB								
Engine	Information			A10	A20	A40	A50	A70	C10 - C30	C20	E01	
All engines	Qty: 4								470 426	C10		
ENGINE												
1.8 TSI 4x4	Petrol	112	11/09-12/17	CDAB								
Engine	Information			A10	A20	A40	A50	A70	C10 - C30	C20	E01	
All engines	x 4, ELDOR, Housing Colour:Black, COIL ON PLUG, incl. spark plug connector								470 426	C10		
ENGINE												
1.8 TSI 4x4	Petrol	118	05/09-12/17	CDAA								
Engine	Information			A10	A20	A40	A50	A70	C10 - C30	C20	E01	
All engines	x 4, ELDOR, Housing Colour:Black, COIL ON PLUG, incl. spark plug connector								470 426	C10		

A10	CONDENSER	A20	CONTACT SET	A40	DISTRIBUTOR CAP	A50	ROTOR	A70	PICK-UP
C10	COIL	C20	IGNITION MODULE	C30	ELECTRONIC IGNITION KIT	E01	IGNITION CABLE SET		

The present application list is a brief version. For the detailed information about the possibility of installation on a specific vehicle, please refer to our web-catalogue <http://catalogo.facet.eu/>

Vehicle	alim.	kW	Date	Engine	FUNCTIONS ON THE VEHICLE							
					A10	A20	A40	A50	A70	C10 - C30	C20	E01

CABRIO

				ENGINE
0.6	Petrol	40	03/00-01/04	M 160 E6AL B03, M 160.910, M 160.920

Engine	Information	A10	A20	A40	A50	A70	C10 - C30	C20	E01
Eng. M 160 E6AL B03, M 160.920	Qty: 3						470 414	C10	
Eng. M 160.910	x 3, D.I.S.						470 414	C10	
Eng. M 160 E6AL B03, M 160.920									360 643

				ENGINE
0.6	Petrol	45	01/01-01/04	M 160 E6AL B05, M 160.910, M 160.920

Engine	Information	A10	A20	A40	A50	A70	C10 - C30	C20	E01
Eng. M 160 E6AL B05, M 160.920	Qty: 3						470 414	C10	
Eng. M 160.910	x 3, D.I.S.						470 414	C10	
All engines									360 643

				ENGINE
0.6	Petrol	46	01/01-01/03	M 160.910

Engine	Information	A10	A20	A40	A50	A70	C10 - C30	C20	E01
All engines	x 3, D.I.S.						470 414	C10	

				ENGINE
0.6	Petrol	52	06/02-01/04	M 160.910, M 160.920

Engine	Information	A10	A20	A40	A50	A70	C10 - C30	C20	E01
Eng. M 160.910	x 3, D.I.S.						470 414	C10	
Eng. M 160.920	Qty: 3						470 414	C10	
Eng. M 160.920									360 643

				ENGINE
0.7	Petrol	45	01/03-01/04	M 160.910, M 160.920

Engine	Information	A10	A20	A40	A50	A70	C10 - C30	C20	E01
Eng. M 160.910	Qty: 3						470 414	C10	
Eng. M 160.920	x 3, D.I.S.						470 414	C10	
Eng. M 160.910									360 643

				ENGINE
0.7	Petrol	55	01/03-01/04	M 160.910, M 160.920

Engine	Information	A10	A20	A40	A50	A70	C10 - C30	C20	E01
Eng. M 160.910	Qty: 3						470 414	C10	
Eng. M 160.920	x 3, D.I.S.						470 414	C10	
Eng. M 160.910									360 643

CITY COUPÉ

				ENGINE
0.6	Petrol	34	12/99-04/03	M 160.910

Engine	Information	A10	A20	A40	A50	A70	C10 - C30	C20	E01
All engines	x 3, D.I.S.						470 414	C10	

CITY-COUPÉ

				ENGINE
0.6	Petrol	33	07/98-01/04	M 160 E6AL B04, M 160.910, M 160.920

Engine	Information	A10	A20	A40	A50	A70	C10 - C30	C20	E01
Eng. M 160 E6AL B04, M 160.920	Qty: 3						470 414	C10	
Eng. M 160.910	x 3, D.I.S.						470 414	C10	
Eng. M 160 E6AL B04, M 160.920									360 643

				ENGINE
0.6	Petrol	40	07/98-01/04	M 160 E6AL B03, M 160.910, M 160.920

Engine	Information	A10	A20	A40	A50	A70	C10 - C30	C20	E01
Eng. M 160 E6AL B03, M 160.920	Qty: 3						470 414	C10	
Eng. M 160.910	x 3, D.I.S.						470 414	C10	
Eng. M 160 E6AL B03, M 160.920									360 643

A10 CONDENSER	A20 CONTACT SET	A40 DISTRIBUTOR CAP	A50 ROTOR	A70 PICK-UP
C10 COIL	C20 IGNITION MODULE	C30 ELECTRONIC IGNITION KIT	E01 IGNITION CABLE SET	

Vehicle	alim.	kW	Date	Engine	FUNCTIONS ON THE VEHICLE								
					A10	A20	A40	A50	A70	C10 - C30	C20	E01	
0.6	Petrol	45	01/01-01/04	ENGINE M 160 E6AL B05, M 160.910, M 160.920									
Engine	Information	A10	A20	A40	A50	A70	C10 - C30	C20	E01				
Eng. M 160 E6AL B05, M 160.920	Qty: 3						470 414	C10					
Eng. M 160.910	x 3, D.I.S.						470 414	C10					
Eng. M 160 E6AL B05, M 160.920												360 643	
0.6	Petrol	52	06/02-01/04	ENGINE M 160.910, M 160.920									
Engine	Information	A10	A20	A40	A50	A70	C10 - C30	C20	E01				
Eng. M 160.910	x 3, D.I.S.						470 414	C10					
Eng. M 160.920	Qty: 3						470 414	C10					
Eng. M 160.920												360 643	
0.7	Petrol	33	07/98-01/04	ENGINE M 160.910									
Engine	Information	A10	A20	A40	A50	A70	C10 - C30	C20	E01				
All engines	Qty: 3						470 414	C10					
All engines												360 643	
0.7	Petrol	37	01/03-01/04	ENGINE M 160.910, M 160.920									
Engine	Information	A10	A20	A40	A50	A70	C10 - C30	C20	E01				
Eng. M 160.910	Qty: 3						470 414	C10					
Eng. M 160.920	x 3, D.I.S.						470 414	C10					
Eng. M 160.910												360 643	
0.7	Petrol	45	01/03-01/04	ENGINE M 160.910, M 160.920									
Engine	Information	A10	A20	A40	A50	A70	C10 - C30	C20	E01				
Eng. M 160.910	Qty: 3						470 414	C10					
Eng. M 160.920	x 3, D.I.S.						470 414	C10					
Eng. M 160.910												360 643	
0.7	Petrol	55	01/03-01/04	ENGINE M 160.910, M 160.920									
Engine	Information	A10	A20	A40	A50	A70	C10 - C30	C20	E01				
Eng. M 160.910	Qty: 3						470 414	C10					
Eng. M 160.920	x 3, D.I.S.						470 414	C10					
Eng. M 160.910												360 643	
CROSSBLADE													
0.6	Petrol	52	06/02-12/03	ENGINE M 160.910, M 160.920									
Engine	Information	A10	A20	A40	A50	A70	C10 - C30	C20	E01				
Eng. M 160.910	x 3, D.I.S.						470 414	C10					
Eng. M 160.920	Qty: 3						470 414	C10					
Eng. M 160.920												360 643	
FORFOUR III													
0.9	Petrol	66	11/14->	ENGINE M 281.910									
Engine	Information	A10	A20	A40	A50	A70	C10 - C30	C20	E01				
All engines	x 3, COIL ON PLUG						470 613	C10					
0.9 Brabus	Petrol	80	07/16->	ENGINE M 281.910									
Engine	Information	A10	A20	A40	A50	A70	C10 - C30	C20	E01				
All engines	x 3, COIL ON PLUG						470 613	C10					
1.0	Petrol	45	11/14->	ENGINE M 281.920									
Engine	Information	A10	A20	A40	A50	A70	C10 - C30	C20	E01				
All engines	x 3, COIL ON PLUG						470 613	C10					
1.0	Petrol	52	07/14->	ENGINE M 281.920									
Engine	Information	A10	A20	A40	A50	A70	C10 - C30	C20	E01				
All engines	x 3, COIL ON PLUG						470 613	C10					

A10 CONDENSER	A20 CONTACT SET	A40 DISTRIBUTOR CAP	A50 ROTOR	A70 PICK-UP
C10 COIL	C20 IGNITION MODULE	C30 ELECTRONIC IGNITION KIT	E01 IGNITION CABLE SET	

The present application list is a brief version. For the detailed information about the possibility of installation on a specific vehicle, please refer to our web-catalogue <http://catalogo.facet.eu/>

Vehicle	alim.	kW	Date	Engine	FUNCTIONS ON THE VEHICLE							
					A10	A20	A40	A50	A70	C10 - C30	C20	E01

FORTWO I

				ENGINE
0.6	Petrol	45	01/04-02/07	M 160.910

Engine	Information	A10	A20	A40	A50	A70	C10 - C30	C20	E01
All engines	x 3, D.I.S.						470 414	C10	

				ENGINE
0.7	Petrol	37	01/04-01/07	M 160.910, M 160.920

Engine	Information	A10	A20	A40	A50	A70	C10 - C30	C20	E01
Eng. M 160.910	Qty: 3						470 414	C10	
Eng. M 160.920	x 3, D.I.S.						470 414	C10	
Eng. M 160.910									360 643

				ENGINE
0.7	Petrol	40	01/04-01/07	M 160.920

Engine	Information	A10	A20	A40	A50	A70	C10 - C30	C20	E01
All engines	x 3, D.I.S.						470 414	C10	

				ENGINE
0.7	Petrol	45	01/04-01/07	M 160.910, M 160.920

Engine	Information	A10	A20	A40	A50	A70	C10 - C30	C20	E01
Eng. M 160.910	Qty: 3						470 414	C10	
Eng. M 160.920	x 3, D.I.S.						470 414	C10	
Eng. M 160.910									360 643

				ENGINE
0.7	Petrol	55	01/04-01/07	M 160.910, M 160.920

Engine	Information	A10	A20	A40	A50	A70	C10 - C30	C20	E01
Eng. M 160.910	Qty: 3						470 414	C10	
Eng. M 160.920	x 3, D.I.S.						470 414	C10	
Eng. M 160.910									360 643

FORTWO II

				ENGINE
1.0	Petrol	45	01/07->	M 132.910

Engine	Information	A10	A20	A40	A50	A70	C10 - C30	C20	E01
All engines	x 3, COIL ON PLUG						470 503	C10	

				ENGINE
1.0	Petrol	52	01/07->	M 132.910

Engine	Information	A10	A20	A40	A50	A70	C10 - C30	C20	E01
All engines	x 3, COIL ON PLUG						470 503	C10	

				ENGINE
1.0 Brabus	Petrol	72	01/08->	M 132.930

Engine	Information	A10	A20	A40	A50	A70	C10 - C30	C20	E01
All engines	x 3, COIL ON PLUG						470 503	C10	

				ENGINE
1.0 Brabus	Petrol	88	04/12->	M 132.930

Engine	Information	A10	A20	A40	A50	A70	C10 - C30	C20	E01
All engines	x 3, COIL ON PLUG						470 503	C10	

				ENGINE
1.0 Turbo	Petrol	62	01/07->	M 132.930

Engine	Information	A10	A20	A40	A50	A70	C10 - C30	C20	E01
All engines	x 3, COIL ON PLUG						470 503	C10	

				ENGINE
1.0 Turbo Brabus	Petrol	75	07/10->	M 132.930

Engine	Information	A10	A20	A40	A50	A70	C10 - C30	C20	E01
All engines	x 3, COIL ON PLUG						470 503	C10	

FORTWO III

				ENGINE
0.9	Petrol	66	09/14->	M 281.910

Engine	Information	A10	A20	A40	A50	A70	C10 - C30	C20	E01
All engines	x 3, COIL ON PLUG						470 613	C10	

				ENGINE
0.9 Brabus	Petrol	80	07/16->	M 281.910

Engine	Information	A10	A20	A40	A50	A70	C10 - C30	C20	E01
All engines	x 3, COIL ON PLUG						470 613	C10	

A10 CONDENSER	A20 CONTACT SET	A40 DISTRIBUTOR CAP	A50 ROTOR	A70 PICK-UP
C10 COIL	C20 IGNITION MODULE	C30 ELECTRONIC IGNITION KIT	E01 IGNITION CABLE SET	

Vehicle	alim.	kW	Date	Engine	FUNCTIONS ON THE VEHICLE								
					A10	A20	A40	A50	A70	C10 - C30	C20	E01	
ENGINE													
1.0	Petrol	45	11/14->	M 281.920									
Engine	Information				A10	A20	A40	A50	A70	C10 - C30	C20	E01	
All engines	x 3, COIL ON PLUG									470 613	C10		
ENGINE													
1.0	Petrol	52	07/14->	M 281.920									
Engine	Information				A10	A20	A40	A50	A70	C10 - C30	C20	E01	
All engines	x 3, COIL ON PLUG									470 613	C10		
ROADSTER													
ENGINE													
0.7	Petrol	45	04/03-11/05	M 160.921, M 160.922									
Engine	Information				A10	A20	A40	A50	A70	C10 - C30	C20	E01	
All engines	x 3, D.I.S.									470 414	C10		
All engines												360 643	
ENGINE													
0.7	Petrol	60	04/03-11/05	M 160.921, M 160.922									
Engine	Information				A10	A20	A40	A50	A70	C10 - C30	C20	E01	
All engines	x 3, D.I.S.									470 414	C10		
All engines												360 643	
ENGINE													
0.7 Brabus	Petrol	74	12/03-11/05	M 160.923									
Engine	Information				A10	A20	A40	A50	A70	C10 - C30	C20	E01	
All engines	x 3, D.I.S.									470 414	C10		
All engines												360 643	

A10	CONDENSER	A20	CONTACT SET	A40	DISTRIBUTOR CAP	A50	ROTOR	A70	PICK-UP
C10	COIL	C20	IGNITION MODULE	C30	ELECTRONIC IGNITION KIT	E01	IGNITION CABLE SET		

The present application list is a brief version. For the detailed information about the possibility of installation on a specific vehicle, please refer to our web-catalogue <http://catalogo.facet.eu/>

Vehicle	alim.	kW	Date	Engine	FUNCTIONS ON THE VEHICLE							
					A10	A20	A40	A50	A70	C10 - C30	C20	E01

CHAIRMAN

3.2	Petrol	165	07/11->	ENGINE G32D
-----	--------	-----	---------	----------------

Engine	Information	A10	A20	A40	A50	A70	C10 - C30	C20	E01
All engines	x 3, SEMI-DIRECT						470 316	C10	

KORANDO

2.0	Petrol	94	05/97-10/02	ENGINE E20, E20M160, E20M161, M111E20
-----	--------	----	-------------	--

Engine	Information	A10	A20	A40	A50	A70	C10 - C30	C20	E01
Eng. E20, M111E20	Qty: 2						470 316	C10	
Eng. E20M160, E20M161	x 2, SEMI-DIRECT, x 2, SEMI-DIRECT						470 316	C10	

2.3	Petrol	103	05/97-02/00	ENGINE --, E23, M 111.970, M111E23
-----	--------	-----	-------------	---------------------------------------

Engine	Information	A10	A20	A40	A50	A70	C10 - C30	C20	E01
Eng. --, M 111.970, M111E23	Qty: 2						470 316	C10	
Eng. E23	x 2, SEMI-DIRECT						470 316	C10	

2.3	Petrol	105	01/99-11/06	ENGINE --, M111E23-143
-----	--------	-----	-------------	---------------------------

Engine	Information	A10	A20	A40	A50	A70	C10 - C30	C20	E01
All engines	Qty: 2						470 316	C10	

3.2	Petrol	154	12/96-11/02	ENGINE E32, M 104.995
-----	--------	-----	-------------	--------------------------

Engine	Information	A10	A20	A40	A50	A70	C10 - C30	C20	E01
Eng. E32	x 3, SEMI-DIRECT, x 3, SEMI-DIRECT						470 316	C10	
Eng. M 104.995	Qty: 3						470 316	C10	

3.2	Petrol	156	01/99-11/02	ENGINE E32, M 104.995
-----	--------	-----	-------------	--------------------------

Engine	Information	A10	A20	A40	A50	A70	C10 - C30	C20	E01
All engines	x 3, SEMI-DIRECT						470 316	C10	
Eng. M 104.995	Qty: 3						470 316	C10	

3.2	Petrol	162	06/97-11/06	ENGINE M 104.992
-----	--------	-----	-------------	---------------------

Engine	Information	A10	A20	A40	A50	A70	C10 - C30	C20	E01
All engines	Qty: 3						470 316	C10	

KYRON

3.2 M320 4x4	Petrol	162	03/08->	ENGINE G32D
--------------	--------	-----	---------	----------------

Engine	Information	A10	A20	A40	A50	A70	C10 - C30	C20	E01
All engines	x 3, SEMI-DIRECT						470 316	C10	

MUSSO

2.0	Petrol	93	10/96-05/05	ENGINE E20, M111E20
-----	--------	----	-------------	------------------------

Engine	Information	A10	A20	A40	A50	A70	C10 - C30	C20	E01
All engines	Qty: 2						470 316	C10	

3.2	Petrol	162	06/96-09/04	ENGINE M 104.992
-----	--------	-----	-------------	---------------------

Engine	Information	A10	A20	A40	A50	A70	C10 - C30	C20	E01
All engines	Qty: 3						470 316	C10	

REXTON I

3.2 RX320 4x4	Petrol	162	04/02->	ENGINE G32D
---------------	--------	-----	---------	----------------

Engine	Information	A10	A20	A40	A50	A70	C10 - C30	C20	E01
All engines	x 3, SEMI-DIRECT						470 316	C10	

RODIUS

3.2	Petrol	162	05/05->	ENGINE M162E32
-----	--------	-----	---------	-------------------

Engine	Information	A10	A20	A40	A50	A70	C10 - C30	C20	E01
All engines	x 3, SEMI-DIRECT, x 3, SEMI-DIRECT, x 3, SEMI-DIRECT, x 3, SEMI-DIRECT						470 316	C10	

A10 CONDENSER	A20 CONTACT SET	A40 DISTRIBUTOR CAP	A50 ROTOR	A70 PICK-UP
C10 COIL	C20 IGNITION MODULE	C30 ELECTRONIC IGNITION KIT	E01 IGNITION CABLE SET	

Vehicle	alim.	kW	Date	Engine	FUNCTIONS ON THE VEHICLE							
					 A10	 A20	 A40	 A50	 A70	 C10 - C30	 C20	 E01

ENGINE				
3.2 4WD	Petrol	162	07/07->	G32D, M162E32

Engine	Information	A10	A20	A40	A50	A70	C10 - C30	C20	E01
All engines	x 3, SEMI-DIRECT, x 3, SEMI-DIRECT, x 3, SEMI-DIRECT, x 3, SEMI-DIRECT						470 316	C10	

A10	CONDENSER	A20	CONTACT SET	A40	DISTRIBUTOR CAP	A50	ROTOR	A70	PICK-UP
C10	COIL	C20	IGNITION MODULE	C30	ELECTRONIC IGNITION KIT	E01	IGNITION CABLE SET		

The present application list is a brief version. For the detailed information about the possibility of installation on a specific vehicle, please refer to our web-catalogue <http://catalogo.facet.eu/>

Vehicle	alim.	kW	Date	Engine	FUNCTIONS ON THE VEHICLE							
					A10	A20	A40	A50	A70	C10 - C30	C20	E01

FORESTER I

2.0	Petrol	90	08/97-09/02	ENGINE EJ20J
-----	--------	----	-------------	-----------------

Engine	Information	A10	A20	A40	A50	A70	C10 - C30	C20	E01
All engines									360 835

2.0 AWD	Petrol	90	08/97-09/02	ENGINE EJ202
---------	--------	----	-------------	-----------------

Engine	Information	A10	A20	A40	A50	A70	C10 - C30	C20	E01
All engines	01/05/00 ->, version HUNTER								360 813
All engines	version NA SPORT								360 817

2.0 AWD	Petrol	92	06/98-09/02	ENGINE EJ202
---------	--------	----	-------------	-----------------

Engine	Information	A10	A20	A40	A50	A70	C10 - C30	C20	E01
All engines	01/05/00 ->, version HUNTER								360 813
All engines	version NA SPORT								360 817

2.0 S Turbo AWD	Petrol	125	06/98-04/01	ENGINE EJ20
-----------------	--------	-----	-------------	----------------

Engine	Information	A10	A20	A40	A50	A70	C10 - C30	C20	E01
All engines	->year 31/08/00								360 887

FORESTER II

2.0 AWD	Petrol	92	06/02-05/05	ENGINE EJ20, EJ201
---------	--------	----	-------------	-----------------------

Engine	Information	A10	A20	A40	A50	A70	C10 - C30	C20	E01
All engines	no specific info conc. application available								360 813

2.5	Petrol	123	02/02->	ENGINE EJ253
-----	--------	-----	---------	-----------------

Engine	Information	A10	A20	A40	A50	A70	C10 - C30	C20	E01
All engines									358 106

2.5	Petrol	130	02/02->	ENGINE EJ251
-----	--------	-----	---------	-----------------

Engine	Information	A10	A20	A40	A50	A70	C10 - C30	C20	E01
All engines									360 813

FORESTER III

2.5	Petrol	126	01/08->	ENGINE EJ253
-----	--------	-----	---------	-----------------

Engine	Information	A10	A20	A40	A50	A70	C10 - C30	C20	E01
All engines									358 106

IMPREZA I

1.6	Petrol	66	01/93-12/00	ENGINE EJ16E
-----	--------	----	-------------	-----------------

Engine	Information	A10	A20	A40	A50	A70	C10 - C30	C20	E01
All engines							470 265	C10	
All engines	01/12/93 ->								360 835

1.6	Petrol	70	09/98-09/00	ENGINE EJ161
-----	--------	----	-------------	-----------------

Engine	Information	A10	A20	A40	A50	A70	C10 - C30	C20	E01
All engines									360 819

1.6 i	Petrol	66	08/92-12/00	ENGINE 8F 140 GA
-------	--------	----	-------------	---------------------

Engine	Information	A10	A20	A40	A50	A70	C10 - C30	C20	E01
All engines							470 265	C10	
All engines	01/12/93 ->								360 835

1.6 i	Petrol	70	06/98-12/00	ENGINE EJ161
-------	--------	----	-------------	-----------------

Engine	Information	A10	A20	A40	A50	A70	C10 - C30	C20	E01
All engines									360 819

1.6 i AWD	Petrol	66	08/92-12/00	ENGINE 8F 140 GA
-----------	--------	----	-------------	---------------------









Engine	Information	A10	A20	A40	A50	A70	C10 - C30	C20	E01
All engines							470 265	C10	
All engines	01/12/93 ->								360 835

A10 CONDENSER	A20 CONTACT SET	A40 DISTRIBUTOR CAP	A50 ROTOR	A70 PICK-UP
C10 COIL	C20 IGNITION MODULE	C30 ELECTRONIC IGNITION KIT	E01 IGNITION CABLE SET	

Vehicle	alim.	kW	Date	Engine	FUNCTIONS ON THE VEHICLE									
					A10	A20	A40	A50	A70	C10 - C30	C20	E01		
ENGINE														
1.6 i AWD	Petrol	70	06/98-12/00	EJ161										
ENGINE														
Engine	Information				A10	A20	A40	A50	A70	C10 - C30	C20	E01		
All engines													360 819	
ENGINE														
1.8	Petrol	76	01/93-10/95	EJ18										
ENGINE														
Engine	Information				A10	A20	A40	A50	A70	C10 - C30	C20	E01		
All engines										470 265	C10			
All engines	01/12/93 ->												360 835	
ENGINE														
1.8 i	Petrol	0	08/92-12/00	EJ181										
ENGINE														
Engine	Information				A10	A20	A40	A50	A70	C10 - C30	C20	E01		
All engines													360 813	
ENGINE														
1.8 i	Petrol	76	11/95-06/96	EJ18E										
ENGINE														
Engine	Information				A10	A20	A40	A50	A70	C10 - C30	C20	E01		
All engines										470 265	C10		360 835	
ENGINE														
1.8 i AWD	Petrol	76	08/92-12/00	EJ18, EJ18E										
ENGINE														
Engine	Information				A10	A20	A40	A50	A70	C10 - C30	C20	E01		
All engines										470 265	C10			
All engines	01/12/93 ->												360 835	
ENGINE														
2.0	Petrol	85	09/96-08/98	EJ20E										
ENGINE														
Engine	Information				A10	A20	A40	A50	A70	C10 - C30	C20	E01		
All engines										470 266	C10			
ENGINE														
2.0	Petrol	92	09/98-09/00	EJ201										
ENGINE														
Engine	Information				A10	A20	A40	A50	A70	C10 - C30	C20	E01		
All engines													360 813	
ENGINE														
2.0 AWD	Petrol	85	12/95-12/00	EJ20E										
ENGINE														
Engine	Information				A10	A20	A40	A50	A70	C10 - C30	C20	E01		
All engines										470 266	C10			
ENGINE														
2.0 i	Petrol	85	11/95-09/00	EJ20E										
ENGINE														
Engine	Information				A10	A20	A40	A50	A70	C10 - C30	C20	E01		
All engines										470 266	C10			
ENGINE														
2.0 i	Petrol	92	09/98-09/00	EJ201										
ENGINE														
Engine	Information				A10	A20	A40	A50	A70	C10 - C30	C20	E01		
All engines													360 813	
ENGINE														
2.0 i 16V AWD	Petrol	92	06/98-12/00	EJ20, EJ20E										
ENGINE														
Engine	Information				A10	A20	A40	A50	A70	C10 - C30	C20	E01		
All engines													360 813	
ENGINE														
2.0 i AWD	Petrol	85	10/95-12/00	EJ20, EJ20E										
ENGINE														
Engine	Information				A10	A20	A40	A50	A70	C10 - C30	C20	E01		
All engines										470 266	C10			
ENGINE														
2.0 i AWD	Petrol	92	06/98-12/00	EJ201										
ENGINE														
Engine	Information				A10	A20	A40	A50	A70	C10 - C30	C20	E01		
All engines													360 813	
ENGINE														
2.0 i Turbo AWD	Petrol	155	03/94-12/00	EJ20 (Turbo)										
ENGINE														
Engine	Information				A10	A20	A40	A50	A70	C10 - C30	C20	E01		
All engines	01/04/96 ->									470 266	C10			

A10 CONDENSER	A20 CONTACT SET	A40 DISTRIBUTOR CAP	A50 ROTOR	A70 PICK-UP
C10 COIL	C20 IGNITION MODULE	C30 ELECTRONIC IGNITION KIT	E01 IGNITION CABLE SET	

The present application list is a brief version. For the detailed information about the possibility of installation on a specific vehicle, please refer to our web-catalogue <http://catalogo.facet.eu/>

				FUNCTIONS ON THE VEHICLE								
Vehicle	alim.	kW	Date	Engine	 A10	 A20	 A40	 A50	 A70	 C10 - C30	 C20	 E01
				ENGINE								
2.0 Turbo AWD	Petrol	155	12/96-12/00	EJ20G								
Engine		Information			A10	A20	A40	A50	A70	C10 - C30	C20	E01
All engines										470 266	C10	
				ENGINE								
2.0 Turbo GT AWD	Petrol	155	03/94-12/00	EJ20 (Turbo)								
Engine		Information			A10	A20	A40	A50	A70	C10 - C30	C20	E01
All engines		01/04/96->								470 266	C10	
				ENGINE								
2.0 Turbo GT AWD	Petrol	160	06/98-12/00	EJ205								
Engine		Information			A10	A20	A40	A50	A70	C10 - C30	C20	E01
All engines												360 887
				ENGINE								
2.2 i	Petrol	0	11/93-08/98	EJ22E, EJ22EZ								
Engine		Information			A10	A20	A40	A50	A70	C10 - C30	C20	E01
Eng. EJ22E		->year 30/06/96								470 266	C10	
All engines		01/07/98->										360 813
				ENGINE								
2.5 i	Petrol	0	11/93-08/98	EJ253								
Engine		Information			A10	A20	A40	A50	A70	C10 - C30	C20	E01
All engines												360 813
				ENGINE								
1.6 AWD	Petrol	70	12/00-06/09	8F 140 GA, EJ161								
Engine		Information			A10	A20	A40	A50	A70	C10 - C30	C20	E01
All engines												360 819
				ENGINE								
2.0 AWD	Petrol	92	12/00-12/07	EJ20								
Engine		Information			A10	A20	A40	A50	A70	C10 - C30	C20	E01
All engines												360 813
				ENGINE								
2.0 i AWD	Petrol	92	12/00-06/09	EJ201								
Engine		Information			A10	A20	A40	A50	A70	C10 - C30	C20	E01
All engines												360 813
				ENGINE								
2.5 AWD	Petrol	112	12/02-09/05	EJ25								
Engine		Information			A10	A20	A40	A50	A70	C10 - C30	C20	E01
All engines												360 813
				ENGINE								
2.5 AWD	Petrol	130	03/01-09/05	EJ251								
Engine		Information			A10	A20	A40	A50	A70	C10 - C30	C20	E01
All engines												360 813
				ENGINE								
2.5 i AWD	Petrol	112	12/02-09/05	EJ251								
Engine		Information			A10	A20	A40	A50	A70	C10 - C30	C20	E01
All engines												360 813
				ENGINE								
1.0i EFC-SYS	Petrol	0	01/89->	--								
Engine		Information			A10	A20	A40	A50	A70	C10 - C30	C20	E01
All engines		version Hitachi					822 041	922 073				
				ENGINE								
1.2i EFC-SYS	Petrol	0	01/89->	--								
Engine		Information			A10	A20	A40	A50	A70	C10 - C30	C20	E01
All engines		version Hitachi					822 041	922 073				
				ENGINE								
1.2i EMPi [USA]	Petrol	0	01/91->	--								
Engine		Information			A10	A20	A40	A50	A70	C10 - C30	C20	E01
All engines		version Denso					813 259	913 029				

A10 CONDENSER	A20 CONTACT SET	A40 DISTRIBUTOR CAP	A50 ROTOR	A70 PICK-UP
C10 COIL	C20 IGNITION MODULE	C30 ELECTRONIC IGNITION KIT	E01 IGNITION CABLE SET	

Vehicle	alim.	kW	Date	Engine	FUNCTIONS ON THE VEHICLE							
					A10	A20	A40	A50	A70	C10 - C30	C20	E01
JUSTY II												
1.3 4x4	Petrol	63	04/01-11/03	G13BB								
Engine	Information				A10	A20	A40	A50	A70	C10 - C30	C20	E01
All engines	Qty: 2									470 570	C10	
1.3i	Petrol	50	05/96-09/00	G13BA								
Engine	Information				A10	A20	A40	A50	A70	C10 - C30	C20	E01
All engines	version Denso						813 123	913 028				
JUSTY III												
1.3 AWD	Petrol	69	09/03->	M13A								
Engine	Information				A10	A20	A40	A50	A70	C10 - C30	C20	E01
All engines	Qty: 2									470 570	C10	
1.5 AWD	Petrol	73	09/03->	M15A								
Engine	Information				A10	A20	A40	A50	A70	C10 - C30	C20	E01
All engines	Qty: 2									470 570	C10	
LEGACY I												
1.6	Petrol	70	05/89-12/93	8F 140 GA								
Engine	Information				A10	A20	A40	A50	A70	C10 - C30	C20	E01
All engines	version Mitsubishi						831 145	931 119				
1.8i SPI	Petrol	0	01/89->	--								
Engine	Information				A10	A20	A40	A50	A70	C10 - C30	C20	E01
All engines	version Hitachi						822 075	922 093				
1800	Petrol	76	01/89-07/94	EJ18 SPI								
Engine	Information				A10	A20	A40	A50	A70	C10 - C30	C20	E01
All engines	->year 31/12/91, version Hitachi						822 075					
All engines	version Hitachi							922 093				
1800 4WD	Petrol	76	01/89-07/94	EJ18 SPI								
Engine	Information				A10	A20	A40	A50	A70	C10 - C30	C20	E01
All engines	->year 31/12/91, version Hitachi						822 075					
All engines	version Hitachi							922 093				
2.0	Petrol	85	08/91-12/93	EJ20E								
Engine	Information				A10	A20	A40	A50	A70	C10 - C30	C20	E01
All engines										470 265	C10	
2.0i 16V	Petrol	85	08/91-12/93	EJ20E								
Engine	Information				A10	A20	A40	A50	A70	C10 - C30	C20	E01
All engines										470 265	C10	
2.2i	Petrol	0	01/90->	--								
Engine	Information				A10	A20	A40	A50	A70	C10 - C30	C20	E01
All engines	+automatic transmission, FOR: (USA)									470 265	C10	
All engines	FOR: (EU), +manual transmission, FOR: (USA)									470 266	C10	
2.2i [USA]	Petrol	0	01/90->	--								
Engine	Information				A10	A20	A40	A50	A70	C10 - C30	C20	E01
All engines	+automatic transmission, FOR: (USA)									470 265	C10	
All engines	FOR: (EU), +manual transmission, FOR: (USA)									470 266	C10	
2.2i 16v	Petrol	100	08/89-10/91	EJ22E								
Engine	Information				A10	A20	A40	A50	A70	C10 - C30	C20	E01
All engines										470 265	C10	

A10 CONDENSER	A20 CONTACT SET	A40 DISTRIBUTOR CAP	A50 ROTOR	A70 PICK-UP
C10 COIL	C20 IGNITION MODULE	C30 ELECTRONIC IGNITION KIT	E01 IGNITION CABLE SET	

The present application list is a brief version. For the detailed information about the possibility of installation on a specific vehicle, please refer to our web-catalogue <http://catalogo.facet.eu/>

Vehicle	alim.	kW	Date	Engine	FUNCTIONS ON THE VEHICLE							
					A10	A20	A40	A50	A70	C10 - C30	C20	E01

ENGINE				
2.2i Turbo [USA]	Petrol	0	01/90->	--

Engine	Information	A10	A20	A40	A50	A70	C10 - C30	C20	E01
All engines	+automatic transmission, FOR: (USA)						470 265	C10	
All engines	FOR: (EU), +manual transmission, FOR: (USA)						470 266	C10	

ENGINE				
2000	Petrol	85	09/91-12/93	EJ20 EMPI

Engine	Information	A10	A20	A40	A50	A70	C10 - C30	C20	E01
All engines							470 265	C10	

ENGINE				
2000 4WD	Petrol	85	08/91-07/94	EJ20 EMPI

Engine	Information	A10	A20	A40	A50	A70	C10 - C30	C20	E01
All engines							470 265	C10	

ENGINE				
2200 4WD	Petrol	100	01/89-07/94	EJ22 EMPI

Engine	Information	A10	A20	A40	A50	A70	C10 - C30	C20	E01
All engines							470 265	C10	

ENGINE				
2200 Super 4WD	Petrol	100	01/89-07/94	EJ22 EMPI

Engine	Information	A10	A20	A40	A50	A70	C10 - C30	C20	E01
All engines							470 265	C10	

LEGACY II

ENGINE				
1.8 4WD	Petrol	76	05/96-09/98	EJ18E

Engine	Information	A10	A20	A40	A50	A70	C10 - C30	C20	E01
All engines	->year 31/05/96						470 265	C10	
All engines	->year 31/05/96, 01/02/97 ->								360 835

ENGINE				
2.0 i	Petrol	85	09/94-03/99	EJ20 EMPI, EJ20E

Engine	Information	A10	A20	A40	A50	A70	C10 - C30	C20	E01
All engines							470 266	C10	360 835

ENGINE				
2.0 i 4WD	Petrol	85	09/94-03/99	EJ201, EJ20E

Engine	Information	A10	A20	A40	A50	A70	C10 - C30	C20	E01
All engines							470 266	C10	360 835

ENGINE				
2.2	Petrol	94	07/94-11/98	2LF479Q3

Engine	Information	A10	A20	A40	A50	A70	C10 - C30	C20	E01
All engines							470 266	C10	

ENGINE				
2.2 i 4WD	Petrol	94	02/94-03/99	EJ22 EMPI

Engine	Information	A10	A20	A40	A50	A70	C10 - C30	C20	E01
All engines							470 266	C10	

ENGINE				
2.2 i 4WD	Petrol	96	06/96-03/99	EJ22 EMPI

Engine	Information	A10	A20	A40	A50	A70	C10 - C30	C20	E01
All engines							470 266	C10	

ENGINE				
2.5	Petrol	110	01/96-12/99	EJ25D

Engine	Information	A10	A20	A40	A50	A70	C10 - C30	C20	E01
All engines							470 266	C10	

ENGINE				
2.5 i 4WD	Petrol	110	06/96-03/99	EJ25D

Engine	Information	A10	A20	A40	A50	A70	C10 - C30	C20	E01
All engines							470 266	C10	

LEGACY III

ENGINE				
2.0	Petrol	102	12/98-08/03	EJ201

Engine	Information	A10	A20	A40	A50	A70	C10 - C30	C20	E01
All engines									360 813

A10 CONDENSER	A20 CONTACT SET	A40 DISTRIBUTOR CAP	A50 ROTOR	A70 PICK-UP
C10 COIL	C20 IGNITION MODULE	C30 ELECTRONIC IGNITION KIT	E01 IGNITION CABLE SET	

Vehicle	alim.	kW	Date	Engine	FUNCTIONS ON THE VEHICLE									
					A10	A20	A40	A50	A70	C10 - C30	C20	E01		
ENGINE														
2.0	Petrol	92	12/98-08/03	EJ201										
ENGINE														
Engine Information					A10	A20	A40	A50	A70	C10 - C30	C20	E01		
All engines													360 813	
2.0 AWD	Petrol	92	12/98-08/03	EJ201										
ENGINE														
Engine Information					A10	A20	A40	A50	A70	C10 - C30	C20	E01		
All engines													360 813	
2.5	Petrol	115	10/98-08/03	EJ251										
ENGINE														
Engine Information					A10	A20	A40	A50	A70	C10 - C30	C20	E01		
All engines													360 813	
2.5 AWD	Petrol	115	10/98-08/03	EJ25										
ENGINE														
Engine Information					A10	A20	A40	A50	A70	C10 - C30	C20	E01		
All engines													360 813	
LEGACY IV														
2.0 AWD	Petrol	101	09/03-10/05	EJ202										
ENGINE														
Engine Information					A10	A20	A40	A50	A70	C10 - C30	C20	E01		
All engines													358 100	
2.5 AWD	Petrol	121	09/03-04/09	EJ25										
ENGINE														
Engine Information					A10	A20	A40	A50	A70	C10 - C30	C20	E01		
All engines													358 106	
2.5 i	Petrol	121	05/03->	EJ252, EJ253										
ENGINE														
Engine Information					A10	A20	A40	A50	A70	C10 - C30	C20	E01		
All engines													358 106	
2.5 i AWD	Petrol	127	09/07-12/09	EJ25										
ENGINE														
Engine Information					A10	A20	A40	A50	A70	C10 - C30	C20	E01		
All engines													358 106	
LOYALE														
1.8i SPi [USA]	Petrol	0	01/90->	--										
ENGINE														
Engine Information					A10	A20	A40	A50	A70	C10 - C30	C20	E01		
All engines							822 046							
1.8i Turbo [USA]	Petrol	0	01/90->	--										
ENGINE														
Engine Information					A10	A20	A40	A50	A70	C10 - C30	C20	E01		
All engines							822 046							
L-SERIES														
1.8i	Petrol	0	01/86-12/91	--										
ENGINE														
Engine Information					A10	A20	A40	A50	A70	C10 - C30	C20	E01		
All engines							822 046							
All engines								913 014						
1.8i TB	Petrol	0	01/86-12/91	--										
ENGINE														
Engine Information					A10	A20	A40	A50	A70	C10 - C30	C20	E01		
All engines							822 046							
1.8i TB 4x4	Petrol	0	01/86-12/91	--										
ENGINE														
Engine Information					A10	A20	A40	A50	A70	C10 - C30	C20	E01		
All engines							822 046							
1.8i Turbo	Petrol	0	01/86-12/91	--										
ENGINE														
Engine Information					A10	A20	A40	A50	A70	C10 - C30	C20	E01		
All engines							822 046							

A10 CONDENSER	A20 CONTACT SET	A40 DISTRIBUTOR CAP	A50 ROTOR	A70 PICK-UP
C10 COIL	C20 IGNITION MODULE	C30 ELECTRONIC IGNITION KIT	E01 IGNITION CABLE SET	

The present application list is a brief version. For the detailed information about the possibility of installation on a specific vehicle, please refer to our web-catalogue <http://catalogo.facet.eu/>

Vehicle	alim.	kW	Date	Engine	FUNCTIONS ON THE VEHICLE							
					A10	A20	A40	A50	A70	C10 - C30	C20	E01

OUTBACK II

2.5 AWD	Petrol	115	10/00-08/03	ENGINE
				EJ25

Engine	Information	A10	A20	A40	A50	A70	C10 - C30	C20	E01
All engines									360 813

OUTBACK III

2.0	Petrol	101	09/03-10/05	ENGINE
				EJ202

Engine	Information	A10	A20	A40	A50	A70	C10 - C30	C20	E01
All engines									358 100

2.0 AWD	Petrol	101	09/03-10/05	ENGINE
				EJ202

Engine	Information	A10	A20	A40	A50	A70	C10 - C30	C20	E01
All engines									358 100

2.5	Petrol	121	09/08-09/09	ENGINE
				EJ252, EJ253

Engine	Information	A10	A20	A40	A50	A70	C10 - C30	C20	E01
All engines									358 106

TRENDY

1.0	Petrol	40	08/86-05/95	ENGINE
				EF10

Engine	Information	A10	A20	A40	A50	A70	C10 - C30	C20	E01
All engines	super unlead (95), version Hitachi			822 041					
All engines	Super (98), version Hitachi			822 048					
All engines	01/04/88 ->, super unlead (95), version Hitachi				913 029				
All engines	->year 31/03/88, super unlead (95), version Hitachi				922 073				

1.2 12v	Petrol	49	06/86-08/95	ENGINE
				EF12

Engine	Information	A10	A20	A40	A50	A70	C10 - C30	C20	E01
All engines	version Hitachi			822 041	922 073				

TREZIA

1.3	Petrol	73	03/11->	ENGINE
				1NR-FE

Engine	Information	A10	A20	A40	A50	A70	C10 - C30	C20	E01
All engines	x 4, COIL ON PLUG						470 537	C10	

A10 CONDENSER	A20 CONTACT SET	A40 DISTRIBUTOR CAP	A50 ROTOR	A70 PICK-UP
C10 COIL	C20 IGNITION MODULE	C30 ELECTRONIC IGNITION KIT	E01 IGNITION CABLE SET	

Vehicle	alim.	kW	Date	Engine	FUNCTIONS ON THE VEHICLE							
					A10	A20	A40	A50	A70	C10 - C30	C20	E01

ALTO I

				ENGINE
0.8	Petrol	29	06/82-08/84	F8A, F8B

Engine	Information	A10	A20	A40	A50	A70	C10 - C30	C20	E01
All engines	version Denso		713 011HV	813 107	913 014				

ALTO IV

				ENGINE
1.0	Petrol	39	09/94-06/02	G10BB

Engine	Information	A10	A20	A40	A50	A70	C10 - C30	C20	E01
All engines	version Denso, no specific info conc. application available			813 123	913 028				
All engines	FOR: (EU), FOR: (AUS), version Denso, no specific info conc. application available			813 256	913 036				
All engines	petrol injection, no specific info conc. application available								358 231
All engines	fuel formation: carburettor, no specific info conc. application available								360 413

ALTO V

				ENGINE
1.0	Petrol	43	01/00-06/02	G10BB

Engine	Information	A10	A20	A40	A50	A70	C10 - C30	C20	E01
All engines	version Denso, no specific info conc. application available			813 123	913 028				
All engines	FOR: (EU), FOR: (AUS), version Denso, no specific info conc. application available			813 256	913 036				
All engines	petrol injection, no specific info conc. application available								358 231
All engines	fuel formation: carburettor, no specific info conc. application available								360 413

ALTO VI

				ENGINE
1.1	Petrol	46	09/04-12/08	6AR02150, F10D, F10DN

Engine	Information	A10	A20	A40	A50	A70	C10 - C30	C20	E01
Eng. F10D	Fitting Position:for cylinder 1, Fitting Position:for cylinder 4, x 2, SEMI-DIRECT						470 535	C10	
Eng. F10DN	->ch. MA3FFB21500280000, Qty: 2						470 535	C10	
Eng. F10DN	ch. MA3FFB21500280001 ->, Qty:2						470 570	C10	
Eng. 6AR02150, F10DN									358 005

BALENO

				ENGINE
1.0	Petrol	82	02/16->	K10CT

Engine	Information	A10	A20	A40	A50	A70	C10 - C30	C20	E01
All engines	x 3, COIL ON PLUG						470 621	C10	

				ENGINE
1.2	Petrol	66	02/16->	K12C

Engine	Information	A10	A20	A40	A50	A70	C10 - C30	C20	E01
All engines	x 4, COIL ON PLUG						470 621	C10	

				ENGINE
1.2 Hybrid	Petrol/ Electric	66	02/16->	K12C

Engine	Information	A10	A20	A40	A50	A70	C10 - C30	C20	E01
All engines	x 4, COIL ON PLUG						470 621	C10	

				ENGINE
1.3 16V	Petrol	63	03/97-05/02	G13BB

Engine	Information	A10	A20	A40	A50	A70	C10 - C30	C20	E01
All engines	01/02/99 ->								358 005
All engines	->year 31/01/99								360 434







				ENGINE
1.3 i 16V	Petrol	63	07/95-05/02	G13BB

Engine	Information	A10	A20	A40	A50	A70	C10 - C30	C20	E01
All engines	01/02/99 ->								358 005
All engines	->year 31/01/99								360 434

				ENGINE
1.6	Petrol	71	07/96-01/99	G16B

Engine	Information	A10	A20	A40	A50	A70	C10 - C30	C20	E01
All engines	ch. 00160001 ->, x 2, SEMI-DIRECT						470 535	C10	

A10	CONDENSER	A20	CONTACT SET	A40	DISTRIBUTOR CAP	A50	ROTOR	A70	PICK-UP
C10	COIL	C20	IGNITION MODULE	C30	ELECTRONIC IGNITION KIT	E01	IGNITION CABLE SET		

				FUNCTIONS ON THE VEHICLE									
Vehicle	alim.	kW	Date	Engine									
				ENGINE									
1.6 i 16V	Petrol	72	07/95-05/02	G16B									
Engine	Information			A10	A20	A40	A50	A70	C10 - C30		C20	E01	
All engines	ch. 00160001 ->, x 2, SEMI-DIRECT								470 535	C10			
All engines	01/02/99 ->											358 005	
All engines	->year 31/01/99											360 434	
				ENGINE									
1.6 i 16V	Petrol	73	08/96-05/02	G16B									
Engine	Information			A10	A20	A40	A50	A70	C10 - C30		C20	E01	
All engines	ch. 00160001 ->, x 2, SEMI-DIRECT								470 535	C10			
All engines	01/02/99 ->											358 005	
All engines	->year 31/01/99											360 434	
				ENGINE									
1.6 i 16V 4x4	Petrol	72	07/95-05/02	G16B									
Engine	Information			A10	A20	A40	A50	A70	C10 - C30		C20	E01	
All engines	ch. 00160001 ->, x 2, SEMI-DIRECT								470 535	C10			
All engines	01/02/99 ->											358 005	
All engines	->year 31/01/99											360 434	
				ENGINE									
1.6 i 16V 4x4	Petrol	73	08/96-05/02	G16B									
Engine	Information			A10	A20	A40	A50	A70	C10 - C30		C20	E01	
All engines	ch. 00160001 ->, x 2, SEMI-DIRECT								470 535	C10			
All engines	01/02/99 ->											358 005	
All engines	->year 31/01/99											360 434	
CARRY													
				ENGINE									
1.3	Petrol	56	02/99-09/04	G13BB									
Engine	Information			A10	A20	A40	A50	A70	C10 - C30		C20	E01	
All engines	x 2, SEMI-DIRECT								470 535	C10			
				ENGINE									
1.3	Petrol	57	03/99-12/06	G13BB									
Engine	Information			A10	A20	A40	A50	A70	C10 - C30		C20	E01	
All engines	x 2, SEMI-DIRECT								470 535	C10			
				ENGINE									
1.3	Petrol	58	03/99->	G13BB									
Engine	Information			A10	A20	A40	A50	A70	C10 - C30		C20	E01	
All engines												358 005	
				ENGINE									
1.3 16 V	Petrol	58	03/00->	G13BB									
Engine	Information			A10	A20	A40	A50	A70	C10 - C30		C20	E01	
All engines	x 2, SEMI-DIRECT								470 535	C10			
All engines												358 005	
ESTEEM													
				ENGINE									
1.6i [USA]	Petrol	70	09/98->	G16B									
Engine	Information			A10	A20	A40	A50	A70	C10 - C30		C20	E01	
All engines	Qty: 2								470 535	C10			
All engines												358 005	
GRAND VITARA I													
				ENGINE									
1.6 4x4	Petrol	69	03/98-07/03	G16B									
Engine	Information			A10	A20	A40	A50	A70	C10 - C30		C20	E01	
All engines	x 1, D.I.S.								470 591	C10			
				ENGINE									
1.6 4x4	Petrol	71	09/03-09/05	G16B									
Engine	Information			A10	A20	A40	A50	A70	C10 - C30		C20	E01	
All engines	x 1, D.I.S.								470 591	C10			
				ENGINE									
1.6 4x4	Petrol	73	02/00-09/02	G16B									
Engine	Information			A10	A20	A40	A50	A70	C10 - C30		C20	E01	
All engines												358 005	

A10 CONDENSER	A20 CONTACT SET	A40 DISTRIBUTOR CAP	A50 ROTOR	A70 PICK-UP
C10 COIL	C20 IGNITION MODULE	C30 ELECTRONIC IGNITION KIT	E01 IGNITION CABLE SET	

Vehicle	alim.	kW	Date	Engine	FUNCTIONS ON THE VEHICLE							
					A10	A20	A40	A50	A70	C10 - C30	C20	E01
GRAND VITARA II												
1.6	Petrol	78	10/05->	M16A								
ENGINE												
Engine	Information			A10	A20	A40	A50	A70	C10 - C30	C20	E01	
All engines	x 2, SEMI-DIRECT								470 535	C10		
1.6 4x4												
1.6 4x4	Petrol	73	09/05-02/15	M16A								
ENGINE												
Engine	Information			A10	A20	A40	A50	A70	C10 - C30	C20	E01	
All engines	Qty: 2								470 535	C10		
All engines											358 013	
1.6 Trazione integrale												
1.6 Trazione integrale	Petrol	73	09/05-02/15	M16A								
ENGINE												
Engine	Information			A10	A20	A40	A50	A70	C10 - C30	C20	E01	
All engines	Fitting Position:for cylinder 2, Fitting Position:for cylinder 4, x 2, SEMI-DIRECT								470 535	C10		
1.6 Trazione integrale												
1.6 Trazione integrale	Petrol	78	04/05-02/15	M16A								
ENGINE												
Engine	Information			A10	A20	A40	A50	A70	C10 - C30	C20	E01	
All engines	x 2, SEMI-DIRECT								470 535	C10		
All engines											358 013	
IGNIS I												
1.3	Petrol	61	10/00-09/03	M13A								
ENGINE												
Engine	Information			A10	A20	A40	A50	A70	C10 - C30	C20	E01	
All engines	x 2, SEMI-DIRECT								470 535	C10		
All engines											358 013	
1.3 4WD												
1.3 4WD	Petrol	61	10/00-09/03	M13A								
ENGINE												
Engine	Information			A10	A20	A40	A50	A70	C10 - C30	C20	E01	
All engines	x 2, SEMI-DIRECT								470 535	C10		
All engines											358 013	
1.5 Sport												
1.5 Sport	Petrol	80	12/03-12/05	M15A								
ENGINE												
Engine	Information			A10	A20	A40	A50	A70	C10 - C30	C20	E01	
All engines	Fitting Position:for cylinder 1, Fitting Position:for cylinder 4, x 2, SEMI-DIRECT								470 535	C10		
All engines											358 013	
IGNIS II												
1.3	Petrol	69	09/03->	M13A								
ENGINE												
Engine	Information			A10	A20	A40	A50	A70	C10 - C30	C20	E01	
All engines	x 2, SEMI-DIRECT								470 570	C10		
All engines											358 013	
1.3 4x4												
1.3 4x4	Petrol	69	09/03->	M13A								
ENGINE												
Engine	Information			A10	A20	A40	A50	A70	C10 - C30	C20	E01	
All engines	x 2, SEMI-DIRECT								470 570	C10		
All engines											358 013	
1.5												
1.5	Petrol	73	09/03->	M15A								
ENGINE												
Engine	Information			A10	A20	A40	A50	A70	C10 - C30	C20	E01	
All engines	Fitting Position:for cylinder 1, Fitting Position:for cylinder 4, x 2, SEMI-DIRECT								470 570	C10		
All engines											358 013	
1.5 4x4												
1.5 4x4	Petrol	73	09/03->	M15A								
ENGINE												
Engine	Information			A10	A20	A40	A50	A70	C10 - C30	C20	E01	
All engines	Fitting Position:for cylinder 1, Fitting Position:for cylinder 4, x 2, SEMI-DIRECT								470 570	C10		
All engines											358 013	

A10 CONDENSER	A20 CONTACT SET	A40 DISTRIBUTOR CAP	A50 ROTOR	A70 PICK-UP
C10 COIL	C20 IGNITION MODULE	C30 ELECTRONIC IGNITION KIT	E01 IGNITION CABLE SET	

The present application list is a brief version. For the detailed information about the possibility of installation on a specific vehicle, please refer to our web-catalogue <http://catalogo.facet.eu/>

Vehicle	alim.	kW	Date	Engine	FUNCTIONS ON THE VEHICLE							
					A10	A20	A40	A50	A70	C10 - C30	C20	E01

IGNIS III

1.2	Petrol	66	10/16->	ENGINE K12C
------------	--------	-----------	---------	------------------------------

Engine	Information	A10	A20	A40	A50	A70	C10 - C30	C20	E01
All engines	x 4, COIL ON PLUG						470 621	C10	

1.2 AllGrip	Petrol	66	10/16->	ENGINE K12C
--------------------	--------	-----------	---------	------------------------------

Engine	Information	A10	A20	A40	A50	A70	C10 - C30	C20	E01
All engines	x 4, COIL ON PLUG						470 621	C10	

1.2 Hybrid	Petrol/ Electric	66	10/16->	ENGINE K12C
-------------------	---------------------	-----------	---------	------------------------------

Engine	Information	A10	A20	A40	A50	A70	C10 - C30	C20	E01
All engines	x 4, COIL ON PLUG						470 621	C10	

1.2 Hybrid AllGrip	Petrol/ Electric	66	10/16->	ENGINE K12C
---------------------------	---------------------	-----------	---------	------------------------------

Engine	Information	A10	A20	A40	A50	A70	C10 - C30	C20	E01
All engines	x 4, COIL ON PLUG						470 621	C10	

JIMNY III

1.3	Petrol	63	08/04->	ENGINE M13A
------------	--------	-----------	---------	------------------------------

Engine	Information	A10	A20	A40	A50	A70	C10 - C30	C20	E01
All engines	x 1, D.I.S.						470 591	C10	

1.3 16V	Petrol	59	09/98->	ENGINE G13BB
----------------	--------	-----------	---------	-------------------------------

Engine	Information	A10	A20	A40	A50	A70	C10 - C30	C20	E01
All engines	x 1, D.I.S.						470 591	C10	
All engines									358 005

1.3 16V	Petrol	60	02/01->	ENGINE M13A
----------------	--------	-----------	---------	------------------------------

Engine	Information	A10	A20	A40	A50	A70	C10 - C30	C20	E01
All engines	x 1, D.I.S.						470 591	C10	
All engines									358 013

1.3 16V 4WD	Petrol	59	09/98->	ENGINE G13BB
--------------------	--------	-----------	---------	-------------------------------

Engine	Information	A10	A20	A40	A50	A70	C10 - C30	C20	E01
All engines	x 1, D.I.S.						470 591	C10	
All engines									358 005

1.3 16V 4WD	Petrol	60	02/01->	ENGINE M13A
--------------------	--------	-----------	---------	------------------------------

Engine	Information	A10	A20	A40	A50	A70	C10 - C30	C20	E01
All engines	x 1, D.I.S.						470 591	C10	
All engines									358 013

1.3 16V 4x4	Petrol	63	08/05->	ENGINE M13A
--------------------	--------	-----------	---------	------------------------------

Engine	Information	A10	A20	A40	A50	A70	C10 - C30	C20	E01
All engines	x 1, D.I.S.						470 591	C10	
All engines									358 013

1.3 4WD	Petrol	62	05/14->	ENGINE M13A
----------------	--------	-----------	---------	------------------------------

Engine	Information	A10	A20	A40	A50	A70	C10 - C30	C20	E01
All engines	x 2, SEMI-DIRECT						470 535	C10	
All engines									358 013

1.3 4WD	Petrol	63	03/13->	ENGINE M13A
----------------	--------	-----------	---------	------------------------------

Engine	Information	A10	A20	A40	A50	A70	C10 - C30	C20	E01
All engines	x 2, SEMI-DIRECT						470 535	C10	

1.3 4x4	Petrol	63	09/98-08/00	ENGINE G13BB
----------------	--------	-----------	-------------	-------------------------------

Engine	Information	A10	A20	A40	A50	A70	C10 - C30	C20	E01
All engines	Qty: 2						470 591	C10	

A10 CONDENSER	A20 CONTACT SET	A40 DISTRIBUTOR CAP	A50 ROTOR	A70 PICK-UP
C10 COIL	C20 IGNITION MODULE	C30 ELECTRONIC IGNITION KIT	E01 IGNITION CABLE SET	

Vehicle	alim.	kW	Date	Engine	FUNCTIONS ON THE VEHICLE									
					A10	A20	A40	A50	A70	C10 - C30	C20	E01		
ENGINE														
1.3 4x4	Petrol	63	09/98-08/00	G13BB										
Engine	Information				A10	A20	A40	A50	A70	C10 - C30	C20	E01		
All engines													358 005	
LIANA														
1.3	Petrol	66	07/01->	M13A										
Engine	Information				A10	A20	A40	A50	A70	C10 - C30	C20	E01		
All engines	x 2, SEMI-DIRECT									470 535	C10			
All engines													358 013	
ENGINE														
1.6	Petrol	76	07/01->	M16A										
Engine	Information				A10	A20	A40	A50	A70	C10 - C30	C20	E01		
All engines	x 2, SEMI-DIRECT									470 535	C10			
All engines													358 013	
ENGINE														
1.6	Petrol	79	01/05->	M16A										
Engine	Information				A10	A20	A40	A50	A70	C10 - C30	C20	E01		
All engines	x 2, SEMI-DIRECT									470 535	C10			
All engines													358 013	
ENGINE														
1.6 4WD	Petrol	76	07/01->	M16A										
Engine	Information				A10	A20	A40	A50	A70	C10 - C30	C20	E01		
All engines	x 2, SEMI-DIRECT									470 535	C10			
All engines													358 013	
ENGINE														
1.6 4WD	Petrol	78	04/02->	M16A										
Engine	Information				A10	A20	A40	A50	A70	C10 - C30	C20	E01		
All engines	x 2, SEMI-DIRECT									470 535	C10			
All engines													358 013	
ENGINE														
1.6 4WD	Petrol	79	01/05-12/07	M16A										
Engine	Information				A10	A20	A40	A50	A70	C10 - C30	C20	E01		
All engines	x 2, SEMI-DIRECT									470 535	C10			
All engines													358 013	
ENGINE														
1.6 i	Petrol	78	04/02->	M16A										
Engine	Information				A10	A20	A40	A50	A70	C10 - C30	C20	E01		
All engines	x 2, SEMI-DIRECT									470 535	C10			
All engines													358 013	
ENGINE														
1.8 i	Petrol	92	10/01->	M18A										
Engine	Information				A10	A20	A40	A50	A70	C10 - C30	C20	E01		
All engines	Qty: 2									470 535	C10			
All engines													358 013	
SAMURAI														
1.3	Petrol	49	08/89-07/92	G13BA										
Engine	Information				A10	A20	A40	A50	A70	C10 - C30	C20	E01		
All engines	version Denso						813 256	913 036						
ENGINE														
1.3	Petrol	52	11/88-03/98	G13BA										
Engine	Information				A10	A20	A40	A50	A70	C10 - C30	C20	E01		
All engines	version Denso						813 256	913 036						
ENGINE														
1.3 Trazione integrale	Petrol	44	11/88-12/04	G13A										
Engine	Information				A10	A20	A40	A50	A70	C10 - C30	C20	E01		
All engines	version Denso						813 093	913 030						

A10	CONDENSER	A20	CONTACT SET	A40	DISTRIBUTOR CAP	A50	ROTOR	A70	PICK-UP
C10	COIL	C20	IGNITION MODULE	C30	ELECTRONIC IGNITION KIT	E01	IGNITION CABLE SET		

The present application list is a brief version. For the detailed information about the possibility of installation on a specific vehicle, please refer to our web-catalogue <http://catalogo.facet.eu/>

Vehicle	alim.	kW	Date	Engine	FUNCTIONS ON THE VEHICLE							
					A10	A20	A40	A50	A70	C10 - C30	C20	E01

ENGINE				
1.3 Trazione integrale	Petrol	47	11/88-12/04	G13A

Engine	Information	A10	A20	A40	A50	A70	C10 - C30	C20	E01
All engines	version Denso			813 256	913 036				

ENGINE				
1.3 Trazione integrale	Petrol	51	11/88-12/04	G13BA

Engine	Information	A10	A20	A40	A50	A70	C10 - C30	C20	E01
All engines	version Denso			813 256	913 036				

ENGINE				
1.3 Trazione integrale	Petrol	59	01/00-12/04	G13BA

Engine	Information	A10	A20	A40	A50	A70	C10 - C30	C20	E01
All engines	version Denso			813 256	913 036				

SIDEKICK

ENGINE				
1.6 JX 4x4	Petrol	59	04/89-04/96	G16A (8V)

Engine	Information	A10	A20	A40	A50	A70	C10 - C30	C20	E01
All engines	version Denso			813 123					
All engines							470 201	C10	358 004

ENGINE				
1.6i [USA]	Petrol	0	01/89->	--

Engine	Information	A10	A20	A40	A50	A70	C10 - C30	C20	E01
All engines	version Denso			813 093	913 030				
All engines	version Mitsubishi			831 140	931 131				
All engines	no specific info conc. application available								360 415, 360 417

ENGINE				
1.6i 16V J1X 4x4	Petrol	71	04/89-04/96	G16B

Engine	Information	A10	A20	A40	A50	A70	C10 - C30	C20	E01
All engines	version Denso			831 144	931 131				

ENGINE				
1.6i 16V JX 4x4	Petrol	71	04/89-04/96	G16B

Engine	Information	A10	A20	A40	A50	A70	C10 - C30	C20	E01
All engines	version Denso			813 123					
All engines							470 201	C10	

SJ410

ENGINE				
1.0	Petrol	33	09/81-07/91	F10A

Engine	Information	A10	A20	A40	A50	A70	C10 - C30	C20	E01
All engines	version Denso		713 011HV		913 014				
All engines	01/01/84 ->, version Denso			813 093					
All engines	RHD								358 020
All engines	LHD								360 413

SJ413

ENGINE				
1.3	Petrol	47	09/84-08/90	G13A

Engine	Information	A10	A20	A40	A50	A70	C10 - C30	C20	E01
All engines	version Denso			813 093	913 030				
All engines									358 020

SUPER CARRY

ENGINE				
1.0	Petrol	30	09/94-03/99	F10A









Engine	Information	A10	A20	A40	A50	A70	C10 - C30	C20	E01
All engines	version Denso		713 011HV	813 093	913 030				

ENGINE				
1.0	Petrol	31	10/92-03/99	F10A

Engine	Information	A10	A20	A40	A50	A70	C10 - C30	C20	E01
All engines	version Denso		713 011HV	813 093	913 030				

A10	CONDENSER	A20	CONTACT SET	A40	DISTRIBUTOR CAP	A50	ROTOR	A70	PICK-UP
C10	COIL	C20	IGNITION MODULE	C30	ELECTRONIC IGNITION KIT	E01	IGNITION CABLE SET		

Vehicle	alim.	kW	Date	Engine	FUNCTIONS ON THE VEHICLE														
					A10	A20	A40	A50	A70	C10 - C30	C20	E01							
ENGINE																			
1.0	Petrol	33	10/85-03/99	F10A															
Engine		Information			A10	A20	A40	A50	A70	C10 - C30	C20	E01							
All engines		version Denso				713 011HV	813 093	913 030											
SWIFT I / II																			
1.0	Petrol	37	10/83-03/89	G10, G10A															
Engine		Information			A10	A20	A40	A50	A70	C10 - C30	C20	E01							
All engines		version Denso						913 030											
ENGINE																			
1.3 GTi/GXi	Petrol	74	08/85-03/89	G13B															
Engine		Information			A10	A20	A40	A50	A70	C10 - C30	C20	E01							
All engines		version Hitachi					822 046												
SWIFT I / II / III																			
1.0	Petrol	37	03/89-05/01	G10A															
Engine		Information			A10	A20	A40	A50	A70	C10 - C30	C20	E01							
All engines		version Denso						913 030											
ENGINE																			
1.0 i	Petrol	39	03/89-12/05	G10, G10A															
Engine		Information			A10	A20	A40	A50	A70	C10 - C30	C20	E01							
All engines		version Denso					813 245	913 034											
ENGINE																			
1.0 i	Petrol	40	03/89-12/91	G10A															
Engine		Information			A10	A20	A40	A50	A70	C10 - C30	C20	E01							
All engines		version Denso						913 030											
ENGINE																			
1.3	Petrol	50	03/89-05/01	G13A															
Engine		Information			A10	A20	A40	A50	A70	C10 - C30	C20	E01							
All engines		version Denso					813 123	913 028											
ENGINE																			
1.3	Petrol	51	03/89-10/96	G13BA															
Engine		Information			A10	A20	A40	A50	A70	C10 - C30	C20	E01							
All engines		version Denso					813 123	913 028											
All engines													360 413						
ENGINE																			
1.3	Petrol	52	03/89-12/91	G13A, G13B															
Engine		Information			A10	A20	A40	A50	A70	C10 - C30	C20	E01							
All engines		version Denso					813 123	913 028											
ENGINE																			
1.3 4WD	Petrol	50	03/89-05/01	G13A															
Engine		Information			A10	A20	A40	A50	A70	C10 - C30	C20	E01							
All engines		version Denso					813 123	913 028											
ENGINE																			
1.3 4WD	Petrol	52	10/89-12/91	G13A															
Engine		Information			A10	A20	A40	A50	A70	C10 - C30	C20	E01							
All engines		version Denso					813 123	913 028											
ENGINE																			
1.3 GTi	Petrol	74	03/89-05/01	G13B															
Engine		Information			A10	A20	A40	A50	A70	C10 - C30	C20	E01							
All engines		version Hitachi					822 046												
ENGINE																			
1.3 GTi DOHC	Petrol	74	10/89-12/95	G13B															
Engine		Information			A10	A20	A40	A50	A70	C10 - C30	C20	E01							
All engines		version Hitachi					822 046												
ENGINE																			
1.3 GTi SOHC	Petrol	50	10/89-12/95	G13B															
Engine		Information			A10	A20	A40	A50	A70	C10 - C30	C20	E01							
All engines		version Denso					813 123	913 028											
All engines		version Mitsubishi					831 132	931 108											
All engines		version TYPE 1											360 413						
A10	CONDENSER			A20	CONTACT SET			A40	DISTRIBUTOR CAP			A50	ROTOR			A70	PICK-UP		
C10	COIL			C20	IGNITION MODULE			C30	ELECTRONIC IGNITION KIT			E01	IGNITION CABLE SET						

					FUNCTIONS ON THE VEHICLE							
Vehicle	alim.	kW	Date	Engine								
SWIFT III												
1.3 [USA]	Petrol	0	06/95-05/01	ENGINE G13BA								
Engine	Information											
All engines	->year 01/12/97, version Denso					813 123	913 028					
All engines	01/01/99->, Qty: 2								470 591	C10		
All engines	01/01/99->											358 005
1.3 i	Petrol	49	06/96-03/01	ENGINE G13BA								
Engine	Information											
All engines	version Denso					813 123	913 028					
All engines												360 413
SWIFT IV												
1.3	Petrol	67	02/05-06/15	ENGINE M13A								
Engine	Information											
All engines	Qty: 2									470 570	C10	
All engines												358 013
1.3	Petrol	68	02/05->	ENGINE M13A								
Engine	Information											
All engines	x 2, SEMI-DIRECT									470 535	C10	
All engines	MADE BY: (H), x 2, SEMI-DIRECT									470 570	C10	
All engines												358 013
1.3 4x4	Petrol	66	01/06->	ENGINE M13A								
Engine	Information											
All engines	x 2, SEMI-DIRECT									470 535	C10	
All engines	MADE BY: (H), x 2, SEMI-DIRECT									470 570	C10	
All engines												358 013
1.3 4x4	Petrol	68	02/05->	ENGINE M13A								
Engine	Information											
All engines	x 2, SEMI-DIRECT									470 535	C10	
All engines	MADE BY: (H), x 2, SEMI-DIRECT									470 570	C10	
All engines												358 013

A10 CONDENSER	A20 CONTACT SET	A40 DISTRIBUTOR CAP	A50 ROTOR	A70 PICK-UP
C10 COIL	C20 IGNITION MODULE	C30 ELECTRONIC IGNITION KIT	E01 IGNITION CABLE SET	

Vehicle	alim.	kW	Date	Engine	FUNCTIONS ON THE VEHICLE									
					A10	A20	A40	A50	A70	C10 - C30	C20	E01		
ENGINE														
1.3 LPG	Petrol/ Liquified Petro- leum Gas (LPG)	68	09/08-12/10	M13A										
Engine	Information				A10	A20	A40	A50	A70	C10 - C30	C20	E01		
All engines	x 2, SEMI-DIRECT									470 535	C10			
All engines	MADE BY: (H), x 2, SEMI-DIRECT									470 570	C10			
ENGINE														
1.5	Petrol	75	02/05->	M15A										
Engine	Information				A10	A20	A40	A50	A70	C10 - C30	C20	E01		
All engines	x 2, SEMI-DIRECT									470 535	C10			
All engines	MADE BY: (H), x 2, SEMI-DIRECT									470 570	C10			
All engines												358 013		
ENGINE														
1.5 4x4	Petrol	74	02/05->	M15A										
Engine	Information				A10	A20	A40	A50	A70	C10 - C30	C20	E01		
All engines	Qty: 2									470 535	C10			
All engines												358 013		
ENGINE														
1.6	Petrol	92	05/06->	M16A										
Engine	Information				A10	A20	A40	A50	A70	C10 - C30	C20	E01		
All engines	x 2, SEMI-DIRECT									470 535	C10			
All engines	MADE BY: (H), x 2, SEMI-DIRECT									470 570	C10			
All engines												358 013		
ENGINE														
1.6 4x4	Petrol	92	02/05->	M16A										
Engine	Information				A10	A20	A40	A50	A70	C10 - C30	C20	E01		
All engines	Qty: 2									470 535	C10			
All engines												358 013		
SWIFT V														
ENGINE														
1.2	Petrol	67	08/12->	K12B										
Engine	Information				A10	A20	A40	A50	A70	C10 - C30	C20	E01		
All engines	Qty: 4									470 621	C10			
ENGINE														
1.2 4WD	Petrol	67	08/12->	K12B										
Engine	Information				A10	A20	A40	A50	A70	C10 - C30	C20	E01		
All engines	Qty: 4									470 621	C10			
SWIFT VI														
ENGINE														
1.0	Petrol	82	04/17->	K10C										
Engine	Information				A10	A20	A40	A50	A70	C10 - C30	C20	E01		
All engines	x 3, COIL ON PLUG									470 621	C10			
ENGINE														
1.0 SHVS	Petrol/ Electric	82	04/17->	K10C										
Engine	Information				A10	A20	A40	A50	A70	C10 - C30	C20	E01		
All engines	x 3, COIL ON PLUG									470 621	C10			
ENGINE														
1.2	Petrol	66	04/17->	K12C										
Engine	Information				A10	A20	A40	A50	A70	C10 - C30	C20	E01		
All engines	x 4, COIL ON PLUG									470 621	C10			
ENGINE														
1.2 AllGrip	Petrol	66	04/17->	K12C										
Engine	Information				A10	A20	A40	A50	A70	C10 - C30	C20	E01		
All engines	x 4, COIL ON PLUG									470 621	C10			
ENGINE														
1.2 SHVS	Petrol/ Electric	66	04/17->	K12C										
Engine	Information				A10	A20	A40	A50	A70	C10 - C30	C20	E01		
All engines	x 4, COIL ON PLUG									470 621	C10			

A10 CONDENSER	A20 CONTACT SET	A40 DISTRIBUTOR CAP	A50 ROTOR	A70 PICK-UP
C10 COIL	C20 IGNITION MODULE	C30 ELECTRONIC IGNITION KIT	E01 IGNITION CABLE SET	

The present application list is a brief version. For the detailed information about the possibility of installation on a specific vehicle, please refer to our web-catalogue <http://catalogo.facet.eu/>

Vehicle	alim.	kW	Date	Engine	FUNCTIONS ON THE VEHICLE							
					A10	A20	A40	A50	A70	C10 - C30	C20	E01

ENGINE				
1.2 SHVS AllGrip	Petrol/ Electric	66	04/17->	K12C

Engine	Information	A10	A20	A40	A50	A70	C10 - C30	C20	E01
All engines	x 4, COIL ON PLUG						470 621	C10	

ENGINE				
1.4 Sport	Petrol	103	09/17->	K14C

Engine	Information	A10	A20	A40	A50	A70	C10 - C30	C20	E01
All engines	x 4, COIL ON PLUG						470 621	C10	

SX4 I

ENGINE				
1.5	Petrol	73	06/06-07/10	M15A

Engine	Information	A10	A20	A40	A50	A70	C10 - C30	C20	E01
All engines	x 2, SEMI-DIRECT						470 535	C10	
All engines	->ch. TSMEYA11S00449999, MADE BY: (H), x 2, SEMI-DIRECT						470 570	C10	
All engines	version TYPE 1, 2								358 013

ENGINE				
1.5 VVT	Petrol	82	07/10->	M15A

Engine	Information	A10	A20	A40	A50	A70	C10 - C30	C20	E01
All engines	x 2, SEMI-DIRECT						470 535	C10	
All engines	->ch. TSMEYA11S00449999, MADE BY: (H), x 2, SEMI-DIRECT						470 570	C10	
All engines	version TYPE 1, 2								358 013

ENGINE				
1.5 VVT 4x4	Petrol	82	07/10->	M15A

Engine	Information	A10	A20	A40	A50	A70	C10 - C30	C20	E01
All engines	x 2, SEMI-DIRECT						470 535	C10	
All engines	->ch. TSMEYA11S00449999, MADE BY: (H), x 2, SEMI-DIRECT						470 570	C10	
All engines	version TYPE 1, 2								358 013

ENGINE				
1.5 VVTi	Petrol	81	07/07-12/15	M15A

Engine	Information	A10	A20	A40	A50	A70	C10 - C30	C20	E01
All engines	x 2, SEMI-DIRECT						470 535	C10	
All engines	->ch. TSMEYA11S00449999, MADE BY: (H), x 2, SEMI-DIRECT						470 570	C10	

ENGINE				
1.6	Petrol	74	06/06->	M16A

Engine	Information	A10	A20	A40	A50	A70	C10 - C30	C20	E01
All engines	ch. JSA, Qty: 2						470 535	C10	
All engines	Qty: 2, version TYPE 1, 2						470 570	C10	
All engines	version TYPE 1, 2								358 013

ENGINE				
1.6	Petrol	75	10/07->	M16A

Engine	Information	A10	A20	A40	A50	A70	C10 - C30	C20	E01
All engines	ch. JSA, Qty: 2						470 535	C10	
All engines									358 013

ENGINE				
1.6	Petrol	79	10/07->	M16A

Engine	Information	A10	A20	A40	A50	A70	C10 - C30	C20	E01
All engines	Fitting Position:for cylinder 2, Fitting Position:for cylinder 4, ->ch. JSAGYB41S00300000, x 2, SEMI-DIRECT						470 535	C10	
All engines	Fitting Position:for cylinder 2, Fitting Position:for cylinder 4, ->ch. TSMEYB21S00450000, ->ch. TSMEYB21S00460000, ->ch. TSMEYB21S00470000, ->ch. TSMEYB21S00490000, ->ch. TSMEYB21S00510000, ->ch. TSMEYB21S00530000, ->ch. TSMEYB21S00560000, ->ch. TSMEYB21S00630000, ->ch. TSMEYB21S00680000, MADE BY: (H), x 2, SEMI-DIRECT						470 570	C10	
All engines									358 013

ENGINE				
1.6	Petrol	88	10/07->	M16A

Engine	Information	A10	A20	A40	A50	A70	C10 - C30	C20	E01
All engines	Fitting Position:for cylinder 2, Fitting Position:for cylinder 4, ->ch. JSAGYB41S00300000, x 2, SEMI-DIRECT						470 535	C10	

A10 CONDENSER	A20 CONTACT SET	A40 DISTRIBUTOR CAP	A50 ROTOR	A70 PICK-UP
C10 COIL	C20 IGNITION MODULE	C30 ELECTRONIC IGNITION KIT	E01 IGNITION CABLE SET	

Vehicle	alim.	kW	Date	Engine	FUNCTIONS ON THE VEHICLE							
					A10	A20	A40	A50	A70	C10 - C30	C20	E01

ENGINE				
1.6	Petrol	88	10/07->	M16A

Engine	Information	A10	A20	A40	A50	A70	C10 - C30	C20	E01
All engines	Fitting Position:for cylinder 2, Fitting Position:for cylinder 4, ->ch. TSMYB21S00450000, ->ch. TSMYB21S00470000, ->ch. TSMYB21S00490000, ->ch. TSMYB21S00510000, ->ch. TSMYB21S00530000, ->ch. TSMYB21S00560000, ->ch. TSMYB21S00630000, ->ch. TSMYB21S00680000, MADE BY: (H), x 2, SEMI-DIRECT						470 570	C10	
All engines									358 013

ENGINE				
1.6 AWD	Petrol	79	10/07-12/11	M16A

Engine	Information	A10	A20	A40	A50	A70	C10 - C30	C20	E01
All engines	Fitting Position:for cylinder 2, Fitting Position:for cylinder 4, ->ch. JSAGYB41S00300000, x 2, SEMI-DIRECT						470 535	C10	
All engines	Fitting Position:for cylinder 2, Fitting Position:for cylinder 4, ->ch. TSMYB21S00450000, ->ch. TSMYB21S00470000, ->ch. TSMYB21S00490000, ->ch. TSMYB21S00510000, ->ch. TSMYB21S00530000, ->ch. TSMYB21S00560000, ->ch. TSMYB21S00630000, ->ch. TSMYB21S00680000, MADE BY: (H), x 2, SEMI-DIRECT						470 570	C10	
All engines									358 013

ENGINE				
1.6 AWD	Petrol	88	10/07->	M16A

Engine	Information	A10	A20	A40	A50	A70	C10 - C30	C20	E01
All engines	ch. JSA, Qty: 2						470 535	C10	
All engines									358 013

ENGINE				
1.6 LPG	Petrol/ Liquified Petro- leum Gas (LPG)	79	06/06-12/12	M16A

Engine	Information	A10	A20	A40	A50	A70	C10 - C30	C20	E01
All engines	Fitting Position:for cylinder 2, Fitting Position:for cylinder 4, ->ch. JSAGYB21S00300000, ->ch. JSAGYC21S00300000, x 2, SEMI-DIRECT						470 535	C10	

ENGINE				
1.6 VVT	Petrol	79	06/06->	M16A

Engine	Information	A10	A20	A40	A50	A70	C10 - C30	C20	E01
All engines	Fitting Position:for cylinder 2, Fitting Position:for cylinder 4, ->ch. JSAGYB41S00300000, x 2, SEMI-DIRECT						470 535	C10	
All engines	Fitting Position:for cylinder 2, Fitting Position:for cylinder 4, ->ch. TSMYB21S00450000, ->ch. TSMYB21S00470000, ->ch. TSMYB21S00490000, ->ch. TSMYB21S00510000, ->ch. TSMYB21S00530000, ->ch. TSMYB21S00560000, ->ch. TSMYB21S00630000, ->ch. TSMYB21S00680000, MADE BY: (H), x 2, SEMI-DIRECT						470 570	C10	
All engines	version TYPE 1, 2								358 013

ENGINE				
1.6 VVT	Petrol	82	11/10-12/15	M16A

Engine	Information	A10	A20	A40	A50	A70	C10 - C30	C20	E01
All engines	Fitting Position:for cylinder 2, Fitting Position:for cylinder 4, ->ch. JSAGYB41S00300000, x 2, SEMI-DIRECT						470 535	C10	
All engines	Fitting Position:for cylinder 2, Fitting Position:for cylinder 4, ->ch. TSMYB21S00450000, ->ch. TSMYB21S00470000, ->ch. TSMYB21S00490000, ->ch. TSMYB21S00510000, ->ch. TSMYB21S00530000, ->ch. TSMYB21S00560000, ->ch. TSMYB21S00630000, ->ch. TSMYB21S00680000, MADE BY: (H), x 2, SEMI-DIRECT						470 570	C10	

ENGINE				
1.6 VVT	Petrol	88	07/09->	M16A

Engine	Information	A10	A20	A40	A50	A70	C10 - C30	C20	E01
All engines	Fitting Position:for cylinder 2, Fitting Position:for cylinder 4, ->ch. JSAGYB41S00300000, x 2, SEMI-DIRECT						470 535	C10	
All engines	Fitting Position:for cylinder 2, Fitting Position:for cylinder 4, ->ch. TSMYB21S00450000, ->ch. TSMYB21S00470000, ->ch. TSMYB21S00490000, ->ch. TSMYB21S00510000, ->ch. TSMYB21S00530000, ->ch. TSMYB21S00560000, ->ch. TSMYB21S00630000, ->ch. TSMYB21S00680000, MADE BY: (H), x 2, SEMI-DIRECT						470 570	C10	
All engines	version TYPE 1, 2								358 013

A10 CONDENSER	A20 CONTACT SET	A40 DISTRIBUTOR CAP	A50 ROTOR	A70 PICK-UP
C10 COIL	C20 IGNITION MODULE	C30 ELECTRONIC IGNITION KIT	E01 IGNITION CABLE SET	

Vehicle	alim.	kW	Date	Engine	FUNCTIONS ON THE VEHICLE							
					A10	A20	A40	A50	A70	C10 - C30	C20	E01

ENGINE				
1.6 VVT 4x4	Petrol	79	06/06->	M16A

Engine	Information	A10	A20	A40	A50	A70	C10 - C30	C20	E01
All engines	Fitting Position:for cylinder 2, Fitting Position:for cylinder 4, ->ch. JSAGYB41500300000, x 2, SEMI-DIRECT						470 535	C10	
All engines	Fitting Position:for cylinder 2, Fitting Position:for cylinder 4, ->ch. TSMYB21500450000, ->ch. TSMYB21500460000, ->ch. TSMYB21500470000, ->ch. TSMYB21500490000, ->ch. TSMYB21500510000, ->ch. TSMYB21500530000, ->ch. TSMYB21500560000, ->ch. TSMYB21500630000, ->ch. TSMYB21500680000, MADE BY: (H), x 2, SEMI-DIRECT						470 570	C10	
All engines	version TYPE 1, 2								358 013

ENGINE				
1.6 VVT 4x4	Petrol	82	07/09->	M16A

Engine	Information	A10	A20	A40	A50	A70	C10 - C30	C20	E01
All engines	Fitting Position:for cylinder 2, Fitting Position:for cylinder 4, ->ch. JSAGYB41500300000, x 2, SEMI-DIRECT						470 535	C10	
All engines	Fitting Position:for cylinder 2, Fitting Position:for cylinder 4, ->ch. TSMYB21500450000, ->ch. TSMYB21500460000, ->ch. TSMYB21500470000, ->ch. TSMYB21500490000, ->ch. TSMYB21500510000, ->ch. TSMYB21500530000, ->ch. TSMYB21500560000, ->ch. TSMYB21500630000, ->ch. TSMYB21500680000, MADE BY: (H), x 2, SEMI-DIRECT						470 570	C10	
All engines	version TYPE 1, 2								358 013

ENGINE				
1.6 VVT 4x4	Petrol	88	07/09->	M16A

Engine	Information	A10	A20	A40	A50	A70	C10 - C30	C20	E01
All engines	Fitting Position:for cylinder 2, Fitting Position:for cylinder 4, ->ch. JSAGYB41500300000, x 2, SEMI-DIRECT						470 535	C10	
All engines	Fitting Position:for cylinder 2, Fitting Position:for cylinder 4, ->ch. TSMYB21500450000, ->ch. TSMYB21500460000, ->ch. TSMYB21500470000, ->ch. TSMYB21500490000, ->ch. TSMYB21500510000, ->ch. TSMYB21500530000, ->ch. TSMYB21500560000, ->ch. TSMYB21500630000, ->ch. TSMYB21500680000, MADE BY: (H), x 2, SEMI-DIRECT						470 570	C10	
All engines	version TYPE 1, 2								358 013

SX4 II				
--------	--	--	--	--

ENGINE				
1.0	Petrol	82	08/16->	K10C

Engine	Information	A10	A20	A40	A50	A70	C10 - C30	C20	E01
All engines	x 3, COIL ON PLUG						470 621	C10	

ENGINE				
1.0 AllGrip	Petrol	82	08/16->	K10C

Engine	Information	A10	A20	A40	A50	A70	C10 - C30	C20	E01
All engines	x 3, COIL ON PLUG						470 621	C10	

ENGINE				
1.4 T	Petrol	103	08/16->	K14C

Engine	Information	A10	A20	A40	A50	A70	C10 - C30	C20	E01
All engines	x 4, COIL ON PLUG						470 621	C10	

ENGINE				
1.4 T AllGrip	Petrol	103	08/16->	K14C

Engine	Information	A10	A20	A40	A50	A70	C10 - C30	C20	E01
All engines	x 4, COIL ON PLUG						470 621	C10	

VITARA I				
----------	--	--	--	--

ENGINE				
1.6	Petrol	55	01/90-12/93	G16A (8V)

Engine	Information	A10	A20	A40	A50	A70	C10 - C30	C20	E01
All engines	version Denso			813 123					
All engines							470 201	C10	358 004

ENGINE				
1.6	Petrol	59	07/88-01/95	G16A (8V)

Engine	Information	A10	A20	A40	A50	A70	C10 - C30	C20	E01
All engines	version Denso			813 123					
All engines							470 201	C10	358 004

ENGINE				
1.6	Petrol	70	02/91-03/98	G16B









Engine	Information	A10	A20	A40	A50	A70	C10 - C30	C20	E01
All engines	version Denso			813 123					

A10	CONDENSER	A20	CONTACT SET	A40	DISTRIBUTOR CAP	A50	ROTOR	A70	PICK-UP
C10	COIL	C20	IGNITION MODULE	C30	ELECTRONIC IGNITION KIT	E01	IGNITION CABLE SET		

Vehicle	alim.	kW	Date	Engine	FUNCTIONS ON THE VEHICLE									
					A10	A20	A40	A50	A70	C10 - C30	C20	E01		
ENGINE														
1.6	Petrol	70	02/91-03/98	G16B										
Engine		Information			A10	A20	A40	A50	A70	C10 - C30	C20	E01		
All engines										470 201	C10		358 004	
ENGINE														
1.6 8V	Petrol	0	01/95-12/98	G16A (8V)										
Engine		Information			A10	A20	A40	A50	A70	C10 - C30	C20	E01		
All engines		fuel formation: carburettor, version Denso					813 093	913 030						
All engines		petrol injection, version Mitsubishi					831 140	931 131						
ENGINE														
1.6 16V	Petrol	69	10/99-10/02	G16B										
Engine		Information			A10	A20	A40	A50	A70	C10 - C30	C20	E01		
All engines		Qty: 2								470 591	C10			
All engines													358 005	
ENGINE														
1.6 i 16V	Petrol	71	07/90-03/99	G16B										
Engine		Information			A10	A20	A40	A50	A70	C10 - C30	C20	E01		
All engines		version Denso					813 123							
All engines										470 201	C10		358 004	
ENGINE														
1.6 i 16V Trazione integrale	Petrol	71	07/90-03/98	G16B										
Engine		Information			A10	A20	A40	A50	A70	C10 - C30	C20	E01		
All engines		version Denso					813 123							
All engines										470 201	C10		358 004	
ENGINE														
1.6 Trazione integrale	Petrol	59	07/88-03/98	G16A (8V)										
Engine		Information			A10	A20	A40	A50	A70	C10 - C30	C20	E01		
All engines		version Denso					813 123							
All engines										470 201	C10		358 004	
ENGINE														
1.6 Trazione integrale	Petrol	60	07/88-12/95	G16A (8V)										
Engine		Information			A10	A20	A40	A50	A70	C10 - C30	C20	E01		
All engines		version Denso					813 123							
All engines										470 201	C10		358 004	
VITARA II														
ENGINE														
1.6i [USA]	Petrol	0	08/99-12/06	--										
Engine		Information			A10	A20	A40	A50	A70	C10 - C30	C20	E01		
All engines		Qty: 2								470 591	C10			
All engines													358 005	
VITARA IV														
ENGINE														
1.0	Petrol	82	10/18->	K10C										
Engine		Information			A10	A20	A40	A50	A70	C10 - C30	C20	E01		
All engines		x 3, COIL ON PLUG								470 621	C10			
ENGINE														
1.0 AllGrip	Petrol	82	10/18->	K10C										
Engine		Information			A10	A20	A40	A50	A70	C10 - C30	C20	E01		
All engines		x 3, COIL ON PLUG								470 621	C10			
ENGINE														
1.4 T	Petrol	103	09/15->	K14C										
Engine		Information			A10	A20	A40	A50	A70	C10 - C30	C20	E01		
All engines		x 4, COIL ON PLUG								470 621	C10			
ENGINE														
1.4 T AllGrip	Petrol	103	09/15->	K14C										
Engine		Information			A10	A20	A40	A50	A70	C10 - C30	C20	E01		
All engines		x 4, COIL ON PLUG								470 621	C10			

A10	CONDENSER	A20	CONTACT SET	A40	DISTRIBUTOR CAP	A50	ROTOR	A70	PICK-UP
C10	COIL	C20	IGNITION MODULE	C30	ELECTRONIC IGNITION KIT	E01	IGNITION CABLE SET		

The present application list is a brief version. For the detailed information about the possibility of installation on a specific vehicle, please refer to our web-catalogue <http://catalogo.facet.eu/>

				FUNCTIONS ON THE VEHICLE								
Vehicle	alim.	kW	Date	Engine	 A10	 A20	 A40	 A50	 A70	 C10 - C30	 C20	 E01
WAGON R II												
1.0	Petrol	48	02/98-05/00	ENGINE K10A				922 073				
Engine		Information			A10	A20	A40	A50	A70	C10 - C30	C20	E01
All engines		version Hitachi						922 073				
All engines												358 028
ENGINE												
1.2	Petrol	51	02/98-05/00	ENGINE K12A				922 073				
Engine		Information			A10	A20	A40	A50	A70	C10 - C30	C20	E01
All engines		version Hitachi						922 073				
All engines												358 028
ENGINE												
1.2 4WD	Petrol	51	02/98-05/00	ENGINE K12A				922 073				
Engine		Information			A10	A20	A40	A50	A70	C10 - C30	C20	E01
All engines		version Hitachi						922 073				
All engines												358 028
ENGINE												
1.3	Petrol	56	04/99-10/00	ENGINE G13BB						470 535	C10	
Engine		Information			A10	A20	A40	A50	A70	C10 - C30	C20	E01
All engines		->ch. 157570, x 2, SEMI-DIRECT								470 535	C10	
All engines		ch. 157571 ->, x 2, SEMI-DIRECT								470 570	C10	
WAGON R III												
1.0	Petrol	44	06/04-08/05	ENGINE Z 10 XEP				813 245	913 034			
Engine		Information			A10	A20	A40	A50	A70	C10 - C30	C20	E01
All engines		version Denso					813 245	913 034				
ENGINE												
1.3	Petrol	65	09/03-12/10	ENGINE M13A						470 570	C10	
Engine		Information			A10	A20	A40	A50	A70	C10 - C30	C20	E01
All engines		x 2, SEMI-DIRECT								470 570	C10	
WAGON R+ II												
1.0	Petrol	51	08/00-07/03	ENGINE K10A				813 245	913 034			
Engine		Information			A10	A20	A40	A50	A70	C10 - C30	C20	E01
All engines		version Denso					813 245	913 034				
ENGINE												
1.0 XT Plus	Petrol	74	08/00-07/01	ENGINE --				813 245	913 034			
Engine		Information			A10	A20	A40	A50	A70	C10 - C30	C20	E01
All engines		version Denso					813 245	913 034				
ENGINE												
1.3	Petrol	56	05/00-12/04	ENGINE G13BB						470 535	C10	
Engine		Information			A10	A20	A40	A50	A70	C10 - C30	C20	E01
All engines		->ch. 157570, x 2, SEMI-DIRECT								470 535	C10	
All engines		ch. 157571 ->, x 2, SEMI-DIRECT								470 570	C10	
All engines												358 005
ENGINE												
1.3	Petrol	65	08/01->	ENGINE M13A						470 535	C10	
Engine		Information			A10	A20	A40	A50	A70	C10 - C30	C20	E01
All engines		Qty: 2								470 535	C10	
All engines												358 005
ENGINE												
1.3	Petrol	69	09/03->	ENGINE M13A						470 570	C10	
Engine		Information			A10	A20	A40	A50	A70	C10 - C30	C20	E01
All engines		x 2, SEMI-DIRECT								470 570	C10	
All engines												358 013
ENGINE												
1.3 4WD	Petrol	56	10/01->	ENGINE G13BB						470 570	C10	
Engine		Information			A10	A20	A40	A50	A70	C10 - C30	C20	E01
All engines		x 2, SEMI-DIRECT								470 570	C10	
All engines												358 005

A10 CONDENSER	A20 CONTACT SET	A40 DISTRIBUTOR CAP	A50 ROTOR	A70 PICK-UP
C10 COIL	C20 IGNITION MODULE	C30 ELECTRONIC IGNITION KIT	E01 IGNITION CABLE SET	

Vehicle	alim.	kW	Date	Engine	FUNCTIONS ON THE VEHICLE							
					A10	A20	A40	A50	A70	C10 - C30	C20	E01

				ENGINE
1.3 4WD	Petrol	69	09/03->	M13A

Engine	Information	A10	A20	A40	A50	A70	C10 - C30	C20	E01
All engines	x 2, SEMI-DIRECT						470 570	C10	
All engines									358 013

				ENGINE
1.6 i 16V	Petrol	71	09/95-12/97	G16B

Engine	Information	A10	A20	A40	A50	A70	C10 - C30	C20	E01
All engines	version Denso				931 136				

				ENGINE
1.6 i 16V 4x4	Petrol	71	09/95-12/97	G16B

Engine	Information	A10	A20	A40	A50	A70	C10 - C30	C20	E01
All engines	version Denso				931 136				

A10	CONDENSER	A20	CONTACT SET	A40	DISTRIBUTOR CAP	A50	ROTOR	A70	PICK-UP
C10	COIL	C20	IGNITION MODULE	C30	ELECTRONIC IGNITION KIT	E01	IGNITION CABLE SET		

The present application list is a brief version. For the detailed information about the possibility of installation on a specific vehicle, please refer to our web-catalogue <http://catalogo.facet.eu/>

Vehicle	alim.	kW	Date	Engine	FUNCTIONS ON THE VEHICLE							
					A10	A20	A40	A50	A70	C10 - C30	C20	E01

1307-1510

				ENGINE
Simca 1307 1.3	Petrol	44	09/75-01/80	--

Engine	Information	A10	A20	A40	A50	A70	C10 - C30	C20	E01
All engines	version Bosch			806 079	906 025R				

				ENGINE
Simca 1307 1.3	Petrol	50	07/75-01/80	--

Engine	Information	A10	A20	A40	A50	A70	C10 - C30	C20	E01
All engines	version Bosch			806 079	906 025R				
All engines	version Ducellier			815 054	915 091				

AVENGER

				ENGINE
1.3	Petrol	44	02/70-07/81	--

Engine	Information	A10	A20	A40	A50	A70	C10 - C30	C20	E01
All engines				828 075	912 090, 928 006				

				ENGINE
1.6	Petrol	51	02/70-07/81	--

Engine	Information	A10	A20	A40	A50	A70	C10 - C30	C20	E01
All engines				828 075	912 090, 928 006				

				ENGINE
1.6	Petrol	59	02/70-07/81	--

Engine	Information	A10	A20	A40	A50	A70	C10 - C30	C20	E01
All engines				828 075	912 090, 928 006				

MATRA BAGHEERA

				ENGINE
1.3	Petrol	62	01/74-03/78	3G4

Engine	Information	A10	A20	A40	A50	A70	C10 - C30	C20	E01
All engines			715 111U						

SAMBA

				ENGINE
1.1	Petrol	37	01/81-06/86	XW7

Engine	Information	A10	A20	A40	A50	A70	C10 - C30	C20	E01
All engines	version Ducellier	615 034	715 103	815 058	915 088				

SOLARA

				ENGINE
1.3	Petrol	40	02/80-07/86	2M 102.979

Engine	Information	A10	A20	A40	A50	A70	C10 - C30	C20	E01
All engines	version Bosch			806 079	906 025R				
All engines	version Ducellier			815 054	915 094				

TAGORA

				ENGINE
2.1	Petrol	85	06/80-12/83	5N2

Engine	Information	A10	A20	A40	A50	A70	C10 - C30	C20	E01
All engines	version Bosch			806 079	906 061R	406 153			
All engines	version Ducellier			815 054	915 094				
All engines							470 101D	C10	

				ENGINE
2.6	Petrol	122	08/81-10/83	9L6

Engine	Information	A10	A20	A40	A50	A70	C10 - C30	C20	E01
All engines	version Bosch				906 049R				

A10 CONDENSER	A20 CONTACT SET	A40 DISTRIBUTOR CAP	A50 ROTOR	A70 PICK-UP
C10 COIL	C20 IGNITION MODULE	C30 ELECTRONIC IGNITION KIT	E01 IGNITION CABLE SET	

Vehicle	alim.	kW	Date	Engine	FUNCTIONS ON THE VEHICLE							
					A10	A20	A40	A50	A70	C10 - C30	C20	E01

4 RUNNER

2.4	Petrol	84	08/88-11/95	ENGINE
				22RE

Engine	Information	A10	A20	A40	A50	A70	C10 - C30	C20	E01
All engines	01/08/92 ->						470 203	C10	

2.4 i [USA]	Petrol	0	01/88-12/93	ENGINE
				22RE

Engine	Information	A10	A20	A40	A50	A70	C10 - C30	C20	E01
All engines	->year 01/12/92, version Denso			813 099					
All engines	01/12/92 ->, version Denso			813 273					
All engines	01/01/92 ->						470 203	C10	

2.7 16V	Petrol	110	11/95-08/00	ENGINE
				3RZ-FE

Engine	Information	A10	A20	A40	A50	A70	C10 - C30	C20	E01
All engines	01/08/96 ->								360 792

2.7 4WD	Petrol	112	11/95-08/02	ENGINE
				3RZ-FE

Engine	Information	A10	A20	A40	A50	A70	C10 - C30	C20	E01
All engines	->year 01/08/96, x 1, DISTRIBUTOR						470 198	C10	

2.7 i	Petrol	112	11/95-03/96	ENGINE
				3RZ-FE

Engine	Information	A10	A20	A40	A50	A70	C10 - C30	C20	E01
All engines	01/08/96 ->								360 792

3.0	Petrol	105	08/88-11/95	ENGINE
				3VZ-E

Engine	Information	A10	A20	A40	A50	A70	C10 - C30	C20	E01
All engines	01/08/91 ->, version Denso			813 272					
All engines	->year 01/08/91						470 202	C10	
All engines	01/08/91 ->						470 203	C10	

3.0	Petrol	112	08/88-10/95	ENGINE
				3VZ-E

Engine	Information	A10	A20	A40	A50	A70	C10 - C30	C20	E01
All engines	01/08/91 ->, version Denso			813 272					
All engines	->year 01/08/91						470 202	C10	
All engines	01/08/91 ->						470 203	C10	

3.0 [USA]	Petrol	0	01/88-12/91	ENGINE
				3VZ-E

Engine	Information	A10	A20	A40	A50	A70	C10 - C30	C20	E01
All engines	->year 01/08/91						470 202	C10	
All engines	01/08/91 ->						470 203	C10	

AQUA

1.5 Hybrid	Petrol/ Electric	54	12/11->	ENGINE
				1NZ-FXE

Engine	Information	A10	A20	A40	A50	A70	C10 - C30	C20	E01
All engines	Qty: 4						470 459	C10	

AURION

3.5	Petrol	200	03/06->	ENGINE
				2GR-FE

Engine	Information	A10	A20	A40	A50	A70	C10 - C30	C20	E01
All engines	x 6, COIL ON PLUG						470 538	C10	

AURIS I

1.33 Dual-VTi	Petrol	73	01/10-09/12	ENGINE
				1NR-FE

Engine	Information	A10	A20	A40	A50	A70	C10 - C30	C20	E01
All engines	x 4, COIL ON PLUG						470 537	C10	

1.33 Dual-VTi	Petrol	74	05/09-09/12	ENGINE
				1NR-FE

Engine	Information	A10	A20	A40	A50	A70	C10 - C30	C20	E01
All engines	x 4, COIL ON PLUG						470 537	C10	

A10 CONDENSER	A20 CONTACT SET	A40 DISTRIBUTOR CAP	A50 ROTOR	A70 PICK-UP
C10 COIL	C20 IGNITION MODULE	C30 ELECTRONIC IGNITION KIT	E01 IGNITION CABLE SET	









				FUNCTIONS ON THE VEHICLE								
Vehicle	alim.	kW	Date	Engine	A10	A20	A40	A50	A70	C10 - C30	C20	E01
				ENGINE								
1.4	Petrol	71	03/07-09/12	85HFC4GB								
Engine		Information			A10	A20	A40	A50	A70	C10 - C30	C20	E01
All engines		x 4, COIL ON PLUG								470 461	C10	
				ENGINE								
1.6	Petrol	91	03/07-09/12	1ZR-FE								
Engine		Information			A10	A20	A40	A50	A70	C10 - C30	C20	E01
All engines		x 4, COIL ON PLUG								470 536	C10	
				ENGINE								
1.6	Petrol	97	05/09-09/12	1ZR-FAE, 1ZR-FE								
Engine		Information			A10	A20	A40	A50	A70	C10 - C30	C20	E01
Eng. 1ZR-FAE		x 4, COIL ON PLUG								470 536	C10	
Eng. 1ZR-FE		Qty: 4								470 536	C10	
				ENGINE								
1.8	Petrol	100	10/06-09/12	2ZR-FAE, 2ZR-FE								
Engine		Information			A10	A20	A40	A50	A70	C10 - C30	C20	E01
Eng. 2ZR-FAE		Qty: 4								470 536	C10	
Eng. 2ZR-FE		x 4, COIL ON PLUG								470 536	C10	
				ENGINE								
1.8	Petrol	106	02/09-09/12	2ZR-FAE								
Engine		Information			A10	A20	A40	A50	A70	C10 - C30	C20	E01
All engines		Qty: 4								470 536	C10	
				ENGINE								
1.8	Petrol	108	02/09-09/12	2ZR-FAE								
Engine		Information			A10	A20	A40	A50	A70	C10 - C30	C20	E01
All engines		x 4, COIL ON PLUG								470 536	C10	
				ENGINE								
1.8 4WD	Petrol	100	10/06-10/09	2ZR-FAE								
Engine		Information			A10	A20	A40	A50	A70	C10 - C30	C20	E01
All engines		Qty: 4								470 536	C10	
				ENGINE								
1.8 Hybrid	Petrol/ Electric	73	09/10-09/12	2ZR-FXE								
Engine		Information			A10	A20	A40	A50	A70	C10 - C30	C20	E01
All engines		x 4, COIL ON PLUG								470 536	C10	
				ENGINE								
1.2	Petrol	85	03/15-12/18	8NR-FTS								
Engine		Information			A10	A20	A40	A50	A70	C10 - C30	C20	E01
All engines		x 4, COIL ON PLUG								470 645	C10	
				ENGINE								
1.3	Petrol	73	10/12-12/18	1NR-FE								
Engine		Information			A10	A20	A40	A50	A70	C10 - C30	C20	E01
All engines		x 4, COIL ON PLUG								470 537	C10	
				ENGINE								
1.6	Petrol	97	10/12-12/18	1ZR-FAE								
Engine		Information			A10	A20	A40	A50	A70	C10 - C30	C20	E01
All engines		x 4, COIL ON PLUG								470 536	C10	
				ENGINE								
1.8 Hybrid	Petrol/ Electric	73	10/12-12/18	2ZR-FXE								
Engine		Information			A10	A20	A40	A50	A70	C10 - C30	C20	E01
All engines		x 4, COIL ON PLUG								470 536	C10	
				ENGINE								
1.6	Petrol	74	09/97-10/00	4A-FE								
Engine		Information			A10	A20	A40	A50	A70	C10 - C30	C20	E01
All engines		version Bosch					806 094	906 121R				
All engines		version Denso					813 265	913 029				
All engines		LHD, Terra, -oil cooler										360 209
All engines		LHD										360 879

A10 CONDENSER	A20 CONTACT SET	A40 DISTRIBUTOR CAP	A50 ROTOR	A70 PICK-UP
C10 COIL	C20 IGNITION MODULE	C30 ELECTRONIC IGNITION KIT	E01 IGNITION CABLE SET	

Vehicle	alim.	kW	Date	Engine	FUNCTIONS ON THE VEHICLE									
					A10	A20	A40	A50	A70	C10 - C30	C20	E01		
ENGINE														
1.6	Petrol	81	09/97-02/03	3ZZ-FE, 4A-FE										
Engine	Information				A10	A20	A40	A50	A70	C10 - C30	C20	E01		
Eng. 4A-FE	version Bosch						806 094	906 121R						
Eng. 4A-FE	version Denso						813 265	913 029						
Eng. 3ZZ-FE	x 4, COIL ON PLUG									470 461	C10			
Eng. 4A-FE	LHD, Terra, -oil cooler												360 209	
Eng. 4A-FE	LHD												360 879	
ENGINE														
1.6 VVT-i	Petrol	81	10/00-02/03	3ZZ-FE										
Engine	Information				A10	A20	A40	A50	A70	C10 - C30	C20	E01		
All engines	x 4, COIL ON PLUG									470 461	C10			
ENGINE														
1.8	Petrol	95	10/00-02/03	1ZZFE										
Engine	Information				A10	A20	A40	A50	A70	C10 - C30	C20	E01		
All engines	x 4, COIL ON PLUG									470 461	C10			
ENGINE														
1.8 VVT-i	Petrol	95	10/00-02/03	1ZZFE										
Engine	Information				A10	A20	A40	A50	A70	C10 - C30	C20	E01		
All engines	x 4, COIL ON PLUG									470 461	C10			
ENGINE														
2.0	Petrol	110	10/00-02/03	1AZ-FSE										
Engine	Information				A10	A20	A40	A50	A70	C10 - C30	C20	E01		
All engines	x 4, COIL ON PLUG, FOR: (J)									470 458	C10			
ENGINE														
2.0	Petrol	94	09/97-10/00	3S-FE										
Engine	Information				A10	A20	A40	A50	A70	C10 - C30	C20	E01		
All engines													360 856	
ENGINE														
2.0 VVT-i	Petrol	110	10/00-02/03	1AZ-FSE										
Engine	Information				A10	A20	A40	A50	A70	C10 - C30	C20	E01		
All engines	x 4, COIL ON PLUG, FOR: (J)									470 458	C10			
AVENSIS II														
ENGINE														
1.6 VVT-i	Petrol	81	04/03-11/08	3ZZ-FE										
Engine	Information				A10	A20	A40	A50	A70	C10 - C30	C20	E01		
All engines	x 4, COIL ON PLUG									470 461	C10			
ENGINE														
1.8	Petrol	95	03/03-11/08	1ZZFE										
Engine	Information				A10	A20	A40	A50	A70	C10 - C30	C20	E01		
All engines	x 4, COIL ON PLUG									470 461	C10			
ENGINE														
2.0	Petrol	108	03/03-11/08	1AZ-FSE										
Engine	Information				A10	A20	A40	A50	A70	C10 - C30	C20	E01		
All engines	x 4, COIL ON PLUG, FOR: (J)									470 458	C10			
ENGINE														
2.0	Petrol	110	08/01-11/09	1AZ-FE										
Engine	Information				A10	A20	A40	A50	A70	C10 - C30	C20	E01		
All engines	x 4, COIL ON PLUG, FOR: (J)									470 466	C10			
ENGINE														
2.0 VVTi	Petrol	114	01/03-11/08	1AZ-FE, 1AZ-FSE										
Engine	Information				A10	A20	A40	A50	A70	C10 - C30	C20	E01		
Eng. 1AZ-FE	01/09/05 ->, Qty: 4									470 458	C10			
Eng. 1AZ-FSE	x 4, COIL ON PLUG, x 4, COIL ON PLUG, FOR: (J), FOR: (J)									470 458	C10			
Eng. 1AZ-FE	->year 01/09/05, Qty: 4									470 466	C10			
Eng. 1AZ-FE	x 4, COIL ON PLUG, FOR: (J)									470 466	C10			
ENGINE														
2.4	Petrol	115	08/01-08/07	2AZ-FE										
Engine	Information				A10	A20	A40	A50	A70	C10 - C30	C20	E01		
All engines	Qty: 4									470 466	C10			

A10	CONDENSER	A20	CONTACT SET	A40	DISTRIBUTOR CAP	A50	ROTOR	A70	PICK-UP
C10	COIL	C20	IGNITION MODULE	C30	ELECTRONIC IGNITION KIT	E01	IGNITION CABLE SET		

The present application list is a brief version. For the detailed information about the possibility of installation on a specific vehicle, please refer to our web-catalogue <http://catalogo.facet.eu/>









					FUNCTIONS ON THE VEHICLE							
Vehicle	alim.	kW	Date	Engine								
ENGINE												
2.4	Petrol	120	10/03-10/08	2AZ-FSE								
Engine Information					A10	A20	A40	A50	A70	C10 - C30	C20	E01
All engines x 4, COIL ON PLUG, FOR: (J)										470 458	C10	
ENGINE												
2.4	Petrol	125	09/03-11/08	2AZ-FSE								
Engine Information					A10	A20	A40	A50	A70	C10 - C30	C20	E01
All engines x 4, COIL ON PLUG, FOR: (J)										470 458	C10	
ENGINE												
2.4 4WD	Petrol	115	11/03-08/06	2AZ-FE								
Engine Information					A10	A20	A40	A50	A70	C10 - C30	C20	E01
All engines Qty: 4										470 466	C10	
AVENSIS III												
ENGINE												
1.6	Petrol	97	11/08-10/18	1ZR-FAE								
Engine Information					A10	A20	A40	A50	A70	C10 - C30	C20	E01
All engines x 4, COIL ON PLUG										470 536	C10	
ENGINE												
1.8	Petrol	108	11/08-10/18	2ZR-FAE								
Engine Information					A10	A20	A40	A50	A70	C10 - C30	C20	E01
All engines x 4, COIL ON PLUG										470 536	C10	
ENGINE												
2.0	Petrol	100	11/08-04/11	1AZ-FE								
Engine Information					A10	A20	A40	A50	A70	C10 - C30	C20	E01
All engines Qty: 4										470 466	C10	
ENGINE												
2.0	Petrol	112	11/08-10/18	3ZR-FAE, 3ZR-FE								
Engine Information					A10	A20	A40	A50	A70	C10 - C30	C20	E01
All engines x 4, COIL ON PLUG										470 536	C10	
AYGO I												
ENGINE												
1.0	Petrol	50	07/05-05/14	1KR-FE								
Engine Information					A10	A20	A40	A50	A70	C10 - C30	C20	E01
All engines x 3, COIL ON PLUG										470 461	C10	
ENGINE												
1.0 GPL	Petrol/ Liquified Petro- leum Gas (LPG)	50	07/05-05/14	1KR-FE								
Engine Information					A10	A20	A40	A50	A70	C10 - C30	C20	E01
All engines x 3, COIL ON PLUG										470 461	C10	
ENGINE												
1.0 VVTi	Petrol	50	07/05-05/14	1KR-FE								
Engine Information					A10	A20	A40	A50	A70	C10 - C30	C20	E01
All engines x 3, COIL ON PLUG										470 461	C10	
AYGO II												
ENGINE												
1.0	Petrol	51	05/14->	1KR-FE								
Engine Information					A10	A20	A40	A50	A70	C10 - C30	C20	E01
All engines x 3, COIL ON PLUG, FOR: (J)										470 459	C10	
ENGINE												
1.0 VVTi	Petrol	53	03/18->	1KR-FE								
Engine Information					A10	A20	A40	A50	A70	C10 - C30	C20	E01
All engines x 3, COIL ON PLUG, FOR: (J)										470 459	C10	
ENGINE												
1.2	Petrol	60	05/14->	1PP								
Engine Information					A10	A20	A40	A50	A70	C10 - C30	C20	E01
All engines x 3, COIL ON PLUG										470 609	C10	

A10 CONDENSER	A20 CONTACT SET	A40 DISTRIBUTOR CAP	A50 ROTOR	A70 PICK-UP
C10 COIL	C20 IGNITION MODULE	C30 ELECTRONIC IGNITION KIT	E01 IGNITION CABLE SET	

Vehicle	alim.	kW	Date	Engine	FUNCTIONS ON THE VEHICLE									
					A10	A20	A40	A50	A70	C10 - C30	C20	E01		
CAMRY														
1.8	Petrol	66	11/86-08/89	1S										
Engine	Information				A10	A20	A40	A50	A70	C10 - C30	C20	E01		
All engines	01/08/87 ->, version Denso							913 027						
2.0	Petrol	108	05/06-09/11	1AZ-FE										
Engine	Information				A10	A20	A40	A50	A70	C10 - C30	C20	E01		
All engines	x 4, version 1, x 4, COIL ON PLUG, version 2, COIL ON PLUG, FOR: (J)									470 458	C10			
2.0	Petrol	109	09/11->	1AZ-FE										
Engine	Information				A10	A20	A40	A50	A70	C10 - C30	C20	E01		
All engines	Qty: 4									470 458	C10			
All engines	x 4, COIL ON PLUG, FOR: (J)									470 458	C10			
2.0	Petrol	110	08/01->	1AZ-FE, 6ARFSE										
Engine	Information				A10	A20	A40	A50	A70	C10 - C30	C20	E01		
Eng. 1AZ-FE	x 4, COIL ON PLUG, FOR: (J)									470 466	C10			
Eng. 6ARFSE	x 4, COIL ON PLUG, FOR: (J)									470 537	C10			
2.0	Petrol	123	12/14->	6ARFSE										
Engine	Information				A10	A20	A40	A50	A70	C10 - C30	C20	E01		
All engines	Qty: 4									470 537	C10			
2.0	Petrol	88	03/83-07/88	3S-FE										
Engine	Information				A10	A20	A40	A50	A70	C10 - C30	C20	E01		
All engines	version Denso							913 029						
All engines										470 197	C10			
2.0	Petrol	89	11/86-02/93	3S-FE										
Engine	Information				A10	A20	A40	A50	A70	C10 - C30	C20	E01		
All engines	version Denso							913 029						
All engines										470 197	C10			
2.0	Petrol	93	09/89-06/91	3S-FE										
Engine	Information				A10	A20	A40	A50	A70	C10 - C30	C20	E01		
All engines	version Denso							913 029						
All engines										470 197	C10			
2.0	Petrol	94	11/86-05/91	3S-FE										
Engine	Information				A10	A20	A40	A50	A70	C10 - C30	C20	E01		
All engines	version Denso							913 029						
All engines										470 197	C10			
2.0 4WD	Petrol	88	03/83-06/91	3S-FE										
Engine	Information				A10	A20	A40	A50	A70	C10 - C30	C20	E01		
All engines	version Denso							913 029						
All engines										470 197	C10			
2.0 4WD	Petrol	94	08/88-05/91	3S-FE										
Engine	Information				A10	A20	A40	A50	A70	C10 - C30	C20	E01		
All engines	version Denso							913 029						
All engines										470 197	C10			
2.2	Petrol	100	06/91-07/96	5S-FE										
Engine	Information				A10	A20	A40	A50	A70	C10 - C30	C20	E01		
All engines	01/08/93 ->, version Denso						813 267							
All engines	version Denso							913 029						
All engines										470 198	C10			
All engines	01/08/93 ->												360 793	

A10 CONDENSER	A20 CONTACT SET	A40 DISTRIBUTOR CAP	A50 ROTOR	A70 PICK-UP
C10 COIL	C20 IGNITION MODULE	C30 ELECTRONIC IGNITION KIT	E01 IGNITION CABLE SET	

The present application list is a brief version. For the detailed information about the possibility of installation on a specific vehicle, please refer to our web-catalogue <http://catalogo.facet.eu/>

					FUNCTIONS ON THE VEHICLE							
Vehicle	alim.	kW	Date	Engine								
ENGINE												
2.2	Petrol	93	02/93-09/02	5S-FE								
Engine	Information				A10	A20	A40	A50	A70	C10 - C30	C20	E01
All engines	01/08/93 ->, version Denso						813 267					
All engines	version Denso						913 029					
All engines									470 198	C10		360 856
All engines	01/08/93 ->											360 793
ENGINE												
2.2	Petrol	96	08/96-11/01	5S-FE								
Engine	Information				A10	A20	A40	A50	A70	C10 - C30	C20	E01
All engines												360 856
ENGINE												
2.2	Petrol	98	08/99->	5S-FNE								
Engine	Information				A10	A20	A40	A50	A70	C10 - C30	C20	E01
All engines												360 856
ENGINE												
2.4	Petrol	112	11/01-11/06	2AZ-FE								
Engine	Information				A10	A20	A40	A50	A70	C10 - C30	C20	E01
All engines	x 4, COIL ON PLUG, FOR: (J)									470 466	C10	
ENGINE												
2.4	Petrol	116	01/06-09/11	2AZ-FE								
Engine	Information				A10	A20	A40	A50	A70	C10 - C30	C20	E01
All engines	->year 01/03/09, x 4, COIL ON PLUG, x 4, COIL ON PLUG, FOR: (J)									470 458	C10	
All engines	01/04/09 ->, x 4, COIL ON PLUG, FOR: (J)									470 466	C10	
ENGINE												
2.4	Petrol	117	09/01-01/06	2AZ-FE								
Engine	Information				A10	A20	A40	A50	A70	C10 - C30	C20	E01
All engines	01/09/05 ->, Qty: 4									470 458	C10	
All engines	->year 01/09/05, Qty: 4									470 466	C10	
ENGINE												
2.4	Petrol	120	01/02-11/06	2AZ-FE								
Engine	Information				A10	A20	A40	A50	A70	C10 - C30	C20	E01
All engines	01/09/05 ->, Qty: 4									470 458	C10	
All engines	->year 01/09/05, Qty: 4									470 466	C10	
ENGINE												
2.4	Petrol	123	01/06-09/11	2AZ-FE								
Engine	Information				A10	A20	A40	A50	A70	C10 - C30	C20	E01
All engines	->year 01/03/09, x 4, COIL ON PLUG, x 4, COIL ON PLUG, FOR: (J)									470 458	C10	
All engines	01/04/09 ->, x 4, COIL ON PLUG, FOR: (J)									470 466	C10	
ENGINE												
2.4	Petrol	127	01/06-09/11	2AZ-FE								
Engine	Information				A10	A20	A40	A50	A70	C10 - C30	C20	E01
All engines	->year 01/03/09, x 4, COIL ON PLUG, x 4, COIL ON PLUG, FOR: (J)									470 458	C10	
All engines	01/04/09 ->, x 4, COIL ON PLUG, FOR: (J)									470 466	C10	
ENGINE												
2.4 [CHN]	Petrol/ Electric	0	03/10->	3AZ-FXE								
Engine	Information				A10	A20	A40	A50	A70	C10 - C30	C20	E01
All engines	Qty: 4									470 458	C10	
ENGINE												
2.4 Hybrid	Petrol/ Electric	105	03/06-07/11	2AZ-FXE								
Engine	Information				A10	A20	A40	A50	A70	C10 - C30	C20	E01
All engines	FOR: (USA), Qty: 4, no specific info conc. application available									470 458	C10	
All engines	NOT FOR: (USA), Qty: 4, no specific info conc. application available									470 466	C10	
ENGINE												
2.4 Hybrid	Petrol/ Electric	110	01/06-09/11	2AZ-FXE								
Engine	Information				A10	A20	A40	A50	A70	C10 - C30	C20	E01
All engines	FOR: (USA), Qty: 4, no specific info conc. application available									470 458	C10	

A10 CONDENSER	A20 CONTACT SET	A40 DISTRIBUTOR CAP	A50 ROTOR	A70 PICK-UP
C10 COIL	C20 IGNITION MODULE	C30 ELECTRONIC IGNITION KIT	E01 IGNITION CABLE SET	

Vehicle	alim.	kW	Date	Engine	FUNCTIONS ON THE VEHICLE											
					A10	A20	A40	A50	A70	C10 - C30	C20	E01				
ENGINE																
2.4 Hybrid	Petrol/ Electric	110	01/06-09/11	2AZ-FXE												
Engine	Information				A10	A20	A40	A50	A70	C10 - C30	C20	E01				
All engines	NOT FOR: (USA), Qty: 4, no specific info conc. application available									470 466	C10					
ENGINE																
2.4 VVTi LE	Petrol	116	01/06-11/06	2AZ-FE												
Engine	Information				A10	A20	A40	A50	A70	C10 - C30	C20	E01				
All engines	Qty: 4									470 466	C10					
ENGINE																
2.5	Petrol	118	10/86-06/91	2VZ-FE												
Engine	Information				A10	A20	A40	A50	A70	C10 - C30	C20	E01				
All engines										470 202	C10					
ENGINE																
2.5	Petrol	129	01/10-09/11	2AR-FE												
Engine	Information				A10	A20	A40	A50	A70	C10 - C30	C20	E01				
All engines	Qty: 4									470 537	C10					
ENGINE																
2.5	Petrol	131	10/11->	2AR-FE												
Engine	Information				A10	A20	A40	A50	A70	C10 - C30	C20	E01				
All engines	x 4, COIL ON PLUG, FOR: (J)									470 537	C10					
ENGINE																
2.5	Petrol	133	09/11->	2AR-FE												
Engine	Information				A10	A20	A40	A50	A70	C10 - C30	C20	E01				
All engines	MADE BY: (USA), x 4, COIL ON PLUG, x 4, COIL ON PLUG, FOR: (J), FOR: (J)									470 537	C10					
ENGINE																
2.5 [CHN]	Petrol	0	12/11->	5AR-FE												
Engine	Information				A10	A20	A40	A50	A70	C10 - C30	C20	E01				
All engines	Qty: 4									470 537	C10					
ENGINE																
2.5 Hybrid	Petrol/ Electric	115	09/11->	2AR-FXE												
Engine	Information				A10	A20	A40	A50	A70	C10 - C30	C20	E01				
All engines	Qty: 4									470 537	C10					
All engines	x 4, COIL ON PLUG, FOR: (J)									470 537	C10					
ENGINE																
2.5 Hybrid	Petrol/ Electric	118	09/11->	2AR-FXE												
Engine	Information				A10	A20	A40	A50	A70	C10 - C30	C20	E01				
All engines	Qty: 4									470 537	C10					
ENGINE																
2.5 Hybrid [CHN]	Petrol/ Electric	118	05/12->	4AR-FXE												
Engine	Information				A10	A20	A40	A50	A70	C10 - C30	C20	E01				
All engines	Qty: 4									470 537	C10					
ENGINE																
3.5	Petrol	183	12/12->	2GR-FE												
Engine	Information				A10	A20	A40	A50	A70	C10 - C30	C20	E01				
All engines	FOR: (J), FOR: (USA), FOR: (RUS), x 6, COIL ON PLUG, x 6, COIL ON PLUG									470 538	C10					
ENGINE																
3.5	Petrol	197	01/06-11/06	2GR-FE												
Engine	Information				A10	A20	A40	A50	A70	C10 - C30	C20	E01				
All engines	Qty: 6									470 538	C10					
ENGINE																
3.5	Petrol	200	01/06-12/11	2GR-FE												
Engine	Information				A10	A20	A40	A50	A70	C10 - C30	C20	E01				
All engines	x 6, COIL ON PLUG									470 538	C10					
ENGINE																
3.5	Petrol	204	09/06-12/17	2GR-FE												
Engine	Information				A10	A20	A40	A50	A70	C10 - C30	C20	E01				
All engines	MADE BY: (J), MADE BY: (USA), x 6, COIL ON PLUG, x 6, COIL ON PLUG									470 538	C10					
ENGINE																
A10	CONDENSER			A20	CONTACT SET			A40	DISTRIBUTOR CAP		A50	ROTOR		A70	PICK-UP	
C10	COIL			C20	IGNITION MODULE			C30	ELECTRONIC IGNITION KIT		E01	IGNITION CABLE SET				

Vehicle	alim.	kW	Date	Engine	FUNCTIONS ON THE VEHICLE							
					A10	A20	A40	A50	A70	C10 - C30	C20	E01

CAMRY SOLARA I

2.2	Petrol	100	06/98-11/02	ENGINE 5S-FE
-----	--------	-----	-------------	-----------------

Engine	Information	A10	A20	A40	A50	A70	C10 - C30	C20	E01
All engines									360 856

CAMRY SOLARA II

2.4	Petrol	117	07/03-11/08	ENGINE 2AZ-FE
-----	--------	-----	-------------	------------------

Engine	Information	A10	A20	A40	A50	A70	C10 - C30	C20	E01
All engines	01/09/05 ->, Qty: 4						470 458	C10	
All engines	->year 01/09/05, Qty: 4						470 466	C10	

CARINA E

1.6	Petrol	73	12/93-09/97	ENGINE 4A-FE
-----	--------	----	-------------	-----------------

Engine	Information	A10	A20	A40	A50	A70	C10 - C30	C20	E01
All engines	no specific info conc. application available, version Bosch			806 094	906 121R				
All engines	no specific info conc. application available, version Denso			813 265	913 029, 913 036				
All engines	no specific info conc. application available						470 199, 470 285S	C10	360 209, 360 879

1.6	Petrol	78	10/95-09/97	ENGINE 4A-FE
-----	--------	----	-------------	-----------------

Engine	Information	A10	A20	A40	A50	A70	C10 - C30	C20	E01
All engines	no specific info conc. application available, version Bosch			806 094	906 121R				
All engines	no specific info conc. application available, version Denso			813 265	913 029, 913 036				
All engines	no specific info conc. application available						470 199, 470 285S	C10	360 209, 360 879

1.6	Petrol	79	01/93-09/97	ENGINE 4A-FE
-----	--------	----	-------------	-----------------

Engine	Information	A10	A20	A40	A50	A70	C10 - C30	C20	E01
All engines	no specific info conc. application available, version Bosch			806 094	906 121R				
All engines	no specific info conc. application available, version Denso			813 265	913 029, 913 036				
All engines	no specific info conc. application available						470 199, 470 285S	C10	360 209, 360 879

1.6	Petrol	85	04/92-09/97	ENGINE 4A-FE
-----	--------	----	-------------	-----------------

Engine	Information	A10	A20	A40	A50	A70	C10 - C30	C20	E01
All engines	no specific info conc. application available, version Bosch			806 094	906 121R				
All engines	no specific info conc. application available, version Denso			813 265	913 029, 913 036				
All engines	no specific info conc. application available						470 199, 470 285S	C10	360 209, 360 879

1.6 16V	Petrol	78	10/95-09/97	ENGINE 4A-FE
---------	--------	----	-------------	-----------------

Engine	Information	A10	A20	A40	A50	A70	C10 - C30	C20	E01
All engines	no specific info conc. application available, version Bosch			806 094	906 121R				
All engines	no specific info conc. application available, version Denso			813 265	913 029, 913 036				
All engines	no specific info conc. application available						470 199, 470 285S	C10	360 209, 360 879

1.6 16V	Petrol	85	12/94-09/97	ENGINE 4A-FE
---------	--------	----	-------------	-----------------

Engine	Information	A10	A20	A40	A50	A70	C10 - C30	C20	E01
All engines	no specific info conc. application available, version Bosch			806 094	906 121R				
All engines	no specific info conc. application available, version Denso			813 265	913 029, 913 036				
All engines	no specific info conc. application available						470 199, 470 285S	C10	360 209, 360 879

1.6 GLI	Petrol	79	04/92-09/97	ENGINE 4A-FE
---------	--------	----	-------------	-----------------

Engine	Information	A10	A20	A40	A50	A70	C10 - C30	C20	E01
All engines	no specific info conc. application available, version Bosch			806 094	906 121R				
All engines	no specific info conc. application available, version Denso			813 265	913 029, 913 036				
All engines	no specific info conc. application available						470 199, 470 285S	C10	360 209, 360 879

A10 CONDENSER	A20 CONTACT SET	A40 DISTRIBUTOR CAP	A50 ROTOR	A70 PICK-UP
C10 COIL	C20 IGNITION MODULE	C30 ELECTRONIC IGNITION KIT	E01 IGNITION CABLE SET	

Vehicle	alim.	kW	Date	Engine	FUNCTIONS ON THE VEHICLE							
					A10	A20	A40	A50	A70	C10 - C30	C20	E01

ENGINE				
1.6 i	Petrol	73	02/95-09/97	4A-FE

Engine	Information	A10	A20	A40	A50	A70	C10 - C30	C20	E01
All engines	no specific info conc. application available, version Bosch			806 094	906 121R				
All engines	no specific info conc. application available, version Denso			813 265	913 029, 913 036				
All engines	no specific info conc. application available						470 199, 470 2855	C10	360 209, 360 879

ENGINE				
1.8	Petrol	79	01/95-09/97	7A-FE

Engine	Information	A10	A20	A40	A50	A70	C10 - C30	C20	E01
All engines	version Denso				913 036				
All engines									360 879

ENGINE				
1.8	Petrol	85	04/92-09/97	7A-FE

Engine	Information	A10	A20	A40	A50	A70	C10 - C30	C20	E01
All engines	version Denso				913 036				
All engines									360 879

ENGINE				
1.8 i	Petrol	79	02/95-09/97	7A-FE

Engine	Information	A10	A20	A40	A50	A70	C10 - C30	C20	E01
All engines	version Denso				913 036				
All engines									360 879

ENGINE				
1.8 i 16V	Petrol	79	01/95-09/97	7A-FE

Engine	Information	A10	A20	A40	A50	A70	C10 - C30	C20	E01
All engines	version Denso				913 036				
All engines									360 879

ENGINE				
2.0	Petrol	98	01/93-09/97	3S-FE

Engine	Information	A10	A20	A40	A50	A70	C10 - C30	C20	E01
All engines	version Denso			813 267	913 029				
All engines							470 198	C10	
All engines	01/05/94 ->								360 793

ENGINE				
2.0 GLI	Petrol	98	04/92-09/97	3S-FE

Engine	Information	A10	A20	A40	A50	A70	C10 - C30	C20	E01
All engines	version Denso			813 267	913 029				
All engines							470 198	C10	
All engines	01/05/94 ->								360 793

ENGINE				
2.0 GTi	Petrol	116	04/92-12/95	3S-GE

Engine	Information	A10	A20	A40	A50	A70	C10 - C30	C20	E01
All engines	version Denso			813 267	913 029				
All engines							470 198	C10	
All engines	01/05/94 ->								360 793

ENGINE				
2.0 GTi 16V	Petrol	129	03/94-09/97	3S-GE

Engine	Information	A10	A20	A40	A50	A70	C10 - C30	C20	E01
All engines	version Denso			813 267	913 029				
All engines							470 198	C10	
All engines	01/05/94 ->								360 793

ENGINE				
2.0 i	Petrol	93	12/92-09/97	3S-FE









Engine	Information	A10	A20	A40	A50	A70	C10 - C30	C20	E01
All engines	version Denso			813 267	913 029				
All engines							470 198	C10	
All engines	01/05/94 ->								360 793

CARINA II

ENGINE				
1.6	Petrol	55	10/83-11/87	4A-LC

Engine	Information	A10	A20	A40	A50	A70	C10 - C30	C20	E01
All engines	version Denso				913 027				

A10 CONDENSER	A20 CONTACT SET	A40 DISTRIBUTOR CAP	A50 ROTOR	A70 PICK-UP
C10 COIL	C20 IGNITION MODULE	C30 ELECTRONIC IGNITION KIT	E01 IGNITION CABLE SET	

				FUNCTIONS ON THE VEHICLE								
Vehicle	alim.	kW	Date	Engine	 A10	 A20	 A40	 A50	 A70	 C10 - C30	 C20	 E01
				ENGINE								
1.6	Petrol	66	12/87-08/90	4A-F								
				ENGINE								
Engine		Information			A10	A20	A40	A50	A70	C10 - C30	C20	E01
All engines		version Denso					813 278	913 029				
All engines										470 199	C10	
				ENGINE								
1.6	Petrol	72	12/87-03/92	4A-FE								
				ENGINE								
Engine		Information			A10	A20	A40	A50	A70	C10 - C30	C20	E01
All engines		version Denso						913 029				
				ENGINE								
1.6	Petrol	75	12/87-03/92	4A-FE								
				ENGINE								
Engine		Information			A10	A20	A40	A50	A70	C10 - C30	C20	E01
All engines		01/11/92 ->, version Denso					813 262					
All engines		version Denso						913 029				
				ENGINE								
1.6 4WD	Petrol	77	06/88-03/92	4A-FE								
				ENGINE								
Engine		Information			A10	A20	A40	A50	A70	C10 - C30	C20	E01
All engines		version Denso						913 029				
				ENGINE								
2.0	Petrol	89	12/87-04/92	3S-FE								
				ENGINE								
Engine		Information			A10	A20	A40	A50	A70	C10 - C30	C20	E01
All engines		version Denso						913 029				
All engines										470 197	C10	
				ENGINE								
2.0	Petrol	94	12/87-03/92	3S-FE								
				ENGINE								
Engine		Information			A10	A20	A40	A50	A70	C10 - C30	C20	E01
All engines		version Denso						913 029				
All engines										470 197	C10	
				ENGINE								
2.0 GLI	Petrol	89	12/87-03/92	3S-FE								
				ENGINE								
Engine		Information			A10	A20	A40	A50	A70	C10 - C30	C20	E01
All engines		version Denso						913 029				
All engines										470 197	C10	
				ENGINE								
2.0 GLi	Petrol	94	12/87-03/92	3S-FE								
				ENGINE								
Engine		Information			A10	A20	A40	A50	A70	C10 - C30	C20	E01
All engines		version Denso						913 029				
All engines										470 197	C10	









				ENGINE								
Vehicle	alim.	kW	Date	Engine	A10	A20	A40	A50	A70	C10 - C30	C20	E01
				ENGINE								
1.6	Petrol	63	04/86-08/89	4A-L								
				ENGINE								
Engine		Information			A10	A20	A40	A50	A70	C10 - C30	C20	E01
All engines		version Denso					813 122	913 029				
All engines										470 199	C10	
				ENGINE								
1.6 GT	Petrol	85	08/87-08/89	4A-GELC								
				ENGINE								
Engine		Information			A10	A20	A40	A50	A70	C10 - C30	C20	E01
All engines		version Denso					813 119	913 027				
				ENGINE								
1.6 GT 16V	Petrol	91	09/85-08/89	4A-GEL								
				ENGINE								
Engine		Information			A10	A20	A40	A50	A70	C10 - C30	C20	E01
All engines		version Denso					813 119	913 027				
				ENGINE								
1.6 GTI 16V	Petrol	92	01/88-12/89	4A-GEL								
				ENGINE								
Engine		Information			A10	A20	A40	A50	A70	C10 - C30	C20	E01
All engines		version Denso					813 119	913 027				
				ENGINE								
2.0i [USA]	Petrol	0	01/85-12/87	2SEL, 3S-FE								
				ENGINE								
Engine		Information			A10	A20	A40	A50	A70	C10 - C30	C20	E01
Eng. 2SEL		version Denso						913 027				
Eng. 3S-FE		version Denso						913 029				

A10 CONDENSER	A20 CONTACT SET	A40 DISTRIBUTOR CAP	A50 ROTOR	A70 PICK-UP
C10 COIL	C20 IGNITION MODULE	C30 ELECTRONIC IGNITION KIT	E01 IGNITION CABLE SET	

Vehicle	alim.	kW	Date	Engine	FUNCTIONS ON THE VEHICLE									
					A10	A20	A40	A50	A70	C10 - C30	C20	E01		
ENGINE														
2.0i [USA]	Petrol	0	01/85-12/87	2SEL, 3S-FE										
Engine	Information				A10	A20	A40	A50	A70	C10 - C30	C20	E01		
All engines										470 197	C10			
CELICA V														
ENGINE														
1.6	Petrol	77	09/89-12/93	4A-FE										
Engine	Information				A10	A20	A40	A50	A70	C10 - C30	C20	E01		
All engines	version Denso						813 262	913 029						
ENGINE														
1.6 16V [USA] [CAN]	Petrol	77	09/89-09/93	4A-FE										
Engine	Information				A10	A20	A40	A50	A70	C10 - C30	C20	E01		
All engines	version Denso							913 029						
ENGINE														
2.0	Petrol	115	10/89-01/94	3S-GE										
Engine	Information				A10	A20	A40	A50	A70	C10 - C30	C20	E01		
All engines	->year 01/08/91, version Denso						813 251							
All engines	version Denso							913 036						
All engines	01/08/91 ->, RHD									470 203	C10			
ENGINE														
2.0	Petrol	118	09/89-10/93	3S-GE										
Engine	Information				A10	A20	A40	A50	A70	C10 - C30	C20	E01		
All engines	->year 01/08/91, version Denso						813 251							
All engines	version Denso							913 036						
All engines	01/08/91 ->, RHD									470 203	C10			
ENGINE														
2.0 4WD	Petrol	150	10/89-11/93	3S-GTE										
Engine	Information				A10	A20	A40	A50	A70	C10 - C30	C20	E01		
All engines	->year 01/08/91, version Denso						813 251							
All engines	version Denso							913 036						
All engines	01/08/91 ->, RHD									470 203	C10			
ENGINE														
2.0 4WD	Petrol	153	10/89-01/94	3S-GTE										
Engine	Information				A10	A20	A40	A50	A70	C10 - C30	C20	E01		
All engines	->year 01/08/91, version Denso						813 251							
All engines	version Denso							913 036						
All engines	01/08/91 ->, RHD									470 203	C10			
ENGINE														
2.0 GTi	Petrol	115	10/89-11/93	3S-GE										
Engine	Information				A10	A20	A40	A50	A70	C10 - C30	C20	E01		
All engines	->year 01/08/91, version Denso						813 251							
All engines	version Denso							913 036						
ENGINE														
2.2	Petrol	100	10/89-12/94	5S-FE										
Engine	Information				A10	A20	A40	A50	A70	C10 - C30	C20	E01		
All engines	version Denso, no specific info conc. application available						813 267	913 029, 913 036						
All engines	no specific info conc. application available									470 198, 470 2855	C10		360 793	
CELICA VI														
ENGINE														
1.8 i 16V	Petrol	85	11/93-11/99	7A-FE										
Engine	Information				A10	A20	A40	A50	A70	C10 - C30	C20	E01		
All engines	version Denso						813 265							
All engines										470 199	C10		360 209	
ENGINE														
1.8 i 16V [USA] [CAN]	Petrol	85	09/93-08/99	7A-FE										
Engine	Information				A10	A20	A40	A50	A70	C10 - C30	C20	E01		
All engines	version Denso						813 265							
All engines	01/08/95 ->									470 198	C10			
All engines	->year 01/08/95									470 199	C10			
All engines													360 209	

A10 CONDENSER	A20 CONTACT SET	A40 DISTRIBUTOR CAP	A50 ROTOR	A70 PICK-UP
C10 COIL	C20 IGNITION MODULE	C30 ELECTRONIC IGNITION KIT	E01 IGNITION CABLE SET	

The present application list is a brief version. For the detailed information about the possibility of installation on a specific vehicle, please refer to our web-catalogue <http://catalogo.facet.eu/>







					FUNCTIONS ON THE VEHICLE							
Vehicle	alim.	kW	Date	Engine								
2.0 GTi												
Petrol	129	08/94-08/99	ENGINE 3S-GE									
Engine	Information				A10	A20	A40	A50	A70	C10 - C30	C20	E01
All engines	version Denso							913 036				
All engines										470 2855	C10	
2.0 i 16V												
Petrol	125	11/93-11/99	ENGINE 3S-GE									
Engine	Information				A10	A20	A40	A50	A70	C10 - C30	C20	E01
All engines	version Denso							913 036				
All engines										470 2855	C10	
2.0 i 16V												
Petrol	129	11/93-11/99	ENGINE 3S-GE									
Engine	Information				A10	A20	A40	A50	A70	C10 - C30	C20	E01
All engines	version Denso							913 036				
All engines										470 2855	C10	
2.0 i Turbo 4WD												
Petrol	178	02/94-11/99	ENGINE 3S-GTE									
Engine	Information				A10	A20	A40	A50	A70	C10 - C30	C20	E01
All engines	version Denso							913 036				
All engines										470 2855	C10	
2.2 GT												
Petrol	100	11/93-08/99	ENGINE 5S-FE									
Engine	Information				A10	A20	A40	A50	A70	C10 - C30	C20	E01
All engines	version Denso, no specific info conc. application available						813 267	913 029, 913 036				
All engines	no specific info conc. application available									470 198, 470 2855	C10	360 793
CELICA VII												
1.8 16V VT-i												
Petrol	105	08/99-07/05	ENGINE 1ZZFE									
Engine	Information				A10	A20	A40	A50	A70	C10 - C30	C20	E01
All engines	x 4, COIL ON PLUG									470 461	C10	
C-HR												
1.2												
Petrol	85	10/16->	ENGINE 8NR-FTS									
Engine	Information				A10	A20	A40	A50	A70	C10 - C30	C20	E01
All engines	x 4, COIL ON PLUG									470 645	C10	
1.2 4WD												
Petrol	85	10/16->	ENGINE 8NR-FTS									
Engine	Information				A10	A20	A40	A50	A70	C10 - C30	C20	E01
All engines	x 4, COIL ON PLUG									470 645	C10	
1.2 4WD												
Petrol	96	10/16->	ENGINE 8NR-FTS									
Engine	Information				A10	A20	A40	A50	A70	C10 - C30	C20	E01
All engines	x 4, COIL ON PLUG									470 645	C10	
2.0												
Petrol	109	11/16->	ENGINE 3ZR-FAE									
Engine	Information				A10	A20	A40	A50	A70	C10 - C30	C20	E01
All engines	x 4, COIL ON PLUG									470 536	C10	
COROLLA												
1.2												
Petrol	85	01/19->	ENGINE 8NR-FTS									
Engine	Information				A10	A20	A40	A50	A70	C10 - C30	C20	E01
All engines	Corolla, x 4, COIL ON PLUG									470 645	C10	
1.6												
Petrol	81	05/97-09/99	ENGINE 4A-FE									
Engine	Information				A10	A20	A40	A50	A70	C10 - C30	C20	E01
All engines	x 1, DISTRIBUTOR									470 199	C10	
1.6 VVTi												
Petrol	90	01/19->	ENGINE 1ZR-FAE, 1ZR-FE									
Engine	Information				A10	A20	A40	A50	A70	C10 - C30	C20	E01
All engines	Corolla, x 4, COIL ON PLUG									470 536	C10	

A10 CONDENSER	A20 CONTACT SET	A40 DISTRIBUTOR CAP	A50 ROTOR	A70 PICK-UP
C10 COIL	C20 IGNITION MODULE	C30 ELECTRONIC IGNITION KIT	E01 IGNITION CABLE SET	

Vehicle	alim.	kW	Date	Engine	FUNCTIONS ON THE VEHICLE								
					A10	A20	A40	A50	A70	C10 - C30	C20	E01	
ENGINE													
1.6 VVTi	Petrol	97	01/19->	1ZR-FAE, 1ZR-FE									
Engine	Information				A10	A20	A40	A50	A70	C10 - C30	C20	E01	
All engines	Corolla, x 4, COIL ON PLUG									470 536	C10		
COROLLA IV													
ENGINE													
1.8	Petrol	56	09/79-05/82	3T-C									
Engine	Information				A10	A20	A40	A50	A70	C10 - C30	C20	E01	
All engines	version Denso							913 027					
ENGINE													
1.8	Petrol	63	08/82-09/83	3T-C									
Engine	Information				A10	A20	A40	A50	A70	C10 - C30	C20	E01	
All engines	version Denso							913 027					
COROLLA IX													
ENGINE													
1.4 VVT-i	Petrol	71	10/01-02/07	02Z24, 67MR20DE									
Engine	Information				A10	A20	A40	A50	A70	C10 - C30	C20	E01	
All engines	Corolla, x 4, COIL ON PLUG, x 4, COIL ON PLUG									470 461	C10		
ENGINE													
1.6	Petrol	91	11/06-07/07	1ZR-FE									
Engine	Information				A10	A20	A40	A50	A70	C10 - C30	C20	E01	
All engines	Qty: 4									470 536	C10		
ENGINE													
1.6 VVT-i	Petrol	81	10/01-03/08	3ZZ-FE									
Engine	Information				A10	A20	A40	A50	A70	C10 - C30	C20	E01	
All engines	Corolla, x 4, COIL ON PLUG, x 4, COIL ON PLUG									470 461	C10		
ENGINE													
1.8	Petrol	100	12/01-12/07	1ZZFE									
Engine	Information				A10	A20	A40	A50	A70	C10 - C30	C20	E01	
All engines	MADE BY: (J), x 4, COIL ON PLUG									470 461	C10		
ENGINE													
1.8	Petrol	92	05/02-05/04	1ZZFE									
Engine	Information				A10	A20	A40	A50	A70	C10 - C30	C20	E01	
All engines	Corolla, x 4, COIL ON PLUG									470 461	C10		
COROLLA V													
ENGINE													
1.6	Petrol	53	08/85-08/87	4A-LC									
Engine	Information				A10	A20	A40	A50	A70	C10 - C30	C20	E01	
All engines										470 197	C10		
ENGINE													
1.6	Petrol	54	08/85-05/88	4A-LC									
Engine	Information				A10	A20	A40	A50	A70	C10 - C30	C20	E01	
All engines										470 197	C10		
ENGINE													
1.6	Petrol	55	08/84-08/87	4A-C									
Engine	Information				A10	A20	A40	A50	A70	C10 - C30	C20	E01	
All engines										470 197	C10		
ENGINE													
1.6	Petrol	58	04/85-05/89	4A-LC									
Engine	Information				A10	A20	A40	A50	A70	C10 - C30	C20	E01	
All engines										470 197	C10		
ENGINE													
1.6	Petrol	85	05/85-04/87	4A-GELC									
Engine	Information				A10	A20	A40	A50	A70	C10 - C30	C20	E01	
All engines	version Denso						813 119	913 027					
ENGINE													
1.6 16V	Petrol	85	12/85-04/87	4A-GEC									
Engine	Information				A10	A20	A40	A50	A70	C10 - C30	C20	E01	
All engines	version Denso							913 027					

A10 CONDENSER	A20 CONTACT SET	A40 DISTRIBUTOR CAP	A50 ROTOR	A70 PICK-UP
C10 COIL	C20 IGNITION MODULE	C30 ELECTRONIC IGNITION KIT	E01 IGNITION CABLE SET	

The present application list is a brief version. For the detailed information about the possibility of installation on a specific vehicle, please refer to our web-catalogue <http://catalogo.facet.eu/>

					FUNCTIONS ON THE VEHICLE							
Vehicle	alim.	kW	Date	Engine	 A10	 A20	 A40	 A50	 A70	 C10 - C30	 C20	 E01
ENGINE												
1.6 SR	Petrol	58	08/83-04/85	4A-C								
Engine	Information				A10	A20	A40	A50	A70	C10 - C30	C20	E01
All engines										470 197	C10	
COROLLA VERSO I												
1.6 VVT-i	Petrol	81	08/01-05/04	3ZZ-FE								
Engine	Information				A10	A20	A40	A50	A70	C10 - C30	C20	E01
All engines	x 4, COIL ON PLUG									470 461	C10	
1.8 VVT-i	Petrol	99	12/01-05/04	1ZZFE								
Engine	Information				A10	A20	A40	A50	A70	C10 - C30	C20	E01
All engines	x 4, COIL ON PLUG									470 461	C10	
1.8 VVTi 4WD	Petrol	99	07/01-02/04	2CJXG								
Engine	Information				A10	A20	A40	A50	A70	C10 - C30	C20	E01
All engines	Qty: 4									470 461	C10	
COROLLA VERSO II												
1.6	Petrol	81	04/04-03/09	3ZZ-FE								
Engine	Information				A10	A20	A40	A50	A70	C10 - C30	C20	E01
All engines	x 4, COIL ON PLUG									470 461	C10	
1.8	Petrol	95	04/04-03/09	1ZZFE								
Engine	Information				A10	A20	A40	A50	A70	C10 - C30	C20	E01
All engines	x 4, COIL ON PLUG									470 461	C10	
COROLLA VI												
1.3	Petrol	55	08/87-06/92	2E								
Engine	Information				A10	A20	A40	A50	A70	C10 - C30	C20	E01
All engines	for emission-controlled vehicles, version Denso						813 122, 813 278					
All engines	version Denso							913 029				
All engines										470 199	C10	360 823
1.3	Petrol	60	05/87-04/92	2E								
Engine	Information				A10	A20	A40	A50	A70	C10 - C30	C20	E01
All engines	for emission-controlled vehicles, version Denso						813 122, 813 278					
All engines	version Denso							913 029				
All engines										470 199	C10	360 823
1.3 i	Petrol	55	08/87-06/92	2E, 2E-E								
Engine	Information				A10	A20	A40	A50	A70	C10 - C30	C20	E01
All engines	for emission-controlled vehicles, version Denso						813 122, 813 278					
All engines	version Denso							913 029				
All engines										470 199	C10	360 823
1.6	Petrol	66	05/87-11/92	4A-F								
Engine	Information				A10	A20	A40	A50	A70	C10 - C30	C20	E01
All engines	version Denso						813 278	913 029				
All engines										470 199	C10	
1.6	Petrol	70	09/89-04/92	4A-F								
Engine	Information				A10	A20	A40	A50	A70	C10 - C30	C20	E01
All engines	version Denso						813 278	913 029				
All engines										470 199	C10	
1.6	Petrol	71	01/88-12/92	4A-F								
Engine	Information				A10	A20	A40	A50	A70	C10 - C30	C20	E01
All engines	version Denso						813 278	913 029				
All engines										470 199	C10	

A10 CONDENSER	A20 CONTACT SET	A40 DISTRIBUTOR CAP	A50 ROTOR	A70 PICK-UP
C10 COIL	C20 IGNITION MODULE	C30 ELECTRONIC IGNITION KIT	E01 IGNITION CABLE SET	

Vehicle	alim.	kW	Date	Engine	FUNCTIONS ON THE VEHICLE							
					A10	A20	A40	A50	A70	C10 - C30	C20	E01

				ENGINE
1.6	Petrol	77	08/89-04/92	4A-FE

Engine	Information	A10	A20	A40	A50	A70	C10 - C30	C20	E01
All engines	AE92, version Denso			813 262					
All engines	version Denso				913 029				
All engines	AE95						470 197	C10	

				ENGINE
1.6 4WD	Petrol	66	08/87-08/89	4A-F

Engine	Information	A10	A20	A40	A50	A70	C10 - C30	C20	E01
All engines	version Denso			813 278	913 029				
All engines							470 199	C10	

				ENGINE
1.6 GL 4WD	Petrol	70	10/87-08/90	4A-F

Engine	Information	A10	A20	A40	A50	A70	C10 - C30	C20	E01
All engines	version Denso			813 278	913 029				
All engines							470 199	C10	

				ENGINE
1.6 GTi	Petrol	85	08/87-10/94	4A-GE

Engine	Information	A10	A20	A40	A50	A70	C10 - C30	C20	E01
All engines	version Denso			813 248	913 027				

				ENGINE
1.6 i	Petrol	77	05/87-05/92	4A-FE

Engine	Information	A10	A20	A40	A50	A70	C10 - C30	C20	E01
All engines	AE92, version Denso			813 262					
All engines	version Denso				913 029				
All engines	AE95						470 197	C10	

				ENGINE
1.6 i 4WD	Petrol	77	10/87-08/90	4A-FE

Engine	Information	A10	A20	A40	A50	A70	C10 - C30	C20	E01
All engines	AE92, version Denso			813 262	913 029				
All engines	AE95						470 197	C10	

				ENGINE
1.6 XL	Petrol	70	09/89-04/92	4A-F

Engine	Information	A10	A20	A40	A50	A70	C10 - C30	C20	E01
All engines	version Denso			813 278	913 029				
All engines							470 199	C10	

				ENGINE
1.6 XLI	Petrol	77	11/89-06/92	4A-FE

Engine	Information	A10	A20	A40	A50	A70	C10 - C30	C20	E01
All engines	version Denso			813 262	913 029				
All engines	AE95						470 197	C10	

COROLLA VII

				ENGINE
1.3 12V	Petrol	53	07/92-04/97	2E

Engine	Information	A10	A20	A40	A50	A70	C10 - C30	C20	E01
All engines	version Denso			813 275	913 029				
All engines							470 199	C10	360 393

				ENGINE
1.3 XLI	Petrol	55	08/95-04/97	4E-FE

Engine	Information	A10	A20	A40	A50	A70	C10 - C30	C20	E01
All engines	version Denso			813 265	913 029				
All engines							470 199	C10	
All engines	01/05/95 ->								360 435

				ENGINE
1.3 XLI	Petrol	65	07/92-04/97	4E-FE

Engine	Information	A10	A20	A40	A50	A70	C10 - C30	C20	E01
All engines	version Denso			813 265	913 029				
All engines							470 199	C10	
All engines	01/05/95 ->								360 435

A10 CONDENSER	A20 CONTACT SET	A40 DISTRIBUTOR CAP	A50 ROTOR	A70 PICK-UP
C10 COIL	C20 IGNITION MODULE	C30 ELECTRONIC IGNITION KIT	E01 IGNITION CABLE SET	

The present application list is a brief version. For the detailed information about the possibility of installation on a specific vehicle, please refer to our web-catalogue <http://catalogo.facet.eu/>

					FUNCTIONS ON THE VEHICLE							
Vehicle	alim.	kW	Date	Engine	 A10	 A20	 A40	 A50	 A70	 C10 - C30	 C20	 E01
1.3 XLI 16V	Petrol	65	07/92-09/95	ENGINE 4E-FE								
Engine	Information				A10	A20	A40	A50	A70	C10 - C30	C20	E01
All engines	version Denso						813 265	913 029				
All engines										470 199	C10	
All engines	01/05/95 ->											360 435
1.6 GLI	Petrol	84	07/92-04/97	ENGINE 4A-FE								
Engine	Information				A10	A20	A40	A50	A70	C10 - C30	C20	E01
All engines	version Denso						813 265					
All engines	01/11/95 ->, version Denso							913 029				
All engines										470 199	C10	360 209
1.6 Si	Petrol	84	07/92-04/97	ENGINE 4A-FE								
Engine	Information				A10	A20	A40	A50	A70	C10 - C30	C20	E01
All engines	version Denso						813 265					
All engines	01/11/95 ->, version Denso							913 029				
All engines										470 199	C10	360 209
1.8 16V 4WD	Petrol	81	09/95-04/97	ENGINE 7A-FE								
Engine	Information				A10	A20	A40	A50	A70	C10 - C30	C20	E01
All engines	version Denso						813 265					
All engines										470 199	C10	360 209
1.8 GT	Petrol	86	11/92-05/95	ENGINE 7A-FE								
Engine	Information				A10	A20	A40	A50	A70	C10 - C30	C20	E01
All engines	version Denso						813 265					
All engines										470 199	C10	360 209
COROLLA VIII												
1.3	Petrol	55	05/97-10/01	ENGINE 2E								
Engine	Information				A10	A20	A40	A50	A70	C10 - C30	C20	E01
All engines	version Denso						813 275	913 029				
All engines	Corolla, x 1, DISTRIBUTOR									470 199	C10	
All engines												360 393
1.4	Petrol	63	04/97-02/00	ENGINE 4E-FE								
Engine	Information				A10	A20	A40	A50	A70	C10 - C30	C20	E01
All engines												360 880
1.6	Petrol	81	04/97-01/02	ENGINE 3ZZ-FE, 4A-FE								
Engine	Information				A10	A20	A40	A50	A70	C10 - C30	C20	E01
Eng. 4A-FE	version Denso						813 265	913 029				
Eng. 4A-FE	Corolla, x 1, DISTRIBUTOR, x 1, DISTRIBUTOR									470 199	C10	
Eng. 3ZZ-FE	Corolla, x 4, COIL ON PLUG									470 461	C10	
Eng. 4A-FE												360 209
1.6 16V	Petrol	81	10/99-12/01	ENGINE 3ZZ-FE								
Engine	Information				A10	A20	A40	A50	A70	C10 - C30	C20	E01
All engines	Corolla, x 4, COIL ON PLUG, x 4, COIL ON PLUG									470 461	C10	
1.6 Aut.	Petrol	79	04/97-02/00	ENGINE 4A-FE								
Engine	Information				A10	A20	A40	A50	A70	C10 - C30	C20	E01
All engines	version Denso						813 265	913 029				
All engines	Corolla, x 1, DISTRIBUTOR, x 1, DISTRIBUTOR									470 199	C10	
All engines												360 209
1.8	Petrol	81	10/97-10/01	ENGINE 7A-FE								
Engine	Information				A10	A20	A40	A50	A70	C10 - C30	C20	E01
All engines	Corolla, x 1, DISTRIBUTOR									470 199	C10	

A10 CONDENSER	A20 CONTACT SET	A40 DISTRIBUTOR CAP	A50 ROTOR	A70 PICK-UP
C10 COIL	C20 IGNITION MODULE	C30 ELECTRONIC IGNITION KIT	E01 IGNITION CABLE SET	

Vehicle	alim.	kW	Date	Engine	FUNCTIONS ON THE VEHICLE									
					A10	A20	A40	A50	A70	C10 - C30	C20	E01		
ENGINE														
1.8 4WD	Petrol	81	04/97-10/01	7A-FE										
Engine	Information				A10	A20	A40	A50	A70	C10 - C30	C20	E01		
All engines	version Denso						813 265							
All engines										470 198	C10		360 209	
COROLLA X														
ENGINE														
1.3 VVT-i	Petrol	63	03/08->	2NZ-FE										
Engine	Information				A10	A20	A40	A50	A70	C10 - C30	C20	E01		
All engines	Qty: 4									470 459	C10			
ENGINE														
1.33	Petrol	74	12/08-07/14	1NR-FE										
Engine	Information				A10	A20	A40	A50	A70	C10 - C30	C20	E01		
All engines	Corolla, x 4, COIL ON PLUG									470 537	C10			
ENGINE														
1.4 VVT-i	Petrol	71	11/06-11/13	4ZZ-FE										
Engine	Information				A10	A20	A40	A50	A70	C10 - C30	C20	E01		
All engines	Corolla, x 4, COIL ON PLUG									470 461	C10			
ENGINE														
1.5	Petrol	81	09/06->	1NZ-FE										
Engine	Information				A10	A20	A40	A50	A70	C10 - C30	C20	E01		
All engines	Qty: 4, -transm. type 4FC									470 458	C10			
All engines	Qty: 4, t.tnr. 4FC									470 459	C10			
ENGINE														
1.5 4WD	Petrol	77	09/06->	1NZ-FE										
Engine	Information				A10	A20	A40	A50	A70	C10 - C30	C20	E01		
All engines	Qty: 4, -transm. type 4FC									470 458	C10			
All engines	Qty: 4, t.tnr. 4FC									470 459	C10			
ENGINE														
1.6	Petrol	97	11/06-11/13	1ZR-FAE, 1ZR-FE										
Engine	Information				A10	A20	A40	A50	A70	C10 - C30	C20	E01		
All engines	Corolla, x 4, COIL ON PLUG									470 536	C10			
ENGINE														
1.6 Dual VVTi	Petrol	91	01/07-07/14	1ZR-FE										
Engine	Information				A10	A20	A40	A50	A70	C10 - C30	C20	E01		
All engines	Corolla, x 4, COIL ON PLUG									470 536	C10			
ENGINE														
1.6 VVTi	Petrol	100	03/07-12/10	1ZR-FE										
Engine	Information				A10	A20	A40	A50	A70	C10 - C30	C20	E01		
All engines	Corolla, x 4, COIL ON PLUG									470 536	C10			
ENGINE														
1.6 VVTi	Petrol	80	12/07-06/13	3ZZ-FE										
Engine	Information				A10	A20	A40	A50	A70	C10 - C30	C20	E01		
All engines	Qty: 4									470 461	C10			
ENGINE														
1.6 VVTi	Petrol	81	08/07-06/13	3ZZ-FE										
Engine	Information				A10	A20	A40	A50	A70	C10 - C30	C20	E01		
All engines	Qty: 4									470 461	C10			
ENGINE														
1.6 VVTi	Petrol	90	07/10-05/14	1ZR-FE										
Engine	Information				A10	A20	A40	A50	A70	C10 - C30	C20	E01		
All engines	Corolla, x 4, COIL ON PLUG									470 536	C10			
ENGINE														
1.8	Petrol	106	09/06->	2ZR-FAE										
Engine	Information				A10	A20	A40	A50	A70	C10 - C30	C20	E01		
All engines	Qty: 4									470 536	C10			
ENGINE														
1.8	Petrol	108	01/09->	2ZR-FAE										
Engine	Information				A10	A20	A40	A50	A70	C10 - C30	C20	E01		
All engines	Qty: 4									470 536	C10			









A10	CONDENSER	A20	CONTACT SET	A40	DISTRIBUTOR CAP	A50	ROTOR	A70	PICK-UP
C10	COIL	C20	IGNITION MODULE	C30	ELECTRONIC IGNITION KIT	E01	IGNITION CABLE SET		

The present application list is a brief version. For the detailed information about the possibility of installation on a specific vehicle, please refer to our web-catalogue <http://catalogo.facet.eu/>

Vehicle	alim.	kW	Date	Engine	FUNCTIONS ON THE VEHICLE								
					A10	A20	A40	A50	A70	C10 - C30	C20	E01	
ENGINE													
1.8	Petrol	111	08/10->	2ZR-FE									
Engine Information					A10	A20	A40	A50	A70	C10 - C30	C20	E01	
All engines Qty: 4, no specific info conc. application available										470 536	C10		
ENGINE													
1.8 16V	Petrol	97	08/07->	2CJXG									
Engine Information					A10	A20	A40	A50	A70	C10 - C30	C20	E01	
All engines Qty: 4										470 461	C10		
ENGINE													
1.8 4WD	Petrol	100	09/07->	2ZR-FAE									
Engine Information					A10	A20	A40	A50	A70	C10 - C30	C20	E01	
All engines Qty: 4										470 536	C10		
ENGINE													
1.8 4WD	Petrol	98	09/06->	2ZR-FAE									
Engine Information					A10	A20	A40	A50	A70	C10 - C30	C20	E01	
All engines Qty: 4										470 536	C10		
ENGINE													
1.8 CNG	CNG	0	06/09->	2CJXG									
Engine Information					A10	A20	A40	A50	A70	C10 - C30	C20	E01	
All engines Qty: 4										470 461	C10		
ENGINE													
1.8 FlexFuel [BRA]	Flexfuel	100	03/08->	1ZZ-FBE									
Engine Information					A10	A20	A40	A50	A70	C10 - C30	C20	E01	
All engines Qty: 4										470 461	C10		
ENGINE													
1.8 VVTi	Petrol	103	08/10->	2ZR-FBE, 2ZR-FE									
Engine Information					A10	A20	A40	A50	A70	C10 - C30	C20	E01	
All engines Qty: 4, no specific info conc. application available										470 536	C10		
ENGINE													
2.0	Petrol	107	04/10->	3ZR-FE									
Engine Information					A10	A20	A40	A50	A70	C10 - C30	C20	E01	
All engines Qty: 4										470 536	C10		
ENGINE													
2.0 FlexFuel	Flexfuel	0	04/10->	3ZR-FBE									
Engine Information					A10	A20	A40	A50	A70	C10 - C30	C20	E01	
All engines Qty: 4										470 536	C10		
ENGINE													
2.0 VVTi	Petrol	116	08/10->	3ZR-FE									
Engine Information					A10	A20	A40	A50	A70	C10 - C30	C20	E01	
All engines Qty: 4										470 536	C10		
ENGINE													
2.4	Petrol	116	01/08->	2AZ-FE									
Engine Information					A10	A20	A40	A50	A70	C10 - C30	C20	E01	
All engines Qty: 4, no specific info conc. application available										470 458, 470 466	C10		
COROLLA XI													
ENGINE													
1.3	Petrol	70	05/12->	1NR-FE									
Engine Information					A10	A20	A40	A50	A70	C10 - C30	C20	E01	
All engines Qty: 4										470 537	C10		
ENGINE													
1.3	Petrol	73	06/13-12/18	1NR-FE									
Engine Information					A10	A20	A40	A50	A70	C10 - C30	C20	E01	
All engines Corolla, x 4, COIL ON PLUG										470 537	C10		
ENGINE													
1.5	Petrol	80	05/12->	1NZ-FE									
Engine Information					A10	A20	A40	A50	A70	C10 - C30	C20	E01	
All engines Qty: 4										470 458	C10		

A10 CONDENSER	A20 CONTACT SET	A40 DISTRIBUTOR CAP	A50 ROTOR	A70 PICK-UP
C10 COIL	C20 IGNITION MODULE	C30 ELECTRONIC IGNITION KIT	E01 IGNITION CABLE SET	

Vehicle	alim.	kW	Date	Engine	FUNCTIONS ON THE VEHICLE									
					A10	A20	A40	A50	A70	C10 - C30	C20	E01		
ENGINE														
1.5 4WD	Petrol	76	05/12->	1NZ-FE										
ENGINE														
All engines					Qty: 4						470 458	C10		
1.5 Hybrid	Petrol/ Electric	54	10/14->	1NZ-FXE										
ENGINE														
All engines					Qty: 4						470 459	C10		
1.6	Petrol	90	06/13-12/18	1ZR-FE										
ENGINE														
All engines					Corolla, x 4, COIL ON PLUG						470 536	C10		
1.6	Petrol	97	06/13-12/18	1ZR-FAE										
ENGINE														
All engines					Corolla, x 4, COIL ON PLUG						470 536	C10		
1.6 BiFuel	Petrol/ Com- pressed Natural Gas (CNG)	90	06/13->	1ZR-FE										
ENGINE														
All engines					Qty: 4						470 536	C10		
1.8	Petrol	103	05/12->	2ZR-FAE										
ENGINE														
All engines					Qty: 4						470 536	C10		
1.8 [USA] [CAN]	Petrol	0	08/13->	2ZR-FAE										
ENGINE														
All engines					Qty: 4						470 536	C10		
1.8 VVTi	Petrol	103	06/13-08/19	2ZR-FE										
ENGINE														
All engines					Corolla, x 4, COIL ON PLUG						470 536	C10		
1.8 VVT-i	Petrol	111	12/13->	2ZR-FE										
ENGINE														
All engines					Qty: 4						470 536	C10		
2.0 VVT-i CNG	Petrol/ Com- pressed Natural Gas (CNG)	105	10/13-12/18	3ZRFECNG										
ENGINE														
All engines					Corolla, x 4, COIL ON PLUG						470 536	C10		
DYNA														
1.6	Diesel	51	05/85-08/87	1Y										
ENGINE														
All engines					version Denso			813 114	913 014					
1.8	Petrol	57	05/95-08/01	2Y										
ENGINE														
All engines					01/09/91 ->, version Denso			813 113						
All engines					->year 01/09/91, version Denso			813 114						
All engines					->year 01/09/89, version Denso				913 014					
All engines					01/09/89 ->, version Denso, no specific info conc. application available				913 027					
All engines					version Denso, no specific info conc. application available				913 030					
A10	CONDENSER		A20	CONTACT SET		A40	DISTRIBUTOR CAP		A50	ROTOR		A70	PICK-UP	
C10	COIL		C20	IGNITION MODULE		C30	ELECTRONIC IGNITION KIT		E01	IGNITION CABLE SET				

					FUNCTIONS ON THE VEHICLE							
Vehicle	alim.	kW	Date	Engine								
2.0 Petrol 65 05/95-10/01 3Y ENGINE												
Engine	Information				A10	A20	A40	A50	A70	C10 - C30	C20	E01
All engines	version Denso, YY211						813 113	913 027				
DYNA 100												
1.8 Petrol 58 08/85-04/95 2Y ENGINE												
Engine	Information				A10	A20	A40	A50	A70	C10 - C30	C20	E01
All engines	01/09/91 ->, version Denso						813 113					
All engines	->year 01/09/91, version Denso						813 114					
All engines	->year 01/09/89, version Denso							913 014				
All engines	01/09/89 ->, version Denso, no specific info conc. application available							913 027				
All engines	version Denso, no specific info conc. application available							913 030				
1.8 Petrol 61 08/87-04/95 2Y ENGINE												
Engine	Information				A10	A20	A40	A50	A70	C10 - C30	C20	E01
All engines	01/09/91 ->, version Denso						813 113					
All engines	->year 01/09/91, version Denso						813 114					
All engines	->year 01/09/89, version Denso							913 014				
All engines	01/09/89 ->, version Denso, no specific info conc. application available							913 027				
All engines	version Denso, no specific info conc. application available							913 030				
DYNA 150												
1.8 Petrol 58 08/85-08/86 2Y ENGINE												
Engine	Information				A10	A20	A40	A50	A70	C10 - C30	C20	E01
All engines	version Denso							913 014				
2.0 Petrol 65 08/85-09/87 3Y ENGINE												
Engine	Information				A10	A20	A40	A50	A70	C10 - C30	C20	E01
All engines	version Denso, YY60						813 114	913 014				
2.0 Petrol 79 08/85-08/88 3Y ENGINE												
Engine	Information				A10	A20	A40	A50	A70	C10 - C30	C20	E01
All engines	version Denso, YY60						813 114	913 014				
DYNA 200												
2.7 Petrol 92 06/95-07/01 3RZ-FE ENGINE												
Engine	Information				A10	A20	A40	A50	A70	C10 - C30	C20	E01
All engines	RHD									470 198	C10	
All engines	01/08/99 ->											360 792
ECHO												
1.5 i 16V [USA] Petrol 81 08/99-> 1NZFE ENGINE												
Engine	Information				A10	A20	A40	A50	A70	C10 - C30	C20	E01
All engines	Qty: 4									470 459	C10	
FJ CRUISER												
4.0 Petrol 176 06/05-10/09 1GR-FE ENGINE												
Engine	Information				A10	A20	A40	A50	A70	C10 - C30	C20	E01
All engines	->year 01/08/09, x 6, COIL ON PLUG, FOR: (J)									470 458	C10	
All engines	01/09/09 ->, x 6, COIL ON PLUG, FOR: (J)									470 537	C10	
4.0 Petrol 178 01/06-12/11 1GR-FE ENGINE												
Engine	Information				A10	A20	A40	A50	A70	C10 - C30	C20	E01
All engines	->year 01/07/09, x 6, COIL ON PLUG, FOR: (J)									470 458	C10	
All engines	01/08/09 ->, x 6, COIL ON PLUG, FOR: (J)									470 537	C10	
4.0 Petrol 191 01/10-06/14 1GR-FE ENGINE												
Engine	Information				A10	A20	A40	A50	A70	C10 - C30	C20	E01
All engines	x 6, COIL ON PLUG, FOR: (J)									470 537	C10	

A10 CONDENSER	A20 CONTACT SET	A40 DISTRIBUTOR CAP	A50 ROTOR	A70 PICK-UP
C10 COIL	C20 IGNITION MODULE	C30 ELECTRONIC IGNITION KIT	E01 IGNITION CABLE SET	

Vehicle	alim.	kW	Date	Engine	FUNCTIONS ON THE VEHICLE									
					A10	A20	A40	A50	A70	C10 - C30	C20	E01		
ENGINE														
4.0 4WD	Petrol	176	06/05-12/09	1GR-FE										
Engine	Information				A10	A20	A40	A50	A70	C10 - C30	C20	E01		
All engines	->year 01/08/09, x 6, COIL ON PLUG, FOR: (J)									470 458	C10			
All engines	01/09/09 ->, x 6, COIL ON PLUG, FOR: (J)									470 537	C10			
ENGINE														
4.0 4WD	Petrol	178	01/06-01/18	1GR-FE										
Engine	Information				A10	A20	A40	A50	A70	C10 - C30	C20	E01		
All engines	->year 01/07/09, x 6, COIL ON PLUG, FOR: (J)									470 458	C10			
All engines	01/08/09 ->, x 6, COIL ON PLUG, FOR: (J)									470 537	C10			
ENGINE														
4.0 4WD	Petrol	191	01/10-06/14	1GR-FE										
Engine	Information				A10	A20	A40	A50	A70	C10 - C30	C20	E01		
All engines	x 6, COIL ON PLUG, FOR: (J)									470 537	C10			
ENGINE														
4.0 4WD	Petrol	203	06/05-01/18	1GR-FE										
Engine	Information				A10	A20	A40	A50	A70	C10 - C30	C20	E01		
All engines	->year 01/08/09, x 6, COIL ON PLUG, FOR: (J)									470 458	C10			
All engines	01/09/09 ->, x 6, COIL ON PLUG, FOR: (J)									470 537	C10			
FORTUNER														
ENGINE														
2.7 4x4	Petrol	122	05/15->	2TR-FE										
Engine	Information				A10	A20	A40	A50	A70	C10 - C30	C20	E01		
All engines	x 4, COIL ON PLUG, FOR: (J)									470 458	C10			
FUNCRUISER														
ENGINE														
2.0 i 16V 4WD	Petrol	94	04/94->	3SFE										
Engine	Information				A10	A20	A40	A50	A70	C10 - C30	C20	E01		
All engines	version Denso						813 267	913 029						
All engines	->year 01/08/96									470 198	C10		360 793	
All engines	FOR: (AUS)									470 2855	C10			
All engines	01/08/96 ->, 01/09/97 ->, FOR: (AUS)												360 856	
HIACE														
ENGINE														
2.4 LPG	LPG	85	08/95-06/99	2RZE										
Engine	Information				A10	A20	A40	A50	A70	C10 - C30	C20	E01		
All engines	x 1, DISTRIBUTOR									470 199	C10			
HIACE III														
ENGINE														
1.8	Petrol	58	12/82-07/89	2Y										
Engine	Information				A10	A20	A40	A50	A70	C10 - C30	C20	E01		
All engines	version Denso						813 262							
ENGINE														
2.0	Petrol	65	12/82-08/89	3Y										
Engine	Information				A10	A20	A40	A50	A70	C10 - C30	C20	E01		
All engines	version Denso						813 114	913 014						
ENGINE														
2.0 4WD	Petrol	65	08/87-07/89	3Y										
Engine	Information				A10	A20	A40	A50	A70	C10 - C30	C20	E01		
All engines	version Denso						813 114	913 014						
ENGINE														
2.2	Petrol	69	09/87-08/89	4Y										
Engine	Information				A10	A20	A40	A50	A70	C10 - C30	C20	E01		
All engines	version Denso						813 114	913 014						
ENGINE														
2.2 4WD	Petrol	69	08/87-08/89	4Y										
Engine	Information				A10	A20	A40	A50	A70	C10 - C30	C20	E01		
All engines	version Denso						813 114	913 014						

A10	CONDENSER	A20	CONTACT SET	A40	DISTRIBUTOR CAP	A50	ROTOR	A70	PICK-UP
C10	COIL	C20	IGNITION MODULE	C30	ELECTRONIC IGNITION KIT	E01	IGNITION CABLE SET		

The present application list is a brief version. For the detailed information about the possibility of installation on a specific vehicle, please refer to our web-catalogue <http://catalogo.facet.eu/>

Vehicle	alim.	kW	Date	Engine	FUNCTIONS ON THE VEHICLE							
					A10	A20	A40	A50	A70	C10 - C30	C20	E01

HIACE IV

Vehicle	alim.	kW	Date	ENGINE	A10	A20	A40	A50	A70	C10 - C30	C20	E01
2.0	Petrol	74	08/89-08/04	1RZ								
Engine Information					A10	A20	A40	A50	A70	C10 - C30	C20	E01
All engines							813 278	913 029				
All engines										470 199	C10	
2.0	Petrol	81	11/96-10/00	1RZ-E								
Engine Information					A10	A20	A40	A50	A70	C10 - C30	C20	E01
All engines										470 199	C10	
2.4	Petrol	85	08/89-12/04	2RZE, 5YTD050W07								
Engine Information					A10	A20	A40	A50	A70	C10 - C30	C20	E01
Eng. 2RZE										470 199	C10	
Eng. 5YTD050W07										470 199	C10	
2.4	Petrol	88	08/89-08/04	5YTD050W07								
Engine Information					A10	A20	A40	A50	A70	C10 - C30	C20	E01
All engines							813 278	913 029				
All engines										470 198, 470 199	C10	
2.4 4WD	Petrol	85	08/95-04/98	2RZE								
Engine Information					A10	A20	A40	A50	A70	C10 - C30	C20	E01
All engines										470 199	C10	
2.4 4WD	Petrol	88	08/89-08/95	5YTD050W07								
Engine Information					A10	A20	A40	A50	A70	C10 - C30	C20	E01
All engines							813 278	913 029				
All engines										470 198	C10	
2.7	Petrol	105	04/98-06/05	3RZ-FE								
Engine Information					A10	A20	A40	A50	A70	C10 - C30	C20	E01
All engines												360 792
2.7	Petrol	106	07/98-12/06	3RZ-FE								
Engine Information					A10	A20	A40	A50	A70	C10 - C30	C20	E01
All engines												360 792
2.7	Petrol	111	01/05->	2TR-FE								
Engine Information					A10	A20	A40	A50	A70	C10 - C30	C20	E01
All engines										470 458	C10	
MADE BY: (GB), x 4, COIL ON PLUG, FOR: (J)												
MADE BY: (J), x 4, COIL ON PLUG, FOR: (J)												
2.7	Petrol	118	01/15->	2TR-FE								
Engine Information					A10	A20	A40	A50	A70	C10 - C30	C20	E01
All engines										470 458	C10	
x 4, COIL ON PLUG, FOR: (J)												
2.7 4WD	Petrol	105	04/98-08/06	3RZ-FE								
Engine Information					A10	A20	A40	A50	A70	C10 - C30	C20	E01
All engines												360 792
->year 01/08/01												
2.7 4WD	Petrol	106	07/98-06/05	3RZ-FE								
Engine Information					A10	A20	A40	A50	A70	C10 - C30	C20	E01
All engines												360 792
->year 01/08/01												
2.7 VVTi	Petrol	111	01/05->	2TR-FE								
Engine Information					A10	A20	A40	A50	A70	C10 - C30	C20	E01
All engines										470 458	C10	
x 4, COIL ON PLUG, FOR: (J)												

A10 CONDENSER	A20 CONTACT SET	A40 DISTRIBUTOR CAP	A50 ROTOR	A70 PICK-UP
C10 COIL	C20 IGNITION MODULE	C30 ELECTRONIC IGNITION KIT	E01 IGNITION CABLE SET	

Vehicle	alim.	kW	Date	Engine	FUNCTIONS ON THE VEHICLE							
					A10	A20	A40	A50	A70	C10 - C30	C20	E01

HIGHLANDER / KLUGER

				ENGINE
2.7	Petrol	138	09/16->	1AR-FE

Engine	Information	A10	A20	A40	A50	A70	C10 - C30	C20	E01
All engines	x 4, COIL ON PLUG, FOR: (J)						470 537	C10	

				ENGINE
3.5 AWD	Petrol	183	09/14->	2GR-FE, 2GR-FKS

Engine	Information	A10	A20	A40	A50	A70	C10 - C30	C20	E01
All engines	FOR: (J), x 6, COIL ON PLUG, x 6, COIL ON PLUG						470 538	C10	

HILUX IV

				ENGINE
1.8	Petrol	58	08/83-03/89	2Y

Engine	Information	A10	A20	A40	A50	A70	C10 - C30	C20	E01
All engines	version Denso, no specific info conc. application available			813 113, 813 114					
All engines	->year 01/03/89, version Denso				913 014				
All engines	YN5, YN6, 01/08/91 ->, FOR: (ZA), version Denso				913 027				
All engines	01/03/89 ->, YN5, YN6, ->year 01/08/91, version Denso				913 030				

				ENGINE
2.2	Petrol	69	08/83-12/89	4Y

Engine	Information	A10	A20	A40	A50	A70	C10 - C30	C20	E01
All engines	01/08/91 ->, FOR: (ZA), version Denso			813 113	913 027				
All engines	version Denso			813 114					
All engines	->year 01/03/89, version Denso				913 014				
All engines	01/03/89 ->, version Denso				913 030				

				ENGINE
2.2 4WD	Petrol	69	11/85-12/89	4Y

Engine	Information	A10	A20	A40	A50	A70	C10 - C30	C20	E01
All engines	01/01/90 ->, version Denso			813 113	913 027				
All engines	->year 01/01/90, version Denso			813 114					
All engines	->year 01/03/89, version Denso				913 014				
All engines	01/03/89 ->, ->year 01/01/90, version Denso				913 030				

				ENGINE
2.4 4WD	Petrol	75	10/88-12/97	22R

Engine	Information	A10	A20	A40	A50	A70	C10 - C30	C20	E01
All engines	->year 01/08/92, version Denso			813 099					
All engines	01/08/92 ->, version Denso			813 273					
All engines	01/08/92 ->						470 203	C10	

HILUX V

				ENGINE
1.8	Petrol	61	09/88-06/98	2Y

Engine	Information	A10	A20	A40	A50	A70	C10 - C30	C20	E01
All engines	version Denso, no specific info conc. application available			813 113, 813 114					
All engines	->year 01/03/89, version Denso				913 014				
All engines	YN5, YN6, 01/08/91 ->, FOR: (ZA), version Denso				913 027				
All engines	01/03/89 ->, YN5, YN6, ->year 01/08/91, version Denso				913 030				

				ENGINE
2.4 4WD	Petrol	75	10/88-08/97	22R

Engine	Information	A10	A20	A40	A50	A70	C10 - C30	C20	E01
All engines	->year 01/08/92, version Denso			813 099					
All engines	01/08/92 ->, version Denso			813 273					
All engines	01/08/92 ->						470 203	C10	









				ENGINE
2.4 i 4WD	Petrol	84	01/89-07/97	22RE

Engine	Information	A10	A20	A40	A50	A70	C10 - C30	C20	E01
All engines	->year 01/08/92, version Denso			813 099					
All engines	01/08/92 ->, version Denso			813 273					
All engines	01/08/92 ->						470 203	C10	

				ENGINE
3.0 4WD	Petrol	112	08/89-11/95	3VZ-E

Engine	Information	A10	A20	A40	A50	A70	C10 - C30	C20	E01
All engines	->year 01/08/91						470 202	C10	

A10	CONDENSER	A20	CONTACT SET	A40	DISTRIBUTOR CAP	A50	ROTOR	A70	PICK-UP
C10	COIL	C20	IGNITION MODULE	C30	ELECTRONIC IGNITION KIT	E01	IGNITION CABLE SET		

					FUNCTIONS ON THE VEHICLE							
Vehicle	alim.	kW	Date	Engine								
ENGINE												
3.0 4WD	Petrol	112	08/89-11/95	3VZ-E								
Engine	Information				A10	A20	A40	A50	A70	C10 - C30	C20	E01
All engines	01/08/91 ->									470 203	C10	
ENGINE												
2.4 i 4WD	Petrol	103	08/97-10/05	2RZ-FE								
Engine	Information				A10	A20	A40	A50	A70	C10 - C30	C20	E01
All engines												360 792
ENGINE												
2.0	Petrol	100	06/05-05/15	1TR-FE								
Engine	Information				A10	A20	A40	A50	A70	C10 - C30	C20	E01
All engines	Qty: 4									470 458	C10	
ENGINE												
2.7	Petrol	118	02/05->	2TR-FE								
Engine	Information				A10	A20	A40	A50	A70	C10 - C30	C20	E01
All engines	Qty: 4									470 458	C10	
ENGINE												
2.7 4WD	Petrol	118	08/05-05/15	2TR-FE								
Engine	Information				A10	A20	A40	A50	A70	C10 - C30	C20	E01
All engines	Qty: 4									470 458	C10	
ENGINE												
4.0	Petrol	175	02/05->	1GR-FE								
Engine	Information				A10	A20	A40	A50	A70	C10 - C30	C20	E01
All engines	Qty: 6									470 458	C10	
ENGINE												
4.0 4WD	Petrol	175	02/05->	1GR-FE								
Engine	Information				A10	A20	A40	A50	A70	C10 - C30	C20	E01
All engines	Qty: 6									470 458	C10	
ENGINE												
1.0	Petrol	50	01/09-12/15	1KR-FE								
Engine	Information				A10	A20	A40	A50	A70	C10 - C30	C20	E01
All engines	x 3, COIL ON PLUG									470 459	C10	
ENGINE												
1.33	Petrol	69	01/09->	1NR-FE								
Engine	Information				A10	A20	A40	A50	A70	C10 - C30	C20	E01
All engines	Qty: 4									470 537	C10	
ENGINE												
1.33	Petrol	72	01/09-12/15	1NR-FE								
Engine	Information				A10	A20	A40	A50	A70	C10 - C30	C20	E01
All engines	x 4, COIL ON PLUG									470 537	C10	
ENGINE												
2.7	Petrol	112	09/02-08/04	3RZ-FE								
Engine	Information				A10	A20	A40	A50	A70	C10 - C30	C20	E01
All engines	no specific info conc. application available											360 792
ENGINE												
2.7	Petrol	120	08/04->	2TR-FE								
Engine	Information				A10	A20	A40	A50	A70	C10 - C30	C20	E01
All engines	Qty: 4									470 458	C10	
ENGINE												
4.0	Petrol	179	01/03-08/09	1GR-FE								
Engine	Information				A10	A20	A40	A50	A70	C10 - C30	C20	E01
All engines	Qty: 6									470 458	C10	
ENGINE												
4.0 V6 VVTi	Petrol	203	08/09->	1GR-FE								
Engine	Information				A10	A20	A40	A50	A70	C10 - C30	C20	E01
All engines	Qty: 6									470 537	C10	

A10 CONDENSER	A20 CONTACT SET	A40 DISTRIBUTOR CAP	A50 ROTOR	A70 PICK-UP
C10 COIL	C20 IGNITION MODULE	C30 ELECTRONIC IGNITION KIT	E01 IGNITION CABLE SET	

Vehicle	alim.	kW	Date	Engine	FUNCTIONS ON THE VEHICLE									
					A10	A20	A40	A50	A70	C10 - C30	C20	E01		
LAND CRUISER 120														
2.7	Petrol	120	11/03-02/10	ENGINE 2TR-FE										
Engine	Information				A10	A20	A40	A50	A70	C10 - C30	C20	E01		
All engines	x 4, COIL ON PLUG, FOR: (J)									470 458	C10			
4.0	Petrol	179	09/02-08/10	ENGINE 1GR-FE										
Engine	Information				A10	A20	A40	A50	A70	C10 - C30	C20	E01		
All engines	x 6, COIL ON PLUG, FOR: (J)									470 458	C10			
4.0	Petrol	183	12/02-12/10	ENGINE 1GR-FE										
Engine	Information				A10	A20	A40	A50	A70	C10 - C30	C20	E01		
All engines	x 6, COIL ON PLUG, FOR: (J)									470 458	C10			
4.0 V6 VVT-i	Petrol	207	01/03-07/09	ENGINE 1GR-FE										
Engine	Information				A10	A20	A40	A50	A70	C10 - C30	C20	E01		
All engines	x 6, COIL ON PLUG, FOR: (J)									470 458	C10			
LAND CRUISER 150														
4.0 V6 Dual VVTi	Petrol	205	08/09->	ENGINE 1GR-FE										
Engine	Information				A10	A20	A40	A50	A70	C10 - C30	C20	E01		
All engines	x 6, COIL ON PLUG, FOR: (J)									470 537	C10			
4.0 V6 VVTi	Petrol	183	11/12->	ENGINE 1GR-FE										
Engine	Information				A10	A20	A40	A50	A70	C10 - C30	C20	E01		
All engines	x 6, COIL ON PLUG, FOR: (J)									470 537	C10			
4.0 V6 VVTi	Petrol	202	08/09->	ENGINE 1GR-FE										
Engine	Information				A10	A20	A40	A50	A70	C10 - C30	C20	E01		
All engines	x 6, COIL ON PLUG, FOR: (J)									470 537	C10			
4.0 V6 VVTi	Petrol	203	01/10->	ENGINE 1GR-FE										
Engine	Information				A10	A20	A40	A50	A70	C10 - C30	C20	E01		
All engines	Qty: 6									470 537	C10			
4.0 V6 VVT-i	Petrol	207	08/09->	ENGINE 1GR-FE										
Engine	Information				A10	A20	A40	A50	A70	C10 - C30	C20	E01		
All engines	x 6, COIL ON PLUG, FOR: (J)									470 537	C10			
LAND CRUISER 200														
4.0	Petrol	176	01/10->	ENGINE 1GR-FE										
Engine	Information				A10	A20	A40	A50	A70	C10 - C30	C20	E01		
All engines	->year 31/01/12, Qty: 6									470 458	C10			
All engines	01/02/12->, Qty: 6									470 537	C10			
4.6 V8	Petrol	227	09/10->	ENGINE 1UR-FE										
Engine	Information				A10	A20	A40	A50	A70	C10 - C30	C20	E01		
All engines	x 8, COIL ON PLUG, FOR: (J)									470 537	C10			
4.6 V8	Petrol	234	01/12->	ENGINE 1UR-FE										
Engine	Information				A10	A20	A40	A50	A70	C10 - C30	C20	E01		
All engines	x 8, COIL ON PLUG, FOR: (J)									470 537	C10			
5.7 V8	Petrol	270	09/11-07/15	ENGINE 3UR-FE										
Engine	Information				A10	A20	A40	A50	A70	C10 - C30	C20	E01		
All engines	Qty: 8									470 537	C10			
5.7 V8	Petrol	284	08/07->	ENGINE 3UR-FE										
Engine	Information				A10	A20	A40	A50	A70	C10 - C30	C20	E01		
All engines	Qty: 8									470 537	C10			

A10 CONDENSER	A20 CONTACT SET	A40 DISTRIBUTOR CAP	A50 ROTOR	A70 PICK-UP
C10 COIL	C20 IGNITION MODULE	C30 ELECTRONIC IGNITION KIT	E01 IGNITION CABLE SET	

The present application list is a brief version. For the detailed information about the possibility of installation on a specific vehicle, please refer to our web-catalogue <http://catalogo.facet.eu/>

Vehicle	alim.	kW	Date	Engine	FUNCTIONS ON THE VEHICLE							
					A10	A20	A40	A50	A70	C10 - C30	C20	E01

LAND CRUISER 70

2.4	Petrol	77	11/84-05/93	ENGINE
				22R

Engine	Information	A10	A20	A40	A50	A70	C10 - C30	C20	E01
All engines	version Denso			813 099	913 027				

2.4	Petrol	81	11/84-05/93	ENGINE
				22R

Engine	Information	A10	A20	A40	A50	A70	C10 - C30	C20	E01
All engines	version Denso			813 099	913 027				

2.4	Petrol	84	12/88-12/96	ENGINE
				22RE

Engine	Information	A10	A20	A40	A50	A70	C10 - C30	C20	E01
All engines	version Denso			813 099					

LAND CRUISER 80

4.0	Petrol	115	01/90-10/92	ENGINE
				3F-E

Engine	Information	A10	A20	A40	A50	A70	C10 - C30	C20	E01
All engines							470 202	C10	

4.5	Petrol	215	08/92-01/98	ENGINE
				1FZ-FE

Engine	Information	A10	A20	A40	A50	A70	C10 - C30	C20	E01
All engines	version Denso			813 272					
All engines							470 2855	C10	

4.5 24V	Petrol	151	08/92-12/97	ENGINE
				1FZ-FE

Engine	Information	A10	A20	A40	A50	A70	C10 - C30	C20	E01
All engines	version Denso			813 272					
All engines							470 2855	C10	

LAND CRUISER 90

2.7	Petrol	110	06/95-08/02	ENGINE
				3RZ-FE

Engine	Information	A10	A20	A40	A50	A70	C10 - C30	C20	E01
All engines	x 1, DISTRIBUTOR						470 198	C10	

LITEACE

1.5	Petrol	51	10/85-09/91	ENGINE
				5K

Engine	Information	A10	A20	A40	A50	A70	C10 - C30	C20	E01
All engines	version Denso			813 114	913 014				

1.5	Petrol	52	07/89-01/95	ENGINE
				5K

Engine	Information	A10	A20	A40	A50	A70	C10 - C30	C20	E01
All engines	version Denso			813 114	913 014				
All engines							470 203	C10	

2.2	Petrol	72	01/92-01/95	ENGINE
				4Y-EC

Engine	Information	A10	A20	A40	A50	A70	C10 - C30	C20	E01
All engines	version Denso			813 113	913 027				
All engines							470 197	C10	

MATRIX

1.8	Petrol	97	01/08-05/14	ENGINE
				2ZR-FE

Engine	Information	A10	A20	A40	A50	A70	C10 - C30	C20	E01
All engines	x 4, COIL ON PLUG						470 536	C10	

2.4	Petrol	117	01/08-05/14	ENGINE
				2AZ-FE









Engine	Information	A10	A20	A40	A50	A70	C10 - C30	C20	E01
All engines	01/01/11 ->, FOR: (USA), NOT FOR: (USA), x 4, COIL ON PLUG						470 458	C10	
All engines	->year 01/12/10, x 4, COIL ON PLUG, FOR: (J)						470 466	C10	

A10 CONDENSER	A20 CONTACT SET	A40 DISTRIBUTOR CAP	A50 ROTOR	A70 PICK-UP
C10 COIL	C20 IGNITION MODULE	C30 ELECTRONIC IGNITION KIT	E01 IGNITION CABLE SET	

Vehicle	alim.	kW	Date	Engine	FUNCTIONS ON THE VEHICLE							
					A10	A20	A40	A50	A70	C10 - C30	C20	E01
2.4 4WD												
ENGINE												
2AZ-FE												
Engine		Information			A10	A20	A40	A50	A70	C10 - C30	C20	E01
All engines		x 4, COIL ON PLUG, FOR: (J)								470 466	C10	
MODEL F												
2.0												
ENGINE												
3Y												
Engine		Information			A10	A20	A40	A50	A70	C10 - C30	C20	E01
All engines		version Denso					813 113	913 027				
2.2												
ENGINE												
4Y-EC												
Engine		Information			A10	A20	A40	A50	A70	C10 - C30	C20	E01
All engines		version Denso					813 113	913 027				
All engines										470 197	C10	
MR 2 I												
1.6 16V												
ENGINE												
4A-GELC												
Engine		Information			A10	A20	A40	A50	A70	C10 - C30	C20	E01
All engines		version Denso					813 119	913 029				
1.6 Supercharged												
ENGINE												
4A-GZE												
Engine		Information			A10	A20	A40	A50	A70	C10 - C30	C20	E01
All engines		version Denso					813 119	913 029				
MR 2 II												
2.0												
ENGINE												
3S-FE												
Engine		Information			A10	A20	A40	A50	A70	C10 - C30	C20	E01
All engines		version Denso						913 036				
All engines										470 203	C10	
2.0 16V												
ENGINE												
3S-GE												
Engine		Information			A10	A20	A40	A50	A70	C10 - C30	C20	E01
All engines		->year 01/12/91, version Denso					813 251					
All engines		version Denso						913 036				
All engines		->year 01/12/91								470 202	C10	
All engines		01/12/91 ->								470 203	C10	
2.0 16V												
ENGINE												
3S-GE												
Engine		Information			A10	A20	A40	A50	A70	C10 - C30	C20	E01
All engines		->year 01/12/91, version Denso					813 251					
All engines		version Denso						913 036				
All engines		->year 01/12/91								470 202	C10	
All engines		01/12/91 ->								470 203	C10	
2.0 16V												
ENGINE												
3S-GE												
Engine		Information			A10	A20	A40	A50	A70	C10 - C30	C20	E01
All engines		->year 01/12/91, version Denso					813 251					
All engines		version Denso						913 036				
All engines		->year 01/12/91								470 202	C10	
All engines		01/12/91 ->								470 203	C10	
2.0 Turbo												
ENGINE												
3S-GTE												
Engine		Information			A10	A20	A40	A50	A70	C10 - C30	C20	E01
All engines		->year 01/01/92, version Denso					813 251					
All engines		version Denso						913 036				
All engines		->year 01/01/92								470 202	C10	
All engines		01/01/92 ->								470 203	C10	
2.2 16V												
ENGINE												
5S-FE												
Engine		Information			A10	A20	A40	A50	A70	C10 - C30	C20	E01
All engines		01/01/92 ->, version Denso					813 267					
All engines		version Denso						913 029				

A10	CONDENSER	A20	CONTACT SET	A40	DISTRIBUTOR CAP	A50	ROTOR	A70	PICK-UP
C10	COIL	C20	IGNITION MODULE	C30	ELECTRONIC IGNITION KIT	E01	IGNITION CABLE SET		

The present application list is a brief version. For the detailed information about the possibility of installation on a specific vehicle, please refer to our web-catalogue <http://catalogo.facet.eu/>









					FUNCTIONS ON THE VEHICLE							
Vehicle	alim.	kW	Date	Engine	 A10	 A20	 A40	 A50	 A70	 C10 - C30	 C20	 E01
2.2 16V												
	Petrol	97	01/90-06/95	ENGINE 5S-FE								
Engine	Information			A10	A20	A40	A50	A70	C10 - C30	C20	E01	
All engines	01/01/92 ->								470 198	C10		
All engines	->year 01/01/92								470 203	C10		
All engines	01/09/93 ->											360 793
MR 2 III												
1.8 16V VT-i												
	Petrol	103	10/99-06/07	ENGINE 1ZZFE								
Engine	Information			A10	A20	A40	A50	A70	C10 - C30	C20	E01	
All engines	x 4, COIL ON PLUG								470 461	C10		
PASEO												
1.5												
	Petrol	66	08/95-06/99	ENGINE 5E-FE								
Engine	Information			A10	A20	A40	A50	A70	C10 - C30	C20	E01	
All engines	version Denso					813 265						
All engines	FOR: (EU)								470 199	C10		
All engines	FOR: (EU), x 1, DISTRIBUTOR								470 199	C10		
All engines	01/09/94 ->, FOR: (EU)											360 435
1.5												
	Petrol	74	06/90-08/95	ENGINE 5E-FE								
Engine	Information			A10	A20	A40	A50	A70	C10 - C30	C20	E01	
All engines	version Denso					813 265	913 029					
All engines	->year 01/08/95								470 198	C10		
All engines	01/09/94 ->											360 435
1.5 Efi												
	Petrol	66	01/97-12/99	ENGINE 5E-FE								
Engine	Information			A10	A20	A40	A50	A70	C10 - C30	C20	E01	
All engines	x 1, DISTRIBUTOR								470 199	C10		
PICNIC I												
2.0												
	Petrol	90	06/00-12/01	ENGINE 3S-FE								
Engine	Information			A10	A20	A40	A50	A70	C10 - C30	C20	E01	
All engines												360 856
2.0 16V												
	Petrol	94	08/96-09/00	ENGINE 3S-FE								
Engine	Information			A10	A20	A40	A50	A70	C10 - C30	C20	E01	
All engines												360 856
PICNIC II												
2.0 VVTi												
	Petrol	110	05/01-08/06	ENGINE 1AZ-FE								
Engine	Information			A10	A20	A40	A50	A70	C10 - C30	C20	E01	
All engines	Qty: 4								470 466	C10		
2.4 VVTi												
	Petrol	115	11/03-08/06	ENGINE 2AZ-FE								
Engine	Information			A10	A20	A40	A50	A70	C10 - C30	C20	E01	
All engines	Qty: 4								470 466	C10		
PREVIA I												
2.4												
	Petrol	97	05/90-08/00	ENGINE 2TZ-FE								
Engine	Information			A10	A20	A40	A50	A70	C10 - C30	C20	E01	
All engines	version Denso					813 252	913 036					
All engines									470 322	C10		
2.4 4WD												
	Petrol	110	05/90-12/99	ENGINE 2TZ-FZE								
Engine	Information			A10	A20	A40	A50	A70	C10 - C30	C20	E01	
All engines	version Denso					813 252	913 036					
All engines									470 322	C10		
2.4 4WD												
	Petrol	97	01/90-08/00	ENGINE 2TZ-FE								
Engine	Information			A10	A20	A40	A50	A70	C10 - C30	C20	E01	
All engines	version Denso					813 252	913 036					

A10 CONDENSER	A20 CONTACT SET	A40 DISTRIBUTOR CAP	A50 ROTOR	A70 PICK-UP
C10 COIL	C20 IGNITION MODULE	C30 ELECTRONIC IGNITION KIT	E01 IGNITION CABLE SET	

Vehicle	alim.	kW	Date	Engine	FUNCTIONS ON THE VEHICLE							
					A10	A20	A40	A50	A70	C10 - C30	C20	E01
PREVIA III												
2.4 4WD	Petrol	97	01/90-08/00	2TZ-FE								
ENGINE												
Engine	Information			A10	A20	A40	A50	A70	C10 - C30	C20	E01	
All engines									470 322	C10		
PREVIA II												
2.4	Petrol	115	02/00-02/06	2AZ-FE								
ENGINE												
Engine	Information			A10	A20	A40	A50	A70	C10 - C30	C20	E01	
All engines	x 4, COIL ON PLUG, FOR: (J)								470 466	C10		
PREVIA III												
2.4	Petrol	125	10/05->	2AZ-FE								
ENGINE												
Engine	Information			A10	A20	A40	A50	A70	C10 - C30	C20	E01	
All engines	x 4, COIL ON PLUG, FOR: (J)								470 466	C10		
3.5												
Petrol	202	01/06->	2GR-FE									
ENGINE												
Engine	Information			A10	A20	A40	A50	A70	C10 - C30	C20	E01	
All engines	Qty: 6								470 538	C10		
3.5												
Petrol	206	01/06->	2GR-FE									
ENGINE												
Engine	Information			A10	A20	A40	A50	A70	C10 - C30	C20	E01	
All engines	Qty: 6								470 538	C10		
All engines	x 6, COIL ON PLUG								470 538	C10		
3.5 4WD												
Petrol	206	01/06->	2GR-FE									
ENGINE												
Engine	Information			A10	A20	A40	A50	A70	C10 - C30	C20	E01	
All engines	Qty: 6								470 538	C10		
PRIUS												
1.8 Plug-In Hybrid	Diesel/ Electro	73	01/12->	2ZR-FXE								
ENGINE												
Engine	Information			A10	A20	A40	A50	A70	C10 - C30	C20	E01	
All engines	x 4, COIL ON PLUG								470 536	C10		
PRIUS C												
1.5 Hybrid	Petrol/ Electric	54	12/11->	1NZ-FXE								
ENGINE												
Engine	Information			A10	A20	A40	A50	A70	C10 - C30	C20	E01	
All engines	Qty: 4								470 459	C10		
PRIUS I												
1.5 Hybrid	Petrol/ Electric	53	05/00-01/04	1NZ-FXE								
ENGINE												
Engine	Information			A10	A20	A40	A50	A70	C10 - C30	C20	E01	
All engines	x 4, COIL ON PLUG								470 459	C10		
PRIUS II												
1.5 Hybrid	Petrol/ Electric	107	09/03-03/09	1NZ-FXE								
ENGINE												
Engine	Information			A10	A20	A40	A50	A70	C10 - C30	C20	E01	
All engines	x 4, COIL ON PLUG								470 459	C10		
1.5 Hybrid												
Petrol/ Electric	57	09/03-12/09	1NZ-FXE									
ENGINE												
Engine	Information			A10	A20	A40	A50	A70	C10 - C30	C20	E01	
All engines	x 4, COIL ON PLUG								470 459	C10		
PRIUS III												
1.8 Hybrid	Petrol/ Electric	0	12/11->	5ZR-FXE								
ENGINE												
Engine	Information			A10	A20	A40	A50	A70	C10 - C30	C20	E01	
All engines	Qty: 4								470 536	C10		

A10	CONDENSER	A20	CONTACT SET	A40	DISTRIBUTOR CAP	A50	ROTOR	A70	PICK-UP
C10	COIL	C20	IGNITION MODULE	C30	ELECTRONIC IGNITION KIT	E01	IGNITION CABLE SET		

The present application list is a brief version. For the detailed information about the possibility of installation on a specific vehicle, please refer to our web-catalogue <http://catalogo.facet.eu/>









					FUNCTIONS ON THE VEHICLE							
Vehicle	alim.	kW	Date	Engine								
1.8 Hybrid												
Petrol/ Electric	100	06/08->	ENGINE 2ZR-FXE									
Engine	Information				A10	A20	A40	A50	A70	C10 - C30	C20	E01
All engines	x 4, COIL ON PLUG									470 536	C10	
1.8 Hybrid												
Petrol/ Electric	73	06/08->	ENGINE 2ZR-FXE									
Engine	Information				A10	A20	A40	A50	A70	C10 - C30	C20	E01
All engines	x 4, COIL ON PLUG									470 536	C10	
PRIUS PLUS												
1.8 Hybrid												
Petrol/ Electric	73	11/14->	ENGINE 2ZR-FXE									
Engine	Information				A10	A20	A40	A50	A70	C10 - C30	C20	E01
All engines	x 4, COIL ON PLUG									470 536	C10	
RAV 4												
2.0 VVTi 4WD												
Petrol	111	12/12-11/18	ENGINE 3ZR-FAE									
Engine	Information				A10	A20	A40	A50	A70	C10 - C30	C20	E01
All engines	x 4, COIL ON PLUG									470 536	C10	
2.0 VVTi 4WD												
Petrol	112	12/12-11/18	ENGINE 3ZR-FAE									
Engine	Information				A10	A20	A40	A50	A70	C10 - C30	C20	E01
All engines	x 4, COIL ON PLUG									470 536	C10	
RAV 4 I												
2.0												
Petrol	99	06/97-09/99	ENGINE 3S-FE									
Engine	Information				A10	A20	A40	A50	A70	C10 - C30	C20	E01
All engines	version Denso						813 267	913 029				
All engines	FOR: (EU), Country Version : General countries; ->year 01/08/96, Hardtop									470 198	C10	
All engines	FOR: (AUS)									470 2855	C10	
All engines	FOR: (EU), Country Version : General countries; ->year 01/08/96											360 793
All engines	FOR: (EU), Country Version : General countries; 01/08/96 ->											360 856
2.0 4WD												
Petrol	94	12/97-06/00	ENGINE 3S-FE									
Engine	Information				A10	A20	A40	A50	A70	C10 - C30	C20	E01
All engines	version Denso						813 267	913 029				
All engines	FOR: (EU), Country Version : General countries; ->year 01/08/96, Hardtop									470 198	C10	
All engines	FOR: (AUS)									470 2855	C10	
All engines	FOR: (EU), Country Version : General countries; ->year 01/08/96											360 793
All engines	01/08/96 ->											360 856
2.0 4WD												
Petrol	95	06/94-06/00	ENGINE 3S-FE									
Engine	Information				A10	A20	A40	A50	A70	C10 - C30	C20	E01
All engines	version Denso						813 267	913 029				
All engines	FOR: (EU), Country Version : General countries; ->year 01/08/96, Hardtop									470 198	C10	
All engines	FOR: (AUS)									470 2855	C10	
All engines	FOR: (EU), Country Version : General countries; ->year 01/08/96											360 793
All engines	FOR: (EU), Country Version : General countries; 01/08/96 ->											360 856
2.0 4WD												
Petrol	99	01/94-09/99	ENGINE 3S-FE									
Engine	Information				A10	A20	A40	A50	A70	C10 - C30	C20	E01
All engines	version Denso						813 267	913 029				
All engines	FOR: (EU), Country Version : General countries; ->year 01/08/96, Hardtop									470 198	C10	
All engines	FOR: (AUS)									470 2855	C10	
All engines	FOR: (EU), Country Version : General countries; ->year 01/08/96											360 793
All engines	FOR: (EU), Country Version : General countries; 01/08/96 ->											360 856

A10 CONDENSER	A20 CONTACT SET	A40 DISTRIBUTOR CAP	A50 ROTOR	A70 PICK-UP
C10 COIL	C20 IGNITION MODULE	C30 ELECTRONIC IGNITION KIT	E01 IGNITION CABLE SET	

Vehicle	alim.	kW	Date	Engine	FUNCTIONS ON THE VEHICLE							
					A10	A20	A40	A50	A70	C10 - C30	C20	E01
RAV 4 II												
1.8	Petrol	92	08/00-11/05	1ZZFE								
ENGINE												
Engine	Information				A10	A20	A40	A50	A70	C10 - C30	C20	E01
All engines	x 4, COIL ON PLUG									470 461	C10	
2.0	Petrol	110	09/00-12/03	1AZ-FE								
ENGINE												
Engine	Information				A10	A20	A40	A50	A70	C10 - C30	C20	E01
All engines	x 4, COIL ON PLUG, FOR: (J)									470 466	C10	
2.0 4WD	Petrol	110	05/00-11/05	1AZ-FE								
ENGINE												
Engine	Information				A10	A20	A40	A50	A70	C10 - C30	C20	E01
All engines	x 4, COIL ON PLUG, FOR: (J)									470 466	C10	
2.4 4WD	Petrol	112	08/03-11/05	2AZ-FE								
ENGINE												
Engine	Information				A10	A20	A40	A50	A70	C10 - C30	C20	E01
All engines	Qty: 4									470 466	C10	
All engines	x 4, COIL ON PLUG, FOR: (J)									470 466	C10	
RAV 4 III												
2.0	Petrol	109	03/09-06/13	3ZR-FAE								
ENGINE												
Engine	Information				A10	A20	A40	A50	A70	C10 - C30	C20	E01
All engines	x 4, COIL ON PLUG									470 536	C10	
2.0	Petrol	116	12/08-06/13	3ZR-FAE								
ENGINE												
Engine	Information				A10	A20	A40	A50	A70	C10 - C30	C20	E01
All engines	x 4, COIL ON PLUG									470 536	C10	
2.0 4WD	Petrol	109	03/09-06/13	3ZR-FAE								
ENGINE												
Engine	Information				A10	A20	A40	A50	A70	C10 - C30	C20	E01
All engines	x 4, COIL ON PLUG									470 536	C10	
2.0 4WD	Petrol	112	02/06-06/13	1AZ-FE								
ENGINE												
Engine	Information				A10	A20	A40	A50	A70	C10 - C30	C20	E01
All engines	x 4, COIL ON PLUG, FOR: (J)									470 466	C10	
2.0 4WD	Petrol	116	12/08-06/13	3ZR-FAE								
ENGINE												
Engine	Information				A10	A20	A40	A50	A70	C10 - C30	C20	E01
All engines	x 4, COIL ON PLUG									470 536	C10	
2.0 VVT-i [CHN]	Petrol	112	03/09->	1AZ-FE								
ENGINE												
Engine	Information				A10	A20	A40	A50	A70	C10 - C30	C20	E01
All engines	Qty: 4									470 458	C10	
2.4	Petrol	125	11/05-12/13	2AZ-FE								
ENGINE												
Engine	Information				A10	A20	A40	A50	A70	C10 - C30	C20	E01
All engines	x 4, COIL ON PLUG, FOR: (J)									470 466	C10	
2.4 4WD	Petrol	125	11/05-06/13	2AZ-FE								
ENGINE												
Engine	Information				A10	A20	A40	A50	A70	C10 - C30	C20	E01
All engines	x 4, COIL ON PLUG, FOR: (J)									470 466	C10	
2.4 VVTi [CHN]	Petrol	125	03/09->	2AR-FE								
ENGINE												
Engine	Information				A10	A20	A40	A50	A70	C10 - C30	C20	E01
All engines	Qty: 4									470 458	C10	
2.5	Petrol	133	12/08->	2AR-FE								
ENGINE												
Engine	Information				A10	A20	A40	A50	A70	C10 - C30	C20	E01
All engines	Qty: 4									470 537	C10	

A10 CONDENSER	A20 CONTACT SET	A40 DISTRIBUTOR CAP	A50 ROTOR	A70 PICK-UP
C10 COIL	C20 IGNITION MODULE	C30 ELECTRONIC IGNITION KIT	E01 IGNITION CABLE SET	

The present application list is a brief version. For the detailed information about the possibility of installation on a specific vehicle, please refer to our web-catalogue <http://catalogo.facet.eu/>

					FUNCTIONS ON THE VEHICLE							
Vehicle	alim.	kW	Date	Engine								
3.5 4WD					ENGINE							
Petrol	201	11/05-12/12	2GR-FE									
Engine	Information				A10	A20	A40	A50	A70	C10 - C30	C20	E01
All engines	x 6, COIL ON PLUG									470 538	C10	
3.5 4WD					ENGINE							
Petrol	206	08/07->	2GR-FE									
Engine	Information				A10	A20	A40	A50	A70	C10 - C30	C20	E01
All engines	Qty: 6									470 538	C10	
RAV 4 IV					ENGINE							
2.0					ENGINE							
Petrol	105	12/12->	3ZR-FE									
Engine	Information				A10	A20	A40	A50	A70	C10 - C30	C20	E01
All engines	x 4, COIL ON PLUG									470 536	C10	
2.0					ENGINE							
Petrol	107	12/12->	3ZR-FE									
Engine	Information				A10	A20	A40	A50	A70	C10 - C30	C20	E01
All engines	x 4, COIL ON PLUG									470 536	C10	
2.0 4WD					ENGINE							
Petrol	107	12/12->	3ZR-FE									
Engine	Information				A10	A20	A40	A50	A70	C10 - C30	C20	E01
All engines	x 4, COIL ON PLUG									470 536	C10	
2.0 4WD					ENGINE							
Petrol	111	12/12->	3ZR-FAE									
Engine	Information				A10	A20	A40	A50	A70	C10 - C30	C20	E01
All engines	x 4, COIL ON PLUG									470 536	C10	
2.0 4WD					ENGINE							
Petrol	112	04/15->	3ZR-FAE									
Engine	Information				A10	A20	A40	A50	A70	C10 - C30	C20	E01
All engines	x 4, COIL ON PLUG									470 536	C10	
2.5					ENGINE							
Petrol	132	12/12-11/18	2AR-FE									
Engine	Information				A10	A20	A40	A50	A70	C10 - C30	C20	E01
All engines	x 4, COIL ON PLUG, FOR: (J)									470 537	C10	
2.5 4WD					ENGINE							
Petrol	131	12/12-12/18	2AR-FE									
Engine	Information				A10	A20	A40	A50	A70	C10 - C30	C20	E01
All engines	Qty: 4									470 537	C10	
2.5 4WD					ENGINE							
Petrol	132	12/12->	2AR-FE									
Engine	Information				A10	A20	A40	A50	A70	C10 - C30	C20	E01
All engines	x 4, COIL ON PLUG, FOR: (J)									470 537	C10	
2.5 Hybrid					ENGINE							
Petrol/ Electric	114	10/15-11/18	2AR-FXE									
Engine	Information				A10	A20	A40	A50	A70	C10 - C30	C20	E01
All engines	x 4, COIL ON PLUG, FOR: (J)									470 537	C10	
2.5 Hybrid					ENGINE							
Petrol/ Electric	145	11/15-11/18	2AR-FXE									
Engine	Information				A10	A20	A40	A50	A70	C10 - C30	C20	E01
All engines	x 4, COIL ON PLUG, FOR: (J)									470 537	C10	
2.5 Hybrid 4WD					ENGINE							
Petrol/ Electric	114	10/15-12/18	2AR-FXE									
Engine	Information				A10	A20	A40	A50	A70	C10 - C30	C20	E01
All engines	x 4, COIL ON PLUG, FOR: (J)									470 537	C10	
SIENNA					ENGINE							
2.7					ENGINE							
Petrol	140	09/10-07/13	1AR-FE									
Engine	Information				A10	A20	A40	A50	A70	C10 - C30	C20	E01
All engines	x 4, COIL ON PLUG, FOR: (J)									470 537	C10	

A10 CONDENSER	A20 CONTACT SET	A40 DISTRIBUTOR CAP	A50 ROTOR	A70 PICK-UP
C10 COIL	C20 IGNITION MODULE	C30 ELECTRONIC IGNITION KIT	E01 IGNITION CABLE SET	

Vehicle	alim.	kW	Date	Engine	FUNCTIONS ON THE VEHICLE									
					A10	A20	A40	A50	A70	C10 - C30	C20	E01		
ENGINE														
3.5	Petrol	196	02/10->	2GR-FE										
Engine					A10	A20	A40	A50	A70	C10 - C30	C20	E01		
All engines										470 538	C10			
ENGINE														
3.5	Petrol	198	01/10->	2GR-FE										
Engine					A10	A20	A40	A50	A70	C10 - C30	C20	E01		
All engines										470 538	C10			
ENGINE														
3.5 4WD	Petrol	196	01/10->	2GR-FE										
Engine					A10	A20	A40	A50	A70	C10 - C30	C20	E01		
All engines										470 538	C10			
ENGINE														
3.5 4WD	Petrol	198	01/10->	2GR-FE										
Engine					A10	A20	A40	A50	A70	C10 - C30	C20	E01		
All engines										470 538	C10			
STARLET														
ENGINE														
1.0	Petrol	33	02/78-09/84	6A25BFXS										
Engine					A10	A20	A40	A50	A70	C10 - C30	C20	E01		
All engines								906 014R						
ENGINE														
1.0	Petrol	40	12/89-12/92	1E										
Engine					A10	A20	A40	A50	A70	C10 - C30	C20	E01		
All engines							813 240	913 014						
All engines							813 275							
All engines										470 199	C10		360 393	
ENGINE														
1.2 S	Petrol	39	10/78-08/82	3K-H										
Engine					A10	A20	A40	A50	A70	C10 - C30	C20	E01		
All engines								906 014R						
ENGINE														
1.3	Petrol	55	01/96-07/99	2E, 4E-FE										
Engine					A10	A20	A40	A50	A70	C10 - C30	C20	E01		
Eng. 4E-FE							813 265	913 029						
All engines										470 199	C10			
Eng. 4E-FE													360 435	
ENGINE														
1.3	Petrol	63	01/96-07/99	4E-FE										
Engine					A10	A20	A40	A50	A70	C10 - C30	C20	E01		
All engines							813 265	913 029						
All engines										470 199	C10		360 435	
ENGINE														
1.3 12V	Petrol	55	12/89-12/92	2E, 2E-E										
Engine					A10	A20	A40	A50	A70	C10 - C30	C20	E01		
All engines							813 122							
All engines							813 275							
All engines								913 029						
All engines										470 199	C10		360 823	
ENGINE														
1.3 12V Cat	Petrol	55	12/89-03/96	2E-E										
Engine					A10	A20	A40	A50	A70	C10 - C30	C20	E01		
All engines							813 122							
All engines							813 275							
All engines								913 029						
All engines										470 199	C10		360 823	
ENGINE														
1.3 XL	Petrol	52	12/89-12/91	2E										
Engine					A10	A20	A40	A50	A70	C10 - C30	C20	E01		
All engines							813 122	913 029						
All engines										470 199	C10		360 823	

A10	CONDENSER	A20	CONTACT SET	A40	DISTRIBUTOR CAP	A50	ROTOR	A70	PICK-UP
C10	COIL	C20	IGNITION MODULE	C30	ELECTRONIC IGNITION KIT	E01	IGNITION CABLE SET		

The present application list is a brief version. For the detailed information about the possibility of installation on a specific vehicle, please refer to our web-catalogue <http://catalogo.facet.eu/>

Vehicle	alim.	kW	Date	Engine	FUNCTIONS ON THE VEHICLE							
					A10	A20	A40	A50	A70	C10 - C30	C20	E01

STOUT

2.2	Petrol	69	04/88-02/00	ENGINE 4Y
-----	--------	----	-------------	--------------

Engine	Information	A10	A20	A40	A50	A70	C10 - C30	C20	E01
All engines	version Denso			813 114					
All engines	->year 01/03/89				913 014				
All engines	01/03/89 ->				913 030				

SUPRA

2.0	Petrol	145	06/19->	ENGINE B48L
-----	--------	-----	---------	----------------

Engine	Information	A10	A20	A40	A50	A70	C10 - C30	C20	E01
All engines	x 4, COIL ON PLUG						470 632	C10	

2.0	Petrol	190	06/19->	ENGINE B48H
-----	--------	-----	---------	----------------

Engine	Information	A10	A20	A40	A50	A70	C10 - C30	C20	E01
All engines	x 4, COIL ON PLUG						470 632	C10	

3.0 GR	Petrol	250	03/19->	ENGINE B58
--------	--------	-----	---------	---------------

Engine	Information	A10	A20	A40	A50	A70	C10 - C30	C20	E01
All engines	x 6, COIL ON PLUG						470 632	C10	

3.0 i	Petrol	168	05/93-07/02	ENGINE 2JZ-GE
-------	--------	-----	-------------	------------------

Engine	Information	A10	A20	A40	A50	A70	C10 - C30	C20	E01
All engines							470 203	C10	

T100

3.0 i [USA]	Petrol	105	08/92-08/94	ENGINE 3VZE
-------------	--------	-----	-------------	----------------

Engine	Information	A10	A20	A40	A50	A70	C10 - C30	C20	E01
All engines							470 203	C10	

TARAGO MPV / SPACE

2.4 VVTi	Petrol	115	02/00-12/05	ENGINE 2AZ-FE
----------	--------	-----	-------------	------------------

Engine	Information	A10	A20	A40	A50	A70	C10 - C30	C20	E01
All engines	CVT, Qty: 4						470 458	C10	
All engines	Qty: 4						470 466	C10	

TERCEL

1.5	Petrol	52	08/83-05/85	ENGINE 3A-C
-----	--------	----	-------------	----------------

Engine	Information	A10	A20	A40	A50	A70	C10 - C30	C20	E01
All engines							470 197	C10	

1.5 4WD	Petrol	50	09/82-01/88	ENGINE 3A-C
---------	--------	----	-------------	----------------

Engine	Information	A10	A20	A40	A50	A70	C10 - C30	C20	E01
All engines							470 197	C10	

1.5 i [USA]	Petrol	0	01/89->	ENGINE 3EE
-------------	--------	---	---------	---------------

Engine	Information	A10	A20	A40	A50	A70	C10 - C30	C20	E01
All engines	version Denso			813 275	913 029				
All engines	->year 01/12/90						470 197	C10	
All engines	01/12/90 ->						470 198	C10	
All engines									360 393

TRUCK

2.4	Petrol	84	08/88-11/95	ENGINE 22RE
-----	--------	----	-------------	----------------

Engine	Information	A10	A20	A40	A50	A70	C10 - C30	C20	E01
All engines	01/08/92 ->						470 203	C10	

2.4 i [USA]	Petrol	0	01/88->	ENGINE 22R, 22RE
-------------	--------	---	---------	---------------------

Engine	Information	A10	A20	A40	A50	A70	C10 - C30	C20	E01
All engines	->year 01/08/92, version Denso			813 099					
Eng. 22RE	01/08/92 ->, version Denso			813 273					
Eng. 22R	version Denso				913 027				

A10 CONDENSER	A20 CONTACT SET	A40 DISTRIBUTOR CAP	A50 ROTOR	A70 PICK-UP
C10 COIL	C20 IGNITION MODULE	C30 ELECTRONIC IGNITION KIT	E01 IGNITION CABLE SET	

Vehicle	alim.	kW	Date	Engine	FUNCTIONS ON THE VEHICLE									
					A10	A20	A40	A50	A70	C10 - C30	C20	E01		
ENGINE														
2.4 i [USA]	Petrol	0	01/88->	22R, 22RE										
Engine	Information				A10	A20	A40	A50	A70	C10 - C30	C20	E01		
Eng. 22RE	01/08/92 ->									470 203	C10			
ENGINE														
3.0	Petrol	105	08/88-11/95	3VZ-E										
Engine	Information				A10	A20	A40	A50	A70	C10 - C30	C20	E01		
All engines	->year 01/08/91									470 202	C10			
All engines	01/08/91 ->									470 203	C10			
ENGINE														
3.0 i [USA]	Petrol	0	01/88->	3VZ-E										
Engine	Information				A10	A20	A40	A50	A70	C10 - C30	C20	E01		
All engines	->year 01/08/91									470 202	C10			
All engines	01/08/91 ->									470 203	C10			
URBAN CRUISER														
ENGINE														
1.33	Petrol	73	01/09-03/16	1NR-FE										
Engine	Information				A10	A20	A40	A50	A70	C10 - C30	C20	E01		
All engines	x 4, COIL ON PLUG									470 537	C10			
ENGINE														
1.33	Petrol	74	04/09-03/16	1NR-FE										
Engine	Information				A10	A20	A40	A50	A70	C10 - C30	C20	E01		
All engines	x 4, COIL ON PLUG									470 537	C10			
VENZA														
ENGINE														
2.7	Petrol	136	11/08-11/16	1AR-FE										
Engine	Information				A10	A20	A40	A50	A70	C10 - C30	C20	E01		
All engines	x 4, COIL ON PLUG, FOR: (J)									470 537	C10			
ENGINE														
2.7 4WD	Petrol	135	11/08-04/12	1AR-FE										
Engine	Information				A10	A20	A40	A50	A70	C10 - C30	C20	E01		
All engines	x 4, COIL ON PLUG, FOR: (J)									470 537	C10			
ENGINE														
2.7 4WD	Petrol	136	11/08-11/16	1AR-FE										
Engine	Information				A10	A20	A40	A50	A70	C10 - C30	C20	E01		
All engines	x 4, COIL ON PLUG, FOR: (J)									470 537	C10			
ENGINE														
3.5	Petrol	200	11/08-11/16	2GR-FE										
Engine	Information				A10	A20	A40	A50	A70	C10 - C30	C20	E01		
All engines	MADE BY: (J), x 6, COIL ON PLUG, x 6, COIL ON PLUG									470 538	C10			
ENGINE														
3.5 4WD	Petrol	200	11/08-11/16	2GR-FE										
Engine	Information				A10	A20	A40	A50	A70	C10 - C30	C20	E01		
All engines	MADE BY: (J), x 6, COIL ON PLUG, x 6, COIL ON PLUG									470 538	C10			
VERSO														
ENGINE														
1.6	Petrol	81	04/09-08/18	1ZR-FAE										
Engine	Information				A10	A20	A40	A50	A70	C10 - C30	C20	E01		
All engines	x 4, COIL ON PLUG									470 536	C10			
ENGINE														
1.6	Petrol	97	04/09-08/18	1ZR-FAE										
Engine	Information				A10	A20	A40	A50	A70	C10 - C30	C20	E01		
All engines	x 4, COIL ON PLUG									470 536	C10			
ENGINE														
1.8	Petrol	108	04/09-08/18	2ZR-FAE										
Engine	Information				A10	A20	A40	A50	A70	C10 - C30	C20	E01		
All engines	x 4, COIL ON PLUG									470 536	C10			
ENGINE														
VVTi	Petrol	108	04/09-08/18	2ZR-FAE										
Engine	Information				A10	A20	A40	A50	A70	C10 - C30	C20	E01		
All engines	x 4, COIL ON PLUG									470 536	C10			

A10 CONDENSER	A20 CONTACT SET	A40 DISTRIBUTOR CAP	A50 ROTOR	A70 PICK-UP
C10 COIL	C20 IGNITION MODULE	C30 ELECTRONIC IGNITION KIT	E01 IGNITION CABLE SET	

The present application list is a brief version. For the detailed information about the possibility of installation on a specific vehicle, please refer to our web-catalogue <http://catalogo.facet.eu/>

VEHICLE					FUNCTIONS ON THE VEHICLE								
Vehicle	alim.	kW	Date	Engine	A10	A20	A40	A50	A70	C10 - C30	C20	E01	
VVTi					ENGINE								
	Petrol	97	04/09-08/18	1ZR-FAE									
Engine Information					A10	A20	A40	A50	A70	C10 - C30	C20	E01	
All engines										470 536	C10		
VERSO S					ENGINE								
	Petrol	70	11/10-10/16	1NR-FE									
Engine Information					A10	A20	A40	A50	A70	C10 - C30	C20	E01	
All engines										470 537	C10		
VIOS / YARIS					ENGINE								
	Petrol	52	09/05-10/13	1KR-FE									
Engine Information					A10	A20	A40	A50	A70	C10 - C30	C20	E01	
All engines										470 461	C10		
	Petrol	64	09/05-10/13	2NZ-FE, 2SZ-FE									
Engine Information					A10	A20	A40	A50	A70	C10 - C30	C20	E01	
All engines										470 459	C10		
	Petrol	64	09/05-04/13	2NZ-FE									
Engine Information					A10	A20	A40	A50	A70	C10 - C30	C20	E01	
All engines										470 459	C10		
	Petrol	81	08/07->	1NZ-FE									
Engine Information					A10	A20	A40	A50	A70	C10 - C30	C20	E01	
All engines										470 459	C10		
YARIS I					ENGINE								
	Petrol	48	03/03-09/05	1SZ-FE									
Engine Information					A10	A20	A40	A50	A70	C10 - C30	C20	E01	
All engines										470 459	C10		
	Petrol	50	04/99-09/05	1SZ-FE									
Engine Information					A10	A20	A40	A50	A70	C10 - C30	C20	E01	
All engines										470 459	C10		
	Petrol	63	08/99-11/05	2NZ-FE									
Engine Information					A10	A20	A40	A50	A70	C10 - C30	C20	E01	
All engines										470 459	C10		
	Petrol	64	04/02-09/05	2SZ-FE									
Engine Information					A10	A20	A40	A50	A70	C10 - C30	C20	E01	
All engines										470 459	C10		
	Petrol	110	03/00-07/05	1NZ-FE									
Engine Information					A10	A20	A40	A50	A70	C10 - C30	C20	E01	
All engines										470 459	C10		
	Petrol	77	01/03-11/05	1NZ-FE									
Engine Information					A10	A20	A40	A50	A70	C10 - C30	C20	E01	
All engines										470 459	C10		
	Petrol	78	04/01-09/05	1NZ-FE									
Engine Information					A10	A20	A40	A50	A70	C10 - C30	C20	E01	
All engines										470 459	C10		

A10 CONDENSER	A20 CONTACT SET	A40 DISTRIBUTOR CAP	A50 ROTOR	A70 PICK-UP
C10 COIL	C20 IGNITION MODULE	C30 ELECTRONIC IGNITION KIT	E01 IGNITION CABLE SET	

Vehicle	alim.	kW	Date	Engine	FUNCTIONS ON THE VEHICLE							
					A10	A20	A40	A50	A70	C10 - C30	C20	E01

YARIS II

Vehicle	alim.	kW	Date	ENGINE
1.0 GPL	Petrol/ Liquified Petro- leum Gas (LPG)	51	01/06-12/11	1KR-FE

Engine	Information	A10	A20	A40	A50	A70	C10 - C30	C20	E01
All engines	Yaris, x 3, COIL ON PLUG						470 461	C10	

Vehicle	alim.	kW	Date	ENGINE
1.0 VVT-i	Petrol	51	08/05-12/11	1KR-FE

Engine	Information	A10	A20	A40	A50	A70	C10 - C30	C20	E01
All engines	Yaris, x 3, COIL ON PLUG						470 461	C10	

Vehicle	alim.	kW	Date	ENGINE
1.3 4WD	Petrol	64	08/07-11/10	2NZ-FE

Engine	Information	A10	A20	A40	A50	A70	C10 - C30	C20	E01
All engines	Qty: 4						470 459	C10	

Vehicle	alim.	kW	Date	ENGINE
1.3 VVT-i	Petrol	63	11/05-12/12	2NZ-FE, 2SZ-FE

Engine	Information	A10	A20	A40	A50	A70	C10 - C30	C20	E01
All engines	Qty: 4						470 459	C10	

Vehicle	alim.	kW	Date	ENGINE
1.3 VVT-i	Petrol	64	08/05-11/10	2SZ-FE

Engine	Information	A10	A20	A40	A50	A70	C10 - C30	C20	E01
All engines	Yaris, x 4, COIL ON PLUG						470 459	C10	

Vehicle	alim.	kW	Date	ENGINE
1.33 VVT-i	Petrol	73	07/10-05/11	1NR-FE

Engine	Information	A10	A20	A40	A50	A70	C10 - C30	C20	E01
All engines	Yaris, x 4, COIL ON PLUG						470 537	C10	

Vehicle	alim.	kW	Date	ENGINE
1.33 VVT-i	Petrol	74	11/08-12/11	1NR-FE

Engine	Information	A10	A20	A40	A50	A70	C10 - C30	C20	E01
All engines	Yaris, x 4, COIL ON PLUG						470 537	C10	

Vehicle	alim.	kW	Date	ENGINE
1.5	Petrol	80	11/05->	1NZ-FE

Engine	Information	A10	A20	A40	A50	A70	C10 - C30	C20	E01
All engines	Qty: 4						470 459	C10	

Vehicle	alim.	kW	Date	ENGINE
1.5	Petrol	81	11/05->	1NZ-FE

Engine	Information	A10	A20	A40	A50	A70	C10 - C30	C20	E01
All engines	Qty: 4						470 459	C10	

Vehicle	alim.	kW	Date	ENGINE
1.6 [CHN]	Petrol	0	05/08->	1ZR-FE

Engine	Information	A10	A20	A40	A50	A70	C10 - C30	C20	E01
All engines	Qty: 4, no specific info conc. application available						470 536	C10	

Vehicle	alim.	kW	Date	ENGINE
1.8 VVTi	Petrol	98	01/07-12/11	2ZR-FE

Engine	Information	A10	A20	A40	A50	A70	C10 - C30	C20	E01
All engines	Yaris, x 4, COIL ON PLUG						470 536	C10	

YARIS III

Vehicle	alim.	kW	Date	ENGINE
1.0	Petrol	51	12/10->	1KR-FE

Engine	Information	A10	A20	A40	A50	A70	C10 - C30	C20	E01
All engines	Yaris, x 3, COIL ON PLUG						470 461	C10	

Vehicle	alim.	kW	Date	ENGINE
1.0 VVTi	Petrol	51	07/14->	1KR-FE









Engine	Information	A10	A20	A40	A50	A70	C10 - C30	C20	E01
All engines	Yaris, x 3, COIL ON PLUG, FOR: (J)						470 459	C10	

Vehicle	alim.	kW	Date	ENGINE
1.3	Petrol	63	12/11->	2NZ-FE

Engine	Information	A10	A20	A40	A50	A70	C10 - C30	C20	E01
All engines	Qty: 4						470 459	C10	

A10 CONDENSER	A20 CONTACT SET	A40 DISTRIBUTOR CAP	A50 ROTOR	A70 PICK-UP
C10 COIL	C20 IGNITION MODULE	C30 ELECTRONIC IGNITION KIT	E01 IGNITION CABLE SET	

The present application list is a brief version. For the detailed information about the possibility of installation on a specific vehicle, please refer to our web-catalogue <http://catalogo.facet.eu/>









					FUNCTIONS ON THE VEHICLE							
Vehicle	alim.	kW	Date	Engine								
ENGINE												
1.3	Petrol	73	09/11->	1NR-FE								
Engine	Information				A10	A20	A40	A50	A70	C10 - C30	C20	E01
All engines	Yaris, x 4, COIL ON PLUG									470 537	C10	
ENGINE												
1.3 4WD	Petrol	70	12/10->	1NR-FE								
Engine	Information				A10	A20	A40	A50	A70	C10 - C30	C20	E01
All engines	Qty: 4									470 537	C10	
ENGINE												
1.3 VVTi	Petrol	73	10/12->	1NR-FE								
Engine	Information				A10	A20	A40	A50	A70	C10 - C30	C20	E01
All engines	Yaris, x 4, COIL ON PLUG									470 537	C10	
ENGINE												
1.5	Petrol	80	12/10->	1NZ-FE								
Engine	Information				A10	A20	A40	A50	A70	C10 - C30	C20	E01
All engines	Qty: 4									470 459	C10	
ENGINE												
1.5	Petrol	82	03/17->	2NR-FKE								
Engine	Information				A10	A20	A40	A50	A70	C10 - C30	C20	E01
All engines	Yaris, x 4, COIL ON PLUG									470 537	C10	
ENGINE												
1.5 Hybrid	Petrol/ Electric	54	04/15->	1NZ-FXE								
Engine	Information				A10	A20	A40	A50	A70	C10 - C30	C20	E01
All engines	Yaris, x 4, COIL ON PLUG									470 459	C10	
ENGINE												
1.5 Hybrid	Petrol/ Electric	55	03/12->	1NZ-FXE								
Engine	Information				A10	A20	A40	A50	A70	C10 - C30	C20	E01
All engines	Yaris, x 4, COIL ON PLUG									470 459	C10	
ENGINE												
1.5 VVTi	Petrol	82	03/17->	2NR-FKE								
Engine	Information				A10	A20	A40	A50	A70	C10 - C30	C20	E01
All engines	Yaris, x 4, COIL ON PLUG									470 537	C10	
ENGINE												
1.8 GRMN	Petrol	156	09/17->	2ZR-FE								
Engine	Information				A10	A20	A40	A50	A70	C10 - C30	C20	E01
All engines	Yaris, x 4, COIL ON PLUG									470 536	C10	
YARIS VERSO												
ENGINE												
1.3	Petrol	62	11/02-09/05	2NZ-FE								
Engine	Information				A10	A20	A40	A50	A70	C10 - C30	C20	E01
All engines	x 4, COIL ON PLUG									470 459	C10	
ENGINE												
1.3	Petrol	63	08/99-10/02	2NZ-FE								
Engine	Information				A10	A20	A40	A50	A70	C10 - C30	C20	E01
All engines	x 4, COIL ON PLUG									470 459	C10	
ENGINE												
1.3 VVTi	Petrol	62	04/03-09/05	2NZ-FE								
Engine	Information				A10	A20	A40	A50	A70	C10 - C30	C20	E01
All engines	x 4, COIL ON PLUG									470 459	C10	
ENGINE												
1.3 VVTi	Petrol	63	03/00-09/05	2NZ-FE								
Engine	Information				A10	A20	A40	A50	A70	C10 - C30	C20	E01
All engines	x 4, COIL ON PLUG									470 459	C10	
ENGINE												
1.5	Petrol	77	03/00-09/05	1NZ-FE								
Engine	Information				A10	A20	A40	A50	A70	C10 - C30	C20	E01
All engines	x 4, COIL ON PLUG									470 459	C10	

A10 CONDENSER	A20 CONTACT SET	A40 DISTRIBUTOR CAP	A50 ROTOR	A70 PICK-UP
C10 COIL	C20 IGNITION MODULE	C30 ELECTRONIC IGNITION KIT	E01 IGNITION CABLE SET	

Vehicle	alim.	kW	Date	Engine	FUNCTIONS ON THE VEHICLE								
					A10	A20	A40	A50	A70	C10 - C30	C20	E01	
ENGINE													
1.5	Petrol	78	03/00-09/05	1NZ-FE									
ENGINE													
Engine		Information			A10	A20	A40	A50	A70	C10 - C30	C20	E01	
All engines		x 4, COIL ON PLUG								470 459	C10		
ENGINE													
1.5	Petrol	80	08/02-09/05	1NZ-FE									
ENGINE													
Engine		Information			A10	A20	A40	A50	A70	C10 - C30	C20	E01	
All engines		Qty: 4								470 459	C10		
ENGINE													
1.5	Petrol	81	01/00-07/02	1NZ-FE									
ENGINE													
Engine		Information			A10	A20	A40	A50	A70	C10 - C30	C20	E01	
All engines		Qty: 4								470 459	C10		
ENGINE													
1.5 VVTi	Petrol	78	03/00-03/03	1NZ-FE									
ENGINE													
Engine		Information			A10	A20	A40	A50	A70	C10 - C30	C20	E01	
All engines		x 4, COIL ON PLUG								470 459	C10		

A10	CONDENSER	A20	CONTACT SET	A40	DISTRIBUTOR CAP	A50	ROTOR	A70	PICK-UP
C10	COIL	C20	IGNITION MODULE	C30	ELECTRONIC IGNITION KIT	E01	IGNITION CABLE SET		

The present application list is a brief version. For the detailed information about the possibility of installation on a specific vehicle, please refer to our web-catalogue <http://catalogo.facet.eu/>

					FUNCTIONS ON THE VEHICLE							
Vehicle	alim.	kW	Date	Engine	 A10	 A20	 A40	 A50	 A70	 C10 - C30	 C20	 E01
1300												
1.3	Petrol	46	01/65-12/70	ENGINE --								
Engine	Information				A10	A20	A40	A50	A70	C10 - C30	C20	E01
All engines							828 075	928 006				
1.3 TC	Petrol	56	01/67-12/70	ENGINE --, GE1EH								
Engine	Information				A10	A20	A40	A50	A70	C10 - C30	C20	E01
All engines							828 075	928 006				
1500												
1.5	Petrol	42	10/70-12/74	ENGINE --, 1EL								
Engine	Information				A10	A20	A40	A50	A70	C10 - C30	C20	E01
All engines							828 075	928 006				
1.5	Petrol	49	01/72-12/74	ENGINE --, 1EH								
Engine	Information				A10	A20	A40	A50	A70	C10 - C30	C20	E01
All engines							828 075	928 006				
2.5 PI												
2.5	Petrol	90	10/68-10/75	ENGINE --, 25PI								
Engine	Information				A10	A20	A40	A50	A70	C10 - C30	C20	E01
All engines								928 007				
2.5	Petrol	99	01/68-12/75	ENGINE 25PI								
Engine	Information				A10	A20	A40	A50	A70	C10 - C30	C20	E01
All engines								928 007				
2000												
2.0	Petrol	65	03/72-04/75	ENGINE 20TC								
Engine	Information				A10	A20	A40	A50	A70	C10 - C30	C20	E01
All engines								928 007				
2.0	Petrol	66	01/68-12/75	ENGINE --, 20TC								
Engine	Information				A10	A20	A40	A50	A70	C10 - C30	C20	E01
All engines								928 007				
2.0 TC	Petrol	68	03/72-12/75	ENGINE --								
Engine	Information				A10	A20	A40	A50	A70	C10 - C30	C20	E01
All engines								928 007				
GT6												
MKI	Petrol	70	01/66-12/68	ENGINE KE1L								
Engine	Information				A10	A20	A40	A50	A70	C10 - C30	C20	E01
All engines								912 090				
MK II	Petrol	77	12/68-12/70	ENGINE KE1L, KE2L								
Engine	Information				A10	A20	A40	A50	A70	C10 - C30	C20	E01
All engines								912 090				
MK III	Petrol	71	12/72-12/73	ENGINE KE2L								
Engine	Information				A10	A20	A40	A50	A70	C10 - C30	C20	E01
All engines								912 090				
MK III	Petrol	77	12/71-12/72	ENGINE KE2L								
Engine	Information				A10	A20	A40	A50	A70	C10 - C30	C20	E01
All engines								912 090				

A10 CONDENSER	A20 CONTACT SET	A40 DISTRIBUTOR CAP	A50 ROTOR	A70 PICK-UP
C10 COIL	C20 IGNITION MODULE	C30 ELECTRONIC IGNITION KIT	E01 IGNITION CABLE SET	

Vehicle	alim.	kW	Date	Engine	FUNCTIONS ON THE VEHICLE							
					A10	A20	A40	A50	A70	C10 - C30	C20	E01
HERALD												
1200	Petrol	29	01/61-10/67	ENGINE --, AJM								
Engine Information					A10	A20	A40	A50	A70	C10 - C30	C20	E01
All engines						728 083MHV	828 075	928 006				
1200												
1200	Petrol	35	01/68-12/69	ENGINE AJM								
Engine Information					A10	A20	A40	A50	A70	C10 - C30	C20	E01
All engines							828 075	928 006				
1200												
1200	Petrol	46	01/67-12/68	ENGINE --								
Engine Information					A10	A20	A40	A50	A70	C10 - C30	C20	E01
All engines							828 075	928 006				
13/60												
13/60	Petrol	46	01/67-12/71	ENGINE --								
Engine Information					A10	A20	A40	A50	A70	C10 - C30	C20	E01
All engines							828 075	928 006				
SPITFIRE												
1.2	Petrol	49	12/64-01/67	ENGINE AJM								
Engine Information					A10	A20	A40	A50	A70	C10 - C30	C20	E01
All engines								912 090				
1.2 MK I												
1.2 MK I	Petrol	46	10/62-12/65	ENGINE AJM								
Engine Information					A10	A20	A40	A50	A70	C10 - C30	C20	E01
All engines								912 090				
1.3												
1.3	Petrol	55	02/67-12/72	ENGINE --, FM3								
Engine Information					A10	A20	A40	A50	A70	C10 - C30	C20	E01
All engines								912 090				
1.5												
1.5	Petrol	51	12/72-11/74	ENGINE --								
Engine Information					A10	A20	A40	A50	A70	C10 - C30	C20	E01
All engines								912 090				
TOLEDO												
1300	Petrol	43	10/70-12/77	ENGINE --								
Engine Information					A10	A20	A40	A50	A70	C10 - C30	C20	E01
All engines							828 075	928 006				
1500												
1500	Petrol	46	10/70-12/77	ENGINE --								
Engine Information					A10	A20	A40	A50	A70	C10 - C30	C20	E01
All engines							828 075	928 006				
1500												
1500	Petrol	49	01/72-12/77	ENGINE --								
Engine Information					A10	A20	A40	A50	A70	C10 - C30	C20	E01
All engines							828 075	928 006				
1500 TC												
1500 TC	Petrol	51	01/71-12/77	ENGINE --								
Engine Information					A10	A20	A40	A50	A70	C10 - C30	C20	E01
All engines							828 075	928 006				
TR 2												
2.0	Petrol	66	01/53-12/55	ENGINE --, HCL								
Engine Information					A10	A20	A40	A50	A70	C10 - C30	C20	E01
All engines								928 006				
TR 3												
2.0	Petrol	67	12/55-12/57	ENGINE --, HCL								
Engine Information					A10	A20	A40	A50	A70	C10 - C30	C20	E01
All engines								928 006				

A10 CONDENSER	A20 CONTACT SET	A40 DISTRIBUTOR CAP	A50 ROTOR	A70 PICK-UP
C10 COIL	C20 IGNITION MODULE	C30 ELECTRONIC IGNITION KIT	E01 IGNITION CABLE SET	

The present application list is a brief version. For the detailed information about the possibility of installation on a specific vehicle, please refer to our web-catalogue <http://catalogo.facet.eu/>

					FUNCTIONS ON THE VEHICLE							
Vehicle	alim.	kW	Date	Engine								

TR 3A

				ENGINE
2.0	Petrol	70	12/57-12/61	--

Engine	Information	A10	A20	A40	A50	A70	C10 - C30	C20	E01
All engines					928 006				

				ENGINE
2.2	Petrol	74	01/59-12/61	--, HE0H

Engine	Information	A10	A20	A40	A50	A70	C10 - C30	C20	E01
All engines					928 006				

TR 4

				ENGINE
2.0	Petrol	75	01/61-12/65	--

Engine	Information	A10	A20	A40	A50	A70	C10 - C30	C20	E01
All engines					928 006				

TR 4A

				ENGINE
2.2	Petrol	76	12/65-12/67	--, HE0H

Engine	Information	A10	A20	A40	A50	A70	C10 - C30	C20	E01
All engines					928 006				

TR 5

				ENGINE
2.5 PI	Petrol	105	01/67-12/68	--

Engine	Information	A10	A20	A40	A50	A70	C10 - C30	C20	E01
All engines					928 007				

TR 6

				ENGINE
2.5	Petrol	121	03/69-01/74	--, CR1H

Engine	Information	A10	A20	A40	A50	A70	C10 - C30	C20	E01
All engines					928 007				

				ENGINE
2.5	Petrol	90	01/72-12/76	CF1

Engine	Information	A10	A20	A40	A50	A70	C10 - C30	C20	E01
All engines			728 083MHV		928 007				

				ENGINE
2.5 PI	Petrol	105	01/69-12/76	--

Engine	Information	A10	A20	A40	A50	A70	C10 - C30	C20	E01
All engines					928 007				

VITESSE

				ENGINE
1.6	Petrol	51	01/62-12/67	--

Engine	Information	A10	A20	A40	A50	A70	C10 - C30	C20	E01
All engines					912 090, 928 007				

				ENGINE
2.0	Petrol	70	12/65-12/71	--, HB1LE

Engine	Information	A10	A20	A40	A50	A70	C10 - C30	C20	E01
All engines					912 090, 928 007				

				ENGINE
2.0	Petrol	77	12/68-12/71	--, HB1HE

Engine	Information	A10	A20	A40	A50	A70	C10 - C30	C20	E01
All engines					912 090, 928 007				

A10 CONDENSER	A20 CONTACT SET	A40 DISTRIBUTOR CAP	A50 ROTOR	A70 PICK-UP
C10 COIL	C20 IGNITION MODULE	C30 ELECTRONIC IGNITION KIT	E01 IGNITION CABLE SET	

Vehicle	alim.	kW	Date	Engine	FUNCTIONS ON THE VEHICLE							
					 A10	 A20	 A40	 A50	 A70	 C10 - C30	 C20	 E01

2500

				ENGINE
2.5	Petrol	78	01/72-12/77	--, CF1

Engine	Information	A10	A20	A40	A50	A70	C10 - C30	C20	E01
All engines					928 007				

VIXEN

				ENGINE
1800	Petrol	70	01/68-12/68	--

Engine	Information	A10	A20	A40	A50	A70	C10 - C30	C20	E01
All engines					928 006				

A10	CONDENSER	A20	CONTACT SET	A40	DISTRIBUTOR CAP	A50	ROTOR	A70	PICK-UP
C10	COIL	C20	IGNITION MODULE	C30	ELECTRONIC IGNITION KIT	E01	IGNITION CABLE SET		

The present application list is a brief version. For the detailed information about the possibility of installation on a specific vehicle, please refer to our web-catalogue <http://catalogo.facet.eu/>

Vehicle	alim.	kW	Date	Engine	FUNCTIONS ON THE VEHICLE							
					A10	A20	A40	A50	A70	C10 - C30	C20	E01

ADAM

				ENGINE
1.0	Petrol	66	07/14->	B 10 XFL

Engine	Information	A10	A20	A40	A50	A70	C10 - C30	C20	E01
All engines	Qty: 3						470 631	C10	

				ENGINE
1.0	Petrol	85	07/14-11/18	B 10 XFT, D 10 XFT

Engine	Information	A10	A20	A40	A50	A70	C10 - C30	C20	E01
All engines	x 3, COIL ON PLUG						470 631	C10	

				ENGINE
1.2	Petrol	51	10/12-04/19	A 12 XEL, B 12 XEL, D 12 XEL

Engine	Information	A10	A20	A40	A50	A70	C10 - C30	C20	E01
All engines	x 1, COIL ON RAIL						470 547	C10	

				ENGINE
1.4	Petrol	64	10/12-02/19	A 14 XEL, B 14 XEL, D 14 XEL

Engine	Information	A10	A20	A40	A50	A70	C10 - C30	C20	E01
All engines	x 1, COIL ON RAIL						470 547	C10	

				ENGINE
1.4	Petrol	74	10/12-02/19	A 14 XER, B 14 XER

Engine	Information	A10	A20	A40	A50	A70	C10 - C30	C20	E01
All engines	x 1, COIL ON RAIL						470 547	C10	

				ENGINE
1.4 LPG	Petrol/ Liquified Petro- leum Gas (LPG)	64	07/13->	A 14 XEL

Engine	Information	A10	A20	A40	A50	A70	C10 - C30	C20	E01
All engines							470 547	C10	

				ENGINE
1.4 S	Petrol	110	11/14-01/19	B 14 NEH

Engine	Information	A10	A20	A40	A50	A70	C10 - C30	C20	E01
All engines	x 1, COIL ON RAIL						470 547	C10	

AGILA A

				ENGINE
1.0 12V	Petrol	43	09/00-08/05	Z 10 XE

Engine	Information	A10	A20	A40	A50	A70	C10 - C30	C20	E01
All engines	x 3, BOSCH, COIL ON PLUG						470 398	C10	

				ENGINE
1.0 12V	Petrol	44	02/00-11/06	Z 10 XEP

Engine	Information	A10	A20	A40	A50	A70	C10 - C30	C20	E01
All engines	x 3, BOSCH, COIL ON PLUG, 12 Volt, Dia: 55 mm, for pre-resistance						470 398	C10	

				ENGINE
1.2 16V	Petrol	55	09/00-03/08	Z 12 XE

Engine	Information	A10	A20	A40	A50	A70	C10 - C30	C20	E01
All engines	x 4, BOSCH, COIL ON PLUG						470 400	C10	

				ENGINE
1.2 16V Twinport	Petrol	59	07/04-11/06	Z 12 XEP

Engine	Information	A10	A20	A40	A50	A70	C10 - C30	C20	E01
All engines	x 1, BOSCH, COIL ON PLUG, incl. spark plug connector						470 400	C10	

AMPERA

				ENGINE
EV 150	Petrol/ Electric	111	03/12->	4ET50, A 14 XFL

Engine	Information	A10	A20	A40	A50	A70	C10 - C30	C20	E01
Eng. 4ET50							470 547	C10	
Eng. A 14 XFL	x 1, COIL ON RAIL						470 547	C10	

A10 CONDENSER	A20 CONTACT SET	A40 DISTRIBUTOR CAP	A50 ROTOR	A70 PICK-UP
C10 COIL	C20 IGNITION MODULE	C30 ELECTRONIC IGNITION KIT	E01 IGNITION CABLE SET	

Vehicle	alim.	kW	Date	Engine	FUNCTIONS ON THE VEHICLE							
					A10	A20	A40	A50	A70	C10 - C30	C20	E01

ASTRA III

				ENGINE
1.4	Petrol	55	09/91-09/93	14 NV

Engine	Information	A10	A20	A40	A50	A70	C10 - C30	C20	E01
All engines	version Bosch			806 256	906 056R				
All engines								465 005	
All engines	->eng. 02BF1476, 19241623								360 237
All engines	eng. type 02BF1477, 19241624 ->								360 529

				ENGINE
1.4 i	Petrol	44	09/91-09/98	C 14 NZ

Engine	Information	A10	A20	A40	A50	A70	C10 - C30	C20	E01
All engines	connector type SAE, version Bosch			806 249					
All engines	connector type M4, version Bosch			806 256					
All engines	version Bosch				906 121R				
All engines	version Lucas				928 028R	428 202			
All engines							470 140	C10	465 036
All engines	->eng. 02BF1476, 19241623								360 237
All engines	eng. type 02BF1477, 19241624 ->								360 529

				ENGINE
1.4 i	Petrol	60	03/91-03/01	C 14 SE

Engine	Information	A10	A20	A40	A50	A70	C10 - C30	C20	E01
All engines	version Lucas			828 100	928 028R				
All engines							470 140	C10	465 036
All engines	eng. type 02T14053, 02BD1413 ->								359 634
All engines	->eng. 02T14052, 19880550								360 237
All engines	eng. type 02BD1413, 19280317 ->								360 531

				ENGINE
1.4 i 16V	Petrol	66	01/96-03/01	X 14 XE

Engine	Information	A10	A20	A40	A50	A70	C10 - C30	C20	E01
All engines									360 559

				ENGINE
1.4 S	Petrol	55	09/91-02/98	14 NV

Engine	Information	A10	A20	A40	A50	A70	C10 - C30	C20	E01
All engines	version Bosch			806 256	906 056R				
All engines								465 005	
All engines	->eng. 02BF1476, 19241623								360 237
All engines	eng. type 02BF1477, 19241624 ->								360 529

				ENGINE
1.6	Petrol	74	03/94-08/95	C 16 SE

Engine	Information	A10	A20	A40	A50	A70	C10 - C30	C20	E01
All engines	->eng. 02BD0920								359 634
All engines	eng. type 02BD0921 ->								360 531

				ENGINE
1.6 i	Petrol	52	02/93-02/98	X 16 SZ

Engine	Information	A10	A20	A40	A50	A70	C10 - C30	C20	E01
All engines	->eng. 02BE6166								359 634
All engines	eng. type 02BE6167 ->								360 531

				ENGINE
1.6 i	Petrol	55	09/91-03/01	C 16 NZ, X 16 SZR

Engine	Information	A10	A20	A40	A50	A70	C10 - C30	C20	E01
Eng. C 16 NZ	version Delco Remy			812 073	912 100	412 010			
Eng. C 16 NZ							470 341	C10	465 025
Eng. C 16 NZ	->eng. 02V65825								359 514
Eng. X 16 SZR	->eng. 02BE6166								359 634
Eng. X 16 SZR	eng. type 02BE6167 ->								360 531

				ENGINE
1.6 i	Petrol	74	03/92-02/98	C 16 SE

Engine	Information	A10	A20	A40	A50	A70	C10 - C30	C20	E01
All engines	->eng. 02BD0920								359 634
All engines	eng. type 02BD0921 ->								360 531

A10 CONDENSER	A20 CONTACT SET	A40 DISTRIBUTOR CAP	A50 ROTOR	A70 PICK-UP
C10 COIL	C20 IGNITION MODULE	C30 ELECTRONIC IGNITION KIT	E01 IGNITION CABLE SET	

The present application list is a brief version. For the detailed information about the possibility of installation on a specific vehicle, please refer to our web-catalogue <http://catalogo.facet.eu/>

Vehicle	alim.	kW	Date	Engine	FUNCTIONS ON THE VEHICLE							
					A10	A20	A40	A50	A70	C10 - C30	C20	E01

1.6 i 16V	Petrol	74	01/94-09/98	ENGINE X 16 XEL
------------------	--------	-----------	-------------	----------------------------------

Engine	Information	A10	A20	A40	A50	A70	C10 - C30	C20	E01
All engines	->eng. 20C17332								359 688
All engines	eng. type 20C17333 ->								360 559

1.6 Si	Petrol	74	03/91-12/94	ENGINE C 16 SE
---------------	--------	-----------	-------------	---------------------------------

Engine	Information	A10	A20	A40	A50	A70	C10 - C30	C20	E01
All engines	->eng. 02BD0920								359 634
All engines	eng. type 02BD0921 ->								360 531

1.8	Petrol	92	09/94-08/96	ENGINE C 18 XE
------------	--------	-----------	-------------	---------------------------------

Engine	Information	A10	A20	A40	A50	A70	C10 - C30	C20	E01
All engines							470 272	C10	
All engines	ch. W2000000 ->, ch. W5000000 ->, ch. W8000000 ->								360 506
All engines	->ch. V2999999, ->ch. V5999999, ->ch. V8999999								360 562

1.8 16V	Petrol	85	11/94-03/01	ENGINE C 18 XEL, X 18 XE
----------------	--------	-----------	-------------	---

Engine	Information	A10	A20	A40	A50	A70	C10 - C30	C20	E01
All engines							470 272	C10	
All engines	ch. W2000000 ->, ch. W5000000 ->, ch. W8000000 ->								360 506
All engines	->ch. V2999999, ->ch. V5999999, ->ch. V8999999								360 562

1.8 i	Petrol	66	09/91-09/98	ENGINE C 18 NZ
--------------	--------	-----------	-------------	---------------------------------

Engine	Information	A10	A20	A40	A50	A70	C10 - C30	C20	E01
All engines	version Bosch			806 257	906 127R				
All engines	version Ducellier			815 084	915 103R				
All engines							470 140	C10	465 036
All engines	FOR: (ZA)						470 192	C10	
All engines	eng. type 14349312 ->								359 689

1.8 i 16V	Petrol	82	09/95-02/98	ENGINE 18 SE
------------------	--------	-----------	-------------	-------------------------------

Engine	Information	A10	A20	A40	A50	A70	C10 - C30	C20	E01
All engines							470 192	C10	

1.8 i 16V	Petrol	85	01/94-02/98	ENGINE C 18 XEL, X 18 XE
------------------	--------	-----------	-------------	---

Engine	Information	A10	A20	A40	A50	A70	C10 - C30	C20	E01
All engines							470 272	C10	
All engines	ch. W2000000 ->, ch. W5000000 ->, ch. W8000000 ->								360 506
All engines	->ch. V2999999, ->ch. V5999999, ->ch. V8999999								360 562

1.8 i 16V	Petrol	92	06/93-02/98	ENGINE C 18 XE
------------------	--------	-----------	-------------	---------------------------------

Engine	Information	A10	A20	A40	A50	A70	C10 - C30	C20	E01
All engines							470 272	C10	
All engines	ch. W2000000 ->, ch. W5000000 ->, ch. W8000000 ->								360 506
All engines	->ch. V2999999, ->ch. V5999999, ->ch. V8999999								360 562

2.0 i	Petrol	85	09/91-09/98	ENGINE C 20 NE
--------------	--------	-----------	-------------	---------------------------------

Engine	Information	A10	A20	A40	A50	A70	C10 - C30	C20	E01
All engines	version Bosch			806 257	906 127R				
All engines	version Ducellier			815 084	915 103R				
All engines							470 192	C10	
All engines	eng. type 14672354 ->, ->ch. R2999999, ->ch. R3999999, ->ch. R4999999, ->ch. R5999999, ->ch. R6999999, ->ch. R8999999								359 689

2.0 i 16V	Petrol	100	01/94-09/98	ENGINE X 20 XEV
------------------	--------	------------	-------------	----------------------------------

Engine	Information	A10	A20	A40	A50	A70	C10 - C30	C20	E01
All engines							470 272	C10	
All engines	ch. W2000000 ->, ch. W5000000 ->, ch. W8000000 ->								360 506
All engines	->ch. V2999999, ->ch. V5999999, ->ch. V8999999								360 562

A10 CONDENSER	A20 CONTACT SET	A40 DISTRIBUTOR CAP	A50 ROTOR	A70 PICK-UP
C10 COIL	C20 IGNITION MODULE	C30 ELECTRONIC IGNITION KIT	E01 IGNITION CABLE SET	

Vehicle	alim.	kW	Date	Engine	FUNCTIONS ON THE VEHICLE									
					A10	A20	A40	A50	A70	C10 - C30	C20	E01		
ENGINE														
2.0 i 16V	Petrol	110	09/91-02/98	C 20 XE										
Engine	Information				A10	A20	A40	A50	A70	C10 - C30	C20	E01		
All engines	->eng. 14137012, version Bosch						806 257	906 121R						
All engines	eng. type 14137013 ->									470 273	C10			
All engines	eng. type 14002935 ->												359 688	
ASTRA IV														
ENGINE														
1.2 16V	Petrol	48	02/98-09/00	X 12 XE										
Engine	Information				A10	A20	A40	A50	A70	C10 - C30	C20	E01		
All engines										470 400	C10			
ENGINE														
1.2 16V	Petrol	55	09/00-05/05	Z 12 XE										
Engine	Information				A10	A20	A40	A50	A70	C10 - C30	C20	E01		
All engines										470 400	C10			
ENGINE														
1.4 16V	Petrol	66	02/98-05/05	X 14 XE, Z 14 XE										
Engine	Information				A10	A20	A40	A50	A70	C10 - C30	C20	E01		
All engines	x 1, COIL ON PLUG, incl. spark plug connector									470 399	C10			
1.4 16V Dualfuel	Petrol/ Liquified Petro- leum Gas (LPG)	66	09/99-06/03	X 14 XE, Z 14 XE										
Engine	Information				A10	A20	A40	A50	A70	C10 - C30	C20	E01		
All engines	x 1, COIL ON PLUG, incl. spark plug connector									470 399	C10			
ENGINE														
1.6	Petrol	55	02/98-04/04	X 16 SZR										
Engine	Information				A10	A20	A40	A50	A70	C10 - C30	C20	E01		
All engines													360 904	
ENGINE														
1.6	Petrol	62	03/98-05/05	Z 16 SE										
Engine	Information				A10	A20	A40	A50	A70	C10 - C30	C20	E01		
All engines													360 904	
ENGINE														
1.6	Petrol	76	12/02-05/05	Z 16 XEP										
Engine	Information				A10	A20	A40	A50	A70	C10 - C30	C20	E01		
All engines	x 1, DELPHI, COIL ON PLUG, incl. spark plug connector									470 450	C10			
ENGINE														
1.6 16V	Petrol	74	02/98-10/05	X 16 XEL, Z 16 XE, Z 16 XEP										
Engine	Information				A10	A20	A40	A50	A70	C10 - C30	C20	E01		
Eng. X 16 XEL, Z 16 XE	x 1, COIL ON PLUG, incl. spark plug connector									470 399	C10			
Eng. Z 16 XEP										470 450	C10			
ENGINE														
1.6 16V	Petrol	76	03/00-10/05	Z 16 XEP										
Engine	Information				A10	A20	A40	A50	A70	C10 - C30	C20	E01		
All engines	x 1, DELPHI, COIL ON PLUG, incl. spark plug connector									470 450	C10			
ENGINE														
1.6 Dualfuel	Petrol/ Liquified Petro- leum Gas (LPG)	63	03/98-05/05	Z 16 XE										
Engine	Information				A10	A20	A40	A50	A70	C10 - C30	C20	E01		
All engines										470 399	C10			
ENGINE														
1.6 Dualfuel	Petrol/ Liquified Petro- leum Gas (LPG)	74	09/99-08/04	X 16 XEL, Z 16 XE										
Engine	Information				A10	A20	A40	A50	A70	C10 - C30	C20	E01		
All engines	x 1, COIL ON PLUG, incl. spark plug connector									470 399	C10			

A10	CONDENSER	A20	CONTACT SET	A40	DISTRIBUTOR CAP	A50	ROTOR	A70	PICK-UP
C10	COIL	C20	IGNITION MODULE	C30	ELECTRONIC IGNITION KIT	E01	IGNITION CABLE SET		

The present application list is a brief version. For the detailed information about the possibility of installation on a specific vehicle, please refer to our web-catalogue <http://catalogo.facet.eu/>

Vehicle	alim.	kW	Date	Engine	FUNCTIONS ON THE VEHICLE							
					A10	A20	A40	A50	A70	C10 - C30	C20	E01

ENGINE				
1.8 16V	Petrol	85	02/98-08/05	X 18 XE1

Engine	Information	A10	A20	A40	A50	A70	C10 - C30	C20	E01
All engines	x 1, COIL ON PLUG, incl. spark plug connector						470 508	C10	

ENGINE				
1.8 16V	Petrol	92	02/98-10/05	Z 18 XE

Engine	Information	A10	A20	A40	A50	A70	C10 - C30	C20	E01
All engines	x 1, COIL ON PLUG, incl. spark plug connector						470 508	C10	

ENGINE				
1.8 16V Dualfuel	Petrol/ Liquified Petro- leum Gas (LPG)	87	02/98-08/05	Z 18 XE

Engine	Information	A10	A20	A40	A50	A70	C10 - C30	C20	E01
All engines	x 1, COIL ON PLUG, incl. spark plug connector						470 508	C10	

ENGINE				
1.8 16V Dualfuel	Petrol/ Liquified Petro- leum Gas (LPG)	92	07/02-08/04	Z 18 XE

Engine	Information	A10	A20	A40	A50	A70	C10 - C30	C20	E01
All engines	x 1, COIL ON PLUG, incl. spark plug connector						470 508	C10	

ENGINE				
2.0	Petrol	118	10/99-08/00	X 20 XER

Engine	Information	A10	A20	A40	A50	A70	C10 - C30	C20	E01
All engines							470 272	C10	360 562

ENGINE				
2.0	Petrol	147	08/02-10/05	Z 20 LET

Engine	Information	A10	A20	A40	A50	A70	C10 - C30	C20	E01
All engines							470 507	C10	
All engines	x 1, COIL ON PLUG						470 507	C10	

ENGINE				
2.0 16V	Petrol	100	02/98-05/05	X 20 XEV

Engine	Information	A10	A20	A40	A50	A70	C10 - C30	C20	E01
All engines							470 272	C10	360 562
All engines	x 1, D.I.S.						470 272	C10	

ENGINE				
2.0 16V Turbo	Petrol	140	09/00-08/05	Z 20 LET

Engine	Information	A10	A20	A40	A50	A70	C10 - C30	C20	E01
All engines	x 1, COIL ON PLUG						470 507	C10	

ENGINE				
2.0 SRI Turbo	Petrol	141	11/01-05/05	Z 20 LET

Engine	Information	A10	A20	A40	A50	A70	C10 - C30	C20	E01
All engines	x 1, COIL ON PLUG						470 507	C10	

ENGINE				
2.0 Turbo	Petrol	141	03/02-10/05	Z 20 LET

Engine	Information	A10	A20	A40	A50	A70	C10 - C30	C20	E01
All engines							470 507	C10	
All engines	x 1, COIL ON PLUG						470 507	C10	

ENGINE				
2.0 Turbo	Petrol	147	08/03-05/05	Z 20 LET

Engine	Information	A10	A20	A40	A50	A70	C10 - C30	C20	E01
All engines							470 507	C10	

ASTRA V

ENGINE				
1.2	Petrol	59	08/05-10/10	Z 12 XEP

Engine	Information	A10	A20	A40	A50	A70	C10 - C30	C20	E01
All engines							470 400	C10	

ENGINE				
1.4	Petrol	55	08/04-10/10	Z 14 XEL









Engine	Information	A10	A20	A40	A50	A70	C10 - C30	C20	E01
All engines							470 400	C10	

A10 CONDENSER	A20 CONTACT SET	A40 DISTRIBUTOR CAP	A50 ROTOR	A70 PICK-UP
C10 COIL	C20 IGNITION MODULE	C30 ELECTRONIC IGNITION KIT	E01 IGNITION CABLE SET	

Vehicle	alim.	kW	Date	Engine	FUNCTIONS ON THE VEHICLE									
					A10	A20	A40	A50	A70	C10 - C30	C20	E01		
ENGINE														
1.4	Petrol	66	01/04-05/09	Z 14 XEP										
Engine	Information				A10	A20	A40	A50	A70	C10 - C30	C20	E01		
All engines	x 1, BOSCH, COIL ON PLUG, incl. spark plug connector									470 400	C10			
ENGINE														
1.4 i 16V	Petrol	66	03/05-11/10	Z 14 XEP										
Engine	Information				A10	A20	A40	A50	A70	C10 - C30	C20	E01		
All engines	x 1, BOSCH, COIL ON PLUG, incl. spark plug connector									470 400	C10			
ENGINE														
1.6	Petrol	132	08/04-11/10	A 16 LET, Z 16 LET										
Engine	Information				A10	A20	A40	A50	A70	C10 - C30	C20	E01		
All engines	x 1, DELPHI, COIL ON PLUG, incl. spark plug connector									470 450	C10			
ENGINE														
1.6	Petrol	77	01/04-11/10	Z 16 XE1, Z 16 XEP										
Engine	Information				A10	A20	A40	A50	A70	C10 - C30	C20	E01		
All engines	x 1, DELPHI, COIL ON PLUG, incl. spark plug connector									470 450	C10			
ENGINE														
1.6	Petrol	85	01/04-03/11	A 16 XER, Z 16 XER										
Engine	Information				A10	A20	A40	A50	A70	C10 - C30	C20	E01		
All engines	x 1, DELPHI, COIL ON PLUG, incl. spark plug connector									470 450	C10			
Eng. Z 16 XER										470 450	C10			
Eng. A 16 XER										470 545	C10			
ENGINE														
1.6 i 16V	Petrol	85	10/06-08/11	A 16 XER, Z 16 XER										
Engine	Information				A10	A20	A40	A50	A70	C10 - C30	C20	E01		
All engines	x 1, DELPHI, COIL ON PLUG, incl. spark plug connector									470 450	C10			
Eng. Z 16 XER										470 450	C10			
ENGINE														
1.6 Turbo	Petrol	132	09/06-09/09	A 16 LET, Z 16 LET										
Engine	Information				A10	A20	A40	A50	A70	C10 - C30	C20	E01		
All engines	x 1, DELPHI, COIL ON PLUG, incl. spark plug connector									470 450	C10			
ENGINE														
1.8	Petrol	103	01/04-11/10	A 18 XER, Z 18 XER										
Engine	Information				A10	A20	A40	A50	A70	C10 - C30	C20	E01		
All engines	x 1, DELPHI, COIL ON PLUG, incl. spark plug connector									470 450	C10			
Eng. A 18 XER										470 545	C10			
ENGINE														
1.8	Petrol	92	01/04-11/10	Z 18 XE										
Engine	Information				A10	A20	A40	A50	A70	C10 - C30	C20	E01		
All engines	x 1, COIL ON PLUG, incl. spark plug connector									470 508	C10			
All engines	x 1, COIL ON PLUG, incl. spark plug connector									470 508	C10			
ENGINE														
1.8 i 16V	Petrol	103	03/07-11/10	A 18 XER, Z 18 XER										
Engine	Information				A10	A20	A40	A50	A70	C10 - C30	C20	E01		
All engines	x 1, DELPHI, COIL ON PLUG, incl. spark plug connector									470 450	C10			
ENGINE														
2.0	Petrol	125	02/06-11/10	Z 20 LEL										
Engine	Information				A10	A20	A40	A50	A70	C10 - C30	C20	E01		
All engines	x 1, COIL ON PLUG									470 507	C10			
ENGINE														
2.0 Turbo	Petrol	125	01/04-11/10	Z 20 LER										
Engine	Information				A10	A20	A40	A50	A70	C10 - C30	C20	E01		
All engines	x 1, COIL ON PLUG									470 507	C10			
ENGINE														
2.0 Turbo	Petrol	147	01/04-11/10	Z 20 LER										
Engine	Information				A10	A20	A40	A50	A70	C10 - C30	C20	E01		
All engines	x 1, COIL ON PLUG									470 507	C10			
ENGINE														
2.0 Turbo	Petrol	177	01/04-05/09	Z 20 LEH										
Engine	Information				A10	A20	A40	A50	A70	C10 - C30	C20	E01		
All engines	x 1, COIL ON PLUG									470 507	C10			

A10 CONDENSER	A20 CONTACT SET	A40 DISTRIBUTOR CAP	A50 ROTOR	A70 PICK-UP
C10 COIL	C20 IGNITION MODULE	C30 ELECTRONIC IGNITION KIT	E01 IGNITION CABLE SET	

The present application list is a brief version. For the detailed information about the possibility of installation on a specific vehicle, please refer to our web-catalogue <http://catalogo.facet.eu/>

					FUNCTIONS ON THE VEHICLE							
Vehicle	alim.	kW	Date	Engine	 A10	 A20	 A40	 A50	 A70	 C10 - C30	 C20	 E01
2.0 VXR												
Petrol 176 02/09-11/10 Z 20 LEH												
ENGINE												
All engines					A10	A20	A40	A50	A70	C10 - C30	C20	E01
Information										470 507	C10	
x 1, COIL ON PLUG												
ASTRA VI												
1.4												
Petrol 103 10/11-10/15 A 14 NET, B 14 NET												
ENGINE												
All engines					A10	A20	A40	A50	A70	C10 - C30	C20	E01
Information										470 547	C10	
x 1, COIL ON RAIL												
1.4												
Petrol 64 12/09-10/15 A 14 XEL												
ENGINE												
All engines					A10	A20	A40	A50	A70	C10 - C30	C20	E01
Information										470 547	C10	
x 1, COIL ON RAIL												
1.4												
Petrol 74 12/09-10/15 A 14 XER, B 14 XER												
ENGINE												
All engines					A10	A20	A40	A50	A70	C10 - C30	C20	E01
Information										470 547	C10	
x 1, COIL ON RAIL												
1.4												
Petrol 88 10/11-10/15 A 14 NEL, B 14 NEL												
ENGINE												
All engines					A10	A20	A40	A50	A70	C10 - C30	C20	E01
Information										470 547	C10	
x 1, COIL ON RAIL												
1.4 Turbo												
Petrol 103 12/09-10/15 A 14 NET, B 14 NET												
ENGINE												
All engines					A10	A20	A40	A50	A70	C10 - C30	C20	E01
Information										470 547	C10	
x 1, COIL ON RAIL												
1.4 Turbo												
Petrol 88 08/10-> A 14 NEL												
ENGINE												
All engines					A10	A20	A40	A50	A70	C10 - C30	C20	E01
Information										470 547	C10	
x 1, COIL ON RAIL										470 547	C10	
1.6												
Petrol 132 10/11-10/15 A 16 LET												
ENGINE												
All engines					A10	A20	A40	A50	A70	C10 - C30	C20	E01
Information										470 545	C10	
x 1, COIL ON PLUG												
1.6												
Petrol 85 12/09-10/15 A 16 XER, B 16 XER												
ENGINE												
All engines					A10	A20	A40	A50	A70	C10 - C30	C20	E01
Information										470 545	C10	
x 1, COIL RAILS												
1.6 Turbo												
Petrol 132 12/09-10/15 A 16 LET												
ENGINE												
All engines					A10	A20	A40	A50	A70	C10 - C30	C20	E01
Information										470 545	C10	
x 1, COIL ON PLUG												
ASTRA VII												
1.0												
Petrol 77 07/15-> B 10 XFL, D 10 XFL												
ENGINE												
All engines					A10	A20	A40	A50	A70	C10 - C30	C20	E01
Information										470 631	C10	
x 3, COIL ON PLUG												
1.4 Turbo												
Petrol 110 07/15-> B 14 XFT												
ENGINE												
All engines					A10	A20	A40	A50	A70	C10 - C30	C20	E01
Information										470 631	C10	
x 4, COIL ON PLUG												
1.4 Turbo												
Petrol 92 07/15-> B 14 XFL												
ENGINE												
All engines					A10	A20	A40	A50	A70	C10 - C30	C20	E01
Information										470 631	C10	
x 4, COIL ON PLUG												
ASTRAVAN I												
1.4 i												
Petrol 44 09/91-08/95 C 14 NZ												
ENGINE												
All engines					A10	A20	A40	A50	A70	C10 - C30	C20	E01
Information							806 249					
connector type SAE, version Bosch							806 256					
All engines												
connector type M4, version Bosch												

A10 CONDENSER	A20 CONTACT SET	A40 DISTRIBUTOR CAP	A50 ROTOR	A70 PICK-UP
C10 COIL	C20 IGNITION MODULE	C30 ELECTRONIC IGNITION KIT	E01 IGNITION CABLE SET	

Vehicle	alim.	kW	Date	Engine	FUNCTIONS ON THE VEHICLE							
					A10	A20	A40	A50	A70	C10 - C30	C20	E01

ASTRAVAN I

1.4 i	Petrol	44	09/91-08/95	ENGINE C 14 NZ
-------	--------	----	-------------	-------------------

Engine	Information	A10	A20	A40	A50	A70	C10 - C30	C20	E01
All engines	version Bosch				906 121R				
All engines	version Lucas				928 028R	428 202			
All engines							470 140	C10	465 036
All engines	->eng. 02BF1476, 19241623								360 237
All engines	eng. type 02BF1477, 19241624 ->								360 529

1.6 i	Petrol	52	09/94-08/96	ENGINE X 16 SZ
-------	--------	----	-------------	-------------------

Engine	Information	A10	A20	A40	A50	A70	C10 - C30	C20	E01
All engines	->eng. 02BE6166								359 634
All engines	eng. type 02BE6167 ->								360 531

1.6 i	Petrol	55	10/91-08/98	ENGINE C 16 NZ
-------	--------	----	-------------	-------------------

Engine	Information	A10	A20	A40	A50	A70	C10 - C30	C20	E01
All engines	version Delco Remy			812 073	912 100	412 010			
All engines							470 341	C10	465 025
All engines	->eng. 02V65825								359 514

ASTRAVAN II

1.4 16V	Petrol	66	09/00-05/05	ENGINE Z 14 XE
---------	--------	----	-------------	-------------------

Engine	Information	A10	A20	A40	A50	A70	C10 - C30	C20	E01
All engines	x 1, COIL ON PLUG, incl. spark plug connector						470 399	C10	

1.6 Dualfuel	Petrol/ Liquified Petro- leum Gas (LPG)	74	07/00-08/05	ENGINE Z 16 XE, Z 16 XEP
--------------	---	----	-------------	-----------------------------

Engine	Information	A10	A20	A40	A50	A70	C10 - C30	C20	E01
Eng. Z 16 XE	x 1, COIL ON PLUG, incl. spark plug connector						470 399	C10	
All engines	x 1, DELPHI, COIL ON PLUG, incl. spark plug connector						470 450	C10	

1.6 Dualfuel 16V	Petrol/ Liquified Petro- leum Gas (LPG)	77	10/04-12/05	ENGINE Z 16 XEP
------------------	---	----	-------------	--------------------

Engine	Information	A10	A20	A40	A50	A70	C10 - C30	C20	E01
All engines	x 1, DELPHI, COIL ON PLUG, incl. spark plug connector						470 450	C10	

1.6 i	Petrol	55	08/98-09/00	ENGINE X 16 SZR
-------	--------	----	-------------	--------------------

Engine	Information	A10	A20	A40	A50	A70	C10 - C30	C20	E01
All engines									360 904

1.6 i	Petrol	62	09/00-08/06	ENGINE Z 16 SE
-------	--------	----	-------------	-------------------

Engine	Information	A10	A20	A40	A50	A70	C10 - C30	C20	E01
All engines									360 904

ASTRAVAN III

1.4 i	Petrol	66	03/05->	ENGINE Z 14 XEP
-------	--------	----	---------	--------------------

Engine	Information	A10	A20	A40	A50	A70	C10 - C30	C20	E01
All engines	x 1, BOSCH, COIL ON PLUG, incl. spark plug connector						470 400	C10	

1.6	Petrol	76	03/05->	ENGINE Z 16 XE1, Z 16 XEP
-----	--------	----	---------	------------------------------

Engine	Information	A10	A20	A40	A50	A70	C10 - C30	C20	E01
All engines	x 1, DELPHI, COIL ON PLUG, incl. spark plug connector						470 450	C10	

CALIBRA

2.0 i	Petrol	85	06/90-07/97	ENGINE C 20 NE
-------	--------	----	-------------	-------------------

Engine	Information	A10	A20	A40	A50	A70	C10 - C30	C20	E01
All engines	version Bosch			806 257	906 127R				
All engines	version Ducellier			815 084	915 103R				

A10 CONDENSER	A20 CONTACT SET	A40 DISTRIBUTOR CAP	A50 ROTOR	A70 PICK-UP
C10 COIL	C20 IGNITION MODULE	C30 ELECTRONIC IGNITION KIT	E01 IGNITION CABLE SET	

FUNCTIONS ON THE VEHICLE

Vehicle	alim.	kW	Date	Engine	 A10	 A20	 A40	 A50	 A70	 C10 - C30	 C20	 E01
---------	-------	----	------	--------	---	---	---	--	---	---	---	---

CALIBRA

				ENGINE
2.0 i	Petrol	85	06/90-07/97	C 20 NE

Engine	Information	A10	A20	A40	A50	A70	C10 - C30	C20	E01
All engines	->eng. 14180385, info WY						470 191	C10	
All engines	eng. type 14180386 ->, info WE						470 192	C10	
All engines	eng. type 14672353 ->, ->ch. R1..., R9..., no specific info conc. application available								359 689

				ENGINE
2.0 i 16V	Petrol	100	06/90-07/97	X 20 XEV

Engine	Information	A10	A20	A40	A50	A70	C10 - C30	C20	E01
All engines							470 272	C10	
All engines	ch. 14195307 ->								360 506
All engines	->ch. 14195306								360 562

				ENGINE
2.0 i 16V	Petrol	110	06/90-02/94	C 20 XE

Engine	Information	A10	A20	A40	A50	A70	C10 - C30	C20	E01
All engines	version Bosch			806 251	906 121R				
All engines	ch. P1000001, P9000001 ->						470 273	C10	359 688

				ENGINE
2.0 i 16V 4x4	Petrol	100	02/94-07/97	X 20 XEV

Engine	Information	A10	A20	A40	A50	A70	C10 - C30	C20	E01
All engines							470 272	C10	
All engines	ch. 14195307 ->								360 506
All engines	->ch. 14195306								360 562

				ENGINE
2.0 i 16V 4x4	Petrol	110	06/90-02/94	C 20 XE

Engine	Information	A10	A20	A40	A50	A70	C10 - C30	C20	E01
All engines	version Bosch			806 251	906 121R				
All engines	ch. P1000001, P9000001 ->						470 273	C10	359 688

				ENGINE
2.0 i 4x4	Petrol	85	06/90-07/97	C 20 NE

Engine	Information	A10	A20	A40	A50	A70	C10 - C30	C20	E01
All engines	version Bosch			806 257	906 127R				
All engines	version Ducellier			815 084	915 103R				
All engines	->eng. 14180385, info WY						470 191	C10	
All engines	eng. type 14180386 ->, info WE						470 192	C10	
All engines	eng. type 14672353 ->, ->ch. R1..., R9..., no specific info conc. application available								359 689

				ENGINE
2.0 i Turbo 4x4	Petrol	150	03/92-07/97	C 20 LET

Engine	Information	A10	A20	A40	A50	A70	C10 - C30	C20	E01
All engines	version Bosch			806 257	906 121R				

CASCADA

				ENGINE
1.4	Petrol	103	02/13->	A 14 NET, B 14 NET

Engine	Information	A10	A20	A40	A50	A70	C10 - C30	C20	E01
All engines	x 1, COIL ON RAIL						470 547	C10	

				ENGINE
1.4	Petrol	88	02/13->	A 14 NEL

Engine	Information	A10	A20	A40	A50	A70	C10 - C30	C20	E01
All engines							470 547	C10	

CAVALIER

				ENGINE
1.3	Petrol	43	08/77-01/81	--, LW4

Engine	Information	A10	A20	A40	A50	A70	C10 - C30	C20	E01
All engines					912 090				

				ENGINE
1300	Petrol	44	08/77-08/81	13 N









Engine	Information	A10	A20	A40	A50	A70	C10 - C30	C20	E01
All engines					912 090				

A10 CONDENSER	A20 CONTACT SET	A40 DISTRIBUTOR CAP	A50 ROTOR	A70 PICK-UP
C10 COIL	C20 IGNITION MODULE	C30 ELECTRONIC IGNITION KIT	E01 IGNITION CABLE SET	

				FUNCTIONS ON THE VEHICLE								
Vehicle	alim.	kW	Date	Engine								
CAVALIER CC												
1.3	Petrol	42	08/75-08/81	ENGINE --, LW4								
Engine Information					A10	A20	A40	A50	A70	C10 - C30	C20	E01
All engines								912 090				
CHEVETTE												
1.2	Petrol	39	09/76-12/85	ENGINE 13 N								
Engine Information					A10	A20	A40	A50	A70	C10 - C30	C20	E01
All engines								912 090				
1300	Petrol	39	03/75-12/85	ENGINE 13 N								
Engine Information					A10	A20	A40	A50	A70	C10 - C30	C20	E01
All engines								912 090				
1300	Petrol	42	09/74-12/85	ENGINE 13 S								
Engine Information					A10	A20	A40	A50	A70	C10 - C30	C20	E01
All engines								912 090				
COMBO B												
1.2	Petrol	33	07/94-10/01	ENGINE C 12 NZ, X 12 SZ								
Engine Information					A10	A20	A40	A50	A70	C10 - C30	C20	E01
Eng. C 12 NZ version Bosch							806 256	906 121R				
Eng. C 12 NZ version Lucas							828 100	928 028R				
Eng. C 12 NZ									470 140	C10	465 036	
All engines ch. 19019894 ->, ->ch. 19334654												358 195
All engines ch. 19334657 ->												358 199
All engines ->ch. 19019893												360 237
1.4	Petrol	44	07/94-10/01	ENGINE C 14 NZ								
Engine Information					A10	A20	A40	A50	A70	C10 - C30	C20	E01
All engines version Bosch							806 256	906 121R				
All engines version Lucas							828 100	928 028R				
All engines									470 140	C10	465 036	
All engines ->ch. 02BF1475, 19241622												358 195
All engines ch. 02BF1476, 19241623 ->, -air conditioning												358 199
All engines ch. 02BF1476, 19241623 ->, +air conditioning												360 529
1.4	Petrol	60	07/94-10/01	ENGINE C 14 SE								
Engine Information					A10	A20	A40	A50	A70	C10 - C30	C20	E01
All engines ->ch. 02BD1412, 19262000												359 634
All engines ch. 02HY3580 ->												360 904
1.4 16V	Petrol	66	08/99-10/01	ENGINE X 14 XE								
Engine Information					A10	A20	A40	A50	A70	C10 - C30	C20	E01
All engines ->ch. 20C17331												359 688
All engines ch. 20C17332 ->												360 559
COMBO C												
1.4	Petrol	66	10/04-09/10	ENGINE Z 14 XEP								
Engine Information					A10	A20	A40	A50	A70	C10 - C30	C20	E01
All engines x 1, BOSCH, COIL ON PLUG, incl. spark plug connector										470 400	C10	
1.4 16V	Petrol	66	10/01-05/07	ENGINE Z 14 XE								
Engine Information					A10	A20	A40	A50	A70	C10 - C30	C20	E01
All engines										470 399	C10	
1.4 i 16V	Petrol	66	01/04-11/11	ENGINE Z 14 XEP								
Engine Information					A10	A20	A40	A50	A70	C10 - C30	C20	E01
All engines x 1, BOSCH, COIL ON PLUG, incl. spark plug connector										470 400	C10	

A10	CONDENSER	A20	CONTACT SET	A40	DISTRIBUTOR CAP	A50	ROTOR	A70	PICK-UP
C10	COIL	C20	IGNITION MODULE	C30	ELECTRONIC IGNITION KIT	E01	IGNITION CABLE SET		

The present application list is a brief version. For the detailed information about the possibility of installation on a specific vehicle, please refer to our web-catalogue <http://catalogo.facet.eu/>

					FUNCTIONS ON THE VEHICLE							
Vehicle	alim.	kW	Date	Engine								
ENGINE												
1.6	Petrol	62	09/01-10/04	Z 16 SE								
Engine Information					A10	A20	A40	A50	A70	C10 - C30	C20	E01
All engines												360 904
ENGINE												
1.6	Petrol	64	10/01-11/11	Z 16 SE								
Engine Information					A10	A20	A40	A50	A70	C10 - C30	C20	E01
All engines												360 904
ENGINE												
1.6 CNG	Petrol/ Com- pressed Natural Gas (CNG)	69	06/06-09/10	Z 16 YNG								
Engine Information					A10	A20	A40	A50	A70	C10 - C30	C20	E01
All engines										470 399	C10	
ENGINE												
1.6 CNG	Petrol/ Com- pressed Natural Gas (CNG)	71	04/05-02/12	Z 16 YNG								
Engine Information					A10	A20	A40	A50	A70	C10 - C30	C20	E01
All engines										470 399	C10	
ENGINE												
1.6 CNG 16V	Petrol/ Com- pressed Natural Gas (CNG)	69	06/06-02/12	Y 16 YNG, Z 16 YNG								
Engine Information					A10	A20	A40	A50	A70	C10 - C30	C20	E01
All engines										470 399	C10	
ENGINE												
1.6 CNG 16V	Petrol/ Com- pressed Natural Gas (CNG)	71	04/05-02/12	Z 16 YNG								
Engine Information					A10	A20	A40	A50	A70	C10 - C30	C20	E01
All engines										470 399	C10	

COMBO D												
Vehicle	alim.	kW	Date	Engine								
1.4	Petrol	70	11/11->	A 14 FP								
Engine Information					A10	A20	A40	A50	A70	C10 - C30	C20	E01
All engines										470 442	C10	

CORSA												
Vehicle	alim.	kW	Date	Engine								
1.2	Petrol	55	07/19->	F 12 XEL (EB2FAD)								
Engine Information					A10	A20	A40	A50	A70	C10 - C30	C20	E01
All engines										470 609	C10	

CORSA B												
Vehicle	alim.	kW	Date	Engine								
1.0 i 12V	Petrol	40	11/96-09/00	X 10 XE								
Engine Information					A10	A20	A40	A50	A70	C10 - C30	C20	E01
All engines										470 398	C10	

ENGINE												
Vehicle	alim.	kW	Date	Engine								
1.2 i	Petrol	33	03/93-09/00	C 12 NZ, X 12 SZ								
Engine Information					A10	A20	A40	A50	A70	C10 - C30	C20	E01
Eng. C 12 NZ							806 256	906 121R				
Eng. C 12 NZ							828 100	928 028R				
Eng. C 12 NZ										470 140	C10	465 036
All engines												358 195
All engines												358 199
All engines												360 237

A10 CONDENSER	A20 CONTACT SET	A40 DISTRIBUTOR CAP	A50 ROTOR	A70 PICK-UP
C10 COIL	C20 IGNITION MODULE	C30 ELECTRONIC IGNITION KIT	E01 IGNITION CABLE SET	

Vehicle	alim.	kW	Date	Engine	FUNCTIONS ON THE VEHICLE									
					A10	A20	A40	A50	A70	C10 - C30	C20	E01		
ENGINE														
1.2 i 16V	Petrol	48	03/98-09/00	X 12 XE										
ENGINE														
ENGINE														
1.4 i	Petrol	44	03/93-09/00	C 14 NZ, X 14 SZ										
ENGINE														
ENGINE														
1.4 i 16V	Petrol	66	09/94-09/00	X 14 XE										
ENGINE														
ENGINE														
1.4 i S	Petrol	60	03/93-09/00	C 14 SE										
ENGINE														
ENGINE														
1.6 GSI 16V	Petrol	80	03/93-09/00	C 16 XE										
ENGINE														
ENGINE														
1.6 i 16V	Petrol	78	09/94-09/00	X 16 XE										
ENGINE														
ENGINE														
CORSA C														
1.0 12V	Petrol	43	09/00-10/03	Z 10 XE										
ENGINE														
ENGINE														
1.0 12V	Petrol	44	11/03-10/06	Z 10 XEP										
ENGINE														
ENGINE														
1.2 16V	Petrol	55	09/00-10/06	Z 12 XE										
ENGINE														
ENGINE														
1.2 16V Dualfuel	Petrol/ Liquified Petro- leum Gas (LPG)	55	08/01-10/06	Z 12 XE										
ENGINE														
ENGINE														
1.2 Twinport	Petrol	59	07/04-10/06	Z 12 XEP										
ENGINE														
ENGINE														

A10	CONDENSER	A20	CONTACT SET	A40	DISTRIBUTOR CAP	A50	ROTOR	A70	PICK-UP
C10	COIL	C20	IGNITION MODULE	C30	ELECTRONIC IGNITION KIT	E01	IGNITION CABLE SET		

The present application list is a brief version. For the detailed information about the possibility of installation on a specific vehicle, please refer to our web-catalogue <http://catalogo.facet.eu/>

CORSA D					FUNCTIONS ON THE VEHICLE							
Vehicle	alim.	kW	Date	Engine	A10	A20	A40	A50	A70	C10 - C30	C20	E01
ENGINE												
1.4 16V	Petrol	66	09/00-10/06	Z 14 XE								
ENGINE												
Engine	Information				A10	A20	A40	A50	A70	C10 - C30	C20	E01
All engines	x 4, COIL ON PLUG, incl. spark plug connector									470 399	C10	
ENGINE												
1.4 Twinport	Petrol	66	06/03-10/06	Z 14 XEP								
ENGINE												
Engine	Information				A10	A20	A40	A50	A70	C10 - C30	C20	E01
All engines	x 1, BOSCH, COIL ON PLUG, incl. spark plug connector									470 400	C10	
ENGINE												
1.8 16V	Petrol	92	08/00-09/06	Z 18 XE								
ENGINE												
Engine	Information				A10	A20	A40	A50	A70	C10 - C30	C20	E01
All engines	x 1, COIL ON PLUG, incl. spark plug connector									470 508	C10	
CORSA D												
ENGINE												
1.0	Petrol	44	08/06-08/14	Z 10 XEP								
ENGINE												
Engine	Information				A10	A20	A40	A50	A70	C10 - C30	C20	E01
All engines	x 3, BOSCH, COIL ON PLUG, 12 Volt, Dia: 55 mm, for pre-resistance									470 398	C10	
ENGINE												
1.2	Petrol	51	06/10-08/14	A 12 XEL								
ENGINE												
Engine	Information				A10	A20	A40	A50	A70	C10 - C30	C20	E01
All engines	x 1, COIL ON RAIL									470 547	C10	
ENGINE												
1.2	Petrol	59	08/06-08/14	Z 12 XEP								
ENGINE												
Engine	Information				A10	A20	A40	A50	A70	C10 - C30	C20	E01
All engines	x 1, BOSCH, COIL ON PLUG, incl. spark plug connector									470 400	C10	
ENGINE												
1.2 i 16V	Petrol	63	12/09-08/14	A 12 XER								
ENGINE												
Engine	Information				A10	A20	A40	A50	A70	C10 - C30	C20	E01
All engines	x 1, COIL ON RAIL									470 547	C10	
ENGINE												
1.2 LPG	Petrol/ Liquified Petro- leum Gas (LPG)	59	09/09-08/14	Z 12 XEP								
ENGINE												
Engine	Information				A10	A20	A40	A50	A70	C10 - C30	C20	E01
All engines	x 1, BOSCH, COIL ON PLUG, incl. spark plug connector									470 400	C10	
ENGINE												
1.2 LPG	Petrol/ Liquified Petro- leum Gas (LPG)	61	06/11-08/14	A 12 XER								
ENGINE												
Engine	Information				A10	A20	A40	A50	A70	C10 - C30	C20	E01
All engines	x 1, COIL ON RAIL									470 547	C10	
ENGINE												
1.2 LPG	Petrol/ Liquified Petro- leum Gas (LPG)	63	08/11-08/14	A 12 XER								
ENGINE												
Engine	Information				A10	A20	A40	A50	A70	C10 - C30	C20	E01
All engines	x 1, COIL ON RAIL									470 547	C10	
ENGINE												
1.4	Petrol	64	09/09-08/14	A 14 XEL								
ENGINE												
Engine	Information				A10	A20	A40	A50	A70	C10 - C30	C20	E01
All engines	x 1, COIL ON RAIL									470 547	C10	
ENGINE												
1.4	Petrol	66	08/06-08/14	Z 14 XEP								
ENGINE												
Engine	Information				A10	A20	A40	A50	A70	C10 - C30	C20	E01
All engines	x 1, BOSCH, COIL ON PLUG, incl. spark plug connector									470 400	C10	
ENGINE												
1.4	Petrol	74	01/10-08/14	A 14 XER								
ENGINE												
Engine	Information				A10	A20	A40	A50	A70	C10 - C30	C20	E01
All engines	x 1, COIL ON RAIL									470 547	C10	

A10 CONDENSER	A20 CONTACT SET	A40 DISTRIBUTOR CAP	A50 ROTOR	A70 PICK-UP
C10 COIL	C20 IGNITION MODULE	C30 ELECTRONIC IGNITION KIT	E01 IGNITION CABLE SET	

Vehicle	alim.	kW	Date	Engine	FUNCTIONS ON THE VEHICLE											
					A10	A20	A40	A50	A70	C10 - C30	C20	E01				
ENGINE																
1.4	Petrol	88	08/12-08/14	A 14 NEL												
ENGINE																
Engine					Information				A10	A20	A40	A50	A70	C10 - C30	C20	E01
All engines					x 1, COIL ON RAIL									470 547	C10	
ENGINE																
1.4 LPG	Petrol/ Liquified Petro- leum Gas (LPG)	64	09/09-08/14	A 14 XEL												
ENGINE																
Engine					Information				A10	A20	A40	A50	A70	C10 - C30	C20	E01
All engines														470 547	C10	
ENGINE																
1.4 LPG	Petrol/ Liquified Petro- leum Gas (LPG)	66	07/06-08/14	Z 14 XEP												
ENGINE																
Engine					Information				A10	A20	A40	A50	A70	C10 - C30	C20	E01
All engines					x 1, BOSCH, COIL ON PLUG, incl. spark plug connector									470 400	C10	
ENGINE																
1.6 SRI	Petrol	110	05/07-08/14	A 16 LEL, Z 16 LEL												
ENGINE																
Engine					Information				A10	A20	A40	A50	A70	C10 - C30	C20	E01
All engines					x 1, DELPHI, COIL ON PLUG, incl. spark plug connector									470 450	C10	
ENGINE																
1.6 VXR	Petrol	141	11/06-08/14	A 16 LER, B16LER, Z 16 LER												
ENGINE																
Engine					Information				A10	A20	A40	A50	A70	C10 - C30	C20	E01
All engines					x 1, DELPHI, COIL ON PLUG, incl. spark plug connector									470 450	C10	
ENGINE																
1.6 VXR	Petrol	150	06/11-08/14	A 16 LES, Z 16 LER												
ENGINE																
Engine					Information				A10	A20	A40	A50	A70	C10 - C30	C20	E01
Eng. A 16 LES					x 1, DELPHI, COIL ON PLUG, incl. spark plug connector									470 450	C10	
Eng. Z 16 LER														470 450	C10	
ENGINE																
1.6 VXR	Petrol	154	06/11-08/14	A 16 LES												
ENGINE																
Engine					Information				A10	A20	A40	A50	A70	C10 - C30	C20	E01
All engines					x 1, DELPHI, COIL ON PLUG, incl. spark plug connector									470 450	C10	
ENGINE																
1.6 VXR	Petrol	155	06/11-03/12	A 16 LES												
ENGINE																
Engine					Information				A10	A20	A40	A50	A70	C10 - C30	C20	E01
All engines					x 1, DELPHI, COIL ON PLUG, incl. spark plug connector									470 450	C10	
CORSA E																
ENGINE																
1.0	Petrol	66	08/14->	B 10 XFL, D 10 XFL, F 10 XFL												
ENGINE																
Engine					Information				A10	A20	A40	A50	A70	C10 - C30	C20	E01
All engines					x 3, COIL ON PLUG									470 631	C10	
ENGINE																
1.0	Petrol	85	08/14->	B 10 XFT, D 10 XFT												
ENGINE																
Engine					Information				A10	A20	A40	A50	A70	C10 - C30	C20	E01
All engines					x 3, COIL ON PLUG									470 631	C10	
ENGINE																
1.2	Petrol	51	08/14->	B 12 XEL												
ENGINE																
Engine					Information				A10	A20	A40	A50	A70	C10 - C30	C20	E01
All engines					x 1, COIL ON RAIL									470 547	C10	
ENGINE																
1.4	Petrol	110	07/15->	B 14 NEH												
ENGINE																
Engine					Information				A10	A20	A40	A50	A70	C10 - C30	C20	E01
All engines					x 1, COIL ON RAIL									470 547	C10	
ENGINE																
1.4	Petrol	55	09/14->	B 14 XEJ												
ENGINE																
Engine					Information				A10	A20	A40	A50	A70	C10 - C30	C20	E01
All engines					x 1, COIL ON RAIL									470 547	C10	

A10	CONDENSER	A20	CONTACT SET	A40	DISTRIBUTOR CAP	A50	ROTOR	A70	PICK-UP
C10	COIL	C20	IGNITION MODULE	C30	ELECTRONIC IGNITION KIT	E01	IGNITION CABLE SET		

The present application list is a brief version. For the detailed information about the possibility of installation on a specific vehicle, please refer to our web-catalogue <http://catalogo.facet.eu/>

					FUNCTIONS ON THE VEHICLE							
Vehicle	alim.	kW	Date	Engine								

				ENGINE
1.4	Petrol	66	08/14->	B 14 XEJ, B 14 XEL, D 14 XEL

Engine	Information	A10	A20	A40	A50	A70	C10 - C30	C20	E01
Eng. B 14 XEJ							470 547	C10	
Eng. B 14 XEL, D 14 XEL	x 1, COIL ON RAIL						470 547	C10	

				ENGINE
1.4	Petrol	74	08/14->	B14NEJ, D 14 NEJ

Engine	Information	A10	A20	A40	A50	A70	C10 - C30	C20	E01
All engines	x 1, COIL ON RAIL						470 547	C10	

				ENGINE
1.4 LPG	Petrol/ Liquified Petro- leum Gas (LPG)	66	08/14->	B 14 XEL

Engine	Information	A10	A20	A40	A50	A70	C10 - C30	C20	E01
All engines							470 547	C10	

				ENGINE
1.6 VXR	Petrol	151	04/15->	B 16 LES

Engine	Information	A10	A20	A40	A50	A70	C10 - C30	C20	E01
All engines	x 1, COIL ON PLUG						470 545	C10	

CORSAVAN I

				ENGINE
1.4 i	Petrol	44	01/94-09/00	C 14 NZ

Engine	Information	A10	A20	A40	A50	A70	C10 - C30	C20	E01
All engines	version Bosch			806 256	906 121R				
All engines	version Lucas			828 100	928 028R				
All engines							470 140	C10	465 036
All engines	->ch. 02BF1475, 19241622								358 195
All engines	ch. 02BF1476, 19241623 ->, -air conditioning								358 199
All engines	ch. 02BF1476, 19241623 ->, +air conditioning								360 529

CORSAVAN II

				ENGINE
1.2 16V	Petrol	55	09/00-06/06	Z 12 XE

Engine	Information	A10	A20	A40	A50	A70	C10 - C30	C20	E01
All engines	->ch. 36999999, ch. 37000000 ->, x 1, x 4, BOSCH, COIL ON PLUG, incl. spark plug connector						470 400	C10	

				ENGINE
1.2 16V	Petrol	59	07/04-11/06	Z 12 XEP

Engine	Information	A10	A20	A40	A50	A70	C10 - C30	C20	E01
All engines	x 1, BOSCH, COIL ON PLUG, incl. spark plug connector						470 400	C10	

				ENGINE
1.2 16V Dualfuel	Petrol/ Liquified Petro- leum Gas (LPG)	55	08/01-06/06	Z 12 XE

Engine	Information	A10	A20	A40	A50	A70	C10 - C30	C20	E01
All engines	->ch. 36999999, ch. 37000000 ->, x 1, x 4, BOSCH, COIL ON PLUG, incl. spark plug connector						470 400	C10	

				ENGINE
1.2 16V Dualfuel	Petrol/ Liquified Petro- leum Gas (LPG)	59	07/04-12/05	Z 12 XEP

Engine	Information	A10	A20	A40	A50	A70	C10 - C30	C20	E01
All engines	x 1, BOSCH, COIL ON PLUG, incl. spark plug connector						470 400	C10	

				ENGINE
1.4	Petrol	66	11/03-06/06	Z 14 XEP

Engine	Information	A10	A20	A40	A50	A70	C10 - C30	C20	E01
All engines	x 1, BOSCH, COIL ON PLUG, incl. spark plug connector						470 400	C10	

CORSAVAN III

				ENGINE
1.2	Petrol	51	01/10->	A 12 XEL









Engine	Information	A10	A20	A40	A50	A70	C10 - C30	C20	E01
All engines	x 1, COIL ON RAIL						470 547	C10	

A10 CONDENSER	A20 CONTACT SET	A40 DISTRIBUTOR CAP	A50 ROTOR	A70 PICK-UP
C10 COIL	C20 IGNITION MODULE	C30 ELECTRONIC IGNITION KIT	E01 IGNITION CABLE SET	

Vehicle	alim.	kW	Date	Engine	FUNCTIONS ON THE VEHICLE									
					A10	A20	A40	A50	A70	C10 - C30	C20	E01		
ENGINE														
1.2	Petrol	59	07/09->	Z 12 XEP										
ENGINE														
All engines					x 1, BOSCH, COIL ON PLUG, incl. spark plug connector						470 400	C10		
CORSAVAN IV														
ENGINE														
1.2	Petrol	51	10/14->	B 12 XEL										
ENGINE														
All engines					x 1, COIL ON RAIL						470 547	C10		
ENGINE														
1.4	Petrol	55	10/14->	B 14 XEJ										
ENGINE														
All engines											470 547	C10		
CRESTA														
ENGINE														
2.7	Petrol	84	01/64-10/72	--										
ENGINE														
All engines								912 090						
ENGINE														
3.3	Petrol	91	01/64-10/72	--										
ENGINE														
All engines								912 090						
CROSSLAND X														
ENGINE														
1.2	Petrol	61	03/17->	B 12 XE (EB2F), D 12 XE (EB2FA), F12XE(EB2FA)										
ENGINE														
All engines					x 3, COIL ON PLUG						470 609	C10		
ENGINE														
1.2	Petrol	81	03/17->	B 12 XHL (EB2DT)										
ENGINE														
All engines					x 3, COIL ON PLUG						470 620	C10		
ENGINE														
1.2	Petrol	96	03/17->	B 12 XHT (EB2DTS)										
ENGINE														
All engines					x 3, COIL ON PLUG						470 620	C10		
FIRENZA														
ENGINE														
1300	Petrol	40	01/71-10/73	--										
ENGINE														
All engines								912 090						
FRONTERA A														
ENGINE														
2.0	Petrol	85	04/95-08/98	C 20 NE, X 20 SE										
ENGINE														
Eng. C 20 NE					version Bosch			806 257	906 127R					
Eng. C 20 NE					version Ducellier			815 084	915 103R					
Eng. C 20 NE										470 192	C10			
Eng. X 20 SE										470 273	C10		360 947	
Eng. C 20 NE					->eng. 14672353								359 527	
Eng. C 20 NE					eng. type 14672354 ->								359 689	
ENGINE														
2.0i	Petrol	85	03/92-10/98	C 20 NE, X 20 SE										
ENGINE														
Eng. C 20 NE					version Bosch			806 257	906 127R					
Eng. C 20 NE					version Ducellier			815 084	915 103R					
Eng. C 20 NE										470 192	C10			
Eng. X 20 SE										470 273	C10		360 947	
Eng. C 20 NE					->eng. 14672353								359 527	
Eng. C 20 NE					eng. type 14672354 ->								359 689	

A10	CONDENSER	A20	CONTACT SET	A40	DISTRIBUTOR CAP	A50	ROTOR	A70	PICK-UP
C10	COIL	C20	IGNITION MODULE	C30	ELECTRONIC IGNITION KIT	E01	IGNITION CABLE SET		

The present application list is a brief version. For the detailed information about the possibility of installation on a specific vehicle, please refer to our web-catalogue <http://catalogo.facet.eu/>

					FUNCTIONS ON THE VEHICLE							
Vehicle	alim.	kW	Date	Engine								
ENGINE												
2.2 i	Petrol	100	03/95-10/98	X 22 XE								
Engine	Information				A10	A20	A40	A50	A70	C10 - C30	C20	E01
All engines										470 273	C10	
ENGINE												
2.4 i	Petrol	92	03/92-10/98	C 24 NE								
Engine	Information				A10	A20	A40	A50	A70	C10 - C30	C20	E01
All engines	version Bosch						806 256	906 121R				
All engines										470 192	C10	
GRANDLAND X												
ENGINE												
1.2 Turbo	Petrol	96	06/17->	B 12 XHT (EB2DTS)								
Engine	Information				A10	A20	A40	A50	A70	C10 - C30	C20	E01
All engines	x 3, COIL ON PLUG									470 620	C10	
ENGINE												
1.6 Turbo Hybrid	Petrol/ Electric	133	12/19->	D 16 XHT (EP6FADTXHP)								
Engine	Information				A10	A20	A40	A50	A70	C10 - C30	C20	E01
All engines	x 4, COIL ON PLUG									470 475	C10	
ENGINE												
1.6 Turbo Hybrid	Petrol/ Electric	165	12/19->	D 16 XHT (EP6FADTXHP)								
Engine	Information				A10	A20	A40	A50	A70	C10 - C30	C20	E01
All engines	x 4, COIL ON PLUG									470 475	C10	
ENGINE												
1.6 Turbo Hybrid4	Petrol/ Electric	147	06/19->	D 16 XHT (EP6FADTXHP)								
Engine	Information				A10	A20	A40	A50	A70	C10 - C30	C20	E01
All engines	x 4, COIL ON PLUG									470 475	C10	
ENGINE												
1.6 Turbo Hybrid4	Petrol/ Electric	221	06/19->	D 16 XHT (EP6FADTXHP)								
Engine	Information				A10	A20	A40	A50	A70	C10 - C30	C20	E01
All engines	x 4, COIL ON PLUG									470 475	C10	
INSIGNIA												
ENGINE												
1.4	Petrol	103	04/11-05/17	A 14 NET, B 14 NET								
Engine	Information				A10	A20	A40	A50	A70	C10 - C30	C20	E01
All engines	x 1, COIL ON RAIL									470 547	C10	
ENGINE												
1.4 LPG	Petrol/ Liquified Petro- leum Gas (LPG)	103	07/12-05/17	A 14 NET								
Engine	Information				A10	A20	A40	A50	A70	C10 - C30	C20	E01
All engines	x 1, COIL ON RAIL									470 547	C10	
ENGINE												
1.5	Petrol	103	03/17->	B 15 SFL, D 15 SFL								
Engine	Information				A10	A20	A40	A50	A70	C10 - C30	C20	E01
All engines	x 4, COIL ON PLUG									470 631	C10	
ENGINE												
1.5	Petrol	121	03/17->	B 15 SFT, D 15 SFT, D15XHT								
Engine	Information				A10	A20	A40	A50	A70	C10 - C30	C20	E01
All engines	x 4, COIL ON PLUG									470 631	C10	
ENGINE												
1.6	Petrol	85	07/08-05/17	A 16 XER								
Engine	Information				A10	A20	A40	A50	A70	C10 - C30	C20	E01
All engines										470 545	C10	
All engines	x 1, COIL ON PLUG									470 545	C10	

A10 CONDENSER	A20 CONTACT SET	A40 DISTRIBUTOR CAP	A50 ROTOR	A70 PICK-UP
C10 COIL	C20 IGNITION MODULE	C30 ELECTRONIC IGNITION KIT	E01 IGNITION CABLE SET	

Vehicle	alim.	kW	Date	Engine	FUNCTIONS ON THE VEHICLE							
					A10	A20	A40	A50	A70	C10 - C30	C20	E01
ENGINE												
1.6 Turbo	Petrol	132	01/09-05/17	A 16 LET								
Engine	Information			A10	A20	A40	A50	A70	C10 - C30	C20	E01	
All engines	x 1, DELPHI, COIL ON PLUG, incl. spark plug connector								470 450	C10		
ENGINE												
1.8	Petrol	103	07/08-05/17	A 18 XER, B 18 XER								
Engine	Information			A10	A20	A40	A50	A70	C10 - C30	C20	E01	
All engines	x 1, COIL ON PLUG								470 545	C10		
Eng. B 18 XER									470 545	C10		
MERIVA I												
ENGINE												
1.4 16V Twinport	Petrol	66	01/03-06/10	Z 14 XEP								
Engine	Information			A10	A20	A40	A50	A70	C10 - C30	C20	E01	
All engines	x 1, BOSCH, COIL ON PLUG, incl. spark plug connector								470 400	C10		
ENGINE												
1.6i	Petrol	64	01/03-06/10	Z 16 SE								
Engine	Information			A10	A20	A40	A50	A70	C10 - C30	C20	E01	
All engines											360 904	
ENGINE												
1.6i 16V	Petrol	74	01/03-09/05	Z 16 XE								
Engine	Information			A10	A20	A40	A50	A70	C10 - C30	C20	E01	
All engines	x 4, COIL ON PLUG, incl. spark plug connector								470 399	C10		
ENGINE												
1.6i 16V Twinport	Petrol	77	05/03-06/10	Z 16 XEP								
Engine	Information			A10	A20	A40	A50	A70	C10 - C30	C20	E01	
All engines	x 1, DELPHI, COIL ON PLUG, incl. spark plug connector								470 450	C10		
ENGINE												
1.6 Turbo	Petrol	132	05/06-06/10	Z 16 LET								
Engine	Information			A10	A20	A40	A50	A70	C10 - C30	C20	E01	
All engines	x 1, DELPHI, COIL ON PLUG, incl. spark plug connector								470 450	C10		
ENGINE												
1.8i 16V	Petrol	92	05/03-06/10	Z 18 XE								
Engine	Information			A10	A20	A40	A50	A70	C10 - C30	C20	E01	
All engines	x 1, COIL ON PLUG, incl. spark plug connector								470 508	C10		
MERIVA II												
ENGINE												
1.4	Petrol	103	06/10->	A 14 NET, B 14 NET								
Engine	Information			A10	A20	A40	A50	A70	C10 - C30	C20	E01	
All engines	x 1, COIL ON RAIL								470 547	C10		
ENGINE												
1.4	Petrol	74	06/10->	A 14 XER, B 14 XER								
Engine	Information			A10	A20	A40	A50	A70	C10 - C30	C20	E01	
All engines	x 1, COIL ON RAIL								470 547	C10		
ENGINE												
1.4	Petrol	88	06/10->	A 14 NEL, B 14 NEL								
Engine	Information			A10	A20	A40	A50	A70	C10 - C30	C20	E01	
All engines	x 1, COIL ON RAIL								470 547	C10		
ENGINE												
1.4 LPG	Petrol/ Liquified Petro- leum Gas (LPG)	88	06/11->	A 14 NEL, B 14 NEL								
Engine	Information			A10	A20	A40	A50	A70	C10 - C30	C20	E01	
Eng. A 14 NEL	x 1, COIL ON RAIL								470 547	C10		
Eng. B 14 NEL									470 547	C10		
MOKKA / MOKKA X												
ENGINE												
1.4	Petrol	103	04/13->	A 14 NET, B 14 NET, D 14 NET								
Engine	Information			A10	A20	A40	A50	A70	C10 - C30	C20	E01	
All engines	x 1, COIL ON RAIL								470 547	C10		

A10 CONDENSER	A20 CONTACT SET	A40 DISTRIBUTOR CAP	A50 ROTOR	A70 PICK-UP
C10 COIL	C20 IGNITION MODULE	C30 ELECTRONIC IGNITION KIT	E01 IGNITION CABLE SET	

The present application list is a brief version. For the detailed information about the possibility of installation on a specific vehicle, please refer to our web-catalogue <http://catalogo.facet.eu/>









					FUNCTIONS ON THE VEHICLE							
Vehicle	alim.	kW	Date	Engine	A10	A20	A40	A50	A70	C10 - C30	C20	E01
ENGINE												
1.4 4x4	Petrol	103	06/12->	A 14 NET, B 14 NET, D 14 NET								
Engine	Information				A10	A20	A40	A50	A70	C10 - C30	C20	E01
All engines	x 1, COIL ON RAIL									470 547	C10	
ENGINE												
1.4 4x4	Petrol	112	06/16->	B 14 XFT								
Engine	Information				A10	A20	A40	A50	A70	C10 - C30	C20	E01
All engines	x 4, COIL ON PLUG									470 631	C10	
ENGINE												
1.6	Petrol	85	06/12->	A 16 XER, B 16 XER, D 16 XER								
Engine	Information				A10	A20	A40	A50	A70	C10 - C30	C20	E01
All engines	x 1, COIL RAILS									470 545	C10	
OMEGA B												
2.0	Petrol	85	03/94-09/99	20 SE, X 20 SE								
Engine	Information				A10	A20	A40	A50	A70	C10 - C30	C20	E01
Eng. 20 SE	->ch. K1999999, version Bosch						806 240					
Eng. 20 SE	ch. L1000001 ->, version Bosch						806 257					
Eng. 20 SE	version Ducellier						815 084	915 103R				
Eng. 20 SE	version Bosch						906 127R					
Eng. 20 SE	->eng. 14180385, ch. K1000099 ->									470 191	C10	
Eng. 20 SE	eng. type 14180386 ->									470 192	C10	
Eng. 20 SE	->ch. K1000098									470 194	C10	
Eng. X 20 SE										470 273	C10	
Eng. 20 SE	->eng. 14312950, eng. type 14180386 ->											359 527
Eng. 20 SE	eng. type 14312951 ->											359 689
ENGINE												
2.0 16V	Petrol	100	03/94-07/01	X 20 XEV								
Engine	Information				A10	A20	A40	A50	A70	C10 - C30	C20	E01
All engines										470 272	C10	360 562
SIGNUM												
1.8	Petrol	103	08/05-05/08	Z 18 XER								
Engine	Information				A10	A20	A40	A50	A70	C10 - C30	C20	E01
All engines	x 1, DELPHI, COIL ON PLUG, incl. spark plug connector									470 450	C10	
ENGINE												
1.8	Petrol	90	06/03-07/05	Z 18 XE								
Engine	Information				A10	A20	A40	A50	A70	C10 - C30	C20	E01
All engines	x 1, COIL ON PLUG, incl. spark plug connector									470 508	C10	
SINTRA												
2.2 i 16V	Petrol	104	11/96-04/99	X 22 XE								
Engine	Information				A10	A20	A40	A50	A70	C10 - C30	C20	E01
All engines	x 1, D.I.S.									470 389	C10	
All engines												360 562
SPEEDSTER												
2.0 Turbo	Petrol	147	03/01-09/06	Z 20 LET								
Engine	Information				A10	A20	A40	A50	A70	C10 - C30	C20	E01
All engines										470 507	C10	
ENGINE												
VXR20	Petrol	162	03/01-09/06	Z 20 LET								
Engine	Information				A10	A20	A40	A50	A70	C10 - C30	C20	E01
All engines										470 507	C10	
TIGRA A												
1.4 16V	Petrol	66	07/94-12/00	X 14 XE								
Engine	Information				A10	A20	A40	A50	A70	C10 - C30	C20	E01
All engines	->ch. 20C17331											359 688
All engines	ch. 20C17332 ->											360 559

A10 CONDENSER	A20 CONTACT SET	A40 DISTRIBUTOR CAP	A50 ROTOR	A70 PICK-UP
C10 COIL	C20 IGNITION MODULE	C30 ELECTRONIC IGNITION KIT	E01 IGNITION CABLE SET	

Vehicle	alim.	kW	Date	Engine	FUNCTIONS ON THE VEHICLE									
					A10	A20	A40	A50	A70	C10 - C30	C20	E01		
ENGINE														
1.6 16V	Petrol	78	07/94-12/00	X 16 XE										
Engine Information					A10	A20	A40	A50	A70	C10 - C30	C20	E01		
All engines													359 688	
All engines													360 559	
TIGRA B														
ENGINE														
1.4	Petrol	66	06/04-08/09	Z 14 XEP										
Engine Information					A10	A20	A40	A50	A70	C10 - C30	C20	E01		
All engines										470 400	C10			
ENGINE														
1.8	Petrol	92	06/04-08/09	Z 18 XE										
Engine Information					A10	A20	A40	A50	A70	C10 - C30	C20	E01		
All engines										470 508	C10			
VECTRA B														
ENGINE														
1.6 i	Petrol	55	08/95-03/02	X 16 SZR										
Engine Information					A10	A20	A40	A50	A70	C10 - C30	C20	E01		
All engines													360 531	
All engines													360 904	
ENGINE														
1.6 i 16V	Petrol	74	08/95-03/02	X 16 XEL, Y 16 XE, Z 16 XE										
Engine Information					A10	A20	A40	A50	A70	C10 - C30	C20	E01		
All engines										470 399	C10			
All engines										470 399	C10			
Eng. X 16 XEL													359 688	
ENGINE														
1.8 Dualfuel	Petrol/ Liquified Petro- leum Gas (LPG)	92	09/00-07/03	Z 18 XE										
Engine Information					A10	A20	A40	A50	A70	C10 - C30	C20	E01		
All engines										470 508	C10			
ENGINE														
1.8 i 16V	Petrol	85	09/95-09/00	X 18 XE, X 18 XE1, Z 18 XEL										
Engine Information					A10	A20	A40	A50	A70	C10 - C30	C20	E01		
Eng. X 18 XE										470 272	C10			
Eng. X 18 XE										470 272	C10			
Eng. X 18 XE1										470 508	C10			
Eng. X 18 XE1, Z 18 XEL										470 508	C10			
Eng. X 18 XE													360 506, 360 562	
ENGINE														
1.8 i 16V	Petrol	92	09/00-07/03	Z 18 XE										
Engine Information					A10	A20	A40	A50	A70	C10 - C30	C20	E01		
All engines										470 508	C10			
ENGINE														
2.0 Dualfuel	Petrol/ Liquified Petro- leum Gas (LPG)	100	05/98-01/01	X 20 XEV										
Engine Information					A10	A20	A40	A50	A70	C10 - C30	C20	E01		
All engines										470 272	C10			
ENGINE														
2.0 i	Petrol	82	10/95-03/02	20 NEJ										
Engine Information					A10	A20	A40	A50	A70	C10 - C30	C20	E01		
All engines										470 273	C10			
ENGINE														
2.0 i 16V	Petrol	100	10/95-01/01	X 20 XEV										
Engine Information					A10	A20	A40	A50	A70	C10 - C30	C20	E01		
All engines										470 272	C10			

A10 CONDENSER	A20 CONTACT SET	A40 DISTRIBUTOR CAP	A50 ROTOR	A70 PICK-UP
C10 COIL	C20 IGNITION MODULE	C30 ELECTRONIC IGNITION KIT	E01 IGNITION CABLE SET	

The present application list is a brief version. For the detailed information about the possibility of installation on a specific vehicle, please refer to our web-catalogue <http://catalogo.facet.eu/>

					FUNCTIONS ON THE VEHICLE							
Vehicle	alim.	kW	Date	Engine								
ENGINE												
2.0 i 16V	Petrol	100	10/95-01/01	Z 20 XEV								
Engine	Information				A10	A20	A40	A50	A70	C10 - C30	C20	E01
All engines	no specific info conc. application available											360 506, 360 562
VECTRA C												
ENGINE												
1.6 16V	Petrol	74	06/04-07/08	Z 16 XE								
Engine	Information				A10	A20	A40	A50	A70	C10 - C30	C20	E01
All engines										470 399	C10	
ENGINE												
1.6 16V	Petrol	77	01/06-07/08	Z 16 XEP								
Engine	Information				A10	A20	A40	A50	A70	C10 - C30	C20	E01
All engines										470 450	C10	
ENGINE												
1.8	Petrol	103	01/06-07/08	Z 18 XER								
Engine	Information				A10	A20	A40	A50	A70	C10 - C30	C20	E01
All engines	x 1, DELPHI, COIL ON PLUG, incl. spark plug connector									470 450	C10	
ENGINE												
1.8	Petrol	81	04/02-07/08	Z 18 XEL								
Engine	Information				A10	A20	A40	A50	A70	C10 - C30	C20	E01
All engines										470 508	C10	
ENGINE												
1.8 16V	Petrol	90	04/02-07/08	Z 18 XE								
Engine	Information				A10	A20	A40	A50	A70	C10 - C30	C20	E01
All engines	x 1, COIL ON PLUG, incl. spark plug connector									470 508	C10	
ENGINE												
1.8 16V Dualfuel	Petrol/ Liquified Petro- leum Gas (LPG)	90	04/02-07/08	Z 18 XE								
Engine	Information				A10	A20	A40	A50	A70	C10 - C30	C20	E01
All engines	x 1, COIL ON PLUG, incl. spark plug connector									470 508	C10	
VELOX												
ENGINE												
2.7	Petrol	70	03/64-10/72	--								
Engine	Information				A10	A20	A40	A50	A70	C10 - C30	C20	E01
All engines								912 090				
ENGINE												
3.3	Petrol	85	09/64-07/65	--								
Engine	Information				A10	A20	A40	A50	A70	C10 - C30	C20	E01
All engines								912 090				
VENTORA												
ENGINE												
3300	Petrol	91	03/69-10/76	--								
Engine	Information				A10	A20	A40	A50	A70	C10 - C30	C20	E01
All engines								912 090				
VICTOR												
ENGINE												
3000	Petrol	91	03/68-09/72	--								
Engine	Information				A10	A20	A40	A50	A70	C10 - C30	C20	E01
All engines								912 090				
VISCOUNT												
ENGINE												
3300	Petrol	91	01/66-10/72	--								
Engine	Information				A10	A20	A40	A50	A70	C10 - C30	C20	E01
All engines								912 090				
VIVA												
ENGINE												
1100	Petrol	33	01/63-10/66	--								
Engine	Information				A10	A20	A40	A50	A70	C10 - C30	C20	E01
All engines								912 090				

A10 CONDENSER	A20 CONTACT SET	A40 DISTRIBUTOR CAP	A50 ROTOR	A70 PICK-UP
C10 COIL	C20 IGNITION MODULE	C30 ELECTRONIC IGNITION KIT	E01 IGNITION CABLE SET	

Vehicle	alim.	kW	Date	Engine	FUNCTIONS ON THE VEHICLE									
					A10	A20	A40	A50	A70	C10 - C30	C20	E01		
ENGINE														
1100	Petrol	35	01/66-09/71	--										
ENGINE														
All engines								912 090						
1100 SL90	Petrol	44	01/65-10/70	--										
ENGINE														
All engines								912 090						
1256	Petrol	43	10/71-10/75	--										
ENGINE														
All engines								912 090						
1256 E	Petrol	43	10/71-10/75	--										
ENGINE														
All engines								912 090						
1300	Petrol	43	10/75-10/79	--										
ENGINE														
All engines								912 090						
VIVARO														
2.0 16V	Petrol	88	08/01-07/14	F4R 720										
ENGINE														
All engines											470 432	C10		
2.0 ECOTEC	Petrol	86	08/06-07/14	F4R 820										
ENGINE														
All engines											470 432	C10		
VX220														
2.0 i Turbo	Petrol	147	03/01-07/05	Z 20 LET										
ENGINE														
All engines											470 507	C10		
2.0 VXR	Petrol	162	10/03-07/05	Z 20 LET										
ENGINE														
All engines											470 507	C10		
ZAFIRA A														
1.6 16V	Petrol	74	04/99-08/05	X 16 XEL, Z 16 XE										
ENGINE														
All engines											470 399	C10		
1.6 CNG	Petrol/ Com- pressed Natural Gas (CNG)	71	09/01-06/05	Z 16 YNG										
ENGINE														
All engines											470 399	C10		
1.6 Dualfuel	Petrol/ Liquified Petro- leum Gas (LPG)	74	11/98-08/05	X 16 XEL										
ENGINE														
All engines											470 399	C10		
1.8 16V	Petrol	85	05/99-08/00	X 18 XE1										
ENGINE														
All engines											470 508	C10		

A10 CONDENSER	A20 CONTACT SET	A40 DISTRIBUTOR CAP	A50 ROTOR	A70 PICK-UP
C10 COIL	C20 IGNITION MODULE	C30 ELECTRONIC IGNITION KIT	E01 IGNITION CABLE SET	

The present application list is a brief version. For the detailed information about the possibility of installation on a specific vehicle, please refer to our web-catalogue <http://catalogo.facet.eu/>

Vehicle	alim.	kW	Date	Engine	FUNCTIONS ON THE VEHICLE									
					A10	A20	A40	A50	A70	C10 - C30	C20	E01		
ENGINE														
1.8 16V	Petrol	92	09/00-08/05	Z 18 XE										
Engine		Information			A10	A20	A40	A50	A70	C10 - C30	C20	E01		
All engines		x 1, COIL ON PLUG, incl. spark plug connector								470 508	C10			
ENGINE														
1.8 Dualfuel	Petrol/ Liquified Petroleum Gas (LPG)	92	09/00-08/05	Z 18 XE										
Engine		Information			A10	A20	A40	A50	A70	C10 - C30	C20	E01		
All engines		x 1, COIL ON PLUG, incl. spark plug connector								470 508	C10			
ENGINE														
2.0	Petrol	147	06/02-06/05	Z 20 LET										
Engine		Information			A10	A20	A40	A50	A70	C10 - C30	C20	E01		
All engines		x 1, COIL ON PLUG								470 507	C10			
ENGINE														
2.0 GSI Turbo	Petrol	141	09/01-06/05	Z 20 LET										
Engine		Information			A10	A20	A40	A50	A70	C10 - C30	C20	E01		
All engines		x 1, COIL ON PLUG								470 507	C10			
ZAFIRA B														
ENGINE														
1.6	Petrol	77	07/05-11/14	Z 16 XE1, Z 16 XEP										
Engine		Information			A10	A20	A40	A50	A70	C10 - C30	C20	E01		
All engines		x 1, DELPHI, COIL ON PLUG, incl. spark plug connector								470 450	C10			
ENGINE														
1.6	Petrol	85	12/07-11/14	A 16 XER, Z 16 XER										
Engine		Information			A10	A20	A40	A50	A70	C10 - C30	C20	E01		
All engines		x 1, DELPHI, COIL ON PLUG, incl. spark plug connector								470 450	C10			
ENGINE														
1.6 CNG	Petrol/ Compressed Natural Gas (CNG)	69	07/05-11/14	Z 16 YNG										
Engine		Information			A10	A20	A40	A50	A70	C10 - C30	C20	E01		
All engines										470 399	C10			
ENGINE														
1.6 CNG Turbo	Petrol/ Compressed Natural Gas (CNG)	110	02/09-11/14	A 16 XNT, Z 16 XNT										
Engine		Information			A10	A20	A40	A50	A70	C10 - C30	C20	E01		
All engines										470 450	C10			
ENGINE														
1.8	Petrol	103	04/05-11/14	A 18 XER, Z 18 XER										
Engine		Information			A10	A20	A40	A50	A70	C10 - C30	C20	E01		
All engines		x 1, DELPHI, COIL ON PLUG, incl. spark plug connector								470 450	C10			
ENGINE														
1.8	Petrol	88	04/13-11/14	A 18 XEL										
Engine		Information			A10	A20	A40	A50	A70	C10 - C30	C20	E01		
All engines		x 1, COIL ON PLUG								470 545	C10			
ENGINE														
2.0	Petrol	147	07/05-11/14	Z 20 LER										
Engine		Information			A10	A20	A40	A50	A70	C10 - C30	C20	E01		
All engines		x 1, COIL ON PLUG								470 507	C10			
ENGINE														
2.0	Petrol	176	01/06-11/14	Z 20 LEH										
Engine		Information			A10	A20	A40	A50	A70	C10 - C30	C20	E01		
All engines		x 1, COIL ON PLUG								470 507	C10			

A10 CONDENSER	A20 CONTACT SET	A40 DISTRIBUTOR CAP	A50 ROTOR	A70 PICK-UP
C10 COIL	C20 IGNITION MODULE	C30 ELECTRONIC IGNITION KIT	E01 IGNITION CABLE SET	

Vehicle	alim.	kW	Date	Engine	FUNCTIONS ON THE VEHICLE							
					A10	A20	A40	A50	A70	C10 - C30	C20	E01

ZAFIRA C

				ENGINE
1.4	Petrol	103	10/11-08/18	A 14 NET, B 14 NET

Engine	Information	A10	A20	A40	A50	A70	C10 - C30	C20	E01
All engines	x 1, COIL ON RAIL						470 547	C10	

				ENGINE
1.4	Petrol	88	10/11-08/18	A 14 NEL

Engine	Information	A10	A20	A40	A50	A70	C10 - C30	C20	E01
All engines	x 1, COIL ON RAIL						470 547	C10	

				ENGINE
1.4 LPG	Petrol/ Liquified Petro- leum Gas (LPG)	103	10/11-08/18	A 14 NET

Engine	Information	A10	A20	A40	A50	A70	C10 - C30	C20	E01
All engines							470 547	C10	

				ENGINE
1.6 CNG	Petrol/ Com- pressed Natural Gas (CNG)	110	10/11-08/18	A 16 XNT

Engine	Information	A10	A20	A40	A50	A70	C10 - C30	C20	E01
All engines	x 1, DELPHI, COIL ON PLUG, incl. spark plug connector						470 450	C10	

				ENGINE
1.8	Petrol	103	10/11-08/18	A 18 XER

Engine	Information	A10	A20	A40	A50	A70	C10 - C30	C20	E01
All engines	x 1, COIL ON PLUG						470 545	C10	

				ENGINE
1.8	Petrol	85	10/11-08/18	A 18 XEL

Engine	Information	A10	A20	A40	A50	A70	C10 - C30	C20	E01
All engines	x 1, COIL ON PLUG						470 545	C10	



				ENGINE
1.8	Petrol	88	10/11->	A 18 XEL

Engine	Information	A10	A20	A40	A50	A70	C10 - C30	C20	E01
All engines							470 545	C10	

A10	CONDENSER	A20	CONTACT SET	A40	DISTRIBUTOR CAP	A50	ROTOR	A70	PICK-UP
C10	COIL	C20	IGNITION MODULE	C30	ELECTRONIC IGNITION KIT	E01	IGNITION CABLE SET		

The present application list is a brief version. For the detailed information about the possibility of installation on a specific vehicle, please refer to our web-catalogue <http://catalogo.facet.eu/>

FUNCTIONS ON THE VEHICLE

Vehicle	alim.	kW	Date	Engine								
---------	-------	----	------	--------	---	---	---	--	---	---	---	---

CADDY

				ENGINE
1.6i	Petrol	66	11/98->	MY4

Engine	Information	A10	A20	A40	A50	A70	C10 - C30	C20	E01
All engines	version Bosch			806 094	906 121R				
All engines						406 233	490 414	C30	

GOL

				ENGINE
1.0i	Petrol	0	11/96->	510

Engine	Information	A10	A20	A40	A50	A70	C10 - C30	C20	E01
All engines	version Bosch			806 094	906 121R	406 233			

				ENGINE
1.0i 16v	Petrol	0	09/97->	511

Engine	Information	A10	A20	A40	A50	A70	C10 - C30	C20	E01
All engines	version Bosch			806 094	906 121R	406 233			

				ENGINE
1.0i 16v Turbo	Petrol	0	06/00->	512

Engine	Information	A10	A20	A40	A50	A70	C10 - C30	C20	E01
All engines							490 420	C30	

				ENGINE
1.6i	Petrol	0	10/96->	540, 541

Engine	Information	A10	A20	A40	A50	A70	C10 - C30	C20	E01
All engines	version Bosch			806 094	906 121R	406 233			

				ENGINE
1.8i	Petrol	0	10/96->	542, 543

Engine	Information	A10	A20	A40	A50	A70	C10 - C30	C20	E01
All engines	version Bosch			806 094	906 121R	406 233			

				ENGINE
2.0i	Petrol	0	09/94->	528, 529, 546, 547

Engine	Information	A10	A20	A40	A50	A70	C10 - C30	C20	E01
All engines	version Bosch			806 094					
Eng. 528, 529	version Bosch				906 055R	406 160			
Eng. 546, 547	version Bosch				906 121R	406 233			

				ENGINE
2.0i 16V	Petrol	0	10/95->	112

Engine	Information	A10	A20	A40	A50	A70	C10 - C30	C20	E01
All engines							470 168	C10	

GOLF

				ENGINE
A4 1.6i	Petrol	74	10/99->	AKL

Engine	Information	A10	A20	A40	A50	A70	C10 - C30	C20	E01
All engines							490 420	C30	360 484

				ENGINE
A4 1.8i Turbo 20v	Petrol	110	10/99->	AGU

Engine	Information	A10	A20	A40	A50	A70	C10 - C30	C20	E01
All engines	incl. spark plug connector, Qty: 4						470 354	C10	
All engines	without spark plug connector, Qty: 4						470 354S	C10	

				ENGINE
A4 2.0i	Petrol	85	08/99->	APK

Engine	Information	A10	A20	A40	A50	A70	C10 - C30	C20	E01
All engines							490 420	C30	360 585

LOGUS

				ENGINE
2.0i	Petrol	0	12/92-12/96	526, 527, 809

Engine	Information	A10	A20	A40	A50	A70	C10 - C30	C20	E01
Eng. 526, 527	version Bosch			806 094	906 055R	406 160			
Eng. 809	version Bosch				906 121R				

PARATI

				ENGINE
1.0i 16v	Petrol	0	09/97->	511









Engine	Information	A10	A20	A40	A50	A70	C10 - C30	C20	E01
All engines	version Bosch			806 094	906 121R	406 233			

A10 CONDENSER	A20 CONTACT SET	A40 DISTRIBUTOR CAP	A50 ROTOR	A70 PICK-UP
C10 COIL	C20 IGNITION MODULE	C30 ELECTRONIC IGNITION KIT	E01 IGNITION CABLE SET	

Vehicle	alim.	kW	Date	Engine	FUNCTIONS ON THE VEHICLE									
					A10	A20	A40	A50	A70	C10 - C30	C20	E01		
ENGINE														
1.0i 16v Turbo	Petrol	0	06/00->	512										
Engine	Information				A10	A20	A40	A50	A70	C10 - C30	C20	E01		
All engines	version Bosch									490 420	C30			
ENGINE														
1.6i	Petrol	0	10/96->	540, 541										
Engine	Information				A10	A20	A40	A50	A70	C10 - C30	C20	E01		
All engines	version Bosch						806 094	906 121R	406 233					
ENGINE														
1.8i	Petrol	0	10/96->	542, 543										
Engine	Information				A10	A20	A40	A50	A70	C10 - C30	C20	E01		
All engines	version Bosch						806 094	906 121R	406 233					
ENGINE														
2.0i	Petrol	0	08/95->	528, 529, 546, 547										
Engine	Information				A10	A20	A40	A50	A70	C10 - C30	C20	E01		
All engines	version Bosch						806 094							
Eng. 528, 529	version Bosch							906 055R	406 160					
Eng. 546, 547	version Bosch							906 121R	406 233					
ENGINE														
2.0i 16V	Petrol	0	02/96->	112										
Engine	Information				A10	A20	A40	A50	A70	C10 - C30	C20	E01		
All engines	version Bosch									470 168	C10			
POINTER														
ENGINE														
2.0i	Petrol	0	11/93-12/96	526, 527, 809										
Engine	Information				A10	A20	A40	A50	A70	C10 - C30	C20	E01		
Eng. 526, 527	version Bosch						806 094	906 055R	406 160					
Eng. 809	version Bosch							906 121R						
POLO														
ENGINE														
1.4	Petrol	55	07/06->	BKY										
Engine	Information				A10	A20	A40	A50	A70	C10 - C30	C20	E01		
All engines	Qty: 4									470 474	C10			
ENGINE														
1.4 16V	Petrol	55	09/02->	BBY										
Engine	Information				A10	A20	A40	A50	A70	C10 - C30	C20	E01		
All engines	Qty: 4									470 474	C10			
ENGINE														
1.6	Petrol	74	02/02->	BAH, CCRA										
Engine	Information				A10	A20	A40	A50	A70	C10 - C30	C20	E01		
All engines	version Bosch									490 420	C30		360 723	
ENGINE														
2.0	Petrol	85	05/02->	BBX										
Engine	Information				A10	A20	A40	A50	A70	C10 - C30	C20	E01		
All engines	version Bosch									490 420	C30		360 585	
SAVEIRO														
ENGINE														
1.6i	Petrol	0	10/96->	540, 541										
Engine	Information				A10	A20	A40	A50	A70	C10 - C30	C20	E01		
All engines	version Bosch						806 094	906 121R	406 233					
ENGINE														
1.8i	Petrol	0	10/96->	542, 543										
Engine	Information				A10	A20	A40	A50	A70	C10 - C30	C20	E01		
All engines	version Bosch						806 094	906 121R	406 233					
ENGINE														
2.0i	Petrol	0	10/96->	546, 547										
Engine	Information				A10	A20	A40	A50	A70	C10 - C30	C20	E01		
All engines	version Bosch						806 094	906 121R	406 233					

A10 CONDENSER	A20 CONTACT SET	A40 DISTRIBUTOR CAP	A50 ROTOR	A70 PICK-UP
C10 COIL	C20 IGNITION MODULE	C30 ELECTRONIC IGNITION KIT	E01 IGNITION CABLE SET	

The present application list is a brief version. For the detailed information about the possibility of installation on a specific vehicle, please refer to our web-catalogue <http://catalogo.facet.eu/>

				FUNCTIONS ON THE VEHICLE								
Vehicle	alim.	kW	Date	Engine								
140												
1.8	Petrol	55	08/66-07/68	B 18 A								
Engine Information				A10	A20	A40	A50	A70	C10 - C30	C20	E01	
All engines					706 021							
140												
1.8 S	Petrol	55	08/66-07/68	B 18 A								
Engine Information				A10	A20	A40	A50	A70	C10 - C30	C20	E01	
All engines					706 021							
140												
1.8 S	Petrol	74	08/66-01/72	B 18 B								
Engine Information				A10	A20	A40	A50	A70	C10 - C30	C20	E01	
All engines					706 047							
240												
1.8	Petrol	66	11/78-07/85	B 17 A								
Engine Information				A10	A20	A40	A50	A70	C10 - C30	C20	E01	
All engines				version Bosch	706 034HVS	806 079	906 025R					
240												
2.0	Petrol	100	10/82-08/84	B 19 ET								
Engine Information				A10	A20	A40	A50	A70	C10 - C30	C20	E01	
All engines				version Bosch		806 079	906 025R	406 153				
240												
2.0	Petrol	60	08/74-07/76	OJX4G20A6L								
Engine Information				A10	A20	A40	A50	A70	C10 - C30	C20	E01	
All engines				version Bosch	706 049HDVS	806 079	906 025R					
240												
2.0	Petrol	76	08/84-07/90	B 200 K								
Engine Information				A10	A20	A40	A50	A70	C10 - C30	C20	E01	
All engines				version Bosch		806 079	906 122R					
240												
2.0	Petrol	82	09/88-12/93	B 200 F								
Engine Information				A10	A20	A40	A50	A70	C10 - C30	C20	E01	
All engines				version Bosch		806 079						
All engines				distr. num. 1367382, 1367468, version Bosch			906 121R					
All engines				distr. num. 1336690, 1346919, version Bosch			906 122R					
240												
2.0	Petrol	86	08/83-07/93	B 200 E								
Engine Information				A10	A20	A40	A50	A70	C10 - C30	C20	E01	
All engines				version Bosch		806 079	906 122R					
240												
2.0	Petrol	89	09/84-12/93	B 200 E								
Engine Information				A10	A20	A40	A50	A70	C10 - C30	C20	E01	
All engines				version Bosch		806 079	906 122R					
240												
2.1 Turbo	Petrol	114	08/80-07/85	B 21 ET								
Engine Information				A10	A20	A40	A50	A70	C10 - C30	C20	E01	
All engines				version Bosch		806 079	906 025R	406 153				
240												
2.1 Turbo	Petrol	121	08/80-07/85	B 21 FT								
Engine Information				A10	A20	A40	A50	A70	C10 - C30	C20	E01	
All engines				version Bosch		806 079	906 025R	406 153				
240												
2.3	Petrol	81	08/84-07/86	B 230 A								
Engine Information				A10	A20	A40	A50	A70	C10 - C30	C20	E01	
All engines				version Bosch		806 079	906 122R					
240												
2.3	Petrol	82	08/80-07/84	B 23 A								
Engine Information				A10	A20	A40	A50	A70	C10 - C30	C20	E01	
All engines							906 067R					

A10 CONDENSER	A20 CONTACT SET	A40 DISTRIBUTOR CAP	A50 ROTOR	A70 PICK-UP
C10 COIL	C20 IGNITION MODULE	C30 ELECTRONIC IGNITION KIT	E01 IGNITION CABLE SET	

Vehicle	alim.	kW	Date	Engine	FUNCTIONS ON THE VEHICLE									
					A10	A20	A40	A50	A70	C10 - C30	C20	E01		
ENGINE														
2.3	Petrol	83	08/86-07/87	B 230 F										
Engine	Information				A10	A20	A40	A50	A70	C10 - C30	C20	E01		
All engines	version Bosch						806 079							
All engines	distr. num. 1332587, version Bosch							906 055R						
All engines	distr. num. 1367382, version Bosch							906 121R						
ENGINE														
2.3	Petrol	85	08/86-07/93	B 230 FD, B 230 K										
Engine	Information				A10	A20	A40	A50	A70	C10 - C30	C20	E01		
All engines	version Bosch						806 079							
All engines	distr. num. 1367382, 1367468, version Bosch							906 121R						
Eng. B 230 FD	distr. num. 1336690, 1346919, version Bosch							906 122R						
ENGINE														
2.3	Petrol	96	08/83-07/92	B 230 E										
Engine	Information				A10	A20	A40	A50	A70	C10 - C30	C20	E01		
All engines	version Bosch						806 079	906 122R						
ENGINE														
2.3 Cat	Petrol	100	08/91-07/92	B 230 F										
Engine	Information				A10	A20	A40	A50	A70	C10 - C30	C20	E01		
All engines	version Bosch						806 079							
All engines	distr. num. 1367382, 1367468, version Bosch							906 121R						
All engines	distr. num. 1336690, 1346919, version Bosch							906 122R						
ENGINE														
2.3 i Cat	Petrol	85	08/86-07/93	B 230 F										
Engine	Information				A10	A20	A40	A50	A70	C10 - C30	C20	E01		
All engines	version Bosch						806 079							
All engines	distr. num. 1332587, version Bosch							906 055R						
All engines	distr. num. 1367382, 1367468, version Bosch							906 121R						
ENGINE														
2.8	Petrol	114	10/80-09/84	B 28 E										
Engine	Information				A10	A20	A40	A50	A70	C10 - C30	C20	E01		
All engines	version Bosch							906 023R						
ENGINE														
260														
ENGINE														
2.8	Petrol	114	08/80-07/85	B 28 E										
Engine	Information				A10	A20	A40	A50	A70	C10 - C30	C20	E01		
All engines	version Bosch							906 023R						
ENGINE														
340-360														
ENGINE														
1.3	Petrol	49	01/89-12/90	B 13										
Engine	Information				A10	A20	A40	A50	A70	C10 - C30	C20	E01		
All engines	version Ducellier						815 059	915 096R						
All engines										470 107	C10		360 332	
ENGINE														
1.4	Petrol	46	08/82-08/85	B 14.3 E										
Engine	Information				A10	A20	A40	A50	A70	C10 - C30	C20	E01		
All engines	version Ducellier						815 059	915 096R						
All engines								912 093R		470 107	C10		360 332	
ENGINE														
1.4	Petrol	50	08/86-12/88	B 14.4 S										
Engine	Information				A10	A20	A40	A50	A70	C10 - C30	C20	E01		
All engines	version Ducellier						815 059	915 096R						
All engines								912 093R		470 107	C10		360 332	
ENGINE														
1.4	Petrol	51	08/87-07/88	B 14.4 S										
Engine	Information				A10	A20	A40	A50	A70	C10 - C30	C20	E01		
All engines	version Ducellier						815 059	915 096R						
All engines								912 093R		470 107	C10		360 332	
ENGINE														
1.4	Petrol	52	08/83-07/86	B 14.4 S										
Engine	Information				A10	A20	A40	A50	A70	C10 - C30	C20	E01		
All engines	version Ducellier						815 059	915 096R						

A10	CONDENSER	A20	CONTACT SET	A40	DISTRIBUTOR CAP	A50	ROTOR	A70	PICK-UP
C10	COIL	C20	IGNITION MODULE	C30	ELECTRONIC IGNITION KIT	E01	IGNITION CABLE SET		

FUNCTIONS ON THE VEHICLE

Vehicle	alim.	kW	Date	Engine	A10	A20	A40	A50	A70	C10 - C30	C20	E01
				ENGINE								
1.4	Petrol	52	08/83-07/86	B 14.4 S								
Engine					A10	A20	A40	A50	A70	C10 - C30	C20	E01
All engines										470 107	C10	360 332
				ENGINE								
1.4	Petrol	53	08/83-07/86	B 14.4 S								
Engine					A10	A20	A40	A50	A70	C10 - C30	C20	E01
All engines							815 059	915 096R				
All engines										470 107	C10	360 332
				ENGINE								
1.7	Petrol	59	08/85-07/91	B 17 2 K								
Engine					A10	A20	A40	A50	A70	C10 - C30	C20	E01
All engines							815 062			470 107	C10	
All engines							815 063	915 097				
				ENGINE								
2.0	Petrol	75	08/84-07/90	B 200 K								
Engine					A10	A20	A40	A50	A70	C10 - C30	C20	E01
All engines							806 079					
All engines								906 121R				
All engines								906 122R				
All engines										470 107	C10	
				ENGINE								
2.0	Petrol	77	08/84-07/87	B 200 K								
Engine					A10	A20	A40	A50	A70	C10 - C30	C20	E01
All engines							806 079					
All engines								906 121R				
All engines								906 122R				
All engines										470 107	C10	
				ENGINE								
2.0	Petrol	80	08/88-07/89	B 200 F								
Engine					A10	A20	A40	A50	A70	C10 - C30	C20	E01
All engines							806 079					
All engines								906 121R				
All engines								906 122R				
All engines										470 107	C10	
				ENGINE								
2.0	Petrol	81	08/87-07/88	B 200 EA, B 200 F								
Engine					A10	A20	A40	A50	A70	C10 - C30	C20	E01
All engines							806 079					
All engines								906 121R				
All engines								906 122R				
All engines										470 107	C10	
				ENGINE								
2.0	Petrol	82	08/86-07/88	B 200 E, B 200 EA, B 200 F								
Engine					A10	A20	A40	A50	A70	C10 - C30	C20	E01
All engines							806 079					
All engines								906 121R				
All engines								906 122R				
All engines										470 107	C10	
				ENGINE								
2.0	Petrol	85	08/84-07/86	B 200 E								
Engine					A10	A20	A40	A50	A70	C10 - C30	C20	E01
All engines							806 079					
All engines								906 121R				
All engines								906 122R				
All engines										470 107	C10	
				ENGINE								
2.0	Petrol	87	08/84-07/86	B 200 E								
Engine					A10	A20	A40	A50	A70	C10 - C30	C20	E01
All engines							806 079					
All engines								906 121R				
All engines								906 122R				
All engines										470 107	C10	









A10	CONDENSER	A20	CONTACT SET	A40	DISTRIBUTOR CAP	A50	ROTOR	A70	PICK-UP
C10	COIL	C20	IGNITION MODULE	C30	ELECTRONIC IGNITION KIT	E01	IGNITION CABLE SET		

Vehicle	alim.	kW	Date	Engine	FUNCTIONS ON THE VEHICLE									
					A10	A20	A40	A50	A70	C10 - C30	C20	E01		
ENGINE														
2.0	Petrol	87	08/84-07/86	B 200 E										
ENGINE														
Engine	Information				A10	A20	A40	A50	A70	C10 - C30	C20	E01		
All engines	MODEL TO: 1986, version Bosch							906 122R						
All engines										470 107	C10			
440														
ENGINE														
1.6	Petrol	61	09/88-12/96	B 16 F										
ENGINE														
Engine	Information				A10	A20	A40	A50	A70	C10 - C30	C20	E01		
All engines	version Ducellier						815 069	915 097						
All engines	Kit, version Ducellier						815 071							
All engines										470 107	C10		359 415	
ENGINE														
1.7	Petrol	58	09/88-08/92	B 18 KD										
ENGINE														
Engine	Information				A10	A20	A40	A50	A70	C10 - C30	C20	E01		
All engines	version Ducellier						815 069	915 097						
All engines	Kit, version Ducellier						815 071							
All engines										470 107	C10		359 415	
ENGINE														
1.7	Petrol	60	09/88-08/89	B 18 K										
ENGINE														
Engine	Information				A10	A20	A40	A50	A70	C10 - C30	C20	E01		
All engines	version Ducellier						815 069	915 097						
All engines	Kit, version Ducellier						815 071							
All engines										470 107	C10		359 415	
ENGINE														
1.7	Petrol	64	09/88-12/96	B 18 KP										
ENGINE														
Engine	Information				A10	A20	A40	A50	A70	C10 - C30	C20	E01		
All engines	version Ducellier						815 069	915 097						
All engines	Kit, version Ducellier						815 071							
All engines										470 107	C10		359 415	
ENGINE														
1.7	Petrol	70	08/88-07/89	B 18 F										
ENGINE														
Engine	Information				A10	A20	A40	A50	A70	C10 - C30	C20	E01		
All engines	version Ducellier						815 069	915 097						
All engines	Kit, version Ducellier						815 071							
All engines										470 107	C10		359 415	
ENGINE														
1.7	Petrol	75	08/89-12/96	B 18 FP										
ENGINE														
Engine	Information				A10	A20	A40	A50	A70	C10 - C30	C20	E01		
All engines	version Ducellier						815 069	915 097						
All engines	Kit, version Ducellier						815 071							
All engines										470 107	C10		359 415	
ENGINE														
1.7	Petrol	78	09/88-12/96	B 18 EP										
ENGINE														
Engine	Information				A10	A20	A40	A50	A70	C10 - C30	C20	E01		
All engines	version Ducellier						815 069	915 097						
All engines	Kit, version Ducellier						815 071							
All engines										470 107	C10		359 415	
ENGINE														
1.7	Petrol	80	08/88-07/89	B 18 E										
ENGINE														
Engine	Information				A10	A20	A40	A50	A70	C10 - C30	C20	E01		
All engines	version Ducellier						815 069	915 097						
All engines	Kit, version Ducellier						815 071							
All engines										470 107	C10		359 415	
ENGINE														
1.7 Turbo	Petrol	88	08/88-07/96	B 18 FT										
ENGINE														
Engine	Information				A10	A20	A40	A50	A70	C10 - C30	C20	E01		
All engines	version Ducellier						815 069	915 097						
All engines	Kit, version Ducellier						815 071							
All engines													359 417	

A10	CONDENSER	A20	CONTACT SET	A40	DISTRIBUTOR CAP	A50	ROTOR	A70	PICK-UP
C10	COIL	C20	IGNITION MODULE	C30	ELECTRONIC IGNITION KIT	E01	IGNITION CABLE SET		

The present application list is a brief version. For the detailed information about the possibility of installation on a specific vehicle, please refer to our web-catalogue <http://catalogo.facet.eu/>

FUNCTIONS ON THE VEHICLE









Vehicle	alim.	kW	Date	Engine								
ENGINE												
1.7 Turbo	Petrol	90	01/91-12/96	B 18 FT								
Engine	Information			A10	A20	A40	A50	A70	C10 - C30	C20	E01	
All engines	version Ducellier					815 069	915 097					
All engines	Kit, version Ducellier					815 071						
All engines												359 417
ENGINE												
1.8	Petrol	66	08/91-12/96	B 18 U								
Engine	Information			A10	A20	A40	A50	A70	C10 - C30	C20	E01	
All engines	version Ducellier					815 069	915 097					
All engines	Kit, version Ducellier					815 071						
All engines									470 107	C10		359 415
ENGINE												
2.0	Petrol	80	08/93-07/96	B 20 F								
Engine	Information			A10	A20	A40	A50	A70	C10 - C30	C20	E01	
All engines	version Ducellier					815 069	915 097					
All engines	Kit, version Ducellier					815 071						
All engines									470 107	C10		359 415
ENGINE												
2.0	Petrol	81	08/92-07/95	B 20 F								
Engine	Information			A10	A20	A40	A50	A70	C10 - C30	C20	E01	
All engines	version Ducellier					815 069	915 097					
All engines	Kit, version Ducellier					815 071						
All engines									470 107	C10		359 415
460												
ENGINE												
1.6	Petrol	61	07/92-07/96	B 16 F								
Engine	Information			A10	A20	A40	A50	A70	C10 - C30	C20	E01	
All engines	version Ducellier					815 069	915 097					
All engines	Kit, version Ducellier					815 071						
All engines									470 107	C10		359 415
ENGINE												
1.7	Petrol	58	08/89-07/92	B 18 K, B 18 KD								
Engine	Information			A10	A20	A40	A50	A70	C10 - C30	C20	E01	
All engines	version Ducellier					815 069	915 097					
All engines	Kit, version Ducellier					815 071						
All engines									470 107	C10		359 415
ENGINE												
1.7	Petrol	64	09/88-07/96	B 18 KP								
Engine	Information			A10	A20	A40	A50	A70	C10 - C30	C20	E01	
All engines	version Ducellier					815 069	915 097					
All engines	Kit, version Ducellier					815 071						
All engines									470 107	C10		359 415
ENGINE												
1.7	Petrol	66	09/90-07/96	B 18 KP								
Engine	Information			A10	A20	A40	A50	A70	C10 - C30	C20	E01	
All engines	version Ducellier					815 069	915 097					
All engines	Kit, version Ducellier					815 071						
All engines									470 107	C10		359 415
ENGINE												
1.7	Petrol	75	08/89-07/95	B 18 EP, B 18 FP								
Engine	Information			A10	A20	A40	A50	A70	C10 - C30	C20	E01	
All engines	version Ducellier					815 069	915 097					
All engines	Kit, version Ducellier					815 071						
All engines									470 107	C10		359 415
ENGINE												
1.7 Turbo	Petrol	88	08/89-07/96	B 18 FT								
Engine	Information			A10	A20	A40	A50	A70	C10 - C30	C20	E01	
All engines	version Ducellier					815 069	915 097					
All engines	Kit, version Ducellier					815 071						
All engines												359 417

A10 CONDENSER	A20 CONTACT SET	A40 DISTRIBUTOR CAP	A50 ROTOR	A70 PICK-UP
C10 COIL	C20 IGNITION MODULE	C30 ELECTRONIC IGNITION KIT	E01 IGNITION CABLE SET	

Vehicle	alim.	kW	Date	Engine	FUNCTIONS ON THE VEHICLE								
					A10	A20	A40	A50	A70	C10 - C30	C20	E01	
1.7 Turbo	Petrol	90	01/91-07/96	ENGINE B 18 FT									
Engine	Information			A10	A20	A40	A50	A70	C10 - C30	C20	E01		
All engines	version Ducellier					815 069	915 097						
All engines	Kit, version Ducellier					815 071							
All engines													359 417
1.8	Petrol	66	08/91-07/96	ENGINE B 18 U									
Engine	Information			A10	A20	A40	A50	A70	C10 - C30	C20	E01		
All engines	version Ducellier					815 069	915 097						
All engines	Kit, version Ducellier					815 071							
All engines									470 107	C10			359 415
2.0	Petrol	80	08/93-07/96	ENGINE B 20 F									
Engine	Information			A10	A20	A40	A50	A70	C10 - C30	C20	E01		
All engines	version Ducellier					815 069	915 097						
All engines	Kit, version Ducellier					815 071							
All engines									470 107	C10			359 415
2.0	Petrol	81	08/92-07/95	ENGINE B 20 F									
Engine	Information			A10	A20	A40	A50	A70	C10 - C30	C20	E01		
All engines	version Ducellier					815 069	915 097						
All engines	Kit, version Ducellier					815 071							
All engines									470 107	C10			359 415
480				ENGINE									
1.7	Petrol	70	08/87-07/89	ENGINE B 18 F									
Engine	Information			A10	A20	A40	A50	A70	C10 - C30	C20	E01		
All engines	version Ducellier					815 069	915 097						
All engines	Kit, version Ducellier					815 071							
All engines									470 107	C10			359 415
1.7	Petrol	75	08/89-07/96	ENGINE B 18 EP, B 18 FP									
Engine	Information			A10	A20	A40	A50	A70	C10 - C30	C20	E01		
All engines	version Ducellier					815 069	915 097						
All engines	Kit, version Ducellier					815 071							
All engines									470 107	C10			359 415
1.7	Petrol	78	04/86-09/95	ENGINE B 18 E, B 18 EP									
Engine	Information			A10	A20	A40	A50	A70	C10 - C30	C20	E01		
All engines	version Ducellier					815 069	915 097						
All engines	Kit, version Ducellier					815 071							
All engines									470 107	C10			359 415
1.7	Petrol	80	08/86-07/88	ENGINE B 18 E									
Engine	Information			A10	A20	A40	A50	A70	C10 - C30	C20	E01		
All engines	version Ducellier					815 069	915 097						
All engines	Kit, version Ducellier					815 071							
All engines									470 107	C10			359 415
1.7 Turbo	Petrol	88	08/87-07/96	ENGINE B 18 FT									
Engine	Information			A10	A20	A40	A50	A70	C10 - C30	C20	E01		
All engines	version Ducellier					815 069	915 097						
All engines	Kit, version Ducellier					815 071							
All engines													359 417
1.7 Turbo	Petrol	90	01/91-07/96	ENGINE B 18 FT									
Engine	Information			A10	A20	A40	A50	A70	C10 - C30	C20	E01		
All engines	version Ducellier					815 069	915 097						
All engines	Kit, version Ducellier					815 071							
All engines													359 417

A10 CONDENSER	A20 CONTACT SET	A40 DISTRIBUTOR CAP	A50 ROTOR	A70 PICK-UP
C10 COIL	C20 IGNITION MODULE	C30 ELECTRONIC IGNITION KIT	E01 IGNITION CABLE SET	

The present application list is a brief version. For the detailed information about the possibility of installation on a specific vehicle, please refer to our web-catalogue <http://catalogo.facet.eu/>

				FUNCTIONS ON THE VEHICLE								
Vehicle	alim.	kW	Date	Engine								
				ENGINE								
2.0	Petrol	81	08/92-09/95	B 20 F								
				ENGINE								
Engine	Information			A10	A20	A40	A50	A70	C10 - C30	C20	E01	
All engines	version Ducellier					815 069	915 097					
All engines	Kit, version Ducellier					815 071						
All engines									470 107	C10		359 415
				ENGINE								
740				ENGINE								
2.0	Petrol	118	01/86-08/90	B 200 ET								
				ENGINE								
Engine	Information			A10	A20	A40	A50	A70	C10 - C30	C20	E01	
All engines	version Bosch					806 127	906 118R					
All engines												359 372
				ENGINE								
2.0	Petrol	120	01/85-12/85	B 200 ET								
				ENGINE								
Engine	Information			A10	A20	A40	A50	A70	C10 - C30	C20	E01	
All engines	version Bosch					806 127	906 118R					
All engines												359 372
				ENGINE								
2.0	Petrol	76	09/88-08/90	B 200 K								
				ENGINE								
Engine	Information			A10	A20	A40	A50	A70	C10 - C30	C20	E01	
All engines	version Bosch					806 127	906 118R	406 222				
				ENGINE								
2.0	Petrol	86	01/87-08/88	B 200 E								
				ENGINE								
Engine	Information			A10	A20	A40	A50	A70	C10 - C30	C20	E01	
All engines	version Bosch					806 127	906 118R	406 222				
All engines												359 372
				ENGINE								
2.0	Petrol	89	08/85-07/92	B 200 G								
				ENGINE								
Engine	Information			A10	A20	A40	A50	A70	C10 - C30	C20	E01	
All engines	version Bosch					806 127	906 118R	406 222				
All engines												359 372
				ENGINE								
2.0 16V	Petrol	100	09/87-08/90	B 204 E								
				ENGINE								
Engine	Information			A10	A20	A40	A50	A70	C10 - C30	C20	E01	
All engines	version Bosch					806 127	906 118R					
				ENGINE								
2.0 16V Turbo	Petrol	136	08/89-07/90	B 204 GT								
				ENGINE								
Engine	Information			A10	A20	A40	A50	A70	C10 - C30	C20	E01	
All engines	version Bosch					806 127	906 118R					
				ENGINE								
2.0 16V Turbo	Petrol	140	08/89-07/90	B 204 FT								
				ENGINE								
Engine	Information			A10	A20	A40	A50	A70	C10 - C30	C20	E01	
All engines	version Bosch					806 127	906 118R					
				ENGINE								
2.0 GLE	Petrol	103	09/87-08/90	B 204 E								
				ENGINE								
Engine	Information			A10	A20	A40	A50	A70	C10 - C30	C20	E01	
All engines	version Bosch					806 127	906 118R					
				ENGINE								
2.0 Turbo	Petrol	114	09/90-08/91	B 200 FT								
				ENGINE								
Engine	Information			A10	A20	A40	A50	A70	C10 - C30	C20	E01	
All engines	version Bosch					806 127	906 118R					
All engines												359 372
				ENGINE								
2.0 Turbo	Petrol	115	09/87-08/90	B 200 ET								
				ENGINE								
Engine	Information			A10	A20	A40	A50	A70	C10 - C30	C20	E01	
All engines	version Bosch					806 127	906 118R					
All engines												359 372
				ENGINE								
2.3	Petrol	111	08/88-08/92	B 234 F								
				ENGINE								
Engine	Information			A10	A20	A40	A50	A70	C10 - C30	C20	E01	
All engines	version Bosch					806 127	906 118R					

A10 CONDENSER	A20 CONTACT SET	A40 DISTRIBUTOR CAP	A50 ROTOR	A70 PICK-UP
C10 COIL	C20 IGNITION MODULE	C30 ELECTRONIC IGNITION KIT	E01 IGNITION CABLE SET	

Vehicle	alim.	kW	Date	Engine	FUNCTIONS ON THE VEHICLE									
					A10	A20	A40	A50	A70	C10 - C30	C20	E01		
2.3	Petrol	114	08/88-07/91	ENGINE B 234 F										
Engine					A10	A20	A40	A50	A70	C10 - C30	C20	E01		
All engines							806 127	906 118R						
All engines														
2.3	Petrol	117	08/87-07/89	ENGINE B 234 F										
Engine					A10	A20	A40	A50	A70	C10 - C30	C20	E01		
All engines							806 127	906 118R						
All engines														
2.3	Petrol	82	08/84-07/86	ENGINE B 230 A										
Engine					A10	A20	A40	A50	A70	C10 - C30	C20	E01		
All engines							806 079	906 122R						
All engines														
2.3	Petrol	83	08/85-12/89	ENGINE B 230 F										
Engine					A10	A20	A40	A50	A70	C10 - C30	C20	E01		
All engines							806 127	906 118R						
All engines									406 222					
All engines													359 372	
2.3	Petrol	84	08/84-07/90	ENGINE B 230 F, B 230 K										
Engine					A10	A20	A40	A50	A70	C10 - C30	C20	E01		
All engines							806 127	906 118R						
All engines									406 222					
All engines													359 372	
2.3	Petrol	85	08/87-07/92	ENGINE B 230 F										
Engine					A10	A20	A40	A50	A70	C10 - C30	C20	E01		
All engines							806 127	906 118R						
All engines									406 222					
All engines													359 372	
2.3	Petrol	86	08/84-07/90	ENGINE B 230 K										
Engine					A10	A20	A40	A50	A70	C10 - C30	C20	E01		
All engines							806 127	906 118R	406 222					
All engines													359 372	
2.3	Petrol	94	08/91-07/92	ENGINE B 230 G										
Engine					A10	A20	A40	A50	A70	C10 - C30	C20	E01		
All engines							806 127	906 118R						
All engines													359 372	
2.3	Petrol	96	08/84-12/92	ENGINE B 230 E, B 230 FB										
Engine					A10	A20	A40	A50	A70	C10 - C30	C20	E01		
All engines							806 127	906 118R						
Eng. B 230 E									406 222					
All engines													359 372	
2.3 GL	Petrol	89	08/84-08/87	ENGINE B 230 E										
Engine					A10	A20	A40	A50	A70	C10 - C30	C20	E01		
All engines							806 127	906 118R	406 222					
All engines													359 372	
2.3 Turbo	Petrol	115	08/86-07/89	ENGINE B 230 FT										
Engine					A10	A20	A40	A50	A70	C10 - C30	C20	E01		
All engines							806 127	906 118R						
All engines									406 222					
All engines													359 372	
2.3 Turbo	Petrol	121	08/89-07/90	ENGINE B 230 FT, B 230 GT										
Engine					A10	A20	A40	A50	A70	C10 - C30	C20	E01		
All engines							806 127	906 118R						

A10 CONDENSER	A20 CONTACT SET	A40 DISTRIBUTOR CAP	A50 ROTOR	A70 PICK-UP
C10 COIL	C20 IGNITION MODULE	C30 ELECTRONIC IGNITION KIT	E01 IGNITION CABLE SET	

The present application list is a brief version. For the detailed information about the possibility of installation on a specific vehicle, please refer to our web-catalogue <http://catalogo.facet.eu/>









					FUNCTIONS ON THE VEHICLE							
Vehicle	alim.	kW	Date	Engine	 A10	 A20	 A40	 A50	 A70	 C10 - C30	 C20	 E01
2.3 Turbo					ENGINE							
Petrol	121	08/89-07/90	B 230 FT, B 230 GT									
Engine	Information	A10	A20	A40	A50	A70	C10 - C30	C20	E01			
Eng. B 230 FT	distr. num. 1336087, version Bosch					406 222						
All engines												359 372
2.3 Turbo					ENGINE							
Petrol	125	09/89-08/91	B 230 FT, B 230 GT									
Engine	Information	A10	A20	A40	A50	A70	C10 - C30	C20	E01			
All engines	version Bosch			806 127	906 118R							
Eng. B 230 FT	distr. num. 1336087, version Bosch					406 222						
All engines												359 372
2.3 Turbo					ENGINE							
Petrol	134	08/85-12/88	B 230 ET									
Engine	Information	A10	A20	A40	A50	A70	C10 - C30	C20	E01			
All engines	version Bosch			806 127	906 118R							
All engines												359 372
2.3 Turbo					ENGINE							
Petrol	140	08/89-07/90	B 230 FT									
Engine	Information	A10	A20	A40	A50	A70	C10 - C30	C20	E01			
All engines	version Bosch			806 127	906 118R							
All engines	distr. num. 1336087, version Bosch					406 222						
All engines												359 372
760					ENGINE							
2.3					B 230 FT							
Petrol	121	01/88-07/92	B 230 FT									
Engine	Information	A10	A20	A40	A50	A70	C10 - C30	C20	E01			
All engines	version Bosch			806 127	906 118R							
All engines	distr. num. 1336087, version Bosch					406 222						
All engines												359 372
2.3					ENGINE							
Petrol	130	08/84-08/87	B 230 ET									
Engine	Information	A10	A20	A40	A50	A70	C10 - C30	C20	E01			
All engines	version Bosch			806 127	906 118R							
All engines												359 372
2.3					ENGINE							
Petrol	84	08/84-08/87	B 230 K									
Engine	Information	A10	A20	A40	A50	A70	C10 - C30	C20	E01			
All engines	version Bosch			806 127	906 118R	406 222						
All engines												359 372
2.3 Turbo					ENGINE							
Petrol	115	08/84-08/90	B 230 FT									
Engine	Information	A10	A20	A40	A50	A70	C10 - C30	C20	E01			
All engines	version Bosch			806 127	906 118R							
All engines	distr. num. 1336087, version Bosch					406 222						
All engines												359 372
2.3 Turbo					ENGINE							
Petrol	119	08/83-07/84	B 23 FT									
Engine	Information	A10	A20	A40	A50	A70	C10 - C30	C20	E01			
All engines	version Bosch			806 079	906 055R							
2.3 Turbo					ENGINE							
Petrol	121	08/89-07/90	B 230 GT									
Engine	Information	A10	A20	A40	A50	A70	C10 - C30	C20	E01			
All engines	version Bosch			806 127	906 118R							
All engines												359 372
2.3 Turbo					ENGINE							
Petrol	127	08/82-07/84	B 23 ET									
Engine	Information	A10	A20	A40	A50	A70	C10 - C30	C20	E01			
All engines	version Bosch			806 079	906 055R							
2.3 Turbo					ENGINE							
Petrol	134	08/84-08/90	B 230 ET									
Engine	Information	A10	A20	A40	A50	A70	C10 - C30	C20	E01			
All engines	version Bosch			806 127	906 118R							

A10 CONDENSER	A20 CONTACT SET	A40 DISTRIBUTOR CAP	A50 ROTOR	A70 PICK-UP
C10 COIL	C20 IGNITION MODULE	C30 ELECTRONIC IGNITION KIT	E01 IGNITION CABLE SET	

Vehicle	alim.	kW	Date	Engine	FUNCTIONS ON THE VEHICLE									
					A10	A20	A40	A50	A70	C10 - C30	C20	E01		
ENGINE														
2.3 Turbo	Petrol	134	08/84-08/90	B 230 ET										
Engine	Information				A10	A20	A40	A50	A70	C10 - C30	C20	E01		
All engines	version Bosch												359 372	
ENGINE														
2.8	Petrol	105	05/86-08/91	B 280 F										
Engine	Information				A10	A20	A40	A50	A70	C10 - C30	C20	E01		
All engines	version Bosch						806 236	906 119R						
ENGINE														
2.8	Petrol	108	08/86-07/90	B 280 F										
Engine	Information				A10	A20	A40	A50	A70	C10 - C30	C20	E01		
All engines	version Bosch						806 236	906 119R						
ENGINE														
2.8	Petrol	112	09/86-10/88	B 280 E										
Engine	Information				A10	A20	A40	A50	A70	C10 - C30	C20	E01		
All engines	version Bosch						806 236	906 119R						
ENGINE														
2.8	Petrol	114	08/82-04/86	B 28 F										
Engine	Information				A10	A20	A40	A50	A70	C10 - C30	C20	E01		
All engines	version Bosch							906 023R						
ENGINE														
2.8	Petrol	115	08/81-08/90	B 28 E, B 280 E										
Engine	Information				A10	A20	A40	A50	A70	C10 - C30	C20	E01		
Eng. B 280 E	version Bosch						806 236	906 119R						
Eng. B 28 E	version Bosch							906 023R						
ENGINE														
2.8	Petrol	125	08/84-08/90	B 280 E										
Engine	Information				A10	A20	A40	A50	A70	C10 - C30	C20	E01		
All engines	version Bosch						806 236	906 119R						
ENGINE														
2.8	Petrol	95	01/82-12/87	B 28 A										
Engine	Information				A10	A20	A40	A50	A70	C10 - C30	C20	E01		
All engines	version Bosch							906 023R						
780														
ENGINE														
2.0i	Petrol	0	01/87-12/90	B 204 GT										
Engine	Information				A10	A20	A40	A50	A70	C10 - C30	C20	E01		
All engines	version Bosch						806 127	906 118R						
ENGINE														
2.0i Turbo	Petrol	0	01/87-12/90	B 200 ET										
Engine	Information				A10	A20	A40	A50	A70	C10 - C30	C20	E01		
All engines	version Bosch						806 127	906 118R						
ENGINE														
2.9	Petrol	108	08/87-07/90	B 280 F										
Engine	Information				A10	A20	A40	A50	A70	C10 - C30	C20	E01		
All engines	version Bosch						806 236	906 119R						
ENGINE														
2.9	Petrol	115	08/86-07/87	B 280 E										
Engine	Information				A10	A20	A40	A50	A70	C10 - C30	C20	E01		
All engines	version Bosch						806 236	906 119R						
850														
ENGINE														
2.0	Petrol	105	06/91-12/96	B 5204 F										
Engine	Information				A10	A20	A40	A50	A70	C10 - C30	C20	E01		
All engines	version Bosch						806 260	906 147R						
All engines	MODEL FROM: 1996									490 423	C30			
All engines													358 064	
ENGINE														
2.0	Petrol	93	08/94-12/96	B 5202 S										
Engine	Information				A10	A20	A40	A50	A70	C10 - C30	C20	E01		
All engines	version Bosch						806 260	906 147R						

A10 CONDENSER	A20 CONTACT SET	A40 DISTRIBUTOR CAP	A50 ROTOR	A70 PICK-UP
C10 COIL	C20 IGNITION MODULE	C30 ELECTRONIC IGNITION KIT	E01 IGNITION CABLE SET	

The present application list is a brief version. For the detailed information about the possibility of installation on a specific vehicle, please refer to our web-catalogue <http://catalogo.facet.eu/>









				FUNCTIONS ON THE VEHICLE								
Vehicle	alim.	kW	Date	Engine								
				ENGINE								
2.0	Petrol	93	08/94-12/96	B 5202 S								
				ENGINE								
Engine		Information		A10	A20	A40	A50	A70	C10 - C30		C20	E01
All engines		MODEL FROM: 1996							490 423	C30		
All engines												358 064
				ENGINE								
2.0 Turbo	Petrol	132	09/93-10/97	B 5204 T2								
				ENGINE								
Engine		Information		A10	A20	A40	A50	A70	C10 - C30		C20	E01
All engines		version Bosch				806 260	906 147R					
All engines		MODEL FROM: 1996							490 423	C30		
All engines												358 064
				ENGINE								
2.0 Turbo	Petrol	155	02/93-12/96	B 5204 FT, B 5204 T								
				ENGINE								
Engine		Information		A10	A20	A40	A50	A70	C10 - C30		C20	E01
All engines		version Bosch				806 260	906 147R					
All engines		MODEL FROM: 1996							490 423	C30		
All engines												358 064
				ENGINE								
2.3	Petrol	106	01/96-10/96	B 5234 FS								
				ENGINE								
Engine		Information		A10	A20	A40	A50	A70	C10 - C30		C20	E01
All engines		version Bosch				806 260	906 147R					
All engines		MODEL FROM: 1996							490 423	C30		
All engines												358 064
				ENGINE								
2.3 T5	Petrol	166	02/93-12/96	9M9T 872								
				ENGINE								
Engine		Information		A10	A20	A40	A50	A70	C10 - C30		C20	E01
All engines		version Bosch				806 260	906 147R					
All engines		MODEL FROM: 1996							490 423	C30		
All engines												358 064
				ENGINE								
2.3 T5-R	Petrol	184	08/95-12/96	B 5234 T4								
				ENGINE								
Engine		Information		A10	A20	A40	A50	A70	C10 - C30		C20	E01
All engines		version Bosch				806 260	906 147R					
All engines		MODEL FROM: 1996							490 423	C30		
All engines												358 064
				ENGINE								
2.3 Turbo R	Petrol	177	06/95-10/97	B 5234 T5								
				ENGINE								
Engine		Information		A10	A20	A40	A50	A70	C10 - C30		C20	E01
All engines		version Bosch				806 260	906 147R					
All engines		MODEL FROM: 1996							490 423	C30		
All engines												358 064
				ENGINE								
2.4	Petrol	103	06/91-07/94	B 5252								
				ENGINE								
Engine		Information		A10	A20	A40	A50	A70	C10 - C30		C20	E01
All engines		version Bosch				806 260	906 147R					
All engines		MODEL FROM: 1996							490 423	C30		
All engines												358 064
				ENGINE								
2.4	Petrol	106	08/94-12/96	B 5252 FS								
				ENGINE								
Engine		Information		A10	A20	A40	A50	A70	C10 - C30		C20	E01
All engines		version Bosch				806 260	906 147R					
All engines		MODEL FROM: 1996							490 423	C30		
All engines												358 064
				ENGINE								
2.4	Petrol	125	08/91-12/96	B 5254 S								
				ENGINE								
Engine		Information		A10	A20	A40	A50	A70	C10 - C30		C20	E01
All engines		version Bosch				806 260	906 147R					
All engines		MODEL FROM: 1996							490 423	C30		
All engines												358 064
				ENGINE								
2.4 AWD	Petrol	142	04/96-12/96	B 5254 T								
				ENGINE								
Engine		Information		A10	A20	A40	A50	A70	C10 - C30		C20	E01
All engines		version Bosch				806 260	906 147R					
All engines		MODEL FROM: 1996							490 423	C30		
All engines												358 064

A10 CONDENSER	A20 CONTACT SET	A40 DISTRIBUTOR CAP	A50 ROTOR	A70 PICK-UP
C10 COIL	C20 IGNITION MODULE	C30 ELECTRONIC IGNITION KIT	E01 IGNITION CABLE SET	

Vehicle	alim.	kW	Date	Engine	FUNCTIONS ON THE VEHICLE									
					A10	A20	A40	A50	A70	C10 - C30	C20	E01		
ENGINE														
2.4 GLE	Petrol	142	09/93-10/97	B 5254 T										
Engine	Information				A10	A20	A40	A50	A70	C10 - C30	C20	E01		
All engines	version Bosch						806 260	906 147R						
All engines										490 423	C30		358 064	
ENGINE														
2.5 10V	Petrol	103	06/91-07/94	B 5252 FS										
Engine	Information				A10	A20	A40	A50	A70	C10 - C30	C20	E01		
All engines	version Bosch						806 260	906 147R						
All engines	MODEL FROM: 1996									490 423	C30			
All engines													358 064	
ENGINE														
2.5 10V	Petrol	106	08/94-12/97	B 5252 FS										
Engine	Information				A10	A20	A40	A50	A70	C10 - C30	C20	E01		
All engines	version Bosch						806 260	906 147R						
All engines	MODEL FROM: 1996									490 423	C30			
All engines													358 064	
940 I														
ENGINE														
2.0	Petrol	82	01/92-07/94	B 200 F										
Engine	Information				A10	A20	A40	A50	A70	C10 - C30	C20	E01		
All engines	version Bosch						806 127	906 118R						
All engines													359 372	
ENGINE														
2.0	Petrol	88	08/90-07/91	B 200 E										
Engine	Information				A10	A20	A40	A50	A70	C10 - C30	C20	E01		
All engines	version Bosch						806 127	906 118R						
All engines													359 372	
ENGINE														
2.0	Petrol	89	09/90-09/93	B 200 E, B 200 G										
Engine	Information				A10	A20	A40	A50	A70	C10 - C30	C20	E01		
All engines	version Bosch						806 127	906 118R						
Eng. B 200 E	version Bosch								406 222					
All engines													359 372	
ENGINE														
2.0 GL	Petrol	103	09/90-04/92	B 204 E										
Engine	Information				A10	A20	A40	A50	A70	C10 - C30	C20	E01		
All engines	version Bosch						806 127	906 118R						
ENGINE														
2.0 Turbo	Petrol	114	08/90-07/95	B 200 FT										
Engine	Information				A10	A20	A40	A50	A70	C10 - C30	C20	E01		
All engines	version Bosch						806 127	906 118R						
All engines													359 372	
ENGINE														
2.3	Petrol	114	08/90-07/91	B 234 F, B 234 G										
Engine	Information				A10	A20	A40	A50	A70	C10 - C30	C20	E01		
All engines	version Bosch						806 127	906 118R						
ENGINE														
2.3	Petrol	84	08/91-07/94	B 230 F										
Engine	Information				A10	A20	A40	A50	A70	C10 - C30	C20	E01		
All engines	version Bosch						806 127	906 118R						
All engines													359 372	
ENGINE														
2.3	Petrol	85	08/92-07/94	B 230 FD										
Engine	Information				A10	A20	A40	A50	A70	C10 - C30	C20	E01		
All engines	version Bosch						806 127	906 118R						
All engines													359 372	
ENGINE														
2.3	Petrol	90	08/90-12/94	B 230 E										
Engine	Information				A10	A20	A40	A50	A70	C10 - C30	C20	E01		
All engines	version Bosch						806 127	906 118R	406 222					
All engines													359 372	

A10	CONDENSER	A20	CONTACT SET	A40	DISTRIBUTOR CAP	A50	ROTOR	A70	PICK-UP
C10	COIL	C20	IGNITION MODULE	C30	ELECTRONIC IGNITION KIT	E01	IGNITION CABLE SET		

The present application list is a brief version. For the detailed information about the possibility of installation on a specific vehicle, please refer to our web-catalogue <http://catalogo.facet.eu/>

				FUNCTIONS ON THE VEHICLE								
Vehicle	alim.	kW	Date	Engine	 A10	 A20	 A40	 A50	 A70	 C10 - C30	 C20	 E01
				ENGINE								
2.3	Petrol	96	08/90-07/95	B 230 E, B 230 FB, B 230 G								
Engine	Information			A10	A20	A40	A50	A70	C10 - C30	C20	E01	
All engines	version Bosch					806 127	906 118R					
Eng. B 230 E	version Bosch							406 222				
All engines												359 372
				ENGINE								
2.3 16V	Petrol	114	08/90-07/92	B 234 G								
Engine	Information			A10	A20	A40	A50	A70	C10 - C30	C20	E01	
All engines	version Bosch					806 127	906 118R					
				ENGINE								
2.3 Turbo	Petrol	121	08/90-07/94	B 230 FT, B 230 GT								
Engine	Information			A10	A20	A40	A50	A70	C10 - C30	C20	E01	
All engines	version Bosch					806 127	906 118R					
Eng. B 230 FT												359 372
				ENGINE								
940 II				ENGINE								
2.0 GLT	Petrol	139	10/94-05/97	B 200 GT								
Engine	Information			A10	A20	A40	A50	A70	C10 - C30	C20	E01	
All engines	version Bosch					806 127	906 118R					
All engines												359 372
				ENGINE								
2.0 Turbo	Petrol	114	04/96-10/98	B 200 FT								
Engine	Information			A10	A20	A40	A50	A70	C10 - C30	C20	E01	
All engines	version Bosch					806 127	906 118R					
All engines												359 372
				ENGINE								
2.3	Petrol	113	10/94-05/97	B 230 GK								
Engine	Information			A10	A20	A40	A50	A70	C10 - C30	C20	E01	
All engines	version Bosch					806 127	906 118R					
All engines												359 372
				ENGINE								
2.3	Petrol	85	08/94-07/95	B 230 FD								
Engine	Information			A10	A20	A40	A50	A70	C10 - C30	C20	E01	
All engines	version Bosch					806 127	906 118R					
All engines												359 372
				ENGINE								
2.3 ti	Petrol	99	01/95-10/98	B 230 FK								
Engine	Information			A10	A20	A40	A50	A70	C10 - C30	C20	E01	
All engines	version Bosch					806 127	906 118R					
All engines												359 372
				ENGINE								
2.3 Turbo	Petrol	104	01/95-10/98	B 230 GK								
Engine	Information			A10	A20	A40	A50	A70	C10 - C30	C20	E01	
All engines	version Bosch					806 127	906 118R					
All engines												359 372
				ENGINE								
2.3 Turbo	Petrol	121	08/94-10/98	B 230 FT								
Engine	Information			A10	A20	A40	A50	A70	C10 - C30	C20	E01	
All engines	version Bosch					806 127	906 118R					
All engines												359 372
				ENGINE								
2.3 Turbo	Petrol	126	01/95-12/98	B 230 FT								
Engine	Information			A10	A20	A40	A50	A70	C10 - C30	C20	E01	
All engines	version Bosch					806 127	906 118R					
All engines												359 372
				ENGINE								
960 I				ENGINE								
2.0	Petrol	140	08/90-09/93	B 204 FT								
Engine	Information			A10	A20	A40	A50	A70	C10 - C30	C20	E01	
All engines	version Bosch					806 127	906 118R					
				FUNCTIONS ON THE VEHICLE								
A10	CONDENSER	A20	CONTACT SET	A40	DISTRIBUTOR CAP	A50	ROTOR	A70	PICK-UP			
C10	COIL	C20	IGNITION MODULE	C30	ELECTRONIC IGNITION KIT	E01	IGNITION CABLE SET					

Vehicle	alim.	kW	Date	Engine	FUNCTIONS ON THE VEHICLE									
					A10	A20	A40	A50	A70	C10 - C30	C20	E01		
ENGINE														
2.3	Petrol	121	08/90-07/94	B 230 GT										
ENGINE														
All engines							806 127	906 118R						
All engines													359 372	
ENGINE														
2.3 Turbo	Petrol	121	09/90-08/93	B 230 FT										
ENGINE														
All engines							806 127	906 118R						
All engines													359 372	
ENGINE														
2.8 GL	Petrol	108	09/90-05/92	B 280 F										
ENGINE														
All engines							806 236	906 119R						
ENGINE														
2.8 GL	Petrol	115	09/90-05/92	B 280 E										
ENGINE														
All engines							806 236	906 119R						
C30														
ENGINE														
1.6	Petrol	74	10/06-12/12	B 4164 S3										
ENGINE														
All engines										470 481	C10			
All engines													358 242	
ENGINE														
1.8	Petrol	92	10/06-12/12	B 4184 S11										
ENGINE														
All engines										470 480	C10			
ENGINE														
1.8 FlexFuel	Petrol/ Ethanol	92	01/07-12/12	B 4184 S8										
ENGINE														
All engines										470 480	C10			
ENGINE														
2.0	Petrol	107	10/06-12/12	B 4204 S3										
ENGINE														
All engines										470 480	C10			
ENGINE														
2.0 FlexFuel	Petrol/ Ethanol	107	01/10-12/12	B 4204 S4										
ENGINE														
All engines										470 480	C10			
ENGINE														
2.4 i	Petrol	125	10/06-12/12	B 5244 S4										
ENGINE														
All engines										470 478	C10			
ENGINE														
T5	Petrol	162	10/06-12/12	B 5254 T3										
ENGINE														
All engines										470 478	C10			
ENGINE														
T5	Petrol	169	03/07-12/12	B 5254 T7										
ENGINE														
All engines										470 478	C10			
ENGINE														
T5	Petrol	184	10/07-12/13	B 5254 T7										
ENGINE														
All engines										470 478	C10			

A10	CONDENSER	A20	CONTACT SET	A40	DISTRIBUTOR CAP	A50	ROTOR	A70	PICK-UP
C10	COIL	C20	IGNITION MODULE	C30	ELECTRONIC IGNITION KIT	E01	IGNITION CABLE SET		

The present application list is a brief version. For the detailed information about the possibility of installation on a specific vehicle, please refer to our web-catalogue <http://catalogo.facet.eu/>

Vehicle	alim.	kW	Date	Engine	FUNCTIONS ON THE VEHICLE							
					A10	A20	A40	A50	A70	C10 - C30	C20	E01

C70 I

ENGINE				
2.0	Petrol	132	03/97-10/05	B 5204 T2

Engine	Information	A10	A20	A40	A50	A70	C10 - C30	C20	E01
All engines	version Bosch			806 260	906 147R				
All engines							490 423	C30	358 064

ENGINE				
2.0 T	Petrol	120	03/00-10/05	B 5204 T4

Engine	Information	A10	A20	A40	A50	A70	C10 - C30	C20	E01
All engines	x 5, COIL ON PLUG, incl. spark plug connector						470 448	C10	

ENGINE				
2.0 T	Petrol	166	03/97-10/05	B 5204 T3

Engine	Information	A10	A20	A40	A50	A70	C10 - C30	C20	E01
All engines	MODEL TO: 1998, version Bosch			806 260	906 147R				
All engines	x 5, COIL ON PLUG, incl. spark plug connector						470 448	C10	
All engines	MODEL TO: 1998								358 064

ENGINE				
2.3 T5	Petrol	176	03/98-10/05	B 5234 T3

Engine	Information	A10	A20	A40	A50	A70	C10 - C30	C20	E01
All engines	MODEL TO: 1998, version Bosch			806 260	906 147R				
All engines	x 5, COIL ON PLUG, incl. spark plug connector						470 448	C10	
All engines	MODEL TO: 1998								358 064

ENGINE				
2.3 T5	Petrol	180	07/02-10/05	B 5234 T9

Engine	Information	A10	A20	A40	A50	A70	C10 - C30	C20	E01
All engines	x 5, COIL ON PLUG, incl. spark plug connector						470 448	C10	

ENGINE				
2.3 T-5	Petrol	176	03/97-09/02	B 5234 T3

Engine	Information	A10	A20	A40	A50	A70	C10 - C30	C20	E01
All engines	MODEL TO: 1998, version Bosch			806 260	906 147R				
All engines	x 5, COIL ON PLUG, incl. spark plug connector						470 448	C10	
All engines	MODEL TO: 1998								358 064

ENGINE				
2.4	Petrol	103	03/99-07/00	B 5244 S

Engine	Information	A10	A20	A40	A50	A70	C10 - C30	C20	E01
All engines	Qty: 5						470 448	C10	

ENGINE				
2.4	Petrol	121	03/99-09/02	B 5254 S, B5254SDENS

Engine	Information	A10	A20	A40	A50	A70	C10 - C30	C20	E01
Eng. B 5254 S	Qty: 5						470 448	C10	
Eng. B5254SDENS	x 5, COIL ON PLUG, incl. spark plug connector						470 448	C10	

ENGINE				
2.4	Petrol	125	06/98-10/05	B 5244 S, B 5254 S

Engine	Information	A10	A20	A40	A50	A70	C10 - C30	C20	E01
Eng. B 5244 S	x 5, COIL ON PLUG, incl. spark plug connector						470 448	C10	
Eng. B 5254 S	Qty: 5						470 448	C10	

ENGINE				
2.4 T	Petrol	142	03/97-10/05	B 5244 T, B 5254 T

Engine	Information	A10	A20	A40	A50	A70	C10 - C30	C20	E01
Eng. B 5254 T	MODEL TO: 1998, version Bosch			806 260	906 147R				
All engines	x 5, COIL ON PLUG, incl. spark plug connector						470 448	C10	
Eng. B 5254 T	MODEL FROM: 1999, Qty: 5						470 448	C10	
Eng. B 5254 T	MODEL TO: 1998						490 423	C30	358 064

ENGINE				
2.4 T	Petrol	147	07/02-10/05	B 5244 T7

Engine	Information	A10	A20	A40	A50	A70	C10 - C30	C20	E01
All engines	x 5, COIL ON PLUG, incl. spark plug connector						470 448	C10	

C70 II

ENGINE				
2.4	Petrol	103	03/06-10/09	B 5244 S5









Engine	Information	A10	A20	A40	A50	A70	C10 - C30	C20	E01
All engines	x 5, COIL ON PLUG						470 478	C10	

A10 CONDENSER	A20 CONTACT SET	A40 DISTRIBUTOR CAP	A50 ROTOR	A70 PICK-UP
C10 COIL	C20 IGNITION MODULE	C30 ELECTRONIC IGNITION KIT	E01 IGNITION CABLE SET	

Vehicle	alim.	kW	Date	Engine	FUNCTIONS ON THE VEHICLE									
					A10	A20	A40	A50	A70	C10 - C30	C20	E01		
ENGINE														
2.4 i	Petrol	125	03/06-10/09	B 5244 S4										
Engine	Information				A10	A20	A40	A50	A70	C10 - C30	C20	E01		
All engines	x 5, COIL ON PLUG									470 478	C10			
ENGINE														
T5	Petrol	162	03/06-02/07	B 5254 T3										
Engine	Information				A10	A20	A40	A50	A70	C10 - C30	C20	E01		
All engines	x 5, COIL ON PLUG									470 478	C10			
ENGINE														
T5	Petrol	169	03/07-06/13	B 5254 T3, B 5254 T7										
Engine	Information				A10	A20	A40	A50	A70	C10 - C30	C20	E01		
All engines	x 5, COIL ON PLUG									470 478	C10			
ENGINE														
P 121														
1.6	Petrol	44	05/59-09/66	B 16 A										
Engine	Information				A10	A20	A40	A50	A70	C10 - C30	C20	E01		
All engines	version BOSCH						806 076							
ENGINE														
1.8	Petrol	50	05/59-09/66	B 18 A										
Engine	Information				A10	A20	A40	A50	A70	C10 - C30	C20	E01		
All engines						706 021								
All engines	version BOSCH						806 076							
ENGINE														
1.8	Petrol	55	02/67-05/71	B 18										
Engine	Information				A10	A20	A40	A50	A70	C10 - C30	C20	E01		
All engines						706 021								
All engines	version BOSCH						806 076							
ENGINE														
2.0	Petrol	60	11/68-05/71	OJX4G20A6L										
Engine	Information				A10	A20	A40	A50	A70	C10 - C30	C20	E01		
All engines	version BOSCH						806 076							
ENGINE														
P 122 S AMAZON														
1.6	Petrol	61	05/59-09/66	B 16										
Engine	Information				A10	A20	A40	A50	A70	C10 - C30	C20	E01		
All engines	version BOSCH						806 076							
ENGINE														
1.8	Petrol	59	05/59-07/67	B 18										
Engine	Information				A10	A20	A40	A50	A70	C10 - C30	C20	E01		
All engines						706 021, 706 047								
All engines	version BOSCH						806 076							
ENGINE														
1.8	Petrol	63	09/66-05/71	B 18										
Engine	Information				A10	A20	A40	A50	A70	C10 - C30	C20	E01		
All engines						706 047								
All engines	version BOSCH						806 076							
ENGINE														
1.8	Petrol	66	02/67-05/71	B 18 D										
Engine	Information				A10	A20	A40	A50	A70	C10 - C30	C20	E01		
All engines						706 047	806 062							
All engines	version BOSCH						806 076							
ENGINE														
1.8	Petrol	76	09/66-05/71	B 18										
Engine	Information				A10	A20	A40	A50	A70	C10 - C30	C20	E01		
All engines						706 047								
All engines	version BOSCH						806 076							
ENGINE														
2.0	Petrol	74	11/68-05/71	B 20 B										
Engine	Information				A10	A20	A40	A50	A70	C10 - C30	C20	E01		
All engines	version BOSCH						806 076							









A10	CONDENSER	A20	CONTACT SET	A40	DISTRIBUTOR CAP	A50	ROTOR	A70	PICK-UP
C10	COIL	C20	IGNITION MODULE	C30	ELECTRONIC IGNITION KIT	E01	IGNITION CABLE SET		

The present application list is a brief version. For the detailed information about the possibility of installation on a specific vehicle, please refer to our web-catalogue <http://catalogo.facet.eu/>

				FUNCTIONS ON THE VEHICLE								
Vehicle	alim.	kW	Date	Engine								
P 1800												
1.8	Petrol	66	04/62-05/70	B 18 A								
ENGINE												
Engine	Information			A10	A20	A40	A50	A70	C10 - C30	C20	E01	
All engines					706 047							
1.8	Petrol	76	04/62-05/70	--								
ENGINE												
Engine	Information			A10	A20	A40	A50	A70	C10 - C30	C20	E01	
All engines					706 047							
1.8S	Petrol	71	04/62-05/70	--								
ENGINE												
Engine	Information			A10	A20	A40	A50	A70	C10 - C30	C20	E01	
All engines					706 047							
P 210 DUETT												
1.8	Petrol	55	08/61-07/67	B 18 A								
ENGINE												
Engine	Information			A10	A20	A40	A50	A70	C10 - C30	C20	E01	
All engines	version BOSCH					806 076						
P 2200												
1.8	Petrol	50	09/64-08/67	B 18 A								
ENGINE												
Engine	Information			A10	A20	A40	A50	A70	C10 - C30	C20	E01	
All engines					706 047							
1.8	Petrol	59	09/64-08/67	B 18 D								
ENGINE												
Engine	Information			A10	A20	A40	A50	A70	C10 - C30	C20	E01	
All engines					706 047							
1.8	Petrol	63	09/64-08/67	B 18 B								
ENGINE												
Engine	Information			A10	A20	A40	A50	A70	C10 - C30	C20	E01	
All engines					706 047							
PV 544												
1.6	Petrol	44	08/61-07/66	B 16 A								
ENGINE												
Engine	Information			A10	A20	A40	A50	A70	C10 - C30	C20	E01	
All engines	version BOSCH					806 076						
1.6	Petrol	61	08/61-07/67	B 16 B								
ENGINE												
Engine	Information			A10	A20	A40	A50	A70	C10 - C30	C20	E01	
All engines	version BOSCH					806 076						
1.8	Petrol	50	08/61-07/67	B 18 A								
ENGINE												
Engine	Information			A10	A20	A40	A50	A70	C10 - C30	C20	E01	
All engines					706 021							
All engines	version BOSCH					806 076						
1.8	Petrol	59	08/61-07/67	B 18 D								
ENGINE												
Engine	Information			A10	A20	A40	A50	A70	C10 - C30	C20	E01	
All engines	version BOSCH					806 076						
S40 I												
1.6	Petrol	77	09/95-08/99	B 4164 S								
ENGINE												
Engine	Information			A10	A20	A40	A50	A70	C10 - C30	C20	E01	
All engines	Fitting Position:for cylinder 1, Fitting Position:for cylinder 4, x 1, D.I.S., connector type SAE								470 355	C10		
All engines	Fitting Position:for cylinder 2, Fitting Position:for cylinder 3, x 1, D.I.S., connector type SAE								470 356	C10		
All engines											358 061	
1.6	Petrol	80	03/99-12/03	B 4164 S2								
ENGINE												
Engine	Information			A10	A20	A40	A50	A70	C10 - C30	C20	E01	
All engines											358 059	









A10 CONDENSER	A20 CONTACT SET	A40 DISTRIBUTOR CAP	A50 ROTOR	A70 PICK-UP
C10 COIL	C20 IGNITION MODULE	C30 ELECTRONIC IGNITION KIT	E01 IGNITION CABLE SET	

Vehicle	alim.	kW	Date	Engine	FUNCTIONS ON THE VEHICLE									
					A10	A20	A40	A50	A70	C10 - C30	C20	E01		
1.8	Petrol	85	07/95-12/03	ENGINE B 4184 S, B 4184 S2, B 4184 S3										
Engine	Information				A10	A20	A40	A50	A70	C10 - C30	C20	E01		
Eng. B 4184 S	Fitting Position:for cylinder 1, Fitting Position:for cylinder 4, x 1, D.I.S., connector type SAE									470 355	C10			
Eng. B 4184 S	Fitting Position:for cylinder 2, Fitting Position:for cylinder 3, x 1, D.I.S., connector type SAE									470 356	C10			
Eng. B 4184 S2, B 4184 S3												358 059		
Eng. B 4184 S												358 061		
1.8	Petrol	90	03/99-12/03	ENGINE B 4184 S2, B 4184 S9										
Engine	Information				A10	A20	A40	A50	A70	C10 - C30	C20	E01		
All engines												358 059		
1.8 16V	Petrol	90	08/00->	ENGINE B 4184 S10										
Engine	Information				A10	A20	A40	A50	A70	C10 - C30	C20	E01		
All engines												358 059		
1.9 T4	Petrol	147	05/97-07/00	ENGINE B 4194 T, B 4194 T2										
Engine	Information				A10	A20	A40	A50	A70	C10 - C30	C20	E01		
All engines												358 059		
2.0	Petrol	100	07/95-12/03	ENGINE B 4204 S, B 4204 S2										
Engine	Information				A10	A20	A40	A50	A70	C10 - C30	C20	E01		
All engines	Fitting Position:for cylinder 1, Fitting Position:for cylinder 4, production date -> 1999, x 1, D.I.S., connector type SAE									470 355	C10			
All engines	Fitting Position:for cylinder 2, Fitting Position:for cylinder 3, production date -> 1999, x 1, D.I.S., connector type SAE									470 356	C10			
Eng. B 4204 S2												358 059		
Eng. B 4204 S												358 061		
2.0	Petrol	103	07/95-08/99	ENGINE B 4204 S										
Engine	Information				A10	A20	A40	A50	A70	C10 - C30	C20	E01		
All engines	Fitting Position:for cylinder 1, Fitting Position:for cylinder 4, x 1, D.I.S., connector type SAE									470 355	C10			
All engines	Fitting Position:for cylinder 2, Fitting Position:for cylinder 3, x 1, D.I.S., connector type SAE									470 356	C10			
All engines												358 061		
2.0 T	Petrol	118	10/97-12/03	ENGINE B 4204 T										
Engine	Information				A10	A20	A40	A50	A70	C10 - C30	C20	E01		
All engines												358 059		
2.0 T	Petrol	120	06/01-12/03	ENGINE B 4204 T3										
Engine	Information				A10	A20	A40	A50	A70	C10 - C30	C20	E01		
All engines												358 059		
2.0 T4	Petrol	147	07/00-12/03	ENGINE B 4204 T5										
Engine	Information				A10	A20	A40	A50	A70	C10 - C30	C20	E01		
All engines												358 059		
S40 II														
1.6	Petrol	74	01/05-12/12	ENGINE B 4164 S3										
Engine	Information				A10	A20	A40	A50	A70	C10 - C30	C20	E01		
All engines	ch. 106167 ->, x 1, D.I.S.									470 481	C10			
All engines	->ch. 106166, x 1, D.I.S.									470 532	C10			
All engines												358 242		
1.8	Petrol	92	04/04-12/10	ENGINE B 4184 S11										
Engine	Information				A10	A20	A40	A50	A70	C10 - C30	C20	E01		
All engines	x 4, COIL ON PLUG									470 480	C10			
A10	CONDENSER		A20	CONTACT SET		A40	DISTRIBUTOR CAP		A50	ROTOR		A70	PICK-UP	
C10	COIL		C20	IGNITION MODULE		C30	ELECTRONIC IGNITION KIT		E01	IGNITION CABLE SET				

					FUNCTIONS ON THE VEHICLE							
Vehicle	alim.	kW	Date	Engine								
ENGINE												
1.8 FlexFuel	Petrol/ Ethanol	92	01/06-12/10	B 4184 S8								
Engine	Information				A10	A20	A40	A50	A70	C10 - C30	C20	E01
All engines	x 4, COIL ON PLUG									470 480	C10	
ENGINE												
2.0	Petrol	107	10/06-12/12	B 4204 S3								
Engine	Information				A10	A20	A40	A50	A70	C10 - C30	C20	E01
All engines	x 4, COIL ON PLUG									470 480	C10	
ENGINE												
2.0 F	Petrol/ Ethanol	107	10/09-12/12	B 4204 S4								
Engine	Information				A10	A20	A40	A50	A70	C10 - C30	C20	E01
All engines	x 4, COIL ON PLUG									470 480	C10	
ENGINE												
2.4	Petrol	103	01/04-12/10	B 5244 S5								
Engine	Information				A10	A20	A40	A50	A70	C10 - C30	C20	E01
All engines	->ch. 81811, ch. 81812 ->, x 5, COIL ON PLUG									470 478	C10	
ENGINE												
2.4	Petrol	125	01/04-12/12	B 5244 S4								
Engine	Information				A10	A20	A40	A50	A70	C10 - C30	C20	E01
All engines	->ch. 83812, ch. 83813 ->, x 5, COIL ON PLUG									470 478	C10	
ENGINE												
T5	Petrol	162	01/04-12/07	B 5254 T3								
Engine	Information				A10	A20	A40	A50	A70	C10 - C30	C20	E01
All engines	x 5, COIL ON PLUG									470 478	C10	
ENGINE												
T5	Petrol	169	03/07-12/12	B 5254 T7								
Engine	Information				A10	A20	A40	A50	A70	C10 - C30	C20	E01
All engines	x 5, COIL ON PLUG									470 478	C10	
ENGINE												
T5 AWD	Petrol	162	04/04-12/07	B 5254 T3								
Engine	Information				A10	A20	A40	A50	A70	C10 - C30	C20	E01
All engines	x 5, COIL ON PLUG									470 478	C10	
ENGINE												
T5 AWD	Petrol	169	03/07-12/10	B 5254 T7								
Engine	Information				A10	A20	A40	A50	A70	C10 - C30	C20	E01
All engines	x 5, COIL ON PLUG									470 478	C10	
S60 I												
ENGINE												
2.0T	Petrol	132	07/00-04/10	B 5204 T5								
Engine	Information				A10	A20	A40	A50	A70	C10 - C30	C20	E01
All engines	->year 01/06/04, x 5, COIL ON PLUG, incl. spark plug connector									470 448	C10	
All engines	01/07/04 ->, x 5, COIL ON PLUG									470 478	C10	
ENGINE												
2.3 T5	Petrol	195	07/00-09/02	B 5234 T7								
Engine	Information				A10	A20	A40	A50	A70	C10 - C30	C20	E01
All engines	Qty: 5									470 448	C10	
All engines	x 5, COIL ON PLUG, incl. spark plug connector									470 448	C10	
ENGINE												
2.4	Petrol	103	07/00-04/10	B 5244 S2								
Engine	Information				A10	A20	A40	A50	A70	C10 - C30	C20	E01
All engines	x 5, COIL ON PLUG, incl. spark plug connector									470 448	C10	
ENGINE												
2.4	Petrol	125	11/00-04/10	B 5244 S								
Engine	Information				A10	A20	A40	A50	A70	C10 - C30	C20	E01
All engines	x 5, COIL ON PLUG, incl. spark plug connector									470 448	C10	
ENGINE												
2.4	Petrol	132	01/05-10/06	B 5244 T4								
Engine	Information				A10	A20	A40	A50	A70	C10 - C30	C20	E01
All engines	x 5, COIL ON PLUG, incl. spark plug connector									470 448	C10	

A10 CONDENSER	A20 CONTACT SET	A40 DISTRIBUTOR CAP	A50 ROTOR	A70 PICK-UP
C10 COIL	C20 IGNITION MODULE	C30 ELECTRONIC IGNITION KIT	E01 IGNITION CABLE SET	

Vehicle	alim.	kW	Date	Engine	FUNCTIONS ON THE VEHICLE									
					A10	A20	A40	A50	A70	C10 - C30	C20	E01		
ENGINE														
2.4 AWD	Petrol	191	02/04-04/10	B 5244 T5										
ENGINE														
All engines					Qty: 5						470 478	C10		
ENGINE														
2.4 Bifuel	Petrol/ Compressed Natural Gas (CNG)	103	07/01-04/10	B 5244 SG, B 5244 SG2										
ENGINE														
All engines					x 5, COIL ON PLUG, incl. spark plug connector						470 448	C10		
All engines					x 5, COIL ON PLUG, incl. spark plug connector						470 448	C10		
ENGINE														
2.4 T	Petrol	147	07/00-04/10	B 5244 T3										
ENGINE														
All engines					x 5, COIL ON PLUG, incl. spark plug connector						470 448	C10		
ENGINE														
2.4 T AWD	Petrol	147	06/01-04/10	B 5244 T3										
ENGINE														
All engines					x 5, COIL ON PLUG, incl. spark plug connector						470 448	C10		
ENGINE														
2.4 T5	Petrol	191	04/04-04/10	B 5244 T5										
ENGINE														
All engines					x 5, COIL ON PLUG, incl. spark plug connector						470 448	C10		
ENGINE														
2.5 AWD	Petrol	224	09/03-04/10	B 5254 T4										
ENGINE														
All engines					Qty: 5						470 478	C10		
ENGINE														
2.5 T	Petrol	154	01/03-04/10	B 5254 T2										
ENGINE														
All engines					x 5, COIL ON PLUG, incl. spark plug connector						470 448	C10		
ENGINE														
2.5 T AWD	Petrol	154	07/02-04/10	B 5254 T2										
ENGINE														
All engines					x 5, COIL ON PLUG, incl. spark plug connector						470 448	C10		
ENGINE														
R 2,5 T AWD	Petrol	221	01/03-04/10	B 5254 T4										
ENGINE														
All engines					x 5, COIL ON PLUG, incl. spark plug connector						470 448	C10		
ENGINE														
T5	Petrol	184	07/00-04/10	B 5234 T3										
ENGINE														
All engines					x 5, COIL ON PLUG, incl. spark plug connector						470 448	C10		
ENGINE														
S60 II														
ENGINE														
2.0 T	Petrol	132	05/12-12/15	B 5204 T8										
ENGINE														
All engines					x 5, COIL ON PLUG						470 478	C10		
ENGINE														
2.5 T	Petrol	183	01/13->	B 5254 T14										
ENGINE														
All engines					Qty: 5						470 478	C10		
ENGINE														
2.5 T5	Petrol	186	09/11-12/15	B 5254 T5										
ENGINE														
All engines					x 5, COIL ON PLUG						470 478	C10		
ENGINE														
2.5 T5 AWD	Petrol	183	03/15-12/18	B 5254 T14										
ENGINE														
All engines					x 5, COIL ON PLUG						470 478	C10		
A10	CONDENSER		A20	CONTACT SET		A40	DISTRIBUTOR CAP		A50	ROTOR		A70	PICK-UP	
C10	COIL		C20	IGNITION MODULE		C30	ELECTRONIC IGNITION KIT		E01	IGNITION CABLE SET				

				FUNCTIONS ON THE VEHICLE								
Vehicle	alim.	kW	Date	Engine								
				ENGINE								
2.5 T5 AWD	Petrol	186	09/12-12/15	B 5254 T5								
Engine		Information			A10	A20	A40	A50	A70	C10 - C30	C20	E01
All engines		Qty: 5								470 478	C10	
				ENGINE								
T	Petrol	157	04/14->	B 5204 T9								
Engine		Information			A10	A20	A40	A50	A70	C10 - C30	C20	E01
All engines		Qty: 5								470 478	C10	
				ENGINE								
T5 AWD	Petrol	187	08/15-12/18	B 5254 T12								
Engine		Information			A10	A20	A40	A50	A70	C10 - C30	C20	E01
All engines		x 5, COIL ON PLUG								470 478	C10	
				ENGINE								
S70												
2.0	Petrol	105	01/97-11/00	B 5204 T2								
Engine		Information			A10	A20	A40	A50	A70	C10 - C30	C20	E01
All engines										490 423	C30	
				ENGINE								
2.0	Petrol	120	01/97-11/00	B 5204 T4								
Engine		Information			A10	A20	A40	A50	A70	C10 - C30	C20	E01
All engines		x 5, COIL ON PLUG, incl. spark plug connector								470 448	C10	
				ENGINE								
2.0	Petrol	132	01/97-11/00	B 5204 T2								
Engine		Information			A10	A20	A40	A50	A70	C10 - C30	C20	E01
All engines		version Bosch					806 260	906 147R				
All engines										490 423	C30	358 064
				ENGINE								
2.0	Petrol	93	01/97-11/00	B 5202 FS, B 5202 S								
Engine		Information			A10	A20	A40	A50	A70	C10 - C30	C20	E01
All engines		version Bosch					806 260	906 147R				
Eng. B 5202 FS										490 423	C30	
Eng. B 5202 S										490 423	C30	
All engines												358 064
				ENGINE								
2.0 Turbo	Petrol	155	01/97-11/00	B 5204 T2								
Engine		Information			A10	A20	A40	A50	A70	C10 - C30	C20	E01
All engines										490 423	C30	
				ENGINE								
2.0 Turbo	Petrol	166	01/97-11/00	B 5204 T3								
Engine		Information			A10	A20	A40	A50	A70	C10 - C30	C20	E01
All engines		MODEL TO: 1998, version Bosch					806 260	906 147R				
All engines										490 423	C30	
All engines		MODEL TO: 1998										358 064
				ENGINE								
2.3	Petrol	120	01/97-07/99	B 5234 F5								
Engine		Information			A10	A20	A40	A50	A70	C10 - C30	C20	E01
All engines		MODEL TO: 1998, version Bosch					806 260	906 147R				
All engines		MODEL FROM: 1999, Qty: 5								470 448	C10	
All engines		MODEL TO: 1998								490 423	C30	358 064
				ENGINE								
2.3	Petrol	177	11/96-11/00	B 5234 T3								
Engine		Information			A10	A20	A40	A50	A70	C10 - C30	C20	E01
All engines										490 423	C30	
				ENGINE								
2.3	Petrol	195	04/99-09/00	B 5234 T7								
Engine		Information			A10	A20	A40	A50	A70	C10 - C30	C20	E01
All engines		MODEL TO: 1998, version Bosch					806 260	906 147R				
All engines		x 5, COIL ON PLUG, incl. spark plug connector								470 448	C10	
All engines		MODEL TO: 1998										358 064

A10 CONDENSER	A20 CONTACT SET	A40 DISTRIBUTOR CAP	A50 ROTOR	A70 PICK-UP
C10 COIL	C20 IGNITION MODULE	C30 ELECTRONIC IGNITION KIT	E01 IGNITION CABLE SET	

Vehicle	alim.	kW	Date	Engine	FUNCTIONS ON THE VEHICLE							
					A10	A20	A40	A50	A70	C10 - C30	C20	E01
ENGINE												
2.3 AWD	Petrol	195	04/99-09/00	B 5234 T7								
Engine	Information			A10	A20	A40	A50	A70	C10 - C30	C20	E01	
All engines	MODEL TO: 1998, version Bosch					806 260	906 147R					
All engines	MODEL FROM: 1999, Qty: 5								470 448	C10		
All engines	MODEL TO: 1998								490 423	C30	358 064	
ENGINE												
2.3 T-5	Petrol	176	01/97-11/00	B 5234 T3								
Engine	Information			A10	A20	A40	A50	A70	C10 - C30	C20	E01	
All engines	MODEL TO: 1998, version Bosch					806 260	906 147R					
All engines									490 423	C30		
All engines	MODEL TO: 1998										358 064	
ENGINE												
2.3 T5 AWD	Petrol	177	11/96-09/98	B 5234 T3								
Engine	Information			A10	A20	A40	A50	A70	C10 - C30	C20	E01	
All engines									490 423	C30		
ENGINE												
2.3 T5 AWD	Petrol	184	07/97-09/00	B 5234 T4								
Engine	Information			A10	A20	A40	A50	A70	C10 - C30	C20	E01	
All engines	version Bosch					806 260	906 147R					
All engines									490 423	C30	358 064	
ENGINE												
2.3 T5-R AWD	Petrol	176	11/96-09/98	B 5234 T2								
Engine	Information			A10	A20	A40	A50	A70	C10 - C30	C20	E01	
All engines	version Bosch					806 260	906 147R					
All engines									490 423	C30	358 064	
ENGINE												
2.3 Turbo	Petrol	184	01/97-11/00	B 5234 FT+, B 5234 T4								
Engine	Information			A10	A20	A40	A50	A70	C10 - C30	C20	E01	
Eng. B 5234 FT+	version Bosch					806 260	906 147R					
Eng. B 5234 FT+									490 423	C30	358 064	
Eng. B 5234 T4									490 423	C30		
ENGINE												
2.4	Petrol	103	08/99-11/00	B 5244 S2, B 5244 SG								
Engine	Information			A10	A20	A40	A50	A70	C10 - C30	C20	E01	
Eng. B 5244 S2	x 5, COIL ON PLUG, incl. spark plug connector								470 448	C10		
Eng. B 5244 SG	Qty: 5								470 448	C10		
ENGINE												
2.4	Petrol	106	01/97-11/00	B 5252 FS								
Engine	Information			A10	A20	A40	A50	A70	C10 - C30	C20	E01	
All engines									490 423	C30		
ENGINE												
2.4	Petrol	121	06/98-11/00	B 5254 S, B5254SDENS								
Engine	Information			A10	A20	A40	A50	A70	C10 - C30	C20	E01	
Eng. B 5254 S	MODEL TO: 1998, version Bosch					806 260	906 147R					
Eng. B 5254 S	MODEL FROM: 1999, Qty: 5								470 448	C10		
Eng. B5254SDENS	x 5, COIL ON PLUG, incl. spark plug connector								470 448	C10		
Eng. B 5254 S	MODEL TO: 1998								490 423	C30	358 064	
ENGINE												
2.4	Petrol	125	01/97-11/00	B 5244 S, B 5254 FS								
Engine	Information			A10	A20	A40	A50	A70	C10 - C30	C20	E01	
Eng. B 5244 S	x 5, COIL ON PLUG, incl. spark plug connector								470 448	C10		
Eng. B 5254 FS									490 423	C30		
ENGINE												
2.4 AWD	Petrol	103	04/99-09/00	B 5244 S2								
Engine	Information			A10	A20	A40	A50	A70	C10 - C30	C20	E01	
All engines	x 5, COIL ON PLUG, incl. spark plug connector								470 448	C10		
ENGINE												
2.4 AWD	Petrol	106	11/96-05/99	B 5252 FS								
Engine	Information			A10	A20	A40	A50	A70	C10 - C30	C20	E01	
All engines	version Bosch					806 260	906 147R					

A10	CONDENSER	A20	CONTACT SET	A40	DISTRIBUTOR CAP	A50	ROTOR	A70	PICK-UP
C10	COIL	C20	IGNITION MODULE	C30	ELECTRONIC IGNITION KIT	E01	IGNITION CABLE SET		

The present application list is a brief version. For the detailed information about the possibility of installation on a specific vehicle, please refer to our web-catalogue <http://catalogo.facet.eu/>

					FUNCTIONS ON THE VEHICLE							
Vehicle	alim.	kW	Date	Engine	A10	A20	A40	A50	A70	C10 - C30	C20	E01
ENGINE												
2.4 AWD	Petrol	106	11/96-05/99	B 5252 FS								
Engine	Information				A10	A20	A40	A50	A70	C10 - C30	C20	E01
All engines										490 423	C30	358 064
ENGINE												
2.4 AWD	Petrol	121	10/98-05/99	B5254SDENS								
Engine	Information				A10	A20	A40	A50	A70	C10 - C30	C20	E01
All engines	x 5, COIL ON PLUG, incl. spark plug connector									470 448	C10	
ENGINE												
2.4 AWD	Petrol	125	04/99-09/00	B 5244 S								
Engine	Information				A10	A20	A40	A50	A70	C10 - C30	C20	E01
All engines	x 5, COIL ON PLUG, incl. spark plug connector									470 448	C10	
ENGINE												
2.4 Bifuel	Natural Gas	103	07/99-11/00	B 5244 SG2								
Engine	Information				A10	A20	A40	A50	A70	C10 - C30	C20	E01
All engines	Qty: 5									470 448	C10	
Eng. B 5244 SG	Qty: 5									470 448	C10	
Eng. B 5244 SG2	x 5, COIL ON PLUG, incl. spark plug connector									470 448	C10	
ENGINE												
2.4 Bifuel	Petrol/Compressed Natural Gas (CNG)	106	10/98-11/00	GB 5252 S								
Engine	Information				A10	A20	A40	A50	A70	C10 - C30	C20	E01
All engines	version Bosch						806 260	906 147R				
All engines										490 423	C30	358 064
ENGINE												
2.4 Blu-Fuel	Petrol/Compressed Natural Gas (CNG)	103	07/97-09/00	B 5244 S2, B 5244 SG								
Engine	Information				A10	A20	A40	A50	A70	C10 - C30	C20	E01
Eng. B 5244 S2	Qty: 5									470 448	C10	
Eng. B 5244 SG	x 5, COIL ON PLUG, incl. spark plug connector									470 448	C10	
ENGINE												
2.4 T5 AWD	Petrol	142	11/96-04/99	B 5254 T								
Engine	Information				A10	A20	A40	A50	A70	C10 - C30	C20	E01
All engines	MODEL TO: 1998, version Bosch						806 260	906 147R				
All engines	01/07/98 ->, x 5, COIL ON PLUG, incl. spark plug connector									470 448	C10	
All engines										490 423	C30	
All engines	MODEL TO: 1998											358 064
ENGINE												
2.4 Turbo	Petrol	142	01/97-11/00	B 5244 T, B 5254 T								
Engine	Information				A10	A20	A40	A50	A70	C10 - C30	C20	E01
Eng. B 5254 T	MODEL TO: 1998, version Bosch						806 260	906 147R				
Eng. B 5244 T	x 5, COIL ON PLUG, incl. spark plug connector									470 448	C10	
Eng. B 5254 T										490 423	C30	
Eng. B 5254 T	MODEL TO: 1998											358 064
ENGINE												
S80												
2.5 T	Petrol	147	01/08->	B 5254 T6								
Engine	Information				A10	A20	A40	A50	A70	C10 - C30	C20	E01
All engines	Qty: 5									470 478	C10	
ENGINE												
2.5 T5	Petrol	187	01/12->	B 5254 T12								
Engine	Information				A10	A20	A40	A50	A70	C10 - C30	C20	E01
All engines	Qty: 5									470 478	C10	

A10 CONDENSER	A20 CONTACT SET	A40 DISTRIBUTOR CAP	A50 ROTOR	A70 PICK-UP
C10 COIL	C20 IGNITION MODULE	C30 ELECTRONIC IGNITION KIT	E01 IGNITION CABLE SET	

Vehicle	alim.	kW	Date	Engine	FUNCTIONS ON THE VEHICLE									
					A10	A20	A40	A50	A70	C10 - C30	C20	E01		
ENGINE														
T4	Petrol	132	01/12->	B 5204 T8										
Engine					A10	A20	A40	A50	A70	C10 - C30	C20	E01		
All engines										470 478	C10			
S80 I														
2.0	Petrol	120	06/98-07/06	B 5204 T4										
Engine					A10	A20	A40	A50	A70	C10 - C30	C20	E01		
All engines										470 448	C10			
ENGINE														
2.0 T	Petrol	132	12/99-07/06	B 5204 T5										
Engine					A10	A20	A40	A50	A70	C10 - C30	C20	E01		
All engines										470 448	C10			
All engines										470 478	C10			
ENGINE														
2.0 T	Petrol	166	06/98-07/06	B 5204 T3										
Engine					A10	A20	A40	A50	A70	C10 - C30	C20	E01		
All engines										470 448	C10			
ENGINE														
2.3 R	Petrol	195	04/00-08/05	B 5234 T7										
Engine					A10	A20	A40	A50	A70	C10 - C30	C20	E01		
All engines										470 448	C10			
All engines										470 448	C10			
ENGINE														
2.4	Petrol	103	01/99-07/06	B 5244 S2										
Engine					A10	A20	A40	A50	A70	C10 - C30	C20	E01		
All engines										470 448	C10			
ENGINE														
2.4	Petrol	125	01/99-07/06	B 5244 S										
Engine					A10	A20	A40	A50	A70	C10 - C30	C20	E01		
All engines										470 448	C10			
ENGINE														
2.4 Bifuel	Petrol/ Com- pressed Natural Gas (CNG)	103	09/01-07/06	B 5244 SG, B 5244 SG2										
Engine					A10	A20	A40	A50	A70	C10 - C30	C20	E01		
Eng. B 5244 SG										470 448	C10			
Eng. B 5244 SG2										470 448	C10			
Eng. B 5244 SG										470 448	C10			
Eng. B 5244 SG2										470 448	C10			
ENGINE														
2.4 LTP	Petrol	132	06/04-07/06	B 5244 T4										
Engine					A10	A20	A40	A50	A70	C10 - C30	C20	E01		
All engines										470 478	C10			
ENGINE														
2.4 T	Petrol	147	06/00-07/06	B 5244 T3										
Engine					A10	A20	A40	A50	A70	C10 - C30	C20	E01		
All engines										470 448	C10			
ENGINE														
2.4 T5 AWD	Petrol	147	04/00-09/03	B 5244 T3										
Engine					A10	A20	A40	A50	A70	C10 - C30	C20	E01		
All engines										470 448	C10			
ENGINE														
2.5 T	Petrol	154	03/03-07/06	B 5254 T2										
Engine					A10	A20	A40	A50	A70	C10 - C30	C20	E01		
All engines										470 448	C10			
ENGINE														
2.5 T AWD	Petrol	154	07/03-07/06	B 5254 T2										
Engine					A10	A20	A40	A50	A70	C10 - C30	C20	E01		
All engines										470 448	C10			
A10	CONDENSER		A20	CONTACT SET		A40	DISTRIBUTOR CAP		A50	ROTOR		A70	PICK-UP	
C10	COIL		C20	IGNITION MODULE		C30	ELECTRONIC IGNITION KIT		E01	IGNITION CABLE SET				









Vehicle	alim.	kW	Date	Engine	FUNCTIONS ON THE VEHICLE									
					A10	A20	A40	A50	A70	C10 - C30	C20	E01		
ENGINE														
2.8 T6	Petrol	200	05/98-12/01	B 6284 T										
Engine	Information				A10	A20	A40	A50	A70	C10 - C30	C20	E01		
All engines	x 6, COIL ON PLUG, incl. spark plug connector									470 448	C10			
ENGINE														
2.9	Petrol	144	05/98-02/08	B 6294 S2										
Engine	Information				A10	A20	A40	A50	A70	C10 - C30	C20	E01		
All engines	x 6, COIL ON PLUG, incl. spark plug connector									470 448	C10			
ENGINE														
2.9	Petrol	147	03/99-07/06	B 6294 S										
Engine	Information				A10	A20	A40	A50	A70	C10 - C30	C20	E01		
All engines	x 6, COIL ON PLUG, incl. spark plug connector									470 448	C10			
ENGINE														
2.9	Petrol	150	05/98-07/06	B 6304 S3										
Engine	Information				A10	A20	A40	A50	A70	C10 - C30	C20	E01		
All engines	x 6, COIL ON PLUG, incl. spark plug connector									470 448	C10			
ENGINE														
2.9 T6	Petrol	200	06/01-07/06	B 6294 T										
Engine	Information				A10	A20	A40	A50	A70	C10 - C30	C20	E01		
All engines	x 6, COIL ON PLUG, incl. spark plug connector									470 448	C10			
ENGINE														
3.0	Petrol	144	06/01-07/06	B 6294 S2										
Engine	Information				A10	A20	A40	A50	A70	C10 - C30	C20	E01		
All engines	x 6, COIL ON PLUG, incl. spark plug connector									470 448	C10			
ENGINE														
3.0 T6	Petrol	200	06/01-07/06	B 6294 T										
Engine	Information				A10	A20	A40	A50	A70	C10 - C30	C20	E01		
All engines	x 6, COIL ON PLUG, incl. spark plug connector									470 448	C10			
S80 II														
ENGINE														
2.0	Petrol	107	01/08-09/12	B 4204 S3										
Engine	Information				A10	A20	A40	A50	A70	C10 - C30	C20	E01		
All engines	x 4, COIL ON PLUG									470 480	C10			
ENGINE														
2.0 FlexFuel	Petrol/ Ethanol	107	01/08-12/11	B 4204 S4										
Engine	Information				A10	A20	A40	A50	A70	C10 - C30	C20	E01		
All engines	x 4, COIL ON PLUG									470 480	C10			
ENGINE														
2.5 T	Petrol	147	03/06-12/11	B 5254 T6										
Engine	Information				A10	A20	A40	A50	A70	C10 - C30	C20	E01		
All engines	x 5, COIL ON PLUG									470 478	C10			
ENGINE														
2.5 T	Petrol	170	01/10-12/12	B 5254 T10										
Engine	Information				A10	A20	A40	A50	A70	C10 - C30	C20	E01		
All engines	x 5, COIL ON PLUG									470 478	C10			
ENGINE														
2.5 T	Petrol	183	09/12-12/16	B 5254 T14										
Engine	Information				A10	A20	A40	A50	A70	C10 - C30	C20	E01		
All engines	x 5, COIL ON PLUG									470 478	C10			
ENGINE														
2.5 T	Petrol	187	01/12-04/16	B 5254 T12										
Engine	Information				A10	A20	A40	A50	A70	C10 - C30	C20	E01		
All engines	x 5, COIL ON PLUG									470 478	C10			
ENGINE														
2.5 T AWD	Petrol	147	10/06-04/09	B 5254 T6										
Engine	Information				A10	A20	A40	A50	A70	C10 - C30	C20	E01		
All engines	Qty: 5									470 478	C10			

A10 CONDENSER	A20 CONTACT SET	A40 DISTRIBUTOR CAP	A50 ROTOR	A70 PICK-UP
C10 COIL	C20 IGNITION MODULE	C30 ELECTRONIC IGNITION KIT	E01 IGNITION CABLE SET	

Vehicle	alim.	kW	Date	Engine	FUNCTIONS ON THE VEHICLE							
					A10	A20	A40	A50	A70	C10 - C30	C20	E01
ENGINE												
2.5 T FlexFuel	Petrol/ Ethanol	147	05/08-12/11	B 5254 T8								
Engine	Information			A10	A20	A40	A50	A70	C10 - C30	C20	E01	
All engines	x 5, COIL ON PLUG								470 478	C10		
ENGINE												
2.5 T FlexFuel	Petrol/ Ethanol	170	01/10-12/11	B 5254 T11								
Engine	Information			A10	A20	A40	A50	A70	C10 - C30	C20	E01	
All engines	x 5, COIL ON PLUG								470 478	C10		
V40 I												
ENGINE												
1.6	Petrol	77	12/95-08/99	B 4164 S								
Engine	Information			A10	A20	A40	A50	A70	C10 - C30	C20	E01	
All engines	Fitting Position:for cylinder 1, Fitting Position:for cylinder 4, x 1, D.I.S., connector type SAE								470 355	C10		
All engines	Fitting Position:for cylinder 2, Fitting Position:for cylinder 3, x 1, D.I.S., connector type SAE								470 356	C10		
All engines											358 061	
ENGINE												
1.6	Petrol	80	03/99-06/04	B 4164 S2								
Engine	Information			A10	A20	A40	A50	A70	C10 - C30	C20	E01	
All engines											358 059	
ENGINE												
1.8	Petrol	85	07/95-08/99	B 4184 S, B 4184 S3								
Engine	Information			A10	A20	A40	A50	A70	C10 - C30	C20	E01	
Eng. B 4184 S	Fitting Position:for cylinder 1, Fitting Position:for cylinder 4, x 1, D.I.S., connector type SAE								470 355	C10		
Eng. B 4184 S	Fitting Position:for cylinder 2, Fitting Position:for cylinder 3, x 1, D.I.S., connector type SAE								470 356	C10		
All engines											358 061	
ENGINE												
1.8	Petrol	90	03/99-06/04	B 4184 S2, B 4184 S3, B 4184 S9								
Engine	Information			A10	A20	A40	A50	A70	C10 - C30	C20	E01	
All engines											358 059	
ENGINE												
1.8 16V	Petrol	90	08/00->	B 4184 S10								
Engine	Information			A10	A20	A40	A50	A70	C10 - C30	C20	E01	
All engines											358 059	
ENGINE												
1.9 T4	Petrol	147	05/97-07/00	B 4194 T								
Engine	Information			A10	A20	A40	A50	A70	C10 - C30	C20	E01	
All engines											358 059	
ENGINE												
2.0	Petrol	100	07/95-06/04	B 4204 S, B 4204 S2								
Engine	Information			A10	A20	A40	A50	A70	C10 - C30	C20	E01	
Eng. B 4204 S	Fitting Position:for cylinder 1, Fitting Position:for cylinder 4, production date -> 1999, x 1, D.I.S., connector type SAE								470 355	C10		
Eng. B 4204 S	Fitting Position:for cylinder 2, Fitting Position:for cylinder 3, production date -> 1999, x 1, D.I.S., connector type SAE								470 356	C10		
Eng. B 4204 S2											358 059	
Eng. B 4204 S											358 061	
ENGINE												
2.0	Petrol	103	07/95-08/99	B 4204 S								
Engine	Information			A10	A20	A40	A50	A70	C10 - C30	C20	E01	
All engines	Fitting Position:for cylinder 1, Fitting Position:for cylinder 4, x 1, D.I.S., connector type SAE								470 355	C10		
All engines	Fitting Position:for cylinder 2, Fitting Position:for cylinder 3, x 1, D.I.S., connector type SAE								470 356	C10		
All engines											358 061	
ENGINE												
2.0 T	Petrol	118	10/97-07/00	B 4204 T								
Engine	Information			A10	A20	A40	A50	A70	C10 - C30	C20	E01	
All engines											358 059	

A10 CONDENSER	A20 CONTACT SET	A40 DISTRIBUTOR CAP	A50 ROTOR	A70 PICK-UP
C10 COIL	C20 IGNITION MODULE	C30 ELECTRONIC IGNITION KIT	E01 IGNITION CABLE SET	

The present application list is a brief version. For the detailed information about the possibility of installation on a specific vehicle, please refer to our web-catalogue <http://catalogo.facet.eu/>









				FUNCTIONS ON THE VEHICLE								
Vehicle	alim.	kW	Date	Engine	 A10	 A20	 A40	 A50	 A70	 C10 - C30	 C20	 E01
				ENGINE								
2.0 T	Petrol	120	06/01-06/04	B 4204 T3								
Engine	Information				A10	A20	A40	A50	A70	C10 - C30	C20	E01
All engines												358 059
				ENGINE								
2.0 T	Petrol	121	07/99-06/04	B 4204 T2								
Engine	Information				A10	A20	A40	A50	A70	C10 - C30	C20	E01
All engines												358 059
				ENGINE								
2.0 T4	Petrol	147	07/00-06/04	B 4204 T5								
Engine	Information				A10	A20	A40	A50	A70	C10 - C30	C20	E01
All engines												358 059
				ENGINE								
V40 II												
T4	Petrol	132	07/13-12/15	B 5204 T8								
Engine	Information				A10	A20	A40	A50	A70	C10 - C30	C20	E01
All engines	x 5, COIL ON PLUG									470 478	C10	
				ENGINE								
T4 AWD	Petrol	132	07/13->	B 5204 T8								
Engine	Information				A10	A20	A40	A50	A70	C10 - C30	C20	E01
All engines	x 5, COIL ON PLUG									470 478	C10	
				ENGINE								
T5	Petrol	157	03/13-12/15	B 5204 T9								
Engine	Information				A10	A20	A40	A50	A70	C10 - C30	C20	E01
All engines	x 5, COIL ON PLUG									470 478	C10	
				ENGINE								
T5	Petrol	183	01/14->	B 5254 T14								
Engine	Information				A10	A20	A40	A50	A70	C10 - C30	C20	E01
All engines	x 5, COIL ON PLUG									470 478	C10	
				ENGINE								
T5	Petrol	187	12/12->	B 5254 T12								
Engine	Information				A10	A20	A40	A50	A70	C10 - C30	C20	E01
All engines	x 5, COIL ON PLUG									470 478	C10	
				ENGINE								
T5 AWD	Petrol	157	03/13->	B 5204 T9								
Engine	Information				A10	A20	A40	A50	A70	C10 - C30	C20	E01
All engines	x 5, COIL ON PLUG									470 478	C10	
				ENGINE								
T5 AWD	Petrol	183	01/14->	B 5254 T14								
Engine	Information				A10	A20	A40	A50	A70	C10 - C30	C20	E01
All engines	x 5, COIL ON PLUG									470 478	C10	
				ENGINE								
T5 AWD	Petrol	187	01/13->	B 5254 T12								
Engine	Information				A10	A20	A40	A50	A70	C10 - C30	C20	E01
All engines	x 5, COIL ON PLUG									470 478	C10	
				ENGINE								
V50												
1.6	Petrol	74	01/05-12/12	B 4164 S3								
Engine	Information				A10	A20	A40	A50	A70	C10 - C30	C20	E01
All engines	ch. 105440 ->, x 1, D.I.S.									470 481	C10	
All engines	->ch. 105439, x 1, D.I.S.									470 532	C10	
All engines												358 242
				ENGINE								
1.8	Petrol	92	04/04-12/10	B 4184 S11								
Engine	Information				A10	A20	A40	A50	A70	C10 - C30	C20	E01
All engines	x 4, COIL ON PLUG									470 480	C10	

A10 CONDENSER	A20 CONTACT SET	A40 DISTRIBUTOR CAP	A50 ROTOR	A70 PICK-UP
C10 COIL	C20 IGNITION MODULE	C30 ELECTRONIC IGNITION KIT	E01 IGNITION CABLE SET	

Vehicle	alim.	kW	Date	Engine	FUNCTIONS ON THE VEHICLE									
					A10	A20	A40	A50	A70	C10 - C30	C20	E01		
ENGINE														
1.8 BiFuel	Petrol/ Liquified Petroleum Gas (LPG)	93	01/09-09/10	B 4184 S8										
Engine	Information				A10	A20	A40	A50	A70	C10 - C30	C20	E01		
All engines	x 4, COIL ON PLUG									470 480	C10			
ENGINE														
1.8 FlexFuel	Petrol/ Ethanol	92	01/05-12/10	B 4184 S8										
Engine	Information				A10	A20	A40	A50	A70	C10 - C30	C20	E01		
All engines	x 4, COIL ON PLUG									470 480	C10			
ENGINE														
2.0	Petrol	107	10/06-12/12	B 4204 S3										
Engine	Information				A10	A20	A40	A50	A70	C10 - C30	C20	E01		
All engines	x 4, COIL ON PLUG									470 480	C10			
ENGINE														
2.0 FlexFuel	Petrol/ Ethanol	107	01/10-12/12	B 4204 S4										
Engine	Information				A10	A20	A40	A50	A70	C10 - C30	C20	E01		
All engines	x 4, COIL ON PLUG									470 480	C10			
ENGINE														
2.4	Petrol	103	04/04-12/10	B 5244 S5										
Engine	Information				A10	A20	A40	A50	A70	C10 - C30	C20	E01		
All engines	->ch. 81811, ch. 81812 ->, x 5, COIL ON PLUG									470 478	C10			
ENGINE														
2.4	Petrol	125	04/04-12/10	B 5244 S4										
Engine	Information				A10	A20	A40	A50	A70	C10 - C30	C20	E01		
All engines	->ch. 81811, ch. 81812 ->, x 5, COIL ON PLUG									470 478	C10			
ENGINE														
2.4 AWD	Petrol	125	08/06-12/09	B 5244 S4										
Engine	Information				A10	A20	A40	A50	A70	C10 - C30	C20	E01		
All engines	Qty: 5									470 478	C10			
ENGINE														
T5	Petrol	162	04/04-12/07	B 5254 T3										
Engine	Information				A10	A20	A40	A50	A70	C10 - C30	C20	E01		
All engines	x 5, COIL ON PLUG									470 478	C10			
ENGINE														
T5	Petrol	169	03/07-12/12	B 5254 T7										
Engine	Information				A10	A20	A40	A50	A70	C10 - C30	C20	E01		
All engines	x 5, COIL ON PLUG									470 478	C10			
ENGINE														
T5 AWD	Petrol	162	04/04-12/07	B 5254 T3										
Engine	Information				A10	A20	A40	A50	A70	C10 - C30	C20	E01		
All engines	x 5, COIL ON PLUG									470 478	C10			
ENGINE														
T5 AWD	Petrol	169	03/07-12/10	B 5254 T7										
Engine	Information				A10	A20	A40	A50	A70	C10 - C30	C20	E01		
All engines	x 5, COIL ON PLUG									470 478	C10			
V60 I														
ENGINE														
2.0 BiFuel	Petrol/ Liquified Petroleum Gas (LPG)	157	03/14-12/15	B 5204 T9										
Engine	Information				A10	A20	A40	A50	A70	C10 - C30	C20	E01		
All engines	x 5, COIL ON PLUG									470 478	C10			
ENGINE														
2.0 T	Petrol	132	01/14-07/18	B 5204 T8										
Engine	Information				A10	A20	A40	A50	A70	C10 - C30	C20	E01		
All engines	x 5, COIL ON PLUG									470 478	C10			

A10 CONDENSER	A20 CONTACT SET	A40 DISTRIBUTOR CAP	A50 ROTOR	A70 PICK-UP
C10 COIL	C20 IGNITION MODULE	C30 ELECTRONIC IGNITION KIT	E01 IGNITION CABLE SET	

The present application list is a brief version. For the detailed information about the possibility of installation on a specific vehicle, please refer to our web-catalogue <http://catalogo.facet.eu/>









				FUNCTIONS ON THE VEHICLE								
Vehicle	alim.	kW	Date	Engine								
				ENGINE								
T5	Petrol	157	10/13-05/18	B 5204 T9								
Engine				Information								
All engines				x 5, COIL ON PLUG								
					A10	A20	A40	A50	A70	C10 - C30	C20	E01
										470 478	C10	
				ENGINE								
T5 AWD	Petrol	183	03/15-05/18	B 5254 T14								
Engine				Information								
All engines				x 5, COIL ON PLUG								
					A10	A20	A40	A50	A70	C10 - C30	C20	E01
										470 478	C10	
				ENGINE								
T5 AWD	Petrol	187	04/15-05/18	B 5254 T12								
Engine				Information								
All engines				x 5, COIL ON PLUG								
					A10	A20	A40	A50	A70	C10 - C30	C20	E01
										470 478	C10	
				ENGINE								
V70												
2.4 LPG	LPG	103	07/97-03/00	B 5244 SG2								
Engine				Information								
All engines				x 5, COIL ON PLUG, incl. spark plug connector								
					A10	A20	A40	A50	A70	C10 - C30	C20	E01
										470 448	C10	
				ENGINE								
V70 I												
2.0	Petrol	105	12/95-03/00	B 5204 T2								
Engine				Information								
All engines												
					A10	A20	A40	A50	A70	C10 - C30	C20	E01
										490 423	C30	
				ENGINE								
2.0	Petrol	120	01/97-12/00	B 5204 T4								
Engine				Information								
All engines				x 5, COIL ON PLUG, incl. spark plug connector								
					A10	A20	A40	A50	A70	C10 - C30	C20	E01
										470 448	C10	
				ENGINE								
2.0	Petrol	132	11/96-03/00	B 5204 T2								
Engine				Information								
All engines				version Bosch								
					A10	A20	A40	A50	A70	C10 - C30	C20	E01
							806 260	906 147R				
										490 423	C30	358 064
				ENGINE								
2.0	Petrol	93	12/95-03/00	B 5202 FS, B 5202 S								
Engine				Information								
Eng. B 5202 S				version Bosch								
					A10	A20	A40	A50	A70	C10 - C30	C20	E01
							806 260	906 147R				
										490 423	C30	358 064
										490 423	C30	
				ENGINE								
2.0 Turbo	Petrol	155	12/95-03/00	B 5204 T2								
Engine				Information								
All engines												
					A10	A20	A40	A50	A70	C10 - C30	C20	E01
										490 423	C30	
				ENGINE								
2.0 Turbo	Petrol	166	11/96-12/00	B 5204 T3								
Engine				Information								
All engines				MODEL TO: 1998, version Bosch								
					A10	A20	A40	A50	A70	C10 - C30	C20	E01
							806 260	906 147R				
										490 423	C30	
												358 064
				ENGINE								
2.0 Turbo AWD	Petrol	166	11/96-12/00	B 5204 T3								
Engine				Information								
All engines				MODEL TO: 1998, version Bosch								
					A10	A20	A40	A50	A70	C10 - C30	C20	E01
							806 260	906 147R				
										490 423	C30	
												358 064
				ENGINE								
2.3	Petrol	120	01/97-07/99	B 5234 FS								
Engine				Information								
All engines				MODEL TO: 1998, version Bosch								
					A10	A20	A40	A50	A70	C10 - C30	C20	E01
							806 260	906 147R				
										470 448	C10	
										490 423	C30	358 064

A10 CONDENSER	A20 CONTACT SET	A40 DISTRIBUTOR CAP	A50 ROTOR	A70 PICK-UP
C10 COIL	C20 IGNITION MODULE	C30 ELECTRONIC IGNITION KIT	E01 IGNITION CABLE SET	

Vehicle	alim.	kW	Date	Engine	FUNCTIONS ON THE VEHICLE									
					A10	A20	A40	A50	A70	C10 - C30	C20	E01		
ENGINE														
2.3	Petrol	177	11/96-11/00	B 5234 T3										
ENGINE														
All engines											490 423	C30		
2.3 AWD	Petrol	177	04/97-09/98	B 5234 T3										
ENGINE														
All engines							806 260	906 147R						
All engines											490 423	C30		
All engines														358 064
2.3 AWD	Petrol	195	12/98-02/00	B 5234 T7, B 5234 T8										
ENGINE														
Eng. B 5234 T7							806 260	906 147R						
Eng. B 5234 T7											470 448	C10		
Eng. B 5234 T8											470 448	C10		
Eng. B 5234 T7											490 423	C30		358 064
2.3 T AWD	Petrol	184	04/97-03/00	B 5234 FT+, B 5234 T4, B 5234 T6										
ENGINE														
All engines							806 260	906 147R						
Eng. B 5234 FT+, B 5234 T6											490 423	C30		
Eng. B 5234 T4, B 5234 T6											490 423	C30		
All engines														358 064
2.3 T-5	Petrol	176	11/96-12/00	B 5234 T3										
ENGINE														
All engines							806 260	906 147R						
All engines											490 423	C30		
All engines														358 064
2.3 T-5 AWD	Petrol	176	01/97-12/00	B 5234 T3										
ENGINE														
All engines							806 260	906 147R						
All engines											490 423	C30		
All engines														358 064
2.3 Turbo	Petrol	160	01/97-12/98	B 5234 T2										
ENGINE														
All engines							806 260	906 147R						
All engines											490 423	C30		358 064
2.3 Turbo	Petrol	184	12/95-03/00	B 5234 FT+, B 5234 T4										
ENGINE														
All engines							806 260	906 147R						
All engines											490 423	C30		358 064
Eng. B 5234 T4											490 423	C30		
2.4	Petrol	103	03/99-12/00	B 5244 S2, B 5244 SG2										
ENGINE														
Eng. B 5244 S2											470 448	C10		
Eng. B 5244 SG2											470 448	C10		
2.4	Petrol	106	12/95-03/00	B 5252 FS										
ENGINE														
All engines							806 260	906 147R			490 423	C30		
2.4	Petrol	121	06/98-12/99	B 5254 S, B5254SDENS										
ENGINE														
Eng. B 5254 S							806 260	906 147R						
Eng. B 5254 S											470 448	C10		

A10 CONDENSER	A20 CONTACT SET	A40 DISTRIBUTOR CAP	A50 ROTOR	A70 PICK-UP
C10 COIL	C20 IGNITION MODULE	C30 ELECTRONIC IGNITION KIT	E01 IGNITION CABLE SET	

The present application list is a brief version. For the detailed information about the possibility of installation on a specific vehicle, please refer to our web-catalogue <http://catalogo.facet.eu/>

					FUNCTIONS ON THE VEHICLE												
Vehicle	alim.	kW	Date	Engine													
ENGINE																	
2.4	Petrol	121	06/98-12/99	B 5254 S, B5254SDENS													
Engine	Information			A10	A20	A40	A50	A70	C10 - C30		C20	E01					
Eng. B5254SDENS	x 5, COIL ON PLUG, incl. spark plug connector								470 448	C10							
Eng. B 5254 S	MODEL TO: 1998								490 423	C30		358 064					
ENGINE																	
2.4	Petrol	125	12/95-05/00	B 5244 S, B 5254 FS													
Engine	Information			A10	A20	A40	A50	A70	C10 - C30		C20	E01					
Eng. B 5244 S	x 5, COIL ON PLUG, incl. spark plug connector								470 448	C10							
Eng. B 5254 FS									490 423	C30							
ENGINE																	
2.4 AWD	Petrol	121	06/98-12/99	B5254SDENS													
Engine	Information			A10	A20	A40	A50	A70	C10 - C30		C20	E01					
All engines	x 5, COIL ON PLUG, incl. spark plug connector								470 448	C10							
ENGINE																	
2.4 Bifuel	Natural Gas	103	08/99-03/00	B 5244 SG2													
Engine	Information			A10	A20	A40	A50	A70	C10 - C30		C20	E01					
All engines	Qty: 5								470 448	C10							
All engines	x 5, COIL ON PLUG, incl. spark plug connector								470 448	C10							
ENGINE																	
2.4 Bifuel	Petrol/Compressed Natural Gas (CNG)	106	05/98-12/99	GB 5252 S													
Engine	Information			A10	A20	A40	A50	A70	C10 - C30		C20	E01					
All engines	version Bosch					806 260	906 147R										
All engines									490 423	C30		358 064					
ENGINE																	
2.4 Turbo	Petrol	142	04/96-12/00	B 5244 T, B 5254 T													
Engine	Information			A10	A20	A40	A50	A70	C10 - C30		C20	E01					
Eng. B 5244 T	x 5, COIL ON PLUG, incl. spark plug connector								470 448	C10							
Eng. B 5254 T									490 423	C30							
ENGINE																	
2.4 Turbo AWD	Petrol	142	04/96-12/00	B 5244 T, B 5254 T													
Engine	Information			A10	A20	A40	A50	A70	C10 - C30		C20	E01					
Eng. B 5254 T	MODEL TO: 1998, version Bosch					806 260	906 147R										
Eng. B 5244 T	x 5, COIL ON PLUG, incl. spark plug connector								470 448	C10							
Eng. B 5254 T									490 423	C30							
Eng. B 5254 T	MODEL TO: 1998											358 064					
ENGINE																	
2.4 Turbo AWD	Petrol	195	03/99-12/00	B 5244 T2													
Engine	Information			A10	A20	A40	A50	A70	C10 - C30		C20	E01					
All engines	x 5, COIL ON PLUG, incl. spark plug connector								470 448	C10							
ENGINE																	
2.5	Petrol	106	01/97-03/00	B 5252 FS													
Engine	Information			A10	A20	A40	A50	A70	C10 - C30		C20	E01					
All engines	version Bosch					806 260	906 147R										
All engines									490 423	C30		358 064					
V70 II																	
ENGINE																	
2.0 T	Petrol	132	11/99-08/07	B 5204 T5													
Engine	Information			A10	A20	A40	A50	A70	C10 - C30		C20	E01					
All engines	x 5, COIL ON PLUG								470 478	C10							
ENGINE																	
2.3	Petrol	195	10/00-09/04	B 5234 T7													
Engine	Information			A10	A20	A40	A50	A70	C10 - C30		C20	E01					
All engines	x 5, COIL ON PLUG, incl. spark plug connector								470 448	C10							
ENGINE																	
2.3 AWD	Petrol	195	10/00-09/04	B 5234 T7													
Engine	Information			A10	A20	A40	A50	A70	C10 - C30		C20	E01					
All engines	Qty: 5								470 448	C10							
A10	CONDENSER	A20	CONTACT SET	A40	DISTRIBUTOR CAP	A50	ROTOR	A70	PICK-UP	C10	COIL	C20	IGNITION MODULE	C30	ELECTRONIC IGNITION KIT	E01	IGNITION CABLE SET

Vehicle	alim.	kW	Date	Engine	FUNCTIONS ON THE VEHICLE									
					A10	A20	A40	A50	A70	C10 - C30	C20	E01		
ENGINE														
2.3 T5	Petrol	184	11/99-12/04	B 5234 T3										
ENGINE														
All engines					x 5, COIL ON PLUG, incl. spark plug connector						470 448	C10		
2.4	Petrol	103	03/00-08/07	B 5244 S2							470 448	C10		
ENGINE														
All engines					x 5, COIL ON PLUG, incl. spark plug connector						470 448	C10		
2.4	Petrol	125	03/00-08/07	B 5244 S							470 448	C10		
ENGINE														
All engines					x 5, COIL ON PLUG, incl. spark plug connector						470 448	C10		
2.4 Bifuel	Petrol/ Com- pressed Natural Gas (CNG)	103	09/01-08/07	B 5244 SG, B 5244 SG2							470 448	C10		
ENGINE														
All engines					x 5, COIL ON PLUG, incl. spark plug connector						470 448	C10		
All engines					x 5, COIL ON PLUG, incl. spark plug connector						470 448	C10		
2.4 T	Petrol	147	11/99-12/05	B 5244 T3, B 5244 T4							470 448	C10		
ENGINE														
Eng. B 5244 T3					x 5, COIL ON PLUG, incl. spark plug connector						470 448	C10		
Eng. B 5244 T4					Qty: 5						470 478	C10		
2.4 T AWD	Petrol	147	09/01-08/02	B 5244 T3							470 448	C10		
ENGINE														
All engines					x 5, COIL ON PLUG, incl. spark plug connector						470 448	C10		
2.4 T5	Petrol	191	04/04-08/07	B 5244 T5							470 478	C10		
ENGINE														
All engines					x 5, COIL ON PLUG						470 478	C10		
2.5 AWD	Petrol	155	09/02-12/04	B 5254 T2							470 448	C10		
ENGINE														
All engines					Qty: 5						470 448	C10		
2.5 R Sport	Petrol	221	12/02-08/07	B 5254 T4							470 478	C10		
ENGINE														
All engines					Qty: 5						470 478	C10		
2.5 T	Petrol	154	07/01-08/07	B 5254 T2							470 478	C10		
ENGINE														
All engines					x 5, COIL ON PLUG						470 478	C10		
2.5 T AWD	Petrol	154	07/02-08/07	B 5254 T2							470 478	C10		
ENGINE														
All engines					x 5, COIL ON PLUG						470 478	C10		
R2,5 T AWD	Petrol	221	03/03-08/07	B 5254 T4							470 478	C10		
ENGINE														
All engines					x 5, COIL ON PLUG						470 478	C10		
V70 III														
2.0	Petrol	107	10/07-12/11	B 4204 S3							470 480	C10		
ENGINE														
All engines					x 4, COIL ON PLUG						470 480	C10		

A10 CONDENSER	A20 CONTACT SET	A40 DISTRIBUTOR CAP	A50 ROTOR	A70 PICK-UP
C10 COIL	C20 IGNITION MODULE	C30 ELECTRONIC IGNITION KIT	E01 IGNITION CABLE SET	

The present application list is a brief version. For the detailed information about the possibility of installation on a specific vehicle, please refer to our web-catalogue <http://catalogo.facet.eu/>

Vehicle	alim.	kW	Date	Engine	FUNCTIONS ON THE VEHICLE							
					A10	A20	A40	A50	A70	C10 - C30	C20	E01

ENGINE				
2.0 BiFuel	Petrol/ Liquified Petroleum Gas (LPG)	157	03/13-12/15	B 5204 T9, B5204T9CNG

Engine	Information	A10	A20	A40	A50	A70	C10 - C30	C20	E01
Eng. B 5204 T9	Qty: 5						470 478	C10	
Eng. B5204T9CNG	x 5, COIL ON PLUG						470 478	C10	

ENGINE				
2.0 FlexiFuel	Petrol/ Ethanol	107	01/08-12/11	B 4204 S4

Engine	Information	A10	A20	A40	A50	A70	C10 - C30	C20	E01
All engines	x 4, COIL ON PLUG						470 480	C10	

ENGINE				
2.0 GDI	Petrol	157	04/12-12/15	B 5204 T9

Engine	Information	A10	A20	A40	A50	A70	C10 - C30	C20	E01
All engines	x 5, COIL ON PLUG						470 478	C10	

ENGINE				
2.5 T	Petrol	147	08/07-12/09	B 5254 T6

Engine	Information	A10	A20	A40	A50	A70	C10 - C30	C20	E01
All engines	x 5, COIL ON PLUG						470 478	C10	

ENGINE				
2.5 T	Petrol	170	04/09-12/12	B 5254 T10

Engine	Information	A10	A20	A40	A50	A70	C10 - C30	C20	E01
All engines	x 5, COIL ON PLUG						470 478	C10	

ENGINE				
2.5 T FlexiFuel	Petrol/ Ethanol	147	05/08-12/09	B 5254 T8

Engine	Information	A10	A20	A40	A50	A70	C10 - C30	C20	E01
All engines	x 5, COIL ON PLUG						470 478	C10	

ENGINE				
2.5 T FlexiFuel	Petrol/ Ethanol	170	04/09-12/11	B 5254 T11

Engine	Information	A10	A20	A40	A50	A70	C10 - C30	C20	E01
All engines	x 5, COIL ON PLUG						470 478	C10	

XC60 I

ENGINE				
T5 AWD	Petrol	183	04/14-02/17	B 5254 T12

Engine	Information	A10	A20	A40	A50	A70	C10 - C30	C20	E01
All engines	x 5, COIL ON PLUG						470 478	C10	

ENGINE				
T5 AWD	Petrol	187	04/14-02/17	B 5254 T12

Engine	Information	A10	A20	A40	A50	A70	C10 - C30	C20	E01
All engines	x 5, COIL ON PLUG						470 478	C10	

XC70 I

ENGINE				
2.3 T XC AWD	Petrol	195	01/01-07/04	B 5234 T7

Engine	Information	A10	A20	A40	A50	A70	C10 - C30	C20	E01
All engines	Qty: 5						470 448	C10	

ENGINE				
2.4 T XC AWD	Petrol	147	01/05-12/06	B 5244 T4

Engine	Information	A10	A20	A40	A50	A70	C10 - C30	C20	E01
All engines	Qty: 5						470 478	C10	

ENGINE				
2.5 T XC AWD	Petrol	154	09/02-08/07	B 5254 T2

Engine	Information	A10	A20	A40	A50	A70	C10 - C30	C20	E01
All engines	x 5, COIL ON PLUG, incl. spark plug connector						470 448	C10	

XC70 II

ENGINE				
T5 AWD	Petrol	187	08/15-12/16	B 5254 T12

Engine	Information	A10	A20	A40	A50	A70	C10 - C30	C20	E01
All engines	x 5, COIL ON PLUG						470 478	C10	

A10 CONDENSER	A20 CONTACT SET	A40 DISTRIBUTOR CAP	A50 ROTOR	A70 PICK-UP
C10 COIL	C20 IGNITION MODULE	C30 ELECTRONIC IGNITION KIT	E01 IGNITION CABLE SET	

Vehicle	alim.	kW	Date	Engine	FUNCTIONS ON THE VEHICLE							
					A10	A20	A40	A50	A70	C10 - C30	C20	E01

ENGINE				
T6 AWD	Petrol	183	03/15-12/16	B 5254 T14

Engine	Information	A10	A20	A40	A50	A70	C10 - C30	C20	E01
All engines	x 5, COIL ON PLUG						470 478	C10	

ENGINE				
--------	--	--	--	--

2.5 T AWD	Petrol	154	10/02-09/14	B 5254 T2, B 5254 T9
------------------	--------	------------	-------------	-----------------------------

Engine	Information	A10	A20	A40	A50	A70	C10 - C30	C20	E01
Eng. B 5254 T2	x 5, COIL ON PLUG, incl. spark plug connector						470 448	C10	
Eng. B 5254 T9	Qty: 5						470 448	C10	

ENGINE				
T6 AWD	Petrol	200	10/02-12/06	B 6294 T

Engine	Information	A10	A20	A40	A50	A70	C10 - C30	C20	E01
All engines	x 6, COIL ON PLUG, incl. spark plug connector						470 448	C10	

A10	CONDENSER	A20	CONTACT SET	A40	DISTRIBUTOR CAP	A50	ROTOR	A70	PICK-UP
C10	COIL	C20	IGNITION MODULE	C30	ELECTRONIC IGNITION KIT	E01	IGNITION CABLE SET		

The present application list is a brief version. For the detailed information about the possibility of installation on a specific vehicle, please refer to our web-catalogue <http://catalogo.facet.eu/>

Vehicle	alim.	kW	Date	Engine	FUNCTIONS ON THE VEHICLE							
					A10	A20	A40	A50	A70	C10 - C30	C20	E01

1500,1600

				ENGINE
1.5	Petrol	33	04/61-07/73	K

Engine	Information	A10	A20	A40	A50	A70	C10 - C30	C20	E01
All engines			706 032HV		906 014R				

				ENGINE
1.5 L	Petrol	33	07/68-07/73	K

Engine	Information	A10	A20	A40	A50	A70	C10 - C30	C20	E01
All engines			706 040						

				ENGINE
1.5 S	Petrol	40	08/63-07/65	--

Engine	Information	A10	A20	A40	A50	A70	C10 - C30	C20	E01
All engines			706 032HV		906 014R				

				ENGINE
1.6	Petrol	40	08/65-07/73	T, U

Engine	Information	A10	A20	A40	A50	A70	C10 - C30	C20	E01
All engines					906 014R				

				ENGINE
1.6 L	Petrol	37	07/64-07/73	P

Engine	Information	A10	A20	A40	A50	A70	C10 - C30	C20	E01
All engines			706 040						

				ENGINE
1.6 L	Petrol	40	08/65-07/73	T, U

Engine	Information	A10	A20	A40	A50	A70	C10 - C30	C20	E01
All engines					906 014R				

				ENGINE
1.6 TL	Petrol	40	08/65-07/73	T, U

Engine	Information	A10	A20	A40	A50	A70	C10 - C30	C20	E01
Eng. T			706 032HV						
All engines					906 014R				

AMAROK

				ENGINE
2.0 TSI	Petrol	118	12/10-10/16	CFPA

Engine	Information	A10	A20	A40	A50	A70	C10 - C30	C20	E01
All engines	x 4, ELDOR, Housing Colour:Black, COIL ON PLUG, incl. spark plug connector						470 426	C10	

ARTEON

				ENGINE
1.4 eHybrid	Petrol/ Electric	115	11/20->	DGEB

Engine	Information	A10	A20	A40	A50	A70	C10 - C30	C20	E01
All engines	x 4, ELDOR, COIL ON PLUG, Number of pins:4, incl. spark plug connector						470 599	C10	

				ENGINE
2.0 TSI	Petrol	140	05/17->	CZPB, DKZA, DNNA

Engine	Information	A10	A20	A40	A50	A70	C10 - C30	C20	E01
All engines	01/10/18 ->, x 4, HITACHI, COIL ON PLUG, incl. spark plug connector						470 636	C10	

				ENGINE
2.0 TSi 4motion	Petrol	200	09/20->	DLRB

Engine	Information	A10	A20	A40	A50	A70	C10 - C30	C20	E01
All engines	x 4, HITACHI, COIL ON PLUG, incl. spark plug connector						470 636	C10	

				ENGINE
2.0 TSI 4motion	Petrol	206	06/20->	DJHC

Engine	Information	A10	A20	A40	A50	A70	C10 - C30	C20	E01
All engines	x 4, HITACHI, COIL ON PLUG, incl. spark plug connector						470 636	C10	

BEETLE

				ENGINE
1.2 TSI	Petrol	77	07/11-07/19	CBZB

Engine	Information	A10	A20	A40	A50	A70	C10 - C30	C20	E01
All engines							490 420	C30	358 248

A10	CONDENSER	A20	CONTACT SET	A40	DISTRIBUTOR CAP	A50	ROTOR	A70	PICK-UP
C10	COIL	C20	IGNITION MODULE	C30	ELECTRONIC IGNITION KIT	E01	IGNITION CABLE SET		

Vehicle	alim.	kW	Date	Engine	FUNCTIONS ON THE VEHICLE									
					A10	A20	A40	A50	A70	C10 - C30	C20	E01		
ENGINE														
1.2 TSI 16V	Petrol	77	12/14-07/19	CYVD										
Engine	Information				A10	A20	A40	A50	A70	C10 - C30	C20	E01		
All engines	x 4, BERU, ELDOR, COIL ON PLUG, incl. spark plug connector, Number of pins:4, incl. spark plug connector									470 599	C10			
ENGINE														
1.4 TSI	Petrol	110	12/14-07/19	CZDA										
Engine	Information				A10	A20	A40	A50	A70	C10 - C30	C20	E01		
All engines	x 4, BERU, ELDOR, COIL ON PLUG, incl. spark plug connector, Number of pins:4, incl. spark plug connector									470 599	C10			
ENGINE														
1.4 TSI	Petrol	118	10/11-07/16	CAVD, CNWA, CTHD, CTKA										
Engine	Information				A10	A20	A40	A50	A70	C10 - C30	C20	E01		
All engines	x 4, COIL ON PLUG, incl. spark plug connector									470 474	C10			
ENGINE														
2.0 TFSI	Petrol	147	04/11-07/16	CBFA, CCTA, CCZA										
Engine	Information				A10	A20	A40	A50	A70	C10 - C30	C20	E01		
All engines	x 4, ELDOR, Housing Colour:Black, COIL ON PLUG, incl. spark plug connector									470 426	C10			
ENGINE														
2.0 TSI	Petrol	155	12/12-07/19	CPLA, CPPA										
Engine	Information				A10	A20	A40	A50	A70	C10 - C30	C20	E01		
All engines	01/01/15 ->, x 4, BERU, COIL ON PLUG, incl. spark plug connector									470 636	C10			
ENGINE														
2.0 TSI	Petrol	162	12/14-09/18	CULC										
Engine	Information				A10	A20	A40	A50	A70	C10 - C30	C20	E01		
All engines	01/02/15 ->, x 4, BERU, COIL ON PLUG, incl. spark plug connector									470 636	C10			
ENGINE														
2.5	Petrol	125	04/11-07/19	CBTA, CBUA, CCA										
Engine	Information				A10	A20	A40	A50	A70	C10 - C30	C20	E01		
All engines	x 5, ELDOR, Housing Colour:Black, COIL ON PLUG, incl. spark plug connector									470 426	C10			
BORA														
ENGINE														
1.4 16V	Petrol	55	03/00-05/05	AHW, AKQ, APE, AXP, BCA										
Engine	Information				A10	A20	A40	A50	A70	C10 - C30	C20	E01		
Eng. BCA	x 4, COIL ON PLUG, incl. spark plug connector									470 474	C10			
Eng. AHW, AKQ, APE, AXP										490 420	C30		360 575	
ENGINE														
1.6	Petrol	74	10/98-05/05	AEH, AKL, APF										
Engine	Information				A10	A20	A40	A50	A70	C10 - C30	C20	E01		
All engines										490 420	C30		360 484	
ENGINE														
1.6	Petrol	75	08/00-05/05	AVU, BFQ										
Engine	Information				A10	A20	A40	A50	A70	C10 - C30	C20	E01		
All engines										490 420	C30		360 585	
ENGINE														
1.6 16V	Petrol	77	02/00-05/05	ATN, AUS, AZD, BCB										
Engine	Information				A10	A20	A40	A50	A70	C10 - C30	C20	E01		
Eng. AZD, BCB	x 4, COIL ON PLUG, incl. spark plug connector									470 474	C10			
Eng. ATN, AUS										490 420	C30		360 575	
ENGINE														
1.6 FSI	Petrol	81	01/02-05/05	BAD										
Engine	Information				A10	A20	A40	A50	A70	C10 - C30	C20	E01		
All engines	x 4, COIL ON PLUG, incl. spark plug connector									470 474	C10			
ENGINE														
1.8	Petrol	92	10/98-05/05	AGN										
Engine	Information				A10	A20	A40	A50	A70	C10 - C30	C20	E01		
All engines													360 489	

A10 CONDENSER	A20 CONTACT SET	A40 DISTRIBUTOR CAP	A50 ROTOR	A70 PICK-UP
C10 COIL	C20 IGNITION MODULE	C30 ELECTRONIC IGNITION KIT	E01 IGNITION CABLE SET	

The present application list is a brief version. For the detailed information about the possibility of installation on a specific vehicle, please refer to our web-catalogue <http://catalogo.facet.eu/>

				FUNCTIONS ON THE VEHICLE													
Vehicle	alim.	kW	Date	Engine	A10	A20	A40	A50	A70	C10 - C30	C20	E01					
				ENGINE													
1.8 4motion	Petrol	92	02/99-05/05	AGN													
Engine	Information			A10	A20	A40	A50	A70	C10 - C30	C20	E01						
All engines									490 420	C30		360 489					
				ENGINE													
1.8 T	Petrol	110	05/00-05/05	AGU, AUM													
Engine	Information			A10	A20	A40	A50	A70	C10 - C30	C20	E01						
Eng. AGU	x 4, COIL ON PLUG								470 354S	C10							
Eng. AUM	x 4, COIL ON PLUG, incl. spark plug connector								470 429	C10							
Eng. AGU										465 076							
				ENGINE													
1.8 T	Petrol	132	03/02-05/05	AUQ													
Engine	Information			A10	A20	A40	A50	A70	C10 - C30	C20	E01						
All engines	x 4, COIL ON PLUG, incl. spark plug connector								470 429	C10							
				ENGINE													
2.0	Petrol	85	10/98-12/13	APK, AQY, AZH, AZJ													
Engine	Information			A10	A20	A40	A50	A70	C10 - C30	C20	E01						
Eng. APK, AQY									490 420	C30							
Eng. AZH									490 420	C30							
Eng. AZJ												358 223					
Eng. APK, AQY, AZH												360 585					
				ENGINE													
2.0 4motion	Petrol	85	04/00-05/05	AZH, AZJ													
Engine	Information			A10	A20	A40	A50	A70	C10 - C30	C20	E01						
Eng. AZH									490 420	C30		360 585					
Eng. AZJ												358 223					
				ENGINE													
2.0 4motion	Petrol	88	12/99-05/03	AZH													
Engine	Information			A10	A20	A40	A50	A70	C10 - C30	C20	E01						
All engines									490 420	C30							
				ENGINE													
2.3 V5	Petrol	110	10/98-10/00	AGZ													
Engine	Information			A10	A20	A40	A50	A70	C10 - C30	C20	E01						
All engines										465 074							
				ENGINE													
2.3 V5	Petrol	125	10/00-05/05	AQN													
Engine	Information			A10	A20	A40	A50	A70	C10 - C30	C20	E01						
All engines	x 5, COIL ON PLUG								470 435	C10							
				ENGINE													
2.3 V5 4motion	Petrol	110	12/98-10/00	AGZ													
Engine	Information			A10	A20	A40	A50	A70	C10 - C30	C20	E01						
All engines										465 074							
				ENGINE													
2.3 V5 4motion	Petrol	125	10/00-05/05	AQN													
Engine	Information			A10	A20	A40	A50	A70	C10 - C30	C20	E01						
All engines	x 5, COIL ON PLUG								470 435	C10							
				ENGINE													
2.8 V6 4motion	Petrol	150	03/99-05/05	AUE, BDE													
Engine	Information			A10	A20	A40	A50	A70	C10 - C30	C20	E01						
All engines	01/05/01 ->, x 6, ch. 1J2000001 ->, COIL ON PLUG, x 6, COIL ON PLUG								470 435	C10							
				ENGINE													
2.8 VR6	Petrol	150	03/00-05/00	AUE													
Engine	Information			A10	A20	A40	A50	A70	C10 - C30	C20	E01						
All engines	ch. 1J-2-000 001 ->, Qty: 6								470 435	C10							
				ENGINE													
				ENGINE													
1.5	Petrol	51	08/82-07/83	JB													
Engine	Information			A10	A20	A40	A50	A70	C10 - C30	C20	E01						
All engines	version Bosch			606 196	706 034HVS	806 079	906 055R										
All engines	ch. 14-F-000 370 ->											359 725					
All engines	->ch. 14-F-000 369											359 727					
A10	CONDENSER	A20	CONTACT SET	A40	DISTRIBUTOR CAP	A50	ROTOR	A70	PICK-UP	C10	COIL	C20	IGNITION MODULE	C30	ELECTRONIC IGNITION KIT	E01	IGNITION CABLE SET

Vehicle	alim.	kW	Date	Engine	FUNCTIONS ON THE VEHICLE							
					A10	A20	A40	A50	A70	C10 - C30	C20	E01

				ENGINE
1.6	Petrol	53	08/83-07/89	HN

Engine	Information	A10	A20	A40	A50	A70	C10 - C30	C20	E01
All engines	version Bosch	606 196	706 034HVS						
All engines	version Bosch, ->ch. 14-F-002 256			806 079	906 055R				
All engines	version Bosch, ch. 14-F-002 257 ->			806 094	906 025R				
All engines	ch. 14-F-000 370 ->								359 725
All engines	->ch. 14-F-000 369								359 727

				ENGINE
1.6	Petrol	55	01/83-07/92	EW

Engine	Information	A10	A20	A40	A50	A70	C10 - C30	C20	E01
All engines	version Bosch	606 196	706 034HVS						
All engines	version Bosch, ->ch. 14-E-003 890			806 079	906 055R				
All engines	version Bosch, ch. 14-E-003 891 ->			806 094	906 025R				
All engines	ch. 14-F-000 370 ->								359 725
All engines	->ch. 14-F-000 369								359 727

				ENGINE
1.8	Petrol	70	08/85-07/92	JH

Engine	Information	A10	A20	A40	A50	A70	C10 - C30	C20	E01
All engines	->ch. 14-G-020 000, version Bosch			806 094					
All engines	ch. 14-H-000 001 ->, version Bosch			806 266					
All engines	version Bosch				906 055R	406 219			
All engines	->ch. 14-J-020 000						470 125	C10	
All engines	ch. 14-K-000 001 ->						470 126	C10	
All engines								465 007	
All engines	ch. 14-F-000 370 ->								359 725
All engines	->ch. 14-F-000 369								359 727

CADDY II

				ENGINE
1.4	Petrol	44	11/95-06/03	AEX, AKV, APQ, AUD

Engine	Information	A10	A20	A40	A50	A70	C10 - C30	C20	E01
Eng. AEX, AKV, APQ	version Bosch			806 094	906 121R	406 223			
Eng. AEX, AKV, APQ	version Marelli			830 116	930 057R				
Eng. AEX, APQ							490 414	C30	
Eng. AUD							490 420	C30	360 601
Eng. AEX, AKV, APQ									360 660

				ENGINE
1.4	Petrol	55	08/00-01/04	AUA

Engine	Information	A10	A20	A40	A50	A70	C10 - C30	C20	E01
All engines							490 420	C30	360 575

				ENGINE
1.4 16V	Petrol	55	08/00-01/04	AUA

Engine	Information	A10	A20	A40	A50	A70	C10 - C30	C20	E01
All engines							490 420	C30	360 575

				ENGINE
1.6	Petrol	55	11/95-12/00	1F, AEE

Engine	Information	A10	A20	A40	A50	A70	C10 - C30	C20	E01
Eng. AEE	version Bosch			806 094					
Eng. 1F	version Bosch			806 266					
Eng. 1F	version Duellier			815 068	915 099R				
Eng. AEE	version Marelli			830 116	930 057R				
All engines	version Bosch				906 121R	406 223			
All engines							490 414	C30	
Eng. 1F									359 965
Eng. AEE	Pickup								360 641
Eng. AEE									360 660

				ENGINE
60 1.4	Petrol	44	11/95-01/04	AEX, APQ, AUD

Engine	Information	A10	A20	A40	A50	A70	C10 - C30	C20	E01
Eng. AEX, APQ	version Bosch			806 094	906 121R	406 223			
Eng. AEX, APQ	version Marelli			830 116	930 057R				
Eng. AEX, APQ							490 414	C30	360 660
Eng. AUD							490 420	C30	360 601

A10	CONDENSER	A20	CONTACT SET	A40	DISTRIBUTOR CAP	A50	ROTOR	A70	PICK-UP
C10	COIL	C20	IGNITION MODULE	C30	ELECTRONIC IGNITION KIT	E01	IGNITION CABLE SET		

Vehicle	alim.	kW	Date	Engine	FUNCTIONS ON THE VEHICLE							
					A10	A20	A40	A50	A70	C10 - C30	C20	E01

ENGINE				
75 1.6	Petrol	55	11/95-09/00	1F, AEE

Engine	Information	A10	A20	A40	A50	A70	C10 - C30	C20	E01
Eng. AEE	version Bosch			806 094					
Eng. 1F	version Bosch			806 266					
Eng. 1F	version Ducellier			815 068	915 099R				
Eng. AEE	version Marelli			830 116	930 057R				
All engines	version Bosch				906 121R	406 223			
All engines							490 414	C30	
Eng. 1F									359 965
Eng. AEE									360 660

CADDY III				
ENGINE				
1.0 TSI	Petrol	62	11/18->	DKRD

Engine	Information	A10	A20	A40	A50	A70	C10 - C30	C20	E01
All engines	x 3, BERU, ELDOR, COIL ON PLUG, incl. spark plug connector, Number of pins:4, incl. spark plug connector						470 599	C10	

ENGINE				
1.0 TSI	Petrol	75	11/15->	CHZG, DKRE

Engine	Information	A10	A20	A40	A50	A70	C10 - C30	C20	E01
All engines	x 3, x 4, BERU, ELDOR, HITACHI, COIL ON PLUG, incl. spark plug connector, Number of pins:4, incl. spark plug connector						470 599	C10	

ENGINE				
1.2 TSI	Petrol	62	06/15->	CYVC

Engine	Information	A10	A20	A40	A50	A70	C10 - C30	C20	E01
All engines	x 4, BERU, ELDOR, HITACHI, COIL ON PLUG, incl. spark plug connector, Number of pins:4, incl. spark plug connector						470 599	C10	

ENGINE				
1.2 TSI	Petrol	63	09/10-05/15	CBZA

Engine	Information	A10	A20	A40	A50	A70	C10 - C30	C20	E01
All engines							490 420	C30	358 248

ENGINE				
1.2 TSI	Petrol	77	09/10-05/15	CBZB

Engine	Information	A10	A20	A40	A50	A70	C10 - C30	C20	E01
All engines							490 420	C30	358 248

ENGINE				
1.4	Petrol	55	03/04-05/06	BCA

Engine	Information	A10	A20	A40	A50	A70	C10 - C30	C20	E01
All engines	x 4, COIL ON PLUG, incl. spark plug connector						470 474	C10	

ENGINE				
1.4	Petrol	59	05/06-08/10	BUD

Engine	Information	A10	A20	A40	A50	A70	C10 - C30	C20	E01
All engines	x 4, COIL ON PLUG, incl. spark plug connector						470 474	C10	

ENGINE				
1.4 TGI CNG	Petrol/ Com- pressed Natural Gas (CNG)	81	06/15->	CPWA

Engine	Information	A10	A20	A40	A50	A70	C10 - C30	C20	E01
All engines	x 4, BERU, ELDOR, HITACHI, COIL ON PLUG, incl. spark plug connector, Number of pins:4, incl. spark plug connector						470 599	C10	

ENGINE				
1.4 TSI	Petrol	92	05/15->	CZCB









Engine	Information	A10	A20	A40	A50	A70	C10 - C30	C20	E01
All engines	x 4, BERU, ELDOR, HITACHI, COIL ON PLUG, incl. spark plug connector, Number of pins:4, incl. spark plug connector						470 599	C10	

ENGINE				
1.4 TSI	Petrol	96	07/18->	DJKD

Engine	Information	A10	A20	A40	A50	A70	C10 - C30	C20	E01
All engines	x 4, BERU, ELDOR, COIL ON PLUG, incl. spark plug connector, Number of pins:4, incl. spark plug connector						470 599	C10	

A10	CONDENSER	A20	CONTACT SET	A40	DISTRIBUTOR CAP	A50	ROTOR	A70	PICK-UP
C10	COIL	C20	IGNITION MODULE	C30	ELECTRONIC IGNITION KIT	E01	IGNITION CABLE SET		

Vehicle	alim.	kW	Date	Engine	FUNCTIONS ON THE VEHICLE									
					A10	A20	A40	A50	A70	C10 - C30	C20	E01		
ENGINE														
1.6	Petrol	74	03/05-05/15	BRY										
ENGINE														
All engines										490 420	C30		360 585	
ENGINE														
1.6	Petrol	75	04/04-05/15	BGU, BSE, BSF										
ENGINE														
All engines										490 420	C30		360 585	
ENGINE														
1.6	Petrol	81	11/15-09/20	CWVA										
ENGINE														
All engines										470 599	C10			
ENGINE														
1.6 [ARG]	Petrol	69	10/05->	UVC										
ENGINE														
All engines									406 233	490 414	C30			
ENGINE														
1.6 BiFuel	Petrol/ Liquified Petro- leum Gas (LPG)	75	05/11-05/15	CHGA										
ENGINE														
All engines										490 420	C30		360 585	
ENGINE														
1.6 SRE	Petrol	81	11/15-09/20	CWVA										
ENGINE														
All engines										470 599	C10			
ENGINE														
1.8 [ARG]	Petrol	72	10/05->	BUR										
ENGINE														
All engines									406 223					
ENGINE														
2.0 EcoFuel	CNG	80	04/06-05/15	BSX										
ENGINE														
All engines													358 223	
CADDY IV														
ENGINE														
1.6 SRE	Petrol	81	02/21->	DWYA										
ENGINE														
All engines										470 599	C10			
CALIFORNIA														
ENGINE														
2.0 TSI	Petrol	110	07/12-07/19	CJKB										
ENGINE														
All engines										470 426	C10			
ENGINE														
2.0 TSI	Petrol	150	05/11-07/19	CJKA										
ENGINE														
All engines										470 426	C10			
ENGINE														
2.0 TSI 4motion	Petrol	150	07/11-07/19	CJKA										
ENGINE														
All engines										470 426	C10			
CAMPMOBILE														
ENGINE														
2.0 Tsi	Petrol	110	07/12-08/15	CJKB										
ENGINE														
All engines										470 426	C10			
ENGINE														
A10	CONDENSER		A20	CONTACT SET		A40	DISTRIBUTOR CAP		A50	ROTOR		A70	PICK-UP	
C10	COIL		C20	IGNITION MODULE		C30	ELECTRONIC IGNITION KIT		E01	IGNITION CABLE SET				

					FUNCTIONS ON THE VEHICLE							
Vehicle	alim.	kW	Date	Engine								
ENGINE												
2.0 TSi	Petrol	150	05/11-08/15	CJKA								
Engine	Information				A10	A20	A40	A50	A70	C10 - C30	C20	E01
All engines	x 4, ELDOR, Housing Colour:Black, COIL ON PLUG, incl. spark plug connector									470 426	C10	
ENGINE												
2.0 TSi BlueMotion	Petrol	110	04/15-07/19	CJKB								
Engine	Information				A10	A20	A40	A50	A70	C10 - C30	C20	E01
All engines	x 4, ELDOR, Housing Colour:Black, COIL ON PLUG, incl. spark plug connector									470 426	C10	
ENGINE												
2.0 TSi BlueMotion	Petrol	150	04/15-07/19	CJKA								
Engine	Information				A10	A20	A40	A50	A70	C10 - C30	C20	E01
All engines	x 4, ELDOR, Housing Colour:Black, COIL ON PLUG, incl. spark plug connector									470 426	C10	
CC												
ENGINE												
1.4 TSi	Petrol	110	05/15-12/16	CZDA								
Engine	Information				A10	A20	A40	A50	A70	C10 - C30	C20	E01
All engines	x 4, BERU, ELDOR, COIL ON PLUG, incl. spark plug connector, Number of pins:4, incl. spark plug connector									470 599	C10	
ENGINE												
1.4 TSi	Petrol	118	11/11-12/16	CTHD								
Engine	Information				A10	A20	A40	A50	A70	C10 - C30	C20	E01
All engines	x 4, COIL ON PLUG, incl. spark plug connector									470 474	C10	
ENGINE												
1.4 TSi MultiFuel	Petrol/ Ethanol	118	11/11-12/16	CKMA								
Engine	Information				A10	A20	A40	A50	A70	C10 - C30	C20	E01
All engines	x 4, COIL ON PLUG, incl. spark plug connector									470 474	C10	
ENGINE												
1.8 TSi	Petrol	112	11/11-12/16	CDAB								
Engine	Information				A10	A20	A40	A50	A70	C10 - C30	C20	E01
All engines	x 4, ELDOR, Housing Colour:Black, COIL ON PLUG, incl. spark plug connector									470 426	C10	
ENGINE												
1.8 TSi	Petrol	118	11/11-12/16	CDA A								
Engine	Information				A10	A20	A40	A50	A70	C10 - C30	C20	E01
All engines	x 4, ELDOR, Housing Colour:Black, COIL ON PLUG, incl. spark plug connector									470 426	C10	
ENGINE												
2.0 TFSI	Petrol	147	11/11-12/16	CBFA, CCTA								
Engine	Information				A10	A20	A40	A50	A70	C10 - C30	C20	E01
All engines	x 4, ELDOR, Housing Colour:Black, COIL ON PLUG, incl. spark plug connector									470 426	C10	
ENGINE												
2.0 TSi	Petrol	147	11/11->	CBFA, CCTA								
Engine	Information				A10	A20	A40	A50	A70	C10 - C30	C20	E01
All engines	Qty: 4									470 426	C10	
ENGINE												
2.0 TSi	Petrol	155	11/11-12/16	CCZB								
Engine	Information				A10	A20	A40	A50	A70	C10 - C30	C20	E01
All engines	x 4, ELDOR, Housing Colour:Black, COIL ON PLUG, incl. spark plug connector									470 426	C10	
CORRADO												
ENGINE												
1.8 16V	Petrol	100	04/89-07/92	KR								
Engine	Information				A10	A20	A40	A50	A70	C10 - C30	C20	E01
All engines	version Bosch						806 266	906 121R	406 223			
All engines										470 126	C10	465 007
ENGINE												
1.8 G60	Petrol	118	09/88-09/93	PG								
Engine	Information				A10	A20	A40	A50	A70	C10 - C30	C20	E01
All engines	version Bosch						806 266	906 121R				
All engines										470 125	C10	465 007
												359 725

A10 CONDENSER	A20 CONTACT SET	A40 DISTRIBUTOR CAP	A50 ROTOR	A70 PICK-UP
C10 COIL	C20 IGNITION MODULE	C30 ELECTRONIC IGNITION KIT	E01 IGNITION CABLE SET	

Vehicle	alim.	kW	Date	Engine	FUNCTIONS ON THE VEHICLE							
					A10	A20	A40	A50	A70	C10 - C30	C20	E01
ENGINE												
2.0 i	Petrol	85	04/93-12/95	2E, ADY								
Engine	Information			A10	A20	A40	A50	A70	C10 - C30	C20	E01	
All engines	version Bosch					806 266	906 121R		490 414	C30		
All engines												
Eng. ADY										465 007	359 725	
Eng. 2E											359 965	
ENGINE												
2.0 i 16V	Petrol	100	08/91-12/95	7TZ220XS560								
Engine	Information			A10	A20	A40	A50	A70	C10 - C30	C20	E01	
All engines	version Bosch					806 266	906 121R	406 223				
All engines										465 007		
ENGINE												
2.9 VR6	Petrol	140	08/91-12/95	ABV								
Engine	Information			A10	A20	A40	A50	A70	C10 - C30	C20	E01	
All engines	version Bosch					806 233						
All engines	-> ch. 50-N-018 000, version Bosch						906 148R					
All engines	ch. 50-N-018 001 ->, version Bosch						906 149R					
All engines	-> ch. 50-P-010 000							470 269	C10			
All engines										465 007		
DERBY												
ENGINE												
1.0	Petrol	29	10/81-12/84	GL								
Engine	Information			A10	A20	A40	A50	A70	C10 - C30	C20	E01	
All engines	version Bosch			606 196	706 049HDVS	806 079	906 114R					
ENGINE												
1.1	Petrol	37	02/77-09/81	HB								
Engine	Information			A10	A20	A40	A50	A70	C10 - C30	C20	E01	
All engines	version Bosch			606 195	706 049HDVS	806 079	906 026R					
All engines	version Ducellier						915 089R					
ENGINE												
1.3	Petrol	40	08/83-12/84	HK								
Engine	Information			A10	A20	A40	A50	A70	C10 - C30	C20	E01	
All engines	version Bosch					806 094	906 056R	406 193				
All engines									470 125	C10	465 004	
ENGINE												
1.3	Petrol	44	02/77-09/81	HH								
Engine	Information			A10	A20	A40	A50	A70	C10 - C30	C20	E01	
All engines	version Bosch			606 195	706 049HDVS	806 079						
All engines	version Bosch, -> year 01/01/83						906 026R					
All engines	version Bosch, 01/01/83 ->						906 114R					
All engines	version Ducellier						915 089R					
ENGINE												
1.3	Petrol	55	09/82-12/84	GK								
Engine	Information			A10	A20	A40	A50	A70	C10 - C30	C20	E01	
All engines	version Bosch					806 094	906 121R	406 223				
All engines									470 125	C10	465 004	
EOS												
ENGINE												
1.4 TSI	Petrol	118	05/08-08/15	CAVD, CTHD								
Engine	Information			A10	A20	A40	A50	A70	C10 - C30	C20	E01	
All engines	x 4, COIL ON PLUG, incl. spark plug connector								470 474	C10		
ENGINE												
1.4 TSI	Petrol	90	11/07-08/15	CAXA								
Engine	Information			A10	A20	A40	A50	A70	C10 - C30	C20	E01	
All engines	x 4, COIL ON PLUG, incl. spark plug connector								470 474	C10		
ENGINE												
1.6 FSI	Petrol	85	06/06-05/08	BLF								
Engine	Information			A10	A20	A40	A50	A70	C10 - C30	C20	E01	
All engines	x 4, COIL ON PLUG, incl. spark plug connector								470 474	C10		

A10 CONDENSER	A20 CONTACT SET	A40 DISTRIBUTOR CAP	A50 ROTOR	A70 PICK-UP
C10 COIL	C20 IGNITION MODULE	C30 ELECTRONIC IGNITION KIT	E01 IGNITION CABLE SET	

					FUNCTIONS ON THE VEHICLE							
Vehicle	alim.	kW	Date	Engine	A10	A20	A40	A50	A70	C10 - C30	C20	E01
ENGINE												
2.0 FSI	Petrol	110	03/06-05/08	BVY, BVZ								
Engine	Information				A10	A20	A40	A50	A70	C10 - C30	C20	E01
All engines	x 4, ELDOR, Housing Colour:Black, COIL ON PLUG, incl. spark plug connector									470 426	C10	
ENGINE												
2.0 TFSI	Petrol	147	03/06-08/15	BPY, BWA, CAWB, CBFA, CCTA, CCZA								
Engine	Information				A10	A20	A40	A50	A70	C10 - C30	C20	E01
All engines	01/06/08 ->, x 4, ELDOR, Housing Colour:Black, COIL ON PLUG, incl. spark plug connector									470 426	C10	
All engines	->year 01/05/08, x 4, COIL ON PLUG, incl. spark plug connector									470 474	C10	
ENGINE												
2.0 TSI	Petrol	155	11/09-08/15	CCZB								
Engine	Information				A10	A20	A40	A50	A70	C10 - C30	C20	E01
All engines	x 4, ELDOR, Housing Colour:Black, COIL ON PLUG, incl. spark plug connector									470 426	C10	
ENGINE												
3.2 V6	Petrol	184	06/06-05/09	BUB, CBRA								
Engine	Information				A10	A20	A40	A50	A70	C10 - C30	C20	E01
All engines	x 6, COIL ON PLUG, incl. spark plug connector									470 434	C10	
ENGINE												
1.0	Petrol	52	10/03->	--								
Engine	Information				A10	A20	A40	A50	A70	C10 - C30	C20	E01
All engines										490 420	C30	360 723
ENGINE												
1.0	Petrol	53	10/03->	AQZ, BNX								
Engine	Information				A10	A20	A40	A50	A70	C10 - C30	C20	E01
All engines										490 420	C30	360 723
ENGINE												
1.0	Petrol	54	04/08->	CCNA								
Engine	Information				A10	A20	A40	A50	A70	C10 - C30	C20	E01
All engines	->year 27/07/09									490 420	C30	360 723
ENGINE												
1.0 Alcohol	Petrol	53	10/03->	BJE, BNX								
Engine	Information				A10	A20	A40	A50	A70	C10 - C30	C20	E01
All engines										490 420	C30	360 723
ENGINE												
1.0 Total Flex	Flexfuel	54	03/08->	CCNA								
Engine	Information				A10	A20	A40	A50	A70	C10 - C30	C20	E01
All engines	->year 27/07/09									490 420	C30	360 723
ENGINE												
1.2	Petrol	40	04/05-07/11	BMD, CHFB								
Engine	Information				A10	A20	A40	A50	A70	C10 - C30	C20	E01
All engines	x 3, COIL ON PLUG, incl. spark plug connector									470 431	C10	
ENGINE												
1.2	Petrol	44	09/10-12/11	CHFA								
Engine	Information				A10	A20	A40	A50	A70	C10 - C30	C20	E01
All engines	x 3, COIL ON PLUG, incl. spark plug connector									470 431	C10	
ENGINE												
1.4	Petrol	55	04/05-12/09	BKR								
Engine	Information				A10	A20	A40	A50	A70	C10 - C30	C20	E01
All engines										490 420	C30	360 723
ENGINE												
1.6	Petrol	74	10/03-08/14	BAH, BLH, BPA, CCRA, CFZA								
Engine	Information				A10	A20	A40	A50	A70	C10 - C30	C20	E01
All engines										490 420	C30	360 723
ENGINE												
1.6 Alcohol	Petrol	76	10/03->	--								
Engine	Information				A10	A20	A40	A50	A70	C10 - C30	C20	E01
All engines										490 420	C30	360 723
A10	CONDENSER	A20	CONTACT SET	A40	DISTRIBUTOR CAP	A50	ROTOR	A70	PICK-UP			
C10	COIL	C20	IGNITION MODULE	C30	ELECTRONIC IGNITION KIT	E01	IGNITION CABLE SET					

Vehicle	alim.	kW	Date	Engine	FUNCTIONS ON THE VEHICLE							
					A10	A20	A40	A50	A70	C10 - C30	C20	E01

				ENGINE
1.6 Total Flex	Petrol/ Ethanol	74	10/03-08/14	BJA, BPA, CCRA

Engine	Information	A10	A20	A40	A50	A70	C10 - C30	C20	E01
All engines							490 420	C30	360 723

				ENGINE
1.3	Petrol	40	08/83-07/86	HK

Engine	Information	A10	A20	A40	A50	A70	C10 - C30	C20	E01
All engines	version Bosch	606 195	706 049HDVS		906 114R				
All engines	->ch. 15-E-027 000, version Bosch			806 079					
All engines	ch. 15-E-027 001 ->, version Bosch			806 094					
All engines	->ch. 15-E-027 000								359 727

				ENGINE
1.6	Petrol	55	08/83-04/92	EW, HN

Engine	Information	A10	A20	A40	A50	A70	C10 - C30	C20	E01
All engines	version Bosch, ->eng. 012 000, ->eng. 005 000			806 079					
All engines	version Bosch, eng. type 012 001 ->, ->eng. 035 000, eng. type 005 001 ->, ->eng. 007 000			806 094					
All engines	version Bosch, eng. type 035 001 ->, eng. type 007 001 ->			806 266					
Eng. EW	version Ducellier, eng. type 012 001 ->			815 068	915 099R				
All engines	version Bosch, eng. type 007 001 ->				906 055R				
All engines	version Bosch, distr. num. 026 905 206 AD, eng. type 024 001 ->, ->eng. 025 000, ->eng. 005 000					406 219			
All engines	ch. 15-E-027 001 ->, ->ch. 15-J-035 000, ch. 15-L-000 001 ->						470 125	C10	
All engines	ch. 15-K-000 001 ->, ->ch. 15-K-035 000						470 126	C10	
All engines	->ch. 15-E-027 000						470 132	C10	359 727
All engines								465 007	
All engines	ch. 15-E-027 001 ->								359 725

				ENGINE
1.8	Petrol	66	08/83-09/92	EX

Engine	Information	A10	A20	A40	A50	A70	C10 - C30	C20	E01
All engines	version Bosch, ->eng. 015 000			806 079					
All engines	version Bosch, eng. type 015 001 ->, ->eng. 035 000			806 094					
All engines	version Bosch, eng. type 035 001 ->			806 266					
All engines	version Ducellier			815 068	915 099R				
All engines	version Bosch				906 055R	406 219			
All engines	ch. 15-E-027 001 ->, ->ch. 15-J-035 000, ch. 15-L-000 001 ->						470 125	C10	
All engines	ch. 15-K-000 001 ->, ->ch. 15-K-035 000						470 126	C10	
All engines	->ch. 15-E-027 000						470 132	C10	359 727
All engines								465 007	
All engines	ch. 15-E-027 001 ->								359 725

				ENGINE
1.8	Petrol	70	08/83-04/93	JH

Engine	Information	A10	A20	A40	A50	A70	C10 - C30	C20	E01
All engines	version Bosch, ->eng. 140 000			806 079	906 055R				
All engines	version Bosch, eng. type 140 001 ->, ->eng. 280 000			806 094					
All engines	version Bosch, eng. type 280 001 ->			806 266					
All engines	version Bosch, ->eng. 140 000, eng. type 280 001 ->					406 219			
All engines	ch. 15-E-027 001 ->, ->ch. 15-J-035 000, ch. 15-L-000 001 ->						470 125	C10	
All engines	ch. 15-K-000 001 ->, ->ch. 15-K-035 000						470 126	C10	
All engines	->ch. 15-E-027 000						470 132	C10	359 727
All engines								465 007	
All engines	ch. 15-E-027 001 ->								359 725

				ENGINE
1.8	Petrol	72	08/89-03/93	2H

Engine	Information	A10	A20	A40	A50	A70	C10 - C30	C20	E01
All engines	version Bosch, ch. 15-L-012 001 ->, ->ch. 15-M-021 000			806 094					
All engines	version Bosch, ->ch. 15-L-012 000, ch. 15-M-021 001 ->			806 266					
All engines	version Bosch				906 121R				
All engines	ch. 15-E-027 001 ->, ->ch. 15-J-035 000, ch. 15-L-000 001 ->						470 125	C10	
All engines	ch. 15-K-000 001 ->, ->ch. 15-K-035 000						470 126	C10	

A10 CONDENSER	A20 CONTACT SET	A40 DISTRIBUTOR CAP	A50 ROTOR	A70 PICK-UP
C10 COIL	C20 IGNITION MODULE	C30 ELECTRONIC IGNITION KIT	E01 IGNITION CABLE SET	

Vehicle	alim.	kW	Date	Engine	FUNCTIONS ON THE VEHICLE							
					A10	A20	A40	A50	A70	C10 - C30	C20	E01

ENGINE				
1.8	Petrol	72	08/89-03/93	2H

Engine	Information	A10	A20	A40	A50	A70	C10 - C30	C20	E01
All engines	->ch. 15-E-027 000						470 132	C10	359 727
All engines								465 007	
All engines	ch. 15-E-027 001 ->								359 725

ENGINE				
1.8	Petrol	82	08/82-12/92	DX, KT

Engine	Information	A10	A20	A40	A50	A70	C10 - C30	C20	E01
Eng. DX	version Bosch, ->eng. 110 000			806 079					
All engines	version Bosch, eng. type 110 001 ->, ->eng. 119 000, ->eng. 004 600			806 094	906 116R				
All engines	version Bosch, eng. type 119 001 ->, eng. type 004 601 ->			806 266					
All engines	version Bosch, ->eng. 110 000, eng. type 119 001 ->, eng. type 004 601 ->				906 055R				
All engines	version Bosch, eng. type 130 001 ->					406 219			
All engines	ch. 15-E-027 001 ->, ->ch. 15-J-035 000, ch. 15-L-000 001 ->						470 125	C10	
All engines	ch. 15-K-000 001 ->, ->ch. 15-K-035 000						470 126	C10	
All engines	->ch. 15-E-027 000						470 132	C10	359 727
All engines								465 007	
All engines	ch. 15-E-027 001 ->								359 725

ENGINE				
1.0	Petrol	33	11/83-08/85	GN

Engine	Information	A10	A20	A40	A50	A70	C10 - C30	C20	E01
All engines	version Bosch, no specific info conc. application available	606 195, 606 196							
All engines	version Bosch		706 049HDVS		906 114R				
All engines	version Bosch, ->ch. 19-E-855 000			806 079					
All engines	version Bosch, ch. 19-E-855 001 ->			806 094					
All engines	ch. 19-E-855 001 ->								359 725
All engines	->ch. 19-E-855 000								359 727

ENGINE				
1.0	Petrol	37	08/85-10/91	HZ

Engine	Information	A10	A20	A40	A50	A70	C10 - C30	C20	E01
All engines	version Bosch, 01/09/86 ->, ->ch. 1G-MB150 000, ->ch. 1G-MW480 000			806 094					
All engines	version Bosch, ch. 1G-MB150 001 ->, ch. 1G-MW480 001 ->			806 266		406 234			
All engines	version Bosch, 01/09/86 ->				906 056R				
All engines	version Bosch, ->ch. 1G-MB150 000, ->ch. 1G-MW480 000					406 193			
All engines	no specific info conc. application available						470 125, 470 126	C10	
All engines								465 007	
All engines	01/08/88 ->, ch. 19-E-855 001 ->								359 493
All engines	01/08/86 ->, ->year 01/08/88								360 671

ENGINE				
1.3	Petrol	37	08/85-12/87	NU

Engine	Information	A10	A20	A40	A50	A70	C10 - C30	C20	E01
All engines	version Bosch, 01/08/86 ->			806 094	906 056R				
All engines	version Bosch					406 193			
All engines							470 125	C10	360 671

ENGINE				
1.3	Petrol	40	08/83-06/87	HK, MH

Engine	Information	A10	A20	A40	A50	A70	C10 - C30	C20	E01
Eng. HK	version Bosch	606 195	706 049HDVS		906 114R				
Eng. HK	version Bosch, ->ch. 19-E-855 000			806 079					
All engines	version Bosch, ch. 19-E-855 001 ->, 01/08/86 ->			806 094					
Eng. MH	version Bosch, 01/08/86 ->				906 056R				
Eng. MH	version Bosch					406 193			
Eng. MH	->year 31/07/87						470 125	C10	
Eng. MH	01/08/87 ->						470 126	C10	
Eng. MH								465 007	
All engines	ch. 19-E-855 001 ->, ->year 31/07/86, 01/08/88 ->								359 493
Eng. HK	->ch. 19-E-855 000								359 727
Eng. MH	01/08/86 ->, ->year 31/07/88								360 671

A10 CONDENSER	A20 CONTACT SET	A40 DISTRIBUTOR CAP	A50 ROTOR	A70 PICK-UP
C10 COIL	C20 IGNITION MODULE	C30 ELECTRONIC IGNITION KIT	E01 IGNITION CABLE SET	

Vehicle	alim.	kW	Date	Engine	FUNCTIONS ON THE VEHICLE							
					A10	A20	A40	A50	A70	C10 - C30	C20	E01

ENGINE				
1.3	Petrol	43	08/83-10/86	GT

Engine	Information	A10	A20	A40	A50	A70	C10 - C30	C20	E01
All engines	version Bosch	606 195	706 049HDVS		906 056R				
All engines	version Bosch, ->ch. 19-E-855 000			806 079					
All engines	version Bosch, ch. 19-E-855 001 ->			806 094					
All engines	ch. 19-E-855 001 ->								359 493
All engines	->ch. 19-E-855 000								359 727

ENGINE				
1.3 Cat	Petrol	40	06/86-12/92	2G, NZ

Engine	Information	A10	A20	A40	A50	A70	C10 - C30	C20	E01
All engines	01/01/87 ->, ->ch. 1G-MB150 000, ->ch. 1G-MW480 000, version Bosch, ->ch. 1G-MB150 000			806 094					
All engines	ch. 1G-MB150 001 ->, ch. 1G-MW480 001 ->, version Bosch			806 266					
All engines	version Bosch				906 056R				
All engines	->ch. 1G-MB150 000, ->ch. 1G-MW480 000, version Bosch, distr. num. 030 905 205 D					406 193			
All engines	ch. 1G-MB150 001 ->, ch. 1G-MW480 001 ->, version Bosch, distr. num. 030 805 205 S					406 234			
All engines	no specific info conc. application available						470 125, 470 126	C10	359 493
All engines								465 007	
Eng. NZ	no specific info conc. application available								360 671

ENGINE				
1.6	Petrol	51	10/86-12/92	PN

Engine	Information	A10	A20	A40	A50	A70	C10 - C30	C20	E01
All engines	version Bosch			806 266	906 055R				
All engines	version Ducellier			815 068	915 099R				
All engines	version Bosch, ->year 31/07/86					406 159			
All engines	version Bosch, 01/08/86 ->					406 219			
All engines	no specific info conc. application available						470 125, 470 126	C10	
All engines								465 007	359 725

ENGINE				
1.6	Petrol	53	02/86-10/91	RF

Engine	Information	A10	A20	A40	A50	A70	C10 - C30	C20	E01
All engines	version Bosch			806 266	906 055R	406 219			
All engines	version Ducellier			815 068	915 099R				
All engines	no specific info conc. application available						470 125, 470 126	C10	
All engines								465 007	359 725

ENGINE				
1.6	Petrol	55	08/83-07/92	ABN, EZ

Engine	Information	A10	A20	A40	A50	A70	C10 - C30	C20	E01
Eng. EZ	version Bosch, ->eng. 309 582	606 196	706 034HVS						
Eng. EZ	version Bosch, distr. num. 050 905 205 C, eng. type 185 001 ->, ->year 01/07/86			806 094					
All engines	version Bosch			806 266					
All engines	version Ducellier, 01/08/85 ->			815 068	915 099R				
Eng. EZ	version Bosch, eng. type 185 001 ->, ->eng. 309 582				906 025R				
All engines	version Bosch, distr. num. 026 905 206, distr. num. 050 905 205, distr. num. 050 905 205 C, ->eng. 185 000, eng. type 309 583 ->				906 055R				
All engines	version Bosch, distr. num. 050 905 205 C, eng. type 309 583 ->					406 219			
All engines	no specific info conc. application available						470 125	C10	
Eng. EZ	no specific info conc. application available						470 126	C10	
All engines								465 007	
All engines	ch. 19-E-855 001 ->								359 725
Eng. EZ	->ch. 19-E-855 000								359 727

ENGINE				
1.6 [CHE] [SWE]	Petrol	60	08/83-07/88	HM

Engine	Information	A10	A20	A40	A50	A70	C10 - C30	C20	E01
All engines	version Bosch, ->eng. 033 000	606 196	706 034HVS						
All engines	version Bosch, ->eng. 016 000			806 079					
All engines	version Bosch, eng. type 016 001 ->, ->year 01/07/86			806 094					
All engines	version Bosch, 01/08/86 ->			806 266					
All engines	version Bosch, eng. type 016 001 ->, ->eng. 033 000				906 025R				

A10	CONDENSER	A20	CONTACT SET	A40	DISTRIBUTOR CAP	A50	ROTOR	A70	PICK-UP
C10	COIL	C20	IGNITION MODULE	C30	ELECTRONIC IGNITION KIT	E01	IGNITION CABLE SET		

Vehicle	alim.	kW	Date	Engine	FUNCTIONS ON THE VEHICLE							
					A10	A20	A40	A50	A70	C10 - C30	C20	E01

ENGINE				
1.6 [CHE] [SWE]	Petrol	60	08/83-07/88	HM

Engine	Information	A10	A20	A40	A50	A70	C10 - C30	C20	E01
All engines	version Bosch, ->eng. 016 000, eng. type 033 001 ->, ->year 31/07/85, 01/08/86 ->				906 055R				
All engines	version Bosch, eng. type 033 001 ->					406 219			
All engines	ch. 19-F-350 000 ->						470 125	C10	
All engines								465 007	
All engines	ch. 19-E-855 001 ->								359 725
All engines	->ch. 19-E-855 000								359 727

ENGINE				
1.6 G	Petrol	51	08/86-07/91	EZA, PN

Engine	Information	A10	A20	A40	A50	A70	C10 - C30	C20	E01
All engines	version Bosch			806 266	906 055R				
All engines	version Ducellier			815 068	915 099R				
Eng. PN	version Bosch, ->year 31/07/86					406 159			
All engines	version Bosch, 01/08/86 ->					406 219			
All engines	no specific info conc. application available						470 125	C10	
Eng. PN	no specific info conc. application available						470 126	C10	
All engines								465 007	359 725

ENGINE				
1.8	Petrol	62	08/86-01/90	RH

Engine	Information	A10	A20	A40	A50	A70	C10 - C30	C20	E01
All engines	version Bosch			806 094	906 055R	406 219			
All engines							470 125	C10	465 007
									359 725

ENGINE				
1.8	Petrol	66	08/84-10/91	GU, GX

Engine	Information	A10	A20	A40	A50	A70	C10 - C30	C20	E01
Eng. GU	version Bosch, ->eng. 003 200			806 079					
All engines	version Bosch, eng. type 003 201 ->, ->eng. 31/07/87, ->year 31/07/86			806 094					
All engines	version Bosch, 01/08/87 ->, 01/08/86 ->			806 266					
Eng. GU	version Ducellier, 01/08/85 ->			815 068	915 099R				
All engines	version Bosch				906 055R	406 219			
All engines	ch. 19-E-855 001 ->						470 125	C10	359 725
Eng. GU	01/08/88 ->, ->year 31/07/89						470 126	C10	
All engines	->ch. 19-E-855 000						470 132	C10	359 727
All engines								465 007	

ENGINE				
1.8	Petrol	77	08/87-10/91	RV

Engine	Information	A10	A20	A40	A50	A70	C10 - C30	C20	E01
All engines	version Bosch, ch. 1G-LB100 001 ->, ch. 1G-LW320 001 ->, ->ch. 1G-MB150 000, ->ch. 1G-MW480 000			806 094					
All engines	version Bosch, ->ch. 1G-LB100 000, ->ch. 1G-LW320 000, ch. 1G-MB150 001 ->, ch. 1G-MW480 001 ->			806 266					
All engines	version Bosch				906 121R				
All engines							470 125	C10	465 007
									359 725

ENGINE				
1.8 [CHE] [SWE]	Petrol	66	04/84-07/87	HV

Engine	Information	A10	A20	A40	A50	A70	C10 - C30	C20	E01
All engines	version Bosch, 01/08/86 ->, ->year 31/07/87			806 266					
All engines	version Bosch, 01/08/86 ->				906 055R	406 219			
All engines	version Bosch, ->year 31/07/86					406 159			
All engines	ch. 19-E-855 001 ->						470 125	C10	359 725
All engines	->ch. 19-E-855 000						470 132	C10	359 727
All engines								465 007	

ENGINE				
1.8 GTI	Petrol	79	08/85-10/87	RD

Engine	Information	A10	A20	A40	A50	A70	C10 - C30	C20	E01
All engines	version Bosch			806 266	906 121R				
All engines							470 125	C10	465 007
									359 725

ENGINE				
1.8 GTI	Petrol	82	08/83-10/91	EV, PB

Engine	Information	A10	A20	A40	A50	A70	C10 - C30	C20	E01
Eng. EV	version Bosch, ->eng. 025 000			806 079					

A10 CONDENSER	A20 CONTACT SET	A40 DISTRIBUTOR CAP	A50 ROTOR	A70 PICK-UP
C10 COIL	C20 IGNITION MODULE	C30 ELECTRONIC IGNITION KIT	E01 IGNITION CABLE SET	

Vehicle	alim.	kW	Date	Engine	FUNCTIONS ON THE VEHICLE							
					A10	A20	A40	A50	A70	C10 - C30	C20	E01

				ENGINE
1.8 GTI	Petrol	82	08/83-10/91	EV, PB

Engine	Information	A10	A20	A40	A50	A70	C10 - C30	C20	E01
All engines	version Bosch, eng. type 025 001 ->, ->year 31/07/86, ch. 1G-LB100 001 ->, ch. 1G-LW320 001 ->, ->ch. 1G-MB150 000, ->ch. 1G-MW480 000			806 094					
All engines	version Bosch, 01/08/86 ->, ->ch. 1G-LB100 000, ->ch. 1G-LW320 000, ch. 1G-MB150 001 ->, ch. 1G-MW480 001 ->			806 266					
Eng. EV	version Bosch, 01/08/85 ->				906 055R				
Eng. EV	version Bosch, ->year 31/07/85				906 116R				
Eng. PB	version Bosch				906 121R				
Eng. EV	version Bosch					406 219			
All engines	ch. 19-E-855 001 ->						470 125	C10	359 725
Eng. EV	->ch. 19-E-855 000						470 132	C10	359 727
All engines								465 007	

				ENGINE
1.8 GTI 16V	Petrol	102	02/86-06/90	KR

Engine	Information	A10	A20	A40	A50	A70	C10 - C30	C20	E01
All engines	version Bosch			806 266	906 121R	406 223			
All engines							470 125	C10	465 007
All engines	->year 31/07/89								359 737

				ENGINE
1.8 GTI 16V	Petrol	95	02/86-10/91	PL

Engine	Information	A10	A20	A40	A50	A70	C10 - C30	C20	E01
All engines	version Bosch			806 266	906 121R	406 223			
All engines	no specific info conc. application available						470 125, 470 126	C10	
All engines								465 007	
All engines	->year 31/07/89								359 737

				ENGINE
1.8 GTI Cat	Petrol	79	01/87-10/91	PF

Engine	Information	A10	A20	A40	A50	A70	C10 - C30	C20	E01
All engines	version Bosch, ch. 1G-LB100 001 ->, ch. 1G-LW320 001 ->, ->ch. 1G-MB150 000, ->ch. 1G-MW480 000			806 094					
All engines	version Bosch, ->ch. 1G-LB100 000, ->ch. 1G-LW320 000, ch. 1G-MB150 001 ->, ch. 1G-MW480 001 ->			806 266					
All engines	version Bosch				906 121R				
All engines							470 125	C10	465 007
All engines									359 725

				ENGINE
1.8 GTI G60	Petrol	118	04/90-07/91	PG

Engine	Information	A10	A20	A40	A50	A70	C10 - C30	C20	E01
All engines	version Bosch, ->ch. 1G-MB150 000, ->ch. 1G-MW480 000			806 094					
All engines	version Bosch, ch. 1G-MB150 001 ->, ch. 1G-MW480 001 ->			806 266					
All engines	version Bosch				906 121R				
All engines							470 125	C10	465 007
All engines									359 725

				ENGINE
1.8 GTI G60 Syncro	Petrol	118	08/88-12/91	1H, PG

Engine	Information	A10	A20	A40	A50	A70	C10 - C30	C20	E01
All engines	version Bosch, ->ch. 1G-MB120 000, ->ch. 1G-MW480 000			806 094					
Eng. PG	version Bosch, ch. 1G-MB150 001 ->, ch. 1G-MW480 001 ->			806 266					
All engines	version Bosch				906 121R				
All engines							470 125	C10	465 007
All engines									359 725





				ENGINE
1.8 i	Petrol	66	08/87-07/91	RP

Engine	Information	A10	A20	A40	A50	A70	C10 - C30	C20	E01
All engines	version Bosch			806 266	906 055R	406 219			
All engines							470 125	C10	465 007
All engines									359 725

				ENGINE
1.8 i Cat	Petrol	66	08/87-10/91	GX, RP

Engine	Information	A10	A20	A40	A50	A70	C10 - C30	C20	E01
Eng. GX	version Bosch, ->year 31/07/86			806 094					
All engines	version Bosch, 01/08/86 ->			806 266					
All engines	version Bosch				906 055R	406 219			
All engines	ch. 19-E-855 001 ->						470 125	C10	359 725

A10 CONDENSER	A20 CONTACT SET	A40 DISTRIBUTOR CAP	A50 ROTOR	A70 PICK-UP
C10 COIL	C20 IGNITION MODULE	C30 ELECTRONIC IGNITION KIT	E01 IGNITION CABLE SET	

				FUNCTIONS ON THE VEHICLE								
Vehicle	alim.	kW	Date	Engine								
				ENGINE								
1.8 i Cat	Petrol	66	08/87-10/91	GX, RP								
Engine	Information			A10	A20	A40	A50	A70	C10 - C30	C20	E01	
Eng. GX	->ch. 19-E-855 000								470 132	C10	359 727	
All engines										465 007		
				ENGINE								
1.8 i Cat Syncro	Petrol	66	08/87-10/91	RP								
Engine	Information			A10	A20	A40	A50	A70	C10 - C30	C20	E01	
All engines	version Bosch					806 266	906 055R	406 219				
All engines									470 125	C10	465 007	359 725
				ENGINE								
1.8 Rallye syncro	Petrol	118	08/88-07/91	1H, PG								
Engine	Information			A10	A20	A40	A50	A70	C10 - C30	C20	E01	
All engines									470 125	C10	465 007	359 725
				ENGINE								
1.8 Syncro	Petrol	62	08/87-07/88	RH								
Engine	Information			A10	A20	A40	A50	A70	C10 - C30	C20	E01	
All engines									470 125	C10	465 007	359 725
				ENGINE								
1.8 Syncro	Petrol	66	02/86-07/91	GU, GX								
Engine	Information			A10	A20	A40	A50	A70	C10 - C30	C20	E01	
All engines	version Bosch, ->ch. 19-G-990 000					806 094						
Eng. GU	version Bosch, ch. ...H-000 001 ->					806 266						
Eng. GU	version Ducellier					815 068	915 099R					
All engines	version Bosch						906 055R	406 219				
All engines	->ch. 1G-J-990000, ch. 1G-L-000 001 ->								470 125	C10		
Eng. GU	->ch. 1G-K-990 000, ch. 1G-K-000 001 ->								470 126	C10		
All engines										465 007	359 725	
				ENGINE								
1.8 Syncro	Petrol	72	08/88-07/91	3E82								
Engine	Information			A10	A20	A40	A50	A70	C10 - C30	C20	E01	
All engines	version Bosch					806 266	906 121R					
All engines	ch. 1G-L-000 001 ->								470 125	C10		
All engines	->ch. 1G-K-990 000								470 126	C10		
All engines										465 007	359 725	
				ENGINE								
1.8i GTI [CHE] [SWE]	Petrol	82	01/84-07/87	GZ								
Engine	Information			A10	A20	A40	A50	A70	C10 - C30	C20	E01	
All engines	version Bosch, ->year 31/07/86					806 094						
All engines	version Bosch, 01/08/86 ->					806 266						
All engines	version Bosch, 01/08/85 ->						906 055R					
All engines	version Bosch, ->year 31/07/85						906 116R					
All engines	version Bosch							406 219				
All engines	ch. 19-E-855 001 ->								470 125	C10	359 725	
All engines	->ch. 19-E-855 000								470 132	C10	359 727	
All engines										465 007		
				ENGINE								
1.8i GTI [SWE]	Petrol	82	08/87-07/88	GZ								
Engine	Information			A10	A20	A40	A50	A70	C10 - C30	C20	E01	
All engines	version Bosch, 01/08/86 ->					806 266						
All engines	version Bosch, 01/08/85 ->						906 055R					
All engines	version Bosch							406 219				
All engines	ch. 19-E-855 001 ->								470 125	C10	359 725	
All engines	->ch. 19-E-855 000								470 132	C10	359 727	
All engines										465 007		
				ENGINE								
1.4	Petrol	40	11/91-04/99	ABD, AEX								
Engine	Information			A10	A20	A40	A50	A70	C10 - C30	C20	E01	
All engines	version Bosch, 01/08/94 ->					806 094						
Eng. ABD	version Bosch, ->year 31/07/94					806 266						
Eng. AEX	version Marelli					830 116	930 057R	430 182				

A10 CONDENSER	A20 CONTACT SET	A40 DISTRIBUTOR CAP	A50 ROTOR	A70 PICK-UP
C10 COIL	C20 IGNITION MODULE	C30 ELECTRONIC IGNITION KIT	E01 IGNITION CABLE SET	

Vehicle	alim.	kW	Date	Engine	FUNCTIONS ON THE VEHICLE							
					A10	A20	A40	A50	A70	C10 - C30	C20	E01

GOLF III				ENGINE
1.4	Petrol	40	11/91-04/99	ABD, AEX

Engine	Information	A10	A20	A40	A50	A70	C10 - C30	C20	E01
All engines	version Bosch				906 121R	406 223			
All engines							490 414	C30	
Eng. ABD	ch. 1H-P-640 001 ->								359 493
Eng. AEX									360 671

				ENGINE
1.4	Petrol	44	10/91-04/99	ABD, AEX

Engine	Information	A10	A20	A40	A50	A70	C10 - C30	C20	E01
All engines	version Bosch, 01/08/94 ->			806 094					
Eng. ABD	version Bosch, ->year 31/07/94			806 266					
Eng. AEX	version Marelli			830 116	930 057R	430 182			
All engines	version Bosch				906 121R	406 223			
All engines							490 414	C30	
Eng. ABD	ch. 1H-P-640 001 ->								359 493
Eng. AEX									360 671

				ENGINE
1.6	Petrol	55	09/92-08/97	ABU, AEA, AEE

Engine	Information	A10	A20	A40	A50	A70	C10 - C30	C20	E01
All engines	version Bosch, 01/08/94 ->			806 094					
Eng. ABU	version Bosch, ->year 31/07/94			806 266					
Eng. AEE	version Marelli			830 116	930 057R	430 182			
All engines	version Bosch				906 121R	406 223			
All engines							490 414	C30	
Eng. ABU	01/08/94 ->								359 493
Eng. ABU, AEA	ch. 1H-P-640 001 ->, ->year 31/07/94								360 364
Eng. AEE	no specific info conc. application available								360 609

				ENGINE
1.6	Petrol	74	07/94-04/99	AEK, AFT, AKS

Engine	Information	A10	A20	A40	A50	A70	C10 - C30	C20	E01
All engines	version Bosch			806 266	906 121R	406 223			
Eng. AEK	version Ducellier			815 068	915 099R				
All engines							490 414	C30	
Eng. AEK									360 551
Eng. AFT	->year 31/05/96								360 933
Eng. AFT, AKS	01/06/96 ->								360 937

				ENGINE
1.8	Petrol	55	08/91-04/99	AAM

Engine	Information	A10	A20	A40	A50	A70	C10 - C30	C20	E01
All engines	version Bosch			806 266	906 121R	406 223			
All engines	version Ducellier			815 068	915 099R				
All engines							490 414	C30	
All engines	->year 31/07/94								359 725
All engines	convertible								359 965
All engines	01/08/94 ->								360 549

				ENGINE
1.8	Petrol	66	08/91-04/99	ABS, ACC, ADZ

Engine	Information	A10	A20	A40	A50	A70	C10 - C30	C20	E01
Eng. ABS, ADZ	version Bosch			806 266	906 121R	406 223			
Eng. ABS, ADZ	version Ducellier			815 068	915 099R				
All engines							490 414	C30	
Eng. ABS, ADZ	convertible								359 725
Eng. ADZ									360 549

				ENGINE
1.8 Syncro	Petrol	66	01/93-04/99	ABS, ADZ

Engine	Information	A10	A20	A40	A50	A70	C10 - C30	C20	E01
All engines	version Bosch			806 266	906 121R				
All engines	version Ducellier			815 068	915 099R				
All engines							490 414	C30	
Eng. ABS									359 725
Eng. ADZ									360 549

A10 CONDENSER	A20 CONTACT SET	A40 DISTRIBUTOR CAP	A50 ROTOR	A70 PICK-UP
C10 COIL	C20 IGNITION MODULE	C30 ELECTRONIC IGNITION KIT	E01 IGNITION CABLE SET	

FUNCTIONS ON THE VEHICLE

Vehicle	alim.	kW	Date	Engine								
---------	-------	----	------	--------	---	---	---	--	---	---	---	---

				ENGINE
2.0	Petrol	79	08/95-04/96	AEP

Engine	Information	A10	A20	A40	A50	A70	C10 - C30	C20	E01
All engines	version Bosch			806 266	906 121R	406 223			
All engines	version Ducellier			815 068	915 099R				
All engines							490 414	C30	360 549

				ENGINE
2.0	Petrol	85	11/91-04/99	2E, ADY, AGG, AKR

Engine	Information	A10	A20	A40	A50	A70	C10 - C30	C20	E01
All engines	version Bosch			806 266	906 121R				
Eng. ADY, AGG, AKR	version Ducellier			815 068	915 099R				
Eng. ADY, AGG, AKR	version Bosch					406 223			
All engines							490 414	C30	
Eng. 2E									359 965
Eng. ADY, AGG, AKR									360 549

				ENGINE
2.0 GL	Petrol	79	08/95-09/97	AEP

Engine	Information	A10	A20	A40	A50	A70	C10 - C30	C20	E01
All engines	version Bosch			806 266	906 121R	406 223			
All engines	version Ducellier			815 068	915 099R				
All engines							490 414	C30	360 549

				ENGINE
2.0 GTI 16V	Petrol	110	08/92-08/97	ABF

Engine	Information	A10	A20	A40	A50	A70	C10 - C30	C20	E01
All engines	version Bosch			806 263		406 223			
All engines							490 414	C30	

				ENGINE
2.0 Syncro	Petrol	85	08/95-04/99	AGG

Engine	Information	A10	A20	A40	A50	A70	C10 - C30	C20	E01
All engines	version Bosch			806 266	906 121R	406 223			
All engines							490 414	C30	360 549

				ENGINE
2.8 VR6	Petrol	120	08/95-09/97	AAA

Engine	Information	A10	A20	A40	A50	A70	C10 - C30	C20	E01
All engines	version Bosch, ->ch. 1H-PB060 000, ->ch. 1H-PW480 000			806 233					
All engines	version Bosch, ->ch. 1H-NB060 000, ->ch. 1H-NW300 000				906 148R				
All engines	version Bosch, ch. 1H-NB060 001 ->, ch. 1H-NW300 000 ->, ->ch. 1H-PB060 000, ->ch. 1H-PW480 000				906 149R				
All engines	->ch. 1H-PB060 000, ->ch. 1H-PW480 000						470 269	C10	

				ENGINE
2.8 VR6	Petrol	128	01/92-08/97	AAA

Engine	Information	A10	A20	A40	A50	A70	C10 - C30	C20	E01
All engines	version Bosch, ->ch. 1H-PB060 000, ->ch. 1H-PW480 000			806 233					
All engines	version Bosch, ->ch. 1H-NB060 000, ->ch. 1H-NW300 000				906 148R				
All engines	version Bosch, ch. 1H-NB060 001 ->, ch. 1H-NW300 000 ->, ->ch. 1H-PB060 000, ->ch. 1H-PW480 000				906 149R				
All engines	->ch. 1H-PB060 000, ->ch. 1H-PW480 000						470 269	C10	

GOLF IV

				ENGINE
1.4	Petrol	55	05/00-06/06	AXP, BCA

Engine	Information	A10	A20	A40	A50	A70	C10 - C30	C20	E01
Eng. BCA	x 4, COIL ON PLUG, incl. spark plug connector						470 474	C10	
Eng. AXP							490 420	C30	

				ENGINE
1.4 16V	Petrol	55	10/97-06/06	AHW, AKQ, APE, AXP, BCA

Engine	Information	A10	A20	A40	A50	A70	C10 - C30	C20	E01
Eng. BCA	x 4, COIL ON PLUG, incl. spark plug connector						470 474	C10	
Eng. AHW, AKQ, APE, AXP							490 420	C30	360 575

A10 CONDENSER	A20 CONTACT SET	A40 DISTRIBUTOR CAP	A50 ROTOR	A70 PICK-UP
C10 COIL	C20 IGNITION MODULE	C30 ELECTRONIC IGNITION KIT	E01 IGNITION CABLE SET	

Vehicle	alim.	kW	Date	Engine	FUNCTIONS ON THE VEHICLE									
					A10	A20	A40	A50	A70	C10 - C30	C20	E01		
1.6	Petrol	74	08/97-05/04	ENGINE AEH, AFT, AKL, AKS, APF										
Engine	Information			A10	A20	A40	A50	A70	C10 - C30	C20	E01			
Eng. AFT, AKS	version Bosch					806 266	906 121R	406 223						
Eng. AFT, AKS									490 414	C30			360 932	
Eng. AEH, AKL									490 420	C30				
Eng. AEH, AKL, APF									490 420	C30				
Eng. AEH, AKL	->ch. 1J-W-050 000												360 479	
Eng. AEH, AKL, APF	ch. 1J-W-050 001 ->												360 484	
1.6	Petrol	75	08/00-06/06	ENGINE AVU, BFQ										
Engine	Information			A10	A20	A40	A50	A70	C10 - C30	C20	E01			
All engines									490 420	C30			360 585	
1.6	Petrol	77	05/00-06/06	ENGINE AUS, AZD, BCB										
Engine	Information			A10	A20	A40	A50	A70	C10 - C30	C20	E01			
Eng. AZD, BCB	x 4, COIL ON PLUG, incl. spark plug connector								470 474	C10				
Eng. AUS									490 420	C30				
1.6 16V	Petrol	77	02/00-06/06	ENGINE ATN, AUS, AZD, BCB										
Engine	Information			A10	A20	A40	A50	A70	C10 - C30	C20	E01			
Eng. AZD, BCB	x 4, COIL ON PLUG, incl. spark plug connector								470 474	C10				
Eng. ATN, AUS									490 420	C30			360 575	
1.6 FSI	Petrol	81	01/02-06/06	ENGINE BAD										
Engine	Information			A10	A20	A40	A50	A70	C10 - C30	C20	E01			
All engines	x 4, COIL ON PLUG, incl. spark plug connector								470 474	C10				
1.6 FSI	Petrol	85	10/03-07/04	ENGINE BAG										
Engine	Information			A10	A20	A40	A50	A70	C10 - C30	C20	E01			
All engines	Qty: 4								470 474	C10				
1.8	Petrol	55	06/98-06/02	ENGINE AAM, ANN										
Engine	Information			A10	A20	A40	A50	A70	C10 - C30	C20	E01			
All engines	version Bosch					806 266	906 121R							
All engines									490 414	C30			360 549	
1.8	Petrol	66	06/98-06/02	ENGINE ADZ, ANP										
Engine	Information			A10	A20	A40	A50	A70	C10 - C30	C20	E01			
All engines	version Bosch					806 266	906 121R							
Eng. ANP									490 414	C30			360 549	
Eng. ADZ									490 414	C30				
1.8	Petrol	92	08/97-06/05	ENGINE AGN										
Engine	Information			A10	A20	A40	A50	A70	C10 - C30	C20	E01			
All engines									490 420	C30			360 489	
1.8 4motion	Petrol	92	05/98-06/06	ENGINE AGN										
Engine	Information			A10	A20	A40	A50	A70	C10 - C30	C20	E01			
All engines									490 420	C30			360 489	
1.8 T	Petrol	110	08/97-06/06	ENGINE AGU, ARZ, AUM										
Engine	Information			A10	A20	A40	A50	A70	C10 - C30	C20	E01			
Eng. AGU	x 4, COIL ON PLUG								470 354S	C10				
Eng. AUM	01/01/02 ->, x 4, COIL ON PLUG, incl. spark plug connector								470 429	C10				
Eng. ARZ, AUM	->year 01/12/01, x 4, COIL ON PLUG, x 4, COIL ON PLUG, incl. spark plug connector, incl. spark plug connector								470 445	C10				
Eng. AGU													465 076	

A10	CONDENSER	A20	CONTACT SET	A40	DISTRIBUTOR CAP	A50	ROTOR	A70	PICK-UP
C10	COIL	C20	IGNITION MODULE	C30	ELECTRONIC IGNITION KIT	E01	IGNITION CABLE SET		

The present application list is a brief version. For the detailed information about the possibility of installation on a specific vehicle, please refer to our web-catalogue <http://catalogo.facet.eu/>

Vehicle	alim.	kW	Date	Engine	FUNCTIONS ON THE VEHICLE							
					A10	A20	A40	A50	A70	C10 - C30	C20	E01

ENGINE				
1.8 T GTI	Petrol	132	08/01-06/05	AUQ

Engine	Information	A10	A20	A40	A50	A70	C10 - C30	C20	E01
All engines	01/01/02 ->, x 4, COIL ON PLUG, incl. spark plug connector						470 429	C10	
All engines	->year 01/12/01, x 4, COIL ON PLUG, incl. spark plug connector						470 445	C10	

ENGINE				
2.0	Petrol	85	06/98-06/06	AGG, AKR, APK, AQY, ATU, AWF, AWG, AZG, AZJ

Engine	Information	A10	A20	A40	A50	A70	C10 - C30	C20	E01
Eng. AGG, AKR, ATU, AWF, AWG	version Bosch			806 266	906 121R				
Eng. AGG, AKR	version Ducellier			815 068	915 099R				
Eng. AGG, AKR, AWF, AWG	version Bosch					406 223			
Eng. AGG, AKR, ATU, AWF, AWG							490 414	C30	
Eng. APK, AQY							490 420	C30	360 585
Eng. AZG, AZJ									358 223

ENGINE				
2.0 4motion	Petrol	85	10/00-06/06	AZH, AZJ

Engine	Information	A10	A20	A40	A50	A70	C10 - C30	C20	E01
Eng. AZH							490 420	C30	360 585
Eng. AZJ									358 223

ENGINE				
2.0 Bi-Fuel	Petrol/Compressed Natural Gas (CNG)	85	02/02-06/06	BEH

Engine	Information	A10	A20	A40	A50	A70	C10 - C30	C20	E01
All engines									358 223

ENGINE				
2.3 V5	Petrol	110	08/97-06/06	AGZ

Engine	Information	A10	A20	A40	A50	A70	C10 - C30	C20	E01
All engines								465 074	

ENGINE				
2.3 V5	Petrol	125	10/00-06/06	AQN

Engine	Information	A10	A20	A40	A50	A70	C10 - C30	C20	E01
All engines	x 5, COIL ON PLUG						470 435	C10	

ENGINE				
2.3 V5 4motion	Petrol	110	12/98-06/06	AGZ

Engine	Information	A10	A20	A40	A50	A70	C10 - C30	C20	E01
All engines								465 074	

ENGINE				
2.3 V5 4motion	Petrol	125	10/00-06/06	AQN

Engine	Information	A10	A20	A40	A50	A70	C10 - C30	C20	E01
All engines	x 5, COIL ON PLUG						470 435	C10	

ENGINE				
2.8 V6 4motion	Petrol	150	05/99-06/06	AUE, BDE

Engine	Information	A10	A20	A40	A50	A70	C10 - C30	C20	E01
All engines	01/05/01 ->, x 6, ch. 1J2000001 ->, COIL ON PLUG, x 6, COIL ON PLUG						470 435	C10	

ENGINE				
2.8 VR6 4motion	Petrol	150	03/99-06/05	AUE, BDE

Engine	Information	A10	A20	A40	A50	A70	C10 - C30	C20	E01
All engines	01/05/01 ->, x 6, ch. 1J2000001 ->, COIL ON PLUG, x 6, COIL ON PLUG						470 435	C10	

ENGINE				
3.2 R32 4motion	Petrol	177	09/02-06/05	BFH, BML

Engine	Information	A10	A20	A40	A50	A70	C10 - C30	C20	E01
All engines	x 6, COIL ON PLUG						470 434	C10	

A10 CONDENSER	A20 CONTACT SET	A40 DISTRIBUTOR CAP	A50 ROTOR	A70 PICK-UP
C10 COIL	C20 IGNITION MODULE	C30 ELECTRONIC IGNITION KIT	E01 IGNITION CABLE SET	

Vehicle	alim.	kW	Date	Engine	FUNCTIONS ON THE VEHICLE									
					A10	A20	A40	A50	A70	C10 - C30	C20	E01		
GOLF PLUS														
1.2 TSi	Petrol	77	11/09-08/14	ENGINE CBZB										
Engine	Information				A10	A20	A40	A50	A70	C10 - C30	C20	E01		
All engines										490 420	C30			
1.4 TSi	Petrol	118	01/09-09/12	ENGINE CAVD										
Engine	Information				A10	A20	A40	A50	A70	C10 - C30	C20	E01		
All engines	x 4, COIL ON PLUG, incl. spark plug connector									470 474	C10			
1.4 TSi	Petrol	90	01/09-08/14	ENGINE CAXA										
Engine	Information				A10	A20	A40	A50	A70	C10 - C30	C20	E01		
All engines	x 4, COIL ON PLUG, incl. spark plug connector									470 474	C10			
GOLF V														
1.2 TSi	Petrol	63	05/10-12/13	ENGINE CBZA										
Engine	Information				A10	A20	A40	A50	A70	C10 - C30	C20	E01		
All engines										490 420	C30			
1.2 TSi	Petrol	77	11/09-12/13	ENGINE CBZB										
Engine	Information				A10	A20	A40	A50	A70	C10 - C30	C20	E01		
All engines										490 420	C30			
1.4	Petrol	59	06/07-07/09	ENGINE BUD										
Engine	Information				A10	A20	A40	A50	A70	C10 - C30	C20	E01		
All engines	x 4, COIL ON PLUG, incl. spark plug connector									470 474	C10			
1.4 16V	Petrol	55	10/03-11/06	ENGINE BCA										
Engine	Information				A10	A20	A40	A50	A70	C10 - C30	C20	E01		
All engines	x 4, COIL ON PLUG, incl. spark plug connector									470 474	C10			
1.4 16V	Petrol	59	05/06-12/13	ENGINE BUD, CGGA										
Engine	Information				A10	A20	A40	A50	A70	C10 - C30	C20	E01		
All engines	x 4, COIL ON PLUG, incl. spark plug connector									470 474	C10			
1.4 FSi	Petrol	66	10/03-11/06	ENGINE BKG, BLN										
Engine	Information				A10	A20	A40	A50	A70	C10 - C30	C20	E01		
All engines	x 4, COIL ON PLUG, incl. spark plug connector									470 474	C10			
1.4 TSi	Petrol	103	05/06-07/09	ENGINE BMY										
Engine	Information				A10	A20	A40	A50	A70	C10 - C30	C20	E01		
All engines	x 4, COIL ON PLUG, incl. spark plug connector									470 474	C10			
1.4 TSi	Petrol	118	06/08-12/13	ENGINE CAVD, CNWA, CTHD										
Engine	Information				A10	A20	A40	A50	A70	C10 - C30	C20	E01		
All engines	x 4, COIL ON PLUG, incl. spark plug connector									470 474	C10			
1.4 TSi	Petrol	125	11/05-07/09	ENGINE BLG										
Engine	Information				A10	A20	A40	A50	A70	C10 - C30	C20	E01		
All engines	x 4, COIL ON PLUG, incl. spark plug connector									470 474	C10			
1.4 TSi	Petrol	90	05/07-12/13	ENGINE CAXA										
Engine	Information				A10	A20	A40	A50	A70	C10 - C30	C20	E01		
All engines	x 4, COIL ON PLUG, incl. spark plug connector									470 474	C10			
1.6	Natural Gas	75	11/08->	ENGINE CHGA										
Engine	Information				A10	A20	A40	A50	A70	C10 - C30	C20	E01		
All engines										490 420	C30		360 585	
All engines										490 420	C30			
Eng. BGU										490 420	C30			

A10 CONDENSER	A20 CONTACT SET	A40 DISTRIBUTOR CAP	A50 ROTOR	A70 PICK-UP
C10 COIL	C20 IGNITION MODULE	C30 ELECTRONIC IGNITION KIT	E01 IGNITION CABLE SET	

The present application list is a brief version. For the detailed information about the possibility of installation on a specific vehicle, please refer to our web-catalogue <http://catalogo.facet.eu/>

Vehicle	alim.	kW	Date	Engine	FUNCTIONS ON THE VEHICLE							
					A10	A20	A40	A50	A70	C10 - C30	C20	E01

ENGINE				
1.6	Natural Gas	75	11/08->	CHGA

Engine	Information	A10	A20	A40	A50	A70	C10 - C30	C20	E01
Eng. BGU, BSE, BSF, CCSA									360 585

ENGINE				
1.6 BiFuel	Petrol/Liquified Petroleum Gas (LPG)	75	05/09-12/13	CHGA

Engine	Information	A10	A20	A40	A50	A70	C10 - C30	C20	E01
All engines							490 420	C30	

ENGINE				
1.6 FSI	Petrol	85	10/03-07/08	BAG, BLF, BLP

Engine	Information	A10	A20	A40	A50	A70	C10 - C30	C20	E01
All engines	x 4, COIL ON PLUG, incl. spark plug connector						470 474	C10	

ENGINE				
1.6 MultiFuel	Petrol/Ethanol	75	10/07-12/13	CCSA, CMXA

Engine	Information	A10	A20	A40	A50	A70	C10 - C30	C20	E01
All engines							490 420	C30	
Eng. CCSA									360 585

ENGINE				
2.0	Petrol	85	01/05-11/08	BHY

Engine	Information	A10	A20	A40	A50	A70	C10 - C30	C20	E01
All engines							490 420	C30	360 585

ENGINE				
2.0 FSI	Petrol	110	01/04-11/08	AXW, BLR, BLX, BLY, BVX, BVY, BVZ

Engine	Information	A10	A20	A40	A50	A70	C10 - C30	C20	E01
All engines	x 4, ELDOR, Housing Colour:Black, COIL ON PLUG, incl. spark plug connector						470 426	C10	

ENGINE				
2.0 FSI 4motion	Petrol	110	08/04-11/08	BLX, BVX

Engine	Information	A10	A20	A40	A50	A70	C10 - C30	C20	E01
All engines	x 4, ELDOR, Housing Colour:Black, COIL ON PLUG, incl. spark plug connector						470 426	C10	

ENGINE				
2.0 GTI	Petrol	147	10/04-02/09	AXX, BPY, BWA, CAWB, CBFA

Engine	Information	A10	A20	A40	A50	A70	C10 - C30	C20	E01
All engines	x 4, ELDOR, Housing Colour:Black, COIL ON PLUG, incl. spark plug connector						470 426	C10	

ENGINE				
2.0 GTI	Petrol	169	09/06-12/08	BYD

Engine	Information	A10	A20	A40	A50	A70	C10 - C30	C20	E01
All engines	x 4, ELDOR, Housing Colour:Black, COIL ON PLUG, incl. spark plug connector						470 426	C10	

ENGINE				
2.0 TFSI	Petrol	147	06/07-07/09	BWA, CAWB

Engine	Information	A10	A20	A40	A50	A70	C10 - C30	C20	E01
All engines	x 4, ELDOR, Housing Colour:Black, COIL ON PLUG, incl. spark plug connector						470 426	C10	

ENGINE				
2.5	Petrol	125	05/07-11/08	CBTA, CBUA

Engine	Information	A10	A20	A40	A50	A70	C10 - C30	C20	E01
All engines	Qty: 5						470 426	C10	

ENGINE				
3.2 R32 4motion	Petrol	184	11/05-11/08	BUB

Engine	Information	A10	A20	A40	A50	A70	C10 - C30	C20	E01
All engines	x 6, COIL ON PLUG						470 434	C10	

GOLF VI				
1.2 TSI	Petrol	63	05/10->	CBZA









Engine	Information	A10	A20	A40	A50	A70	C10 - C30	C20	E01
All engines							490 420	C30	358 248

A10	CONDENSER	A20	CONTACT SET	A40	DISTRIBUTOR CAP	A50	ROTOR	A70	PICK-UP
C10	COIL	C20	IGNITION MODULE	C30	ELECTRONIC IGNITION KIT	E01	IGNITION CABLE SET		

Vehicle	alim.	kW	Date	Engine	FUNCTIONS ON THE VEHICLE							
					A10	A20	A40	A50	A70	C10 - C30	C20	E01
ENGINE												
1.2 TSI	Petrol	77	11/08->	CBZB								
Engine	Information				A10	A20	A40	A50	A70	C10 - C30	C20	E01
All engines										490 420	C30	358 248
ENGINE												
1.2 TSI 16V	Petrol	77	11/13-05/16	CJZA, CYVD								
Engine	Information				A10	A20	A40	A50	A70	C10 - C30	C20	E01
All engines	x 4, BERU, ELDOR, COIL ON PLUG, incl. spark plug connector, Number of pins:4, incl. spark plug connector									470 599	C10	
ENGINE												
1.2 Tsi BlueMotion	Petrol	77	05/09-11/12	CBZB								
Engine	Information				A10	A20	A40	A50	A70	C10 - C30	C20	E01
All engines										490 420	C30	
ENGINE												
1.4	Petrol	118	04/11-05/12	CNWA								
Engine	Information				A10	A20	A40	A50	A70	C10 - C30	C20	E01
All engines	Qty: 4									470 474	C10	
ENGINE												
1.4	Petrol	59	10/08->	BUD, CGGA								
Engine	Information				A10	A20	A40	A50	A70	C10 - C30	C20	E01
All engines	Qty: 4, Qty: 4									470 474	C10	
All engines	x 4, COIL ON PLUG, incl. spark plug connector									470 474	C10	
ENGINE												
1.4 16V	Petrol	59	01/09-05/11	BUD, CGGA								
Engine	Information				A10	A20	A40	A50	A70	C10 - C30	C20	E01
All engines	Qty: 4, Qty: 4									470 474	C10	
ENGINE												
1.4 TSI	Petrol	110	11/13-05/16	CZDA								
Engine	Information				A10	A20	A40	A50	A70	C10 - C30	C20	E01
All engines	x 4, BERU, ELDOR, COIL ON PLUG, incl. spark plug connector, Number of pins:4, incl. spark plug connector									470 599	C10	
ENGINE												
1.4 Tsi	Petrol	118	10/08->	CAVD, CNWA, CTHD, CTKA								
Engine	Information				A10	A20	A40	A50	A70	C10 - C30	C20	E01
All engines	Qty: 4									470 474	C10	
All engines	x 4, COIL ON PLUG, x 4, COIL ON PLUG, incl. spark plug connector, incl. spark plug connector									470 474	C10	
ENGINE												
1.4 TSI	Petrol	90	10/08->	CAXA								
Engine	Information				A10	A20	A40	A50	A70	C10 - C30	C20	E01
All engines	Qty: 4									470 474	C10	
All engines	x 4, COIL ON PLUG, incl. spark plug connector									470 474	C10	
ENGINE												
1.4 TSI	Petrol	92	11/13-05/16	CZCA								
Engine	Information				A10	A20	A40	A50	A70	C10 - C30	C20	E01
All engines	x 4, BERU, ELDOR, COIL ON PLUG, incl. spark plug connector, Number of pins:4, incl. spark plug connector									470 599	C10	
ENGINE												
1.6	Petrol	75	10/08->	BSE, BSF, CCSA, CMXA								
Engine	Information				A10	A20	A40	A50	A70	C10 - C30	C20	E01
All engines										490 420	C30	360 585
ENGINE												
1.6 BiFuel	Natural Gas	75	05/11->	CHGA								
Engine	Information				A10	A20	A40	A50	A70	C10 - C30	C20	E01
All engines										490 420	C30	360 585
All engines										490 420	C30	
Eng. CHGA												360 585
ENGINE												
1.6 MultiFuel	Natural Gas	75	05/09->	CHGA								
Engine	Information				A10	A20	A40	A50	A70	C10 - C30	C20	E01
All engines										490 420	C30	360 585
All engines										490 420	C30	360 585

A10 CONDENSER	A20 CONTACT SET	A40 DISTRIBUTOR CAP	A50 ROTOR	A70 PICK-UP
C10 COIL	C20 IGNITION MODULE	C30 ELECTRONIC IGNITION KIT	E01 IGNITION CABLE SET	

The present application list is a brief version. For the detailed information about the possibility of installation on a specific vehicle, please refer to our web-catalogue <http://catalogo.facet.eu/>









				FUNCTIONS ON THE VEHICLE								
Vehicle	alim.	kW	Date	Engine								
1.8 TSI	Petrol	118	06/09-01/11	ENGINE CDA A								
Engine	Information			A10	A20	A40	A50	A70	C10 - C30	C20	E01	
All engines	x 4, ELDOR, Housing Colour:Black, COIL ON PLUG, incl. spark plug connector								470 426	C10		
2.0	Petrol	199	05/11->	ENGINE CDL F								
Engine	Information			A10	A20	A40	A50	A70	C10 - C30	C20	E01	
All engines	Qty: 4								470 426	C10		
2.0 GTi	Petrol	147	06/09-11/13	ENGINE CBFA, CCTA								
Engine	Information			A10	A20	A40	A50	A70	C10 - C30	C20	E01	
All engines	x 4, ELDOR, Housing Colour:Black, COIL ON PLUG, incl. spark plug connector								470 426	C10		
2.0 GTi	Petrol	155	02/09-05/16	ENGINE CCZ B								
Engine	Information			A10	A20	A40	A50	A70	C10 - C30	C20	E01	
All engines	x 4, ELDOR, Housing Colour:Black, COIL ON PLUG, incl. spark plug connector								470 426	C10		
2.0 GTi	Petrol	173	05/11-11/12	ENGINE CDL G								
Engine	Information			A10	A20	A40	A50	A70	C10 - C30	C20	E01	
All engines	x 4, ELDOR, Housing Colour:Black, COIL ON PLUG, incl. spark plug connector								470 426	C10		
2.0 R	Petrol	195	01/13-05/16	ENGINE CDL A								
Engine	Information			A10	A20	A40	A50	A70	C10 - C30	C20	E01	
All engines	x 4, ELDOR, Housing Colour:Black, COIL ON PLUG, incl. spark plug connector								470 426	C10		
2.0 R 4motion	Petrol	188	11/09-11/13	ENGINE CDL C								
Engine	Information			A10	A20	A40	A50	A70	C10 - C30	C20	E01	
All engines	x 4, ELDOR, Housing Colour:Black, COIL ON PLUG, incl. spark plug connector								470 426	C10		
2.0 R 4motion	Petrol	199	11/09-11/12	ENGINE CDL F								
Engine	Information			A10	A20	A40	A50	A70	C10 - C30	C20	E01	
All engines	x 4, ELDOR, Housing Colour:Black, COIL ON PLUG, incl. spark plug connector								470 426	C10		
2.0 TFSi	Petrol	147	07/09-07/13	ENGINE CCZ A								
Engine	Information			A10	A20	A40	A50	A70	C10 - C30	C20	E01	
All engines	x 4, ELDOR, Housing Colour:Black, COIL ON PLUG, incl. spark plug connector								470 426	C10		
2.0 TFSi	Petrol	188	11/11->	ENGINE CRZ A								
Engine	Information			A10	A20	A40	A50	A70	C10 - C30	C20	E01	
All engines	Qty: 4								470 426	C10		
2.0 TFSi Gti	Petrol	147	05/11->	ENGINE CBFA, CCTA								
Engine	Information			A10	A20	A40	A50	A70	C10 - C30	C20	E01	
All engines	Qty: 4, version BOSCH								470 426	C10		
2.0 TFSi Gti	Petrol	155	05/11->	ENGINE CCZ B								
Engine	Information			A10	A20	A40	A50	A70	C10 - C30	C20	E01	
All engines	Qty: 4, version BOSCH								470 426	C10		
2.0 TFSi Gti	Petrol	173	05/11->	ENGINE CDL G								
Engine	Information			A10	A20	A40	A50	A70	C10 - C30	C20	E01	
All engines	Qty: 4								470 426	C10		
2.0 TSI	Petrol	188	01/13->	ENGINE CDL C								
Engine	Information			A10	A20	A40	A50	A70	C10 - C30	C20	E01	
All engines	Qty: 4								470 426	C10		

A10 CONDENSER	A20 CONTACT SET	A40 DISTRIBUTOR CAP	A50 ROTOR	A70 PICK-UP
C10 COIL	C20 IGNITION MODULE	C30 ELECTRONIC IGNITION KIT	E01 IGNITION CABLE SET	

Vehicle	alim.	kW	Date	Engine	FUNCTIONS ON THE VEHICLE							
					A10	A20	A40	A50	A70	C10 - C30	C20	E01
ENGINE												
2.0 TSi R 4motion	Petrol	199	11/09-11/12	CDLF								
Engine	Information				A10	A20	A40	A50	A70	C10 - C30	C20	E01
All engines	x 4, ELDOR, Housing Colour:Black, COIL ON PLUG, incl. spark plug connector									470 426	C10	
ENGINE												
2.5	Petrol	125	07/09->	CBTA, CBUA								
Engine	Information				A10	A20	A40	A50	A70	C10 - C30	C20	E01
All engines	Qty: 5									470 426	C10	
All engines	x 5, ELDOR, Housing Colour:Black, COIL ON PLUG, incl. spark plug connector									470 426	C10	
ENGINE												
TSi	Petrol	90	10/08-11/12	CAXA								
Engine	Information				A10	A20	A40	A50	A70	C10 - C30	C20	E01
All engines	x 4, COIL ON PLUG, incl. spark plug connector									470 474	C10	
GOLF VII												
ENGINE												
1.0 TSI	Petrol	63	01/17->	CHZK, DKLB								
Engine	Information				A10	A20	A40	A50	A70	C10 - C30	C20	E01
All engines	x 3, BERU, ELDOR, HITACHI, COIL ON PLUG, incl. spark plug connector, Number of pins:4, incl. spark plug connector									470 599	C10	
ENGINE												
1.0 TSI	Petrol	81	11/16->	CHZC								
Engine	Information				A10	A20	A40	A50	A70	C10 - C30	C20	E01
All engines	x 3, BERU, ELDOR, HITACHI, COIL ON PLUG, incl. spark plug connector, Number of pins:4, incl. spark plug connector									470 599	C10	
ENGINE												
1.0 TSI	Petrol	85	05/15->	CHZD, DKRF								
Engine	Information				A10	A20	A40	A50	A70	C10 - C30	C20	E01
All engines	x 3, BERU, ELDOR, HITACHI, COIL ON PLUG, incl. spark plug connector, Number of pins:4, incl. spark plug connector									470 599	C10	
ENGINE												
1.2 TSI	Petrol	63	08/12->	CJZB, CVVA								
Engine	Information				A10	A20	A40	A50	A70	C10 - C30	C20	E01
All engines	x 4, BERU, ELDOR, COIL ON PLUG, incl. spark plug connector, Number of pins:4, incl. spark plug connector									470 599	C10	
ENGINE												
1.2 TSI	Petrol	77	11/12->	CJZA								
Engine	Information				A10	A20	A40	A50	A70	C10 - C30	C20	E01
All engines	x 4, BERU, ELDOR, COIL ON PLUG, incl. spark plug connector, Number of pins:4, incl. spark plug connector									470 599	C10	
ENGINE												
1.2 TSI	Petrol	81	04/14->	CYVB								
Engine	Information				A10	A20	A40	A50	A70	C10 - C30	C20	E01
All engines	x 4, BERU, ELDOR, COIL ON PLUG, incl. spark plug connector, Number of pins:4, incl. spark plug connector									470 599	C10	
ENGINE												
1.2 TSi BlueMotion	Petrol	63	08/12->	CJZB, CVVA								
Engine	Information				A10	A20	A40	A50	A70	C10 - C30	C20	E01
All engines	x 4, BERU, ELDOR, COIL ON PLUG, incl. spark plug connector, Number of pins:4, incl. spark plug connector									470 599	C10	
ENGINE												
1.2 TSi BlueMotion	Petrol	77	11/12->	CJZA								
Engine	Information				A10	A20	A40	A50	A70	C10 - C30	C20	E01
All engines	x 4, BERU, ELDOR, COIL ON PLUG, incl. spark plug connector, Number of pins:4, incl. spark plug connector									470 599	C10	
ENGINE												
1.4 GTE Hybrid	Petrol/ Electric	110	05/14->	CUKB, DGEA								
Engine	Information				A10	A20	A40	A50	A70	C10 - C30	C20	E01
All engines	x 4, BERU, ELDOR, HITACHI, COIL ON PLUG, incl. spark plug connector, Number of pins:4, incl. spark plug connector									470 599	C10	

A10	CONDENSER	A20	CONTACT SET	A40	DISTRIBUTOR CAP	A50	ROTOR	A70	PICK-UP
C10	COIL	C20	IGNITION MODULE	C30	ELECTRONIC IGNITION KIT	E01	IGNITION CABLE SET		

The present application list is a brief version. For the detailed information about the possibility of installation on a specific vehicle, please refer to our web-catalogue <http://catalogo.facet.eu/>



					FUNCTIONS ON THE VEHICLE							
Vehicle	alim.	kW	Date	Engine								
ENGINE												
1.4 TGI CNG	Petrol/ Compressed Natural Gas (CNG)	81	06/13->	CPWA, CZBA								
Engine	Information				A10	A20	A40	A50	A70	C10 - C30	C20	E01
All engines	x 4, BERU, ELDOR, HITACHI, x 4, BERU, COIL ON PLUG, ELDOR, COIL ON PLUG, incl. spark plug connector, Number of pins:4, incl. spark plug connector									470 599	C10	
ENGINE												
1.4 TSI	Petrol	103	08/12-03/17	CHPA, CPTA								
Engine	Information				A10	A20	A40	A50	A70	C10 - C30	C20	E01
All engines	x 4, BERU, ELDOR, COIL ON PLUG, incl. spark plug connector, Number of pins:4, incl. spark plug connector									470 599	C10	
ENGINE												
1.4 TSI	Petrol	110	02/14->	CHPB, CZDA, CZEA								
Engine	Information				A10	A20	A40	A50	A70	C10 - C30	C20	E01
All engines	x 4, BERU, ELDOR, HITACHI, x 4, BERU, COIL ON PLUG, ELDOR, COIL ON PLUG, incl. spark plug connector, Number of pins:4, incl. spark plug connector									470 599	C10	
Eng. CHPB	Qty: 4									470 599	C10	
ENGINE												
1.4 TSI	Petrol	90	11/12->	CMBA, CPVA, CXSA								
Engine	Information				A10	A20	A40	A50	A70	C10 - C30	C20	E01
Eng. CMBA, CXSA	x 4, BERU, ELDOR, COIL ON PLUG, incl. spark plug connector, Number of pins:4, incl. spark plug connector									470 599	C10	
Eng. CPVA	Qty: 4									470 599	C10	
ENGINE												
1.4 TSI	Petrol	92	04/14->	CPVB, CZCA, CZDD								
Engine	Information				A10	A20	A40	A50	A70	C10 - C30	C20	E01
Eng. CPVB, CZDD	Qty: 4									470 599	C10	
Eng. CZCA, CZDD	x 4, BERU, ELDOR, HITACHI, COIL ON PLUG, incl. spark plug connector, Number of pins:4, incl. spark plug connector									470 599	C10	
ENGINE												
1.4 TSi BlueMotion	Petrol	103	08/12->	CHPA								
Engine	Information				A10	A20	A40	A50	A70	C10 - C30	C20	E01
All engines	x 4, BERU, ELDOR, COIL ON PLUG, incl. spark plug connector, Number of pins:4, incl. spark plug connector									470 599	C10	
ENGINE												
1.4 TSi BlueMotion	Petrol	90	05/13->	CXSA								
Engine	Information				A10	A20	A40	A50	A70	C10 - C30	C20	E01
All engines	x 4, BERU, ELDOR, COIL ON PLUG, incl. spark plug connector, Number of pins:4, incl. spark plug connector									470 599	C10	
ENGINE												
1.4 TSI MultiFuel	Petrol/ Ethanol	90	04/13->	CPVA								
Engine	Information				A10	A20	A40	A50	A70	C10 - C30	C20	E01
All engines	x 4, BERU, ELDOR, COIL ON PLUG, incl. spark plug connector, Number of pins:4, incl. spark plug connector									470 599	C10	
ENGINE												
1.4 TSI MultiFuel	Petrol/ Ethanol	92	12/13->	CPVB								
Engine	Information				A10	A20	A40	A50	A70	C10 - C30	C20	E01
All engines	x 4, BERU, ELDOR, HITACHI, COIL ON PLUG, incl. spark plug connector, Number of pins:4, incl. spark plug connector									470 599	C10	
ENGINE												
1.6	Petrol	81	05/14->	CWVA								
Engine	Information				A10	A20	A40	A50	A70	C10 - C30	C20	E01
All engines	x 4, BERU, ELDOR, COIL ON PLUG, incl. spark plug connector, Number of pins:4, incl. spark plug connector									470 599	C10	
ENGINE												
1.8 TSI 4motion	Petrol	132	12/14->	CJSB								
Engine	Information				A10	A20	A40	A50	A70	C10 - C30	C20	E01
All engines	x 4, HITACHI, COIL ON PLUG, incl. spark plug connector									470 636	C10	

A10 CONDENSER	A20 CONTACT SET	A40 DISTRIBUTOR CAP	A50 ROTOR	A70 PICK-UP
C10 COIL	C20 IGNITION MODULE	C30 ELECTRONIC IGNITION KIT	E01 IGNITION CABLE SET	

Vehicle	alim.	kW	Date	Engine	FUNCTIONS ON THE VEHICLE							
					A10	A20	A40	A50	A70	C10 - C30	C20	E01
ENGINE												
2.0 GTI	Petrol	155	11/13->	CXCA								
Engine	Information			A10	A20	A40	A50	A70	C10 - C30	C20	E01	
All engines	Qty: 4								470 636	C10		
ENGINE												
2.0 GTI	Petrol	162	04/13->	CXDA								
Engine	Information			A10	A20	A40	A50	A70	C10 - C30	C20	E01	
All engines	x 4, BERU, COIL ON PLUG, incl. spark plug connector								470 636	C10		
ENGINE												
2.0 GTI TCR	Petrol	213	11/18->	CJXH, DNUC								
Engine	Information			A10	A20	A40	A50	A70	C10 - C30	C20	E01	
All engines	01/11/19 ->, x 4, HITACHI, COIL ON PLUG, incl. spark plug connector								470 636	C10		
ENGINE												
2.0 R 4motion	Petrol	213	12/16->	CJXD, DJHB, DNUC								
Engine	Information			A10	A20	A40	A50	A70	C10 - C30	C20	E01	
All engines	01/11/19 ->, x 4, HITACHI, COIL ON PLUG, incl. spark plug connector								470 636	C10		
ENGINE												
2.0 R 4motion	Petrol	221	11/13->	CJXC, DNUC								
Engine	Information			A10	A20	A40	A50	A70	C10 - C30	C20	E01	
All engines	01/11/19 ->, x 4, HITACHI, COIL ON PLUG, incl. spark plug connector								470 636	C10		
ENGINE												
2.0 R 4motion	Petrol	228	12/16->	CJXG, DJHA								
Engine	Information			A10	A20	A40	A50	A70	C10 - C30	C20	E01	
All engines	01/11/19 ->, x 4, HITACHI, COIL ON PLUG, incl. spark plug connector								470 636	C10		
GOLF VIII												
ENGINE												
1.0 eTSI	Petrol/ Electric	81	06/20->	DLAA								
Engine	Information			A10	A20	A40	A50	A70	C10 - C30	C20	E01	
All engines	x 3, HITACHI, COIL ON PLUG, incl. spark plug connector								470 599	C10		
ENGINE												
1.0 TSI	Petrol	66	02/20->	DLAB								
Engine	Information			A10	A20	A40	A50	A70	C10 - C30	C20	E01	
All engines	x 3, HITACHI, COIL ON PLUG, incl. spark plug connector								470 599	C10		
ENGINE												
1.0 TSI	Petrol	81	02/20->	DLAA								
Engine	Information			A10	A20	A40	A50	A70	C10 - C30	C20	E01	
All engines	x 3, HITACHI, COIL ON PLUG, incl. spark plug connector								470 599	C10		
ENGINE												
1.4 GTE Plug-in Hybrid	Petrol/ Electric	110	07/20->	DGEA								
Engine	Information			A10	A20	A40	A50	A70	C10 - C30	C20	E01	
All engines	x 4, ELDOR, COIL ON PLUG, Number of pins:4, incl. spark plug connector								470 599	C10		
ENGINE												
1.4 GTE Plug-in Hybrid	Petrol/ Electric	180	07/20->	DGEA								
Engine	Information			A10	A20	A40	A50	A70	C10 - C30	C20	E01	
All engines	x 4, ELDOR, COIL ON PLUG, Number of pins:4, incl. spark plug connector								470 599	C10		
ENGINE												
1.4 TSI eHybrid	Petrol/ Electric	110	07/20->	DGEA								
Engine	Information			A10	A20	A40	A50	A70	C10 - C30	C20	E01	
All engines	x 4, ELDOR, COIL ON PLUG, Number of pins:4, incl. spark plug connector								470 599	C10		
ENGINE												
2.0 GTI	Petrol	180	09/20->	DNPA								
Engine	Information			A10	A20	A40	A50	A70	C10 - C30	C20	E01	
All engines	x 4, HITACHI, COIL ON PLUG, incl. spark plug connector								470 636	C10		

A10	CONDENSER	A20	CONTACT SET	A40	DISTRIBUTOR CAP	A50	ROTOR	A70	PICK-UP
C10	COIL	C20	IGNITION MODULE	C30	ELECTRONIC IGNITION KIT	E01	IGNITION CABLE SET		

The present application list is a brief version. For the detailed information about the possibility of installation on a specific vehicle, please refer to our web-catalogue <http://catalogo.facet.eu/>

					FUNCTIONS ON THE VEHICLE							
Vehicle	alim.	kW	Date	Engine								

				ENGINE
2.0 GTI Clubsport	Petrol	221	10/20->	DNFC

Engine	Information	A10	A20	A40	A50	A70	C10 - C30	C20	E01
All engines	x 4, HITACHI, COIL ON PLUG, incl. spark plug connector						470 636	C10	

				ENGINE
2.0 TSI R 4motion	Petrol	235	09/20->	DNFG, DSFE, DSFF

Engine	Information	A10	A20	A40	A50	A70	C10 - C30	C20	E01
All engines	x 4, HITACHI, COIL ON PLUG, incl. spark plug connector						470 636	C10	

JETTA II				ENGINE
1.0	Petrol	37	08/85-10/91	HZ

Engine	Information	A10	A20	A40	A50	A70	C10 - C30	C20	E01
All engines	->ch. 1G-MB150 000, ->ch. 1G-MW480 000, version Bosch			806 094		406 193			
All engines	ch. 1G-MB150 001 ->, ch. 1G-MW480 001 ->, version Bosch			806 266		406 234			
All engines	01/08/86 ->, version Bosch				906 056R				
All engines	no specific info conc. application available						470 125, 470 126	C10	
All engines								465 007	359 493

				ENGINE
1.3	Petrol	37	08/85-12/87	NU

Engine	Information	A10	A20	A40	A50	A70	C10 - C30	C20	E01
All engines	version Bosch			806 094	906 056R	406 193			
All engines							470 125	C10	360 671

				ENGINE
1.3	Petrol	40	01/84-06/87	HK, MH

Engine	Information	A10	A20	A40	A50	A70	C10 - C30	C20	E01
Eng. HK	version Bosch	606 195	706 049HDVS		906 114R				
Eng. HK	->ch. 19-E-855 000, version Bosch			806 079					
All engines	ch. 19-E-855 001 ->, version Bosch			806 094					
Eng. MH	version Bosch				906 056R	406 193			
Eng. MH	->year 31/07/87						470 125	C10	
Eng. MH	01/08/87 ->						470 126	C10	
Eng. MH								465 007	
All engines	ch. 19-E-855 001 ->, ->year 31/07/86, 01/08/88 ->								359 493
Eng. HK	->ch. 19-E-855 000								359 727
Eng. MH	01/08/86 ->, ->year 31/07/88								360 671

				ENGINE
1.3	Petrol	43	01/84-10/86	GT

Engine	Information	A10	A20	A40	A50	A70	C10 - C30	C20	E01
All engines	version Bosch	606 195	706 049HDVS		906 056R				
All engines	->ch. 19-E-855 000, version Bosch			806 079					
All engines	ch. 19-E-855 001 ->, version Bosch			806 094					
All engines	ch. 19-E-855 001 ->								359 493
All engines	->ch. 19-E-855 000								359 727

				ENGINE
1.3 Cat	Petrol	40	06/87-12/91	2G, MH, NZ

Engine	Information	A10	A20	A40	A50	A70	C10 - C30	C20	E01
All engines	->ch. 1G-MB150 000, ->ch. 1G-MW480 000, version Bosch			806 094					
Eng. 2G, NZ	ch. 1G-MB150 001 ->, ch. 1G-MW480 001 ->, version Bosch			806 266					
All engines	version Bosch				906 056R				
All engines	->ch. 1G-MB150 000, ->ch. 1G-MW480 000, version Bosch, distr. num. 030 905 205 D					406 193			
Eng. 2G, NZ	ch. 1G-MB150 001 ->, ch. 1G-MW480 001 ->, version Bosch, distr. num. 030 805 205 S					406 234			
All engines	->year 31/07/87, no specific info conc. application available						470 125	C10	
All engines	01/08/87 ->, no specific info conc. application available						470 126	C10	
All engines								465 007	
All engines	->year 31/07/86, ->year 31/01/87, 01/08/88 ->								359 493
Eng. MH, NZ	01/08/86 ->, 01/02/87 ->, ->year 31/07/88								360 671

				ENGINE
1.6	Petrol	51	08/86-10/91	EZA, PN

Engine	Information	A10	A20	A40	A50	A70	C10 - C30	C20	E01
All engines	version Bosch			806 266	906 055R				

A10 CONDENSER	A20 CONTACT SET	A40 DISTRIBUTOR CAP	A50 ROTOR	A70 PICK-UP
C10 COIL	C20 IGNITION MODULE	C30 ELECTRONIC IGNITION KIT	E01 IGNITION CABLE SET	

Vehicle	alim.	kW	Date	Engine	FUNCTIONS ON THE VEHICLE									
					A10	A20	A40	A50	A70	C10 - C30	C20	E01		
1.6	Petrol	51	08/86-10/91	ENGINE EZA, PN										
Engine	Information				A10	A20	A40	A50	A70	C10 - C30	C20	E01		
All engines	version Ducellier						815 068	915 099R						
Eng. PN	->year 31/07/86, version Bosch								406 159					
All engines	01/08/86 ->, version Bosch								406 219					
All engines	no specific info conc. application available									470 125	C10			
Eng. PN	no specific info conc. application available									470 126	C10			
All engines											465 007		359 725	
1.6	Petrol	53	03/86-10/91	ENGINE RF										
Engine	Information				A10	A20	A40	A50	A70	C10 - C30	C20	E01		
All engines	version Bosch						806 266	906 055R	406 219					
All engines	version Ducellier						815 068	915 099R						
All engines	no specific info conc. application available									470 125, 470 126	C10			
All engines											465 007		359 725	
1.6	Petrol	55	01/84-07/92	ENGINE ABN, EZ										
Engine	Information				A10	A20	A40	A50	A70	C10 - C30	C20	E01		
Eng. EZ	version Bosch				606 196	706 034HVS								
Eng. EZ	version Bosch, distr. num. 050 905 205 C, eng. type 185 001 ->, ->year 01/07/86						806 094							
All engines	version Bosch						806 266							
All engines	version Ducellier, 01/08/85 ->						815 068	915 099R						
Eng. EZ	version Bosch, eng. type 185 001 ->, ->eng. 309 582							906 025R						
All engines	version Bosch, distr. num. 026 905 206, distr. num. 050 905 205, distr. num. 050 905 205 C, ->eng. 185 000, eng. type 309 583 ->							906 055R						
All engines	version Bosch, distr. num. 050 905 205 C, eng. type 309 583 ->								406 219					
All engines	no specific info conc. application available									470 125	C10			
Eng. EZ	no specific info conc. application available									470 126	C10			
All engines											465 007			
All engines	ch. 19-E-855 001 ->												359 725	
Eng. EZ	->ch. 19-E-855 000												359 727	
1.6	Petrol	60	12/83-07/88	ENGINE HM										
Engine	Information				A10	A20	A40	A50	A70	C10 - C30	C20	E01		
All engines	version Bosch				606 196	706 034HVS		906 055R						
All engines	version Bosch, ->eng. 016 000						806 079							
All engines	version Bosch, eng. type 016 001 ->, ->year 01/07/86						806 094							
All engines	01/08/86 ->, version Bosch						806 266							
All engines	version Bosch, eng. type 033 001 ->								406 219					
All engines	ch. 19-F-350 000 ->									470 125	C10			
All engines											465 007			
All engines	ch. 19-E-855 001 ->												359 725	
All engines	->ch. 19-E-855 000												359 727	
1.8	Petrol	62	08/86-01/90	ENGINE RH										
Engine	Information				A10	A20	A40	A50	A70	C10 - C30	C20	E01		
All engines	version Bosch						806 094	906 055R	406 219					
All engines										470 125	C10	465 007	359 725	
1.8	Petrol	66	08/84-10/91	ENGINE GU, GX										
Engine	Information				A10	A20	A40	A50	A70	C10 - C30	C20	E01		
Eng. GU	version Bosch, ->eng. 003 200						806 079							
All engines	version Bosch, ->year 31/07/86, eng. type 003 201 ->, ->eng. 31/07/87						806 094							
All engines	version Bosch, 01/08/86 ->, 01/08/87 ->						806 266							
Eng. GU	version Ducellier, 01/08/85 ->						815 068	915 099R						
All engines	version Bosch							906 055R	406 219					
All engines	ch. 19-E-855 001 ->									470 125	C10		359 725	
All engines	->ch. 19-E-855 000									470 132	C10		359 727	
All engines											465 007			

A10 CONDENSER	A20 CONTACT SET	A40 DISTRIBUTOR CAP	A50 ROTOR	A70 PICK-UP
C10 COIL	C20 IGNITION MODULE	C30 ELECTRONIC IGNITION KIT	E01 IGNITION CABLE SET	

The present application list is a brief version. For the detailed information about the possibility of installation on a specific vehicle, please refer to our web-catalogue <http://catalogo.facet.eu/>

Vehicle	alim.	kW	Date	Engine	FUNCTIONS ON THE VEHICLE							
					A10	A20	A40	A50	A70	C10 - C30	C20	E01

ENGINE				
1.8	Petrol	77	08/87-10/91	RV

Engine	Information	A10	A20	A40	A50	A70	C10 - C30	C20	E01
All engines	version Bosch, ch. 1G-LB100 001 ->, ch. 1G-LW320 001 ->, ->ch. 1G-MB150 000, ->ch. 1G-MW480 000			806 094					
All engines	version Bosch, ->ch. 1G-LB100 000, ->ch. 1G-LW320 000, ch. 1G-MB150 001 ->, ch. 1G-MW480 001 ->			806 266					
All engines	version Bosch				906 121R				
All engines							470 125	C10	465 007
									359 725

ENGINE				
1.8	Petrol	79	08/85-10/87	RD

Engine	Information	A10	A20	A40	A50	A70	C10 - C30	C20	E01
All engines	version Bosch			806 266	906 121R				
All engines							470 125	C10	465 007
									359 725

ENGINE				
1.8	Petrol	82	01/84-10/91	EV, PB

Engine	Information	A10	A20	A40	A50	A70	C10 - C30	C20	E01
Eng. EV	version Bosch, ->eng. 025 000			806 079					
All engines	version Bosch, eng. type 025 001 ->, ->year 31/07/86, ch. 1G-LB100 001 ->, ch. 1G-LW320 001 ->, ->ch. 1G-MB150 000, ->ch. 1G-MW480 000			806 094					
All engines	version Bosch, 01/08/86 ->, ->ch. 1G-LB100 000, ->ch. 1G-LW320 000, ch. 1G-MB150 001 ->, ch. 1G-MW480 001 ->			806 266					
Eng. EV	version Bosch, 01/08/85 ->				906 055R				
Eng. EV	version Bosch, ->year 31/07/85				906 116R				
Eng. PB	version Bosch				906 121R				
Eng. EV	version Bosch					406 219			
All engines	ch. 19-E-855 001 ->						470 125	C10	359 725
Eng. EV	->ch. 19-E-855 000						470 132	C10	359 727
All engines								465 007	

ENGINE				
1.8 16V	Petrol	102	06/87-12/89	KR

Engine	Information	A10	A20	A40	A50	A70	C10 - C30	C20	E01
All engines	version Bosch			806 266	906 121R	406 223			
All engines							470 125	C10	465 007
All engines	->year 31/07/89								359 737

ENGINE				
1.8 16V	Petrol	95	08/86-10/91	PL

Engine	Information	A10	A20	A40	A50	A70	C10 - C30	C20	E01
All engines	version Bosch			806 266	906 121R	406 223			
All engines	no specific info conc. application available						470 125, 470 126	C10	
All engines								465 007	
All engines	->year 31/07/89								359 737

ENGINE				
1.8 Cat	Petrol	66	08/87-10/91	GX, RP

Engine	Information	A10	A20	A40	A50	A70	C10 - C30	C20	E01
Eng. GX	version Bosch, ->year 31/07/86			806 094					
All engines	version Bosch, 01/08/86 ->			806 266					
All engines	version Bosch				906 055R	406 219			
All engines	ch. 19-E-855 001 ->						470 125	C10	359 725
Eng. GX	->ch. 19-E-855 000						470 132	C10	359 727
All engines								465 007	

ENGINE				
1.8 Cat	Petrol	79	01/87-10/91	PF

Engine	Information	A10	A20	A40	A50	A70	C10 - C30	C20	E01
All engines	version Bosch, ch. 1G-LB100 001 ->, ch. 1G-LW320 001 ->, ->ch. 1G-MB150 000, ->ch. 1G-MW480 000			806 094					
All engines	version Bosch, ->ch. 1G-LB100 000, ->ch. 1G-LW320 000, ch. 1G-MB150 001 ->, ch. 1G-MW480 001 ->			806 266					
All engines	version Bosch				906 121R				
All engines							470 125	C10	465 007
									359 725

ENGINE				
1.8 G60	Petrol	118	04/90-07/91	PG

Engine	Information	A10	A20	A40	A50	A70	C10 - C30	C20	E01
All engines	version Bosch, ->ch. 1G-MB150 000, ->ch. 1G-MW480 000			806 094					

A10	CONDENSER	A20	CONTACT SET	A40	DISTRIBUTOR CAP	A50	ROTOR	A70	PICK-UP
C10	COIL	C20	IGNITION MODULE	C30	ELECTRONIC IGNITION KIT	E01	IGNITION CABLE SET		

Vehicle	alim.	kW	Date	Engine	FUNCTIONS ON THE VEHICLE								
					A10	A20	A40	A50	A70	C10 - C30	C20	E01	
ENGINE													
1.8 G60	Petrol	118	04/90-07/91	PG									
Engine	Information				A10	A20	A40	A50	A70	C10 - C30	C20	E01	
All engines	version Bosch, ch. 1G-MB150 001 ->, ch. 1G-MW480 001 ->						806 266						
All engines	version Bosch						906 121R						
All engines									470 125	C10	465 007	359 725	
ENGINE													
1.8 Syncro	Petrol	62	08/87-07/88	RH									
Engine	Information				A10	A20	A40	A50	A70	C10 - C30	C20	E01	
All engines										470 125	C10	465 007	359 725
ENGINE													
1.8 Syncro	Petrol	66	08/85-12/88	GU, GX, RP									
Engine	Information				A10	A20	A40	A50	A70	C10 - C30	C20	E01	
Eng. GU	version Bosch, ->eng. 003 200						806 079						
Eng. GU	version Bosch, eng. type 003 201 ->, ->year 31/07/87						806 094						
Eng. GU, RP	version Bosch, 01/08/87 ->						806 266						
Eng. GU	version Ducellier, 01/08/85 ->						815 068	915 099R					
Eng. GU, RP	version Bosch							906 055R	406 219				
All engines	ch. 1G-L-000 001 ->									470 125	C10		
Eng. GU	->ch. 1G-K-990 000									470 126	C10		
All engines											465 007		
All engines	ch. 19-E-855 001 ->											359 725	
Eng. GU	->ch. 19-E-855 000											359 727	
ENGINE													
1.8 Syncro	Petrol	72	08/88-07/91	3E82									
Engine	Information				A10	A20	A40	A50	A70	C10 - C30	C20	E01	
All engines	ch. 1G-L-000 001 ->									470 125	C10		
All engines	->ch. 1G-K-990 000									470 126	C10		
All engines											465 007	359 725	
ENGINE													
1.8i GT	Petrol	82	12/83-07/88	GZ									
Engine	Information				A10	A20	A40	A50	A70	C10 - C30	C20	E01	
All engines	->year 31/07/86, version Bosch						806 094						
All engines	version Bosch, 01/08/86 ->						806 266						
All engines	version Bosch, 01/08/85 ->							906 055R					
All engines	version Bosch, ->year 31/07/85							906 116R					
All engines	version Bosch								406 219				
All engines	ch. 19-E-855 001 ->									470 125	C10	359 725	
All engines	->ch. 19-E-855 000									470 132	C10	359 727	
All engines											465 007		
JETTA V													
ENGINE													
1.4 TSI	Petrol	103	07/06-10/10	BMV									
Engine	Information				A10	A20	A40	A50	A70	C10 - C30	C20	E01	
All engines	x 4, COIL ON PLUG, incl. spark plug connector									470 474	C10		
ENGINE													
1.4 TSI	Petrol	118	07/08-10/10	CAVD									
Engine	Information				A10	A20	A40	A50	A70	C10 - C30	C20	E01	
All engines	x 4, COIL ON PLUG, incl. spark plug connector									470 474	C10		
ENGINE													
1.4 TSI	Petrol	125	07/06-10/10	BLG									
Engine	Information				A10	A20	A40	A50	A70	C10 - C30	C20	E01	
All engines	x 4, COIL ON PLUG, incl. spark plug connector									470 474	C10		
ENGINE													
1.4 TSI	Petrol	90	05/07-10/10	CAXA									
Engine	Information				A10	A20	A40	A50	A70	C10 - C30	C20	E01	
All engines	x 4, COIL ON PLUG, incl. spark plug connector									470 474	C10		
ENGINE													
1.6	Petrol	75	09/04-10/10	BSE, BSF, CCSA									
Engine	Information				A10	A20	A40	A50	A70	C10 - C30	C20	E01	
All engines										490 420	C30	360 585	

A10	CONDENSER	A20	CONTACT SET	A40	DISTRIBUTOR CAP	A50	ROTOR	A70	PICK-UP
C10	COIL	C20	IGNITION MODULE	C30	ELECTRONIC IGNITION KIT	E01	IGNITION CABLE SET		

The present application list is a brief version. For the detailed information about the possibility of installation on a specific vehicle, please refer to our web-catalogue <http://catalogo.facet.eu/>

Vehicle	alim.	kW	Date	Engine	FUNCTIONS ON THE VEHICLE							
					A10	A20	A40	A50	A70	C10 - C30	C20	E01

ENGINE				
1.6 [CHN]	Petrol	68	01/05->	BJG

Engine	Information	A10	A20	A40	A50	A70	C10 - C30	C20	E01
All engines							490 420	C30	360 585

ENGINE				
1.6 FSI	Petrol	85	09/05-10/10	BLF

Engine	Information	A10	A20	A40	A50	A70	C10 - C30	C20	E01
All engines	x 4, COIL ON PLUG, incl. spark plug connector						470 474	C10	

ENGINE				
1.6 MultiFuel	Petrol/ Ethanol	75	01/08-10/10	CCSA

Engine	Information	A10	A20	A40	A50	A70	C10 - C30	C20	E01
All engines							490 420	C30	360 585

ENGINE				
2.0 FSI	Petrol	110	08/05-10/10	BLR, BLY, BVY, BVZ

Engine	Information	A10	A20	A40	A50	A70	C10 - C30	C20	E01
All engines	x 4, ELDOR, Housing Colour:Black, COIL ON PLUG, incl. spark plug connector						470 426	C10	

ENGINE				
2.0 TFSI	Petrol	147	10/05-10/10	BPY, BWA, CAWB, CBFA, CCTA, CCZA

Engine	Information	A10	A20	A40	A50	A70	C10 - C30	C20	E01
Eng. BPY, CCZA	Qty: 4						470 426	C10	
Eng. BWA, CAWB, CBFA, CCTA	x 4, ELDOR, Housing Colour:Black, COIL ON PLUG, incl. spark plug connector						470 426	C10	

ENGINE				
2.5	Petrol	110	01/05->	BGP, BGQ, BTK

Engine	Information	A10	A20	A40	A50	A70	C10 - C30	C20	E01
Eng. BGP, BTK	->ch. 1K7133612, ch. 1K7133613 ->, x 5, COIL ON PLUG, ELDOR, Housing Colour:Black, COIL ON PLUG, incl. spark plug connector						470 426	C10	
Eng. BGQ	Qty: 5						470 426	C10	

ENGINE				
2.5	Petrol	125	07/08-10/10	CBTA, CCCA

Engine	Information	A10	A20	A40	A50	A70	C10 - C30	C20	E01
Eng. CBTA	x 5, ELDOR, Housing Colour:Black, COIL ON PLUG, incl. spark plug connector						470 426	C10	
Eng. CCCA	Qty: 5						470 426	C10	

JETTA VI

ENGINE				
1.2 TSI	Petrol	77	10/10->	CBZB, CYVD

Engine	Information	A10	A20	A40	A50	A70	C10 - C30	C20	E01
Eng. CYVD	Qty: 4						470 599	C10	
Eng. CBZB							490 420	C30	358 248

ENGINE				
1.2 TSI 16V	Petrol	77	08/14-12/17	CYVD

Engine	Information	A10	A20	A40	A50	A70	C10 - C30	C20	E01
All engines	x 4, BERU, ELDOR, COIL ON PLUG, incl. spark plug connector, Number of pins:4, incl. spark plug connector						470 599	C10	

ENGINE				
1.4 TSI	Petrol	110	04/11->	CAVA, CTHA, CZDA, CZTA

Engine	Information	A10	A20	A40	A50	A70	C10 - C30	C20	E01
Eng. CAVA, CTHA	x 4, COIL ON PLUG, incl. spark plug connector						470 474	C10	
Eng. CZDA	x 4, BERU, ELDOR, COIL ON PLUG, incl. spark plug connector, Number of pins:4, incl. spark plug connector						470 599	C10	
Eng. CZTA	Qty: 4						470 599	C10	

ENGINE				
1.4 TSI	Petrol	118	04/11->	CAVD, CTHD

Engine	Information	A10	A20	A40	A50	A70	C10 - C30	C20	E01
All engines	x 4, COIL ON PLUG, incl. spark plug connector						470 474	C10	

ENGINE				
1.4 TSI	Petrol	90	05/11->	CAXA, CMSB

Engine	Information	A10	A20	A40	A50	A70	C10 - C30	C20	E01
All engines	x 4, COIL ON PLUG, incl. spark plug connector						470 474	C10	

A10 CONDENSER	A20 CONTACT SET	A40 DISTRIBUTOR CAP	A50 ROTOR	A70 PICK-UP
C10 COIL	C20 IGNITION MODULE	C30 ELECTRONIC IGNITION KIT	E01 IGNITION CABLE SET	

Vehicle	alim.	kW	Date	Engine	FUNCTIONS ON THE VEHICLE								
					A10	A20	A40	A50	A70	C10 - C30	C20	E01	
1.4 TSI	Petrol	92	08/14->	ENGINE CZCA									
Engine	Information				A10	A20	A40	A50	A70	C10 - C30	C20	E01	
All engines	x 4, BERU, ELDOR, HITACHI, COIL ON PLUG, incl. spark plug connector, Number of pins:4, incl. spark plug connector									470 599	C10		
1.4 TSI Hybrid	Petrol/ Electric	110	04/11->	ENGINE CNLA									
Engine	Information				A10	A20	A40	A50	A70	C10 - C30	C20	E01	
All engines	x 4, BERU, ELDOR, COIL ON PLUG, incl. spark plug connector, Number of pins:4, incl. spark plug connector									470 599	C10		
1.6	Petrol	63	03/13->	ENGINE CFNB									
Engine	Information				A10	A20	A40	A50	A70	C10 - C30	C20	E01	
All engines	x 4, COIL ON PLUG, incl. spark plug connector									470 474	C10		
1.6	Petrol	77	12/11->	ENGINE CFNA, CLRA									
Engine	Information				A10	A20	A40	A50	A70	C10 - C30	C20	E01	
All engines	x 4, COIL ON PLUG, incl. spark plug connector									470 474	C10		
1.6	Petrol	81	09/15->	ENGINE CWVA									
Engine	Information				A10	A20	A40	A50	A70	C10 - C30	C20	E01	
All engines	x 4, BERU, ELDOR, COIL ON PLUG, incl. spark plug connector, Number of pins:4, incl. spark plug connector									470 599	C10		
1.6 [RUS]	Petrol	66	01/15->	ENGINE CWVB									
Engine	Information				A10	A20	A40	A50	A70	C10 - C30	C20	E01	
All engines	Qty: 4									470 599	C10		
1.6 [RUS]	Petrol	81	01/15->	ENGINE CWVA									
Engine	Information				A10	A20	A40	A50	A70	C10 - C30	C20	E01	
All engines	Qty: 4									470 599	C10		
1.6 MPI	Petrol	66	09/15-04/18	ENGINE CWVB									
Engine	Information				A10	A20	A40	A50	A70	C10 - C30	C20	E01	
All engines	x 4, BERU, ELDOR, COIL ON PLUG, incl. spark plug connector, Number of pins:4, incl. spark plug connector									470 599	C10		
1.8 TSI	Petrol	125	07/14->	ENGINE CPKA, CPRA									
Engine	Information				A10	A20	A40	A50	A70	C10 - C30	C20	E01	
All engines	01/01/15 ->, x 4, BERU, COIL ON PLUG, incl. spark plug connector									470 636	C10		
2.0	Petrol	85	06/10-12/17	ENGINE CBPA, CKJA									
Engine	Information				A10	A20	A40	A50	A70	C10 - C30	C20	E01	
Eng. CBPA										490 420	C30	360 585	
Eng. CKJA												358 223	
2.0 TFSI	Petrol	147	12/10->	ENGINE CBFA, CCTA, CCZA									
Engine	Information				A10	A20	A40	A50	A70	C10 - C30	C20	E01	
All engines	x 4, ELDOR, Housing Colour:Black, COIL ON PLUG, incl. spark plug connector									470 426	C10		
2.0 TSI	Petrol	155	12/12-12/17	ENGINE CPLA, CPPA									
Engine	Information				A10	A20	A40	A50	A70	C10 - C30	C20	E01	
All engines	01/01/15 ->, x 4, BERU, COIL ON PLUG, incl. spark plug connector									470 636	C10		
2.5	Petrol	125	04/10->	ENGINE CBTA, CBUA, CCA									
Engine	Information				A10	A20	A40	A50	A70	C10 - C30	C20	E01	
All engines	x 5, ELDOR, Housing Colour:Black, COIL ON PLUG, incl. spark plug connector									470 426	C10		

A10 CONDENSER	A20 CONTACT SET	A40 DISTRIBUTOR CAP	A50 ROTOR	A70 PICK-UP
C10 COIL	C20 IGNITION MODULE	C30 ELECTRONIC IGNITION KIT	E01 IGNITION CABLE SET	

The present application list is a brief version. For the detailed information about the possibility of installation on a specific vehicle, please refer to our web-catalogue <http://catalogo.facet.eu/>

Vehicle	alim.	kW	Date	Engine	FUNCTIONS ON THE VEHICLE							
					A10	A20	A40	A50	A70	C10 - C30	C20	E01

KAEFER

1.2	Petrol	22	01/54-07/65	M51										
ENGINE														
Engine	Information				A10	A20	A40	A50	A70	C10 - C30	C20	E01		
All engines						706 040	806 062	906 018R						
1200 1.2	Petrol	25	01/60-12/85	D										
ENGINE														
Engine	Information				A10	A20	A40	A50	A70	C10 - C30	C20	E01		
All engines						706 040		906 021R						
1300 1.3	Petrol	27	08/65-07/70	E										
ENGINE														
Engine	Information				A10	A20	A40	A50	A70	C10 - C30	C20	E01		
All engines						706 040		906 014R						
1300 1.3	Petrol	29	01/65-07/70	F										
ENGINE														
Engine	Information				A10	A20	A40	A50	A70	C10 - C30	C20	E01		
All engines						706 040								
1300 1.3	Petrol	32	01/70-01/73	AB										
ENGINE														
Engine	Information				A10	A20	A40	A50	A70	C10 - C30	C20	E01		
All engines						706 040		906 021R						
1302 1.2	Petrol	25	08/69-08/72	D										
ENGINE														
Engine	Information				A10	A20	A40	A50	A70	C10 - C30	C20	E01		
All engines						706 040								
1302 1.3	Petrol	29	08/70-07/75	AC										
ENGINE														
Engine	Information				A10	A20	A40	A50	A70	C10 - C30	C20	E01		
All engines						706 040								
1302 1.3	Petrol	32	08/70-08/72	AB										
ENGINE														
Engine	Information				A10	A20	A40	A50	A70	C10 - C30	C20	E01		
All engines						706 040		906 021R						
1302 1.6	Petrol	34	08/70-07/74	AF										
ENGINE														
Engine	Information				A10	A20	A40	A50	A70	C10 - C30	C20	E01		
All engines						706 040								
1302 1.6	Petrol	35	07/71-07/74	AE, AH, AK										
ENGINE														
Engine	Information				A10	A20	A40	A50	A70	C10 - C30	C20	E01		
All engines						706 040								
1302 1.6	Petrol	37	01/70-01/73	AD										
ENGINE														
Engine	Information				A10	A20	A40	A50	A70	C10 - C30	C20	E01		
All engines						706 040		906 021R						
1302,1303 1.6	Petrol	37	07/70-06/79	AD										
ENGINE														
Engine	Information				A10	A20	A40	A50	A70	C10 - C30	C20	E01		
All engines						706 040								
1303 1.3	Petrol	32	08/72-07/75	AB, AR										
ENGINE														
Engine	Information				A10	A20	A40	A50	A70	C10 - C30	C20	E01		
All engines						706 040								
1303 1.6	Petrol	35	08/70-12/79	AD, AE, AH, AK										
ENGINE														
Engine	Information				A10	A20	A40	A50	A70	C10 - C30	C20	E01		
All engines						706 040								
1303 LS, S 1.6	Petrol	37	08/72-12/79	AD, AJ, AS										
ENGINE														
Engine	Information				A10	A20	A40	A50	A70	C10 - C30	C20	E01		
All engines						706 040								

A10 CONDENSER	A20 CONTACT SET	A40 DISTRIBUTOR CAP	A50 ROTOR	A70 PICK-UP
C10 COIL	C20 IGNITION MODULE	C30 ELECTRONIC IGNITION KIT	E01 IGNITION CABLE SET	

Vehicle	alim.	kW	Date	Engine	FUNCTIONS ON THE VEHICLE									
					A10	A20	A40	A50	A70	C10 - C30	C20	E01		
ENGINE														
1500 1.5	Petrol	32	01/66-11/73	45C20M150Q6										
Engine	Information				A10	A20	A40	A50	A70	C10 - C30	C20	E01		
All engines						706 032HV, 706 040		906 014R, 906 021R						
ENGINE														
1500 1.6	Petrol	37	07/70-01/73	AD										
Engine	Information				A10	A20	A40	A50	A70	C10 - C30	C20	E01		
All engines						706 040								
KARMANN GHIA														
ENGINE														
1500	Petrol	32	01/66-12/69	45C20M150Q6										
Engine	Information				A10	A20	A40	A50	A70	C10 - C30	C20	E01		
All engines								906 021R						
ENGINE														
1600	Petrol	37	01/70-12/73	AD										
Engine	Information				A10	A20	A40	A50	A70	C10 - C30	C20	E01		
All engines								906 021R						
LT I														
ENGINE														
2.4	Petrol	66	12/82-07/92	DL										
Engine	Information				A10	A20	A40	A50	A70	C10 - C30	C20	E01		
All engines	version Bosch					706 034HVS		906 117R						
ENGINE														
2.4 4WD	Petrol	66	12/82-07/92	DL										
Engine	Information				A10	A20	A40	A50	A70	C10 - C30	C20	E01		
All engines	version Bosch					706 034HVS		906 117R						
ENGINE														
2.4 i	Petrol	69	08/89-06/96	1E										
Engine	Information				A10	A20	A40	A50	A70	C10 - C30	C20	E01		
All engines	version Bosch					706 034HVS	806 233							
All engines										470 125	C10			
LT II														
ENGINE														
2.3	Petrol	105	05/96-07/06	AGL										
Engine	Information				A10	A20	A40	A50	A70	C10 - C30	C20	E01		
All engines	LT 28, x 1, D.I.S., Dia: 4 mm, connector type, saw teeth									470 316	C10			
LUPO														
ENGINE														
1.0	Petrol	37	09/98-07/05	AER, ALD, ALL, ANV, AUC										
Engine	Information				A10	A20	A40	A50	A70	C10 - C30	C20	E01		
Eng. AER, ALL	version Bosch						806 094	906 121R	406 223					
Eng. AER, ALL	version Marelli						830 116	930 057R						
Eng. AER, ALL										490 414	C30		360 641	
Eng. ALD, ANV, AUC										490 420	C30			
Eng. ALD, ANV													360 595	
Eng. AUC													360 601	
ENGINE														
1.4	Petrol	44	10/00-07/05	AUD										
Engine	Information				A10	A20	A40	A50	A70	C10 - C30	C20	E01		
All engines										490 420	C30		360 601	
ENGINE														
1.4 16V	Petrol	55	09/98-07/05	AHW, AKQ, APE, AUA, BBY										
Engine	Information				A10	A20	A40	A50	A70	C10 - C30	C20	E01		
Eng. BBY	x 4, COIL ON PLUG, incl. spark plug connector									470 474	C10			
Eng. AHW, AKQ, APE, AUA										490 420	C30		360 575	
ENGINE														
1.4 16V	Petrol	74	08/99-07/05	AFK, ANM, AQQ, AUB										
Engine	Information				A10	A20	A40	A50	A70	C10 - C30	C20	E01		
All engines										490 420	C30			
Eng. AFK, AQQ, AUB													360 575	

A10	CONDENSER	A20	CONTACT SET	A40	DISTRIBUTOR CAP	A50	ROTOR	A70	PICK-UP
C10	COIL	C20	IGNITION MODULE	C30	ELECTRONIC IGNITION KIT	E01	IGNITION CABLE SET		

The present application list is a brief version. For the detailed information about the possibility of installation on a specific vehicle, please refer to our web-catalogue <http://catalogo.facet.eu/>

					FUNCTIONS ON THE VEHICLE							
Vehicle	alim.	kW	Date	Engine	A10	A20	A40	A50	A70	C10 - C30	C20	E01
1.6 GTI												
Petrol 92 09/00-07/05												
ENGINE												
AVY												
Engine												
Information					A10	A20	A40	A50	A70	C10 - C30	C20	E01
All engines										490 420	C30	360 575
MULTIVAN												
1.4 e-Hybrid												
Petrol/Electric 110 08/21->												
ENGINE												
DGEA												
Engine												
Information					A10	A20	A40	A50	A70	C10 - C30	C20	E01
All engines										470 599	C10	
1.4 e-Hybrid												
Petrol/Electric 160 08/21->												
ENGINE												
DGEA												
Engine												
Information					A10	A20	A40	A50	A70	C10 - C30	C20	E01
All engines										470 599	C10	
2.0												
Petrol 85 11/03-08/15												
ENGINE												
AXA												
Engine												
Information					A10	A20	A40	A50	A70	C10 - C30	C20	E01
All engines										490 420	C30	360 585
2.0 TSI												
Petrol 110 07/12-07/19												
ENGINE												
CJKB												
Engine												
Information					A10	A20	A40	A50	A70	C10 - C30	C20	E01
All engines										470 426	C10	
2.0 TSI												
Petrol 150 05/11->												
ENGINE												
CJKA, DRNB												
Engine												
Information					A10	A20	A40	A50	A70	C10 - C30	C20	E01
Eng. CJKA										470 426	C10	
Eng. DRNB										470 636	C10	
2.0 TSI 4motion												
Petrol 150 07/11-07/19												
ENGINE												
CJKA												
Engine												
Information					A10	A20	A40	A50	A70	C10 - C30	C20	E01
All engines										470 426	C10	
3.2 V6												
Petrol 170 02/04-06/04												
ENGINE												
BDL												
Engine												
Information					A10	A20	A40	A50	A70	C10 - C30	C20	E01
All engines										470 434	C10	
3.2 V6												
Petrol 173 02/04-12/09												
ENGINE												
BKK, CFLA												
Engine												
Information					A10	A20	A40	A50	A70	C10 - C30	C20	E01
All engines										470 434	C10	
3.2 V6 4motion												
Petrol 173 07/04-12/09												
ENGINE												
BKK, CFLA												
Engine												
Information					A10	A20	A40	A50	A70	C10 - C30	C20	E01
All engines										470 434	C10	
NEW BEETLE												
1.4												
Petrol 55 11/01-09/10												
ENGINE												
BCA												
Engine												
Information					A10	A20	A40	A50	A70	C10 - C30	C20	E01
All engines										470 474	C10	
1.6												
Petrol 74 10/99-09/00												
ENGINE												
AWH												
Engine												
Information					A10	A20	A40	A50	A70	C10 - C30	C20	E01
All engines										490 420	C30	360 585
1.6												
Petrol 75 06/00-09/10												
ENGINE												
AYD, BFS												
Engine												
Information					A10	A20	A40	A50	A70	C10 - C30	C20	E01
All engines										490 420	C30	360 585

A10 CONDENSER	A20 CONTACT SET	A40 DISTRIBUTOR CAP	A50 ROTOR	A70 PICK-UP
C10 COIL	C20 IGNITION MODULE	C30 ELECTRONIC IGNITION KIT	E01 IGNITION CABLE SET	

Vehicle	alim.	kW	Date	Engine	FUNCTIONS ON THE VEHICLE									
					A10	A20	A40	A50	A70	C10 - C30	C20	E01		
ENGINE														
1.8 T	Petrol	110	10/99-09/10	OD19TCIE2, AGU, APH, AVC, AWU, AWV, BKF										
Engine	Information				A10	A20	A40	A50	A70	C10 - C30	C20	E01		
Eng. AGU, APH, AVC, AWU, AWV, BKF	01/05/00 ->, x 4, ch. 1C1400001 ->, COIL ON PLUG, incl. spark plug connector, x 4, COIL ON PLUG, incl. spark plug connector									470 429	C10			
Eng. BKF	Qty: 4									470 429	C10			
Eng. AGU, APH, AVC, AWU, AWV	->year 01/04/00, ->ch. 1CY499999, x 4, COIL ON PLUG, incl. spark plug connector									470 445	C10			
Eng. OD19TCIE2, AVC, AWV											465 076			
ENGINE														
1.8 T	Petrol	132	11/01-06/05	AWP, BNU										
Engine	Information				A10	A20	A40	A50	A70	C10 - C30	C20	E01		
All engines	x 4, COIL ON PLUG, incl. spark plug connector									470 429	C10			
ENGINE														
2.0	Petrol	85	01/98-10/10	AEG, APK, AQY, AZG, AZJ, BDC, BEJ, BER, BEV, BGD, BHP, CBPA										
Engine	Information				A10	A20	A40	A50	A70	C10 - C30	C20	E01		
Eng. AEG, APK, AQY, BER										490 420	C30			
Eng. AQY										490 420	C30			
Eng. AZG, AZJ, BDC, BEJ, BER, BEV, BGD, BHP	->year 30/06/05												358 223	
Eng. AEG, APK, AQY, BER, BHP, CBPA	01/07/05 ->												360 585	
ENGINE														
2.3 V5	Petrol	125	10/00-09/10	AQN										
Engine	Information				A10	A20	A40	A50	A70	C10 - C30	C20	E01		
All engines	x 5, COIL ON PLUG									470 435	C10			
ENGINE														
2.5	Petrol	110	07/05-09/10	BPR, BPS										
Engine	Information				A10	A20	A40	A50	A70	C10 - C30	C20	E01		
All engines	->ch. 1C8518695, ch. 1C8518696 ->, ch. 1Y7418899 ->, ch. 1Y8418407 ->, ->ch. 1Y8418406, x 5, COIL ON PLUG, ELDOR, x 5, COIL ON PLUG, Housing Colour:Black, COIL ON PLUG, incl. spark plug connector									470 426	C10			
ENGINE														
3.2 RSI 4motion	Petrol	165	04/00-05/01	AXJ										
Engine	Information				A10	A20	A40	A50	A70	C10 - C30	C20	E01		
All engines	x 6, COIL ON PLUG									470 435	C10			
PASSAT														
ENGINE														
1.4 TSi BlueMotion	Petrol	90	08/10-12/14	CAXA										
Engine	Information				A10	A20	A40	A50	A70	C10 - C30	C20	E01		
All engines	x 4, COIL ON PLUG, incl. spark plug connector									470 474	C10			
ENGINE														
1.8 TFSi	Petrol	118	08/10-12/14	CDAA										
Engine	Information				A10	A20	A40	A50	A70	C10 - C30	C20	E01		
All engines	x 4, ELDOR, Housing Colour:Black, COIL ON PLUG, incl. spark plug connector									470 426	C10			
ENGINE														
2.0 TFSi	Petrol	155	11/10-12/14	CCZB										
Engine	Information				A10	A20	A40	A50	A70	C10 - C30	C20	E01		
All engines	x 4, ELDOR, Housing Colour:Black, COIL ON PLUG, incl. spark plug connector									470 426	C10			
PASSAT CC														
ENGINE														
1.4 TSI MultiFuel	Petrol/ Ethanol	118	01/11-01/12	CKMA										
Engine	Information				A10	A20	A40	A50	A70	C10 - C30	C20	E01		
All engines	x 4, COIL ON PLUG, incl. spark plug connector									470 474	C10			
ENGINE														
1.8 TSI	Petrol	112	11/08-05/10	CDAB, CGYA										
Engine	Information				A10	A20	A40	A50	A70	C10 - C30	C20	E01		
All engines	x 4, ELDOR, Housing Colour:Black, COIL ON PLUG, incl. spark plug connector									470 426	C10			

A10 CONDENSER	A20 CONTACT SET	A40 DISTRIBUTOR CAP	A50 ROTOR	A70 PICK-UP
C10 COIL	C20 IGNITION MODULE	C30 ELECTRONIC IGNITION KIT	E01 IGNITION CABLE SET	

Vehicle	alim.	kW	Date	Engine	FUNCTIONS ON THE VEHICLE							
					A10	A20	A40	A50	A70	C10 - C30	C20	E01

ENGINE				
1.8 TSI	Petrol	118	06/08-01/12	BZB, CDAА

Engine	Information	A10	A20	A40	A50	A70	C10 - C30	C20	E01
All engines	x 4, ELDOR, Housing Colour:Black, COIL ON PLUG, incl. spark plug connector						470 426	C10	

ENGINE				
2.0 TFSI	Petrol	147	06/08-01/12	CAWB, CBFA, CCTA, CCZA

Engine	Information	A10	A20	A40	A50	A70	C10 - C30	C20	E01
Eng. CAWB, CBFA, CCZA	x 4, ELDOR, Housing Colour:Black, COIL ON PLUG, incl. spark plug connector						470 426	C10	
Eng. CCTA	Qty: 4						470 426	C10	

ENGINE				
2.0 TSI	Petrol	155	11/10-01/12	CCZB

Engine	Information	A10	A20	A40	A50	A70	C10 - C30	C20	E01
All engines	x 4, ELDOR, Housing Colour:Black, COIL ON PLUG, incl. spark plug connector						470 426	C10	

PASSAT II

ENGINE				
1.3	Petrol	44	08/80-07/86	79SU16

Engine	Information	A10	A20	A40	A50	A70	C10 - C30	C20	E01
All engines	version Bosch			806 079	906 056R				
All engines							470 132	C10	465 004

ENGINE				
1.6	Petrol	55	08/80-03/88	DT

Engine	Information	A10	A20	A40	A50	A70	C10 - C30	C20	E01
All engines	version Bosch, ->year 31/12/84			806 079					
All engines	version Bosch, 01/01/85 ->			806 094					
All engines	version Ducellier, 01/01/85 ->			815 068					
All engines	version Bosch				906 055R				
All engines	version Ducellier				915 099R				
All engines	01/01/85 ->						470 125	C10	
All engines	->year 31/12/84						470 132	C10	
All engines									465 004

ENGINE				
1.8	Petrol	66	01/83-03/88	DS

Engine	Information	A10	A20	A40	A50	A70	C10 - C30	C20	E01
All engines	version Bosch			806 094	906 055R				
All engines	version Ducellier			815 068	915 099R				
All engines							470 125	C10	465 004

ENGINE				
1.8 Syncro	Petrol	66	01/86-03/88	DS

Engine	Information	A10	A20	A40	A50	A70	C10 - C30	C20	E01
All engines	version Bosch			806 094	906 055R				
All engines	version Ducellier			815 068	915 099R				
All engines							470 125	C10	465 004

ENGINE				
1.9	Petrol	85	01/81-07/83	WN

Engine	Information	A10	A20	A40	A50	A70	C10 - C30	C20	E01
All engines	version Bosch			806 093	906 059R				
All engines							470 132	C10	465 004

ENGINE				
2.0	Petrol	85	08/83-03/88	JS

Engine	Information	A10	A20	A40	A50	A70	C10 - C30	C20	E01
All engines	version Bosch			806 231	906 055R, 906 116R				
All engines	version Bosch, 01/01/88 ->					406 219			
All engines							470 125	C10	465 004

ENGINE				
2.0 Syncro	Petrol	85	05/84-03/88	JS

Engine	Information	A10	A20	A40	A50	A70	C10 - C30	C20	E01
All engines	version Bosch			806 231	906 055R, 906 116R				
All engines	version Bosch, 01/01/88 ->					406 219			
All engines							470 125	C10	465 004

A10 CONDENSER	A20 CONTACT SET	A40 DISTRIBUTOR CAP	A50 ROTOR	A70 PICK-UP
C10 COIL	C20 IGNITION MODULE	C30 ELECTRONIC IGNITION KIT	E01 IGNITION CABLE SET	

Vehicle	alim.	kW	Date	Engine	FUNCTIONS ON THE VEHICLE							
					A10	A20	A40	A50	A70	C10 - C30	C20	E01

ENGINE				
2.2	Petrol	85	01/85-03/88	KX

Engine	Information	A10	A20	A40	A50	A70	C10 - C30	C20	E01
All engines	version Bosch			806 093	906 055R				
All engines							470 132	C10	465 004

PASSAT III				
ENGINE				
1.6	Petrol	55	04/88-07/92	1F, ABN, EZ

Engine	Information	A10	A20	A40	A50	A70	C10 - C30	C20	E01
Eng. 1F, EZ	version Bosch, ->ch. 31-M-280 000			806 094					
All engines	version Bosch, ch. 31-M-280 001 ->			806 266					
All engines	version Bosch				906 055R				
Eng. 1F, EZ	version Bosch					406 219			
Eng. 1F, EZ	ch. 31-L-000 001 ->, ->ch. 31-M-240 000						470 125	C10	
Eng. 1F, EZ	->ch. 31-K-400 000						470 126	C10	
Eng. 1F, EZ	ch. 31-M-240 001 ->						470 159	C10	
All engines	pole nr. 3						490 414	C30	
All engines	pole nr. 6						490 416	C30	
Eng. 1F, EZ	->ch. 31-M-240 000								465 007
All engines									359 725

ENGINE				
1.6	Petrol	74	07/94-08/96	AEK, AFT

Engine	Information	A10	A20	A40	A50	A70	C10 - C30	C20	E01
All engines	version Bosch			806 266	906 121R				
Eng. AEK	version Ducellier			815 068	915 099R				
All engines							490 414	C30	
Eng. AEK									360 551
Eng. AFT									360 932

ENGINE				
1.8	Petrol	102	08/91-09/93	KR

Engine	Information	A10	A20	A40	A50	A70	C10 - C30	C20	E01
All engines	version Bosch			806 266	906 121R	406 223			
All engines	ch. 31-L-000 001 ->						470 125	C10	
All engines	->ch. 31-K-400 000						470 126	C10	
All engines									465 007

ENGINE				
1.8	Petrol	55	08/90-05/97	AAM

Engine	Information	A10	A20	A40	A50	A70	C10 - C30	C20	E01
All engines	version Bosch			806 266	906 121R				
All engines	version Ducellier			815 068	915 099R				
All engines	pole nr. 3						490 414	C30	
All engines	pole nr. 6						490 416	C30	
All engines	->year 30/09/93								359 725
All engines	01/10/93 ->								359 965





ENGINE				
1.8	Petrol	66	02/88-05/97	ABS, ADZ, RP

Engine	Information	A10	A20	A40	A50	A70	C10 - C30	C20	E01
All engines	version Bosch			806 266					
Eng. ABS, ADZ	version Ducellier			815 068	915 099R				
Eng. RP	version Bosch, ->ch. 31-L-400 000				906 055R				
All engines	version Bosch, ch. 31-L-400 001 ->				906 121R				
Eng. RP	version Bosch					406 219			
Eng. RP							470 125	C10	
All engines	pole nr. 3						490 414	C30	
Eng. RP	pole nr. 6						490 416	C30	
Eng. ABS, RP	->year 30/09/93								359 725
Eng. ABS, ADZ	01/10/93 ->								359 965

ENGINE				
1.8	Petrol	79	04/88-07/93	PF

Engine	Information	A10	A20	A40	A50	A70	C10 - C30	C20	E01
All engines	version Bosch, ch. 31-L-160 001 ->			806 094					
All engines	version Bosch, ->ch. 31-L-160 000			806 266					
All engines	version Bosch				906 121R				

A10	CONDENSER	A20	CONTACT SET	A40	DISTRIBUTOR CAP	A50	ROTOR	A70	PICK-UP
C10	COIL	C20	IGNITION MODULE	C30	ELECTRONIC IGNITION KIT	E01	IGNITION CABLE SET		

				FUNCTIONS ON THE VEHICLE									
Vehicle	alim.	kW	Date	Engine									
				ENGINE									
1.8	Petrol	79	04/88-07/93	PF									
				ENGINE									
Engine		Information			A10	A20	A40	A50	A70	C10 - C30	C20	E01	
All engines										470 125	C10	465 007	359 725
				ENGINE									
1.8	Petrol	82	04/88-07/92	PB									
				ENGINE									
Engine		Information			A10	A20	A40	A50	A70	C10 - C30	C20	E01	
All engines		version Bosch, ch. 31-L-160 001 ->					806 094						
All engines		version Bosch, ->ch. 31-L-160 000					806 266						
All engines		version Bosch					906 121R						
All engines										470 125	C10	465 007	359 725
				ENGINE									
1.8 16V	Petrol	100	04/88-12/89	KR									
				ENGINE									
Engine		Information			A10	A20	A40	A50	A70	C10 - C30	C20	E01	
All engines		version Bosch					806 266	906 121R	406 223				
All engines		ch. 31-L-000 001 ->								470 125	C10		
All engines		->ch. 31-K-400 000								470 126	C10		
All engines											465 007		
				ENGINE									
1.8 G60 Syncro	Petrol	118	08/88-05/97	PG									
				ENGINE									
Engine		Information			A10	A20	A40	A50	A70	C10 - C30	C20	E01	
All engines										470 125	C10	359 725	
				ENGINE									
1.8 GL	Petrol	102	08/91-09/93	KR									
				ENGINE									
Engine		Information			A10	A20	A40	A50	A70	C10 - C30	C20	E01	
All engines		version Bosch					806 266	906 121R	406 223				
All engines		ch. 31-L-000 001 ->								470 125	C10		
All engines		->ch. 31-K-400 000								470 126	C10		
All engines											465 007		
				ENGINE									
2.0	Petrol	79	03/95-08/96	AEP									
				ENGINE									
Engine		Information			A10	A20	A40	A50	A70	C10 - C30	C20	E01	
All engines		version Bosch					806 266	906 121R					
All engines										490 414	C30	359 965	
				ENGINE									
2.0	Petrol	85	02/90-05/97	2E, ADY, AGG									
				ENGINE									
Engine		Information			A10	A20	A40	A50	A70	C10 - C30	C20	E01	
Eng. 2E		version Bosch, ->ch. 31-M-280 000					806 094						
All engines		version Bosch, ch. 31-M-280 001 ->					806 266						
All engines		version Bosch					906 121R						
Eng. 2E										470 159	C10		
All engines										490 414	C30		
Eng. 2E		->year 30/09/93										359 725	
All engines		01/10/93 ->										359 965	
				ENGINE									
2.0 16V	Petrol	100	08/88-09/93	7TZ220XS560									
				ENGINE									
Engine		Information			A10	A20	A40	A50	A70	C10 - C30	C20	E01	
All engines		version Bosch					806 266	906 121R					
				ENGINE									
2.0 16V	Petrol	110	01/94-05/97	ABF									
				ENGINE									
Engine		Information			A10	A20	A40	A50	A70	C10 - C30	C20	E01	
All engines		version Bosch					806 263	906 121R					
All engines										490 414	C30		
				ENGINE									
2.0 Syncro	Petrol	85	03/90-12/96	2E, ADY, AGG									
				ENGINE									
Engine		Information			A10	A20	A40	A50	A70	C10 - C30	C20	E01	
Eng. 2E		version Bosch, ->ch. 31-M-280 000					806 094						
All engines		version Bosch, ch. 31-M-280 001 ->					806 266						
All engines		version Bosch					906 121R						
All engines										490 414	C30		
Eng. 2E		->year 30/09/93										359 725	
All engines		01/10/93 ->										359 965	

A10 CONDENSER	A20 CONTACT SET	A40 DISTRIBUTOR CAP	A50 ROTOR	A70 PICK-UP
C10 COIL	C20 IGNITION MODULE	C30 ELECTRONIC IGNITION KIT	E01 IGNITION CABLE SET	

Vehicle	alim.	kW	Date	Engine	FUNCTIONS ON THE VEHICLE							
					A10	A20	A40	A50	A70	C10 - C30	C20	E01

ENGINE				
2.0i	Petrol	78	08/92-12/96	ACX

Engine	Information	A10	A20	A40	A50	A70	C10 - C30	C20	E01
All engines	version Bosch			806 266	906 121R				
All engines							490 414	C30	359 725

ENGINE				
2.8 VR6	Petrol	128	06/91-05/97	AAA

Engine	Information	A10	A20	A40	A50	A70	C10 - C30	C20	E01
All engines	->year 31/07/93, version Bosch			806 233					
All engines	->ch. 31-N-240 000, version Bosch				906 148R				
All engines	ch. 31-N-240 001 ->, version Bosch				906 149R				
All engines	->ch. 31-P-136 398						470 269	C10	

PASSAT IV

ENGINE				
1.6	Petrol	74	10/96-11/00	ADP, AHL, ANA, ARM

Engine	Information	A10	A20	A40	A50	A70	C10 - C30	C20	E01
Eng. ADP	version Bosch			806 266	906 121R	406 223			
Eng. ADP	version Ducellier			815 068	915 099R				
Eng. AHL, ANA, ARM							490 420	C30	360 585
Eng. ADP									360 353

ENGINE				
1.6	Petrol	75	11/00-05/05	ALZ

Engine	Information	A10	A20	A40	A50	A70	C10 - C30	C20	E01
All engines							490 420	C30	360 585

ENGINE				
1.8	Petrol	85	01/97-11/00	AFY

Engine	Information	A10	A20	A40	A50	A70	C10 - C30	C20	E01
All engines									360 491

ENGINE				
1.8	Petrol	92	10/96-03/05	ADR, APT, ARG

Engine	Information	A10	A20	A40	A50	A70	C10 - C30	C20	E01
All engines									360 491

ENGINE				
1.8 [CHN]	Petrol	110	06/01->	AWL

Engine	Information	A10	A20	A40	A50	A70	C10 - C30	C20	E01
All engines	Qty: 4						470 429	C10	

ENGINE				
1.8 [CHN]	Petrol	92	03/00-12/03	ANQ

Engine	Information	A10	A20	A40	A50	A70	C10 - C30	C20	E01
All engines	Qty: 4						470 445	C10	

ENGINE				
1.8 4motion	Petrol	125	03/01-05/05	AWM

Engine	Information	A10	A20	A40	A50	A70	C10 - C30	C20	E01
All engines	Qty: 4						470 429	C10	
All engines	x 4, COIL ON PLUG, incl. spark plug connector						470 429	C10	

ENGINE				
1.8 Syncro/4motion	Petrol	92	12/96-11/00	ADR, APT, ARG

Engine	Information	A10	A20	A40	A50	A70	C10 - C30	C20	E01
All engines									360 491

ENGINE				
1.8 T	Petrol	110	10/96-11/00	AEB, ANB, APU

Engine	Information	A10	A20	A40	A50	A70	C10 - C30	C20	E01
All engines	x 4, COIL ON PLUG						470 354S	C10	
All engines	ch. 3B-W-045 001 ->								465 072
Eng. AEB	->ch. 3B-W-045 000								465 076

ENGINE				
1.8 T	Petrol	125	02/01-11/05	AWM

Engine	Information	A10	A20	A40	A50	A70	C10 - C30	C20	E01
All engines	x 4, COIL ON PLUG, incl. spark plug connector						470 429	C10	

A10 CONDENSER	A20 CONTACT SET	A40 DISTRIBUTOR CAP	A50 ROTOR	A70 PICK-UP
C10 COIL	C20 IGNITION MODULE	C30 ELECTRONIC IGNITION KIT	E01 IGNITION CABLE SET	

Vehicle	alim.	kW	Date	Engine	FUNCTIONS ON THE VEHICLE							
					A10	A20	A40	A50	A70	C10 - C30	C20	E01

ENGINE				
1.8 T 20V	Petrol	110	11/00-05/05	AWL, AWT

Engine	Information	A10	A20	A40	A50	A70	C10 - C30	C20	E01
Eng. AWL	Qty: 4						470 429	C10	
Eng. AWT	x 4, COIL ON PLUG, incl. spark plug connector						470 429	C10	

ENGINE				
1.8 T 4motion	Petrol	125	11/03-05/05	AWM

Engine	Information	A10	A20	A40	A50	A70	C10 - C30	C20	E01
All engines	x 4, COIL ON PLUG, incl. spark plug connector						470 429	C10	

ENGINE				
1.8 T Syncro	Petrol	110	11/96-08/00	AEB

Engine	Information	A10	A20	A40	A50	A70	C10 - C30	C20	E01
All engines	incl. spark plug connector, Qty: 4						470 354	C10	
All engines	without spark plug connector, Qty: 4						470 354S	C10	
All engines	ch. 3B-W-045 001 ->							465 072	
All engines	->ch. 3B-W-045 000							465 076	

ENGINE				
2.0	Petrol	85	11/00-05/05	AZM, BFF

Engine	Information	A10	A20	A40	A50	A70	C10 - C30	C20	E01
Eng. AZM							490 420	C30	
Eng. BFF							490 420	C30	
All engines									360 585

ENGINE				
2.0	Petrol	96	11/01-05/05	ALT

Engine	Information	A10	A20	A40	A50	A70	C10 - C30	C20	E01
All engines	x 4, COIL ON PLUG, incl. spark plug connector						470 429	C10	

ENGINE				
2.0 [CHN]	Petrol	85	06/03->	BFF

Engine	Information	A10	A20	A40	A50	A70	C10 - C30	C20	E01
All engines							490 420	C30	360 585

ENGINE				
2.0 4motion	Petrol	85	11/00-05/05	AZM

Engine	Information	A10	A20	A40	A50	A70	C10 - C30	C20	E01
All engines							490 420	C30	360 585

ENGINE				
2.3 V5	Petrol	125	11/00-05/05	AZX

Engine	Information	A10	A20	A40	A50	A70	C10 - C30	C20	E01
All engines	x 1, D.I.S.						470 437	C10	

ENGINE				
2.3 V5 4motion	Petrol	125	11/00-05/05	AZX

Engine	Information	A10	A20	A40	A50	A70	C10 - C30	C20	E01
All engines	x 1, D.I.S.						470 437	C10	

ENGINE				
2.3 VR5	Petrol	110	10/96-11/00	AGZ

Engine	Information	A10	A20	A40	A50	A70	C10 - C30	C20	E01
All engines								465 074	

ENGINE				
2.3 VR5	Petrol	125	11/00-05/05	AZX

Engine	Information	A10	A20	A40	A50	A70	C10 - C30	C20	E01
All engines	x 1, D.I.S.						470 437	C10	

ENGINE				
2.3 VR5 4motion	Petrol	125	11/00-05/05	AZX

Engine	Information	A10	A20	A40	A50	A70	C10 - C30	C20	E01
All engines	x 1, D.I.S.						470 437	C10	

ENGINE				
2.3 VR5 Syncro/4motion	Petrol	110	10/97-11/00	AGZ









Engine	Information	A10	A20	A40	A50	A70	C10 - C30	C20	E01
All engines								465 074	

A10 CONDENSER	A20 CONTACT SET	A40 DISTRIBUTOR CAP	A50 ROTOR	A70 PICK-UP
C10 COIL	C20 IGNITION MODULE	C30 ELECTRONIC IGNITION KIT	E01 IGNITION CABLE SET	

Vehicle	alim.	kW	Date	Engine	FUNCTIONS ON THE VEHICLE								
					A10	A20	A40	A50	A70	C10 - C30	C20	E01	
PASSAT V													
1.4 TSI	Petrol	118	11/12-12/14	CTHD									
Engine	Information				A10	A20	A40	A50	A70	C10 - C30	C20	E01	
All engines	x 4, COIL ON PLUG, incl. spark plug connector									470 474	C10		
1.4 TSI	Petrol	90	05/07-12/14	CAXA									
Engine	Information				A10	A20	A40	A50	A70	C10 - C30	C20	E01	
All engines	x 4, COIL ON PLUG, incl. spark plug connector									470 474	C10		
1.4 TSI EcoFuel	Petrol/ Com- pressed Natural Gas (CNG)	110	01/09-12/14	CDGA									
Engine	Information				A10	A20	A40	A50	A70	C10 - C30	C20	E01	
All engines	x 4, COIL ON PLUG, incl. spark plug connector									470 474	C10		
1.4 TSI MultiFuel	Petrol/ Ethanol	118	11/10-12/14	CKMA									
Engine	Information				A10	A20	A40	A50	A70	C10 - C30	C20	E01	
All engines	x 4, COIL ON PLUG, incl. spark plug connector									470 474	C10		
1.6	Petrol	75	05/05-11/10	BSE, BSF									
Engine	Information				A10	A20	A40	A50	A70	C10 - C30	C20	E01	
All engines										490 420	C30	360 585	
1.6 FSI	Petrol	85	03/05-06/08	BLF									
Engine	Information				A10	A20	A40	A50	A70	C10 - C30	C20	E01	
All engines	x 4, COIL ON PLUG, incl. spark plug connector									470 474	C10		
1.8 TSI	Petrol	112	11/09-12/14	CDAB, CGYA									
Engine	Information				A10	A20	A40	A50	A70	C10 - C30	C20	E01	
All engines	x 4, ELDOR, Housing Colour:Black, COIL ON PLUG, incl. spark plug connector									470 426	C10		
1.8 TSI	Petrol	118	05/07-12/14	BZB, CDAA									
Engine	Information				A10	A20	A40	A50	A70	C10 - C30	C20	E01	
All engines	x 4, ELDOR, Housing Colour:Black, COIL ON PLUG, incl. spark plug connector									470 426	C10		
1.8 TSI	Petrol	125	06/13->	CPKA, CPRA									
Engine	Information				A10	A20	A40	A50	A70	C10 - C30	C20	E01	
All engines	Qty: 4, version NAR									470 636	C10		
2.0 FSI	Petrol	110	03/05-11/10	BLR, BLY, BVY, BVZ									
Engine	Information				A10	A20	A40	A50	A70	C10 - C30	C20	E01	
All engines	x 4, ELDOR, Housing Colour:Black, COIL ON PLUG, incl. spark plug connector									470 426	C10		
2.0 FSI	Petrol	125	08/07-11/10	CCTB									
Engine	Information				A10	A20	A40	A50	A70	C10 - C30	C20	E01	
All engines	Qty: 4									470 426	C10		
All engines	x 4, ELDOR, Housing Colour:Black, COIL ON PLUG, incl. spark plug connector									470 426	C10		
2.0 FSI 4motion	Petrol	110	09/05-11/10	BLX, BLY, BVX									
Engine	Information				A10	A20	A40	A50	A70	C10 - C30	C20	E01	
All engines	x 4, ELDOR, Housing Colour:Black, COIL ON PLUG, incl. spark plug connector									470 426	C10		
2.0 TFSI	Petrol	147	07/05-11/10	AXX, BPY, BWA, CAWB									
Engine	Information				A10	A20	A40	A50	A70	C10 - C30	C20	E01	
All engines	x 4, ELDOR, Housing Colour:Black, COIL ON PLUG, incl. spark plug connector									470 426	C10		

A10 CONDENSER	A20 CONTACT SET	A40 DISTRIBUTOR CAP	A50 ROTOR	A70 PICK-UP
C10 COIL	C20 IGNITION MODULE	C30 ELECTRONIC IGNITION KIT	E01 IGNITION CABLE SET	

The present application list is a brief version. For the detailed information about the possibility of installation on a specific vehicle, please refer to our web-catalogue <http://catalogo.facet.eu/>

					FUNCTIONS ON THE VEHICLE							
Vehicle	alim.	kW	Date	Engine								
ENGINE												
2.0 TSI	Petrol	155	11/10-12/15	CCZB								
Engine	Information				A10	A20	A40	A50	A70	C10 - C30	C20	E01
All engines	x 4, ELDOR, Housing Colour:Black, COIL ON PLUG, incl. spark plug connector									470 426	C10	
ENGINE												
2.0 TSI 4motion	Petrol	155	01/12-12/14	CCZB								
Engine	Information				A10	A20	A40	A50	A70	C10 - C30	C20	E01
All engines	x 4, ELDOR, Housing Colour:Black, COIL ON PLUG, incl. spark plug connector									470 426	C10	
ENGINE												
2.5 SRE	Petrol	125	01/11->	CBTA, CBUA, CCA								
Engine	Information				A10	A20	A40	A50	A70	C10 - C30	C20	E01
All engines	Qty: 5									470 426	C10	
ENGINE												
3.2 FSI 4motion	Petrol	184	11/05-11/10	AXZ								
Engine	Information				A10	A20	A40	A50	A70	C10 - C30	C20	E01
All engines	01/05/07->, ->year 01/04/08, ->ch. 3C8270000, x 6, COIL ON PLUG, incl. spark plug connector									470 434	C10	
ENGINE												
3.6 FSI	Petrol	206	06/05-11/10	BLV								
Engine	Information				A10	A20	A40	A50	A70	C10 - C30	C20	E01
All engines	->ch. 3C-8-270 000, Qty: 6									470 434	C10	
ENGINE												
3.6 FSI 4motion	Petrol	206	09/05-11/10	BLV								
Engine	Information				A10	A20	A40	A50	A70	C10 - C30	C20	E01
All engines	->ch. 3C-8-270 000, Qty: 6									470 434	C10	
ENGINE												
3.6 R36 4motion	Petrol	220	04/07-11/10	BWS								
Engine	Information				A10	A20	A40	A50	A70	C10 - C30	C20	E01
All engines	->year 01/04/08, ->ch. 3C8270000, x 6, COIL ON PLUG, x 6, COIL ON PLUG, incl. spark plug connector, incl. spark plug connector									470 434	C10	
PASSAT VI												
ENGINE												
1.4 GTE Hybrid	Petrol/ Electric	115	06/15->	CUKC, DGEB								
Engine	Information				A10	A20	A40	A50	A70	C10 - C30	C20	E01
All engines	x 4, BERU, ELDOR, COIL ON PLUG, incl. spark plug connector, Number of pins:4, incl. spark plug connector									470 599	C10	
ENGINE												
1.4 TSI	Petrol	110	11/14->	CZDA, CZIA								
Engine	Information				A10	A20	A40	A50	A70	C10 - C30	C20	E01
All engines	x 4, BERU, ELDOR, HITACHI, COIL ON PLUG, incl. spark plug connector, Number of pins:4, incl. spark plug connector									470 599	C10	
ENGINE												
1.4 TSI	Petrol	92	11/14->	CZCA								
Engine	Information				A10	A20	A40	A50	A70	C10 - C30	C20	E01
All engines	x 4, BERU, ELDOR, COIL ON PLUG, incl. spark plug connector, Number of pins:4, incl. spark plug connector									470 599	C10	
ENGINE												
1.4 TSI 4motion	Petrol	110	02/15->	CZEA								
Engine	Information				A10	A20	A40	A50	A70	C10 - C30	C20	E01
All engines	x 4, BERU, ELDOR, COIL ON PLUG, incl. spark plug connector, Number of pins:4, incl. spark plug connector									470 599	C10	
ENGINE												
1.8 TSI	Petrol	132	02/15->	CJSA, CJSC								
Engine	Information				A10	A20	A40	A50	A70	C10 - C30	C20	E01
All engines	x 4, HITACHI, COIL ON PLUG, incl. spark plug connector									470 636	C10	
ENGINE												
2.0 TSI	Petrol	140	11/18->	CZPB, DKZA, DRFA								
Engine	Information				A10	A20	A40	A50	A70	C10 - C30	C20	E01
All engines	x 4, HITACHI, COIL ON PLUG, incl. spark plug connector									470 636	C10	

A10 CONDENSER	A20 CONTACT SET	A40 DISTRIBUTOR CAP	A50 ROTOR	A70 PICK-UP
C10 COIL	C20 IGNITION MODULE	C30 ELECTRONIC IGNITION KIT	E01 IGNITION CABLE SET	

Vehicle	alim.	kW	Date	Engine	FUNCTIONS ON THE VEHICLE							
					A10	A20	A40	A50	A70	C10 - C30	C20	E01

ENGINE				
2.0 TSI	Petrol	162	08/14->	CXDA

Engine	Information	A10	A20	A40	A50	A70	C10 - C30	C20	E01
All engines	x 4, BERU, COIL ON PLUG, incl. spark plug connector						470 636	C10	

PHAETON

ENGINE				
3.2 V6	Petrol	177	04/02-05/05	AYT, BKL

Engine	Information	A10	A20	A40	A50	A70	C10 - C30	C20	E01
All engines	x 6, COIL ON PLUG						470 434	C10	

ENGINE				
3.2 V6 4motion	Petrol	177	02/04-11/08	BKL, BRK

Engine	Information	A10	A20	A40	A50	A70	C10 - C30	C20	E01
All engines	x 6, COIL ON PLUG						470 434	C10	

ENGINE				
4.2 V8 4motion	Petrol	246	05/03-03/16	BGH, BGJ

Engine	Information	A10	A20	A40	A50	A70	C10 - C30	C20	E01
All engines	x 8, COIL ON PLUG						470 425	C10	

POLO II

ENGINE				
1.0	Petrol	29	10/81-10/86	GL

Engine	Information	A10	A20	A40	A50	A70	C10 - C30	C20	E01
All engines	version Bosch	606 196	706 049HDVS		906 114R				
All engines	version Bosch, ->ch. 86-E-150 000			806 079					
All engines	version Bosch, ch. 86-E-150 001 ->			806 094					
All engines	version Bosch, +catalytic converter				906 056R				
All engines	ch. ...E-150 001 ->, ->ch. 80-K-140 000								359 493

ENGINE				
1.0	Petrol	33	01/85-09/94	AAK, AAU, HZ

Engine	Information	A10	A20	A40	A50	A70	C10 - C30	C20	E01
All engines	version Bosch, ->ch. 80-M-100 000			806 094					
Eng. AAU, HZ	version Bosch, ch. 80-M-100 001 ->			806 266					
Eng. AAK, HZ	version Bosch				906 056R				
Eng. AAU	version Bosch				906 121R	406 223			
Eng. AAK, HZ	version Bosch, ->ch. 80-M-100 000					406 193			
Eng. HZ	version Bosch, ch. 80-M-100 001 ->					406 234			
Eng. AAK, HZ	ch. ...G-000 001 ->, ->ch. 80-H-220 000, ch. 80-L-000 001 ->, ->year 30/09/90						470 125	C10	
Eng. HZ	ch. 80-J-000 001 ->, ->ch. 80-K-220 000						470 126	C10	
Eng. AAU, HZ	01/10/90 ->, pole nr. 3						490 414	C30	
Eng. HZ	01/10/90 ->, pole nr. 6						490 416	C30	
Eng. HZ	->ch. ...H-060 000							465 004	
Eng. AAK, HZ	ch. ...H-060 001 ->							465 007	
Eng. AAK, HZ	ch. ...E-150 001 ->, ->ch. 80-K-140 000								359 493
Eng. AAU, HZ	ch. 80-P-320 001 ->								360 364
Eng. AAU, HZ	01/10/90 ->, ->ch. 80-P-320 000								360 518

ENGINE				
1.0 Cat	Petrol	33	08/89-09/94	AAK, AAU, ACM

Engine	Information	A10	A20	A40	A50	A70	C10 - C30	C20	E01
Eng. AAK, AAU	version Bosch, ->ch. 80-M-100 000			806 094					
Eng. AAU, ACM	version Bosch, ch. 80-M-100 001 ->			806 266					
Eng. AAK, ACM	version Bosch				906 056R				
Eng. AAU	version Bosch				906 121R	406 223			
Eng. AAK	version Bosch					406 193			
Eng. ACM	version Bosch					406 234			
Eng. AAK							470 125	C10	465 007
Eng. AAU, ACM	pole nr. 3						490 414	C30	
Eng. ACM	pole nr. 6						490 416	C30	
Eng. AAK	ch. ...E-150 001 ->, ->ch. 80-K-140 000								359 493
Eng. AAU, ACM	ch. 80-P-320 001 ->								360 364
Eng. AAU, ACM	->ch. 80-P-320 000								360 518

A10 CONDENSER	A20 CONTACT SET	A40 DISTRIBUTOR CAP	A50 ROTOR	A70 PICK-UP
C10 COIL	C20 IGNITION MODULE	C30 ELECTRONIC IGNITION KIT	E01 IGNITION CABLE SET	

The present application list is a brief version. For the detailed information about the possibility of installation on a specific vehicle, please refer to our web-catalogue <http://catalogo.facet.eu/>

Vehicle	alim.	kW	Date	Engine	FUNCTIONS ON THE VEHICLE							
					A10	A20	A40	A50	A70	C10 - C30	C20	E01

1.1	Petrol	37	10/81-09/89	HB	ENGINE							
------------	--------	-----------	-------------	-----------	---------------	--	--	--	--	--	--	--

Engine	Information	A10	A20	A40	A50	A70	C10 - C30	C20	E01
All engines	version Bosch	606 195	706 049HDVS		906 026R				
All engines	version Bosch, ->ch. 86-E-150 000			806 079					
All engines	version Bosch, ch. 86-E-150 001 ->			806 094					
All engines	version Ducellier				915 089R				
All engines	->ch. 80-K-140 000, ch. ...-E-150 001 ->								359 493

1.3	Petrol	37	08/83-07/85	HW	ENGINE							
------------	--------	-----------	-------------	-----------	---------------	--	--	--	--	--	--	--

Engine	Information	A10	A20	A40	A50	A70	C10 - C30	C20	E01
All engines	version Bosch	606 195	706 049HDVS	806 079	906 114R				
All engines	ch. ...-E-150 001 ->, ->ch. 80-K-140 000								359 493

1.3	Petrol	40	08/83-07/94	AAV, HK, MH	ENGINE							
------------	--------	-----------	-------------	--------------------	---------------	--	--	--	--	--	--	--

Engine	Information	A10	A20	A40	A50	A70	C10 - C30	C20	E01
Eng. HK	version Bosch	606 195	706 049HDVS		906 114R				
Eng. HK	version Bosch, ->ch. 86-E-150 000			806 079					
All engines	version Bosch, ch. 86-E-150 001 ->, ->ch. 80-M-100 000			806 094					
Eng. AAV	version Bosch, ch. 80-M-100 001 ->			806 266					
Eng. MH	version Bosch				906 056R	406 193			
Eng. AAV	version Bosch				906 121R	406 223			
Eng. AAV							490 414	C30	
Eng. MH	->ch. ...-H-060 000								465 004
Eng. MH	ch. ...-H-060 001 ->								465 007
Eng. HK, MH	ch. ...-E-150 001 ->, ->ch. 80-K-140 000								359 493
Eng. AAV	ch. 80-P-320 001 ->								360 364
Eng. AAV	->ch. 80-P-320 000								360 518

1.3	Petrol	43	08/82-07/88	GT, HJ	ENGINE							
------------	--------	-----------	-------------	---------------	---------------	--	--	--	--	--	--	--

Engine	Information	A10	A20	A40	A50	A70	C10 - C30	C20	E01
All engines	version Bosch	606 195	706 049HDVS		906 026R				
All engines	version Bosch, ->ch. 86-E-150 000			806 079					
All engines	version Bosch, ch. 86-E-150 001 ->			806 094					
All engines	ch. ...-E-150 001 ->, ->ch. 80-K-140 000								359 493

1.3	Petrol	44	10/81-07/83	HH	ENGINE							
------------	--------	-----------	-------------	-----------	---------------	--	--	--	--	--	--	--

Engine	Information	A10	A20	A40	A50	A70	C10 - C30	C20	E01
All engines	version Bosch	606 195	706 049HDVS	806 079	906 026R				
All engines	version Ducellier				915 089R				
All engines	ch. ...-E-150 001 ->, ->ch. 80-K-140 000								359 493

1.3	Petrol	55	09/82-09/89	GK	ENGINE							
------------	--------	-----------	-------------	-----------	---------------	--	--	--	--	--	--	--

Engine	Information	A10	A20	A40	A50	A70	C10 - C30	C20	E01
All engines	version Bosch, ->ch. 86-E-150 000			806 079					
All engines	version Bosch, ch. 86-E-150 001 ->			806 094					
All engines	version Bosch, ->eng. GK012.822				906 056R				
All engines	version Bosch, eng. type GK012.823 ->				906 121R				
All engines	version Bosch					406 223			
All engines	ch. ...-E-150 001 ->, ->ch. 80-H-220 000						470 125	C10	
All engines	ch. 80-J-000 001 ->, ->ch. 80-K-220 000						470 126	C10	
All engines	->ch. ...-E-150 000						470 132	C10	
All engines	ch. ...-E-150 001 ->, ->ch. 80-K-140 000								359 493

1.3	Petrol	56	10/90-08/94	3F	ENGINE							
------------	--------	-----------	-------------	-----------	---------------	--	--	--	--	--	--	--

Engine	Information	A10	A20	A40	A50	A70	C10 - C30	C20	E01
All engines	version Bosch, ->ch. 80-M-100 000			806 094					
All engines	version Bosch, ch. 80-M-100 001 ->			806 266					
All engines	version Bosch				906 121R				
All engines	version Bosch, 01/10/90 ->					406 233			
All engines	->year 30/09/90						470 125	C10	465 007
All engines	01/10/90 ->						490 414	C30	
All engines	ch. 80-P-320 001 ->								360 364

A10 CONDENSER	A20 CONTACT SET	A40 DISTRIBUTOR CAP	A50 ROTOR	A70 PICK-UP
C10 COIL	C20 IGNITION MODULE	C30 ELECTRONIC IGNITION KIT	E01 IGNITION CABLE SET	

Vehicle	alim.	kW	Date	Engine	FUNCTIONS ON THE VEHICLE							
					A10	A20	A40	A50	A70	C10 - C30	C20	E01

ENGINE				
1.3	Petrol	56	10/90-08/94	3F

Engine	Information	A10	A20	A40	A50	A70	C10 - C30	C20	E01
All engines	01/10/90 ->, ->ch. 80-P-320 000								360 518

ENGINE				
1.3	Petrol	57	03/91-09/94	3F

Engine	Information	A10	A20	A40	A50	A70	C10 - C30	C20	E01
All engines	version Bosch, ->ch. 80-M-100 000			806 094					
All engines	version Bosch, ch. 80-M-100 001 ->			806 266					
All engines	version Bosch				906 121R				
All engines	version Bosch, 01/10/90 ->					406 233			
All engines	->year 30/09/90						470 125	C10	465 007
All engines	01/10/90 ->						490 414	C30	
All engines	ch. 80-P-320 001 ->								360 364
All engines	01/10/90 ->, ->ch. 80-P-320 000								360 518

ENGINE				
1.3 Cat	Petrol	40	07/87-09/94	2G, AAV, MH, NZ

Engine	Information	A10	A20	A40	A50	A70	C10 - C30	C20	E01
All engines	version Bosch, ->ch. 80-M-100 000			806 094					
Eng. 2G, AAV	version Bosch, ch. 80-M-100 001 ->			806 266					
Eng. 2G, MH, NZ	version Bosch				906 056R				
Eng. AAV	version Bosch				906 121R	406 223			
Eng. 2G, MH, NZ	version Bosch, ->ch. 80-M-100 000					406 193			
Eng. 2G	version Bosch, ch. 80-M-100 001 ->					406 234			
Eng. 2G, MH, NZ	ch. ...-G-000 001 ->, ->ch. 80-H-220 000, ch. 80-L-000 001 ->, ->year 30/09/90						470 125	C10	
Eng. 2G, MH, NZ	ch. 80-J-000 001 ->, ->ch. 80-K-220 000						470 126	C10	
All engines	01/10/90 ->, pole nr. 3						490 414	C30	
Eng. 2G, MH, NZ	01/10/90 ->, pole nr. 6						490 416	C30	
Eng. MH, NZ	->ch. ...-H-060 000								465 004
Eng. 2G, MH, NZ	ch. ...-H-060 001 ->, ->year 30/09/90								465 007
Eng. 2G, MH, NZ	ch. ...-E-150 001 ->, ->ch. 80-K-140 000								359 493
All engines	ch. 80-P-320 001 ->								360 364
All engines	01/10/90 ->, ->ch. 80-P-320 000								360 518

ENGINE				
1.3 Cat	Petrol	55	10/89-09/94	3F

Engine	Information	A10	A20	A40	A50	A70	C10 - C30	C20	E01
All engines	version Bosch, ->ch. 80-M-100 000			806 094					
All engines	version Bosch, ch. 80-M-100 001 ->			806 266					
All engines	version Bosch				906 121R				
All engines	version Bosch, 01/10/90 ->					406 233			
All engines	->year 30/09/90						470 125	C10	465 007
All engines	01/10/90 ->						490 414	C30	
All engines	ch. 80-P-320 001 ->								360 364
All engines	01/10/90 ->, ->ch. 80-P-320 000								360 518

ENGINE				
1.3 G40	Petrol	83	08/90-09/94	PY

Engine	Information	A10	A20	A40	A50	A70	C10 - C30	C20	E01
All engines	version Bosch, ->ch. 80-M-100 000			806 094					
All engines	version Bosch, ch. 80-M-100 001 ->			806 266					
All engines	version Bosch				906 121R	406 233			
All engines	ch. 80-P-320 001 ->						490 414	C30	
All engines	->ch. 80-P-320 000								360 364
All engines									360 518

ENGINE				
1.3 G40	Petrol	85	01/87-08/90	PY

Engine	Information	A10	A20	A40	A50	A70	C10 - C30	C20	E01
All engines	version Bosch			806 094	906 121R	406 233			
All engines							470 125	C10	465 007
All engines	->ch. 80-K-140 000, ch. ...-E-150 001 ->								359 493

A10 CONDENSER	A20 CONTACT SET	A40 DISTRIBUTOR CAP	A50 ROTOR	A70 PICK-UP
C10 COIL	C20 IGNITION MODULE	C30 ELECTRONIC IGNITION KIT	E01 IGNITION CABLE SET	

The present application list is a brief version. For the detailed information about the possibility of installation on a specific vehicle, please refer to our web-catalogue <http://catalogo.facet.eu/>

Vehicle	alim.	kW	Date	Engine	FUNCTIONS ON THE VEHICLE							
					A10	A20	A40	A50	A70	C10 - C30	C20	E01

POLO III

1.0	Petrol	33	10/94-12/99	ENGINE AEV
------------	--------	-----------	-------------	----------------------

Engine	Information	A10	A20	A40	A50	A70	C10 - C30	C20	E01
All engines							490 414	C30	

1.0	Petrol	37	05/99-05/02	ENGINE AER, ALD, ALL, AUC
------------	--------	-----------	-------------	-------------------------------------

Engine	Information	A10	A20	A40	A50	A70	C10 - C30	C20	E01
All engines							490 414	C30	
Eng. ALD, AUC							490 420	C30	360 601

1.4	Petrol	40	12/98-09/01	ENGINE AEX, AKP, ANX
------------	--------	-----------	-------------	--------------------------------

Engine	Information	A10	A20	A40	A50	A70	C10 - C30	C20	E01
Eng. ANX	version Bosch			806 094	906 121R	406 223			
Eng. ANX	version Marelli			830 116	930 057R				
Eng. AEX, ANX							490 414	C30	
Eng. AKP							490 420	C30	360 601
Eng. ANX									360 640

1.4	Petrol	44	05/97-09/01	ENGINE AEX, AKK, AKV, ANW, APQ, AUD
------------	--------	-----------	-------------	---

Engine	Information	A10	A20	A40	A50	A70	C10 - C30	C20	E01
Eng. AEX, AKV, APQ	version Bosch			806 094	906 121R	406 223			
Eng. AEX, AKV, APQ	version Marelli			830 116	930 057R				
Eng. AEX, AKV, APQ							490 414	C30	
Eng. APQ							490 414	C30	
Eng. AKK, ANW, AUD							490 420	C30	360 601
Eng. AEX, AKV, APQ	->ch. 6N-V-300 000								360 640
Eng. AEX	ch. 6N-W-000 001 ->								360 641

1.4	Petrol	55	06/00-09/01	ENGINE AUA
------------	--------	-----------	-------------	----------------------

Engine	Information	A10	A20	A40	A50	A70	C10 - C30	C20	E01
All engines							490 420	C30	

1.4 16V	Petrol	55	10/99-09/01	ENGINE AHW, APE, AUA
----------------	--------	-----------	-------------	--------------------------------

Engine	Information	A10	A20	A40	A50	A70	C10 - C30	C20	E01
All engines							490 420	C30	360 575

1.4 16V	Petrol	74	10/99-09/01	ENGINE AFH, AFK, AUB
----------------	--------	-----------	-------------	--------------------------------

Engine	Information	A10	A20	A40	A50	A70	C10 - C30	C20	E01
Eng. AFH							490 414	C30	
Eng. AFK, AUB							490 420	C30	360 575

1.6	Petrol	55	09/94-09/01	ENGINE AEA, AEE, ALM
------------	--------	-----------	-------------	--------------------------------

Engine	Information	A10	A20	A40	A50	A70	C10 - C30	C20	E01
All engines	version Bosch			806 094	906 121R	406 223			
All engines	version Marelli			830 116	930 057R				
Eng. AEE, ALM							490 414	C30	360 640
Eng. AEA							490 414	C30	

1.6	Petrol	65	05/96-09/01	ENGINE AKL
------------	--------	-----------	-------------	----------------------

Engine	Information	A10	A20	A40	A50	A70	C10 - C30	C20	E01
All engines							490 420	C30	

1.6	Petrol	74	05/97-09/01	ENGINE AEH, AFT, AKL, APF, AUR
------------	--------	-----------	-------------	--

Engine	Information	A10	A20	A40	A50	A70	C10 - C30	C20	E01
Eng. AFT	version Bosch			806 266	906 121R	406 223			
Eng. AFT							490 414	C30	360 932
Eng. AEH, AKL, APF, AUR							490 420	C30	
Eng. AEH, AKL									360 484
Eng. APF, AUR									360 585
Eng. AFT	+automatic transmission								360 933

A10 CONDENSER	A20 CONTACT SET	A40 DISTRIBUTOR CAP	A50 ROTOR	A70 PICK-UP
C10 COIL	C20 IGNITION MODULE	C30 ELECTRONIC IGNITION KIT	E01 IGNITION CABLE SET	

Vehicle	alim.	kW	Date	Engine	FUNCTIONS ON THE VEHICLE									
					A10	A20	A40	A50	A70	C10 - C30	C20	E01		
ENGINE														
1.6 16V GTI	Petrol	92	10/99-09/01	ARC, AVY										
Engine	Information				A10	A20	A40	A50	A70	C10 - C30	C20	E01		
All engines										490 420	C30		360 575	
ENGINE														
100 1.4 16V	Petrol	74	04/96-10/99	AFH, AFK, AUB										
Engine	Information				A10	A20	A40	A50	A70	C10 - C30	C20	E01		
Eng. AFH	version Bosch						806 094	906 121R	406 223					
Eng. AFH	version Marelli						830 116	930 057R						
Eng. AFH										490 414	C30		360 580	
Eng. AFK, AUB										490 420	C30			
ENGINE														
100 1.6	Petrol	74	12/95-09/01	AEH, AFT, AKL, APF, AUR										
Engine	Information				A10	A20	A40	A50	A70	C10 - C30	C20	E01		
Eng. AFT	version Bosch						806 266	906 121R	406 223					
Eng. AFT										490 414	C30		360 932	
Eng. AEH, AKL, APF, AUR										490 420	C30			
Eng. AEH, AKL													360 484	
Eng. APF, AUR													360 585	
Eng. AFT	+automatic transmission												360 933	
ENGINE														
120 1.6 16V GTI	Petrol	88	09/98-10/99	AJV										
Engine	Information				A10	A20	A40	A50	A70	C10 - C30	C20	E01		
All engines										490 420	C30		360 575	
ENGINE														
2.0	Petrol	85	08/99-09/01	ADC										
Engine	Information				A10	A20	A40	A50	A70	C10 - C30	C20	E01		
All engines	version Bosch						806 266	906 121R						
All engines										490 414	C30			
All engines	-> ch. 6K-Y-502 794												360 551	
ENGINE														
45 1.0	Petrol	33	10/94-09/96	AEV										
Engine	Information				A10	A20	A40	A50	A70	C10 - C30	C20	E01		
All engines	version Bosch						806 094	906 121R	406 223					
All engines										490 414	C30		360 364	
ENGINE														
50 1.0	Petrol	37	09/96-10/99	AER, ALD, ALL, AUC										
Engine	Information				A10	A20	A40	A50	A70	C10 - C30	C20	E01		
Eng. AER, ALL	version Bosch						806 094	906 121R	406 223					
Eng. AER, ALL	version Marelli						830 116	930 057R						
All engines										490 414	C30			
Eng. ALD, AUC										490 420	C30			
Eng. AER	-> ch. 6N-V-300 000												360 364	
Eng. AER, ALL	ch. 6N-W-000 001 ->												360 641	
ENGINE														
54 1.4	Petrol	40	01/98-08/99	ANX										
Engine	Information				A10	A20	A40	A50	A70	C10 - C30	C20	E01		
All engines	version Bosch						806 094	906 121R	406 223					
All engines	version Marelli						830 116	930 057R						
All engines										490 414	C30		360 640	
ENGINE														
55 1.3	Petrol	40	10/94-04/97	ADX										
Engine	Information				A10	A20	A40	A50	A70	C10 - C30	C20	E01		
All engines	version Bosch						806 094	906 121R	406 223					
All engines	version Marelli						830 116	930 057R						
All engines										490 414	C30		360 364	
ENGINE														
55 1.4	Petrol	40	08/95-10/99	AEX, AKP, ANX										
Engine	Information				A10	A20	A40	A50	A70	C10 - C30	C20	E01		
Eng. AEX	version Bosch						806 094	906 121R	406 223					
Eng. AEX	version Marelli						830 116	930 057R						
Eng. AEX, ANX										490 414	C30			

A10 CONDENSER	A20 CONTACT SET	A40 DISTRIBUTOR CAP	A50 ROTOR	A70 PICK-UP
C10 COIL	C20 IGNITION MODULE	C30 ELECTRONIC IGNITION KIT	E01 IGNITION CABLE SET	

The present application list is a brief version. For the detailed information about the possibility of installation on a specific vehicle, please refer to our web-catalogue <http://catalogo.facet.eu/>

Vehicle	alim.	kW	Date	Engine	FUNCTIONS ON THE VEHICLE							
					A10	A20	A40	A50	A70	C10 - C30	C20	E01

ENGINE				
55 1.4	Petrol	40	08/95-10/99	AEX, AKP, ANX

Engine	Information	A10	A20	A40	A50	A70	C10 - C30	C20	E01
Eng. AKP							490 420	C30	
Eng. AEX	->ch. 6N-V-300 000								360 640
Eng. AEX	ch. 6N-W-000 001 ->								360 641

ENGINE				
60 1.4	Petrol	44	07/95-09/01	AEX, AKK, AKV, ANW, APQ, AUD

Engine	Information	A10	A20	A40	A50	A70	C10 - C30	C20	E01
Eng. AEX, AKV, APQ	version Bosch			806 094	906 121R	406 223			
Eng. AEX, AKV, APQ	version Marelli			830 116	930 057R				
Eng. AEX, AKV, APQ							490 414	C30	
Eng. AKK, ANW, AUD							490 420	C30	360 601
Eng. AEX, AKV, APQ	->ch. 6N-V-300 000								360 640
Eng. AEX, AKV	ch. 6N-W-000 001 ->								360 641

ENGINE				
75 1.4 16V	Petrol	55	10/99-09/01	APE, AUA

Engine	Information	A10	A20	A40	A50	A70	C10 - C30	C20	E01
All engines							490 420	C30	360 575

ENGINE				
75 1.6	Petrol	55	10/94-09/01	1F, AEA, AEE, AHS, ALM

Engine	Information	A10	A20	A40	A50	A70	C10 - C30	C20	E01
Eng. AEA, AEE, AHS, ALM	version Bosch			806 094		406 223			
Eng. 1F	version Bosch			806 266					
Eng. 1F	version Ducellier			815 068	915 099R				
Eng. AEA, AEE, AHS, ALM	version Marelli			830 116	930 057R				
All engines	version Bosch				906 121R				
All engines							490 414	C30	
Eng. 1F									359 965
Eng. AEE, ALM	->ch. 6N-V-300 000								360 640
Eng. AEE, AHS	ch. 6N-W-000 001 ->								360 641

ENGINE				
75 1.6 4motion	Petrol	55	08/95-10/99	AEA

Engine	Information	A10	A20	A40	A50	A70	C10 - C30	C20	E01
All engines	version Bosch			806 094	906 121R	406 223			
All engines	version Marelli			830 116	930 057R				

ENGINE				
90 1.8	Petrol	66	01/97-09/01	ADD

Engine	Information	A10	A20	A40	A50	A70	C10 - C30	C20	E01
All engines	version Bosch			806 266	906 121R				
All engines							490 414	C30	360 549

POLO IV				
---------	--	--	--	--

ENGINE				
1.0	Petrol	37	08/96-12/01	AER

Engine	Information	A10	A20	A40	A50	A70	C10 - C30	C20	E01
All engines	version Bosch			806 094	906 121R	406 223			
All engines	version Marelli			830 116	930 057R				
All engines							490 414	C30	
All engines	->ch. 6N-V-300 000								360 364
All engines	ch. 6N-W-000 001 ->								360 641

ENGINE				
1.0	Petrol	58	02/03-10/03	ARA

Engine	Information	A10	A20	A40	A50	A70	C10 - C30	C20	E01
All engines									360 575

ENGINE				
1.2	Petrol	40	01/02-05/07	AWY, BMD

Engine	Information	A10	A20	A40	A50	A70	C10 - C30	C20	E01
All engines	x 3, COIL ON PLUG, incl. spark plug connector						470 431	C10	

A10 CONDENSER	A20 CONTACT SET	A40 DISTRIBUTOR CAP	A50 ROTOR	A70 PICK-UP
C10 COIL	C20 IGNITION MODULE	C30 ELECTRONIC IGNITION KIT	E01 IGNITION CABLE SET	

Vehicle	alim.	kW	Date	Engine	FUNCTIONS ON THE VEHICLE												
					A10	A20	A40	A50	A70	C10 - C30	C20	E01					
ENGINE																	
1.2	Petrol	44	05/07-11/09	BBM													
ENGINE																	
Engine					Information					A10	A20	A40	A50	A70	C10 - C30	C20	E01
All engines					x 3, COIL ON PLUG, incl. spark plug connector										470 431	C10	
1.2 12V	Petrol	47	10/01-07/07	AZQ, BME													
ENGINE																	
Engine					Information					A10	A20	A40	A50	A70	C10 - C30	C20	E01
All engines					x 3, COIL ON PLUG, incl. spark plug connector										470 474	C10	
1.2 12V	Petrol	51	05/07-11/09	BZG													
ENGINE																	
Engine					Information					A10	A20	A40	A50	A70	C10 - C30	C20	E01
All engines					x 3, COIL ON PLUG, incl. spark plug connector										470 474	C10	
1.4	Petrol	55	11/02-04/12	BBY, BKY													
ENGINE																	
Engine					Information					A10	A20	A40	A50	A70	C10 - C30	C20	E01
All engines					x 4, COIL ON PLUG, incl. spark plug connector										470 474	C10	
1.4	Petrol	61	08/02-08/10	BLM													
ENGINE																	
Engine					Information					A10	A20	A40	A50	A70	C10 - C30	C20	E01
All engines					x 4, COIL ON PLUG, incl. spark plug connector										490 420	C30	360 723
1.4	Petrol	63	12/03-05/05	BLM													
ENGINE																	
Engine					Information					A10	A20	A40	A50	A70	C10 - C30	C20	E01
All engines					x 4, COIL ON PLUG, incl. spark plug connector										490 420	C30	360 723
1.4	Petrol	74	11/03-06/05	BBZ													
ENGINE																	
Engine					Information					A10	A20	A40	A50	A70	C10 - C30	C20	E01
All engines					x 4, COIL ON PLUG, incl. spark plug connector										470 474	C10	
1.4 16V	Petrol	55	10/01-05/08	AUA, BBY, BKY													
ENGINE																	
Engine					Information					A10	A20	A40	A50	A70	C10 - C30	C20	E01
Eng. BBY, BKY					x 4, COIL ON PLUG, incl. spark plug connector										470 474	C10	
Eng. AUA															490 420	C30	360 575
1.4 16V	Petrol	59	05/06-11/09	BUD													
ENGINE																	
Engine					Information					A10	A20	A40	A50	A70	C10 - C30	C20	E01
All engines					x 4, COIL ON PLUG, incl. spark plug connector										470 474	C10	
1.4 16V	Petrol	74	10/01-05/08	AUB, BBZ													
ENGINE																	
Engine					Information					A10	A20	A40	A50	A70	C10 - C30	C20	E01
All engines					x 4, COIL ON PLUG, incl. spark plug connector										470 474	C10	
1.4 BiFuel	Petrol/ Liquified Petroleum Gas (LPG)	60	05/06-11/09	BUD													
ENGINE																	
Engine					Information					A10	A20	A40	A50	A70	C10 - C30	C20	E01
All engines					x 4, COIL ON PLUG, incl. spark plug connector										470 474	C10	
1.4 FSI	Petrol	63	02/02-07/06	AXU													
ENGINE																	
Engine					Information					A10	A20	A40	A50	A70	C10 - C30	C20	E01
All engines					x 4, COIL ON PLUG, incl. spark plug connector										470 474	C10	
1.6	Petrol	74	08/02->	BAH, BPA													
ENGINE																	
Engine					Information					A10	A20	A40	A50	A70	C10 - C30	C20	E01
All engines															490 420	C30	360 723
Eng. BAH															490 420	C30	
1.6 16V	Petrol	77	05/06-11/09	BTS													
ENGINE																	
Engine					Information					A10	A20	A40	A50	A70	C10 - C30	C20	E01
All engines					x 4, COIL ON PLUG, incl. spark plug connector										470 474	C10	

A10	CONDENSER	A20	CONTACT SET	A40	DISTRIBUTOR CAP	A50	ROTOR	A70	PICK-UP
C10	COIL	C20	IGNITION MODULE	C30	ELECTRONIC IGNITION KIT	E01	IGNITION CABLE SET		

The present application list is a brief version. For the detailed information about the possibility of installation on a specific vehicle, please refer to our web-catalogue <http://catalogo.facet.eu/>

Vehicle	alim.	kW	Date	Engine	FUNCTIONS ON THE VEHICLE							
					A10	A20	A40	A50	A70	C10 - C30	C20	E01

ENGINE				
1.6 Flex	Petrol/ Ethanol	76	12/04-10/14	BPA

Engine	Information	A10	A20	A40	A50	A70	C10 - C30	C20	E01
All engines							490 420	C30	360 723

ENGINE				
1.6 Total Flex	Petrol/ Ethanol	74	10/04-06/06	BPA

Engine	Information	A10	A20	A40	A50	A70	C10 - C30	C20	E01
All engines							490 420	C30	360 723

ENGINE				
1.8 GTI	Petrol	110	09/05-11/09	BJX

Engine	Information	A10	A20	A40	A50	A70	C10 - C30	C20	E01
All engines	x 4, COIL ON PLUG, incl. spark plug connector						470 429	C10	

ENGINE				
1.8 GTi Cup Edition	Petrol	132	05/06-11/09	BBU

Engine	Information	A10	A20	A40	A50	A70	C10 - C30	C20	E01
All engines	x 4, COIL ON PLUG, incl. spark plug connector						470 429	C10	

ENGINE				
2.0	Petrol	85	09/02->	BBX

Engine	Information	A10	A20	A40	A50	A70	C10 - C30	C20	E01
All engines							490 420	C30	360 585

POLO V

ENGINE				
1.0	Petrol	44	01/14->	CHYA

Engine	Information	A10	A20	A40	A50	A70	C10 - C30	C20	E01
All engines	x 3, BERU, ELDOR, COIL ON PLUG, incl. spark plug connector, Number of pins:4, incl. spark plug connector						470 599	C10	

ENGINE				
1.0	Petrol	55	01/14->	CHYB

Engine	Information	A10	A20	A40	A50	A70	C10 - C30	C20	E01
All engines	x 3, BERU, ELDOR, COIL ON PLUG, incl. spark plug connector, Number of pins:4, incl. spark plug connector						470 599	C10	

ENGINE				
1.0 TSI	Petrol	70	11/14->	CHZB

Engine	Information	A10	A20	A40	A50	A70	C10 - C30	C20	E01
All engines	x 3, BERU, ELDOR, COIL ON PLUG, incl. spark plug connector, Number of pins:4, incl. spark plug connector						470 599	C10	

ENGINE				
1.0 TSI	Petrol	81	11/14->	CHZC

Engine	Information	A10	A20	A40	A50	A70	C10 - C30	C20	E01
All engines	x 3, BERU, ELDOR, COIL ON PLUG, incl. spark plug connector, Number of pins:4, incl. spark plug connector						470 599	C10	

ENGINE				
1.2	Petrol	44	03/09->	CGPB

Engine	Information	A10	A20	A40	A50	A70	C10 - C30	C20	E01
All engines	x 3, COIL ON PLUG, incl. spark plug connector						470 474	C10	

ENGINE				
1.2	Petrol	51	06/09->	CGPA

Engine	Information	A10	A20	A40	A50	A70	C10 - C30	C20	E01
All engines	x 3, COIL ON PLUG, incl. spark plug connector						470 474	C10	

ENGINE				
1.2 [IND]	Petrol	55	08/11->	CJLA

Engine	Information	A10	A20	A40	A50	A70	C10 - C30	C20	E01
All engines	Qty: 3						470 474	C10	

ENGINE				
1.2 BlueMotion	Petrol	51	03/09-05/14	CGPA

Engine	Information	A10	A20	A40	A50	A70	C10 - C30	C20	E01
All engines	x 3, COIL ON PLUG, incl. spark plug connector						470 474	C10	

ENGINE				
1.2 TSI	Petrol	66	05/11->	CBZC, CJZC

Engine	Information	A10	A20	A40	A50	A70	C10 - C30	C20	E01
Eng. CJZC	x 4, BERU, ELDOR, COIL ON PLUG, incl. spark plug connector, Number of pins:4, incl. spark plug connector						470 599	C10	
Eng. CBZC							490 420	C30	358 248

A10	CONDENSER	A20	CONTACT SET	A40	DISTRIBUTOR CAP	A50	ROTOR	A70	PICK-UP
C10	COIL	C20	IGNITION MODULE	C30	ELECTRONIC IGNITION KIT	E01	IGNITION CABLE SET		

Vehicle	alim.	kW	Date	Engine	FUNCTIONS ON THE VEHICLE								
					A10	A20	A40	A50	A70	C10 - C30	C20	E01	
ENGINE													
1.2 TSI	Petrol	77	11/09->	CBZB									
Engine	Information												
All engines									490 420	C30		358 248	
ENGINE													
1.2 TSI	Petrol	81	01/14->	CJZD									
Engine	Information												
All engines	x 4, BERU, ELDOR, COIL ON PLUG, incl. spark plug connector, Number of pins:4, incl. spark plug connector								470 599	C10			
ENGINE													
1.2 TSI 16V	Petrol	66	02/14-10/17	CJZC									
Engine	Information												
All engines	x 4, BERU, ELDOR, COIL ON PLUG, incl. spark plug connector, Number of pins:4, incl. spark plug connector								470 599	C10			
ENGINE													
1.2 TSi BlueMotion	Petrol	77	11/09-05/14	CBZB									
Engine	Information												
All engines									490 420	C30			
ENGINE													
1.4	Petrol	63	03/09-05/14	CDDA, CGGB, CLPA									
Engine	Information												
Eng. CDDA	Qty: 4								470 474	C10			
Eng. CGGB, CLPA	x 4, COIL ON PLUG, incl. spark plug connector								470 474	C10			
ENGINE													
1.4 BiFuel	Petrol/ Liquified Petro- leum Gas (LPG)	60	03/10-01/11	CMAA									
Engine	Information												
All engines	x 4, COIL ON PLUG, incl. spark plug connector								470 474	C10			
ENGINE													
1.4 GTi	Petrol	132	05/10->	CAVE, CTHE									
Engine	Information												
All engines	x 4, COIL ON PLUG, incl. spark plug connector								470 474	C10			
ENGINE													
1.4 TSI	Petrol	103	10/12-05/14	CPTA									
Engine	Information												
All engines	x 4, BERU, ELDOR, COIL ON PLUG, incl. spark plug connector, Number of pins:4, incl. spark plug connector								470 599	C10			
ENGINE													
1.4 TSI	Petrol	110	05/14->	CZEA									
Engine	Information												
All engines	x 4, BERU, ELDOR, COIL ON PLUG, incl. spark plug connector, Number of pins:4, incl. spark plug connector								470 599	C10			
ENGINE													
1.4 TSi	Petrol	92	05/16->	CZCA									
Engine	Information												
All engines	x 4, BERU, ELDOR, COIL ON PLUG, incl. spark plug connector, Number of pins:4, incl. spark plug connector								470 599	C10			
ENGINE													
1.4 TSi [RUS]	Petrol	92	05/14->	CZCA									
Engine	Information												
All engines	Qty: 4								470 599	C10			
ENGINE													
1.6	Petrol	63	05/10->	CFNB									
Engine	Information												
All engines	Qty: 4								470 474	C10			
All engines	x 4, COIL ON PLUG, incl. spark plug connector								470 474	C10			
ENGINE													
1.6	Petrol	66	07/14->	CWVB									
Engine	Information												
All engines	x 4, BERU, ELDOR, COIL ON PLUG, incl. spark plug connector, Number of pins:4, incl. spark plug connector								470 599	C10			

A10	CONDENSER	A20	CONTACT SET	A40	DISTRIBUTOR CAP	A50	ROTOR	A70	PICK-UP
C10	COIL	C20	IGNITION MODULE	C30	ELECTRONIC IGNITION KIT	E01	IGNITION CABLE SET		

The present application list is a brief version. For the detailed information about the possibility of installation on a specific vehicle, please refer to our web-catalogue <http://catalogo.facet.eu/>

Vehicle	alim.	kW	Date	Engine	FUNCTIONS ON THE VEHICLE							
					A10	A20	A40	A50	A70	C10 - C30	C20	E01

ENGINE				
1.6	Petrol	77	01/10->	CFNA, CLSA

Engine	Information	A10	A20	A40	A50	A70	C10 - C30	C20	E01
All engines	x 4, COIL ON PLUG, x 4, COIL ON PLUG, incl. spark plug connector, incl. spark plug connector						470 474	C10	
Eng. CLSA	Qty: 4						470 474	C10	

ENGINE				
1.6	Petrol	81	07/14->	CWVA

Engine	Information	A10	A20	A40	A50	A70	C10 - C30	C20	E01
All engines	x 4, BERU, ELDOR, COIL ON PLUG, incl. spark plug connector, Number of pins:4, incl. spark plug connector						470 599	C10	

ENGINE				
1.6 BiFuel	Petrol/ Liquified Petro- leum Gas (LPG)	60	01/11-05/14	CNKA

Engine	Information	A10	A20	A40	A50	A70	C10 - C30	C20	E01
All engines	x 4, COIL ON PLUG, incl. spark plug connector						470 474	C10	

ENGINE				
1.8 GTI	Petrol	141	11/14->	DAJA, DAJB

Engine	Information	A10	A20	A40	A50	A70	C10 - C30	C20	E01
All engines	x 4, HITACHI, COIL ON PLUG, incl. spark plug connector						470 636	C10	

ENGINE				
2.0 RWRC	Petrol	162	08/13-05/14	CDLJ

Engine	Information	A10	A20	A40	A50	A70	C10 - C30	C20	E01
All engines	x 4, ELDOR, Housing Colour:Black, COIL ON PLUG, incl. spark plug connector						470 426	C10	

POLO VI

ENGINE				
1.0	Petrol	48	08/17-02/20	CHYC, DFNB

Engine	Information	A10	A20	A40	A50	A70	C10 - C30	C20	E01
All engines	x 3, BERU, ELDOR, HITACHI, COIL ON PLUG, incl. spark plug connector, Number of pins:4, incl. spark plug connector						470 599	C10	

ENGINE				
1.0	Petrol	55	06/17-08/21	CHYB

Engine	Information	A10	A20	A40	A50	A70	C10 - C30	C20	E01
All engines	x 3, x 4, BERU, ELDOR, HITACHI, COIL ON PLUG, incl. spark plug connector, Number of pins:4, incl. spark plug connector						470 599	C10	

ENGINE				
1.0 TGI	Petrol/ Com- pressed Natural Gas (CNG)	66	09/17->	DBYA

Engine	Information	A10	A20	A40	A50	A70	C10 - C30	C20	E01
All engines	x 3, BERU, ELDOR, COIL ON PLUG, incl. spark plug connector, Number of pins:4, incl. spark plug connector						470 599	C10	

ENGINE				
1.0 TSI	Petrol	70	06/17->	CHZL, DKLA, DLAC

Engine	Information	A10	A20	A40	A50	A70	C10 - C30	C20	E01
All engines	x 3, BERU, ELDOR, HITACHI, COIL ON PLUG, incl. spark plug connector, Number of pins:4, incl. spark plug connector						470 599	C10	

ENGINE				
1.0 TSI	Petrol	81	07/20->	DLAA

Engine	Information	A10	A20	A40	A50	A70	C10 - C30	C20	E01
All engines	x 3, BERU, ELDOR, HITACHI, COIL ON PLUG, incl. spark plug connector, Number of pins:4, incl. spark plug connector						470 599	C10	

ENGINE				
1.0 TSI	Petrol	85	09/17->	CHZJ, DKJA, DKRF

Engine	Information	A10	A20	A40	A50	A70	C10 - C30	C20	E01
All engines	x 3, BERU, ELDOR, COIL ON PLUG, incl. spark plug connector, Number of pins:4, incl. spark plug connector						470 599	C10	

ENGINE				
2.0 GTI	Petrol	147	11/17->	CZPC, DKZC

Engine	Information	A10	A20	A40	A50	A70	C10 - C30	C20	E01
All engines	x 4, HITACHI, COIL ON PLUG, incl. spark plug connector						470 636	C10	

A10	CONDENSER	A20	CONTACT SET	A40	DISTRIBUTOR CAP	A50	ROTOR	A70	PICK-UP
C10	COIL	C20	IGNITION MODULE	C30	ELECTRONIC IGNITION KIT	E01	IGNITION CABLE SET		

Vehicle	alim.	kW	Date	Engine	FUNCTIONS ON THE VEHICLE							
					A10	A20	A40	A50	A70	C10 - C30	C20	E01

SANTANA

				ENGINE
1.6	Petrol	55	08/81-12/84	DT

Engine	Information	A10	A20	A40	A50	A70	C10 - C30	C20	E01
All engines	version Bosch			806 094	906 055R	406 231			
All engines							470 125	C10	465 004

				ENGINE
1.8	Petrol	66	01/83-12/84	DS

Engine	Information	A10	A20	A40	A50	A70	C10 - C30	C20	E01
All engines	version Bosch			806 094	906 055R	406 231			
All engines							470 125	C10	465 004

				ENGINE
1.9	Petrol	85	08/81-07/83	WN

Engine	Information	A10	A20	A40	A50	A70	C10 - C30	C20	E01
All engines	version Bosch			806 093	906 116R				
All engines							470 132	C10	465 004

				ENGINE
2.0	Petrol	85	08/83-12/84	JS

Engine	Information	A10	A20	A40	A50	A70	C10 - C30	C20	E01
All engines	version Bosch			806 231	906 116R				
All engines	version Bosch, 01/01/88 ->					406 219			
All engines							470 125	C10	465 004

SCIROCCO I

				ENGINE
1.1	Petrol	37	04/74-07/79	FA

Engine	Information	A10	A20	A40	A50	A70	C10 - C30	C20	E01
All engines	version Bosch	606 195	706 034HVS	806 079	906 121R				
All engines	version Ducellier				915 089R				
All engines									359 727

				ENGINE
1.3	Petrol	44	08/79-07/80	GF

Engine	Information	A10	A20	A40	A50	A70	C10 - C30	C20	E01
All engines	version Bosch	606 195	706 049HDVS	806 079	906 114R				
All engines									359 727

				ENGINE
1.5	Petrol	51	08/77-07/80	JB

Engine	Information	A10	A20	A40	A50	A70	C10 - C30	C20	E01
All engines	version Bosch	606 196	706 034HVS	806 079	906 055R				
All engines									359 727

SCIROCCO II

				ENGINE
1.3	Petrol	40	08/83-07/84	HK

Engine	Information	A10	A20	A40	A50	A70	C10 - C30	C20	E01
All engines	version Bosch	606 195	706 049HDVS		906 114R				
All engines	version Bosch, ->ch. 53-E-046 000			806 079					
All engines	version Bosch, ch. 53-E-046 001 ->			806 094					
All engines	ch. 53-E-046 001 ->								359 493
All engines	->ch. 53-E-046 000								359 727

				ENGINE
1.3	Petrol	44	08/80-12/83	GF

Engine	Information	A10	A20	A40	A50	A70	C10 - C30	C20	E01
All engines	version Bosch			806 079	906 056R				
All engines							470 132	C10	465 004

				ENGINE
1.6	Petrol	51	08/83-07/84	EWA

Engine	Information	A10	A20	A40	A50	A70	C10 - C30	C20	E01
All engines	version Bosch			806 266	906 055R	406 219			
All engines	version Ducellier			815 068	915 099R				
All engines	ch. 53-E-046 001 ->						470 125	C10	359 725
All engines	->ch. 53-E-046 000						470 132	C10	359 727

A10	CONDENSER	A20	CONTACT SET	A40	DISTRIBUTOR CAP	A50	ROTOR	A70	PICK-UP
C10	COIL	C20	IGNITION MODULE	C30	ELECTRONIC IGNITION KIT	E01	IGNITION CABLE SET		

Vehicle	alim.	kW	Date	Engine	FUNCTIONS ON THE VEHICLE							
					A10	A20	A40	A50	A70	C10 - C30	C20	E01

ENGINE				
1.6	Petrol	53	08/83-07/90	HN, RE

Engine	Information	A10	A20	A40	A50	A70	C10 - C30	C20	E01
Eng. HN	version Bosch, ->eng. HN 005 000			806 079					
Eng. HN	version Bosch, eng. type HN 005 001 ->, ->eng. HN 007 000			806 094					
All engines	version Bosch, eng. type HN 007 001 ->			806 266					
Eng. RE	version Ducellier			815 068	915 099R				
All engines	version Bosch				906 055R	406 219			
All engines	ch. 53-E-046 001 ->, ->ch. 53-J-020 000, ch. 53-L-000 001 ->						470 125	C10	
Eng. RE	ch. 53-K-000 001 ->, ->ch. 53-K-020 000						470 126	C10	
Eng. HN	->ch. 53-E-046 000						470 132	C10	359 727
Eng. HN								465 007	
All engines	ch. 53-E-046 001 ->								359 725

ENGINE				
1.6	Petrol	55	01/83-12/89	EW

Engine	Information	A10	A20	A40	A50	A70	C10 - C30	C20	E01
All engines	version Bosch, ->eng. EW 012 000			806 079					
All engines	version Bosch, eng. type EW 012 001 ->, ->eng. EW 035 000			806 094					
All engines	version Bosch, eng. type EW 035 001 ->			806 266					
All engines	version Ducellier			815 068	915 099R				
All engines	version Bosch				906 055R	406 219			
All engines	ch. 53-E-046 001 ->, ->ch. 53-J-020 000, ch. 53-L-000 001 ->						470 125	C10	
All engines	ch. 53-K-000 001 ->, ->ch. 53-K-020 000						470 126	C10	
All engines	->ch. 53-E-046 000						470 132	C10	359 727
All engines								465 007	
All engines	ch. 53-E-046 001 ->								359 725

ENGINE				
1.6	Petrol	63	08/80-04/84	1HyFAD

Engine	Information	A10	A20	A40	A50	A70	C10 - C30	C20	E01
All engines	version Bosch	606 196	706 034HVS	806 079	906 027R				

ENGINE				
1.8	Petrol	66	08/83-07/92	EX

Engine	Information	A10	A20	A40	A50	A70	C10 - C30	C20	E01
All engines	version Bosch, ->eng. EX 015 000			806 079					
All engines	version Bosch, eng. type EX 015 001 ->, ->eng. EX 035 000			806 094					
All engines	version Bosch, eng. type EX 035 000 ->			806 266					
All engines	version Ducellier			815 068	915 099R				
All engines	version Bosch				906 055R	406 219			
All engines	ch. 53-E-046 001 ->, ->ch. 53-J-020 000, ch. 53-L-000 001 ->						470 125	C10	
All engines	ch. 53-K-000 001 ->, ->ch. 53-K-020 000						470 126	C10	
All engines	->ch. 53-E-046 000						470 132	C10	359 727
All engines								465 007	
All engines	ch. 53-E-046 001 ->								359 725

ENGINE				
1.8	Petrol	70	11/85-07/92	JH

Engine	Information	A10	A20	A40	A50	A70	C10 - C30	C20	E01
All engines	version Bosch, ->eng. JH 240 000			806 079					
All engines	version Bosch, eng. type JH 240 001 ->, ->eng. JH 280 000			806 094					
All engines	version Bosch, eng. type JH 280 001 ->			806 266					
All engines	version Bosch				906 055R	406 219			
All engines	ch. 53-E-046 001 ->, ->ch. 53-J-020 000, ch. 53-L-000 001 ->						470 125	C10	
All engines	ch. 53-K-000 001 ->, ->ch. 53-K-020 000						470 126	C10	
All engines	->ch. 53-E-046 000						470 132	C10	359 727
All engines								465 007	
All engines	ch. 53-E-046 001 ->								359 725

ENGINE				
1.8	Petrol	82	08/82-12/89	DX, KT

Engine	Information	A10	A20	A40	A50	A70	C10 - C30	C20	E01
Eng. DX	version Bosch, ->eng. DX 110 000			806 079					
All engines	version Bosch, eng. type DX 110 001 ->, ->eng. DX 119 000, ->eng. KT 004 600			806 094	906 116R				

A10	CONDENSER	A20	CONTACT SET	A40	DISTRIBUTOR CAP	A50	ROTOR	A70	PICK-UP
C10	COIL	C20	IGNITION MODULE	C30	ELECTRONIC IGNITION KIT	E01	IGNITION CABLE SET		

Vehicle	alim.	kW	Date	Engine	FUNCTIONS ON THE VEHICLE							
					A10	A20	A40	A50	A70	C10 - C30	C20	E01

ENGINE				
1.8	Petrol	82	08/82-12/89	DX, KT

Engine	Information	A10	A20	A40	A50	A70	C10 - C30	C20	E01
All engines	version Bosch, eng. type DX 119 001 ->, eng. type KT 004 601 ->			806 266					
All engines	version Bosch, ->eng. DX 110 000, eng. type DX 119 001 ->, eng. type KT 004 601 ->				906 055R				
All engines	version Bosch					406 219			
All engines	ch. 53-E-046 001 ->, ->ch. 53-J-020 000, ch. 53-L-000 001 ->						470 125	C10	
All engines	ch. 53-K-000 001 ->, ->ch. 53-K-020 000						470 126	C10	
All engines	->ch. 53-E-046 000						470 132	C10	359 727
All engines								465 007	
All engines	ch. 53-E-046 001 ->								359 725

ENGINE				
1.8 16V	Petrol	102	10/85-07/89	KR

Engine	Information	A10	A20	A40	A50	A70	C10 - C30	C20	E01
All engines	version Bosch			806 266	906 121R	406 223			
All engines	ch. 53-E-046 001 ->, ->ch. 53-J-020 000, ch. 53-L-000 001 ->						470 125	C10	
All engines	ch. 53-K-000 001 ->, ->ch. 53-K-020 000						470 126	C10	
All engines	->ch. 53-E-046 000						470 132	C10	
All engines								465 007	359 737

ENGINE				
1.8 16V	Petrol	95	03/86-07/92	PL

Engine	Information	A10	A20	A40	A50	A70	C10 - C30	C20	E01
All engines	version Bosch			806 266	906 121R	406 223			
All engines	ch. 53-L-000 001 ->						470 125	C10	
All engines	->ch. 53-K-020 000						470 126	C10	
All engines								465 007	359 737

SCIROCCO III

ENGINE				
1.4 TSI	Petrol	110	07/15-11/17	CZDA

Engine	Information	A10	A20	A40	A50	A70	C10 - C30	C20	E01
All engines	x 4, BERU, ELDOR, COIL ON PLUG, incl. spark plug connector, Number of pins:4, incl. spark plug connector						470 599	C10	

ENGINE				
1.4 TSI	Petrol	118	05/08-11/17	CAVD, CNWA, CTHD, CTKA

Engine	Information	A10	A20	A40	A50	A70	C10 - C30	C20	E01
All engines	x 4, COIL ON PLUG, incl. spark plug connector						470 474	C10	

ENGINE				
1.4 TSI	Petrol	90	08/08-11/17	CAXA, CMSB

Engine	Information	A10	A20	A40	A50	A70	C10 - C30	C20	E01
All engines	x 4, COIL ON PLUG, incl. spark plug connector						470 474	C10	

ENGINE				
1.4 TSI	Petrol	92	11/13-11/17	CZCA

Engine	Information	A10	A20	A40	A50	A70	C10 - C30	C20	E01
All engines	x 4, BERU, ELDOR, COIL ON PLUG, incl. spark plug connector, Number of pins:4, incl. spark plug connector						470 599	C10	

ENGINE				
1.4 TSI	Petrol	96	07/15->	CZDC

Engine	Information	A10	A20	A40	A50	A70	C10 - C30	C20	E01
All engines	Qty: 4						470 599	C10	









ENGINE				
2.0 R	Petrol	188	11/09-11/17	CDLC

Engine	Information	A10	A20	A40	A50	A70	C10 - C30	C20	E01
All engines	x 4, ELDOR, Housing Colour:Black, COIL ON PLUG, incl. spark plug connector						470 426	C10	

ENGINE				
2.0 R	Petrol	195	11/09-11/17	CDLA









Engine	Information	A10	A20	A40	A50	A70	C10 - C30	C20	E01
All engines	x 4, ELDOR, Housing Colour:Black, COIL ON PLUG, incl. spark plug connector						470 426	C10	

A10 CONDENSER	A20 CONTACT SET	A40 DISTRIBUTOR CAP	A50 ROTOR	A70 PICK-UP
C10 COIL	C20 IGNITION MODULE	C30 ELECTRONIC IGNITION KIT	E01 IGNITION CABLE SET	

					FUNCTIONS ON THE VEHICLE												
Vehicle	alim.	kW	Date	Engine	 A10	 A20	 A40	 A50	 A70	 C10 - C30	 C20	 E01					
ENGINE																	
2.0 R	Petrol	206	05/14-11/17	CDLK													
Engine	Information			A10	A20	A40	A50	A70	C10 - C30	C20	E01						
All engines	x 4, ELDOR, Housing Colour:Black, COIL ON PLUG, incl. spark plug connector								470 426	C10							
ENGINE																	
2.0 TFSI	Petrol	147	05/08-11/09	CAWB													
Engine	Information			A10	A20	A40	A50	A70	C10 - C30	C20	E01						
All engines	x 4, ELDOR, Housing Colour:Black, COIL ON PLUG, incl. spark plug connector								470 426	C10							
ENGINE																	
2.0 TFSi	Petrol	155	11/09-05/14	CCZB													
Engine	Information			A10	A20	A40	A50	A70	C10 - C30	C20	E01						
All engines	x 4, ELDOR, Housing Colour:Black, COIL ON PLUG, incl. spark plug connector								470 426	C10							
ENGINE																	
2.0 TSI	Petrol	155	11/09-11/17	CCZB													
Engine	Information			A10	A20	A40	A50	A70	C10 - C30	C20	E01						
All engines	x 4, ELDOR, Housing Colour:Black, COIL ON PLUG, incl. spark plug connector								470 426	C10							
SHARAN I																	
1.8 T 20V	Petrol	110	09/97-03/10	AJH, AWC													
Engine	Information			A10	A20	A40	A50	A70	C10 - C30	C20	E01						
Eng. AJH	x 4, COIL ON PLUG								470 3545	C10							
Eng. AWC	x 4, COIL ON PLUG, incl. spark plug connector								470 445	C10							
Eng. AJH											465 076						
ENGINE																	
2.0	Petrol	85	09/95-03/10	ADY, ATM													
Engine	Information			A10	A20	A40	A50	A70	C10 - C30	C20	E01						
Eng. ADY	version Bosch					806 266	906 121R										
Eng. ADY									490 414	C30		360 667					
Eng. ATM									490 420	C30		360 585					
ENGINE																	
2.0 LPG	Petrol/ Liquified Petro- leum Gas (LPG)	85	04/06-03/10	ATM													
Engine	Information			A10	A20	A40	A50	A70	C10 - C30	C20	E01						
All engines									490 420	C30		360 585					
ENGINE																	
2.8 V6 24V	Petrol	150	04/00-03/10	AYL													
Engine	Information			A10	A20	A40	A50	A70	C10 - C30	C20	E01						
All engines	x 6, COIL ON PLUG								470 435	C10							
ENGINE																	
2.8 V6 24V 4motion	Petrol	150	04/00-03/10	AYL													
Engine	Information			A10	A20	A40	A50	A70	C10 - C30	C20	E01						
All engines	x 6, COIL ON PLUG								470 435	C10							
ENGINE																	
2.8 VR6	Petrol	150	08/01-05/03	AYL													
Engine	Information			A10	A20	A40	A50	A70	C10 - C30	C20	E01						
All engines	x 6, COIL ON PLUG								470 435	C10							
SHARAN II																	
1.4 TSI	Petrol	110	05/10->	CAVA, CTHA, CZDA, DJKA													
Engine	Information			A10	A20	A40	A50	A70	C10 - C30	C20	E01						
Eng. CAVA, CTHA	x 4, COIL ON PLUG, x 4, COIL ON PLUG, incl. spark plug connector, incl. spark plug connector								470 474	C10							
Eng. CZDA, DJKA	x 4, BERU, ELDOR, HITACHI, COIL ON PLUG, incl. spark plug connector, Number of pins:4, incl. spark plug connector								470 599	C10							
ENGINE																	
1.8 TSI	Petrol	118	11/11->	CDAA													
Engine	Information			A10	A20	A40	A50	A70	C10 - C30	C20	E01						
All engines	Qty: 4								470 426	C10							
A10	CONDENSER	A20	CONTACT SET	A40	DISTRIBUTOR CAP	A50	ROTOR	A70	PICK-UP	C10	COIL	C20	IGNITION MODULE	C30	ELECTRONIC IGNITION KIT	E01	IGNITION CABLE SET

Vehicle	alim.	kW	Date	Engine	FUNCTIONS ON THE VEHICLE							
					A10	A20	A40	A50	A70	C10 - C30	C20	E01
ENGINE												
2.0 TFSI	Petrol	147	12/10-11/15	CCZA								
Engine	Information				A10	A20	A40	A50	A70	C10 - C30	C20	E01
All engines	x 4, ELDOR, Housing Colour:Black, COIL ON PLUG, incl. spark plug connector									470 426	C10	
ENGINE												
2.0 TSI	Petrol	147	12/10-11/15	CCZA								
Engine	Information				A10	A20	A40	A50	A70	C10 - C30	C20	E01
All engines	x 4, ELDOR, Housing Colour:Black, COIL ON PLUG, incl. spark plug connector									470 426	C10	
SPACEFOX / SPACE CROSS												
ENGINE												
1.6	Petrol	74	03/06->	BAH, BLH								
Engine	Information				A10	A20	A40	A50	A70	C10 - C30	C20	E01
All engines										490 420	C30	360 723
ENGINE												
1.6 FSI	Petrol	74	03/06->	BPA, CCRA, CFZA								
Engine	Information				A10	A20	A40	A50	A70	C10 - C30	C20	E01
All engines										490 420	C30	360 723
ENGINE												
1.6 Total Flex	Flexfuel	74	03/06->	BPA, CCRA, CFZA								
Engine	Information				A10	A20	A40	A50	A70	C10 - C30	C20	E01
All engines										490 420	C30	360 723
TAIGO												
ENGINE												
1.0 TSI	Petrol	70	09/21->	DLAC								
Engine	Information				A10	A20	A40	A50	A70	C10 - C30	C20	E01
All engines	x 4, ELDOR, HITACHI, COIL ON PLUG, incl. spark plug connector									470 599	C10	
ENGINE												
1.0 TSI	Petrol	81	09/21->	DLAA								
Engine	Information				A10	A20	A40	A50	A70	C10 - C30	C20	E01
All engines	x 4, ELDOR, HITACHI, COIL ON PLUG, incl. spark plug connector									470 599	C10	
TAOS												
ENGINE												
1.4 TSI	Petrol	110	10/20->	DJKA								
Engine	Information				A10	A20	A40	A50	A70	C10 - C30	C20	E01
All engines	x 4, ELDOR, HITACHI, COIL ON PLUG, incl. spark plug connector									470 599	C10	
ENGINE												
1.4 TSI 4motion	Petrol	110	05/21->	DJKA								
Engine	Information				A10	A20	A40	A50	A70	C10 - C30	C20	E01
All engines	x 4, ELDOR, HITACHI, COIL ON PLUG, incl. spark plug connector									470 599	C10	
ENGINE												
1.6 MPI	Petrol	81	07/21->	DWYA								
Engine	Information				A10	A20	A40	A50	A70	C10 - C30	C20	E01
All engines	x 4, ELDOR, HITACHI, COIL ON PLUG, incl. spark plug connector									470 599	C10	
TARO												
ENGINE												
1.8	Petrol	61	04/89-09/94	2Y								
Engine	Information				A10	A20	A40	A50	A70	C10 - C30	C20	E01
All engines	->ch. 7A-L9503 250, ->ch. 7A-LH003 500, version Denso					713 011HV	813 114	913 014				
All engines	ch. 7A-L9503 251 ->, ch. 7A-LH003 501 ->, version Denso						813 113	913 027				
ENGINE												
2.2	Petrol	69	06/89-07/94	4Y								
Engine	Information				A10	A20	A40	A50	A70	C10 - C30	C20	E01
All engines	->ch. 7A-L9503 250, ->ch. 7A-LH003 500, version Denso					713 011HV	813 114	913 014				
All engines	ch. 7A-L9503 251 ->, ch. 7A-LH003 501 ->, version Denso						813 113	913 027				

A10 CONDENSER	A20 CONTACT SET	A40 DISTRIBUTOR CAP	A50 ROTOR	A70 PICK-UP
C10 COIL	C20 IGNITION MODULE	C30 ELECTRONIC IGNITION KIT	E01 IGNITION CABLE SET	









					FUNCTIONS ON THE VEHICLE							
Vehicle	alim.	kW	Date	Engine	 A10	 A20	 A40	 A50	 A70	 C10 - C30	 C20	 E01
ENGINE												
2.2 4x4	Petrol	69	06/89-07/94	4Y								
Engine	Information				A10	A20	A40	A50	A70	C10 - C30	C20	E01
All engines	->ch. 7A-L9503 250, ->ch. 7A-LH003 500, version Denso					713 011HV	813 114	913 014				
All engines	ch. 7A-L9503 251 ->, ch. 7A-LH003 501 ->, version Denso						813 113	913 027				
ENGINE												
2.4 i 4x4	Petrol	84	06/89-03/97	22R								
Engine	Information				A10	A20	A40	A50	A70	C10 - C30	C20	E01
All engines	->ch. 7A-N9510 000, version Denso						813 099					
All engines	ch. 7A-P9500 001 ->, version Denso						813 273					
All engines	ch. 7A-P9500 001 ->									470 203	C10	
T-CROSS												
ENGINE												
1.0 TSi	Petrol	70	12/18->	CHZL, DKLA, DLAC								
Engine	Information				A10	A20	A40	A50	A70	C10 - C30	C20	E01
All engines	x 3, BERU, ELDOR, HITACHI, COIL ON PLUG, incl. spark plug connector, Number of pins:4, incl. spark plug connector									470 599	C10	
ENGINE												
1.0 TSi	Petrol	81	06/20->	DLAA								
Engine	Information				A10	A20	A40	A50	A70	C10 - C30	C20	E01
All engines	x 3, BERU, COIL ON PLUG, incl. spark plug connector									470 599	C10	
ENGINE												
1.0 TSi	Petrol	85	12/18->	DKJA, DKRF								
Engine	Information				A10	A20	A40	A50	A70	C10 - C30	C20	E01
All engines	x 3, BERU, ELDOR, HITACHI, COIL ON PLUG, incl. spark plug connector, Number of pins:4, incl. spark plug connector									470 599	C10	
TIGUAN I												
ENGINE												
1.4 [CHN]	Petrol	96	11/11->	CFBA.								
Engine	Information				A10	A20	A40	A50	A70	C10 - C30	C20	E01
All engines	Qty: 4									470 474	C10	
ENGINE												
1.4 TSi	Petrol	110	05/08-07/18	BWK, CAVA, CZDA								
Engine	Information				A10	A20	A40	A50	A70	C10 - C30	C20	E01
Eng. BWK	Qty: 4									470 474	C10	
Eng. CAVA	x 4, COIL ON PLUG, incl. spark plug connector									470 474	C10	
Eng. CZDA	x 4, BERU, ELDOR, COIL ON PLUG, incl. spark plug connector, Number of pins:4, incl. spark plug connector									470 599	C10	
ENGINE												
1.4 TSi	Petrol	118	05/11-07/18	CAVD, CTHD								
Engine	Information				A10	A20	A40	A50	A70	C10 - C30	C20	E01
All engines	x 4, COIL ON PLUG, incl. spark plug connector									470 474	C10	
ENGINE												
1.4 TSi	Petrol	90	08/10-07/18	CAXA								
Engine	Information				A10	A20	A40	A50	A70	C10 - C30	C20	E01
All engines	x 4, COIL ON PLUG, incl. spark plug connector									470 474	C10	
ENGINE												
1.4 TSi	Petrol	92	05/15-07/18	CZDB								
Engine	Information				A10	A20	A40	A50	A70	C10 - C30	C20	E01
All engines	x 4, BERU, ELDOR, COIL ON PLUG, incl. spark plug connector, Number of pins:4, incl. spark plug connector									470 599	C10	
ENGINE												
1.4 TSi 4motion	Petrol	110	09/07-07/18	BWK, CAVA								
Engine	Information				A10	A20	A40	A50	A70	C10 - C30	C20	E01
All engines	x 4, COIL ON PLUG, incl. spark plug connector									470 474	C10	
ENGINE												
1.4 TSi 4motion	Petrol	118	05/11-07/18	CAVD, CTHD								
Engine	Information				A10	A20	A40	A50	A70	C10 - C30	C20	E01
All engines	x 4, COIL ON PLUG, incl. spark plug connector									470 474	C10	

A10 CONDENSER	A20 CONTACT SET	A40 DISTRIBUTOR CAP	A50 ROTOR	A70 PICK-UP
C10 COIL	C20 IGNITION MODULE	C30 ELECTRONIC IGNITION KIT	E01 IGNITION CABLE SET	

Vehicle	alim.	kW	Date	Engine	FUNCTIONS ON THE VEHICLE							
					A10	A20	A40	A50	A70	C10 - C30	C20	E01
ENGINE												
2.0 TFSI	Petrol	125	05/08->	CCTB								
Engine	Information			A10	A20	A40	A50	A70	C10 - C30	C20	E01	
All engines	Qty: 4								470 426	C10		
ENGINE												
2.0 TFSI	Petrol	147	11/07-07/18	CAWB, CCTA								
Engine	Information			A10	A20	A40	A50	A70	C10 - C30	C20	E01	
All engines	x 4, ELDOR, Housing Colour:Black, COIL ON PLUG, incl. spark plug connector								470 426	C10		
ENGINE												
2.0 TFSI 4motion	Petrol	125	09/07-07/18	CAWA, CCTB, CCZC								
Engine	Information			A10	A20	A40	A50	A70	C10 - C30	C20	E01	
All engines	x 4, ELDOR, Housing Colour:Black, COIL ON PLUG, incl. spark plug connector								470 426	C10		
ENGINE												
2.0 TFSI 4motion	Petrol	147	09/07-07/18	CAWB, CCTA, CCZA								
Engine	Information			A10	A20	A40	A50	A70	C10 - C30	C20	E01	
All engines	x 4, ELDOR, Housing Colour:Black, COIL ON PLUG, incl. spark plug connector								470 426	C10		
ENGINE												
2.0 TSI 4motion	Petrol	125	11/09-05/11	CCZC								
Engine	Information			A10	A20	A40	A50	A70	C10 - C30	C20	E01	
All engines	x 4, ELDOR, Housing Colour:Black, COIL ON PLUG, incl. spark plug connector								470 426	C10		
ENGINE												
2.0 TSI 4motion	Petrol	132	05/11-07/18	CCZD								
Engine	Information			A10	A20	A40	A50	A70	C10 - C30	C20	E01	
All engines	x 4, ELDOR, Housing Colour:Black, COIL ON PLUG, incl. spark plug connector								470 426	C10		
ENGINE												
2.0 TSI 4motion	Petrol	147	11/09-05/11	CCZA								
Engine	Information			A10	A20	A40	A50	A70	C10 - C30	C20	E01	
All engines	x 4, ELDOR, Housing Colour:Black, COIL ON PLUG, incl. spark plug connector								470 426	C10		
ENGINE												
2.0 TSI 4motion	Petrol	155	05/11-07/18	CCZB								
Engine	Information			A10	A20	A40	A50	A70	C10 - C30	C20	E01	
All engines	x 4, ELDOR, Housing Colour:Black, COIL ON PLUG, incl. spark plug connector								470 426	C10		
TIGUAN II												
ENGINE												
1.4 TSI	Petrol	110	05/16->	CZDA, CZEA, DJVA								
Engine	Information			A10	A20	A40	A50	A70	C10 - C30	C20	E01	
All engines	x 4, BERU, ELDOR, HITACHI, COIL ON PLUG, incl. spark plug connector, Number of pins:4, incl. spark plug connector								470 599	C10		
ENGINE												
1.4 TSI	Petrol	92	01/16->	CZCA, CZDB								
Engine	Information			A10	A20	A40	A50	A70	C10 - C30	C20	E01	
All engines	x 4, BERU, ELDOR, HITACHI, COIL ON PLUG, incl. spark plug connector, Number of pins:4, incl. spark plug connector								470 599	C10		
ENGINE												
1.4 TSI 4motion	Petrol	110	05/16-07/18	CZDA, CZEA								
Engine	Information			A10	A20	A40	A50	A70	C10 - C30	C20	E01	
All engines	x 4, BERU, ELDOR, HITACHI, COIL ON PLUG, incl. spark plug connector, Number of pins:4, incl. spark plug connector								470 599	C10		
ENGINE												
2.0 TSI	Petrol	137	04/17->	DGUA, DTEA								
Engine	Information			A10	A20	A40	A50	A70	C10 - C30	C20	E01	
All engines	x 4, HITACHI, x 4, BERU, COIL ON PLUG, HITACHI, COIL ON PLUG, incl. spark plug connector, incl. spark plug connector								470 636	C10		
ENGINE												
2.0 TSI 4motion	Petrol	132	01/16->	CZPA, DGVA								
Engine	Information			A10	A20	A40	A50	A70	C10 - C30	C20	E01	
All engines	x 4, HITACHI, x 4, BERU, COIL ON PLUG, HITACHI, COIL ON PLUG, incl. spark plug connector, incl. spark plug connector								470 636	C10		

A10 CONDENSER	A20 CONTACT SET	A40 DISTRIBUTOR CAP	A50 ROTOR	A70 PICK-UP
C10 COIL	C20 IGNITION MODULE	C30 ELECTRONIC IGNITION KIT	E01 IGNITION CABLE SET	

The present application list is a brief version. For the detailed information about the possibility of installation on a specific vehicle, please refer to our web-catalogue <http://catalogo.facet.eu/>

					FUNCTIONS ON THE VEHICLE							
Vehicle	alim.	kW	Date	Engine								
ENGINE												
2.0 TSI 4motion	Petrol	137	04/17->	DGUA, DTEA								
Engine	Information			A10	A20	A40	A50	A70	C10 - C30	C20	E01	
All engines	x 4, HITACHI, x 4, BERU, COIL ON PLUG, HITACHI, COIL ON PLUG, incl. spark plug connector, incl. spark plug connector								470 636	C10		
ENGINE												
2.0 TSI 4motion	Petrol	140	09/18->	DKZA, DNLA, DNNA								
Engine	Information			A10	A20	A40	A50	A70	C10 - C30	C20	E01	
All engines	x 4, HITACHI, COIL ON PLUG, incl. spark plug connector								470 636	C10		
ENGINE												
2.0 TSI 4motion	Petrol	162	07/17->	CXDA, DNJA								
Engine	Information			A10	A20	A40	A50	A70	C10 - C30	C20	E01	
All engines	x 4, BERU, HITACHI, COIL ON PLUG, incl. spark plug connector								470 636	C10		
ENGINE												
2.0 TSI 4motion	Petrol	180	09/20->	DNPA								
Engine	Information			A10	A20	A40	A50	A70	C10 - C30	C20	E01	
All engines	x 4, HITACHI, COIL ON PLUG, incl. spark plug connector								470 636	C10		
ENGINE												
2.0 TSI R 4motion	Petrol	235	11/20->	DNFG								
Engine	Information			A10	A20	A40	A50	A70	C10 - C30	C20	E01	
All engines	x 4, HITACHI, COIL ON PLUG, incl. spark plug connector								470 636	C10		
ENGINE												
3.2 V6	Petrol	162	10/02-11/06	AZZ, BAA, BKJ, BMV, BMX, BRJ								
Engine	Information			A10	A20	A40	A50	A70	C10 - C30	C20	E01	
Eng. AZZ, BKJ, BMV, BMX, BRJ	->year 01/06/06, x 6, COIL ON PLUG								470 434	C10		
Eng. BAA	Qty: 6								470 434	C10		
ENGINE												
3.2 V6	Petrol	177	11/04-11/06	BKJ, BMV, BMX, BRJ								
Engine	Information			A10	A20	A40	A50	A70	C10 - C30	C20	E01	
All engines	->year 01/05/05, ->ch. 7L5090000, x 6, COIL ON PLUG 01/06/05 ->, ch. 7L6000001 ->, x 6, COIL ON PLUG								470 434	C10		
ENGINE												
3.6 V6 FSI	Petrol	206	10/05-05/10	BHL								
Engine	Information			A10	A20	A40	A50	A70	C10 - C30	C20	E01	
All engines	Qty: 6								470 434	C10		
ENGINE												
4.2 V8	Petrol	228	12/02-11/06	AXQ								
Engine	Information			A10	A20	A40	A50	A70	C10 - C30	C20	E01	
All engines	->year 01/05/05, x 8, COIL ON PLUG								470 425	C10		
All engines	01/06/05 ->, x 8, Colour:Red, COIL ON PLUG, incl. spark plug connector								470 427	C10		
ENGINE												
4.2 V8 FSI	Petrol	257	06/06-05/10	BAR								
Engine	Information			A10	A20	A40	A50	A70	C10 - C30	C20	E01	
All engines	x 8, ELDOR, Housing Colour:Black, COIL ON PLUG, incl. spark plug connector								470 426	C10		
All engines	x 8, Colour:Red, COIL ON PLUG, incl. spark plug connector								470 427	C10		
ENGINE												
2.0 TFSi 4motion	Petrol	183	05/18->	CYRC								
Engine	Information			A10	A20	A40	A50	A70	C10 - C30	C20	E01	
All engines	x 4, HITACHI, COIL ON PLUG, incl. spark plug connector								470 636	C10		
ENGINE												
3.0 TFSi	Petrol	235	01/15->	CYJA								
Engine	Information			A10	A20	A40	A50	A70	C10 - C30	C20	E01	
All engines	Qty: 6								470 427	C10		
ENGINE												
3.0 V6 TSI	Petrol	213	08/10-03/18	CJTA								
Engine	Information			A10	A20	A40	A50	A70	C10 - C30	C20	E01	
All engines	x 6, Colour:Red, COIL ON PLUG, incl. spark plug connector								470 427	C10		

A10 CONDENSER	A20 CONTACT SET	A40 DISTRIBUTOR CAP	A50 ROTOR	A70 PICK-UP
C10 COIL	C20 IGNITION MODULE	C30 ELECTRONIC IGNITION KIT	E01 IGNITION CABLE SET	

Vehicle	alim.	kW	Date	Engine	FUNCTIONS ON THE VEHICLE									
					A10	A20	A40	A50	A70	C10 - C30	C20	E01		
ENGINE														
3.0 V6 TSI Hybrid	Petrol/ Electric	245	04/10-03/18	CGEA, CGFA										
Engine	Information				A10	A20	A40	A50	A70	C10 - C30	C20	E01		
All engines	x 6, Colour:Red, COIL ON PLUG, incl. spark plug connector									470 427	C10			
ENGINE														
4.2 V8 FSI	Petrol	265	01/11-03/18	CGNA										
Engine	Information				A10	A20	A40	A50	A70	C10 - C30	C20	E01		
All engines	x 8, Colour:Red, COIL ON PLUG, incl. spark plug connector									470 427	C10			
TOURAN I														
ENGINE														
1.2 TSI	Petrol	77	05/10-05/15	CBZB										
Engine	Information				A10	A20	A40	A50	A70	C10 - C30	C20	E01		
All engines										490 420	C30		358 248	
ENGINE														
1.4 TSI	Petrol	103	02/06-05/15	BMY, CAVC, CTHC										
Engine	Information				A10	A20	A40	A50	A70	C10 - C30	C20	E01		
All engines	x 4, COIL ON PLUG, incl. spark plug connector									470 474	C10			
ENGINE														
1.4 TSI	Petrol	125	11/06-05/15	BLG, CAVB, CTHB										
Engine	Information				A10	A20	A40	A50	A70	C10 - C30	C20	E01		
All engines	x 4, COIL ON PLUG, incl. spark plug connector									470 474	C10			
ENGINE														
1.4 TSI EcoFuel	CNG	110	05/09-05/10	CDGA										
Engine	Information				A10	A20	A40	A50	A70	C10 - C30	C20	E01		
All engines	x 4, COIL ON PLUG, incl. spark plug connector									470 474	C10			
All engines	x 4, COIL ON PLUG, incl. spark plug connector									470 474	C10			
ENGINE														
1.6	Petrol	75	07/03-05/10	BGU, BSE, BSF										
Engine	Information				A10	A20	A40	A50	A70	C10 - C30	C20	E01		
All engines										490 420	C30		360 585	
ENGINE														
1.6 BiFuel	Petrol/ Liquified Petro- leum Gas (LPG)	75	11/06-05/10	BSF										
Engine	Information				A10	A20	A40	A50	A70	C10 - C30	C20	E01		
All engines										490 420	C30			
ENGINE														
1.6 FSI	Petrol	85	02/03-01/07	BAG, BLF, BLP										
Engine	Information				A10	A20	A40	A50	A70	C10 - C30	C20	E01		
All engines	x 4, COIL ON PLUG, incl. spark plug connector									470 474	C10			
Eng. BLP	Qty: 4									470 474	C10			
ENGINE														
2.0 EcoFuel	CNG	80	02/06-05/09	BSX										
Engine	Information				A10	A20	A40	A50	A70	C10 - C30	C20	E01		
All engines													358 223	
ENGINE														
2.0 FSI	Petrol	110	10/03-01/07	AXW, BLR, BLX, BLY, BVY, BVZ										
Engine	Information				A10	A20	A40	A50	A70	C10 - C30	C20	E01		
All engines	x 4, ELDOR, Housing Colour:Black, COIL ON PLUG, incl. spark plug connector									470 426	C10			
Eng. AXW, BLX, BVY	Qty: 4									470 426	C10			
ENGINE														
2.0 FSI	Petrol	85	10/04-05/10	BJZ										
Engine	Information				A10	A20	A40	A50	A70	C10 - C30	C20	E01		
All engines										490 420	C30		360 585	
ENGINE														
2.0 TDI [CHN]	Petrol	88	04/09->	CGZA										
Engine	Information				A10	A20	A40	A50	A70	C10 - C30	C20	E01		
All engines										490 420	C30		360 585	

A10 CONDENSER	A20 CONTACT SET	A40 DISTRIBUTOR CAP	A50 ROTOR	A70 PICK-UP
C10 COIL	C20 IGNITION MODULE	C30 ELECTRONIC IGNITION KIT	E01 IGNITION CABLE SET	

The present application list is a brief version. For the detailed information about the possibility of installation on a specific vehicle, please refer to our web-catalogue <http://catalogo.facet.eu/>

Vehicle	alim.	kW	Date	Engine	FUNCTIONS ON THE VEHICLE							
					A10	A20	A40	A50	A70	C10 - C30	C20	E01

				ENGINE
FSI	Petrol	85	02/03-11/06	BAG, BLF, BLP

Engine	Information	A10	A20	A40	A50	A70	C10 - C30	C20	E01
All engines	x 4, COIL ON PLUG, incl. spark plug connector						470 474	C10	

TOURAN II

				ENGINE
1.0 TSI	Petrol	85	12/18->	DKRB

Engine	Information	A10	A20	A40	A50	A70	C10 - C30	C20	E01
All engines	x 3, BERU, ELDOR, COIL ON PLUG, incl. spark plug connector, Number of pins:4, incl. spark plug connector						470 599	C10	

				ENGINE
1.2 TSI	Petrol	81	05/15->	CVVB

Engine	Information	A10	A20	A40	A50	A70	C10 - C30	C20	E01
All engines	x 4, BERU, ELDOR, HITACHI, COIL ON PLUG, incl. spark plug connector, Number of pins:4, incl. spark plug connector						470 599	C10	

				ENGINE
1.4 TSI	Petrol	110	05/15->	CZDA

Engine	Information	A10	A20	A40	A50	A70	C10 - C30	C20	E01
All engines	x 4, BERU, ELDOR, HITACHI, COIL ON PLUG, incl. spark plug connector, Number of pins:4, incl. spark plug connector						470 599	C10	

				ENGINE
1.8 TSI	Petrol	132	11/15->	CJSA

Engine	Information	A10	A20	A40	A50	A70	C10 - C30	C20	E01
All engines	->year 01/09/18, x 4, HITACHI, COIL ON PLUG, incl. spark plug connector						470 636	C10	

TRANSPORTER II

				ENGINE
2.0	Petrol	51	08/75-04/79	CJ, GD, GE

Engine	Information	A10	A20	A40	A50	A70	C10 - C30	C20	E01
All engines					906 067R				

TRANSPORTER III

				ENGINE
1.9	Petrol	44	08/82-07/92	DF

Engine	Information	A10	A20	A40	A50	A70	C10 - C30	C20	E01
All engines					906 067R			465 007	358 159
All engines	ch. 24-L-000 001 ->						470 125	C10	
All engines	->ch. 24-K-175 000						470 126	C10	

				ENGINE
1.9	Petrol	57	08/82-07/92	DG

Engine	Information	A10	A20	A40	A50	A70	C10 - C30	C20	E01
All engines					906 067R			465 007	358 159
All engines	ch. 24-L-000 001 ->						470 125	C10	
All engines	->ch. 24-K-175 000						470 126	C10	

				ENGINE
1.9 Syncro	Petrol	57	11/84-07/92	DG

Engine	Information	A10	A20	A40	A50	A70	C10 - C30	C20	E01
All engines					906 067R			465 007	358 159
All engines	ch. 24-L-000 001 ->						470 125	C10	
All engines	->ch. 24-K-175 000						470 126	C10	

				ENGINE
2.1	Petrol	64	10/86-07/92	SR

Engine	Information	A10	A20	A40	A50	A70	C10 - C30	C20	E01
All engines							470 125	C10	465 007

				ENGINE
2.1	Petrol	70	08/85-07/92	MV

Engine	Information	A10	A20	A40	A50	A70	C10 - C30	C20	E01
All engines							470 125	C10	465 007

				ENGINE
2.1	Petrol	82	08/84-07/92	DJ

Engine	Information	A10	A20	A40	A50	A70	C10 - C30	C20	E01
All engines	ch. 24-L-000 001 ->						470 125	C10	
All engines	->ch. 24-K-175 000						470 126	C10	
All engines								465 007	358 159

A10 CONDENSER	A20 CONTACT SET	A40 DISTRIBUTOR CAP	A50 ROTOR	A70 PICK-UP
C10 COIL	C20 IGNITION MODULE	C30 ELECTRONIC IGNITION KIT	E01 IGNITION CABLE SET	

Vehicle	alim.	kW	Date	Engine	FUNCTIONS ON THE VEHICLE							
					A10	A20	A40	A50	A70	C10 - C30	C20	E01
ENGINE												
2.1 Cat	Petrol	70	06/89-07/92	MV								
Engine	Information				A10	A20	A40	A50	A70	C10 - C30	C20	E01
All engines										470 125	C10	465 007
ENGINE												
2.1 i	Petrol	68	07/89-07/92	SS								
Engine	Information				A10	A20	A40	A50	A70	C10 - C30	C20	E01
All engines										470 125	C10	465 007
ENGINE												
2.1 Syncro	Petrol	64	10/86-07/92	SR								
Engine	Information				A10	A20	A40	A50	A70	C10 - C30	C20	E01
All engines										470 125	C10	465 007
ENGINE												
2.1 Syncro	Petrol	70	08/85-07/92	MV								
Engine	Information				A10	A20	A40	A50	A70	C10 - C30	C20	E01
All engines										470 125	C10	465 007
ENGINE												
2.1 Syncro	Petrol	82	01/86-07/92	DJ								
Engine	Information				A10	A20	A40	A50	A70	C10 - C30	C20	E01
All engines	ch. 24-L-000 001 ->									470 125	C10	
All engines	->ch. 24-K-175 000									470 126	C10	
All engines											465 007	358 159
TRANSPORTER IV												
ENGINE												
1.8	Petrol	49	12/90-07/92	5K7M 710								
Engine	Information				A10	A20	A40	A50	A70	C10 - C30	C20	E01
All engines	version Bosch						806 266	906 055R				
All engines										490 416	C30	
All engines	->ch. 70-N-180 000											360 671
ENGINE												
2.0	Petrol	62	07/90-04/03	AAC								
Engine	Information				A10	A20	A40	A50	A70	C10 - C30	C20	E01
All engines	->ch. 70-M-040 000, version Bosch						806 094					
All engines	ch. 70-M-040 001 ->, version Bosch						806 266					
All engines	version Bosch							906 121R				
All engines										490 414	C30	
All engines	->ch. 70-N-180 000											360 671
ENGINE												
2.5	Petrol	81	09/90-06/03	AAF, ACU, AEU								
Engine	Information				A10	A20	A40	A50	A70	C10 - C30	C20	E01
All engines	version Bosch						806 231	906 121R				
Eng. ACU, AEU	version Bosch								406 223			
All engines										490 414	C30	
ENGINE												
2.5	Petrol	85	08/96-04/03	AET, APL, AVT								
Engine	Information				A10	A20	A40	A50	A70	C10 - C30	C20	E01
All engines	version Bosch						806 231	906 121R	406 223			
All engines										490 414	C30	
ENGINE												
2.5 Syncro	Petrol	81	08/92-04/03	AAF, ACU, AEU								
Engine	Information				A10	A20	A40	A50	A70	C10 - C30	C20	E01
All engines	version Bosch						806 231	906 121R				
Eng. ACU, AEU	version Bosch								406 223			
All engines										490 414	C30	
ENGINE												
2.5 Syncro	Petrol	85	07/96-04/03	AET, APL, AVT								
Engine	Information				A10	A20	A40	A50	A70	C10 - C30	C20	E01
All engines	version Bosch						806 231	906 121R	406 223			
All engines										490 414	C30	

A10	CONDENSER	A20	CONTACT SET	A40	DISTRIBUTOR CAP	A50	ROTOR	A70	PICK-UP
C10	COIL	C20	IGNITION MODULE	C30	ELECTRONIC IGNITION KIT	E01	IGNITION CABLE SET		

The present application list is a brief version. For the detailed information about the possibility of installation on a specific vehicle, please refer to our web-catalogue <http://catalogo.facet.eu/>

Vehicle	alim.	kW	Date	Engine	FUNCTIONS ON THE VEHICLE							
					A10	A20	A40	A50	A70	C10 - C30	C20	E01

TRANSPORTER V

2.0	Petrol	85	11/03-08/15	ENGINE AXA
-----	--------	----	-------------	---------------

Engine	Information	A10	A20	A40	A50	A70	C10 - C30	C20	E01
All engines							490 420 C30		360 585

2.0 BiFuel	Petrol/ Com- pressed Natural Gas (CNG)	85	05/11-08/15	ENGINE AXA
------------	---	----	-------------	---------------

Engine	Information	A10	A20	A40	A50	A70	C10 - C30	C20	E01
All engines							490 420 C30		

2.0 CNG	Petrol/ Com- pressed Natural Gas (CNG)	85	11/03-08/15	ENGINE AXACNG
---------	---	----	-------------	------------------

Engine	Information	A10	A20	A40	A50	A70	C10 - C30	C20	E01
All engines							490 420 C30		

2.0 TSI	Petrol	110	07/12-08/15	ENGINE CJKB
---------	--------	-----	-------------	----------------

Engine	Information	A10	A20	A40	A50	A70	C10 - C30	C20	E01
All engines	x 4, ELDOR, Housing Colour:Black, COIL ON PLUG, incl. spark plug connector						470 426 C10		

2.0 TSI	Petrol	150	05/11-08/15	ENGINE CJKA
---------	--------	-----	-------------	----------------

Engine	Information	A10	A20	A40	A50	A70	C10 - C30	C20	E01
All engines	x 4, ELDOR, Housing Colour:Black, COIL ON PLUG, incl. spark plug connector						470 426 C10		

2.0 TSI 4motion	Petrol	150	07/11-08/15	ENGINE CJKA
-----------------	--------	-----	-------------	----------------

Engine	Information	A10	A20	A40	A50	A70	C10 - C30	C20	E01
All engines	x 4, ELDOR, Housing Colour:Black, COIL ON PLUG, incl. spark plug connector						470 426 C10		

3.2 4motion	Petrol	170	11/03-11/09	ENGINE BDL
-------------	--------	-----	-------------	---------------

Engine	Information	A10	A20	A40	A50	A70	C10 - C30	C20	E01
All engines	x 6, COIL ON PLUG						470 434 C10		

3.2 4motion	Petrol	173	11/03-11/09	ENGINE BKK, CFLA
-------------	--------	-----	-------------	---------------------

Engine	Information	A10	A20	A40	A50	A70	C10 - C30	C20	E01
All engines	x 6, COIL ON PLUG						470 434 C10		

3.2 V6	Petrol	170	04/03-11/09	ENGINE BDL
--------	--------	-----	-------------	---------------

Engine	Information	A10	A20	A40	A50	A70	C10 - C30	C20	E01
All engines	x 6, COIL ON PLUG						470 434 C10		

3.2 V6	Petrol	173	08/03-11/09	ENGINE BKK, CFLA
--------	--------	-----	-------------	---------------------

Engine	Information	A10	A20	A40	A50	A70	C10 - C30	C20	E01
All engines	x 6, COIL ON PLUG						470 434 C10		
Eng. BKK	Qty: 6						470 434 C10		

3.2 V6 4motion	Petrol	170	04/03-06/05	ENGINE BDL
----------------	--------	-----	-------------	---------------

Engine	Information	A10	A20	A40	A50	A70	C10 - C30	C20	E01
All engines	x 6, COIL ON PLUG						470 434 C10		

3.2 V6 4motion	Petrol	173	11/03-12/09	ENGINE BKK, CFLA
----------------	--------	-----	-------------	---------------------

Engine	Information	A10	A20	A40	A50	A70	C10 - C30	C20	E01
All engines	x 6, COIL ON PLUG						470 434 C10		

A10 CONDENSER	A20 CONTACT SET	A40 DISTRIBUTOR CAP	A50 ROTOR	A70 PICK-UP
C10 COIL	C20 IGNITION MODULE	C30 ELECTRONIC IGNITION KIT	E01 IGNITION CABLE SET	

Vehicle	alim.	kW	Date	Engine	FUNCTIONS ON THE VEHICLE							
					A10	A20	A40	A50	A70	C10 - C30	C20	E01

TRANSPORTER VI

				ENGINE
2.0 TSI	Petrol	110	04/15-07/19	CJKB

Engine	Information	A10	A20	A40	A50	A70	C10 - C30	C20	E01
All engines	x 4, ELDOR, Housing Colour:Black, COIL ON PLUG, incl. spark plug connector						470 426	C10	

				ENGINE
2.0 TSI	Petrol	150	04/15-07/19	CJKA

Engine	Information	A10	A20	A40	A50	A70	C10 - C30	C20	E01
All engines	x 4, ELDOR, Housing Colour:Black, COIL ON PLUG, incl. spark plug connector						470 426	C10	

				ENGINE
2.0 TSI 4motion	Petrol	150	06/15-07/19	CJKA

Engine	Information	A10	A20	A40	A50	A70	C10 - C30	C20	E01
All engines	x 4, ELDOR, Housing Colour:Black, COIL ON PLUG, incl. spark plug connector						470 426	C10	

T-ROC

				ENGINE
1.0 TSI	Petrol	81	09/20->	DLA A

Engine	Information	A10	A20	A40	A50	A70	C10 - C30	C20	E01
All engines	x 3, ELDOR, HITACHI, COIL ON PLUG, incl. spark plug connector, Number of pins:4, incl. spark plug connector						470 599	C10	

				ENGINE
1.0 TSI	Petrol	85	07/17-11/20	CHZJ, DKRF

Engine	Information	A10	A20	A40	A50	A70	C10 - C30	C20	E01
All engines	x 3, BERU, ELDOR, HITACHI, x 3, BERU, COIL ON PLUG, ELDOR, HITACHI, COIL ON PLUG, incl. spark plug connector, Number of pins:4, incl. spark plug connector, Number of pins:4, incl. spark plug connector						470 599	C10	

				ENGINE
2.0 R 4motion	Petrol	221	09/19->	DNFC, DNU E

Engine	Information	A10	A20	A40	A50	A70	C10 - C30	C20	E01
All engines	01/11/19 ->, x 4, HITACHI, COIL ON PLUG, incl. spark plug connector						470 636	C10	

				ENGINE
2.0 TSI 4motion	Petrol	140	07/17->	CZPB, DKZA, DNNA

Engine	Information	A10	A20	A40	A50	A70	C10 - C30	C20	E01
All engines	01/10/18 ->, x 4, HITACHI, COIL ON PLUG, incl. spark plug connector						470 636	C10	

UP

				ENGINE
1.0	Petrol	44	08/11->	CHYA, CHYE, DAFA

Engine	Information	A10	A20	A40	A50	A70	C10 - C30	C20	E01
All engines	x 3, BERU, ELDOR, HITACHI, COIL ON PLUG, incl. spark plug connector, Number of pins:4, incl. spark plug connector						470 599	C10	
Eng. DAFA	Qty: 3						470 599	C10	

				ENGINE
1.0	Petrol	55	08/11-11/19	CHYB

Engine	Information	A10	A20	A40	A50	A70	C10 - C30	C20	E01
All engines	x 3, BERU, ELDOR, HITACHI, COIL ON PLUG, incl. spark plug connector, Number of pins:4, incl. spark plug connector						470 599	C10	



				ENGINE
1.0	Petrol	56	01/14->	--

Engine	Information	A10	A20	A40	A50	A70	C10 - C30	C20	E01
All engines	Qty: 3						470 599	C10	

				ENGINE
1.0 EcoFuel	Petrol/ Com- pressed Natural Gas (CNG)	50	11/12->	CPGA

Engine	Information	A10	A20	A40	A50	A70	C10 - C30	C20	E01
All engines	x 3, x 4, BERU, ELDOR, HITACHI, COIL ON PLUG, incl. spark plug connector, Number of pins:4, incl. spark plug connector						470 599	C10	

A10 CONDENSER	A20 CONTACT SET	A40 DISTRIBUTOR CAP	A50 ROTOR	A70 PICK-UP
C10 COIL	C20 IGNITION MODULE	C30 ELECTRONIC IGNITION KIT	E01 IGNITION CABLE SET	

					FUNCTIONS ON THE VEHICLE							
Vehicle	alim.	kW	Date	Engine	 A10	 A20	 A40	 A50	 A70	 C10 - C30	 C20	 E01
ENGINE												
1.0 GTI	Petrol	85	11/17->	DKRA								
Engine	Information			A10	A20	A40	A50	A70	C10 - C30	C20	E01	
All engines	x 3, BERU, ELDOR, HITACHI, COIL ON PLUG, incl. spark plug connector, Number of pins:4, incl. spark plug connector								470 599	C10		
ENGINE												
1.0 TSI	Petrol	66	05/16-09/18	CHZA, DKLC								
Engine	Information			A10	A20	A40	A50	A70	C10 - C30	C20	E01	
All engines	x 3, x 4, BERU, ELDOR, HITACHI, COIL ON PLUG, incl. spark plug connector, Number of pins:4, incl. spark plug connector								470 599	C10		
VENTO												
ENGINE												
1.4	Petrol	40	11/91-09/98	ABD, AEX								
Engine	Information			A10	A20	A40	A50	A70	C10 - C30	C20	E01	
Eng. ABD	version Bosch					806 094	906 121R	406 223				
All engines									490 414	C30		
Eng. ABD											359 493	
Eng. AEX	01/06/96 ->										360 640	
ENGINE												
1.4	Petrol	44	11/91-09/98	ABD, AEX, APQ								
Engine	Information			A10	A20	A40	A50	A70	C10 - C30	C20	E01	
Eng. ABD	version Bosch					806 094	906 121R	406 223				
All engines									490 414	C30		
Eng. ABD											359 493	
Eng. AEX	01/06/96 ->										360 640	
Eng. APQ											360 660	
ENGINE												
1.6	Petrol	55	09/92-09/98	ABU, AEA, AEE								
Engine	Information			A10	A20	A40	A50	A70	C10 - C30	C20	E01	
Eng. ABU, AEA	version Bosch					806 094	906 121R					
Eng. AEA	version Bosch							406 223				
All engines									490 414	C30		
Eng. ABU	->ch. 1H-P-560 000										359 736	
Eng. ABU	ch. 1H-P-560 001 ->										360 364	
Eng. AEA											360 549	
Eng. AEE	01/06/96 ->										360 609	
ENGINE												
1.6	Petrol	74	10/94-02/99	AEK, AFT, AKS								
Engine	Information			A10	A20	A40	A50	A70	C10 - C30	C20	E01	
All engines	version Bosch					806 266	906 121R	406 223				
Eng. AEK	version Ducellier					815 068	915 099R					
All engines									490 414	C30		
Eng. AEK											360 551	
Eng. AFT	->year 31/05/96										360 933	
Eng. AFT, AKS	01/06/96 ->										360 937	
ENGINE												
1.8	Petrol	55	11/91-09/98	AAM								
Engine	Information			A10	A20	A40	A50	A70	C10 - C30	C20	E01	
All engines	version Bosch					806 094	906 121R					
All engines	version Ducellier					815 068	915 099R					
All engines									490 414	C30		
All engines	->ch. 1H-R-990 000										359 725	
All engines	ch. 1H-S-000 001 ->										360 549	
ENGINE												
1.8	Petrol	66	11/91-02/99	ABS, ADZ, ANP								
Engine	Information			A10	A20	A40	A50	A70	C10 - C30	C20	E01	
Eng. ABS, ADZ	version Bosch					806 094	906 121R					
Eng. ABS, ADZ	version Ducellier					815 068	915 099R					
All engines									490 414	C30		
Eng. ABS											359 725	
Eng. ADZ, ANP											360 549	

A10 CONDENSER	A20 CONTACT SET	A40 DISTRIBUTOR CAP	A50 ROTOR	A70 PICK-UP
C10 COIL	C20 IGNITION MODULE	C30 ELECTRONIC IGNITION KIT	E01 IGNITION CABLE SET	

Vehicle	alim.	kW	Date	Engine	FUNCTIONS ON THE VEHICLE							
					A10	A20	A40	A50	A70	C10 - C30	C20	E01

ENGINE				
2.0	Petrol	85	11/91-09/98	2E, ADY, AGG, AKR

Engine	Information	A10	A20	A40	A50	A70	C10 - C30	C20	E01
Eng. 2E, ADY	version Bosch			806 094	906 121R				
All engines							490 414	C30	
Eng. AKR									359 725
Eng. 2E									359 965
Eng. ADY, AGG									360 549

ENGINE				
2.0 GL	Petrol	79	05/96-12/97	AEP

Engine	Information	A10	A20	A40	A50	A70	C10 - C30	C20	E01
All engines							490 414	C30	360 549









ENGINE				
2.8 VR6	Petrol	120	08/95-04/96	AAA

Engine	Information	A10	A20	A40	A50	A70	C10 - C30	C20	E01
All engines	->ch. 1H-PW480 000, ->ch. 1H-PB060 000, version Bosch			806 233					
All engines	->ch. 1H-NW300 000, ->ch. 1H-NB060 000, version Bosch				906 148R				
All engines	ch. 1H-NW300 001 ->, ->ch. 1H-PW480 000, ch. 1H-NB060 001 ->, ->ch. 1H-PB060 000, version Bosch				906 149R				
All engines	->ch. 1H-PW480 000						470 269	C10	

ENGINE				
2.8 VR6	Petrol	128	01/92-09/98	AAA

Engine	Information	A10	A20	A40	A50	A70	C10 - C30	C20	E01
All engines	->ch. 1H-PW480 000, ->ch. 1H-PB060 000, version Bosch			806 233					
All engines	->ch. 1H-NW300 000, ->ch. 1H-NB060 000, version Bosch				906 148R				
All engines	ch. 1H-NW300 001 ->, ->ch. 1H-PW480 000, ch. 1H-NB060 001 ->, ->ch. 1H-PB060 000, version Bosch				906 149R				
All engines	->ch. 1H-PW480 000						470 269	C10	

A10	CONDENSER	A20	CONTACT SET	A40	DISTRIBUTOR CAP	A50	ROTOR	A70	PICK-UP
C10	COIL	C20	IGNITION MODULE	C30	ELECTRONIC IGNITION KIT	E01	IGNITION CABLE SET		

					FUNCTIONS ON THE VEHICLE							
Vehicle	alim.	kW	Date	Engine	 A10	 A20	 A40	 A50	 A70	 C10 - C30	 C20	 E01
1300												
1.3	Petrol	43	01/68-10/71	ENGINE --, 12 H								
Engine Information					A10	A20	A40	A50	A70	C10 - C30	C20	E01
All engines							828 075	928 006				
1.3 TC												
1.3 TC	Petrol	48	10/71-10/73	ENGINE --, 12 H								
Engine Information					A10	A20	A40	A50	A70	C10 - C30	C20	E01
All engines							828 075	928 006				
16/60												
1.6	Petrol	46	01/61-12/71	ENGINE --								
Engine Information					A10	A20	A40	A50	A70	C10 - C30	C20	E01
All engines							828 075	928 006				
18/85												
1.8	Petrol	64	08/69-12/72	ENGINE --, 18HL								
Engine Information					A10	A20	A40	A50	A70	C10 - C30	C20	E01
All engines							828 075	928 006				
1.8 S												
1.8 S	Petrol	71	01/70-12/72	ENGINE --, 18HH								
Engine Information					A10	A20	A40	A50	A70	C10 - C30	C20	E01
All engines							828 075	928 006				
HORNET												
1.0	Petrol	28	01/61-12/70	ENGINE --, 99LFD								
Engine Information					A10	A20	A40	A50	A70	C10 - C30	C20	E01
All engines						728 083MHV		928 006				
SIX												
2.2	Petrol	82	01/72-10/75	ENGINE --								
Engine Information					A10	A20	A40	A50	A70	C10 - C30	C20	E01
All engines								928 007				

A10 CONDENSER	A20 CONTACT SET	A40 DISTRIBUTOR CAP	A50 ROTOR	A70 PICK-UP
C10 COIL	C20 IGNITION MODULE	C30 ELECTRONIC IGNITION KIT	E01 IGNITION CABLE SET	

Vehicle	alim.	kW	Date	Engine	FUNCTIONS ON THE VEHICLE							
					 A10	 A20	 A40	 A50	 A70	 C10 - C30	 C20	 E01

311

				ENGINE
1.1	Petrol	41	04/83-04/91	128A4

Engine	Information	A10	A20	A40	A50	A70	C10 - C30	C20	E01
All engines			706 029HV						

511

				ENGINE
1.1	Petrol	41	04/83-04/91	128A4

Engine	Information	A10	A20	A40	A50	A70	C10 - C30	C20	E01
All engines			706 029HV						

A10	CONDENSER	A20	CONTACT SET	A40	DISTRIBUTOR CAP	A50	ROTOR	A70	PICK-UP
C10	COIL	C20	IGNITION MODULE	C30	ELECTRONIC IGNITION KIT	E01	IGNITION CABLE SET		

The present application list is a brief version. For the detailed information about the possibility of installation on a specific vehicle, please refer to our web-catalogue <http://catalogo.facet.eu/>

Vehicle	alim.	kW	Date	Engine	FUNCTIONS ON THE VEHICLE							
					A10	A20	A40	A50	A70	C10 - C30	C20	E01

101

					ENGINE
1.1	Petrol	37	12/75-01/80		128 A.000

Engine	Information	A10	A20	A40	A50	A70	C10 - C30	C20	E01
All engines			730 140	830 081	930 036R		470 101D	C10	

					ENGINE
1.1	Petrol	40	06/73-01/90		128 A.000

Engine	Information	A10	A20	A40	A50	A70	C10 - C30	C20	E01
All engines	version Cajavec		707 701	807 701	907 701R				
All engines							470 101D	C10	

					ENGINE
1.1	Petrol	41	05/75-12/93		128 A.064

Engine	Information	A10	A20	A40	A50	A70	C10 - C30	C20	E01
All engines			730 140	830 081	930 036R		470 101D	C10	

					ENGINE
1.1 Super	Petrol	47	07/79-09/81		128 AC5.000

Engine	Information	A10	A20	A40	A50	A70	C10 - C30	C20	E01
All engines			730 140	830 081	930 036R		470 101D	C10	

YUGO

					ENGINE
0.9	Petrol	33	04/80-06/92		9A

Engine	Information	A10	A20	A40	A50	A70	C10 - C30	C20	E01
All engines	version Cajavec		707 701	807 701	907 701R				
All engines	version Marelli		730 140		930 036R				





A10	CONDENSER	A20	CONTACT SET	A40	DISTRIBUTOR CAP	A50	ROTOR	A70	PICK-UP
C10	COIL	C20	IGNITION MODULE	C30	ELECTRONIC IGNITION KIT	E01	IGNITION CABLE SET		



GLOSSARY OF FUNCTIONS ON THE VEHICLE

KW-IGN22Q1

· GLOSSARIO PER FUNZIONI SU VETTURA · GLOSSAIRE DES FONCTIONS SUR LE VÉHICULE · GLOSSAR NACH FUNKTION IM AUTO · GLOSARIO DE LAS FUNCIONES EN LOS VEHICULOS

#	ENGLISH 	ITALIANO 	FRANÇAIS 	DEUTSCH 	ESPAÑOL 
A10	CONDENSERS	CONDENSATORI	CONDENSATEURS	KONDENSATOREN	CONDENSADORES
A20	CONTACT SET	COPPIA CONTATTI	RUPTEUR	KONTAKTSATZ	PLATINOS
A40	DISTRIBUTOR CAP	CALOTTA	TETE D'ALLUMEUR	VERTEILERKAPPE	TAPA DEL DISTRIBUIDOR
A50	ROTOR	DISTRIBUTORE	DISRUPTEUR	VERTEILERLÄUFER	ROTOR DEL DISTRIBUIDOR
A70	PICK-UP	IMPULSORE	CAPTEUR	IMPULSGEBER	CAPTADOR
C10	COIL	BOBINA	BOBINE	ZÜNDSPULE	BOBINA
C20	IGNITION MODULE	MODULO DI ACCENSIONE	MODULES D'ALLUMAGE	ZÜNDUNGSMODUL	MÓDULO DE ENCENDIDO
C30	ELECTRONIC IGNITION KIT	KIT ACCENSIONE ELETTRONICA	KIT POUR ALLUMAGE ELECTRONIQUE	ELEKTRONISCHE ZÜNDUNGSSATZ	JUEGO DE ENCENDIDO ELECTRÓNICO
E01	IGNITION CABLE SET	SERIE CAVI COMPLETA	JEU CABLES D'ALLUMAGE	ZÜNDKABELSATZ	JUEGO DE CABLES DE ENCENDIDO



PRODUCTS BY VEHICLE MANUFACTURER

KW-IGN22Q1

-ELENCO PRODOTTI PER MARCA -PRODUITS PAR FABRICANT VEHICULE -LISTE DER PRODUKTE JE NACH FAHRZEUGMARKE -PRODUCTOS POR FABRICANTE DE VEHÍCULO

ABARTH

A50

ROTOR
- DISTRIBUTORE
- DISRUPTEUR
- VERTEILERLÄUFER
- ROTOR DEL DISTRIBUIDOR
930 054R

A70

PICK-UP
- IMPULSORE
- CAPTEUR
- IMPULSGEBER
- CAPTADOR
430 161/1

G10

COIL
- BOBINA
- BOBINE
- ZÜNDSPULE
- BOBINA
470 549

ACURA

A40

DISTRIBUTOR CAP
- CALOTTA
- TETE D'ALLUMEUR
- VERTEILERKAPPE
- TAPA DEL DISTRIBUIDOR
822 068
822 069
822 084

A50

ROTOR
- DISTRIBUTORE
- DISRUPTEUR
- VERTEILERLÄUFER
- ROTOR DEL DISTRIBUIDOR
922 056
922 082
922 095
922 095, 922 097R

G10

COIL
- BOBINA
- BOBINE
- ZÜNDSPULE
- BOBINA
470 212
470 213
470 214
470 215

G20

IGNITION MODULE
- MODULO DI ACCENSIONE
- MODULES D'ALLUMAGE
- ZÜNDUNGSMODUL
- MÓDULO DE ENCENDIDO
465 052

ALFA ROMEO

A10

CONDENSER
- CONDENSATORE
- CONDENSATEUR
- KONDENSATOR
- CONDENSADOR
615 034
630 117

A20

CONTACT SET
- COPPIA CONTATTI
- RUPTEUR
- KONTAKTSATZ
- PLATINOS
706 029HV
706 034HVS
706 047

A40

DISTRIBUTOR CAP
- CALOTTA
- TETE D'ALLUMEUR
- VERTEILERKAPPE
- TAPA DEL DISTRIBUIDOR
806 062
806 076
806 079
806 081
806 236
815 049
815 054
830 115

A50

ROTOR
- DISTRIBUTORE
- DISRUPTEUR
- VERTEILERLÄUFER
- ROTOR DEL DISTRIBUIDOR
906 024R
906 025R
906 055R
906 061R
906 113R
906 119R
906 121R
906 123R
930 042R
930 051R
930 054R
930 055R
930 059

A70

PICK-UP
- IMPULSORE
- CAPTEUR
- IMPULSGEBER
- CAPTADOR
406 153

G10

COIL
- BOBINA
- BOBINE
- ZÜNDSPULE
- BOBINA
470 101D
470 146
470 168
470 313
470 386
470 386K
470 387
470 387K
470 397
470 397K
470 423
470 442
470 450
470 549

G20

IGNITION MODULE
- MODULO DI ACCENSIONE
- MODULES D'ALLUMAGE
- ZÜNDUNGSMODUL
- MÓDULO DE ENCENDIDO
465 005

E01

IGNITION CABLE SET
- SERIE CAVI COMPLETA
- JEU CABLES D'ALLUMAGE
- ZÜNDKABELSATZ
- JUEGO DE CABLES DE ENCENDIDO
358 170
359 623
359 660
359 666
359 716
360 607
360 608

ALPINA

G10

COIL
- BOBINA
- BOBINE
- ZÜNDSPULE
- BOBINA
470 475

ALPINE

A40

DISTRIBUTOR CAP
- CALOTTA
- TETE D'ALLUMEUR
- VERTEILERKAPPE
- TAPA DEL DISTRIBUIDOR
806 236

A50

ROTOR
- DISTRIBUTORE
- DISRUPTEUR
- VERTEILERLÄUFER
- ROTOR DEL DISTRIBUIDOR
906 023R
906 119R

G10

COIL
- BOBINA
- BOBINE
- ZÜNDSPULE
- BOBINA
470 107

ASTON MARTIN

A20

CONTACT SET
- COPPIA CONTATTI
- RUPTEUR
- KONTAKTSATZ
- PLATINOS
728 083MHV

A50

ROTOR
- DISTRIBUTORE
- DISRUPTEUR
- VERTEILERLÄUFER
- ROTOR DEL DISTRIBUIDOR
928 007

G10

COIL
- BOBINA
- BOBINE
- ZÜNDSPULE
- BOBINA
470 537

AUDI

A20

CONTACT SET
- COPPIA CONTATTI
- RUPTEUR
- KONTAKTSATZ
- PLATINOS

A20

706 029HV

A40

DISTRIBUTOR CAP
- CALOTTA
- TETE D'ALLUMEUR
- VERTEILERKAPPE
- TAPA DEL DISTRIBUIDOR
806 079
806 093
806 094
806 129
806 231
806 248
806 266
815 068

A50

ROTOR
- DISTRIBUTORE
- DISRUPTEUR
- VERTEILERLÄUFER
- ROTOR DEL DISTRIBUIDOR
906 021R
906 055R
906 059R
906 116R
906 121R
915 099R

A70

PICK-UP
- IMPULSORE
- CAPTEUR
- IMPULSGEBER
- CAPTADOR
406 219
406 223
406 231

G10

COIL
- BOBINA
- BOBINE
- ZÜNDSPULE
- BOBINA
470 125
470 126
470 127
470 132
470 354S
470 422
470 426
470 427
470 429
470 433
470 434
470 436
470 445
470 474
470 599
470 636



PRODUCTS BY VEHICLE MANUFACTURER

-ELENCO PRODOTTI PER MARCA -PRODUITS PAR FABRICANT VEHICULE -LISTE DER PRODUKTE JE NACH FAHRZEUGMARKE -PRODUCTOS POR FABRICANTE DE VEHÍCULO

C20

IGNITION MODULE
- MODULO DI ACCENSIONE
- MODULES D'ALLUMAGE
- ZÜNDUNGSMODUL
- MÓDULO DE ENCENDIDO

465 004

465 007

465 051

465 072

465 076

C30

ELECTRONIC IGNITION KIT
- KIT ACCENSIONE ELETTRONICA
- KIT POUR ALLUMAGE ELECTRONIQUE
- ELEKTRONISCHE ZÜNDUNGSSETZ
- JUEGO DE ENCENDIDO ELECTRÓNICO

490 414

490 420

E01

IGNITION CABLE SET
- SERIE CAVI COMPLETA
- JEU CABLES D'ALLUMAGE
- ZÜNDKABELSATZ
- JUEGO DE CABLES DE ENCENDIDO

358 248

359 768

360 353

360 356

360 479

360 484

360 489

360 491

360 575

360 585

360 682

AUSTIN

A20

CONTACT SET
- COPPIA CONTATTI
- RUPTEUR
- KONTAKTSATZ
- PLATINOS

728 083MHV

A40

DISTRIBUTOR CAP
- CALOTTA
- TETE D'ALLUMEUR
- VERTEILERKAPPE
- TAPA DEL DISTRIBUIDOR

828 075

828 093

828 094

A50

ROTOR
- DISTRIBUTORE
- DISRUPTEUR
- VERTEILERLÄUFER
- ROTOR DEL DISTRIBUIDOR

928 006

928 024R

928 025

AUSTIN-HEALEY

A50

ROTOR
- DISTRIBUTORE
- DISRUPTEUR
- VERTEILERLÄUFER
- ROTOR DEL DISTRIBUIDOR

928 006

928 007

BEDFORD

A50

ROTOR
- DISTRIBUTORE
- DISRUPTEUR
- VERTEILERLÄUFER
- ROTOR DEL DISTRIBUIDOR

912 090

BENTLEY

G10

COIL
- BOBINA
- BOBINE
- ZÜNDSPULE
- BOBINA

470 636

BMW

A20

CONTACT SET
- COPPIA CONTATTI
- RUPTEUR
- KONTAKTSATZ
- PLATINOS

706 029HV

706 062

A40

DISTRIBUTOR CAP
- CALOTTA
- TETE D'ALLUMEUR
- VERTEILERKAPPE
- TAPA DEL DISTRIBUIDOR

806 062

806 081

806 094

806 121

806 238

806 247

A50

ROTOR
- DISTRIBUTORE
- DISRUPTEUR
- VERTEILERLÄUFER
- ROTOR DEL DISTRIBUIDOR

906 018R

906 055R

906 055R, 906 115R

906 060R, 906 112R

906 112R

906 115R

906 119R

G10

COIL
- BOBINA
- BOBINE
- ZÜNDSPULE
- BOBINA

470 112

470 162S

470 352

470 412

470 413

470 475

470 607

470 632

G20

IGNITION MODULE
- MODULO DI ACCENSIONE
- MODULES D'ALLUMAGE
- ZÜNDUNGSMODUL
- MÓDULO DE ENCENDIDO

465 005

E01

IGNITION CABLE SET
- SERIE CAVI COMPLETA
- JEU CABLES D'ALLUMAGE
- ZÜNDKABELSATZ
- JUEGO DE CABLES DE ENCENDIDO

358 069

359 572

359 573

359 578

359 587

359 597

359 605

359 900

360 921

BOND

A40

DISTRIBUTOR CAP
- CALOTTA
- TETE D'ALLUMEUR
- VERTEILERKAPPE
- TAPA DEL DISTRIBUIDOR

828 075

A50

ROTOR
- DISTRIBUTORE
- DISRUPTEUR
- VERTEILERLÄUFER
- ROTOR DEL DISTRIBUIDOR

912 090, 928 007

928 006

BORGWARD

A50

ROTOR
- DISTRIBUTORE
- DISRUPTEUR
- VERTEILERLÄUFER
- ROTOR DEL DISTRIBUIDOR

906 018R

CHEVROLET

A40

DISTRIBUTOR CAP
- CALOTTA
- TETE D'ALLUMEUR
- VERTEILERKAPPE
- TAPA DEL DISTRIBUIDOR

831 139

831 172

A50

ROTOR
- DISTRIBUTORE
- DISRUPTEUR
- VERTEILERLÄUFER
- ROTOR DEL DISTRIBUIDOR

931 131

931 139

G10

COIL
- BOBINA
- BOBINE
- ZÜNDSPULE
- BOBINA

470 219

470 545

470 547

470 585

E01

IGNITION CABLE SET
- SERIE CAVI COMPLETA
- JEU CABLES D'ALLUMAGE
- ZÜNDKABELSATZ
- JUEGO DE CABLES DE ENCENDIDO

358 006

358 007

358 247

358 249

360 509

360 634

360 677

360 680

360 730

360 731

CHRYSLER

A40

DISTRIBUTOR CAP
- CALOTTA
- TETE D'ALLUMEUR
- VERTEILERKAPPE
- TAPA DEL DISTRIBUIDOR

831 116

831 161

A50

ROTOR
- DISTRIBUTORE
- DISRUPTEUR
- VERTEILERLÄUFER
- ROTOR DEL DISTRIBUIDOR

910 179

931 109

G10

COIL
- BOBINA
- BOBINE
- ZÜNDSPULE
- BOBINA

470 417

470 423

470 549

E01

IGNITION CABLE SET
- SERIE CAVI COMPLETA
- JEU CABLES D'ALLUMAGE
- ZÜNDKABELSATZ
- JUEGO DE CABLES DE ENCENDIDO

360 343

360 345

360 507

360 508

360 511

360 511, 360 764

360 719

360 990



PRODUCTS BY VEHICLE MANUFACTURER

KW-IGN22Q1

-ELENCO PRODOTTI PER MARCA -PRODUITS PAR FABRICANT VEHICULE -LISTE DER PRODUKTE JE NACH FAHRZEUGMARKE -PRODUCTOS POR FABRICANTE DE VEHÍCULO

CITROËN

A10

CONDENSER

- CONDENSATORE
- CONDENSATEUR
- KONDENSATOR
- CONDENSADOR

615 034

A20

CONTACT SET

- COPPIA CONTATTI
- RUPTEUR
- KONTAKTSATZ
- PLATINOS

715 064

A40

DISTRIBUTOR CAP

- CALOTTA
- TÊTE D'ALLUMEUR
- VERTEILERKAPPE
- TAPA DEL DISTRIBUIDOR

806 124**806 241****806 252****815 058****815 059****815 067****815 074****815 077****815 078****815 087**

A50

ROTOR

- DISTRIBUTORE
- DISRUPTEUR
- VERTEILERLÄUFER
- ROTOR DEL DISTRIBUIDOR

906 056R**906 061R****906 119R****915 083R****915 088****915 091****915 094****915 102R****915 104****930 060**

A70

PICK-UP

- IMPULSORE
- CAPTEUR
- IMPULSgeber
- CAPTADOR

415 017**415 019**

G10

COIL

- BOBINA
- BOBINE
- ZÜNDSPULE
- BOBINA

470 105**470 106****470 155****470 168****470 188****470 189****470 403****470 405****470 407****470 408****470 459****470 461****470 475****470 476****470 483****470 497****470 505****470 509****470 609****470 620**

G20

IGNITION MODULE

- MODULO DI ACCENSIONE
- MODULES D'ALLUMAGE
- ZÜNDUNGSMODUL
- MÓDULO DE ENCENDIDO

465 005**465 034**

E01

IGNITION CABLE SET

- SERIE CAVI COMPLETA
- JEU CABLES D'ALLUMAGE
- ZÜNDKABELSATZ
- JUEGO DE CABLES DE ENCENDIDO

359 491**359 494****359 655****359 674****359 747****360 374****360 376**

CUPRA

G10

COIL

- BOBINA
- BOBINE
- ZÜNDSPULE
- BOBINA

470 599**470 636**

DACIA

A10

CONDENSER

- CONDENSATORE
- CONDENSATEUR
- KONDENSATOR
- CONDENSADOR

615 023

A20

CONTACT SET

- COPPIA CONTATTI
- RUPTEUR
- KONTAKTSATZ
- PLATINOS

715 055**715 101**

A40

DISTRIBUTOR CAP

- CALOTTA
- TÊTE D'ALLUMEUR
- VERTEILERKAPPE
- TAPA DEL DISTRIBUIDOR

815 049**815 054**

A50

ROTOR

- DISTRIBUTORE
- DISRUPTEUR
- VERTEILERLÄUFER
- ROTOR DEL DISTRIBUIDOR

915 091

G10

COIL

- BOBINA
- BOBINE
- ZÜNDSPULE
- BOBINA

470 101D**470 432****470 518****470 552****470 596****470 613**

E01

IGNITION CABLE SET

- SERIE CAVI COMPLETA
- JEU CABLES D'ALLUMAGE
- ZÜNDKABELSATZ
- JUEGO DE CABLES DE ENCENDIDO

358 244**358 246****358 252****359 511**

DAEWOO

A40

DISTRIBUTOR CAP

- CALOTTA
- TÊTE D'ALLUMEUR
- VERTEILERKAPPE
- TAPA DEL DISTRIBUIDOR

812 075**831 139****831 172**

A50

ROTOR

- DISTRIBUTORE
- DISRUPTEUR
- VERTEILERLÄUFER
- ROTOR DEL DISTRIBUIDOR

912 098**931 131****931 139**

G10

COIL

- BOBINA
- BOBINE
- ZÜNDSPULE
- BOBINA

470 219**470 316****470 585**

E01

IGNITION CABLE SET

- SERIE CAVI COMPLETA
- JEU CABLES D'ALLUMAGE
- ZÜNDKABELSATZ
- JUEGO DE CABLES DE ENCENDIDO

358 006**358 007****360 433****360 509****360 634****360 677****360 680****360 730****360 731****360 942**

DAIHATSU

A20

CONTACT SET

- COPPIA CONTATTI
- RUPTEUR
- KONTAKTSATZ
- PLATINOS

713 011HV

A40

DISTRIBUTOR CAP

- CALOTTA
- TÊTE D'ALLUMEUR
- VERTEILERKAPPE
- TAPA DEL DISTRIBUIDOR

813 094

A40

813 128**813 257****813 258**

A50

ROTOR

- DISTRIBUTORE
- DISRUPTEUR
- VERTEILERLÄUFER
- ROTOR DEL DISTRIBUIDOR

913 014**913 028****913 029****913 030**

G10

COIL

- BOBINA
- BOBINE
- ZÜNDSPULE
- BOBINA

470 252**470 461****470 537**

E01

IGNITION CABLE SET

- SERIE CAVI COMPLETA
- JEU CABLES D'ALLUMAGE
- ZÜNDKABELSATZ
- JUEGO DE CABLES DE ENCENDIDO

360 436**360 732**

DAIMLER

A50

ROTOR

- DISTRIBUTORE
- DISRUPTEUR
- VERTEILERLÄUFER
- ROTOR DEL DISTRIBUIDOR

928 007

DS

G10

COIL

- BOBINA
- BOBINE
- ZÜNDSPULE
- BOBINA

470 475**470 609****470 620**



PRODUCTS BY VEHICLE MANUFACTURER

KW-IGN22Q1

-ELENCO PRODOTTI PER MARCA -PRODUITS PAR FABRICANT VEHICULE -LISTE DER PRODUKTE JE NACH FAHRZEUGMARKE -PRODUCTOS POR FABRICANTE DE VEHÍCULO

FIAT

A10

CONDENSER

- CONDENSATORE
- CONDENSATEUR
- KONDENSATOR
- CONDENSADOR

615 023

615 034

615 039

630 117

630 127

630 128

A20

CONTACT SET

- COPPIA CONTATTI
- RUPTEUR
- KONTAKTSATZ
- PLATINOS

715 055

715 056

715 056HV

715 101

715 105

715 106

715 122

717 020

730 120

730 132

730 139

730 140

730 142

730 146M

730 149M

730 150M

A40

DISTRIBUTOR CAP

- CALOTTA
- TETE D'ALLUMEUR
- VERTEILERKAPPE
- TAPA DEL DISTRIBUIDOR

806 079

815 045

815 049

815 054

815 058

815 059

815 080

815 087

817 016

830 059

830 069

830 081

830 082

830 086

830 090

830 093

830 098

830 101

830 104

A40

830 109

830 114

830 115

A50

ROTOR

- DISTRIBUTORE
- DISRUPTEUR
- VERTEILERLÄUFER
- ROTOR DEL DISTRIBUIDOR

906 025R

906 061R

915 083R

915 091

915 094

915 096R

917 052

917 052R

930 029

930 036R

930 037

930 037R

930 040

930 041

930 042R

930 047R

930 047R, 930 060

930 054R

930 055R

930 057R

930 059

930 060

A70

PICK-UP

- IMPULSORE
- CAPTEUR
- IMPULSGEBER
- CAPTADOR

406 153

415 019

430 161/1

430 176M

430 177/1

430 180M

G10

COIL

- BOBINA
- BOBINE
- ZÜNDSPULE
- BOBINA

470 101D

470 102

470 103

470 108

470 146

470 148

470 158

470 168

470 188

470 314

470 345

G10

470 384

470 405

470 408

470 416

470 423

470 442

470 450

470 549

470 570

G20

IGNITION MODULE

- MODULO DI ACCENSIONE
- MODULES D'ALLUMAGE
- ZÜNDUNGSMODUL
- MÓDULO DE ENCENDIDO

465 005

465 020

465 029

G30

ELECTRONIC IGNITION KIT

- KIT ACCENSIONE ELETTRONICA
- KIT POUR ALLUMAGE ELECTRONIQUE
- ELEKTRONISCHE ZÜNDUNGSSATZ
- JUEGO DE ENCENDIDO ELECTRONICO

490 303

E01

IGNITION CABLE SET

- SERIE CAVI COMPLETA
- JEU CABLES D'ALLUMAGE
- ZÜNDKABELSATZ
- JUEGO DE CABLES DE ENCENDIDO

358 013

358 170

359 347

359 351

359 354

359 386

359 398

359 429

359 432

359 456

359 466

359 494

359 507

359 613

359 615

359 616

359 650

359 655

359 674

359 692

359 694

359 700

359 808

359 815

359 887

359 888

359 889

360 363

360 451

E01

360 503

360 504

360 505

360 527

FIAT (BR)

A40

DISTRIBUTOR CAP

- CALOTTA
- TETE D'ALLUMEUR
- VERTEILERKAPPE
- TAPA DEL DISTRIBUIDOR

830 101

830 114

830 115

A50

ROTOR

- DISTRIBUTORE
- DISRUPTEUR
- VERTEILERLÄUFER
- ROTOR DEL DISTRIBUIDOR

930 055R

930 059

930 060

A70

PICK-UP

- IMPULSORE
- CAPTEUR
- IMPULSGEBER
- CAPTADOR

430 177/1

G10

COIL

- BOBINA
- BOBINE
- ZÜNDSPULE
- BOBINA

470 146

470 168

470 314

470 345

470 384

470 416

G30

ELECTRONIC IGNITION KIT

- KIT ACCENSIONE ELETTRONICA
- KIT POUR ALLUMAGE ELECTRONIQUE
- ELEKTRONISCHE ZÜNDUNGSSATZ
- JUEGO DE ENCENDIDO ELECTRONICO

490 303

E01

IGNITION CABLE SET

- SERIE CAVI COMPLETA
- JEU CABLES D'ALLUMAGE
- ZÜNDKABELSATZ
- JUEGO DE CABLES DE ENCENDIDO

E01

359 650

359 655

360 503

360 505

FORD

A20

CONTACT SET

- COPPIA CONTATTI
- RUPTEUR
- KONTAKTSATZ
- PLATINOS

706 021

706 049HDVS

719 043HV

719 044HV

728 083MHV

A40

DISTRIBUTOR CAP

- CALOTTA
- TETE D'ALLUMEUR
- VERTEILERKAPPE
- TAPA DEL DISTRIBUIDOR

806 062

806 079

806 079, 806 109

806 081

806 109

806 235

806 253

819 083

819 092

822 046

822 089

828 070

828 070, 828 075

828 075

828 083

828 096

830 098

830 101

831 121

A50

ROTOR

- DISTRIBUTORE
- DISRUPTEUR
- VERTEILERLÄUFER
- ROTOR DEL DISTRIBUIDOR

906 012R

906 018R

906 025R

906 060R

906 060R, 906 061R

906 061R

906 112R

906 121R

906 140R



PRODUCTS BY VEHICLE MANUFACTURER

KW-IGN22Q1

-ELENCO PRODOTTI PER MARCA -PRODUITS PAR FABRICANT VEHICULE -LISTE DER PRODUKTE JE NACH FAHRZEUGMARKE -PRODUCTOS POR FABRICANTE DE VEHÍCULO

A50

- 919 085
- 919 092
- 919 094R
- 922 070
- 922 102
- 928 006
- 928 007
- 928 026R
- 930 057R
- 931 132
- 931 137

A70

- PICK-UP**
- IMPULSORE
- CAPTEUR
- IMPULSGEBER
- CAPTADOR
- 406 233

G10

- COIL**
- BOBINA
- BOBINE
- ZÜNDSPULE
- BOBINA

- 470 135
- 470 135, 470 312
- 470 169
- 470 169, 470 312
- 470 170
- 470 289
- 470 299
- 470 299, 470 312
- 470 299S
- 470 312
- 470 312, 470 364
- 470 364
- 470 366S
- 470 423
- 470 435
- 470 478
- 470 480
- 470 481
- 470 532
- 470 619
- 470 623

E01

- IGNITION CABLE SET**
- SERIE CAVI COMPLETA
- JEU CABLES D'ALLUMAGE
- ZÜNDKABELSATZ
- JUEGO DE CABLES DE ENCENDIDO
- 358 170
 - 358 208
 - 358 214
 - 358 242
 - 359 864
 - 360 007
 - 360 078
 - 360 145
 - 360 281

E01

- 360 568
- 360 619
- 360 624
- 360 625
- 360 630
- 360 639
- 360 789
- 360 976

FORD (BR)

G10

- COIL**
- BOBINA
- BOBINE
- ZÜNDSPULE
- BOBINA
- 470 532

E01

- IGNITION CABLE SET**
- SERIE CAVI COMPLETA
- JEU CABLES D'ALLUMAGE
- ZÜNDKABELSATZ
- JUEGO DE CABLES DE ENCENDIDO
- 360 691

FORD AUSTRALIA

A20

- CONTACT SET**
- COPPIA CONTATTI
- RUPTEUR
- KONTAKTSATZ
- PLATINOS
- 706 034HVS

A40

- DISTRIBUTOR CAP**
- CALOTTA
- TETE D'ALLUMEUR
- VERTEILERKAPPE
- TAPA DEL DISTRIBUIDOR
- 806 079
 - 806 244
 - 822 077, 822 092
 - 831 003/001
 - 831 003/001, 831 109
 - 831 003/001, 831 109,
 - 831 118
 - 831 109
 - 831 131
 - 831 137, 831 149
 - 831 150

A50

- ROTOR**
- DISTRIBUTORE
- DISRUPTEUR
- VERTEILERLÄUFER
- ROTOR DEL DISTRIBUIDOR
- 906 012R
 - 906 131
 - 922 094, 922 102
 - 931 023
 - 931 119
 - 931 132
 - 931 133, 931 134

G10

- COIL**
- BOBINA
- BOBINE
- ZÜNDSPULE
- BOBINA
- 470 170

FORD USA

A40

- DISTRIBUTOR CAP**
- CALOTTA
- TETE D'ALLUMEUR
- VERTEILERKAPPE
- TAPA DEL DISTRIBUIDOR
- 831 137

A50

- ROTOR**
- DISTRIBUTORE
- DISRUPTEUR
- VERTEILERLÄUFER
- ROTOR DEL DISTRIBUIDOR
- 931 133
 - 931 134

G10

- COIL**
- BOBINA
- BOBINE
- ZÜNDSPULE
- BOBINA
- 470 170
 - 470 289

FSO

A10

- CONDENSER**
- CONDENSATORE
- CONDENSATEUR
- KONDENSATOR
- CONDENSADOR
- 630 128

A20

- CONTACT SET**
- COPPIA CONTATTI
- RUPTEUR
- KONTAKTSATZ
- PLATINOS
- 730 120
 - 730 127
 - 730 146M
 - 730 150M
 - 749 350

A40

- DISTRIBUTOR CAP**
- CALOTTA
- TETE D'ALLUMEUR
- VERTEILERKAPPE
- TAPA DEL DISTRIBUIDOR
- 830 086

A50

- ROTOR**
- DISTRIBUTORE
- DISRUPTEUR
- VERTEILERLÄUFER
- ROTOR DEL DISTRIBUIDOR
- 930 040

G10

- COIL**
- BOBINA
- BOBINE
- ZÜNDSPULE
- BOBINA
- 470 101D

GINETTA

A50

- ROTOR**
- DISTRIBUTORE
- DISRUPTEUR
- VERTEILERLÄUFER
- ROTOR DEL DISTRIBUIDOR
- 928 006

HOLDEN

A20

- CONTACT SET**
- COPPIA CONTATTI
- RUPTEUR
- KONTAKTSATZ
- PLATINOS
- 706 034HVS
 - 713 011HV
 - 722 056HV

A40

- DISTRIBUTOR CAP**
- CALOTTA
- TETE D'ALLUMEUR
- VERTEILERKAPPE
- TAPA DEL DISTRIBUIDOR
- 806 080
 - 806 112
 - 806 256
 - 806 257
 - 812 075
 - 813 092
 - 813 093
 - 813 254
 - 813 265
 - 813 267
 - 813 278
 - 822 003
 - 822 057
 - 822 060
 - 828 100
 - 831 131
 - 831 132

A50

- ROTOR**
- DISTRIBUTORE
- DISRUPTEUR
- VERTEILERLÄUFER
- ROTOR DEL DISTRIBUIDOR
- 906 056R
 - 906 121R
 - 906 127R
 - 906 131
 - 912 098
 - 913 014
 - 913 027
 - 913 028
 - 913 029
 - 913 030
 - 922 052
 - 922 069
 - 928 028R
 - 931 108
 - 931 119

G10

- COIL**
- BOBINA
- BOBINE
- ZÜNDSPULE
- BOBINA
- 470 140
 - 470 197
 - 470 198
 - 470 199
 - 470 219
 - 470 272
 - 470 273



PRODUCTS BY VEHICLE MANUFACTURER

KW-IGN22Q1

-ELENCO PRODOTTI PER MARCA -PRODUITS PAR FABRICANT VEHICULE -LISTE DER PRODUKTE JE NACH FAHRZEUGMARKE -PRODUCTOS POR FABRICANTE DE VEHÍCULO

C20

IGNITION MODULE
- MODULO DI ACCENSIONE
- MODULES D'ALLUMAGE
- ZÜNDUNGSMODUL
- MÓDULO DE ENCENDIDO

465 036**E01**

IGNITION CABLE SET
- SERIE CAVI COMPLETA
- JEU CABLES D'ALLUMAGE
- ZÜNDKABELSATZ
- JUEGO DE CABLES DE ENCENDIDO

358 020**359 688****359 689****360 209****360 237****360 562****360 793****360 947****HONDA****A40**

DISTRIBUTOR CAP
- CALOTTA
- TÊTE D'ALLUMEUR
- VERTEILERKAPPE
- TAPA DEL DISTRIBUIDOR

822 022**822 060****822 068****822 069****822 071****822 076****822 076, 822 082****822 082****822 093****828 106****A50**

ROTOR
- DISTRIBUTORE
- DISRUPTEUR
- VERTEILERLÄUFER
- ROTOR DEL DISTRIBUIDOR

922 056**922 069****922 081****922 082****922 092****922 095****922 095, 922 098****922 097R****922 098****922 102****G10**

COIL
- BOBINA
- BOBINE
- ZÜNDSPULE
- BOBINA

470 168**470 211****470 212****470 213****470 214****470 215****470 216****470 347****470 457****470 522****470 527****470 529****470 529, 470 608****470 603****470 608****C20**

IGNITION MODULE
- MODULO DI ACCENSIONE
- MODULES D'ALLUMAGE
- ZÜNDUNGSMODUL
- MÓDULO DE ENCENDIDO

465 052**E01**

IGNITION CABLE SET
- SERIE CAVI COMPLETA
- JEU CABLES D'ALLUMAGE
- ZÜNDKABELSATZ
- JUEGO DE CABLES DE ENCENDIDO

360 686**360 699****360 702****360 709****360 711****HYUNDAI****A20**

CONTACT SET
- COPPIA CONTATTI
- RUPTEUR
- KONTAKTSATZ
- PLATINOS

731 084**A40**

DISTRIBUTOR CAP
- CALOTTA
- TÊTE D'ALLUMEUR
- VERTEILERKAPPE
- TAPA DEL DISTRIBUIDOR

806 124**831 003/001****831 116****831 121****831 170****A50**

ROTOR
- DISTRIBUTORE
- DISRUPTEUR
- VERTEILERLÄUFER
- ROTOR DEL DISTRIBUIDOR

906 121R**931 023****931 107****931 109****931 138****A70**

PICK-UP
- IMPULSORE
- CAPTEUR
- IMPULSGEBER
- CAPTADOR

406 244**G10**

COIL
- BOBINA
- BOBINE
- ZÜNDSPULE
- BOBINA

470 394**470 492****470 495****470 496****470 543****470 543, 470 611****470 556****470 579****470 580****470 581****470 582****470 582, 470 583****470 582, 470 584****470 583****470 584****470 585****470 586****470 587****470 611****470 612****470 614****470 622****470 638****470 647****E01**

IGNITION CABLE SET
- SERIE CAVI COMPLETA
- JEU CABLES D'ALLUMAGE
- ZÜNDKABELSATZ
- JUEGO DE CABLES DE ENCENDIDO

358 111**358 119****358 120****358 235****358 236****358 241****358 255****360 385****E01****360 401****INFINITI****A40**

DISTRIBUTOR CAP
- CALOTTA
- TÊTE D'ALLUMEUR
- VERTEILERKAPPE
- TAPA DEL DISTRIBUIDOR

822 073**831 151****A50**

ROTOR
- DISTRIBUTORE
- DISRUPTEUR
- VERTEILERLÄUFER
- ROTOR DEL DISTRIBUIDOR

922 085**931 136****G10**

COIL
- BOBINA
- BOBINE
- ZÜNDSPULE
- BOBINA

470 533**470 552****470 626****INNOCENTI****A40**

DISTRIBUTOR CAP
- CALOTTA
- TÊTE D'ALLUMEUR
- VERTEILERKAPPE
- TAPA DEL DISTRIBUIDOR

830 101**830 104****830 114****830 115****A50**

ROTOR
- DISTRIBUTORE
- DISRUPTEUR
- VERTEILERLÄUFER
- ROTOR DEL DISTRIBUIDOR

930 047R, 930 060**930 059****930 060****A70**

PICK-UP
- IMPULSORE
- CAPTEUR
- IMPULSGEBER
- CAPTADOR

430 176M**430 177/1****G10**

COIL
- BOBINA
- BOBINE
- ZÜNDSPULE
- BOBINA

470 146**470 148****470 158****470 188****C20**

IGNITION MODULE
- MODULO DI ACCENSIONE
- MODULES D'ALLUMAGE
- ZÜNDUNGSMODUL
- MÓDULO DE ENCENDIDO

465 020**E01**

IGNITION CABLE SET
- SERIE CAVI COMPLETA
- JEU CABLES D'ALLUMAGE
- ZÜNDKABELSATZ
- JUEGO DE CABLES DE ENCENDIDO

359 655**ISUZU****A40**

DISTRIBUTOR CAP
- CALOTTA
- TÊTE D'ALLUMEUR
- VERTEILERKAPPE
- TAPA DEL DISTRIBUIDOR

812 075**A50**

ROTOR
- DISTRIBUTORE
- DISRUPTEUR
- VERTEILERLÄUFER
- ROTOR DEL DISTRIBUIDOR

912 098**922 069****G10**

COIL
- BOBINA
- BOBINE
- ZÜNDSPULE
- BOBINA

470 219



PRODUCTS BY VEHICLE MANUFACTURER

KW-IGN22Q1

-ELENCO PRODOTTI PER MARCA -PRODUITS PAR FABRICANT VEHICULE -LISTE DER PRODUKTE JE NACH FAHRZEUGMARKE -PRODUCTOS POR FABRICANTE DE VEHÍCULO

C20

IGNITION MODULE
- MODULO DI ACCENSIONE
- MODULES D'ALLUMAGE
- ZÜNDUNGSMODUL
- MÓDULO DE ENCENDIDO

465 025**IVECO****C10**

COIL
- BOBINA
- BOBINE
- ZÜNDSPULE
- BOBINA

470 345**470 442****JAGUAR****A20**

CONTACT SET
- COPPIA CONTATTI
- RUPTEUR
- KONTAKTSATZ
- PLATINOS

728 083MHV**A40**

DISTRIBUTOR CAP
- CALOTTA
- TÊTE D'ALLUMEUR
- VERTEILERKAPPE
- TAPA DEL DISTRIBUIDOR

828 098**830 110****A50**

ROTOR
- DISTRIBUTORE
- DISRUPTEUR
- VERTEILERLÄUFER
- ROTOR DEL DISTRIBUIDOR

928 007**928 027R****930 058****C10**

COIL
- BOBINA
- BOBINE
- ZÜNDSPULE
- BOBINA

470 170**JEEP****A40**

DISTRIBUTOR CAP
- CALOTTA
- TÊTE D'ALLUMEUR
- VERTEILERKAPPE
- TAPA DEL DISTRIBUIDOR

819 093**A50**

ROTOR
- DISTRIBUTORE
- DISRUPTEUR
- VERTEILERLÄUFER
- ROTOR DEL DISTRIBUIDOR

919 092**C10**

COIL
- BOBINA
- BOBINE
- ZÜNDSPULE
- BOBINA

470 107**470 549****E01**

IGNITION CABLE SET
- SERIE CAVI COMPLETA
- JEU CABLES D'ALLUMAGE
- ZÜNDKABELSATZ
- JUEGO DE CABLES DE ENCENDIDO

358 181**JENSEN****A40**

DISTRIBUTOR CAP
- CALOTTA
- TÊTE D'ALLUMEUR
- VERTEILERKAPPE
- TAPA DEL DISTRIBUIDOR

828 075**A50**

ROTOR
- DISTRIBUTORE
- DISRUPTEUR
- VERTEILERLÄUFER
- ROTOR DEL DISTRIBUIDOR

928 006**KIA****A40**

DISTRIBUTOR CAP
- CALOTTA
- TÊTE D'ALLUMEUR
- VERTEILERKAPPE
- TAPA DEL DISTRIBUIDOR

831 121**831 122****A50**

ROTOR
- DISTRIBUTORE
- DISRUPTEUR
- VERTEILERLÄUFER
- ROTOR DEL DISTRIBUIDOR

931 108**C10**

COIL
- BOBINA
- BOBINE
- ZÜNDSPULE
- BOBINA

470 168**470 219****470 492****470 495****470 543****470 543, 470 611****470 556****470 579****470 580****470 580, 470 587****470 581****470 582****470 584****470 586****470 587****470 589****470 611****470 612****470 614****470 622****470 638****470 647****E01**

IGNITION CABLE SET
- SERIE CAVI COMPLETA
- JEU CABLES D'ALLUMAGE
- ZÜNDKABELSATZ
- JUEGO DE CABLES DE ENCENDIDO

358 111**358 119****358 235****358 236****358 239****358 241****360 385****360 398****360 401****360 841****360 851****LADA****A20**

CONTACT SET
- COPPIA CONTATTI
- RUPTEUR
- KONTAKTSATZ
- PLATINOS

A20**746 070****746 071****A40****DISTRIBUTOR CAP**

- CALOTTA
- TÊTE D'ALLUMEUR
- VERTEILERKAPPE
- TAPA DEL DISTRIBUIDOR

847 025**847 027****A50****ROTOR**

- DISTRIBUTORE
- DISRUPTEUR
- VERTEILERLÄUFER
- ROTOR DEL DISTRIBUIDOR

946 014R**946 016R****C10****COIL**

- BOBINA
- BOBINE
- ZÜNDSPULE
- BOBINA

470 101D**470 432****470 596****470 613****E01**

IGNITION CABLE SET
- SERIE CAVI COMPLETA
- JEU CABLES D'ALLUMAGE
- ZÜNDKABELSATZ
- JUEGO DE CABLES DE ENCENDIDO

359 511**LANCIA****A10****CONDENSER**

- CONDENSATORE
- CONDENSATEUR
- KONDENSATOR
- CONDENSADOR

615 023**A20**

CONTACT SET
- COPPIA CONTATTI
- RUPTEUR
- KONTAKTSATZ
- PLATINOS

715 101**A40**

DISTRIBUTOR CAP
- CALOTTA
- TÊTE D'ALLUMEUR
- VERTEILERKAPPE
- TAPA DEL DISTRIBUIDOR

806 079**806 236****815 058****815 080****830 093****830 098****830 101****830 101, 830 104****830 104****830 109****830 114****830 115****A50****ROTOR**

- DISTRIBUTORE
- DISRUPTEUR
- VERTEILERLÄUFER
- ROTOR DEL DISTRIBUIDOR

906 023R**906 025R****906 119R****915 083R****915 094****930 047R****930 054R****930 055R****930 055R, 930 059****930 057R****930 057R, 930 060****930 059****930 060****A70****PICK-UP**

- IMPULSORE
- CAPTEUR
- IMPULSgeber
- CAPTADOR

430 161/1**430 163/1****430 176M****430 177/1****430 180M****C10****COIL**

- BOBINA
- BOBINE
- ZÜNDSPULE
- BOBINA

470 101D**470 103****470 108****470 126****470 146****470 148****470 158****470 168**



PRODUCTS BY VEHICLE MANUFACTURER

KW-IGN22Q1

-ELENCO PRODOTTI PER MARCA -PRODUITS PAR FABRICANT VEHICULE -LISTE DER PRODUKTE JE NACH FAHRZEUGMARKE -PRODUCTOS POR FABRICANTE DE VEHÍCULO

G10

470 188
470 313
470 314
470 345
470 384
470 408
470 423
470 442
470 549

G20

IGNITION MODULE
- MODULO DI ACCENSIONE
- MODULES D'ALLUMAGE
- ZÜNDUNGSMODUL
- MÓDULO DE ENCENDIDO

465 020
465 029

G30

ELECTRONIC IGNITION KIT
- KIT ACCENSIONE ELETTRONICA
- KIT POUR ALLUMAGE ELECTRONIQUE
- ELEKTRONISCHE ZÜNDUNGSATZ
- JUEGO DE ENCENDIDO ELECTRÓNICO

490 303

E01

IGNITION CABLE SET
- SERIE CAVI COMPLETA
- JEU CABLES D'ALLUMAGE
- ZÜNDKABELSATZ
- JUEGO DE CABLES DE ENCENDIDO

358 170
359 347
359 354
359 398
359 456
359 471
359 616
359 650
359 655
359 692
359 694
359 700
359 888
359 889
360 363
360 451
360 503
360 504
360 505

LAND ROVER**A10**

CONDENSER
- CONDENSATORE
- CONDENSATEUR
- KONDENSATOR
- CONDENSADOR

A10

615 034

A20

CONTACT SET
- COPPIA CONTATTI
- RUPTEUR
- KONTAKTSATZ
- PLATINOS

728 083MHV
728 089

A40

DISTRIBUTOR CAP
- CALOTTA
- TETE D'ALLUMEUR
- VERTEILERKAPPE
- TAPA DEL DISTRIBUIDOR

815 054
828 070, 828 075
828 078
828 091
828 093

A50

ROTOR
- DISTRIBUTORE
- DISRUPTEUR
- VERTEILERLÄUFER
- ROTOR DEL DISTRIBUIDOR

915 091
928 006
928 012
928 021, 928 022
928 022
928 029R

G10

COIL
- BOBINA
- BOBINE
- ZÜNDSPULE
- BOBINA

470 101D
470 168
470 352
470 374
470 413

E01

IGNITION CABLE SET
- SERIE CAVI COMPLETA
- JEU CABLES D'ALLUMAGE
- ZÜNDKABELSATZ
- JUEGO DE CABLES DE ENCENDIDO

358 107
360 889
360 900

LEXUS**G10**

COIL
- BOBINA
- BOBINE
- ZÜNDSPULE
- BOBINA

470 202
470 203
470 458
470 466
470 536
470 537
470 538

LOTUS**A40**

DISTRIBUTOR CAP
- CALOTTA
- TETE D'ALLUMEUR
- VERTEILERKAPPE
- TAPA DEL DISTRIBUIDOR

828 075

MAN**A40**

DISTRIBUTOR CAP
- CALOTTA
- TETE D'ALLUMEUR
- VERTEILERKAPPE
- TAPA DEL DISTRIBUIDOR

806 081
806 081, 806 258

G10

COIL
- BOBINA
- BOBINE
- ZÜNDSPULE
- BOBINA

470 417

MARUTI**A20**

CONTACT SET
- COPPIA CONTATTI
- RUPTEUR
- KONTAKTSATZ
- PLATINOS

713 011HV

A40

DISTRIBUTOR CAP
- CALOTTA
- TETE D'ALLUMEUR
- VERTEILERKAPPE
- TAPA DEL DISTRIBUIDOR

A40

813 107

A50

ROTOR
- DISTRIBUTORE
- DISRUPTEUR
- VERTEILERLÄUFER
- ROTOR DEL DISTRIBUIDOR

913 030

MASERATI**A50**

ROTOR
- DISTRIBUTORE
- DISRUPTEUR
- VERTEILERLÄUFER
- ROTOR DEL DISTRIBUIDOR

930 054R

MAZDA**A20**

CONTACT SET
- COPPIA CONTATTI
- RUPTEUR
- KONTAKTSATZ
- PLATINOS

731 084

A40

DISTRIBUTOR CAP
- CALOTTA
- TETE D'ALLUMEUR
- VERTEILERKAPPE
- TAPA DEL DISTRIBUIDOR

822 077
822 077, 822 092

822 088

822 092

831 003/001

831 109

831 117

831 118

831 118, 831 132

831 121

831 121, 831 131

831 122

831 122, 831 132

831 125

831 125, 831 132

831 131

831 132

831 137

831 149

831 150

831 154

A50

ROTOR
- DISTRIBUTORE
- DISRUPTEUR
- VERTEILERLÄUFER
- ROTOR DEL DISTRIBUIDOR

922 073

922 094

922 094, 922 102

922 102

931 023

931 108

931 108, 931 119

931 113

931 119

931 132

931 132, 931 137

931 133

931 134

931 137

G10

COIL
- BOBINA
- BOBINE
- ZÜNDSPULE
- BOBINA

470 135

470 135, 470 312

470 233

470 289

470 299

470 299, 470 312

470 366S

470 480

470 481

470 514

470 516

470 532

470 627

G20

IGNITION MODULE
- MODULO DI ACCENSIONE
- MODULES D'ALLUMAGE
- ZÜNDUNGSMODUL
- MÓDULO DE ENCENDIDO

465 073

E01

IGNITION CABLE SET
- SERIE CAVI COMPLETA
- JEU CABLES D'ALLUMAGE
- ZÜNDKABELSATZ
- JUEGO DE CABLES DE ENCENDIDO

358 242

358 245

359 884

360 231

360 398

360 729

360 738

360 739

360 740

360 741



PRODUCTS BY VEHICLE MANUFACTURER

KW-IGN22Q1

-ELENCO PRODOTTI PER MARCA -PRODUITS PAR FABRICANT VEHICULE -LISTE DER PRODUKTE JE NACH FAHRZEUGMARKE -PRODUCTOS POR FABRICANTE DE VEHÍCULO

E01360 745
360 760
360 767**MERCEDES-BENZ****A20****CONTACT SET**
- COPPIA CONTATTI
- RUPTEUR
- KONTAKTSATZ
- PLATINOS706 021
706 021, 706 029HV
706 029HV
706 029HV, 706 062
706 034HVS
706 062**A40****DISTRIBUTOR CAP**
- CALOTTA
- TETE D'ALLUMEUR
- VERTEILERKAPPE
- TAPA DEL DISTRIBUIDOR806 062
806 079
806 090
806 092
806 108
806 123
806 234
806 237
806 239**A50****ROTOR**
- DISTRIBUTORE
- DISRUPTEUR
- VERTEILERLÄUFER
- ROTOR DEL DISTRIBUIDOR906 018R
906 021R
906 023R
906 024R
906 025R
906 034R
906 049R
906 055R
906 060R
906 121R
906 125R
906 126R
906 146R**G10****COIL**
- BOBINA
- BOBINE
- ZÜNDSPULE
- BOBINA470 101D
470 178
470 179
470 180
470 316
470 316K
470 317
470 417
470 417, 470 487
470 420
470 487
470 613
470 626**E01****IGNITION CABLE SET**
- SERIE CAVI COMPLETA
- JEU CABLES D'ALLUMAGE
- ZÜNDKABELSATZ
- JUEGO DE CABLES DE ENCENDIDO358 232
358 234
360 300
360 305
360 323
360 649
360 654
360 657**MG****A20****CONTACT SET**
- COPPIA CONTATTI
- RUPTEUR
- KONTAKTSATZ
- PLATINOS

728 083MHV

A40**DISTRIBUTOR CAP**
- CALOTTA
- TETE D'ALLUMEUR
- VERTEILERKAPPE
- TAPA DEL DISTRIBUIDOR828 075
828 093**A50****ROTOR**
- DISTRIBUTORE
- DISRUPTEUR
- VERTEILERLÄUFER
- ROTOR DEL DISTRIBUIDOR928 006
928 007
928 029R**G10****COIL**
- BOBINA
- BOBINE
- ZÜNDSPULE
- BOBINA470 374
470 413**E01****IGNITION CABLE SET**
- SERIE CAVI COMPLETA
- JEU CABLES D'ALLUMAGE
- ZÜNDKABELSATZ
- JUEGO DE CABLES DE ENCENDIDO360 888
360 889**MINI****G10****COIL**
- BOBINA
- BOBINE
- ZÜNDSPULE
- BOBINA470 475
470 632**E01****IGNITION CABLE SET**
- SERIE CAVI COMPLETA
- JEU CABLES D'ALLUMAGE
- ZÜNDKABELSATZ
- JUEGO DE CABLES DE ENCENDIDO

360 719

MITSUBISHI**A20****CONTACT SET**
- COPPIA CONTATTI
- RUPTEUR
- KONTAKTSATZ
- PLATINOS

731 085

A40**DISTRIBUTOR CAP**
- CALOTTA
- TETE D'ALLUMEUR
- VERTEILERKAPPE
- TAPA DEL DISTRIBUIDOR813 117
831 003/001
831 116
831 131
831 134
831 134, 831 158
831 135
831 138
831 138, 831 168**A40**831 143
831 147
831 158
831 168
831 169**A50****ROTOR**
- DISTRIBUTORE
- DISRUPTEUR
- VERTEILERLÄUFER
- ROTOR DEL DISTRIBUIDOR913 030
931 023
931 107
931 109
931 119
931 131
931 134
931 136
931 136, 931 137
931 137**G10****COIL**
- BOBINA
- BOBINE
- ZÜNDSPULE
- BOBINA470 497
470 503
470 505**E01****IGNITION CABLE SET**
- SERIE CAVI COMPLETA
- JEU CABLES D'ALLUMAGE
- ZÜNDKABELSATZ
- JUEGO DE CABLES DE ENCENDIDO358 251
360 278
360 344
360 401
360 753
360 764
360 882
360 883**MORRIS****A20****CONTACT SET**
- COPPIA CONTATTI
- RUPTEUR
- KONTAKTSATZ
- PLATINOS

728 083MHV

A40**DISTRIBUTOR CAP**
- CALOTTA
- TETE D'ALLUMEUR
- VERTEILERKAPPE
- TAPA DEL DISTRIBUIDOR

828 075

A50**ROTOR**
- DISTRIBUTORE
- DISRUPTEUR
- VERTEILERLÄUFER
- ROTOR DEL DISTRIBUIDOR

928 006

NISSAN**A10****CONDENSER**
- CONDENSATORE
- CONDENSATEUR
- KONDENSATOR
- CONDENSADOR

631 131

A20**CONTACT SET**
- COPPIA CONTATTI
- RUPTEUR
- KONTAKTSATZ
- PLATINOS722 056HV
731 085**A40****DISTRIBUTOR CAP**
- CALOTTA
- TETE D'ALLUMEUR
- VERTEILERKAPPE
- TAPA DEL DISTRIBUIDOR

822 003

822 040

822 046

822 057

822 063

822 073

822 079

822 089

828 101

828 102

828 103

828 104

828 104, 828 105

828 105

831 003/001

831 114

831 120

831 126

831 136

831 151

831 152

831 155



PRODUCTS BY VEHICLE MANUFACTURER

KW-IGN22Q1

-ELENCO PRODOTTI PER MARCA -PRODUITS PAR FABRICANT VEHICULE -LISTE DER PRODUKTE JE NACH FAHRZEUGMARKE -PRODUCTOS POR FABRICANTE DE VEHÍCULO

A50**ROTOR**
-DISTRIBUTORE
-DISRUPTEUR
-VERTEILERLÄUFER
-ROTOR DEL DISTRIBUIDOR

922 052

922 066

922 070

922 070, 922 086

922 070, 922 102

922 085

922 086

922 102

928 030

931 023

931 030

931 110

931 118

931 131

931 136

G10**COIL**
-BOBINA
-BOBINE
-ZÜNDSPULE
-BOBINA

470 296

470 419

470 432

470 489

470 518

470 533

470 551

470 552

470 557

470 596

470 602

470 613

E01**IGNITION CABLE SET**
-SERIE CAVI COMPLETA
-JEU CABLES D'ALLUMAGE
-ZÜNDKABELSATZ
-JUEGO DE CABLES DE ENCENDIDO

358 230

358 244

358 246

359 608

359 609

360 399

360 411

360 658

360 789

NSU**A50****ROTOR**
-DISTRIBUTORE
-DISRUPTEUR
-VERTEILERLÄUFER
-ROTOR DEL DISTRIBUIDOR

906 021R

OPEL**A10****CONDENSER**
-CONDENSATORE
-CONDENSATEUR
-KONDENSATOR
-CONDENSADOR

606 212

A20**CONTACT SET**
-COPPIA CONTATTI
-RUPTEUR
-KONTAKTSATZ
-PLATINOS

706 029HV

706 034HVS

706 049HDVS

712 055HVS

A40**DISTRIBUTOR CAP**
-CALOTTA
-TETE D'ALLUMEUR
-VERTEILERKAPPE
-TAPA DEL DISTRIBUIDOR

806 062

806 076

806 080

806 081

806 099

806 240

806 249

806 251

806 256

806 257

806 258

812 066

812 073

812 074

813 093

813 254

815 084

822 060

828 099

828 100

A50**ROTOR**
-DISTRIBUTORE
-DISRUPTEUR
-VERTEILERLÄUFER
-ROTOR DEL DISTRIBUIDOR

906 012R

A50

906 026R

906 055R

906 056R

906 061R

906 067R

906 121R

906 127R

912 093

912 093R

912 095R

912 096

912 097

912 100

913 030

915 103R

922 069

928 028R

A70**PICK-UP**
-IMPULSORE
-CAPTEUR
-IMPULSGEBER
-CAPTADOR

412 010

412 011

428 202

G10**COIL**
-BOBINA
-BOBINE
-ZÜNDSPULE
-BOBINA

470 109

470 111

470 140

470 191

470 192

470 194

470 219

470 272

470 273

470 341

470 389

470 398

470 399

470 400

470 432

470 442

470 450

470 475

470 507

470 508

470 545

470 547

470 609

470 620

470 631

G20**IGNITION MODULE**
-MODULO DI ACCENSIONE
-MODULES D'ALLUMAGE
-ZÜNDUNGSMODUL
-MÓDULO DE ENCENDIDO

465 004

465 005

465 025

465 034

465 036

E01**IGNITION CABLE SET**
-SERIE CAVI COMPLETA
-JEU CABLES D'ALLUMAGE
-ZÜNDKABELSATZ
-JUEGO DE CABLES DE ENCENDIDO

358 195

358 199

359 509

359 513

359 514

359 527

359 634

359 688

359 689

359 956

360 237

360 506

360 506, 360 562

360 529

360 531

360 559

360 562

360 904

360 942

360 947

PEUGEOT**A10****CONDENSER**
-CONDENSATORE
-CONDENSATEUR
-KONDENSATOR
-CONDENSADOR

615 023

615 034

A20**CONTACT SET**
-COPPIA CONTATTI
-RUPTEUR
-KONTAKTSATZ
-PLATINOS

706 040

706 040, 715 111U

715 055

715 076

715 102

715 103

715 105

A20

715 111U

730 146M

A40**DISTRIBUTOR CAP**
-CALOTTA
-TETE D'ALLUMEUR
-VERTEILERKAPPE
-TAPA DEL DISTRIBUIDOR

806 079

806 124

806 241

806 252

815 049

815 054

815 058

815 059

815 067

815 074

815 077

815 078

815 079

830 098

830 101

A50**ROTOR**
-DISTRIBUTORE
-DISRUPTEUR
-VERTEILERLÄUFER
-ROTOR DEL DISTRIBUIDOR

906 014R

906 025R

906 026R

906 049R

906 055R

906 056R

906 061R

906 119R

915 088

915 091

915 094

915 102R

915 104

930 047R

930 060

A70**PICK-UP**
-IMPULSORE
-CAPTEUR
-IMPULSGEBER
-CAPTADOR

406 153

406 159

415 017

415 019

430 178M



PRODUCTS BY VEHICLE MANUFACTURER

KW-IGN22Q1

-ELENCO PRODOTTI PER MARCA -PRODUITS PAR FABRICANT VEHICULE -LISTE DER PRODUKTE JE NACH FAHRZEUGMARKE -PRODUCTOS POR FABRICANTE DE VEHÍCULO

G10**COIL**

- BOBINA
- BOBINE
- ZÜNDSPULE
- BOBINA

470 101D

470 105

470 105, 470 155

470 106

470 155

470 168

470 188

470 189

470 403

470 405

470 407

470 408

470 459

470 461

470 475

470 476

470 483

470 497

470 505

470 509

470 609

470 620

G20**IGNITION MODULE**

- MODULO DI ACCENSIONE
- MODULES D'ALLUMAGE
- ZÜNDUNGSMODUL
- MÓDULO DE ENCENDIDO

465 005

465 034

E01**IGNITION CABLE SET**

- SERIE CAVI COMPLETA
- JEU CABLES D'ALLUMAGE
- ZÜNDKABELSATZ
- JUEGO DE CABLES DE ENCENDIDO

359 491

359 494

359 655

359 674

359 747

359 748

359 780

359 846

360 025

360 374

PIAGGIO**A50****ROTOR**

- DISTRIBUTORE
- DISRUPTEUR
- VERTEILERLÄUFER
- ROTOR DEL DISTRIBUIDOR

A50

913 030

PORSCHE**A20****CONTACT SET**

- COPPIA CONTATTI
- RUPTEUR
- KONTAKTSATZ
- PLATINOS

706 047

706 062

A40**DISTRIBUTOR CAP**

- CALOTTA
- TETE D'ALLUMEUR
- VERTEILERKAPPE
- TAPA DEL DISTRIBUIDOR

806 072

806 076

806 079

806 090

806 117

806 123

806 128

A50**ROTOR**

- DISTRIBUTORE
- DISRUPTEUR
- VERTEILERLÄUFER
- ROTOR DEL DISTRIBUIDOR

906 018R, 906 021R

906 021R

906 025R

906 070R

906 113R

G10**COIL**

- BOBINA
- BOBINE
- ZÜNDSPULE
- BOBINA

470 427

470 434

470 636

G20**IGNITION MODULE**

- MODULO DI ACCENSIONE
- MODULES D'ALLUMAGE
- ZÜNDUNGSMODUL
- MÓDULO DE ENCENDIDO

465 034

PUCH**A20****CONTACT SET**

- COPPIA CONTATTI
- RUPTEUR
- KONTAKTSATZ
- PLATINOS

706 034HVS

A40**DISTRIBUTOR CAP**

- CALOTTA
- TETE D'ALLUMEUR
- VERTEILERKAPPE
- TAPA DEL DISTRIBUIDOR

806 092

806 108

806 123

806 234

806 237

A50**ROTOR**

- DISTRIBUTORE
- DISRUPTEUR
- VERTEILERLÄUFER
- ROTOR DEL DISTRIBUIDOR

906 024R

906 034R

906 055R

906 060R

906 121R

906 125R

G10**COIL**

- BOBINA
- BOBINE
- ZÜNDSPULE
- BOBINA

470 178

470 180

470 316

470 316K

470 417

E01**IGNITION CABLE SET**

- SERIE CAVI COMPLETA
- JEU CABLES D'ALLUMAGE
- ZÜNDKABELSATZ
- JUEGO DE CABLES DE ENCENDIDO

360 654

360 657

RELIANT**A40****DISTRIBUTOR CAP**

- CALOTTA
- TETE D'ALLUMEUR
- VERTEILERKAPPE
- TAPA DEL DISTRIBUIDOR

828 075

A50**ROTOR**

- DISTRIBUTORE
- DISRUPTEUR
- VERTEILERLÄUFER
- ROTOR DEL DISTRIBUIDOR

928 006

RENAULT**A10****CONDENSER**

- CONDENSATORE
- CONDENSATEUR
- KONDENSATOR
- CONDENSADOR

615 023

615 034

617 097

642 056

A20**CONTACT SET**

- COPPIA CONTATTI
- RUPTEUR
- KONTAKTSATZ
- PLATINOS

706 040

715 055

715 061

715 086

715 126

717 024

717 026

730 148M

742 054

A40**DISTRIBUTOR CAP**

- CALOTTA
- TETE D'ALLUMEUR
- VERTEILERKAPPE
- TAPA DEL DISTRIBUIDOR

806 094

806 236

806 260

815 041

815 054

815 059

815 062

815 063

815 065

815 066

815 069

815 070

815 072

815 073

815 079

815 081

815 082

815 083

815 085

815 086

A40

815 088

815 091

817 023

830 098

830 101

830 111

842 043

A50**ROTOR**

- DISTRIBUTORE
- DISRUPTEUR
- VERTEILERLÄUFER
- ROTOR DEL DISTRIBUIDOR

906 012R

906 014R

906 023R

906 119R

906 147R

915 081

915 088

915 091

915 094

915 097

915 101

917 058

930 047R

930 059

G10**COIL**

- BOBINA
- BOBINE
- ZÜNDSPULE
- BOBINA

470 101D

470 107

470 196

470 228

470 275

470 276

470 355

470 356

470 365

470 376

470 378

470 419

470 432

470 489

470 518

470 533

470 551

470 552

470 596

470 613

G30**ELECTRONIC IGNITION KIT**

- KIT ACCENSIONE ELETTRONICA
- KIT POUR ALLUMAGE ELECTRONIQUE
- ELEKTRONISCHE ZÜNDUNGSSATZ
- JUEGO DE ENCENDIDO ELECTRONICO

490 423



PRODUCTS BY VEHICLE MANUFACTURER

KW-IGN22Q1

-ELENCO PRODOTTI PER MARCA -PRODUITS PAR FABRICANT VEHICULE -LISTE DER PRODUKTE JE NACH FAHRZEUGMARKE -PRODUCTOS POR FABRICANTE DE VEHÍCULO

E01**IGNITION CABLE SET**

- SERIE CAVI COMPLETA
- JEU CABLES D'ALLUMAGE
- ZÜNDKABELSATZ
- JUEGO DE CABLES DE ENCENDIDO

358 049**358 061****358 064****358 229****358 230****358 244****358 246****358 252****359 415****359 539****359 543****359 801****359 802****359 839****359 920****360 332****360 443****360 446****360 447****360 492****360 497****360 499****360 501****360 681****RILEY****A40****DISTRIBUTOR CAP**

- CALOTTA
- TETE D'ALLUMEUR
- VERTEILERKAPPE
- TAPA DEL DISTRIBUIDOR

828 075**A50****ROTOR**

- DISTRIBUTORE
- DISRUPTEUR
- VERTEILERLÄUFER
- ROTOR DEL DISTRIBUIDOR

928 006**ROLLS-ROYCE****G10****COIL**

- BOBINA
- BOBINE
- ZÜNDSPULE
- BOBINA

470 475**ROVER****A20****CONTACT SET**

- COPPIA CONTATTI
- RUPTEUR
- KONTAKTSATZ
- PLATINOS

728 083MHV**A40****DISTRIBUTOR CAP**

- CALOTTA
- TETE D'ALLUMEUR
- VERTEILERKAPPE
- TAPA DEL DISTRIBUIDOR

822 022**822 068****822 069****822 082****828 075****828 093****828 094****828 106****A50****ROTOR**

- DISTRIBUTORE
- DISRUPTEUR
- VERTEILERLÄUFER
- ROTOR DEL DISTRIBUIDOR

922 056**922 082****922 095****922 098****922 102****928 006****928 024R****928 025****928 026R****928 029R****G10****COIL**

- BOBINA
- BOBINE
- ZÜNDSPULE
- BOBINA

470 189**470 211****470 213****470 214****470 347****470 374****470 413****G20****IGNITION MODULE**

- MODULO DI ACCENSIONE
- MODULES D'ALLUMAGE
- ZÜNDUNGSMODUL
- ZÜNDUNGSMODUL
- MÓDULO DE ENCENDIDO

465 052**E01****IGNITION CABLE SET**

- SERIE CAVI COMPLETA
- JEU CABLES D'ALLUMAGE
- ZÜNDKABELSATZ
- JUEGO DE CABLES DE ENCENDIDO

360 711**360 888****360 889****360 914****SAAB****A40****DISTRIBUTOR CAP**

- CALOTTA
- TETE D'ALLUMEUR
- VERTEILERKAPPE
- TAPA DEL DISTRIBUIDOR

806 079**806 124****A50****ROTOR**

- DISTRIBUTORE
- DISRUPTEUR
- VERTEILERLÄUFER
- ROTOR DEL DISTRIBUIDOR

906 021R**906 026R****906 055R****906 121R****906 123R****A70****PICK-UP**

- IMPULSORE
- CAPTEUR
- IMPULSgeber
- CAPTADOR

406 193**406 244****G10****COIL**

- BOBINA
- BOBINE
- ZÜNDSPULE
- BOBINA

470 192**470 450****470 508****G20****IGNITION MODULE**

- MODULO DI ACCENSIONE
- MODULES D'ALLUMAGE
- ZÜNDUNGSMODUL
- MÓDULO DE ENCENDIDO

465 004**465 007****465 034****E01****IGNITION CABLE SET**

- SERIE CAVI COMPLETA
- JEU CABLES D'ALLUMAGE
- ZÜNDKABELSATZ
- JUEGO DE CABLES DE ENCENDIDO

360 138**360 140****SEAT****A10****CONDENSER**

- CONDENSATORE
- CONDENSATEUR
- KONDENSATOR
- CONDENSADOR

615 039**630 117****630 128****A20****CONTACT SET**

- COPPIA CONTATTI
- RUPTEUR
- KONTAKTSATZ
- PLATINOS

717 020**730 132****730 142****730 146M****A40****DISTRIBUTOR CAP**

- CALOTTA
- TETE D'ALLUMEUR
- VERTEILERKAPPE
- TAPA DEL DISTRIBUIDOR

806 079**806 094****806 263****806 266****815 058****815 068****817 014****817 016****817 016, 817 029****830 076****830 098****830 101****830 116****A50****ROTOR**

- DISTRIBUTORE
- DISRUPTEUR
- VERTEILERLÄUFER
- ROTOR DEL DISTRIBUIDOR

906 055R**906 056R****906 121R****915 083R****915 091****A50****915 099R****917 052****917 052R****930 037****930 042R****930 047R****930 054R****930 057R****A70****PICK-UP**

- IMPULSORE
- CAPTEUR
- IMPULSgeber
- CAPTADOR

406 159**406 193****406 223****406 233****406 234****430 182****G10****COIL**

- BOBINA
- BOBINE
- ZÜNDSPULE
- BOBINA

470 101D**470 125****470 159****470 196****470 354S****470 426****470 429****470 431****470 434****470 435****470 445****470 474****470 599****470 636****G20****IGNITION MODULE**

- MODULO DI ACCENSIONE
- MODULES D'ALLUMAGE
- ZÜNDUNGSMODUL
- MÓDULO DE ENCENDIDO

465 007**465 074****465 076****G30****ELECTRONIC IGNITION KIT**

- KIT ACCENSIONE ELETTRONICA
- KIT POUR ALLUMAGE ELECTRONIQUE
- ELEKTRONISCHE ZÜNDUNGSSATZ
- JUEGO DE ENCENDIDO ELECTRONICO

490 414**490 416****490 420**



PRODUCTS BY VEHICLE MANUFACTURER

KW-IGN22Q1

-ELENCO PRODOTTI PER MARCA -PRODUITS PAR FABRICANT VEHICULE -LISTE DER PRODUKTE JE NACH FAHRZEUGMARKE -PRODUCTOS POR FABRICANTE DE VEHÍCULO

E01

IGNITION CABLE SET
 - SERIE CAVI COMPLETA
 - JEU CABLES D'ALLUMAGE
 - ZÜNDKABELSATZ
 - JUEGO DE CABLES DE ENCENDIDO

358 248

359 612

359 725

359 736

359 965

360 364

360 484

360 489

360 549

360 569

360 575

360 585

360 595

360 601

360 640

360 641

360 660

360 667

360 723

360 932

360 937

A70

PICK-UP
 - IMPULSORE
 - CAPTEUR
 - IMPULSGEBER
 - CAPTADOR

406 223

G10

COIL
 - BOBINA
 - BOBINE
 - ZÜNDSPULE
 - BOBINA

470 3545

470 426

470 429

470 431

470 445

470 474

470 599

470 636

G20

IGNITION MODULE
 - MODULO DI ACCENSIONE
 - MODULES D'ALLUMAGE
 - ZÜNDUNGSMODUL
 - MÓDULO DE ENCENDIDO

465 076

G30

ELECTRONIC IGNITION KIT
 - KIT ACCENSIONE ELETTRONICA
 - KIT POUR ALLUMAGE ELECTRONIQUE
 - ELEKTRONISCHE ZÜNDUNGSSATZ
 - JUEGO DE ENCENDIDO ELECTRONICO

490 414

490 420

E01

IGNITION CABLE SET
 - SERIE CAVI COMPLETA
 - JEU CABLES D'ALLUMAGE
 - ZÜNDKABELSATZ
 - JUEGO DE CABLES DE ENCENDIDO

358 223

358 248

360 373

360 479

360 484

360 489

360 569

360 575

360 585

360 609

SMART**G10**

COIL
 - BOBINA
 - BOBINE
 - ZÜNDSPULE
 - BOBINA

470 414

470 503

470 613

E01

IGNITION CABLE SET
 - SERIE CAVI COMPLETA
 - JEU CABLES D'ALLUMAGE
 - ZÜNDKABELSATZ
 - JUEGO DE CABLES DE ENCENDIDO

360 643

SSANGYONG**G10**

COIL
 - BOBINA
 - BOBINE
 - ZÜNDSPULE
 - BOBINA

470 316

SUBARU**A40**

DISTRIBUTOR CAP
 - CALOTTA
 - TETE D'ALLUMEUR
 - VERTEILERKAPPE
 - TAPA DEL DISTRIBUIDOR

813 123

813 259

822 041

822 046

822 048

822 075

831 145

A50

ROTOR
 - DISTRIBUTORE
 - DISRUPTEUR
 - VERTEILERLÄUFER
 - ROTOR DEL DISTRIBUIDOR

913 014

913 028

913 029

922 073

922 093

931 119

G10

COIL
 - BOBINA
 - BOBINE
 - ZÜNDSPULE
 - BOBINA

470 265

470 266

470 537

470 570

E01

IGNITION CABLE SET
 - SERIE CAVI COMPLETA
 - JEU CABLES D'ALLUMAGE
 - ZÜNDKABELSATZ
 - JUEGO DE CABLES DE ENCENDIDO

358 100

358 106

360 813

360 817

360 819

360 835

360 887

SUZUKI**A20**

CONTACT SET
 - COPPIA CONTATTI
 - RUPTEUR
 - KONTAKTSATZ
 - PLATINOS

713 011HV

A40

DISTRIBUTOR CAP
 - CALOTTA
 - TETE D'ALLUMEUR
 - VERTEILERKAPPE
 - TAPA DEL DISTRIBUIDOR

813 093

813 107

813 123

813 245

813 256

822 046

831 132

831 140

831 144

A50

ROTOR
 - DISTRIBUTORE
 - DISRUPTEUR
 - VERTEILERLÄUFER
 - ROTOR DEL DISTRIBUIDOR

913 014

913 028

913 030

913 034

913 036

922 073

A50

931 108

931 131

931 136

G10

COIL
 - BOBINA
 - BOBINE
 - ZÜNDSPULE
 - BOBINA

470 201

470 535

470 570

470 591

470 621

E01

IGNITION CABLE SET
 - SERIE CAVI COMPLETA
 - JEU CABLES D'ALLUMAGE
 - ZÜNDKABELSATZ
 - JUEGO DE CABLES DE ENCENDIDO

358 004

358 005

358 013

358 020

358 028

358 231

360 413

360 415, 360 417

360 434

TALBOT**A10**

CONDENSER
 - CONDENSATORE
 - CONDENSATEUR
 - KONDENSATOR
 - CONDENSADOR

615 034

A20

CONTACT SET
 - COPPIA CONTATTI
 - RUPTEUR
 - KONTAKTSATZ
 - PLATINOS

715 103

715 111U

A40

DISTRIBUTOR CAP
 - CALOTTA
 - TETE D'ALLUMEUR
 - VERTEILERKAPPE
 - TAPA DEL DISTRIBUIDOR

806 079

815 054

815 058

828 075

SKODA**A20**

CONTACT SET
 - COPPIA CONTATTI
 - RUPTEUR
 - KONTAKTSATZ
 - PLATINOS

736 045

A40

DISTRIBUTOR CAP
 - CALOTTA
 - TETE D'ALLUMEUR
 - VERTEILERKAPPE
 - TAPA DEL DISTRIBUIDOR

806 094

830 116

838 242

838 243

A50

ROTOR
 - DISTRIBUTORE
 - DISRUPTEUR
 - VERTEILERLÄUFER
 - ROTOR DEL DISTRIBUIDOR

906 121R

930 057R

938 262R

938 262R, 938 263R

938 263R



PRODUCTS BY VEHICLE MANUFACTURER

-ELENCO PRODOTTI PER MARCA -PRODUITS PAR FABRICANT VEHICULE -LISTE DER PRODUKTE JE NACH FAHRZEUGMARKE -PRODUCTOS POR FABRICANTE DE VEHÍCULO

A50

ROTOR
-DISTRIBUTORE
-DISRUPTEUR
-VERTEILERLÄUFER
-ROTOR DEL DISTRIBUIDOR

- 906 025R
- 906 049R
- 906 061R
- 912 090, 928 006
- 915 088
- 915 091
- 915 094

A70

PICK-UP
-IMPULSORE
-CAPTEUR
-IMPULSGEBER
-CAPTADOR

406 153

G10

COIL
-BOBINA
-BOBINE
-ZÜNDSPULE
-BOBINA

470 101D

TOYOTA

A40

DISTRIBUTOR CAP
-CALOTTA
-TETE D'ALLUMEUR
-VERTEILERKAPPE
-TAPA DEL DISTRIBUIDOR

- 806 094
- 813 099
- 813 113
- 813 113, 813 114
- 813 114
- 813 119
- 813 122
- 813 122, 813 278
- 813 240
- 813 248
- 813 251
- 813 252
- 813 262
- 813 265
- 813 267
- 813 272
- 813 273
- 813 275
- 813 278

A50

ROTOR
-DISTRIBUTORE
-DISRUPTEUR
-VERTEILERLÄUFER
-ROTOR DEL DISTRIBUIDOR

- 906 014R
- 906 121R
- 913 014
- 913 027
- 913 029
- 913 029, 913 036
- 913 030
- 913 036

G10

COIL
-BOBINA
-BOBINE
-ZÜNDSPULE
-BOBINA

- 470 197
- 470 198
- 470 198, 470 199
- 470 198, 470 2855
- 470 199
- 470 199, 470 2855
- 470 202
- 470 203
- 470 2855
- 470 322
- 470 458
- 470 458, 470 466
- 470 459
- 470 461
- 470 466
- 470 536
- 470 537
- 470 538
- 470 609
- 470 632
- 470 645

E01

IGNITION CABLE SET
-SERIE CAVI COMPLETA
-JEU CABLES D'ALLUMAGE
-ZÜNDKABELSATZ
-JUEGO DE CABLES DE ENCENDIDO

- 360 209
- 360 209, 360 879
- 360 393
- 360 435
- 360 792
- 360 793
- 360 823
- 360 856
- 360 879
- 360 880

TRIUMPH

A20

CONTACT SET
-COPPIA CONTATTI
-RUPTEUR
-KONTAKTSATZ
-PLATINOS

728 083MHV

A40

DISTRIBUTOR CAP
-CALOTTA
-TETE D'ALLUMEUR
-VERTEILERKAPPE
-TAPA DEL DISTRIBUIDOR

828 075

A50

ROTOR
-DISTRIBUTORE
-DISRUPTEUR
-VERTEILERLÄUFER
-ROTOR DEL DISTRIBUIDOR

- 912 090
- 912 090, 928 007
- 928 006
- 928 007

TVR

A50

ROTOR
-DISTRIBUTORE
-DISRUPTEUR
-VERTEILERLÄUFER
-ROTOR DEL DISTRIBUIDOR

928 006
928 007

VAUXHALL

A40

DISTRIBUTOR CAP
-CALOTTA
-TETE D'ALLUMEUR
-VERTEILERKAPPE
-TAPA DEL DISTRIBUIDOR

- 806 240
- 806 249
- 806 251
- 806 256
- 806 257
- 812 073
- 815 084
- 828 100

A50

ROTOR
-DISTRIBUTORE
-DISRUPTEUR
-VERTEILERLÄUFER
-ROTOR DEL DISTRIBUIDOR

906 056R

A50

- 906 121R
- 906 127R
- 912 090
- 912 100
- 915 103R
- 928 028R

A70

PICK-UP
-IMPULSORE
-CAPTEUR
-IMPULSGEBER
-CAPTADOR

412 010
428 202

G10

COIL
-BOBINA
-BOBINE
-ZÜNDSPULE
-BOBINA

- 470 140
- 470 191
- 470 192
- 470 194
- 470 272
- 470 273
- 470 341
- 470 389
- 470 398
- 470 399
- 470 400
- 470 432
- 470 442
- 470 450
- 470 475
- 470 507
- 470 508
- 470 545
- 470 547
- 470 609
- 470 620
- 470 631

G20

IGNITION MODULE
-MODULO DI ACCENSIONE
-MODULES D'ALLUMAGE
-ZÜNDUNGSMODUL
-MÓDULO DE ENCENDIDO

465 005
465 025
465 036

E01

IGNITION CABLE SET
-SERIE CAVI COMPLETA
-JEU CABLES D'ALLUMAGE
-ZÜNDKABELSATZ
-JUEGO DE CABLES DE ENCENDIDO

358 195
358 199

E01

- 359 514
- 359 527
- 359 634
- 359 688
- 359 689
- 360 237
- 360 506
- 360 506, 360 562
- 360 529
- 360 531
- 360 559
- 360 562
- 360 904
- 360 947

VOLKSWAGEN (BR)

A40

DISTRIBUTOR CAP
-CALOTTA
-TETE D'ALLUMEUR
-VERTEILERKAPPE
-TAPA DEL DISTRIBUIDOR

806 094

A50

ROTOR
-DISTRIBUTORE
-DISRUPTEUR
-VERTEILERLÄUFER
-ROTOR DEL DISTRIBUIDOR

906 055R
906 121R

A70

PICK-UP
-IMPULSORE
-CAPTEUR
-IMPULSGEBER
-CAPTADOR

406 160
406 233

G10

COIL
-BOBINA
-BOBINE
-ZÜNDSPULE
-BOBINA

470 168
470 354
470 354S
470 474

G30

ELECTRONIC IGNITION KIT
-KIT ACCENSIONE ELETTRONICA
-KIT POUR ALLUMAGE ELECTRONIQUE
-ELEKTRONISCHE ZÜNDUNGSSATZ
-JUEGO DE ENCENDIDO ELECTRONICO

490 414



PRODUCTS BY VEHICLE MANUFACTURER

KW-IGN22Q1

-ELENCO PRODOTTI PER MARCA -PRODUITS PAR FABRICANT VEHICULE -LISTE DER PRODUKTE JE NACH FAHRZEUGMARKE -PRODUCTOS POR FABRICANTE DE VEHÍCULO

G30

490 420

E01**IGNITION CABLE SET**

- SERIE CAVI COMPLETA
- JEU CABLES D'ALLUMAGE
- ZÜNDKABELSATZ
- JUEGO DE CABLES DE ENCENDIDO

360 484

360 585

360 723

VOLVO**A20****CONTACT SET**

- COPPIA CONTATTI
- RUPTEUR
- KONTAKTSATZ
- PLATINOS

706 021

706 021, 706 047

706 034HVS

706 047

706 049HDVS

A40**DISTRIBUTOR CAP**

- CALOTTA
- TETE D'ALLUMEUR
- VERTEILERKAPPE
- TAPA DEL DISTRIBUIDOR

806 062

806 076

806 079

806 127

806 236

806 260

815 059

815 062

815 063

815 069

815 071

A50**ROTOR**

- DISTRIBUTORE
- DISRUPTEUR
- VERTEILERLÄUFER
- ROTOR DEL DISTRIBUIDOR

906 023R

906 025R

906 055R

906 067R

906 118R

906 119R

906 121R

906 122R

906 147R

912 093R

915 096R

A50

915 097

A70**PICK-UP**

- IMPULSORE
- CAPTEUR
- IMPULSGEBER
- CAPTADOR

406 153

406 222

G10**COIL**

- BOBINA
- BOBINE
- ZÜNDSPULE
- BOBINA

470 107

470 355

470 356

470 448

470 478

470 480

470 481

470 532

G30**ELECTRONIC IGNITION KIT**

- KIT ACCENSIONE ELETTRONICA
- KIT POUR ALLUMAGE ELECTRONIQUE
- ELEKTRONISCHE ZÜNDUNGSSATZ
- JUEGO DE ENCENDIDO ELECTRONICO

490 423

E01**IGNITION CABLE SET**

- SERIE CAVI COMPLETA
- JEU CABLES D'ALLUMAGE
- ZÜNDKABELSATZ
- JUEGO DE CABLES DE ENCENDIDO

358 059

358 061

358 064

358 242

359 372

359 415

359 417

360 332

VW**A10****CONDENSER**

- CONDENSATORE
- CONDENSATEUR
- KONDENSATOR
- CONDENSADOR

606 195

606 195, 606 196

606 196

A20**CONTACT SET**

- COPPIA CONTATTI
- RUPTEUR
- KONTAKTSATZ
- PLATINOS

706 032HV

706 032HV, 706 040

706 034HVS

706 040

706 049HDVS

713 011HV

A40**DISTRIBUTOR CAP**

- CALOTTA
- TETE D'ALLUMEUR
- VERTEILERKAPPE
- TAPA DEL DISTRIBUIDOR

806 062

806 079

806 093

806 094

806 231

806 233

806 263

806 266

813 099

813 113

813 114

813 273

815 068

830 116

A50**ROTOR**

- DISTRIBUTORE
- DISRUPTEUR
- VERTEILERLÄUFER
- ROTOR DEL DISTRIBUIDOR

906 014R

906 014R, 906 021R

906 018R

906 021R

906 025R

906 026R

906 027R

906 055R

906 055R, 906 116R

906 056R

906 059R

906 067R

906 114R

906 116R

906 117R

906 121R

906 148R

906 149R

913 014

913 027

915 089R

915 099R

930 057R

A70**PICK-UP**

- IMPULSORE
- CAPTEUR
- IMPULSGEBER
- CAPTADOR

406 159

406 193

406 219

406 223

406 231

406 233

406 234

430 182

G10**COIL**

- BOBINA
- BOBINE
- ZÜNDSPULE
- BOBINA

470 125

470 125, 470 126

470 126

470 132

470 159

470 203

470 269

470 316

470 354

470 354S

470 425

470 426

470 427

470 429

470 431

470 434

470 435

470 437

470 445

470 474

470 599

470 636

G20**IGNITION MODULE**

- MODULO DI ACCENSIONE
- MODULES D'ALLUMAGE
- ZÜNDUNGSMODUL
- MÓDULO DE ENCENDIDO

465 004

465 007

465 072

465 074

465 076

G30**ELECTRONIC IGNITION KIT**

- KIT ACCENSIONE ELETTRONICA
- KIT POUR ALLUMAGE ELECTRONIQUE
- ELEKTRONISCHE ZÜNDUNGSSATZ
- JUEGO DE ENCENDIDO ELECTRONICO

490 414

490 416

490 420

E01**IGNITION CABLE SET**

- SERIE CAVI COMPLETA
- JEU CABLES D'ALLUMAGE
- ZÜNDKABELSATZ
- JUEGO DE CABLES DE ENCENDIDO

358 159

358 223

358 248

359 493

359 725

359 727

359 736

359 737

359 965

360 353

360 364

360 479

360 484

360 489

360 491

360 518

360 549

360 551

360 575

360 580

360 585

360 595

360 601

360 609

360 640

360 641

360 660

360 667

360 671

360 723

360 932

360 933

360 937

WOLSELEY**A20****CONTACT SET**

- COPPIA CONTATTI
- RUPTEUR
- KONTAKTSATZ
- PLATINOS

728 083MHV

A40**DISTRIBUTOR CAP**

- CALOTTA
- TETE D'ALLUMEUR
- VERTEILERKAPPE
- TAPA DEL DISTRIBUIDOR

828 075



PRODUCTS BY VEHICLE MANUFACTURER

KW-IGN22Q1

-ELENCO PRODOTTI PER MARCA -PRODUITS PAR FABRICANT VEHICULE -LISTE DER PRODUKTE JE NACH FAHRZEUGMARKE -PRODUCTOS POR FABRICANTE DE VEHÍCULO

A50

ROTOR

- DISTRIBUTORE
- DISRUPTEUR
- VERTEILERLÄUFER
- ROTOR DEL DISTRIBUIDOR

928 006

928 007

YUGO

A20

CONTACT SET

- COPPIA CONTATTI
- RUPTEUR
- KONTAKTSATZ
- PLATINOS

706 029HV

ZASTAVA

A20

CONTACT SET

- COPPIA CONTATTI
- RUPTEUR
- KONTAKTSATZ
- PLATINOS

707 701

730 140

A40

DISTRIBUTOR CAP

- CALOTTA
- TETE D'ALLUMEUR
- VERTEILERKAPPE
- TAPA DEL DISTRIBUIDOR

807 701

830 081

A50

ROTOR

- DISTRIBUTORE
- DISRUPTEUR
- VERTEILERLÄUFER
- ROTOR DEL DISTRIBUIDOR

907 701R

930 036R

G10

COIL

- BOBINA
- BOBINE
- ZÜNDSPULE
- BOBINA

470 101D



APPLICATION LIST GLOSSARY

KW-IGN22Q1

·GLOSSARIO GUIDA APPLICAZIONI ·GLOSSAIRE LISTE D'APPLICATIONS ·GLOSSAR DER VERWENDUNGSLISTE ·GLOSARIO LISTA APLICACIONES





#	ENGLISH 	ITALIANO 	FRANÇAIS 	DEUTSCH 	ESPAÑOL
->ch.: xxx	Vehicle Identification Number to: xxx	N° telaio fino a: xxx	N° de châssis jusqu'à: xxx	Fahrgestellnummer bis: xxx	n° de chasis hasta: xxx
->eng.: xxx	Engine Number to: xxx	N° motore fino a: xxx	N° de moteur à: xxx	Motornummer bis: xxx	n° de motor hasta: xxx
->prod. nr.: xxx	Production number to: xxx	N° produzione fino a: xxx	N° de production jusqu'à: xxx	Produktionsnummer bis: xxx	n° de producción hasta: xxx
->VET.: xxx	VET Number to: xxx	N° VET fino a: xxx	Numéro VET jusqu'à: xxx	VET-Nummer bis: xxx	n° VET hasta: xxx
->year: xxx	Construction year to: xxx	Anno fino a: xxx	Année jusqu'à: xxx	Baujahr bis: xxx	año construcción hasta: xxx
3 Speed	Number of Gears: 3 Speed	N° marce: 3 marce	Nombre de vitesses: 3 vitesses	Ganganzahl: 3-Gang	Número de marchas: 3 velocidades
4 Speed	Number of Gears: 4 Speed	N° marce: 4 marce	Nombre de vitesses: 4 vitesses	Ganganzahl: 4-Gang	Número de marchas: 4 velocidades
5 Speed	Number of Gears: 5 Speed	N° marce: 5 marce	Nombre de vitesses: 5 vitesses	Ganganzahl: 5-Gang	Número de marchas: 5 velocidades
6 Speed	Number of Gears: 6 Speed	N° marce: 6 marce	Nombre de vitesses: 6 vitesses	Ganganzahl: 6-Gang	Número de marchas: 6 velocidades
96 EEC	Emission Standard: 96 EEC	Norma sui gas di scarico: 96 EEC	Norme concernant les gaz d'échappement: 96 EEC	Abgasnorm: 96 EEC	Norma de emisiones: 96 EEC
Black	Housing Colour: xxx	Colore alloggiamento: xxx	Couleur du carter: xxx	Gehäusefarbe: xxx	Color de carcasa: xxx
Blue	Housing Colour: xxx	Colore alloggiamento: xxx	Couleur du carter: xxx	Gehäusefarbe: xxx	Color de carcasa: xxx
Brown	Housing Colour: xxx	Colore alloggiamento: xxx	Couleur du carter: xxx	Gehäusefarbe: xxx	Color de carcasa: xxx
ch.: xxx	Vehicle Identification Number: xxx	N° telaio: xxx	N° de châssis: xxx	Fahrgestellnummer: xxx	N° de chasis: xxx
ch.: xxx->	Vehicle Identification Number from: xxx	N° telaio da: xxx	N° de châssis à partir de: xxx	Fahrgestellnummer ab: xxx	n° de chasis desde: xxx
Chrome / Black	Housing Colour: xxx	Colore alloggiamento: xxx	Couleur du carter: xxx	Gehäusefarbe: xxx	Color de carcasa: xxx
COL: xxx	Colour: xxx	Colore: xxx	Couleur: xxx	Farbe: xxx	Color: xxx
cyl. num.: xxx	Number of Cylinders: xxx	N° cilindri: xxx	Nombre de cylindres: xxx	Zylinderanzahl: xxx	Número de cilindros: xxx
Dia: xxxmm	Diameter [mm]: xxx	Diametro [mm]: xxx	Diamètre [mm]: xxx	Durchmesser [mm]: xxx	Diámetro [mm]: xxx
distr. num.: xxx	Distributor Number: xxx	N° distributore accensione: xxx	Numéro de distributeur: xxx	Zündverteilernummer: xxx	Número de distribuidor de encendido: xxx
DOHC	Camshaft: DOHC	Albero a camme: DOHC	Arbre à cames: DOHC	Nockenwelle: DOHC	Árbol de levas: DOHC
electronic carburettor	Fuel Mixture Formation: Electronic Carburettor	Preparazione carburante: Carburatore elettronico	Préparation de carburant: Carburateur électronique	Kraftstoffaufbereitung: Elektronischer Vergaser	Preparación del combustible: Carburador electrónico
eng. type: xxx->	Engine Number from: xxx	N° motore da: xxx	N° de moteur de: xxx	Motornummer ab: xxx	n° de motor desde: xxx
eng.: xxx	Engine Code: xxx	Codice motore: xxx	Code moteur: xxx	Motorcode: xxx	Código de motor: xxx
-eng.: xxx	not for engine code: xxx	non per codice motore: xxx	pas pour code moteur: xxx	nicht für Motorcode: xxx	no para código de motor: xxx
euro 1	Emission Standard: Euro 1	Norma sui gas di scarico: Euro 1	Norme concernant les gaz d'échappement: Euro 1	Abgasnorm: Euro 1	Norma de emisiones: Euro 1
euro 2	Emission Standard: Euro 2	Norma sui gas di scarico: Euro 2	Norme concernant les gaz d'échappement: Euro 2	Abgasnorm: Euro 2	Norma de emisiones: Euro 2
euro 3	Emission Standard: Euro 3	Norma sui gas di scarico: Euro 3	Norme concernant les gaz d'échappement: Euro 3	Abgasnorm: Euro 3	Norma de emisiones: Euro 3
euro 3 (D3)	Emission Standard: Euro 3 (D3)	Norma sui gas di scarico: Euro 3 (D3)	Norme concernant les gaz d'échappement: Euro 3 (D3)	Abgasnorm: Euro 3 (D3)	Norma de emisiones: Euro 3
euro 4 (D4)	Emission Standard: Euro 4 (D4)	Norma sui gas di scarico: Euro 4 (D4)	Norme concernant les gaz d'échappement: Euro 4 (D4)	Abgasnorm: Euro 4 (D4)	Norma de emisiones: Euro 4
euro 5	Emission Standard: Euro 5	Norma sui gas di scarico: Euro 5	Norme concernant les gaz d'échappement: Euro 5	Abgasnorm: Euro 5	Norma de emisiones: Euro 5
euro 6	Emission Standard: Euro 6	Norma sui gas di scarico: Euro 6	Norme concernant les gaz d'échappement: Euro 6	Abgasnorm: Euro 6	Norma de emisiones: Euro 6
euro1/euro2	Emission Standard: Euro1/ Euro2	Norma sui gas di scarico: Euro1/Euro2	Norme concernant les gaz d'échappement: Euro1/Euro2	Abgasnorm: Euro1/Euro2	Norma de emisiones: Euro1/Euro2
euro2/euro3	Emission Standard: Euro2/ Euro3	Norma sui gas di scarico: Euro2/Euro3	Norme concernant les gaz d'échappement: Euro2/Euro3	Abgasnorm: Euro2/Euro3	Norma de emisiones: Euro2/Euro3
euro3/euro4	Emission Standard: Euro3/ Euro4	Norma sui gas di scarico: Euro3/Euro4	Norme concernant les gaz d'échappement: Euro3/Euro4	Abgasnorm: Euro3/Euro4	Norma de emisiones: Euro3/Euro4
euro4/euro5	Emission Standard: Euro4/ Euro5	Norma sui gas di scarico: Euro4/Euro5	Norme concernant les gaz d'échappement: euro4 euro5	Abgasnorm: Euro4/Euro5	Norma de emisiones: Euro 4/Euro 5



APPLICATION LIST GLOSSARY

KW-IGN22Q1

-GLOSSARIO GUIDA APPLICAZIONI -GLOSSAIRE LISTE D'APPLICATIONS -GLOSSAR DER VERWENDUNGSLISTE -GLOSARIO LISTA APLICACIONES





#	ENGLISH 	ITALIANO 	FRANÇAIS 	DEUTSCH 	ESPAÑOL 
euro5/euro6	Emission Standard: Euro5/ Euro6	Norma sui gas di scarico: Euro5/Euro6	Norme concernant les gaz d'échappement: Euro5/Euro6	Abgasnorm: Euro5/Euro6	Norma de emisiones: Euro5/Euro6
ext. thread: xxxmm	External Thread [mm]: xxx	Filetto esterno [mm]: xxx	Filetage extérieur [mm]: xxx	Außengewinde [mm]: xxx	Rosca exterior [mm]: xxx
for 1st gear	Number of Gears: for 1st gear	N° marce: per 1ª marcia	Nombre de vitesses: pour 1re vitesse	Ganganzahl: für 1. Gang	Número de marchas: para primera marcha
for emission-controlled vehicles	for emission-controlled vehicles: xxx	per veicoli sveleniti gas scarico: xxx	pour véhicules à émissions de gaz limitées: xxx	für abgasentgiftete Fahrzeuge: xxx	para vehículos con decontaminación de gases: xxx
for individual equipment ID: xxx	for individual equipment ID: xxx	per ID-equipaggiamento individuale: xxx	pour ID d'équipement individuel: xxx	für Individualausstattungs-ID: xxx	para ID equipamiento individual: xxx
for manuf. exhaust norm: xxx	for manufacturer exhaust norm: xxx	per norma sui gas di scarico-Costruttore: xxx	pour norme des gaz d'échappementdes fabricants: xxx	für Hersteller-Abgasnorm: xxx	para norma de emisión/fabricante: xxx
FOR MODEL: xxx	for model year: xxx	per anno d. modello: xxx	pour année: xxx	für Modelljahr: xxx	para modelo (año): xxx
FOR: xxx	Country-spec. model: xxx	Modello p. paesi: xxx	Type de pays: xxx	Länderausführung: xxx	Modelo por país: xxx
FP: after soot particulate filter	Fitting Position: after soot particulate filter	Lato montaggio: dopo il/ al Filtro antiparticolato	Côté d'assemblage: après filtre à particules	Einbauseite: nach Rußpartikelfilter	Lado de montaje: con filtro de partículas
FP: Air Filter Housing	Fitting Position: Air Filter Housing	Lato montaggio: Carter filtro aria	Côté d'assemblage: Boîtier de filtre à air	Einbauseite: Luftfiltergehäuse	Lado de montaje: Caja filtro de aire
FP: before soot particulate filter	Fitting Position: before soot particulate filter	Lato montaggio: davanti al filtro antiparticolato	Côté d'assemblage: devant le filtre à particules	Einbauseite: vor Rußpartikelfilter	Lado de montaje: antes de filtro de partículas
FP: Behind exhaust turbo charger	Fitting Position: Behind exhaust turbo charger	Lato montaggio: a valle del turbocompressore	Côté d'assemblage: derrière turbocompresseur	Einbauseite: nach Abgasturbolader	Lado de montaje: al turbocompresor de gases de escape
FP: Boot	Fitting Position: Boot	Lato montaggio: Bagagliaio	Côté d'assemblage: Coffre à bagages	Einbauseite: Kofferraum	Lado de montaje: Maletero
FP: Brake Booster	Fitting Position: Brake Booster	Lato montaggio: Servofreno	Côté d'assemblage: Servofrein	Einbauseite: Bremskraftverstärker	Lado de montaje: Servofrenos
FP: Centre	Fitting Position: Centre	Lato montaggio: centro	Côté d'assemblage: centre	Einbauseite: mitte	Lado de montaje: centro
FP: Compressor Side	Fitting Position: Compressor Side	Lato montaggio: Lato compressore	Côté d'assemblage: Côté compresseur	Einbauseite: Verdichterseite	Lado de montaje: compresor
FP: Cylinder Head	Fitting Position: Cylinder Head	Lato montaggio: Testa a cilindro	Côté d'assemblage: Culasse de cylindre	Einbauseite: Zylinderkopf	Lado de montaje: Cabeza cilíndrica
FP: Elbow at exhaust manifold	Fitting Position: Elbow at exhaust manifold	Lato montaggio: Curva al collettore per scarico	Côté d'assemblage: Tube coudé au collecteur d'échappement	Einbauseite: Rohrkrümmer an Abgaskrümmer	Lado de montaje: codo en colector de escape
FP: End Silencer	Fitting Position: End Silencer	Lato montaggio: Silenziatore posteriore	Côté d'assemblage: Silencieux arrière	Einbauseite: Endschalldämpfer	Lado de montaje: Silenciador posterior
FP: Engine Side	Fitting Position: Engine Side	Lato montaggio: Lato motore	Côté d'assemblage: du côté moteur	Einbauseite: motorseitig	Lado de montaje: motor
FP: Exhaust Manifold	Fitting Position: Exhaust Manifold	Lato montaggio: Collettore gas scarico	Côté d'assemblage: Collecteur des gaz d'échappement	Einbauseite: Abgaskrümmer	Lado de montaje: Colector de escape
FP: Exhaust Pipe at exh. Turbocharger	Fitting Position: Exhaust Pipe at exhaust turbocharger	Lato montaggio: Condotto gas scarico a Turbocompressore a gas scarico	Côté d'assemblage: Tuyau d'échappement au turbocompresseur	Einbauseite: Abgasrohr an Abgasturbolader	Lado de montaje: Colector de escape en turbocompresor
FP: Exhaust Pipe on silencer	Fitting Position: Exhaust Pipe on silencer	Lato montaggio: Tubo gas scarico alla marmitta	Côté d'assemblage: Tuyau d'échappement au silencieux	Einbauseite: Abgasrohr an Schalldämpfer	Lado de montaje: Tubo de escape en silenciador
FP: Fan side	Fitting Position: Fan side	Lato montaggio: lato ventola	Côté d'assemblage: du côté du ventilateur	Einbauseite: Lüfterseitig	Lado de montaje: del lado del ventilador
FP: Flywheel side	Fitting Position: Flywheel side	Lato montaggio: lato disco del volante	Côté d'assemblage: du côté du volant moteur	Einbauseite: schwungradscheibenseitig	Lado de montaje: del lado del volante
FP: Front	Fitting Position: Front	Lato montaggio: anteriore	Côté d'assemblage: avant	Einbauseite: vorne	Lado de montaje: delante
FP: Front and Rear	Fitting Position: Front and Rear	Lato montaggio: anteriore e posteriore	Côté d'assemblage: avant et arrière	Einbauseite: vorne und hinten	Lado de montaje: delante y detrás
FP: Front Axle Left	Fitting Position: Front Axle Left	Lato montaggio: Assale anteriore Sx	Côté d'assemblage: Essieu avant gauche	Einbauseite: Vorderachse links	Lado de montaje: Eje delantero, izquierda
FP: Front Axle left and right	Fitting Position: Front Axle left and right	Lato montaggio: Assale anteriore bilaterale	Côté d'assemblage: des deux côtés de l'essieu avant	Einbauseite: Vorderachse beidseitig	Lado de montaje: eje delantero, ambos lados
FP: Front Axle Right	Fitting Position: Front Axle Right	Lato montaggio: Assale anteriore Dx	Côté d'assemblage: Essieu avant droit	Einbauseite: Vorderachse rechts	Lado de montaje: Eje delantero, derecha
FP: Fuel Line	Fitting Position: Fuel Line	Lato montaggio: Condotto carburante	Côté d'assemblage: Tube d'alimentation	Einbauseite: Kraftstoffleitung	Lado de montaje: Tubería de combustible



APPLICATION LIST GLOSSARY

KW-IGN22Q1

·GLOSSARIO GUIDA APPLICAZIONI ·GLOSSAIRE LISTE D'APPLICATIONS ·GLOSSAR DER VERWENDUNGSLISTE ·GLOSARIO LISTA APLICACIONES

#	ENGLISH 	ITALIANO 	FRANÇAIS 	DEUTSCH 	ESPAÑOL 
FP: In front of exhaust turbocharger	Fitting Position: in front of exhaust turbocharger	Lato montaggio: davanti a turbocompressore	Côté d'assemblage: devant le turbocompresseur à gaz d'échappement	Einbauseite: vor Abgasturbolader	Lado de montaje: de turbocompresor escape
FP: In front of the catalyst	Fitting Position: in front of the catalyst	Lato montaggio: davanti al catalizzatore	Côté d'assemblage: devant le catalyseur	Einbauseite: vor Katalysator	Lado de montaje: delante del catalizador
FP: In front of the radiator	Fitting Position: in front of the radiator	Lato montaggio: davanti al radiatore	Côté d'assemblage: devant le radiateur	Einbauseite: vor dem Kühler	Lado de montaje: delante del radiador
FP: In fuel tank	Fitting Position: in fuel tank	Lato montaggio: nel serbatoio carburante	Côté d'assemblage: dans le réservoir de carburant	Einbauseite: im Kraftstoffbehälter	Lado de montaje: incl. depósito combustible
FP: in transm.housing	Fitting Position: in transmission housing	Lato montaggio: nella scatola del cambio	Côté d'assemblage: dans la boîte de transmission	Einbauseite: im Getriebegehäuse	Lado de montaje: en cárter de transmisión
FP: Inlet	Fitting Position: Inlet	Lato montaggio: Entrata	Côté d'assemblage: Entrée	Einbauseite: Eingang	Lado de montaje: Entrada
FP: Inner	Fitting Position: inner	Lato montaggio: interno	Côté d'assemblage: intérieur	Einbauseite: innen	Lado de montaje: interior
FP: Intake Manifold	Fitting Position: Intake Manifold	Lato montaggio: Collettore d'aspirazione	Côté d'assemblage: Collecteur d'admission	Einbauseite: Ansaugkrümmer	Lado de montaje: Colector de admisión
FP: Intake Side	Fitting Position: Intake Side	Lato montaggio: Lato aspirazione	Côté d'assemblage: Côté d'admission	Einbauseite: Einlassseite	Lado de montaje: Lado de admisión
FP: Intercooler	Fitting Position: Intercooler	Lato montaggio: Intercooler	Côté d'assemblage: Intercooler, échangeur	Einbauseite: Ladeluftkühler	Lado de montaje: Refrigerador de aire de sobrealimentación
FP: Left	Fitting Position: Left	Lato montaggio: Sx	Côté d'assemblage: gauche	Einbauseite: links	Lado de montaje: izquierda
FP: Left and right	Fitting Position: Left and right	Lato montaggio: bilaterale	Côté d'assemblage: côté conducteur + passager av.	Einbauseite: beidseitig	Lado de montaje: ambos lados
FP: Left Front	Fitting Position: Left Front	Lato montaggio: anteriore Sx	Côté d'assemblage: avant gauche	Einbauseite: vorne links	Lado de montaje: Delante, izquierda
FP: Left Front	Fitting Position: Left	Lato montaggio: Sx	Côté d'assemblage: gauche	Einbauseite: links	Lado de montaje: izquierda
FP: Left Rear	Fitting Position: Left Rear	Lato montaggio: posteriore Sx	Côté d'assemblage: arrière gauche	Einbauseite: hinten links	Lado de montaje: Atrás izquierda
FP: Lower	Fitting Position: Lower	Lato montaggio: inferiore	Côté d'assemblage: inférieur	Einbauseite: unten	Lado de montaje: debajo
FP: Middle Silencer	Fitting Position: Middle Silencer	Lato montaggio: Silenziatore centrale	Côté d'assemblage: Pot de détente	Einbauseite: Mittelschalldämpfer	Lado de montaje: silenciador del medio
FP: Outer	Fitting Position: Outer	Lato montaggio: Esterno	Côté d'assemblage: extérieur	Einbauseite: außen	Lado de montaje: exterior
FP: Outlet	Fitting Position: Outlet	Lato montaggio: Uscita	Côté d'assemblage: Sortie	Einbauseite: Ausgang	Lado de montaje: Salida
FP: Outlet Side	Fitting Position: Exhaust Side	Lato montaggio: Lato scarico	Côté d'assemblage: Côté d'échappement	Einbauseite: Auslassseite	Lado de montaje: Lado de escape
FP: Particulate Filter	Fitting Position: Particulate Filter	Lato montaggio: Filtro particellare	Côté d'assemblage: Filtre à particules	Einbauseite: Partikelfilter	Lado de montaje: Filtro de partículas
FP: Pipe at EGR valve	Fitting Position: Pipe at EGR valve	Lato montaggio: Condotto a valvola-EGR	Côté d'assemblage: Ligne à la valve EGR	Einbauseite: Leitung an AGR-Ventil	Lado de montaje: Tubo en válvula EGR
FP: Post-catalyst	Fitting Position: Post-catalyst	Lato montaggio: al Catalizzatore	Côté d'assemblage: après catalyseur	Einbauseite: nach Katalysator	Lado de montaje: después de catalizador
FP: Rear	Fitting Position: Rear	Lato montaggio: posteriore	Côté d'assemblage: arrière	Einbauseite: hinten	Lado de montaje: posterior
FP: Rear Axle	Fitting Position: Rear Axle	Lato montaggio: Assale posteriore	Côté d'assemblage: Essieu arrière	Einbauseite: Hinterachse	Lado de montaje: Eje trasero
FP: Rear Axle Left	Fitting Position: Rear Axle Left	Lato montaggio: Assale posteriore Sx	Côté d'assemblage: Essieu arrière gauche	Einbauseite: Hinterachse links	Lado de montaje: Eje trasero izquierda
FP: Rear Axle left and right	Fitting Position: Rear Axle left and right	Lato montaggio: Assale post. bilaterale	Côté d'assemblage: des deux côtés du pont arrière	Einbauseite: Hinterachse beidseitig	Lado de montaje: eje trasero ambos lados
FP: Rear Axle Right	Fitting Position: Rear Axle Right	Lato montaggio: Assale posteriore Dx	Côté d'assemblage: Essieu arrière droit	Einbauseite: Hinterachse rechts	Lado de montaje: Eje trasero, derecha
FP: right	Fitting Position: Right	Lato montaggio: Dx	Côté d'assemblage: droite	Einbauseite: rechts	Lado de montaje: derecha
FP: Right front	Fitting Position: Right Front	Lato montaggio: anteriore Dx	Côté d'assemblage: avant droite	Einbauseite: vorne rechts	Lado de montaje: Delante, derecha
FP: Right Rear	Fitting Position: Right Rear	Lato montaggio: posteriore Dx	Côté d'assemblage: arrière droite	Einbauseite: hinten rechts	Lado de montaje: Atrás derecha
FP: Throttle Housing	Fitting Position: Throttle Housing	Lato montaggio: Sede valvola a farfalla	Côté d'assemblage: Boîtier papillon	Einbauseite: Drosselklappengehäuse	Lado de montaje: Caja mariposa
FP: to cylinder 3	Fitting Position: to cylinder 3	Lato montaggio: al cilindro 3	Côté d'assemblage: au cylindre 3	Einbauseite: zum Zylinder 3	Lado de montaje: al cilindro 3
FP: to cylinder 4	Fitting Position: to cylinder 4	Lato montaggio: al cilindro 4	Côté d'assemblage: au cylindre 4	Einbauseite: zum Zylinder 4	Lado de montaje: al cilindro 4



APPLICATION LIST GLOSSARY

KW-IGN22Q1

-GLOSSARIO GUIDA APPLICAZIONI -GLOSSAIRE LISTE D'APPLICATIONS -GLOSSAR DER VERWENDUNGSLISTE -GLOSARIO LISTA APLICACIONES





#	ENGLISH	ITALIANO	FRANÇAIS	DEUTSCH	ESPAÑOL
FP: Transmission End	Fitting Position: Transmission End	Lato montaggio: sul lato del cambio	Côté d'assemblage: du côté boîte de vitesses	Einbauseite: getriebeseitig	Lado de montaje: lado de engranaje
FP: Turbine Inlet	Fitting Position: Turbine Inlet	Lato montaggio: Entrata turbina	Côté d'assemblage: Entrée de turbine	Einbauseite: Turbineneingang	Lado de montaje: Entrada turbina
FP: Upper	Fitting Position: Upper	Lato montaggio: Superiore	Côté d'assemblage: supérieur	Einbauseite: oben	Lado de montaje: arriba
FP: Water Pump	Fitting Position: Water Pump	Lato montaggio: Pompa acqua	Côté d'assemblage: Pompe à eau	Einbauseite: Wasserpumpe	Lado de montaje: bomba de agua
fuel formation: carburettor	Fuel Mixture Formation: Carburettor	Preparazione carburante: Carburatore	Préparation de carburant: Carburateur	Kraftstoffaufbereitung: Vergaser	Preparación del combustible: Carburador
fuel formation: direct injection	Fuel Mixture Formation: Direct Injection	Preparazione carburante: Iniezione diretta	Préparation de carburant: Injection directe	Kraftstoffaufbereitung: Direkteinspritzung	Preparación del combustible: Inyección directa
fuel formation: motronic	Fuel Mixture Formation: Motronic	Preparazione carburante: Motronic	Préparation de carburant: Motronic	Kraftstoffaufbereitung: Motronic	Preparación del combustible: Motronic
Green	Housing Colour: xxx	Colore alloggiamento: xxx	Couleur du carter: xxx	Gehäusefarbe: xxx	Color de carcasa: xxx
Grey	Housing Colour: xxx	Colore alloggiamento: xxx	Couleur du carter: xxx	Gehäusefarbe: xxx	Color de carcasa: xxx
info: xxx	Technical Information Number: xxx	N° informazione tecnica: xxx	Numéro d'information technique: xxx	Technische Informationsnummer: xxx	N° de información técnica: xxx
interference suppressed	Interference suppressed: xxx	schermato/a: xxx	déparasité: xxx	entstört: xxx	con supresión de interferencias: xxx
L: xxxmm	Length [mm]: xxx	Lunghezza [mm]: xxx	Longueur [mm]: xxx	Länge [mm]: xxx	Longitud [mm]: xxx
L3	Emission Standard: L3	Norma sui gas di scarico: L3	Norme concernant les gaz d'échappement: L3	Abgasnorm: L3	Norma de emisiones: L3
L4	Emission Standard: L4	Norma sui gas di scarico: L 4	Norme concernant les gaz d'échappement: L4	Abgasnorm: L4	Norma de emisiones: L4
MADE BY: xxx	Vehicle Production Country: xxx	Paese produzione veicolo: xxx	Pays constructeur du véhicule: xxx	Fahrzeugproduktionsland: xxx	País producción vehículo: xxx
MODEL FROM: xxx	Model year from: xxx	Anno modello da: xxx	Année à partir de: xxx	Modelljahr ab: xxx	año modelo desde: xxx
MODEL TO: xxx	Model year to: xxx	Anno modello fino a: xxx	Année jusqu'à: xxx	Modelljahr bis: xxx	año modelo hasta: xxx
-model: xxx	not for code: xxx	non per modello: xxx	pas pour le modèle: xxx	nicht für Baumuster: xxx	no apto para el tipo: xxx
Multi Point Injection (MPI)	Injection System: Multi Point Injection (MPI)	Sistema iniezione: MPI (Multipoint)	Système d'injection: MPI (MultiPoint)	Einspritzsystem: MPI (MultiPoint)	Sistema de inyección: MPI (MultiPoint)
NOT FOR: xxx	not for country-spec. model: xxx	non per versione per paese: xxx	pas pour version-pays: xxx	nicht für Länderausführung: xxx	no para modelo país: xxx
NOT MADE BY: xxx	not for vehicle production country: xxx	non per paese produzione veicolo: xxx	pas pour pays constructeur du véhicule: xxx	nicht für Fahrzeugproduktionsland: xxx	no para país producción vehículos: xxx
oe: xxx	for OE number: xxx	per N° OE: xxx	pour numéro OE: xxx	für OE-Nummer: xxx	para OE N°: xxx
Orange	Housing Colour: xxx	Colore alloggiamento: xxx	Couleur du carter: xxx	Gehäusefarbe: xxx	Color de carcasa: xxx
org.: xxx->	for organisation number from: xxx	per numero organizzazione da: xxx	pour numéro d'organisation à partir de: xxx	für Organisationsnummer ab: xxx	para números de organización desde: xxx
petrol injection	Fuel Mixture Formation: Petrol Injection	Preparazione carburante: Iniezione benzina	Préparation de carburant: Injection d'essence	Kraftstoffaufbereitung: Benzineinspritzung	Preparación del combustible: Inyección de gasolina
pole nr.: xxx	Number of Poles: xxx	N° poli: xxx	Nombres de pôles: xxx	Pol-Anzahl: xxx	Número de polos: xxx
prod. nr.: xxx->	Production number from: xxx	N° produzione da: xxx	N° de production à partir de: xxx	Produktionsnummer ab: xxx	n° de producción desde: xxx
production date ->: xxx	Production date to: xxx	Data di produzione fino a: xxx	Date de production jusqu'à: xxx	Produktionsdatum bis: xxx	fecha de producción hasta: xxx
production date: xxx->	Production date from: xxx	Data di produzione da: xxx	Date de production à partir de: xxx	Produktionsdatum ab: xxx	fecha de producción desde: xxx
Qty: xxx	Quantity: xxx	Quantità: xxx	Quantité: xxx	Menge: xxx	Cantidad: xxx
Red	Housing Colour: xxx	Colore alloggiamento: xxx	Couleur du carter: xxx	Gehäusefarbe: xxx	Color de carcasa: xxx
resist.: xxxohm	Resistance [Ohm]: xxx	Resistenza [Ohm]: xxx	Résistance [ohm]: xxx	Widerstand [Ohm]: xxx	Resistencia [Ohm]: xxx
RPM to: xxx[1/min]	RPM to [1/min]: xxx	N° giri fino a [1/min.]: xxx	Régime mot. jusqu'à [1/min]: xxx	Drehzahl bis [1/min]: xxx	vel. giro hasta [1/min]: xxx
SA: xxx	for SA code: xxx	per codice SA: xxx	pour SA code: xxx	für SA Code: xxx	para código SA: xxx
-SA: xxx	not for SA code: xxx	non per codice SA: xxx	pas pour SA code: xxx	nicht für SA Code: xxx	no para código SA: xxx
SOHC/OHC	Camshaft: SOHC/OHC	Albero a camme: SOHC/OHC	Arbre à cames: SOHC/OHC	Nockenwelle: SOHC/OHC	Árbol de levas: SOHC/OHC
t.tnr.: xxx	Transmission Type: xxx	Tipo di trasmissione: xxx	Type de boîte de vitesses: xxx	Getriebetyp: xxx	Tipo de caja de cambios: xxx



APPLICATION LIST GLOSSARY

KW-IGN22Q1

•GLOSSARIO GUIDA APPLICAZIONI •GLOSSAIRE LISTE D'APPLICATIONS •GLOSSAR DER VERWENDUNGSLISTE •GLOSARIO LISTA APLICACIONES

#	ENGLISH 	ITALIANO 	FRANÇAIS 	DEUTSCH 	ESPAÑOL 
-transm. type: xxx	not for transmission type: xxx	non per tipo di trasmissione: xxx	pas pour type de transmission: xxx	nicht für Getriebetyp: xxx	no para tipo de transmisión: xxx
version: xxx	Version: xxx	Versione: xxx	Version: xxx	Version: xxx	Versión: xxx
VET.: xxx->	VET Number from: xxx	N° VET da: xxx	Numéro VET à partir de: xxx	VET-Nummer ab: xxx	nº VET desde: xxx
White	Housing Colour: xxx	Colore alloggio: xxx	Couleur du carter: xxx	Gehäusefarbe: xxx	Color de carcasa: xxx
xxx->	Construction year from: xxx	Anno da: xxx	Année à partir de: xxx	Baujahr ab: xxx	año construcción desde: xxx
xxxkW	Power [kW]: xxx	Potenza [KW]: xxx	Puissance [kW]: xxx	Leistung [kW]: xxx	Potencia [kW]: xxx
Yellow	Housing Colour: xxx	Colore alloggio: xxx	Couleur du carter: xxx	Gehäusefarbe: xxx	Color de carcasa: xxx

ILLUSTRATED SECTION

KW-IGN22Q1

-PARTE FIGURATA -PARTIE ILLUSTRÉE -BILDTEIL -PARTE ILUSTRADA





CONDENSERS

-CONDENSATORI -CONDENSATEURS -KONDENSATOREN -CONDENSADORES

(A) P/NRS. - NOTES

- CODICI - NOTE
- RÉFS. - NOTES
- ARTIKEL-NR. - ANMERKUNGEN
- CODIGOS - NOTAS

1 **606 196** 3 1

CONDENSERS

Adatt./Su. 2 **Bole: BOSCH** 4

BOSCH
1 237 330 310

GENERAL MOTORS
93 150 082

VW
060 905 295

3 **Supplied until depletion**

- Fornibile fino ad esaurimento delle scorte
- Fourni jusqu'à épuisement du stock
- Lieferbar solange vorrat reicht
- Suministrado hasta el stock termina

(A)

- 1 **# KW**
- 2 **OEM P/NRS.**
- CODICI ORIGINALI
 - RÉFS. D'ORIGINE
 - ORIGINALTEILE-NR.
 - CODIGOS ORIGINALES
- 3 **PACKAGING SIZE**
- FORMATO CONFEZIONE
 - FORMAT DU CONDITIONNEMENT
 - ABPACKENSGROSSE
 - TAMAÑO DEL ENVASE
- 4 **NOTE**
- NOTE
 - NOTES
 - BEMERKUNGEN
 - NOTAS

(B) PICTURE + TECHNICAL INFO

- FOTO + INFORMAZIONE TECNICA
- ILLUSTRATION + INFORMATION TECHNIQUE
- BILD + TECHNISCHE INFO
- FOTO + INFORMACIÓN TÉCNICA

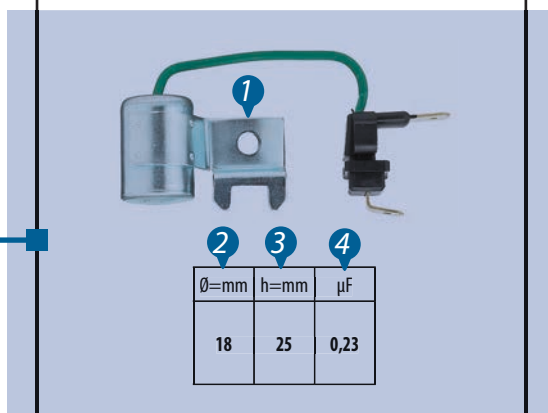

(C) APPLICATION LIST

- GUIDA APPLICAZIONI
- LISTE D'APPLICATIONS
- ANWENDUNGSTABELLE
- LISTA DE APLICACIONES

VW		
CADDY I 1.5	JB	08/82 ⇒ 07/83
CADDY I 1.6	EW, HN	01/83 ⇒ 07/92
DERBY 1.0	GL	10/81 ⇒ 12/84
GOLF II 1.0	GN	11/83 ⇒ 08/85
GOLF II 1.6	EZ	08/83 ⇒ 07/92
GOLF II 1.6 (CHE) [SWE]	HM	08/83 ⇒ 07/85
JETTA II 1.6	EZ, HM	12/83 ⇒ 07/92
POLO II 1.0	GL	10/81 ⇒ 10/86
SCIROCCO I 1.5	JB	08/77 ⇒ 07/80
SCIROCCO II 1.6	FR, FR	08/80 ⇒ 04/84

(B)

- 1 **PICTURE**
- FOTO
 - PHOTO
 - BILD
 - FOTO

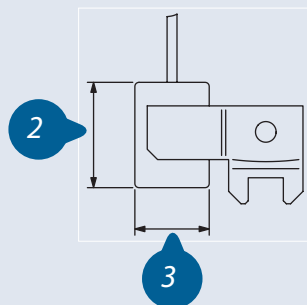

- 4 **CAPACITY**
- CAPACITÀ
 - CAPACITÉ
 - CAPAZITÄT
 - CAPACIDAD

KW 606 030



CONDENSERS

Adatt./Suitable: BOSCH

BOSCH

1 237 330 035
1 237 330 036
1 237 330 039
2 207 330 011

⁰³ Supplied until depletion

- Fornibile fino ad esaurimento delle scorte
- Fourni jusqu'à épuisement du stock
- Lieferbar solange vorrat reicht
- Suministrado hasta el stock termina

VW

411 963 073



Ø=mm	h=mm	µF
18	21	0,18

KW 606 180



CONDENSERS

Adatt./Suitable: BOSCH

BOSCH

2 207 330 041
2 207 330 050

⁰⁰ Eliminated on 01-03-2022. Please verify the availability through our local distributors

- Eliminato il 01-03-2022. Verificare la disponibilità presso i nostri distributori
- Éliminé le 01-03-2022. Vérifier la disponibilité auprès de nos distributeurs sur place
- Am 01-03-2022 gestrichen. Evtl. Verfügbarkeit bitte bei unseren Händlern prüfen
- Eliminado en fecha 01-03-2022. Verificar la disponibilidad a través de nuestros distribuidores locales



Ø=mm	h=mm	µF
18	21	0,18

KW 606 195



CONDENSERS

Adatt./Suitable: BOSCH

BOSCH

1 237 330 316

GENERAL MOTORS
93 150 083

SAAB

93 51 743

VW

052 905 295

⁰⁰ Eliminated on 07-04-2021. Please verify the availability through our local distributors

- Eliminato il 07-04-2021. Verificare la disponibilità presso i nostri distributori
- Éliminé le 07-04-2021. Vérifier la disponibilité auprès de nos distributeurs sur place
- Am 07-04-2021 gestrichen. Evtl. Verfügbarkeit bitte bei unseren Händlern prüfen
- Eliminado en fecha 07-04-2021. Verificar la disponibilidad a través de nuestros distribuidores locales

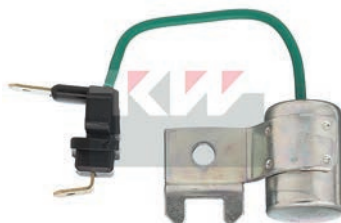

Ø=mm	h=mm	µF
18	25	0,23

VW

POLO II 1.1	HB	10/81 ⇔ 09/89
POLO II 1.3	GT, HH, HJ, HK, HW	10/81 ⇔ 07/88
JETTA II 1.3	GT, HK	01/84 ⇔ 06/87
DERBY 1.1	HB	02/77 ⇔ 09/81
DERBY 1.3	HH	02/77 ⇔ 09/81
GOLF I 1.3	HK	08/83 ⇔ 07/86
GOLF II 1.0	GN	11/83 ⇔ 08/85
GOLF II 1.3	GT, HK	08/83 ⇔ 06/87
SCIROCCO I 1.1	FA	04/74 ⇔ 07/79
SCIROCCO I 1.3	GF	08/79 ⇔ 07/80
SCIROCCO II 1.3	HK	08/83 ⇔ 07/84

KW 606 196



CONDENSERS

Adatt./Suitable: BOSCH

BOSCH

1 237 330 310

GENERAL MOTORS
93 150 082

VW

060 905 295

⁰³ Supplied until depletion

- Fornibile fino ad esaurimento delle scorte
- Fourni jusqu'à épuisement du stock
- Lieferbar solange vorrat reicht
- Suministrado hasta el stock termina



Ø=mm	h=mm	µF
18	25	0,23

VW

POLO II 1.0	GL	10/81 ⇔ 10/86
JETTA II 1.6	EZ, HM	12/83 ⇔ 07/92
CADDY I 1.5	JB	08/82 ⇔ 07/83
CADDY I 1.6	EW, HN	01/83 ⇔ 07/92
DERBY 1.0	GL	10/81 ⇔ 12/84

VW

GOLF II 1.0	GN	11/83 ⇔ 08/85
GOLF II 1.6	EZ	08/83 ⇔ 07/92
GOLF II 1.6 [CHE] [SWE]	HM	08/83 ⇔ 07/85
SCIROCCO I 1.5	JB	08/77 ⇔ 07/80
SCIROCCO II 1.6	1HyFAD	08/80 ⇔ 04/84

KW 606 212



CONDENSERS

Adatt./Suitable: BOSCH

BOSCH

1 237 330 307
1 237 330 340
1 237 330 353

GENERAL MOTORS

90 009 490
90 114 106
93 150 118
93 150 586

OPEL

12 12 253
12 12 259
12 12 260
90009490

⁰³ Supplied until depletion

- Fornibile fino ad esaurimento delle scorte
- Fourni jusqu'à épuisement du stock
- Lieferbar solange vorrat reicht
- Suministrado hasta el stock termina



Ø=mm	h=mm	µF
18	25	0,23

OPEL

CORSA A 1.0	10S	09/82 ⇔ 03/93
CORSA A 1.2	12N, 12NC	09/82 ⇔ 08/90
CORSA A 1.2 N	12NC	01/85 ⇔ 10/87
KADETT B 1.1	11N	08/71 ⇔ 08/73
KADETT D 1.0	10N	09/79 ⇔ 08/82
KADETT E 1.2	12SC	09/84 ⇔ 07/86

KW 606 257



CONDENSERS

Adatt./Suitable: BOSCH

BOSCH

1 237 330 348

VW

036 905 295 B

⁰³ Supplied until depletion

- Fornibile fino ad esaurimento delle scorte
- Fourni jusqu'à épuisement du stock
- Lieferbar solange vorrat reicht
- Suministrado hasta el stock termina

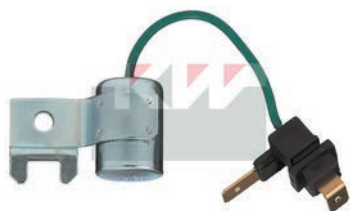

Ø=mm	h=mm	µF
18	25	0,23

KW 615 023



CONDENSERS

Adatt./Suitable: DUCELLIER

ALFA ROMEO

116 55 05 011 03/04

BOSCH

1 237 330 801

1 237 330 803

DUCELLIER

1203

FIAT

9934266

GENERAL MOTORS

3 474 600

LANCIA

9934266

Motorcraft

EDC 62

EDC 173

PEUGEOT

5948 05

5948 06

RENAULT

08 53 712 500

77 01 022 130

VOLVO

3102885

31028855

3277441

32774416

⁰⁰ Eliminated on 10-12-2021. Please verify the availability through our local distributors

- Eliminato il 10-12-2021. Verificare la disponibilità presso i nostri distributori
- Éliminé le 10-12-2021. Vérifier la disponibilité auprès de nos distributeurs sur place
- Am 10-12-2021 gestrichen. Evtl. Verfügbarkeit bitte bei unseren Händlern prüfen
- Eliminado en fecha 10-12-2021. Verificar la disponibilidad a través de nuestros distribuidores locales



Ø=mm	h=mm	µF
17	38,5	0,23

DACIA

1210 1.2	--	01/69 ⇨
1310 1.3	810-02/-99	05/83 ⇨ 07/04
1410 1.4	--	01/69 ⇨
ARO 10	--	01/72 ⇨ 12/80

FIAT

127 0.9	100GL.048	06/71 ⇨ 05/83
128 1.1	128A.000	03/69 ⇨ 12/84
131 1.3 Mirafiori	131A6.000	10/74 ⇨ 09/81
132 1.6	132C.000	05/77 ⇨ 09/82
242 1.6	124B3.000	10/75 ⇨ 07/82
FIORINO I 900	100GL.000	10/77 ⇨ 10/86

LANCIA

A 112 0.9 Junior	A112A5.000	03/81 ⇨ 06/86
------------------	------------	---------------

PEUGEOT

504 1.8 Injection	KF5, KF6	07/68 ⇨ 02/71
-------------------	----------	---------------

RENAULT

4 0.8	80001, 800705	09/71 ⇨ 12/88
5 1.3	810719, 810726	09/76 ⇨ 09/84
20 2.0	829700, 829701, 829702, 829703, 829.01	10/77 ⇨ 12/83

KW 615 034



CONDENSERS

Adatt./Suitable: DUCELLIER

ALFA ROMEO

700 299

60748381

9950152

BOSCH

1 237 330 805

1 237 330 806

DUCELLIER

609 504

FIAT

9937715

GENERAL MOTORS

7 992 353

7 992 359

93 150 117

93 150 124

PEUGEOT

5948 11

5948 17

5948 27

RENAULT

77 01 018 729

77 01 020 079

ROVER

GSC113

RTC6620

⁰⁰ Eliminated on 31-08-2021. Please verify the availability through our local distributors

- Eliminato il 31-08-2021. Verificare la disponibilità presso i nostri distributori
- Éliminé le 31-08-2021. Vérifier la disponibilité auprès de nos distributeurs sur place
- Am 31-08-2021 gestrichen. Evtl. Verfügbarkeit bitte bei unseren Händlern prüfen
- Eliminado en fecha 31-08-2021. Verificar la disponibilidad a través de nuestros distribuidores locales

⁰³ Supplied until depletion

- Fornibile fino ad esaurimento delle scorte
- Fourni jusqu'à épuisement du stock
- Lieferbar solange vorrat reicht
- Suministrado hasta el stock termina



Ø=mm	h=mm	µF
17	38,5	0,23

ALFA ROMEO

ALFASUD 1.2	AR30102	06/72 ⇨ 09/84
-------------	---------	---------------

CITROËN

AXEL 11	G11/631	01/84 ⇨ 03/91
CX I 2400	M23-623	08/76 ⇨ 06/80

FIAT

DUCATO 11.8	169B	01/82 ⇨ 12/88
-------------	------	---------------

LAND ROVER

90 2.5 4x4	17H	09/85 ⇨ 08/90
110/127 2.5 4x4	17H	10/85 ⇨ 07/90
DEFENDER 2.25	--	01/87 ⇨

PEUGEOT

104 0.9	108(XV5)	10/79 ⇨ 10/83
305 1.5	117(XR5S)	05/80 ⇨ 09/82
505 1.8	105(XM7), 105C(XM7A)	06/81 ⇨ 10/86
J9 1.6	XC7P	03/80 ⇨ 06/87

RENAULT

5 1.4 Alpine A5	840725	09/77 ⇨ 09/81
14 1.4	150	09/79 ⇨ 06/83

ROVER

MINI 1.0	--	01/85 ⇨
MINI 1.3	--	01/85 ⇨

TALBOT

SAMBA 1.1	XW7	01/81 ⇨ 06/86
-----------	-----	---------------

KW 615 039



CONDENSERS

Adatt./Suitable: DUCELLIER

DUCELLIER

450 005

FIAT

9936734

9938166

GENERAL MOTORS

93 150 455

SEAT

000 389 973 1

000 993 673 4

SE 141914.007C

⁰⁰ Eliminated on 02-08-2021. Please verify the availability through our local distributors

- Eliminato il 02-08-2021. Verificare la disponibilità presso i nostri distributori
- Éliminé le 02-08-2021. Vérifier la disponibilité auprès de nos distributeurs sur place
- Am 02-08-2021 gestrichen. Evtl. Verfügbarkeit bitte bei unseren Händlern prüfen
- Eliminado en fecha 02-08-2021. Verificar la disponibilidad a través de nuestros distribuidores locales



Ø=mm	h=mm	µF
17	38,5	0,23

FIAT

PANDA I 750	141B.000	01/86 ⇨ 01/95
PANDA I 800	100GL6.000	02/81 ⇨ 12/85
PANDA I 900	100GL3.000	10/80 ⇨ 06/94
PANDA I 900 CL	146A.048	01/86 ⇨ 04/91
REGATA 1.1 60, 60 L	138B.000	10/83 ⇨ 08/86
REGATA 1.6	149A.000	10/84 ⇨ 06/89
REGATA 70 1.3	138B2.000, 149A3.000	09/83 ⇨ 07/89
REGATA 85 1.6	149A.000	10/83 ⇨ 06/90
RITMO I 1.1	146A4.048	04/85 ⇨ 12/87
RITMO I 1.3	149A3.000	11/83 ⇨ 08/85
RITMO II 75 1.5	138A2.000	09/85 ⇨ 12/88
UNO 45 0.9	146A.000, 146A1.000	03/83 ⇨ 07/96
UNO 45 0.9 Trend	146A.048	09/89 ⇨ 09/92
UNO 60 1.1 SX	--	01/83 ⇨ 12/85

SEAT

FURA 0.9	100GL3000	01/82 ⇨ 06/86
IBIZA I 0.9	146A000	08/86 ⇨ 05/93
PANDA 34 850	--	01/80 ⇨ 12/83
PANDA 35 850	--	01/80 ⇨ 12/83

KW **617 097**

1

CONDENSERSAdatt./Suitable: **FEMSA****BOSCH**
9 232 337 354
9 232 337 354 706**FEMSA**
10249-43**RENAULT**
77 02 124 317

- ⁰³ **Supplied until depletion**
- Fornibile fino ad esaurimento delle scorte
 - Fourni jusqu'à épuisement du stock
 - Lieferbar solange vorrat reicht
 - Suministrado hasta el stock termina



Ø=mm	h=mm	µF
18	31,5	0,25

RENAULT

4.0.8 | 80001 | 09/71 ⇨ 12/88

KW **630 117**

1

CONDENSERSAdatt./Suitable: **MARELLI****ALFA ROMEO**
701 707
116 55 05 011 01/09
60730444
60749285**BOSCH**
1 237 330 828**FIAT**
9928245**GENERAL MOTORS**
93 150 084**MAGNETI MARELLI**
CE 22 B
CE 22 C
CE 39 A
CE 39 G**SEAT**
000 389 806 0
NG1 811 683 1

- ⁰³ **Supplied until depletion**
- Fornibile fino ad esaurimento delle scorte
 - Fourni jusqu'à épuisement du stock
 - Lieferbar solange vorrat reicht
 - Suministrado hasta el stock termina



Ø=mm	h=mm	µF
18	25	0,25

ALFA ROMEO

ALFASUD 1.2	AR30102	06/72 ⇨ 09/84
ALFETTA 1.8	AR01608X	07/74 ⇨ 04/82
GIULIETTA 1.3	AR01644	10/77 ⇨ 06/83

FIAT

127 0.9	100GL.048	06/71 ⇨ 05/83
127 1.0	127A.000	01/77 ⇨ 12/86
131 1.3 Mirafiori	131A6.000	10/74 ⇨ 09/81

FIAT

132 1.6	132C.000	05/77 ⇨ 09/82
ARGENTA 1600	132D.000	04/81 ⇨ 12/85
ARGENTA 1600 i.e	132D.000	04/81 ⇨ 12/85
FIORINO 1 1.0	127A.000	01/80 ⇨ 12/87
FIORINO 1 1050	127A.000	01/80 ⇨ 12/87
FIORINO 1 900	100GL.000	10/77 ⇨ 10/86
PANDA 1 800	100GL6.000	02/81 ⇨ 12/85
PANDA 1 950	A112B1.054	09/82 ⇨ 08/83
PANDA 1 950 4x4	A112B1.054	09/83 ⇨ 12/86

SEAT

FURA 0.9	100GL3000	01/82 ⇨ 06/86
PANDA 34 850	--	01/80 ⇨ 12/83
PANDA 35 850	--	01/80 ⇨ 12/83

KW **630 127**

1

CONDENSERSAdatt./Suitable: **MARELLI****FIAT**
9938268**MAGNETI MARELLI**
CE 39 P

- ⁰³ **Supplied until depletion**
- Fornibile fino ad esaurimento delle scorte
 - Fourni jusqu'à épuisement du stock
 - Lieferbar solange vorrat reicht
 - Suministrado hasta el stock termina



Ø=mm	h=mm	µF
18	25	0,25

FIAT

REGATA 1.6	149A.000	10/84 ⇨ 06/89
REGATA 70 1.3	138B2.000, 149A3.000	09/83 ⇨ 07/89
REGATA 85 1.6	149A.000	10/83 ⇨ 06/90
UNO 60 1.1 SX	--	01/83 ⇨ 12/85

KW **630 128**

1

CONDENSERSAdatt./Suitable: **MARELLI****FIAT**
9938269**MAGNETI MARELLI**
CE 39 R**SEAT**
SE 141914.007A

- ⁰³ **Supplied until depletion**
- Fornibile fino ad esaurimento delle scorte
 - Fourni jusqu'à épuisement du stock
 - Lieferbar solange vorrat reicht
 - Suministrado hasta el stock termina



Ø=mm	h=mm	µF
18	25	0,25

FIAT

126 700	126A2.000, 126A2.048	09/87 ⇨ 06/96
PANDA 1 750	141B.000	01/86 ⇨ 01/95
PANDA 1 900	100GL3.000	10/80 ⇨ 06/94
PANDA 1 900 CL	146A.048	01/86 ⇨ 12/92
UNO 45 0.9	146A.000, 146A1.000	03/83 ⇨ 07/96
UNO 45 0.9 Trend	146A.048	09/89 ⇨ 09/92

FSO

126P 0.6	126A1.048	07/77 ⇨ 12/91
----------	-----------	---------------

SEAT

IBIZA 1 0.9	146A000	08/86 ⇨ 05/93
MARBELLA 0.9	09NCA	01/87 ⇨ 12/93
TERRA 0.9	09NCA	02/87 ⇨ 12/96

KW 631 131



CONDENSERS

Adatt./Suitable: **MITSUBISHI****BOSCH**

F 005 X04 582

NISSAN

22102-01M11

⁰³ Supplied until depletion

- Fornibile fino ad esaurimento delle scorte
- Fourni jusqu'à épuisement du stock
- Lieferbar solange vorrat reicht
- Suministrado hasta el stock termina



Ø=mm	h=mm	µF
15	23	0,22

NISSAN

VANETTE II 2.0

Z20S, Z20S

07/87 ⇨ 08/94

KW 642 056



CONDENSERS

Adatt./Suitable: **SEV****BOSCH**

0 190 309 009

1 237 330 810

1 237 330 811

DAF

200889

GENERAL MOTORS

7 992 253

7 992 680

7 992 850

7 992 852

MAGIRUS-DEUTZ

1169097

MAN

90.80110-1111

MERCEDES-BENZ

A 001 154 43 06

A 001 154 48 06

PEUGEOT

5948 04

RENAULT

08 02 119 800

08 51 877 600

08 54 233 000

08 54 910 100

08 54 923 300

08 54 943 800

77 01 000 998

77 01 008 855

77 01 012 471

77 01 021 676

⁰⁰ Eliminated on 10-12-2021. Please verify the availability through our local distributors

- Eliminato il 10-12-2021. Verificare la disponibilità presso i nostri distributori

- Éliminé le 10-12-2021. Vérifier la disponibilité auprès de nos distributeurs sur place

- Am 10-12-2021 gestrichen. Evtl. Verfügbarkeit bitte bei unseren Händlern prüfen

- Eliminado en fecha 10-12-2021. Verificar la disponibilidad a través de nuestros distribuidores locales



Ø=mm	h=mm	µF
17	38,5	0,23

RENAULT

4 0.8

800705

10/83 ⇨ 10/88



CONTACT SETS

-COPPIE CONTATTI -RUPTEURS -KONTAKTSÄTZE -PLATINOS

(A) P/NRS. - NOTES

- CODICI - NOTE
- RÉFS. - NOTES
- ARTIKEL-NR. - ANMERKUNGEN
- CODIGOS - NOTAS

730 140  **1**

CONTACT SETS

Adatt./Suitable: **MARELLI**

FIAT
8660
9919623
9919723

MAGNETI MARELLI
711 185 01
711 985 01

RENAULT
77 02 038 190

ZASTAVA
1335052

Ventilated contact set:

160 **4** Contatti ventilati:
• Rupteur en version ventilée:
• Belüfteter Kontaktsatz:
• Juego platinos ventilados:

730 140HV

(A)

1 # KW

2 OEM P/NRS.
• CODICI ORIGINALI
• RÉFS. D'ORIGINE
• ORIGINALTEILE-NR.
• CODIGOS ORIGINALES

3 PACKAGING SIZE
• FORMATO CONFEZIONE
• FORMAT DU CONDITIONNEMENT
• ABPACKENSGROSSE
• TAMAÑO DEL ENVASE

4 NOTE
• NOTE
• NOTES
• BEMERKUNGEN
• NOTAS

(B) PICTURE + TECHNICAL INFO

- FOTO + INFORMAZIONE TECNICA
- ILLUSTRATION + INFORMATION TECHNIQUE
- BILD + TECHNISCHE INFO
- FOTO + INFORMACIÓN TÉCNICA

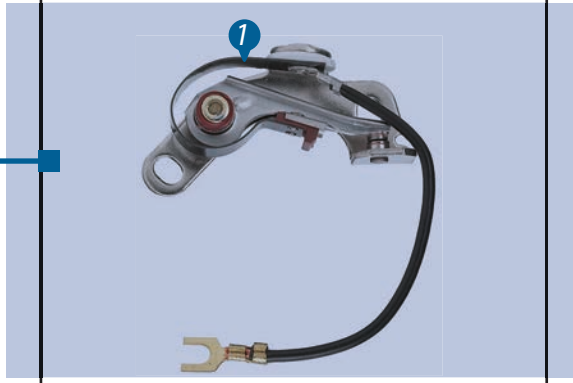

(C) APPLICATION LIST

- GUIDA APPLICAZIONI
- LISTE D'APPLICATIONS
- ANWENDUNGSTABELLE
- LISTA DE APLICACIONES

FIAT		
X 1/9 1.3	128A5.000	10/75 ⇨ 06/78
ZASTAVA		
101 1.1	128A.000, 128A.064	05/75 ⇨ 12/93
101 1.1 Super	128AC5.000	07/79 ⇨ 09/81
YUGO 0.9	9A, 9A	04/80 ⇨ 06/92

(B)

1 PICTURE
• FOTO
• PHOTO
• BILD
• FOTO

KW 701 005



CONTACT SETS

Adatt./Suitable: ACME

ACME
1002
101.300
711.101.300



KW 701 006



CONTACT SETS

Adatt./Suitable: ACME

ACME
005.300
3186
711.005.300



KW 706 021



CONTACT SETS

Adatt./Suitable: BOSCH

BOSCH
1 237 013 008

FORD
1 151 630 2
5 441 16
G 516 302

GENERAL MOTORS
7 992 221

MERCEDES-BENZ
A 000 158 20 90

PORSCHE
616 602 226 00

VOLVO
238036
2380368
238859
2388593

- ⁰³ Supplied until depletion
- Fornibile fino ad esaurimento delle scorte
 - Fourni jusqu'à épuisement du stock
 - Lieferbar solange vorrat reicht
 - Suministrado hasta el stock termina



FORD

TAUNUS 12M 1.2	--	12/51 ⇒ 04/67
TAUNUS 12M 1.5	--	09/58 ⇒ 04/67
TAUNUS 12M 1.5 TS	--	12/62 ⇒ 04/67
TAUNUS 15M 1.5	--, TV15H	09/54 ⇒ 07/71
TAUNUS 15M 1.5 XL/RS	--, TV15H	01/68 ⇒ 06/71
TAUNUS 17M 1.5	--	09/60 ⇒ 10/68
TAUNUS 17M 1.7	--	08/57 ⇒ 04/74
TAUNUS 17M 1.7 S	--	09/60 ⇒ 01/65
TRANSIT I 1.5	--	06/58 ⇒ 08/65
TRANSIT I 1250 S-2 Klein-LKW	--	10/57 ⇒ 07/67
TRANSIT I K-40 1.5	--	04/55 ⇒ 04/67

MERCEDES-BENZ

CLASSE S I 250 SE	M129.980	01/66 ⇒ 12/67
-------------------	----------	---------------

MERCEDES-BENZ

CLASSE SL III 300 SL	M103.982	09/85 ⇒ 08/89
COUPE 250 SE	M129.980, M129.981	01/65 ⇒ 12/67
COUPE 280 SE	M130.980, M130.984	01/67 ⇒ 12/71
HECKFLOSSE 200	M121.940	07/65 ⇒ 02/68
PAGODE 250 SL	M129.982	01/66 ⇒ 01/68

VOLVO

140 1.8	B18A	08/66 ⇒ 07/68
140 1.8 S	B18A	08/66 ⇒ 07/68
P 121 1.8	B18, B18A	05/59 ⇒ 05/71
P 122 S AMAZON 1.8	B18	05/59 ⇒ 07/67
PV 544 1.8	B18A	08/61 ⇒ 07/67

KW 706 029HV



CONTACT SETS

Adatt./Suitable: BOSCH

BOSCH
1 237 013 006

FIAT
9927624

MERCEDES-BENZ
A 000 158 07 90
A 000 158 18 90

OPEL
16 12 006
RP121202

VOLVO
233910
2339109

VW
SP 183
SP 184
111 998 053
111 998 055
181 998 053
892 031 090



ALFA ROMEO

GIULIA 1300 Super	AR00530	01/74 ⇒ 12/78
GIULIA 1300 TI	--	04/69 ⇒ 07/75

AUDI

90 SUPER 1.8	21, 8921	09/66 ⇒ 08/71
--------------	----------	---------------

BMW

1500-2000 1600	M10B16(16A)	04/64 ⇒ 04/68
1500-2000 1800	M118	08/63 ⇒ 09/69
1500-2000 1800 Ti	M118	10/63 ⇒ 04/68
1500-2000 2000 Ti / Tilux	18F209	01/66 ⇒ 07/72
1502-2002 1600 Ti	M10B16(16A)	09/67 ⇒ 11/69
1502-2002 2002	18F209	02/68 ⇒ 07/75
1502-2002 2002 Ti	18F209	06/68 ⇒ 04/72
1502-2002 2002 Tii	18F209	01/71 ⇒ 07/75
1600 GT 1.6	M10B16(16A)	10/67 ⇒ 05/69
2000 CS	18F209	10/65 ⇒ 06/70

MERCEDES-BENZ

/8 230.6	M180.954	01/68 ⇒ 11/76
/8 250	M114.920	01/68 ⇒ 08/72
/8 250 C	M114.920	04/69 ⇒ 06/72
/8 250 CE	M114.980	04/69 ⇒ 04/72
/8 280	M110.921	06/72 ⇒ 11/76
/8 280 C	M110.921	06/72 ⇒ 02/77
CLASSE S I 280 S	M110.922	08/72 ⇒ 07/80
CLASSE SL I 190 SL	M121.921, M121.928	01/55 ⇒ 12/63
HECKFLOSSE 190 C	M121.924	04/61 ⇒ 08/65
HECKFLOSSE 200	M121.940	07/65 ⇒ 02/68
PONTON 190 b	M121.920	06/59 ⇒ 12/61

OPEL

ADMIRAL 2.6 S	26S	04/64 ⇒ 09/65
---------------	-----	---------------

YUGO

311 1.1	128A4	04/83 ⇒ 04/91
511 1.1	128A4	04/83 ⇒ 04/91

KW 706 032HV



CONTACT SETS

Adatt./Suitable: BOSCH

BOSCH
1 237 013 039
7 992 222

GENERAL MOTORS
7 992 222

VW
SP 186
111 998 059

- ⁰³ Supplied until depletion
- Fornibile fino ad esaurimento delle scorte
 - Fourni jusqu'à épuisement du stock
 - Lieferbar solange vorrat reicht
 - Suministrado hasta el stock termina



VW

1500,1600 1.5	K	04/61 ⇒ 07/73
1500,1600 1.5 S	--	08/63 ⇒ 07/65
1500,1600 1.6 TL	T	08/65 ⇒ 07/73
KAEFER 1500 1.5	45C20M150Q6	08/66 ⇒ 11/73

KW 706 034HVS



1

CONTACT SETS

Adatt./Suitable: BOSCH

ALFA ROMEO

700 220
140 20 05 011 00/01
60739126

BMW

12 11 1 243 843
12 11 1 267 391
12 11 1 267 393
12 11 1 354 502
12 11 1 359 705
12 11 1 359 873
12 11 1 360 648
12 11 1 361 760
12 11 8 730 024

BOSCH

1 237 013 044
9 232 081 044

DAF

163791
509890

FIAT

7073052
82305235

FORD

4 641 63
77HF-12107-AA

MERCEDES-BENZ

0001582890
0001583790
A 000 158 23 90
A 000 158 24 90
A 000 158 40 90
A 607 158 00 90

OPEL

12 16 011
16 12 011
16 12 385
RP 1 212 007

PEUGEOT

5927 50

PORSCHE

177 860 820 20
616 602 223 00

RENAULT

77 02 037 711

SAAB

78 66 353

SEAT

NG9 810 442 9

TOYOTA

19145-40010C

VOLVO

1306169
13061692
241664
2416642
243460
245664
2456642

VW

059 998 015
059 998 051
059 998 051 B
073 998 051
111 998 295
311 998 063
311 998 063 1

ALFA ROMEO

ALFASUD 1.2	AR30102	06/72 ⇒ 09/84
ALFETTA 1.8	AR01608X	07/74 ⇒ 04/82
GIULIETTA I 1.3	AR01644	10/77 ⇒ 06/83

FIAT (BR)

147 1.1	--	01/76 ⇒ 12/81
PREMIO	--	01/85 ⇒ 12/88
UNO 1.05	1.05	01/85 ⇒ 12/87
UNO 1.3	1.3	01/85 ⇒ 12/91
UNO 1.3 Furgoneta	1.3	01/85 ⇒ 12/91
UNO CS 1.3	1.3	01/85 ⇒ 12/91

FORD AUSTRALIA

CORTINA 2.0	--	06/77 ⇒ 08/82
ESCORT 2.0	--	01/77 ⇒ 12/81
ESCORT 2.0 RS	--	01/77 ⇒ 12/81

HOLDEN

COMMODORE 1.9	--	09/78 ⇒ 04/86
---------------	----	---------------

MERCEDES-BENZ

CLASSE G 1230 G	M115.973	03/79 ⇒ 07/93
CLASSE G 1280 GE	M110.994	11/79 ⇒ 08/89

OPEL

ASCONA C 1.3 N	13N	09/81 ⇒ 08/86
CORSA A 1.0	10S	09/82 ⇒ 03/93
CORSA A 1.2	12N, 12NC	09/82 ⇒ 08/90
CORSA A 1.2 N	12NC	01/85 ⇒ 10/87
KADETT B 1.1	11N	08/71 ⇒ 08/73
KADETT D 1.0	10N	09/79 ⇒ 08/82
KADETT E 1.2	12SC	09/84 ⇒ 07/86
MANTA B 1.3 N	13N	03/79 ⇒ 12/80
MANTA B 1.6 S	16S	09/75 ⇒ 12/81
MANTA B 1.9 N	19N	08/76 ⇒ 12/81
MANTA B 2.0	20N	08/77 ⇒ 12/80

PUCH

G-MODELL 280 GE	M110.994	01/86 ⇒ 12/91
-----------------	----------	---------------

VOLKSWAGEN (BR)

VWB 1.5	--	01/75 ⇒ 12/82
---------	----	---------------

VOLVO

240 1.8	B17A	11/78 ⇒ 07/85
---------	------	---------------

VW

JETTA II 1.6	EZ, HM	12/83 ⇒ 07/92
CADDY I 1.5	JB	08/82 ⇒ 07/83
CADDY I 1.6	EW, HN	01/83 ⇒ 07/92
GOLF II 1.6	EZ	08/83 ⇒ 07/92
GOLF II 1.6 [CHE] [SWE]	HM	08/83 ⇒ 07/85
LT I 2.4	DL	12/82 ⇒ 07/92
LT I 2.4 4WD	DL	12/82 ⇒ 07/92
LT I 2.4 i	1E	08/89 ⇒ 06/96
SCIROCCO I 1.1	FA	04/74 ⇒ 07/79
SCIROCCO I 1.5	JB	08/77 ⇒ 07/80
SCIROCCO II 1.6	1HyFAD	08/80 ⇒ 04/84

KW 706 040



1

CONTACT SETS

Adatt./Suitable: BOSCH

BOSCH

1 237 013 057

GENERAL MOTORS

7 992 226
7 992 645

PEUGEOT

5927 30

RENAULT

77 01 200 876

VW

111 998 063

Eliminated on 28-09-2020. Please verify the availability through our local distributors

• Eliminato il 28-09-2020. Verificare la disponibilità presso i nostri distributori

• Éliminé le 28-09-2020. Vérifier la disponibilité auprès de nos distributeurs sur place

• Am 28-09-2020 gestrichen. Evtl. Verfügbarkeit bitte bei unseren Händlern prüfen

• Eliminado en fecha 28-09-2020. Verificar la disponibilidad a través de nuestros distribuidores locales



PEUGEOT

404 1.6	XC6	04/63 ⇒ 12/71
504 1.8	XM7	01/71 ⇒ 07/86
504 2.0	106(XN1)	03/71 ⇒ 07/86
504 2.0 TI	107(XN2)	01/71 ⇒ 06/83
505 1.8	105(XM7)	06/81 ⇒ 10/85
505 2.0	--, 106(XN1)	11/80 ⇒ 11/87

RENAULT

4 1.1	688712, C1E714, C1E719	06/78 ⇒ 06/90
5 1.0	689710	01/72 ⇒ 12/85
5 1.3	810725, 810726	09/75 ⇒ 09/84
5 1.4	847725, C2J713	01/82 ⇒ 12/85
5 1.4 Automatik	847712	06/82 ⇒ 09/84
12 1.3	810.02, 810.05, 810.06, 810-02/97	10/69 ⇒ 08/80
12 1.3 TS	810.05, 810.06	08/72 ⇒ 08/80
18 1.4	847720, 847722	04/78 ⇒ 07/86

VW

1500,1600 1.5 L	K	07/68 ⇒ 07/73
1500,1600 1.6 L	P	07/64 ⇒ 07/73
KAEFER 1.2	M51	01/54 ⇒ 07/65
KAEFER 1200 1.2	D	01/60 ⇒ 12/85
KAEFER 1300 1.3	AB, E, F	01/65 ⇒ 01/73
KAEFER 1302 1.2	D	08/69 ⇒ 08/72
KAEFER 1302 1.3	AB, AC	08/70 ⇒ 07/75
KAEFER 1302 1.6	AD, AE, AF, AH, AK	01/70 ⇒ 07/74
KAEFER 1302,1303 1.6	AD	07/70 ⇒ 06/79

VW

KAEFER 1303 1.3	AB, AR	08/72 ⇒ 07/75
KAEFER 1303 1.6	AD, AE, AH, AK	08/70 ⇒ 12/79
KAEFER 1303 LS, S 1.6	AD, AJ, AS	08/72 ⇒ 12/79
KAEFER 1500 1.5	45C20M150Q6	01/66 ⇒ 12/70
KAEFER 1500 1.6	AD	07/70 ⇒ 01/73

KW 706 047



1

CONTACT SETS

Adatt./Suitable: BOSCH

BOSCH

1 237 013 000

FORD

1 154 411 5
G 509 193

GENERAL MOTORS

7 992 219
7 992 658

OPEL

16 12 005
RP121201

PORSCHE

616 602 226 02
901 602 960 03

VOLVO

240149
2401495

VW

SP 181
111 998 051

Eliminated on 26-10-2021. Please verify the availability through our local distributors

• Eliminato il 26-10-2021. Verificare la disponibilità presso i nostri distributori

• Éliminé le 26-10-2021. Vérifier la disponibilité auprès de nos distributeurs sur place

• Am 26-10-2021 gestrichen. Evtl. Verfügbarkeit bitte bei unseren Händlern prüfen

• Eliminado en fecha 26-10-2021. Verificar la disponibilidad a través de nuestros distribuidores locales



ALFA ROMEO

1750-2000 1.7	AR10525	04/68 ⇒ 11/71
1750-2000 1750	AR00548	03/68 ⇒ 10/72
GIULIA 1600 Super	AR00526	06/64 ⇒ 08/69
GT 1.8	AR10525	04/68 ⇒ 11/71
GT 1300 Junior	AR00530	01/66 ⇒ 12/77
GT V 1750	AR00548	01/67 ⇒ 12/72
SPIDER I 1.7	AR10525	04/68 ⇒ 11/71
SPIDER I 1300	AR00530	01/68 ⇒ 12/77
SPIDER I 1600	AR00526, AR00536, AR01600	03/66 ⇒ 12/68
SPIDER I 1750	AR00548	01/67 ⇒ 12/71

PORSCHE

356 A 1600	--	01/55 ⇒ 12/59
356 A 1600 GS Carrera	--	01/55 ⇒ 12/61
356 A 1600 S	616.15	01/55 ⇒ 12/59
356 A 1600 Super	616.15	01/55 ⇒ 12/59
356 B 1600	--	09/59 ⇒ 08/63
356 B 1600 Super 75	616.15	01/59 ⇒ 12/63
356 B 1600 Super 90	--	01/59 ⇒ 12/63
356 C 1600	616.15	01/63 ⇒ 12/65
356 C 1600 SC	--	01/63 ⇒ 12/65
911 1.2.0 L	--	08/67 ⇒ 11/68
911 1.2.0 S	901.02, 901.08, 901.10	07/66 ⇒ 02/72
912 1.6	616.36, 616.39, 616.40	01/65 ⇒ 02/70

VOLVO

140 1.8 S	B18B	08/66 ⇒ 01/72
P 122 S AMAZON 1.8	B18, B18D	08/61 ⇒ 05/71
P 1800 1.8	--, B18A	04/62 ⇒ 05/70
P 1800 1.8 S	--	04/62 ⇒ 05/70
P 2200 1.8	B18A, B18B, B18D	09/64 ⇒ 08/67

KW 706 049HDVS



CONTACT SETS

Adatt./Suitable: **BOSCH****BMW**12 11 1 267 394
12 11 1 354 584
12 11 1 356 919**BOSCH**

1 237 013 052

FIAT00009049
38326146
638326146
82289883
AXE2055**FORD**0 464 163
0 548 495
1 154 849 5
1 568 737
1 584 304
1 584 305
5 018 844
5 019 831
5 484 95
6 138 918
77BF-12107-AA
77BF-12171-AA**MAN**

51.26310-0003

MERCEDES-BENZ0001582790
A 000 158 22 90
A 000 158 31 90**OPEL**

16 12 433

PEUGEOT

5927 65

PORSCHE

901 602 960 00

RENAULT

77 01 012 533

SAAB

83 55 919

93 59 597

VOLVO

241652

2416527

VW036 998 051
036 998 051 A
036 998 051 C
036 998 051 D
052 998 051
052 998 051 D

FORD		
ESCORT III 1.1	GSE	08/83 ⇒ 12/85
FIESTA I 0.9	TKA, TKW, TLA	05/76 ⇒ 08/83
FIESTA I 1.1	GLA, GLW	05/76 ⇒ 08/83
FIESTA II 1.1	GLC, GSF	09/83 ⇒ 02/89
TRANSIT II 1.6	LAC, LAT	09/85 ⇒ 09/92
TRANSIT II 2.0	NAT, NAV, NAW	09/85 ⇒ 09/92
TRANSIT II 2.0 L	NAW, NAX	10/85 ⇒ 03/91
INNOCENTI		
MINI 120	--	01/75 ⇒ 12/83
NISSAN		
200 B [AUS]	--	01/78 ⇒ 12/81
OPEL		
KADETT D 1.3 S	13S	08/79 ⇒ 08/84
VOLVO		
240 2.0	OJX4G20A6L	08/74 ⇒ 07/76
VW		
POLO II 1.0	GL	10/81 ⇒ 10/86
POLO II 1.1	HB	10/81 ⇒ 09/89
POLO II 1.3	GT, HH, HJ, HK, HW	10/81 ⇒ 07/88
JETTA II 1.3	GT, HK	01/84 ⇒ 06/87
DERBY 1.0	GL	10/81 ⇒ 12/84
DERBY 1.1	HB	02/77 ⇒ 09/81
DERBY 1.3	HH	02/77 ⇒ 09/81
GOLF I 1.3	HK	08/83 ⇒ 07/86
GOLF II 1.0	GN	11/83 ⇒ 08/85
GOLF II 1.3	GT, HK	08/83 ⇒ 06/87
SCIROCCO I 1.3	GF	08/79 ⇒ 07/80
SCIROCCO II 1.3	HK	08/83 ⇒ 07/84

KW 706 060



CONTACT SETS

Adatt./Suitable: **BOSCH****BOSCH**

1 217 013 001

⁰³ Supplied until depletion

- Fornibile fino ad esaurimento delle scorte
- Fourni jusqu'à épuisement du stock
- Lieferbar solange vorrat reicht
- Suministrado hasta el stock termina



KW 706 062



CONTACT SETS

Adatt./Suitable: **BOSCH****BMW**12 11 1 267 392
12 11 1 271 687
12 11 1 355 624**BOSCH**

1 237 013 075

GENERAL MOTORS

7 992 344

MERCEDES-BENZA 000 158 28 90
A 000 158 35 90
A 000 158 37 90
A 000 158 39 90**VOLVO**

243801

2438018

VW058 998 051
058 998 051 A
058 998 051 B

BMW		
31320 i	18F209	06/75 ⇒ 08/82
2500-3.3.3.0 S	M30B30	05/71 ⇒ 04/77
MERCEDES-BENZ		
/8 280	M110.921	06/72 ⇒ 11/76
/8 280 C	M110.921	06/72 ⇒ 02/77
/8 280 CE	M110.981	06/72 ⇒ 01/77
/8 280 E	M110.981	06/72 ⇒ 11/76
PORSCHE		
911 I 2.7	911.41, 911.43, 911.46, 911.48, 911.81, 911.82, 911.84, 911.85, 911.86, 911.89, 911.90, 911.92, 911.94, 911.97, 911.99	09/73 ⇒ 06/77
911 I 2.7 S	911.42, 911.47, 911.93, 911.98	08/73 ⇒ 01/76
911 I 2.7 S Carrera	911.42, 911.47, 911.93, 911.98	08/73 ⇒ 01/76
911 I 2.7 SC Carrera RS	911.83	08/72 ⇒ 01/79

KW 706 064



CONTACT SETS

Adatt./Suitable: **BOSCH****BOSCH**

1 217 013 009

⁰⁰ Eliminated on 06-07-2021. Please verify the availability through our local distributors

- Eliminato il 06-07-2021. Verificare la disponibilità presso i nostri distributori
- Éliminé le 06-07-2021. Vérifier la disponibilité auprès de nos distributeurs sur place
- Am 06-07-2021 gestrichen. Evtl. Verfügbarkeit bitte bei unseren Händlern prüfen
- Eliminado en fecha 06-07-2021. Verificar la disponibilidad a través de nuestros distribuidores locales



KW 706 068



CONTACT SETS

Adatt./Suitable: **BOSCH****BOSCH**

1 217 013 021



KW 706 071



CONTACT SETS

Adatt./Suitable: **BOSCH****MOTO GUZZI**

77 900 507 97

⁰³ Supplied until depletion

- Fornibile fino ad esaurimento delle scorte
- Fourni jusqu'à épuisement du stock
- Lieferbar solange vorrat reicht
- Suministrado hasta el stock termina

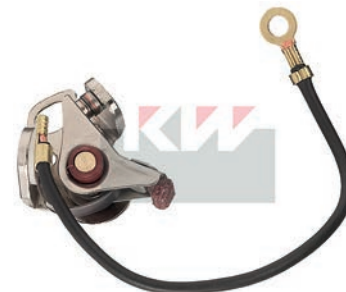

KW **706 083****CONTACT SETS**Adatt./Suitable: **BOSCH****BOSCH**
1 217 013 020**03 Supplied until depletion**

- Fornibile fino ad esaurimento delle scorte
- Fourni jusqu'à épuisement du stock
- Lieferbar solange vorrat reicht
- Suministrado hasta el stock termina

KW **707 701****CONTACT SETS**Adatt./Suitable: **CAJAVEC****CAJAVEC**
5247810
ZASTAVA
46600861**ZASTAVA**

101 1.1	128A.000	06/73 ⇨ 01/90
YUGO 0.9	9A	04/80 ⇨ 06/92

KW **711 046****CONTACT SETS**Adatt./Suitable: **DANSI****MOTO GUZZI**
19 709 620KW **712 055HVS****CONTACT SETS**Adatt./Suitable: **DELCO REMY****DELCO REMY**
3 470 026**GENERAL MOTORS**03 470 026
3 470 026
90 010 696**OPEL**12 12 154
16 12 229
RP 1 212 154**VOLVO**3277840
32778409**03 Supplied until depletion**

- Fornibile fino ad esaurimento delle scorte
- Fourni jusqu'à épuisement du stock
- Lieferbar solange vorrat reicht
- Suministrado hasta el stock termina

**OPEL**

CORSA A 1.0	10S	09/82 ⇨ 03/93
KADETT B 1.1	11N	08/71 ⇨ 08/73
KADETT D 1.0	10N	09/79 ⇨ 08/82
KADETT E 1.2	12SC	09/84 ⇨ 07/86

KW **713 011HV****CONTACT SETS**Adatt./Suitable: **DENSO****DAIHATSU**02935-00200
19145-26060-000
19145-87203-000
19145-87206-000
19145-87701
19145-87701-000
99329-35902**FIAT**553221203
6553202203
6553221203**HOLDEN**

3314074010

SUZUKI33140-74010
33140-74010-000**TOYOTA**04191-41010
19145-26060
19145-38011
19145-40010
19145-41010
19145-41020
19145-41030
19145-87701**VW**

J19 145 260 60

**** Available contact set only-not plate**

- Fornibile solo contatto, no piastra
- Disponible rupteur seul, pas le plateau
- Erhältlich nur unterbrecher, nicht die platte
- Disponible el platino solo, no la plancha

**DAIHATSU**

850 0.8	--	07/86 ⇨ 12/89
1000 1.0	CB10	07/86 ⇨ 12/89
CHARADE III 1.0	CB23, CB22	03/87 ⇨ 02/93
FEROZA 1.6i	--	01/84 ⇨ 12/89
HIJET I 1.0	CB	06/86 ⇨ 12/89

HOLDEN

SCURRY_NB 1.0	F10A	10/85 ⇨ 05/86
---------------	------	---------------

INNOCENTI

500 L; LS	--	⇨ 12/86
SMALL 990	--	07/90 ⇨ 12/92

MARUTI

800 0.8	F8B	01/91 ⇨ 12/06
---------	-----	---------------

SUZUKI

ALTO I 0.8	F8A, F8B	06/82 ⇨ 08/84
SJ410 1.0	F10A	09/81 ⇨ 07/91
SUPER CARRY 1.0	F10A	10/85 ⇨ 03/99

VW

TARO 1.8	2Y	04/89 ⇨ 09/94
TARO 2.2	4Y	06/89 ⇨ 07/94
TARO 2.2 4x4	4Y	06/89 ⇨ 07/94

KW **713 022HV****CONTACT SETS**Adatt./Suitable: **DENSO****DAIHATSU**19103-87204-000
19145-87204-000
19145-87205-000**FIAT**

6553206203

GENERAL MOTORS93 150 904
94 208 408**ISUZU**8-94208403-0
8-94208408-0**SUBARU**39146-4302
39146-4312**TOYOTA**19145-10020
19145-14010
98989-01161**03 Supplied until depletion**

- Fornibile fino ad esaurimento delle scorte
- Fourni jusqu'à épuisement du stock
- Lieferbar solange vorrat reicht
- Suministrado hasta el stock termina

**INNOCENTI**

SMALL 500	--	07/90 ⇨ 12/92
-----------	----	---------------

SUBARU

L-SERIES 1.3	--	01/87 ⇨ 12/91
M60 600	--	01/88 ⇨ 12/89
M70 700	--	01/88 ⇨ 12/89

KW **715 055****CONTACT SETS**Adatt./Suitable: **DUCELLIER****ALFA ROMEO**116 55 05 011 03/02
60730445**CHRYSLER**

83 300 134

CITROËN54 524 22G
DM 211-17**DUCELLIER**71 133
608 012
618 701**FIAT**

9916118

PEUGEOT

5927 09

RENAULT

08 54 137 800

VOLVO3100134
31001340
3267443
32674434**DACIA**

1210 1.2	--	01/69 ⇨
1310 1.3	810-02/-99	05/83 ⇨ 07/04
1410 1.4	--	01/69 ⇨

FIAT

242 1.6	12483.000	10/75 ⇨ 07/82
---------	-----------	---------------

715 056

PEUGEOT		
504 1.8 Injection	KF5, KF6	07/68 ⇒ 02/71
RENAULT		
4 0.8	800705	10/83 ⇒ 10/88

KW 715 056



CONTACT SETS

Adatt./Suitable: **DUCELLIER**

CITROËN

54 463 39M

DUCELLIER

71 129

FIAT

9919038

9919040

9921039

GENERAL MOTORS

7 992 668

LEYLAND

GCS160

RENAULT

08 54 954 600

⁰⁰Eliminated on 15-01-2020. Please verify the availability through our local distributors

• Eliminato il 15-01-2020. Verificare la disponibilità presso i nostri distributori

• Éliminé le 15-01-2020. Vérifier la disponibilité auprès de nos distributeurs sur place

• Am 15-01-2020 gestrichen. Evtl. Verfügbarkeit bitte bei unseren Händlern prüfen

• Eliminado en fecha 15-01-2020. Verificar la disponibilidad a través de nuestros distribuidores locales



FIAT		
124 1200	124A.000	07/66 ⇒ 10/73
124 1400 Special	124B2.000	12/68 ⇒ 12/72
124 1600 Special T	132AC.000	01/73 ⇒ 07/75
850 0.8	100G.000	07/64 ⇒ 10/72

KW 715 056HV



CONTACT SETS

Adatt./Suitable: **DUCELLIER**

⁰⁰Eliminated on 15-01-2020. Please verify the availability through our local distributors

• Eliminato il 15-01-2020. Verificare la disponibilità presso i nostri distributori

• Éliminé le 15-01-2020. Vérifier la disponibilité auprès de nos distributeurs sur place

• Am 15-01-2020 gestrichen. Evtl. Verfügbarkeit bitte bei unseren Händlern prüfen

• Eliminado en fecha 15-01-2020. Verificar la disponibilidad a través de nuestros distribuidores locales



FIAT		
128 1.1	128A.000	03/69 ⇒ 12/84
131 1.3 Mirafiori	131A6.000	10/74 ⇒ 09/81
132 1.6	132C.000	05/77 ⇒ 09/82

FIAT		
FIORINO 1 900	100GL.000	10/77 ⇒ 10/86

KW 715 061



CONTACT SETS

Adatt./Suitable: **DUCELLIER**

DUCELLIER

71 974

GENERAL MOTORS

7 992 228

RENAULT

08 54 725 600

⁰³Supplied until depletion

• Fornibile fino ad esaurimento delle scorte

• Fourni jusqu'à épuisement du stock

• Lieferbar solange vorrat reicht

• Suministrado hasta el stock termina



RENAULT		
4 0.8	80001	09/71 ⇒ 12/88
5 1.3	810719	06/79 ⇒ 09/84

KW 715 064



CONTACT SETS

Adatt./Suitable: **DUCELLIER**

CITROËN

54 747 41

AZ 211-17

DUCELLIER

23 263



CITROËN		
2 CV 6	A06/635, A06/664	02/70 ⇒ 10/85
ACADIANE 6	M28(AM2)	08/78 ⇒ 10/88
DYANE 4	A79/1(AVA2)	04/68 ⇒ 07/75
MEHARI 0.6	M28/1(AK2)	05/68 ⇒ 10/79

KW 715 067



CONTACT SETS

Adatt./Suitable: **DUCELLIER**

DUCELLIER

608 640

⁰⁰Eliminated on 18-02-2022. Please verify the availability through our local distributors

• Eliminato il 18-02-2022. Verificare la disponibilità presso i nostri distributori

• Éliminé le 18-02-2022. Vérifier la disponibilité auprès de nos distributeurs sur place

• Am 18-02-2022 gestrichen. Evtl. Verfügbarkeit bitte bei unseren Händlern prüfen

• Eliminado en fecha 18-02-2022. Verificar la disponibilidad a través de nuestros distribuidores locales



L = mm
700

KW 715 076



CONTACT SETS

Adatt./Suitable: **DUCELLIER**

CITROËN

79 015 927 44

DUCELLIER

618 015

GENERAL MOTORS

7 992 346

PEUGEOT

5927 43

5927 44

⁰⁰ Eliminated on 18-02-2022. Please verify the availability through our local distributors

- Eliminato il 18-02-2022. Verificare la disponibilità presso i nostri distributori

- Éliminé le 18-02-2022. Vérifier la disponibilité auprès de nos distributeurs sur place

- Am 18-02-2022 gestrichen. Evtl. Verfügbarkeit bitte bei unseren Händlern prüfen

- Eliminado en fecha 18-02-2022. Verificar la disponibilidad a través de nuestros distribuidores locales



L = mm

260

PEUGEOT

104 0.9

108(XV3), 108(XV5)

10/72 ⇨ 10/83

104 1.1

109(XW3)

07/76 ⇨ 06/83

KW 715 086



CONTACT SETS

Adatt./Suitable: **DUCELLIER**

CHRYSLER

83 300 133

CITROËN

95 534 913

DUCELLIER

582 018

GENERAL MOTORS

93 150 077

RENAULT

77 01 200 739

⁰³ Supplied until depletion

- Fornibile fino ad esaurimento delle scorte

- Fourni jusqu'à épuisement du stock

- Lieferbar solange vorrat reicht

- Suministrado hasta el stock termina



RENAULT

5 1.3

810726

09/76 ⇨ 09/79

20 2.0

829700, 829701, 829702, 829703, 829.01

10/77 ⇨ 12/83

KW 715 101



CONTACT SETS

Adatt./Suitable: **DUCELLIER**

DUCELLIER

618 642

618 765

FIAT

9935150

⁰³ Supplied until depletion

- Fornibile fino ad esaurimento delle scorte

- Fourni jusqu'à épuisement du stock

- Lieferbar solange vorrat reicht

- Suministrado hasta el stock termina



DACIA

ARO 10

--

01/72 ⇨ 12/80

FIAT

127 0.9

100GL.048

06/71 ⇨ 05/83

LANCIA

A 112 0.9 Junior

A112A5.000

03/81 ⇨ 06/86

KW 715 102



CONTACT SETS

Adatt./Suitable: **DUCELLIER**

DUCELLIER

582 130

PEUGEOT

5927 73

⁰⁰ Eliminated on 14-04-2020. Please verify the availability through our local distributors

- Eliminato il 14-04-2020. Verificare la disponibilità presso i nostri distributori

- Éliminé le 14-04-2020. Vérifier la disponibilité auprès de nos distributeurs sur place

- Am 14-04-2020 gestrichen. Evtl. Verfügbarkeit bitte bei unseren Händlern prüfen

- Eliminado en fecha 14-04-2020. Verificar la disponibilidad a través de nuestros distribuidores locales



L = mm

240

RENAULT

5 1.3

810726

09/76 ⇨ 09/79

20 2.0

829700, 829701, 829702, 829703, 829.01

10/77 ⇨ 12/83

PEUGEOT

305 1.5

117(XR5S)

05/80 ⇨ 09/82

KW 715 103



CONTACT SETS

Adatt./Suitable: **DUCELLIER**

CITROËN

79 015 927 83

DUCELLIER

582 133

PEUGEOT

5927 83

5927 96

⁰⁰ Eliminated on 22-02-2021. Please verify the availability through our local distributors

- Eliminato il 22-02-2021. Verificare la disponibilità presso i nostri distributori

- Éliminé le 22-02-2021. Vérifier la disponibilité auprès de nos distributeurs sur place

- Am 22-02-2021 gestrichen. Evtl. Verfügbarkeit bitte bei unseren Händlern prüfen

- Eliminado en fecha 22-02-2021. Verificar la disponibilidad a través de nuestros distribuidores locales



L = mm

250

PEUGEOT

104 0.9

108(XV5)

10/79 ⇨ 10/83

TALBOT

SAMBA 1.1

XW7

01/81 ⇨ 06/86

KW 715 105



1

CONTACT SETS

Adatt./Suitable: **DUCELLIER****DUCELLIER**

582 156

FIAT

9937709

PEUGEOT

5927 92

⁰³ Supplied until depletion

- Fornibile fino ad esaurimento delle scorte
- Fourni jusqu'à épuisement du stock
- Lieferbar solange vorrat reicht
- Suministrado hasta el stock termina



L = mm
650

FIAT		
DUCATO I 1.8	169B	01/82 ⇨ 12/88
PEUGEOT		
505 1.8	105(XM7)	06/81 ⇨ 10/85
J9 1.6	XC7P	03/80 ⇨ 06/87

KW 715 106



1

CONTACT SETS

Adatt./Suitable: **DUCELLIER****DUCELLIER**

582 186

582 191

582 199

FIAT

9936677

⁰³ Supplied until depletion

- Fornibile fino ad esaurimento delle scorte
- Fourni jusqu'à épuisement du stock
- Lieferbar solange vorrat reicht
- Suministrado hasta el stock termina



L = mm
200

FIAT		
PANDA I 800	100GL6.000	02/81 ⇨ 12/85
RITMO I 1.3	149A3.000	11/83 ⇨ 08/85
RITMO II 75 1.5	138A2.000	09/85 ⇨ 12/88
SEAT		
PANDA 34 850	--	01/80 ⇨ 12/83
PANDA 35 850	--	01/80 ⇨ 12/83

KW 715 111U



1

CONTACT SETS

Adatt./Suitable: **DUCELLIER****DUCELLIER**

608 514

⁰⁰ Eliminated on 18-02-2022. Please verify the availability through our local distributors

- Eliminato il 18-02-2022. Verificare la disponibilità presso i nostri distributori
- Éliminé le 18-02-2022. Vérifier la disponibilité auprès de nos distributeurs sur place
- Am 18-02-2022 gestrichen. Evtl. Verfügbarkeit bitte bei unseren Händlern prüfen
- Eliminado en fecha 18-02-2022. Verificar la disponibilidad a través de nuestros distribuidores locales



L = mm
215

PEUGEOT		
204 1.1	XX, XK4, XK5	10/65 ⇨ 07/77
204 1.1 Grand Luxe	XK4	05/69 ⇨ 10/77

PEUGEOT

504 1.8

XM7

01/71 ⇨ 07/86

TALBOT

MATRA BAGHEERA 1.3

3G4

01/74 ⇨ 03/78

KW 715 112U



1

CONTACT SETS

Adatt./Suitable: **DUCELLIER****DUCELLIER**

608 719

PEUGEOT

5927 35

⁰⁰ Eliminated on 22-02-2021. Please verify the availability through our local distributors

- Eliminato il 22-02-2021. Verificare la disponibilità presso i nostri distributori
- Éliminé le 22-02-2021. Vérifier la disponibilité auprès de nos distributeurs sur place
- Am 22-02-2021 gestrichen. Evtl. Verfügbarkeit bitte bei unseren Händlern prüfen
- Eliminado en fecha 22-02-2021. Verificar la disponibilidad a través de nuestros distribuidores locales



KW 715 122



1

CONTACT SETS

Adatt./Suitable: **DUCELLIER****DUCELLIER**

582 309

FIAT

9938573



FIAT		
PANDA I 750	141B.000	01/86 ⇨ 01/95
PANDA I 900	100GL3.000	10/80 ⇨ 06/94
PANDA I 900 CL	146A.048	01/86 ⇨ 04/91
UNO 45 0.9	146A.000, 146A1.000	03/83 ⇨ 07/96
UNO 45 0.9 Trend	146A.048	09/89 ⇨ 09/92

KW 715 126



3

CONTACT SETS

Adatt./Suitable: **DUCELLIER****DUCELLIER**582 482 *P
2 590 166 *P**RENAULT**77 01 031 149 *P
77 01 032 418 *P***P Kit Condenser - Contact set**

- Kit Condensatore - Contatto
- Kit Condensateur - Rupteur
- Bausatz Kondensator - unterbrecher
- Juego Condensador - Platino

03 Supplied until depletion

- Fornibile fino ad esaurimento delle scorte
- Fourni jusqu'à épuisement du stock
- Lieferbar solange vorrat reicht
- Suministrado hasta el stock termina



Ø = mm	h = mm	µF
17	38,5	0,23

RENAULT

9 1.1	C1E715	09/81 ⇒ 05/87
9 1.2	C1G700, C1G710	09/85 ⇒ 12/88
11 1.1	C1E715, C1E720	03/83 ⇒ 06/86
11 1.2	C1G700, C1G710	10/84 ⇒ 12/88
19 1.4	C1J	01/89 ⇒ 12/92
CLIO 1.1	C1E700	01/91 ⇒ 09/98
EXPRESS 955	C1C	01/85 ⇒ 10/90

KW 715 127



3

CONTACT SETS

Adatt./Suitable: **DUCELLIER****RENAULT**

77 01 031 411 *P

***P Kit Condenser - Contact set**

- Kit Condensatore - Contatto
- Kit Condensateur - Rupteur
- Bausatz Kondensator - unterbrecher
- Juego Condensador - Platino

03 Supplied until depletion

- Fornibile fino ad esaurimento delle scorte
- Fourni jusqu'à épuisement du stock
- Lieferbar solange vorrat reicht
- Suministrado hasta el stock termina



Ø = mm	h = mm	µF
17	38,5	0,23

RENAULT

EXPRESS 1.1 | C1E | 01/85 ⇒ 10/90

KW 717 020



1

CONTACT SETS

Adatt./Suitable: **FEMSA****FEMSA**

23373- 1

FIAT

9936823

SEATNGO 020 010 6
SE 127914.006A**FIAT**

127 0.9	100GL.048	06/71 ⇒ 05/83
131 1.3 Mirafiori	131A6.000	10/74 ⇒ 09/81
132 1.6	132C.000	05/77 ⇒ 09/82
PANDA I 800	100GL6.000	02/81 ⇒ 12/85

SEAT

FURA 0.9	100GL3000	01/82 ⇒ 06/86
MARBELLA 0.8	5K9K718	08/86 ⇒ 12/93
PANDA 34 850	--	01/80 ⇒ 12/83
PANDA 35 850	--	01/80 ⇒ 12/83

KW 717 024



1

CONTACT SETS

Adatt./Suitable: **FEMSA****FEMSA**

33924- 2

LAND ROVER

00000A.00071

RENAULT

77 02 124 314

00 Eliminated on 12-04-2021. Please verify the availability through our local distributors

- Eliminato il 12-04-2021. Verificare la disponibilità presso i nostri distributori
- Éliminé le 12-04-2021. Vérifier la disponibilité auprès de nos distributeurs sur place
- Am 12-04-2021 gestrichen. Evtl. Verfügbarkeit bitte bei unseren Händlern prüfen
- Eliminado en fecha 12-04-2021. Verificar la disponibilidad a través de nuestros distribuidores locales

**RENAULT**

4 0.8 | 80001 | 09/71 ⇒ 12/88

KW 717 026



1

CONTACT SETS

Adatt./Suitable: **FEMSA****FEMSA**

33924- 4

RENAULT

77 02 163 081

03 Supplied until depletion

- Fornibile fino ad esaurimento delle scorte
- Fourni jusqu'à épuisement du stock
- Lieferbar solange vorrat reicht
- Suministrado hasta el stock termina

**RENAULT**

4 1.1	688712	02/78 ⇒ 06/90
9 1.2	C1G700, C1G710	09/85 ⇒ 12/88
11 1.2	C1G700, C1G710	10/84 ⇒ 12/88
11 1.7	F2N700	10/83 ⇒ 12/87
EXPRESS 1.1	C1E	01/85 ⇒ 10/90
EXPRESS 955	C1C	01/85 ⇒ 10/90

KW 719 043HV



CONTACT SETS

Adatt./Suitable: **FORD****FORD**

1 458 944
681F-12107-AA
C3DF-12171-A
C3DZ-12171-A
C5AZ-12171-A
C6AH-12171-A

03 Supplied until depletion

- Fornibile fino ad esaurimento delle scorte
- Fourni jusqu'à épuisement du stock
- Lieferbar solange vorrat reicht
- Suministrado hasta el stock termina

Motorcraft
EDP 1



FORD		
CORTINA 1300	KL13H	10/70 ⇒ 03/72
FIESTA I 0.9	TKA, TKW, TLA	05/76 ⇒ 08/83
FIESTA I 1.3	J3E	08/77 ⇒ 08/83

KW 719 044HV



CONTACT SETS

Adatt./Suitable: **FORD****FORD**

1 458 945
5 027 482
6 234 60
682F-12107-AA
920X-12107-BA
C6CH-12171-A

03 Supplied until depletion

- Fornibile fino ad esaurimento delle scorte
- Fourni jusqu'à épuisement du stock
- Lieferbar solange vorrat reicht
- Suministrado hasta el stock termina

GENERAL MOTORS
7 992 202

Motorcraft
EDP 2



FORD		
TAUNUS 1.6	LCJ	07/79 ⇒ 07/82
TRANSIT I 1.6	4RB	11/77 ⇒ 10/86
TRANSIT I 2.0	4RC	11/77 ⇒ 07/82

KW 722 056HV



CONTACT SETS

Adatt./Suitable:

BOSCH

1 987 231 004
1 987 231 904
F 005 X04 543

03 Supplied until depletion

- Fornibile fino ad esaurimento delle scorte
- Fourni jusqu'à épuisement du stock
- Lieferbar solange vorrat reicht
- Suministrado hasta el stock termina

DAIHATSU

19145-87301

FORD

A720-X12171-EA
A730-X12171-BA

GENERAL MOTORS

7 992 340
94 022 297

HITACHI

4461-13301
44613330
4461-3330 A
4461-4330 AY
44A5-13301
44A513301Z
44AZ-13301

HOLDEN

GH203

HONDA

30105-590-075
30105-634-005
30105-634-0051
30105-657-005
30105-679-005
33105-590-075

ISUZU

2-23115-15
8-23115-14
8-23115-15
9-40222-97
9-82311515-0
9-82311518-0

Motorcraft
ADP 5007

NISSAN

22145-18005
22145-71301
22145-78506
22145-U6001
22145-U6002

SUBARU

49146-7011
89146-4111
89146-4821



HOLDEN		
ASTRA LB 1.5	E15	08/84 ⇒ 01/86
NISSAN		
PATROL III 2.8	L28	07/80 ⇒ 08/88
SUBARU		
L-SERIES 1.3	--	01/79 ⇒ 12/87

KW 727 093



CONTACT SETS

Adatt./Suitable: **LOMBARDINI**

KW 728 083MHV



CONTACT SETS

Adatt./Suitable: **LUCAS****FIAT**

31322118
631322118

FORD

EOTA 12 160
EOTA 12 162 C
EOTA 12 199 C

LAND ROVER

269987
RTC3270
RTC3313
RTC3881

Motorcraft
ADP 1



ASTON MARTIN		
DB6 4.0	--, AJ6	10/64 ⇒ 12/70
AUSTIN		
1000-SERIES 1100	--	01/70 ⇒ 12/74
1000-SERIES 1300	--	01/70 ⇒ 12/74
1000-SERIES 1300 GT	--	01/70 ⇒ 12/74
ALLEGRO 1.3	12H	05/73 ⇒ 03/82
ALLEGRO 1.5 Super	14H	05/73 ⇒ 03/82
MAXI 1500	--, 14H	04/69 ⇒ 07/80
MAXI 1750	17H	04/69 ⇒ 10/80
MAXI 1750 HL	--, 17LA	10/72 ⇒ 10/80
MINI 1000	99H	10/67 ⇒ 09/84
MINI 1275 GT	12H	10/69 ⇒ 08/80
FORD		
CORTINA 1200	--	10/62 ⇒ 09/66
CORTINA 1500	--	10/62 ⇒ 09/66
CORTINA GT	--	10/62 ⇒ 09/66
JAGUAR		
E-TYPE 4.2	XK4.2(82-87)	05/64 ⇒ 09/70
II 240	--	09/59 ⇒ 10/69
II 340	--	09/55 ⇒ 10/70
LAND ROVER		
88/109 2.3 4x4	10H, 11H	09/61 ⇒ 12/86
MG		
MAGNETTE 1.6	--	03/61 ⇒ 09/68
MGB 1.8	--	05/62 ⇒ 12/80
MGB GT 1.8	--, 18G	07/65 ⇒ 11/80
MORRIS		
MARINA 1.8	--	04/71 ⇒ 12/79
MARINA 1.8 TC	--	04/71 ⇒ 09/75
MARINA 1300	--	04/71 ⇒ 06/80
MARINA 1800	--	04/71 ⇒ 12/75
MARINA 1800 TC	--	04/71 ⇒ 12/75
ROVER		
2000-3500 2200	--	10/73 ⇒ 05/76
A60 CAMBRIDGE 1.7	--	01/62 ⇒ 10/69
TRIUMPH		
HERALD 1200	--, AJM	01/61 ⇒ 10/67
TR 6 2.5	CF1	01/72 ⇒ 12/76
WOLSELEY		
HORNET 1.0	--, 99LFD	01/61 ⇒ 12/70

KW 728 089



1

CONTACT SETS

Adatt./Suitable: **LUCAS****FORD**
6 087 381
815F-12171-CA**JAGUAR**
JLM 9522**LAND ROVER**
RTC3282
RTC5946
RTC5947
RTC6627**RENAULT**
77 01 025 238**ROVER**
GCS124
RTC6627⁰⁰ Eliminated on 28-07-2021. Please verify the availability through our local distributors

• Eliminato il 28-07-2021. Verificare la disponibilità presso i nostri distributori

• Éliminé le 28-07-2021. Vérifier la disponibilité auprès de nos distributeurs sur place

• Am 28-07-2021 gestrichen. Evtl. Verfügbarkeit bitte bei unseren Händlern prüfen

• Eliminado en fecha 28-07-2021. Verificar la disponibilidad a través de nuestros distribuidores locales

²²¹ Replaces old code ..."HDV"

- Sostituisce vecchio codice ..."HDV"
- Remplace l'ancien modèle ..."HDV"
- Ersetzt alten Artikel ..."HDV"
- Sustituye el precedente modelo ..."HDV"



JAGUAR		
XJ 3.4 Series 3	--	01/86 ⇨ 12/94
LAND ROVER		
90 2.5 4x4	17H	09/85 ⇨ 08/90
110/127 2.5 4x4	17H	10/85 ⇨ 07/90
DEFENDER 2.25	--	01/87 ⇨
DEFENDER 2.5 90, 110	--	08/90 ⇨ 09/01
ROVER		
MINI 1.0	--	01/85 ⇨

KW 730 096



1

CONTACT SETS

Adatt./Suitable: **MARELLI****MAGNETI MARELLI**
718 098 01⁰³ Supplied until depletion

- Fornibile fino ad esaurimento delle scorte
- Fourni jusqu'à épuisement du stock
- Lieferbar solange vorrat reicht
- Suministrado hasta el stock termina



KW 730 120



1

CONTACT SETS

Adatt./Suitable: **MARELLI****FIAT**
9903324
9909413
9911552**MAGNETI MARELLI**
710 067 01**MOTO GUZZI**
12 715 445**SEAT**
007083.06

FIAT		
126 600	126A.000	09/72 ⇨ 06/77
500 0.5	110F.000, 120.000	01/60 ⇨ 12/75
500 0.6	111A000	08/68 ⇨ 01/76
600 0.6	--	03/55 ⇨ 05/61
PANDA I 650	141A.000	01/82 ⇨ 07/04
FSO		
126P 0.6	--	09/72 ⇨ 07/77

KW 730 123



1

CONTACT SETS

Adatt./Suitable: **MARELLI****FIAT**
2194051
9911554**GENERAL MOTORS**
7 992 318**MAGNETI MARELLI**
701 184 01
710 070 01⁰³ Supplied until depletion

- Fornibile fino ad esaurimento delle scorte
- Fourni jusqu'à épuisement du stock
- Lieferbar solange vorrat reicht
- Suministrado hasta el stock termina



KW 730 126



1

CONTACT SETS

Adatt./Suitable: **MARELLI****MAGNETI MARELLI**
718 097 01⁰⁰ Eliminated on 12-01-2021. Please verify the availability through our local distributors

• Eliminato il 12-01-2021. Verificare la disponibilità presso i nostri distributori

• Éliminé le 12-01-2021. Vérifier la disponibilité auprès de nos distributeurs sur place

• Am 12-01-2021 gestrichen. Evtl. Verfügbarkeit bitte bei unseren Händlern prüfen

• Eliminado en fecha 12-01-2021. Verificar la disponibilidad a través de nuestros distribuidores locales



KW 730 127



1

CONTACT SETS

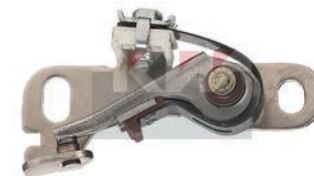
Adatt./Suitable: **MARELLI****ALFA ROMEO**
105 02 05 011 00/03
60710643**FIAT**
82205020
9911453
9912921
9912922**SEAT**
102541.06

FSO		
POLONEZ I 1.5	AA	10/77 ⇨ 08/88

KW 730 132



CONTACT SETS

Adatt./Suitable: MARELLI

FIAT

9913862

MAGNETI MARELLI

710 650 01
711 985 02

PEUGEOT

00 600 665 00

PORSCHE

901 602 932 00

RENAULT

08 57 113 600
77 02 001 761

SEAT

000 389 117 3
121461.06
NG1 214 610 6
SE 141914.006B

TALBOT

0060 06 6500



FIAT		
124 1200	124A.000	07/66 ⇒ 10/73
124 1400 Special	124B2.000	12/68 ⇒ 12/72
124 1600 Special T	132AC.000	01/73 ⇒ 07/75
850 0.8	100G.000	07/64 ⇒ 10/72

SEAT		
IBIZA I 0.9	146A000	08/86 ⇒ 05/93
MARBELLA 0.9	09NCA	01/87 ⇒ 12/93
PANDA 0.9	100GL3000	10/80 ⇒ 12/86
PANDA 45	--	01/82 ⇒ 12/85
TERRA 0.9	09NCA	02/87 ⇒ 12/96

KW 730 139



CONTACT SETS

Adatt./Suitable: MARELLI

ALFA ROMEO

105 48 05 011 04/03
116 34 05 011 00/03
60714274
60727364

FIAT

3895010
7980793
82272761
8661
9919346
9920036
9925257
9929182

MOTO GUZZI

14 715 429

SEAT

233731.06
NG1 116 013 1
NG2 337 310 6

FIAT		
127 0.9	100GL.000	09/71 ⇒ 12/84
131 1.3 Mirafiori	131A6.000	10/74 ⇒ 09/81
132 1.6	132C.000	05/77 ⇒ 09/82
242 1.6	124B3.000	10/75 ⇒ 07/82
DUCCATO I 1.8	169B	01/82 ⇒ 12/88
ARGENTA 1600	132D.000	04/81 ⇒ 12/85
ARGENTA 1600 i.e	132D.000	04/81 ⇒ 12/85

MOTO GUZZI (I)

850 LeMans III	--	01/76 ⇒
850 T3 California	--	01/76 ⇒
850 T3,T4	--	01/76 ⇒
1000 SP	--	01/76 ⇒
V1000 Californiall	--	01/76 ⇒
V1000 Convert	--	01/76 ⇒
V1000 G5	--	01/76 ⇒

KW 730 140



CONTACT SETS

Adatt./Suitable: MARELLI

FIAT

8660
9919623
9919723

MAGNETI MARELLI

711 185 01
711 985 01

RENAULT

77 02 038 190

ZASTAVA

1335052

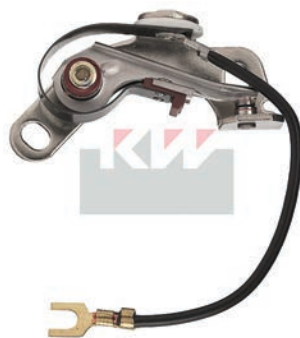

FIAT		
X 1/9 1.3	128AS.000	10/75 ⇒ 06/78

ZASTAVA		
101 1.1	128A.000, 128A.064	05/75 ⇒ 12/93
101 1.1 Super	128AC5.000	07/79 ⇒ 09/81
YUGO 0.9	9A	04/80 ⇒ 06/92

KW 730 140HV



CONTACT SETS

Adatt./Suitable: MARELLI

Eliminated on 20-09-2019. Please verify the availability through our local distributors

- Eliminato il 20-09-2019. Verificare la disponibilità presso i nostri distributori
- Éliminé le 20-09-2019. Vérifier la disponibilité auprès de nos distributeurs sur place
- Am 20-09-2019 gestrichen. Evtl. Verfügbarkeit bitte bei unseren Händlern prüfen
- Eliminado en fecha 20-09-2019. Verificar la disponibilidad a través de nuestros distribuidores locales



KW 730 142



CONTACT SETS

Adatt./Suitable: MARELLI

CITROËN

54 862 21M

FIAT

9928255
9929188

MAGNETI MARELLI

711 975 01
711 975 02

SEAT

000 992 918 8
NG1 975 023 1
SE 127914.006B

FIAT		
127 0.9	100GL.048	06/71 ⇒ 05/83
127 1.0	127A.000	01/77 ⇒ 12/86
128 1.1	128A.000	03/69 ⇒ 12/84
131 1.3 Mirafiori	131A6.000	10/74 ⇒ 09/81
132 1.6	132C.000	05/77 ⇒ 09/82
ARGENTA 1600	132D.000	04/81 ⇒ 12/85
ARGENTA 1600 i.e	132D.000	04/81 ⇒ 12/85
FIORINO I 1.0	127A.000	01/80 ⇒ 12/87
FIORINO I 1050	127A.000	01/80 ⇒ 12/87
FIORINO I 900	100GL.000	10/77 ⇒ 10/86
PANDA 1800	100GL6.000	02/81 ⇒ 12/85
PANDA 1950	A112B1.054	09/82 ⇒ 08/83
PANDA 1950 4x4	A112B1.054	09/83 ⇒ 12/86

SEAT		
FURA 0.9	100GL3000	01/82 ⇒ 06/86
MARBELLA 0.8	5K9K718	08/86 ⇒ 12/93
PANDA 34 850	--	01/80 ⇒ 12/83
PANDA 35 850	--	01/80 ⇒ 12/83

KW 730 143



CONTACT SETS

Adatt./Suitable: MARELLI

MAGNETI MARELLI

711 476 01

MOTO GUZZI

14 715 430



MOTO GUZZI (I)		
850 LeMans III	--	01/76 ⇒
850 T3 California	--	01/76 ⇒
850 T3,T4	--	01/76 ⇒
1000 SP	--	01/76 ⇒
V1000 Californiall	--	01/76 ⇒
V1000 Convert	--	01/76 ⇒
V1000 G5	--	01/76 ⇒

KW 730 146M



3,5

CONTACT SETS

Adatt./Suitable: MARELLI

FIAT

9938276

MAGNETI MARELLI

071277902010

712 478 02

712 779 02

712 779 03

PEUGEOT

5945 10

SEAT

SE 141914.006A



FIAT		
PANDA I 750	141B.000	01/86 ⇨ 01/95
PANDA I 900	100GL3.000	10/80 ⇨ 06/94
PANDA I 900 CL	146A.048	01/86 ⇨ 12/92
REGATA 1.1 60, 60 L	138B.000	10/83 ⇨ 08/86
REGATA 1.6	149A.000	10/84 ⇨ 06/89
REGATA 70 1.3	138B2.000, 149A3.000	09/83 ⇨ 07/89
REGATA 85 1.6	149A.000	10/83 ⇨ 06/90
RITMO I 1.1	146A4.048	04/85 ⇨ 12/87
UNO 45 0.9	146A.000, 146A1.000	03/83 ⇨ 07/96
UNO 45 0.9 Trend	146A.048	09/89 ⇨ 09/92
UNO 60 1.1 SX	--	01/83 ⇨ 12/85
FSO		
126P 0.6	126A1.048	07/77 ⇨ 12/91
PEUGEOT		
305 1.5	117(XR5S)	05/80 ⇨ 09/82
SEAT		
IBIZA I 0.9	146A000	08/86 ⇨ 05/93
MARBELLA 0.9	09NCA	01/87 ⇨ 12/93
TERRA 0.9	09NCA	02/87 ⇨ 12/96

KW 730 148M



3,5

CONTACT SETS

Adatt./Suitable: MARELLI

MAGNETI MARELLI

071293402010

712 934 02

RENAULT

77 01 031 989



RENAULT		
11 1.7	F2N700	10/83 ⇨ 12/87

KW 730 149



1

CONTACT SETS

Adatt./Suitable: MARELLI

⁰⁰ Eliminated on 27-01-2021. Please verify the availability through our local distributors

- Eliminato il 27-01-2021. Verificare la disponibilità presso i nostri distributori
- Éliminé le 27-01-2021. Vérifier la disponibilité auprès de nos distributeurs sur place
- Am 27-01-2021 gestrichen. Evtl. Verfügbarkeit bitte bei unseren Händlern prüfen
- Eliminado en fecha 27-01-2021. Verificar la disponibilidad a través de nuestros distribuidores locales

¹¹¹ Paired article numbers

- N° articolo appaiato
- Numéro d'article en paire
- paarige Artikelnummer
- Referencia artículo par

730 149M

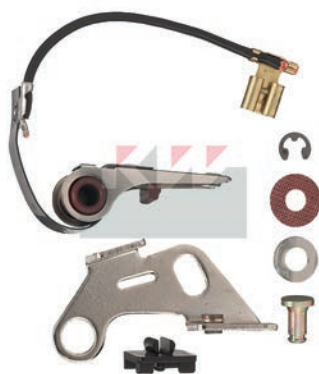

KW 730 149M



3,5

CONTACT SETS

Adatt./Suitable: MARELLI

FIAT

9940569

MAGNETI MARELLI

071277905010

712 779 05

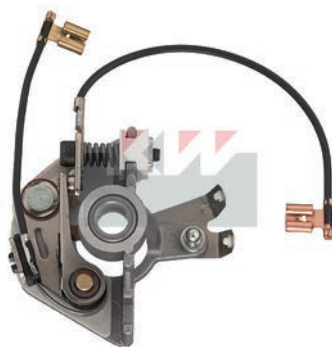

FIAT		
PANDA I 1000	156A2.000	12/93 ⇨
PANDA I 1000 CLX	156A2.000	05/91 ⇨ 12/94
PANDA I 1000 Fire	156A2.000	05/86 ⇨ 04/91
PANDA I 750	156A4.000	01/86 ⇨ 10/03

KW 730 150M



1

CONTACT SETS

Adatt./Suitable: MARELLI

FIAT

9909412

⁰³ Supplied until depletion

- Fornibile fino ad esaurimento delle scorte
- Fourni jusqu'à épuisement du stock
- Lieferbar solange vorrat reicht
- Suministrado hasta el stock termina



FIAT		
126 650	126A1.048	07/77 ⇨ 09/87
FSO		
126P 0.6	126A1.048	07/77 ⇨ 12/91

KW 731 084



1

CONTACT SETS

Adatt./Suitable: MITSUBISHI

GENERAL MOTORS

93 150 421

93 150 584

HYUNDAI

27135-11000

MAZDA

0494-24-314

3763-24-314

3823-24-314

3879-24-314

MITSUBISHI

MD607101

SUBARU

22107-KA080

22136-KA050 *F

^{*F} Available contact set only-not plate

- Fornibile solo contatto, no piastra
- Disponible rupteur seul, pas le plateau
- Erhältlich nur unterbrecher, nicht die platte
- Disponible el platino solo, no la plancha

⁰³ Supplied until depletion

- Fornibile fino ad esaurimento delle scorte
- Fourni jusqu'à épuisement du stock
- Lieferbar solange vorrat reicht
- Suministrado hasta el stock termina



FORD AUSTRALIA		
COURIER 1.8	--	01/79 ⇨ 12/84
COURIER 2.0	--	01/79 ⇨
HYUNDAI		
STELLAR 1.4	4G33	10/83 ⇨ 08/86
STELLAR 1.6	G32B	10/83 ⇨ 12/91
MAZDA		
929 I 2.0	MA	05/79 ⇨ 07/86
SUBARU		
J-SERIES 1.0	--	01/87 ⇨ 12/91

KW 731 085



CONTACT SETS

Adatt./Suitable: **MITSUBISHI**

NISSAN

22145-73415
22145-89900
22145-89901
22145-89905⁰³ Supplied until depletion

- Fornibile fino ad esaurimento delle scorte
- Fourni jusqu'à épuisement du stock
- Lieferbar solange vorrat reicht
- Suministrado hasta el stock termina



MITSUBISHI

COLT I 1.2 GL	4G11	12/78 ⇨ 01/84
CORDIA 1.8 [USA]	G62B	01/82 ⇨ 12/84
CORDIA 1.8 Turbo [USA]	G62B	01/82 ⇨ 12/84
PAJERO I 2.6	4G54	01/83 ⇨ 11/90
PAJERO I 2.6 4WD	4G54	01/83 ⇨ 05/91
SHOGUN I 2.6 4x4	4G54	01/84 ⇨ 02/91

NISSAN

URVAN III 2.0	Z20	05/87 ⇨ 05/97
VANETTE II 1.5	A15	04/87 ⇨ 11/94
VANETTE II 2.0	Z20S	07/87 ⇨ 08/94

KW 736 045



CONTACT SETS

Adatt./Suitable: **PAL**

SKODA

113 911 401

⁰³ Supplied until depletion

- Fornibile fino ad esaurimento delle scorte
- Fourni jusqu'à épuisement du stock
- Lieferbar solange vorrat reicht
- Suministrado hasta el stock termina



SKODA

105,120 1.0	33*	08/76 ⇨ 12/89
105,120 1.0 105 S, L	742.10	08/76 ⇨ 12/90
105,120 1.0 105 S, L, GL	742.10	08/76 ⇨ 08/83
105,120 1.0 105 S, L, LS	742.10	10/83 ⇨ 12/90
105,120 1.2	37*, 55*	08/76 ⇨ 12/89
105,120 1.2 120 GLS	742.12X	02/83 ⇨ 12/90
105,120 1.2 120 L	742.12, 742.12X	08/76 ⇨ 12/90
105,120 1.2 120 LS	742.12X	08/76 ⇨ 12/90
130 1.3	43*	01/84 ⇨ 12/88
135 1.3	43*	01/87 ⇨ 12/89
136 1.3	46*	01/87 ⇨ 12/89

KW 742 054



CONTACT SETS

Adatt./Suitable: **SEV**

GENERAL MOTORS

7 992 234

RENAULT

08 54 921 500
77 01 003 813
77 01 008 141**SEV-MARCHAL**
S 406⁰³ Supplied until depletion

- Fornibile fino ad esaurimento delle scorte
- Fourni jusqu'à épuisement du stock
- Lieferbar solange vorrat reicht
- Suministrado hasta el stock termina



RENAULT

40.8	800705	10/83 ⇨ 10/88
------	--------	---------------

KW 746 070



CONTACT SETS

Adatt./Suitable: **U.D.S.S.R.**

LADA

21010-3706800-10
2101-3706800-10⁰³ Supplied until depletion

- Fornibile fino ad esaurimento delle scorte
- Fourni jusqu'à épuisement du stock
- Lieferbar solange vorrat reicht
- Suministrado hasta el stock termina



LADA

LADA 1.2	--	01/80 ⇨
LADA 1.3	--	01/80 ⇨
LADA 1.5	--	01/80 ⇨
NIVA I 1600	BA32121	12/76 ⇨ 12/93
RIVA 1.5	--	01/85 ⇨
RIVA 1.6	--	01/85 ⇨

KW 746 071



CONTACT SETS

Adatt./Suitable: **U.D.S.S.R.**

FIAT

9918269

LADA

2101-3706800



LADA

LADA 1.2	--	01/80 ⇨
LADA 1.3	--	01/80 ⇨
LADA 1.5	--	01/80 ⇨
NIVA I 1600	BA32121, BA32121	12/76 ⇨ 12/93

KW 749 350



CONTACT SETS

Adatt./Suitable: **ZELMOT**

FIAT

9942108

⁰³ Supplied until depletion

- Fornibile fino ad esaurimento delle scorte
- Fourni jusqu'à épuisement du stock
- Lieferbar solange vorrat reicht
- Suministrado hasta el stock termina



FSO

126P 0.6	126A1.048	07/77 ⇨ 12/91
----------	-----------	---------------



DISTRIBUTOR CAPS

-CALOTTE -TETES D'ALLUMEUR -VERTEILERKAPPEN -TAPAS DEL DISTRIBUIDOR

(A) P/NRS. - NOTES

- CODICI - NOTE
- RÉFS. - NOTES
- ARTIKEL-NR. - ANMERKUNGEN
- CODIGOS - NOTAS

1 **806 234** **3** **05**

DISTRIBUTOR CAPS

Adatt./Suitable: **BOSCH**

BOSCH **2**

1 235 522 340 *A
1 235 522 381

MERCEDES-BENZ

A 000 158 48 02 *A
A 000 158 49 02

***A without cover**

- senza copertura
- sans revêtement
- ohne Abdeckung
- sin cubierta **4**

210 Interference Suppression 1k0hm

- schermato/a, 1 k0hm
- Antiparasitage, 1k0hm
- entstört, 1 k0hm
- supresión de interferencias, 1 k0hm

(A)

1 # KW

2 OEM P/NRS.

- CODICI ORIGINALI
- RÉFS. D'ORIGINE
- ORIGINALTEILE-NR.
- CODIGOS ORIGINALES

3 PACKAGING SIZE

- FORMATO CONFEZIONE
- FORMAT DU CONDITIONNEMENT
- ABPACKENSGROSSE
- TAMAÑO DEL ENVASE

4 NOTE

- NOTE
- NOTES
- BERMERKUNGEN
- NOTAS

(B) PICTURE + TECHNICAL INFO

- FOTO + INFORMAZIONE TECNICA
- ILLUSTRATION + INFORMATION TECHNIQUE
- BILD + TECHNISCHE INFO
- FOTO + INFORMACIÓN TÉCNICA



(C) APPLICATION LIST

- GUIDA APPLICAZIONI
- LISTE D'APPLICATIONS
- ANWENDUNGSTABELLE
- LISTA DE APLICACIONES

MERCEDES-BENZ		
190 2.3	M102.985	09/87 ⇨ 09/88
190 2.3 E	M102.985	10/82 ⇨ 09/88
190 E 1.8	M102.910, M102.919	04/90 ⇨ 12/93
190 E 2.0	M102.962	10/82 ⇨ 08/93
190 E 2.3	M102.985	09/86 ⇨ 08/93
190 E 2.3-16	M102.983	04/84 ⇨ 08/88
190 E 2.5-16	M102.990, M102.991	09/88 ⇨ 08/93
190 E Evolution II 2.5	M102.992	05/90 ⇨ 08/93
CLASSE G I 230 GE	M102.998	05/87 ⇨ 08/92
CLASSE G II 200 GE	M102.965	01/90 ⇨ 07/93
CLASSE G II 230 G	M102.958	04/92 ⇨
CLASSE G II 230 GE	M102.979, M102.989, M102.996, M102.997, M102.998	09/89 ⇨
COUPE 200 CE	M102.963	09/89 ⇨ 06/93
COUPE 230 CE	M102.982	03/87 ⇨ 12/92
COUPE 230 CE Cat	M102.982	06/89 ⇨ 12/92

(B)

1 PICTURE

- FOTO
- PHOTO
- BILD
- FOTO

KW 806 062



04

DISTRIBUTOR CAPS

Adatt./Suitable: **BOSCH**

ALFA ROMEO

130 85 50 06/07

BMW

12 11 1 271 656
12 11 1 354 499
12 11 1 354 999
12 11 8 630 146
12 11 8 730 055

BOSCH

1 235 522 107
1 235 522 134
1 235 522 157

MERCEDES-BENZ

A 000 158 06 02

OPEL

12 12 128
12 12 147

PORSCHE

616 602 215 00

VOLVO

233260
2332609
241655
870690
8706905

VW

111 905 207 B



ALFA ROMEO		
GT 1300 Junior	AR00530	01/66 ⇌ 12/77
BMW		
51 518	M10B18(184VB)	07/74 ⇌ 05/81
1502-2002 1602	M10B16A	04/71 ⇌ 07/75
FORD		
TAUNUS 17M 1.5	--	09/64 ⇌ 10/68
MERCEDES-BENZ		
CLASSE SL 190 SL	M121.921, M121.928	01/55 ⇌ 12/63
OPEL		
GT 1.1	11SR	09/68 ⇌ 12/70
VOLVO		
P 122 S AMAZON 1.8	B18D	02/67 ⇌ 05/71
VW		
KAEFFER 1.2	M51	01/54 ⇌ 07/65

KW 806 072



04

DISTRIBUTOR CAPS

Adatt./Suitable: **BOSCH**

BMW

12 11 1 351 446
12 11 1 353 117
12 11 1 354 501

BOSCH

1 235 522 051

DAF

163793
232634

FORD

0 710 256
1 144 700 2
1 171 025 6
1 171 026 8

MERCEDES-BENZ

10001585302
A 000 158 07 02
A 000 158 16 02
A 000 158 25 02
A 000 158 53 02

OPEL

12 12 131
12 12 135
12 12 138

PORSCHE

901 602 901 00
901 602 963 00

VOLVO

241669
2416691



PORSCHE		
911 12.0L	901.01, 901.05	01/67 ⇌ 12/68

KW 806 076



04

DISTRIBUTOR CAPS

Adatt./Suitable: **BOSCH**

ALFA ROMEO

105 48 05 011 06/01
60714282

BOSCH

1 235 522 050
1 235 522 058
1 235 522 059

FORD

0 710 255
1 171 025 5

MERCEDES-BENZ

A 000 158 24 02

OPEL

12 11 253
12 12 136
12 12 137

PORSCHE

616 602 215 02

VOLVO

241653
2416535
243632
2436327

VW

059 905 207
111 905 207 D
892 031 048



ALFA ROMEO		
GT 1300 Junior	AR00530	01/66 ⇌ 12/77
GT 1600	AR00526S	03/63 ⇌ 12/66

ALFA ROMEO		
GT A 1600	AR10538	01/65 ⇌ 12/70
OPEL		
GT 1.1	11SR	09/68 ⇌ 12/70
GT 1.9	19S	09/68 ⇌ 08/73
PORSCHE		
356 A 1600 S	616.15	01/55 ⇌ 12/59
356 A 1600 Super	616.15	01/55 ⇌ 12/59
912 1.6	616.36, 616.39, 616.40	01/65 ⇌ 02/70
VOLVO		
P 121 1.6	B16A	05/59 ⇌ 09/66
P 121 1.8	B18, B18A	05/59 ⇌ 05/71
P 121 2.0	OJX4G20A6L	11/68 ⇌ 05/71
P 122 S AMAZON 1.6	B16	05/59 ⇌ 09/66
P 122 S AMAZON 1.8	B18, B18D	05/59 ⇌ 05/71
P 122 S AMAZON 2.0	B20B	11/68 ⇌ 05/71
P 210 DUETT 1.8	B18A	08/61 ⇌ 07/67
PV 544 1.6	B16A, B16B	08/61 ⇌ 07/67
PV 544 1.8	B18A, B18D	08/61 ⇌ 07/67

KW 806 079



04

DISTRIBUTOR CAPS

Adatt./Suitable: **BOSCH**

ALFA ROMEO

700 216
705 410
105 48 05 011 08/02
116 55 05 011 00/02
165 55 05 011 00/02
60714284
60801306
82305237
96586846

BMW

12 11 1 354 449
12 11 1 359 874
12 11 1 363 191
12 11 1 363 291
12 11 1 363 423

BOSCH

1 235 522 056
1 235 522 183

DAF

744626

FIAT

7080442
82301920
82305237
82348987
82361894
9934652
9936014

FORD

0 710 254
1 144 706 9
1 171 025 4
1 523 817
3 240 336
72HF-12106-AA
DIFZ-12106-A

MERCEDES-BENZ

A 000 158 18 02
A 000 158 28 02

OPEL

12 12 143

PEUGEOT

5941 27

RENAULT

77 01 012 536
77 01 029 263
77 02 038 122

SEAT

000 398 066 5
SE 021914.001A

VOLVO

243797
2437978
546279

VW

043 905 207
049 905 207
058 905 207
113 905 207 A
113 905 207 B
113 905 207 C

ZASTAVA

46600193
5248175



ALFA ROMEO		
3311.2	AR30585	06/83 ⇌ 12/89

ALFA ROMEO			
33 I 1.3	AR30168, AR30586, AR30587	06/83 ⇒ 12/89	
33 I 1.3 i.e.	AR30168	05/83 ⇒ 12/89	
33 I 1.4	AR30587	01/84 ⇒ 12/88	
33 I 1.5	AR30588	07/86 ⇒ 12/89	
33 I 1.5 4x4	AR30508, AR30588	07/86 ⇒ 12/89	
33 I 1.5 QV	AR30146, AR30508, AR30588	06/84 ⇒ 12/89	
33 I 1.7	AR30550	01/86 ⇒ 06/90	
33 I 1.7 i.e.	AR30558	09/88 ⇒ 12/89	
33 I 1.7 i.e. 4x4	AR30558	09/88 ⇒ 12/89	
33 I 1.7 QV	AR30550	03/88 ⇒ 12/89	
33 II 1.2	AR30743	01/90 ⇒ 08/91	
33 II 1.3	AR30732	09/91 ⇒ 10/94	
33 II 1.4 4x4	AR30755	07/90 ⇒ 12/92	
33 II 1.4 i.e.	AR30755	06/91 ⇒ 09/94	
33 II 1.4 i.e. 4x4	AR30755	07/90 ⇒ 09/94	
33 II 1.5	AR30734	01/90 ⇒ 04/93	
33 II 1.5 i.e.	AR30751	01/90 ⇒ 09/94	
33 II 1.5 i.e.	AR30750	07/90 ⇒ 08/91	
33 II 1.7 16V	AR30746, AR30747	01/90 ⇒ 09/94	
33 II 1.7 16V 4x4	AR30746, AR30747	01/90 ⇒ 09/94	
33 II 1.7 i.e.	AR30736, AR30737	01/90 ⇒ 09/94	
33 II 1.7 i.e. 4x4	AR30736, AR30737	01/90 ⇒ 09/94	
75 1.6	AR06100	05/85 ⇒ 09/89	
75 1.6 Cat	AR61101	05/89 ⇒ 02/92	
75 1.8	AR06168, AR06202, AR61102, AR61201	09/85 ⇒ 02/92	
75 1.8 i.e.	61202	08/89 ⇒ 02/92	
75 1.8 i.e. Turbo America	61203	02/86 ⇒ 01/90	
75 1.8 Turbo	AR06134	09/86 ⇒ 02/92	
75 2.0 T.S Cat	AR06224	05/85 ⇒ 02/92	
75 2.0 T.S.	AR06166, AR06224	01/87 ⇒ 02/92	
90 1.8	AR06202	10/84 ⇒ 07/87	
90 2.0 i.e.	AR06210	10/84 ⇒ 07/87	
164 2.0 T.S.	AR06416, AR06420	06/87 ⇒ 09/92	
164 2.0 Twin Spark	AR06420	06/87 ⇒ 09/92	
ALFASUD 1.2	AR30102	06/72 ⇒ 09/84	
ALFASUD 1.5 ti	AR30128	05/80 ⇒ 06/84	
ALFETTA 1.6	AR01600	01/75 ⇒ 12/84	
ALFETTA 1.8	AR01608, AR01608X	07/74 ⇒ 12/84	
GIULIETTA I 1.3	AR01644	10/77 ⇒ 06/83	
GIULIETTA I 1.6	AR01600	10/77 ⇒ 04/85	
GIULIETTA I 1.8	AR01678	04/79 ⇒ 04/85	
GIULIETTA I 2.0	AR01655	06/80 ⇒ 04/85	
SPIDER I 1600	AR00526, AR01563	03/76 ⇒ 12/93	
SPIDER I 2.0i [CAN]	AR01588	09/90 ⇒ 10/93	
SPIDER I 2.0i [USA]	AR01588	09/90 ⇒ 10/93	
SPIDER I 2.0i Veloce [CAN]	AR01588	09/90 ⇒ 10/93	
SPIDER I 2.0i Veloce [USA]	AR01588	09/90 ⇒ 10/93	
SPIDER I 2000	AR01544, AR01588, AR01590	01/77 ⇒ 12/93	
AUDI			
80 I 1.6	WV	08/78 ⇒ 07/86	
100 III 1.8	DR	08/82 ⇒ 12/87	
FIAT			
132 2.0	132C2.000	01/76 ⇒ 06/81	
DUCATO I 1.8	169B	01/82 ⇒ 12/88	
ARGENTA 2000	132D1.000	06/78 ⇒ 12/85	
FIAT (BR)			
147 1.1	--	01/82 ⇒ 12/84	
PREMIO	--	01/85 ⇒ 12/88	
PREMIO 1.3	--	01/85 ⇒	
UNO 1.3	1.3	01/85 ⇒ 12/91	
UNO 1.5	1.5	01/91 ⇒ 12/93	
UNO CS 1.3	1.3	01/85 ⇒ 12/91	
UNO CS 1.5	1.5	01/91 ⇒ 12/93	
UNO CS 1.5 Furgoneta	1.5	01/91 ⇒ 12/93	
UNO MILLE 1.0	1.0	01/91 ⇒ 04/93	
FORD			
CAPRI III 1.3	J1E	01/78 ⇒ 06/85	
ESCORT III 1.1	GSE	08/83 ⇒ 12/85	
ESCORT III 1.4 i	F6B, F6D, FUC	02/86 ⇒ 07/90	
ESCORT IV 1.4	F6B, F6D, FUA, FUC	01/86 ⇒ 07/90	
ESCORT IV 1.6 Turbo RS	LNB	01/86 ⇒ 07/90	
ESCORT IV 1.6 XR3i	LR2, LRB	01/86 ⇒ 07/90	
FIESTA 10.9	TKA, TKW, TLA	05/76 ⇒ 08/83	
FIESTA I 1.1	GLA, GLW	05/76 ⇒ 08/83	
FIESTA I 1.6 XR2	L3E	08/81 ⇒ 08/83	
FIESTA II 1.1	GLC, GSF, GSH	09/83 ⇒ 02/89	
FIESTA II 1.3	JPC	09/83 ⇒ 09/89	
FIESTA II 1.4	FUB, FUD	10/85 ⇒ 11/89	
FIESTA III 1.4	F6E	03/89 ⇒ 12/95	
GRANADA 1.7	TV17LC	08/77 ⇒ 05/82	
GRANADA 2.0	NEP	08/79 ⇒ 08/85	
SIERRA I 2.0	NET, NR2, NRD, NYT	08/82 ⇒ 12/86	
SIERRA I 2.0 i	NR2	03/85 ⇒ 12/86	
ORION I 1.3	JPA	11/86 ⇒ 07/88	
ORION I 1.4	FUA, FUC	12/85 ⇒ 07/90	
FORD			
ORION I 1.4 Cat	F6B, F6D	02/87 ⇒ 07/90	
ORION I 1.6 i	LRB	03/86 ⇒ 07/90	
SCORPIO I 1.8	REC	04/85 ⇒ 02/92	
SCORPIO I 2.0	TL20H-NE4, TL20H-NE5	10/84 ⇒ 02/90	
SCORPIO I 2.0 i	NRA, NRI	04/85 ⇒ 02/92	
SIERRA II 2.0	N8C, NES	01/87 ⇒ 02/93	
TRANSIT I 1.6	4RB	11/77 ⇒ 10/86	
TRANSIT I 2.0	4RC	11/77 ⇒ 07/82	
TRANSIT II 1.6	LAC, LAT	09/85 ⇒ 09/92	
TRANSIT II 2.0	N6TS, NAT, NAV, NAW, NBA, NCA	09/85 ⇒ 09/94	
TRANSIT II 2.0 Cat	N6T	11/85 ⇒ 09/92	
TRANSIT II 2.0 EFI	--	08/91 ⇒ 08/94	
TRANSIT II 2.0 i	NCA	09/91 ⇒ 07/94	
TRANSIT II 2.0 L	NAW, NAX	10/85 ⇒ 03/91	
FORD AUSTRALIA			
CORTINA 2.0	--	06/77 ⇒ 08/82	
ESCORT 2.0	--	01/77 ⇒ 12/81	
ESCORT 2.0 RS	--	01/77 ⇒ 12/81	
LANCIA			
BETA 1600	828B.000	08/73 ⇒ 07/82	
MERCEDES-BENZ			
O 309	M115.952	01/68 ⇒ 02/89	
PEUGEOT			
505 2.0	106E(XN1A)	09/85 ⇒ 09/95	
505 2.0 Ti, STI	829(ZEJ)	08/79 ⇒ 10/86	
505 2.1 i	XN9T	01/83 ⇒ 12/88	
505 2.2	851(ZDJJ), 851X(ZDJL)	05/81 ⇒ 12/93	
505 2.2 GTI	851B(ZDJL)	08/83 ⇒ 12/93	
PORSCHE			
924 2.0 Turbo	M31.03	06/80 ⇒ 10/86	
SAAB			
90 2.0	B20I	08/84 ⇒ 08/87	
900 I 2.0 -16	5B6304GS, B202XI	01/86 ⇒ 06/94	
900 I 2.0 c	B201XC	09/79 ⇒ 12/88	
900 I 2.0 i	OTLE4G15, B201XI	11/80 ⇒ 08/90	
900 I 2.0 S Turbo-16	B202S	07/91 ⇒ 06/94	
900 I 2.0 Turbo	B201XL	01/86 ⇒ 12/91	
900 I 2.0 Turbo-16	B202L, B202XL	11/85 ⇒ 06/94	
900 I 2.0 Turbo-16 S	B202XL	01/84 ⇒ 06/94	
900 I 2.0 Turbo-16 S Cat	B202XL	01/89 ⇒ 12/93	
900 I 2.1 -16	B212I	08/90 ⇒ 06/94	
9000 2.0 -16	5B6304GS, B202XI	12/85 ⇒ 01/93	
9000 2.0 -16 CS	5B6304GS	01/89 ⇒ 12/98	
9000 2.0 -16 Turbo	B202XL	09/84 ⇒ 08/93	
9000 2.0 -16 Turbo CD	B202XL	09/88 ⇒ 08/93	
9000 2.3 -16 CD	B234I	08/89 ⇒ 12/98	
9000 2.3 -16 CS	B234I	09/89 ⇒ 12/98	
SEAT			
CORDOBA I 1.6 i	ALM	02/93 ⇒ 12/02	
IBIZA I 1.2	O21A1000	11/84 ⇒ 12/93	
IBIZA I 1.2 i	O21C.1000	01/89 ⇒ 05/93	
IBIZA I 1.5 i	O21B.2000	10/86 ⇒ 05/93	
MALAGA 1.2	O21A1000	05/85 ⇒ 12/93	
MALAGA 1.5	O21A2000	05/85 ⇒ 12/93	
MALAGA 1.5 i	O21B.2000	01/87 ⇒ 12/93	
TALBOT			
1307-1510 Simca 1307 1.3	--	07/75 ⇒ 01/80	
SIMCA 1309	--	01/78 ⇒ 12/86	
SOLARA 1.3	2M102.979	02/80 ⇒ 07/86	
TAGORA 2.1	5N2	06/80 ⇒ 12/83	
VOLVO			
240 1.8	B17A	11/78 ⇒ 07/85	
240 2.0	OJX4G20A6L, B19ET, B200E, B200F, B200K	08/74 ⇒ 12/93	
240 2.1 Turbo	B21ET, B21FT	08/80 ⇒ 07/85	
240 2.3	B230A, B230E, B230F, B230FD, B230FX, B230K	08/83 ⇒ 08/93	
240 2.3 Cat	B230F	08/91 ⇒ 07/92	
240 2.3 i Cat	B230F	08/86 ⇒ 07/93	
340-360 2.0	B200E, B200EA, B200F, B200K	08/84 ⇒ 07/90	
740 2.3	B230A	08/84 ⇒ 07/86	
760 2.3 Turbo	B23ET, B23FT	08/82 ⇒ 07/84	
VW			
PASSAT II 1.3	79SU16	08/80 ⇒ 07/86	
PASSAT II 1.6	DT	08/80 ⇒ 03/88	
POLO II 1.0	GL	10/81 ⇒ 10/86	
POLO II 1.1	HB	10/81 ⇒ 09/89	
POLO II 1.3	GK, GT, HH, HJ, HK, HW	10/81 ⇒ 09/89	
JETTA II 1.3	GT, HK	01/84 ⇒ 06/87	
JETTA II 1.6	HM	12/83 ⇒ 07/88	
JETTA II 1.8	EV, GU	01/84 ⇒ 10/91	
JETTA II 1.8 Syncro	GU	08/87 ⇒ 12/88	
CADDY I 1.5	JB	08/82 ⇒ 07/83	
CADDY I 1.6	EW, HN	01/83 ⇒ 07/92	
DERBY 1.0	GL	10/81 ⇒ 12/84	
DERBY 1.1	HB	02/77 ⇒ 09/81	
DERBY 1.3	HH	02/77 ⇒ 09/81	
VW			
GOLF I 1.3	HK	08/83 ⇒ 07/86	
GOLF I 1.6	EW, HN	08/83 ⇒ 04/92	
GOLF I 1.8	DX, EX, JH	08/82 ⇒ 04/93	
GOLF II 1.0	GN	11/83 ⇒ 08/85	
GOLF II 1.3	GT, HK	08/83 ⇒ 06/87	
GOLF II 1.6 [CHE] [SWE]	HM	08/83 ⇒ 07/85	
GOLF II 1.8	GU	08/84 ⇒ 10/91	
GOLF II 1.8 GTI	EV	08/83 ⇒ 10/91	
QUANTUM 1.7	--	01/85 ⇒ 12/87	
SCIROCCO I 1.1	FA	04/74 ⇒ 07/79	
SCIROCCO I 1.3	GF	08/79 ⇒ 07/80	
SCIROCCO I 1.5	JB	08/77 ⇒ 07/80	
SCIROCCO II 1.3	GF, HK	08/80 ⇒ 07/84	
SCIROCCO II 1.6	1HyFAD, EW, HN	08/80 ⇒ 12/89	
SCIROCCO II 1.8	DX, EX, JH	08/82 ⇒ 07/92	
ZASTAVA			
YUGO 45 [USA]	--	01/86 ⇒	

KW 806 080  04

DISTRIBUTOR CAPS

Adatt./Suitable: BOSCH

BOSCH

1 235 522 196

1 235 522 409 *A

OPEL

03469033

12 11 252

12 11 265

12 11 267 *A

*Available distributor cap only not screen

- Fornita solo calotta, no copertura
- Disponible seulement la tete et non pas le couvercle
- Erhältlich nur die kappe, nicht die haube
- Disponible solo la tapa, no la cobertura



HOLDEN

CAMIRA 1.6	16JH	08/82 ⇒ 02/86
CAMIRA 1.8 MPFI	6T2204XS85K01	11/84 ⇒ 01/86
CAMIRA 1.8 SPFI	6T2204XS85K01	02/86 ⇒ 03/87

OPEL

ASCONA C 1.3 N	13N	09/81 ⇒ 08/86
ASCONA C 1.6	16N	09/81 ⇒ 08/88
ASCONA C 1.6 S	16SH	09/81 ⇒ 08/86
ASCONA C 1.8 E	C18NE	01/85 ⇒ 08/86
ASCONA C 1.8 i	18E	09/82 ⇒ 08/86
CORSA A 1.0	10S	09/82 ⇒ 03/93
CORSA A 1.2	12N, 12NC, E12GV	09/82 ⇒ 08/90
CORSA A 1.2 N	12NC, E12GV	01/85 ⇒ 10/87
CORSA A 1.6 GSI	E16SE	05/88 ⇒ 03/92
KADETT B 1.1	11N	08/71 ⇒ 08/73
KADETT D 1.0	10N	09/79 ⇒ 08/82
KADETT E 1.2	12SC	09/84 ⇒ 07/86
KADETT E 1.6 S	16S	09/84 ⇒ 08/86
KADETT E 1.8 E	C18NE	10/85 ⇒ 08/86
KADETT E 1.8 GSI	18E	09/84 ⇒ 08/86
KADETT E 1.8 i	18E, C18NE, C18NT	08/84 ⇒ 09/92
MANTA B 1.3 N	13N	03/79 ⇒ 12/80
MANTA B 1.3 S	13S	08/81 ⇒ 08/86
MANTA B 1.6 S	16S	09/75 ⇒ 12/81
MANTA B 1.9 N	19N	08/76 ⇒ 12/81
MANTA B 2.0	20N	08/77 ⇒ 12/80
OMEGA A 2.4 i	C24NE	09/88 ⇒ 03/94
VECTRA A 1.4 S	14NV	04/88 ⇒ 06/92

KW 806 081



05

DISTRIBUTOR CAPS

Adatt./Suitable: BOSCH

ALFA ROMEO
119 00 05 011 04/02
60735405

BMW
12 11 1 271 657
12 11 1 355 626
12 11 1 359 706
12 11 1 363 292
12 11 1 363 422

BOSCH
1 235 522 040
1 235 522 362 *A

DAF
698594

FORD
1 523 785
1 583 458
72TF-12106-AA
78TF-12106-AA

MAN
51.26310-0001
MERCEDES-BENZ
A 000 158 22 02
A 000 158 50 02

OPEL
12 11 250
12 12 141

PORSCHE
930 602 904 00
930 602 908 00

VOLVO
243658
2436582
243803
2438034

VW
073 905 207

- *A Available distributor cap only not screen
- Fornita solo calotta, no copertura
 - Disponible seulement la tete et non pas le couvercle
 - Erhältlich nur die kappe, nicht die haube
 - Disponible solo la tapa, no la cobertura



ALFA ROMEO

6.2.0	AR01932	07/81 ⇒ 12/86
75 2.5 V6	AR01646, AR01648, AR01911	05/85 ⇒ 08/86
75 3.0 V6	AR06120, AR61503	01/87 ⇒ 02/92
75 3.0 V6 Cat	AR06124	01/87 ⇒ 02/92
90 2.5 i.e. V6	AR01646	10/84 ⇒ 07/87

BMW

5 II 525 i	M30B25(256EA)	06/81 ⇒ 12/87
5 II 528 i	M30B28(286EA)	06/81 ⇒ 12/87
6 I 628 CSi	M30B28	09/79 ⇒ 08/87
7 I 728	M30B28	05/77 ⇒ 08/79
7 I 728 i	M30B28	09/77 ⇒ 08/86
7 I 730	M30B30	05/77 ⇒ 08/79

FORD

TRANSIT II 2.9 i	BRT	01/91 ⇒ 09/94
------------------	-----	---------------

MAN

E2000	E2866DF01	05/00 ⇒
F2000	E2866DF01	03/00 ⇒
NG	E2866DUH01	01/95 ⇒ 07/99
NL	E2866DUH01, E2866DUH02	05/93 ⇒ 07/99

OPEL

OMEGA A 3.0	30NE, C30LE, C30NE	03/87 ⇒ 03/94
OMEGA A 3.0 Cat	C30NE	03/87 ⇒ 03/94
SENATOR B 2.5 i	25NE	09/90 ⇒ 09/93
SENATOR B 3.0	30NE, C30LE	09/87 ⇒ 09/93
SENATOR B 3.0 i Cat	C30NE	01/88 ⇒ 09/93

KW 806 090



07

DISTRIBUTOR CAPS

Adatt./Suitable: BOSCH

BOSCH
0 290 004 500 *A
0 290 004 502 *A
1 235 522 208

MERCEDES-BENZ
A 000 158 34 02 *A
A 000 158 42 02 *A

PORSCHE
928 602 902 00 *A

- *A Available distributor cap only not screen
- Fornita solo calotta, no copertura
 - Disponible seulement la tete et non pas le couvercle
 - Erhältlich nur die kappe, nicht die haube
 - Disponible solo la tapa, no la cobertura

210 interference Suppression 1k0hm

- schermato/a, 1 k0hm
- Antiparasitage, 1k0hm
- entstört, 1 k0hm
- supresión de interferencias, 1 k0hm



MERCEDES-BENZ

CLASSE S II 380 SE, SEL	M116.961, M116.963	09/80 ⇒ 08/85
CLASSE S II 380 SEC	M116.963	10/81 ⇒ 07/85
CLASSE S II 500 SE, SEL	M117.961, M117.963	12/79 ⇒ 08/85
CLASSE S II 500 SEC	M117.963	08/80 ⇒ 08/85
CLASSE SL III 380 SL	M116.960, M116.962	09/80 ⇒ 08/85

PORSCHE

928 4.7 S	M28.11, M28.12	09/79 ⇒ 07/83
-----------	----------------	---------------

KW 806 092



07

DISTRIBUTOR CAPS

Adatt./Suitable: BOSCH

BOSCH
0 290 004 501 *A
0 290 004 503
1 235 522 074
1 235 522 323

MERCEDES-BENZ
A 000 158 27 02 *A
A 000 158 36 02 *A
A 000 158 41 02 *A

- *A Available distributor cap only not screen
- Fornita solo calotta, no copertura
 - Disponible seulement la tete et non pas le couvercle
 - Erhältlich nur die kappe, nicht die haube
 - Disponible solo la tapa, no la cobertura

210 interference Suppression 1k0hm

- schermato/a, 1 k0hm
- Antiparasitage, 1k0hm
- entstört, 1 k0hm
- supresión de interferencias, 1 k0hm



MERCEDES-BENZ

CLASSE G I 280 GE	M110.994	11/79 ⇒ 08/89
CLASSE G II 280 GE	M110.994	04/92 ⇒
CLASSE S II 280 S	M110.924	12/79 ⇒ 07/85
CLASSE SL III 280 SL	M110.986	06/76 ⇒ 09/81
CLASSE SL III 280 SLC	M110.986	06/76 ⇒ 09/81
TRE VOLUMI I 280 E	M110.984	02/76 ⇒ 11/85

PUCH

G-MODELL 280 GE	M110.994	01/86 ⇒ 12/91
-----------------	----------	---------------

KW 806 093



04

DISTRIBUTOR CAPS

Adatt./Suitable: BOSCH

AUDI
035 905 207 A
BOSCH
1 235 522 218

VW
035 905 207
035 905 207 A

- ⁰³ Supplied until depletion
- Fornibile fino ad esaurimento delle scorte
 - Fourni jusqu'à épuisement du stock
 - Lieferbar solange vorrat reicht
 - Suministrado hasta el stock termina



AUDI

100 III 1.9	WH	08/82 ⇒ 07/84
100 III 2.2	KZ	10/84 ⇒ 09/86

VW

PASSAT II 1.9	WN	01/81 ⇒ 07/83
PASSAT II 2.2	KX	01/85 ⇒ 03/88
SANTANA 1.9	WN	08/81 ⇒ 07/83

KW 806 094



04

DISTRIBUTOR CAPS

Adatt./Suitable: BOSCH

AUDI
027 905 207
030 905 207

BMW
12 11 1 326 765
12 11 1 706 122

BOSCH
1 235 522 213

SEAT
026 905 207 2
030 905 207

TOYOTA
19101-02020

VW
026 905 207 2
027 905 207
030 905 207
055 905 207
281 905 207
325 905 207 2



AUDI

80 II 1.3	EP	09/78 ⇒ 07/86
80 II 1.6	DT, JU, WV	08/78 ⇒ 03/87
80 II 1.8	DS, JN	01/83 ⇒ 08/86
80 II 1.8 CC quattro	JN, JV	08/84 ⇒ 08/86
80 II 1.8 GTE	DZ	10/84 ⇒ 08/86
80 IV 2.0 E quattro	ABK	09/91 ⇒ 12/94
90 I 1.8	JN	06/84 ⇒ 03/87
100 IV 2.0 E quattro	AAD	12/90 ⇒ 07/92

BMW

3 II 316	M10B18(184VC), M10B18(184VD)	09/83 ⇒ 06/88
3 II 316 i	M10B18(184KA)	08/87 ⇒ 08/88
3 II 318 i	M10B18(184EA), M10B18(184KA)	09/82 ⇒ 08/88
3 I 315	M10B16(164VB)	03/81 ⇒ 03/84
5 II 518	M10B18(184VC), M10B18(184VD)	06/81 ⇒ 09/84
5 II 518 i	M10B18(184EB)	05/81 ⇒ 12/87
5 I 518	M10B18(184VB)	07/74 ⇒ 05/81

RENAULT

FUEGO 1.6 [USA] R1368	A7L752	01/82 ⇒ 12/84
-----------------------	--------	---------------

SEAT			
AROSA 1.0	AER, ALL	05/97	⇒ 06/04
AROSA 1.4	AEX, AKV, APQ	05/97	⇒ 06/04
CORDOBA I 1.0 16V	AST, AVZ	05/00	⇒ 10/02
CORDOBA I 1.0 i	AER	09/96	⇒ 10/02
CORDOBA I 1.4	ANX	12/97	⇒ 04/99
CORDOBA I 1.4 i	ABD, AEX, AKV, APQ	06/94	⇒ 12/02
CORDOBA I 1.4 i 16V	AFH	09/96	⇒ 10/02
CORDOBA I 1.6 i	1F, ABU, AEE, AFT	02/93	⇒ 06/99
CORDOBA I 1.8 i	ABS, ACC, ADZ	02/93	⇒ 09/02
CORDOBA I 1.8 i 16V	148D	10/93	⇒ 08/96
CORDOBA I 2.0 i	2E	02/93	⇒ 06/99
IBIZA II 1.0	AAU	03/93	⇒ 09/96
IBIZA II 1.0 i	AER	09/96	⇒ 02/02
IBIZA II 1.3 i	AAV	03/93	⇒ 08/99
IBIZA II 1.4	ANX	12/97	⇒ 04/99
IBIZA II 1.4 i	ABD, AEX, AKV, APQ	09/93	⇒ 02/02
IBIZA II 1.4 i 16V	AFH	06/97	⇒ 02/02
IBIZA II 1.6 i	1F, ABU, AEE, AFT, ALM	03/93	⇒ 06/99
IBIZA II 1.8 i	ABS, ACC, ADZ	03/93	⇒ 08/99
IBIZA II 1.8 i 16V	148D	11/93	⇒ 08/96
IBIZA II 2.0 i	2E, AGG	03/93	⇒ 08/99
INCA 1.4 i	AEX, AKV, APQ	11/95	⇒ 06/03
INCA 1.6 i	1F, AEE	11/95	⇒ 05/98
TOLEDO I 1.6 i	1F, ABN, EZ	05/91	⇒ 03/99
TOLEDO I 1.8 16V	KR, PL	05/91	⇒ 03/99
TOLEDO I 1.8 GT	KR	05/91	⇒ 11/92
TOLEDO I 1.8 i	ABS, RP	05/91	⇒ 12/96
TOLEDO I 2.0 i	2E	05/91	⇒ 03/99

SKODA			
FELICIA 1.6	6A16XHT	06/97	⇒ 04/02
FELICIA 1.6 GLX	6A16XHT	08/95	⇒ 03/98
FELICIA 1.6 LX	6A16XHT	08/95	⇒ 03/98
OCTAVIA I 1.6	6A16XHT	09/96	⇒ 09/04

TOYOTA			
AVENSIS I 1.6	4A-FE	09/97	⇒ 10/00
CARINA E 1.6	4A-FE	04/92	⇒ 09/97
CARINA E 1.6 16V	4A-FE	12/94	⇒ 09/97
CARINA E 1.6 GLI	4A-FE	04/92	⇒ 09/97
CARINA E 1.6 i	4A-FE	02/95	⇒ 09/97

VOLKSWAGEN (BR)			
APOLLO 1.8	424, 599	06/90	⇒ 11/92
CADDY 1.6i	MY4	11/98	⇒
GOL 1.0i	510	11/96	⇒
GOL 1.0i 16v	511	09/97	⇒
GOL 1.6	504, 505	09/94	⇒ 01/97
GOL 1.6i	540, 541	10/96	⇒
GOL 1.8	521, 522	04/94	⇒ 01/97
GOL 1.8i	542, 543	10/96	⇒
GOL 2.0i	528, 529, 546, 547	09/94	⇒
LOGUS 1.6	504, 505	10/94	⇒ 12/96
LOGUS 1.8	524, 525, 599	12/92	⇒ 12/96
LOGUS 2.0	653	11/93	⇒ 05/94
LOGUS 2.0i	526, 527	05/94	⇒ 12/96
PARATI 1.0i 16v	511	09/97	⇒
PARATI 1.6	504, 505	08/95	⇒ 01/97
PARATI 1.6i	540, 541	10/96	⇒
PARATI 1.8	521, 522	08/95	⇒ 01/97
PARATI 1.8i	542	10/96	⇒
PARATI 2.0i	528, 529, 546, 547	08/95	⇒
POINTER 1.8	524, 525, 599	11/93	⇒ 12/96
POINTER 2.0	653	12/92	⇒ 05/94
POINTER 2.0i	526, 527	05/94	⇒ 12/96
POLO 1.6	MJ3, MY4	07/00	⇒
POLO 1.8	MJ2, MY5, MY6	12/96	⇒
SAVEIRO 1.6i	540, 541	10/96	⇒
SAVEIRO 1.8i	542, 543	10/96	⇒
SAVEIRO 2.0i	546, 547	10/96	⇒

VW			
PASSAT II 1.6	DT	08/80	⇒ 03/88
PASSAT II 1.8	DS	01/83	⇒ 03/88
PASSAT II 1.8 Syncro	DS	01/86	⇒ 03/88
POLO II 1.0	AAK, AAU, GL, HZ	10/81	⇒ 09/94
POLO II 1.0 Cat	AAK, AAU	08/89	⇒ 09/94
POLO II 1.1	HB	10/81	⇒ 09/89
POLO II 1.3	3F, AAV, GK, GT, HJ, HK, MH	08/82	⇒ 09/94
POLO II 1.3 Cat	2G, 3F, AAV, MH, NZ	07/87	⇒ 09/94
POLO II 1.3 G40	PY	01/87	⇒ 09/94
JETTA II 1.0	HZ	08/85	⇒ 10/91
JETTA II 1.3	GT, HK, MH, NU	01/84	⇒ 12/87
JETTA II 1.3 Cat	2G, MH, NZ	06/87	⇒ 12/91
JETTA II 1.6	EZ, HM	12/83	⇒ 07/92
JETTA II 1.8	EV, GU, GX, PB, RH, RV	01/84	⇒ 10/91
JETTA II 1.8 Cat	GX, PF	01/87	⇒ 10/91
JETTA II 1.8 G60	PG	04/90	⇒ 07/91
JETTA II 1.8 Syncro	GU	08/87	⇒ 12/88
JETTA II 1.8i GT	GZ	12/83	⇒ 07/88
CADDY I 1.6	EW, HN	01/83	⇒ 07/92

VW			
CADDY I 1.8	JH	08/85	⇒ 07/92
CADDY II 1.4	AEX, AKV, APQ	11/95	⇒ 06/03
CADDY II 1.6	AEE	06/96	⇒ 12/00
CADDY II 60 1.4	AEX, APQ	11/95	⇒ 01/04
CADDY II 75 1.6	AEE	11/95	⇒ 09/00
DERBY 1.3	GK, HK	09/82	⇒ 12/84
GOLF I 1.3	HK	08/83	⇒ 07/86
GOLF I 1.6	EW, HN	08/83	⇒ 04/92
GOLF I 1.8	2H, DX, EX, JH, KT	08/82	⇒ 04/93
GOLF II 1.0	GN, HZ	11/83	⇒ 10/91
GOLF II 1.3	GT, HK, MH, NU	08/83	⇒ 12/87
GOLF II 1.3 Cat	2G, NZ	06/86	⇒ 12/92
GOLF II 1.6	EZ	08/83	⇒ 07/92
GOLF II 1.6 [CHE] [SWE]	HM	08/83	⇒ 07/86
GOLF II 1.8	GU, GX, RH, RV	08/84	⇒ 10/91
GOLF II 1.8 GTI	EV, PB	08/83	⇒ 10/91
GOLF II 1.8 GTI Cat	PF	01/87	⇒ 10/91
GOLF II 1.8 GTI G60	PG	04/90	⇒ 07/91
GOLF II 1.8 GTI G60 Syncro	1H, PG	08/88	⇒ 12/91
GOLF II 1.8 i Cat	GX	08/87	⇒ 10/91
GOLF II 1.8 Syncro	GU, GX	02/86	⇒ 07/91
GOLF II 1.8i GTI [CHE] [SWE]	GZ	01/84	⇒ 07/86
GOLF III 1.4	ABD, AEX	10/91	⇒ 04/99
GOLF III 1.6	ABU, AEA, AEE	09/92	⇒ 08/97
LUPU 1.0	AER, ALL	09/98	⇒ 07/05
POLO III 1.4	AEX, AKV, ANX, APQ	05/97	⇒ 09/01
POLO III 1.6	AEA, AEE, ALM	09/94	⇒ 09/01
POLO III 100 1.4 16V	AFH	04/96	⇒ 10/99
POLO III 45 1.0	AEV	10/94	⇒ 09/96
POLO III 50 1.0	AER, ALL	09/96	⇒ 10/99
POLO III 54 1.4	ANX	01/98	⇒ 08/99
POLO III 55 1.3	ADX	10/94	⇒ 04/97
POLO III 55 1.4	AEX	08/95	⇒ 10/99
POLO III 60 1.4	AEX, AKV, APQ	07/95	⇒ 09/01
POLO III 75 1.6	AEA, AEE, AHS, ALM	10/94	⇒ 09/01
POLO III 75 1.6 4motion	AEA	08/95	⇒ 10/99
PASSAT III 1.6	1F, EZ	04/88	⇒ 07/92
PASSAT III 1.8	PB, PF	04/88	⇒ 07/93
PASSAT III 2.0	ZE	02/90	⇒ 05/97
PASSAT III 2.0 Syncro	2E	03/90	⇒ 12/96
POLO IV 1.0	AER	08/96	⇒ 12/01
SANTANA 1.6	DT	08/81	⇒ 12/84
SANTANA 1.8	DS	01/83	⇒ 12/84
SCIROCCO II 1.3	HK	08/83	⇒ 07/84
SCIROCCO II 1.6	EW, HN	01/83	⇒ 12/89
SCIROCCO II 1.8	DX, EX, JH, KT	08/82	⇒ 07/92
TRANSPORTER IV 2.0	AAC	07/90	⇒ 04/03
VENTO 1.4	ABD	11/91	⇒ 09/98
VENTO 1.6	ABU, AEA	09/92	⇒ 09/98
VENTO 1.8	AAM, ABS, ADZ	11/91	⇒ 09/98
VENTO 2.0	2E, ADY	11/91	⇒ 09/98

KW 806 098



DISTRIBUTOR CAPS

Adatt./Suitable: **BOSCH**

BOSCH
9 231 081 319
9 231 081 413
9 231 081 678

FIAT
7073055

VW
041 905 207 2
71 314 348

Eliminated on 17-12-2019. Please verify the availability through our local distributors

• Eliminato il 17-12-2019. Verificare la disponibilità presso i nostri distributori

• Éliminé le 17-12-2019. Vérifier la disponibilité auprès de nos distributeurs sur place

• Am 17-12-2019 gestrichen. Evtl. Verfügbarkeit bitte bei unseren Händlern prüfen

• Eliminado en fecha 17-12-2019. Verificar la disponibilidad a través de nuestros distribuidores locales



FIAT (BR)			
147 1.1	--	01/76	⇒ 12/81
PREMIO	--	01/85	⇒ 12/88
UNO 1.05	1.05	01/85	⇒ 12/87
UNO 1.3	1.3	01/85	⇒ 12/91

FIAT (BR)			
UNO 1.3 Furgoneta	1.3	01/85	⇒ 12/91
UNO CS 1.3	1.3	01/85	⇒ 12/91
VOLKSWAGEN (BR)			
VWB 1.5	--	01/75	⇒ 12/82

KW 806 099



DISTRIBUTOR CAPS

Adatt./Suitable: **BOSCH**

BOSCH
1 235 522 307

Eliminated on 22-02-2022. Please verify the availability through our local distributors

• Eliminato il 22-02-2022. Verificare la disponibilità presso i nostri distributori

• Éliminé le 22-02-2022. Vérifier la disponibilité auprès de nos distributeurs sur place

• Am 22-02-2022 gestrichen. Evtl. Verfügbarkeit bitte bei unseren Händlern prüfen

• Eliminado en fecha 22-02-2022. Verificar la disponibilidad a través de nuestros distribuidores locales



OPEL			
KADETT D 1.3 S	135	08/79	⇒ 08/84

KW 806 108



DISTRIBUTOR CAPS

Adatt./Suitable: **BOSCH**

BOSCH
1 235 522 326
1 235 522 327 *A

MERCEDES-BENZ
A 000 158 43 02 *A

***A Available distributor cap only not screen**

• Fornita solo calotta, no copertura

• Disponible seulement la tete et non pas le couvercle

• Erhältlich nur die kappe, nicht die haube

• Disponible solo la tapa, no la cobertura

210 interference Suppression 1k0hm

• schermato/a, 1 k0hm

• Antiparasitage, 1k0hm

• entstört, 1 k0hm

• supresión de interferencias, 1 k0hm



MERCEDES-BENZ			
124 200 CE	M102.963	09/89	⇒ 06/93
124 230 CE	M102.982	03/87	⇒ 12/92
124 230 CE Cat	M102.982	06/89	⇒ 12/92
190 2.0	M102.921, M102.924	10/82	⇒ 05/90
190 2.3	M102.985	09/87	⇒ 09/88
190 2.3 E	M102.985	10/82	⇒ 09/88
190 E 2.0	M102.962	10/82	⇒ 08/93
190 E 2.3	M102.985	09/86	⇒ 08/93

MERCEDES-BENZ

CLASSE G I 200 GE	M102.964	02/80 ⇒ 08/92
CLASSE G I 230 G	M115.973	03/79 ⇒ 07/93
CLASSE G I 230 GE	M102.981, M102.987	04/82 ⇒ 08/92
CLASSE G II 230 GE	M102.981	04/92 ⇒
KOMBI I 200 T	M102.920, M102.939	11/80 ⇒ 11/85
KOMBI II 200 T	M102.922	09/85 ⇒ 05/90
KOMBI II 200 TE	M102.962, M102.963	09/88 ⇒ 08/92
KOMBI II 230 E Chassis	M102.982	09/86 ⇒ 06/93
KOMBI II 230 TE	M102.982	09/85 ⇒ 08/92
KOMBI II 230 TE Cat	M102.982	06/89 ⇒ 08/92
O 309	M102.943	01/68 ⇒ 02/89
T1 210 2.3	M102.942, M102.945	04/77 ⇒ 02/96
T1 310 2.3	M102.942, M102.945	08/82 ⇒ 02/96
T1 410 2.3	M102.942, M102.945	08/82 ⇒ 06/95
T2/LN1 510	M102.946	04/86 ⇒ 12/94
TRE VOLUMI II 200	M102.922	12/85 ⇒ 10/92
TRE VOLUMI II 200 E	M102.963	09/88 ⇒ 08/93
TRE VOLUMI II 230 E	M102.982	12/84 ⇒ 06/93
TRE VOLUMI II 230 E Cat	M102.982	06/89 ⇒ 06/93

PUCH

G-MODELL 230 GE	M102.981, M102.987	03/79 ⇒ 12/91
-----------------	--------------------	---------------

KW 806 109



04

DISTRIBUTOR CAPS

Adatt./Suitable: **BOSCH**

BOSCH

1 235 522 322

FORD

1 595 255
6 077 549
81SF-12106-EA

Motorcraft

EDH 125

*3 Supplied until depletion

- Fornibile fino ad esaurimento delle scorte
- Fourni jusqu'à épuisement du stock
- Lieferbar solange vorrat reicht
- Suministrado hasta el stock termina



FORD

CORTINA 1300	KL13H	10/70 ⇒ 03/72
SIERRA I 1.3	JCT	08/82 ⇒ 12/86
SIERRA I 2.0	NET, NYT	08/82 ⇒ 12/86
P 100 2.0	NAE	10/87 ⇒ 12/92
TRANSIT I 1.6	4RB	11/77 ⇒ 10/86
TRANSIT II 1.6	LAC, LAT	09/85 ⇒ 09/92
TRANSIT II 2.0	NAT, NAV, NAW, NBA, NCA	09/85 ⇒ 09/94
TRANSIT II 2.0 i	NCA	09/91 ⇒ 07/94
TRANSIT II 2.0 L	NAW, NAX	10/85 ⇒ 03/91

KW 806 112



07

DISTRIBUTOR CAPS

Adatt./Suitable: **BOSCH**

BOSCH

9 231 065 501
9 231 065 506
9 231 065 516
9 231 065 546

GENERAL MOTORS

V 510 867

HOLDEN

GB835
GB926

FORD AUSTRALIA

BRONCO 5.8	--	01/81 ⇒ 12/85
------------	----	---------------

HOLDEN

CALAIS_VN 5.0i	5.0V8EFI	08/88 ⇒ 09/91
CALAIS_VP 5.0i Sedan	5.0V8EFI	10/91 ⇒ 07/93
CALAIS_VR 5.0i Sedan	5.0PFIV8	07/93 ⇒ 04/95
CALAIS_VS 5.0i Sedan	5.0V8PFI	04/95 ⇒ 05/96
CALAIS_VS-II 5.0i Sedan	5.0V8PFI	06/96 ⇒ 08/97
CAPRICE_VQ 5.0i Sedan	5.0V8EFI	03/90 ⇒ 11/93
CAPRICE_VR 5.0i Sedan	5.0PFIV8	12/93 ⇒ 04/95
CAPRICE_VS 5.0i Sedan	5.0V8PFI	03/95 ⇒ 08/96
CAPRICE_VS-II 5.0i Sedan	5.0V8PFI	09/96 ⇒ 08/97
COMMODORE VR 5.0i	5.0PFIV8	07/93 ⇒ 04/95
COMMODORE VR 5.0i Wagon	5.0PFIV8	07/93 ⇒ 04/95
COMMODORE VS 5.0i	5.0V8PFI	04/95 ⇒ 05/96
COMMODORE VS-II 5.0i	5.0V8PFI	06/96 ⇒ 08/97
COMMODORE_VL 5.0i Group A SS	5.0V8EFI	02/87 ⇒ 07/88
COMMODORE_VN 5.0i	5.0V8EFI	08/88 ⇒ 09/91
COMMODORE_VN 5.0i Group A SS	5.0V8EFI	08/88 ⇒ 09/91
COMMODORE_VP 5.0i	5.0V8EFI	10/91 ⇒ 07/93
FORMULA_VR 5.0i	5.0PFIV8	07/93 ⇒ 04/95
STATESMAN_VQ 5.0i	5.0V8EFI	03/90 ⇒ 11/93
STATESMAN_VR 5.0i	5.0PFIV8	12/93 ⇒ 04/95
STATESMAN_VS 5.0i	5.0V8PFI	03/95 ⇒ 08/96
STATESMAN_VS-II 5.0i	5.0V8PFI	09/96 ⇒ 08/97
UTILITY_VG 5.0i	5.0V8EFI	08/88 ⇒ 09/91
UTILITY_VP 5.0i	5.0V8EFI	10/91 ⇒ 07/93
UTILITY_VR COUPE 5.0i	5.0PFIV8	07/93 ⇒ 04/95

KW 806 117



05

DISTRIBUTOR CAPS

Adatt./Suitable: **BOSCH**

BOSCH

1 235 522 325 *A

944 602 251 00 *A

944 602 902 00 *A

*A Available distributor cap only not screen

- Fornita solo calotta, no copertura
- Disponible seulement la tete et non pas le couvercle
- Erhältlich nur die kappe, nicht die haube
- Disponible solo la tapa, no la cobertura

*210 interference Suppression 1kOhm

- schermato/a, 1 kOhm
- Antiparasitage, 1kOhm
- entstört, 1 kOhm
- supresión de interferencias, 1 kOhm



PORSCHE

924 2.5 S	M44.07	09/85 ⇒ 07/87
928 4.7 S	M28.11, M28.12	09/79 ⇒ 07/83

KW 806 121



07

DISTRIBUTOR CAPS

Adatt./Suitable: **BOSCH**

BMW

12 11 1 284 372

12 11 1 289 519

BOSCH

1 235 522 333

1 235 522 361



BMW

3 II 323 i	M20B23(236EC)	09/82 ⇒ 09/86
5 II 520 i	M20B20(206EA)	06/81 ⇒ 12/87

KW 806 123

07

DISTRIBUTOR CAPS

Adatt./Suitable: BOSCH

BOSCH

1 235 522 329
1 235 522 330 *A
1 235 522 368

MERCEDES-BENZ

A 000 158 44 02 *A

PORSCHE

930 602 919 00 *A

*A Available distributor cap only not screen

- Fornita solo calotta, no copertura
- Disponible seulement la tete et non pas le couvricle
- Erhältlich nur die kappe, nicht die haube
- Disponible solo la tapa, no la cobertura

210 interference Suppression 1kOhm

- schermato/a, 1 kOhm
- Antiparasitage, 1kOhm
- entstört, 1 kOhm
- supresión de interferencias, 1 kOhm



MERCEDES-BENZ

123 280 CE	M110.988	03/77 ⇒ 11/85
CLASSE G I 280 GE	M110.994	11/79 ⇒ 08/89
CLASSE G II 280 GE	M110.994	04/92 ⇒
CLASSE S II 280 SE, SEL	M110.989	10/79 ⇒ 07/85
TRE VOLUMI I 280 E	M110.988	02/76 ⇒ 11/85

PORSCHE

911 I 3.2 SC Carrera	930.20	08/83 ⇒ 08/89
911 III 3.6 Turbo 4	M64.60	03/95 ⇒ 09/97
911 III 3.6 Turbo GT2	M64.60R	03/95 ⇒ 09/97
911 III 3.6 Turbo GT2 4	M64.60R, M64.60RS	08/95 ⇒ 09/97

PUCH

G-MODELL 280 GE	M110.994	01/86 ⇒ 12/91
-----------------	----------	---------------

KW 806 124

05

DISTRIBUTOR CAPS

Adatt./Suitable: BOSCH

BOSCH

1 235 522 332

CITROËN

94 059 413 28

HYUNDAI

27110-22000

PEUGEOT

5941 32

SAAB

91 70 259



CITROËN

BX 1.4	150C, K1F, K2D	07/86 ⇒ 12/94
BX 1.4 E	150B(XY8), 150J, 150Y, K1F, KAZ	09/82 ⇒ 12/94
BX 1.6	182A, B2C, B6D, B6E	01/87 ⇒ 12/94
BX 1.9	159B, 159C, D6U, DKK	05/85 ⇒ 12/94
BX 1.9 GTi	D6D, D6K	01/87 ⇒ 01/92
BX 14	150C	01/86 ⇒ 02/93
BX 14 E	150A, 150C, K1G	10/82 ⇒ 02/93
BX 15	B1E(XU51C)	01/87 ⇒ 05/92
BX 16	171A, 171B, 171C, 171D, 180Z, 23DH, B1E(XU51C), BAY(XU5CP), BAZ(XU5CP)	10/82 ⇒ 12/94
BX 19	159A, D2A(XU92C), D2C(XU92C), D2E, D6A(XU9J2), DKZ(XU9JA)	09/84 ⇒ 12/94

CITROËN

BX 19 Cat	DFZ(XU9J1)	07/86 ⇒ 12/94
BX 19 E 4x4	D2F	04/89 ⇒ 02/93
BX 19 GTi	D6A(XU9J2), DKZ(XU9JA)	07/86 ⇒ 02/93
BX 19 GTi 4x4	DKZ(XU9JA)	06/88 ⇒ 02/93
C15 1.0	108C	10/84 ⇒ 07/88
C15 1.0 E	TU9K	11/92 ⇒ 07/96
C15 1.1	109K, E1A, XW7	10/84 ⇒ 12/96
C15 1.3	G1A	07/87 ⇒ 05/88
C15 1.4	150D(XY7)	05/87 ⇒ 10/92
C15 1.4 E	150D(XY7)	05/87 ⇒ 12/96
LNA 1.1	109/5E	07/82 ⇒ 04/85
VISA 11 E	109K	09/78 ⇒ 06/88

HYUNDAI

S COUPE 1.5 i	G4EK	04/92 ⇒ 05/96
S COUPE 1.5 i Turbo	G4EK-TC	04/91 ⇒ 05/96

PEUGEOT

104 1.0	108C(XV8)	09/83 ⇒ 06/88
205 I 1.0	108C(XV8)	02/83 ⇒ 12/90
205 I 1.3	G1A	02/84 ⇒ 10/87
205 I 1.4	150B(XY8), 150G(XY7), 150H(XY8), J2	01/83 ⇒ 12/90
205 I 1.5	Y2/K	02/84 ⇒ 10/87
205 I 1.6	B1A(XU51C), B1E(XU51C), BAZ(XU5CP)	08/86 ⇒ 10/87
205 I 1.6 GTI	180A(XU5J), B6D(XU5JA), XU5J1	01/83 ⇒ 12/90
205 I 1.9 GTI	DFZ(XU9J1)	03/87 ⇒ 10/87
205 II 1.1 XA	E1	07/87 ⇒ 10/88
205 II 1.2	F1	01/87 ⇒ 12/90
205 II 1.3	G1A	08/90 ⇒ 07/92
205 II 1.4	150B(XY8), 150G(XY7), 150H(XY8), J2	10/87 ⇒ 12/94
205 II 1.4 CJ	150G(XY7)	03/88 ⇒ 05/89
205 II 1.4 CT	150B(XY8), 150H(XY8)	04/86 ⇒ 12/88
205 II 1.6	B1A(XU51C), B1E(XU51C), BAZ(XU5CP)	10/87 ⇒ 09/98
205 II 1.6 GTI	180A(XU5J), 180Z(XU5J)	03/86 ⇒ 10/90
205 II 1.6 GTi	180A(XU5J), 180Z(XU5J)	10/87 ⇒ 12/89
205 II 1.9 CTi	DFZ(XU9J1)	10/87 ⇒ 12/94
205 II 1.9 GTi Cat	DFZ(XU9J1)	10/87 ⇒ 07/94
309 I 1.1	E1	10/85 ⇒ 07/89
309 I 1.3	G1A, G2S	10/85 ⇒ 08/89
309 I 1.5	Y2/K	06/87 ⇒ 12/89
309 I 1.6	--, 180Z(XU5J), B1A(XU51C), B1D(XU51C), B1E(XU51C), B6B(XU5J), J2, XU5JA	10/85 ⇒ 07/89
309 I 1.6 Cat	BAZ(XU5CP)	09/86 ⇒ 12/89
309 I 1.9	D2B(XU9S), DFZ(XU9J1), XU92C	10/85 ⇒ 07/89
309 II 1.6	18EM, J2, XU5JA	07/89 ⇒ 12/93
309 II 1.6 GTi	--	09/89 ⇒ 10/93
309 II 1.9	XU92C	07/89 ⇒ 12/93
405 I 1.9	DFZ(XU9J1)	05/88 ⇒ 08/92
405 I 1.9 Antipollution	XU92C	01/87 ⇒ 12/92
405 I 1.9 Injection	DFZ(XU9J1)	07/87 ⇒ 12/92
405 I 1.9 Trazione integrale	DFZ(XU9J1)	09/88 ⇒ 07/92

SAAB

9-3 2.0 i	B204I	02/98 ⇒ 08/03
9-3 2.3 i	B234I	02/98 ⇒ 08/03
900 II 2.0 i	B204I, B206I	07/93 ⇒ 02/98
900 II 2.3 -16	B234I	07/93 ⇒ 02/98

KW 806 127

07

DISTRIBUTOR CAPS

Adatt./Suitable: BOSCH

BOSCH

1 235 522 366
1 235 522 382 *A

VOLVO

1346788 *A
13467881 *A

*A Available distributor cap only not screen

- Fornita solo calotta, no copertura
- Disponible seulement la tete et non pas le couvricle
- Erhältlich nur die kappe, nicht die haube
- Disponible solo la tapa, no la cobertura



VOLVO

960 I 2.0	B204FT	08/90 ⇒ 09/93
960 I 2.3	B230GT	08/90 ⇒ 07/94
960 I 2.3 Turbo	B230FT	09/90 ⇒ 08/93
740 2.0	B200E, B200ET, B200G, B200K	01/85 ⇒ 07/92
740 2.0 16V	B204E	09/87 ⇒ 08/90
740 2.0 16V Turbo	B204FT, B204GT	08/89 ⇒ 07/90
740 2.0 GLE	B204E	09/87 ⇒ 08/90
740 2.0 Turbo	B200ET, B200FT	09/87 ⇒ 08/91
740 2.3	B230E, B230F, B230FB, B230G, B230K, B234F	08/84 ⇒ 12/92
740 2.3 GL	B230E	08/84 ⇒ 08/87
740 2.3 Turbo	B230ET, B230FT, B230GT	08/85 ⇒ 08/91
760 2.3	B230ET, B230FT, B230K	08/84 ⇒ 07/92
760 2.3 Turbo	B230ET, B230FT, B230GT	08/84 ⇒ 08/90
780 2.0i	B204GT	01/87 ⇒ 12/90
780 2.0i Turbo	B200ET	01/87 ⇒ 12/90
940 I 2.0	B200E, B200F, B200G	08/90 ⇒ 07/94
940 I 2.0 GL	B204E	09/90 ⇒ 04/92
940 I 2.0 Turbo	B200FT	08/90 ⇒ 07/95
940 I 2.3	B230E, B230F, B230FB, B230FD, B230G, B234F, B234G	08/90 ⇒ 07/95
940 I 2.3 16V	B234G	08/90 ⇒ 07/92
940 I 2.3 Turbo	B230FT, B230GT	08/90 ⇒ 07/94
940 II 2.0 GLT	B200GT	10/94 ⇒ 05/97
940 II 2.0 Turbo	B200FT	04/96 ⇒ 10/98
940 II 2.3	B230FD, B230GK	08/94 ⇒ 05/97
940 II 2.3 ti	B230FK	01/95 ⇒ 10/98
940 II 2.3 Turbo	B230FT, B230GK	08/94 ⇒ 12/98

KW 806 128

07

DISTRIBUTOR CAPS

Adatt./Suitable: BOSCH

BOSCH

1 235 522 395 *A

PORSCHE

928 602 211 01 *A

*A Available distributor cap only not screen

- Fornita solo calotta, no copertura
- Disponible seulement la tete et non pas le couvricle
- Erhältlich nur die kappe, nicht die haube
- Disponible solo la tapa, no la cobertura



PORSCHE

928 4.7 S	M28.21, M28.22	08/83 ⇒ 07/86
928 5.4 GTS	M28.49, M28.50	08/91 ⇒ 11/95
968 3.0	M44.43, M44.44	06/91 ⇒ 11/95

KW 806 129



04

DISTRIBUTOR CAPS

Adatt./Suitable: **BOSCH**

AUDI

026 905 209

BOSCH
 1 235 522 370

VW

 026 905 207
 026 905 209
 325 905 207 1

AUDI

80 III 1.8 quattro	SD	09/86 ⇒ 08/90
80 III 1.8 S quattro	JN	09/86 ⇒ 09/91
80 III 2.0 E quattro	3A	08/88 ⇒ 09/90
100 III 1.8	DS, JW, NP	08/83 ⇒ 07/89
100 III 1.8 Cat quattro	4B	08/85 ⇒ 11/90
100 III 1.8 quattro	NP, SH	10/84 ⇒ 07/90

KW 806 231



04

DISTRIBUTOR CAPS

Adatt./Suitable: **BOSCH**

AUDI

023 905 207

034 905 207 B

BOSCH

0 290 004 032

0 290 004 035

1 235 522 369

1 235 522 371

1 235 522 385

1 235 522 404

1 235 522 405

VW

023 905 207

034 905 207

034 905 207 A

034 905 207 B

035 905 209 B



AUDI

80 II 2.0	HP, JS	10/83 ⇒ 09/84
80 II 2.0 quattro	JS	10/83 ⇒ 09/84
80 IV 2.3 E	NG	09/91 ⇒ 01/96
80 IV 2.3 E quattro	NG	09/91 ⇒ 11/94
90 I 2.0	HP, JL, JS, SK	10/84 ⇒ 03/87
90 I 2.0 quattro	JS	08/84 ⇒ 08/86
90 I 2.2	9C54, HY, KX	10/84 ⇒ 03/87
90 I 2.2 E quattro	9C54	11/84 ⇒ 03/87
90 II 2.0	PS	07/88 ⇒ 09/91
90 II 2.0 20 V quattro	NM	08/88 ⇒ 09/91
90 II 2.2 E	9C54	04/87 ⇒ 07/91
90 II 2.2 E quattro	9C54	04/87 ⇒ 09/91
90 II 2.3 E	NG	04/87 ⇒ 09/91
90 II 2.3 E 20V quattro	7A	06/88 ⇒ 09/91
90 II 2.3 E quattro	NG	04/87 ⇒ 09/91
100 III 2.0	KP	08/84 ⇒ 12/87
100 III 2.0 Cat	RT	01/88 ⇒ 11/90
100 III 2.0 E	KP	01/85 ⇒ 12/87
100 III 2.0 E Cat	RT	01/88 ⇒ 11/90
100 III 2.2 Cat	KU	06/89 ⇒ 11/90
100 III 2.2 Cat quattro	KU	06/89 ⇒ 11/90

AUDI

100 III 2.2 E Turbo quattro	MC	08/86 ⇒ 11/90
100 III 2.2 Turbo	MC	08/86 ⇒ 11/90
100 III 2.3	NF	08/86 ⇒ 11/90
100 III 2.3 E	NF	10/86 ⇒ 11/90
100 III 2.3 E quattro	NF	08/86 ⇒ 11/90
100 III 2.3 quattro	NF	01/90 ⇒ 11/90
100 IV 2.3 E	7M15A-FKS	12/90 ⇒ 07/94
100 IV 2.3 E quattro	7M15A-FKS	12/90 ⇒ 07/94
200 II 2.2	KU	08/84 ⇒ 07/85
200 II 2.2 Turbo	1B, MC	08/85 ⇒ 09/91
200 II 2.2 Turbo quattro	1B, MC	01/85 ⇒ 12/91
A6 I 2.3	7M15A-FKS	06/94 ⇒ 12/95
A6 I 2.3 quattro	7M15A-FKS	06/94 ⇒ 12/95
CABRIOLET 2.3 E	NG	05/91 ⇒ 07/94
COUPE 2.0 20V	NM	08/89 ⇒ 07/91
COUPE 2.0 20V quattro	NM	08/89 ⇒ 07/91
COUPE 2.2	9C54	11/88 ⇒ 07/91
COUPE 2.2 GT	9C54	09/84 ⇒ 10/88
COUPE 2.2 quattro	9C54, JT	10/84 ⇒ 07/91
COUPE 2.3	NG	10/88 ⇒ 12/96
COUPE 2.3 20V	7A	08/89 ⇒ 07/91
COUPE 2.3 20V quattro	7A	11/88 ⇒ 12/96
COUPE 2.3 quattro	NG	01/87 ⇒ 12/96
COUPE S2	3B	09/90 ⇒ 09/92
COUPE S2 quattro	3B	09/90 ⇒ 09/92

VW

PASSAT II 2.0	JS	08/83 ⇒ 03/88
PASSAT II 2.0 Syncro	JS	05/84 ⇒ 03/88
QUANTUM 2.1	--	01/81 ⇒ 12/89
SANTANA 2.0	JS	08/83 ⇒ 12/84
TRANSPORTER IV 2.5	AAF, ACU, AET, AEU, APL, AVT	09/90 ⇒ 06/03
TRANSPORTER IV 2.5 Syncro	AAF, ACU, AET, AEU, APL, AVT	08/92 ⇒ 04/03

KW 806 233



07

DISTRIBUTOR CAPS

Adatt./Suitable: **BOSCH**

BOSCH

1 235 522 390

1 235 522 426

1 235 522 449

VW

021 905 207

073 905 207 B

*A Available distributor cap only not screen

- Fornita solo calotta, no copertura
- Disponible seulement la tete et non pas le couvrcl
- Erhältlich nur die kappe, nicht die haube
- Disponible solo la tapa, no la copertura

*A Available distributor cap only not screen

- Fornita solo calotta, no copertura
- Disponible seulement la tete et non pas le couvrcl
- Erhältlich nur die kappe, nicht die haube
- Disponible solo la tapa, no la copertura

*B Supplied until depletion

- Fornibile fino ad esaurimento delle scorte
- Fourni jusqu'à épuisement du stock
- Lieferbar solange vorrat reicht
- Suministrado hasta el stock termina



VW

CORRADO 2.9 VR6	ABV	08/91 ⇒ 12/95
GOLF III 2.8 VR6	AAA	01/92 ⇒ 09/97
LT I 2.4 i	1E	08/89 ⇒ 06/96
PASSAT III 2.8 VR6	AAA	06/91 ⇒ 05/97
VENTO 2.8 VR6	AAA	01/92 ⇒ 09/98

KW 806 234



05

DISTRIBUTOR CAPS

Adatt./Suitable: **BOSCH**

BOSCH

1 235 522 380

1 235 522 381

MERCEDES-BENZ

A 000 158 48 02

A 000 158 49 02

*A Available distributor cap only not screen

- Fornita solo calotta, no copertura
- Disponible seulement la tete et non pas le couvrcl
- Erhältlich nur die kappe, nicht die haube
- Disponible solo la tapa, no la copertura

*B interference Suppression 1kOhm

- schermato/a, 1 kOhm
- Antiparasitage, 1kOhm
- entstört, 1 kOhm
- supresión de interferencias, 1 kOhm



MERCEDES-BENZ

124 200 CE	M102.963	09/89 ⇒ 06/93
124 230 CE	M102.982	03/87 ⇒ 12/92
124 230 CE Cat	M102.982	06/89 ⇒ 12/92
190 2.3	M102.985	09/87 ⇒ 09/88
190 2.3 E	M102.985	10/82 ⇒ 09/88
190 E 1.8	M102.910, M102.919	04/90 ⇒ 12/93
190 E 2.0	M102.962	10/82 ⇒ 08/93
190 E 2.3	M102.985	09/86 ⇒ 08/93
190 E 2.3-16	M102.983	04/84 ⇒ 08/88
190 E 2.5-16	M102.990	09/88 ⇒ 08/93
190 E 2.5-16 Evolution	M102.991	03/89 ⇒ 08/93
190 E 2.5-16 Evolution II	M102.992	05/90 ⇒ 08/93
CLASSE G I 230 GE	M102.998	05/87 ⇒ 08/92
CLASSE G II 200 GE	M102.965	01/90 ⇒ 07/93
CLASSE G II 230 G	M102.958	04/92 ⇒
CLASSE G II 230 GE	M102.979, M102.989, M102.996, M102.997, M102.998	09/89 ⇒
KOMBI II 200 T	M102.922	09/85 ⇒ 05/90
KOMBI II 200 TE	M102.962, M102.963	09/88 ⇒ 08/92
KOMBI II 230 E Chassis	M102.982	09/86 ⇒ 06/93
KOMBI II 230 TE	M102.982	09/85 ⇒ 08/92
KOMBI II 230 TE Cat	M102.982	06/89 ⇒ 08/92
TRE VOLUMI II 200	M102.922	12/85 ⇒ 10/92
TRE VOLUMI II 200 E	M102.963	09/88 ⇒ 08/93
TRE VOLUMI II 230 E	M102.982	12/84 ⇒ 06/93
TRE VOLUMI II 230 E Cat	M102.982	06/89 ⇒ 06/93

PUCH

G-MODELL 230 GE	M102.989	07/89 ⇒ 07/00
-----------------	----------	---------------

KW 806 235

05

DISTRIBUTOR CAPS

Adatt./Suitable: BOSCH

BOSCH
1 235 522 374

FORD
6 146 423

Motorcraft
EDH 183

⁰⁰ Eliminated on 22-02-2021. Please verify the availability through our local distributors

- Eliminato il 22-02-2021. Verificare la disponibilità presso i nostri distributori
- Éliminé le 22-02-2021. Vérifier la disponibilité auprès de nos distributeurs sur place
- Am 22-02-2021 gestrichen. Evtl. Verfügbarkeit bitte bei unseren Händlern prüfen
- Eliminado en fecha 22-02-2021. Verificar la disponibilidad a través de nuestros distribuidores locales



FORD

SIERRA I 1.8	REB	10/84 ⇨ 12/86
SIERRA I 2.0	NET, NYT	08/82 ⇨ 12/86

KW 806 236

07,5

DISTRIBUTOR CAPS

Adatt./Suitable: BOSCH

ALFA ROMEO
195 32 05 021 00/00
60513050 *A

^{*A} Available distributor cap only not screen

BOSCH
1 235 522 387
1 235 522 388 *A

CHRYSLER
T0267694 *A

FIAT
60809702
7700267694

LANCIA
60809702

PEUGEOT
5941 42 *A

RENAULT
77 00 267 694 *A
77 00 267 728 *A
77 01 041 745 *A

VOLVO
1269920 *A
12699203 *A

⁰³ Supplied until depletion

- Fornibile fino ad esaurimento delle scorte
- Fourni jusqu'à épuisement du stock
- Lieferbar solange vorrat reicht
- Suministrado hasta el stock termina



ALFA ROMEO

164 2.0 Turbo	AR64102	07/90 ⇨ 10/92
164 2.0 V6 Turbo	AR64101, AR64102	03/91 ⇨ 09/98
164 3.0	AR06410	11/87 ⇨ 09/91
164 3.0 i.e. QV	AR64301	09/90 ⇨ 09/92
164 3.0 Lusso [USA] [CAN]	AR06412	10/91 ⇨ 03/93
164 3.0 Sport [CAN] [USA]	AR64301	11/90 ⇨ 03/92
164 3.0 Super	64303	06/87 ⇨ 09/92
164 3.0 V6	AR06410, AR06412	06/87 ⇨ 09/92
GTV 2.0 V6 Turbo	AR16202	06/95 ⇨ 09/98
SPIDER II 2.0 V6 Turbo	AR16202	05/98 ⇨ 04/05

ALPINE

V6 TURBO	Z7U730, Z7U732, Z7U734	01/88 ⇨ 12/90
----------	------------------------	---------------

LANCIA

THEMA 2850 V6 i.e.	834E.146	06/88 ⇨ 05/92
--------------------	----------	---------------

RENAULT

25 2.4 V6 Turbo	Z7U702	10/84 ⇨ 05/90
-----------------	--------	---------------

RENAULT

25 2.5 V6 Turbo	Z7U700	01/90 ⇨ 12/92
25 2.8 V6	Z7W700, Z7W701	06/87 ⇨ 02/90
25 2.8 V6 Injection	Z7W706, Z7W707, Z7W709	06/87 ⇨ 12/92
ESPACE II 2.8 V6	Z7W712, Z7W713, Z7W717	01/91 ⇨ 10/96
SAFRANE I 3.0	Z7X723	02/93 ⇨ 06/96
SAFRANE I 3.0 Biturbo 4x4	Z7X726	02/93 ⇨ 07/96
SAFRANE I 3.0 V6	Z7X721, Z7X722, Z7X723, Z7X753	12/92 ⇨ 07/96
SAFRANE I 3.0 V6 4x4	Z7X721, Z7X722, Z7X723	12/92 ⇨ 07/96
SAFRANE II 2.9 24V	L7X713	03/99 ⇨ 12/00
SAFRANE II 3.0 V6	6216K4FU	10/96 ⇨ 12/00

VOLVO

760 2.8	B280E, B280F	08/81 ⇨ 08/91
780 2.9	B280E, B280F	08/86 ⇨ 07/90
960 I 2.8 GL	B280E, B280F	09/90 ⇨ 05/92

KW 806 237

07

DISTRIBUTOR CAPS

Adatt./Suitable: BOSCH

BOSCH
1 235 522 384

MERCEDES-BENZ
A 103 158 00 02

⁰³ Supplied until depletion

- Fornibile fino ad esaurimento delle scorte
- Fourni jusqu'à épuisement du stock
- Lieferbar solange vorrat reicht
- Suministrado hasta el stock termina

²¹⁰ interference Suppression 1k0hm

- schermato/a, 1 k0hm
- Antiparasitage, 1k0hm
- entstört, 1 k0hm
- supresión de interferencias, 1 k0hm



MERCEDES-BENZ

CLASSE E I E 300 4-matic	M103.985	06/93 ⇨ 06/95
CLASSE E I E 300 T 4-matic	M103.985	06/93 ⇨ 06/96
124 300 CE	M103.983	03/87 ⇨ 05/93
190 2.6	M103.942	10/82 ⇨ 09/88
190 E 2.6	M103.942	09/86 ⇨ 08/93
190 E 3.2 AMG	M103.983	01/88 ⇨
CLASSE G II 300 GE	M103.987	09/89 ⇨ 09/97
CLASSE S II 260 SE	M103.941	09/85 ⇨ 06/91
CLASSE S II 300 SE, SEL	M103.981	09/85 ⇨ 06/91
CLASSE SL III 300 SL	M103.982	09/85 ⇨ 08/89
CLASSE SL IV 300 SL	M103.984	03/89 ⇨ 08/93
KOMBI II 260 TE FGST.	M103.940	09/89 ⇨ 08/92
KOMBI II 300 TE	M103.983	01/86 ⇨ 08/92
KOMBI II 300 TE 4-matic	M103.985	09/86 ⇨ 06/93
TRE VOLUMI II 260 E	M103.940	09/85 ⇨ 08/92
TRE VOLUMI II 260 E 4-matic	M103.943	09/86 ⇨ 08/92
TRE VOLUMI II 300 E	M103.983	06/85 ⇨ 08/92
TRE VOLUMI II 300 E 4-matic	M103.943, M103.983, M103.985	01/86 ⇨ 12/93

PUCH

G-MODELL 300 GE	M103.987	06/89 ⇨ 08/93
-----------------	----------	---------------

KW 806 238

07,5

DISTRIBUTOR CAPS

Adatt./Suitable: BOSCH

BMW
1 715 903
12 11 1 285 058 *A
12 11 1 720 124
12 11 1 722 649
12 11 1 725 070

BOSCH
1 235 522 364
1 235 522 365 *A
1 235 522 421

^{*A} Available distributor cap only not screen

- Fornita solo calotta, no copertura
- Disponible seulement la tete et non pas le couvercle
- Erhältlich nur die kappe, nicht die haube
- Disponible solo la tapa, no la cobertura

⁰³ Supplied until depletion

- Fornibile fino ad esaurimento delle scorte
- Fourni jusqu'à épuisement du stock
- Lieferbar solange vorrat reicht
- Suministrado hasta el stock termina



BMW

3 II 320 i	M20B20(206EB), M20B20(206KA)	09/82 ⇨ 11/93
3 II 325 e 2.7	M20B27(276KA), M20B27(276KB)	10/83 ⇨ 12/88
3 II 325 i	M20B25(256E1), M20B25(256E2), M20B25(256EX), M20B25(256K1)	09/83 ⇨ 11/93
3 II 325 i X	M20B25(256E1), M20B25(256E2), M20B25(256EX), M20B25(256K1)	03/86 ⇨ 10/93
5 II 520 i	M20B20(206KA)	08/85 ⇨ 12/87
5 II 525 e	M20B27(276EA), M20B27(276EB), M20B27(276KA), M20B27(276KB)	09/81 ⇨ 12/87
5 II 528 i [USA]	--	01/81 ⇨ 12/87
5 II 530 i	--	01/84 ⇨ 12/88
5 II 535 i	M30B34(346EC)	01/85 ⇨ 12/87
5 II 535 i, M 535 i	M30B34(346KA), M30B35(Motronic)	01/85 ⇨ 12/87
5 II M5	S38B35(356ED)	08/85 ⇨ 12/87
5 III 520 i	M20B20(206KA)	06/87 ⇨ 09/90
5 III 525 i	M20B25(256K1)	02/88 ⇨ 08/90
5 III 530 i	M30B30(306KA)	01/88 ⇨ 04/90
5 III 535 i	M30B34(346KB)	11/87 ⇨ 02/93
5 III M5	S38B36(366S1)	09/88 ⇨ 03/92
5 III M5 Cat	S38B36(366S1)	09/88 ⇨ 03/92
6 I 635 CSI	M30B35(Motronic, 9.3:1)	06/78 ⇨ 04/82
6 I M 635 CSI	M88B35(356ED), S38B35(356ED)	04/84 ⇨ 02/89
7 I 735 i	M30B35(Motronic)	04/85 ⇨ 08/86
7 II 730 i, iL	M30B30(306EA), M30B30(306KA)	03/85 ⇨ 03/94
7 II 735 i, iL	M30B34(346KB), M30B35(Motronic, 9.2:1)	06/86 ⇨ 07/92
7 II 750 i, iL V12	M70B50(5012A)	09/87 ⇨ 09/94
7 III 750 i, iL	M73B54(54121), M73B54(54122)	11/94 ⇨ 07/01
8 850 CSI	S70B56(56121)	11/92 ⇨ 12/96
8 850 i, Ci	M70B50(5012A)	01/90 ⇨ 08/94
Z1 2.5	M20B25(256K1)	06/88 ⇨ 06/91

KW 806 239



08

DISTRIBUTOR CAPS

Adatt./Suitable: BOSCH

BOSCH

1 235 522 391
1 235 522 392 *A

MERCEDES-BENZ

A 000 158 52 02 *A

*A Available distributor cap only not screen

- Fornita solo calotta, no copertura
- Disponible seulement la tete et non pas le couvrle
- Erhältlich nur die kappe, nicht die haube
- Disponibile solo la tapa, no la copertura

210 Interference Suppression 1kOhm

- schermato/a, 1 kOhm
- Antiparasitage, 1kOhm
- entstört, 1 kOhm
- supresión de interferencias, 1 kOhm



MERCEDES-BENZ

CLASSE G II 500 GE	M117.965	09/93 ⇒ 12/94
CLASSE S II 420 SE, SEL	M116.965	10/85 ⇒ 06/91
CLASSE S II 420 SEC	M116.965	10/85 ⇒ 06/91
CLASSE S II 500 SE, SEL	M117.965	09/85 ⇒ 06/91
CLASSE S II 500 SE, SEL Cat	M117.965	06/89 ⇒ 06/91
CLASSE S II 500 SEC	M117.965	09/85 ⇒ 06/91
CLASSE S II 500 SEC Cat	M117.965	06/89 ⇒ 06/91
CLASSE S II 560 SE, SEL	M117.968	10/85 ⇒ 06/91
CLASSE S II 560 SEC	M117.968	10/85 ⇒ 06/91
CLASSE SL III 420 SL	M116.964	01/86 ⇒ 08/89
CLASSE SL III 500 SL	M117.964	01/86 ⇒ 08/89
CLASSE SL III 560 SL	M117.967	09/85 ⇒ 12/89

KW 806 240



07

DISTRIBUTOR CAPS

Adatt./Suitable: BOSCH

BOSCH

1 235 522 399
1 235 522 400 *A

GENERAL MOTORS

90 230 575 *A

OPEL

12 11 261 *A
90230575

*A Available distributor cap only not screen

- Fornita solo calotta, no copertura
- Disponible seulement la tete et non pas le couvrle
- Erhältlich nur die kappe, nicht die haube
- Disponibile solo la tapa, no la copertura

03 Supplied until depletion

- Fornibile fino ad esaurimento delle scorte
- Fourni jusqu'à épuisement du stock
- Lieferbar solange vorrat reicht
- Suministrado hasta el stock termina



OPEL

ASCONA C 1.8	18SE, E18NV	09/81 ⇒ 08/88
ASCONA C 1.8 E	S18NV	01/85 ⇒ 08/86
ASCONA C 2.0 i	20NE	09/86 ⇒ 08/88
ASCONA C 2.0 i Cat	C20NE	09/86 ⇒ 08/88
ASCONA C 2.0 i GT	20SEH	03/87 ⇒ 08/88
KADETT E 1.8	18SE	01/86 ⇒ 08/91

OPEL

KADETT E 1.8 i	S18NV	06/85 ⇒ 08/91
KADETT E 1.8 S	E18NV	09/87 ⇒ 08/91
KADETT E 2.0 GSI	20NE, 20SEH	09/86 ⇒ 08/91
KADETT E 2.0 GSI Cat	C20NE	09/86 ⇒ 08/91
KADETT E 2.0 i	20NE	10/86 ⇒ 02/93
KADETT E 2.0 i Cat	C20NE	10/86 ⇒ 02/93
OMEGA A 1.8	18SEH, E18NVR, S18NV	09/86 ⇒ 03/94
OMEGA A 1.8 N	18NV	09/86 ⇒ 08/87
OMEGA A 1.8 S	18SV	09/86 ⇒ 03/94
OMEGA A 2.0	20SE, C20NE	09/86 ⇒ 04/94
OMEGA A 2.0 i	C20NE	09/86 ⇒ 04/94
OMEGA B 2.0	20SE	03/94 ⇒ 12/00
VECTRA A 1.8 i	18SV	09/88 ⇒ 10/90
VECTRA A 1.8 S	18SV, E18NVR	09/88 ⇒ 10/90
VECTRA A 1.8 S 4x4	E18NVR	01/89 ⇒ 07/89
VECTRA A 2.0 i	20NE, 20SEH	09/88 ⇒ 09/92
VECTRA A 2.0 i 4x4	20NE, 20SEH	01/89 ⇒ 07/92
VECTRA A 2.0 i Cat	C20NE	09/88 ⇒ 11/95
VECTRA A 2.0 i Cat 4x4	C20NE	01/89 ⇒ 11/95
VECTRA A 2.0 i GT	20SEH	09/88 ⇒ 11/95

VAUXHALL

OMEGA B 2.0	20SE	09/95 ⇒ 09/96
-------------	------	---------------

KW 806 241



05

DISTRIBUTOR CAPS

Adatt./Suitable: BOSCH

BOSCH

1 235 522 401
1 237 000 065 *A

CITROËN

95 619 491
95 659 654 *A

PEUGEOT

5940 52
5941 44

*A Available distributor cap only not screen

- Fornita solo calotta, no copertura
- Disponible seulement la tete et non pas le couvrle
- Erhältlich nur die kappe, nicht die haube
- Disponibile solo la tapa, no la copertura



CITROËN

AX 1.3 Sport	M4A	04/87 ⇒ 12/88
AX 10	C1A	09/86 ⇒ 06/92
AX 10 E	C3A	12/86 ⇒ 12/88
AX 11	H1A, H1B, HDZ(TU1M)	09/86 ⇒ 12/97
AX 11 4x4	H1A	06/91 ⇒ 07/92
AX 11 Cat	HAZ(TU1CP)	09/88 ⇒ 12/89
AX 14	K1A(TU3), K1B, K1F, K1G, K1J, K2A, K2B, K2D, KAY(TU3CP), KDX(TU3M/Z), KDY(TU3FM), KDZ(TU3M/Z)	09/86 ⇒ 04/97
AX 14 4x4	KD4, KDX(TU3M/Z), KDY(TU3FM), KDZ(TU3M/Z)	06/91 ⇒ 12/96
AX 14 GT	KDZ(TU3M/Z)	01/89 ⇒ 12/91
BX 1.1	109LA, H1A	04/86 ⇒ 06/91
BX 1.4	150C, K1F, K2D	07/86 ⇒ 12/94
BX 1.4 E	150B(XY8), 150J, 150Y, K1F, KAZ	09/82 ⇒ 12/94
BX 1.6	182A, B2C, B6D, B6E	01/87 ⇒ 12/94
BX 1.9	159B, 159C, D6U, DKK	05/85 ⇒ 12/94
BX 1.9 GTi	D6D, D6K	01/87 ⇒ 01/92
BX 14	150C, KDY(TU3M), KDZ(TU3M/Z)	01/86 ⇒ 02/93
BX 14 E	150A, 150C, K1G	10/82 ⇒ 02/93
BX 16	171A, 171B, 171C, 171D, 180Z, BAY(XU5CP), BAZ(XU5CP)	10/82 ⇒ 12/94
BX 19	159A, D2A(XU92C), D2C(XU92C), D2E, D6A(XU92J), DKZ(XU92A)	09/84 ⇒ 12/94
BX 19 Cat	DFZ(XU92J)	07/86 ⇒ 12/94
BX 19 E 4x4	D2F	04/89 ⇒ 02/93
BX 19 GTi	D6A(XU92J), DKZ(XU92A)	07/86 ⇒ 02/93
BX 19 GTi 4x4	DKZ(XU92A)	06/88 ⇒ 02/93
C15 1.0	108C(XV8), C1A, C1A(TU9/K), C1B(TU9/W), TU9	10/84 ⇒ 12/97
C15 1.1	H1A, HDZ(TU1M), TU1	08/88 ⇒ 07/96
C15 1.1 i	HDZ(TU1M), TU1MZ	07/88 ⇒ 12/96
C15 1.4	K1A, K1G, K1H(TU3A), KDY(TU3M)	07/87 ⇒ 12/96

CITROËN

C15 1.4 E	K1F, K1J, K2D, K3A, KAZ	07/86 ⇒ 12/96
C15 1.4 i	KDY(TU3FM), KDY(TU3M)	05/91 ⇒ 12/96
ZX 1.1	H1A, H1B, HDZ(TU1M), TU1	03/91 ⇒ 06/97
ZX 1.4 i	KDY(TU3M)	10/93 ⇒ 10/97

PEUGEOT

106 I 1.0	TU9	09/91 ⇒ 03/01
106 I 1.1	H1B(TU1), HDZ(TU1M)	08/91 ⇒ 04/96
106 I 1.4	K5A(TU3), KDY(TU3M), TU3.2	08/91 ⇒ 04/96
205 I 1.4	TU3	01/83 ⇒ 12/90
205 I 1.9 GTI	D6B(XU9JA)	10/86 ⇒ 10/87
205 II 1.0	TU9	10/87 ⇒ 09/98
205 II 1.1	H1B(TU1), HDZ(TU1M)	10/87 ⇒ 09/98
205 II 1.1 CJ	HDZ(TU1M)	10/89 ⇒ 12/94
205 II 1.3	TU24	01/91 ⇒ 12/94
205 II 1.3 Rallye	TU24	10/87 ⇒ 10/90
205 II 1.4	K1D(TU3A), K2B(TU3S), KDY(TU3M), KDZ(TU3M)	06/87 ⇒ 09/98
205 II 1.4 Cat	KAY(TU3CP)	08/87 ⇒ 09/93
205 II 1.4 CJ	K1D(TU3A), KDY(TU3M), KDZ(TU3M)	03/89 ⇒ 12/94
205 II 1.4 CJ Cat	KAY(TU3CP)	01/89 ⇒ 09/93
205 II 1.6 GTI	XU5JA	01/91 ⇒ 12/94
205 II 1.9 GTI	D6B(XU9JA)	10/87 ⇒ 09/98
306 1.4	TU3	01/93 ⇒ 04/97
309 I 1.4	K1D(TU3A), KDY(TU3M), KDZ(TU3M)	03/89 ⇒ 07/89
309 I 1.9 GTI	D6B(XU9JA)	10/86 ⇒ 07/89
309 II 1.1	H1B(TU1), HDZ(TU1M)	09/89 ⇒ 12/93
309 II 1.4	KDZ(TU3M), TU3, TU3F2	07/89 ⇒ 12/93
309 II 1.6	XU5JA	07/89 ⇒ 12/93
309 II 1.6 GTi	--	09/89 ⇒ 10/93
405 I 1.4	K5A(TU3), TU3A, TU3F2	01/87 ⇒ 12/92
405 I 1.6	--	01/87 ⇒ 12/92
405 I 1.9	D2C(XU92C), D6A(XU92J)	07/87 ⇒ 12/93
405 II 1.4	TU3F2	01/93 ⇒ 12/96
405 II 1.6	18EM	08/92 ⇒ 05/97
405 II 1.9	XU92C	01/93 ⇒ 12/96

KW 806 244



05

DISTRIBUTOR CAPS

Adatt./Suitable: BOSCH

BOSCH

9 231 065 529

FORD AUSTRALIA

ADH-2

Motorcraft

ADH 2

03 Supplied until depletion

- Fornibile fino ad esaurimento delle scorte
- Fourni jusqu'à épuisement du stock
- Lieferbar solange vorrat reicht
- Suministrado hasta el stock termina



FORD AUSTRALIA

FAIRLANE 3.2i EFI	--	01/89 ⇒
FAIRLANE 3.9i EFI	--	01/89 ⇒
FAIRLANE 3.9i MPEFi	--	01/89 ⇒
FAIRLANE 4.0i MPEFi	--	01/89 ⇒
FAIRLANE ZL 4.1i	--	01/84 ⇒
FALCON 3.2 Efi	--	03/88 ⇒ 12/88
FALCON 3.3	--	10/84 ⇒ 12/87
FALCON 3.9 Efi	--	07/91 ⇒ 04/92
FALCON 3.9 MPFi	--	03/88 ⇒ 04/92
FALCON 3.9 SPFi	--	03/88 ⇒ 04/92
FALCON 4.1	--	10/84 ⇒ 02/86

KW 806 247



07,5

DISTRIBUTOR CAPS

Adatt./Suitable: BOSCH

BMW

12 11 1 289 425
12 11 1 734 109 *A

BOSCH

1 235 522 396 *A
1 235 522 397

- *A Available distributor cap only not screen
- Fornita solo calotta, no copertura
 - Disponible seulement la tete et non pas le couvrle
 - Erhältlich nur die kappe, nicht die haube
 - Disponible solo la tapa, no la cobertura

03 Supplied until depletion

- Fornibile fino ad esaurimento delle scorte
- Fourni jusqu'à épuisement du stock
- Lieferbar solange vorrat reicht
- Suministrado hasta el stock termina



BMW		
3 III 316 i	M40B16(164E1), M43B16(164E2)	09/90 ⇒ 09/93
3 III 318 i	M40B18(184E1)	09/90 ⇒ 08/93
3 II 316 i	M40B16(164E1)	09/87 ⇒ 06/94
3 II 318 i	M40B18(184E1)	06/87 ⇒ 06/94
5 III 518 i	M40B18(184E1)	09/89 ⇒ 04/94

KW 806 248



07

DISTRIBUTOR CAPS

Adatt./Suitable: BOSCH

AUDI

077 905 205 *A
077 905 207 *A

BOSCH

1 235 522 419
1 235 522 420 *A

VW

077 905 205 *A
077 905 207 *A

- *A Available distributor cap only not screen
- Fornita solo calotta, no copertura
 - Disponible seulement la tete et non pas le couvrle
 - Erhältlich nur die kappe, nicht die haube
 - Disponible solo la tapa, no la cobertura

03 Supplied until depletion

- Fornibile fino ad esaurimento delle scorte
- Fourni jusqu'à épuisement du stock
- Lieferbar solange vorrat reicht
- Suministrado hasta el stock termina



AUDI		
80 III 2.0 E 16V	6A	03/90 ⇒ 09/91
80 III 2.0 E 16V quattro	6A	03/90 ⇒ 08/91
80 IV 2.0 E 16V	6A, ACE	09/91 ⇒ 01/96
100 IV 2.0 E 16V	ACE	01/92 ⇒ 07/94
100 IV 2.0 E 16V quattro	ACE	07/92 ⇒ 07/94
A6 I 2.0 16V	ACE	06/94 ⇒ 12/97
A6 I 2.0 16V quattro	ACE	06/94 ⇒ 12/97
A6 I S6 4.2 quattro	AEC	06/94 ⇒ 12/97
CABRIOLET 2.0 16V	ACE	06/95 ⇒ 07/96
COUPE 2.0 16V	6A, ACE	01/92 ⇒ 12/96
V8 3.6 quattro	PT	10/88 ⇒ 02/94
V8 4.2 quattro	ABH	10/91 ⇒ 02/94

KW 806 249



04

DISTRIBUTOR CAPS

Adatt./Suitable: BOSCH

BOSCH

1 235 522 436

GENERAL MOTORS
90 350 765

OPEL

12 11 000
12 11 268
90350765

03 Supplied until depletion

- Fornibile fino ad esaurimento delle scorte
- Fourni jusqu'à épuisement du stock
- Lieferbar solange vorrat reicht
- Suministrado hasta el stock termina



OPEL		
ASTRA F 1.4 i	C14NZ	09/91 ⇒ 01/05
CORSA A 1.4 i	C14NZ	01/85 ⇒ 03/93
CORSA A 1.6 GSI	E16SE	05/88 ⇒ 03/92
KADETT E 1.4 i	C14NZ	01/90 ⇒ 07/94
KADETT E 1.6	16SV	09/86 ⇒ 12/91
KADETT E 1.6 i	16SV	07/89 ⇒ 02/93
KADETT E 1.6 S	16SV	09/86 ⇒ 08/91
VECTRA A 1.6	16SV	09/88 ⇒ 05/93
VECTRA A 1.6 S	16SV	09/88 ⇒ 05/93

VAUXHALL

ASTRA III 1.4 i	C14NZ	09/91 ⇒ 09/98
ASTRAVAN I 1.4 i	C14NZ	09/91 ⇒ 08/95

KW 806 251



07

DISTRIBUTOR CAPS

Adatt./Suitable: BOSCH

BOSCH

1 235 522 417 *A
1 235 522 418GENERAL MOTORS
90 297 426

OPEL

12 11 262
90297426

- *A Available distributor cap only not screen
- Fornita solo calotta, no copertura
 - Disponible seulement la tete et non pas le couvrle
 - Erhältlich nur die kappe, nicht die haube
 - Disponible solo la tapa, no la cobertura

03 Supplied until depletion

- Fornibile fino ad esaurimento delle scorte
- Fourni jusqu'à épuisement du stock
- Lieferbar solange vorrat reicht
- Suministrado hasta el stock termina



OPEL		
CALIBRA A 2.0 i 16V	C20XE	06/90 ⇒ 02/94
CALIBRA A 2.0 i 16V 4x4	C20XE	06/90 ⇒ 02/94
KADETT E 2.0 GSI 16V	20XE	12/87 ⇒ 08/91
KADETT E 2.0 GSI 16V Cat	C20XE	03/88 ⇒ 08/91
VECTRA A 2.0 i 16V	20XEJ	02/89 ⇒ 10/90
VECTRA A 2.0 i 16V 4x4	C20XE	08/89 ⇒ 08/95
VECTRA A 2.0 i 16V Cat	C20XE	02/90 ⇒ 11/95
VECTRA A 2000 16V 4x4	20XEJ	01/89 ⇒ 10/90
VECTRA A 2000/GT 16V	20XEJ	01/89 ⇒ 06/94
VECTRA A 2000/GT 16V Cat	C20XE	02/90 ⇒ 11/95
VECTRA A 2000/GT 16V Cat 4x4	C20XE	02/90 ⇒ 11/95

VAUXHALL

CALIBRA 2.0 i 16V	C20XE	06/90 ⇒ 02/94
-------------------	-------	---------------

VAUXHALL

CALIBRA 2.0 i 16V 4x4 C20XE 06/90 ⇒ 02/94

KW 806 252



07,5

DISTRIBUTOR CAPS

Adatt./Suitable: BOSCH

BOSCH

1 235 522 442 *A

CITROËN

5941 47 *A
96 054 877

PEUGEOT

5941 47 *A

*A Available distributor cap only not screen

- Fornita solo calotta, no copertura
- Disponible seulement la tete et non pas le couvrle
- Erhältlich nur die kappe, nicht die haube
- Disponible solo la tapa, no la cobertura

03 Supplied until depletion

- Fornibile fino ad esaurimento delle scorte
- Fourni jusqu'à épuisement du stock
- Lieferbar solange vorrat reicht
- Suministrado hasta el stock termina



CITROËN		
XM I 3.0	UFZ(ZPJ/Z)	05/89 ⇒ 05/94
XM I 3.0 V6	SFZ(ZPJ/Z), UFZ(ZPJ/Z)	05/89 ⇒ 06/94
XM I 3.0 V6 24V	SKZ(ZPJ4/Z), UKZ(ZPJ4/Z)	07/90 ⇒ 06/94
XM II 3.0 V6	SFZ(ZPJ/Z), UFZ(ZPJ/Z)	05/94 ⇒ 10/00
XM II 3.0 V6 24V	SKZ(ZPJ4/Z), UKZ(ZPJ4/Z)	05/94 ⇒ 10/00

PEUGEOT

605 3.0	UFZ(ZPJ), UKZ(ZPJ4/Z)	08/89 ⇒ 09/99
605 3.0 SV 24	UKZ(ZPJ4/Z)	08/89 ⇒ 09/99

KW 806 253



05

DISTRIBUTOR CAPS

Adatt./Suitable: BOSCH

BOSCH

1 235 522 423

FORD

6 182 127

Motorcraft

EDH 279

03 Supplied until depletion

- Fornibile fino ad esaurimento delle scorte
- Fourni jusqu'à épuisement du stock
- Lieferbar solange vorrat reicht
- Suministrado hasta el stock termina



FORD		
SCORPIO I 2.0 i	N9B, N9D, N9F, NRA, NRI	05/89 ⇒ 09/94
SIERRA II 2.0 i	N4A, N4I, N9B	01/87 ⇒ 02/93
TRANSIT II 2.0	NSF, NSG	06/94 ⇒ 03/00
TRANSIT II 2.0 CNG	NSH	06/94 ⇒ 03/00
TRANSIT TOURNEO 2.0	NSH	11/94 ⇒ 12/00

KW 806 256



04

DISTRIBUTOR CAPS

Adatt./Suitable: **BOSCH**
BOSCH
 0 237 521 024 *B
 1 235 522 437

GENERAL MOTORS
 90 350 988

HOLDEN
 90350988

OPEL
 12 11 269
 90350988

HOLDEN

BARINA 1.4 i	C14NZ	04/94 ⇒ 07/97
BARINA_SB 1.2i	C12NZ	04/94 ⇒ 07/97
COMBO 1.4 i	C14NZ	03/96 ⇒ 07/97
COMBO_SB 1.4i	C14NZ	04/94 ⇒ 07/97

OPEL

ASTRA F 1.4	14NV	09/91 ⇒ 09/93
ASTRA F 1.4 i	C14NZ	09/91 ⇒ 01/05
COMBO B 1.2	C12NZ	07/94 ⇒ 10/01
COMBO B 1.4	C14NZ	07/94 ⇒ 10/01
CORSA A 1.2	12NC, E12GV	09/82 ⇒ 08/90
CORSA A 1.2 i	C12NZ	09/89 ⇒ 03/93
CORSA A 1.2 N	12NC, E12GV	01/85 ⇒ 10/87
CORSA A 1.4 S	14NV	09/89 ⇒ 03/93
CORSA A 1.6 GSI	E16SE	05/88 ⇒ 03/92
CORSA B 1.2 i	12NZ, C12NZ	03/93 ⇒ 09/00
CORSA B 1.4 i	C14NZ	03/93 ⇒ 09/00
FRONTERA A 2.4 i	C24NE	03/92 ⇒ 10/98
KADETT E 1.4 i	C14NZ	01/90 ⇒ 07/94
KADETT E 1.4 S	14NV	07/89 ⇒ 02/93
KADETT E 1.6	16SV	09/86 ⇒ 12/91
KADETT E 1.6 i	16SV	07/89 ⇒ 02/93
KADETT E 1.6 S	16SV	09/86 ⇒ 08/91
OMEGA A 2.4 i	C24NE	09/88 ⇒ 03/94
VECTRA A 1.4 S	14NV	04/88 ⇒ 06/92
VECTRA A 1.6	16SV	09/88 ⇒ 05/93
VECTRA A 1.6 S	16SV	09/88 ⇒ 05/93

VAUXHALL

ASTRA III 1.4	14NV	09/91 ⇒ 09/93
ASTRA III 1.4 i	C14NZ	09/91 ⇒ 09/98
ASTRA III 1.4 S	14NV	09/91 ⇒ 02/98
ASTRAVAN I 1.4 i	C14NZ	09/91 ⇒ 08/95
COMBO B 1.2	C12NZ	07/94 ⇒ 10/01
COMBO B 1.4	C14NZ	07/94 ⇒ 10/01
CORSA B 1.2 i	C12NZ	03/93 ⇒ 09/00
CORSA B 1.4 i	C14NZ	03/93 ⇒ 09/00
CORSAVAN I 1.4 i	C14NZ	01/94 ⇒ 09/00
FRONTERA A 2.4 i	C24NE	03/92 ⇒ 10/98

KW 806 257



07

DISTRIBUTOR CAPS

Adatt./Suitable: **BOSCH**
BOSCH
 1 235 522 434
 1 235 522 435 *A

GENERAL MOTORS
 90 336 536 *A
 90 442 358 *A

HOLDEN
 90336536

OPEL
 12 11 270 *A
 12 11 276 *A
 90336536

*A Available distributor cap only not screen

- Fornita solo calotta, no copertura
- Disponible seulement la tete et non pas le couvercle
- Erhältlich nur die kappe, nicht die haube
- Disponible solo la tapa, no la cobertura

03 Supplied until depletion

- Fornibile fino ad esaurimento delle scorte
- Fourni jusqu'à épuisement du stock
- Lieferbar solange vorrat reicht
- Suministrado hasta el stock termina



HOLDEN

CALIBRA_YE 2.0i	C20NE	09/91 ⇒ 07/95
CALIBRA_YE 2.0i 16V	C20XE	09/91 ⇒ 07/95
CALIBRA_YE 2.0i 16V Turbo	C20LET	06/94 ⇒ 10/97

OPEL

ASTRA F 1.8 i	C18NZ	09/91 ⇒ 09/98
ASTRA F 2.0 GSI 16V	C20XE	09/91 ⇒ 01/98
ASTRA F 2.0 i	C20NE	09/91 ⇒ 09/98
ASTRA F 2.0 i 16V	C20XE	03/93 ⇒ 01/98
CALIBRA A 2.0 i	C20NE	08/89 ⇒ 12/96
CALIBRA A 2.0 i 4x4	C20NE	06/90 ⇒ 07/97
CALIBRA A 2.0 i Turbo 4x4	C20LET	08/91 ⇒ 07/97
FRONTERA A 2.0 i	C20NE	03/92 ⇒ 10/98
KADETT E 1.8	18SE	01/86 ⇒ 08/91
KADETT E 1.8 i	C18NZ, S18NV	06/85 ⇒ 05/92
KADETT E 1.8 S	E18NV	09/87 ⇒ 08/91
KADETT E 2.0 GSI	20NE, 20SEH	09/86 ⇒ 08/91
KADETT E 2.0 GSI 16V	20XE	12/87 ⇒ 08/91
KADETT E 2.0 GSI 16V Cat	C20XE	03/88 ⇒ 08/91
KADETT E 2.0 GSI Cat	C20NE	09/86 ⇒ 08/91
KADETT E 2.0 i	20NE	10/86 ⇒ 02/93
KADETT E 2.0 i Cat	C20NE	10/86 ⇒ 02/93
OMEGA A 1.8	18SEH, E18NVR, S18NV	09/86 ⇒ 03/94
OMEGA A 1.8 N	18NV	09/86 ⇒ 08/87
OMEGA A 1.8 S	18SV	09/86 ⇒ 03/94
OMEGA A 2.0	20SE, C20NE	09/86 ⇒ 04/94
OMEGA A 2.0 i	C20NE	09/86 ⇒ 04/94
OMEGA B 2.0	20SE	03/94 ⇒ 12/00
VECTRA A 1.8 i	18SV	09/88 ⇒ 10/90
VECTRA A 1.8 i Cat	C18NZ	03/90 ⇒ 11/95
VECTRA A 1.8 S	18SV, E18NVR	09/88 ⇒ 10/90
VECTRA A 1.8 S 4x4	E18NVR	01/89 ⇒ 07/89
VECTRA A 2.0 i	20NE, 20SEH	09/88 ⇒ 09/92
VECTRA A 2.0 i 16V	20XEJ	02/89 ⇒ 10/90
VECTRA A 2.0 i 16V 4x4	C20XE	08/89 ⇒ 08/95
VECTRA A 2.0 i 16V Cat	C20XE	02/90 ⇒ 11/95
VECTRA A 2.0 i 4x4	20NE, 20SEH	01/89 ⇒ 07/92
VECTRA A 2.0 i Cat	C20NE	09/88 ⇒ 11/95
VECTRA A 2.0 i Cat 4x4	C20NE	01/89 ⇒ 11/95
VECTRA A 2.0 i GT	20SEH	09/88 ⇒ 11/95
VECTRA A 2.0 i Turbo 4x4	C20LET	06/94 ⇒ 11/95
VECTRA A 2000 16V 4x4	20XEJ	01/89 ⇒ 10/90
VECTRA A 2000/GT 16V	20XEJ	01/89 ⇒ 06/94
VECTRA A 2000/GT 16V Cat	C20XE	02/90 ⇒ 11/95
VECTRA A 2000/GT 16V Cat 4x4	C20XE	02/90 ⇒ 11/95

VAUXHALL

ASTRA III 1.8 i	C18NZ	09/91 ⇒ 09/98
ASTRA III 2.0 i	C20NE	09/91 ⇒ 09/98
ASTRA III 2.0 i 16V	C20XE	09/91 ⇒ 02/98
CALIBRA 2.0 i	C20NE	06/90 ⇒ 07/97
CALIBRA 2.0 i 4x4	C20NE	06/90 ⇒ 07/97
CALIBRA 2.0 i Turbo 4x4	C20LET	03/92 ⇒ 07/97
FRONTERA A 2.0	C20NE	04/95 ⇒ 08/98
FRONTERA A 2.0 i	C20NE	03/92 ⇒ 10/98
OMEGA B 2.0	20SE	09/95 ⇒ 09/96

KW 806 258



07

DISTRIBUTOR CAPS

Adatt./Suitable: **BOSCH**
BOSCH
 1 235 522 438
 1 235 522 439 *A

GENERAL MOTORS
 90 369 031

MAN
 51.26310-0009

OPEL
 12 11 273

00 Eliminated on 13-09-2021. Please verify the availability through our local distributors

- Eliminato il 13-09-2021. Verificare la disponibilità presso i nostri distributori
- Éliminé le 13-09-2021. Vérifier la disponibilité auprès de nos distributeurs sur place
- Am 13-09-2021 gestrichen. Evtl. Verfügbarkeit bitte bei unseren Händlern prüfen
- Eliminado en fecha 13-09-2021. Verificar la disponibilidad a través de nuestros distribuidores locales

*A Available distributor cap only not screen

- Fornita solo calotta, no copertura
- Disponible seulement la tete et non pas le couvercle
- Erhältlich nur die kappe, nicht die haube
- Disponible solo la tapa, no la cobertura

03 Supplied until depletion

- Fornibile fino ad esaurimento delle scorte
- Fourni jusqu'à épuisement du stock
- Lieferbar solange vorrat reicht
- Suministrado hasta el stock termina



MAN

NG	E2866DUH01	01/95 ⇒ 07/99
NL	E2866DUH01, E2866DUH02	05/93 ⇒ 07/99

OPEL

OMEGA A 2.6 i	C26NE	09/90 ⇒ 03/94
OMEGA A 3.0	30NE, C30LE, C30NE	03/87 ⇒ 03/94
OMEGA A 3.0 24V	C30SE	09/89 ⇒ 03/94
OMEGA A 3.0 24V Omega 3000	C30SE	09/88 ⇒ 04/94
OMEGA A 3.0 Cat	C30NE	03/87 ⇒ 03/94
SENATOR B 2.5 i	25NE	09/90 ⇒ 09/93
SENATOR B 3.0	30NE, C30LE	09/87 ⇒ 09/93
SENATOR B 3.0 24V	C30SE	09/89 ⇒ 09/93
SENATOR B 3.0 i Cat	C30NE	01/88 ⇒ 09/93

KW 806 260



07

DISTRIBUTOR CAPS

Adatt./Suitable: BOSCH

BOSCH
1 235 522 408 *A
1 235 522 447

RENAULT
74 33 501 944

VOLVO
3501944 *A
35019447 *A

- *A Available distributor cap only not screen
- Fornita solo calotta, no copertura
 - Disponible seulement la tete et non pas le couvercle
 - Erhältlich nur die kappe, nicht die haube
 - Disponible solo la tapa, no la cobertura



RENAULT		
SAFRANE II 2.5 20V	N7U700, N7U701	07/96 ⇒ 12/00
VOLVO		
850 2.0	B5202S, B5204F, B5204FS	06/91 ⇒ 12/96
850 2.0 10V	B5202FS	08/94 ⇒ 12/97
850 2.0 Turbo	B5204FT, B5204T, B5204T2	02/93 ⇒ 10/97
850 2.3	B5234FS	01/96 ⇒ 10/96
850 2.3 T5	9M91872	02/93 ⇒ 12/96
850 2.3 T5-R	B5234T4	08/95 ⇒ 12/96
850 2.3 Turbo R	B5234T5	06/95 ⇒ 10/97
850 2.4	B5252, B5252FS, B5254S	06/91 ⇒ 12/96
850 2.4 AWD	B5254T	04/96 ⇒ 12/96
850 2.4 GLE	B5254T	09/93 ⇒ 10/97
850 2.5 10V	B5252FS	06/91 ⇒ 12/97
850 2.5 20V	B5254FS	08/91 ⇒ 12/97
C70 I 2.0	B5204T2	03/97 ⇒ 10/05
C70 I 2.0 T	B5204T3	03/97 ⇒ 10/05
C70 I 2.3 T5	B5234T3	03/98 ⇒ 10/05
C70 I 2.3 T-5	B5234T3	03/97 ⇒ 09/02
C70 I 2.4 T	B5254T	03/97 ⇒ 10/05
S70 2.0	B5202FS, B5202S, B5204T2	01/97 ⇒ 11/00
S70 2.0 Turbo	B5204T3	01/97 ⇒ 11/00
S70 2.3	B5234FS, B5234T7	01/97 ⇒ 07/99
S70 2.3 AWD	B5234T7	04/99 ⇒ 09/00
S70 2.3 T-5	B5234T3	01/97 ⇒ 11/00
S70 2.3 T5 AWD	B5234T4	07/97 ⇒ 09/00
S70 2.3 T5-R AWD	B5234T2	11/96 ⇒ 09/98
S70 2.3 Turbo	B5234FT+	01/97 ⇒ 11/00
S70 2.4	B5254S	06/98 ⇒ 11/00
S70 2.4 AWD	B5252FS	11/96 ⇒ 05/99
S70 2.4 Bifuel	GB5252S	10/98 ⇒ 11/00
S70 2.4 T5 AWD	B5254T	11/96 ⇒ 04/99
S70 2.4 Turbo	B5254T	01/97 ⇒ 11/00
S70 2.5 20V	B5254FS	01/97 ⇒ 12/98
S70 2.5 Bifuel	GB5252S2	01/99 ⇒ 12/99
V70 I 2.0	B5202FS, B5202S, B5204T2	12/95 ⇒ 03/00
V70 I 2.0 Turbo	B5204T3	11/96 ⇒ 12/00
V70 I 2.0 Turbo AWD	B5204T3	11/96 ⇒ 12/00
V70 I 2.3	B5234FS	01/97 ⇒ 07/99
V70 I 2.3 AWD	B5234T3, B5234T7	04/97 ⇒ 09/98
V70 I 2.3 T AWD	B5234FT+, B5234T4, B5234T6	04/97 ⇒ 12/98
V70 I 2.3 T-5	B5234T3	11/96 ⇒ 12/00
V70 I 2.3 T-5 AWD	B5234T3	01/97 ⇒ 12/00
V70 I 2.3 Turbo	B5234FT+, B5234T2, B5234T4	12/95 ⇒ 12/98
V70 I 2.4	B5252FS, B5254S	12/95 ⇒ 12/99
V70 I 2.4 Bifuel	GB5252S	05/98 ⇒ 12/99
V70 I 2.4 Turbo AWD	B5254T	04/96 ⇒ 12/00
V70 I 2.5	B5252FS	01/97 ⇒ 03/00
V70 I 2.5 20V	B5254FS	01/97 ⇒ 12/99
V70 I 2.5 Bifuel	GB5252S2	01/99 ⇒ 12/99

KW 806 261



04

DISTRIBUTOR CAPS

Adatt./Suitable: BOSCH

BOSCH
1 235 522 372

- 00 Eliminated on 14-04-2020. Please verify the availability through our local distributors
- Eliminato il 14-04-2020. Verificare la disponibilità presso i nostri distributori
 - Éliminé le 14-04-2020. Vérifier la disponibilité auprès de nos distributeurs sur place
 - Am 14-04-2020 gestrichen. Evtl. Verfügbarkeit bitte bei unseren Händlern prüfen
 - Eliminado en fecha 14-04-2020. Verificar la disponibilidad a través de nuestros distribuidores locales



KW 806 263



05

DISTRIBUTOR CAPS

Adatt./Suitable: BOSCH

BOSCH
1 235 522 453 *A
1 235 522 454 *A

SEAT
037 905 207

VW
037 905 207 *A

- *A Available distributor cap only not screen
- Fornita solo calotta, no copertura
 - Disponible seulement la tete et non pas le couvercle
 - Erhältlich nur die kappe, nicht die haube
 - Disponible solo la tapa, no la cobertura



SEAT		
CORDOBA I 2.0 i 16V	ABF	08/96 ⇒ 06/99
IBIZA II 2.0 i 16V	ABF	08/96 ⇒ 08/99
TOLEDO I 2.0 i 16V	ABF	11/93 ⇒ 03/99
VW		
GOLF III 2.0 GTI 16V	ABF	08/92 ⇒ 08/97
PASSAT III 2.0 16V	ABF	01/94 ⇒ 05/97

KW 806 266



07

DISTRIBUTOR CAPS

Adatt./Suitable: BOSCH

AUDI
027 905 207 A
051 905 207

BOSCH
0 290 004 019
1 230 591 040
1 235 522 375
1 235 522 444

SEAT
027 905 207 A
051 905 207

VW
027 905 207 A
051 905 207



AUDI		
80 II 1.6	SA	02/86 ⇒ 07/86
80 II 1.8	SF	02/86 ⇒ 07/86
80 II 1.8 GTE	DZ, MU, PV	06/84 ⇒ 03/87
80 III 1.4	SE	08/86 ⇒ 07/88
80 III 1.6	ABB, PP, RN, RNA	09/86 ⇒ 10/91
80 III 1.8	RU, SD	09/86 ⇒ 01/90
80 III 1.8 E	DZ	06/86 ⇒ 08/91
80 III 1.8 S	JN, JV, NE, PM, SF	08/86 ⇒ 10/91
80 III 2.0	AAD	10/90 ⇒ 08/91
80 III 2.0 E	3A	08/88 ⇒ 10/90
80 IV 1.6	ABB, ABM	09/91 ⇒ 12/94
80 IV 1.6 E	ADA	06/93 ⇒ 01/96
80 IV 2.0	ABT	09/91 ⇒ 01/96
80 IV 2.0 E	ABK	09/91 ⇒ 01/96
80 IV 2.0 quattro	ADW	11/93 ⇒ 01/96
100 III 1.8	NP, SH	02/86 ⇒ 12/90
100 III 1.8 Cat	4B, PH	03/85 ⇒ 11/90
100 IV 1.6	ABB	03/92 ⇒ 07/93
100 IV 2.0	AAE	12/90 ⇒ 07/94
100 IV 2.0 E	AAD, AAE, ABK	12/90 ⇒ 07/94
A6 I 2.0	AAE, ABK, ADW	06/94 ⇒ 12/97
A4 I 1.6	ADP	11/94 ⇒ 09/01
CABRIOLET 2.0 E	ABK	01/93 ⇒ 07/98
COUPE 1.8	DZ	08/89 ⇒ 07/91
COUPE 2.0	3A, AAD, ABK	05/89 ⇒ 12/96
SEAT		
CORDOBA I 1.0 16V	AST, AVZ	05/00 ⇒ 10/02
CORDOBA I 1.0 CL	AAU	02/93 ⇒ 06/96
CORDOBA I 1.3	AAV	02/93 ⇒ 08/94
CORDOBA I 2.0 i	AGG	02/93 ⇒ 06/99
IBIZA II 1.0 16V	AST, AVZ	10/99 ⇒ 02/02
IBIZA II 1.3 i	8C20H00D	03/93 ⇒ 08/99
INCA 1.4 i	AEX, AKV, APQ	11/95 ⇒ 06/03
INCA 1.6 i	1F, AEE	11/95 ⇒ 05/98
ALHAMBRA I / II 2.0 i	ADY	04/96 ⇒ 03/10
TOLEDO I 1.6 i	1F, AFT	05/91 ⇒ 03/99
TOLEDO I 1.8 i	ADZ, RP	05/91 ⇒ 12/96
TOLEDO I 2.0 i	AGG	05/91 ⇒ 03/99
VW		
PASSAT IV 1.6	ADP	10/96 ⇒ 11/00
POLO II 1.0	AAU, HZ	01/85 ⇒ 09/94
POLO II 1.0 Cat	AAU, ACM	08/89 ⇒ 09/94
POLO II 1.3	3F	10/90 ⇒ 09/94
POLO II 1.3 Cat	2G, 3F, AAV	07/87 ⇒ 09/94
POLO II 1.3 G40	PY	08/90 ⇒ 09/94
JETTA II 1.0	HZ	08/85 ⇒ 10/91
JETTA II 1.3 Cat	2G, NZ	06/87 ⇒ 12/91
JETTA II 1.6	ABN, EZ, EZA, HM, PN, RF	12/83 ⇒ 07/92
JETTA II 1.8	EV, GU, GX, PB, RD, RV	01/84 ⇒ 10/91
JETTA II 1.8 16V	KR, PL	08/86 ⇒ 10/91
JETTA II 1.8 Cat	GX, PF, RP	01/87 ⇒ 10/91
JETTA II 1.8 G60	PG	04/90 ⇒ 07/91
JETTA II 1.8 Syncro	GU, RP	08/87 ⇒ 12/88
JETTA II 1.8i GT	GZ	12/83 ⇒ 07/88
CADDY I 1.8	JH	08/85 ⇒ 07/92
CADDY II 1.6	1F	11/95 ⇒ 05/97
CADDY II 75 1.6	1F	11/95 ⇒ 05/97
CORRADO 1.8 16V	KR	04/89 ⇒ 07/92

VW			
CORRADO 1.8 G60	PG	09/88	⇒ 09/93
CORRADO 2.0 i	2E, ADY	04/93	⇒ 12/95
CORRADO 2.0 i 16V	7TZ220XS560	08/91	⇒ 12/95
GOLF I 1.6	EW, HN	08/83	⇒ 04/92
GOLF I 1.8	2H, DX, EX, JH, KT	08/82	⇒ 04/93
GOLF II 1.0	HZ	08/85	⇒ 10/91
GOLF II 1.3 Cat	2G, NZ	06/86	⇒ 12/92
GOLF II 1.6	ABN, EZ, PN, RF	08/83	⇒ 12/92
GOLF II 1.6 [CHE] [SWE]	HM	08/86	⇒ 07/88
GOLF II 1.6 G	EZA, PN	08/86	⇒ 07/91
GOLF II 1.8	GU, GX, RV	08/84	⇒ 10/91
GOLF II 1.8 [CHE] [SWE]	HV	08/86	⇒ 07/87
GOLF II 1.8 GTI	EV, PB, RD	08/83	⇒ 10/91
GOLF II 1.8 GTI 16V	KR, PL	02/86	⇒ 10/91
GOLF II 1.8 GTI Cat	PF	01/87	⇒ 10/91
GOLF II 1.8 GTI G60	PG	04/90	⇒ 07/91
GOLF II 1.8 GTI G60 Syncro	PG	08/88	⇒ 12/91
GOLF II 1.8 i	RP	08/87	⇒ 07/91
GOLF II 1.8 i Cat	GX, RP	08/87	⇒ 10/91
GOLF II 1.8 i Cat Syncro	RP	08/87	⇒ 10/91
GOLF II 1.8 Syncro	3E82, GU	02/86	⇒ 07/91
GOLF II 1.8i GTI [CHE] [SWE]	GZ	08/86	⇒ 07/87
GOLF II 1.8i GTI [SWE]	GZ	08/87	⇒ 07/88
PASSAT III 1.6	1F, ABN, AEK, AFT, EZ	04/88	⇒ 08/96
PASSAT III 1.8	AAM, ABS, ADZ, KR, PB, PF, RP	02/88	⇒ 05/97
PASSAT III 1.8 16V	KR	04/88	⇒ 12/89
PASSAT III 1.8 GL	KR	08/91	⇒ 09/93
PASSAT III 2.0	2E, ADY, AEP, AGG	02/90	⇒ 05/97
PASSAT III 2.0 16V	7TZ220XS560	08/88	⇒ 09/93
PASSAT III 2.0 Syncro	2E, ADY, AGG	03/90	⇒ 12/96
PASSAT III 2.0i	ACX	08/92	⇒ 12/96
GOLF III 1.4	ABD	10/91	⇒ 04/99
GOLF III 1.6	ABU, AEK, AFT, AKS	09/92	⇒ 04/99
GOLF III 1.8	AAM, ABS, ADZ	08/91	⇒ 04/99
GOLF III 1.8 Syncro	ABS, ADZ	01/93	⇒ 04/99
GOLF III 2.0	2E, ADY, AEP, AGG, AKR	11/91	⇒ 04/99
GOLF III 2.0 GL	AEP	08/95	⇒ 09/97
GOLF III 2.0 Syncro	AGG	08/95	⇒ 04/99
GOLF IV 1.6	AFT, AKS	06/98	⇒ 06/02
GOLF IV 1.8	AAM, ADZ, ANN, ANP	06/98	⇒ 06/02
GOLF IV 2.0	AGG, AKR, ATU, AWF, AWG	06/98	⇒ 06/02
POLO III 1.6	AFT	05/97	⇒ 09/01
POLO III 100 1.6	AFT	12/95	⇒ 09/01
POLO III 2.0	ADC	08/99	⇒ 09/01
POLO III 75 1.6	1F	11/95	⇒ 09/97
POLO III 90 1.8	ADD	01/97	⇒ 09/01
SCIROCCO II 1.6	EW, EWA, HN, RE	01/83	⇒ 07/90
SCIROCCO II 1.8	DX, EX, JH, KT	08/82	⇒ 07/92
SCIROCCO II 1.8 16V	KR, PL	10/85	⇒ 07/92
SHARAN I 2.0	ADY	09/95	⇒ 03/10
TRANSPORTER IV 1.8	5K7M710	12/90	⇒ 07/92
TRANSPORTER IV 2.0	AAC	07/90	⇒ 04/03
VENTO 1.6	AEK, AFT, AKS	10/94	⇒ 02/99

KW 807 701



04

DISTRIBUTOR CAPS

Adatt./Suitable: CAJAVEC

YUGO

4660870

ZASTAVA

4660870



ZASTAVA

101 1.1	128A.000	06/73	⇒ 01/90
YUGO 0.9	9A	04/80	⇒ 06/92

KW 812 066



04

DISTRIBUTOR CAPS

Adatt./Suitable: DELCO REMY

OPEL

12 12 140

VOLVO

3277854

32778540

03 Supplied until depletion

- Fornibile fino ad esaurimento delle scorte
- Fourni jusqu'à épuisement du stock
- Lieferbar solange vorrat reicht
- Suministrado hasta el stock termina



OPEL

CORSA A 1.0	10S	09/82	⇒ 03/93
KADETT B 1.1	11N	08/71	⇒ 08/73
KADETT D 1.0	10N	09/79	⇒ 08/82
KADETT E 1.2	12SC	09/84	⇒ 07/86

KW 812 073



07

DISTRIBUTOR CAPS

Adatt./Suitable: DELCO REMY

DELCO REMY

1 972 927

D-340

GENERAL MOTORS

01 972 927

1 972 927

OPEL

01972927

12 11 258

03 Supplied until depletion

- Fornibile fino ad esaurimento delle scorte
- Fourni jusqu'à épuisement du stock
- Lieferbar solange vorrat reicht
- Suministrado hasta el stock termina



KW 812 074



07

DISTRIBUTOR CAPS

Adatt./Suitable: DELCO REMY

DELCO REMY

1 985 771

GENERAL MOTORS

01 985 771

1 985 771

OPEL

01985771

12 11 260

00 Eliminated on 22-02-2022. Please verify the availability through our local distributors

- Eliminato il 22-02-2022. Verificare la disponibilità presso i nostri distributori
- Éliminé le 22-02-2022. Vérifier la disponibilité auprès de nos distributeurs sur place
- Am 22-02-2022 gestrichen. Evtl. Verfügbarkeit bitte bei unseren Händlern prüfen
- Eliminado en fecha 22-02-2022. Verificar la disponibilidad a través de nuestros distribuidores locales



OPEL

ASCONA C 1.6	16SV	09/86	⇒ 08/88
CORSA A 1.2	12S	09/82	⇒ 08/90
CORSA A 1.2 S	12S	09/82	⇒ 10/87
CORSA A 1.3	13NB	09/85	⇒ 10/89
KADETT E 1.3 N	13N, 13NB	09/84	⇒ 08/91
KADETT E 1.3 S	13S	09/84	⇒ 02/93
KADETT E 1.6	16SV	09/86	⇒ 12/91
KADETT E 1.6 i	16SV	07/89	⇒ 02/93
KADETT E 1.6 S	16SV	09/86	⇒ 08/91

KW 812 075



07

DISTRIBUTOR CAPS

Adatt./Suitable: DELCO REMY

BOSCH

F 005 X04 443

F 005 X04 444

DAEWOO

10467543

10496278

HOLDEN

10457153

10496278

ISUZU

8-10496278-0

03 Supplied until depletion

- Fornibile fino ad esaurimento delle scorte
- Fourni jusqu'à épuisement du stock
- Lieferbar solange vorrat reicht
- Suministrado hasta el stock termina



DAEWOO

ARANOS 1.5	V15L	01/95	⇒ 11/97
ARANOS 1.8	Y18L	01/95	⇒ 11/97
ARANOS 2.0	Y20L	01/95	⇒ 11/97
ESPERO 1.5 16V	A15MF	02/95	⇒ 06/99
ESPERO 1.8	C18LE	02/95	⇒ 06/99
ESPERO 2.0	C20LE	02/95	⇒ 06/99
NEXIA 1.5	G15MF	02/95	⇒ 08/97
NEXIA 1.5 16V	A15MF	02/95	⇒ 08/97

HOLDEN

ASTRA_LD 1.6i	16LE	07/87	⇒ 07/89
ASTRA_LD 1.8i Hatchback	18LE	07/87	⇒ 07/89
ASTRA_LD 1.8i Sedan	18LE	07/87	⇒ 07/89
CAMIRA 1.8 SPFi	6T2204X85K01	02/86	⇒ 03/87

HOLDEN		
CAMIRA 2.0 i	C20JE	04/87 ⇒ 07/89
ISUZU		
IMPULSE 1.6i [USA]	RLK	01/90 ⇒
IMPULSE 1.8i [USA]	RLX	01/91 ⇒
STYLUS 1.6i DOHC [USA]	RLK	01/90 ⇒ 12/91
STYLUS 1.6i SOHC [USA]	RLR	01/90 ⇒
STYLUS 1.8i DOHC [USA]	RLX	01/91 ⇒

KW 813 092

04

DISTRIBUTOR CAPS

Adatt./Suitable: DENSO

GENERAL MOTORS

94 216 730

HOLDEN

8942167300

TOYOTA

19101-15010

⁰³ Supplied until depletion

- Fornibile fino ad esaurimento delle scorte
- Fourni jusqu'à épuisement du stock
- Lieferbar solange vorrat reicht
- Suministrado hasta el stock termina



HOLDEN		
GEMINI_RB 1.5	4XC1	04/85 ⇒ 06/87

KW 813 093

04

DISTRIBUTOR CAPS

Adatt./Suitable: DENSO

BOSCH

F 005 X04 427

DAIHATSU

19101-2507

19101-25070-000

HOLDEN

3332160A10

3332175110

SUZUKI

8-94129202-0

8-94219202-0

OPEL

42 94 009

SUZUKI

33321-60A10

33321-60A10-000

33321-75110

33321-75110-000

TOYOTA

19101-25070

19101-38011



HOLDEN		
DROVER QB 1.3	G13A	02/85 ⇒ 12/87
JACKAROO_UBS 2.2 4x4	4ZD1	03/87 ⇒ 10/88
RODEO_KB 2.3	2.25	03/87 ⇒ 07/88
RODEO_KB 2.3 4x4	2.25	03/87 ⇒ 07/88
SCURRY_NB 1.0	F10A	10/85 ⇒ 05/86
SHUTTLE_WFR 2.0	4ZC1	06/86 ⇒ 06/89

OPEL

MIDI 2.0 i

MIDI 2.0 i 4x4

SUZUKI

SAMURAI 1.3 Trazione

integrale

SIDEKICK 1.6i [USA]

SJ410 1.0

SJ413 1.3

SUPER CARRY 1.0

VITARA 1.6 8V

TOYOTA		
STARLET 1.3 [USA]	4KE	01/82 ⇒ 12/84

KW 813 094

05

DISTRIBUTOR CAPS

Adatt./Suitable: DENSO

BOSCH

F 005 X04 426

DAIHATSU

19101-87703

19101-87703-000

FIAT

553221201

6553221201

INNOCENTI

6553221201

⁰³ Supplied until depletion

- Fornibile fino ad esaurimento delle scorte
- Fourni jusqu'à épuisement du stock
- Lieferbar solange vorrat reicht
- Suministrado hasta el stock termina



DAIHATSU		
CHARADE III 1.0	CB23, CB22	03/87 ⇒ 02/93
INNOCENTI		
500 L; LS	--	⇒ 12/86
SMALL 990	--	07/90 ⇒ 12/92

KW 813 099

07

DISTRIBUTOR CAPS

Adatt./Suitable: DENSO

BOSCH

F 005 X04 496

TOYOTA

19101-35020

19101-35120

19101-35140

19101-35180

19101-35190

19101-38210

VW

J19 101 351 80

⁰³ Supplied until depletion

- Fornibile fino ad esaurimento delle scorte
- Fourni jusqu'à épuisement du stock
- Lieferbar solange vorrat reicht
- Suministrado hasta el stock termina



TOYOTA		
4 RUNNER 2.4 i [USA]	22RE	01/88 ⇒ 12/93
HILUX IV 2.4 4WD	22R	10/88 ⇒ 12/97
HILUX V 2.4 4WD	22R	10/88 ⇒ 08/97
HILUX V 2.4 i 4WD	22RE	01/89 ⇒ 07/97
LAND CRUISER 70 2.4	22R, 22RE	11/84 ⇒ 12/96
TRUCK 2.4 i [USA]	22R, 22RE	01/88 ⇒ 12/92
VW		
TARO 2.4 i 4x4	22R	06/89 ⇒ 03/97

SUZUKI		
SAMURAI 1.3 Trazione	G13A	11/88 ⇒ 12/04
integrale		
SIDEKICK 1.6i [USA]	--	01/89 ⇒ 12/91
SJ410 1.0	F10A	09/81 ⇒ 07/91
SJ413 1.3	G13A	09/84 ⇒ 08/90
SUPER CARRY 1.0	F10A	10/85 ⇒ 03/99
VITARA 1.6 8V	--	01/90 ⇒ 12/98

KW 813 102

04

DISTRIBUTOR CAPS

Adatt./Suitable: DENSO

SUZUKI

33321-79210

33321-79210-000

⁰³ Supplied until depletion

- Fornibile fino ad esaurimento delle scorte
- Fourni jusqu'à épuisement du stock
- Lieferbar solange vorrat reicht
- Suministrado hasta el stock termina



KW 813 107

04

DISTRIBUTOR CAPS

Adatt./Suitable: DENSO

SUZUKI

33321-78110

33321-78110-000

33321-79611

33321-79611-000

33321-82010

33321-82010-000

⁰³ Supplied until depletion

- Fornibile fino ad esaurimento delle scorte
- Fourni jusqu'à épuisement du stock
- Lieferbar solange vorrat reicht
- Suministrado hasta el stock termina



MARUTI		
800 0.8	F8B	01/91 ⇒ 12/06
SUZUKI		
ALTO I 0.8	F8A, F8B	06/82 ⇒ 08/84

KW 813 113

07

DISTRIBUTOR CAPS

Adatt./Suitable: DENSO

BOSCH

F 005 X04 503

TOYOTA

19101-71010

VW

J19 101 710 10

⁰³ Supplied until depletion

- Fornibile fino ad esaurimento delle scorte
- Fourni jusqu'à épuisement du stock
- Lieferbar solange vorrat reicht
- Suministrado hasta el stock termina

²¹¹ Resistance [kOhm] 15

- Resistenza [kOhm] 15
- Résistance [kOhm] 15
- Widerstand [kOhm] 15
- Resistencia [kOhm] 15



TOYOTA		
DYNA 1.8	2Y	05/95 ⇒ 08/01
DYNA 2.0	3Y	05/95 ⇒ 10/01
DYNA 100 1.8	2Y	08/85 ⇒ 04/95
HILUX IV 1.8	2Y	08/83 ⇒ 03/89
HILUX IV 2.2	4Y	08/83 ⇒ 12/89
HILUX IV 2.2 4WD	4Y	11/85 ⇒ 12/89

813 114

TOYOTA			
HILUX V 1.8	2Y	09/88	⇒ 06/98
LITEACE 2.2	4Y-EC	01/92	⇒ 01/95
MODEL F 2.0	3Y	08/88	⇒ 01/90
MODEL F 2.2	4Y-EC	08/85	⇒ 01/90
VAN 2.0 [USA]	3YEC	01/83	⇒ 12/90
VAN 2.2 [USA]	4YEC	01/83	⇒ 12/90
VW			
TARO 1.8	2Y	04/89	⇒ 09/94
TARO 2.2	4Y	06/89	⇒ 07/94
TARO 2.2 4x4	4Y	06/89	⇒ 07/94

KW 813 114



04

DISTRIBUTOR CAPS

Adatt./Suitable: DENSO

TOYOTA

19101-71020

VW

J19 101 710 20

⁰³ Supplied until depletion

- Fornibile fino ad esaurimento delle scorte
- Fourni jusqu'à épuisement du stock
- Lieferbar solange vorrat reicht
- Suministrado hasta el stock termina



TOYOTA

DYNA 1.6	1Y	05/85	⇒ 08/87
DYNA 1.8	2Y	05/95	⇒ 08/01
DYNA 100 1.8	2Y	08/85	⇒ 04/95
DYNA 150 2.0	3Y	08/85	⇒ 08/88
HIACE III 2.0	3Y	12/82	⇒ 08/89
HIACE III 2.0 4WD	3Y	08/87	⇒ 07/89
HIACE III 2.2	4Y	09/87	⇒ 08/89
HIACE III 2.2 4WD	4Y	08/87	⇒ 08/89
HILUX IV 1.8	2Y	08/83	⇒ 03/89
HILUX IV 2.2	4Y	08/83	⇒ 12/89
HILUX IV 2.2 4WD	4Y	11/85	⇒ 12/89
HILUX V 1.8	2Y	09/88	⇒ 06/98
LITEACE 1.5	5K	10/85	⇒ 01/92
STOUT 2.2	4Y	04/88	⇒ 02/00

VW

TARO 1.8	2Y	04/89	⇒ 09/94
TARO 2.2	4Y	06/89	⇒ 07/94
TARO 2.2 4x4	4Y	06/89	⇒ 07/94

KW 813 117



04

DISTRIBUTOR CAPS

Adatt./Suitable: DENSO

BOSCH

1 987 233 120

MITSUBISHI

MD604411

⁰³ Supplied until depletion

- Fornibile fino ad esaurimento delle scorte
- Fourni jusqu'à épuisement du stock
- Lieferbar solange vorrat reicht
- Suministrado hasta el stock termina



MITSUBISHI

VALLEY 2.0	4G63-T	09/92	⇒ 10/94
------------	--------	-------	---------

KW 813 119



05

DISTRIBUTOR CAPS

Adatt./Suitable: DENSO

BOSCH

F 005 X04 492

F 005 X04 521

TOYOTA

19101-01030

19101-16080

19101-16220

⁰³ Supplied until depletion

- Fornibile fino ad esaurimento delle scorte
- Fourni jusqu'à épuisement du stock
- Lieferbar solange vorrat reicht
- Suministrado hasta el stock termina



TOYOTA

CELICA IV 1.6 GT	4A-GELC	08/87	⇒ 08/89
CELICA IV 1.6 GT 16V	4A-GEL	09/85	⇒ 08/89
CELICA IV 1.6 GTi 16V	4A-GEL	01/88	⇒ 12/89
COROLLA V 1.6	4A-GELC	05/85	⇒ 04/87
MR 2 I 1.6 16V	4A-GELC	11/84	⇒ 06/90
MR 2 I 1.6 Supercharged	4A-GZE	08/86	⇒ 12/89

KW 813 122



07

DISTRIBUTOR CAPS

Adatt./Suitable: DENSO

GENERAL MOTORS

94 404 560

ISUZU

8-94404560-0

TOYOTA

19101-11010

⁰³ Supplied until depletion

- Fornibile fino ad esaurimento delle scorte
- Fourni jusqu'à épuisement du stock
- Lieferbar solange vorrat reicht
- Suministrado hasta el stock termina

²¹¹ Resistance [kOhm] 15

- Resistenza [kOhm] 15
- Résistance [kOhm] 15
- Widerstand [kOhm] 15
- Resistencia [kOhm] 15



TOYOTA

CELICA IV 1.6	4A-L	04/86	⇒ 08/89
COROLLA VI 1.3	2E	05/87	⇒ 06/92
COROLLA VI 1.3 i	2E, 2E-E	08/87	⇒ 06/92
STARLET 1.3 12V	2E, 2E-E	12/89	⇒ 12/92
STARLET 1.3 12V Cat	2E-E	12/89	⇒ 03/96
STARLET 1.3 XL	2E	12/89	⇒ 12/91
TERCEL 1.5	--	01/86	⇒

KW 813 123



04

DISTRIBUTOR CAPS

Adatt./Suitable: DENSO

GENERAL MOTORS

96 066 464

SUBARU

33321-63B10

SUZUKI

33321-63B10

33321-63B10-000

33321-86510

33321-86510-000



SUBARU

JUSTY II 1.3i	G13BA	05/96	⇒ 09/00
---------------	-------	-------	---------

SUZUKI

ALTO IV 1.0	G10BB	09/94	⇒ 06/02
ALTO V 1.0	G10BB	01/00	⇒ 06/02
SWIFT I / II / III 1.3	G13A, G13B, G13BA	03/89	⇒ 10/96
SWIFT I / II / III 1.3 4WD	G13A	03/89	⇒ 12/91
SWIFT I / II / III 1.3 GTi SOHC	G13B	10/89	⇒ 12/95
SWIFT I / II / III 1.3 i	G13BA	09/91	⇒ 10/96
SWIFT I / II / III 1.3i SOHC [USA]	--	01/89	⇒ 12/94
SWIFT I / II / III 1.6 i 16V	G16BA	08/92	⇒ 10/96
SWIFT I / II / III 1.6 i 16V 4x4	G16BA	08/92	⇒ 10/96
SIDEKICK 1.6 JX 4x4	G16A(8V)	04/89	⇒ 04/96
SIDEKICK 1.6i 16V JX 4x4	G16B	04/89	⇒ 04/96
SWIFT III 1.3 [USA]	--	06/95	⇒ 05/01
SWIFT III 1.3 i	G13BA	06/96	⇒ 03/01
VITARA I 1.6	G16A(8V), G16B	07/88	⇒ 03/98
VITARA I 1.6 i 16V	G16B	07/90	⇒ 03/99
VITARA I 1.6 i 16V Trazione integrale	G16B	07/90	⇒ 03/98
VITARA I 1.6 Trazione integrale	G16A(8V)	07/88	⇒ 03/98

KW 813 128



04

DISTRIBUTOR CAPS

Adatt./Suitable: DENSO

DAIHATSU

19101-87207-000

⁰⁰ Eliminated on 14-04-2021. Please verify the availability through our local distributors

- Eliminato il 14-04-2021. Verificare la disponibilità presso i nostri distributori
- Éliminé le 14-04-2021. Vérifier la disponibilité auprès de nos distributeurs sur place
- Am 14-04-2021 gestrichen. Evtl. Verfügbarkeit bitte bei unseren Händlern prüfen
- Eliminado en fecha 14-04-2021. Verificar la disponibilidad a través de nuestros distribuidores locales



DAIHATSU

CUORE II 0.8	ED10	09/85	⇒ 12/90
CUORE II 0.8 4WD	ED10	09/86	⇒ 10/88
DOMINO 0.8	ED	08/85	⇒ 07/90
MIRA 847	--	01/87	⇒

KW **813 240****04****DISTRIBUTOR CAPS**Adatt./Suitable: **DENSO****BOSCH**
1 987 233 101
TOYOTA
19101-10020**00** Eliminated on 02-08-2021. Please verify the availability through our local distributors

- Eliminato il 02-08-2021. Verificare la disponibilità presso i nostri distributori
- Éliminé le 02-08-2021. Vérifier la disponibilité auprès de nos distributeurs sur place
- Am 02-08-2021 gestrichen. Evtl. Verfügbarkeit bitte bei unseren Händlern prüfen
- Eliminado en fecha 02-08-2021. Verificar la disponibilidad a través de nuestros distribuidores locales

**TOYOTA**

STARLET 1.0 | 1E | 12/89 ⇨ 12/92

KW **813 241****04****DISTRIBUTOR CAPS**Adatt./Suitable: **DENSO****SUBARU**
22162-KA010**03** Supplied until depletion

- Fornibile fino ad esaurimento delle scorte
- Fourni jusqu'à épuisement du stock
- Lieferbar solange vorrat reicht
- Suministrado hasta el stock termina

**SUBARU**E-SERIES 1.0 | -- | 01/87 ⇨ 12/92
E-SERIES 1.2 | -- | 01/87 ⇨ 12/92KW **813 245****04****DISTRIBUTOR CAPS**Adatt./Suitable: **DENSO****BOSCH**
1 987 233 128
GENERAL MOTORS
96 061 557
SUZUKI
33321-85570
33321-85570-000**SUZUKI**SWIFT I / II / III 1.0 i | G10 | 03/89 ⇨ 12/05
WAGON R III 1.0 | Z10XEP | 06/04 ⇨ 08/05
WAGON R+ II 1.0 | K10A | 08/00 ⇨ 07/03**SUZUKI**

WAGON R+ II 1.0 XT Plus | -- | 08/00 ⇨ 07/01

KW **813 248****07****DISTRIBUTOR CAPS**Adatt./Suitable: **DENSO****TOYOTA**
19101-16250**03** Supplied until depletion

- Fornibile fino ad esaurimento delle scorte
- Fourni jusqu'à épuisement du stock
- Lieferbar solange vorrat reicht
- Suministrado hasta el stock termina

**TOYOTA**

COROLLA VI 1.6 GTi | 4A-GE | 08/87 ⇨ 10/94

KW **813 251****07****DISTRIBUTOR CAPS**Adatt./Suitable: **DENSO****BOSCH**
F 005 X12 276
TOYOTA
19101-88363**00** Eliminated on 06-08-2020. Please verify the availability through our local distributors

- Eliminato il 06-08-2020. Verificare la disponibilità presso i nostri distributori
- Éliminé le 06-08-2020. Vérifier la disponibilité auprès de nos distributeurs sur place
- Am 06-08-2020 gestrichen. Evtl. Verfügbarkeit bitte bei unseren Händlern prüfen
- Eliminado en fecha 06-08-2020. Verificar la disponibilidad a través de nuestros distribuidores locales

KW **813 252****07****DISTRIBUTOR CAPS**Adatt./Suitable: **DENSO****TOYOTA**
19101-76010**03** Supplied until depletion

- Fornibile fino ad esaurimento delle scorte
- Fourni jusqu'à épuisement du stock
- Lieferbar solange vorrat reicht
- Suministrado hasta el stock termina

**TOYOTA**PREVIA I 2.4 | 2TZ-FE | 05/90 ⇨ 08/00
PREVIA I 2.4 4WD | 2TZ-FE, 2TZ-FZE | 01/90 ⇨ 12/99KW **813 254****05****DISTRIBUTOR CAPS**Adatt./Suitable: **DENSO****BOSCH**
F 005 X12 274
OPEL
43 00 976**03** Supplied until depletion

- Fornibile fino ad esaurimento delle scorte
- Fourni jusqu'à épuisement du stock
- Lieferbar solange vorrat reicht
- Suministrado hasta el stock termina

**HOLDEN**

RODEO TF 2.2 | 4ZD1 | 03/91 ⇨ 08/93

OPEL

CAMPO 2.3 | 23P | 08/94 ⇨ 09/96

KW **813 256****07****DISTRIBUTOR CAPS**Adatt./Suitable: **DENSO****BOSCH**
F 005 X12 302
SUZUKI
33321-80C10
33321-80C10-000**03** Supplied until depletion

- Fornibile fino ad esaurimento delle scorte
- Fourni jusqu'à épuisement du stock
- Lieferbar solange vorrat reicht
- Suministrado hasta el stock termina

**SUZUKI**ALTO IV 1.0 | G10BB | 09/94 ⇨ 06/02
ALTO V 1.0 | G10BB | 01/00 ⇨ 06/02
SAMURAI 1.3 | G13BA | 11/88 ⇨ 03/98
SAMURAI 1.3 Trazione integrale | G13A, G13BA | 01/00 ⇨ 12/04

KW 813 257



05

DISTRIBUTOR CAPS

Adatt./Suitable: DENSO

BOSCH

F 005 X12 272

DAIHATSU
19101-87601-000⁰³ Supplied until depletion

- Fornibile fino ad esaurimento delle scorte
- Fourni jusqu'à épuisement du stock
- Lieferbar solange vorrat reicht
- Suministrado hasta el stock termina



DAIHATSU

FEROZA 1.6 16V	HD-C	10/88 ⇒ 12/99
FEROZA 1.6 16V 4x4	HD-C	10/88 ⇒ 12/99
FEROZA 1.6 i 16V	HD-E	10/88 ⇒ 12/99
FEROZA 1.6 i 16V 4x4	HD-E	10/88 ⇒ 12/99
FEROZA 1.6i	--	01/90 ⇒
ROCKY 2.0i [USA]	--	01/89 ⇒
SPORTACK 1.6 16v 4x4	HD-C	10/88 ⇒ 08/93

KW 813 258



04

DISTRIBUTOR CAPS

Adatt./Suitable: DENSO

BOSCH

F 005 X04 522

DAIHATSU
19101-87103-000
19101-87105-000⁰³ Supplied until depletion

- Fornibile fino ad esaurimento delle scorte
- Fourni jusqu'à épuisement du stock
- Lieferbar solange vorrat reicht
- Suministrado hasta el stock termina



DAIHATSU

APPLAUSE I 1.6 16V	HD, HD-E	06/89 ⇒ 07/97
APPLAUSE I 1.6 16V 4WD	HD-E	06/89 ⇒ 07/97
CHARADE III 1.3	HC-C	09/88 ⇒ 01/92
CHARADE III 1.3i [USA]	HC-E	01/89 ⇒

KW 813 259



07

DISTRIBUTOR CAPS

Adatt./Suitable: DENSO

SUBARU

22162-KA100

⁰⁰ Eliminated on 03-02-2020. Please verify the availability through our local distributors

- Eliminato il 03-02-2020. Verificare la disponibilità presso i nostri distributori
- Éliminé le 03-02-2020. Vérifier la disponibilité auprès de nos distributeurs sur place
- Am 03-02-2020 gestrichen. Evtl. Verfügbarkeit bitte bei unseren Händlern prüfen
- Eliminado en fecha 03-02-2020. Verificar la disponibilidad a través de nuestros distribuidores locales



SUBARU

JUSTY 1.2i EMPI [USA] -- 01/91 ⇒

KW 813 262



07

DISTRIBUTOR CAPS

Adatt./Suitable: DENSO

DAIHATSU

19101-1516

19101-15160-000

TOYOTA

19101-15140

19101-15160

⁰³ Supplied until depletion

- Fornibile fino ad esaurimento delle scorte
- Fourni jusqu'à épuisement du stock
- Lieferbar solange vorrat reicht
- Suministrado hasta el stock termina

²¹¹ Resistance [kOhm] 15

- Resistenza [kOhm] 15
- Résistance [kOhm] 15
- Widerstand [kOhm] 15
- Resistencia [kOhm] 15



TOYOTA

CARINA II 1.6	4A-FE	12/87 ⇒ 03/92
CELICA V 1.6	4A-FE	09/89 ⇒ 12/93
COROLLA VI 1.6	4A-FE	08/89 ⇒ 04/92
COROLLA VI 1.6 i	4A-FE	05/87 ⇒ 05/92
COROLLA VI 1.6 i 4WD	4A-FE	10/87 ⇒ 08/90
COROLLA VI 1.6 XLI	4A-FE	11/89 ⇒ 06/92
HIACE III 1.8	2Y	12/82 ⇒ 07/89

KW 813 265



07

DISTRIBUTOR CAPS

Adatt./Suitable: DENSO

BOSCH

F 005 X04 526

HOLDEN
1910111060

HOLDEN

1910111060

TOYOTA

19101-11060

²¹¹ Resistance [kOhm] 15

- Resistenza [kOhm] 15
- Résistance [kOhm] 15
- Widerstand [kOhm] 15
- Resistencia [kOhm] 15



HOLDEN

NOVA_LF 1.8i Hatchback	7AFE	08/91 ⇒ 03/93
NOVA_LF 1.8i Sedan	7AFE	08/91 ⇒ 03/93
NOVA_LG 1.6i Hatchback	4AFE	09/94 ⇒ 09/96
NOVA_LG 1.6i Sedan	4AFE	09/94 ⇒ 09/96
NOVA_LG 1.8i Hatchback	7AFE	09/94 ⇒ 09/96
NOVA_LG 1.8i Sedan	7AFE	09/94 ⇒ 09/96

TOYOTA

AVENSIS I 1.6	4A-FE	09/97 ⇒ 10/00
CARINA E 1.6	4A-FE	04/92 ⇒ 09/97
CARINA E 1.6 16V	4A-FE	12/94 ⇒ 09/97
CARINA E 1.6 GLI	4A-FE	04/92 ⇒ 09/97
CARINA E 1.6 i	4A-FE	02/95 ⇒ 09/97
COROLLA VII 1.3 XLI	4E-FE	07/92 ⇒ 04/97
COROLLA VII 1.3 XLI 16V	4E-FE	07/92 ⇒ 09/95
COROLLA VII 1.6 GLI	4A-FE	07/92 ⇒ 04/97
COROLLA VII 1.6 Si	4A-FE	07/92 ⇒ 04/97
COROLLA VII 1.8 16V 4WD	7A-FE	09/95 ⇒ 04/97
COROLLA VII 1.8 GT	7A-FE	11/92 ⇒ 05/95
COROLLA VIII 1.6	4A-FE	04/97 ⇒ 02/00
COROLLA VIII 1.6 GLI	4A-FE	04/97 ⇒ 02/00
COROLLA VIII 1.8 4WD	7A-FE	04/97 ⇒ 10/01
CELICA VI 1.8 i 16V	7A-FE	11/93 ⇒ 11/99
CELICA VI 1.8 i 16V [USA] [CAN]	7A-FE	09/93 ⇒ 08/99
PASEO 1.5	5E-FE	06/90 ⇒ 06/99
STARLET 1.3	4E-FE	01/96 ⇒ 07/99

KW 813 267



07

DISTRIBUTOR CAPS

Adatt./Suitable: DENSO

BOSCH

1 987 233 106

HOLDEN

1910174180

TOYOTA

19101-74180

⁰³ Supplied until depletion

- Fornibile fino ad esaurimento delle scorte
- Fourni jusqu'à épuisement du stock
- Lieferbar solange vorrat reicht
- Suministrado hasta el stock termina

²¹¹ Resistance [kOhm] 15

- Resistenza [kOhm] 15
- Résistance [kOhm] 15
- Widerstand [kOhm] 15
- Resistencia [kOhm] 15



HOLDEN

APOLLO 2.2 i 08GR-FXS 03/93 ⇒ 05/97

TOYOTA

CAMRY 2.2 5S-FE 06/91 ⇒ 07/96

TOYOTA		
CARINA E 2.0	3S-FE	01/93 ⇒ 09/97
CARINA E 2.0 GLI	3S-FE	04/92 ⇒ 09/97
CARINA E 2.0 GTi	3S-GE	04/92 ⇒ 12/95
CARINA E 2.0 GTi 16V	3S-GE	03/94 ⇒ 09/97
CARINA E 2.0 i	3S-FE	12/92 ⇒ 09/97
CELICA V 2.2	5S-FE	10/89 ⇒ 12/94
FUNCRUISER 2.0 i 16V 4WD	3SFE	04/94 ⇒
MR 2 II 2.2 16V	5S-FE	01/90 ⇒ 06/95
CELICA VI 2.2 GT	5S-FE	11/93 ⇒ 08/99
RAV 4 I 2.0	3S-FE	06/97 ⇒ 09/99
RAV 4 I 2.0 4WD	3S-FE	01/94 ⇒ 06/00

KW 813 272



07

DISTRIBUTOR CAPS

Adatt./Suitable: DENSO

BOSCH
F 005 X12 899

TOYOTA
19101-66010

⁰⁰ Eliminated on 22-02-2022. Please verify the availability through our local distributors

- Eliminato il 22-02-2022. Verificare la disponibilità presso i nostri distributori
- Éliminé le 22-02-2022. Vérifier la disponibilité auprès de nos distributeurs sur place
- Am 22-02-2022 gestrichen. Evtl. Verfügbarkeit bitte bei unseren Händlern prüfen
- Eliminado en fecha 22-02-2022. Verificar la disponibilidad a través de nuestros distribuidores locales



TOYOTA

4 RUNNER 3.0	3VZ-E	08/88 ⇒ 10/95
LAND CRUISER 80 4.5	1FZ-FE	08/92 ⇒ 01/98
LAND CRUISER 80 4.5 24V	1FZ-FE	08/92 ⇒ 12/97

KW 813 273



07

DISTRIBUTOR CAPS

Adatt./Suitable: DENSO

BOSCH
F 005 X12 270

TOYOTA
19101-35010

VW
J19 101 350 10

⁰⁰ Eliminated on 06-09-2021. Please verify the availability through our local distributors

- Eliminato il 06-09-2021. Verificare la disponibilità presso i nostri distributori
- Éliminé le 06-09-2021. Vérifier la disponibilité auprès de nos distributeurs sur place
- Am 06-09-2021 gestrichen. Evtl. Verfügbarkeit bitte bei unseren Händlern prüfen
- Eliminado en fecha 06-09-2021. Verificar la disponibilidad a través de nuestros distribuidores locales

⁰³ Supplied until depletion

- Fornibile fino ad esaurimento delle scorte
- Fourni jusqu'à épuisement du stock
- Lieferbar solange vorrat reicht
- Suministrado hasta el stock termina



TOYOTA

4 RUNNER 2.4 i [USA]	22RE	01/89 ⇒ 12/93
HILUX IV 2.4 4WD	22R	10/88 ⇒ 12/97
HILUX V 2.4 4WD	22R	10/88 ⇒ 08/97
HILUX V 2.4 i 4WD	22RE	01/89 ⇒ 07/97
TRUCK 2.4 i [USA]	22RE	01/92 ⇒

VW

TARO 2.4 i 4x4	22R	06/89 ⇒ 03/97
----------------	-----	---------------

KW 813 275



07

DISTRIBUTOR CAPS

Adatt./Suitable: DENSO

BOSCH
1 987 233 107

TOYOTA
19101-11300

²¹¹ Resistance [kOhm] 15

- Resistenza [kOhm] 15
- Résistance [kOhm] 15
- Widerstand [kOhm] 15
- Resistencia [kOhm] 15



TOYOTA

COROLLA VII 1.3 12V	2E	07/92 ⇒ 04/97
COROLLA VIII 1.3	2E	05/97 ⇒ 10/01
STARLET 1.0	1E	12/89 ⇒ 12/92
STARLET 1.3 12V	2E, 2E-E	12/89 ⇒ 12/92
STARLET 1.3 12V Cat	2E-E	12/89 ⇒ 03/96
TERCEL 1.5 i [USA]	3EE	01/93 ⇒

KW 813 278



07

DISTRIBUTOR CAPS

Adatt./Suitable: DENSO

BOSCH
F 005 X04 527

HOLDEN
1910115120
1910174050

TOYOTA
19101-11032
19101-15120
19101-74050
19101-75040

²¹¹ Resistance [kOhm] 15

- Resistenza [kOhm] 15
- Résistance [kOhm] 15
- Widerstand [kOhm] 15
- Resistencia [kOhm] 15



HOLDEN

APOLLO 2.0	3S-FC	08/89 ⇒ 08/91
NOVA_LE 1.4 Hatchback	6AFC	07/89 ⇒ 07/91
NOVA_LE 1.6 Hatchback	4AFC	07/89 ⇒ 07/91
NOVA_LE 1.6 Sedan	4AFC	07/89 ⇒ 07/91

TOYOTA

CARINA II 1.6	4A-F	12/87 ⇒ 08/90
COROLLA VI 1.3	2E	05/87 ⇒ 06/92
COROLLA VI 1.3 i	2E, 2E-E	08/87 ⇒ 06/92
COROLLA VI 1.6	4A-F	05/87 ⇒ 12/92
COROLLA VI 1.6 4WD	4A-F	08/87 ⇒ 08/89
COROLLA VI 1.6 GL 4WD	4A-F	10/87 ⇒ 08/90
COROLLA VI 1.6 XL	4A-F	09/89 ⇒ 04/92
HIACE IV 2.0	1RZ	08/89 ⇒ 08/04
HIACE IV 2.4	5YTD050W07	08/89 ⇒ 08/03
HIACE IV 2.4 4WD	5YTD050W07	08/89 ⇒ 08/95

KW 815 041



04

DISTRIBUTOR CAPS

Adatt./Suitable: DUCELLIER

DUCELLIER
72 196
662 434

GENERAL MOTORS
7 992 272

RENAULT
08 54 719 900
77 01 019 886
77 01 022 175

⁰⁰ Eliminated on 04-10-2021. Please verify the availability through our local distributors

- Eliminato il 04-10-2021. Verificare la disponibilità presso i nostri distributori
- Éliminé le 04-10-2021. Vérifier la disponibilité auprès de nos distributeurs sur place
- Am 04-10-2021 gestrichen. Evtl. Verfügbarkeit bitte bei unseren Händlern prüfen
- Eliminado en fecha 04-10-2021. Verificar la disponibilidad a través de nuestros distribuidores locales

⁰³ Supplied until depletion

- Fornibile fino ad esaurimento delle scorte
- Fourni jusqu'à épuisement du stock
- Lieferbar solange vorrat reicht
- Suministrado hasta el stock termina



RENAULT

4 0.8	800, 800705	10/62 ⇒ 09/83
-------	-------------	---------------

KW 815 045



04

DISTRIBUTOR CAPS

Adatt./Suitable: **DUCELLIER**

BOSCH
1 235 522 805
1 235 522 806
1 235 525 806

CITROËN
54 524 19Z
DX 211-215A
GX 061 800 1A

⁰³ Supplied until depletion

- Fornibile fino ad esaurimento delle scorte
- Fourni jusqu'à épuisement du stock
- Lieferbar solange vorrat reicht
- Suministrado hasta el stock termina

FIAT
9920029
9921198
9934549
9935176

¹⁰⁰⁶ After depletion of stock this part is replaced by:

- Esaurite le scorte questo pezzo sarà sostituito da:
- Après épuisement du stock, cette pièce est remplacée par:
- Nach Vorraterschöpfung wird ersetzt durch:
- Después agotamiento stock, sera sustituido por:

815 058

RENAULT
77 01 012 957

TALBOT
3065 2H
3888 0
4613 6



FIAT		
242 1.6	124B3.000	10/75 ⇒ 07/82
FIORINO I 900	100GL.000	10/77 ⇒ 10/86

KW 815 049



04

DISTRIBUTOR CAPS

Adatt./Suitable: **DUCELLIER**

ALFA ROMEO
700 291
60748373

BOSCH
1 235 522 803
1 235 525 803

⁰³ Supplied until depletion

- Fornibile fino ad esaurimento delle scorte
- Fourni jusqu'à épuisement du stock
- Lieferbar solange vorrat reicht
- Suministrado hasta el stock termina

CITROËN
DM 211-15

DUCELLIER
18 132
47 430
611 149

FIAT
9916116
9935177
9937592

LAND ROVER
RTC3295

PEUGEOT
5941 06
5941 08
5941 20

RENAULT
08 51 874 100
77 01 019 468
85 51 874 100

ROVER
GDC214

VOLVO
3100771
31007719
3277442
32774422
32774424

VW
028 905 207 C



ALFA ROMEO		
ALFASUD 1.2	AR30102	06/72 ⇒ 09/84
DACIA		
1210 1.2	--	01/69 ⇒

DACIA		
1310 1.3	810-02/-99	05/83 ⇒ 07/04
1410 1.4	--	01/69 ⇒ 12/79
ARO 10	--	01/72 ⇒ 12/80

FIAT		
128 1.1	128A.000	03/69 ⇒ 12/84
850 0.8	100G.000	07/64 ⇒ 10/72
RITMO 1.1.3	149A3.000	11/83 ⇒ 08/85
RITMO II 75 1.5	138A2.000	09/85 ⇒ 12/88

PEUGEOT		
305 1.5	117(XR5S)	05/80 ⇒ 09/82

ROVER		
MINI 1.0	--	01/85 ⇒
MINI 1.3	--	01/85 ⇒

KW 815 054



04

DISTRIBUTOR CAPS

Adatt./Suitable: **DUCELLIER**

ALFA ROMEO
705 559
60749869

CHRYSLER
83 300 122

CITROËN
95 534 910

DUCELLIER
661 450
661 822
661 822 E
662 165

FIAT
9937716

PEUGEOT
5941 23

RENAULT
77 01 020 784

VOLVO
3277417
32774176



ALFA ROMEO		
3311.2	AR30585	06/83 ⇒ 12/89
3311.3	AR30168, AR30586, AR30587	06/83 ⇒ 12/89
3311.3 i.e.	AR30168	05/83 ⇒ 12/89
3311.4	AR30587	01/84 ⇒ 12/88
3311.5	AR30588	07/86 ⇒ 12/89
3311.5 4x4	AR30508, AR30588	07/86 ⇒ 12/89
3311.5 QV	AR30146, AR30508, AR30588	06/84 ⇒ 12/89
3311.7	AR30550	01/86 ⇒ 06/90
3311.7 QV	AR30550	03/88 ⇒ 12/89
ALFASUD 1.5 ti	AR30128	05/80 ⇒ 06/84

DACIA		
1410 1.4	--	01/80 ⇒

FIAT		
DUCATO I 1.8	169B	01/82 ⇒ 12/88
DUCATO I 2.0	170B, 170D, 170C(XN1T), XN1T	01/82 ⇒ 05/94

DUCATO I 2.0 4x4	170D	06/90 ⇒ 05/94
REGATA 1.1 60, 60 L	138B.000	10/83 ⇒ 08/86
REGATA 1.6	149A.000	10/84 ⇒ 06/89
REGATA 70 1.3	138B2.000, 149A3.000	09/83 ⇒ 07/89
REGATA 85 1.6	149A.000	10/83 ⇒ 06/90
RITMO I 1.1	146A4.048	04/85 ⇒ 12/87
TALENTO 2.0	170B	03/89 ⇒ 03/94

LAND ROVER		
90 2.5 4x4	17H	09/85 ⇒ 08/90
110/127 2.5 4x4	17H	10/85 ⇒ 07/90
DEFENDER 2.25	--	01/87 ⇒

PEUGEOT		
504 1.8 Injection	KF5, KF6	07/68 ⇒ 02/71
505 1.8	105(XM7), 105C(XM7A)	06/81 ⇒ 10/86
505 2.0	106E(XN1A)	09/85 ⇒ 09/95
J5 1.8	169B(XM7T)	01/83 ⇒ 11/88
J9 1.6	XC7P	03/80 ⇒ 06/87
J9 2.0	XN1P	03/80 ⇒ 06/87

RENAULT		
40.8	800705	10/83 ⇒ 10/88

RENAULT		
5 1.4 Alpine A5	840725	09/77 ⇒ 09/81
9 1.1	C1E715	09/81 ⇒ 05/87
11 1.1	C1E715, C1E720	03/83 ⇒ 06/86
19 I 1.4	C1J	01/89 ⇒ 12/92
20 2.0	829700, 829701, 829702, 829703, 829.01	10/77 ⇒ 12/83
CLIO I 1.1	C1E700	01/91 ⇒ 09/98
EXPRESS 1.1	C1E	01/85 ⇒ 10/90
EXPRESS 955	C1C	01/85 ⇒ 10/90
FUEGO 1.6 [USA] R1368	A7L752	01/82 ⇒ 12/84
MASTER I 2.0	829731	07/80 ⇒ 06/85
MASTER I 28-35 2.0	829731	08/80 ⇒ 10/86
RAPID 1.0	C1C706	09/85 ⇒ 05/92
RAPID 1.1	C1E750, C1E752, C1E754, C1E756, C1E760, C1E762, C1E764	07/85 ⇒ 10/97
SUPER 5 1.1	C1E752, C1E754, C1E756, C1E760	10/84 ⇒ 12/96
TRAFIC I 1.4	C1J700	03/80 ⇒ 06/91

TALBOT		
1307-1510 Simca 1307 1.3	--	07/75 ⇒ 01/80
SOLARA 1.3	2M102.979	02/80 ⇒ 07/86
TAGORA 2.1	5N2	06/80 ⇒ 12/83

KW 815 058



04

DISTRIBUTOR CAPS

Adatt./Suitable: **DUCELLIER**

CITROËN
75 520 155
95 539 165

DUCELLIER
16 575
19 401
22 321
607 374
608 728
609 082
611 514
660 542
661 920
662 913

FEMSA
33829-7

FIAT
9936735

FORD
A700X-12276-AGA
A770-X12276-CA
A830-X12276-FA

GENERAL MOTORS
7 992 617
7 992 857
93 150 379

LANCIA
9936735

PEUGEOT
5941 26

SEAT
000 993 673 5
SE 141914.001D



CITROËN		
AXEL 11	--, G11/631	01/84 ⇒ 03/91
BX 1.1	109LA, H1A	04/86 ⇒ 06/91
BX 1.4	150C, K1F, K2D	07/86 ⇒ 12/94
BX 1.4 E	150B(XY8), 150J, 150Y, K1F, KAZ	09/82 ⇒ 12/94
BX 1.6	B2C	02/88 ⇒ 12/94
BX 14	150C	01/86 ⇒ 02/93
BX 14 E	150A, 150C, K1G	10/82 ⇒ 02/93
BX 16	171A, 171B, 171C, 171D, BAY(XU5CP), BAZ(XU5CP)	10/82 ⇒ 12/94
C15 1.0	108C	10/84 ⇒ 07/88
C15 1.0 E	TU9K	11/92 ⇒ 07/96
C15 1.1	109K, E1A, XW7	10/84 ⇒ 12/96
C15 1.3	G1A	07/87 ⇒ 05/88
CX I 2000	829A5	06/79 ⇒ 08/85
CX II 20 RE	829A5	08/85 ⇒ 12/92
CX II 22 TRS	J6TA500	07/85 ⇒ 12/92
GS A 1.3	G13/625	07/78 ⇒ 07/86
LNA 1.1	109/SE	07/82 ⇒ 04/85

CITROËN		
VISA 11 E	109K	09/78 ⇒ 06/88
FIAT		
127 0.9	100GL.048	06/71 ⇒ 05/83
DUCATO I 2.0	170D	07/90 ⇒ 03/94
PANDA I 750	141B.000	01/86 ⇒ 01/95
PANDA I 800	100GL6.000	02/81 ⇒ 12/85
PANDA I 900	100GL3.000	10/80 ⇒ 06/94
PANDA I 900 CL	146A.048	01/86 ⇒ 04/91
UNO 45 0.9	146A.000, 146A1.000	03/83 ⇒ 07/96
UNO 45 0.9 Trend	146A.048	09/89 ⇒ 09/92
LANCIA		
A 112 0.9 Junior	A112A5.000	03/81 ⇒ 06/86
PEUGEOT		
104 0.9	108(XV5)	10/79 ⇒ 10/83
205 I 1.0	108C(XV8)	02/83 ⇒ 12/90
205 I 1.1	109F(XW7), 109N(XW7)	02/83 ⇒ 10/87
205 I 1.3	G1A	02/84 ⇒ 10/87
205 I 1.4	150(XY6B), 150B(XY8), 150D(XY7), 150G(XY7), 150H(XY8)	02/83 ⇒ 10/87
205 I 1.5	Y2/K	02/84 ⇒ 10/87
205 I 1.6	B1A(XU51C), B1E(XU51C), BAZ(XU5CP)	08/86 ⇒ 10/87
205 II 1.1	109N(XW7)	10/87 ⇒ 10/90
205 II 1.1 XA	E1	07/87 ⇒ 10/88
205 II 1.2	F1	01/87 ⇒ 12/90
205 II 1.3	G1A	08/90 ⇒ 07/92
205 II 1.4	150B(XY8), 150G(XY7), 150H(XY8)	10/87 ⇒ 05/89
205 II 1.4 CJ	150D(XY7), 150G(XY7)	03/88 ⇒ 05/89
205 II 1.4 CT	150B(XY8), 150H(XY8)	04/86 ⇒ 12/88
205 II 1.6	B1A(XU51C), B1E(XU51C), BAZ(XU5CP)	10/87 ⇒ 09/98
309 I 1.1	E1	10/85 ⇒ 07/89
309 I 1.3	G1A, G2S	10/85 ⇒ 08/89
309 I 1.3 XL	--	09/86 ⇒ 08/89
309 I 1.5	Y2/K	06/87 ⇒ 12/89
309 I 1.6	B1A(XU51C), B1D(XU51C), B1E(XU51C)	10/85 ⇒ 07/89
309 I 1.6 Cat	BAZ(XU5CP)	09/86 ⇒ 12/89
504 1.8	XM7	01/71 ⇒ 06/83
SEAT		
FURA 0.9	100GL3000	01/82 ⇒ 06/86
IBIZA I 0.9	146A000	08/86 ⇒ 05/93
PANDA 34 850	--	01/80 ⇒ 12/83
PANDA 35 850	--	01/80 ⇒ 12/83
TALBOT		
SAMBA 1.1	XW7	01/81 ⇒ 06/86

KW 815 059



04

DISTRIBUTOR CAPS

Adatt./Suitable: **DUCELLIER**

CHRYSLER

83 300 121
T1407311

CITROËN

54 656 04
54 656 04P
75 524 767
95 610 822

DUCELLIER

22 946
660 588
662 471
663 205
664 813

FIAT

9919037
9934545

PEUGEOT

5941 28

RENAULT

77 01 027 411
77 01 027 491

VOLVO

3213392
32133928
3287598
32875981

CITROËN

CX I 2400	M23-623	08/76 ⇒ 06/80
CX I 2400 GTi	M23-622	06/77 ⇒ 06/83

FIAT		
124 1200	124A.000	07/66 ⇒ 10/73
124 1400 Special	124B2.000	12/68 ⇒ 12/72
124 1600 Special T	132AC.000	01/73 ⇒ 07/75
131 1.3 Mirafiori	131A6.000	10/74 ⇒ 09/81
132 1.6	132C.000	05/77 ⇒ 09/82
PEUGEOT		
505 2.0 TI, STI	829(ZEJ)	08/79 ⇒ 10/86
RENAULT		
5 1.4 Alpine Turbo	840726	10/81 ⇒ 01/85
9 1.2	C1G700, C1G710	09/85 ⇒ 12/88
11 1.2	C1G700, C1G710	10/84 ⇒ 12/88
11 1.4	C2J720, C2J766, C2J767, C2J768	03/83 ⇒ 12/88
18 1.4	847720, 847722	04/78 ⇒ 07/86
18 1.6 TS	A6M725, A6M726	05/82 ⇒ 07/86
18 2.0	J6R716	05/82 ⇒ 07/86
19 I 1.2	C1G730	01/88 ⇒ 12/92
19 I 1.4	C2J772, C2J776, C3J710	07/88 ⇒ 05/93
19 I 1.4 Cat	C3J710	01/89 ⇒ 04/92
19 II 1.4	C3J710	04/92 ⇒ 12/95
21 1.4	C2J770, C2L717	06/88 ⇒ 10/93
21 1.6	C2L	01/87 ⇒ 12/94
25 2.0	J6R706, J6R707	04/84 ⇒ 12/92
25 2.2	J7T706, J7T707	04/84 ⇒ 12/89
CLIO I 1.2	C3G720	06/94 ⇒ 02/98
ESPACE II 2.2	J7T772	01/91 ⇒ 10/96
ESPACE II 2.2 4x4	J7T772	03/91 ⇒ 12/96
EXPRESS 1.2	C1G	01/85 ⇒ 10/90
EXPRESS 1.4	C1J, C2J	01/85 ⇒ 10/90
EXPRESS 1.4i	C3G/C3J	01/85 ⇒ 10/90
FUEGO 1.6 [USA] R136A	A7L	01/82 ⇒ 12/86
FUEGO 1.6 [USA] R136B	A7L	01/84 ⇒ 12/86
SUPER 5 1.2	C1G702	01/87 ⇒ 12/96
SUPER 5 1.4	C2J798	10/84 ⇒ 07/89
SUPER 5 1.4 Turbo	C1J784	04/85 ⇒ 08/90
TWINGO I 1.2	C3G700, C3G702	03/93 ⇒ 10/96
VOLVO		
340-360 1.3	B13, B13.4E	08/88 ⇒ 12/90
340-360 1.4	B14.3E, B14.4E, B14.4ED, B14.40, B14.45	08/82 ⇒ 07/91

KW 815 062



05

DISTRIBUTOR CAPS

Adatt./Suitable: **DUCELLIER**

DUCELLIER

666 592

03 Supplied until depletion

- Fornibile fino ad esaurimento delle scorte
- Fourni jusqu'à épuisement du stock
- Lieferbar solange vorrat reicht
- Suministrado hasta el stock termina

1246 Alternative Repair Kit

- Kit riparazione alternativo
- Kit de réparation alternative
- alternativer Reparatursatz
- Juego alternativo de reparación

815 073



RENAULT

91.7	F2N700, F2N704, F2N708, F2N710, F2N730, F2N798, F3N708, F3N718	09/84 ⇒ 12/89
11 1.7	F2N700, F2N704, F2N708, F2N710, F2N730, F2N732, F2N742, F2N798, F3N718	10/83 ⇒ 12/88

VOLVO

340-360 1.7	B172K	08/85 ⇒ 07/91
-------------	-------	---------------

KW 815 063



05

DISTRIBUTOR CAPS

Adatt./Suitable: **DUCELLIER**

CHRYSLER

83 300 124

DUCELLIER

582 514

665 757

RENAULT

77 01 029 971

77 01 202 293

VOLVO

3342161

33421611

03 Supplied until depletion

- Fornibile fino ad esaurimento delle scorte
- Fourni jusqu'à épuisement du stock
- Lieferbar solange vorrat reicht
- Suministrado hasta el stock termina

111 Paired article numbers

- N° articolo appaiato
- Numéro d'article en paire
- paarige Artikelnummer
- Referencia artículo par

815 073



RENAULT

11 1.7	F2N700	10/83 ⇒ 12/87
--------	--------	---------------

VOLVO

340-360 1.7	B172K	08/85 ⇒ 07/91
-------------	-------	---------------

KW 815 065



05

DISTRIBUTOR CAPS

Adatt./Suitable: **DUCELLIER**

CHRYSLER

83 300 123

DUCELLIER

664 369

03 Supplied until depletion

- Fornibile fino ad esaurimento delle scorte
- Fourni jusqu'à épuisement du stock
- Lieferbar solange vorrat reicht
- Suministrado hasta el stock termina

111 Paired article numbers

- N° articolo appaiato
- Numéro d'article en paire
- paarige Artikelnummer
- Referencia artículo par

815 066



RENAULT

21 2.0	14ZR, 8CPD, J6R758, J6R759, J6R793, J7R747, J7R750, J7R751	03/86 ⇒ 12/93
21 2.2	J7T754, J7T755	04/86 ⇒ 06/94
21 2.2 4x4	J7T754, J7T755	06/86 ⇒ 06/94
ESPACE II 2.0	J7R768	01/91 ⇒ 10/96
ESPACE II 2.2	J7T772, J7T773, J7T776	01/91 ⇒ 10/96
TRAFIC I 2.2	J7T600, J7T780	05/89 ⇒ 04/98
TRAFIC I 2.2 4x4	J7T600, J7T780	05/89 ⇒ 10/97

KW 815 066



05

DISTRIBUTOR CAPS

Adatt./Suitable: **DUCELLIER**

RENAULT

77 00 730 116 *B
77 01 202 683 *M

*B Available distributor cap and rotor, only not the distributor assy

- Forniti solo calotta e distributore rotante, no lo spinterogeno completo
- Disponibles seulement la tete et le rotor, non pas l'allumeur complet
- Erhältlich nur kappe und rotor, nicht der komplette verteiler
- Disponibles solo la tapa y el rotor, no el distribuidor completo

*M Kit Distributor cap / Rotor

- Kit Calotta / Distributore
- Kit Tête d'allumeur / Disrupteur
- Bausatz Verteiler/Kappe / -läufer
- Juego Tapa del distribuidor / Rotor

03 Supplied until depletion

- Fornibile fino ad esaurimento delle scorte
- Fourni jusqu'à épuisement du stock
- Lieferbar solange vorrat reicht
- Suministrado hasta el stock termina

216 contains article number

- contiene il numero articolo
- contient le numéro d'article
- beinhaltet Artikelnummer
- número de artículo incluido

815 065

915 094



RENAULT

21 2.0	14ZR, J6R758, J6R793, J7R747, J7R750, J7R751	03/86 ⇒ 12/93
21 2.0 4x4	14ZR, J7R747	03/89 ⇒ 12/93
21 2.2	J6T790, J6T791, J7T754, J7T755, J7T756	03/86 ⇒ 12/95
21 2.2 4x4	J7T754, J7T755	06/86 ⇒ 06/94
ESPACE II 2.0	J7R768	01/91 ⇒ 10/96
ESPACE II 2.2	J7T776	01/91 ⇒ 10/96
TRAFIC I 2.2	J7T600, J7T780	05/89 ⇒ 04/98
TRAFIC I 2.2 4x4	J7T600, J7T780	05/89 ⇒ 04/98

KW 815 067



04

DISTRIBUTOR CAPS

Adatt./Suitable: **DUCELLIER**

CITROËN

95 618 396

DUCELLIER

667 287

PEUGEOT

5941 41



CITROËN

BX 1.4	150C, K1F, K2D	07/86 ⇒ 12/94
BX 1.4 E	150B(XY8), 150J, 150Y, K1F, KAZ	09/82 ⇒ 12/94
BX 1.6	B2C	02/88 ⇒ 12/94
BX 1.9	159B, 159C, D6U, DKK	05/85 ⇒ 12/94

CITROËN

BX 1.9 GTi	D6D, D6K	01/87 ⇒ 01/92
BX 14	150C	01/86 ⇒ 02/93
BX 14 E	150A, 150C, K1G	10/82 ⇒ 02/93
BX 15	B1E(XU51C)	01/87 ⇒ 05/92
BX 16	171A, 171B, 171C, 171D, 23DH, B1E(XU51C), BAY(XU5CP), BAZ(XU5CP)	10/82 ⇒ 12/94
BX 19	159A, D2A(XU92C), D2C(XU92C), D2E, D6A(XU9J2), DKZ(XU9JA)	09/84 ⇒ 12/94
BX 19 Cat	DFZ(XU9J1)	07/86 ⇒ 12/94
BX 19 E 4x4	D2F	04/89 ⇒ 02/93
BX 19 GTi	D6A(XU9J2), DKZ(XU9JA)	07/86 ⇒ 02/93
BX 19 GTi 4x4	DKZ(XU9JA)	06/88 ⇒ 02/93
C15 1.4	150D(XY7)	05/87 ⇒ 10/92
C15 1.4 E	150D(XY7)	05/87 ⇒ 12/96

PEUGEOT

205 I 1.0	108C(XV8)	10/87 ⇒ 12/90
205 I 1.1	109F(XW7), 109N(XW7)	02/83 ⇒ 10/87
205 I 1.4	150(XY6B), 150D(XY7), 150G(XY7)	02/83 ⇒ 10/87
205 I 1.6	B1A(XU51C), B1E(XU51C), BAZ(XU5CP)	08/86 ⇒ 10/87
205 I 1.9 GTI	DFZ(XU9J1)	03/87 ⇒ 10/87
205 II 1.1	109N(XW7)	10/87 ⇒ 10/90
205 II 1.4	150(XY6B), 150B(XY8), 150D(XY7), 150G(XY7)	01/87 ⇒ 05/89
205 II 1.4 CJ	150D(XY7), 150G(XY7)	03/88 ⇒ 05/89
205 II 1.6	B1A(XU51C), B1E(XU51C), BAZ(XU5CP)	10/87 ⇒ 09/98
205 II 1.9 CTI	DFZ(XU9J1)	10/87 ⇒ 12/94
205 II 1.9 GTI Cat	DFZ(XU9J1)	10/87 ⇒ 07/94
309 I 1.6	B1A(XU51C), B1D(XU51C), B1E(XU51C)	10/85 ⇒ 07/89
309 I 1.6 Cat	BAZ(XU5CP)	09/86 ⇒ 12/89
309 I 1.9	D2B(XU9S), DFZ(XU9J1), XU92C	10/85 ⇒ 07/89
309 II 1.9	XU92C	07/89 ⇒ 12/93
405 I 1.9	DFZ(XU9J1)	05/88 ⇒ 08/92
405 I 1.9 Antipollution	XU92C	01/87 ⇒ 12/92
405 I 1.9 Injection	DFZ(XU9J1)	07/87 ⇒ 12/92
405 I 1.9 Trazione integrale	DFZ(XU9J1)	09/88 ⇒ 07/92

KW 815 068



04

DISTRIBUTOR CAPS

Adatt./Suitable: **DUCELLIER**

AUDI

026 905 207 A

DUCELLIER

666 349

SEAT

026 905 207 A

VW

026 905 207 A



AUDI

80 II 1.6	DT	08/78 ⇒ 03/87
80 II 1.8	DS	01/83 ⇒ 08/86
80 III 1.4	SE	08/86 ⇒ 07/88
80 III 1.6	PP, RN, RNA	09/86 ⇒ 09/91
80 III 1.8	RU	10/86 ⇒ 01/90
80 III 1.8 S	NE	09/86 ⇒ 10/91
100 III 1.8	DS, NP	08/83 ⇒ 12/90
100 III 1.8 quattro	NP, SH	10/84 ⇒ 07/90
A4 I 1.6	ADP	11/94 ⇒ 09/01

SEAT

CORDOBA I 1.6 i	1F	05/94 ⇒ 06/99
CORDOBA I 1.8 i	ABS, ACC, ADZ	02/93 ⇒ 09/02
IBIZA II 1.6 i	1F	09/94 ⇒ 06/99
IBIZA II 1.8 i	ABS, ACC, ADZ	03/93 ⇒ 08/99
INCA 1.4 i	AEX, AKV, APQ	11/95 ⇒ 06/03
INCA 1.6 i	1F, AEE	11/95 ⇒ 05/98
TOLEDO I 1.8 i	ADZ	11/93 ⇒ 12/96

VW

PASSAT II 1.6	DT	08/80 ⇒ 03/88
PASSAT II 1.8	DS	01/83 ⇒ 03/88
PASSAT II 1.8 Syncro	DS	01/86 ⇒ 03/88

VW

PASSAT IV 1.6	ADP	10/96 ⇒ 11/00
JETTA II 1.6	ABN, EZ, EZA, PN, RF	01/84 ⇒ 07/92
JETTA II 1.8	GU	08/84 ⇒ 10/91
JETTA II 1.8 Syncro	GU	08/87 ⇒ 12/88
CADDY III 1.6	1F	11/95 ⇒ 05/97
CADDY II 75 1.6	1F	11/95 ⇒ 05/97
GOLF I 1.6	EW	08/83 ⇒ 04/92
GOLF I 1.8	EX	08/83 ⇒ 09/92
GOLF II 1.6	ABN, EZ, PN, RF	08/83 ⇒ 12/92
GOLF II 1.6 G	EZA, PN	08/86 ⇒ 07/91
GOLF II 1.8	GU	08/84 ⇒ 10/91
GOLF II 1.8 Syncro	GU	02/86 ⇒ 07/91
GOLF III 1.6	AEK	07/94 ⇒ 04/99
GOLF III 1.8	AAM, ABS, ADZ	08/91 ⇒ 04/99
GOLF III 1.8 Syncro	ABS, ADZ	01/93 ⇒ 04/99
GOLF III 2.0	ADY, AEP, AGG, AKR	11/91 ⇒ 04/99
GOLF III 2.0 GL	AEP	08/95 ⇒ 09/97
GOLF IV 2.0	AGG, AKR	06/98 ⇒ 06/02
PASSAT III 1.6	AEK	07/94 ⇒ 08/96
PASSAT III 1.8	AAM, ABS, ADZ	02/88 ⇒ 05/97
POLO III 75 1.6	1F	11/95 ⇒ 09/97
SCIROCCO II 1.6	EW, EWA, RE	01/83 ⇒ 07/90
SCIROCCO II 1.8	EX	08/83 ⇒ 07/92
VENTO 1.6	AEK	10/94 ⇒ 09/98
VENTO 1.8	AAM, ABS, ADZ	11/91 ⇒ 09/98

KW 815 069



05

DISTRIBUTOR CAPS

Adatt./Suitable: **DUCELLIER**

DUCELLIER

525 536 F

2 524 086

RENAULT

77 00 726 736

VOLVO

3342442

33424425

3342862

33428624

1246 Alternative Repair Kit

- Kit riparazione alternativo
- Kit de réparation alternative
- alternativer Reparatursatz
- Juego alternativo de reparación

815 072



RENAULT

19 I 1.7	F2N720, F2N721, F2N722, F2N724, F3N740, F3N741, F3N742, F3N743, F3N746	07/88 ⇒ 12/92
19 II 1.7	F2N720, F2N721, F2N726, F2N727, F3N740, F3N741, F3N742, F3N743, F3N746	09/90 ⇒ 12/95
19 II 1.8	5F140FE, 8NA20S, F3P682, F3P704, F3P705, F3P706, F3P707, F3P708, F3P764, F3P765	04/92 ⇒ 06/96
21 1.7	F2N710, F2N711, F2N712, F2N722, F2N750, F2N752, F2N754, F2N758, F2N786, F3N722, F3N723, F3N726	03/86 ⇒ 12/95
21 1.7 Cat	F3N726	05/88 ⇒ 06/93
21 2.0	F2R702	09/89 ⇒ 12/91
CLIO I 1.7	F2N770	01/91 ⇒ 12/93
CLIO I 1.8	F3P710, F3P714, F3P754	01/91 ⇒ 09/98
CLIO I 1.8 Rsi	F3P712, F3P758	01/93 ⇒ 09/98
SUPER 5 1.7	F2N740, F2N742, F3N716, F3N717	10/86 ⇒ 03/95
SUPER 5 1.7 i	F3N702	10/86 ⇒ 08/91
TRAFIC I 1.7	F1N720	05/89 ⇒ 08/94

VOLVO

440 1.6	B16F	09/88 ⇒ 12/96
440 1.7	B18E, B18EP, B18F, B18FP, B18K, B18KD, B18KP, B18KPD	08/88 ⇒ 12/96
440 1.7 Turbo	B18FT	08/88 ⇒ 12/96
440 1.8	B18U	08/91 ⇒ 12/96
440 2.0	B20F	08/92 ⇒ 07/96
460 1.6	B16F	07/92 ⇒ 07/96
460 1.7	B18EP, B18FP, B18K, B18KD, B18KP	09/88 ⇒ 07/96
460 1.7 Turbo	B18FT	08/89 ⇒ 07/96
460 1.8	B18U	08/91 ⇒ 07/96
460 2.0	B20F	08/92 ⇒ 07/96

VOLVO		
480 1.7	B18E, B18ED, B18EP, B18F, B18FP	04/86 ⇒ 07/96
480 1.7 Turbo	B18FT	08/87 ⇒ 07/96
480 2.0	B20F	08/92 ⇒ 09/95

KW 815 070



04

DISTRIBUTOR CAPS

Adatt./Suitable: **DUCELLIER**

DUCELLIER

665 752
2 524 128RENAULT
77 01 029 973

VOLVO

3342164
33421645
3342443
33424433
3342864
33428640

111 Paired article numbers

- N° articolo appaiato
- Numéro d'article en paire
- paarige Artikelnummer
- Referencia artículo par

815 072 815 073



RENAULT

CLIO 1.8 | F3P710, F3P714, F3P754 | 01/91 ⇒ 09/98

KW 815 071



05

DISTRIBUTOR CAPS

Adatt./Suitable: **DUCELLIER**

111 Paired article numbers

- N° articolo appaiato
- Numéro d'article en paire
- paarige Artikelnummer
- Referencia artículo par

815 072



VOLVO

440 1.6	B16F	09/88 ⇒ 12/96
440 1.7	B18E, B18EP, B18F, B18FP, B18K, B18KD, B18KP, B18KPD	08/88 ⇒ 12/96
440 1.7 Turbo	B18FT	08/88 ⇒ 12/96
440 1.8	B18U	08/91 ⇒ 12/96
440 2.0	B20F	08/92 ⇒ 07/96
460 1.6	B16F	07/92 ⇒ 07/96
460 1.7	B18EP, B18FP, B18K, B18KD, B18KP	09/88 ⇒ 07/96
460 1.7 Turbo	B18FT	08/89 ⇒ 07/96
460 1.8	B18U	08/91 ⇒ 07/96
460 2.0	B20F	08/92 ⇒ 07/96
480 1.7	B18E, B18ED, B18EP, B18F, B18FP	04/86 ⇒ 07/96
480 1.7 Turbo	B18FT	08/87 ⇒ 07/96
480 2.0	B20F	08/92 ⇒ 09/95

KW 815 072



05

DISTRIBUTOR CAPS

Adatt./Suitable: **DUCELLIER**

DUCELLIER

525 536 *M
525 536 B *MRENAULT
77 00 102 012 *M
77 00 736 209 *M
77 00 851 781 *M

VOLVO

3342440 *M
33424409 *M

216 contains article number

- contiene il numero articolo
- contient le numéro d'article
- beinhaltet Artikelnummer
- número de artículo incluido

815 069



RENAULT

19 I 1.7	F2N720, F2N721, F2N722, F2N724, F3N740, F3N741, F3N742, F3N743, F3N746	07/88 ⇒ 12/92
19 II 1.7	F2N720, F2N721, F2N726, F2N727, F3N740, F3N741, F3N742, F3N743, F3N746	09/90 ⇒ 12/95
19 II 1.8	5F140FE, 8NA20S, F3P682, F3P704, F3P705, F3P706, F3P707, F3P708, F3P764, F3P765	04/92 ⇒ 06/96
21 1.7	F2N710, F2N711, F2N712, F2N722, F2N750, F2N752, F2N754, F2N758, F2N786, F3N722, F3N723, F3N726	03/86 ⇒ 12/95
21 1.7 Cat	F3N726	05/88 ⇒ 06/93
21 2.0	F2R702	09/89 ⇒ 12/91
CLIO I 1.7	F2N770	01/91 ⇒ 12/93
CLIO I 1.8	F3P710, F3P714, F3P754	01/91 ⇒ 09/98
CLIO I 1.8 Rsi	F3P712, F3P758	01/93 ⇒ 09/98
SUPER 5 1.7	F2N740, F2N742, F3N716, F3N717	10/86 ⇒ 03/95
SUPER 5 1.7 i	F3N702	10/86 ⇒ 08/91
TRAFIC I 1.7	F1N720	05/89 ⇒ 08/94

KW 815 073



05

DISTRIBUTOR CAPS

Adatt./Suitable: **DUCELLIER**

DUCELLIER

525 409 D *M
666 203 *M
666 778 *M

RENAULT

77 00 733 982 *M

*M Kit Distributor cap / Rotor

- Kit Calotta / Distributore
- Kit Tête d'allumeur / Disrupteur
- Bausatz VerteilerKappe / -läufer
- Juego Tapa del distribuidor / Rotor

03 Supplied until depletion

- Fornibile fino ad esaurimento delle scorte
- Fourni jusqu'à épuisement du stock
- Lieferbar solange vorrat reicht
- Suministrado hasta el stock termina



RENAULT

11 1.7 | F2N700 | 10/83 ⇒ 12/87

KW 815 074



04

DISTRIBUTOR CAPS

Adatt./Suitable: **DUCELLIER**

CITROËN

95 624 985

DUCELLIER

2 524 134

PEUGEOT

5941 46



CITROËN

AX 1.3 Sport	M4A	04/87 ⇒ 12/88
AX 10	C1A	09/86 ⇒ 06/92
AX 10 E	C3A	12/86 ⇒ 12/88
AX 11	H1A, H1B, HDZ(TU1M)	09/86 ⇒ 12/97
AX 11 4x4	H1A	06/91 ⇒ 07/92
AX 11 Cat	HAZ(TU1CP)	09/88 ⇒ 12/89
AX 14	K1A(TU3), K1B, K1F, K1G, K1J, K2A, K2B, K2D, KAY(TU3CP), KDX(TU3M/Z), KDY(TU3FM), KDY(TU3M), KDZ(TU3M/Z)	09/86 ⇒ 04/97
AX 14 4x4	KD4, KDX(TU3M/Z), KDY(TU3FM), KDZ(TU3M/Z)	06/91 ⇒ 12/96
AX 14 GT	KDZ(TU3M/Z)	01/89 ⇒ 12/91
BX 1.1	109LA, H1A	04/86 ⇒ 06/91
BX 1.4	150C, K1F, K2D	07/86 ⇒ 12/94
BX 1.4 E	150B(XY8), 150J, 150Y, K1F, KAZ	09/82 ⇒ 12/94
BX 1.6	B2C	02/88 ⇒ 12/94
BX 1.9	159B, 159C, D6U, DKK	05/85 ⇒ 12/94
BX 1.9 GTi	D6D, D6K	01/87 ⇒ 01/92
BX 14	150C, KDY(TU3M), KDZ(TU3M/Z)	01/86 ⇒ 02/93
BX 14 E	150A, 150C, K1G	10/82 ⇒ 02/93
BX 15	B1E(XU51C)	01/87 ⇒ 05/92

CITROËN		
BX 16	171A, 171B, 171C, 171D, 23DH, B1E(XU51C), BAY(XU5CP), BAZ(XU5CP), BDY(XU5M), BDZ(XU5M)	10/82 ⇒ 12/94
BX 16 E	BDY(XU5M), BDZ(XU5M)	05/89 ⇒ 02/93
BX 19	159A, D2A(XU92C), D2C(XU92C), D2E, D6A(XU9J2), DDZ(XU9M), DKZ(XU9JA)	09/84 ⇒ 12/94
BX 19 4x4	DDZ(XU9M)	10/90 ⇒ 05/91
BX 19 Cat	DFZ(XU9J1)	07/86 ⇒ 12/94
BX 19 E	DDZ(XU9M)	06/88 ⇒ 02/93
BX 19 E 4x4	D2F	04/89 ⇒ 02/93
BX 19 GTi	D6A(XU9J2), DKZ(XU9JA)	07/86 ⇒ 02/93
BX 19 GTi 4x4	DKZ(XU9JA)	06/88 ⇒ 02/93
C15 1.0	108C(XV8), C1A, C1A(TU9/K), C1B(TU9/W), TU9	10/84 ⇒ 12/97
C15 1.1	H1A, HDZ(TU1M), TU1	08/88 ⇒ 07/96
C15 1.1 i	HDZ(TU1M), TU1MZ	07/88 ⇒ 12/96
C15 1.4	K1A, K1G, K1H(TU3A), KDY(TU3M)	07/87 ⇒ 12/96
C15 1.4 E	K1F, K1J, K2D, K3A, KAZ	07/86 ⇒ 12/96
C15 1.4 i	KDY(TU3FM), KDY(TU3M)	05/91 ⇒ 12/96
JUMPER I 2.0	XU102C	02/94 ⇒ 02/02
XM I 2.0	--	05/89 ⇒ 04/94
XM I 2.0 i	RDZ(XU10MZ), RFZ(XU10J2)	05/89 ⇒ 06/94
BERLINGO I 1.4	TU32	07/96 ⇒ 10/98
ZX 1.1	H1A, H1B, HDZ(TU1M), TU1	03/91 ⇒ 06/97
ZX 1.4 i	KDY(TU3M)	10/93 ⇒ 10/97
ZX 1.9	D6E(XU9JA)	03/91 ⇒ 06/97
ZX 1.9 i	DKZ(XU9JA), XU9JA	03/91 ⇒ 06/97
PEUGEOT		
106 I 1.0	TU9	09/91 ⇒ 03/01
106 I 1.1	H1B(TU1), HDZ(TU1M)	08/91 ⇒ 04/96
106 I 1.4	K5A(TU3), KDY(TU3M), TU3.2	08/91 ⇒ 04/96
106 II 1.1	H1B(TU1)	04/96 ⇒
205 I 1.4	TU3	01/83 ⇒ 12/90
205 I 1.6	B1A(XU51C), B1E(XU51C)	08/86 ⇒ 10/87
205 II 1.0	TU9	10/87 ⇒ 09/98
205 II 1.1	H1B(TU1), HDZ(TU1M)	10/87 ⇒ 09/98
205 II 1.1 CJ	HDZ(TU1M)	10/89 ⇒ 12/94
205 II 1.4	K1D(TU3A), K2B(TU3S), KDY(TU3M), KDZ(TU3M)	06/87 ⇒ 09/98
205 II 1.4 CJ	K1D(TU3A), KDY(TU3M)	03/89 ⇒ 12/94
205 II 1.6	B1A(XU51C), B1E(XU51C)	10/87 ⇒ 09/98
205 II 1.9 GTI	DKZ(XU9JAZ)	10/87 ⇒ 10/94
306 1.4	TU3	01/93 ⇒ 04/02
309 I 1.4	K1D(TU3A), K2B(TU3S), KDY(TU3M), KDZ(TU3M)	08/88 ⇒ 08/89
309 II 1.1	H1B(TU1), HDZ(TU1M)	09/89 ⇒ 12/93
309 II 1.4	KDZ(TU3M), TU3, TU3F2	07/89 ⇒ 12/93
309 II 1.6	18EM, BDZ(XU5M)	07/89 ⇒ 12/93
309 II 1.9	DDZ(XU9M), XU92C	07/89 ⇒ 12/93
309 II 1.9 GTI	DKZ(XU9JAZ)	07/89 ⇒ 12/93
405 I 1.4	K5A(TU3), TU3A, TU3F2	01/87 ⇒ 12/92
405 I 1.6	--, 18EM, B1E(XU51C), BDZ(XU5M)	01/87 ⇒ 12/92
405 I 1.6 4x4	BDZ(XU5M)	04/88 ⇒ 07/92
405 I 1.6 SRi 4x4	BDZ(XU5M)	04/88 ⇒ 07/92
405 I 1.9	D2C(XU92C), DDZ(XU9M), DKZ(XU9JAZ), XU9J2, XU9J2/D6D	01/87 ⇒ 12/92
405 I 1.9 4x4	DDZ(XU9M), DKZ(XU9JAZ)	06/87 ⇒ 12/92
405 II 1.4	TU3F2	01/93 ⇒ 12/96
405 II 1.6	18EM	08/92 ⇒ 05/97
405 II 1.9	XU92C	01/93 ⇒ 12/96
605 2.0	--, RSA(XU102C), XU10M	01/89 ⇒ 09/99

KW 815 075



05

DISTRIBUTOR CAPS

Adatt./Suitable: **DUCELLIER****DUCELLIER**
2 537 268⁰³ Supplied until depletion

- Fornibile fino ad esaurimento delle scorte
- Fourni jusqu'à épuisement du stock
- Lieferbar solange vorrat reicht
- Suministrado hasta el stock termina



KW 815 077



05

DISTRIBUTOR CAPS

Adatt./Suitable: **DUCELLIER****CITROËN**
91 538 999
96 074 954**DUCELLIER**
2 590 935**PEUGEOT**
5941 45
5941 48⁰³ Eliminated on 16-02-2022. Please verify the availability through our local distributors

- Eliminato il 16-02-2022. Verificare la disponibilità presso i nostri distributori
- Éliminé le 16-02-2022. Vérifier la disponibilité auprès de nos distributeurs sur place
- Am 16-02-2022 gestrichen. Evtl. Verfügbarkeit bitte bei unseren Händlern prüfen
- Eliminado en fecha 16-02-2022. Verificar la disponibilidad a través de nuestros distribuidores locales

**CITROËN**

BX 1.9 GTi 16V	159K, DFK	01/87 ⇒ 12/94
BX 19 GTi 16V	D6C(XU9J4), DFW(XU9J4)	09/87 ⇒ 02/93

PEUGEOT

309 II 1.9 GTi 16V	D6C(XU9J4)	08/89 ⇒ 07/90
405 I 1.9	D6C(XU9J4)	06/87 ⇒ 07/92
405 I 1.9 4x4	D6C(XU9J4)	06/87 ⇒ 07/92
405 I 1.9 Sport MI-16	D6C(XU9J4), DFW(XU9J4Z)	06/87 ⇒ 11/92
405 I 1.9 Sport MI-16 4x4	DFW(XU9J4Z)	06/87 ⇒ 07/92
405 I 1.9 Trazione integrale	D6C(XU9J4)	06/87 ⇒ 07/92

KW 815 078



05

DISTRIBUTOR CAPS

Adatt./Suitable: **DUCELLIER****CITROËN**91 539 003 *M
91 541 615 *M
96 038 183 *M
96 038 185 *M**DUCELLIER**2 525 628 *M
2 525 628 B *M⁰³ Eliminated on 16-02-2022. Please verify the availability through our local distributors

- Eliminato il 16-02-2022. Verificare la disponibilità presso i nostri distributori
- Éliminé le 16-02-2022. Vérifier la disponibilité auprès de nos distributeurs sur place
- Am 16-02-2022 gestrichen. Evtl. Verfügbarkeit bitte bei unseren Händlern prüfen
- Eliminado en fecha 16-02-2022. Verificar la disponibilidad a través de nuestros distribuidores locales

²¹⁶ Kit Distributor cap / Rotor

- Kit Calotta / Distributore
- Kit Tête d'allumeur / Disrupteur
- Bausatz VerteilerKappe / -läufer
- Juego Tapa del distribuidor / Rotor

²¹⁶ contains article number

- contiene il numero articolo
- contient le numéro d'article
- beinhaltet Artikelnummer
- número de artículo incluido

815 075

**CITROËN**

BX 1.9 GTi 16V	159K, DFK	01/87 ⇒ 12/94
BX 19 GTi 16V	D6C(XU9J4), DFW(XU9J4)	09/87 ⇒ 02/93

PEUGEOT

309 II 1.9 GTi 16V	D6C(XU9J4)	08/89 ⇒ 07/90
405 I 1.9	D6C(XU9J4)	06/87 ⇒ 07/92
405 I 1.9 4x4	D6C(XU9J4)	06/87 ⇒ 07/92
405 I 1.9 Sport MI-16	D6C(XU9J4), DFW(XU9J4Z)	06/87 ⇒ 11/92
405 I 1.9 Sport MI-16 4x4	DFW(XU9J4Z)	06/87 ⇒ 07/92
405 I 1.9 Trazione integrale	D6C(XU9J4)	06/87 ⇒ 07/92

KW **815 079**

04

DISTRIBUTOR CAPS

Adatt./Suitable: **DUCELLIER****DUCELLIER**
667 308⁰³ Supplied until depletion

- Fornibile fino ad esaurimento delle scorte
- Fourni jusqu'à épuisement du stock
- Lieferbar solange vorrat reicht
- Suministrado hasta el stock termina



PEUGEOT		
604 2.0 i	XN6	01/85 ⇒ 12/86
RENAULT		
18 2.0	J6R716	05/82 ⇒ 07/86
ESPACE I 2.0	53AZ-FXE, J6R234, J6R236	07/84 ⇒ 12/90
MASTER I 2.0	J5R718, J5R728	06/85 ⇒ 12/95
MASTER I 2.2	J7T788	08/93 ⇒ 02/98
MASTER I 28-35 2.0	J5R718	10/86 ⇒ 07/98
MASTER I 30 2.2	J7T782, J7T788	08/80 ⇒ 07/98
TRAFIC I 2.0	J5R716	05/89 ⇒ 08/90

KW **815 080**

04

DISTRIBUTOR CAPS

Adatt./Suitable: **DUCELLIER****DUCELLIER**
2 537 065**FIAT**

9941721

LANCIA

9941721



FIAT		
PANDA I 1000	156A2.000	12/93 ⇒
PANDA I 1000 CLX	156A2.000	05/91 ⇒ 12/94
PANDA I 1000 Fire	156A2.000	05/86 ⇒ 04/91
PANDA I 750	156A4.000	01/86 ⇒ 10/03
PANDA I 750 Cat	156A4.048	01/95 ⇒ 10/03
PANDA I 750 Fire	156A4.048	11/88 ⇒ 04/91
TIPO I 1.1	160A3.000	01/88 ⇒ 10/91
UNO 45 1.0	156A2.000	09/89 ⇒ 09/92
UNO 45 1.0 Fire	--	01/83 ⇒ 12/89
UNO 60 1.1	160A3.000	04/89 ⇒ 12/92
LANCIA		
Y10 1.0 Fire Trazione integrale	156A2.000, 156A2.100, 156A2.246	12/86 ⇒ 02/92
Y10 1.1 i.e Fire	156C.000	08/89 ⇒ 06/92
Y10 1.1 i.e Fire Trazione integrale	156C.000	08/89 ⇒ 06/92

KW **815 081**

04

DISTRIBUTOR CAPS

Adatt./Suitable: **DUCELLIER****RENAULT**

77 01 033 621



RENAULT		
19 I 1.2i	E7F	01/89 ⇒ 12/92
19 I 1.4	E6J700, E6J701, E7J700	01/88 ⇒ 12/92
19 I 1.8 16V	F7P700, F7P704	06/89 ⇒ 09/92
19 II 1.2	E7F730	05/92 ⇒ 09/94
19 II 1.4	E6J706, E7J706, E7J707, E7J742, E7J745	01/92 ⇒ 12/95
19 II 1.8 16V	F7P704	04/92 ⇒ 06/96
25 2.0 12V	74AR-FXE, 7CYQD80D-E3, J7R721	06/88 ⇒ 12/93
CLIO I 1.2	E5F710, E5F716, E7F700, E7F706, E7F708, E7F750	05/90 ⇒ 09/98
CLIO I 1.4	E6J712, E6J713, E6J718, E7J601, E7J710, E7J711, E7J716, E7J718, E7J719, E7J754, E7J756, E7J757	01/90 ⇒ 09/98
CLIO I 1.8 16V	F7P720, F7P722	01/91 ⇒ 03/96
CLIO I Williams	F7R700	01/94 ⇒ 09/98
MEGANE I 1.4	E7J764	09/96 ⇒ 08/03
MEGANE I 1.4 e	E7J764	01/96 ⇒ 08/03
MEGANE I 1.4 Eco	E7J624	01/96 ⇒ 03/99
MEGANE SCÉNIC I 1.4 i	E7J764	01/97 ⇒ 09/99
RAPID 1.4	E6J738, E7J720, E7J724, E7J726, E7J728, E7J770, E7J771, E7J773	09/91 ⇒ 03/98
RAPID 1.4 RN	E6J734	09/91 ⇒ 08/93
SAFRANE I 2.0	0LJY, J7R732, J7R738, J7R739	08/92 ⇒ 09/96
SAFRANE I 2.0 12V	J7R734, J7R735	04/92 ⇒ 07/96
SAFRANE I 2.2	1MR4790B, J7T761, J7T762	04/92 ⇒ 07/96
TRAFIC I 2.0	J5R726	05/89 ⇒ 08/90
TRAFIC I 2.0 RWD	J5R726	05/89 ⇒ 10/97

KW **815 082**

05

DISTRIBUTOR CAPS

Adatt./Suitable: **DUCELLIER****RENAULT**

77 01 203 118

¹¹¹ Paired article numbers

- N° articolo appaiato
- Numéro d'article en paire
- paarige Artikelnummer
- Referencia artículo par

815 083

RENAULT		
21 2.0	J7R740	02/90 ⇒ 06/94
21 2.0 4x4	J7R740	12/89 ⇒ 02/94
21 2.0 Turbo	J7R752, J7R756	04/87 ⇒ 10/92
21 2.0 Turbo 4x4	J7R752, J7R756	08/89 ⇒ 10/93
21 2.0 TXi	1SCRMP10U1, J7R740	07/89 ⇒ 05/93
CLIO I 1.8 16V	F7P720, F7P722	01/91 ⇒ 03/96
CLIO I Williams	F7R700	01/94 ⇒ 09/98
SAFRANE I 2.0	0LJY, J7R732, J7R738, J7R739	08/92 ⇒ 09/96
SAFRANE I 2.0 12V	J7R734, J7R735	04/92 ⇒ 07/96

RENAULT

SAFRANE I 2.2	1MR4790B, J7T761, J7T762	04/92 ⇒ 07/96
---------------	--------------------------	---------------

KW **815 083**

05

DISTRIBUTOR CAPS

Adatt./Suitable: **DUCELLIER****DUCELLIER**

2 525 645 A *B

RENAULT77 00 739 893 *B
77 00 742 853 *B
77 00 743 290 *M
77 00 743 602 *M
77 01 203 118 *M^{*B} Available distributor cap and rotor, only-not the distributor assy

- Forniti solo calotta e distributore rotante, no lo spinterogeno completo
- Disponibles seulement la tete et le rotor, non pas l'allumeur complet
- Erhältlich nur kappe und rotor, nicht der komplette verteiler
- Disponibles solo la tapa y el rotor, no el distribuidor completo

^{*M} Kit Distributor cap / Rotor

- Kit Calotta / Distributore
- Kit Tête d'allumeur / Disrupteur
- Bausatz VerteilerKappe / -läufer
- Juego Tapa del distribuidor / Rotor



RENAULT		
21 2.0	J7R740	02/90 ⇒ 06/94
21 2.0 4x4	J7R740	12/89 ⇒ 02/94
21 2.0 Turbo	J7R752, J7R756	04/87 ⇒ 10/92
21 2.0 Turbo 4x4	J7R752, J7R756	08/89 ⇒ 10/93
21 2.0 TXi	1SCRMP10U1, J7R740	07/89 ⇒ 05/93
25 2.0 12V	74AR-FXE, 7CYQD80D-E3, J7R721	06/88 ⇒ 12/93
CLIO I 1.8 16V	F7P720, F7P722	01/91 ⇒ 03/96
CLIO I Williams	F7R700	01/94 ⇒ 09/98
SAFRANE I 2.0	0LJY, J7R732, J7R738, J7R739	08/92 ⇒ 09/96
SAFRANE I 2.0 12V	J7R734, J7R735	04/92 ⇒ 07/96
SAFRANE I 2.2	1MR4790B, J7T761, J7T762	04/92 ⇒ 07/96

KW **815 084**

07

DISTRIBUTOR CAPS

Adatt./Suitable: **DUCELLIER****GENERAL MOTORS**

90 442 011

OPEL

12 11 275

⁰³ Supplied until depletion

- Fornibile fino ad esaurimento delle scorte
- Fourni jusqu'à épuisement du stock
- Lieferbar solange vorrat reicht
- Suministrado hasta el stock termina



OPEL		
ASTRA F 1.6	16LZ2, 16NZ2	09/94 ⇒ 09/98
ASTRA F 1.8 i	C18NZ	09/91 ⇒ 09/98
ASTRA F 2.0 i	C20NE	09/91 ⇒ 09/98
CALIBRA A 2.0 i	C20NE	08/89 ⇒ 12/96
CALIBRA A 2.0 i 4x4	C20NE	06/90 ⇒ 07/97
FRONTERA A 2.0 i	C20NE	03/92 ⇒ 10/98
KADETT E 1.8	18SE	01/86 ⇒ 08/91
KADETT E 1.8 i	C18NZ, S18NV	06/85 ⇒ 05/92

OPEL			
KADETT E 2.0 GSI	20NE, 20SEH	09/86 ⇒ 08/91	
KADETT E 2.0 GSI Cat	C20NE	09/86 ⇒ 08/91	
KADETT E 2.0 i	20NE	10/86 ⇒ 02/93	
KADETT E 2.0 i Cat	C20NE	10/86 ⇒ 02/93	
OMEGA A 1.8	18SEH, E18NVR, S18NV	09/86 ⇒ 03/94	
OMEGA A 1.8 N	18NV	09/86 ⇒ 08/87	
OMEGA A 1.8 S	18SV	09/86 ⇒ 03/94	
OMEGA A 2.0	20SE, C20NE	09/86 ⇒ 04/94	
OMEGA A 2.0 i	C20NE	09/86 ⇒ 04/94	
OMEGA B 2.0	20SE	03/94 ⇒ 12/00	
VECTRA 1.6	C16LZ2	08/92 ⇒ 07/93	
VECTRA 1.6 i	C16NZ2	09/88 ⇒ 11/95	
VECTRA 1.6 i Cat	C16NZ2	09/88 ⇒ 11/95	
VECTRA A 1.8 i	18SV	09/88 ⇒ 10/90	
VECTRA A 1.8 i Cat	C18NZ	03/90 ⇒ 11/95	
VECTRA A 1.8 S	18SV, E18NVR	09/88 ⇒ 10/90	
VECTRA A 1.8 S 4x4	E18NVR	01/89 ⇒ 07/89	
VECTRA A 2.0 i	20NE, 20SEH	09/88 ⇒ 09/92	
VECTRA A 2.0 i 4x4	20NE, 20SEH	01/89 ⇒ 07/92	
VECTRA A 2.0 i Cat	C20NE	09/88 ⇒ 11/95	
VECTRA A 2.0 i Cat 4x4	C20NE	01/89 ⇒ 11/95	
VECTRA A 2.0 i GT	20SEH	09/88 ⇒ 11/95	
VECTRA B 1.6 i	16LZ2	10/95 ⇒ 07/03	
VAUXHALL			
ASTRA III 1.8 i	C18NZ	09/91 ⇒ 09/98	
ASTRA III 2.0 i	C20NE	09/91 ⇒ 09/98	
CALIBRA 2.0 i	C20NE	06/90 ⇒ 07/97	
CALIBRA 2.0 i 4x4	C20NE	06/90 ⇒ 07/97	
FRONTERA A 2.0	C20NE	04/95 ⇒ 08/98	
FRONTERA A 2.0 i	C20NE	03/92 ⇒ 10/98	
OMEGA B 2.0	20SE	09/95 ⇒ 09/96	

KW 815 086

05

DISTRIBUTOR CAPS

Adatt./Suitable: **DUCELLIER**

DUCELLIER
2 525 623 D *M
RENAULT
77 00 859 053 *M

- *M Kit Distributor cap / Rotor**
- Kit Calotta / Distributore
 - Kit Tête d'allumeur / Disrupteur
 - Bausatz VerteilerKappe / -läufer
 - Juego Tapa del distribuidor / Rotor



RENAULT

CLIO I 1.8	0HR10DE	08/90 ⇒ 09/98
LAGUNA I 1.8	F3P678, F3P720, F3P724	11/93 ⇒ 03/01
LAGUNA I 2.0	6Z7U730, F3R722	11/93 ⇒ 03/01

KW 815 087

04

DISTRIBUTOR CAPS

Adatt./Suitable: **DUCELLIER**

CITROËN
5940 57
FIAT
9567469880

- 212 Resistance Rotor [Ohm] 1000**
- Rotore resistenza [Ohm] 1000
 - Résistance roteur [ohm] 1000
 - Widerstand-Rotor [Ohm] 1000
 - Resistencia rotor [ohm] 1000



CITROËN

AX 1.3 Sport	M4A	04/87 ⇒ 12/88
AX 10	C1A	09/86 ⇒ 06/92
AX 10 E	C3A	12/86 ⇒ 12/88
AX 11	H1A, H1B, HDZ(TU1M)	09/86 ⇒ 12/97
AX 11 4x4	H1A	06/91 ⇒ 07/92
AX 11 Cat	HAZ(TU1CP)	09/88 ⇒ 12/89
AX 14	K1A(TU3), K1B, K1F, K1G, K1J, K2A, K2B, K2D, KAY(TU3CP), KDX(TU3M/Z), KDY(TU3FM), KDZ(TU3M/Z)	09/86 ⇒ 04/97
AX 14 4x4	KD4, KDX(TU3M/Z), KDY(TU3FM), KDZ(TU3M/Z)	06/91 ⇒ 12/96
AX 14 GT	KDZ(TU3M/Z)	01/89 ⇒ 12/91
BX 1.1	109LA, H1A	04/86 ⇒ 06/91
BX 1.4	150C, K1F, K2D	07/86 ⇒ 12/94
BX 1.4 E	150B(XY8), 150J, 150Y, K1F, KAZ	09/82 ⇒ 12/94
BX 1.6	B2C	02/88 ⇒ 12/94
BX 1.9	159B, 159C, D6U, DKK	05/85 ⇒ 12/94
BX 1.9 GTi	D6D, D6K	01/87 ⇒ 01/92
BX 14	150C, KDY(TU3M), KDZ(TU3M/Z)	01/86 ⇒ 02/93
BX 14 E	150A, 150C, K1G	10/82 ⇒ 02/93
BX 15	B1E(XU51C)	01/87 ⇒ 05/92

KW 815 085

05

DISTRIBUTOR CAPS

Adatt./Suitable: **DUCELLIER****111 Paired article numbers**

- N° articolo appaiato
- Numéro d'article en paire
- paarige Artikelnummer
- Referencia artículo par

815 086



RENAULT

CLIO I 1.8	0HR10DE	08/90 ⇒ 09/98
LAGUNA I 1.8	F3P678, F3P720, F3P724	11/93 ⇒ 03/01
LAGUNA I 2.0	6Z7U730, F3R722	11/93 ⇒ 03/01

CITROËN

BX 16	171A, 171B, 171C, 171D, 23DH, B1E(XU51C), BAY(XU5CP), BAZ(XU5CP), BDY(XU5M), BDZ(XU5M)	10/82 ⇒ 12/94
BX 16 E	BDY(XU5M), BDZ(XU5M)	05/89 ⇒ 02/93
BX 19	159A, D2A(XU92C), D2C(XU92C), D2E, D6A(XU9J2), DDZ(XU9M), DKZ(XU9JA)	09/84 ⇒ 12/94
BX 19 4x4	DDZ(XU9M)	10/90 ⇒ 05/91
BX 19 Cat	DFZ(XU9J1)	07/86 ⇒ 12/94
BX 19 E	DDZ(XU9M)	06/88 ⇒ 02/93
BX 19 E 4x4	D2F	04/89 ⇒ 02/93
BX 19 GTi	D6A(XU9J2), DKZ(XU9JA)	07/86 ⇒ 02/93
BX 19 GTi 4x4	DKZ(XU9JA)	06/88 ⇒ 02/93
C15 1.0	108C(XV8), C1A, C1A(TU9/K), C1B(TU9/W), TU9	10/84 ⇒ 12/97
C15 1.1	H1A, HDZ(TU1M), TU1	08/88 ⇒ 07/96
C15 1.1 i	HDZ(TU1M), TU1MZ	07/88 ⇒ 12/96
C15 1.4	K1A, K1G, K1H(TU3A), KDY(TU3M)	07/87 ⇒ 12/96
C15 1.4 E	K1F, K1J, K2D, K3A, KAZ	07/86 ⇒ 12/96
C15 1.4 i	KDY(TU3FM), KDY(TU3M)	05/91 ⇒ 12/96
JUMPER I 2.0	XU102C	02/94 ⇒ 02/02
XMI 2.0	--	05/89 ⇒ 04/94
XMI 2.0 i	RDZ(XU10MZ), RFZ(XU10J2)	05/89 ⇒ 06/94
BERLINGO I 1.4	TU32	07/96 ⇒ 10/98
ZX 1.1	H1A, H1B, HDZ(TU1M), TU1	03/91 ⇒ 06/97
ZX 1.4 i	KDY(TU3M)	10/93 ⇒ 10/97
ZX 1.9	D6E(XU9JA)	03/91 ⇒ 06/97
ZX 1.9 i	DKZ(XU9JA), XU9JA	03/91 ⇒ 06/97
FIAT		
DUCATO II 2.0	--, R5B	03/94 ⇒ 12/95

KW 815 088

04

DISTRIBUTOR CAPS

Adatt./Suitable: **DUCELLIER**

RENAULT
77 01 202 755 *M

***M Kit Distributor cap / Rotor**

- Kit Calotta / Distributore
- Kit Tête d'allumeur / Disrupteur
- Bausatz VerteilerKappe / -läufer
- Juego Tapa del distribuidor / Rotor

03 Supplied until depletion

- Fornibile fino ad esaurimento delle scorte
- Fourni jusqu'à épuisement du stock
- Lieferbar solange vorrat reicht
- Suministrado hasta el stock termina

216 contains article number

- contiene il numero articolo
- contient le numéro d'article
- beinhaltet Artikelnummer
- número de artículo incluido

815 067

915 096R



RENAULT

ESPACE I 2.0 i	J7R760	01/89 ⇒ 12/90
ESPACE I 2.0 i Quadra	J7R760	03/88 ⇒ 12/92
ESPACE I 2.2	20G15DE	07/86 ⇒ 12/90
ESPACE I 2.2 Quadra	20G15DE	01/88 ⇒ 12/90

KW **815 091**

04

DISTRIBUTOR CAPSAdatt./Suitable: **DUCELLIER****RENAULT**

77 00 729 838 *B

*B Available distributor cap and rotor, only-not the distributor assy

- Forniti solo calotta e distributore rotante, no lo spinterogeno completo
- Disponibles seulement la tete et le rotor, non pas l'allumeur complet
- Erhältlich nur kappe und rotor, nicht der komplette verteiler
- Disponibles solo la tapa y el rotor, no el distribuidor completo

*03 Supplied until depletion

- Fornibile fino ad esaurimento delle scorte
- Fourni jusqu'à épuisement du stock
- Lieferbar solange vorrat reicht
- Suministrado hasta el stock termina

216 contains article number

- contiene il numero articolo
- contient le numéro d'article
- beinhaltet Artikelnummer
- número de artículo incluido

815 059**915 088**

RENAULT		
21 1.4	C2L714	06/88 ⇨ 12/95
25 2.0	08A, J6R763, J7R722, J7R723	04/84 ⇨ 12/93
25 2.0 12V	74AR-FXE, 7CYQD80D-E3, J7R721	06/88 ⇨ 12/93
25 2.2	04TNV88-C, 74G69-S4M, J7T708, J7T715, J7T730, J7T731, J7T732	04/84 ⇨ 12/92
RAPID 1.2	C1G726, C3G710, C3G712	09/91 ⇨ 03/98
RAPID 1.4	C1J768, C1J780, C2J784	07/85 ⇨ 08/91
RAPID 1.4 Cat	C3J700, C3J702, C3J760, C3J762	08/88 ⇨ 03/98
SUPER 5 1.2	C1G720, C1G722	01/87 ⇨ 08/90
SUPER 5 1.4	C1J768, C1J780, C1J788, C2J700, C2J780, C2J781, C2J782, C2J784, C2J788, C2J789, C3J700	10/84 ⇨ 08/90
SUPER 5 1.4 Cat	C3J700, C3J702, C3J760	10/85 ⇨ 12/96
SUPER 5 1.4 Turbo	C1J782, C1J788	04/85 ⇨ 08/90

KW **817 014**

07

DISTRIBUTOR CAPSAdatt./Suitable: **FEMSA****GENERAL MOTORS**

93 150 093

SEAT000 389 978 9
186035.06
SE 141914.001C

*00 Eliminated on 29-07-2020. Please verify the availability through our local distributors

- Eliminato il 29-07-2020. Verificare la disponibilità presso i nostri distributori
- Éliminé le 29-07-2020. Vérifier la disponibilité auprès de nos distributeurs sur place
- Am 29-07-2020 gestrichen. Evtl. Verfügbarkeit bitte bei unseren Händlern prüfen
- Eliminado en fecha 29-07-2020. Verificar la disponibilidad a través de nuestros distribuidores locales



SEAT		
IBIZA I 0.9	146A000	08/86 ⇨ 05/93
MARBELLA 0.9	09NCA	01/87 ⇨ 12/93
PANDA 0.9	100GL3000	10/80 ⇨ 12/86
PANDA 45	--	01/82 ⇨ 12/85
TERRA 0.9	09NCA	02/87 ⇨ 12/96

KW **817 016**

07

DISTRIBUTOR CAPSAdatt./Suitable: **FEMSA****FIAT**

9936814

SEAT000 993 681 4
186036.06
NG1 860 360 6
SE 127914.001A

*03 Supplied until depletion

- Fornibile fino ad esaurimento delle scorte
- Fourni jusqu'à épuisement du stock
- Lieferbar solange vorrat reicht
- Suministrado hasta el stock termina



FIAT		
127 0.9	100GL.048	06/71 ⇨ 05/83

SEAT		
FURA 0.9	100GL3000	01/82 ⇨ 06/86
MARBELLA 0.8	5K9K718	08/86 ⇨ 12/93
PANDA 34 850	--	01/80 ⇨ 12/83
PANDA 35 850	--	01/80 ⇨ 12/83

KW **817 023**

04

DISTRIBUTOR CAPSAdatt./Suitable: **FEMSA****RENAULT**

77 02 124 325



RENAULT		
4 0.8	80001	09/71 ⇨ 12/88
4 1.1	688712	02/78 ⇨ 06/90
5 1.4	847725	01/82 ⇨ 12/85
11 1.4	C2J720, C2J766, C2J767, C2J768	03/83 ⇨ 12/88
11 1.7	F2N700	10/83 ⇨ 12/87
18 1.4	847720, 847722	04/78 ⇨ 07/86
19 I 1.2	C1G730	01/88 ⇨ 12/92
19 I 1.4	C2J772, C2J776, C3J710	07/88 ⇨ 05/93
19 I 1.4 Cat	C3J710	01/89 ⇨ 04/92
19 II 1.4	C3J710	04/92 ⇨ 12/95
EXPRESS 1.1	C1E	01/85 ⇨ 10/90
EXPRESS 955	C1C	01/85 ⇨ 10/90
RAPID 1.1	C1E750, C1E760	07/85 ⇨ 04/95
SUPER 5 1.0	C1C700	10/84 ⇨ 10/88

KW **817 029**

07

DISTRIBUTOR CAPSAdatt./Suitable: **FEMSA****SEAT**

SE 028914.001B

*03 Supplied until depletion

- Fornibile fino ad esaurimento delle scorte
- Fourni jusqu'à épuisement du stock
- Lieferbar solange vorrat reicht
- Suministrado hasta el stock termina



SEAT		
MARBELLA 0.8	5K9K718	08/86 ⇨ 12/93

KW 819 083



07

DISTRIBUTOR CAPS

Adatt./Suitable: FORD

FORD

0 267 2617
0 623 389
1 462 196
5 014 402
C6AH-12106-A
C7KH-12106-A

⁰³ Supplied until depletion

- Fornibile fino ad esaurimento delle scorte
- Fourni jusqu'à épuisement du stock
- Lieferbar solange vorrat reicht
- Suministrado hasta el stock termina

GENERAL MOTORS

7 992 207

Motorcraft

EDH 12
EDH 12 D
EDH 12 S
EDH 16



FORD		
CORTINA 1300	KL13H	10/70 ⇒ 03/72
FIESTA I 0.9	TKA, TKW, TLA	05/76 ⇒ 08/83
FIESTA I 1.3	J3E	08/77 ⇒ 08/83
TAUNUS 1.6	LCJ	07/79 ⇒ 07/82
TRANSIT I 1.6	4RB	11/77 ⇒ 10/86
TRANSIT I 2.0	4RC	11/77 ⇒ 07/82

KW 819 092



07

DISTRIBUTOR CAPS

Adatt./Suitable: FORD

FORD

1 628 315
1 641 810
1 665 193
E3EE-12106-BA
E3EE-12106-BB
E5FZ-12106-B
E5FZ-12106-C
E9FZ-12106-A

⁰³ Supplied until depletion

- Fornibile fino ad esaurimento delle scorte
- Fourni jusqu'à épuisement du stock
- Lieferbar solange vorrat reicht
- Suministrado hasta el stock termina

Motorcraft

DH 390
DH 390B
DH 390E
DHE 411
EDH 390



FORD		
SIERRA I 2.0	NR2	03/85 ⇒ 12/86
SIERRA I 2.0 i	NR2	03/85 ⇒ 12/86
SCORPIO I 2.0 i	NRA, NRI	04/85 ⇒ 02/92

KW 819 093



07

DISTRIBUTOR CAPS

Adatt./Suitable: FORD

FORD

1 643 632
E6AE-12106-CA
E6AZ-12106-A

JEEP

33004024
56026876

MAZDA

ZZM0-24-310
ZZM1-24-310
ZZM2-24-310

Motorcraft

DH 433
DH 434

RENAULT

89 33 004 024
89 56 026 876

⁰³ Supplied until depletion

- Fornibile fino ad esaurimento delle scorte
- Fourni jusqu'à épuisement du stock
- Lieferbar solange vorrat reicht
- Suministrado hasta el stock termina



JEEP		
CHEROKEE II 4.0 i	--, 1Z7K, ERH, MX	10/86 ⇒ 09/01
CHEROKEE II 4.0 i 4x4	ERH	01/95 ⇒ 09/01
COMANCHE 4.0 i	1Z7K	10/87 ⇒ 09/90
GRAND CHEROKEE 4.0 Laredo	ERH	10/96 ⇒ 09/98
GRAND WAGONEER 4.0 i	1Z7K	10/86 ⇒ 09/90
WAGONEER 4.0 i	1Z7K	10/86 ⇒ 09/90
WRANGLER 4.0	1Z7K, ERH	10/86 ⇒ 09/96

KW 822 003



04

DISTRIBUTOR CAPS

Adatt./Suitable: HITACHI

BOSCH

F 005 X04 549

DAIHATSU

19101-87301

GENERAL MOTORS

7 992 396
94 021 067

HITACHI

44612700
82311214

HOLDEN

GH506

ISUZU

94021G67

MAZDA

3710-24-310

NISSAN

15501-208
22162-21007
22162-71300
22162-71312
22162-N8801
22162-N8801MP

⁰³ Supplied until depletion

- Fornibile fino ad esaurimento delle scorte
- Fourni jusqu'à épuisement du stock
- Lieferbar solange vorrat reicht
- Suministrado hasta el stock termina



HOLDEN		
ASTRA_LB 1.5	E15	08/84 ⇒ 01/86
NISSAN		
VANETTE II 1.5	A15	04/87 ⇒ 11/94

KW 822 011



04

DISTRIBUTOR CAPS

Adatt./Suitable: HITACHI

HONDA

30102-PA1-732
30102-PA6-924
30102-PC1-004

LEYLAND

GDC147
GDC307

⁰⁰ Eliminated on 15-01-2020. Please verify the availability through our local distributors

- Eliminato il 15-01-2020. Verificare la disponibilità presso i nostri distributori
- Éliminé le 15-01-2020. Vérifier la disponibilité auprès de nos distributeurs sur place
- Am 15-01-2020 gestrichen. Evtl. Verfügbarkeit bitte bei unseren Händlern prüfen
- Eliminado en fecha 15-01-2020. Verificar la disponibilidad a través de nuestros distribuidores locales



HONDA		
CIVIC II 1.3 [USA]	--	01/81 ⇒ 12/83

KW 822 022



05

DISTRIBUTOR CAPS

Adatt./Suitable: HITACHI

HONDA

30102-PD2-006
30102-PD2-016

⁰³ Supplied until depletion

- Fornibile fino ad esaurimento delle scorte
- Fourni jusqu'à épuisement du stock
- Lieferbar solange vorrat reicht
- Suministrado hasta el stock termina



HONDA		
ACCORD III 1.6 L	A16A1	11/85 ⇒ 12/89
ACCORD III 2.0	A20A2	01/86 ⇒ 12/86
ACCORD III 2.0 16V EXS	B20A2	01/88 ⇒ 12/89
ACCORD III 2.0 EX	A20A2	11/85 ⇒ 05/89
ACCORD III 2.0 i 16V	B20A2, B20A8	01/87 ⇒ 12/89
ACCORD VI 1.6	A16A5	10/98 ⇒ 12/02
CIVIC III 1.5 i Si [USA]	--	01/84 ⇒ 12/87
ROVER		
200 I 213 S	EV2	09/85 ⇒ 09/89

KW 822 040



07,5

DISTRIBUTOR CAPS

Adatt./Suitable: **HITACHI****BOSCH**F 005 X04 563
F 005 X04 581**03 Supplied until depletion**

- Fornibile fino ad esaurimento delle scorte
- Fourni jusqu'à épuisement du stock
- Lieferbar solange vorrat reicht
- Suministrado hasta el stock termina

NISSAN22162-06W00
22162-06W03
22162-06W03MP
22162-06W04
22162-06W04MP
22162-06W05
22162-06W06
22162-18F01
22162-W4502
B2162-06W05**NISSAN**

200 SX 1.8i Turbo	CA18ET	01/87 ⇒
PICK UP I 2.4 [USA]	Z24i	01/85 ⇒ 12/89
TERRANO I 2.4 i 4WD	Z24i	10/87 ⇒ 02/93
URVAN III 2.4 i	Z24i	05/89 ⇒ 09/93
VAN 2.4 [USA]	Z24i	01/86 ⇒ 12/89
VANETTE II 2.0	Z20S	07/87 ⇒ 08/94

KW 822 041



04

DISTRIBUTOR CAPS

Adatt./Suitable: **HITACHI****BOSCH**

1 987 233 108

03 Supplied until depletion

- Fornibile fino ad esaurimento delle scorte
- Fourni jusqu'à épuisement du stock
- Lieferbar solange vorrat reicht
- Suministrado hasta el stock termina

NISSAN

22162-KA020

SUBARU22162-KA020
22162-KA050**SUBARU**

J-SERIES 1.0i EFC-SYS	--	01/89 ⇒
J-SERIES 1.2	--	01/87 ⇒ 12/91
J-SERIES 1.2 SDX	--	01/89 ⇒ 12/91
J-SERIES 1.2i EFC-SYS	--	01/89 ⇒
JUSTY 1.2 [USA]	--	01/87 ⇒ 12/92
TRENDY 1.0	EF10	08/86 ⇒ 05/95
TRENDY 1.2 12v	EF12	06/86 ⇒ 08/95

KW 822 046



05

DISTRIBUTOR CAPS

Adatt./Suitable: **HITACHI****FORD**

1 953 281

03 Supplied until depletion

- Fornibile fino ad esaurimento delle scorte
- Fourni jusqu'à épuisement du stock
- Lieferbar solange vorrat reicht
- Suministrado hasta el stock termina

NISSAN22162-01B01
22162-12E01
22162-17M00
22162-17M01
22162-17M02
22162-17M03
22162-17M04
22162-17M05
22162-21F03
22162-40F00
22162-78A00**SUBARU**

22162-AA040

SUZUKI33321-64B10
33321-64B10-000**FORD**

MAVERICK 2.4 i	KA24E	02/93 ⇒ 08/96
----------------	-------	---------------

NISSAN

100NX 1.6	GA16DS	03/90 ⇒ 10/94
BLUEBIRD 1.8 Turbo	CA18T	04/84 ⇒ 11/92
BLUEBIRD 2.0 i	CA20E	04/84 ⇒ 12/90
NX1600 1.6i [USA]	GA16, GA16DE	01/88 ⇒ 12/92
PICK UP I 2.4 i [USA]	KA24E	01/89 ⇒
PICK UP I 2.4 i 12V	KA24E	04/92 ⇒ 02/98
PICK UP I 2.4 i 12V 4WD	KA24E	04/92 ⇒ 02/98
PRIMERA I 1.6 i	GA16DS	07/90 ⇒ 03/98
PULSAR NX 1.6 [USA]	GA16	01/88 ⇒
SENTRA III 1.6i [USA]	GA16DE	01/90 ⇒ 12/92
SILVIA 1.8	--	01/84 ⇒
SUNNY II 1.0 L	E10S	07/86 ⇒ 09/90
SUNNY II 1.6 i 12V	GA16i	06/86 ⇒ 06/91
SUNNY III 1.6 16V 4x4	GA16DS	11/90 ⇒ 05/95
SUNNY III 1.6 i	GA16DE, GA16DS	10/90 ⇒ 03/00
SUNNY III 1.6 i 16V 4WD	GA16DE, GA16DS	10/90 ⇒ 06/95
SUNNY III 1.6 i 16V 4x4	GA16DE	10/92 ⇒ 03/00
TERRANO II 2.4 4WD	KA24E	05/96 ⇒ 09/07
TERRANO II 2.4 i 12V 4WD	KA24E	02/93 ⇒ 12/97

SUBARU

LOYALE 1.8i SPi [USA]	--	01/90 ⇒
LOYALE 1.8i Turbo [USA]	--	01/90 ⇒
L-SERIES 1.8i	--	01/86 ⇒ 12/91
L-SERIES 1.8i TB	--	01/86 ⇒ 12/91
L-SERIES 1.8i TB 4x4	--	01/86 ⇒ 12/91
L-SERIES 1.8i Turbo	--	01/86 ⇒ 12/91
XT 1.8 [USA]	--	01/87 ⇒ 12/92

SUZUKI

SWIFT I / II / III 1.3 GTi	G13B	03/89 ⇒ 05/01
SWIFT I / II / III 1.3 GTi DOHC	G13B	10/89 ⇒ 12/95
SWIFT I / II 1.3 GTi/GXi	G13B	08/85 ⇒ 03/89

KW 822 048



04

DISTRIBUTOR CAPS

Adatt./Suitable: **HITACHI****HITACHI**

43J83-17001

SUBARU

49100-5501

03 Supplied until depletion

- Fornibile fino ad esaurimento delle scorte
- Fourni jusqu'à épuisement du stock
- Lieferbar solange vorrat reicht
- Suministrado hasta el stock termina

**SUBARU**

J-SERIES 1.0	--	01/87 ⇒ 12/91
TRENDY 1.0	EF10	08/86 ⇒ 05/95

KW 822 057



07

DISTRIBUTOR CAPS

Adatt./Suitable: **HITACHI****BOSCH**

F 005 X04 565

HOLDEN2216215M04
GH617**NISSAN**22162-15M00
22162-15M01
22162-15M01MP
22162-15M02
22162-15M02MP
22162-15M03
22162-15M03MP
22162-15M04
22162-52A01**SUBARU**

49100-8711

03 Supplied until depletion

- Fornibile fino ad esaurimento delle scorte
- Fourni jusqu'à épuisement du stock
- Lieferbar solange vorrat reicht
- Suministrado hasta el stock termina

**HOLDEN**

ASTRA_LB 1.5	E15	08/84 ⇒ 01/86
ASTRA_LC 1.6	E16S	02/86 ⇒ 06/87

NISSAN

LAUREL 2.0 GL	CA20S	11/84 ⇒ 12/85
PULSAR 1.6	E16	01/84 ⇒ 12/86
PULSAR 1.6 [USA]	E16	01/82 ⇒ 12/83
SUNNY II 1.0 L	E10S	07/86 ⇒ 09/90
SUNNY II 1.3	E13S	06/86 ⇒ 10/91
SUNNY II 1.5	E15S	06/86 ⇒ 10/88
SUNNY II 1.6	E16S	06/86 ⇒ 10/88

SUBARU

L-SERIES 1.3	--	01/79 ⇒ 12/91
L-SERIES 1.6	--	01/86 ⇒ 12/87

KW 822 058



05

DISTRIBUTOR CAPS

Adatt./Suitable: **HITACHI****SUBARU**
22162-AA030**00 Eliminated on 22-02-2022. Please verify the availability through our local distributors**

- Eliminato il 22-02-2022. Verificare la disponibilità presso i nostri distributori
- Éliminé le 22-02-2022. Vérifier la disponibilité auprès de nos distributeurs sur place
- Am 22-02-2022 gestrichen. Evtl. Verfügbarkeit bitte bei unseren Händlern prüfen
- Eliminado en fecha 22-02-2022. Verificar la disponibilidad a través de nuestros distribuidores locales

**SUBARU**

L-SERIES 1.6 -- | 01/87 ⇒ 12/91

KW 822 060



05

DISTRIBUTOR CAPS

Adatt./Suitable: **HITACHI****BOSCH**
F 005 X12 695**GENERAL MOTORS**
94 322 990**HOLDEN**
8943229900**HONDA**
8-94322-990-0**ISUZU**
8-94322990-0**OPEL**
43 00 982**03 Supplied until depletion**

- Fornibile fino ad esaurimento delle scorte
- Fourni jusqu'à épuisement du stock
- Lieferbar solange vorrat reicht
- Suministrado hasta el stock termina

**HOLDEN**

RODEO_TF 2.6i 4ZE1 | 08/88 ⇒ 03/96

RODEO_TF 2.6i 4x4 4ZE1 | 08/88 ⇒ 03/96

HONDA

PASSPORT 2.6 i [USA] 4ZE1 | 01/94 ⇒

ISUZU

AMIGO 2.3i [USA] LW3 | 01/88 ⇒

AMIGO 2.6i [USA] RLJ | 01/88 ⇒

PICK-UP 2.3i [USA] LW3 | 01/88 ⇒

PICK-UP 2.6i [USA] RLJ | 01/88 ⇒

RODEO 2.6i [USA] RLJ | 01/90 ⇒

OPEL

CAMPO 2.3 23P | 08/94 ⇒ 09/96

KW 822 063



05

DISTRIBUTOR CAPS

Adatt./Suitable: **HITACHI****NISSAN**
22162-11E07**00 Eliminated on 14-04-2020. Please verify the availability through our local distributors**

- Eliminato il 14-04-2020. Verificare la disponibilità presso i nostri distributori
- Éliminé le 14-04-2020. Vérifier la disponibilité auprès de nos distributeurs sur place
- Am 14-04-2020 gestrichen. Evtl. Verfügbarkeit bitte bei unseren Händlern prüfen
- Eliminado en fecha 14-04-2020. Verificar la disponibilidad a través de nuestros distribuidores locales

**NISSAN**

BLUEBIRD 1.6 CA16S | 12/85 ⇒ 06/90

BLUEBIRD 1.6 DX CA16S | 11/83 ⇒ 02/88

BLUEBIRD 2.0 CA20S | 12/85 ⇒ 09/90

KW 822 068



07

DISTRIBUTOR CAPS

Adatt./Suitable: **HITACHI****ACURA**

30102-P54-006

30102-PT2-006

BOSCH

1 987 233 127

F 005 X12 891

HONDA

30102-P54-006

30102-PCB-004

30102-PEL-J01

30102-PT2-006

30102-PT2-016

30102-PT2-026

ROVER

GDC405

GDC406

NJD100150

**ACURA**

INTEGRA II 1.8 F18A2 | 10/90 ⇒ 09/93

INTEGRA III 1.8 LS F18C1 | 10/93 ⇒ 09/01

INTEGRA III 1.8 Sport F18C1 | 10/93 ⇒ 09/01

HONDA

ACCORD IV 2.0 16V F20A5 | 01/90 ⇒ 12/93

ACCORD IV 2.0 i 16V F20A4, F20A7, F20A8, F20Z3 | 01/90 ⇒ 12/93

ACCORD IV 2.2 F22A6 | 05/92 ⇒ 12/93

ACCORD IV 2.2 i 16V F22A3, F22A7, F22A8 | 01/90 ⇒ 12/93

ACCORD IV 2.2 i 16V F22A3 | 01/90 ⇒ 03/93

ACCORD V 1.8 16V F18A3 | 01/94 ⇒ 12/95

ACCORD V 2.0 F20B3 | 09/93 ⇒ 12/97

ACCORD V 2.0 i F20Z2 | 03/93 ⇒ 01/96

ACCORD V 2.0 i LS 16V F20B3 | 09/93 ⇒ 02/98

ACCORD V 2.0 i S F20Z1 | 03/93 ⇒ 01/96

ACCORD V 2.2 i 16V F22B4 | 08/95 ⇒ 12/97

HONDA

ACCORD V 2.2 i ES F22B5 | 09/93 ⇒ 02/98

ACCORD V 2.3 i SR H23A3 | 03/93 ⇒ 01/96

ACCORD VI 2.2 Type-R H22A7 | 02/99 ⇒ 12/02

CIVIC V 1.5 D15B7 | 08/93 ⇒ 12/95

CIVIC V 1.5 i 16V D15B2, D15Z1 | 10/91 ⇒ 11/95

CIVIC V 1.5 i LSi D15B7 | 08/93 ⇒ 11/95

CIVIC V 1.6 16V Vtec D16Z6, D16Z7 | 10/91 ⇒ 11/95

CIVIC V 1.6 4x4 D16Z7 | 01/92 ⇒ 10/95

CIVIC V 1.6 EX D16A7 | 08/93 ⇒ 10/95

CIVIC V 1.6 i D16V7 | 01/94 ⇒ 11/95

CIVIC V 1.6 i Vtec B16A2, D16Z9 | 01/94 ⇒ 03/96

CIVIC V 1.6 VTi B16A2 | 10/91 ⇒ 11/95

CIVIC V 1.6 VTi 16V B16A2 | 10/91 ⇒ 11/95

BALLADE 1.6i B16A6 | 01/97 ⇒ 02/01

BALLADE 1.8 i B18B4 | 01/96 ⇒ 02/01

CIVIC IV 1.6i -- | 01/90 ⇒ 12/91

CIVIC VI 1.4 i D14A2, D14A5, D14Z2 | 06/95 ⇒ 02/01

CIVIC VI 1.4 i S D14Z2 | 11/95 ⇒ 02/01

CIVIC VI 1.4i 16V D14Z1 | 11/98 ⇒ 03/01

CIVIC VI 1.5 i D15Z6 | 11/95 ⇒ 02/01

CIVIC VI 1.5 i Vtec-E D15Z3 | 09/94 ⇒ 01/97

CIVIC VI 1.6 -- | 05/96 ⇒ 04/99

CIVIC VI 1.6 i D16Y3 | 09/94 ⇒ 03/00

CIVIC VI 1.6 i Vtec B16A2, D16Y2, D16Y8 | 09/94 ⇒ 02/01

CIVIC VI 1.6 VTi B16A2 | 11/95 ⇒ 02/01

CIVIC VI 1.6i 16V D16V7 | 01/96 ⇒

CIVIC VI 1.6i 16V Vtec D16V8 | 01/96 ⇒ 09/99

CR-V 1.2.0 B20Z1 | 04/99 ⇒ 02/02

CR-V 1.2.0 16V 4WD B20B, B20Z1 | 10/95 ⇒ 02/02

CR-V 1.2.0 i 16V B20B3, B20B4, B20B9, B20Z3 | 02/97 ⇒ 04/99

CRX III 1.6 ESi D16Y8, D16Z6 | 03/92 ⇒ 12/98

CRX III 1.6 i VTi B16A2 | 03/92 ⇒ 12/98

HR-V 1.6 16V 350Y | 03/99 ⇒

HR-V 1.6 16V 4WD 350Y, D16W5 | 03/99 ⇒

HR-V 1.6i 16V D16W2 | 04/99 ⇒

INTEGRA 1.8 i B18B1 | 01/98 ⇒

LOGO 1.3 D13B7 | 03/99 ⇒ 03/02

PRELUDE IV 2.0 i 16V F20A4 | 02/92 ⇒ 09/96

PRELUDE IV 2.2 i 16V Vtec H22A2 | 02/93 ⇒ 09/96

PRELUDE IV 2.3 i 16V H23A2 | 02/92 ⇒ 09/96

PRELUDE V 2.0 16V F20A4 | 10/96 ⇒ 10/00

PRELUDE V 2.2 16V H22A5 | 10/96 ⇒ 10/00

PRELUDE V 2.2 i 16V F22A2 | 10/96 ⇒ 10/01

PRELUDE V 2.2 i 16V VTi-R H22A8 | 10/98 ⇒ 12/01

PRELUDE V 2.2 Si F22Z6 | 03/97 ⇒ 07/02

SHUTTLE 2.2 16V F22B8 | 10/94 ⇒ 02/98

ROVER

400 II 416 Si D16Y2 | 03/95 ⇒ 03/00

600 618 i/Si F18A3 | 03/96 ⇒ 02/99

600 620 i F20Z2 | 08/93 ⇒ 06/96

600 620 Si F20Z1 | 08/93 ⇒ 02/99

600 623 Si H23A3 | 08/93 ⇒ 06/99

KW **822 069** **07,5****DISTRIBUTOR CAPS**Adatt./Suitable: **HITACHI****ACURA**30102-PM5-A02
BOSCH
1 987 233 125**03 Supplied until depletion**

- Fornibile fino ad esaurimento delle scorte
- Fourni jusqu'à épuisement du stock
- Lieferbar solange vorrat reicht
- Suministrado hasta el stock termina

HONDA30102-PM5-A02
30102-PM5-A03
30102-PM5-A04
30102-PM5-A05
30102-PM7-006
30102-PM7-016
30102-PM7-036
30102-PR3-003
30102-PR3-006
30102-PR3-026
30102-PR4-A02**211 Resistance [kOhm] 5**

- Resistenza [kOhm] 5
- Résistance [kOhm] 5
- Widerstand [kOhm] 5
- Resistencia [kOhm] 5

ROVERGDC346
GDC347
NJD10006
NJD10008
NJD10009**ACURA**

INTEGRA I 1.6	D16A1	01/85 ⇨ 12/90
INTEGRA I 1.6 i	D16A8	01/85 ⇨ 12/90

HONDA

CIVIC IV 1.5 i 16V	D15B2	10/87 ⇨ 09/91
CIVIC IV 1.6i	--	01/90 ⇨ 12/91
CIVIC IV SHUTTLE 1.5 i 16V	D15B2	01/88 ⇨ 11/91
CIVIC IV SHUTTLE 1.6i	--	01/88 ⇨ 12/91
CIVIC IV SHUTTLE 1.6i 16V 4WD	D16Z2	01/88 ⇨ 12/92
CONCERTO 1.5 i	--	01/90 ⇨ 12/91
CONCERTO 1.6i DOHC	--	01/90 ⇨ 12/91
CONCERTO 1.6i SOHC	--	01/90 ⇨ 12/91

ROVER

200 II 216 GSi	1GH5E-180, D16A7	10/89 ⇨ 12/95
200 II 216 GTi	D16A8, D16A9	01/90 ⇨ 10/95
400 I 416 GTI/GTE	D16A9	04/90 ⇨ 04/95

KW **822 071** **07****DISTRIBUTOR CAPS**Adatt./Suitable: **HITACHI****BOSCH**

1 987 233 126

03 Supplied until depletion

- Fornibile fino ad esaurimento delle scorte
- Fourni jusqu'à épuisement du stock
- Lieferbar solange vorrat reicht
- Suministrado hasta el stock termina

HONDA30102-PM3-015
30102-PM3-025
30102-PM3-035
30102-PM3-045**HONDA**

ACCORD IV 1.8	--	01/90 ⇨ 12/91
ACCORD IV 2.0 16V	F20A2, F20A3, F20A6	01/90 ⇨ 03/93
CIVIC V 1.3	D13B2	01/92 ⇨ 12/92
CIVIC V 1.3 16V	D13B2	10/91 ⇨ 11/95
CIVIC IV 1.2	D12B1	01/88 ⇨ 12/91
CIVIC IV 1.3	D13B1	10/87 ⇨ 12/89
CIVIC IV 1.3 [USA]	--	09/87 ⇨ 12/89
CIVIC IV 1.3 16V Cat	D13B2	09/89 ⇨ 09/91

HONDA

CIVIC IV 1.4 L	D14A1	10/87 ⇨ 12/89
CIVIC IV 1.4i 16V	D14A1	01/90 ⇨ 12/91
CIVIC IV SHUTTLE 1.4 i 16V	D14A1	01/88 ⇨ 12/92
CONCERTO 1.4	D14A1	08/89 ⇨ 10/92
CONCERTO 1.6i	D16A	01/90 ⇨ 12/91

KW **822 073** **05****DISTRIBUTOR CAPS**Adatt./Suitable: **HITACHI****INFINITI**

22162-53J00

NISSAN

22162-53J00

03 Supplied until depletion

- Fornibile fino ad esaurimento delle scorte
- Fourni jusqu'à épuisement du stock
- Lieferbar solange vorrat reicht
- Suministrado hasta el stock termina

**INFINITI**

G20 2.0	SR20DE	01/90 ⇨ 12/97
---------	--------	---------------

NISSAN

100NX 2.0	SR20DE	10/90 ⇨ 10/94
100NX 2.0 GTI	SR20DE	03/91 ⇨ 10/94
PRIMERA I 2.0 i	SR20DI	07/90 ⇨ 03/98
SENTRA III 2.0i [USA]	SR20DE	01/90 ⇨
SUNNY III 2.0 GTI 16V	SR20DE	10/90 ⇨ 05/95
SUNNY III 2.0 GTI-R 4x4	SR20DET	10/90 ⇨ 05/95

KW **822 075** **05****DISTRIBUTOR CAPS**Adatt./Suitable: **HITACHI****SUBARU**

22162-AA060

03 Supplied until depletion

- Fornibile fino ad esaurimento delle scorte
- Fourni jusqu'à épuisement du stock
- Lieferbar solange vorrat reicht
- Suministrado hasta el stock termina

**SUBARU**

LEGACY I 1.8i Spi	--	01/89 ⇨
LEGACY I 1800	EJ18SPI	01/89 ⇨ 07/94
LEGACY I 1800 4WD	EJ18SPI	01/89 ⇨ 07/94

KW **822 076** **07****DISTRIBUTOR CAPS**Adatt./Suitable: **HITACHI****HONDA**30102-P12-A01
30102-P12-A01
30102-PT3-A12**03 Supplied until depletion**

- Fornibile fino ad esaurimento delle scorte
- Fourni jusqu'à épuisement du stock
- Lieferbar solange vorrat reicht
- Suministrado hasta el stock termina

**HONDA**

ACCORD V 2.0	F20B3	09/93 ⇨ 12/97
ACCORD V 2.0 i LS 16V	F20B3	09/93 ⇨ 02/98
ACCORD V 2.2 i [USA]	--	01/94 ⇨ 12/95
ACCORD V 2.2 i 16V	F22B4	08/95 ⇨ 12/97
ACCORD V 2.2 i ES	F22B5	09/93 ⇨ 02/98
PRELUDE V 2.2 i 16V VTi-R	H22A4, H22Z1	10/96 ⇨ 12/98

KW **822 077** **05****DISTRIBUTOR CAPS**Adatt./Suitable: **HITACHI****MAZDA**

FS05-18-V00

03 Supplied until depletion

- Fornibile fino ad esaurimento delle scorte
- Fourni jusqu'à épuisement du stock
- Lieferbar solange vorrat reicht
- Suministrado hasta el stock termina

**FORD AUSTRALIA**

TELSTAR 2.0 Efi	FS	10/94 ⇨ 11/96
-----------------	----	---------------

MAZDA

626 V 1.8	FP, FP01LP	08/91 ⇨ 04/97
626 V 1.8 i	--, FP	08/91 ⇨ 06/97
626 V 2.0 i	FS	08/91 ⇨ 04/97
626 V 2.0 i 4WD	FS	04/92 ⇨ 04/97
MX-6 2.0	FS	02/92 ⇨ 02/97

KW 822 079



07

DISTRIBUTOR CAPS

Adatt./Suitable: **HITACHI****NISSAN**
22162-73C00⁰³ Supplied until depletion

- Fornibile fino ad esaurimento delle scorte
- Fourni jusqu'à épuisement du stock
- Lieferbar solange vorrat reicht
- Suministrado hasta el stock termina

**NISSAN**

PRIMERA I 1.6 i	GA16DE	02/91 ⇒ 03/98
SUNNY III 1.4 i	GA14DE	10/90 ⇒ 05/95
SUNNY III 1.4 i 16V	GA14DE	10/90 ⇒ 06/95
SUNNY III 1.6 i	GA16DE	10/90 ⇒ 05/95
SUNNY III 1.6 i 16V	GA16DE	10/92 ⇒ 05/95

KW 822 082



07,5

DISTRIBUTOR CAPS

Adatt./Suitable: **HITACHI****HONDA**
30102-P0A-A01
30102-P0A-A02
30102-P2M-A01
30102-P45-G02⁰³ Supplied until depletion

- Fornibile fino ad esaurimento delle scorte
- Fourni jusqu'à épuisement du stock
- Lieferbar solange vorrat reicht
- Suministrado hasta el stock termina

ROVER
GDC407
NJD100190**HONDA**

ACCORD V 1.9 i	F18A3	02/96 ⇒ 10/98
ACCORD V 2.0 i LS	F20Z1	02/96 ⇒ 10/98
ACCORD V 2.2	F22B1, F22Z2	10/93 ⇒ 12/97
ACCORD V 2.2 16V	F22Z1	01/96 ⇒ 09/98
ACCORD V 2.2 i [USA]	--	01/94 ⇒ 12/95
ACCORD V 2.2 i VTEC	F22Z2	02/96 ⇒ 10/98
CIVIC VI 1.4 i	D14A2, D14A5	06/95 ⇒ 02/01
CIVIC VI 1.4i 16V	D14Z3, D14Z4	11/98 ⇒ 12/00
CIVIC VI 1.4i 16V Vtec	D14Z4	01/99 ⇒
CIVIC VI 1.5 16V	D15Z8	01/97 ⇒ 02/01
CIVIC VI 1.6	D16W4	11/98 ⇒ 03/01
CIVIC VI 1.6 i	D16Y3	09/94 ⇒ 02/01
CIVIC VI 1.6 i Vtec	D16Y6	11/95 ⇒ 02/01
CIVIC VI 1.6i 16V	D16W3	11/98 ⇒ 12/00
CIVIC V 1.6 i Vtec	D16Y6	01/94 ⇒ 03/96
ODYSSEY 2.2	F22B6	01/95 ⇒ 12/97

ROVER

400 II 416 Si	D16Y2	03/95 ⇒ 03/00
600 618 i/Si	F18A3	03/96 ⇒ 02/99
600 620 i	F20Z2	08/93 ⇒ 06/96
600 620 Si	F20Z1	08/93 ⇒ 02/99

KW 822 084



07,5

DISTRIBUTOR CAPS

Adatt./Suitable: **HITACHI****ACURA**
30102-PV1-A05
HONDA
30102-PV1-A03
30102-PV1-A04
30102-PV1-A05⁰⁰ Eliminated on 22-02-2022. Please verify the availability through our local distributors

- Eliminato il 22-02-2022. Verificare la disponibilità presso i nostri distributori
- Éliminé le 22-02-2022. Vérifier la disponibilité auprès de nos distributeurs sur place
- Am 22-02-2022 gestrichen. Evtl. Verfügbarkeit bitte bei unseren Händlern prüfen
- Eliminado en fecha 22-02-2022. Verificar la disponibilidad a través de nuestros distribuidores locales

**ACURA**

VIGOR 2.5 | G25A | 09/91 ⇒

KW 822 088



05

DISTRIBUTOR CAPS

Adatt./Suitable: **HITACHI****BOSCH**
F 005 X04 754
MAZDA
B3C7-18-V00⁰³ Supplied until depletion

- Fornibile fino ad esaurimento delle scorte
- Fourni jusqu'à épuisement du stock
- Lieferbar solange vorrat reicht
- Suministrado hasta el stock termina

²¹¹ Resistance [kOhm] 10

- Resistenza [kOhm] 10
- Résistance [kOhm] 10
- Widerstand [kOhm] 10
- Resistencia [kOhm] 10

**MAZDA**

121 II 1.3 16V	B3(16V)	11/90 ⇒ 03/96
121 II 1.3 i 16V	B3(16V)	11/90 ⇒ 03/96

KW 822 089



07

DISTRIBUTOR CAPS

Adatt./Suitable: **HITACHI****BOSCH**
F 00E 140 211
F 00E 140 438
FORD
1 961 043
NISSAN
22162-03M00
22162-0M200
22162-0M300
22162-1S700
22162-3S500**FORD**

MAVERICK 2.4 i | KA24 | 09/96 ⇒ 04/98

NISSAN

ALMERA I 1.4	GA14DE	09/95 ⇒ 07/00
ALMERA I 1.4 GX, LX	GA14DE	09/95 ⇒ 07/00
ALMERA I 1.4 S, GX, LX	GA14DE	09/95 ⇒ 03/00
ALMERA I 1.6	GA16DE	07/95 ⇒ 07/00
ALMERA I 1.6 SLX	GA16DE	09/95 ⇒ 07/00
ALMERA I 1.6 SR, SLX	GA16DE	09/95 ⇒ 03/00
PICK UP I 2.4 i 12V	KA24E	04/92 ⇒ 02/98
PICK UP I 2.4 i 12V 4WD	KA24E	04/92 ⇒ 02/98
PICK UP II 2.4 i	KA24E	02/98 ⇒ 04/05
PICK UP II 2.4 i 4WD	KA24E	02/98 ⇒ 04/05
PRIMERA I 1.6 i	GA16DE	02/91 ⇒ 03/98
SENTRA IV 1.6i	GA16DE	01/95 ⇒ 12/97
SUNNY III 1.6 i	GA16DE	06/91 ⇒ 03/00
TERRANO II 2.4 4WD	KA24E	05/96 ⇒ 09/07
TERRANO II 2.4 i 12V 4WD	KA24E	02/93 ⇒ 12/97

KW 822 092



07

DISTRIBUTOR CAPS

Adatt./Suitable: **HITACHI****BOSCH**
F 005 X12 884
FORD AUSTRALIA
F S90-18-V00
MAZDA
FS90-18-V00⁰⁰ Eliminated on 09-08-2021. Please verify the availability through our local distributors

- Eliminato il 09-08-2021. Verificare la disponibilità presso i nostri distributori
- Éliminé le 09-08-2021. Vérifier la disponibilité auprès de nos distributeurs sur place
- Am 09-08-2021 gestrichen. Evtl. Verfügbarkeit bitte bei unseren Händlern prüfen
- Eliminado en fecha 09-08-2021. Verificar la disponibilidad a través de nuestros distribuidores locales

⁰³ Supplied until depletion

- Fornibile fino ad esaurimento delle scorte
- Fourni jusqu'à épuisement du stock
- Lieferbar solange vorrat reicht
- Suministrado hasta el stock termina

**FORD AUSTRALIA**

TELSTAR 2.0 EFi | FS | 10/94 ⇒ 11/96

MAZDA

626 V 1.8 | FP, FP01LP | 08/91 ⇒ 04/97

MAZDA		
626 V 1.8 i	--, FP	08/91 ⇒ 06/97
626 V 2.0 i	FS	08/91 ⇒ 04/97
626 V 2.0 i 4WD	FS	04/92 ⇒ 04/97
MX-6 2.0	FS	02/92 ⇒ 02/97

KW 822 093

07

DISTRIBUTOR CAPS

Adatt./Suitable: **HITACHI**

HONDA

30102-P2A-J01

⁰³ Supplied until depletion

- Fornibile fino ad esaurimento delle scorte
- Fourni jusqu'à épuisement du stock
- Lieferbar solange vorrat reicht
- Suministrado hasta el stock termina



HONDA

BALLADE 1.5	D1524	01/97 ⇒
BALLADE 1.6i	D16Y9	01/96 ⇒ 02/01
CIVICVI 1.4	D14A4	11/95 ⇒ 10/98
CIVICVI 1.4 i	D14A3, D14A4, D14Z1	11/95 ⇒ 02/01
CIVICVI 1.4 i S	D14A4	11/95 ⇒ 02/01

KW 828 070

04

DISTRIBUTOR CAPS

Adatt./Suitable: **LUCAS**

FORD

1 00E-12116-A
1 00E-12116-B⁰³ Supplied until depletion

- Fornibile fino ad esaurimento delle scorte
- Fourni jusqu'à épuisement du stock
- Lieferbar solange vorrat reicht
- Suministrado hasta el stock termina



FORD

CORSAIR 1.5	EV15LN, EV15N	10/63 ⇒ 09/65
CORSAIR 1.5 GT	EV15LH	10/63 ⇒ 09/65
CORTINA 1200	--	10/62 ⇒ 09/66
CORTINA 1500	--	10/62 ⇒ 09/66
CORTINA 1500 GT	--	10/62 ⇒ 09/66
CORTINA GT	--	10/62 ⇒ 09/66
ZEPHYR 1.7	--, EL17L	03/62 ⇒ 03/68

LAND ROVER

88/109 2.3 4x4	10H, 11H	09/61 ⇒ 12/86
----------------	----------	---------------

KW 828 075

04

DISTRIBUTOR CAPS

Adatt./Suitable: **LUCAS**

FORD

1 13E-12116-A

Motorcraft
EDH 10
EDH 10D⁰³ Supplied until depletion

- Fornibile fino ad esaurimento delle scorte
- Fourni jusqu'à épuisement du stock
- Lieferbar solange vorrat reicht
- Suministrado hasta el stock termina



AUSTIN

1000-SERIES 1100	--	01/70 ⇒ 12/74
1000-SERIES 1300	--	01/70 ⇒ 12/74
1000-SERIES 1300 GT	--	01/70 ⇒ 12/74
ALLEGRO 1.1	10H	05/73 ⇒ 10/81
ALLEGRO 1.3	12H	05/73 ⇒ 03/82
ALLEGRO 1.5 Super	14H	05/73 ⇒ 03/82
APACHE 1300	--	11/71 ⇒ 10/74
APACHE 1300 TC	--	11/71 ⇒ 10/74
MAXI 1500	--, 14H	04/69 ⇒ 07/80
MAXI 1750	17H	04/69 ⇒ 10/80
MAXI 1750 HL	--, 17LA	10/72 ⇒ 10/80
MINI 1.3	12HC	09/69 ⇒ 09/80
MINI 1000	--, 99H	10/67 ⇒ 09/84
MINI 1275 GT	12H	10/69 ⇒ 08/80
MINI I 850	781Y	06/59 ⇒ 08/69
MINI I Cooper S	--	09/62 ⇒ 12/71

BOND

EQUIPE 1300 GT	--	01/67 ⇒ 12/70
----------------	----	---------------

FORD

CORTINA 1200	--	10/62 ⇒ 09/66
CORTINA 1500	--	10/62 ⇒ 09/66
CORTINA 1500 GT	--	10/62 ⇒ 09/66
CORTINA GT	--	10/62 ⇒ 09/66
ESCORT I RS 1600	--, BDA	01/70 ⇒ 10/74
ESCORT II 1.6 RS	LC	12/74 ⇒ 08/80
ESCORT II 1.8	--	12/74 ⇒ 08/80
ESCORT II RS 1800	KL18S	03/75 ⇒ 08/77

JENSEN

GT 2.0	--	06/75 ⇒ 12/76
HEALEY 2.0	--	01/72 ⇒ 12/75

LAND ROVER

88/109 2.3 4x4	10H, 11H	09/61 ⇒ 12/86
----------------	----------	---------------

LOTUS

ECLAT 2.0	907	10/75 ⇒ 05/80
ELITE 2.0	907	05/74 ⇒ 05/80
ESPRIT 2.0	907	10/75 ⇒ 05/80

MG

1300 MK.II 1300	--	09/67 ⇒ 09/70
MAGNETTE 1.6	--	03/61 ⇒ 09/68
MGB 1.8	--	05/62 ⇒ 12/80
MGB GT 1.8	--, 18G	07/65 ⇒ 11/80

MORRIS

MARINA 1.8	--	04/71 ⇒ 12/79
MARINA 1.8 TC	--	04/71 ⇒ 09/75
MARINA 1300	--	04/71 ⇒ 06/80
MARINA 1800	--	04/71 ⇒ 12/75
MARINA 1800 TC	--	04/71 ⇒ 12/75
MINOR 1.1	--	01/62 ⇒ 10/71
OXFORD 1.7	--	05/62 ⇒ 04/70

RELIANT

REBEL 700	--	01/68 ⇒ 08/71
REBEL 750	--	08/71 ⇒ 12/73
ROBIN 850	--	11/73 ⇒ 10/02

RILEY

4/72 1.7	--	03/61 ⇒ 10/68
ELF 1.0	--	03/63 ⇒ 10/68
KESTREL 1300	12H	03/67 ⇒ 12/69

ROVER

2000-3500 2200	--	10/73 ⇒ 05/76
AG0 CAMBRIDGE 1.7	--	01/62 ⇒ 10/69

TALBOT

AVENGER 1.3	--	02/70 ⇒ 07/81
AVENGER 1.6	--	02/70 ⇒ 07/81

TRIUMPH

1300 1.3	--	01/65 ⇒ 12/70
1300 1.3 TC	--, GE1EH	01/67 ⇒ 12/70
1500 1.5	--, 1EH, 1EL	10/70 ⇒ 12/74
HERALD 1200	--, AJM	01/61 ⇒ 12/69
HERALD 13/60	--	01/67 ⇒ 12/71
TOLEDO 1300	--	10/70 ⇒ 12/77
TOLEDO 1500	--	10/70 ⇒ 12/77
TOLEDO 1500 TC	--	01/71 ⇒ 12/77

WOLSELEY

16/60 1.6	--	01/61 ⇒ 12/71
18/85 1.8	--, 18HL	08/69 ⇒ 12/72
18/85 1.8 S	--, 18HH	01/70 ⇒ 12/72
1300 1.3	--, 12H	01/68 ⇒ 10/71
1300 1.3 TC	--, 12H	10/71 ⇒ 10/73

KW 828 078

04

DISTRIBUTOR CAPS

Adatt./Suitable: **LUCAS**

FIAT

59321119
659321119

INNOCENTI

659321119

LAND ROVER

RTC3278

ROVER

GDC136

⁰³ Supplied until depletion

- Fornibile fino ad esaurimento delle scorte
- Fourni jusqu'à épuisement du stock
- Lieferbar solange vorrat reicht
- Suministrado hasta el stock termina



INNOCENTI

MINI 120	--	01/75 ⇒ 12/83
----------	----	---------------

LAND ROVER

90 2.5 4x4	17H	09/85 ⇒ 08/90
110/127 2.5 4x4	17H	10/85 ⇒ 07/90
DEFENDER 2.25	--	01/87 ⇒
DEFENDER 2.5 90, 110	--	08/90 ⇒ 09/01

ROVER

MINI 1.0	--	01/85 ⇒
----------	----	---------

KW 828 083

07

DISTRIBUTOR CAPS

Adatt./Suitable: **LUCAS**

FORD

6 077 487
815F-12106-DA

Motorcraft

EDH 128

⁰³ Supplied until depletion

- Fornibile fino ad esaurimento delle scorte
- Fourni jusqu'à épuisement du stock
- Lieferbar solange vorrat reicht
- Suministrado hasta el stock termina



FORD

ESCORT III 1.3	JPA	09/80 ⇒ 02/86
ESCORT III 1.6	LP1, LPA	09/80 ⇒ 12/85
ORION 1.3	JPA	07/83 ⇒ 03/86
ORION 1.6	LP1, LPA	07/83 ⇒ 03/86

KW 828 085



04

DISTRIBUTOR CAPS

Adatt./Suitable: LUCAS

JAGUAR

AEU 1502
JLM 9528⁰³ Supplied until depletion

- Fornibile fino ad esaurimento delle scorte
- Fourni jusqu'à épuisement du stock
- Lieferbar solange vorrat reicht
- Suministrado hasta el stock termina



JAGUAR

XJ 4.2i Series 3

--

01/86 ⇒ 12/94

KW 828 091



07

DISTRIBUTOR CAPS

Adatt./Suitable: LUCAS

BOSCH

F 005 X04 656
F 005 X04 666

LAND ROVER

605190
RTC3197
STC8368

ROVER

STC8368



LAND ROVER

DEFENDER 3.5 4x4	15G, 21G, 22D	09/90 ⇒ 12/98
DISCOVERY I 3.5	--	09/89 ⇒ 06/94
DISCOVERY I 3.5 4x4	22D	06/89 ⇒ 06/94
DISCOVERY I 4.0 4x4	35D, 36D	09/93 ⇒ 10/98
RANGE ROVER I 3.5 4x4	31D	01/87 ⇒ 09/90
RANGE ROVER I 3.5 Vogue 4x4	11D, 24D, 25D	08/81 ⇒ 09/90
RANGE ROVER I 3.9 4x4	35D	11/88 ⇒ 12/92
RANGE ROVER I 3.9 Cat 4x4	37D, 38D	11/88 ⇒ 07/94
RANGE ROVER I 3.9 Vogue SEI 4x4	35D, 36D	11/88 ⇒ 07/94
RANGE ROVER I 4.3 Vogue LSE 4x4	40D	09/92 ⇒ 07/94

KW 828 093



07

DISTRIBUTOR CAPS

Adatt./Suitable: LUCAS

BOSCH

F 005 X13 537

LAND ROVER

NJD10010

ROVER

AUU1186

GDC152

GDC160

GDC377

GDC384

NJD10010



AUSTIN

MONTEGO 1.6 LS	16HC37	10/84 ⇒ 08/88
MONTEGO 1.6 LS, HL	16HC37	04/84 ⇒ 08/88
MONTEGO 2.0	20HSC	04/84 ⇒ 08/88
MONTEGO 2.0 Turbo	20HC85	04/84 ⇒ 08/88

LAND ROVER

FREELANDER 1.8 16V 4x4	18K4F	04/98 ⇒ 10/06
FREELANDER 1.8 i 16V 4x4	18K4F	02/98 ⇒ 10/06

MG

MGF 1.8 i 16V	18K4F	03/95 ⇒ 03/02
MG TF 115	16K4F	03/02 ⇒ 12/09
MG TF 120	18K4F	03/02 ⇒ 12/09
MG TF 135	18K4F	03/02 ⇒ 12/09
MG ZR 105	14K4F	06/01 ⇒ 04/05
MG ZR 120	18K4F	06/01 ⇒ 04/05

ROVER

25 1.4 16V	14K4F, 14K4M	10/99 ⇒ 05/05
25 1.6 16V	16K4F	10/99 ⇒ 05/05
25 1.8 16V	18K4F	10/99 ⇒ 05/05
100 / METRO 111 C/L/S	11K2D	03/90 ⇒ 12/98
100 / METRO 114 GSi	14K4F	10/94 ⇒ 10/95
100 / METRO 114 GTi 16V	14K4C, 14K4D, 14K4F	03/90 ⇒ 12/98
100 / METRO 114 GTi/GT 16V Cat	14K4C, 14K4D	03/90 ⇒ 12/98
100 / METRO 114 S/L/GTA	14K2D	03/90 ⇒ 12/98
100 111	11K2D	04/94 ⇒ 10/97
100 114	14K2D	04/94 ⇒ 10/97
200 II 214	14K2A, 14K2D	09/93 ⇒ 12/95
200 II 214 1.4	14K4C, 14K4D	01/92 ⇒ 11/99
200 II 214 1.4i 16V	14K4F	01/93 ⇒ 11/99
200 II 214 GSi/Si	14K4C, 14K4F	01/90 ⇒ 10/95
200 II 214 Si/Gsi	14K4C, 14K4D	10/89 ⇒ 10/95
200 II 216	16K4F	01/96 ⇒ 12/97
200 II 216 1.6i 16V	16K4F	01/96 ⇒ 11/99
200 II 220 16V	--	01/92 ⇒ 12/95
200 II 220 GSi	1CA4GA15-01	05/94 ⇒ 06/99
200 II 220 GTi	1CA4GA15-01, 20M4F	09/91 ⇒ 10/95
200 II 220 Turbo	20T4G	10/92 ⇒ 06/99
200 III 211	11K2D	01/98 ⇒ 03/00
200 III 214 i	14K2F	11/95 ⇒ 03/00
200 III 214 Si	14K4F	11/95 ⇒ 03/00
200 III 216 Si	16K4F	11/95 ⇒ 06/99
400 II 414 Si	14K4F	05/95 ⇒ 03/00
400 II 416 Si	16K4F, D16Y2	03/95 ⇒ 03/00
600 620 Ti Vitesse	20T4G	05/94 ⇒ 08/98
800 820	--	10/88 ⇒ 10/91
800 820 16V Turbo	T16	11/91 ⇒ 02/99
800 820 I/SI	1CA4GA15-01, 20HD	10/88 ⇒ 02/99
800 820 SI	20HDM16	10/88 ⇒ 12/91
800 820 Sport	20T4G	04/94 ⇒ 03/96
400 I 1.6 i	16K4F, D16A8	05/94 ⇒ 11/98
400 I 414	14K4C	01/93 ⇒ 04/95
400 I 414 GSi/SI	14K4C, 14K4D	04/90 ⇒ 04/95
400 I 414 GSi/SI Cat	14K4F	10/92 ⇒ 04/95
400 I 420 16V	--	01/91 ⇒ 12/92
400 I 420 GSi/SLI/GTi/Vite	1CA4GA15-01	01/93 ⇒ 04/95
400 I 420 GTi/GSi/Vitesse	20M4F	02/92 ⇒ 04/95
400 I 420 Turbo	20T4G	01/93 ⇒ 04/95
MAESTRO 1.6	16H	09/90 ⇒ 01/95
MAESTRO 2.0	--	01/86 ⇒
MONTEGO 2.0 GTi	20H	02/85 ⇒ 10/91

KW 828 094



04

DISTRIBUTOR CAPS

Adatt./Suitable: LUCAS

Motorcraft

EDH 216

ROVER

GDC156

⁰⁰ Eliminated on 04-08-2020. Please verify the availability through our local distributors

- Eliminato il 04-08-2020. Verificare la disponibilità presso i nostri distributori
- Éliminé le 04-08-2020. Vérifier la disponibilité auprès de nos distributeurs sur place
- Am 04-08-2020 gestrichen. Evtl. Verfügbarkeit bitte bei unseren Händlern prüfen
- Eliminado en fecha 04-08-2020. Verificar la disponibilidad a través de nuestros distribuidores locales



AUSTIN

MONTEGO 1.3	--, 12HL	10/84 ⇒ 08/88
-------------	----------	---------------

ROVER

100 / METRO 111 C/L/S	11K2A	03/90 ⇒ 12/98
100 / METRO 114 S/L/GTA	14K2A	03/90 ⇒ 12/98
100 114	14K2A	04/94 ⇒ 10/97
2000-3500 2000	--	10/82 ⇒ 10/86
MAESTRO 1.3	12HE	09/90 ⇒ 01/95
MINI 1.3 Cooper	--	01/85 ⇒
MINI 1.3i Cooper	--	01/85 ⇒
MINI 1.3i Turbo	--	01/85 ⇒
MINI 1300	12A2A, 12A2B, 12A2D, 12A2E, 12A2L	01/91 ⇒ 04/95
MONTEGO 1.3	12HL	10/84 ⇒ 10/88

KW 828 096



04

DISTRIBUTOR CAPS

Adatt./Suitable: LUCAS

FORD

6 153 386
845F-12106-AA

Motorcraft

EDH 199

⁰⁰ Eliminated on 01-09-2020. Please verify the availability through our local distributors

- Eliminato il 01-09-2020. Verificare la disponibilità presso i nostri distributori
- Éliminé le 01-09-2020. Vérifier la disponibilité auprès de nos distributeurs sur place
- Am 01-09-2020 gestrichen. Evtl. Verfügbarkeit bitte bei unseren Händlern prüfen
- Eliminado en fecha 01-09-2020. Verificar la disponibilidad a través de nuestros distribuidores locales



FORD

ESCORT IV 1.4	F6D, FUA, FUC	01/86 ⇒ 07/90
FIESTA II 1.6 XR2	LUB, LUD	03/84 ⇒ 02/89
FIESTA III 1.4	F6E	03/89 ⇒ 12/95
ESCORT III 1.4 i	F6D, FUC	02/86 ⇒ 07/90
ORION I 1.4	FUA, FUC	12/85 ⇒ 07/90
ORION I 1.4 Cat	F6D	02/87 ⇒ 07/90

KW 828 098



07

DISTRIBUTOR CAPS

Adatt./Suitable: LUCAS

JAGUAR

JLM 150



JAGUAR

XJ 3.6	9DPALA, 9DPANA	10/86 ⇨ 05/91
XJ 4.0	9EPCNA, 9LPFRB	10/89 ⇨ 03/96
XJ 6 3.2 24V	9BPMNA	09/90 ⇨ 11/94
XJ 6 3.6	9DPANA, AJ6(3.6, 156KW)	10/86 ⇨ 08/89
XJ 6 4.0	9EPCNA	09/89 ⇨ 11/94
XJSC 3.6	9DPALA, 9DPANA	08/87 ⇨ 05/91
XJSC 4.0	9EPCNA, 9LPFRB	05/91 ⇨ 03/96

KW 828 099



07

DISTRIBUTOR CAPS

Adatt./Suitable: LUCAS

GENERAL MOTORS

90 349 878

OPEL

12 11 266

00 Eliminated on 14-04-2020. Please verify the availability through our local distributors

- Eliminato il 14-04-2020. Verificare la disponibilità presso i nostri distributori
- Éliminé le 14-04-2020. Vérifier la disponibilité auprès de nos distributeurs sur place
- Am 14-04-2020 gestrichen. Evtl. Verfügbarkeit bitte bei unseren Händlern prüfen
- Eliminado en fecha 14-04-2020. Verificar la disponibilidad a través de nuestros distribuidores locales



OPEL

KADETT E 1.6	16SV	09/86 ⇨ 12/91
KADETT E 1.6 i	16SV	07/89 ⇨ 02/93
KADETT E 1.6 S	16SV	09/86 ⇨ 08/91
VECTRA A 1.6	16SV	09/88 ⇨ 05/93
VECTRA A 1.6 S	16SV	09/88 ⇨ 05/93

KW 828 100



07

DISTRIBUTOR CAPS

Adatt./Suitable: LUCAS

BOSCH

1 987 233 200

F 005 X13 536

GENERAL MOTORS

90 350 997

HOLDEN

90350997

OPEL

12 11 271

90350997

03 Supplied until depletion

- Fornibile fino ad esaurimento delle scorte
- Fourni jusqu'à épuisement du stock
- Lieferbar solange vorrat reicht
- Suministrado hasta el stock termina



HOLDEN

BARINA 1.4 i	C14NZ	04/94 ⇨ 07/97
BARINA_SB 1.2i	C12NZ	04/94 ⇨ 07/97
COMBO 1.4 i	C14NZ	03/96 ⇨ 07/97
COMBO_SB 1.4i	C14NZ	04/94 ⇨ 07/97

OPEL

ASTRA F 1.4	14SE	09/92 ⇨ 09/98
ASTRA F 1.4 Si	C14SE	03/92 ⇨ 03/01
COMBO B 1.2	C12NZ	07/94 ⇨ 10/01
COMBO B 1.4	C14NZ	07/94 ⇨ 10/01
CORSA A 1.2 i	C12NZ	09/89 ⇨ 03/93
CORSA A 1.4 Si	C14SE	09/91 ⇨ 03/93
CORSA A 1.6 GSi	E16SE	05/88 ⇨ 03/92
CORSA B 1.2 i	12NZ, C12NZ	03/93 ⇨ 09/00
CORSA B 1.4 i	C14NZ	03/93 ⇨ 09/00
KADETT E 1.4 i	C14NZ	01/90 ⇨ 07/94
KADETT E 1.6	16SV	09/86 ⇨ 12/91
KADETT E 1.6 i	16SV	07/89 ⇨ 02/93
KADETT E 1.6 S	16SV	09/86 ⇨ 08/91
VECTRA A 1.6	16SV	09/88 ⇨ 05/93
VECTRA A 1.6 S	16SV	09/88 ⇨ 05/93

VAUXHALL

ASTRA III 1.4 i	C14SE	03/91 ⇨ 03/01
COMBO B 1.2	C12NZ	07/94 ⇨ 10/01
COMBO B 1.4	C14NZ	07/94 ⇨ 10/01
CORSA B 1.2 i	C12NZ	03/93 ⇨ 09/00
CORSA B 1.4 i	C14NZ	03/93 ⇨ 09/00
CORSAVAN I 1.4 i	C14NZ	01/94 ⇨ 09/00

KW 828 101



05

DISTRIBUTOR CAPS

Adatt./Suitable: LUCAS

BOSCH

1 987 233 113

NISSAN

22162-71J10

22162-94M01

03 Supplied until depletion

- Fornibile fino ad esaurimento delle scorte
- Fourni jusqu'à épuisement du stock
- Lieferbar solange vorrat reicht
- Suministrado hasta el stock termina



NISSAN

100NX 1.6	GA16DS	03/90 ⇨ 10/94
PRIMERA I 1.6	GA16DS	06/90 ⇨ 01/96
PRIMERA I 1.6 i	GA16DS	07/90 ⇨ 03/98
SUNNY II 1.4 LX	GA14S	10/88 ⇨ 08/91
SUNNY III 1.4	GA14DS	10/90 ⇨ 06/95
SUNNY III 1.4 i	GA14DS	10/90 ⇨ 05/95
SUNNY III 1.6 16V 4x4	GA16DS	11/90 ⇨ 05/95

NISSAN

SUNNY III 1.6 i

GA16DE, GA16DS

10/90 ⇨ 03/00

KW 828 102



05

DISTRIBUTOR CAPS

Adatt./Suitable: LUCAS

BOSCH

1 987 233 111

NISSAN

22162-70J00

03 Supplied until depletion

- Fornibile fino ad esaurimento delle scorte
- Fourni jusqu'à épuisement du stock
- Lieferbar solange vorrat reicht
- Suministrado hasta el stock termina



NISSAN

PRIMERA I 2.0	SR20DE	06/90 ⇨ 04/93
PRIMERA I 2.0 16V	SR20DI	06/90 ⇨ 01/96
PRIMERA I 2.0 16V 4x4	SR20DI	04/91 ⇨ 06/96
PRIMERA I 2.0 GT	SR20DE	06/90 ⇨ 01/96
PRIMERA I 2.0 GT 4x4	SR20DE	03/91 ⇨ 04/93
PRIMERA I 2.0 i	SR20DE	01/95 ⇨ 06/96
PRIMERA II 2.0 16V	SR20DE	08/99 ⇨ 12/01

KW 828 103



05

DISTRIBUTOR CAPS

Adatt./Suitable: LUCAS

NISSAN

22162-71J00

03 Supplied until depletion

- Fornibile fino ad esaurimento delle scorte
- Fourni jusqu'à épuisement du stock
- Lieferbar solange vorrat reicht
- Suministrado hasta el stock termina



NISSAN

PRIMERA I 1.6

GA16DS

06/90 ⇨ 01/96

KW 828 104



05

DISTRIBUTOR CAPS

Adatt./Suitable: LUCAS

BOSCH

1 987 233 110

NISSAN

22162-99B00



NISSAN

MICRA II 1.0 i 16V	CG10DE	08/92 ⇨ 07/00
MICRA II 1.3 i 16V	CG13DE	08/92 ⇨ 09/00

KW 828 105



05

DISTRIBUTOR CAPS

Adatt./Suitable: **LUCAS****BOSCH**

1 987 233 110

NISSAN22162-41B00
22162-82J00**NISSAN**

MICRA II 1.3 i 16V	CG13DE	08/92 ⇨ 09/00
PRIMERA II 1.6 16V	GA16DE	09/96 ⇨ 07/02
PRIMERA I 1.6	GA16DE	06/93 ⇨ 01/96

KW 828 106



07

DISTRIBUTOR CAPS

Adatt./Suitable: **LUCAS****HONDA**

30102-P1J-E01

ROVER

NJD100200

⁰³ Supplied until depletion

- Fornibile fino ad esaurimento delle scorte
- Fourni jusqu'à épuisement du stock
- Lieferbar solange vorrat reicht
- Suministrado hasta el stock termina

²¹¹ Resistance [kOhm] 5

- Resistenza [kOhm] 5
- Résistance [kOhm] 5
- Widerstand [kOhm] 5
- Resistencia [kOhm] 5

**HONDA**

CIVICVI 1.4 16V	D14A7, D14A8	01/97 ⇨ 02/01
CIVICVI 1.4 i	D14A8	06/95 ⇨ 02/01
CIVICVI 1.4i	D14A6	01/99 ⇨
CIVICVI 1.6 16V	D16B2	01/97 ⇨ 02/01

ROVER

400 II 416 Si	D16Y2	03/95 ⇨ 03/00
---------------	-------	---------------

KW 830 059



04

DISTRIBUTOR CAPS

Adatt./Suitable: **MARELLI****FIAT**

9908338

GENERAL MOTORS

7 992 274

MAGNETI MARELLI070005501010
700 055 01**FIAT**

500 0.5	110F.000, 120.000	01/60 ⇨ 12/75
---------	-------------------	---------------

KW 830 069



07

DISTRIBUTOR CAPS

Adatt./Suitable: **MARELLI****FIAT**

9913860

FORDA760-X12276-CA
A760-X12276-EA
A800-X12276-RA**SEAT**102312.06
NG1 023 020 6⁰³ Supplied until depletion

- Fornibile fino ad esaurimento delle scorte
- Fourni jusqu'à épuisement du stock
- Lieferbar solange vorrat reicht
- Suministrado hasta el stock termina

**FIAT**

124 1200	124A.000	07/66 ⇨ 10/73
124 1400 Special	124B2.000	12/68 ⇨ 12/72
124 1600 Special T	132AC.000	01/73 ⇨ 07/75
850 0.8	100G.000	07/64 ⇨ 10/72

KW 830 076



07

DISTRIBUTOR CAPS

Adatt./Suitable: **MARELLI****FIAT**

9915391

GENERAL MOTORS

93 150 385

MAGNETI MARELLI

710 851 01

⁰⁰ Eliminated on 21-07-2020. Please verify the availability through our local distributors

- Eliminato il 21-07-2020. Verificare la disponibilità presso i nostri distributori
- Éliminé le 21-07-2020. Vérifier la disponibilité auprès de nos distributeurs sur place
- Am 21-07-2020 gestrichen. Evtl. Verfügbarkeit bitte bei unseren Händlern prüfen
- Eliminado en fecha 21-07-2020. Verificar la disponibilidad a través de nuestros distribuidores locales

**SEAT**

IBIZA I 0.9	09NCA	08/90 ⇨ 05/93
MARBELLA 0.9	08NCB, 100GL7000	01/87 ⇨ 10/98
MARBELLA 0.9 Cat	08NCB, 09NCB, 100GL7000	01/87 ⇨ 10/98

KW 830 081



04

DISTRIBUTOR CAPS

Adatt./Suitable: **MARELLI****FIAT**98080037
9919628
9920581**GENERAL MOTORS**

7 992 280

MAGNETI MARELLI710 613 03
711 275 01**ZASTAVA**

1335050

⁰³ Supplied until depletion

- Fornibile fino ad esaurimento delle scorte
- Fourni jusqu'à épuisement du stock
- Lieferbar solange vorrat reicht
- Suministrado hasta el stock termina

**FIAT**

128 1.1	128A.000	03/69 ⇨ 12/84
---------	----------	---------------

ZASTAVA

101 1.1	128A.000, 128A.064	05/75 ⇨ 12/93
101 1.1 Super	128AC5.000	07/79 ⇨ 09/81

KW 830 082



07

DISTRIBUTOR CAPS

Adatt./Suitable: **MARELLI**

FIAT

9911509
9921509

MAGNETI MARELLI

711 290 01

⁰³ Supplied until depletion

- Fornibile fino ad esaurimento delle scorte
- Fourni jusqu'à épuisement du stock
- Lieferbar solange vorrat reicht
- Suministrado hasta el stock termina



FIAT

124 Spider, Sport [USA]	--	01/79 ⇒ 12/86
131 2.0 Brava [USA]	--	01/79 ⇒ 12/84
ARGENTA 2000	132D1.000	06/78 ⇒ 12/85

KW 830 086



04

DISTRIBUTOR CAPS

Adatt./Suitable: **MARELLI**

FIAT

9924316
9925993

GENERAL MOTORS

7 992 978

MAGNETI MARELLI

071171101010
711 711 01

FIAT

126 600	126A.000	09/72 ⇒ 06/77
500 0.6	111A000	08/68 ⇒ 01/76

FSO

126P 0.6	--	09/72 ⇒ 07/77
----------	----	---------------

KW 830 090



05

DISTRIBUTOR CAPS

Adatt./Suitable: **MARELLI**

CITROËN

54 862 24

FIAT

9928250

GENERAL MOTORS

93 150 091

MAGNETI MARELLI

711 743 01

⁰³ Supplied until depletion

- Fornibile fino ad esaurimento delle scorte
- Fourni jusqu'à épuisement du stock
- Lieferbar solange vorrat reicht
- Suministrado hasta el stock termina



FIAT

127 1.0	127A.000	01/77 ⇒ 12/86
132 1.6	132C.000	05/77 ⇒ 09/82
ARGENTA 1600	132D.000	04/81 ⇒ 12/85
ARGENTA 1600 i.e	132D.000	04/81 ⇒ 12/85
FIORINO I 1.0	127A.000	01/80 ⇒ 12/87
FIORINO I 1050	127A.000	01/80 ⇒ 12/87
FIORINO I 900	100GL.000	10/77 ⇒ 10/86

KW 830 093



07

DISTRIBUTOR CAPS

Adatt./Suitable: **MARELLI**

FIAT

82368100
9934728

GENERAL MOTORS

93 150 907

LANCIA

9934728

MAGNETI MARELLI

712 155 01

SEAT

NG2 155 013 1

⁰³ Supplied until depletion

- Fornibile fino ad esaurimento delle scorte
- Fourni jusqu'à épuisement du stock
- Lieferbar solange vorrat reicht
- Suministrado hasta el stock termina



FIAT

132 2.0	132C2.000	01/76 ⇒ 06/81
ARGENTA 2000	132D1.000	06/78 ⇒ 12/85
ARGENTA 2000 i.e.	132C3.000	06/81 ⇒ 07/86

LANCIA

A 112 1.0 Abarth	A112A2.000	03/78 ⇒ 02/84
------------------	------------	---------------

KW 830 098



04

DISTRIBUTOR CAPS

Adatt./Suitable: **MARELLI**

ALFA ROMEO

9950051

FIAT

9936027

9938272

9938359

9944630

FORD

1 641 610

LANCIA

9936027

MAGNETI MARELLI

071243702010

071366801010

712 437 01

712 437 02

712 437 04

712 437 05

713 668 01

713 668 02

71376201

Motorcraft

EDH 170

EDH 196

EDH 201

EDH 208

EDH 226

PEUGEOT

5941 43

RENAULT

77 01 025 240

SEAT

000 389 976 9

SE 141914.001B



FIAT

CROMA I 1600	154A.048	12/85 ⇒ 12/90
CROMA I 2000 CHT	154A1.000, 154C5.000	12/85 ⇒ 09/92
CROMA I 2000 i.e.	834B.048	03/86 ⇒ 09/90
CROMA I 2000 i.e. Turbo	154A2.000	12/85 ⇒ 06/90
PANDA I 750	141B.000	01/86 ⇒ 01/95
PANDA I 900	100GL3.000	10/80 ⇒ 06/94
PANDA I 900 CL	146A.048	01/86 ⇒ 12/92
REGATA 1.6	--	09/86 ⇒ 06/89
REGATA 90 i.e. 1.6	149C2.000	01/87 ⇒ 07/89
TIPO I 1.4 i.e.	159A2.000	05/89 ⇒ 04/95
UNO 1.3 Turbo i.e.	146A2.000	04/85 ⇒ 08/89
UNO 45 0.9	146A.000, 146A1.000	03/83 ⇒ 07/96
UNO 45 0.9 Trend	146A.048	09/89 ⇒ 09/92

FORD

ESCORT V RS Cosworth 4x4	N5F	10/91 ⇒ 01/95
--------------------------	-----	---------------

LANCIA

PRISMA 1.6	831B6.000	08/86 ⇒ 02/92
PRISMA 1.6 i.e.	831B7.000	05/86 ⇒ 12/89
PRISMA 2.0 i.e. Trazione integrale	831B4.000	04/86 ⇒ 12/89

PEUGEOT

505 2.0	106E(XN1A)	09/85 ⇒ 09/95
---------	------------	---------------

RENAULT

14 1.4	150	09/79 ⇒ 06/83
--------	-----	---------------

SEAT

IBIZA I 0.9	146A000	08/86 ⇒ 05/93
MARBELLA 0.9	09NCA	01/87 ⇒ 12/93
TERRA 0.9	09NCA	02/87 ⇒ 12/96

KW 830 101



04

DISTRIBUTOR CAPS

Adatt./Suitable: **MARELLI**

FIAT

82361914
9938273
9939787
9940656
9944794

FORD

6 542 391
V90H-F12106-AA

INNOCENTI

9944794

LANCIA

9939787

MAGNETI MARELLI

071246105010
071366701010
071366702010
712 461 04
712 461 05
712 461 06
712 462 03
713 667 01
713 667 02

PEUGEOT

5941 30

RENAULT

77 01 030 505

SEAT

000 398 090 7
SE 021914.001B

FIAT

DUNA 60 1.1	146A6.000	01/87 ⇒ 12/91
DUNA 70 1.3	146A5.000	01/87 ⇒ 12/91
ELBA 1.3	146A5.000	04/91 ⇒ 02/95
FIORINO I 1.1 60	146A9.000	11/86 ⇒ 04/88
FIORINO I 1.3	146A5.000	12/87 ⇒ 08/93
FIORINO II 1.3	146A5.000	01/88 ⇒ 12/94
FIORINO II 60 1.1	146A9.000	05/88 ⇒ 12/93
FIORINO II 70 1.3	146A5.000	01/88 ⇒ 12/94
REGATA 1.1 60, 60 L	138B.000	10/83 ⇒ 08/86
REGATA 1.6	149A.000	10/84 ⇒ 06/89
REGATA 70 1.3	138B2.000, 149A3.000	09/83 ⇒ 07/89
REGATA 85 1.5	149A5.000	05/85 ⇒ 12/87
REGATA 85 1.6	149A.000	10/83 ⇒ 06/90
RITMO I 1.1	146A4.048	04/85 ⇒ 12/87
RITMO I 1.3	146A3.000	11/83 ⇒ 08/85
TEMPRA 1.4 i.e.	159A2.000	04/90 ⇒ 08/96
TIPO I 1.4	160A1.000	07/87 ⇒ 12/89
TIPO I 1.4 i.e.	159A2.000	05/89 ⇒ 04/95
UNO 1.4 Turbo i.e.	146A8.000, 146A8.046	09/89 ⇒ 12/96
UNO 60 1.1	146A4.048, 146A6.000	05/85 ⇒ 02/92
UNO 60 1.1 SX	--	01/83 ⇒ 12/89
UNO CS 1.1	146A6.000	09/87 ⇒ 09/91

FIAT (BR)

UNO 1.4i Turbo	1.4Mpi	01/94 ⇒ 12/96
UNO CS 11116	--	01/88 ⇒

FORD

ESCORT V RS Cosworth 4x4	NSF	10/91 ⇒ 01/95
--------------------------	-----	---------------

INNOCENTI

ELBA 1.3	146A5.000	08/91 ⇒ 12/96
----------	-----------	---------------

LANCIA

DELTA I 1.1	831B8.000	01/86 ⇒ 12/90
DELTA I 1.3	1831B.000, 3831B.000, 831A2.000, 831B.000	09/79 ⇒ 10/92
PRISMA 1.3	831A2.000	01/83 ⇒ 12/89
Y10 1.3 i.e.	146A5.046, 156B.000	11/87 ⇒ 12/95

PEUGEOT

305 1.5	117(XRS5)	05/80 ⇒ 09/82
---------	-----------	---------------

RENAULT

4 1.1	688712	02/78 ⇒ 06/90
9 1.1	C1E715	09/81 ⇒ 05/87
11 1.1	C1E715, C1E720	03/83 ⇒ 06/86
RAPID 1.1	C1E750, C1E760	07/85 ⇒ 04/95
SUPER 5 1.0	C1C700	10/84 ⇒ 10/88

SEAT

IBIZA I 1.2	021A1000	11/84 ⇒ 12/93
MALAGA 1.2	021A1000	05/85 ⇒ 12/93
MALAGA 1.5	021A2000	05/85 ⇒ 12/93

KW 830 104



04

DISTRIBUTOR CAPS

Adatt./Suitable: **MARELLI**

FIAT

9938274
9938360

INNOCENTI

9938360

LANCIA

9938360

MAGNETI MARELLI

712 461 07



FIAT

CROMA I 1600	154A.048	12/85 ⇒ 12/90
ELBA 1.5	149C1.000	01/92 ⇒ 12/96
FIORINO I 1.5	149C1.000	01/88 ⇒ 08/93
FIORINO II 1.5 iE	149C1.000	01/88 ⇒ 10/92
FIORINO II 75 i.e. 1.5	149C1.000	05/88 ⇒ 12/93
REGATA 1.6	--	09/86 ⇒ 06/89
REGATA 100 Super 1.6	149A2.000	10/83 ⇒ 12/90
REGATA 85 1.5	149A5.000	05/85 ⇒ 12/87
RITMO I 1.5	138C2.048	10/85 ⇒ 05/87
RITMO I 1.6	149A4.000	01/83 ⇒ 12/87
RITMO II 75 1.5	138A2.000	09/85 ⇒ 12/88
TEMPRA 1.4 i.e.	160A1.046	04/90 ⇒ 08/96
TEMPRA 1.6	159A3.000, 159A3.048, 159A3.098	03/90 ⇒ 12/96

TEMPRA 1.6 i.e.	159A3.046, 159A3.048	06/90 ⇒ 08/96
TEMPRA 1.8 4x4	159A4.000	07/92 ⇒ 06/93
TEMPRA 1.8 i.e.	159A4.000, 159A4.046	03/90 ⇒ 08/96
TEMPRA 2.0	159A6.046	04/90 ⇒ 06/93
TEMPRA 2.0 i.e.	159A6.046	10/90 ⇒ 09/96
TEMPRA 2.0 i.e. 4x4	159A6.046	03/92 ⇒ 03/95
TIPO I 1.4	160A1.048	07/87 ⇒ 12/89
TIPO I 1.4 i.e.	160A1.046	05/89 ⇒ 04/95
TIPO I 1.6	159A3.048, 160A2.000, 835C1.000	01/88 ⇒ 10/95
TIPO I 1.6 i.e.	159A3.046, 159A3.048, 835C1.000	07/90 ⇒ 04/95

TIPO I 1.6 i.e. [BRA]	160E2.011	03/93 ⇒ 04/95
TIPO I 1.6 SX DGT	159A3.000	05/89 ⇒ 10/95
TIPO I 1.8 i.e.	159A4.000, 159A4.046	10/90 ⇒ 06/93
TIPO I 1.8 i.e. 16V Sport	160A5.000	11/89 ⇒ 06/92
TIPO I 2.0	159A5.046, 159A6.046	10/90 ⇒ 10/92
TIPO I 2.0 16V	160A8.046	07/91 ⇒ 04/95
TIPO I 2.0 i.e.	159A5.046, 159A6.046	03/90 ⇒ 04/95
TIPO I 2.0 i.e. [BRA]	159A6.011	03/93 ⇒ 10/95
UNO 1.4 Super	146C2.028	09/89 ⇒ 09/92
UNO 70 1.3i SX	--	01/83 ⇒ 12/89
UNO 70 i.e. 1.4	146C1.000, 160A1.046	09/89 ⇒ 07/96
UNO 70 S 1.4	160A1.048	10/88 ⇒ 06/06
UNO 75 i.e. 1.5	138C2.048, 149C1.000	10/85 ⇒ 12/93

INNOCENTI

ELBA 1.5 i.e.	149C1.000	08/92 ⇒ 09/94
---------------	-----------	---------------

LANCIA

DEDRA 1.6 i.e.	835A1.000, 835A1.046	08/89 ⇒ 06/94
DELTA I 1.3	831A2.000, 831B.000	09/79 ⇒ 08/92
DELTA I 1.5	831A1.000, 831B1.000	09/79 ⇒ 12/92
PRISMA 1.5	831A1.000, 831B1.000	01/83 ⇒ 07/89

KW 830 109



04

DISTRIBUTOR CAPS

Adatt./Suitable: **MARELLI**

FIAT

9939789

LANCIA

9939789

MAGNETI MARELLI

071302701010
713 027 01

FIAT

FIORINO II 1.0 iE	156A2.246	11/92 ⇒ 04/96
PALIO 1.1	17889.033	07/97 ⇒ 10/03
PANDA I 1.1	156C.046	05/91 ⇒ 03/95
PANDA I 1000	156A2.000, 156A2.100, 156A3.000	01/85 ⇒

PANDA I 1000 4x4	156A2.100, 156A2.246, 156A3.000	01/86 ⇒ 12/94
------------------	---------------------------------	---------------

PANDA I 1000 CLX	156A2.000	05/91 ⇒ 12/94
PANDA I 1000 Fire	156A2.000	05/86 ⇒ 04/91
PANDA I 1000 Fire [CHE]	156A2.146	11/87 ⇒ 04/91
PANDA I 1000 Fire [DEU]	156A2.048	01/86 ⇒ 07/89
PANDA I 1000 i.e.	156A2.246	08/92 ⇒ 02/04
PANDA I 1000 i.e. Cat	156A2.246	10/87 ⇒ 08/98
PANDA I 1100 i.e.	156C.046	01/86 ⇒ 04/91
PANDA I 1100 Trekking 4x4	156C.046	10/91 ⇒ 07/04
PANDA I 750	156A4.000	01/86 ⇒ 10/03
PANDA I 750 Cat	156A4.048	01/95 ⇒ 10/03
PANDA I 750 Fire	156A4.048	11/88 ⇒ 04/91
TIPO I 1.1	160A3.000	01/88 ⇒ 10/91
UNO 1.0	146A2.166	11/94 ⇒ 08/00
UNO 45 1.0	156A2.000, 156A2.100	06/86 ⇒ 12/93
UNO 45 1.0 Fire	--	01/83 ⇒ 12/89
UNO 45 i.e. 1.0	156A2.246	10/84 ⇒ 10/95
UNO 50 1.1	156C.046	01/90 ⇒ 12/93
UNO 50 i.e. 1.1	146C3.000	06/92 ⇒ 12/93
UNO 60 1.1	160A3.000	04/89 ⇒ 12/92
UNO Mondo 1.0	146A2.166	01/98 ⇒
UNO Mondo 1.0 [IND]	146A2.166	01/98 ⇒

LANCIA

Y10 1.0 Fire	156A2.100	06/85 ⇒ 06/91
Y10 1.0 Fire Catalytic-Conv	156A2.246	10/87 ⇒ 02/92
Y10 1.0 Fire Trazione integrale	156A2.000, 156A2.100, 156A2.246	12/86 ⇒ 02/92
Y10 1.1 i.e. Fire	156C.000	08/89 ⇒ 06/92
Y10 1.1 i.e. Fire Trazione integrale	156C.000	08/89 ⇒ 06/92
Y10 1.1 i.e. Fire	156C.046	07/89 ⇒ 09/95

KW 830 110



08

DISTRIBUTOR CAPS

Adatt./Suitable: **MARELLI**

JAGUAR

JLM 1909

MAGNETI MARELLI

713 528 01

⁰³ Supplied until depletion

- Fornibile fino ad esaurimento delle scorte
- Fourni jusqu'à épuisement du stock
- Lieferbar solange vorrat reicht
- Suministrado hasta el stock termina



JAGUAR

XJ 5.3	85(92-93)	05/91 ⇒ 08/93
--------	-----------	---------------

JAGUAR		
XJ 6.0	8D	05/93 ⇒ 03/96
XJ V12 6.0	8C(92-94)	03/93 ⇒ 11/94
XJSC 5.3	8S(92-93)	05/91 ⇒ 08/93
XJSC 6.0	8D	05/93 ⇒ 03/96

KW 830 111



04

DISTRIBUTOR CAPS

Adatt./Suitable: MARELLI

MAGNETI MARELLI
071358401010
713 584 01RENAULT
77 01 034 946

RENAULT		
19 I 1.2i	E7F	01/89 ⇒ 12/92
19 I 1.4	E6J700, E6J701, E7J700	01/88 ⇒ 12/92
19 II 1.2	E7F730	05/92 ⇒ 09/94
19 II 1.4	E6J706, E7J706, E7J707, E7J742, E7J745	01/92 ⇒ 12/95
CLIO I 1.2	E5F710, E5F716, E7F700, E7F706, E7F708, E7F750	05/90 ⇒ 09/98
CLIO I 1.4	E6J712, E6J713, E6J718, E7J601, E7J710, E7J711, E7J716, E7J718, E7J719, E7J754, E7J756, E7J757	01/90 ⇒ 09/98
EXPRESS 1.4	E6J/E7J	01/85 ⇒ 10/90
MEGANE I 1.4	E7J764	09/96 ⇒ 08/03
MEGANE I 1.4 e	E7J764	01/96 ⇒ 08/03
MEGANE I 1.4 Eco	E7J624	01/96 ⇒ 03/99
MEGANE SCÉNIC I 1.4 i	E7J764	01/97 ⇒ 09/99
RAPID 1.4	E6J738, E7J720, E7J724, E7J726, E7J728, E7J770, E7J771, E7J773	09/91 ⇒ 03/98
RAPID 1.4 RN	E6J734	09/91 ⇒ 08/93

KW 830 114



04

DISTRIBUTOR CAPS

Adatt./Suitable: MARELLI

FIAT
9944576
9946355INNOCENTI
9946355LANCIA
9944576

FIAT		
COUPE 2.0 16V	836A3.000	11/93 ⇒ 08/96
COUPE 2.0 16V [BRA]	836A3.011	11/93 ⇒ 08/96
ELBA 1.5	149C1.000	01/92 ⇒ 12/96
FIORINO I 1.5	149C1.000	01/88 ⇒ 08/93
FIORINO II 1.5 iE	149C1.000	01/88 ⇒ 10/92
FIORINO II 70 i.e. 1.4	146C5.000	05/94 ⇒ 05/01
FIORINO II 75 i.e. 1.5	149C1.000	05/88 ⇒ 12/93
TEMPRA 1.6	159A3.000, 159A3.048, 159A3.098	03/90 ⇒ 12/96
TEMPRA 1.6 i.e.	159A3.046, 159A3.048	06/90 ⇒ 08/96
TEMPRA 1.8 4x4	159A4.000	07/92 ⇒ 06/93
TEMPRA 1.8 i.e.	159A4.000, 159A4.046	03/90 ⇒ 08/96
TEMPRA 2.0	159A6.046	04/90 ⇒ 06/93

FIAT		
TEMPRA 2.0 i.e.	159A6.046	10/90 ⇒ 09/96
TEMPRA 2.0 i.e. [BRA]	159A6.011	04/93 ⇒ 12/96
TEMPRA 2.0 i.e. 4x4	159A6.046	03/92 ⇒ 03/95
TIPO I 1.6	159A3.048, 835C1.000	03/93 ⇒ 10/95
TIPO I 1.6 i.e.	159A3.046, 159A3.048, 835C1.000	07/90 ⇒ 04/95
TIPO I 1.6 i.e. [BRA]	160E2.011	03/93 ⇒ 04/95
TIPO I 1.8 i.e.	159A4.000, 159A4.046	10/90 ⇒ 06/93
TIPO I 2.0	159A5.046, 159A6.046, 836A3.011	10/90 ⇒ 04/95
TIPO I 2.0 16V	160A8.046	07/91 ⇒ 04/95
TIPO I 2.0 i.e.	159A5.046, 159A6.046	03/90 ⇒ 04/95
TIPO I 2.0 i.e. [BRA]	159A6.011	03/93 ⇒ 10/95
TIPO I 2.0 i.e. 16V Sport	836A3.000	03/93 ⇒ 04/95
UNO 1.4 Super	146C2.028	09/89 ⇒ 09/92
UNO 70 i.e. 1.4	146C1.000, 160A1.046	09/89 ⇒ 07/96
UNO 70 S 1.4	160A1.048	10/88 ⇒ 06/06
UNO 75 i.e. 1.5	149C1.000	10/85 ⇒ 12/93
UNO Mondo 1.4 Super	146C2.028	01/96 ⇒

FIAT (BR)		
COUPE 2.0i 16V	2.0Mpi	01/95 ⇒ 12/97
TIPO 2.0i 16V	2.0Mpi	01/94 ⇒ 12/95

INNOCENTI		
ELBA 1.4 i.e.	146C5.000	09/94 ⇒ 12/96
ELBA 1.5 i.e.	149C1.000	08/92 ⇒ 09/94
MILLE 1.4	160A1046	07/95 ⇒ 05/97

LANCIA		
DEDRA 1.6	835A1000	07/94 ⇒ 02/97
DEDRA 2.0 16V	836A3.000	07/94 ⇒ 07/99
DEDRA 2.0 i.e.	835A5.046	09/89 ⇒ 07/99
DEDRA 2.0 Integrale	836A3.000	07/94 ⇒ 07/99
DELTA II 2.0 16V	836A3.000	06/93 ⇒ 08/99

KW 830 115



04

DISTRIBUTOR CAPS

Adatt./Suitable: MARELLI

ALFA ROMEO
9950519FIAT
9944668
9947326
9950519INNOCENTI
9944668LANCIA
9944668

ALFA ROMEO		
164 2.0 Turbo	AR06476	10/87 ⇒ 09/98

FIAT		
CROMA I 2000 i.e.	154C3.000, 154C3.046, 834B.000, 834B.146	03/87 ⇒ 12/96
CROMA I 2000 i.e. Turbo	154C4.000, 154C4.046, 834C.146	11/86 ⇒ 08/96
FIORINO II 1.6	146C6.000	01/94 ⇒ 05/01
FIORINO II 75 i.e. 1.6	146C6.000	10/93 ⇒ 05/01
TEMPRA 1.4 i.e.	160A1.046	04/90 ⇒ 08/96
TEMPRA 1.6	159A3.000, 159A3.048, 159A3.098	03/90 ⇒ 12/96
TEMPRA 1.6 i.e.	159A3.046, 159A3.048	06/90 ⇒ 08/96
TEMPRA 1.8 4x4	159A4.000	07/92 ⇒ 06/93
TEMPRA 1.8 i.e.	159A4.000, 159A4.046	03/90 ⇒ 08/96
TEMPRA 2.0	159A6.046	04/90 ⇒ 06/93
TEMPRA 2.0 i.e.	159A6.046	10/90 ⇒ 09/96
TEMPRA 2.0 i.e. [BRA]	159A6.011	04/93 ⇒ 12/96
TEMPRA 2.0 i.e. 4x4	159A6.046	03/92 ⇒ 03/95
TIPO I 1.4 i.e.	160A1.046	05/89 ⇒ 04/95
TIPO I 1.6	159A3.048, 835C1.000	03/93 ⇒ 10/95
TIPO I 1.6 i.e.	159A3.046, 159A3.048, 835C1.000	07/90 ⇒ 04/95
TIPO I 1.6 i.e. [BRA]	160E2.011	03/93 ⇒ 04/95
TIPO I 1.6 SX DGT	159A3.000	05/89 ⇒ 10/95
TIPO I 1.8 i.e.	159A4.000, 159A4.046	10/90 ⇒ 06/93
TIPO I 2.0	159A5.046, 159A6.046	10/90 ⇒ 10/92
TIPO I 2.0 i.e.	159A5.046, 159A6.046	03/90 ⇒ 04/95
TIPO I 2.0 i.e. [BRA]	159A6.011	03/93 ⇒ 10/95
UNO 1.3 Turbo i.e.	146A2.246	09/89 ⇒ 03/91

FIAT (BR)		
TIPO 2.0i 8v	2.0Mpi	01/94 ⇒ 12/95
UNO 1.4i Turbo	1.4Mpi	01/94 ⇒ 12/96

INNOCENTI		
ELBA 1.6 i.e.	146C6.000	09/94 ⇒ 12/96

LANCIA		
DEDRA 1.6 i.e.	835A1.046	08/89 ⇒ 03/93
DEDRA 1.8 i.e.	835A2.000, 835A2.046, 835C5.000	09/89 ⇒ 07/99
DEDRA 2.0 HF Integrale	835A7.046	11/90 ⇒ 07/94
DEDRA 2.0 i.e.	835A5.000	09/89 ⇒ 07/92
DEDRA 2.0 i.e. Turbo	835A8.046	04/91 ⇒ 07/99
DEDRA 2.0 i.e. Turbo Integrale	835A7.000	04/90 ⇒ 08/91
DEDRA 2.0 Turbo	835A8.000	11/90 ⇒ 06/94
DELTA I 1.6 GT i.e.	149C2.000, 831B7.000	08/86 ⇒ 08/92
DELTA I 1.6 HF Turbo	831B3.000, 831B7.046	08/86 ⇒ 03/89
DELTA I 2.0 16V HF Evo Integrale	831E5.000	06/93 ⇒ 01/94
DELTA I 2.0 16V HF Integrale	831D5.000	03/89 ⇒ 09/91
DELTA I 2.0 HF Integrale	831B5.000, 831C5.000, 831C5.046	11/86 ⇒ 12/92
DELTA II 1.4 i.e.	160A1.046	10/94 ⇒ 08/99
THEMA 2000 i.e	834B1.000	09/88 ⇒ 05/92
THEMA 2000 i.e.	834B.146	09/87 ⇒ 05/92
THEMA 2000 i.e. Turbo	834C.146	07/86 ⇒ 05/90
THEMA 2000 Turbo	834C.146	12/88 ⇒ 03/92

KW 830 116



04

DISTRIBUTOR CAPS

Adatt./Suitable: MARELLI

MAGNETI MARELLI
0.71374201.010
713 756 01
71374201SEAT
030 905 207 ASKODA
030 905 207 AVW
030 905 207 A

SEAT		
AROSA 1.0	AER, ALL	05/97 ⇒ 06/04
AROSA 1.4	AEX, AKV, APQ	05/97 ⇒ 06/04
CORDOBA I 1.0 i	AER	09/96 ⇒ 10/02
CORDOBA I 1.4	ANX	12/97 ⇒ 04/99
CORDOBA I 1.4 i	AKV, APQ	06/94 ⇒ 12/02
CORDOBA I 1.4 i 16V	AFH	09/96 ⇒ 10/02
CORDOBA I 1.6 i	AEE, ALM	02/93 ⇒ 12/02
IBIZA II 1.0 i	AER	09/96 ⇒ 02/02
IBIZA II 1.4	ANX	12/97 ⇒ 04/99
IBIZA II 1.4 i	ABD, AEX, AKV, APQ	09/93 ⇒ 02/02
IBIZA II 1.4 i 16V	AFH	06/97 ⇒ 02/02
IBIZA II 1.6 i	AEE, ALM	03/93 ⇒ 02/02
INCA 1.4 i	AEX, AKV, APQ	11/95 ⇒ 06/03
INCA 1.6 i	1F, AEE	11/95 ⇒ 05/98

SKODA		
FELICIA 1.6	6A16XHT	06/97 ⇒ 04/02
FELICIA 1.6 GLX	6A16XHT	08/95 ⇒ 03/98
FELICIA 1.6 LX	6A16XHT	08/95 ⇒ 03/98
OCTAVIA I 1.6	6A16XHT	09/96 ⇒ 09/04

VW		
CADDY II 1.4	AEX, AKV, APQ	11/95 ⇒ 06/03
CADDY III 1.6	AEE	06/96 ⇒ 12/00
CADDY II 60 1.4	AEX, APQ	11/95 ⇒ 01/04
CADDY II 75 1.6	AEE	11/95 ⇒ 09/00
GOLF III 1.4	AEX	10/91 ⇒ 04/99
GOLF III 1.6	AEE	09/92 ⇒ 08/97
LUPO 1.0	AER, ALL	09/98 ⇒ 07/05
POLO III 1.4	AEX, AKV, ANX, APQ	05/97 ⇒ 09/01
POLO III 1.6	AEA, AEE, ALM	09/94 ⇒ 09/01
POLO III 100 1.4 16V	AFH	04/96 ⇒ 10/99
POLO III 50 1.0	AER, ALL	09/96 ⇒ 10/99
POLO III 54 1.4	ANX	01/98 ⇒ 08/99
POLO III 55 1.3	ADX	10/94 ⇒ 04/97
POLO III 55 1.4	AEX	08/95 ⇒ 10/99

831 003/001

VW			
POLO III 60 1.4	AEX, AKV, APQ	07/95 →	09/01
POLO III 75 1.6	AEA, AEE, AHS, ALM	10/94 →	09/01
POLO III 75 1.6 4motion	AEA	08/95 →	10/99
POLO IV 1.0	AER	08/96 →	12/01

KW 831 003/001

04

DISTRIBUTOR CAPS

Adatt./Suitable: **MITSUBISHI****BOSCH**

F 005 X04 726

HYUNDAI27110-21020
27110-21021
27110-21060
27110-32810
27120-11000**MAZDA**0324-24-310
AM15-18-V00
H612-24-310**MITSUBISHI**08605
27110-21060
27110-32810
MD602756
MD602949
MD607597
MD611604
MD611686
MD618210
T42271**NISSAN**22162-R9006
22162-R9007**FORD AUSTRALIA**

COURIER 1.8	--	01/79 →	12/84
COURIER 2.0	--	01/79 →	
LASER 1.3	E3	03/81 →	02/83
LASER 1.5	E5	03/81 →	02/83
LASER 1.5 Sport	E5	03/81 →	02/83
METEOR 1.3	--	04/82 →	09/85

HYUNDAI

ELANTRA I 1.5	--	10/90 →	04/95
ELANTRA I 1.5 i GL	G4DJ	12/90 →	08/94
EXCEL 1.3	G4AN	07/85 →	07/91
EXCEL 1.5	G4AJ	07/85 →	08/89
H-1 1.2.4	G4CS	06/97 →	04/04
H-1 1.2.4 4WD	G4CS	02/98 →	04/04
H100 2.4	G4CS	07/93 →	12/04
LANTRA I 1.5	G4DJ	10/90 →	04/95
LANTRA I 1.5 i.e.	G4DJ	10/90 →	11/95
PONY 1.3	G13B	10/85 →	01/95
PONY 1.5	G15B, G4DJ	10/85 →	01/95
PONY 1.5 i	G15B, G4DJ	10/89 →	01/95
PONY / EXCEL 1.3	G4DG	01/90 →	01/95
PONY / EXCEL 1.5	G15B, G4DJ	01/90 →	01/95
PONY / EXCEL 1.5 i	G15B, G4DJ	01/90 →	01/95
PORTER I 2.4	G4CS	03/96 →	04/04
PRECIS 1.5 i [USA]	G4DJ	01/89 →	
SANTAMO 2.0 16V	G4JP	05/99 →	12/02
SANTAMO 2.0 16V 4x4	G4CP-D	05/99 →	12/02
S COUPE 1.5	G4DJA	03/90 →	12/92
S COUPE 1.5 i	G4DJ	02/90 →	05/96
SONATA II 2.4 i	G4CS	09/88 →	08/91
SONATA III 1.8 GLS	G4DM	07/96 →	05/98
SONATA III 1.8 i	G4CM	05/93 →	06/98
SONATA III 2.0 i	G4CP, G4EP	06/94 →	06/98
STELLAR 1.4	4G33	10/83 →	08/86
STELLAR 1.6	G32B	10/83 →	12/91
STELLAR 2.0	--	01/87 →	12/91

MAZDA

929 I 2.0	MA	05/79 →	07/86
-----------	----	---------	-------

MITSUBISHI

COLT I 1.2 GL	4G11	12/78 →	01/84
COLT III 1.3 GL	4G13(8V), G13B	04/88 →	12/90
COLT III 1.5 GLXi	4G15(8V)	04/88 →	05/92
COLT II 1.3 EL, GL	G13B	06/86 →	04/88
CORDIA 1.8 [USA]	G62B	01/82 →	12/88
CORDIA 1.8 Turbo [USA]	G62B	01/82 →	12/88

MITSUBISHI

LANCER V 1.2 GL	4G16	05/88 →	08/92
LANCER V 1.3	4G13(8V), G13B	04/88 →	05/92
LANCER V 1.3 GL	G13B	05/88 →	06/90
LANCER V 1.5	4G15(12V), 4G15(8V)	04/88 →	05/92
LANCER V 1.5 12V	4G15(12V)	05/89 →	05/92
LANCER V 1.5 GLS	4G15(12V)	08/89 →	08/92
LANCER V 1.8 4WD	4G37	03/89 →	06/92
LANCER III/IV 1.2	4G16	08/86 →	04/88
GALANT VI 1.6	4G32	01/88 →	10/92
GALANT VI 1.8	4G37	11/87 →	10/92
GALANT VI 2.0	4G63(SOHC8V)	11/87 →	12/92
GALANT VI 2.0 4WD	4G63(SOHC8V)	12/88 →	10/92
L200 II 1.6	4G32	04/87 →	10/96
L200 II 2.4	4G64(12V)	06/90 →	10/96
L200 II 2.6 4WD	G54B	11/89 →	05/95
MONTERO 2.4 16V	4G64(12V)	04/91 →	
MONTERO 2.6i [USA]	4G54	01/83 →	12/90
PAJERO I 2.6	4G54	01/83 →	11/90
PAJERO I 2.6 4WD	4G54	01/83 →	05/91
PAJERO II 2.4	4G64(12V)	04/91 →	04/00
PAJERO II 2.6 4WD	4G54	03/91 →	10/97
PAJERO III 2.4	4G64(12V)	10/01 →	08/06
PAJERO III 2.4 4x4	4G64(12V)	10/01 →	12/06
PAJERO SPORT II 2.4	4G64(16V)	07/08 →	
PRECIS 1.5 i [USA]	G4DJ	01/89 →	12/94
SHOGUN I 2.6 4x4	4G54	01/84 →	02/91
STARION 2.0 Turbo Eci	4G63-T(ECI), 4G63-T/C	06/82 →	08/87
TRUCK 2.4i [USA]	4G64	01/89 →	
TRUCK 2.6 [USA]	G54B	01/86 →	
VALLEY 2.4 i	4G64	09/92 →	10/94

NISSAN

URVAN III 2.0	Z20	05/87 →	05/97
---------------	-----	---------	-------

KW 831 109

07

DISTRIBUTOR CAPS

Adatt./Suitable: **MITSUBISHI****MAZDA**E594-24-310
FE01-24-310
FE01-24-310A**Motorcraft**

EDH 189

⁰³ Supplied until depletion

- Fornibile fino ad esaurimento delle scorte
- Fourni jusqu'à épuisement du stock
- Lieferbar solange vorrat reicht
- Suministrado hasta el stock termina

**FORD AUSTRALIA**

LASER 1.3	E3	03/83 →	09/85
LASER 1.5	E5	03/83 →	09/85
METEOR 1.3	--	04/82 →	09/85
METEOR 1.5	E5	04/82 →	09/85
TELSTAR 2.0 TX5	FE	05/83 →	10/87

MAZDA

323 IV 1.1	E1	11/80 →	10/85
626 III 1.6	F6	11/82 →	09/87
626 III 2.0	FE(8V)	03/83 →	01/90
929 II 2.0	FE(8V)	03/84 →	07/87

KW 831 114

05

DISTRIBUTOR CAPS

Adatt./Suitable: **MITSUBISHI****BOSCH**1 987 233 112
F 005 X12 906**NISSAN**22162-23G15
22162-40F10
22162-78A10
22162-G5710
22162-G5711**NISSAN**

NAVARA I 2.4	Z24i	06/92 →	02/97
NX1600 1.6 [USA]	E16	01/87 →	12/90
PICK UP I 2.4 i [USA]	KA24E	01/89 →	
PICK UP I 2.4 i 12V	KA24E	04/92 →	02/98
PICK UP I 2.4 i 12V 4WD	KA24E	04/92 →	02/98
PULSAR NX 1.6 [USA]	E16	01/86 →	
SUNNY II 1.6 i	E16i	06/86 →	10/90
SUNNY II 1.6 i 12V	GA16i	06/86 →	06/91
SUNNY II 1.6 i 4x4	E16i	06/86 →	10/90
SUNNY III 1.4	GA14DS	10/90 →	06/95
SUNNY III 1.4 i	GA14DS	10/90 →	05/95
VANETTE II 2.0	Z20S	07/87 →	08/94

KW 831 116

07

DISTRIBUTOR CAPS

Adatt./Suitable: **MITSUBISHI****CHRYSLER**

MD611 526

HYUNDAI

27110-36010

MITSUBISHI

MD611526

⁰³ Supplied until depletion

- Fornibile fino ad esaurimento delle scorte
- Fourni jusqu'à épuisement du stock
- Lieferbar solange vorrat reicht
- Suministrado hasta el stock termina

**CHRYSLER**

LE BARON 3.0 i V6	6G72	01/90 →	12/96
VOYAGER I 3.0 i [USA]	EFA	10/84 →	07/90
VOYAGER 3.0 i	300, 6G72	01/91 →	09/95
VOYAGER 3.3	EGA	10/89 →	09/90

HYUNDAI

GALLOPER 3.0 V6	G6AT	08/98 →	12/03
INNOVATION 3.0 V6	G6AT	05/00 →	

MITSUBISHI

PAJERO I 3.0 i 4WD	6G72(SOHC12V)	05/88 →	05/91
PAJERO I 3.0 V6	6G72(SOHC12V)	11/88 →	11/90
PAJERO II 3.0 V6	6G72(SOHC12V)	12/90 →	12/95
PAJERO II 3.0 V6 4WD	6G72(SOHC12V)	12/90 →	12/95

KW 831 117



04

DISTRIBUTOR CAPS

Adatt./Suitable: **MITSUBISHI****MAZDA**FE1H-18-V00
FE1H-18-V00A
FEH1-18-V00A⁰³ Supplied until depletion

- Fornibile fino ad esaurimento delle scorte
- Fourni jusqu'à épuisement du stock
- Lieferbar solange vorrat reicht
- Suministrado hasta el stock termina

**FORD AUSTRALIA**

SPECTRON 2.0 OHC 01/84 ⇨

MAZDA

929 III 2.2 -- 01/86 ⇨ 12/91

929 III 2.2 12V F2, F21, F267, F2E 02/87 ⇨ 05/89

929 III 2.2 i F2-EGI 05/87 ⇨ 12/88

KW 831 118



07

DISTRIBUTOR CAPS

Adatt./Suitable: **MITSUBISHI****MAZDA**

ESD5-18-V00A

MITSUBISHI

T45071

⁰³ Supplied until depletion

- Fornibile fino ad esaurimento delle scorte
- Fourni jusqu'à épuisement du stock
- Lieferbar solange vorrat reicht
- Suministrado hasta el stock termina

**FORD AUSTRALIA**

LASER 1.3 E3 10/85 ⇨ 09/87

METEOR 1.3 -- 10/85 ⇨ 09/87

MAZDA

323 V 1.1 E1 09/85 ⇨ 10/89

323 V 1.3 E3, E391, E393 08/85 ⇨ 05/89

323 V 1.3 i B3E 09/85 ⇨ 08/89

323 V 1.5 B5, B50, B53, E5 08/85 ⇨ 10/89

KW 831 120



04

DISTRIBUTOR CAPS

Adatt./Suitable: **MITSUBISHI****NISSAN**22162-25G10
22162-25G11
22162-A3514**NISSAN**

VANETTE II 1.5 A15 04/87 ⇨ 11/94

KW 831 121



04

DISTRIBUTOR CAPS

Adatt./Suitable: **MITSUBISHI****BOSCH**

F 005 X04 740

FORD4 132 265
F220 18V00 A
XM34-12106-BA**HYUNDAI**

27110-02503

KIAKK137-18V00
MF220-18-V00A**MAZDA**BP05-18-V00
F220-18-V00A
F2G8-18-V00
G609-18-V00**Motorcraft**DH 444
DHE 441**FORD**

ENDEAVOUR 2.6 -- 10/06 ⇨

ENDEAVOUR 2.6 EFI -- 08/03 ⇨

EVEREST 2.6 -- 10/06 ⇨

EVEREST 2.6 EFI -- 08/03 ⇨

RANGER IV 2.2 -- 03/02 ⇨ 09/05

RANGER IV 2.2 EFI -- 03/99 ⇨

RANGER IV 2.6 -- 10/02 ⇨ 09/04

RANGER IV 2.6 EFI -- 10/06 ⇨

HYUNDAI

ATOS 1.0 i G4HC 02/98 ⇨ 03/02

ATOS PRIME 1.0 i G4HC 08/99 ⇨

KIA

AVELLA 1.3 B3 11/95 ⇨ 12/01

AVELLA 1.5 -- 02/97 ⇨ 12/01

CLARUS 2.0 i 16V FE(16V) 07/96 ⇨

CREDOS 2.0 [AUS] -- 06/95 ⇨ 10/00

PRIDE 1.3 B3, B3A5 01/90 ⇨ 09/01

PRIDE 1.3 i [GBR] -- 01/90 ⇨

SEPHIA I 1.6 i B6 09/93 ⇨ 10/97

MAZDA

323 VI C 1.6 B6E 09/89 ⇨ 06/91

323 VI C 1.6 16V B6 03/91 ⇨ 10/94

323 VI F 1.6 B6E 09/89 ⇨ 06/91

323 VI F 1.6 16V B6 03/91 ⇨ 10/94

323 VI F 1.8 16V BP 08/89 ⇨ 07/94

323 VI F 1.8 16V GT BP(DOHC) 08/89 ⇨ 07/94

323 VI F 1.8i 16v GRSi BP31 06/89 ⇨ 03/91

323 VI S 1.3 16V B3(16V) 04/91 ⇨ 07/94

323 VI S 1.6 B6E 09/89 ⇨ 06/91

323 VI S 1.6 16V B6 08/89 ⇨ 10/96

323 VI S 1.8 16V BPS2 08/89 ⇨ 07/94

323 VI S 1.8 16V 4WD BPS2 09/91 ⇨ 07/94

323 VI S 1.8 16V Turbo 4WD BPTurbo 01/91 ⇨ 07/94

626 IV 2.0 16V FE(16V) 06/87 ⇨ 05/92

626 IV 2.2 12V F2 11/87 ⇨ 04/92

626 IV 2.2 12V 4WD F2 11/87 ⇨ 07/90

B2600 2.6i 12v 4x4 R585 02/99 ⇨

B-SERIE 2.2 4WD R5A2 02/99 ⇨ 11/06

323 VI 1.8i 16v 4x4 BPS1 06/89 ⇨ 03/91

323 VI 1.8i 16v GRSi BP22 06/89 ⇨ 03/91

323 VI 1.8i 16v GT Formula 4 BPS5 04/91 ⇨ 04/94

323 VI 1.8i 16v GT-R Formula 4 BPSJ 04/91 ⇨ 04/94

323 VI 1.8i 16v Turbo 4x4 BPS5 06/89 ⇨ 03/91

E2000 2.0i 12v FERW, FEY9 04/97 ⇨

E2000 2.0i 12v 4x4 FEJM, FEY9 09/90 ⇨ 08/99

BT-50 2.2 --, F2E 09/06 ⇨

BT-50 2.6 G6, G6Y1 09/06 ⇨

MPV I [USA] 2.6 12V -- 01/89 ⇨ 12/94

MPV I [USA] 2.6 12V 4WD -- 01/89 ⇨ 12/94

MX-3 1.6 B69 05/91 ⇨ 10/93

PROTEGE 1.8i DOHC [USA] -- 01/90 ⇨

PROTEGE 1.8i OHC [USA] -- 01/90 ⇨

KW 831 122



05

DISTRIBUTOR CAPS

Adatt./Suitable: **MITSUBISHI****BOSCH**

F 005 X12 889

FORD

KK 150 18 V00

HYUNDAI

KK150-18V00A

KIAKK150-18V00
KK150-18-V00A**MAZDA**B303-18-V00
B3B1-18-V00
G602-18-V00**Motorcraft**

DHE 439

⁰³ Supplied until depletion

- Fornibile fino ad esaurimento delle scorte
- Fourni jusqu'à épuisement du stock
- Lieferbar solange vorrat reicht
- Suministrado hasta el stock termina

**FORD AUSTRALIA**

FESTIVA 1.3 -- 01/91 ⇨

KIA

PRIDE 1.1 i B1 01/91 ⇨ 10/00

PRIDE 1.3 [GBR] -- 01/90 ⇨

PRIDE 1.3 i -- 01/90 ⇨ 05/97

MAZDA

121 I 1.1 B115, B116 10/87 ⇨ 01/91

121 I 1.3 B3 10/87 ⇨ 06/91

323 V 1.6 93AF1006, B6E 09/86 ⇨ 10/95

323 V 1.6 4x4 B65M, B6E 05/90 ⇨ 03/93

323 V 1.6 GT 93AF1006 01/86 ⇨ 10/89

323 V 1.6i 16v Formula 4 B6F2 08/87 ⇨ 05/89

MPV I [USA] 2.6 12V -- 01/89 ⇨ 12/94

MPV I [USA] 2.6 12V AWD -- 01/89 ⇨ 12/94

KW 831 125



07

DISTRIBUTOR CAPS

Adatt./Suitable: **MITSUBISHI****BOSCH**

1 987 233 117

MAZDAB616-18-V00
F201-18-V00**Motorcraft**

DHE 440

⁰³ Supplied until depletion

- Fornibile fino ad esaurimento delle scorte
- Fourni jusqu'à épuisement du stock
- Lieferbar solange vorrat reicht
- Suministrado hasta el stock termina

**MAZDA**

323 V 1.6 GT 93AF1006 01/86 ⇨ 10/89

323 V 1.6i B681, B682 06/86 ⇨ 07/87

323 V 1.6i 16v 4x4 B595 06/86 ⇨ 07/87

323 V 1.6i 16v Formula 4 B6F2 08/87 ⇨ 05/89

626 IV 1.8 F8(12V) 09/87 ⇨ 05/92

626 IV 2.0 FE(12V) 09/87 ⇨ 10/90

626 IV 2.0 12V FE(12V), FEFJ, FEFK 09/87 ⇨ 05/92

626 IV 2.2 12V F2 11/87 ⇨ 04/92

626 IV 2.2 12V 4WD F2 11/87 ⇨ 07/90

KW **831 137** **07,5****DISTRIBUTOR CAPS**Adatt./Suitable: **MITSUBISHI****BOSCH**

F 005 X04 755

03 Supplied until depletion

- Fornibile fino ad esaurimento delle scorte
- Fourni jusqu'à épuisement du stock
- Lieferbar solange vorrat reicht
- Suministrado hasta el stock termina

FORD3 898 173
F32Z-12106-C
KL01-18V00-A**FORD USA**

3 898 173

MAZDAKL01-18-V00
KL01-18-V00A**Motorcraft**

DHE 448

211 Resistance [kOhm] 5

- Resistenza [kOhm] 5
- Résistance [kOhm] 5
- Widerstand [kOhm] 5
- Resistencia [kOhm] 5

**FORD AUSTRALIA**

TELSTAR 2.5	KL-ZE	01/92 ⇨ 10/95
TELSTAR 2.5 TX5 EFI	KL-ZE	10/94 ⇨ 11/96

FORD USA

PROBE II 2.5 V6 24V	KL	10/93 ⇨ 03/98
---------------------	----	---------------

MAZDA

626 V 2.5 24V	KL	01/92 ⇨ 04/97
626 V 2.5i V6 [USA]	--	01/94 ⇨
MX-3 1.8 i V6	K819	01/92 ⇨ 01/94
MX-6 2.5 24V	KL	02/92 ⇨ 09/97

KW **831 138** **05****DISTRIBUTOR CAPS**Adatt./Suitable: **MITSUBISHI****BOSCH**

1 987 233 122

MITSUBISHIMD618555
MD618977**03 Supplied until depletion**

- Fornibile fino ad esaurimento delle scorte
- Fourni jusqu'à épuisement du stock
- Lieferbar solange vorrat reicht
- Suministrado hasta el stock termina

**MITSUBISHI**

COLT IV 1.6 4WD	4G92(SOHC16V)	08/93 ⇨ 08/95
COLT IV 1.6 GLXi 16V	4G92(SOHC16V)	04/92 ⇨ 04/96
EXPOLRV 2.4i [USA]	4G64	01/92 ⇨
LANCER V 1.6 16V	4G92(SOHC16V)	06/92 ⇨ 05/94
LANCER V 1.6 4WD	4G92(SOHC16V)	06/92 ⇨ 11/93
LANCER VI 1.6 16V	4G92(SOHC16V)	06/92 ⇨ 10/03
LANCER VI 1.6 16V 4WD	4G92(SOHC16V)	06/92 ⇨ 10/03
SPACE RUNNER 1.8	4G93(SOHC16V)	10/91 ⇨ 08/99
SPACE RUNNER 1.8 4WD	4G93(SOHC16V)	10/91 ⇨ 08/99
SPACE WAGON 1.8	4G93(SOHC16V)	10/91 ⇨ 10/98
SPACE WAGON 1.8 4WD	4G93(SOHC16V)	10/91 ⇨ 10/98
SPACE WAGON 2.0	4G63(SOHC16V)	10/92 ⇨ 10/98
SPACE WAGON 2.0 4WD	4G63(SOHC16V)	10/92 ⇨ 10/98

KW **831 139** **04****DISTRIBUTOR CAPS**Adatt./Suitable: **MITSUBISHI****CHEVROLET**

93740920

DAEWOO33321-78B40-000
93740920
TS100C00601**GENERAL MOTORS**

93 740 920

SUZUKI33321-78B40
33321-78B40-000**CHEVROLET**

SPARK I 0.8 F&CV 09/00 ⇨ 12/06

DAEWOO

MATIZ 0.8 F&CV 08/98 ⇨

KW **831 140** **04****DISTRIBUTOR CAPS**Adatt./Suitable: **MITSUBISHI****GENERAL MOTORS**

96 064 788

SUZUKI33321-56B10
33321-56B10-000**03 Supplied until depletion**

- Fornibile fino ad esaurimento delle scorte
- Fourni jusqu'à épuisement du stock
- Lieferbar solange vorrat reicht
- Suministrado hasta el stock termina

**SUZUKI**

SIDEKICK 1.6i [USA] -- 01/91 ⇨

VITARA I 1.6 8V -- 01/90 ⇨ 12/98

KW **831 143** **07,5****DISTRIBUTOR CAPS**Adatt./Suitable: **MITSUBISHI****BOSCH**

F 005 X04 749

MITSUBISHIMD618431
MD619176**03 Supplied until depletion**

- Fornibile fino ad esaurimento delle scorte
- Fourni jusqu'à épuisement du stock
- Lieferbar solange vorrat reicht
- Suministrado hasta el stock termina

**MITSUBISHI**

SIGMA 3.0 6G72(SOHC12V) 06/92 ⇨ 10/96

SIGMA 3.0 V6 6G72(SOHC12V) 12/90 ⇨ 07/96

KW **831 144** **04****DISTRIBUTOR CAPS**Adatt./Suitable: **MITSUBISHI****GENERAL MOTORS**

96 068 686

SUZUKI33321-58B10
33321-58B10-000**03 Supplied until depletion**

- Fornibile fino ad esaurimento delle scorte
- Fourni jusqu'à épuisement du stock
- Lieferbar solange vorrat reicht
- Suministrado hasta el stock termina

**SUZUKI**

SIDEKICK 1.6i 16V J1X 4x4 G16B 04/89 ⇨ 04/96

KW **831 145** **05****DISTRIBUTOR CAPS**Adatt./Suitable: **MITSUBISHI****SUBARU**

22162-AA090

03 Supplied until depletion

- Fornibile fino ad esaurimento delle scorte
- Fourni jusqu'à épuisement du stock
- Lieferbar solange vorrat reicht
- Suministrado hasta el stock termina

**SUBARU**

LEGACY I 1.6 -- 01/89 ⇨

LEGACY I 1.8 -- 01/89 ⇨

KW **831 147** **07****DISTRIBUTOR CAPS**Adatt./Suitable: **MITSUBISHI****MITSUBISHI**MD618760
MD618979**00 Eliminated on 08-06-2020. Please verify the availability through our local distributors**

- Eliminato il 08-06-2020. Verificare la disponibilità presso i nostri distributori
- Éliminé le 08-06-2020. Vérifier la disponibilité auprès de nos distributeurs sur place
- Am 08-06-2020 gestrichen. Evtl. Verfügbarkeit bitte bei unseren Händlern prüfen
- Eliminado en fecha 08-06-2020. Verificar la disponibilidad a través de nuestros distribuidores locales

**MITSUBISHI**

GALANT VII 1.8 GLSi 4G93(SOHC16V) 11/92 ⇨ 08/96

GALANT VII 2.0 GLSi 4G63(SOHC16V) 11/92 ⇨ 08/96

GALANT VII 2.0 GLSi 4WD 4G63(SOHC16V) 11/92 ⇨ 08/96

KW 831 149



07,5

DISTRIBUTOR CAPS

Adatt./Suitable: **MITSUBISHI****BOSCH**

F 005 X04 751

MAZDA
KF34-18-V00⁰³ Supplied until depletion

- Fornibile fino ad esaurimento delle scorte
- Fourni jusqu'à épuisement du stock
- Lieferbar solange vorrat reicht
- Suministrado hasta el stock termina

²¹¹ Resistance [kOhm] 5

- Resistenza [kOhm] 5
- Résistance [kOhm] 5
- Widerstand [kOhm] 5
- Resistencia [kOhm] 5

**FORD AUSTRALIA**

TELSTAR 2.5	KL-ZE	01/92 ⇨ 10/95
TELSTAR 2.5 TX5 EFI	KL-ZE	10/94 ⇨ 11/96

MAZDA

323 VII 2.0 24V	KF	08/94 ⇨ 09/98
626 V 2.5 24V	KL	08/94 ⇨ 04/97
MILLENNIA 2.5i [USA]	--	05/99 ⇨
MX-3 1.8 i V6	K838, K8-ZE	01/94 ⇨ 10/97
MX-6 2.5 24V	KL	02/92 ⇨ 09/97
MX-6 2.5 i 24V	KL	08/94 ⇨ 02/97
XEDOS 9 2.0	KF	08/98 ⇨ 08/00
XEDOS 9 2.0 24V	KF	08/93 ⇨ 01/00
XEDOS 9 2.5 24V	KL	07/93 ⇨ 07/00
XEDOS 9 2.5 V6	KL	07/00 ⇨ 09/02

KW 831 150



04

DISTRIBUTOR CAPS

Adatt./Suitable: **MITSUBISHI****BOSCH**

1 987 233 123

FORD

F4BZ-12106-A

FORD AUSTRALIA

B 593-18-V00 A

KIAMB593-18V00
MB593-18-V00A**MAZDA**B3S5-18-V00
B593-18-V00
B593-18-V00A²¹¹ Resistance [kOhm] 5

- Resistenza [kOhm] 5
- Résistance [kOhm] 5
- Widerstand [kOhm] 5
- Resistencia [kOhm] 5

**FORD AUSTRALIA**

LASER 1.6 i	B6(DOHC16V)	10/94 ⇨ 03/99
LASER 1.8 i	BP(DOHC)	10/94 ⇨ 03/99

MAZDA

323 VII C 1.5 16V	Z5-DE	08/94 ⇨ 09/98
323 VII C 1.8 16V	BP-ZE	08/94 ⇨ 09/98
323 VII 1.5 16V	Z5-DE	07/94 ⇨ 09/98
323 VII 1.8 16V	BP-ZE	08/94 ⇨ 09/98
323 VII P 1.5 16V	Z5-DE	10/96 ⇨ 09/98
323 VIII S 1.5 16V	Z5-DE	08/94 ⇨ 09/98
323 VIII S 1.8 16V	BP-ZE	08/94 ⇨ 09/98
DEMIO 1.3 16V	B3ME	08/98 ⇨ 07/03
DEMIO 1.5 16V	B5E	04/00 ⇨ 07/03
MX-3 1.6 i	B6D	11/93 ⇨ 09/98

KW 831 151



07

DISTRIBUTOR CAPS

Adatt./Suitable: **MITSUBISHI****BOSCH**

F 005 X12 624

INFINITI
22162-0M811**NISSAN**22162-0M810
22162-0M811⁰³ Supplied until depletion

- Fornibile fino ad esaurimento delle scorte
- Fourni jusqu'à épuisement du stock
- Lieferbar solange vorrat reicht
- Suministrado hasta el stock termina

²¹¹ Resistance [kOhm] 5

- Resistenza [kOhm] 5
- Résistance [kOhm] 5
- Widerstand [kOhm] 5
- Resistencia [kOhm] 5

**INFINITI**

G20 2.0	SR20DE	01/90 ⇨ 12/97
---------	--------	---------------

NISSAN

PRIMERA I 2.0	SR20DE	07/94 ⇨ 01/98
---------------	--------	---------------

KW 831 152



07

DISTRIBUTOR CAPS

Adatt./Suitable: **MITSUBISHI****BOSCH**

F 00E 000 232

NISSAN22162-70F10
22162-70F11⁰³ Supplied until depletion

- Fornibile fino ad esaurimento delle scorte
- Fourni jusqu'à épuisement du stock
- Lieferbar solange vorrat reicht
- Suministrado hasta el stock termina

²¹¹ Resistance [kOhm] 5

- Resistenza [kOhm] 5
- Résistance [kOhm] 5
- Widerstand [kOhm] 5
- Resistencia [kOhm] 5

**NISSAN**

240SX 2.4	KA24DE	05/94 ⇨ 08/97
-----------	--------	---------------

KW 831 154



07

DISTRIBUTOR CAPS

Adatt./Suitable: **MITSUBISHI****MAZDA**

B3M5-18-V00

⁰⁰ Eliminated on 06-07-2021. Please verify the availability through our local distributors

- Eliminato il 06-07-2021. Verificare la disponibilità presso i nostri distributori
- Éliminé le 06-07-2021. Vérifier la disponibilité auprès de nos distributeurs sur place
- Am 06-07-2021 gestrichen. Evtl. Verfügbarkeit bitte bei unseren Händlern prüfen
- Eliminado en fecha 06-07-2021. Verificar la disponibilidad a través de nuestros distribuidores locales

²¹¹ Resistance [kOhm] 5

- Resistenza [kOhm] 5
- Résistance [kOhm] 5
- Widerstand [kOhm] 5
- Resistencia [kOhm] 5

**MAZDA**

323 VII C 1.3 16V	B3(16V)	08/94 ⇨ 09/98
323 VII P 1.3 16V	B3(16V)	10/96 ⇨ 09/98
323 VIII F 1.4	B3(16V)	01/01 ⇨ 05/04
323 VIII F 1.4 16V	B3ME	09/98 ⇨ 01/01
323 VIII S 1.3	B3(16V)	01/01 ⇨ 05/04
323 VIII S 1.3 16V	B3(16V)	08/94 ⇨ 01/01

KW 831 155



05

DISTRIBUTOR CAPS

Adatt./Suitable: **MITSUBISHI****BOSCH**

1 987 233 114

NISSAN

22162-72Y10

⁰³ Supplied until depletion

- Fornibile fino ad esaurimento delle scorte
- Fourni jusqu'à épuisement du stock
- Lieferbar solange vorrat reicht
- Suministrado hasta el stock termina

**NISSAN**

SUNNY III 1.4	GA14DS	10/90 ⇨ 06/95
SUNNY III 1.4 i	GA14DS	10/90 ⇨ 05/95
SUNNY III 1.6 i	GA16DE, GA16DS	10/90 ⇨ 03/00

KW **831 158**

07

DISTRIBUTOR CAPSAdatt./Suitable: **MITSUBISHI****BOSCH**1 987 233 124
MITSUBISHI
MD618283
MD619186**03 Supplied until depletion**

- Fornibile fino ad esaurimento delle scorte
- Fourni jusqu'à épuisement du stock
- Lieferbar solange vorrat reicht
- Suministrado hasta el stock termina

**MITSUBISHI**

COLT III 1.3 12V	4G13(12V)	04/88 ⇒ 05/92
COLT III 1.3 GL	4G13(8V)	04/88 ⇒ 12/90
COLT V 1.5	301353C	09/95 ⇒ 09/03
COLT V 1.5 16V	301353C	10/99 ⇒ 09/03
LANCER V 1.3	4G13(8V), G13B	04/88 ⇒ 05/92
LANCER V 1.3 12V	4G13(12V)	07/90 ⇒ 07/93
LANCER V 1.5	4G15(12V), 4G15(8V)	04/88 ⇒ 05/92
LANCER VI 1.5	4G15(12V)	09/92 ⇒ 07/96
LANCER VII 1.5	301353C	06/00 ⇒ 08/03
LANCER VII 1.5 16V	301353C	10/99 ⇒ 08/03

KW **831 161**

07,5

DISTRIBUTOR CAPSAdatt./Suitable: **MITSUBISHI****CHRYSLER**MD61 9050
MITSUBISHI
MD619050**03 Supplied until depletion**

- Fornibile fino ad esaurimento delle scorte
- Fourni jusqu'à épuisement du stock
- Lieferbar solange vorrat reicht
- Suministrado hasta el stock termina

211 Resistance [kOhm] 5

- Resistenza [kOhm] 5
- Résistance [kOhm] 5
- Widerstand [kOhm] 5
- Resistencia [kOhm] 5

**CHRYSLER**

CIRRUS 2.5 LX	EEB	10/94 ⇒ 09/00
SEBRING I 2.5 LE	EEB	05/95 ⇒ 12/96
STRATUS 2.5 LX	625H	04/96 ⇒ 04/01
STRATUS 2.5 LX V6	5RG225	12/95 ⇒ 04/01
STRATUS 2.5 V6	5RG225	12/95 ⇒ 04/01

KW **831 168**

05

DISTRIBUTOR CAPSAdatt./Suitable: **MITSUBISHI****MITSUBISHI**MD619363
MD619388
MD619468**211 Resistance [kOhm] 5**

- Resistenza [kOhm] 5
- Résistance [kOhm] 5
- Widerstand [kOhm] 5
- Resistencia [kOhm] 5

**MITSUBISHI**

COLT V 1300 GL, GLX	4G13(12V)	05/96 ⇒ 06/00
LANCER VI 1.6 16V	4G92(SOHC16V)	12/92 ⇒ 10/03
LANCER VI 1.6 16V 4WD	4G92(SOHC16V)	12/92 ⇒ 10/03
LANCER VII 1.3 12V	4G13(12V)	12/95 ⇒ 08/03
SPACE STAR 1.3 16V	4G13(16V)	09/00 ⇒ 12/04

KW **831 169**

07

DISTRIBUTOR CAPSAdatt./Suitable: **MITSUBISHI****MITSUBISHI**MD619092
MD619387**00 Eliminated on 18-11-2019. Please verify the availability through our local distributors**

- Eliminato il 18-11-2019. Verificare la disponibilità presso i nostri distributori
- Éliminé le 18-11-2019. Vérifier la disponibilité auprès de nos distributeurs sur place
- Am 18-11-2019 gestrichen. Evtl. Verfügbarkeit bitte bei unseren Händlern prüfen
- Eliminado en fecha 18-11-2019. Verificar la disponibilidad a través de nuestros distribuidores locales

211 Resistance [kOhm] 5

- Resistenza [kOhm] 5
- Résistance [kOhm] 5
- Widerstand [kOhm] 5
- Resistencia [kOhm] 5

**MITSUBISHI**

CARISMA 1.6	4G92(SOHC16V)	07/95 ⇒ 06/06
CARISMA 1.8	4G93(SOHC16V)	07/95 ⇒ 07/97

KW **831 170**

04

DISTRIBUTOR CAPSAdatt./Suitable: **MITSUBISHI****HYUNDAI**

27110-02750

**HYUNDAI**

ATOS 1.0 i	G4HC	02/98 ⇒ 03/02
ATOS PRIME 1.0 i	G4HC	08/99 ⇒

KW **831 172**

04

DISTRIBUTOR CAPSAdatt./Suitable: **DAC****CHEVROLET**

93740943

DAEWOO

329010

93740943

GENERAL MOTORS

93 740 943

**CHEVROLET**

SPARK 1.0.8	F8CV	09/00 ⇒ 12/06
-------------	------	---------------

DAEWOO

MATIZ 0.8	F8CV	08/98 ⇒
-----------	------	---------

KW **838 242**

04

DISTRIBUTOR CAPSAdatt./Suitable: **PAL****SKODA**

113 911 051

113 911 052

**SKODA**

105,120 1.0	33*	08/76 ⇒ 12/89
105,120 1.0 105 S, L	742.10	08/76 ⇒ 12/90
105,120 1.0 105 S, L, GL	742.10	08/76 ⇒ 08/83
105,120 1.0 105 S, L, LS	742.10	10/83 ⇒ 12/90
105,120 1.2	37*, 55*	08/76 ⇒ 12/89
105,120 1.2 120 GLS	742.12X	02/83 ⇒ 12/90
105,120 1.2 120 L	742.12, 742.12X	08/76 ⇒ 12/90
105,120 1.2 120 LS	742.12X	08/76 ⇒ 12/90
130 1.3	43*	01/84 ⇒ 12/88
135 1.3	43*	01/87 ⇒ 12/89
136 1.3	46*	01/87 ⇒ 12/89

838 243

SKODA		
FAVORIT 1.3	135B, 136B, 781.135, 781.135E, OHC	08/91 ⇒ 06/97
FAVORIT 1.3 135	781.135	10/90 ⇒ 09/94
FAVORIT 1.3 135 X, LX, GLX	781.135E	01/90 ⇒ 09/94
FAVORIT 1.3 135L	781.135	05/89 ⇒ 09/94
FAVORIT 1.3 136	136L	10/90 ⇒ 09/94

KW 838 243

04

DISTRIBUTOR CAPS

Adatt./Suitable: PAL

SKODA

004 026 254 A



SKODA

FELICIA 1.3	061GW4G15K, 135, 135L, 136I	10/94 ⇒ 03/98
-------------	-----------------------------	---------------

KW 842 043

04

DISTRIBUTOR CAPS

Adatt./Suitable: SEV

GENERAL MOTORS

7 992 279

RENAULT

08 54 913 400
77 01 020 378

SEV-MARCHAL

S 4010

⁰³ Supplied until depletion

- Fornibile fino ad esaurimento delle scorte
- Fourni jusqu'à épuisement du stock
- Lieferbar solange vorrat reicht
- Suministrado hasta el stock termina



RENAULT

40.8	800705	10/83 ⇒ 10/88
------	--------	---------------

KW 847 025

05

DISTRIBUTOR CAPS

Adatt./Suitable: U.D.S.S.R.

FIAT

9918275

GENERAL MOTORS

7 992 618

LADA

21010-3706500-00
2101-3706500
2107-3706500
38-37065-00

LADA

LADA 1.2	--	01/80 ⇒
LADA 1.3	--	01/80 ⇒
LADA 1.5	--	01/80 ⇒
NIVA I 1600	BA32121, BA32121	12/76 ⇒ 12/93
RIVA 1.5	--	01/85 ⇒
RIVA 1.6	--	01/85 ⇒

KW 847 027

05

DISTRIBUTOR CAPS

Adatt./Suitable: U.D.S.S.R.

LADA

2108-3706500
2108-3706500-10⁰³ Supplied until depletion

- Fornibile fino ad esaurimento delle scorte
- Fourni jusqu'à épuisement du stock
- Lieferbar solange vorrat reicht
- Suministrado hasta el stock termina



LADA

SAMARA 1.5	--	01/97 ⇒
SAMARA 1100	BA321081	02/88 ⇒ 12/94
SAMARA 1300	BA32108	01/86 ⇒ 12/94
SAMARA 1500	BA321083	09/87 ⇒ 12/96



ROTORS

-DISTRIBUTORI -DISRUPTEURS -VERTEILERLÄUFER -ROTORES DEL DISTRIBUIDOR

(A) P/NRS. - NOTES

- CODICI - NOTE
- RÉFS. - NOTES
- ARTIKEL-NR. - ANMERKUNGEN
- CODIGOS - NOTAS

(B) PICTURE + TECHNICAL INFO

- FOTO + INFORMAZIONE TECNICA
- ILLUSTRATION + INFORMATION TECHNIQUE
- BILD + TECHNISCHE INFO
- FOTO + INFORMACIÓN TÉCNICA

(C) APPLICATION LIST

- GUIDA APPLICAZIONI
- LISTE D'APPLICATIONS
- ANWENDUNGSTABELLE
- LISTA DE APLICACIONES

930 055R **1**

ROTORS

Adatt./Suitable: **MARELLI**

ALFA ROMEO 2

993 817 3
995 004 7

FIAT

9938173

LANCIA

9938173

MAGNETI MARELLI

712 753 01

4 **Resistance Rotor [Ohm] : 1000**

- Rotore resistenza [Ohm] : 1000
- Résistance rotor [ohm] : 1000
- Widerstand-Rotor [Ohm] : 1000
- Resistencia rotor [ohm] : 1000



ALFA ROMEO		
164 2.0 Turbo	AR06476	10/87 ⇨ 09/98
FIAT		
CROMA I 1600	154A.048	12/85 ⇨ 12/90
CROMA I 2000 CHT	154A1.000, 154C5.000	12/85 ⇨ 09/92
CROMA I 2000 i.e. Turbo	154A2.000	12/85 ⇨ 06/90
FIORINO I 1.5	149C1.000	01/88 ⇨ 08/93
FIORINO II 1.5 iE	149C1.000	01/88 ⇨ 10/92
FIORINO II 75 i.e. 1.5	149C1.000	05/88 ⇨ 12/93
REGATA 1.6	--	09/86 ⇨ 06/89
REGATA 100 Super 1.6	149A2.000	10/83 ⇨ 12/90
REGATA 85 1.5	149A5.000	05/85 ⇨ 12/87
RITMO I 1.5	138C2.048	10/85 ⇨ 05/87
RITMO I 1.6	149A4.000	01/83 ⇨ 12/87
RITMO II 75 1.5	138A2.000	09/85 ⇨ 12/88
TEMPRA 1.6	159A3.000, 159A3.048, 159A3.098	03/90 ⇨ 12/96
TEMPRA 1.6 i.e.	159A3.046, 159A3.048	06/90 ⇨ 08/96
TIPO I 1.4	160A1.048	07/87 ⇨ 12/89
TIPO I 1.4 i.e.	160A1.046	05/89 ⇨ 04/95
TIPO I 1.6	160A2.000	01/88 ⇨ 10/92
TIPO I 1.6 SX DGT	159A3.000	05/89 ⇨ 10/95
UNO 1.3 Turbo i.e.	146A2.000	04/85 ⇨ 08/89
UNO 1.4 Super	146C2.028	09/89 ⇨ 09/92
UNO 1.4 Turbo i.e.	146A8.000, 146A8.046	09/89 ⇨ 12/96

(A)

1 # KW

2 OEM P/NRS.

- CODICI ORIGINALI
- RÉFS. D'ORIGINE
- ORIGINALTEILE-NR.
- CODIGOS ORIGINALES

3 PACKAGING SIZE

- FORMATO CONFEZIONE
- FORMAT DU CONDITIONNEMENT
- ABPACKENSGROESSE
- TAMAÑO DEL ENVASE

4 NOTE

- NOTE
- NOTES
- BERMERKUNGEN
- NOTAS

- 1
- PICTURE**
- FOTO
 - PHOTO
 - BILD
 - FOTO

(B)

KW 906 012R



ROTORS

Adatt./Suitable: BOSCH

ALFA ROMEO

700 218
105 48 05 011 00/01
140 20 05 011 00/03
60739128

²¹² Resistance Rotor [Ohm] 5000

- Rotore resistenza [Ohm] 5000
- Résistance rotor [ohm] 5000
- Widerstand-Rotor [Ohm] 5000
- Resistencia rotor [ohm] 5000

BMW

12 11 1 351 447
12 11 1 354 503
12 11 8 630 144

BOSCH

1 234 332 033
1 234 332 074
1 234 332 902

DAF

163792

FORD

0 425 981
1 142 596 1
1 142 598 1
1 451 676
71HM-12200-AA
DIFZ-12200-A

GENERAL MOTORS

06 682 671
7 992 284
7 992 285

Motorcraft

EDR 12
EDR 12 D
EDR 12 S
EDR 40
EDR 40 D

OPEL

17 84 226
17 84 235

PORSCHE

901 602 928 00

RENAULT

77 01 012 535
77 02 037 713

SAAB

78 63 236

VOLVO

240247
2402477
240305
2403053

VW

181 905 225



FORD

CAPRI III 1.3	J1E	01/78 ⇒ 06/85
TRANSIT I 1.6	4RB	11/77 ⇒ 10/86
TRANSIT I 2.0	4RC	11/77 ⇒ 07/82

FORD AUSTRALIA

CORTINA 2.0	--	06/77 ⇒ 08/82
ESCORT 2.0	--	01/77 ⇒ 12/81
ESCORT 2.0 RS	--	01/77 ⇒ 12/81

OPEL

CORSA A 1.0	10S	09/82 ⇒ 03/93
CORSA A 1.2	12N, 12NC	09/82 ⇒ 08/90
CORSA A 1.2 N	12NC	01/85 ⇒ 10/87
KADETT B 1.1	11N	08/71 ⇒ 08/73
KADETT D 1.0	10N	09/79 ⇒ 08/82
KADETT E 1.2	12SC	09/84 ⇒ 07/86
MANTA B 1.3 N	13N	03/79 ⇒ 12/80
MANTA B 1.6 S	16S	09/75 ⇒ 12/81
MANTA B 1.9 N	19N	08/76 ⇒ 12/81
MANTA B 2.0	20N	08/77 ⇒ 12/80

RENAULT

FUEGO 1.6 [USA] R1368	A7L752	01/82 ⇒ 12/84
-----------------------	--------	---------------

KW 906 014R



ROTORS

Adatt./Suitable: BOSCH

BOSCH

1 234 332 076
1 234 332 082
1 234 332 089

²¹² Resistance Rotor [Ohm] 5000

- Rotore resistenza [Ohm] 5000
- Résistance rotor [ohm] 5000
- Widerstand-Rotor [Ohm] 5000
- Resistencia rotor [ohm] 5000

FORD

0 425 469
1 142 546 9

GENERAL MOTORS

7 992 286
7 992 640
7 992 887

VW

111 905 225 F
111 905 225 G



PEUGEOT

204 1.1	XK, XK4, XK5	10/65 ⇒ 07/77
204 1.1 Grand Luxe	XK4	05/69 ⇒ 10/77
304 1.1	XK5	10/76 ⇒ 10/80
304 1.3	XL3, XL3S, XL5	03/70 ⇒ 10/80
304 1.3 GL	XL5	09/72 ⇒ 10/79
304 1.3 GT	XL3	10/69 ⇒ 09/75
404 1.6	XC6	04/63 ⇒ 12/71
404 1.6 GT	XC6	07/71 ⇒ 12/71
504 1.8	XM7	01/71 ⇒ 07/86
504 2.0	106(XN1)	03/71 ⇒ 07/86
505 1.8	105(XM7)	06/81 ⇒ 10/85
505 2.0	106(XN1)	11/80 ⇒ 12/85

RENAULT

12 1.3	810.02, 810-02/97	10/69 ⇒ 08/80
--------	-------------------	---------------

TOYOTA

STARLET 1.0	6A25BFXS	02/78 ⇒ 09/84
STARLET 1.2 S	3K-H	10/78 ⇒ 08/82

VW

1500,1600 1.5	K	04/61 ⇒ 07/73
1500,1600 1.5 S	--	08/63 ⇒ 07/65
1500,1600 1.6	T, U	08/65 ⇒ 07/73
1500,1600 1.6 L	T, U	08/65 ⇒ 07/73
1500,1600 1.6 TL	T, U	08/65 ⇒ 07/73
KAEFER 1300 1.3	E	08/65 ⇒ 07/70
KAEFER 1500 1.5	4SC20M1500G	08/66 ⇒ 11/73

KW 906 018R



ROTORS

Adatt./Suitable: BOSCH

BOSCH

1 234 332 024
1 234 332 029
1 234 332 030
1 234 332 062
1 234 332 072
1 234 332 087
1 234 332 088

²¹² Resistance Rotor [Ohm] 5000

- Rotore resistenza [Ohm] 5000
- Résistance rotor [ohm] 5000
- Widerstand-Rotor [Ohm] 5000
- Resistencia rotor [ohm] 5000

DAF

52 84 20

GENERAL MOTORS

7 992 289
7 992 878
7 992 883

INTERNATIONAL HARV.

883092R91

MERCEDES-BENZ

A 000 158 15 31
A 000 158 20 31

PORSCHE

616 602 221 00

VW

111 905 225 B
111 905 225 C
892 031 520



BMW

1500-2000 2000	18F209	09/68 ⇒ 07/72
1502-2002 2002	M10B20A	02/68 ⇒ 07/75

BORGWARD

ISABELLA 1.5	--	06/54 ⇒ 02/62
--------------	----	---------------

FORD

TAUNUS 17M 1.7	--	08/57 ⇒ 11/60
----------------	----	---------------

MERCEDES-BENZ

/8 230.6	M180.954	01/68 ⇒ 11/76
/8 250	M114.920	01/68 ⇒ 08/72
/8 250 2.8	M130.923	06/72 ⇒ 11/76
/8 250 C	M114.920	04/69 ⇒ 06/72
/8 250 C 2.8	M130.923	06/72 ⇒ 11/76
CLASSE S I 250 S	M108.920	01/66 ⇒ 12/69
CLASSE S I 250 SE	M129.980	01/66 ⇒ 12/67
CLASSE S I 280 S	M130.920	10/67 ⇒ 07/72
CLASSE S I 280 SE, SEL	M130.980	01/68 ⇒ 08/72
CLASSE SL I 190 SL	M121.921, M121.928	01/55 ⇒ 12/63
COUPE 220 SEB	M127.984	01/61 ⇒ 12/65
COUPE 250 SE	M129.980, M129.981	01/65 ⇒ 12/67
HECKFLOSSE 190 C	M121.924	04/61 ⇒ 08/65
HECKFLOSSE 200	M115.926, M121.940	07/65 ⇒ 02/68
HECKFLOSSE 220 B	M180.940	08/59 ⇒ 08/65
HECKFLOSSE 220 SB	M180.941	08/59 ⇒ 08/65
HECKFLOSSE 220 SEB	M127.982	08/59 ⇒ 08/65
HECKFLOSSE 230	M180.945, M180.949, M180.950	07/65 ⇒ 02/68
HECKFLOSSE 230 S	M180.947, M180.950	07/65 ⇒ 01/68
PAGODE 230 SL	M127.981	01/63 ⇒ 01/67
PAGODE 250 SL	M129.982	01/66 ⇒ 01/68
PAGODE 280 SL	M130.983	01/68 ⇒ 03/71
PONTON 220	M180.921	01/54 ⇒ 12/56
PONTON 220 S	M180.924	01/56 ⇒ 12/59

PORSCHE

356 C 1600 SC	--	01/63 ⇒ 12/65
---------------	----	---------------

VW

KAEFER 1.2	M51	01/54 ⇒ 07/65
------------	-----	---------------

KW 906 021R



ROTORS

Adatt./Suitable: BOSCH

BOSCH

1 234 332 106
1 234 332 107
1 234 332 109

⁰³ Supplied until depletion

- Fornibile fino ad esaurimento delle scorte
- Fourni jusqu'à épuisement du stock
- Lieferbar solange vorrat reicht
- Suministrado hasta el stock termina

DAF

22 45 66

GENERAL MOTORS

7 992 290
7 992 888

MERCEDES-BENZ

A 000 158 21 31

PORSCHE

616 602 221 05

VOLVO

076978
0769786

VW

059 905 225
113 905 225 E



AUDI		
100 III 1.8	DR, DS, JW, NP, RS	08/82 ⇨ 07/89
100 III 1.8 quattro	JW, NP	10/84 ⇨ 07/88
MERCEDES-BENZ		
/8 200	M115.923, M115.926	01/68 ⇨ 01/77
COUPE 280 SE	M130.980, M130.984	01/67 ⇨ 12/71
NSU		
1000 C	--	08/63 ⇨ 12/72
PORSCHE		
356 A 1600	--	01/55 ⇨ 12/59
356 A 1600 S	616.15	01/55 ⇨ 12/59
356 A 1600 Super	616.15	01/55 ⇨ 12/59
356 B 1600	--	09/59 ⇨ 08/63
356 B 1600 Super 75	616.15	01/59 ⇨ 12/63
356 B 1600 Super 90	--	01/59 ⇨ 12/63
356 C 1600 SC	--	01/63 ⇨ 12/65
SAAB		
900 I 2.0 Turbo	B201XL	01/86 ⇨ 12/91
VW		
KAEFER 1200 1.2	D	01/60 ⇨ 12/85
KAEFER 1300 1.3	AB	01/70 ⇨ 01/73
KAEFER 1302 1.3	AB	08/70 ⇨ 08/72
KAEFER 1302 1.6	AD	01/70 ⇨ 01/73
KAEFER 1500 1.5	45C20M150Q6	01/66 ⇨ 12/70
KARMANN GHIA 1500	45C20M150Q6	01/66 ⇨ 12/69
KARMANN GHIA 1600	AD	01/70 ⇨ 12/73

KW 906 023R



ROTORS

Adatt./Suitable: BOSCH

BOSCH

1 234 332 177

FIAT
9939707

GENERAL MOTORS

7 992 985

LANCIA

9939707

MERCEDES-BENZ

A 000 158 23 31

PEUGEOT

5937 21

PORSCHE

928 602 904 03

RENAULT

77 01 021 905

VOLVO

243922

2439222

²¹² Resistance Rotor [0hm] 5000

- Rotore resistenza [0hm] 5000
- Résistance rotor [ohm] 5000
- Widerstand-Rotor [0hm] 5000
- Resistencia rotor [ohm] 5000



ALPINE		
V6 GT	Z6W	01/85 ⇨ 12/90
LANCIA		
THEMA 2850 V6 i.e.	834E.000	11/84 ⇨ 09/88
MERCEDES-BENZ		
CLASSE S II 380 SE, SEL	M116.961	09/80 ⇨ 10/81
CLASSE S II 500 SE, SEL	M117.961	12/79 ⇨ 08/85
CLASSE SL III 380 SL	M116.960	09/80 ⇨ 08/81
RENAULT		
25 2.7 V6 Injection	Z7V708, Z7V709, Z7V711	04/84 ⇨ 08/89
25 2.8 V6 Injection	Z7W702	06/86 ⇨ 02/88
VOLVO		
240 2.8	B28E	10/80 ⇨ 09/84
260 2.8	B28E	08/80 ⇨ 07/85
760 2.8	B28A, B28E, B28F	08/81 ⇨ 07/88

KW 906 024R



ROTORS

Adatt./Suitable: BOSCH

ALFA ROMEO

119 11 05 011 00/02
60735860

BMW

12 11 1 267 464
12 11 1 360 306

BOSCH

1 234 332 173
1 234 332 197
1 234 332 236
1 234 332 237
1 234 332 332

FORD

1 604 959
6 002 610
72TF-12200-AA
73TF-12200-AA
82TF-12200-AA

GENERAL MOTORS

7 992 630

MAN

51.26310-0002

MERCEDES-BENZ

A 000 158 22 31

Motorcraft

EDR 23
EDR 49
EDR 113

OPEL

1 46 015

PORSCHE

930 602 902 00

VOLVO

243657

2436574

VW

073 905 225



ALFA ROMEO		
6 2.0	AR01932	07/81 ⇨ 12/86
MERCEDES-BENZ		
CLASSE G I 280 GE	M110.994	11/79 ⇨ 08/89
CLASSE G II 280 GE	M110.994	04/92 ⇨
TRE VOLUMI I 280 E	M110.984	02/76 ⇨ 11/85
PUCH		
G-MODELL 280 GE	M110.994	01/86 ⇨ 12/91

KW 906 025R  **1**

ROTORS

Adatt./Suitable: **BOSCH**
ALFA ROMEO ²¹² Resistance Rotor [Ohm] 5000
 116 36 05 011 01/01
 9927967
 9950021
BOSCH
 1 234 332 213
 1 234 332 215
 1 234 332 261
DAF
 744625
FIAT
 38326383
 638326383
 82288614
 82316498
 9927962
 9927967
 AXE2056
FORD
 1 606 399
 3 240 335
 5 027 532
 78MU-12200-A
 82HF-12200-AA
GENERAL MOTORS
 9 977 034
 90 114 107
INNOCENTI
 638326383
LANCIA
 9927962
MERCEDES-BENZ
 A 000 158 27 31
 A 000 158 31 31
Motorcraft
 DR 22
 EDR 109
PEUGEOT
 5937 32
PORSCHE
 923 602 929 00
RENAULT
 77 02 038 439
SAAB
 83 55 950
 93 06 697
SEAT
 NG9 810 462 9
TALBOT
 0013 52 9900
 1352 99 00
 1832 20 01
VOLVO
 243796
 243903
 2439032
VW
 027 905 225
 043 905 225
 181 905 225 C
 ZBA 905 225 B



LANCIA			
BETA 1600	8288.000	08/73	⇒ 07/82
MERCEDES-BENZ			
0 309	M115.952	01/68	⇒ 02/89
PEUGEOT			
205 I 1.5	Y2/K	02/84	⇒ 10/87
309 I 1.5	Y2/K	06/87	⇒ 12/89
PORSCHE			
924 2.0 Turbo	M31.03	06/80	⇒ 10/86
TALBOT			
1307-1510 Simca 1307 1.3	--	07/75	⇒ 01/80
SIMCA 1309	--	01/78	⇒ 12/86
SOLARA 1.3	2M102.979	02/80	⇒ 07/86
VOLVO			
240 1.8	B17A	11/78	⇒ 07/85
240 2.0	OJX4G20A6L, B19ET	08/74	⇒ 08/84
240 2.1 Turbo	B21ET, B21FT	08/80	⇒ 07/85
VW			
JETTA II 1.6	EZ	01/84	⇒ 07/92
CADDY I 1.6	EW, HN	01/83	⇒ 07/92
GOLF II 1.6	EZ	08/83	⇒ 07/92
GOLF II 1.6 [CHE] [SWE]	HM	08/83	⇒ 07/85

KW 906 026R  **1**

ROTORS

Adatt./Suitable: **BOSCH**
BOSCH ²¹² Resistance Rotor [Ohm] 5000
 1 234 332 216
 1 234 332 285
 • Rotore resistenza [Ohm] 5000
 • Résistance rotor [ohm] 5000
 • Widerstand-Rotor [Ohm] 5000
 • Resistencia rotor [ohm] 5000
FIAT
 9935782
GENERAL MOTORS
 7 992 986
 90 087 360
 94 632 557
OPEL
 12 12 213
PEUGEOT
 5937 51
 5940 52
SAAB
 93 50 323
 93 55 488
VW
 052 905 225



OPEL			
ASCONA C 1.3 N	13N	09/81	⇒ 08/86
KADETT D 1.3 S	13S	08/79	⇒ 08/84
PEUGEOT			
106 I 1.1	HDZ(TU1M)	09/91	⇒ 04/96
106 I 1.4	K5A(TU3), TU3.2	08/91	⇒ 03/96
205 II 1.1	HDZ(TU1M)	07/89	⇒ 09/98
205 II 1.4	KDY(TU3M), KDZ(TU3M)	07/88	⇒ 09/98
205 II 1.4 CJ	KDY(TU3M), KDZ(TU3M)	05/91	⇒ 12/94
306 1.4	TU3	01/93	⇒ 04/97
309 I 1.4	KDY(TU3M), KDZ(TU3M)	03/89	⇒ 07/89
309 II 1.1	HDZ(TU1M)	08/90	⇒ 12/93
309 II 1.4	KDZ(TU3M), TU3F2	07/89	⇒ 12/93
309 II 1.6	XUSJA	07/89	⇒ 12/93
309 II 1.6 GTi	--	09/89	⇒ 10/93
405 I 1.4	TU3F2	01/87	⇒ 12/92
405 I 1.9	D2C(XU92C)	07/87	⇒ 12/92
405 II 1.4	TU3F2	01/93	⇒ 12/96
405 II 1.9	XU92C	01/93	⇒ 12/96
SAAB			
90 2.0	B20I	08/84	⇒ 08/87
900 I 2.0 c	B201XC	09/79	⇒ 12/88
900 I 2.0 i	OTLE4G15, B201XI	11/80	⇒ 08/90
900 I 2.0 Turbo	B201XL	01/86	⇒ 12/91
VW			
DERBY 1.1	HB	02/77	⇒ 09/81
DERBY 1.3	HH	02/77	⇒ 09/81
POLO II 1.1	HB	10/81	⇒ 09/89
POLO II 1.3	GT, HH, HJ	10/81	⇒ 07/88

ALFA ROMEO			
ALFETTA 1.8	AR01608X	07/74	⇒ 04/82
GIULIETTA I 1.3	AR01644	10/77	⇒ 06/83
FIAT			
132 2.0	132C2.000	01/76	⇒ 06/81
DUCATO I 1.8	169B	01/82	⇒ 12/88
ARGENTA 2000	132D1.000	06/78	⇒ 12/85
FIAT (BR)			
147 1.1	--	01/82	⇒ 12/84
FORD			
CORTINA 1300	KL13H	10/70	⇒ 03/72
ESCORT III 1.1	GSE	08/83	⇒ 12/85
FIESTA I 0.9	TKA, TKW, TLA	05/76	⇒ 08/83
FIESTA I 1.1	GLA, GLW	05/76	⇒ 08/83
FIESTA I 1.6 XR2	L3E	08/81	⇒ 08/83
FIESTA II 1.1	GLC, GSF	09/83	⇒ 02/89
FIESTA II 1.3	JPC	09/83	⇒ 09/89
SIERRA I 1.3	JCT	08/82	⇒ 12/86
SIERRA I 2.0	NET, NYT	08/82	⇒ 12/86
P 100 2.0	NAE	10/87	⇒ 12/92
TRANSIT II 1.6	LAC, LAT	09/85	⇒ 09/92
TRANSIT II 2.0	NAT, NAV, NAW, NBA, NCA	09/85	⇒ 09/94
TRANSIT II 2.0 i	NCA	09/91	⇒ 07/94
TRANSIT II 2.0 L	NAW, NAX	10/85	⇒ 03/91
INNOCENTI			
MINI 120	--	01/75	⇒ 12/83

KW 906 027R  **3**

ROTORS

Adatt./Suitable: **BOSCH**
BMW
 12 11 1 355 211
 12 11 1 360 305
 12 11 1 362 221
 12 12 1 355 211
BOSCH
 1 234 332 208
 1 234 332 280
 1 234 335 280
GENERAL MOTORS
 7 992 638
VW
 055 905 225
⁰³ Supplied until depletion
 • Fornibile fino ad esaurimento delle scorte
 • Fourni jusqu'à épuisement du stock
 • Lieferbar solange vorrat reicht
 • Suministrado hasta el stock termina
²¹² Resistance Rotor [Ohm] 5000
 • Rotore resistenza [Ohm] 5000
 • Résistance rotor [ohm] 5000
 • Widerstand-Rotor [Ohm] 5000
 • Resistencia rotor [ohm] 5000
³¹⁰ RPM to [1/min] 6600
 • N° giri fino a [1/min.] 6600
 • Régime mot. jusqu'à [1/min] 6600
 • Drehzahl bis [1/min] 6600
 • vel. giro hasta [1/min] 6600



VW			
SCIROCCO II 1.6	1HyFAD	08/80	⇒ 04/84

KW 906 034R  **3**

ROTORS

Adatt./Suitable: **BOSCH**
BOSCH
 1 234 332 204
GENERAL MOTORS
 93 150 102
MERCEDES-BENZ
 A 000 158 26 31
⁰⁰ Eliminated on 05-10-2021. Please verify the availability through our local distributors
 • Eliminato il 05-10-2021. Verificare la disponibilità presso i nostri distributori
 • Éliminé le 05-10-2021. Vérifier la disponibilité auprès de nos distributeurs sur place
 • Am 05-10-2021 gestrichen. Evtl. Verfügbarkeit bitte bei unseren Händlern prüfen
 • Eliminado en fecha 05-10-2021. Verificar la disponibilidad a través de nuestros distribuidores locales

⁰³ Supplied until depletion
 • Fornibile fino ad esaurimento delle scorte
 • Fourni jusqu'à épuisement du stock
 • Lieferbar solange vorrat reicht
 • Suministrado hasta el stock termina

²¹² Resistance Rotor [Ohm] 5000
 • Rotore resistenza [Ohm] 5000
 • Résistance rotor [ohm] 5000
 • Widerstand-Rotor [Ohm] 5000
 • Resistencia rotor [ohm] 5000

³¹⁰ RPM to [1/min] 6650
 • N° giri fino a [1/min.] 6650
 • Régime mot. jusqu'à [1/min] 6650
 • Drehzahl bis [1/min] 6650
 • vel. giro hasta [1/min] 6650



MERCEDES-BENZ			
CLASSE G I 280 GE	M110.994	11/79	⇒ 08/89
CLASSE G II 280 GE	M110.994	04/92	⇒

MERCEDES-BENZ

CLASSE S II 280 S	M110.924	12/79 ⇒ 07/85
CLASSE SL III 280 SL	M110.986	06/76 ⇒ 09/81
CLASSE SL III 280 SLC	M110.986	06/76 ⇒ 09/81
TRE VOLUMI I 280 E	M110.984	02/76 ⇒ 11/85

PUCH

G-MODELL 280 GE	M110.994	01/86 ⇒ 12/91
-----------------	----------	---------------

KW 906 045R



ROTORS

Adatt./Suitable: BOSCH

BOSCH

9 231 081 628

FIAT

7073054

GENERAL MOTORS

9 300 152

VW

040 905 225

71 314 347

Eliminated on 22-02-2022. Please verify the availability through our local distributors

• Eliminato il 22-02-2022. Verificare la disponibilità presso i nostri distributori

• Eliminé le 22-02-2022. Vérifier la disponibilité auprès de nos distributeurs sur place

• Am 22-02-2022 gestrichen. Evtl. Verfügbarkeit bitte bei unseren Händlern prüfen

• Eliminado en fecha 22-02-2022. Verificar la disponibilidad a través de nuestros distribuidores locales

212 Resistance Rotor [Ohm] 5000

- Rotore resistenza [Ohm] 5000
- Résistance rotor [ohm] 5000
- Widerstand-Rotor [Ohm] 5000
- Resistencia rotor [ohm] 5000



FIAT (BR)

147 1.1	--	01/76 ⇒ 12/81
PREMIO	--	01/85 ⇒ 12/88
UNO 1.05	1.05	01/85 ⇒ 12/87
UNO 1.3	1.3	01/85 ⇒ 12/91
UNO 1.3 Furgoneta	1.3	01/85 ⇒ 12/91
UNO CS 1.3	1.3	01/85 ⇒ 12/91

VOLKSWAGEN (BR)

VWB 1.5	--	01/75 ⇒ 12/82
---------	----	---------------

KW 906 049R



ROTORS

Adatt./Suitable: BOSCH

BOSCH

1 234 332 282

1 234 332 337

MERCEDES-BENZ

A 000 158 36 31

PEUGEOT

5937 26

212 Resistance Rotor [Ohm] 1000

- Rotore resistenza [Ohm] 1000
- Résistance rotor [ohm] 1000
- Widerstand-Rotor [Ohm] 1000
- Resistencia rotor [ohm] 1000



MERCEDES-BENZ

CLASSE S II 380 SE, SEL	M116.963	10/81 ⇒ 08/85
CLASSE S II 380 SEC	M116.963	10/81 ⇒ 07/85
CLASSE S II 500 SE, SEL	M117.963	12/79 ⇒ 08/85
CLASSE S II 500 SEC	M117.963	08/80 ⇒ 08/85
CLASSE SL III 380 SL	M116.962	09/80 ⇒ 08/85

PEUGEOT

604 2.7 SL	112(ZM)	08/77 ⇒ 05/83
------------	---------	---------------

604 2.7 TI, STI	140(ZMJ)	08/77 ⇒ 05/83
-----------------	----------	---------------

TALBOT

TAGORA 2.6	9L6	08/81 ⇒ 10/83
------------	-----	---------------

KW 906 055R



ROTORS

Adatt./Suitable: BOSCH

ALFA ROMEO

115 44 05 011 00/02

60723008

60752000

AUDI

035 905 225 B

055 905 225 B

BMW

12 111 1 272 144

BOSCH

1 234 332 300

1 234 332 301

1 234 332 309

1 234 332 359

GENERAL MOTORS

90 141 495

MERCEDES-BENZ

A 000 158 34 31

OPEL

12 12 216

PEUGEOT

5937 31

PORSCHE

931 602 906 00

SAAB

75 19 309

SEAT

055 905 225 B

SKODA

115 911 400

VOLVO

1336240

13362405

1336241

13362413

VW

026 905 225 1

035 905 225 B

055 905 225 B



ALFA ROMEO

75 1.6	AR06100	05/85 ⇒ 09/89
75 1.8	AR06168	09/88 ⇒ 02/92
SPIDER I 1600	AR00526, AR01563	03/76 ⇒ 12/93
SPIDER I 2000	AR01544	08/86 ⇒ 12/90

AUDI

80 II 1.3	EP	09/78 ⇒ 07/86
80 II 1.6	DT, JU, SA, WV	08/78 ⇒ 03/87
80 II 1.8	DS, JN, SF	01/83 ⇒ 08/86
80 II 1.8 CC quattro	JN, JV	08/84 ⇒ 08/86
80 II 1.8 GTE	DZ, MU	06/84 ⇒ 03/87
80 II 2.0	HP, JS	10/83 ⇒ 09/84
80 II 2.0 quattro	JS	10/83 ⇒ 09/84
80 III 1.4	SE	08/86 ⇒ 07/88
80 III 1.6	ABB, PP, RN, RNA	09/86 ⇒ 10/91
80 III 1.8	RU	10/86 ⇒ 01/90
80 III 1.8 E	DZ	06/86 ⇒ 08/91
80 III 1.8 S	JN, JV, NE, PM, SF	08/86 ⇒ 10/91
80 III 1.8 S quattro	JN	09/86 ⇒ 09/91
80 IV 1.6	ABB	03/92 ⇒ 05/93
90 I 1.8	JN	06/84 ⇒ 03/87
90 I 2.0	HP, JL, JS	10/84 ⇒ 03/87
90 I 2.0 quattro	JS	08/84 ⇒ 08/86
90 I 2.2	KX	01/85 ⇒ 03/87
90 II 2.0	PS	07/88 ⇒ 09/91
90 II 2.2 E	9CS4	04/87 ⇒ 07/91
90 II 2.2 E quattro	9CS4	04/87 ⇒ 09/91
100 III 1.8	DR, DS, JW, NP, SH	08/82 ⇒ 12/90
100 III 1.8 Cat	4B, PH	03/85 ⇒ 11/90
100 III 1.8 Cat quattro	4B	08/85 ⇒ 11/90
100 III 1.8 quattro	NP, SH	10/84 ⇒ 07/90
100 III 2.0	KP	08/84 ⇒ 12/87
100 III 2.0 Cat	RT	01/88 ⇒ 11/90
100 III 2.0 E	KP	01/85 ⇒ 12/87
100 III 2.0 E Cat	RT	01/88 ⇒ 11/90
100 III 2.2 Cat	KU	06/89 ⇒ 11/90
100 III 2.2 Cat quattro	KU	06/89 ⇒ 11/90
100 IV 1.6	ABB	03/92 ⇒ 07/93
200 II 2.2 Turbo quattro	MC	01/85 ⇒ 12/91
COUPE 1.8	DZ	08/89 ⇒ 07/91
COUPE 2.2	9CS4	11/88 ⇒ 07/91
COUPE 2.2 GT	9CS4	09/84 ⇒ 10/88
COUPE 2.2 quattro	9CS4, JT	10/84 ⇒ 07/91

BMW

3 I 316 i	M10B18(184KA)	08/87 ⇒ 08/88
3 I 318 i	M10B18(184EA), M10B18(184KA)	09/82 ⇒ 08/88
5 I 518 i	M10B18(184EB)	05/81 ⇒ 12/87

MERCEDES-BENZ

124 200 CE	M102.963	09/89 ⇒ 06/93
124 230 CE	M102.982	03/87 ⇒ 12/92
124 230 CE Cat	M102.982	06/89 ⇒ 12/92
190 2.0	M102.921, M102.924	10/82 ⇒ 05/90
190 2.3	M102.985	09/87 ⇒ 09/88
190 2.3 E	M102.985	10/82 ⇒ 09/88
190 E 2.0	M102.962	10/82 ⇒ 08/93
190 E 2.3	M102.985	09/86 ⇒ 08/93
CLASSE G I 200 GE	M102.964	02/80 ⇒ 08/92
CLASSE G I 230 GE	M102.981, M102.987	04/82 ⇒ 08/92
CLASSE G II 230 G	M102.958	04/92 ⇒
CLASSE G II 230 GE	M102.981, M102.996, M102.997	04/92 ⇒

KOMBI I 200 T	M102.920, M102.939	11/80 ⇒ 11/85
KOMBI II 200 T	M102.922	09/85 ⇒ 05/90
KOMBI II 200 TE	M102.962, M102.963	09/88 ⇒ 08/92
KOMBI II 230 E Chassis	M102.982	09/86 ⇒ 06/93
KOMBI II 230 TE	M102.982	09/85 ⇒ 08/92
KOMBI II 230 TE Cat	M102.982	06/89 ⇒ 08/92
O 309	M102.943	01/68 ⇒ 02/89
T1 210 2.3	M102.942, M102.945	04/77 ⇒ 02/96
T1 310 2.3	M102.942, M102.945	08/82 ⇒ 02/96
T1 410 2.3	M102.942, M102.945	08/82 ⇒ 06/95
T2/LN1 510	M102.946	04/86 ⇒ 12/94
TRE VOLUMI II 200	M102.922	12/85 ⇒ 10/92
TRE VOLUMI II 200 E	M102.963	09/88 ⇒ 08/93
TRE VOLUMI II 230 E	M102.982	12/84 ⇒ 06/93
TRE VOLUMI II 230 E Cat	M102.982	06/89 ⇒ 06/93

OPEL

MANTA B 1.3 S	13S	08/81 ⇒ 08/86
---------------	-----	---------------

PEUGEOT

505 2.0	106E(XN1A)	09/85 ⇒ 09/95
505 2.1 i	XN9T	01/83 ⇒ 12/88
505 2.2	851(ZDJ), 851X(ZDJL)	05/81 ⇒ 12/93
505 2.2 GTI	851B(ZDJL)	08/83 ⇒ 12/93

PUCH

G-MODELL 230 GE	M102.981, M102.987, M102.996	03/79 ⇒ 07/00
-----------------	------------------------------	---------------

SAAB

9000 2.0 -16 Turbo	B202XL	09/84 ⇒ 08/93
9000 2.0 -16 Turbo CD	B202XL	09/88 ⇒ 08/93

SEAT

TOLEDO I 1.6 i	1F, ABN, EZ	05/91 ⇒ 03/99
TOLEDO I 1.8 i	RP	05/91 ⇒ 12/96

SKODA

FELICIA 1.3	061GW4G15K	10/94 ⇒ 07/96
-------------	------------	---------------

VOLKSWAGEN (BR)

GOL 1.6	504, 505	09/94 ⇒ 01/97
GOL 1.8	521, 522	04/94 ⇒ 01/97
GOL 2.0i	528, 529	09/94 ⇒ 01/97
LOGUS 1.6	504, 505	10/94 ⇒ 12/96
LOGUS 1.8	524, 525, 599	12/92 ⇒ 12/96
LOGUS 2.0	653	11/93 ⇒ 05/94
LOGUS 2.0i	526, 527	05/94 ⇒ 12/96
PARATI 1.6	504, 505	08/95 ⇒ 01/97
PARATI 1.8	521	08/95 ⇒ 01/97
PARATI 2.0i	528, 529	08/95 ⇒ 01/97
POINTER 1.8	524, 525, 599	11/93 ⇒ 12/96
POINTER 2.0	653	12/92 ⇒ 05/94
POINTER 2.0i	526, 527	05/94 ⇒ 12/96

VOLVO

240 2.3	B230F	08/86 ⇒ 07/87
240 2.3 i Cat	B230F	08/86 ⇒ 07/93
760 2.3 Turbo	B23ET, B23FT	08/82 ⇒ 07/84

VW

PASSAT II 1.6	DT	08/80 ⇒ 03/88
PASSAT II 1.8	DS	01/83 ⇒ 03/88
PASSAT II 1.8 Syncro	DS	01/86 ⇒ 03/88
PASSAT II 2.0	JS	08/83 ⇒ 03/88
PASSAT II 2.0 Syncro	JS	05/84 ⇒ 03/88
PASSAT II 2.2	KX	01/85 ⇒ 03/88
JETTA II 1.6	ABN, EZ, EZA, HM, PN, RF	12/83 ⇒ 07/92
JETTA II 1.8	EV, GU, GX, RH	01/84 ⇒ 10/91
JETTA II 1.8 Cat	GX, RP	08/87 ⇒ 10/91
JETTA II 1.8 Syncro	GU, RP	08/87 ⇒ 12/88
JETTA II 1.8i GT	GZ	12/83 ⇒ 07/88
CADDY I 1.5	JB	08/82 ⇒ 07/83
CADDY I 1.6	EW, HN	01/83 ⇒ 07/92
CADDY I 1.8	JH	08/85 ⇒ 07/92
GOLF I 1.6	EW, HN	08/83 ⇒ 04/92
GOLF I 1.8	DX, EX, JH, KT	08/82 ⇒ 04/93
GOLF II 1.6	ABN, EZ, PN, RF	08/83 ⇒ 12/92
GOLF II 1.6 [CHE] [SWE]	HM	08/83 ⇒ 07/88
GOLF II 1.6 G	EZA, PN	08/86 ⇒ 07/91

VW			
GOLF II 1.8	GU, GX, RH	08/84 ⇒ 10/91	
GOLF II 1.8 [CHE] [SWE]	HV	08/86 ⇒ 07/87	
GOLF II 1.8 GTI	EV	08/83 ⇒ 10/91	
GOLF II 1.8 i	RP	08/87 ⇒ 07/91	
GOLF II 1.8 i Cat	GX, RP	08/87 ⇒ 10/91	
GOLF II 1.8 i Cat Syncro	RP	08/87 ⇒ 10/91	
GOLF II 1.8 Syncro	GU, GX	02/86 ⇒ 07/91	
GOLF II 1.8i GTI [CHE] [SWE]	GZ	08/85 ⇒ 07/87	
GOLF II 1.8i GTI [SWE]	GZ	08/87 ⇒ 07/88	
PASSAT III 1.6	1F, ABN, EZ	04/88 ⇒ 07/92	
PASSAT III 1.8	RP	02/88 ⇒ 05/97	
QUANTUM 1.7	--	01/85 ⇒ 12/87	
QUANTUM 2.1	--	01/81 ⇒ 12/89	
SANTANA 1.6	DT	08/81 ⇒ 12/84	
SANTANA 1.8	DS	01/83 ⇒ 12/84	
SCIROCCO I 1.5	JB	08/77 ⇒ 07/80	
SCIROCCO II 1.6	EW, EWA, HN, RE	01/83 ⇒ 07/90	
SCIROCCO II 1.8	DX, EX, JH, KT	08/82 ⇒ 07/92	
TRANSPORTER IV 1.8	5K7M710	12/90 ⇒ 07/92	
ZASTAVA			
YUGO 45 [USA]	--	01/86 ⇒	

KW 906 056R



1

ROTORS

Adatt./Suitable: BOSCH

BOSCH

1 234 332 273

CITROËN

95 602 185

GENERAL MOTORS

90 006 547

90 141 911

HOLDEN

GB838

OPEL

12 12 217

12 12 220

PEUGEOT

5937 25

SEAT

000 398 066 6

036 905 225 H

SE 021914.004A

VW

036 905 225 H

212 Resistance Rotor [Ohm] 1000

- Rotore resistenza [Ohm] 1000
- Résistance rotor [ohm] 1000
- Widerstand-Rotor [Ohm] 1000
- Resistencia rotor [ohm] 1000



CITROËN

AX 1.3 Sport	M4A	04/87 ⇒ 12/88
AX 10	C1A	09/86 ⇒ 06/92
AX 10 E	C3A	12/86 ⇒ 12/88
AX 11	H1A, H1B, HDZ(TU1M)	09/86 ⇒ 12/97
AX 11 4x4	H1A	06/91 ⇒ 07/92
AX 11 Cat	HAZ(TU1CP)	09/88 ⇒ 12/89
AX 14	K1A(TU3), K1B, K1F, K1G, K1J, K2A, K2B, K2D, KAY(TU3CP), KDX(TU3M/Z), KDY(TU3FM), KDY(TU3M), KDZ(TU3M/Z)	09/86 ⇒ 04/97
AX 14 4x4	KD4, KDX(TU3M/Z), KDY(TU3FM), KDY(TU3M), KDZ(TU3M/Z)	06/91 ⇒ 12/96
AX 14 GT	KDZ(TU3M/Z)	01/89 ⇒ 12/91
BX 1.1	109LA, H1A	04/86 ⇒ 06/91
BX 1.4	150C, K1F, K2D	07/86 ⇒ 12/94
BX 1.4 E	150B(XY8), 150J, 150Y, K1F, KAZ	09/82 ⇒ 12/94
BX 1.6	182A, B2C, B6D, B6E	01/87 ⇒ 12/94
BX 1.9	159B, 159C, D6U, DKK	05/85 ⇒ 12/94
BX 1.9 GTi	D6D, D6K	01/87 ⇒ 01/92
BX 14	150C, KDY(TU3M), KDZ(TU3M/Z)	01/86 ⇒ 02/93
BX 14 E	150A, 150C, K1G	10/82 ⇒ 02/93
BX 15	B1E(XU51C)	01/87 ⇒ 05/92
BX 16	171A, 171B, 171C, 171D, 180Z, 23DH, B1E(XU51C), BAY(XU5CP), BAZ(XU5CP)	10/82 ⇒ 12/94
BX 19	159A, D2A(XU92C), D2C(XU92C), D2E, D6A(XU9J2), DKZ(XU9JA)	09/84 ⇒ 12/94
BX 19 Cat	DFZ(XU9J1)	07/86 ⇒ 12/94
BX 19 E 4x4	D2F	04/89 ⇒ 02/93
BX 19 GTi	D6A(XU9J2), DKZ(XU9JA)	07/86 ⇒ 02/93

CITROËN

BX 19 GTi 4x4	DKZ(XU9JA)	06/88 ⇒ 02/93
C15 1.0	108C, 108C(XV8), C1A, C1A(TU9/K), C1B(TU9/W), TU9	10/84 ⇒ 12/97
C15 1.0 E	TU9K	11/92 ⇒ 07/96
C15 1.1	109K, H1A, HDZ(TU1M), TU1, XW7	10/84 ⇒ 12/96
C15 1.1 i	HDZ(TU1M), TU1MZ	07/88 ⇒ 12/96
C15 1.4	150D(XY7), K1A, K1G, K1H(TU3A), KDY(TU3M)	05/87 ⇒ 12/96
C15 1.4 E	150D(XY7), K1F, K1J, K2D, K3A, KAZ	07/86 ⇒ 12/96
C15 1.4 i	KDY(TU3FM), KDY(TU3M)	05/91 ⇒ 12/96
LNA 1.1	109/5E	07/82 ⇒ 04/85
VISA 11 E	109K	09/78 ⇒ 06/88
ZX 1.1	H1A, H1B, HDZ(TU1M), TU1	03/91 ⇒ 06/97
ZX 1.4 i	KDY(TU3M)	10/93 ⇒ 10/97

HOLDEN

CAMIRA 1.6	161H	08/82 ⇒ 02/86
CAMIRA 1.8 MPFi	6T2204XS85K01	11/84 ⇒ 01/86
CAMIRA 1.8 SPFi	6T2204XS85K01	02/86 ⇒ 03/87

OPEL

ASCONA C 1.6	16N	09/81 ⇒ 08/88
ASCONA C 1.6 S	16SH	09/81 ⇒ 08/86
ASCONA C 1.8 E	C18NE	01/85 ⇒ 08/86
ASCONA C 1.8 i	18E	09/82 ⇒ 08/86
ASTRA F 1.4	14NV	09/91 ⇒ 09/93
CORSA A 1.4 S	14NV	09/89 ⇒ 03/93
CORSA A 1.6 GSi	E16SE	05/88 ⇒ 03/92
KADETT E 1.4 S	14NV	07/89 ⇒ 02/93
KADETT E 1.6 S	16S	09/84 ⇒ 08/86
KADETT E 1.8 E	C18NE	10/85 ⇒ 08/86
KADETT E 1.8 GSi	18E	09/84 ⇒ 08/86
KADETT E 1.8 i	18E, C18NE, C18NT	08/84 ⇒ 09/92
OMEGA A 2.6 i	C26NE	09/90 ⇒ 03/94
OMEGA A 3.0	30NE, C30LE, C30NE	03/87 ⇒ 03/94
OMEGA A 3.0 24V	C30SE	09/89 ⇒ 03/94
OMEGA A 3.0 24V Omega 3000	C30SE	09/88 ⇒ 04/94
OMEGA A 3.0 Cat	C30NE	03/87 ⇒ 03/94
SENATOR B 2.5 i	25NE	09/90 ⇒ 09/93
SENATOR B 3.0	30NE, C30LE	09/87 ⇒ 09/93
SENATOR B 3.0 24V	C30SE	09/89 ⇒ 09/93
SENATOR B 3.0 i Cat	C30NE	01/88 ⇒ 09/93
VECTRA A 1.4 S	14NV	04/88 ⇒ 06/92

PEUGEOT

104 1.0	108C(XV8)	09/83 ⇒ 06/88
106 I 1.0	TU9	09/91 ⇒ 03/01
106 I 1.1	H1B(TU1)	08/91 ⇒ 03/96
106 I 1.4	KDY(TU3M)	09/91 ⇒ 04/96
205 I 1.0	108C(XV8)	02/83 ⇒ 12/90
205 I 1.4	150B(XY8), 150G(XY7), 150H(XY8), TU3	01/83 ⇒ 12/90
205 I 1.6	B1A(XU51C), B1E(XU51C), BAZ(XU5CP)	08/86 ⇒ 10/87
205 I 1.6 GTI	180A(XU5J), B6D(XU5JA), XU5J1	01/83 ⇒ 12/90
205 I 1.9 GTI	D6B(XU9JA), DFZ(XU9J1)	10/86 ⇒ 10/87
205 II 1.0	TU9	10/87 ⇒ 09/98
205 II 1.1	H1B(TU1)	10/87 ⇒ 12/94
205 II 1.1 CJ	HDZ(TU1M)	10/89 ⇒ 12/94
205 II 1.4	150B(XY8), 150G(XY7), 150H(XY8), K1D(TU3A), K2B(TU3S)	06/87 ⇒ 10/90
205 II 1.4 Cat	KAY(TU3CP)	08/87 ⇒ 09/93
205 II 1.4 CJ	150G(XY7), K1D(TU3A)	03/88 ⇒ 12/94
205 II 1.4 CJ Cat	KAY(TU3CP)	01/89 ⇒ 09/93
205 II 1.4 CT	150B(XY8), 150H(XY8)	04/86 ⇒ 12/88
205 II 1.6	B1A(XU51C), B1E(XU51C), BAZ(XU5CP)	10/87 ⇒ 09/98
205 II 1.6 CTi	180A(XU5J), 180Z(XU5J)	03/86 ⇒ 10/90
205 II 1.6 GTI	180A(XU5J), 180Z(XU5J), XU5JA	10/87 ⇒ 12/94
205 II 1.9 CTi	DFZ(XU9J1)	10/87 ⇒ 12/94
205 II 1.9 GTI	D6B(XU9JA)	10/87 ⇒ 09/98
205 II 1.9 GTI Cat	DFZ(XU9J1)	10/87 ⇒ 07/94
309 I 1.4	K1D(TU3A)	03/89 ⇒ 07/89
309 I 1.6	--, 180Z(XU5J), B1A(XU51C), B1D(XU51C), B1E(XU51C), B6B(XU5J), XU5JA	10/85 ⇒ 07/89
309 I 1.6 Cat	BAZ(XU5CP)	09/86 ⇒ 12/89
309 I 1.9	D2B(XU9S), DFZ(XU9J1), XU92C	10/85 ⇒ 07/89
309 I 1.9 GTI	D6B(XU9JA)	10/86 ⇒ 07/89
309 II 1.1	H1B(TU1)	09/89 ⇒ 10/93
309 II 1.4	TU3	07/89 ⇒ 12/93
309 II 1.6	XU5JA	07/89 ⇒ 12/93
309 II 1.6 GTi	--	09/89 ⇒ 10/93
309 II 1.9	XU92C	07/89 ⇒ 12/93
405 I 1.4	K5A(TU3), TU3A	01/87 ⇒ 12/92
405 I 1.6	--	01/87 ⇒ 12/92
405 I 1.9	D6A(XU9J2), DFZ(XU9J1)	07/87 ⇒ 12/93

PEUGEOT

405 I 1.9 Antipollution	XU92C	01/87 ⇒ 12/92
405 I 1.9 Injection	DFZ(XU9J1)	07/87 ⇒ 12/92
405 I 1.9 Trazione integrale	DFZ(XU9J1)	09/88 ⇒ 07/92
405 II 1.6	18EM	08/92 ⇒ 05/97
505 2.0 Ti, STI	829(ZEJ)	08/79 ⇒ 10/86

SEAT

IBIZA I 1.2	021A1000	11/84 ⇒ 12/93
IBIZA II 1.3 i	8C20HD0D	03/93 ⇒ 08/99
MALAGA 1.2	021A1000	05/85 ⇒ 12/93
MALAGA 1.5	021A2000	05/85 ⇒ 12/93

VAUXHALL

ASTRA III 1.4	14NV	09/91 ⇒ 09/93
ASTRA III 1.4 S	14NV	09/91 ⇒ 02/98

VW

POLO II 1.0	AAK, GL, HZ	10/81 ⇒ 09/94
POLO II 1.0 Cat	AAK, ACM	08/89 ⇒ 09/94
POLO II 1.3	GK, MH	09/82 ⇒ 09/89
POLO II 1.3 Cat	2G, MH, NZ	07/87 ⇒ 09/94
JETTA II 1.0	HZ	08/85 ⇒ 10/91
JETTA II 1.3	GT, MH, NU	01/84 ⇒ 12/87
JETTA II 1.3 Cat	2G, MH, NZ	06/87 ⇒ 12/91
DERBY 1.3	HK	08/83 ⇒ 12/84
GOLF II 1.0	HZ	08/85 ⇒ 10/91
GOLF II 1.3	GT, MH, NU	08/83 ⇒ 12/87
GOLF II 1.3 Cat	2G, NZ	06/86 ⇒ 12/92
PASSAT II 1.3	79SU16	08/80 ⇒ 07/86
SCIROCCO II 1.3	GF	08/80 ⇒ 12/83

KW 906 059R



3

ROTORS

Adatt./Suitable: BOSCH

AUDI

035 905 225 C

BOSCH

1 234 332 305

1 234 335 305

VW

035 905 225 C

03 Supplied until depletion

- Fornibile fino ad esaurimento delle scorte
- Fourni jusqu'à épuisement du stock
- Lieferbar solange vorrat reicht
- Suministrado hasta el stock termina

212 Resistance Rotor [Ohm] 1000

- Rotore resistenza [Ohm] 1000
- Résistance rotor [ohm] 1000
- Widerstand-Rotor [Ohm] 1000
- Resistencia rotor [ohm] 1000

310 RPM to [1/min] 6700

- N° giri fino a [1/min.] 6700
- Régime mot. jusqu'à [1/min] 6700
- Drehzahl bis [1/min] 6700
- vel. giro hasta [1/min] 6700



AUDI

100 III 1.9	WH	08/82 ⇒ 07/84
100 III 2.2	KZ	10/84 ⇒ 09/86
200 II 2.2	KU	08/84 ⇒ 07/85
200 II 2.2 Turbo quattro	MC	01/85 ⇒ 12/91

VW

PASSAT II 1.9	WN	01/81 ⇒ 07/83
---------------	----	---------------

KW 906 060R



1

ROTORS

Adatt./Suitable: BOSCH

BMW
12 11 1 707 263**BOSCH**
1 234 332 279
1 234 332 296**DAF**
698595**FORD**
6 075 742
815F-12200-FA**MAN**
51.26310-0005**MERCEDES-BENZ**
A 000 158 35 31**Motorcraft**
EDR 98**ROVER**
GRA2236
GRA2264**212 Resistance Rotor [Ohm] 1000**
• Rotore resistenza [Ohm] 1000
• Résistance rotor [ohm] 1000
• Widerstand-Rotor [Ohm] 1000
• Resistencia rotor [ohm] 1000

BMW		
3 II 323 i	M20B23(236EC)	09/82 ⇒ 09/86
5 II 520 i	M20B20(206EA)	06/81 ⇒ 12/87
5 II 525 i	M30B25(256EA)	06/81 ⇒ 12/87
5 II 528 i	M30B28(286EA)	06/81 ⇒ 12/87
FORD		
ESCORT III 1.3	JPA	09/80 ⇒ 02/86
ESCORT III 1.6	LP1, LPA	09/80 ⇒ 12/85
ORION I 1.3	JPA	07/83 ⇒ 03/86
ORION I 1.6	LP1, LPA	07/83 ⇒ 03/86
MERCEDES-BENZ		
123 280 CE	M110.988	03/77 ⇒ 11/85
CLASSE G I 280 GE	M110.994	11/79 ⇒ 08/89
CLASSE G II 280 GE	M110.994	04/92 ⇒
CLASSE S II 280 SE, SEL	M110.989	10/79 ⇒ 07/85
TRE VOLUMI I 280 E	M110.988	02/76 ⇒ 11/85
PUCH		
G-MODELL 280 GE	M110.994	01/86 ⇒ 12/91

KW 906 061R



1

ROTORS

Adatt./Suitable: BOSCH

ALFA ROMEO
116 97 05 011 00/04
60755007
9940437**BMW**
12 11 1 272 300**BOSCH**
1 234 332 271
1 234 332 275
1 234 332 401**FIAT**
7080449
9940437**FORD**
5 021 112
6 124 108
6 182 579
80SX-12200-AA
845F-12200-AA
88SX-12200-AA
895F-12200-AA**GENERAL MOTORS**
91 103 092**MERCEDES-BENZ**
0001582731
A 000 158 33 31**Motorcraft**
EDR 151
EDR 157
EDR 187**OPEL**
12 12 219**PEUGEOT**
5937 40**TALBOT**
0043 23 7300**VW**
039 905 225
053 905 225 1**212 Resistance Rotor [Ohm] 1000**
• Rotore resistenza [Ohm] 1000
• Résistance rotor [ohm] 1000
• Widerstand-Rotor [Ohm] 1000
• Resistencia rotor [ohm] 1000

ALFA ROMEO		
33 I 1.2	AR30585	06/83 ⇒ 12/89
33 I 1.3	AR30168, AR30586, AR30587	06/83 ⇒ 12/89
33 I 1.3 i.e.	AR30168	05/83 ⇒ 12/89
33 I 1.4	AR30587	01/84 ⇒ 12/88
33 I 1.5	AR30588	07/86 ⇒ 12/89
33 I 1.5 4x4	AR30508, AR30588	07/86 ⇒ 12/89
33 I 1.5 QV	AR30146, AR30508, AR30588	06/84 ⇒ 12/89
33 I 1.7	AR30550	01/86 ⇒ 06/90
33 I 1.7 i.e.	AR30558	09/88 ⇒ 12/89
33 I 1.7 i.e. 4x4	AR30558	09/88 ⇒ 12/89
33 I 1.7 QV	AR30550	03/88 ⇒ 12/89
33 II 1.2	AR30743	01/90 ⇒ 08/91
33 II 1.3	AR30732	09/91 ⇒ 10/94
33 II 1.5	AR30734	01/90 ⇒ 04/93
75 1.8	AR06202	09/85 ⇒ 06/89
90 1.8	AR06202	10/84 ⇒ 07/87
90 2.0 i.e.	AR06210	10/84 ⇒ 07/87
ALFETTA 1.6	AR01600	01/75 ⇒ 12/84
ALFETTA 1.8	AR01608	10/79 ⇒ 12/84
GIULIETTA I 1.6	AR01600	10/77 ⇒ 04/85
GIULIETTA I 1.8	AR01678	04/79 ⇒ 04/85
GIULIETTA I 2.0	AR01655	06/80 ⇒ 04/85
CITROËN		
C15 1.1	E1A	10/84 ⇒ 12/96
C15 1.3	G1A	07/87 ⇒ 05/88
FIAT		
UNO 70 1.3i SX	--	01/83 ⇒ 12/89
UNO 75 i.e. 1.5	138C2.048	10/85 ⇒ 12/93
FIAT (BR)		
PREMIO	--	01/85 ⇒ 12/88
PREMIO 1.3	--	01/85 ⇒
PREMIO 1.5	--	01/85 ⇒
UNO 1.3	1.3	01/85 ⇒ 12/91
UNO 1.5	1.5	01/91 ⇒ 12/93
UNO 1.5R	1.5	01/87 ⇒ 12/89
UNO 1.6R	1.6	01/90 ⇒ 12/93
UNO CS 1.3	1.3	01/85 ⇒ 12/91
UNO CS 1.5	1.5	01/89 ⇒ 12/93
UNO CS 1.5 Furgoneta	1.5	01/91 ⇒ 12/93
UNO CSL 1.6	1.6	01/91 ⇒ 12/93
UNO MILLE 1.0	1.0	01/91 ⇒ 04/93

FORD		
ESCORT IV 1.4	F6D, FUA, FUC	01/86 ⇒ 07/90
FIESTA II 1.1	G5H	05/86 ⇒ 02/89
FIESTA II 1.4	FUB, FUD	10/85 ⇒ 11/89
ESCORT III 1.4 i	F6D, FUC	02/86 ⇒ 07/90
ORION I 1.3	JPA	11/86 ⇒ 07/88
ORION I 1.4	FUA, FUC	12/85 ⇒ 07/90
ORION I 1.4 Cat	F6D	02/87 ⇒ 07/90
OPEL		
CORSA A 1.2	E12GV	09/82 ⇒ 08/90
CORSA A 1.2 N	E12GV	01/85 ⇒ 10/87
PEUGEOT		
205 11.3	G1A	02/84 ⇒ 10/87
205 11.4	J2	01/83 ⇒ 12/90
205 II 1.1 XA	E1	07/87 ⇒ 10/88
205 II 1.2	F1	01/87 ⇒ 12/90
205 II 1.3	G1A	08/90 ⇒ 07/92
205 II 1.4	J2	01/91 ⇒ 12/94
309 11.1	E1	10/85 ⇒ 07/89
309 11.3	G1A, G2S	10/85 ⇒ 08/89
309 11.6	--, J2	01/86 ⇒ 07/89
309 II 1.6	18EM, J2	07/89 ⇒ 12/93
TALBOT		
TAGORA 2.1	5N2	06/80 ⇒ 12/83
VOLKSWAGEN (BR)		
APOLLO 1.8		06/90 ⇒ 11/92

KW 906 067R



3

ROTORS

Adatt./Suitable: BOSCH

BOSCH
1 234 332 144
1 234 332 158
1 234 332 162
1 234 332 209
1 234 332 291
1 234 332 303**GENERAL MOTORS**
93 150 099**VW**
021 905 225
071 905 225
071 905 225 A**03 Supplied until depletion**
• Fornibile fino ad esaurimento delle scorte
• Fourni jusqu'à épuisement du stock
• Lieferbar solange vorrat reicht
• Suministrado hasta el stock termina**212 Resistance Rotor [Ohm] 1000**
• Rotore resistenza [Ohm] 1000
• Résistance rotor [ohm] 1000
• Widerstand-Rotor [Ohm] 1000
• Resistencia rotor [ohm] 1000**310 RPM to [1/min] 5400**
• N° giri fino a [1/min.] 5400
• Régime mot. jusqu'à [1/min] 5400
• Drehzahl bis [1/min] 5400
• vel. giro hasta [1/min] 5400

OPEL		
REKORD E 1.7	17N	09/77 ⇒ 10/82
REKORD E 1.9	19N	09/77 ⇒ 10/82
REKORD E 2.0	20N	09/77 ⇒ 10/82
VOLVO		
240 2.3	B23A	08/80 ⇒ 07/84
VW		
TRANSPORTER II 2.0	CJ, GD, GE	08/75 ⇒ 04/79
TRANSPORTER III 1.9	DF, DG	08/82 ⇒ 07/92
TRANSPORTER III 1.9 Syncro	DG	11/84 ⇒ 07/92

KW 906 070R



3

ROTORS

Adatt./Suitable: BOSCH

BOSCH

1 234 332 333

PORSCHÉ

944 602 901 00

944 602 906 01

ROLLS-ROYCE

UE 46152

²¹² Resistance Rotor [Ohm] 1000

- Rotore resistenza [Ohm] 1000
- Résistance rotor [ohm] 1000
- Widerstand-Rotor [Ohm] 1000
- Resistencia rotor [ohm] 1000



PORSCHÉ

924 2.5 S	M44.07	09/85 ⇒ 07/87
928 4.7 S	M28.11, M28.12	09/79 ⇒ 07/83

KW 906 112R



3

ROTORS

Adatt./Suitable: BOSCH

BMW

12 11 1 276 277

12 11 1 286 111

BOSCH

1 234 332 276

1 234 332 313

1 234 332 344

1 234 332 351

FORD

1 612 099

1 617 277

V835-F12200-AA

V835-F12200-AB

MERCEDES-BENZ

A 000 158 37 31

Motorcraft

EDR 123

EDR 135

⁰³ Supplied until depletion

- Fornibile fino ad esaurimento delle scorte
- Fourni jusqu'à épuisement du stock
- Lieferbar solange vorrat reicht
- Suministrado hasta el stock termina

²¹² Resistance Rotor [Ohm] 1000

- Rotore resistenza [Ohm] 1000
- Résistance rotor [ohm] 1000
- Widerstand-Rotor [Ohm] 1000
- Resistencia rotor [ohm] 1000

³¹⁰ RPM to [1/min] 6500

- N° giri fino a [1/min.] 6500
- Régime mot. jusqu'à [1/min] 6500
- Drehzahl bis [1/min] 6500
- vel. giro hasta [1/min] 6500



BMW

3 II 323 i	M20B23(236EC)	09/82 ⇒ 09/86
5 II 520 i	M20B20(206EA)	06/81 ⇒ 12/87
5 II 525 i	M30B25(256EA)	06/81 ⇒ 12/87
5 II 528 i	M30B28(286EA)	06/81 ⇒ 12/87
6 I 628 CSI	M30B28	09/79 ⇒ 08/87

FORD

ESCORT III 1.6 i	LR1	09/83 ⇒ 12/85
ESCORT III 1.6 XR3i	LR1, LRA	10/82 ⇒ 12/85
ORION I 1.6 i	LR1, LRA	07/83 ⇒ 03/86

KW 906 113R



1

ROTORS

Adatt./Suitable: BOSCH

ALFA ROMEO

116 69 05 011 00/02

60732287

BOSCH

1 234 332 200

1 234 332 346

JAGUAR

JLM 839

MERCEDES-BENZ

0001583531

PORSCHÉ

930 602 902 01

930 602 902 02

⁰⁰ Eliminated on 09-03-2022. Please verify the availability through our local distributors

- Eliminato il 09-03-2022. Verificare la disponibilità presso i nostri distributori
- Éliminé le 09-03-2022. Vérifier la disponibilité auprès de nos distributeurs sur place
- Am 09-03-2022 gestrichen. Evtl. Verfügbarkeit bitte bei unseren Händlern prüfen
- Eliminado en fecha 09-03-2022. Verificar la disponibilidad a través de nuestros distribuidores locales

²¹² Resistance Rotor [Ohm] 1000

- Rotore resistenza [Ohm] 1000
- Résistance rotor [ohm] 1000
- Widerstand-Rotor [Ohm] 1000
- Resistencia rotor [ohm] 1000



ALFA ROMEO

75 2.5 V6	AR01911	05/85 ⇒ 08/86
75 3.0 V6	AR06120, AR61503	01/87 ⇒ 02/92
75 3.0 V6 Cat	AR06124	01/87 ⇒ 02/92

PORSCHÉ

911 II 3.3 Turbo	M30.69	08/90 ⇒ 09/93
911 II 3.3 Turbo S	M30.69S	06/91 ⇒ 12/92
911 II 3.6 Carrera	M64.01, M64.02	12/88 ⇒ 05/94
911 II 3.6 Carrera 4	M64.01	12/88 ⇒ 05/94
911 II 3.6 Carrera RS	M64.03	06/91 ⇒ 09/93
911 II 3.6 Turbo	M64.50	01/93 ⇒ 09/93
911 I 3.2 SC Carrera	930.20	08/83 ⇒ 08/89
911 III 3.6 Carrera	M64.05, M64.06, M64.07, M64.08, M64.21, M64.22, M64.23, M64.24	10/93 ⇒ 09/97
911 III 3.6 Carrera 4	M64.05, M64.07, M64.21, M64.23	07/94 ⇒ 09/97
911 III 3.6 Turbo 4	M64.60	03/95 ⇒ 09/97
911 III 3.6 Turbo GT2	M64.60R	03/95 ⇒ 09/97
911 III 3.6 Turbo GT2 4	M64.60R, M64.60RS	08/95 ⇒ 09/97
911 III 3.8 Carrera	M64.05S, M64.06S, M64.21S	06/95 ⇒ 09/97
911 III 3.8 Carrera 4	M64.05S, M64.06S, M64.21S	06/95 ⇒ 09/97
911 III 3.8 Carrera RS	M64.20	06/95 ⇒ 09/97

KW 906 114R



3

ROTORS

Adatt./Suitable: BOSCH

BOSCH

1 234 332 340

VW

052 905 225 B

⁰³ Supplied until depletion

- Fornibile fino ad esaurimento delle scorte
- Fourni jusqu'à épuisement du stock
- Lieferbar solange vorrat reicht
- Suministrado hasta el stock termina

²¹² Resistance Rotor [Ohm] 5000

- Rotore resistenza [Ohm] 5000
- Résistance rotor [ohm] 5000
- Widerstand-Rotor [Ohm] 5000
- Resistencia rotor [ohm] 5000

³¹⁰ RPM to [1/min] 6500

- N° giri fino a [1/min.] 6500
- Régime mot. jusqu'à [1/min] 6500
- Drehzahl bis [1/min] 6500
- vel. giro hasta [1/min] 6500



VW

POLO II 1.0	GL	10/81 ⇒ 10/86
POLO II 1.3	HK, HW	08/83 ⇒ 07/88
JETTA II 1.3	HK	01/84 ⇒ 06/87
DERBY 1.0	GL	10/81 ⇒ 12/84
DERBY 1.3	HH	02/77 ⇒ 09/81
GOLF I 1.3	HK	08/83 ⇒ 07/86
GOLF II 1.0	GN	11/83 ⇒ 08/85
GOLF II 1.3	HK	08/83 ⇒ 06/87
SCIROCCO I 1.3	GF	08/79 ⇒ 07/80
SCIROCCO II 1.3	HK	08/83 ⇒ 07/84

KW 906 115R



3

ROTORS

Adatt./Suitable: BOSCH

BMW

12 11 1 286 110

12 11 1 357 720

12 11 1 710 735

BOSCH

1 234 332 220

1 234 332 281

1 234 332 288

1 234 332 343

FIAT

82357741

VW

049 905 225 C

049 905 225 D

⁰³ Supplied until depletion

- Fornibile fino ad esaurimento delle scorte
- Fourni jusqu'à épuisement du stock
- Lieferbar solange vorrat reicht
- Suministrado hasta el stock termina

²¹² Resistance Rotor [Ohm] 1000

- Rotore resistenza [Ohm] 1000
- Résistance rotor [ohm] 1000
- Widerstand-Rotor [Ohm] 1000
- Resistencia rotor [ohm] 1000

³¹⁰ RPM to [1/min] 6400

- N° giri fino a [1/min.] 6400
- Régime mot. jusqu'à [1/min] 6400
- Drehzahl bis [1/min] 6400
- vel. giro hasta [1/min] 6400



BMW

3 II 316	M10B18(184VC), M10B18(184VD)	09/83 ⇒ 06/88
3 II 318 i	M10B18(184EA), M10B18(184KA)	09/82 ⇒ 08/88
3 I 315	M10B16(164VB)	03/81 ⇒ 03/84
5 II 518	M10B18(184VC), M10B18(184VD)	06/81 ⇒ 09/84
5 II 518 i	M10B18(184EB)	05/81 ⇒ 12/87

BMW		
51518	M10B18(184VB)	07/74 ⇒ 05/81

KW 906 116R



ROTORS

Adatt./Suitable: BOSCH

AUDI

026 905 225
035 905 225

BOSCH

1 234 332 242
1 234 332 348

GENERAL MOTORS

93 150 911

VW

026 905 225
035 905 225

03 Supplied until depletion

- Fornibile fino ad esaurimento delle scorte
- Fourni jusqu'à épuisement du stock
- Lieferbar solange vorrat reicht
- Suministrado hasta el stock termina

212 Resistance Rotor [Ohm] 1000

- Rotore resistenza [Ohm] 1000
- Résistance rotor [ohm] 1000
- Widerstand-Rotor [Ohm] 1000
- Resistencia rotor [ohm] 1000

310 RPM to [1/min] 6700

- N° giri fino a [1/min.] 6700
- Régime mot. jusqu'à [1/min] 6700
- Drehzahl bis [1/min] 6700
- vel. giro hasta [1/min] 6700



AUDI		
80 II 1.8 GTE	DZ	10/84 ⇒ 08/86
80 II 2.0	HP, JS	10/83 ⇒ 09/84
80 II 2.0 quattro	JS	10/83 ⇒ 09/84
90 I 2.0	HP, JS	10/84 ⇒ 03/87
90 I 2.0 quattro	JS	08/84 ⇒ 08/86
90 I 2.2	9C54, HY	10/84 ⇒ 03/87
90 I 2.2 E quattro	9C54	11/84 ⇒ 03/87
100 III 2.0	KP	08/84 ⇒ 12/87
100 III 2.0 E	KP	01/85 ⇒ 12/87
100 III 2.2	KZ	10/84 ⇒ 09/86
COUPE 2.2 GT	9C54	09/84 ⇒ 10/88
COUPE 2.2 quattro	9C54	10/84 ⇒ 07/91

VW		
PASSAT II 2.0	JS	08/83 ⇒ 03/88
PASSAT II 2.0 Syncro	JS	05/84 ⇒ 03/88
JETTA II 1.8	EV	01/84 ⇒ 10/91
JETTA II 1.8i GT	GZ	12/83 ⇒ 07/88
GOLF I 1.8	DX, KT	08/82 ⇒ 12/92
GOLF II 1.8 GTI	EV	08/83 ⇒ 10/91
GOLF II 1.8i GTI [CHE] [SWE]	GZ	01/84 ⇒ 07/85
SANTANA 1.9	WN	08/81 ⇒ 07/83
SANTANA 2.0	JS	08/83 ⇒ 12/84
SCIROCCO II 1.8	DX, KT	08/82 ⇒ 12/89

KW 906 117R



ROTORS

Adatt./Suitable: BOSCH

BMW

12 111 1 304 909
12 111 1 328 430

BOSCH

1 234 332 272
1 234 332 277
1 234 332 284
1 234 332 317
1 234 332 353

VW

073 905 225 A

00 Eliminated on 07-07-2021. Please verify the availability through our local distributors

- Eliminato il 07-07-2021. Verificare la disponibilità presso i nostri distributori
- Éliminé le 07-07-2021. Vérifier la disponibilité auprès de nos distributeurs sur place
- Am 07-07-2021 gestrichen. Evtl. Verfügbarkeit bitte bei unseren Händlern prüfen
- Eliminado en fecha 07-07-2021. Verificar la disponibilidad a través de nuestros distribuidores locales

212 Resistance Rotor [Ohm] 5000

- Rotore resistenza [Ohm] 5000
- Résistance rotor [ohm] 5000
- Widerstand-Rotor [Ohm] 5000
- Resistencia rotor [ohm] 5000

310 RPM to [1/min] 5900

- N° giri fino a [1/min.] 5900
- Régime mot. jusqu'à [1/min] 5900
- Drehzahl bis [1/min] 5900
- vel. giro hasta [1/min] 5900



VW		
LT I 2.4	DL	12/82 ⇒ 07/92
LT I 2.4 4WD	DL	12/82 ⇒ 07/92

KW 906 118R



ROTORS

Adatt./Suitable: BOSCH

BOSCH

1 234 332 349

VOLVO

1346787
13467873

212 Resistance Rotor [Ohm] 1000

- Rotore resistenza [Ohm] 1000
- Résistance rotor [ohm] 1000
- Widerstand-Rotor [Ohm] 1000
- Resistencia rotor [ohm] 1000

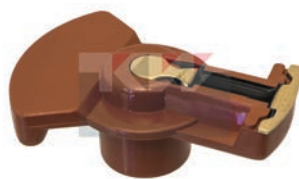

VOLVO		
960 I 2.0	B204FT	08/90 ⇒ 09/93
960 I 2.3	B230GT	08/90 ⇒ 07/94
960 I 2.3 Turbo	B230FT	09/90 ⇒ 08/93
740 2.0	B200E, B200ET, B200G, B200K	01/85 ⇒ 07/92
740 2.0 16V	B204E	09/87 ⇒ 08/90
740 2.0 16V Turbo	B204FT, B204GT	08/89 ⇒ 07/90
740 2.0 GLE	B204E	09/87 ⇒ 08/90
740 2.0 Turbo	B200ET, B200FT	09/87 ⇒ 08/91
740 2.3	B230E, B230F, B230FB, B230G, B230K, B234F	08/84 ⇒ 12/92
740 2.3 GL	B230E	08/84 ⇒ 08/87
740 2.3 Turbo	B230ET, B230FT, B230GT	08/85 ⇒ 08/91
760 2.3	B230ET, B230FT, B230K	08/84 ⇒ 07/92
760 2.3 Turbo	B230ET, B230FT, B230GT	08/84 ⇒ 08/90
780 2.0i	B204GT	01/87 ⇒ 12/90
780 2.0i Turbo	B200ET	01/87 ⇒ 12/90
940 I 2.0	B200E, B200F, B200G	08/90 ⇒ 07/94
940 I 2.0 GL	B204E	09/90 ⇒ 04/92
940 I 2.0 Turbo	B200FT	08/90 ⇒ 07/95

VOLVO		
940 I 2.3	B230E, B230F, B230FB, B230FD, B230G, B234F, B234G	08/90 ⇒ 07/95
940 I 2.3 16V	B234G	08/90 ⇒ 07/92
940 I 2.3 Turbo	B230FT, B230GT	08/90 ⇒ 07/94
940 II 2.0 GLT	B200GT	10/94 ⇒ 05/97
940 II 2.0 Turbo	B200FT	04/96 ⇒ 10/98
940 II 2.3	B230FD, B230GK	08/94 ⇒ 05/97
940 II 2.3 ti	B230FK	01/95 ⇒ 10/98
940 II 2.3 Turbo	B230FT, B230GK	08/94 ⇒ 12/98

KW 906 119R



ROTORS

Adatt./Suitable: BOSCH

ALFA ROMEO

195 32 05 023 00/00
60513052

BMW

12 111 1 284 446
12 111 1 734 110

BOSCH

1 234 332 347

CHRYSLER

T0267693

CITROËN

5937 42
77 002 676 93

FIAT

7700267693

LANCIA

7700267693

PEUGEOT

5937 42

RENAULT

77 00 267 693

VOLVO

1269921
12699211

03 Supplied until depletion

- Fornibile fino ad esaurimento delle scorte
- Fourni jusqu'à épuisement du stock
- Lieferbar solange vorrat reicht
- Suministrado hasta el stock termina

212 Resistance Rotor [Ohm] 1000

- Rotore resistenza [Ohm] 1000
- Résistance rotor [ohm] 1000
- Widerstand-Rotor [Ohm] 1000
- Resistencia rotor [ohm] 1000



ALFA ROMEO		
164 2.0 Turbo	AR64102	07/90 ⇒ 10/92
164 2.0 V6 Turbo	AR64101	03/91 ⇒ 09/92
164 3.0	AR06410	11/87 ⇒ 09/91
164 3.0 i.e. QV	AR64301	09/90 ⇒ 09/92
164 3.0 Lusso [USA] [CAN]	AR06412	10/91 ⇒ 03/93
164 3.0 Sport [CAN] [USA]	AR64301	11/90 ⇒ 03/92
164 3.0 Super	64303	06/87 ⇒ 09/92
164 3.0 V6	AR06410, AR06412	06/87 ⇒ 09/92
GTV 2.0 V6 Turbo	AR16202	06/95 ⇒ 09/98
SPIDER II 2.0 V6 Turbo	AR16202	05/98 ⇒ 04/05

ALPINE		
V6 TURBO	Z7U730, Z7U732, Z7U734	01/88 ⇒ 12/90

BMW		
3 III 316 i	M40B16(164E1), M43B16(164E2)	09/90 ⇒ 09/93
3 III 318 i	M40B18(184E1)	09/90 ⇒ 08/93
3 II 316 i	M40B16(164E1)	09/87 ⇒ 06/94
3 II 318 i	M40B18(184E1)	06/87 ⇒ 06/94
3 II 320 i	M20B20(206EB), M20B20(206KA)	09/82 ⇒ 11/93
3 II 325 e 2.7	M20B27(276KA), M20B27(276KB)	10/83 ⇒ 12/88
3 II 325 i	M20B25(256E1), M20B25(256E2), M20B25(256EX), M20B25(256K1)	09/83 ⇒ 11/93
3 II 325 i X	M20B25(256E1), M20B25(256E2), M20B25(256EX), M20B25(256K1)	03/86 ⇒ 10/93
5 II 520 i	M20B20(206KA)	08/85 ⇒ 12/87
5 II 525 e	M20B27(276EA), M20B27(276EB), M20B27(276KA), M20B27(276KB)	09/81 ⇒ 12/87
5 II 528 i [USA]	--	01/81 ⇒ 12/87
5 II 530 i	--	01/84 ⇒ 12/88
5 II 535 i	M30B34(346EC)	01/85 ⇒ 12/87
5 II 535 i, M 535 i	M30B34(346KA), M30B35(Motronic)	01/85 ⇒ 12/87
5 II M5	S38B35(356ED)	08/85 ⇒ 12/87
5 III 518 i	M40B18(184E1)	09/89 ⇒ 04/94
5 III 520 i	M20B20(206KA)	06/87 ⇒ 09/90
5 III 525 i	M20B25(256K1)	02/88 ⇒ 08/90
5 III 530 i	M30B30(306KA)	01/88 ⇒ 04/90

BMW		
5 III 535 i	M30B34(346KB)	11/87 ⇒ 02/93
5 III M5	S38B36(366S1)	09/88 ⇒ 03/92
5 III M5 Cat	S38B36(366S1)	09/88 ⇒ 03/92
6 I 635 CSi	M30B35(Motronic, 9.3:1)	06/78 ⇒ 04/82
6 I M 635 CSi	M88B35(356ED), S38B35(356ED)	04/84 ⇒ 02/89
7 I 735 i	M30B35(Motronic)	04/85 ⇒ 08/86
7 II 730 i, iL	M30B30(306EA), M30B30(306KA)	03/85 ⇒ 03/94
7 II 735 i, iL	M30B34(346KB), M30B35(Motronic, 9.2:1)	06/86 ⇒ 07/92
7 II 750 i, iL V12	M70B50(S012A)	09/87 ⇒ 09/94
7 III 750 i, iL	M73B54(S4121), M73B54(S4122)	11/94 ⇒ 07/01
8 850 CSi	S70B56(S6121)	11/92 ⇒ 12/96
8 850 i, Ci	M70B50(S012A)	01/90 ⇒ 08/94
Z1 2.5	M20B25(S256K1)	06/88 ⇒ 06/91

CITROËN		
XM I 3.0	UFZ(ZPJ/Z)	05/89 ⇒ 05/94
XM I 3.0 V6	SFZ(ZPJ/Z), UFZ(ZPJ/Z)	05/89 ⇒ 06/94
XM I 3.0 V6 24V	SKZ(ZPJ4/Z), UKZ(ZPJ4/Z)	07/90 ⇒ 06/94
XM II 3.0 V6	SFZ(ZPJ/Z), UFZ(ZPJ/Z)	05/94 ⇒ 10/00
XM II 3.0 V6 24V	SKZ(ZPJ4/Z), UKZ(ZPJ4/Z)	05/94 ⇒ 10/00

LANCIA		
THEMA 2850 V6 i.e.	834E.146	06/88 ⇒ 05/92

PEUGEOT		
605 3.0	UFZ(ZPJ), UKZ(ZPJ4/Z)	08/89 ⇒ 09/99
605 3.0 SV 24	UKZ(ZPJ4/Z)	08/89 ⇒ 09/99

RENAULT		
25 2.4 V6 Turbo	Z7U702	10/84 ⇒ 05/90
25 2.5 V6 Turbo	Z7U700	01/90 ⇒ 12/92
25 2.8 V6	Z7W700, Z7W701	06/87 ⇒ 02/90
25 2.8 V6 Injection	Z7W706, Z7W707, Z7W709	06/87 ⇒ 12/92
SPACE II 2.8 V6	Z7W712, Z7W713, Z7W717	01/91 ⇒ 10/96

SAFRANE I 3.0	Z7X723	02/93 ⇒ 06/96
SAFRANE I 3.0 Biturbo 4x4	Z7X726	02/93 ⇒ 07/96
SAFRANE I 3.0 V6	Z7X721, Z7X722, Z7X723, Z7X753	12/92 ⇒ 07/96
SAFRANE I 3.0 V6 4x4	Z7X721, Z7X722, Z7X723	12/92 ⇒ 07/96
SAFRANE II 2.9 24V	L7X713	03/99 ⇒ 12/00
SAFRANE II 3.0 V6	6216K4FU	10/96 ⇒ 12/00

VOLVO		
760 2.8	B280E, B280F	08/81 ⇒ 08/91
780 2.9	B280E, B280F	08/86 ⇒ 07/90
960 I 2.8 GL	B280E, B280F	09/90 ⇒ 05/92

KW 906 121R



ROTORS

Adatt./Suitable: **BOSCH**

ALFA ROMEO

195 05 05 011 02/01
195 17 05 011 00/02
60743670
60743768

212 Resistance Rotor [Ohm] 1000

- Rotore resistenza [Ohm] 1000
- Résistance rotor [ohm] 1000
- Widerstand-Rotor [Ohm] 1000
- Resistencia rotor [ohm] 1000

AUDI

051 905 225
052 905 225 C

BOSCH

0 237 521 024
1 234 332 350
1 234 332 360
1 234 332 366
1 234 332 374
1 234 332 387
1 234 332 393
1 234 332 399
1 234 332 402
1 234 332 414
9 231 087 677

FORD

1 660 332
6 134 771
845F-12200-BA
895F-12200-BA

GENERAL MOTORS

90 008 612

HOLDEN

90008612
VS21273

HYUNDAI

27131-22000

MERCEDES-BENZ

1583931
1584231
A 000 158 39 31
A 000 158 42 31

Motorcraft

EDR 130
EDR 182
EDR 183
EDR 248

OPEL

12 12 222

SAAB

88 22 686

SEAT

026 905 225 2
051 905 225
052 905 225 C
SE 021914.004B

SKODA

052 905 225 C

TOYOTA

19102-02020

VOLVO

1389425
13894258

VW

026 905 225 2
035 905 225 D
035 905 225 F
051 905 225
052 905 225 C



ALFA ROMEO

33 I 1.7 i.e.	AR30558	09/88 ⇒ 12/89
33 I 1.7 i.e. 4x4	AR30558	09/88 ⇒ 12/89
33 II 1.4 4x4	AR30755	07/90 ⇒ 12/92
33 II 1.4 i.e.	AR30755	06/91 ⇒ 09/94
33 II 1.4 i.e. 4x4	AR30755	07/90 ⇒ 09/94
33 II 1.5 i.e.	AR30751	01/90 ⇒ 09/94
33 II 1.5 i.e.	AR30750	07/90 ⇒ 08/91
33 II 1.7 i.e.	AR30736, AR30737	01/90 ⇒ 09/94
33 II 1.7 i.e. 4x4	AR30736, AR30737	01/90 ⇒ 09/94
75 1.8	AR06202	09/85 ⇒ 06/89
75 1.8 i.e. Turbo America	61203	02/86 ⇒ 01/90
75 1.8 Turbo	AR06134	09/86 ⇒ 02/92
90 1.8	AR06202	10/84 ⇒ 07/87
90 2.0 i.e.	AR06210	10/84 ⇒ 07/87

AUDI

80 II 1.8 GTE	PV	08/85 ⇒ 07/86
80 III 1.8	SD	09/86 ⇒ 07/88
80 III 1.8 quattro	SD	09/86 ⇒ 08/90
80 III 1.8 S	PM	09/86 ⇒ 10/91
80 III 2.0	AAD	10/90 ⇒ 08/91
80 III 2.0 E	3A	08/88 ⇒ 10/90
80 III 2.0 E quattro	3A	08/88 ⇒ 09/90
80 IV 1.6	ABM	09/91 ⇒ 12/94
80 IV 1.6 E	ADA	06/93 ⇒ 01/96

AUDI

80 IV 2.0	ABT	09/91 ⇒ 01/96
80 IV 2.0 E	ABK	09/91 ⇒ 01/96
80 IV 2.0 E quattro	ABK	09/91 ⇒ 12/94
80 IV 2.0 quattro	ADW	11/93 ⇒ 01/96
80 IV 2.3 E	NG	09/91 ⇒ 01/96
80 IV 2.3 E quattro	NG	09/91 ⇒ 11/94
90 I 2.0	SK	03/86 ⇒ 03/87
90 II 2.0	PS	07/88 ⇒ 09/91
90 II 2.3 E	NG	04/87 ⇒ 09/91
90 II 2.3 E 20V quattro	7A	06/88 ⇒ 09/91
90 II 2.3 E quattro	NG	04/87 ⇒ 09/91
100 III 2.0 Cat	RT	01/88 ⇒ 11/90
100 III 2.0 E Cat	RT	01/88 ⇒ 11/90
100 III 2.2 E Turbo quattro	MC	08/86 ⇒ 11/90
100 III 2.2 Turbo	MC	08/86 ⇒ 11/90
100 III 2.3	NF	08/86 ⇒ 11/90
100 III 2.3 E	NF	10/86 ⇒ 11/90
100 III 2.3 E quattro	NF	08/86 ⇒ 11/90
100 III 2.3 quattro	NF	01/90 ⇒ 11/90
100 IV 2.0	AAE	12/90 ⇒ 07/94
100 IV 2.0 E	AAE, AAE, ABK	12/90 ⇒ 07/94
100 IV 2.0 E quattro	AAE	12/90 ⇒ 07/92
100 IV 2.3 E	7M15A-FKS	12/90 ⇒ 07/94
100 IV 2.3 E quattro	7M15A-FKS	12/90 ⇒ 07/94
200 II 2.2 Turbo	1B, MC	08/85 ⇒ 09/91
200 II 2.2 Turbo quattro	1B	02/88 ⇒ 11/90
A6 I 2.0	AAE, ABK, ADW	06/94 ⇒ 12/97
A6 I 2.3	7M15A-FKS	06/94 ⇒ 12/95
A6 I 2.3 quattro	7M15A-FKS	06/94 ⇒ 12/95
A4 I 1.6	ADP	11/94 ⇒ 09/01
CABRIOLET 2.0 E	ABK	01/93 ⇒ 07/98
CABRIOLET 2.3 E	NG	05/91 ⇒ 07/94
COUPE 2.0	3A, AAD, ABK	05/89 ⇒ 12/96
COUPE 2.3	NG	10/88 ⇒ 12/96
COUPE 2.3 quattro	NG	01/87 ⇒ 12/96

FORD

ESCORT IV 1.4	F6B	01/86 ⇒ 07/90
ESCORT IV 1.6 Turbo RS	LNB	01/86 ⇒ 07/90
ESCORT IV 1.6 XR3i	LR2, LRB	01/86 ⇒ 07/90
FIESTA III 1.4	F6E	03/89 ⇒ 12/95
GRANADA 1.7	TV17LC	08/77 ⇒ 05/82
GRANADA 2.0	NEP	08/79 ⇒ 08/85
SIERRA I 1.8	REB	10/84 ⇒ 12/86
SIERRA I 2.0	NET, NR2, NRD	08/82 ⇒ 12/86
SIERRA I 2.0 i	NR2	03/85 ⇒ 12/86
ESCORT III 1.4 i	F6B	02/86 ⇒ 07/90
ORION I 1.4 Cat	F6B	02/87 ⇒ 07/90
ORION I 1.6 i	LRB	03/86 ⇒ 07/90
SCORPIO I 1.8	REC	04/85 ⇒ 02/92
SCORPIO I 2.0	TL20H-NE4, TL20H-NER	10/84 ⇒ 02/90
SCORPIO I 2.0 i	NRA, NRI	04/85 ⇒ 02/92
SIERRA II 2.0	N8C, NES	01/87 ⇒ 02/93
TRANSIT II 2.0	N6TS	10/85 ⇒ 03/91
TRANSIT II 2.0 Cat	N6T	11/85 ⇒ 09/92
TRANSIT II 2.0 EFI	--	08/91 ⇒ 08/94

HOLDEN

BARINA 1.4 i	C14NZ	04/94 ⇒ 07/97
BARINA_SB 1.2i	C12NZ	04/94 ⇒ 07/97
COMBO 1.4 i	C14NZ	03/96 ⇒ 07/97
COMBO_SB 1.4i	C14NZ	04/94 ⇒ 07/97

HYUNDAI

S COUPE 1.5 i	G4EK	04/92 ⇒ 05/96
S COUPE 1.5 i Turbo	G4EK-TC	04/91 ⇒ 05/96

MERCEDES-BENZ

124 200 CE	M102.963	09/89 ⇒ 06/93
124 230 CE	M102.982	03/87 ⇒ 12/92
124 230 CE Cat	M102.982	06/89 ⇒ 12/92
190 2.0	M102.924	08/83 ⇒ 05/90
190 2.3	M102.985	09/87 ⇒ 09/88
190 2.3 E	M102.985	10/82 ⇒ 09/88
190 E 1.8	M102.910, M102.919	04/90 ⇒ 12/93
190 E 2.0	M102.962	10/82 ⇒ 08/93
190 E 2.3	M102.985	09/86 ⇒ 08/93
190 E 2.3-16	M102.983	04/84 ⇒ 08/88
190 E 2.5-16	M102.990	09/88 ⇒ 08/93
190 E 2.5-16 Evolution	M102.991	03/89 ⇒ 08/93
CLASSE G II 200 GE	M102.965	01/90 ⇒ 07/93
CLASSE G II 230 GE	M102.979	09/89 ⇒ 07/96
KOMBI II 200 T	M102.922	09/85 ⇒ 05/90
KOMBI II 200 TE	M102.962, M102.963	09/88 ⇒ 08/92
KOMBI II 230 E Chassis	M102.982	09/86 ⇒ 06/93
KOMBI II 230 TE	M102.982	09/85 ⇒ 08/92
KOMBI II 230 TE Cat	M102.982	06/89 ⇒ 08/92
TRE VOLUMI II 200	M102.922	12/85 ⇒ 10/92
TRE VOLUMI II 200 E	M102.963	09/88 ⇒ 08/93
TRE VOLUMI II 230 E	M102.982	12/84 ⇒ 06/93
TRE VOLUMI II 230 E Cat	M102.982	06/89 ⇒ 06/93

OPEL			
ASTRA F 1.4 i	C14NZ	09/91 → 01/05	
ASTRA F 2.0 GSI 16V	C20XE	09/91 → 01/98	
ASTRA F 2.0 i 16V	C20XE	03/93 → 01/98	
CALIBRA A 2.0 i 16V	C20XE	06/90 → 02/94	
CALIBRA A 2.0 i 16V 4x4	C20XE	06/90 → 02/94	
CALIBRA A 2.0 i Turbo 4x4	C20LET	08/91 → 07/97	
COMBO B 1.2	C12NZ	07/94 → 10/01	
COMBO B 1.4	C14NZ	07/94 → 10/01	
CORSA A 1.2 i	C12NZ	09/89 → 03/93	
CORSA A 1.4 i	C14NZ	01/85 → 03/93	
CORSA A 1.6 GSI	E16SE	05/88 → 03/92	
CORSA B 1.2 i	12NZ, C12NZ	03/93 → 09/00	
CORSA B 1.4 i	C14NZ	03/93 → 09/00	
FRONTERA A 2.4 i	C24NE	03/92 → 10/98	
KADETT E 1.4 i	C14NZ	01/90 → 07/94	
KADETT E 1.6	16SV	09/86 → 12/91	
KADETT E 1.6 i	16SV	07/89 → 02/93	
KADETT E 1.6 S	16SV	09/86 → 08/91	
KADETT E 2.0 GSI 16V	20XE	12/87 → 08/91	
KADETT E 2.0 GSI 16V Cat	C20XE	03/88 → 08/91	
OMEGA A 2.4 i	C24NE	09/88 → 03/94	
VECTRA A 1.6	16SV	09/88 → 05/93	
VECTRA A 1.6 S	16SV	09/88 → 05/93	
VECTRA A 2.0 i 16V	20XE	02/89 → 10/90	
VECTRA A 2.0 i 16V 4x4	C20XE	08/89 → 08/95	
VECTRA A 2.0 i 16V Cat	C20XE	02/90 → 11/95	
VECTRA A 2.0 i Turbo 4x4	C20LET	06/94 → 11/95	
VECTRA A 2000 16V 4x4	20XE	01/89 → 10/90	
VECTRA A 2000/GT 16V	20XE	01/89 → 06/94	
VECTRA A 2000/GT 16V Cat	C20XE	02/90 → 11/95	
VECTRA A 2000/GT 16V Cat 4x4	C20XE	02/90 → 11/95	

PUCH			
G-MODELL 230 GE	M102.989	07/89 → 08/93	

SAAB			
9-3 2.0 i	B204I	02/98 → 08/03	
9-3 2.3 i	B234I	02/98 → 08/03	
900 II 2.0 i	B204I, B206I	07/93 → 02/98	
900 II 2.3 - 16	B234I	07/93 → 02/98	

SEAT			
AROSA 1.0	AER, ALL	05/97 → 06/04	
AROSA 1.4	AEX, AKV, APQ	05/97 → 06/04	
CORDOBA I 1.0 16V	AST, AVZ	05/00 → 10/02	
CORDOBA I 1.0 CL	AAU	02/93 → 06/96	
CORDOBA I 1.0 i	AER	09/96 → 10/02	
CORDOBA I 1.3	AAV	02/93 → 08/94	
CORDOBA I 1.4	ANX	12/97 → 04/99	
CORDOBA I 1.4 i	ABD, AEX, AKV, APQ	06/94 → 12/02	
CORDOBA I 1.4 i 16V	AFH	09/96 → 10/02	
CORDOBA I 1.6 i	1F, ABU, AEE, AFT, ALM	02/93 → 06/99	
CORDOBA I 1.8 i	ABS, ACC, ADZ	02/93 → 09/02	
CORDOBA I 1.8 i 16V	148D	10/93 → 08/96	
CORDOBA I 2.0 i	2E, AGG	02/93 → 06/99	
CORDOBA I 2.0 i 16V	ABF	08/96 → 06/99	
IBIZA I 1.2 i	021C.1000	01/89 → 05/93	
IBIZA I 1.5 i	021B.2000	10/86 → 05/93	
IBIZA II 1.0	AAU	03/93 → 09/96	
IBIZA II 1.0 16V	AST, AVZ	10/99 → 02/02	
IBIZA II 1.0 i	AER	09/96 → 02/02	
IBIZA II 1.3 i	AAV	03/93 → 08/99	
IBIZA II 1.4	ANX	12/97 → 04/99	
IBIZA II 1.4 i	ABD, AEX, AKV, APQ	09/93 → 02/02	
IBIZA II 1.4 i 16V	AFH	06/97 → 02/02	
IBIZA II 1.6 i	1F, ABU, AEE, AFT, ALM	03/93 → 06/99	
IBIZA II 1.8 i	ABS, ACC, ADZ	03/93 → 08/99	
IBIZA II 1.8 i 16V	148D	11/93 → 08/96	
IBIZA II 2.0 i	2E, AGG	03/93 → 08/99	
IBIZA II 2.0 i 16V	ABF	08/96 → 08/99	
INCA 1.4 i	AEX, AKV, APQ	11/95 → 06/03	
INCA 1.6 i	1F, AEE	11/95 → 05/98	
ALHAMBRA I / II 2.0 i	ADY	04/96 → 03/10	
MALAGA 1.5 i	021B.2000	01/87 → 12/93	
TOLEDO I 1.6 i	1F, AFT	05/91 → 03/99	
TOLEDO I 1.8 16V	KR, PL	05/91 → 03/99	
TOLEDO I 1.8 GT	KR	05/91 → 11/92	
TOLEDO I 1.8 i	ABS, ADZ, RP	05/91 → 12/96	
TOLEDO I 2.0 i	2E, AGG	05/91 → 03/99	

SKODA			
FELICIA 1.6	6A16XHT	06/97 → 04/02	
FELICIA 1.6 GLX	6A16XHT	08/95 → 03/98	
FELICIA 1.6 LX	6A16XHT	08/95 → 03/98	
OCTAVIA I 1.6	6A16XHT	09/96 → 09/04	

TOYOTA			
AVENSIS I 1.6	4A-FE	09/97 → 10/00	
CARINA E 1.6	4A-FE	04/92 → 09/97	
CARINA E 1.6 16V	4A-FE	12/94 → 09/97	
CARINA E 1.6 GLI	4A-FE	04/92 → 09/97	
CARINA E 1.6 i	4A-FE	02/95 → 09/97	

VAUXHALL			
ASTRA III 1.4 i	C14NZ	09/91 → 09/98	
ASTRA III 2.0 i 16V	C20XE	09/91 → 02/98	
ASTRAVAN I 1.4 i	C14NZ	09/91 → 08/95	
CALIBRA 2.0 i 16V	C20XE	06/90 → 02/94	
CALIBRA 2.0 i 16V 4x4	C20XE	06/90 → 02/94	
CALIBRA 2.0 i Turbo 4x4	C20LET	03/92 → 07/97	
COMBO B 1.2	C12NZ	07/94 → 10/01	
COMBO B 1.4	C14NZ	07/94 → 10/01	
CORSA B 1.2 i	C12NZ	03/93 → 09/00	
CORSA B 1.4 i	C14NZ	03/93 → 09/00	
CORSAVAN I 1.4 i	C14NZ	01/94 → 09/00	
FRONTERA A 2.4 i	C24NE	03/92 → 10/98	

VOLKSWAGEN (BR)			
CADDY 1.6i	MY4	11/98 →	
GOL 1.0i	510	11/96 →	
GOL 1.0i 16v	511	09/97 →	
GOL 1.6i	540, 541	10/96 →	
GOL 1.8i	542, 543	10/96 →	
GOL 2.0i	546, 547	10/96 →	
LOGUS 2.0i	809	12/92 → 05/94	
PARATI 1.0i 16v	511	09/97 →	
PARATI 1.6i	540, 541	10/96 →	
PARATI 1.8i	542	10/96 →	
PARATI 2.0i	546, 547	10/96 →	
POINTER 2.0i	809	11/93 → 05/94	
POLO 1.6	MJ3, MY4	07/00 →	
POLO 1.8	MJ2, MY5, MY6	12/96 →	
SAVEIRO 1.6i	540, 541	10/96 →	
SAVEIRO 1.8i	542, 543	10/96 →	
SAVEIRO 2.0i	546, 547	10/96 →	

VOLVO			
240 2.0	B200F	09/88 → 12/93	
240 2.3	B230F, B230FD, B230FX, B230K	08/86 → 08/93	
240 2.3 Cat	B230F	08/91 → 07/92	
240 2.3 i Cat	B230F	08/86 → 07/93	
340-360 2.0	B200E, B200EA, B200F, B200K	08/84 → 07/90	

VW			
PASSAT IV 1.6	ADP	10/96 → 11/00	
POLO II 1.0	AAU	01/85 → 09/94	
POLO II 1.0 Cat	AAU	08/89 → 09/94	
POLO II 1.3	3F, AAV, GK	09/82 → 09/94	
POLO II 1.3 Cat	3F, AAV	07/87 → 09/94	
POLO II 1.3 G40	PY	01/87 → 09/94	
JETTA II 1.8	PB, RD, RV	01/84 → 10/91	
JETTA II 1.8 16V	KR, PL	08/86 → 10/91	
JETTA II 1.8 Cat	PF	01/87 → 10/91	
JETTA II 1.8 G60	PG	04/90 → 07/91	
CADDY II 1.4	AEX, AKV, APQ	11/95 → 06/03	
CADDY II 1.6	1F, AEE	11/95 → 12/00	
CADDY II 60 1.4	AEX, APQ	11/95 → 01/04	
CADDY II 75 1.6	1F, AEE	11/95 → 05/97	
CORRADO 1.8 16V	KR	04/89 → 07/92	
CORRADO 1.8 G60	PG	09/88 → 09/93	
CORRADO 2.0 i	2E, ADY	04/93 → 12/95	
CORRADO 2.0 i 16V	7T2220XS560	08/91 → 12/95	
DERBY 1.3	GK	09/82 → 12/84	
GOLF I 1.8	2H	08/89 → 03/93	
GOLF II 1.8	RV	08/87 → 10/91	
GOLF II 1.8 GTI	PB, RD	08/83 → 10/91	
GOLF II 1.8 GTI 16V	KR, PL	02/86 → 10/91	
GOLF II 1.8 GTI Cat	PF	01/87 → 10/91	
GOLF II 1.8 GTI G60	PG	04/90 → 07/91	
GOLF II 1.8 GTI G60 Syncro	1H, PG	08/88 → 12/91	
GOLF II 1.8 Syncro	3E82	08/88 → 07/91	
PASSAT III 1.6	AEK, AFT	07/94 → 08/96	
PASSAT III 1.8	AAM, ABS, ADZ, KR, PB, PF, RP	02/88 → 05/97	
PASSAT III 1.8 16V	KR	04/88 → 12/89	
PASSAT III 1.8 GL	KR	08/91 → 09/93	
PASSAT III 2.0	2E, ADY, AEP, AGG	02/90 → 05/97	
PASSAT III 2.0 16V	7T2220XS560, ABF	08/88 → 05/97	
PASSAT III 2.0 Syncro	2E, ADY, AGG	03/90 → 12/96	
PASSAT III 2.0i	ACX	08/92 → 12/96	
GOLF III 1.4	ABD, AEX	10/91 → 04/99	
GOLF III 1.6	ABU, AEA, AEE, AEK, AFT, AKS	09/92 → 04/99	
GOLF III 1.8	AAM, ABS, ADZ	08/91 → 04/99	
GOLF III 1.8 Syncro	ABS, ADZ	01/93 → 04/99	
GOLF III 2.0	2E, ADY, AEP, AGG, AKR	11/91 → 04/99	
GOLF III 2.0 GL	AEP	08/95 → 09/97	
GOLF III 2.0 Syncro	AGG	08/95 → 04/99	
GOLF IV 1.6	AFT, AKS	06/98 → 06/02	
GOLF IV 1.8	AAM, ADZ, ANN, ANP	06/98 → 06/02	
GOLF IV 2.0	AGG, AKR, ATU, AWF, AWG	06/98 → 06/02	
LUPO 1.0	AER, ALL	09/98 → 07/05	
POLO III 1.4	AEX, AKV, ANX, APQ	05/97 → 09/01	
POLO III 1.6	AEA, AEE, AFT, ALM	09/94 → 09/01	

VW			
POLO III 100 1.4 16V	AFH	04/96 → 10/99	
POLO III 100 1.6	AFT	12/95 → 09/01	
POLO III 2.0	ADC	08/99 → 09/01	
POLO III 45 1.0	AEV	10/94 → 09/96	
POLO III 50 1.0	AER, ALL	09/96 → 10/99	
POLO III 54 1.4	ANX	01/98 → 08/99	
POLO III 55 1.3	ADX	10/94 → 04/97	
POLO III 55 1.4	AEX	08/95 → 10/99	
POLO III 60 1.4	AEX, AKV, APQ	07/95 → 09/01	
POLO III 75 1.6	1F, AEA, AEE, AHS, ALM	10/94 → 10/99	
POLO III 75 1.6 4motion	AEA	08/95 → 10/99	
POLO III 90 1.8	ADD	01/97 → 09/01	
POLO IV 1.0	AER	08/96 → 12/01	
SCIROCCO I 1.1	FA	04/74 → 07/79	
SCIROCCO II 1.8 16V	KR, PL	10/85 → 07/92	
SHARAN I 2.0	ADY	09/95 → 03/10	
TRANSPORTER IV 2.0	AAC	07/90 → 04/03	
TRANSPORTER IV 2.5	AAF, ACU, AET, AEU, APL, AVT	09/90 → 06/03	
TRANSPORTER IV 2.5 Syncro	AAF, ACU, AET, AEU, APL, AVT	08/92 → 04/03	
VENTO 1.4	ABD	11/91 → 09/98	
VENTO 1.6	ABU, AEA, AEK, AFT, AKS	09/92 → 02/99	
VENTO 1.8	AAM, ABS, ADZ	11/91 → 09/98	
VENTO 2.0	2E, ADY	11/91 → 09/98	

KW		906 122R		3	
----	--	----------	--	---	--

ROTORS

Adatt./Suitable: BOSCH

BOSCH

1 234 332 341
1 234 332 364
1 234 332 371

VOLVO

1357418
13574181
1367052
13670526

⁰⁰ Eliminated on 16-03-2021. Please verify the availability through our local distributors

- Eliminato il 16-03-2021. Verificare la disponibilità presso i nostri distributori
- Éliminé le 16-03-2021. Vérifier la disponibilité auprès de nos distributeurs sur place
- Am 16-03-2021 gestrichen. Evtl. Verfügbarkeit bitte bei unseren Händlern prüfen
- Eliminado en fecha 16-03-2021. Verificar la disponibilidad a través de nuestros distribuidores locales

²¹² Resistance Rotor [Ohm] 1000

- Rotore resistenza [Ohm] 1000
- Résistance rotor [ohm] 1000
- Widerstand-Rotor [Ohm] 1000
- Resistencia rotor [ohm] 1000

³¹⁰ RPM to [1/min] 6200

- N° giri fino a [1/min.] 6200
- Régime mot. jusqu'à [1/min] 6200
- Drehzahl bis [1/min] 6200
- vel. giro hasta [1/min] 6200



VOLVO			
240 2.0	B200E, B200F, B200K	08/83 → 12/93	
240 2.3	B230A, B230E, B230FD, B230FX	08/83 → 08/93	
240 2.3 Cat	B230F	08/91 → 07/92	
340-360 2.0	B200E, B200EA, B200F, B200K	08/84 → 07/90	
740 2.3	B230A	08/84 → 07/86	

KW 906 123R  **3**

ROTORS

Adatt./Suitable: **BOSCH**

ALFA ROMEO

60755091

BOSCH

1 234 332 370

SAAB

75 64 420

212 Resistance Rotor [Ohm] 1000

- Rotore resistenza [Ohm] 1000
- Résistance rotor [ohm] 1000
- Widerstand-Rotor [Ohm] 1000
- Resistencia rotor [ohm] 1000



ALFA ROMEO

33 II 1.7 16V	AR30746, AR30747	01/90 ⇒ 09/94
33 II 1.7 16V 4x4	AR30746, AR30747	01/90 ⇒ 09/94
SPIDER I 2.0i [CAN]	AR01588	09/90 ⇒ 10/93
SPIDER I 2.0i [USA]	AR01588	09/90 ⇒ 10/93
SPIDER I 2.0i Veloce [CAN]	AR01588	09/90 ⇒ 10/93
SPIDER I 2.0i Veloce [USA]	AR01588	09/90 ⇒ 10/93

SAAB

900 I 2.0 -16	5B6304GS, B202XI	01/86 ⇒ 06/94
900 I 2.0 Turbo-16	B202XL	11/85 ⇒ 06/94
900 I 2.0 Turbo-16 S	B202XL	01/84 ⇒ 06/94
900 I 2.0 Turbo-16 S Cat	B202XL	01/89 ⇒ 12/93
900 I 2.1 -16	B212I	08/90 ⇒ 06/94
9000 2.0 -16	5B6304GS, B202XI	12/85 ⇒ 01/93
9000 2.0 -16 CS	5B6304GS	01/89 ⇒ 12/98
9000 2.0 -16 Turbo	B202XL	09/84 ⇒ 08/93
9000 2.0 -16 Turbo CD	B202XL	09/88 ⇒ 08/93
9000 2.3 -16 CD	B234I	08/89 ⇒ 12/98
9000 2.3 -16 CS	B234I	09/89 ⇒ 12/98

KW 906 125R  **3,5**

ROTORS

Adatt./Suitable: **BOSCH**

BOSCH

1 234 332 365

1 234 332 417

MERCEDES-BENZ

A 103 158 02 31

A 103 158 03 31

03 Supplied until depletion

- Fornibile fino ad esaurimento delle scorte
- Fourni jusqu'à épuisement du stock
- Lieferbar solange vorrat reicht
- Suministrado hasta el stock termina

212 Resistance Rotor [Ohm] 1000

- Rotore resistenza [Ohm] 1000
- Résistance rotor [ohm] 1000
- Widerstand-Rotor [Ohm] 1000
- Resistencia rotor [ohm] 1000



MERCEDES-BENZ

CLASSE E I E 300 4-matic	M103.985	06/93 ⇒ 06/95
CLASSE E I E 300 T 4-matic	M103.985	06/93 ⇒ 06/96
124 300 CE	M103.983	03/87 ⇒ 05/93
190 2.6	M103.942	10/82 ⇒ 09/88
190 E 2.6	M103.942	09/86 ⇒ 08/93
190 E 3.2 AMG	M103.983	01/88 ⇒
CLASSE G II 300 GE	M103.987	09/89 ⇒ 09/97
CLASSE S II 260 SE	M103.941	09/85 ⇒ 06/91
CLASSE S II 300 SE, SEL	M103.981	09/85 ⇒ 06/91
CLASSE SL III 300 SL	M103.982	09/85 ⇒ 08/89
CLASSE SL IV 300 SL	M103.984	09/89 ⇒ 08/93
KOMBI II 260 TE FGST.	M103.940	09/89 ⇒ 08/92
KOMBI II 300 TE	M103.983	01/86 ⇒ 08/92
KOMBI II 300 TE 4-matic	M103.985	09/86 ⇒ 06/93
TRE VOLUMI II 260 E	M103.940	09/85 ⇒ 08/92
TRE VOLUMI II 260 E 4-matic	M103.943	09/86 ⇒ 08/92
TRE VOLUMI II 300 E	M103.983	06/85 ⇒ 08/92

MERCEDES-BENZ

TRE VOLUMI II 300 E 4-matic	M103.943, M103.983, M103.985	01/86 ⇒ 12/93
-----------------------------	------------------------------	---------------

PUCH

G-MODELL 300 GE	M103.987	06/89 ⇒ 08/93
-----------------	----------	---------------

KW 906 126R  **04**

ROTORS

Adatt./Suitable: **BOSCH**

BOSCH

1 234 332 382

MERCEDES-BENZ

A 000 158 40 31

212 Resistance Rotor [Ohm] 1000

- Rotore resistenza [Ohm] 1000
- Résistance rotor [ohm] 1000
- Widerstand-Rotor [Ohm] 1000
- Resistencia rotor [ohm] 1000



MERCEDES-BENZ

CLASSE G II 500 GE	M117.965	09/93 ⇒ 12/94
CLASSE S II 420 SE, SEL	M116.965	10/85 ⇒ 06/91
CLASSE S II 420 SEC	M116.965	10/85 ⇒ 06/91
CLASSE S II 500 SE, SEL	M117.965	09/85 ⇒ 06/91
CLASSE S II 500 SE, SEL Cat	M117.965	06/89 ⇒ 06/91
CLASSE S II 500 SEC	M117.965	09/85 ⇒ 06/91
CLASSE S II 500 SEC Cat	M117.965	06/89 ⇒ 06/91
CLASSE S II 560 SE, SEL	M117.968	10/85 ⇒ 06/91
CLASSE S II 560 SEC	M117.968	10/85 ⇒ 06/91
CLASSE SL III 420 SL	M116.964	01/86 ⇒ 08/89
CLASSE SL III 500 SL	M117.964	01/86 ⇒ 08/89
CLASSE SL III 560 SL	M117.967	09/85 ⇒ 12/89

KW 906 127R  **3**

ROTORS

Adatt./Suitable: **BOSCH**

BOSCH

1 234 332 381

GENERAL MOTORS

90 230 573

90 442 356

HOLDEN

VS19424

OPEL

12 12 206

12 12 224

212 Resistance Rotor [Ohm] 1000

- Rotore resistenza [Ohm] 1000
- Résistance rotor [ohm] 1000
- Widerstand-Rotor [Ohm] 1000
- Resistencia rotor [ohm] 1000



HOLDEN

CALIBRA_YE 2.0i	C20NE	09/91 ⇒ 07/95
-----------------	-------	---------------

OPEL

ASCONA C 1.8	18SE, E18NV	09/81 ⇒ 08/88
ASCONA C 1.8 E	S18NV	01/85 ⇒ 08/86
ASCONA C 2.0 i	20NE	09/86 ⇒ 08/88
ASCONA C 2.0 i Cat	C20NE	09/86 ⇒ 08/88
ASCONA C 2.0 i GT	20SEH	03/87 ⇒ 08/88
ASTRA F 1.8 i	C18NZ	09/91 ⇒ 09/98
ASTRA F 2.0 i	C20NE	09/91 ⇒ 09/98
CALIBRA A 2.0 i	C20NE	08/89 ⇒ 12/96
CALIBRA A 2.0 i 4x4	C20NE	06/90 ⇒ 07/97
FRONTERA A 2.0 i	C20NE	03/92 ⇒ 10/98
KADETT E 1.8	18SE	01/86 ⇒ 08/91
KADETT E 1.8 i	C18NZ, S18NV	06/85 ⇒ 05/92
KADETT E 1.8 S	E18NV	09/87 ⇒ 08/91
KADETT E 2.0 GSI	20NE, 20SEH	09/86 ⇒ 08/91
KADETT E 2.0 GSI Cat	C20NE	09/86 ⇒ 08/91
KADETT E 2.0 i	20NE	10/86 ⇒ 02/93
KADETT E 2.0 i Cat	C20NE	10/86 ⇒ 02/93
OMEGA A 1.8	18SEH, E18NVR, S18NV	09/86 ⇒ 03/94

OPEL

OMEGA A 1.8 N	18NV	09/86 ⇒ 08/87
OMEGA A 1.8 S	18SV	09/86 ⇒ 03/94
OMEGA A 2.0	20SE, C20NE	09/86 ⇒ 04/94
OMEGA A 2.0 i	C20NE	09/86 ⇒ 04/94
OMEGA B 2.0	20SE	03/94 ⇒ 12/00
VECTRA A 1.8 i	18SV	09/88 ⇒ 10/90
VECTRA A 1.8 i Cat	C18NZ	03/90 ⇒ 11/95
VECTRA A 1.8 S	18SV, E18NVR	09/88 ⇒ 10/90
VECTRA A 1.8 S 4x4	E18NVR	01/89 ⇒ 07/89
VECTRA A 2.0 i	20NE, 20SEH	09/88 ⇒ 09/92
VECTRA A 2.0 i 4x4	20NE, 20SEH	01/89 ⇒ 07/92
VECTRA A 2.0 i Cat	C20NE	09/88 ⇒ 11/95
VECTRA A 2.0 i Cat 4x4	C20NE	01/89 ⇒ 11/95
VECTRA A 2.0 i GT	20SEH	09/88 ⇒ 11/95

VAUXHALL

ASTRA III 1.8 i	C18NZ	09/91 ⇒ 09/98
ASTRA III 2.0 i	C20NE	09/91 ⇒ 09/98
CALIBRA 2.0 i	C20NE	06/90 ⇒ 07/97
CALIBRA 2.0 i 4x4	C20NE	06/90 ⇒ 07/97
FRONTERA A 2.0	C20NE	04/95 ⇒ 08/98
FRONTERA A 2.0 i	C20NE	03/92 ⇒ 10/98
OMEGA B 2.0	20SE	09/95 ⇒ 09/96

KW 906 131  **3**

ROTORS

Adatt./Suitable: **BOSCH**

BOSCH

9 231 064 336

9 231 064 346

FORD AUSTRALIA

ADR-3

HOLDEN

GB901

Motorcraft

ADR 3



FORD AUSTRALIA

FAIRLANE 3.2i EFI	--	01/89 ⇒
FAIRLANE 3.9i EFI	--	01/89 ⇒
FAIRLANE 3.9i MPEFi	--	01/89 ⇒
FAIRLANE 4.0i MPEFi	--	01/89 ⇒
FAIRLANE ZL 4.1i	--	01/84 ⇒
FALCON 3.2 Efi	--	03/88 ⇒ 12/88
FALCON 3.9 Efi	--	07/91 ⇒ 04/92
FALCON 3.9 MPFi	--	03/88 ⇒ 04/92
FALCON 3.9 SPFi	--	03/88 ⇒ 04/92

HOLDEN

CALAIS_VN 5.0i	5.0V8EFI	08/88 ⇒ 09/91
CALAIS_VP 5.0i Sedan	5.0V8EFI	10/91 ⇒ 07/93
CALAIS_VR 5.0i Sedan	5.0PFIV8	07/93 ⇒ 04/95
CALAIS_VS 5.0i Sedan	5.0V8PFI	04/95 ⇒ 05/96
CALAIS_VS-II 5.0i Sedan	5.0V8PFI	06/96 ⇒ 08/97
CAPRICE_VQ 5.0i Sedan	5.0V8EFI	03/90 ⇒ 11/93
CAPRICE_VR 5.0i Sedan	5.0PFIV8	12/93 ⇒ 04/95
CAPRICE_VS 5.0i Sedan	5.0V8PFI	03/95 ⇒ 08/96
CAPRICE_VS-II 5.0i Sedan	5.0V8PFI	09/96 ⇒ 08/97
COMMODORE VR 5.0i	5.0PFIV8	07/93 ⇒ 04/95
COMMODORE VR 5.0i Wagon	5.0PFIV8	07/93 ⇒ 04/95
COMMODORE VS 5.0i	5.0V8PFI	04/95 ⇒ 05/96
COMMODORE VS-II 5.0i	5.0V8PFI	06/96 ⇒ 08/97
COMMODORE_VL 5.0i Group A SS	5.0V8EFI	02/87 ⇒ 07/88
COMMODORE_VN 5.0i	5.0V8EFI	08/88 ⇒ 09/91
COMMODORE_VN 5.0i Group A SS	5.0V8EFI	08/88 ⇒ 09/91
COMMODORE_VP 5.0i	5.0V8EFI	10/91 ⇒ 07/93
FORMULA_VR 5.0i	5.0PFIV8	07/93 ⇒ 04/95
STATESMAN_VQ 5.0i	5.0V8EFI	03/90 ⇒ 11/93
STATESMAN_VR 5.0i	5.0PFIV8	12/93 ⇒ 04/95
STATESMAN_VS 5.0i	5.0V8PFI	03/95 ⇒ 08/96
STATESMAN_VS-II 5.0i	5.0V8PFI	09/96 ⇒ 08/97
UTILITY_VG 5.0i	5.0V8EFI	08/88 ⇒ 09/91
UTILITY_VP 5.0i	5.0V8EFI	10/91 ⇒ 07/93
UTILITY_VR COUPÉ 5.0i	5.0PFIV8	07/93 ⇒ 04/95

KW 906 140R



3,5

ROTORS

Adatt./Suitable: BOSCH

BOSCH

1 234 332 395

FORD

6 177 981

Motorcraft

EDR 240

²¹² Resistance Rotor [Ohm] 1000

- Rotore resistenza [Ohm] 1000
- Résistance rotor [ohm] 1000
- Widerstand-Rotor [Ohm] 1000
- Resistencia rotor [ohm] 1000



FORD

SCORPIO I 2.0 i	N9B, N9D, N9F, NRA, NRI	05/89 ⇒ 09/94
SIERRA II 2.0 i	N4A, N4I, N9B	01/87 ⇒ 02/93
TRANSIT II 2.0	NSF, NSG	06/94 ⇒ 03/00
TRANSIT II 2.0 CNG	NSH	06/94 ⇒ 03/00
TRANSIT TOURNEO 2.0	NSH	11/94 ⇒ 12/00

KW 906 146R



3,5

ROTORS

Adatt./Suitable: BOSCH

BOSCH

1 234 332 408

1 234 332 422

MERCEDES-BENZ

A 119 158 01 31

A 119 158 02 31

A 119 158 03 31

²¹² Resistance Rotor [Ohm] 1000

- Rotore resistenza [Ohm] 1000
- Résistance rotor [ohm] 1000
- Widerstand-Rotor [Ohm] 1000
- Resistencia rotor [ohm] 1000



MERCEDES-BENZ

CLASSE E I E 420	M119.975	06/93 ⇒ 06/95
CLASSE E I E 500	M119.974	06/93 ⇒ 06/95
CLASSE E I E 60 AMG	M119.974(AMG6.0)	05/94 ⇒ 06/95
CLASSE S III 400 SE, SEL/S420	M119.971	02/91 ⇒ 10/98
CLASSE S III 500 SE, SEL	M119.970	02/91 ⇒ 10/98
CLASSE S III 500 SEC / CL 500	M119.970	10/92 ⇒ 12/99
CLASSE S III S 420	M119.971	01/93 ⇒ 10/98
CLASSE S III S 500	M119.970	01/93 ⇒ 10/98
CLASSE S III SEC/CL 420	M119.971	10/94 ⇒ 02/99
CLASSE SL IV 500	M119.972	09/92 ⇒ 10/01
CLASSE SL IV 500 SL	M119.960	09/89 ⇒ 08/92
TRE VOLUMI II 400 E 4.2	M119.975	10/92 ⇒ 06/93
TRE VOLUMI II 500 E	M119.974	01/91 ⇒ 06/93
TRE VOLUMI II 500 E AMG 6.0	M119.974(AMG6.0)	01/92 ⇒ 06/93

KW 906 147R



3,5

ROTORS

Adatt./Suitable: BOSCH

BOSCH

1 234 332 390

RENAULT

74 31 367 783

VOLVO

1367783

13677836

²¹² Resistance Rotor [Ohm] 1000

- Rotore resistenza [Ohm] 1000
- Résistance rotor [ohm] 1000
- Widerstand-Rotor [Ohm] 1000
- Resistencia rotor [ohm] 1000



RENAULT

SAFRANE II 2.5 20V	N7U700, N7U701	07/96 ⇒ 12/00
--------------------	----------------	---------------

VOLVO

850 2.0	B5202S, B5204F, B5204FS	06/91 ⇒ 12/96
850 2.0 10V	B5202FS	08/94 ⇒ 12/97
850 2.0 Turbo	B5204FT, B5204T, B5204T2	02/93 ⇒ 10/97
850 2.3	B5234FS	01/96 ⇒ 10/96
850 2.3 T5	9M9T872	02/93 ⇒ 12/96
850 2.3 T5-R	B5234T4	08/95 ⇒ 12/96
850 2.3 Turbo R	B5234T5	06/95 ⇒ 10/97
850 2.4	B5252, B5252FS, B5254S	06/91 ⇒ 12/96
850 2.4 AWD	B5254T	04/96 ⇒ 12/96
850 2.4 GLE	B5254T	09/93 ⇒ 10/97
850 2.5 10V	B5252FS	06/91 ⇒ 12/97
850 2.5 20V	B5254FS	08/91 ⇒ 12/97
C70 I 2.0	B5204T2	03/97 ⇒ 10/05
C70 I 2.0 T	B5204T3	03/97 ⇒ 10/05
C70 I 2.3 T5	B5234T3	03/98 ⇒ 10/05
C70 I 2.3 T-5	B5234T3	03/97 ⇒ 09/02
C70 I 2.4 T	B5254T	03/97 ⇒ 10/05
S70 2.0	B5202FS, B5202S, B5204T2	01/97 ⇒ 11/00
S70 2.0 Turbo	B5204T3	01/97 ⇒ 11/00
S70 2.3	B5234FS, B5234T7	01/97 ⇒ 07/99
S70 2.3 AWD	B5234T7	04/99 ⇒ 09/00
S70 2.3 T-5	B5234T3	01/97 ⇒ 11/00
S70 2.3 T5 AWD	B5234T4	07/97 ⇒ 09/00
S70 2.3 T5-R AWD	B5234T2	11/96 ⇒ 09/98
S70 2.3 Turbo	B5234FT+	01/97 ⇒ 11/00
S70 2.4	B5254S	06/98 ⇒ 11/00
S70 2.4 AWD	B5252FS	11/96 ⇒ 05/99
S70 2.4 Bifuel	GB5252S	10/98 ⇒ 11/00
S70 2.4 T5 AWD	B5254T	11/96 ⇒ 04/99
S70 2.4 Turbo	B5254T	01/97 ⇒ 11/00
S70 2.5 20V	B5254FS	01/97 ⇒ 12/98
S70 2.5 Bifuel	GB5252S2	01/99 ⇒ 12/99
V70 I 2.0	B5202FS, B5202S, B5204T2	12/95 ⇒ 03/00
V70 I 2.0 Turbo	B5204T3	11/96 ⇒ 12/00
V70 I 2.0 Turbo AWD	B5204T3	11/96 ⇒ 12/00
V70 I 2.3	B5234FS	01/97 ⇒ 07/99
V70 I 2.3 AWD	B5234T3, B5234T7	04/97 ⇒ 09/98
V70 I 2.3 T AWD	B5234FT+, B5234T4, B5234T6	04/97 ⇒ 12/98
V70 I 2.3 T-5	B5234T3	11/96 ⇒ 12/00
V70 I 2.3 T-5 AWD	B5234T3	01/97 ⇒ 12/00
V70 I 2.3 Turbo	B5234FT+, B5234T2, B5234T4	12/95 ⇒ 12/98
V70 I 2.4	B5252FS, B5254S	12/95 ⇒ 12/99
V70 I 2.4 Bifuel	GB5252S	05/98 ⇒ 12/99
V70 I 2.4 Turbo AWD	B5254T	04/96 ⇒ 12/00
V70 I 2.5	B5252FS	01/97 ⇒ 03/00
V70 I 2.5 20V	B5254FS	01/97 ⇒ 12/99
V70 I 2.5 Bifuel	GB5252S2	01/99 ⇒ 12/99

KW 906 148R



1

ROTORS

Adatt./Suitable: BOSCH

BOSCH

1 234 332 421

VW

021 905 225 B

⁰³ Supplied until depletion

- Fornibile fino ad esaurimento delle scorte
- Fourni jusqu'à épuisement du stock
- Lieferbar solange vorrat reicht
- Suministrado hasta el stock termina

²¹² Resistance Rotor [Ohm] 1000

- Rotore resistenza [Ohm] 1000
- Résistance rotor [ohm] 1000
- Widerstand-Rotor [Ohm] 1000
- Resistencia rotor [ohm] 1000



VW

CORRADO 2.9 VR6	ABV	08/91 ⇒ 12/95
GOLF III 2.8 VR6	AAA	01/92 ⇒ 09/97
PASSAT III 2.8 VR6	AAA	06/91 ⇒ 05/97
VENTO 2.8 VR6	AAA	01/92 ⇒ 09/98

KW 906 149R



1

ROTORS

Adatt./Suitable: BOSCH

BOSCH

1 234 332 426

VW

021 905 225 C

²¹² Resistance Rotor [Ohm] 1000

- Rotore resistenza [Ohm] 1000
- Résistance rotor [ohm] 1000
- Widerstand-Rotor [Ohm] 1000
- Resistencia rotor [ohm] 1000



VW

CORRADO 2.9 VR6	ABV	08/91 ⇒ 12/95
GOLF III 2.8 VR6	AAA	01/92 ⇒ 09/97
PASSAT III 2.8 VR6	AAA	06/91 ⇒ 05/97
VENTO 2.8 VR6	AAA	01/92 ⇒ 09/98

KW 907 701R



1

ROTORS

Adatt./Suitable: CAJAVEC

CAJAVEC
5247098YUGO
46600871ZASTAVA
46600871²¹² Resistance Rotor [Ohm] 5000

- Rotore resistenza [Ohm] 5000
- Résistance rotor [ohm] 5000
- Widerstand-Rotor [Ohm] 5000
- Resistencia rotor [ohm] 5000



ZASTAVA

101 1.1	128A.000	06/73 ⇒ 01/90
YUGO 0.9	9A	04/80 ⇒ 06/92

KW 910 179



3

ROTORS

Adatt./Suitable: CHRYSLER

CHRYSLER
5226535⁰³ Supplied until depletion

- Fornibile fino ad esaurimento delle scorte
- Fourni jusqu'à épuisement du stock
- Lieferbar solange vorrat reicht
- Suministrado hasta el stock termina



CHRYSLER

LE BARON 2.2 i	--	10/83 ⇒ 12/94
LE BARON 2.2 i Turbo	--, EDG, EDR	10/83 ⇒ 01/91
LE BARON 2.5 i	EDM	09/86 ⇒ 12/94
LE BARON 2.5 i Turbo	EDT	01/89 ⇒ 12/94
VOYAGER 1.2.5 i [USA]	EDM	10/84 ⇒ 07/90
VOYAGER 2.5 i	K, K00	08/90 ⇒ 09/95

KW 912 090



1

ROTORS

Adatt./Suitable: DELCO REMY

DELCO REMY

1 847 291
1 849 955
1 883 500
1 905 590
1 909 590
8 204 45GENERAL MOTORS
82 044 5Motorcraft
ADR 5004⁰³ Supplied until depletion

- Fornibile fino ad esaurimento delle scorte
- Fourni jusqu'à épuisement du stock
- Lieferbar solange vorrat reicht
- Suministrado hasta el stock termina



BEDFORD

CHEVANNE 1.3	13D, LW4	06/76 ⇒ 12/82
--------------	----------	---------------

BOND

EQUIPE 2.0 GT	--	01/68 ⇒ 12/71
---------------	----	---------------

TALBOT

AVENGER 1.3	--	02/70 ⇒ 07/81
AVENGER 1.6	--	02/70 ⇒ 07/81

TRIUMPH

GT6 MK I	KE1L	01/66 ⇒ 12/68
GT6 MK II	KE1L, KE2L	12/68 ⇒ 12/70
GT6 MK III	KE2L	12/71 ⇒ 12/73
SPITFIRE 1.2	AJM	12/64 ⇒ 01/67
SPITFIRE 1.2 MK I	AJM	10/62 ⇒ 12/65
SPITFIRE 1.3	--, FM3	02/67 ⇒ 12/72
SPITFIRE 1.5	--	12/72 ⇒ 11/74
VITESSE 1.6	--	01/62 ⇒ 12/67
VITESSE 2.0	--, HB1HE, HB1LE	12/65 ⇒ 12/71

VAUXHALL

CAVALIER 1.3	--, LW4	08/77 ⇒ 01/81
CAVALIER 1300	13N	08/77 ⇒ 08/81
CAVALIER CC 1.3	--, LW4	08/75 ⇒ 08/81
CHEVETTE 1.2	13N	09/76 ⇒ 12/85
CHEVETTE 1300	13N, 13S	09/74 ⇒ 12/85
CRESTA 2.7	--	01/64 ⇒ 10/72
CRESTA 3.3	--	01/64 ⇒ 10/72
FIRENZA 1300	--	01/71 ⇒ 10/73
VELOX 2.7	--	03/64 ⇒ 10/72
VELOX 3.3	--	09/64 ⇒ 07/65
VENTORA 3300	--	03/69 ⇒ 10/76
VICTOR 3000	--	03/68 ⇒ 09/72
VISCOUNT 3300	--	01/66 ⇒ 10/72
VIVA 1100	--	01/63 ⇒ 09/71
VIVA 1100 SL90	--	01/65 ⇒ 10/70
VIVA 1256	--	10/71 ⇒ 10/75
VIVA 1256 E	--	10/71 ⇒ 10/75
VIVA 1300	--	10/75 ⇒ 10/79

KW 912 093



1

ROTORS

Adatt./Suitable: DELCO REMY

BOSCH

1 234 332 800

DELCO REMY

0 347 0056
1 212 208
3 470 056

GENERAL MOTORS

03 470 056
3 470 056

OPEL

12 12 208

⁰⁰ Eliminated on 26-10-2021. Please verify the availability through our local distributors

- Eliminato il 26-10-2021. Verificare la disponibilità presso i nostri distributori

- Éliminé le 26-10-2021. Vérifier la disponibilité auprès de nos distributeurs sur place

- Am 26-10-2021 gestrichen. Evtl. Verfügbarkeit bitte bei unseren Händlern prüfen

- Eliminado en fecha 26-10-2021. Verificar la disponibilidad a través de nuestros distribuidores locales



OPEL

KADETT B 1.1	11N	08/71 ⇒ 08/73
KADETT D 1.0	10N	09/79 ⇒ 08/82

KW 912 093R



1

ROTORS

Adatt./Suitable: DELCO REMY

GENERAL MOTORS

3 470 093
3 470 391

OPEL

17 84 228
17 84 231⁰³ Supplied until depletion

- Fornibile fino ad esaurimento delle scorte
- Fourni jusqu'à épuisement du stock
- Lieferbar solange vorrat reicht
- Suministrado hasta el stock termina

²¹² Resistance Rotor [Ohm] 5000

- Rotore resistenza [Ohm] 5000
- Résistance rotor [ohm] 5000
- Widerstand-Rotor [Ohm] 5000
- Resistencia rotor [ohm] 5000



OPEL

ASCONA B 2.0 N	20N	08/77 ⇒ 08/81
CORSA A 1.0	10S	09/82 ⇒ 03/93
KADETT C 1.2	12N	05/75 ⇒ 07/79
KADETT C 1.2 S	12S	08/73 ⇒ 07/79
KADETT C 1.6 S	16S	09/76 ⇒ 07/79
KADETT E 1.2	12SC	09/84 ⇒ 07/86
MANTA B 1.2 S	12S	09/75 ⇒ 02/79
MANTA B 1.9 N	19N	08/76 ⇒ 12/81
REKORD D 1.7	17N	03/75 ⇒ 08/77

VOLVO

340-360 1.4	B14.3E, B14.4S	08/82 ⇒ 12/88
-------------	----------------	---------------

KW 912 095R



1

ROTORS

Adatt./Suitable: DELCO REMY

DELCO REMY

0 348 6037
3 486 037

GENERAL MOTORS

90 010 695

OPEL

17 84 234

VOLVO

3277855

32778557

⁰³ Supplied until depletion

- Fornibile fino ad esaurimento delle scorte
- Fourni jusqu'à épuisement du stock
- Lieferbar solange vorrat reicht
- Suministrado hasta el stock termina

²¹² Resistance Rotor [Ohm] 5000

- Rotore resistenza [Ohm] 5000
- Résistance rotor [ohm] 5000
- Widerstand-Rotor [Ohm] 5000
- Resistencia rotor [ohm] 5000



OPEL

CORSA A 1.0	10S	09/82 ⇒ 03/93
KADETT E 1.2	12SC	09/84 ⇒ 07/86

KW 912 096



3,5

ROTORS

Adatt./Suitable: **DELCO REMY**

BOSCH

1 234 332 861

DELCO REMY

1 936 109

1 986 109

GENERAL MOTORS

01 986 109

1 986 109

OPEL

12 12 218



OPEL

ASCONA C 1.3 N	13N	09/81 ⇒ 08/86
CORSA A 1.2	12S, 12ST	09/82 ⇒ 08/90
CORSA A 1.2 N	12NV	01/90 ⇒ 03/93
CORSA A 1.2 S	12S, 12ST	09/82 ⇒ 03/93
CORSA A 1.3	13SB	02/86 ⇒ 04/89
CORSA A 1.3 GL	13S	09/82 ⇒ 03/93
CORSA A 1.3 S	13SB	09/82 ⇒ 10/89
KADETT D 1.2	12ST	08/82 ⇒ 08/84
KADETT E 1.3 N	13N, 13NB	09/84 ⇒ 08/91
KADETT E 1.3 S	13S	09/84 ⇒ 02/93
MANTA B 1.3 S	13S	08/81 ⇒ 08/86

KW 912 097



3,5

ROTORS

Adatt./Suitable: **DELCO REMY**

DELCO REMY

1 988 515

D-436

GENERAL MOTORS

01 988 515

1 988 515

OPEL

12 12 221

⁰⁰ Eliminated on 17-05-2021. Please verify the availability through our local distributors

• Eliminato il 17-05-2021. Verificare la disponibilità presso i nostri distributori

• Éliminé le 17-05-2021. Vérifier la disponibilité auprès de nos distributeurs sur place

• Am 17-05-2021 gestrichen. Evtl. Verfügbarkeit bitte bei unseren Händlern prüfen

• Eliminado en fecha 17-05-2021. Verificar la disponibilidad a través de nuestros distribuidores locales



OPEL

ASCONA C 1.6	16SV	09/86 ⇒ 08/88
ASCONA C 1.6 i Cat	C16LZ, C16NZ	09/86 ⇒ 08/88

KW 912 098



3,5

ROTORS

Adatt./Suitable: **DELCO REMY**

BOSCH

F 005 X04 443

F 005 X04 444

CHEVROLET

10495411

DAEWOO

10495411

DELCO REMY

1 046 7546

1 049 5408

1 049 5411

D-444

HOLDEN

10467546

10495411

ISUZU

8-10495411-0



DAEWOO

ARANOS 1.8	Y18L	01/95 ⇒ 11/97
ARANOS 2.0	Y20L	01/95 ⇒ 11/97
ESPERO 1.8	C18LE	02/95 ⇒ 06/99
ESPERO 2.0	C20LE	02/95 ⇒ 06/99
NEXIA 1.5	G15MF	02/95 ⇒ 08/97

HOLDEN

ASTRA_LD 1.6i	16LE	07/87 ⇒ 07/89
ASTRA_LD 1.8i Hatchback	18LE	07/87 ⇒ 07/89
ASTRA_LD 1.8i Sedan	18LE	07/87 ⇒ 07/89
CAMIRA 1.8 SPFi	6TZ204XS85K01	02/86 ⇒ 03/87
CAMIRA 2.0 i	C20JE	04/87 ⇒ 07/89

ISUZU

IMPULSE 1.6i [USA]	RLK	01/90 ⇒
IMPULSE 1.8i [USA]	RLX	01/91 ⇒
STYLUS 1.6i DOHC [USA]	RLK	01/90 ⇒ 12/91
STYLUS 1.6i SOHC [USA]	RLR	01/90 ⇒
STYLUS 1.8i DOHC [USA]	RLX	01/91 ⇒

KW 912 100



3,5

ROTORS

Adatt./Suitable: **DELCO REMY**

GENERAL MOTORS

10 469 006

OPEL

12 12 203



OPEL

ASTRA F 1.6 i	C16NZ	09/91 ⇒ 09/98
CORSA A 1.2	12S, 12ST	09/82 ⇒ 08/90
CORSA A 1.2 N	12NV	01/90 ⇒ 03/93
CORSA A 1.2 S	12S, 12ST	09/82 ⇒ 03/93
CORSA A 1.3	13NB	09/85 ⇒ 10/89
KADETT E 1.3 i Cat	C13N	09/85 ⇒ 08/91
KADETT E 1.3 N	13N, 13NB	09/84 ⇒ 08/91
KADETT E 1.3 S	13S	09/84 ⇒ 02/93
KADETT E 1.6	16SV	09/86 ⇒ 12/91
KADETT E 1.6 i	16SV, C16NZ, E16NZ	09/86 ⇒ 07/94
KADETT E 1.6 i Cat	C16LZ, C16NZ	09/86 ⇒ 02/93
KADETT E 1.6 S	16SV	09/86 ⇒ 08/91
VECTRA A 1.6 i	C16NZ, E16NZ, X16SZ	09/88 ⇒ 11/95
VECTRA A 1.6 i Cat	C16NZ	09/88 ⇒ 11/95

VAUXHALL

ASTRA III 1.6 i	C16NZ	09/91 ⇒ 12/98
-----------------	-------	---------------

VAUXHALL

ASTRAVAN I 1.6 i C16NZ 10/91 ⇒ 08/98

KW 913 014



1

ROTORS

Adatt./Suitable: **DENSO**

BOSCH

1 234 332 827

1 234 332 828

1 987 234 001

1 987 234 003

1 987 234 021

1 987 234 901

F 005 X04 414

DAIHATSU

19102-26150-000

19102-33012-000

19102-87204-000

19102-87701-000

DENSO

029180-0240

029180-0241

029180-0340

029180-0430

029180-0580

FIAT

553221400

6553221400

GENERAL MOTORS

7 992 988

9 977 032

94 206 140

94 216 729

94 221 206

HOLDEN

8942212060

INNOCENTI

6553221400

ISUZU

8-94206140-0

8-94216729-0

8-94221206-0

8-94221-206-00

894338910

896052016

8-96055178-0

9-42212-06

MITSUBISHI

MD604338

Motorcraft

ADR 5031

SUBARU

39101-4302

49101-3202

49101-7102

SUZUKI

33310-73010

33310-73010-000

33310-77090

33310-77090-000

TOYOTA

19102-10020

19102-26150

19102-26151

19102-33011

19102-33012

19102-38160

VW

J19 102 261 51



DAIHATSU

850 0.8	--	07/86 ⇒ 12/89
1000 1.0	CB10	07/86 ⇒ 12/89
CHARADE III 1.0	CB23, CB22	03/87 ⇒ 02/93
CUORE II 0.8	ED10	09/85 ⇒ 12/90
CUORE II 0.8 4WD	ED10	09/86 ⇒ 10/88
DOMINO 0.8	ED	08/85 ⇒ 07/90
FEROZA 1.6i	--	01/84 ⇒ 12/89
HIJET I 1.0	CB	06/86 ⇒ 12/89
MIRA 847	--	01/87 ⇒

FORD AUSTRALIA

HUSKY 1.8	ZA	01/85 ⇒
-----------	----	---------

HOLDEN

JACKAROO_UBS 2.2 4x4	4ZD1	03/87 ⇒ 10/88
RODEO_KB 2.3	2.25	03/87 ⇒ 07/88
RODEO_KB 2.3 4x4	2.25	03/87 ⇒ 07/88
RODEO_TF 2.2	4ZD1	03/91 ⇒ 08/93
SHUTTLE_WFR 2.0	4ZC1	06/86 ⇒ 06/89

INNOCENTI

500 L; LS	--	⇒ 12/86
SMALL 990	--	07/90 ⇒ 12/92

SUBARU

E-SERIES 1.0	--	01/87 ⇒ 12/88
--------------	----	---------------

SUBARU		
L-SERIES 1.3	--	01/87 ⇒ 12/91
L-SERIES 1.8i	--	01/86 ⇒ 12/91
SUZUKI		
ALTO I 0.8	F8A, F8B	06/82 ⇒ 08/84
SJ410 1.0	F10A	09/81 ⇒ 07/91
TOYOTA		
DYNA 1.6	1Y	05/85 ⇒ 08/87
DYNA 1.8	2Y	05/95 ⇒ 08/01
DYNA 100 1.8	2Y	08/85 ⇒ 04/95
DYNA 150 1.8	2Y	08/85 ⇒ 08/86
DYNA 150 2.0	3Y	08/85 ⇒ 08/88
HIACE III 2.0	3Y	12/82 ⇒ 08/89
HIACE III 2.0 4WD	3Y	08/87 ⇒ 07/89
HIACE III 2.2	4Y	09/87 ⇒ 08/89
HIACE III 2.2 4WD	4Y	08/87 ⇒ 08/89
HILUX IV 1.8	2Y	08/83 ⇒ 03/89
HILUX IV 2.2	4Y	08/83 ⇒ 12/89
HILUX IV 2.2 4WD	4Y	11/85 ⇒ 12/89
HILUX V 1.8	2Y	09/88 ⇒ 06/98
LITEACE 1.5	5K	10/85 ⇒ 01/95
STARLET 1.0	1E	12/89 ⇒ 12/92
STARLET 1.3 [USA]	4KE	01/82 ⇒ 12/84
STOUT 2.2	4Y	04/88 ⇒ 02/00
VW		
TARO 1.8	2Y	04/89 ⇒ 09/94
TARO 2.2	4Y	06/89 ⇒ 07/94
TARO 2.2 4x4	4Y	06/89 ⇒ 07/94

TOYOTA		
LAND CRUISER 70 2.4	22R	11/84 ⇒ 05/93
LITEACE 2.2	4Y-EC	01/92 ⇒ 01/95
MODEL F 2.0	3Y	08/88 ⇒ 01/90
MODEL F 2.2	4Y-EC	08/85 ⇒ 01/90
TRUCK 2.4i [USA]	22R	01/88 ⇒ 12/90
VAN 2.2 [USA]	4YEC	01/83 ⇒ 12/90
VW		
TARO 1.8	2Y	04/89 ⇒ 09/94
TARO 2.2	4Y	06/89 ⇒ 07/94
TARO 2.2 4x4	4Y	06/89 ⇒ 07/94

KW 913 028



ROTORS

Adatt./Suitable: DENSO

BOSCH

1 987 234 041
F 005 X04 442

DAIHATSU

19102-87101-000
19102-87102-000

DENSO

029180-0920
029180-0921
029180-1310
029180-1391

GENERAL MOTORS

96 066 463

HOLDEN

3331082610
GD696

SUBARU

33310-71C30

SUZUKI

33310-63B10
33310-63B10-000
33310-71C30
33310-71C30-000
33310-82610
33310-82610-000

DAIHATSU

APPLAUSE I 1.6 16V	HD, HD-E	06/89 ⇒ 07/97
APPLAUSE I 1.6 16V 4WD	HD-E	06/89 ⇒ 07/97
CHARADE III 1.0i	G102	01/88 ⇒
CHARADE III 1.3	HC-C	09/88 ⇒ 02/93
CHARADE III 1.3 i	HC-E	06/88 ⇒ 12/92
CHARADE III 1.3 i 4WD	HC-E	06/88 ⇒ 01/93
CHARADE III 1.3i [USA]	HC-E	01/89 ⇒
FEROZA 1.6 16V	HD-C	10/88 ⇒ 12/99
FEROZA 1.6 16V 4x4	HD-C	10/88 ⇒ 12/99
FEROZA 1.6i 16V	HD-E	10/88 ⇒ 12/99
FEROZA 1.6i 16V 4x4	HD-E	10/88 ⇒ 12/99
FEROZA 1.6i	--	01/90 ⇒
ROCKY 2.0i [USA]	--	01/89 ⇒
SPORTTRACK 1.6 16v 4x4	HD-C	10/88 ⇒ 08/93

HOLDEN

BARINA 1.3	G13A	08/86 ⇒ 12/89
BARINA 1.3 GL	G13A	02/85 ⇒ 08/86

SUBARU

JUSTY II 1.3i	G13BA	05/96 ⇒ 09/00
---------------	-------	---------------

SUZUKI

ALTO IV 1.0	G10BB	09/94 ⇒ 06/02
ALTO V 1.0	G10BB	01/00 ⇒ 06/02
SWIFT I / II / III 1.3	G13A, G13B, G13BA	03/89 ⇒ 10/96
SWIFT I / II / III 1.3 4WD	G13A	03/89 ⇒ 12/91
SWIFT I / II / III 1.3 GTi SOHC	G13B	10/89 ⇒ 12/95
SWIFT I / II / III 1.3 i	G13BA	09/91 ⇒ 10/96
SWIFT I / II / III 1.3i SOHC [USA]	--	01/89 ⇒ 12/94
SWIFT I / II / III 1.6 i 16V	G16BA	08/92 ⇒ 10/96
SWIFT I / II / III 1.6 i 16V 4x4	G16BA	08/92 ⇒ 10/96
SA413 1.3	--	01/84 ⇒
SWIFT III 1.3 [USA]	--	06/95 ⇒ 05/01
SWIFT III 1.3 i	G13BA	06/96 ⇒ 03/01

KW 913 027



ROTORS

Adatt./Suitable: DENSO

BOSCH

1 987 234 025
F 005 X04 493

DAIHATSU

19102-38210-000

DENSO

029180-0660

GENERAL MOTORS

12 338 891
94 844 585
94 845 144

HOLDEN

1910202010
8942389820

ISUZU

8-94238982-0

LUV CHEVROLET

94220291
94238982

TOYOTA

19102-02010
19102-15021
19102-16040
19102-16060
19102-35160
19102-38210

VW

J19 102 160 60



HOLDEN

PIAZZA_YB 2.0i Turbo	2LH.C.	04/86 ⇒ 12/87
----------------------	--------	---------------

TOYOTA

CAMRY 1.8	1S	11/86 ⇒ 08/89
CARINA II 1.6	4A-LC	10/83 ⇒ 11/87
CELICA IV 1.6 GT	4A-GELC	08/87 ⇒ 08/89
CELICA IV 1.6 GT 16V	4A-GEL	09/85 ⇒ 08/89
CELICA IV 1.6 GTi 16V	4A-GEL	01/88 ⇒ 12/89
CELICA IV 2.0i [USA]	2SEL	01/85 ⇒ 12/86
COROLLA IV 1.8	3T-C	09/79 ⇒ 09/83
COROLLA V 1.6	4A-GELC	05/85 ⇒ 04/87
COROLLA V 1.6 16V	4A-GEC	12/85 ⇒ 04/87
COROLLA VI 1.6 GTi	4A-GE	08/87 ⇒ 10/94
DYNA 1.8	2Y	05/95 ⇒ 08/01
DYNA 2.0	3Y	05/95 ⇒ 10/01
DYNA 100 1.8	2Y	08/85 ⇒ 04/95
HILUX IV 1.8	2Y	08/83 ⇒ 03/89
HILUX IV 2.2	4Y	08/83 ⇒ 12/89
HILUX IV 2.2 4WD	4Y	11/85 ⇒ 12/89
HILUX V 1.8	2Y	09/88 ⇒ 06/98

KW 913 029



3

ROTORS

Adatt./Suitable: DENSO

BOSCH

1 987 234 027
F 005 X04 495

DAIHATSU

19102-87703-000
19102-87705-000

DENSO

029180-0910
029180-0930
029180-1230

GENERAL MOTORS

94 404 559
94 847 241

HOLDEN

1910211010
1910211031
1910211370

ISUZU

8-94404559-0
8-94404559-9
8-94847241-0

SUBARU

22157-KA040

TOYOTA

19102-11010
19102-11030
19102-11031
19102-11050
19102-11370
19102-87705

DAIHATSU

CHARADE III 1.0	CB90	11/90 ⇒ 12/92
CHARADE III 1.0 GTi	CB80T	03/87 ⇒ 12/92
CHARADE III 1.0i [USA]	CB	01/89 ⇒
CHARADE III 1.0i 12v GTi	CB70	11/90 ⇒ 02/93

HOLDEN

APOLLO 2.0	3S-FC	08/89 ⇒ 08/91
APOLLO 2.0 i	3S-FE	08/89 ⇒ 02/93
APOLLO 2.2 i	08GR-FXS	03/93 ⇒ 05/97
NOVA_LE 1.4 Hatchback	6AFC	07/89 ⇒ 07/91
NOVA_LE 1.6 Hatchback	4AFC	07/89 ⇒ 07/91
NOVA_LE 1.6 Sedan	4AFC	07/89 ⇒ 07/91
NOVA_LF 1.6i Hatchback	4AFE	08/91 ⇒ 03/93
NOVA_LF 1.6i Sedan	4AFE	08/91 ⇒ 03/93
NOVA_LF 1.8i Hatchback	7AFE	08/91 ⇒ 03/93
NOVA_LF 1.8i Sedan	7AFE	08/91 ⇒ 03/93
NOVA_LG 1.6i Hatchback	4AFE	09/94 ⇒ 09/96
NOVA_LG 1.6i Sedan	4AFE	09/94 ⇒ 09/96
NOVA_LG 1.8i Hatchback	7AFE	09/94 ⇒ 09/96
NOVA_LG 1.8i Sedan	7AFE	09/94 ⇒ 09/96

SUBARU

JUSTY 1.2i EMPI [USA]	--	01/91 ⇒
TRENDY 1.0	EF10	08/86 ⇒ 05/95

TOYOTA

AVENSIS I 1.6	4A-FE	09/97 ⇒ 10/00
CAMRY 2.0	3S-FE	03/83 ⇒ 02/93
CAMRY 2.0 4WD	3S-FE	03/83 ⇒ 06/91
CAMRY 2.2	5S-FE	06/91 ⇒ 07/96
CARINA II 1.6	4A-F, 4A-FE	12/87 ⇒ 03/92
CARINA II 1.6 4WD	4A-FE	06/88 ⇒ 03/92
CARINA II 2.0	3S-FE	12/87 ⇒ 04/92
CARINA II 2.0 GLI	3S-FE	12/87 ⇒ 03/92
CARINA E 1.6	4A-FE	04/92 ⇒ 09/97
CARINA E 1.6 16V	4A-FE	12/94 ⇒ 09/97
CARINA E 1.6 GLI	4A-FE	04/92 ⇒ 09/97
CARINA E 1.6 i	4A-FE	02/95 ⇒ 09/97
CARINA E 2.0	3S-FE	01/93 ⇒ 09/97
CARINA E 2.0 GLI	3S-FE	04/92 ⇒ 09/97
CARINA E 2.0 GTi	3S-GE	04/92 ⇒ 12/95
CARINA E 2.0 GTi 16V	3S-GE	03/94 ⇒ 09/97
CARINA E 2.0 i	3S-FE	12/92 ⇒ 09/97
CELICA IV 1.6	4A-L	04/86 ⇒ 08/89
CELICA IV 2.0i [USA]	3S-FE	01/85 ⇒ 12/87
CELICA V 1.6	4A-FE	09/89 ⇒ 12/93
CELICA V 1.6 16V [USA] [CAN]	4A-FE	09/89 ⇒ 09/93
CELICA V 2.2	5S-FE	10/89 ⇒ 12/94
COROLLA VI 1.3	2E	05/87 ⇒ 06/92
COROLLA VI 1.3 i	2E, 2E-E	08/87 ⇒ 06/92
COROLLA VI 1.6	4A-F, 4A-FE	05/87 ⇒ 12/92
COROLLA VI 1.6 4WD	4A-F	08/87 ⇒ 08/89

TOYOTA			
COROLLA VI 1.6 GL 4WD	4A-F	10/87 ⇒ 08/90	
COROLLA VI 1.6 i	4A-FE	05/87 ⇒ 05/92	
COROLLA VI 1.6 i 4WD	4A-FE	10/87 ⇒ 08/90	
COROLLA VI 1.6 XL	4A-F	09/89 ⇒ 04/92	
COROLLA VI 1.6 XLI	4A-FE	11/89 ⇒ 06/92	
COROLLA VII 1.3 12V	2E	07/92 ⇒ 04/97	
COROLLA VII 1.3 XLI	4E-FE	07/92 ⇒ 04/97	
COROLLA VII 1.3 XLI 16V	4E-FE	07/92 ⇒ 09/95	
COROLLA VII 1.6 GLI	4A-FE	07/92 ⇒ 04/97	
COROLLA VII 1.6 Si	4A-FE	07/92 ⇒ 04/97	
COROLLA VIII 1.3	2E	05/97 ⇒ 10/01	
COROLLA VIII 1.6	4A-FE	04/97 ⇒ 02/00	
COROLLA VIII 1.6 Aut.	4A-FE	04/97 ⇒ 02/00	
FUNCRUISER 2.0 i 16V 4WD	3SFE	04/94 ⇒	
MR 2 II 2.2 16V	5S-FE	01/90 ⇒ 06/95	
HIACE IV 2.0	1RZ	08/89 ⇒ 08/04	
HIACE IV 2.4	5YTD050W07	08/89 ⇒ 08/03	
HIACE IV 2.4 4WD	5YTD050W07	08/89 ⇒ 08/95	
CELICA VI 2.2 GT	5S-FE	11/93 ⇒ 08/99	
MR 2 I 1.6 16V	4A-GELC	11/84 ⇒ 06/90	
MR 2 I 1.6 Supercharged	4A-GZE	08/86 ⇒ 12/89	
PASEO 1.5	5E-FE	06/90 ⇒ 08/95	
RAV 4 I 2.0	3S-FE	06/97 ⇒ 09/99	
RAV 4 I 2.0 4WD	3S-FE	01/94 ⇒ 06/00	
STARLET 1.3	4E-FE	01/96 ⇒ 07/99	
STARLET 1.3 12V	2E, 2E-E	12/89 ⇒ 12/92	
STARLET 1.3 12V Cat	2E-E	12/89 ⇒ 03/96	
STARLET 1.3 XL	2E	12/89 ⇒ 12/91	
TERCEL 1.5	--	01/86 ⇒	
TERCEL 1.5 [USA]	3E	01/86 ⇒ 12/90	
TERCEL 1.5 i [USA]	3EE	01/89 ⇒	

KW 913 030



ROTORS

Adatt./Suitable: DENSO

DAIHATSU

19102-87206-000
19102-87704-000

DENSO

029180-0990
029180-1130
029180-1260

GENERAL MOTORS

91 125 557
94 338 910
96 052 016
96 055 178

HOLDEN

3331082010
8943389100

ISUZU

8-94338910-0

MARUTI

33310-82110

MITSUBISHI

MD620555

OPEL

42 91 891
43 13 484

PIAGGIO

19102-87704-000

SUBARU

22157-KA020

SUZUKI

33310-82010
33310-82010-000
33310-82110
33310-82110-000

TOYOTA

19102-73060
19102-75010

DAIHATSU

850 0.8	--	07/86 ⇒ 12/89
1000 1.0	CB10	07/86 ⇒ 12/89
CHARADE III 1.0	CB23, CB22	03/87 ⇒ 02/93
CUORE II 0.8	ED10	09/85 ⇒ 12/90
CUORE II 0.8 4WD	ED10	09/86 ⇒ 10/88
DOMINO 0.8	ED	08/85 ⇒ 07/90

HOLDEN

DROVER QB 1.3	G13A	02/85 ⇒ 12/87
GEMINI_RB 1.5	4XC1	04/85 ⇒ 06/87
SCURRY_NB 1.0	F10A	10/85 ⇒ 05/86

HOLDEN			
SHUTTLE_WFR 2.0	4ZC1	06/86 ⇒ 06/89	
MARUTI			
800 0.8	F8B	01/91 ⇒ 12/06	
MITSUBISHI			
VALLEY 2.0	4G63-T	09/92 ⇒ 10/94	
OPEL			
MIDI 2.0 i	20PET	09/92 ⇒ 08/94	
MIDI 2.0 i 4x4	20PET	09/92 ⇒ 08/94	
PIAGGIO			
PORTER 1.0	CB41	02/93 ⇒ 06/94	
SUBARU			
E-SERIES 1.0	--	01/88 ⇒ 12/92	
E-SERIES 1.2	--	01/87 ⇒ 12/92	
L-SERIES 1.8	--	01/86 ⇒ 12/91	
SUZUKI			
SWIFT I / II / III 1.0	G10A	03/89 ⇒ 05/01	
SWIFT I / II / III 1.0 i	G10A	03/89 ⇒ 12/91	
SWIFT I / II 1.0	G10, G10A	10/83 ⇒ 03/89	
SAMURAI 1.3 Trazione integrale	G13A	11/88 ⇒ 12/04	
SIDEKICK 1.6i [USA]	--	01/89 ⇒ 12/91	
SJ413 1.3	G13A	09/84 ⇒ 08/90	
SUPER CARRY 1.0	F10A	10/85 ⇒ 03/99	
VITARA I 1.6 8V	--	01/90 ⇒ 12/98	
TOYOTA			
DYNA 1.8	2Y	05/95 ⇒ 08/01	
DYNA 100 1.8	2Y	08/85 ⇒ 04/95	
HILUX IV 1.8	2Y	08/83 ⇒ 03/89	
HILUX IV 2.2	4Y	08/83 ⇒ 12/89	
HILUX IV 2.2 4WD	4Y	11/85 ⇒ 12/89	
HILUX V 1.8	2Y	09/88 ⇒ 06/98	
STOUT 2.2	4Y	04/88 ⇒ 02/00	

KW 913 034



ROTORS

Adatt./Suitable: DENSO

DAIHATSU

19102-87207-000

DENSO

029180-1280
029180-1300

FIAT

6553206400

GENERAL MOTORS

96 061 556

INNOCENTI

6553206400

SUZUKI

33310-60B50
33310-60B50-000

03 Supplied until depletion

- Fornibile fino ad esaurimento delle scorte
- Fourni jusqu'à épuisement du stock
- Lieferbar solange vorrat reicht
- Suministrado hasta el stock termina



INNOCENTI

SMALL 500	--	07/90 ⇒ 12/92
SMALL 500 Cat.	--	07/90 ⇒ 12/92

SUZUKI

SWIFT I / II / III 1.0 i	G10	03/89 ⇒ 12/05
WAGON R III 1.0	Z10XEP	06/04 ⇒ 08/05
WAGON R+ II 1.0	K10A	08/00 ⇒ 07/03
WAGON R+ II 1.0 XT Plus	--	08/00 ⇒ 07/01

KW 913 036

ROTORS

Adatt./Suitable: DENSO

BOSCH

1 987 234 065

SUZUKI

33310-80C10
33310-80C10-000

TOYOTA

19102-02030
19102-74040

SUZUKI

ALTO IV 1.0	G10BB	09/94 ⇒ 06/02
ALTO V 1.0	G10BB	01/00 ⇒ 06/02
SAMURAI 1.3	G13BA	11/88 ⇒ 03/98
SAMURAI 1.3 Trazione integrale	G13A, G13BA	01/00 ⇒ 12/04

TOYOTA

CARINA E 1.6	4A-FE	04/92 ⇒ 09/97
CARINA E 1.6 16V	4A-FE	12/94 ⇒ 09/97
CARINA E 1.6 GLI	4A-FE	04/92 ⇒ 09/97
CARINA E 1.6 i	4A-FE	02/95 ⇒ 09/97
CARINA E 1.8	7A-FE	04/92 ⇒ 09/97
CARINA E 1.8 i	7A-FE	02/95 ⇒ 09/97
CARINA E 1.8 i 16V	7A-FE	01/95 ⇒ 09/97
CELICA V 2.0	3S-GE	09/89 ⇒ 01/94
CELICA V 2.0 4WD	3S-GTE	10/89 ⇒ 01/94
CELICA V 2.0 GTi	3S-GE	10/89 ⇒ 11/93
CELICA V 2.2	5S-FE	10/89 ⇒ 12/94
CELICA VI 2.0 GTi	3S-GE	08/94 ⇒ 08/99
CELICA VI 2.0 i 16V	3S-GE	11/93 ⇒ 11/99
CELICA VI 2.0 i Turbo 4WD	3S-GTE	02/94 ⇒ 11/99
CELICA VI 2.2 GT	5S-FE	11/93 ⇒ 08/99
MR 2 II 2.0	3S-FE	12/89 ⇒ 08/92
MR 2 II 2.0 16V	3S-GE	12/89 ⇒ 09/99
MR 2 II 2.0 Turbo	3S-GTE	12/89 ⇒ 07/99
PREVIA I 2.4	2TZ-FE	05/90 ⇒ 08/00
PREVIA I 2.4 4WD	2TZ-FE, 2TZ-FZE	01/90 ⇒ 12/99

KW 915 080

ROTORS

Adatt./Suitable: DUCELLIER

00 Eliminated on 29-07-2019. Please verify the availability through our local distributors

- Eliminato il 29-07-2019. Verificare la disponibilità presso i nostri distributori
- Éliminé le 29-07-2019. Vérifier la disponibilité auprès de nos distributeurs sur place
- Am 29-07-2019 gestrichen. Evtl. Verfügbarkeit bitte bei unseren Händlern prüfen
- Eliminado en fecha 29-07-2019. Verificar la disponibilidad a través de nuestros distribuidores locales

202 without resistance

- senza resistenza
- sans résistance
- ohne Widerstand
- sin resistencia



915 081

KW 915 081



1

ROTORS

Adatt./Suitable: **DUCELLIER**

BOSCH
1 234 332 803
DUCELLIER
72 192

GENERAL MOTORS
7 992 292

RENAULT
08 54 720 000
77 01 019 885

⁰³ Supplied until depletion

- Fornibile fino ad esaurimento delle scorte
- Fourni jusqu'à épuisement du stock
- Lieferbar solange vorrat reicht
- Suministrado hasta el stock termina



RENAULT

4.0.8 | 80001 | 09/71 ⇨ 12/88

KW 915 083R



3

ROTORS

Adatt./Suitable: **DUCELLIER**

ALFA ROMEO
116 55 05 011 03/01
9916117

CITROËN
54 283 90
54 283 90P
95 539 596

DUCELLIER
18 137
79 432
450 002
450 009
661 156

FIAT
9916117
9924733
9936866
9937480

GENERAL MOTORS
7 992 892

LANCIA
9924733

PEUGEOT
5937 17

RENAULT
08 55 054 100

SEAT
000 389 842 4
000 993 686 6
SE 127914.004B

TALBOT
9611 6

VOLVO
284509
2845097
3100770
31007701

²¹² Resistance Rotor [Ohm] 5000

- Rotore resistenza [Ohm] 5000
- Résistance rotor [ohm] 5000
- Widerstand-Rotor [Ohm] 5000
- Resistencia rotor [ohm] 5000



CITROËN

CX I 2400 GTi | M23-622 | 06/77 ⇨ 06/83

FIAT

124 1200	124A.000	07/66 ⇨ 10/73
124 1400 Special	124B2.000	12/68 ⇨ 12/72
124 1600 Special T	132AC.000	01/73 ⇨ 07/75
127 0.9	100GL.048	06/71 ⇨ 05/83
128 1.1	128A.000	03/69 ⇨ 12/84
131 1.3 Mirafiori	131A6.000	10/74 ⇨ 09/81
850 0.8	100G.000	07/64 ⇨ 10/72
FIORINO I 900	100GL.000	10/77 ⇨ 10/86
PANDA I 750	141B.000	01/86 ⇨ 01/95
PANDA I 800	100GL6.000	02/81 ⇨ 12/85
PANDA I 900	100GL3.000	10/80 ⇨ 06/94
PANDA I 900 CL	146A.048	01/86 ⇨ 04/91

FIAT

REGATA 1.1 60 , 60 L	1388.000	10/83 ⇨ 08/86
REGATA 1.6	149A.000	10/84 ⇨ 06/89
REGATA 70 1.3	138B2.000, 149A3.000	09/83 ⇨ 07/89
REGATA 85 1.6	149A.000	10/83 ⇨ 06/90
RITMO I 1.1	146A4.048	04/85 ⇨ 12/87
RITMO I 1.3	149A3.000	11/83 ⇨ 08/85
RITMO II 75 1.5	138A2.000	09/85 ⇨ 12/88
UNO 45 0.9	146A.000, 146A1.000	03/83 ⇨ 07/96
UNO 45 0.9 Trend	146A.048	09/89 ⇨ 09/92
UNO 60 1.1 SX	—	01/83 ⇨ 12/85

LANCIA

A 112 0.9 Junior | A112A5.000 | 03/81 ⇨ 06/86

SEAT

FURA 0.9	100GL3000	01/82 ⇨ 06/86
PANDA 34 850	—	01/80 ⇨ 12/83
PANDA 35 850	—	01/80 ⇨ 12/83

KW 915 088



1

ROTORS

Adatt./Suitable: **DUCELLIER**

CHRYSLER
83 300 127
T1020357
T1407311

CITROËN
79 015 937 22

DUCELLIER
610 891
661 371
664 225

GENERAL MOTORS
93 150 104

PEUGEOT
5937 09
5937 22

RENAULT
77 01 020 357

TALBOT
9405 93 7228

⁰³ Supplied until depletion

- Fornibile fino ad esaurimento delle scorte
- Fourni jusqu'à épuisement du stock
- Lieferbar solange vorrat reicht
- Suministrado hasta el stock termina

²⁰² without resistance

- senza resistenza
- sans résistance
- ohne Widerstand
- sin resistencia



CITROËN

AXEL 11 | G11/631 | 01/84 ⇨ 03/91

PEUGEOT

104 0.9 | 108(XV5) | 10/79 ⇨ 10/83

RENAULT

5 1.4 Alpine Turbo	840726	10/81 ⇨ 01/85
11 1.4	C2J720, C2J766, C2J767, C2J768	03/83 ⇨ 12/88
14 1.4	150	09/79 ⇨ 06/83
18 1.4	847720, 847722	04/78 ⇨ 07/86
18 1.6 TS	A6M725, A6M726	05/82 ⇨ 07/86
19 I 1.2	C1G730	01/88 ⇨ 12/92
19 I 1.4	C2J772, C2J776, C3J710	07/88 ⇨ 05/93
19 I 1.4 Cat	C3J710	01/89 ⇨ 04/92
19 II 1.4	C3J710	04/92 ⇨ 12/95
21 1.4	C2J770, C2L717	06/88 ⇨ 10/93
21 1.6	C2L	01/87 ⇨ 12/94
CLIO I 1.2	C3G720	06/94 ⇨ 02/98
EXPRESS 1.2	C1G	01/85 ⇨ 10/90
EXPRESS 1.4	C1J, C2J	01/85 ⇨ 10/90
EXPRESS 1.4i	C3G/C3J	01/85 ⇨ 10/90
SUPER 5 1.2	C1G702	01/87 ⇨ 12/96
SUPER 5 1.4	C2J798	10/84 ⇨ 07/89
SUPER 5 1.4 Turbo	C1J784	04/85 ⇨ 08/90
TWINGO I 1.2	C3G700, C3G702	03/93 ⇨ 10/96

TALBOT

SAMBA 1.1 | XW7 | 01/81 ⇨ 06/86

KW 915 088R



1

ROTORS

Adatt./Suitable: **DUCELLIER**

DUCELLIER
660 548

GENERAL MOTORS
7 992 639
93 150 134

PEUGEOT
5937 18

⁰⁰ Eliminated on 14-04-2020. Please verify the availability through our local distributors

- Eliminato il 14-04-2020. Verificare la disponibilità presso i nostri distributori
- Éliminé le 14-04-2020. Vérifier la disponibilité auprès de nos distributeurs sur place
- Am 14-04-2020 gestrichen. Evtl. Verfügbarkeit bitte bei unseren Händlern prüfen
- Eliminado en fecha 14-04-2020. Verificar la disponibilidad a través de nuestros distribuidores locales

¹¹¹ Paired article numbers

- N° articolo appaiato
- Numéro d'article en paire
- paargige Artikelnummer
- Referencia artículo par

915 088

²¹² Resistance Rotor [Ohm] 5000

- Rotore resistenza [Ohm] 5000
- Résistance rotor [ohm] 5000
- Widerstand-Rotor [Ohm] 5000
- Resistencia rotor [ohm] 5000

²¹⁸ with resistance

- con resistenza
- avec résistance
- mit Widerstand
- con resistencia



KW 915 089R



3

ROTORS

Adatt./Suitable: **DUCELLIER**

DUCELLIER
660 740
662 899

GENERAL MOTORS
93 150 645

VW
052 905 225 A

⁰³ Supplied until depletion

- Fornibile fino ad esaurimento delle scorte
- Fourni jusqu'à épuisement du stock
- Lieferbar solange vorrat reicht
- Suministrado hasta el stock termina

²¹² Resistance Rotor [Ohm] 5000

- Rotore resistenza [Ohm] 5000
- Résistance rotor [ohm] 5000
- Widerstand-Rotor [Ohm] 5000
- Resistencia rotor [ohm] 5000



VW

DERBY 1.1	HB	02/77 ⇨ 09/81
DERBY 1.3	HH	02/77 ⇨ 09/81
POLO II 1.1	HB	10/81 ⇨ 09/89
POLO II 1.3	HH	10/81 ⇨ 07/83
SCIROCCO I 1.1	FA	04/74 ⇨ 07/79

KW 915 091



3

ROTORS

Adatt./Suitable: **DUCELLIER**

ALFA ROMEO

700 295
60748377

BOSCH

1 234 332 802
1 234 335 802

CHRYSLER

83 300 126

CITROËN

54 524 21
54 524 21W
55 081 70
95 610 822
DM 211-16

DAF

22 48 85

DUCELLIER

16 903
49 423
611 723
661 004
661 154
661 764
662 368
664 895

FEMSA

33830-1

FIAT

9934708

FORD

A790-X12200-DA

GENERAL MOTORS

7 992 291

LAND ROVER

RTC3341
RTC3616
RTC4933

Motorcraft

EDR 85

PEUGEOT

5937 05
5937 16
5937 34

RENAULT

08 54 120 600
77 01 021 981

ROVER

GRA2123

SEAT

000 993 470 8
SE 141914.004D

SEV-MARCHAL

D 4511
402 60003

TALBOT

0017 67 1100
1350 03 00
5135 00 300
7506 60 02

RENAULT

19I 1.4	C1J	01/89 ⇒ 12/92
20 2.0	829700, 829701, 829702, 829703, 829.01	10/77 ⇒ 12/83
CLIO I 1.1	C1E700	01/91 ⇒ 09/98
EXPRESS 1.1	C1E	01/85 ⇒ 10/90
EXPRESS 955	C1C	01/85 ⇒ 10/90
FUEGO 1.6 [USA] R1368	A7L752	01/82 ⇒ 12/84
MASTER I 2.0	829731	07/80 ⇒ 06/85
MASTER I 28-35 2.0	829731	08/80 ⇒ 10/86
RAPID 1.0	C1C706	09/85 ⇒ 05/92
RAPID 1.1	C1E750, C1E752, C1E754, C1E756, C1E760, C1E762, C1E764	07/85 ⇒ 10/97
SUPER 5 1.1	C1E752, C1E754, C1E756, C1E760	10/84 ⇒ 12/96
TRAFICI 1.4	C1J700	03/80 ⇒ 06/91

ROVER

MINI 1.0	--	01/85 ⇒
MINI 1.3	--	01/85 ⇒

SEAT

IBIZA I 0.9	146A000	08/86 ⇒ 05/93
-------------	---------	---------------

TALBOT

1307-1510 Simca 1307 1.3	--	07/75 ⇒ 01/80
--------------------------	----	---------------

KW 915 094



1

ROTORS

Adatt./Suitable: **DUCELLIER**

BOSCH

1 234 332 860

CHRYSLER

83 300 128

CITROËN

95 559 241
95 611 732

DUCELLIER

663 550
663 869
664 203

FIAT

9940302

LANCIA

9940302

PEUGEOT

5937 28
5937 43

RENAULT

77 01 026 824
77 01 027 870

TALBOT

0043 21 2900

*** Paired article numbers

- N° articolo appaiato
- Numéro d'article en paire
- paarige Artikelnummer
- Referencia artículo par

915 094R

202 without resistance

- senza resistenza
- sans résistance
- ohne Widerstand
- sin resistencia



CITROËN

AXEL 11	--	01/84 ⇒ 03/91
BX 1.1	109LA, H1A	04/86 ⇒ 06/91
BX 1.4	150C, K1F, K2D	07/86 ⇒ 12/94
BX 1.4 E	150B(XY8), 150J, 150Y, K1F, KAZ	09/82 ⇒ 12/94
BX 1.6	B2C	02/88 ⇒ 12/94
BX 1.9	159B, 159C, D6U, DKK	05/85 ⇒ 12/94
BX 1.9 GTi	D6D, D6K	01/87 ⇒ 01/92
BX 14	150C	01/86 ⇒ 02/93
BX 14 E	150A, 150C, K1G	10/82 ⇒ 02/93
BX 15	B1E(XU51C)	01/87 ⇒ 05/92
BX 16	171A, 171B, 171C, 171D, 23DH, B1E(XU51C), BAY(XU5CP), BAZ(XU5CP)	10/82 ⇒ 12/94
BX 19	159A, D2A(XU92C), D2C(XU92C), D2E, D6A(XU9J2), DKZ(XU9JA)	09/84 ⇒ 12/94
BX 19 Cat	DFZ(XU9J1)	07/86 ⇒ 12/94
BX 19 E 4x4	D2F	04/89 ⇒ 02/93
BX 19 GTi	D6A(XU9J2), DKZ(XU9JA)	07/86 ⇒ 02/93
BX 19 GTi 4x4	DKZ(XU9JA)	06/88 ⇒ 02/93
C15 1.0	108C	10/84 ⇒ 07/88
C15 1.0 E	TU9K	11/92 ⇒ 07/96
C15 1.1	109K, E1A, XW7	10/84 ⇒ 12/96
C15 1.3	G1A	07/87 ⇒ 05/88
C15 1.4	150D(XY7)	05/87 ⇒ 10/92
C15 1.4 E	150D(XY7)	05/87 ⇒ 12/96
CX I 2000	829A5	06/79 ⇒ 08/85
CX II 20 RE	829A5	08/85 ⇒ 12/92
CX II 22 TRS	J6TA500	07/85 ⇒ 12/92

CITROËN

GS A 1.3	G13/625	07/78 ⇒ 07/86
LNA 1.1	109/5E	07/82 ⇒ 04/85
VISA 11 E	109K	09/78 ⇒ 06/88

FIAT

DUCATO I 2.0	170B, 170D, 170C(XN1T), XN1T	01/82 ⇒ 05/94
DUCATO I 2.0 4x4	170D	06/90 ⇒ 05/94
PANDA I 1000	156A2.000	12/93 ⇒
PANDA I 1000 CLX	156A2.000	05/91 ⇒ 12/94
PANDA I 1000 Fire	156A2.000	05/86 ⇒ 04/91
PANDA I 750	156A4.000	01/86 ⇒ 10/03
PANDA I 750 Cat	156A4.048	01/95 ⇒ 10/03
PANDA I 750 Fire	156A4.048	11/88 ⇒ 04/91
TALENTO 2.0	170B	03/89 ⇒ 03/94
TIPO I 1.1	160A3.000	01/88 ⇒ 10/91
UNO 45 1.0	156A2.000	09/89 ⇒ 09/92
UNO 45 1.0 Fire	--	01/83 ⇒ 12/89
UNO 60 1.1	160A3.000	04/89 ⇒ 12/92

LANCIA

Y10 1.0 Fire Trazione integrale	156A2.000, 156A2.100, 156A2.246	12/86 ⇒ 02/92
Y10 1.1 i.e Fire	156C.000	08/89 ⇒ 06/92
Y10 1.1 i.e Fire Trazione integrale	156C.000	08/89 ⇒ 06/92

PEUGEOT

205 I 1.0	108C(XV8)	02/83 ⇒ 12/90
205 I 1.1	109F(XW7), 109N(XW7)	02/83 ⇒ 10/87
205 I 1.3	G1A	02/84 ⇒ 10/87
205 I 1.4	150(XY6B), 150B(XY8), 150D(XY7), 150G(XY7), 150H(XY8)	02/83 ⇒ 10/87
205 I 1.5	Y2/K	02/84 ⇒ 10/87
205 I 1.6	B1A(XU51C), B1E(XU51C), BAZ(XU5CP)	08/86 ⇒ 10/87
205 I 1.9 GTI	DFZ(XU9J1)	03/87 ⇒ 10/87
205 II 1.1	109N(XW7)	10/87 ⇒ 10/90
205 II 1.1 XA	E1	07/87 ⇒ 10/88
205 II 1.2	F1	01/87 ⇒ 12/90
205 II 1.3	G1A	08/90 ⇒ 07/92
205 II 1.4	150(XY6B), 150B(XY8), 150D(XY7), 150G(XY7), 150H(XY8)	01/87 ⇒ 05/89
205 II 1.4 CJ	150D(XY7), 150G(XY7)	03/88 ⇒ 05/89
205 II 1.4 CT	150B(XY8), 150H(XY8)	04/86 ⇒ 12/88
205 II 1.6	B1A(XU51C), B1E(XU51C), BAZ(XU5CP)	10/87 ⇒ 09/98
205 II 1.9 CTI	DFZ(XU9J1)	10/87 ⇒ 12/94
205 II 1.9 GTI Cat	DFZ(XU9J1)	10/87 ⇒ 07/94
309 I 1.1	E1	10/85 ⇒ 07/89
309 I 1.3	G1A, G2S	10/85 ⇒ 08/89
309 I 1.3 XL	--	09/86 ⇒ 08/89
309 I 1.5	Y2/K	06/87 ⇒ 12/89
309 I 1.6	B1A(XU51C), B1D(XU51C), B1E(XU51C)	10/85 ⇒ 07/89
309 I 1.6 Cat	BAZ(XU5CP)	09/86 ⇒ 12/89
309 I 1.9	D2B(XU9S), DFZ(XU9J1), XU92C	10/85 ⇒ 07/89
309 II 1.9	XU92C	07/89 ⇒ 12/93
505 2.0	106E(XN1A)	09/85 ⇒ 09/95
604 2.0 i	XN6	01/85 ⇒ 12/86
J5 1.8	169B(XM7T)	01/83 ⇒ 11/88
J9 2.0	XN1P	03/80 ⇒ 06/87

RENAULT

5 1.4 Alpine Turbo	840726	10/81 ⇒ 01/85
9 1.2	C1G700, C1G710	09/85 ⇒ 12/88
11 1.2	C1G700, C1G710	10/84 ⇒ 12/88
11 1.4	C2J720, C2J766, C2J767, C2J768	03/83 ⇒ 12/88
18 1.4	847720, 847722	04/78 ⇒ 07/86
18 1.6 TS	AGM725, AGM726	05/82 ⇒ 07/86
18 2.0	J6R716	05/82 ⇒ 07/86
19 I 1.2	C1G730	01/88 ⇒ 12/92
19 I 1.4	C2J772, C2J776, C3J710	07/88 ⇒ 05/93
19 I 1.4 Cat	C3J710	01/89 ⇒ 04/92
19 II 1.4	C3J710	04/92 ⇒ 12/95
21 1.6	C2L	01/87 ⇒ 12/94
25 2.0	J6R706, J6R707	04/84 ⇒ 12/92
25 2.0 12V	74AR-FXE, 7CYQD80D-E3, J7R721	06/88 ⇒ 12/93
25 2.2	J7T706, J7T707	04/84 ⇒ 12/89
CLIO I 1.2	C3G720	06/94 ⇒ 02/98
ESPACE I 2.0	53AZ-FXE, J6R234, J6R236	07/84 ⇒ 12/90
ESPACE II 2.0	J7R768	01/91 ⇒ 10/96
ESPACE II 2.2	J7T772	01/91 ⇒ 10/96
ESPACE II 2.2 4x4	J7T772	03/91 ⇒ 12/96
EXPRESS 1.2	C1G	01/85 ⇒ 10/90
EXPRESS 1.4	C1J, C2J	01/85 ⇒ 10/90
EXPRESS 1.4i	C3G/C3J	01/85 ⇒ 10/90
FUEGO 1.6 [USA] R136A	A7L	01/82 ⇒ 12/86
FUEGO 1.6 [USA] R136B	A7L	01/84 ⇒ 12/86
MASTER I 2.0	J5R718, J5R728	06/85 ⇒ 12/95

CITROËN

CX I 2400	M23-623	08/76 ⇒ 06/80
-----------	---------	---------------

DACIA

1210 1.2	--	01/69 ⇒
1310 1.3	810-02/-99	05/83 ⇒ 07/04
1410 1.4	--	01/69 ⇒
ARO 10	--	01/72 ⇒ 12/80

FIAT

132 1.6	132C.000	05/77 ⇒ 09/82
DUCATO I 1.8	169B	01/82 ⇒ 12/88

LAND ROVER

90 2.5 4x4	17H	09/85 ⇒ 08/90
110/127 2.5 4x4	17H	10/85 ⇒ 07/90
DEFENDER 2.25	--	01/87 ⇒

PEUGEOT

305 1.5	117(XR55)	05/80 ⇒ 09/82
504 1.8	XM7	01/71 ⇒ 06/83
504 1.8 Injection	KF5, KF6	07/68 ⇒ 02/71
505 1.8	105(XM7), 105C(XM7A)	06/81 ⇒ 10/86
505 2.0 TI, STI	829(ZEJ)	08/79 ⇒ 10/86
J9 1.6	XC7P	03/80 ⇒ 06/87

RENAULT

4 0.8	800705	10/83 ⇒ 10/88
5 1.3	810726	09/76 ⇒ 09/79
5 1.4 Alpine A5	840725	09/77 ⇒ 09/81
9 1.1	C1E715	09/81 ⇒ 05/87
11 1.1	C1E715, C1E720	03/83 ⇒ 06/86

915 094R

RENAULT		
MASTER I 2.2	J7T788	08/93 ⇒ 02/98
MASTER I 28-35 2.0	J5R718	10/86 ⇒ 07/98
MASTER I 30 2.2	J7T782, J7T788	08/80 ⇒ 07/98
SUPER 5 1.2	C1G702	01/87 ⇒ 12/96
SUPER 5 1.4	C2J798	10/84 ⇒ 07/89
SUPER 5 1.4 Turbo	C1J784	04/85 ⇒ 08/90
TRAFIC I 1.4	C1J700	03/80 ⇒ 06/91
TRAFIC I 2.0	J5R716	05/89 ⇒ 08/90
TRAFIC I 2.2	J7T600, J7T780	05/89 ⇒ 04/98
TRAFIC I 2.2 4x4	J7T600, J7T780	05/89 ⇒ 04/98
TALBOT		
SOLARA 1.3	2M102.979	02/80 ⇒ 07/86
TAGORA 2.1	5N2	06/80 ⇒ 12/83

KW 915 094R

ROTORS

Adatt./Suitable: **DUCELLIER**¹¹¹ Paired article numbers

- N° articolo appaiato
- Numéro d'article en paire
- paarige Artikelnummer
- Referencia artículo par

915 094

²¹² Resistance Rotor [Ohm] 5000

- Rotore resistenza [Ohm] 5000
- Résistance rotor [ohm] 5000
- Widerstand-Rotor [Ohm] 5000
- Resistencia rotor [ohm] 5000

²¹⁸ with resistance

- con resistenza
- avec résistance
- mit Widerstand
- con resistencia



KW 915 096R

ROTORS

Adatt./Suitable: **DUCELLIER**

CITROËN

94 059 373 08

DUCELLIER

664 518
2 558 654

FIAT

9405937478

PEUGEOT

5937 30
5937 49

VOLVO

3213390
32133902
3287599
32875999⁰³ Supplied until depletion

- Fornibile fino ad esaurimento delle scorte
- Fourni jusqu'à épuisement du stock
- Lieferbar solange vorrat reicht
- Suministrado hasta el stock termina

²¹² Resistance Rotor [Ohm] 5000

- Rotore resistenza [Ohm] 5000
- Résistance rotor [ohm] 5000
- Widerstand-Rotor [Ohm] 5000
- Resistencia rotor [ohm] 5000



FIAT		
DUCATO I 2.0	170D	07/90 ⇒ 03/94
VOLVO		
340-360 1.3	B13, B13.4E	08/88 ⇒ 12/90
340-360 1.4	B14.3E, B14.4E, B14.4ED, B14.40, B14.45	08/82 ⇒ 07/91

KW 915 097

ROTORS

Adatt./Suitable: **DUCELLIER**

CHRYSLER

83 300 129

DUCELLIER

665 852
666 777
2 524 132
2 559 115

RENAULT

77 00 727 261
77 01 029 972

VOLVO

3342163
33421637
3342441
3342863
33428632
3449620

RENAULT

11 1.7	F2N700	10/83 ⇒ 12/87
19 I 1.7	F2N720, F2N721, F2N722, F2N724, F3N740, F3N741, F3N742, F3N743, F3N746	07/88 ⇒ 12/92
19 II 1.7	F2N720, F2N721, F2N726, F2N727, F3N740, F3N741, F3N742, F3N743, F3N746	09/90 ⇒ 12/95
19 II 1.8	5F140FE, 8NA20S, F3P682, F3P704, F3P705, F3P706, F3P707, F3P708, F3P764, F3P765	04/92 ⇒ 06/96
21 1.7	F2N710, F2N711, F2N712, F2N722, F2N750, F2N752, F2N754, F2N758, F2N786, F3N722, F3N723, F3N726	03/86 ⇒ 12/95
21 1.7 Cat	F3N726	05/88 ⇒ 06/93
21 2.0	F2R702	09/89 ⇒ 12/91
CLIO I 1.7	F2N770	01/91 ⇒ 12/93
CLIO I 1.8	QHR10DE, F3P710, F3P714, F3P754	08/90 ⇒ 09/98
CLIO I 1.8 Rsi	F3P712, F3P758	01/93 ⇒ 09/98
LAGUNA I 1.8	F3P678, F3P720, F3P724	11/93 ⇒ 03/01
LAGUNA I 2.0	6Z7U730, F3R722	11/93 ⇒ 03/01
SUPER 5 1.7	F2N740, F2N742, F3N716, F3N717	10/86 ⇒ 03/95
SUPER 5 1.7 i	F3N702	10/86 ⇒ 08/91
TRAFIC I 1.7	F1N720	05/89 ⇒ 08/94

VOLVO

340-360 1.7	B172K	08/85 ⇒ 07/91
440 1.6	B16F	09/88 ⇒ 12/96
440 1.7	B18E, B18EP, B18F, B18FP, B18K, B18KD, B18KP, B18KPD	08/88 ⇒ 12/96
440 1.7 Turbo	B18FT	08/88 ⇒ 12/96
440 1.8	B18U	08/91 ⇒ 12/96
440 2.0	B20F	08/92 ⇒ 07/96
460 1.6	B16F	07/92 ⇒ 07/96
460 1.7	B18EP, B18FP, B18K, B18KD, B18KP	09/88 ⇒ 07/96
460 1.7 Turbo	B18FT	08/89 ⇒ 07/96
460 1.8	B18U	08/91 ⇒ 07/96
460 2.0	B20F	08/92 ⇒ 07/96
480 1.7	B18E, B18ED, B18EP, B18F, B18FP	04/86 ⇒ 07/96
480 1.7 Turbo	B18FT	08/87 ⇒ 07/96
480 2.0	B20F	08/92 ⇒ 09/95

KW 915 099R

ROTORS

Adatt./Suitable: **DUCELLIER**

AUDI

026 905 225 K

DUCELLIER

666 867

SEAT

026 905 225 K

VW

026 905 225 K

²¹² Resistance Rotor [Ohm] 1000

- Rotore resistenza [Ohm] 1000
- Résistance rotor [ohm] 1000
- Widerstand-Rotor [Ohm] 1000
- Resistencia rotor [ohm] 1000



AUDI

80 II 1.6	DT	08/78 ⇒ 03/87
80 II 1.8	DS	01/83 ⇒ 08/86
80 III 1.4	SE	08/86 ⇒ 07/88
80 III 1.6	PP, RN, RNA	09/86 ⇒ 09/91
80 III 1.8	RU	10/86 ⇒ 01/90
80 III 1.8 S	NE	09/86 ⇒ 10/91
100 III 1.8	DS, NP	08/83 ⇒ 12/90
100 III 1.8 quattro	NP, SH	10/84 ⇒ 07/90
A4 I 1.6	ADP	11/94 ⇒ 09/01

SEAT

CORDOBA I 1.6 i	1F	05/94 ⇒ 06/99
CORDOBA I 1.8 i	ABS, ACC, ADZ	02/93 ⇒ 09/02
IBIZA II 1.6 i	1F	09/94 ⇒ 06/99
IBIZA II 1.8 i	ABS, ACC, ADZ	03/93 ⇒ 08/99
INCA 1.4 i	AEX, AKV, APQ	11/95 ⇒ 06/03
INCA 1.6 i	1F, AEE	11/95 ⇒ 05/98
TOLEDO I 1.8 i	ADZ	11/93 ⇒ 12/96

VW

PASSAT II 1.6	DT	08/80 ⇒ 03/88
PASSAT II 1.8	DS	01/83 ⇒ 03/88
PASSAT II 1.8 Syncro	DS	01/86 ⇒ 03/88
PASSAT IV 1.6	ADP	10/96 ⇒ 11/00
JETTA II 1.6	ABN, EZ, EZA, PN, RF	01/84 ⇒ 07/92
JETTA II 1.8	GU	08/84 ⇒ 10/91
JETTA II 1.8 Syncro	GU	08/87 ⇒ 12/88
CADDY II 1.6	1F	11/95 ⇒ 05/97
CADDY II 75 1.6	1F	11/95 ⇒ 05/97
GOLF I 1.6	EW	08/83 ⇒ 04/92
GOLF I 1.8	EX	08/83 ⇒ 09/92
GOLF II 1.6	ABN, EZ, PN, RF	08/83 ⇒ 12/92
GOLF II 1.6 G	EZA, PN	08/86 ⇒ 07/91
GOLF II 1.8	GU	08/84 ⇒ 10/91
GOLF II 1.8 Syncro	GU	02/86 ⇒ 07/91
GOLF III 1.6	AEK	07/94 ⇒ 04/99
GOLF III 1.8	AAM, ABS, ADZ	08/91 ⇒ 04/99
GOLF III 1.8 Syncro	ABS, ADZ	01/93 ⇒ 04/99
GOLF III 2.0	ADY, AEP, AGG, AKR	11/91 ⇒ 04/99
GOLF III 2.0 GL	AEP	08/95 ⇒ 09/97
GOLF IV 2.0	AGG, AKR	06/98 ⇒ 06/02
PASSAT III 1.6	AEK	07/94 ⇒ 08/96
PASSAT III 1.8	AAM, ABS, ADZ	02/88 ⇒ 05/97
POLO III 75 1.6	1F	11/95 ⇒ 09/97
SCIROCCO II 1.6	EW, EWA, RE	01/83 ⇒ 07/90
SCIROCCO II 1.8	EX	08/83 ⇒ 07/92
VENTO 1.6	AEK	10/94 ⇒ 09/98
VENTO 1.8	AAM, ABS, ADZ	11/91 ⇒ 09/98

KW 915 101



1

ROTORS

Adatt./Suitable: **DUCELLIER****DUCELLIER**

2 558 743

RENAULT

77 01 033 622



RENAULT

19 I 1.2i	E7F	01/89 ⇒ 12/92
19 I 1.4	E6J700, E6J701, E7J700	01/88 ⇒ 12/92
19 I 1.8 16V	F7P700, F7P704	06/89 ⇒ 09/92
19 II 1.2	E7F730	05/92 ⇒ 09/94
19 II 1.4	E6J706, E7J706, E7J707, E7J742, E7J745	01/92 ⇒ 12/95
19 II 1.8 16V	F7P704	04/92 ⇒ 06/96
21 2.0	J7R740	02/90 ⇒ 06/94
21 2.0 4x4	J7R740	12/89 ⇒ 02/94
21 2.0 Turbo	J7R752, J7R756	04/87 ⇒ 10/92
21 2.0 Turbo 4x4	J7R752, J7R756	08/89 ⇒ 10/93
21 2.0 TXi	15CRMP10U1, J7R740	07/89 ⇒ 05/93
25 2.0 12V	74AR-FXE, 7CYQD80D-E3, J7R721	06/88 ⇒ 12/93
CLIO I 1.2	E5F710, E5F716, E7F700, E7F706, E7F708, E7F750	05/90 ⇒ 09/98
CLIO I 1.4	E6J712, E6J713, E6J718, E7J601, E7J710, E7J711, E7J716, E7J718, E7J719, E7J754, E7J756, E7J757	01/90 ⇒ 09/98
CLIO I 1.8 16V	F7P720, F7P722	01/91 ⇒ 03/96
CLIO I Williams	F7R700	01/94 ⇒ 09/98
MEGANE I 1.4	E7J764	09/96 ⇒ 08/03
MEGANE I 1.4 e	E7J764	01/96 ⇒ 08/03
MEGANE I 1.4 Eco	E7J624	01/96 ⇒ 03/99
MEGANE SCÉNIC I 1.4 i	E7J764	01/97 ⇒ 09/99
RAPID 1.4	E6J738, E7J720, E7J724, E7J726, E7J728, E7J770, E7J771, E7J773	09/91 ⇒ 03/98
RAPID 1.4 RN	E6J734	09/91 ⇒ 08/93
SAFRANE I 2.0	0LJY, J7R732, J7R738, J7R739	08/92 ⇒ 09/96
SAFRANE I 2.0 12V	J7R734, J7R735	04/92 ⇒ 07/96
SAFRANE I 2.2	1MR479QB, J7T761, J7T762	04/92 ⇒ 07/96
TRAFIC I 2.0	J5R726	05/89 ⇒ 08/90
TRAFIC I 2.0 RWD	J5R726	05/89 ⇒ 10/97

KW 915 102R



3

ROTORS

Adatt./Suitable: **DUCELLIER****CITROËN**

95 651 019

PEUGEOT

5937 47

²¹²Resistance Rotor [Ohm] 1000

- Rotore resistenza [Ohm] 1000
- Résistance rotor [ohm] 1000
- Widerstand-Rotor [Ohm] 1000
- Resistencia rotor [ohm] 1000



CITROËN

AX 1.3 Sport	M4A	04/87 ⇒ 12/88
AX 10	C1A	09/86 ⇒ 06/92
AX 10 E	C3A	12/86 ⇒ 12/88
AX 11	H1A, H1B, HDZ(TU1M)	09/86 ⇒ 12/97
AX 11 4x4	H1A	06/91 ⇒ 07/92
AX 11 Cat	HAZ(TU1CP)	09/88 ⇒ 12/89

CITROËN

AX 14	K1A(TU3), K1B, K1F, K1G, K1J, K2A, K2B, K2D, KAY(TU3CP), KDX(TU3M/Z), KDY(TU3FM), KDY(TU3M), KDZ(TU3M/Z)	09/86 ⇒ 04/97
AX 14 4x4	KD4, KDX(TU3M/Z), KDY(TU3FM), KDY(TU3M), KDZ(TU3M/Z)	06/91 ⇒ 12/96
AX 14 GT	KDZ(TU3M/Z)	01/89 ⇒ 12/91
BX 1.1	109LA, H1A	04/86 ⇒ 06/91
BX 1.4	150C, K1F, K2D	07/86 ⇒ 12/94
BX 1.4 E	150B(XY8), 150J, 150Y, K1F, KAZ	09/82 ⇒ 12/94
BX 1.6	B2C	02/88 ⇒ 12/94
BX 1.9	159B, 159C, D6U, DKK	05/85 ⇒ 12/94
BX 1.9 GTi	D6D, D6K	01/87 ⇒ 01/92
BX 14	150C, KDY(TU3M), KDZ(TU3M/Z)	01/86 ⇒ 02/93
BX 14 E	150A, 150C, K1G	10/82 ⇒ 02/93
BX 15	B1E(XU51C)	01/87 ⇒ 05/92
BX 16	171A, 171B, 171C, 171D, 23DH, B1E(XU51C), BAY(XU5CP), BAZ(XU5CP), BDY(XU5M), BDZ(XU5M)	10/82 ⇒ 12/94
BX 16 E	BDY(XU5M), BDZ(XU5M)	05/89 ⇒ 02/93
BX 19	159A, D2A(XU92C), D2C(XU92C), D2E, D6A(XU9J2), DDZ(XU9M), DKZ(XU9JA)	09/84 ⇒ 12/94
BX 19 4x4	DDZ(XU9M)	10/90 ⇒ 05/91
BX 19 Cat	DFZ(XU9J1)	07/86 ⇒ 12/94
BX 19 E	DDZ(XU9M)	06/88 ⇒ 02/93
BX 19 E 4x4	D2F	04/89 ⇒ 02/93
BX 19 GTi	D6A(XU9J2), DKZ(XU9JA)	07/86 ⇒ 02/93
BX 19 GTi 4x4	DKZ(XU9JA)	06/88 ⇒ 02/93
C15 1.0	108C(XV8), C1A, C1A(TU9/K), C1B(TU9/W), TU9	10/84 ⇒ 12/97
C15 1.1	H1A, HDZ(TU1M), TU1	08/88 ⇒ 07/96
C15 1.1 i	HDZ(TU1M), TU1MZ	07/88 ⇒ 12/96
C15 1.4	K1A, K1G, K1H(TU3A), KDY(TU3M)	07/87 ⇒ 12/96
C15 1.4 E	K1F, K1J, K2D, K3A, KAZ	07/86 ⇒ 12/96
C15 1.4 i	KDY(TU3FM), KDY(TU3M)	05/91 ⇒ 12/96
JUMPER I 2.0	XU102C	02/94 ⇒ 02/02
XM I 2.0	--	05/89 ⇒ 04/94
XM I 2.0 i	RDZ(XU10MZ), RFZ(XU10J2)	05/89 ⇒ 06/94
BERLINGO I 1.4	TU32	07/96 ⇒ 10/98
ZX 1.1	H1A, H1B, HDZ(TU1M), TU1	03/91 ⇒ 06/97
ZX 1.4 i	KDY(TU3M)	10/93 ⇒ 10/97
ZX 1.9	D6E(XU9JA)	03/91 ⇒ 06/97
ZX 1.9 i	DKZ(XU9JA), XU9JA	03/91 ⇒ 06/97

PEUGEOT

106 I 1.0	TU9	09/91 ⇒ 03/01
106 I 1.1	H1B(TU1), HDZ(TU1M)	08/91 ⇒ 04/96
106 I 1.4	K5A(TU3), KDY(TU3M), TU3.2	08/91 ⇒ 04/96
106 II 1.1	H1B(TU1)	04/96 ⇒
205 I 1.4	TU3	01/83 ⇒ 12/90
205 I 1.6	B1A(XU51C), B1E(XU51C)	08/86 ⇒ 10/87
205 II 1.0	TU9	10/87 ⇒ 09/98
205 II 1.1	H1B(TU1), HDZ(TU1M)	10/87 ⇒ 09/98
205 II 1.1 CJ	HDZ(TU1M)	10/89 ⇒ 12/94
205 II 1.4	K1D(TU3A), K2B(TU3S), KDY(TU3M), KDZ(TU3M)	06/87 ⇒ 09/98
205 II 1.4 CJ	K1D(TU3A), KDY(TU3M)	03/89 ⇒ 12/94
205 II 1.6	B1A(XU51C), B1E(XU51C)	10/87 ⇒ 09/98
205 II 1.9 GTI	DKZ(XU9JAZ)	10/87 ⇒ 10/94
306 1.4	TU3	01/93 ⇒ 04/02
309 I 1.4	K1D(TU3A), K2B(TU3S), KDY(TU3M), KDZ(TU3M)	08/88 ⇒ 08/89
309 II 1.1	H1B(TU1), HDZ(TU1M)	09/89 ⇒ 12/93
309 II 1.4	KDZ(TU3M), TU3, TU3F2	07/89 ⇒ 12/93
309 II 1.6	18EM, BDZ(XU5M)	07/89 ⇒ 12/93
309 II 1.9	DDZ(XU9M), XU92C	07/89 ⇒ 12/93
309 II 1.9 GTI	DKZ(XU9JAZ)	07/89 ⇒ 12/93
405 I 1.4	K5A(TU3), TU3A, TU3F2	01/87 ⇒ 12/92
405 I 1.6	--, 18EM, B1E(XU51C), BDZ(XU5M)	01/87 ⇒ 12/92
405 I 1.6 4x4	BDZ(XU5M)	04/88 ⇒ 07/92
405 I 1.6 SRI 4x4	BDZ(XU5M)	04/88 ⇒ 07/92
405 I 1.9	D2C(XU92C), DDZ(XU9M), DFZ(XU9J1), DKZ(XU9JAZ), XU9J2, XU9J2/D6D	01/87 ⇒ 12/92
405 I 1.9 4x4	DDZ(XU9M), DKZ(XU9JAZ)	06/87 ⇒ 12/92
405 I 1.9 Antipollution	XU92C	01/87 ⇒ 12/92
405 I 1.9 Injection	DFZ(XU9J1)	07/87 ⇒ 12/92
405 I 1.9 Trazione integrale	DFZ(XU9J1)	09/88 ⇒ 07/92
405 II 1.4	TU3F2	01/93 ⇒ 12/96
405 II 1.6	18EM	08/92 ⇒ 05/97
405 II 1.9	XU92C	01/93 ⇒ 12/96
605 2.0	--, R5A(XU102C), XU10M	01/89 ⇒ 09/99

KW 915 103R



3

ROTORS

Adatt./Suitable: **DUCELLIER****GENERAL MOTORS**

90 376 979

90 540 398

OPEL

12 12 204

12 12 207

²¹²Resistance Rotor [Ohm] 1000

- Rotore resistenza [Ohm] 1000
- Résistance rotor [ohm] 1000
- Widerstand-Rotor [Ohm] 1000
- Resistencia rotor [ohm] 1000



OPEL

ASTRA F 1.6	16LZ2, 16N2Z	09/94 ⇒ 09/98
ASTRA F 1.8 i	C18NZ	09/91 ⇒ 09/98
ASTRA F 2.0 i	C20NE	09/91 ⇒ 09/98
CALIBRA A 2.0 i	C20NE	08/89 ⇒ 12/96
CALIBRA A 2.0 i 4x4	C20NE	06/90 ⇒ 07/97
FRONTERA A 2.0 i	C20NE	03/92 ⇒ 10/98
KADETT E 1.8	18SE	01/86 ⇒ 08/91
KADETT E 1.8 i	C18NZ, S18NV	06/85 ⇒ 05/92
KADETT E 2.0 GSI	20NE, 20SEH	09/86 ⇒ 08/91
KADETT E 2.0 GSI Cat	C20NE	09/86 ⇒ 08/91
KADETT E 2.0 i	20NE	10/86 ⇒ 02/93
KADETT E 2.0 i Cat	C20NE	10/86 ⇒ 02/93
OMEGA A 1.8	18SEH, E18NVR, S18NV	09/86 ⇒ 03/94
OMEGA A 1.8 N	18NV	09/86 ⇒ 08/87
OMEGA A 1.8 S	18SV	09/86 ⇒ 03/94
OMEGA A 2.0	20SE, C20NE	09/86 ⇒ 04/94
OMEGA A 2.0 i	C20NE	09/86 ⇒ 04/94
OMEGA B 2.0	20SE	03/94 ⇒ 12/00
VECTRA A 1.6	C16L2Z	08/92 ⇒ 07/93
VECTRA A 1.6 i	C16N2Z	09/88 ⇒ 11/95
VECTRA A 1.6 i Cat	C16N2Z	09/88 ⇒ 11/95
VECTRA A 1.8 i	18SV	09/88 ⇒ 10/90
VECTRA A 1.8 i Cat	C18NZ	03/90 ⇒ 11/95
VECTRA A 1.8 S	18SV, E18NVR	09/88 ⇒ 10/90
VECTRA A 1.8 S 4x4	E18NVR	01/89 ⇒ 07/89
VECTRA A 2.0 i	20NE, 20SEH	09/88 ⇒ 09/92
VECTRA A 2.0 i 4x4	20NE, 20SEH	01/89 ⇒ 07/92
VECTRA A 2.0 i Cat	C20NE	09/88 ⇒ 11/95
VECTRA A 2.0 i Cat 4x4	C20NE	01/89 ⇒ 11/95
VECTRA A 2.0 i GT	20SEH	09/88 ⇒ 11/95
VECTRA B 1.6 i	16L2Z	10/95 ⇒ 07/03

VAUXHALL

ASTRA III 1.8 i	C18NZ	09/91 ⇒ 09/98
ASTRA III 2.0 i	C20NE	09/91 ⇒ 09/98
CALIBRA 2.0 i	C20NE	06/90 ⇒ 07/97
CALIBRA 2.0 i 4x4	C20NE	06/90 ⇒ 07/97
FRONTERA A 2.0	C20NE	04/95 ⇒ 08/98
FRONTERA A 2.0 i	C20NE	03/92 ⇒ 10/98
OMEGA B 2.0	20SE	09/95 ⇒ 09/96

KW 915 104  **3**

ROTORS
 Adatt./Suitable: **DUCELLIER**
DUCELLIER ⁰³ Supplied until depletion
 2 537 260
PEUGEOT
 5937 44

- Fornibile fino ad esaurimento delle scorte
- Fourni jusqu'à épuisement du stock
- Lieferbar solange vorrat reicht
- Suministrado hasta el stock termina



CITROËN		
BX 1.9 GTi 16V	159K, DFK	01/87 ⇨ 12/94
BX 19 GTi 16V	D6C(XU9J4), DFW(XU9J4)	09/87 ⇨ 02/93
PEUGEOT		
309 II 1.9 GTi 16V	D6C(XU9J4)	08/89 ⇨ 07/90
405 I 1.9	D6C(XU9J4)	06/87 ⇨ 07/92
405 I 1.9 4x4	D6C(XU9J4)	06/87 ⇨ 07/92
405 I 1.9 Sport MI-16	D6C(XU9J4), DFW(XU9J4Z)	06/87 ⇨ 11/92
405 I 1.9 SPort MI-16 4x4	DFW(XU9J4Z)	06/87 ⇨ 07/92
405 I 1.9 Trazione integrale	D6C(XU9J4)	06/87 ⇨ 07/92

KW 917 052  **3,5**

ROTORS
 Adatt./Suitable: **FEMSA**
FEMSA ⁰³ Supplied until depletion
 12133- 1
 12133- 4
 22488- 1
FIAT
 3892873
 3895702
 9936807
FIAT (YV)
 7073054/1
RENAULT
 08 57 113 700
SEAT
 000 389 287 3
 3892873
 NG1 213 340 6

- Fornibile fino ad esaurimento delle scorte
- Fourni jusqu'à épuisement du stock
- Lieferbar solange vorrat reicht
- Suministrado hasta el stock termina

¹¹¹ Paired article numbers

- N° articolo appaiato
- Numéro d'article en paire
- paarige Artikelnummer
- Referencia artículo par

917 052R

²⁰² without resistance

- senza resistenza
- sans résistance
- ohne Widerstand
- sin resistencia



FIAT		
131 1.3 Mirafiori	131A6.000	10/74 ⇨ 09/81
SEAT		
RONDA 1.2	021A1000	08/83 ⇨ 05/85
RONDA 1.6	138AR6.000	08/83 ⇨ 09/85

KW 917 052R  **3,5**

ROTORS
 Adatt./Suitable: **FEMSA**
FEMSA ¹¹¹ Paired article numbers
 32493
FIAT
 9936831
SEAT
 000 993 683 1
 SE 141914.004C

- N° articolo appaiato
- Numéro d'article en paire
- paarige Artikelnummer
- Referencia artículo par

917 052

²¹² Resistance Rotor [Ohm] 5000

- Rotore resistenza [Ohm] 5000
- Résistance rotor [ohm] 5000
- Widerstand-Rotor [Ohm] 5000
- Resistencia rotor [ohm] 5000

²¹⁸ with resistance

- con resistenza
- avec résistance
- mit Widerstand
- con resistencia



FIAT		
127 0.9	100GL.048	06/71 ⇨ 05/83
132 1.6	132C.000	05/77 ⇨ 09/82
PANDA I 800	100GL6.000	02/81 ⇨ 12/85
SEAT		
FURA 0.9	100GL3000	01/82 ⇨ 06/86
IBIZA I 0.9	146A000	08/86 ⇨ 05/93
MARBELLA 0.8	5K9K718	08/86 ⇨ 12/93
MARBELLA 0.9	09NCA	01/87 ⇨ 12/93
PANDA 0.9	100GL3000	10/80 ⇨ 12/86
PANDA 34 850	--	01/80 ⇨ 12/83
PANDA 35 850	--	01/80 ⇨ 12/83
PANDA 45	--	01/82 ⇨ 12/85
TERRA 0.9	09NCA	02/87 ⇨ 12/96

KW 917 058  **1**

ROTORS
 Adatt./Suitable: **FEMSA**
BOSCH ⁰³ Supplied until depletion
 9 231 334 371
FEMSA
 28994- 1
 28994- 1J
LAND ROVER
 00000A00070
RENAULT
 77 02 124 320

- Fornibile fino ad esaurimento delle scorte
- Fourni jusqu'à épuisement du stock
- Lieferbar solange vorrat reicht
- Suministrado hasta el stock termina



RENAULT		
4 0.8	80001	09/71 ⇨ 12/88
4 1.1	688712	02/78 ⇨ 06/90
5 1.4	847725	01/82 ⇨ 12/85
9 1.2	C1G700, C1G710	09/85 ⇨ 12/88
11 1.2	C1G700, C1G710	10/84 ⇨ 12/88
11 1.4	C2J720, C2J766, C2J767, C2J768	03/83 ⇨ 12/88
11 1.7	F2N700	10/83 ⇨ 12/87
18 1.4	847720, 847722	04/78 ⇨ 07/86
19 I 1.2	C1G730	01/88 ⇨ 12/92
19 I 1.4	C2J772, C2J776, C3J710	07/88 ⇨ 05/93
19 I 1.4 Cat	C3J710	01/89 ⇨ 04/92
19 II 1.4	C3J710	04/92 ⇨ 12/95
EXPRESS 1.1	C1E	01/85 ⇨ 10/90
EXPRESS 955	C1C	01/85 ⇨ 10/90

RENAULT		
RAPID 1.1	C1E750, C1E760	07/85 ⇨ 04/95
SUPER 5 1.0	C1C700	10/84 ⇨ 10/88

KW 919 085  **1**

ROTORS
 Adatt./Suitable: **FORD**
FORD ²⁰² without resistance
 0 267 26
 1 444 043
 5 014 405
 C6AH-12200-A
 C7AH-12200-A
 D5FZ-12200-A
 DORY-12200-A
GENERAL MOTORS
 7 992 217
Motorcraft
 DR 220A
 DRE 90
 EDR 3
 EDR 3 D
 EDR 3 S

- senza resistenza
- sans résistance
- ohne Widerstand
- sin resistencia



FORD		
CORTINA 1300	KL13H	10/70 ⇨ 03/72
FIESTA I 0.9	TKA, TKW, TLA	05/76 ⇨ 08/83
TAUNUS 1.6	LCJ	07/79 ⇨ 07/82
TRANSIT I 1.6	4RB	11/77 ⇨ 10/86
TRANSIT I 2.0	4RC	11/77 ⇨ 07/82

KW 919 092  **1**

ROTORS
 Adatt./Suitable: **FORD**
CHRYSLER ⁰³ Supplied until depletion
 56 027 075
FORD
 1 643 692
 E6EE-12200-AA
 E6FZ-12200-A
JEEP
 33003389
 56027075
MAZDA
 ZZM0-24-312
Motorcraft
 DR 375A
RENAULT
 89 33 003 389

- Fornibile fino ad esaurimento delle scorte
- Fourni jusqu'à épuisement du stock
- Lieferbar solange vorrat reicht
- Suministrado hasta el stock termina



FORD		
SCORPIO I 2.4 i	ARC	09/86 ⇨ 09/88
SCORPIO I 2.9 i	BRC, BRD, BRE, BRF	09/86 ⇨ 12/94
SCORPIO I 2.9 i 4x4	BRC, BRD, BRE, BRF	09/86 ⇨ 10/94
SCORPIO I 2.9 i Cat	BRE	10/87 ⇨ 08/94
SCORPIO II 2.9 i	BRG	02/95 ⇨ 08/98

JEEP		
CHEROKEE II 4.0 i	--, 127K, ERH, MX	10/86 ⇨ 09/01
CHEROKEE II 4.0 i 4x4	ERH	01/95 ⇨ 09/01
COMANCHE 4.0 i	127K	10/87 ⇨ 09/90
GRAND WAGONEER 4.0 i	127K	10/86 ⇨ 09/90
WAGONEER 4.0 i	127K	10/86 ⇨ 09/90
WRANGLER 2.5	EPE	12/91 ⇨ 08/96
WRANGLER 4.0	127K, ERH	10/86 ⇨ 08/96

KW 919 094R



3,5

ROTORS

Adatt./Suitable: FORD

FORD
1 649 200
E7EE-12200-DA

⁰⁰Eliminated on 04-08-2020. Please verify the availability through our local distributors

- Eliminato il 04-08-2020. Verificare la disponibilità presso i nostri distributori
- Éliminé le 04-08-2020. Vérifier la disponibilité auprès de nos distributeurs sur place
- Am 04-08-2020 gestrichen. Evtl. Verfügbarkeit bitte bei unseren Händlern prüfen
- Eliminado en fecha 04-08-2020. Verificar la disponibilidad a través de nuestros distribuidores locales

²¹²Resistance Rotor [Ohm] 1000

- Rotore resistenza [Ohm] 1000
- Résistance rotor [ohm] 1000
- Widerstand-Rotor [Ohm] 1000
- Resistencia rotor [ohm] 1000

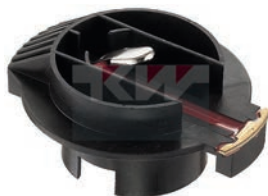

FORD

SIERRA II 1.8	R2C, R6A	05/88 ⇨ 02/93
---------------	----------	---------------

KW 922 052



3

ROTORS

Adatt./Suitable: HITACHI

BOSCH
1 987 234 015
F 005 X04 557

HITACHI
44A2-16001
44R84-16002

HOLDEN
22157H9560
GH605

HONDA
30103-657-005

NISSAN
22149-B8900
22149-N3602
22157-H3602
22157-H9560
22157-N3602
22157-U6001
22157-U6091
22157-U6091MP
22157-U6094
22157-U6094DY

SUBARU
22157-AA030
49101-8711

⁰³Supplied until depletion

- Fornibile fino ad esaurimento delle scorte
- Fourni jusqu'à épuisement du stock
- Lieferbar solange vorrat reicht
- Suministrado hasta el stock termina



HOLDEN

ASTRA_LB 1.5	E15	08/84 ⇨ 01/86
ASTRA_LC 1.6	E16S	02/86 ⇨ 06/87

NISSAN

PULSAR 1.6	E16	01/84 ⇨ 12/86
PULSAR 1.6 [USA]	E16	01/82 ⇨ 12/83

SUBARU

L-SERIES 1.3	--	01/79 ⇨ 12/87
L-SERIES 1.6	--	01/86 ⇨ 12/87

KW 922 056



1

ROTORS

Adatt./Suitable: HITACHI

ACURA
30103-PAI-732

BOSCH
1 987 234 042

HONDA
30103-PA1-732
30103-PA1-733
30103-PAI-732
30103-PC3-822
30103-PE9-006

ROVER
GRA2245

⁰³Supplied until depletion

- Fornibile fino ad esaurimento delle scorte
- Fourni jusqu'à épuisement du stock
- Lieferbar solange vorrat reicht
- Suministrado hasta el stock termina



ACURA

INTEGRA I 1.6	D16A1	01/85 ⇨ 12/90
INTEGRA I 1.6 i	D16A8	01/85 ⇨ 12/90

HONDA

ACCORD III 1.6 L	A16A1	11/85 ⇨ 12/89
ACCORD III 2.0	A20A2	01/86 ⇨ 12/86
ACCORD III 2.0 12V	A20A1, A20A3	01/86 ⇨ 12/89
ACCORD III 2.0 16V EXS	B20A2	01/88 ⇨ 12/89
ACCORD III 2.0 EX	A20A1, A20A2	11/85 ⇨ 12/89
ACCORD III 2.0 EXi	A20A3, A20A4	11/85 ⇨ 12/89
ACCORD III 2.0 i 16V	B20A2, B20A8	01/87 ⇨ 12/89
ACCORD VI 1.6	A16A5	10/98 ⇨ 12/02
CIVIC II 1.3 [USA]	--	01/81 ⇨ 12/83
CIVIC III 1.5 i Si [USA]	--	01/84 ⇨ 12/87
JAZZ I 45 1.2	ER2	02/84 ⇨ 10/86

ROVER

200 I 213 S	EV2	09/85 ⇨ 09/89
-------------	-----	---------------

KW 922 066



04

ROTORS

Adatt./Suitable: HITACHI

NISSAN
22157-18F00
22157-20R00

⁰³Supplied until depletion

- Fornibile fino ad esaurimento delle scorte
- Fourni jusqu'à épuisement du stock
- Lieferbar solange vorrat reicht
- Suministrado hasta el stock termina



NISSAN

200 SX 1.8i Turbo	CA18ET	01/87 ⇨
BLUEBIRD 2.0 i	CA20E	04/84 ⇨ 12/90
PICK UP I 2.4 [USA]	Z24i	01/85 ⇨ 12/89
STANZA 2.0 [USA]	CA20	01/82 ⇨ 12/87
TERRANO I 2.4 i 4WD	Z24i	10/87 ⇨ 02/93
URVAN III 2.4 i	Z24i	05/89 ⇨ 09/93
VAN 2.4 [USA]	Z24i	01/86 ⇨ 12/89
VANETTE II 2.0	Z20S	07/87 ⇨ 08/94

KW 922 069



1

ROTORS

Adatt./Suitable: HITACHI

BOSCH
F 005 X04 502
GENERAL MOTORS
94 174 468

HOLDEN
8941744680

HONDA
8-94174-468-0

ISUZU
8-94174468-0

OPEL
43 12 974



HOLDEN

JACKAROO_UBS 2.6i 4x4	4ZE1	11/88 ⇨ 12/91
RODEO_TF 2.6i	4ZE1	08/88 ⇨ 03/96
RODEO_TF 2.6i 4x4	4ZE1	08/88 ⇨ 03/96

HONDA

PASSPORT 2.6 i [USA]	4ZE1	01/94 ⇨
----------------------	------	---------

ISUZU

AMIGO 2.6i [USA]	RLJ	01/88 ⇨
PICK-UP 2.6i [USA]	RLJ	01/88 ⇨
RODEO 2.6i [USA]	RLJ	01/90 ⇨
TROOPER 2.6 4WD	4ZE1	11/86 ⇨ 07/91
TROOPER 2.6 i	4ZE1	10/87 ⇨ 12/91

OPEL

CAMPO 2.3	23P	08/94 ⇨ 09/96
-----------	-----	---------------

KW 922 070



3,5

ROTORS

Adatt./Suitable: HITACHI

BOSCH
1 987 234 050
1 987 234 052

FORD
1 953 279

NISSAN
22157-17B00
22157-21E00
22157-21E01
22157-21F01
22157-27M02
22157-40F00
22157-55Y00
22157-71J00
22157-78A00

⁰³Supplied until depletion

- Fornibile fino ad esaurimento delle scorte
- Fourni jusqu'à épuisement du stock
- Lieferbar solange vorrat reicht
- Suministrado hasta el stock termina



FORD

MAVERICK 2.4 i	KA24E	02/93 ⇨ 08/96
----------------	-------	---------------

NISSAN

100NX 1.6	GA16DS	03/90 ⇨ 10/94
BLUEBIRD 1.8 Turbo	CA18T	04/84 ⇨ 11/92
BLUEBIRD 2.0 i	CA20E	04/84 ⇨ 12/90
NX1600 1.6i [USA]	GA16, GA16DE	01/88 ⇨ 12/92
PICK UP I 2.4 i [USA]	KA24E	01/89 ⇨
PICK UP I 2.4 i 12V	KA24E	04/92 ⇨ 02/98
PICK UP I 2.4 i 12V 4WD	KA24E	04/92 ⇨ 02/98
PRIMERA I 1.6	GA16DS	06/90 ⇨ 01/96
PRIMERA I 1.6 i	GA16DS	07/90 ⇨ 03/98
PULSAR NX 1.6 [USA]	GA16	01/88 ⇨
SENTRA III 1.6i [USA]	GA16DE	01/90 ⇨ 12/92
SILVIA 1.8	--	01/84 ⇨
SUNNY II 1.6 i 12V	GA16i	06/86 ⇨ 06/91

NISSAN		
SUNNY III 1.6 16V 4x4	GA16DS	11/90 ⇒ 05/95
SUNNY III 1.6 i	GA16DE, GA16DS	10/90 ⇒ 03/00
SUNNY III 1.6 i 16V 4WD	GA16DE, GA16DS	10/90 ⇒ 06/95
SUNNY III 1.6 i 16V 4x4	GA16DE	10/92 ⇒ 03/00
TERRANO II 2.4 4WD	KA24E	05/96 ⇒ 09/07
TERRANO II 2.4 i 12V 4WD	KA24E	02/93 ⇒ 12/97

KW 922 073  1

ROTORS

Adatt./Suitable: **HITACHI**

BOSCH

1 987 234 031

FORD

E7GZ-12200-A

HITACHI

43S85-16001

43S86-16001

44R86-16001

HONDA

30103-PE1-731

MAZDA

B601-18-V05

Motorcraft

DRE 381

NISSAN

22157-KA030

SUBARU

22157-AA040

22157-KA010

22157-KA030

SUZUKI

33310-75F00

33310-75F00-000



MAZDA

323 V 1.6	93AF1006, B6E	09/86 ⇒ 10/95
323 V 1.6 GT	93AF1006	01/86 ⇒ 10/89
323 V 1.6i	B681, B682	06/86 ⇒ 07/87
323 V 1.6i 16v 4x4	B595	06/86 ⇒ 07/87

SUBARU

J-SERIES 1.0i EFC-SYS	--	01/89 ⇒
J-SERIES 1.2	--	01/87 ⇒ 12/91
J-SERIES 1.2 SDX	--	01/89 ⇒ 12/91
J-SERIES 1.2i EFC-SYS	--	01/89 ⇒
JUSTY 1.2 [USA]	--	01/87 ⇒ 12/92
L-SERIES 1.6	--	01/87 ⇒ 12/91
TRENDY 1.0	EF10	08/86 ⇒ 05/95
TRENDY 1.2 12v	EF12	06/86 ⇒ 08/95

SUZUKI

WAGON R II 1.0	K10A	02/98 ⇒ 05/00
WAGON R II 1.2	K12A	02/98 ⇒ 05/00
WAGON R II 1.2 4WD	K12A	02/98 ⇒ 05/00

KW 922 081  3

ROTORS

Adatt./Suitable: **HITACHI**

HONDA

30103-P01-005

30103-PM0-B01

30103-PM3-015

30103-PM3-025

Eliminated on 12-01-2022. Please verify the availability through our local distributors

• Eliminato il 12-01-2022. Verificare la disponibilità presso i nostri distributori

• Éliminé le 12-01-2022. Vérifier la disponibilité auprès de nos distributeurs sur place

• Am 12-01-2022 gestrichen. Evtl. Verfügbarkeit bitte bei unseren Händlern prüfen

• Eliminado en fecha 12-01-2022. Verificar la disponibilidad a través de nuestros distribuidores locales



HONDA

ACCORD IV 1.8	--	01/90 ⇒ 12/91
ACCORD IV 2.0 16V	F20A2, F20A3, F20A6	01/90 ⇒ 03/93
CIVIC V 1.3	D13B2	01/92 ⇒ 12/92
CIVIC V 1.3 16V	D13B2	10/91 ⇒ 11/95
CIVIC IV 1.2	D12B1	01/88 ⇒ 12/91
CIVIC IV 1.3	D13B1	10/87 ⇒ 12/89
CIVIC IV 1.3 [USA]	--	09/87 ⇒ 12/89
CIVIC IV 1.3 16V Cat	D13B2	09/89 ⇒ 09/91
CIVIC IV 1.4 L	D14A1	10/87 ⇒ 12/89
CIVIC IV 1.4i 16V	D14A1	01/90 ⇒ 12/91
CIVIC IV SHUTTLE 1.4 i 16V	D14A1	01/88 ⇒ 12/92
CONCERTO 1.4	D14A1	08/89 ⇒ 10/92
CONCERTO 1.6i	D16A	01/90 ⇒ 12/91

KW 922 082  1

ROTORS

Adatt./Suitable: **HITACHI**

ACURA

30103-PM5-A04

BOSCH

1 987 234 063

HONDA

30103-PM5-702

30103-PM5-703

30103-PM5-A02

30103-PM5-A04

30103-PR3-006

ROVER

GRA2287



ACURA

INTEGRA I 1.6	D16A1	01/85 ⇒ 12/90
INTEGRA I 1.6 i	D16A8	01/85 ⇒ 12/90

HONDA

CIVIC IV 1.5	D15B1	01/88 ⇒ 12/89
CIVIC IV 1.5 i 16V	D15B2	10/87 ⇒ 09/91
CIVIC IV 1.6 16V 4x4	D16A6	11/87 ⇒ 09/91
CIVIC IV 1.6 i 16V	D16A6, D16A9, D16Z2	09/87 ⇒ 09/91
CIVIC IV 1.6 i 16V 4x4	D16A6, D16Z2	01/89 ⇒ 12/91
CIVIC IV 1.6i 16V	D16A7, D16A8, D16A9	01/88 ⇒ 05/92
CIVIC IV 1.6i 16V 4WD	D16A1, D16Z2	01/88 ⇒ 12/91
CIVIC IV SHUTTLE 1.5 i 16V	D15B2	01/88 ⇒ 11/91
CIVIC IV SHUTTLE 1.6 4x4	D16A, D16A7	01/88 ⇒ 12/92
CIVIC IV SHUTTLE 1.6 i 16V 4WD	D16A6	01/88 ⇒ 02/95
CIVIC IV SHUTTLE 1.6i 16V 4WD	D16Z2	01/88 ⇒ 12/92
CIVIC V 1.5	D15B2	01/92 ⇒ 12/92

HONDA

CONCERTO 1.5 i	--	01/90 ⇒ 12/91
CONCERTO 1.6i DOHC	--	01/90 ⇒ 12/91
CONCERTO 1.6i SOHC	--	01/90 ⇒ 12/91
CRX II 1.6 i 16V	D16A9, D16Z5	10/87 ⇒ 02/92

ROVER

200 II 216 GSi	1GH5E-180, D16A7	10/89 ⇒ 12/95
200 II 216 GTi	D16A8, D16A9	01/90 ⇒ 10/95
400 I 416 GTI/GTE	D16A9	04/90 ⇒ 04/95

KW 922 085  3

ROTORS

Adatt./Suitable: **HITACHI**

BOSCH

1 987 234 053

INFINITI

22157-70J00

Motorcraft

ADR 5050

NISSAN

22157-30R00

22157-54C01

22157-70J00

22157-70J01

Supplied until depletion

• Fornibile fino ad esaurimento delle scorte

• Fourni jusqu'à épuisement du stock

• Lieferbar solange vorrat reicht

• Suministrado hasta el stock termina



INFINITI

G20 2.0	SR20DE	01/90 ⇒ 12/97
---------	--------	---------------

NISSAN

100NX 2.0	SR20DE	10/90 ⇒ 10/94
100NX 2.0 GTi	SR20DE	03/91 ⇒ 10/94
PRAIRIE PRO 2.4 i	KA24E	01/90 ⇒ 07/94
PRAIRIE PRO 2.4 i 4x4	KA24E	04/92 ⇒ 07/94
PRIMERA I 2.0	SR20DE	06/90 ⇒ 04/93
PRIMERA I 2.0 16V	SR20D1	06/90 ⇒ 01/96
PRIMERA I 2.0 16V 4x4	SR20D1	04/91 ⇒ 06/96
PRIMERA I 2.0 GT	SR20DE	06/90 ⇒ 01/96
PRIMERA I 2.0 GT 4x4	SR20DE	03/91 ⇒ 04/93
PRIMERA I 2.0 i	SR20DE	07/90 ⇒ 03/98
PRIMERA II 2.0 16V	SR20DE	08/99 ⇒ 12/01
SENTRA III 2.0i [USA]	SR20DE	01/90 ⇒
SUNNY III 2.0 GTi 16V	SR20DE	10/90 ⇒ 05/95
SUNNY III 2.0 GTi-R 4x4	SR20DET	10/90 ⇒ 05/95

KW 922 086  1

ROTORS

Adatt./Suitable: **HITACHI**

BOSCH

1 987 234 052

NISSAN

22157-03A00

22157-71J10

22157-77A01

Supplied until depletion

• Fornibile fino ad esaurimento delle scorte

• Fourni jusqu'à épuisement du stock

• Lieferbar solange vorrat reicht

• Suministrado hasta el stock termina



NISSAN

100NX 1.6	GA16DS	03/90 ⇒ 10/94
PRIMERA I 1.6	GA16DS	06/90 ⇒ 01/96
PRIMERA I 1.6 i	GA16DS	07/90 ⇒ 03/98
SUNNY II 1.0 L	E10S	07/86 ⇒ 09/90
SUNNY II 1.3	E13S	06/86 ⇒ 10/91
SUNNY II 1.4 LX	GA14S	10/88 ⇒ 08/91
SUNNY II 1.5	E15S	06/86 ⇒ 10/88
SUNNY II 1.6	E16S	06/86 ⇒ 10/88

NISSAN			
SUNNY III 1.4	GA14DS	10/90 ⇒	06/95
SUNNY III 1.4 i	GA14DS	10/90 ⇒	05/95
SUNNY III 1.6 16V 4x4	GA16DS	11/90 ⇒	05/95
SUNNY III 1.6 i	GA16DE, GA16DS	10/90 ⇒	03/00
SUNNY III 1.6 i 16V 4WD	GA16DE, GA16DS	10/90 ⇒	06/95
SUNNY III 1.6 i 16V 4x4	GA16DE	10/92 ⇒	03/00

KW 922 092

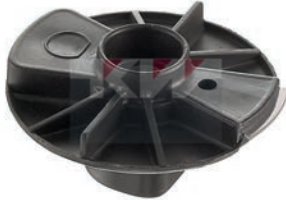

ROTORS

Adatt./Suitable: **HITACHI****HONDA**
30103-PT2-016

HONDA

ACCORD IV 2.0 16V	F20A5	01/92 ⇒	12/93
ACCORD IV 2.0 i 16V	F20A7	01/90 ⇒	12/93
ACCORD IV 2.2	F22A6	05/92 ⇒	12/93
ACCORD IV 2.2 i 16V	F22A3, F22A7, F22A8	01/90 ⇒	12/93
ACCORD IV 2.2 i 16V Automatik	F22A3	01/90 ⇒	03/93

KW 922 093



ROTORS

Adatt./Suitable: **HITACHI****HITACHI**
44P88-16001**SUBARU**
22157-AA080⁰³ Supplied until depletion

- Fornibile fino ad esaurimento delle scorte
- Fourni jusqu'à épuisement du stock
- Lieferbar solange vorrat reicht
- Suministrado hasta el stock termina



SUBARU

LEGACY I 1.8i SPi	--	01/89 ⇒	
LEGACY I 1800	EJ185PI	01/89 ⇒	07/94
LEGACY I 1800 4WD	EJ185PI	01/89 ⇒	07/94

KW 922 094



ROTORS

Adatt./Suitable: **HITACHI****BOSCH**
F 005 X04 744
F 005 X04 757**MAZDA**
B3C7-18-V05
FS05-18-V05

FORD AUSTRALIA

TELSTAR 2.0 Efi	FS	10/94 ⇒	11/96
-----------------	----	---------	-------

MAZDA

121 II 1.3 16V	B3(16V)	11/90 ⇒	03/96
121 II 1.3 i 16V	B3(16V)	11/90 ⇒	03/96
626 V 1.8	FP, FP01LP	08/91 ⇒	04/97
626 V 1.8 i	--, FP	08/91 ⇒	06/97
626 V 2.0 i	FS	08/91 ⇒	04/97
626 V 2.0 i 4WD	FS	04/92 ⇒	04/97
MX-6 2.0	FS	02/92 ⇒	02/97

KW 922 095



ROTORS

Adatt./Suitable: **HITACHI****ACURA**
30103-P08-003**BOSCH**
1 987 234 064**HONDA**
30103-P08-003
30103-P72-003**ROVER**
GRA2324
NJE100060

ACURA

INTEGRA II 1.8	F18A2	10/90 ⇒	09/93
INTEGRA III 1.8 GS-R	F18C2	10/93 ⇒	09/01
INTEGRA III 1.8 LS	F18C1	10/93 ⇒	09/01
INTEGRA III 1.8 Sport	F18C1	10/93 ⇒	09/01

HONDA

ACCORD V 1.8 16V	F18A3	01/94 ⇒	12/95
ACCORD V 2.0	F20B3	09/93 ⇒	12/97
ACCORD V 2.0 i	F20Z2	03/93 ⇒	01/96
ACCORD V 2.0 i LS 16V	F20B3	09/93 ⇒	02/98
ACCORD V 2.0 i S	F20Z1	03/93 ⇒	01/96
ACCORD V 2.2 i [USA]	--	01/94 ⇒	12/95
ACCORD V 2.2 i 16V	F22B4	08/95 ⇒	12/97
ACCORD V 2.2 i ES	F22B5	09/93 ⇒	02/98
ACCORD V 2.3 i SR	H23A3	03/93 ⇒	01/96
ACCORD VI 2.2 Type-R	H22A7	02/99 ⇒	12/02
CIVIC V 1.5	D15B7	08/93 ⇒	12/95
CIVIC V 1.5 i 16V	D15B2, D15Z1	10/91 ⇒	11/95
CIVIC V 1.5 i LSi	D15B7	08/93 ⇒	11/95
CIVIC V 1.6 16V Vtec	D16Z6, D16Z7	10/91 ⇒	11/95
CIVIC V 1.6 4x4	D16Z7	01/92 ⇒	10/95
CIVIC V 1.6 EX	D16A7	08/93 ⇒	10/95
CIVIC V 1.6 i	D16Y7	01/94 ⇒	11/95
CIVIC V 1.6 i Vtec	B16A2, D16Z9	01/94 ⇒	03/96
CIVIC V 1.6 VTi	B16A2	10/91 ⇒	11/95
CIVIC V 1.6 VTi 16V	B16A2	10/91 ⇒	11/95
BALLADE 1.6i	B16A6	01/97 ⇒	02/01
BALLADE 1.8 i	B18B4	01/96 ⇒	02/01
CIVIC IV 1.6i	--	01/90 ⇒	12/91
CIVIC VI 1.4 i	D14A2, D14A5, D14Z2	06/95 ⇒	02/01

HONDA

CIVIC VI 1.4 i S	D14Z2	11/95 ⇒	02/01
CIVIC VI 1.4i 16V	D14Z1	11/98 ⇒	03/01
CIVIC VI 1.5 i	D15Z6	11/95 ⇒	02/01
CIVIC VI 1.5 i Vtec-E	D15Z3	09/94 ⇒	01/97
CIVIC VI 1.6	--	05/96 ⇒	04/99
CIVIC VI 1.6 i	D16Y3	09/94 ⇒	03/00
CIVIC VI 1.6 i Vtec	B16A2, D16Y2, D16Y8	09/94 ⇒	02/01
CIVIC VI 1.6 VTi	B16A2	11/95 ⇒	02/01
CIVIC VI 1.6i 16V	D16Y7	01/96 ⇒	
CIVIC VI 1.6i 16V Vtec	D16Y8	01/96 ⇒	09/99
CR-V I 2.0	B20Z1	04/99 ⇒	02/02
CR-V I 2.0 16V 4WD	B20B, B20Z1	10/95 ⇒	02/02
CR-V I 2.0 i 16V	B20B3, B20B4, B20B9, B20Z3	02/97 ⇒	04/99
CRX III 1.6 ESi	D16Y8, D16Z6	03/92 ⇒	12/98
CRX III 1.6 i VTi	B16A2	03/92 ⇒	12/98
HR-V 1.6 16V	350Y	03/99 ⇒	
HR-V 1.6 16V 4WD	350Y, D16W5	03/99 ⇒	
HR-V 1.6i 16V	D16W2	04/99 ⇒	
INTEGRA 1.8 i	B18B1	01/98 ⇒	
LOGO 1.3	D13B7	03/99 ⇒	03/02
PRELUDE IV 2.0 i 16V	F20A4	02/92 ⇒	09/96
PRELUDE IV 2.2 i 16V Vtec	H22A2	02/93 ⇒	09/96
PRELUDE IV 2.3 i 16V	H23A2	02/92 ⇒	09/96
PRELUDE V 2.0 16V	F20A4	10/96 ⇒	10/00
PRELUDE V 2.2 16V	H22A5	10/96 ⇒	10/00
PRELUDE V 2.2 i 16V	F22A2	10/96 ⇒	10/01
PRELUDE V 2.2 i 16V VTi-R	H22A4, H22A8, H22Z1	10/96 ⇒	12/98
PRELUDE V 2.2 Si	F22Z6	03/97 ⇒	07/02
SHUTTLE 2.2 16V	F22B8	10/94 ⇒	02/98

ROVER

400 II 416 Si	D16Y2	03/95 ⇒	03/00
600 618 i/Si	F18A3	03/96 ⇒	02/99
600 620 i	F20Z2	08/93 ⇒	06/96
600 620 Si	F20Z1	08/93 ⇒	02/99
600 623 Si	H23A3	08/93 ⇒	06/99

KW 922 097R



ROTORS

Adatt./Suitable: **HITACHI****ACURA**
30103-PW0-G02**HONDA**
30103-PW0-G02
30103-PW0-G03⁰⁰ Eliminated on 22-02-2022. Please verify the availability through our local distributors

- Eliminato il 22-02-2022. Verificare la disponibilità presso i nostri distributori
- Éliminé le 22-02-2022. Vérifier la disponibilité auprès de nos distributeurs sur place
- Am 22-02-2022 gestrichen. Evtl. Verfügbarkeit bitte bei unseren Händlern prüfen
- Eliminado en fecha 22-02-2022. Verificar la disponibilidad a través de nuestros distribuidores locales

²¹² Resistance Rotor [Ohm] 25

- Rotore resistenza [Ohm] 25
- Résistance rotor [ohm] 25
- Widerstand-Rotor [Ohm] 25
- Resistencia rotor [ohm] 25



ACURA

INTEGRA II 1.8	F18A2	10/90 ⇒	09/93
INTEGRA III 1.8 LS	F18C1	10/93 ⇒	09/01
INTEGRA III 1.8 Sport	F18C1	10/93 ⇒	09/01

HONDA

CIVIC IV 1.6i	--	01/90 ⇒	12/91
---------------	----	---------	-------

KW 922 098



ROTORS

Adatt./Suitable: **HITACHI**

HONDA

30103-P0A-A01
30103-PA-A-A01
30103-PDA-E01

ISUZU

5-86202573-0

ROVER

GRA2327
NUJ100030

HONDA			
ACCORD V 1.9 i	F18A3	02/96 →	10/98
ACCORD V 2.0 i LS	F20Z1	02/96 →	10/98
ACCORD V 2.2	F22B1, F22Z2	10/93 →	12/97
ACCORD V 2.2 16V	F22Z1	01/96 →	09/98
ACCORD V 2.2 i [USA]	--	01/94 →	12/95
ACCORD V 2.2 i VTEC	F22Z2	02/96 →	10/98
ACCORD VI 1.8 16V Vtec	3B630WM, F18B3	04/99 →	
ACCORD VI 1.8 i	3B630WM	10/98 →	12/02
ACCORD VI 1.8 i 16V Vtec	F18B4	11/98 →	12/99
ACCORD VI 2.0	F20B6	11/99 →	12/02
ACCORD VI 2.0 16V Vtec	F20B6	04/99 →	
ACCORD VI 2.0 i	F20B6	10/98 →	01/01
ACCORD VI 2.0 i 16V	F20B5, F20B7	02/98 →	06/03
ACCORD VI 2.3	F23Z5	11/00 →	06/03
ACCORD VI 2.3 i 16V Vtec	F23Z5	11/00 →	
ACCORD VI 2.3 VTi	F23A3	02/98 →	10/02
CIVIC VI 1.4 i	D14A2, D14A5	06/95 →	02/01
CIVIC VI 1.4i 16V	D14Z3, D14Z4	11/98 →	12/00
CIVIC VI 1.4i 16V Vtec	D14Z4	01/99 →	
CIVIC VI 1.5 16V	D15Z8	01/97 →	02/01
CIVIC VI 1.6	D16W4	11/98 →	03/01
CIVIC VI 1.6 i	D16Y3	09/94 →	02/01
CIVIC VI 1.6 i Vtec	D16Y6	11/95 →	02/01
CIVIC VI 1.6i 16V	D16W3	11/98 →	12/00
CIVIC V 1.6 i Vtec	D16Y6	01/94 →	03/96
ODYSSEY 2.2	F22B6	01/95 →	12/97
ODYSSEY 2.3	F23A	10/97 →	09/03
ODYSSEY 2.3 4x4	F23A	10/97 →	09/03
ODYSSEY 2.3 i 16V Vtec	F23A8	01/98 →	
SHUTTLE 2.3 16V	F23A7, F23A8	10/97 →	06/04
ROVER			
400 II 416 Si	D16Y2	03/95 →	03/00
600 618 i/Si	F18A3	03/96 →	02/99
600 620 i	F20Z2	08/93 →	06/96
600 620 Si	F20Z1	08/93 →	02/99

KW 922 102



ROTORS

Adatt./Suitable: **HITACHI**

FORD

1 960 491 *C

FORD AUSTRALIA

F S90-18-V05

HONDA

30103-P2A-J01

MAZDA

F590-18-V05

NISSAN

22157-4B000

22157-72B00

ROVER

NJE100100

*C Available rotor only-not, the distributor assy

- Fornito solo distributore rotante, non lo spinterogeno completo
- Disponible seulement le rotor, non pas l'allumeur complet
- Erhältlich nur rotor, nicht der komplette verteiler
- Disponible solo el rotor, no el distribuidor completo



FORD			
MAVERICK 2.4 i	KA24	09/96 →	04/98
FORD AUSTRALIA			
TELSTAR 2.0 EFI	FS	10/94 →	11/96
HONDA			
BALLADE 1.5	D15Z4	01/97 →	
BALLADE 1.6i	D16Y9	01/96 →	02/01
CIVIC VI 1.4	D14A4	11/95 →	10/98
CIVIC VI 1.4 16V	D14A7, D14A8	01/97 →	02/01
CIVIC VI 1.4 i	D14A3, D14A4, D14A8, D14Z1	06/95 →	02/01
CIVIC VI 1.4 i S	D14A4	11/95 →	02/01
CIVIC VI 1.4i	D14A6	01/99 →	
CIVIC VI 1.6 16V	D16B2	01/97 →	02/01
MAZDA			
626 V 1.8	FP, FP01LP	08/91 →	04/97
626 V 1.8 i	--, FP	08/91 →	06/97
626 V 2.0 i	FS	08/91 →	04/97
626 V 2.0 i 4WD	FS	04/92 →	04/97
MX-6 2.0	FS	02/92 →	02/97
NISSAN			
ALMERA I 1.4	GA14DE	09/95 →	07/00
ALMERA I 1.4 GX, LX	GA14DE	09/95 →	07/00
ALMERA I 1.4 S, GX, LX	GA14DE	09/95 →	03/00
ALMERA I 1.6	GA16DE	07/95 →	07/00
ALMERA I 1.6 SLX	GA16DE	09/95 →	07/00
ALMERA I 1.6 SR, SLX	GA16DE	09/95 →	03/00
MICRA II 1.0 i 16V	CG10DE	08/92 →	07/00
MICRA II 1.3 i 16V	CG13DE	08/92 →	09/00
TERRANO II 2.4 4WD	KA24E	05/96 →	09/07
TERRANO II 2.4 i 12V 4WD	KA24E	02/93 →	12/97
ROVER			
400 II 416 Si	D16Y2	03/95 →	03/00

KW 928 006



ROTORS

Adatt./Suitable: **LUCAS**

FIAT

31322322

631322322

GENERAL MOTORS

7 992 214

LAND ROVER

RTC3612

Motorcraft

ADR 71

EDR 2

EDR 2 D



AUSTIN			
1000-SERIES 1100	--	01/70 →	12/74
1000-SERIES 1300	--	01/70 →	12/74

AUSTIN			
1000-SERIES 1300 GT	--	01/70 →	12/74
ALLEGRO 1.1	10H	05/73 →	10/81
ALLEGRO 1.3	12H	05/73 →	03/82
ALLEGRO 1.5 Super	14H	05/73 →	03/82
APACHE 1300	--	11/71 →	10/74
APACHE 1300 TC	--	11/71 →	10/74
MAXI 1500	--, 14H	04/69 →	07/80
MAXI 1750	17H	04/69 →	10/80
MAXI 1750 HL	--, 17LA	10/72 →	10/80
MINI 1.3	12HC	09/69 →	09/80
MINI 1000	--, 99H	10/67 →	09/84
MINI 1275 GT	12H	10/69 →	08/80
MINI 850	--	01/60 →	12/69
MINI I 1.0	--	09/62 →	08/69
MINI I 1.1	--	11/62 →	08/64
MINI I 1.3	--	09/62 →	08/69
MINI I 850	781Y	06/59 →	08/69
MINI I Cooper	99H	01/61 →	12/67
MINI I Cooper S	--	09/62 →	12/71

AUSTIN-HEALEY			
SPRITE MK.III 1.1	--	03/64 →	09/66
SPRITE 1.3	--, 12CC	03/66 →	10/71

BOND			
EQUIPE 1300 GT	--	01/67 →	12/70

FORD			
CORSAIR 1.5	EV15LN, EV15N	10/63 →	09/65
CORSAIR 1.5 GT	EV15LH	10/63 →	09/65
CORTINA 1200	--	10/62 →	09/66
CORTINA 1500	--	10/62 →	09/66
CORTINA 1500 GT	--	10/62 →	09/66
CORTINA GT	--	10/62 →	09/66
CORTINA Lotus	--	10/62 →	09/70
CORTINA Lotus Spezial	--	10/62 →	09/66
ESCORT I RS 1600	--, BDA	01/70 →	10/74
ESCORT I Twin Cam	K5	03/68 →	08/71
ESCORT II 1.6 RS	LC	12/74 →	08/80
ESCORT II 1.8	--	12/74 →	08/80
ESCORT II RS 1800	KL18S	03/75 →	08/77
ZEPHYR 1.7	--, EL17L	03/62 →	03/68

GINETTA			
G15 0.9	--	01/67 →	12/75

JENSEN			
GT 2.0	--	06/75 →	12/76
HEALEY 2.0	--	01/72 →	12/75

LAND ROVER			
88/109 2.3 4x4	10H, 11H	09/61 →	12/86

MG			
1300 MK.II 1300	--	09/67 →	09/70
MAGNETTE 1.5	--	01/53 →	04/58
MAGNETTE 1.6	--	03/61 →	09/68
MGA 1.5	--	05/55 →	04/60
MGA 1.6	--	01/58 →	07/62
MGB 1.8	--	05/62 →	12/80
MGB GT 1.8	--, 18G	07/65 →	11/80
MGY 1.3	--	01/50 →	12/51
MIDGET 1.1	--	01/64 →	12/66
MIDGET 1.3	--	01/67 →	09/74

MORRIS			
MARINA 1.8	--	04/71 →	12/79
MARINA 1.8 TC	--	04/71 →	09/75
MARINA 1300	--	04/71 →	06/80
MARINA 1800	--	04/71 →	12/75
MARINA 1800 TC	--	04/71 →	12/75
MINOR 0.9	--	11/55 →	12/62
MINOR 1.1	--	01/62 →	10/71
OXFORD 1.5	--	11/59 →	09/62
OXFORD 1.7	--	05/62 →	04/70

RELIANT			
REBEL 700	--	01/68 →	08/71
REBEL 750	--	08/71 →	12/73
ROBIN 850	--	11/73 →	10/02

RILEY			
4/72 1.7	--	03/61 →	10/68
ELF 1.0	--	03/63 →	10/68
KESTREL 1100	--, 10H	03/65 →	04/67
KESTREL 1300	12H	03/67 →	12/69

ROVER			
A60 CAMBRIDGE 1.7	--	01/62 →	10/69

TALBOT			
AVENGER 1.3	--	02/70 →	07/81
AVENGER 1.6	--	02/70 →	07/81

TRIUMPH			
1300 1.3	--	01/65 →	12/70
1300 1.3 TC	--, GE1EH	01/67 →	12/70
1500 1.5	--, 1EH, 1EL	10/70 →	12/74
HERALD 1200	--, AJM	01/61 →	12/69
HERALD 13/60	--	01/67 →	12/71
TOLEDO 1300	--	10/70 →	12/77

TRIUMPH		
TOLEDO 1500	--	10/70 ⇒ 12/77
TOLEDO 1500 TC	--	01/71 ⇒ 12/77
TR 2 2.0	--, HCL	01/53 ⇒ 12/55
TR 3 2.0	--, HCL	12/55 ⇒ 12/57
TR 4 2.0	--	01/61 ⇒ 12/65
TR 3A 2.0	--	12/57 ⇒ 12/61
TR 3A 2.2	--, HE0H	01/59 ⇒ 12/61
TR 4A 2.2	--, HE0H	12/65 ⇒ 12/67
TVR		
VIXEN 1800	--	01/68 ⇒ 12/68
WOLSELEY		
16/60 1.6	--	01/61 ⇒ 12/71
18/85 1.8	--, 18HL	08/69 ⇒ 12/72
18/85 1.8 S	--, 18HH	01/70 ⇒ 12/72
1300 1.3	--, 12H	01/68 ⇒ 10/71
1300 1.3 TC	--, 12H	10/71 ⇒ 10/73
HORNET 1.0	--, 99LFD	01/61 ⇒ 12/70

TRIUMPH		
2000 2.0	--, 20TC	01/68 ⇒ 12/75
2000 2.0 TC	--	03/72 ⇒ 12/75
TR 5 2.5 PI	--	01/67 ⇒ 12/68
TR 6 2.5	--, CF1, CR1H	03/69 ⇒ 12/76
TR 6 2.5 PI	--	01/69 ⇒ 12/76
VITESSE 1.6	--	01/62 ⇒ 12/67
VITESSE 2.0	--, HB1HE, HB1LE	12/65 ⇒ 12/71
TVR		
2500 2.5	--, CF1	01/72 ⇒ 12/77
WOLSELEY		
SIX 2.2	--	01/72 ⇒ 10/75



ROTORS

Adatt./Suitable: LUCAS

LAND ROVER
RTC3618⁰³ Supplied until depletion

- Fornibile fino ad esaurimento delle scorte
- Fourni jusqu'à épuisement du stock
- Lieferbar solange vorrat reicht
- Suministrado hasta el stock termina



LAND ROVER

DEFENDER 3.5 4x4

15G, 21G, 22D

09/90 ⇒ 12/98



ROTORS

Adatt./Suitable: LUCAS

BOSCH

F 005 X04 636

LAND ROVER

RTC3199

RTC6629

STC1857



LAND ROVER

DEFENDER 3.5 4x4

15G, 21G, 22D

09/90 ⇒ 12/98

DISCOVERY I 3.5

--

09/89 ⇒ 06/94

DISCOVERY I 3.5 4x4

22D

06/89 ⇒ 06/94

DISCOVERY I 4.0 4x4

35D, 36D

09/93 ⇒ 10/98

RANGE ROVER I 3.5 4x4

31D

01/87 ⇒ 09/90

RANGE ROVER I 3.5 Vogue

24D, 25D

10/85 ⇒ 09/90

4x4

RANGE ROVER I 3.9 4x4

35D

11/88 ⇒ 12/92

RANGE ROVER I 3.9 Cat 4x4

37D, 38D

11/88 ⇒ 07/94

RANGE ROVER I 3.9 Vogue

35D, 36D

11/88 ⇒ 07/94

SEI 4x4

RANGE ROVER I 4.3 Vogue

40D

09/92 ⇒ 07/94

LSE 4x4



ROTORS

Adatt./Suitable: LUCAS

FORD

EOTT-A1220-0A

EOTT-A1220-0B

EOTT-A1220-0C

GENERAL MOTORS

7 992 216

LAND ROVER

262704

Motorcraft

ADR 76

VAUXHALL

7079424

7101586



ROTORS

Adatt./Suitable: LUCAS

BOSCH

1 234 332 848

FIAT

59321324

659321324

GENERAL MOTORS

7 992 996

INNOCENTI

659321324

JAGUAR

AEU 1501

JLM 9623

LAND ROVER

RTC3339

RTC3614

LEYLAND

GRA114

RENAULT

77 01 025 237

ROVER

GRA114

TALBOT

7506 37 64



INNOCENTI

MINI 120

--

01/75 ⇒ 12/83

JAGUAR

XJ 4.2i Series 3

--

01/86 ⇒ 12/94

LAND ROVER

90 2.5 4x4

17H

09/85 ⇒ 08/90

110/127 2.5 4x4

17H

10/85 ⇒ 07/90

DEFENDER 2.25

--

01/87 ⇒

DEFENDER 2.5 90, 110

--

08/90 ⇒ 09/01

ROVER

MINI 1.0

--

01/85 ⇒



ROTORS

Adatt./Suitable: LUCAS

FORD

A790-X12200-RA

⁰³ Supplied until depletion

• Fornibile fino ad esaurimento delle scorte

• Fourni jusqu'à épuisement du stock

• Lieferbar solange vorrat reicht

• Suministrado hasta el stock termina

LAND ROVER

RTC3613

Motorcraft

EDR 92



ASTON MARTIN		
DB6 4.0	--, AJ6	10/64 ⇒ 12/70
DBS 4.0	--, AJ6	01/66 ⇒ 12/72
AUSTIN-HEALEY		
3000 3.0 Sport	--	03/64 ⇒ 10/68
BOND		
EQUIPE 2.0 GT	--	01/68 ⇒ 12/71
DAIMLER		
2.8 - 5.3 Sovereign 2.8	--	10/69 ⇒ 05/75
2.8 - 5.3 Sovereign 4.2	--	10/69 ⇒ 03/79
FORD		
ZEPHYR 2.0	EV20A, EV20B	03/68 ⇒ 10/72
ZEPHYR 2.5	EL25L, EL25, EV25B, EV25L	03/62 ⇒ 10/72
ZEPHYR 3.0	EV30A, EV30B	03/68 ⇒ 10/72
ZODIAK 2.5	EL25HV, EL25LV	03/62 ⇒ 10/72
JAGUAR		
E-TYPE 3.8	--	04/61 ⇒ 07/64
E-TYPE 4.2	--, 8L(85-87), XK4.2(82-87)	05/64 ⇒ 04/75
E-TYPE 2+2 4.2	7L, 8LC	06/66 ⇒ 04/75
I 2.4	--	09/55 ⇒ 09/59
I 3.4	--	09/55 ⇒ 09/59
II 240	--	09/59 ⇒ 10/69
II 3.8 S	--	09/59 ⇒ 09/66
II 340	--	09/55 ⇒ 10/70
IX 3.8	--	10/58 ⇒ 07/61
X 3.4	--	10/61 ⇒ 10/64
X 4.2	--	09/61 ⇒ 07/68
X 420	--	09/67 ⇒ 10/69
X 420G	--	09/66 ⇒ 10/70
S-TYPE 3.4	--	05/63 ⇒ 08/68
S-TYPE 3.8	--	05/63 ⇒ 08/68
XJ 2.8	--	10/68 ⇒ 10/73
XJ 6 2.8	--	09/68 ⇒ 10/75
XJ 6 4.2	XK4.2(-79)	10/69 ⇒ 05/75
XK 120	--	01/50 ⇒ 10/54
XK 150	--	09/57 ⇒ 10/60
XK 150 S	--	09/57 ⇒ 10/60
MG		
MGC 3.0	--	01/67 ⇒ 09/69
MGC GT 3.0	--	01/67 ⇒ 09/69
TRIUMPH		
2.5 PI 2.5	--, 25PI	01/68 ⇒ 12/75

KW 928 024R



ROTORS

Adatt./Suitable: LUCAS

ROVER

AUU1690
GRA138
GRA2138
GRA2274

⁰³ Supplied until depletion

- Fornibile fino ad esaurimento delle scorte
- Fourni jusqu'à épuisement du stock
- Lieferbar solange vorrat reicht
- Suministrado hasta el stock termina

²¹² Resistance Rotor [Ohm] 1000

- Rotore resistenza [Ohm] 1000
- Résistance rotor [ohm] 1000
- Widerstand-Rotor [Ohm] 1000
- Resistencia rotor [ohm] 1000



AUSTIN

MONTEGO 1.6 LS	16HC37	10/84 ⇒ 08/88
MONTEGO 1.6 LS, HL	16HC37	04/84 ⇒ 08/88
MONTEGO 2.0	20HSC	04/84 ⇒ 08/88
MONTEGO 2.0 Turbo	20HC85	04/84 ⇒ 08/88

ROVER

200 II 220 GTi	20M4F	09/91 ⇒ 10/95
800 820	--	10/88 ⇒ 10/91
800 820 i/Si	20HD	10/88 ⇒ 12/91
800 820 Si	20HDM16	10/88 ⇒ 12/91
400 I 420 16V	--	01/91 ⇒ 12/92
400 I 420 GTi/GSi/Vitesse	20M4F	02/92 ⇒ 04/95
MAESTRO 1.6	20MH	09/90 ⇒ 01/95
MAESTRO 2.0	--	01/86 ⇒
MONTEGO 2.0 GTi	20H	02/85 ⇒ 10/91

KW 928 025



ROTORS

Adatt./Suitable: LUCAS

ROVER

GRA143
GRA2143

⁰³ Supplied until depletion

- Fornibile fino ad esaurimento delle scorte
- Fourni jusqu'à épuisement du stock
- Lieferbar solange vorrat reicht
- Suministrado hasta el stock termina



AUSTIN

MONTEGO 1.3	--, 12HL	10/84 ⇒ 08/88
-------------	----------	---------------

ROVER

100 / METRO 111 C/L/S	11K2A	03/90 ⇒ 12/98
100 / METRO 114 S/L/GTA	14K2A	03/90 ⇒ 12/98
100 114	14K2A	04/94 ⇒ 10/97
MAESTRO 1.3	12HE	09/90 ⇒ 01/95
MINI 1.3 Cooper	--	01/85 ⇒
MINI 1.3i Cooper	--	01/85 ⇒
MINI 1.3i Turbo	--	01/85 ⇒
MINI 1300	12A2A, 12A2B, 12A2D, 12A2E, 12A2L	01/91 ⇒ 04/95
MONTEGO 1.3	12HL	10/84 ⇒ 10/88

KW 928 026R



ROTORS

Adatt./Suitable: LUCAS

FORD

1 655 993
6 153 387
6 182 581
845F-12200-CA

Motorcraft

EDR 159
EDR 249

²¹² Resistance Rotor [Ohm] 1000

- Rotore resistenza [Ohm] 1000
- Résistance rotor [ohm] 1000
- Widerstand-Rotor [Ohm] 1000
- Resistencia rotor [ohm] 1000



FORD

ESCORT IV 1.4	F6D, FUA, FUC	01/86 ⇒ 07/90
FIESTA II 1.6 XR2	LUB, LUD	03/84 ⇒ 02/89
FIESTA III 1.4	F6E	03/89 ⇒ 12/95
ESCORT III 1.4 i	F6D, FUC	02/86 ⇒ 07/90
ORION I 1.4	FUA, FUC	12/85 ⇒ 07/90
ORION I 1.4 Cat	F6D	02/87 ⇒ 07/90

ROVER

2000-3500 2000	--	10/82 ⇒ 10/86
----------------	----	---------------

KW 928 027R



ROTORS

Adatt./Suitable: LUCAS

JAGUAR

JLM 381

²¹² Resistance Rotor [Ohm] 1000

- Rotore resistenza [Ohm] 1000
- Résistance rotor [ohm] 1000
- Widerstand-Rotor [Ohm] 1000
- Resistencia rotor [ohm] 1000

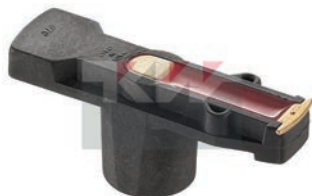

JAGUAR

XJ 3.6	9DPALA, 9DPANA	10/86 ⇒ 05/91
XJ 4.0	9EPCNA, 9LPFRB	10/89 ⇒ 03/96
XJ 6 3.2 24V	9BPMNA	09/90 ⇒ 11/94
XJ 6 3.6	9DPANA, AJ6(3.6, 156KW)	10/86 ⇒ 08/89
XJ 6 4.0	9EPCNA	09/89 ⇒ 11/94
XJSC 3.6	9DPALA, 9DPANA	08/87 ⇒ 05/91
XJSC 4.0	9EPCNA, 9LPFRB	05/91 ⇒ 03/96

KW 928 028R



ROTORS

Adatt./Suitable: LUCAS

BOSCH

F 005 X04 676

GENERAL MOTORS

90 349 877

HOLDEN

90349877

OPEL

12 12 200

²¹² Resistance Rotor [Ohm] 5000

- Rotore resistenza [Ohm] 5000
- Résistance rotor [ohm] 5000
- Widerstand-Rotor [Ohm] 5000
- Resistencia rotor [ohm] 5000



HOLDEN

BARINA 1.4 i	C14NZ	04/94 ⇒ 07/97
BARINA_SB 1.2i	C12NZ	04/94 ⇒ 07/97
COMBO 1.4 i	C14NZ	03/96 ⇒ 07/97
COMBO_SB 1.4i	C14NZ	04/94 ⇒ 07/97

OPEL

ASTRA F 1.4	14SE	09/92 ⇒ 09/98
ASTRA F 1.4 i	C14NZ	09/91 ⇒ 01/05
ASTRA F 1.4 Si	C14SE	03/92 ⇒ 03/01
COMBO B 1.2	C12NZ	07/94 ⇒ 10/01
COMBO B 1.4	C14NZ	07/94 ⇒ 10/01
CORSA A 1.2 i	C12NZ	09/89 ⇒ 03/93
CORSA A 1.4 Si	C14SE	09/91 ⇒ 03/93
CORSA A 1.6 GSI	E16SE	05/88 ⇒ 03/92
CORSA B 1.2 i	12NZ, C12NZ	03/93 ⇒ 09/00
CORSA B 1.4 i	C14NZ	03/93 ⇒ 09/00
KADETT E 1.4 i	C14NZ	01/90 ⇒ 07/94
KADETT E 1.6	16SV	09/86 ⇒ 12/91
KADETT E 1.6 i	16SV	07/89 ⇒ 02/93
KADETT E 1.6 S	16SV	09/86 ⇒ 08/91
VECTRA A 1.6	16SV	09/88 ⇒ 05/93
VECTRA A 1.6 S	16SV	09/88 ⇒ 05/93

VAUXHALL

ASTRA III 1.4 i	C14NZ, C14SE	03/91 ⇒ 09/98
ASTRAVAN I 1.4 i	C14NZ	09/91 ⇒ 08/95
COMBO B 1.2	C12NZ	07/94 ⇒ 10/01
COMBO B 1.4	C14NZ	07/94 ⇒ 10/01
CORSA B 1.2 i	C12NZ	03/93 ⇒ 09/00
CORSA B 1.4 i	C14NZ	03/93 ⇒ 09/00
CORSAVAN I 1.4 i	C14NZ	01/94 ⇒ 09/00

KW 928 029R



ROTORS

Adatt./Suitable: LUCAS

BOSCH

F 005 X04 678

LAND ROVER

NJE10003

ROVER

AUU1641
GRA2285
GRA2310
NJE100070

²¹² Resistance Rotor [Ohm] 1000

- Rotore resistenza [Ohm] 1000
- Résistance rotor [ohm] 1000
- Widerstand-Rotor [Ohm] 1000
- Resistencia rotor [ohm] 1000



LAND ROVER

FREELANDER 1.8 16V 4x4	18K4F	04/98 ⇒ 10/06
FREELANDER 1.8 i 16V 4x4	18K4F	02/98 ⇒ 10/06

MG

MGF 1.8 i 16V	18K4F	03/95 ⇒ 03/02
MG TF 115	16K4F	03/02 ⇒ 12/09
MG TF 120	18K4F	03/02 ⇒ 12/09
MG TF 135	18K4F	03/02 ⇒ 12/09
MG ZR 105	14K4F	06/01 ⇒ 04/05

MG		
MG ZR 120	18K4F	06/01 ⇒ 04/05
ROVER		
25 1.4 16V	14K4F, 14K4M	10/99 ⇒ 05/05
25 1.6 16V	16K4F	10/99 ⇒ 05/05
25 1.8 16V	18K4F	10/99 ⇒ 05/05
100 / METRO 111 C/L/S	11K2D	03/90 ⇒ 12/98
100 / METRO 114 GSi	14K4F	10/94 ⇒ 10/95
100 / METRO 114 GTI 16V	14K4C, 14K4D, 14K4F	03/90 ⇒ 12/98
100 / METRO 114 GTI/GT 16V Cat	14K4C, 14K4D	03/90 ⇒ 12/98
100 / METRO 114 S/L/GTA	14K2D	03/90 ⇒ 12/98
100 111	11K2D	04/94 ⇒ 10/97
100 114	14K2D	04/94 ⇒ 10/97
200 II 214	14K2A, 14K2D	09/93 ⇒ 12/95
200 II 214 1.4	14K4C, 14K4D	01/92 ⇒ 11/99
200 II 214 1.4i 16V	14K4F	01/93 ⇒ 11/99
200 II 214 GSi/Si	14K4C, 14K4F	01/90 ⇒ 10/95
200 II 214 Si/Gsi	14K4C, 14K4D	10/89 ⇒ 10/95
200 II 216	16K4F	01/96 ⇒ 12/97
200 II 216 1.6i 16V	16K4F	01/96 ⇒ 11/99
200 II 220 16V	--	01/92 ⇒ 12/95
200 II 220 GSi	1CA4GA15-01	05/94 ⇒ 06/99
200 II 220 GTi	1CA4GA15-01, 20M4F	09/91 ⇒ 10/95
200 II 220 Turbo	20T4G	10/92 ⇒ 06/99
200 III 211	11K2D	01/98 ⇒ 03/00
200 III 214 i	14K2F	11/95 ⇒ 03/00
200 III 214 Si	14K4F	11/95 ⇒ 03/00
200 III 216 Si	16K4F	11/95 ⇒ 06/99
400 II 414 Si	14K4F	05/95 ⇒ 03/00
400 II 416 Si	16K4F, D16Y2	03/95 ⇒ 03/00
600 620 Ti Vitesse	20T4G	05/94 ⇒ 08/98
800 820 16V Turbo	T16	11/91 ⇒ 02/99
800 820 I/Si	1CA4GA15-01	01/91 ⇒ 02/99
800 820 Sport	20T4G	04/94 ⇒ 03/96
400 I 1.6 i	16K4F, D16A8	05/94 ⇒ 11/98
400 I 414	14K4C	01/93 ⇒ 04/95
400 I 414 GSi/Si	14K4C, 14K4D	04/90 ⇒ 04/95
400 I 414 GSi/Si Cat	14K4F	10/92 ⇒ 04/95
400 I 420 GSi/SLI/GTI/Vite	1CA4GA15-01	01/93 ⇒ 04/95
400 I 420 GTI/GSi/Vitesse	20M4F	02/92 ⇒ 04/95
400 I 420 Turbo	20T4G	01/93 ⇒ 04/95
COUPE 1.6 16V	16K4F	03/96 ⇒ 11/99

KW 928 030



ROTORS

Adatt./Suitable: LUCAS

NISSAN

22157-73C00
22157-99B01
22157-99B03



NISSAN

MICRA II 1.0 i 16V	CG10DE	08/92 ⇒ 07/00
MICRA II 1.3 i 16V	CG13DE	08/92 ⇒ 09/00
PRIMERA II 1.6 16V	GA16DE	09/96 ⇒ 07/02

KW 930 029



ROTORS

Adatt./Suitable: MARELLI

FEMSA

4765
8415

FIAT

9902725
9908418
9909418
9911960

GENERAL MOTORS

7 992 296
7 992 896

MAGNETI MARELLI

070189501010
701 895 01
S 57/45

SEAT

008415.06



FIAT

500 0.5	110F.000, 120.000	01/60 ⇒ 12/75
500 0.6	111A000	08/68 ⇒ 01/76
600 0.6	--	03/55 ⇒ 05/61

KW 930 036R



ROTORS

Adatt./Suitable: MARELLI

FIAT

4210514
9808037
9919627
9920580
9922446
9934741

GENERAL MOTORS

7 992 304
93 150 396

MAGNETI MARELLI

710 615 01
711 195 01
711 195 02
711 195 04
711 299 01
711 424 01

ZASTAVA

1335055



FIAT

128 1.1	128A.000	03/69 ⇒ 12/84
X 1/9 1.3	128AS.000	10/75 ⇒ 06/78

ZASTAVA

101 1.1	128A.000, 128A.064	05/75 ⇒ 12/93
101 1.1 Super	128AC5.000	07/79 ⇒ 09/81
YUGO 0.9	9A	04/80 ⇒ 06/92

KW 930 037



ROTORS

Adatt./Suitable: MARELLI

BOSCH

1 234 332 808
1 234 332 810
1 234 332 812

FIAT

9913856
9915910
9919348
9921508
9923115
9924654

GENERAL MOTORS

7 992 299
7 992 300
7 992 632

MAGNETI MARELLI

710 640 01
710 640 02
711 214 01
711 323 01

SEAT

121334.06
NG1 323 013 1

⁰³ Supplied until depletion

- Fornibile fino ad esaurimento delle scorte
- Fourni jusqu'à épuisement du stock
- Lieferbar solange vorrat reicht
- Suministrado hasta el stock termina



FIAT

125 1.6	125A.000	07/67 ⇒ 03/74
131 1.3 Mirafiori	131A6.000	10/74 ⇒ 09/81
131 1.3 Super Mirafiori	131B.000	03/78 ⇒ 12/80
131 1.4 Mirafiori	131C.000, 131C1.000	11/80 ⇒ 01/84
131 1.6	131A1.000	10/74 ⇒ 09/81
131 1.6 Super	131C3.000	03/78 ⇒ 01/84
131 2.0 Super	131C4.000	01/81 ⇒ 12/84
850 0.8	100G.000, 100G.002	07/64 ⇒ 10/72
850 0.8 Special	100GB.000	03/68 ⇒ 10/72
850 0.9 Sport	--, 100GL.040	02/68 ⇒ 12/72

SEAT

IBIZA I 0.9	09NCA, 146A000	08/90 ⇒ 05/93
MARBELLA 0.9	09NCA, 100GL7000	01/87 ⇒ 12/93

KW 930 037R



ROTORS

Adatt./Suitable: MARELLI

FIAT

4157304
82301158
82345471
9913857
9916593
9917213
9921476
9934726
9934727
9937729

GENERAL MOTORS

7 992 633

MAGNETI MARELLI

710 861 01
710 930 01
710 930 02
711 215 01
711 215 02
711 539 01

SEAT

NGO 930 023 1
NG1 215 023 1
NG1 539 013 1

²¹² Resistance Rotor [Ohm] 5000

- Rotore resistenza [Ohm] 5000
- Résistance rotor [ohm] 5000
- Widerstand-Rotor [Ohm] 5000
- Resistencia rotor [ohm] 5000



FIAT

127 0.9	100GL.000	09/71 ⇒ 12/84
131 1.3 Mirafiori	131A6.000	10/74 ⇒ 09/81
132 1.6	132C.000	05/77 ⇒ 09/82

FIAT		
850 0.8	100G.000	07/64 ⇒ 10/72
ARGENTA 2000	132D1.000	06/78 ⇒ 12/85

KW 930 040 

ROTORS
Adatt./Suitable: **MARELLI**

FIAT
9926748
MAGNETI MARELLI
071171301010
711 713 01



FIAT		
126 600	126A.000	09/72 ⇒ 06/77
FSO		
126P 0.6	--	09/72 ⇒ 07/77

KW 930 041 

ROTORS
Adatt./Suitable: **MARELLI**

FEMSA
2443- 1
22431- 1
24431- 1
FIAT
82309214
9924394
GENERAL MOTORS
93 150 398
MAGNETI MARELLI
703 880 03
SEAT
244311.06

Eliminated on 21-01-2020. Please verify the availability through our local distributors

- Eliminato il 21-01-2020. Verificare la disponibilità presso i nostri distributori
- Éliminé le 21-01-2020. Vérifier la disponibilité auprès de nos distributeurs sur place
- Am 21-01-2020 gestrichen. Evtl. Verfügbarkeit bitte bei unseren Händlern prüfen
- Eliminado en fecha 21-01-2020. Verificar la disponibilidad a través de nuestros distribuidores locales



FIAT		
132 1.6	132C.000	05/77 ⇒ 09/82
ARGENTA 1600	132D.000	04/81 ⇒ 12/85
ARGENTA 1600 i.e	132D.000	04/81 ⇒ 12/85

KW 930 042R 

ROTORS
Adatt./Suitable: **MARELLI**

ALFA ROMEO
116 55 05 011 01/01
60730437
CITROËN
2L 548 622 2Y
95 538 865

- Supplied until depletion**
- Fornibile fino ad esaurimento delle scorte
 - Fourni jusqu'à épuisement du stock
 - Lieferbar solange vorrat reicht
 - Suministrado hasta el stock termina

FIAT
9924187
9928247
9929187

GENERAL MOTORS
93 150 120
93 150 399

MAGNETI MARELLI
711 195 03
711 195 05
711 424 02
712 279 01

SEAT
000 389 806 5
000 993 623 8
NG1 195 053 1
NG1 424 023 1
SE 127914.004A

- 212 Resistance Rotor [Ohm] 5000**
- Rotore resistenza [Ohm] 5000
 - Résistance rotor [ohm] 5000
 - Widerstand-Rotor [Ohm] 5000
 - Resistencia rotor [ohm] 5000

- 218 with resistance**
- con resistenza
 - avec résistance
 - mit Widerstand
 - con resistencia



ALFA ROMEO		
ALFETTA 1.8	AR01608X	07/74 ⇒ 04/82
GIULIETTA I 1.3	AR01644	10/77 ⇒ 06/83
FIAT		
127 0.9	100GL.048	06/71 ⇒ 05/83
127 1.0	127A.000	01/77 ⇒ 12/86
131 1.3 Mirafiori	131A6.000	10/74 ⇒ 09/81
132 1.6	132C.000	05/77 ⇒ 09/82
ARGENTA 1600	132D.000	04/81 ⇒ 12/85
ARGENTA 1600 i.e	132D.000	04/81 ⇒ 12/85
FIORINO I 1.0	127A.000	01/80 ⇒ 12/87
FIORINO I 1050	127A.000	01/80 ⇒ 12/87
FIORINO I 900	100GL.000	10/77 ⇒ 10/86
PANDA I 800	100GL6.000	02/81 ⇒ 12/85
PANDA I 950	A112B1.054	09/82 ⇒ 08/83
PANDA I 950 4x4	A112B1.054	09/83 ⇒ 12/86
SEAT		
FURA 0.9	100GL3000	01/82 ⇒ 06/86
MARBELLA 0.8	5K9K718	08/86 ⇒ 12/93
PANDA 34 850	--	01/80 ⇒ 12/83
PANDA 35 850	--	01/80 ⇒ 12/83

KW 930 047R 

ROTORS
Adatt./Suitable: **MARELLI**

FIAT
82361915
9936023
INNOCENTI
82361915

- 212 Resistance Rotor [Ohm] 5000**
- Rotore resistenza [Ohm] 5000
 - Résistance rotor [ohm] 5000
 - Widerstand-Rotor [Ohm] 5000
 - Resistencia rotor [ohm] 5000

LANCIA
9936023
MAGNETI MARELLI
712 372 01
712 378 01

PEUGEOT
5937 29

RENAULT
77 01 025 241

SEAT
000 389 977 0
SE 141914.004B



FIAT		
CROMA I 2000 CHT	154A1.000, 154C5.000	12/85 ⇒ 09/92
DUNA 60 1.1	146A6.000	01/87 ⇒ 12/91
DUNA 70 1.3	146A5.000	01/87 ⇒ 12/91
ELBA 1.3	146A5.000	04/91 ⇒ 02/95
FIORINO I 1.1 60	146A9.000	11/86 ⇒ 04/88
FIORINO I 1.3	146A5.000	12/87 ⇒ 08/93
FIORINO II 1.3	146A5.000	01/88 ⇒ 12/94
FIORINO II 60 1.1	146A9.000	05/88 ⇒ 12/93
FIORINO II 70 1.3	146A5.000	01/88 ⇒ 12/94
PANDA I 750	141B.000	01/86 ⇒ 01/95
PANDA I 900	100GL3.000	10/80 ⇒ 06/94
PANDA I 900 CL	146A.048	01/86 ⇒ 12/92
REGATA 1.1 60 , 60 L	138B.000	10/83 ⇒ 08/86
REGATA 1.6	--	10/84 ⇒ 06/89
REGATA 70 1.3	138B2.000, 149A3.000	09/83 ⇒ 07/89
REGATA 85 1.5	149A5.000	05/85 ⇒ 12/87
REGATA 85 1.6	149A.000	10/83 ⇒ 06/90
RITMO I 1.1	146A4.048	04/85 ⇒ 12/87
RITMO I 1.3	149A3.000	11/83 ⇒ 08/85
TIPO I 1.4	160A1.000	07/87 ⇒ 12/89
UNO 45 0.9	146A.000, 146A1.000	03/83 ⇒ 07/96
UNO 45 0.9 Trend	146A.048	09/89 ⇒ 09/92
UNO 60 1.1	146A4.048	05/85 ⇒ 02/92
UNO 60 1.1 SX	--	01/83 ⇒ 12/89
UNO CS 1.1	146A6.000	09/87 ⇒ 09/91
FIAT (BR)		
UNO CS 1116	--	01/88 ⇒
INNOCENTI		
ELBA 1.3	146A5.000	08/91 ⇒ 12/96
LANCIA		
DELTA I 1.1	831B8.000	01/86 ⇒ 12/90
DELTA I 1.3	1831B.000, 3831B.000, 831A2.000, 831B.000	09/79 ⇒ 10/92
PRISMA 1.3	831A2.000	01/83 ⇒ 12/89
PRISMA 1.5	831A1.000	01/83 ⇒ 04/86
PEUGEOT		
305 1.5	117(XR55)	05/80 ⇒ 09/82
505 2.0	106E(XN1A)	09/85 ⇒ 09/95
RENAULT		
4 1.1	688712	02/78 ⇒ 06/90
9 1.1	C1E715	09/81 ⇒ 05/87
11 1.1	C1E715, C1E720	03/83 ⇒ 06/86
11 1.7	F2N700	10/83 ⇒ 12/87
14 1.4	150	09/79 ⇒ 06/83
RAPID 1.1	C1E750, C1E760	07/85 ⇒ 04/95
SUPER 5 1.0	C1C700	10/84 ⇒ 10/88
SEAT		
IBIZA I 0.9	146A000	08/86 ⇒ 05/93
IBIZA I 1.2	021A1000	11/84 ⇒ 12/93
MALAGA 1.2	021A1000	05/85 ⇒ 12/93
MALAGA 1.5	021A2000	05/85 ⇒ 12/93
MARBELLA 0.9	09NCA	01/87 ⇒ 12/93
TERRA 0.9	09NCA	02/87 ⇒ 12/96

KW 930 051R



3,5

ROTORS

Adatt./Suitable: MARELLI

ALFA ROMEO

705 390
60749769

MAGNETI MARELLI

711 016 07

00 Eliminated on 22-02-2022. Please verify the availability through our local distributors

- Eliminato il 22-02-2022. Verificare la disponibilità presso i nostri distributori
- Éliminé le 22-02-2022. Vérifier la disponibilité auprès de nos distributeurs sur place
- Am 22-02-2022 gestrichen. Evtl. Verfügbarkeit bitte bei unseren Händlern prüfen
- Eliminado en fecha 22-02-2022. Verificar la disponibilidad a través de nuestros distribuidores locales

212 Resistance Rotor [Ohm] 5000

- Rotore resistenza [Ohm] 5000
- Résistance rotor [ohm] 5000
- Widerstand-Rotor [Ohm] 5000
- Resistencia rotor [ohm] 5000

310 RPM to [1/min] 6800

- N° giri fino a [1/min.] 6800
- Régime mot. jusqu'à [1/min] 6800
- Drehzahl bis [1/min] 6800
- vel. giro hasta [1/min] 6800



ALFA ROMEO

33 I 1.3	AR30168	10/84 ⇨ 12/89
33 I 1.3 i.e.	AR30168	05/83 ⇨ 12/89
33 I 1.5 4x4	AR30508	12/86 ⇨ 03/89
ALFASUD 1.5 ti	AR30128	05/80 ⇨ 06/84

KW 930 054R



3,5

ROTORS

Adatt./Suitable: MARELLI

ABARTH

9937767

ALFA ROMEO

116 58 05 011 00/02
60731801

FIAT

313220203
6313220203
9937767

GENERAL MOTORS

7 992 874

LANCIA

9937767

MAGNETI MARELLI

710 930 03

MASERATI

313220203
6313220203

SEAT

000 389 948 9
3899489**212 Resistance Rotor [Ohm] 5000**

- Rotore resistenza [Ohm] 5000
- Résistance rotor [ohm] 5000
- Widerstand-Rotor [Ohm] 5000
- Resistencia rotor [ohm] 5000



ABARTH

RITMO 125 TC 2.0	138AR1.000	11/81 ⇨ 12/87
------------------	------------	---------------

ALFA ROMEO

75 1.8	AR06202	09/85 ⇨ 06/89
90 1.8	AR06202	10/84 ⇨ 07/87
90 2.0 i.e.	AR06210	10/84 ⇨ 07/87

ALFA ROMEO

ALFETTA 1.6	AR01600	01/75 ⇨ 12/84
ALFETTA 1.8	AR01608	10/79 ⇨ 12/84
GIULIETTA I 1.6	AR01600	10/77 ⇨ 04/85
GIULIETTA I 1.8	AR01678	04/79 ⇨ 04/85
GIULIETTA I 2.0	AR01655	06/80 ⇨ 04/85

FIAT

124 1200	124A.000	07/66 ⇨ 10/73
124 1400 Special	124B2.000	12/68 ⇨ 12/72
124 1600 Special T	132AC.000	01/73 ⇨ 07/75
124 Spider, Sport [USA]	--	01/79 ⇨ 12/86
131 2.0 Brava [USA]	--	01/79 ⇨ 12/84
132 2.0	132C2.000	01/76 ⇨ 06/81
ARGENTA 2000	132D1.000	06/78 ⇨ 12/85
ARGENTA 2000 i.e.	132C3.000	06/81 ⇨ 07/86
RITMO II 105 1.6	138AR.000	01/83 ⇨ 12/87

LANCIA

A 112 1.0 Abarth	A112A2.000	03/78 ⇨ 02/84
BETA 1600	828B.000	08/73 ⇨ 07/82

MASERATI

BITURBO i	AM452	07/85 ⇨ 04/87
-----------	-------	---------------

SEAT

RONDA 1.2	021A1000	08/83 ⇨ 05/85
-----------	----------	---------------

KW 930 055R



1

ROTORS

Adatt./Suitable: MARELLI

ALFA ROMEO

9938173

9950047

FIAT

9938173

LANCIA

9938173

MAGNETI MARELLI

712 753 01

212 Resistance Rotor [Ohm] 1000

- Rotore resistenza [Ohm] 1000
- Résistance rotor [ohm] 1000
- Widerstand-Rotor [Ohm] 1000
- Resistencia rotor [ohm] 1000



ALFA ROMEO

164 2.0 Turbo	AR06476	10/87 ⇨ 09/98
---------------	---------	---------------

FIAT

CROMA I 1600	154A.048	12/85 ⇨ 12/90
CROMA I 2000 CHT	154A1.000, 154C5.000	12/85 ⇨ 09/92
CROMA I 2000 i.e. Turbo	154A2.000	12/85 ⇨ 06/90
FIORINO I 1.5	149C1.000	01/88 ⇨ 08/93
FIORINO II 1.5 iE	149C1.000	01/88 ⇨ 10/92
FIORINO II 75 i.e. 1.5	149C1.000	05/88 ⇨ 12/93
REGATA 1.6	--	09/86 ⇨ 06/89
REGATA 100 Super 1.6	149A2.000	10/83 ⇨ 12/90
REGATA 85 1.5	149A5.000	05/85 ⇨ 12/87
RITMO I 1.5	138C2.048	10/85 ⇨ 05/87
RITMO I 1.6	149A4.000	01/83 ⇨ 12/87
RITMO II 75 1.5	138A2.000	09/85 ⇨ 12/88
TEMPRA 1.6	159A3.000, 159A3.048, 159A3.098	03/90 ⇨ 12/96

TEMPRA 1.6 i.e.	159A3.046, 159A3.048	06/90 ⇨ 08/96
TIPO I 1.4	160A1.048	07/87 ⇨ 12/89
TIPO I 1.4 i.e.	160A1.046	05/89 ⇨ 04/95
TIPO I 1.6	160A2.000	01/88 ⇨ 10/92
TIPO I 1.6 SX DGT	159A3.000	05/89 ⇨ 10/95
UNO 1.3 Turbo i.e.	146A2.000	04/85 ⇨ 08/89
UNO 1.4 Super	146C2.028	09/89 ⇨ 09/92
UNO 1.4 Turbo i.e.	146A8.000, 146A8.046	09/89 ⇨ 12/96
UNO 70 1.3i SX	--	01/83 ⇨ 12/89
UNO 70 i.e. 1.4	146C1.000, 160A1.046	09/89 ⇨ 07/96
UNO 70 S 1.4	160A1.048	10/88 ⇨ 06/06
UNO 75 i.e. 1.5	138C2.048, 149C1.000	10/85 ⇨ 12/93

FIAT (BR)

UNO 1.4i Turbo	1.4Mpi	01/94 ⇨ 12/96
----------------	--------	---------------

LANCIA

DEDRA 1.6 i.e.	835A1.000, 835A1.046	08/89 ⇨ 06/94
DELTA I 1.5	831A1.000, 831B1.000	09/79 ⇨ 12/92
PRISMA 1.5	831B1.000	05/86 ⇨ 07/89
PRISMA 1.6	831B6.000	08/86 ⇨ 02/92
THEMA 2000 i.e	834B1.000	09/88 ⇨ 05/92
THEMA 2000 i.e.	834B.146	09/87 ⇨ 05/92
THEMA 2000 i.e. Turbo	834C.146	07/86 ⇨ 05/90
THEMA 2000 Turbo	834C.146	12/88 ⇨ 03/92

LANCIA

Y10 1.3 i.e.	146A5.046, 156B.000	11/87 ⇨ 12/95
--------------	---------------------	---------------

KW 930 057R



1

ROTORS

Adatt./Suitable: MARELLI

FIAT

9940428

FORD

1 641 611
V83H-F12200-AA

LANCIA

9940428

MAGNETI MARELLI

712 372 02

713 774 02

Motorcraft

EDR 161

EDR 210

SEAT

030 905 225 C

SKODA

030 905 225 C

VW

030 905 225 C



FIAT

CROMA I 2000 i.e.	154C3.000, 834B.048, 834B.048	03/86 ⇨ 09/92
-------------------	-------------------------------	---------------

REGATA 90 i.e. 1.6	149C2.000	01/87 ⇨ 07/89
--------------------	-----------	---------------

FORD

ESCORT V RS Cosworth 4x4	N5F	10/91 ⇨ 01/95
--------------------------	-----	---------------

LANCIA

DELTA I 1.6 GT i.e.	149C2.000, 831B7.000	08/86 ⇨ 08/92
DELTA I 1.6 HF Turbo	831B3.000, 831B7.046	08/86 ⇨ 03/89
DELTA I 2.0 16V HF Integrale	831D5.000	03/89 ⇨ 09/91
DELTA I 2.0 HF Integrale	831B5.000, 831C5.000, 831C5.046	11/86 ⇨ 12/92
PRISMA 1.6 i.e.	831B7.000	05/86 ⇨ 12/89
PRISMA 2.0 i.e. Trazione integrale	831B4.000	04/86 ⇨ 12/89

SEAT

AROSA 1.0	AER, ALL	05/97 ⇨ 06/04
AROSA 1.4	AEX, AKV, APQ	05/97 ⇨ 06/04
CORDOBA I 1.0 i	AER	09/96 ⇨ 10/02
CORDOBA I 1.4	ANX	12/97 ⇨ 04/99
CORDOBA I 1.4 i	AKV, APQ	06/94 ⇨ 12/02
CORDOBA I 1.4 i 16V	AFH	09/96 ⇨ 10/02
CORDOBA I 1.6 i	AEE, ALM	02/93 ⇨ 12/02
IBIZA II 1.0 i	AER	09/96 ⇨ 02/02
IBIZA II 1.4	ANX	12/97 ⇨ 04/99
IBIZA II 1.4 i	ABD, AEX, AKV, APQ	09/93 ⇨ 02/02
IBIZA II 1.4 i 16V	AFH	06/97 ⇨ 02/02
IBIZA II 1.6 i	AEE, ALM	03/93 ⇨ 02/02
INCA 1.4 i	AEX, AKV, APQ	11/95 ⇨ 06/03
INCA 1.6 i	1F, AEE	11/95 ⇨ 05/98

SKODA

FELICIA 1.6	6A16XHT	06/97 ⇨ 04/02
FELICIA 1.6 GLX	6A16XHT	08/95 ⇨ 03/98
FELICIA 1.6 LX	6A16XHT	08/95 ⇨ 03/98
OCTAVIA I 1.6	6A16XHT	09/96 ⇨ 09/04

VW

CADDY II 1.4	AEX, AKV, APQ	11/95 ⇨ 06/03
CADDY II 1.6	AEE	06/96 ⇨ 12/00
CADDY II 60 1.4	AEX, APQ	11/95 ⇨ 01/04
CADDY II 75 1.6	AEE	11/95 ⇨ 09/00
GOLF III 1.4	AEX	10/91 ⇨ 04/99
GOLF III 1.6	AEE	09/92 ⇨ 08/97
LUPU 1.0	AER, ALL	09/98 ⇨ 07/05
POLO III 1.4	AEX, AKV, ANX, APQ	05/97 ⇨ 09/01
POLO III 1.6	AEA, AEE, ALM	09/94 ⇨ 09/01
POLO III 100 1.4 16V	AFH	04/96 ⇨ 10/99
POLO III 50 1.0	AER, ALL	09/96 ⇨ 10/99
POLO III 54 1.4	ANX	01/98 ⇨ 08/99
POLO III 55 1.3	ADX	10/94 ⇨ 04/97
POLO III 55 1.4	AEX	08/95 ⇨ 10/99
POLO III 60 1.4	AEX, AKV, APQ	07/95 ⇨ 09/01
POLO III 75 1.6	AEA, AEE, AHS, ALM	10/94 ⇨ 09/01
POLO III 75 1.6 4motion	AEA	08/95 ⇨ 10/99
POLO IV 1.0	AER	08/96 ⇨ 12/01

KW 930 058



3

ROTORS

Adatt./Suitable: MARELLI

JAGUAR
JLM 1911MAGNETI MARELLI
713 524 01

Eliminated on 25-07-2019. Please verify the availability through our local distributors

- Eliminato il 25-07-2019. Verificare la disponibilità presso i nostri distributori
- Éliminé le 25-07-2019. Vérifier la disponibilité auprès de nos distributeurs sur place
- Am 25-07-2019 gestrichen. Evtl. Verfügbarkeit bitte bei unseren Händlern prüfen
- Eliminado en fecha 25-07-2019. Verificar la disponibilidad a través de nuestros distribuidores locales



JAGUAR

XJ 5.3	85(92-93)	05/91 ⇒ 08/93
XJ 6.0	8D	05/93 ⇒ 03/96
XJ V12 6.0	8C(92-94)	03/93 ⇒ 11/94
XJSC 5.3	85(92-93)	05/91 ⇒ 08/93
XJSC 6.0	8D	05/93 ⇒ 03/96

KW 930 059



1

ROTORS

Adatt./Suitable: MARELLI

ALFA ROMEO
9950142FIAT
9943506INNOCENTI
9943506LANCIA
9943506MAGNETI MARELLI
071351702010
71351702RENAULT
77 01 034 947

ALFA ROMEO

164 2.0 Turbo	AR06476	10/87 ⇒ 09/98
---------------	---------	---------------

FIAT

CROMA I 2000 CHT	154A1.000, 154C5.000	12/85 ⇒ 09/92
CROMA I 2000 i.e.	154C3.000, 154C3.046, 834B.146	10/87 ⇒ 12/96
CROMA I 2000 i.e. Turbo	154A2.000, 154C4.000, 154C4.046, 834C.146	12/85 ⇒ 08/96
ELBA 1.5	149C1.000	01/92 ⇒ 12/96
FIORINO I 1.5	149C1.000	01/88 ⇒ 08/93
FIORINO II 1.5 iE	149C1.000	01/88 ⇒ 10/92
FIORINO II 1.6	146C6.000	01/94 ⇒ 05/01
FIORINO II 70 i.e. 1.4	146C5.000	05/94 ⇒ 05/01
FIORINO II 75 i.e. 1.5	149C1.000	05/88 ⇒ 12/93
FIORINO II 75 i.e. 1.6	146C6.000	10/93 ⇒ 05/01
TEMPRA 1.4 i.e.	159A2.000, 160A1.046	04/90 ⇒ 08/96
TEMPRA 1.6	159A3.000, 159A3.048, 159A3.098	03/90 ⇒ 12/96
TEMPRA 1.6 i.e.	159A3.046, 159A3.048	06/90 ⇒ 08/96
TIPO I 1.4	160A1.048	07/87 ⇒ 12/89
TIPO I 1.4 i.e.	160A1.046	05/89 ⇒ 04/95
TIPO I 1.6	159A3.048, 835C1.000	03/93 ⇒ 10/95
TIPO I 1.6 i.e.	159A3.046, 159A3.048, 835C1.000	07/90 ⇒ 04/95
TIPO I 1.6 i.e. [BRA]	160E2.011	03/93 ⇒ 04/95
TIPO I 1.6 SX DGT	159A3.000	05/89 ⇒ 10/95

FIAT

UNO 1.3 Turbo i.e.	146A2.246	09/89 ⇒ 03/91
UNO 1.4 Super	146C2.028	09/89 ⇒ 09/92
UNO 45 1.0 Fire	--	01/83 ⇒ 12/89
UNO 70 i.e. 1.4	146C1.000, 160A1.046	09/89 ⇒ 07/96
UNO 70 S 1.4	160A1.048	10/88 ⇒ 06/06
UNO 75 i.e. 1.5	149C1.000	10/85 ⇒ 12/93
UNO Mondo 1.4 Super	146C2.028	01/96 ⇒

FIAT (BR)

UNO 1.4i Turbo	1.4Mpi	01/94 ⇒ 12/96
----------------	--------	---------------

INNOCENTI

ELBA 1.5 i.e.	149C1.000	08/92 ⇒ 09/94
ELBA 1.6 i.e.	146C6.000	09/94 ⇒ 12/96
MILLE 1.4	160A1046	07/95 ⇒ 05/97

LANCIA

DEDRA 1.6	835A1000	07/94 ⇒ 02/97
DEDRA 1.6 i.e.	835A1.000, 835A1.046	08/89 ⇒ 06/94
DELTA II 1.4 i.e.	160A1.046	10/94 ⇒ 08/99
THEMA 2000 i.e.	834B1.000	09/88 ⇒ 05/92
THEMA 2000 i.e.	834B.146	09/87 ⇒ 05/92
THEMA 2000 i.e. Turbo	834C.146	07/86 ⇒ 05/90
THEMA 2000 Turbo	834C.146	12/88 ⇒ 03/92

RENAULT

19 I 1.2i	E7F	01/89 ⇒ 12/92
19 I 1.4	E6J700, E6J701, E7J700	01/88 ⇒ 12/92
19 II 1.2	E7F730	05/92 ⇒ 09/94
19 II 1.4	E6J706, E7J706, E7J707, E7J742, E7J745	01/92 ⇒ 12/95
CLIO I 1.2	E5F710, E5F716, E7F700, E7F706, E7F708, E7F750	05/90 ⇒ 09/98
CLIO I 1.4	E6J712, E6J713, E6J718, E7J601, E7J710, E7J711, E7J716, E7J718, E7J719, E7J754, E7J756, E7J757	01/90 ⇒ 09/98
EXPRESS 1.4	E6J/E7J	01/85 ⇒ 10/90
MEGANE I 1.4	E7J764	09/96 ⇒ 08/03
MEGANE I 1.4 e	E7J764	01/96 ⇒ 08/03
MEGANE I 1.4 Eco	E7J624	01/96 ⇒ 03/99
MEGANE SCÉNIC I 1.4 i	E7J764	01/97 ⇒ 09/99
RAPID 1.4	E6J738, E7J720, E7J724, E7J726, E7J728, E7J770, E7J771, E7J773	09/91 ⇒ 03/98
RAPID 1.4 RN	E6J734	09/91 ⇒ 08/93

KW 930 060



1

ROTORS

Adatt./Suitable: MARELLI

FIAT

9939790
9944407
9946356INNOCENTI
9946356LANCIA
9944407MAGNETI MARELLI
071371301010
713 053 01
713 713 01

CITROËN

AX 10	C1A	09/86 ⇒ 06/92
AX 10 E	C3A	12/86 ⇒ 12/88
AX 11	H1A, H1B	12/86 ⇒ 04/94
AX 11 4x4	H1A	06/91 ⇒ 07/92
AX 11 Cat	HAZ(TU1CP)	09/88 ⇒ 12/89
ZX 1.1	H1A, H1B, TU1	03/91 ⇒ 08/95

FIAT

COUPE 2.0 16V	836A3.000	11/93 ⇒ 08/96
COUPE 2.0 16V [BRA]	836A3.011	11/93 ⇒ 08/96
CROMA I 2000 i.e.	154C3.000, 834B.000, 834B.048	03/86 ⇒ 09/92

ELBA 1.3	146A5.000	04/91 ⇒ 02/95
FIORINO I 1.1 60	146A9.000	11/86 ⇒ 04/88
FIORINO I 1.3	146A5.000	12/87 ⇒ 08/93
FIORINO II 1.0 iE	156A2.246	11/92 ⇒ 04/96
FIORINO II 1.3	146A5.000	01/88 ⇒ 12/94
FIORINO II 60 1.1	146A9.000	05/88 ⇒ 12/93
FIORINO II 70 1.3	146A5.000	01/88 ⇒ 12/94
PALIO 1.1	178B9.033	07/97 ⇒ 10/03
PANDA I 1.1	156C.046	05/91 ⇒ 03/95

FIAT

PANDA I 1000	156A2.000, 156A2.100, 156A3.000	01/85 ⇒
PANDA I 1000 4x4	156A2.100, 156A2.246, 156A3.000	01/86 ⇒ 12/94
PANDA I 1000 CLX	156A2.000	05/91 ⇒ 12/94
PANDA I 1000 Fire	156A2.000	05/86 ⇒ 04/91
PANDA I 1000 Fire [CHE]	156A2.146	11/87 ⇒ 04/91
PANDA I 1000 Fire [DEU]	156A2.048	01/86 ⇒ 07/89
PANDA I 1000 i.e.	156A2.246	08/92 ⇒ 02/04
PANDA I 1000 i.e. Cat	156A2.246	10/87 ⇒ 08/98
PANDA I 1100 i.e.	156C.046	01/86 ⇒ 04/91
PANDA I 1100 Trekking 4x4	156C.046	10/91 ⇒ 07/04
PANDA I 750	156A4.000	01/86 ⇒ 10/03
PANDA I 750 Cat	156A4.048	01/95 ⇒ 10/03
PANDA I 750 Fire	156A4.048	11/88 ⇒ 04/91
TEMPRA 1.4 i.e.	159A2.000, 160A1.046	04/90 ⇒ 08/96
TEMPRA 1.6	159A3.000, 159A3.048, 159A3.098	03/90 ⇒ 12/96
TEMPRA 1.6 i.e.	159A3.046, 159A3.048	06/90 ⇒ 08/96
TEMPRA 1.8 4x4	159A4.000	07/92 ⇒ 06/93
TEMPRA 1.8 i.e.	159A4.000, 159A4.046	03/90 ⇒ 08/96
TEMPRA 2.0	159A6.046	04/90 ⇒ 06/93
TEMPRA 2.0 i.e.	159A6.046	10/90 ⇒ 09/96
TEMPRA 2.0 i.e. [BRA]	159A6.011	04/93 ⇒ 12/96
TEMPRA 2.0 i.e. 4x4	159A6.046	03/92 ⇒ 03/95
TIPO I 1.1	160A3.000	01/88 ⇒ 10/91
TIPO I 1.4 i.e.	159A2.000	05/89 ⇒ 04/95
TIPO I 1.8 i.e.	159A4.000, 159A4.046	10/90 ⇒ 06/93
TIPO I 1.8 i.e. 16V Sport	160A5.000	11/89 ⇒ 06/92
TIPO I 2.0	159A5.046, 159A6.046, 836A3.011	10/90 ⇒ 04/95
TIPO I 2.0 16V	160A8.046	07/91 ⇒ 04/95
TIPO I 2.0 i.e.	159A5.046, 159A6.046	03/90 ⇒ 04/95
TIPO I 2.0 i.e. [BRA]	159A6.011	03/93 ⇒ 10/95
TIPO I 2.0 i.e. 16V Sport	836A3.000	03/93 ⇒ 04/95
UNO 1.0	146A2.166	11/94 ⇒ 08/00
UNO 45 1.0	156A2.000, 156A2.100	06/86 ⇒ 12/93
UNO 45 i.e. 1.0	156A2.246	10/84 ⇒ 10/95
UNO 50 1.1	156C.046	01/90 ⇒ 12/93
UNO 50 i.e. 1.1	146C3.000	06/92 ⇒ 12/93
UNO 60 1.1	146A4.048	02/88 ⇒ 12/92
UNO 60 1.1 SX	--	01/85 ⇒ 12/89
UNO Mondo 1.0	146A2.166	01/98 ⇒
UNO Mondo 1.0 [IND]	146A2.166	01/98 ⇒

FIAT (BR)

COUPE 2.0i 16V	2.0Mpi	01/95 ⇒ 12/97
TIPO 2.0i 16V	2.0Mpi	01/94 ⇒ 12/95
TIPO 2.0i 8v	2.0Mpi	01/94 ⇒ 12/95

INNOCENTI

ELBA 1.3	146A5.000	08/91 ⇒ 12/96
ELBA 1.4 i.e.	146C5.000	09/94 ⇒ 12/96

LANCIA

DEDRA 1.8 i.e.	835A2.000, 835A2.046, 835C5.000	09/89 ⇒ 07/99
DEDRA 2.0 16V	836A3.000	07/94 ⇒ 07/99
DEDRA 2.0 HF Integrale	835A7.046	11/90 ⇒ 07/94
DEDRA 2.0 i.e.	835A5.000, 835A5.046	09/89 ⇒ 07/99
DEDRA 2.0 i.e. Turbo	835A8.046	04/91 ⇒ 07/99
DEDRA 2.0 i.e. Turbo Integrale	835A7.000	04/90 ⇒ 08/91
DEDRA 2.0 Integrale	836A3.000	07/94 ⇒ 07/99
DEDRA 2.0 Turbo	835A8.000	11/90 ⇒ 06/94
DELTA I 1.3	1831B.000, 3831B.000, 831A2.000, 831B.000	09/79 ⇒ 10/92
DELTA I 1.6 GT i.e.	149C2.000, 831B7.000	08/86 ⇒ 08/92
DELTA I 1.6 HF Turbo	831B3.000, 831B7.046	08/86 ⇒ 03/89
DELTA I 2.0 16V HF Evo Integrale	831E5.000	06/93 ⇒ 01/94
DELTA I 2.0 HF Integrale	831C5.046	12/86 ⇒ 12/92
DELTA II 2.0 16V	836A3.000	06/93 ⇒ 08/99
PRISMA 1.3	831A2.000	01/83 ⇒ 12/89
Y10 1.0 Fire	156A2.100	06/85 ⇒ 06/91
Y10 1.0 Fire Catalytic-Conv	156A2.246	10/87 ⇒ 02/92
Y10 1.0 Fire Trazione integrale	156A2.000, 156A2.100, 156A2.246	12/86 ⇒ 02/92
Y10 1.1 i.e. Fire	156C.000	08/89 ⇒ 06/92
Y10 1.1 i.e. Fire Trazione integrale	156C.000	08/89 ⇒ 06/92
Y10 1.1 i.e. Fire	156C.046	07/89 ⇒ 09/95

PEUGEOT

106 I 1.0	TU9	09/91 ⇒ 03/01
106 I 1.1	H1B(TU1)	08/91 ⇒ 03/96
205 II 1.0	TU9	10/87 ⇒ 09/98
309 II 1.1	H1B(TU1)	09/89 ⇒ 10/93

KW 931 023



ROTORS

Adatt./Suitable: **MITSUBISHI****BOSCH**1 987 234 009
1 987 234 024
1 987 234 909**GENERAL MOTORS**7 992 636
7 992 994**HYUNDAI**27115-21020
27131-11000
27132-11000**MAZDA**0324-24-312
AM01-24-312
F855-24-312**MITSUBISHI**MD602758
MD611850
T12271
T880T12271**Motorcraft**

EDR 80

NISSAN22157-10B10
22157-R9006
22157-R9007⁰³ Supplied until depletion

- Fornibile fino ad esaurimento delle scorte
- Fourni jusqu'à épuisement du stock
- Lieferbar solange vorrat reicht
- Suministrado hasta el stock termina

²⁰² without resistance

- senza resistenza
- sans résistance
- ohne Widerstand
- sin resistencia

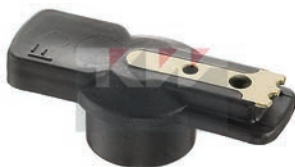
**FORD AUSTRALIA**

COURIER 1.8	--	01/79 ⇒ 12/84
COURIER 2.0	--	01/79 ⇒
LASER 1.3	E3	03/81 ⇒ 02/83
LASER 1.5	E5	03/81 ⇒ 02/83
LASER 1.5 Sport	E5	03/81 ⇒ 02/83
METEOR 1.3	--	04/82 ⇒ 09/85

HYUNDAI

ELANTRA I 1.5	--	10/90 ⇒ 04/95
EXCEL 1.3	G4AN	07/85 ⇒ 07/91
EXCEL 1.5	G4AJ	07/85 ⇒ 08/89
LANTRA I 1.5	G4DJ	10/90 ⇒ 04/95
PONY 1.3	G13B	10/85 ⇒ 01/95
PONY 1.5	G15B, G4DJ	10/85 ⇒ 01/95
PONY / EXCEL 1.3	G4DG	01/90 ⇒ 01/95
PONY / EXCEL 1.5	G15B, G4DJ	01/90 ⇒ 01/95
S COUPE 1.5	G4DJIA	03/90 ⇒ 12/92
STELLAR 1.4	G4G3	10/83 ⇒ 08/86
STELLAR 1.6	G32B	10/83 ⇒ 12/91
STELLAR 2.0	--	01/87 ⇒ 12/91

MAZDA

929 I 2.0	MA	05/79 ⇒ 07/86
929 II 2.0	FE(8V)	03/84 ⇒ 07/87

MITSUBISHI

COLT I 1.2 GL	4G11	12/78 ⇒ 01/84
COLT III 1.3 GL	4G13(8V)	04/88 ⇒ 12/90
COLT II 1.3 EL, GL	G13B	06/86 ⇒ 04/88
CORDIA 1.8 [USA]	G62B	01/82 ⇒ 12/88
CORDIA 1.8 Turbo [USA]	G62B	01/82 ⇒ 12/88
LANCER V 1.2 GL	4G16	05/88 ⇒ 08/92
LANCER V 1.3	4G13(8V), G13B	04/88 ⇒ 05/92
LANCER V 1.3 GL	G13B	05/88 ⇒ 06/90
LANCER V 1.5	4G15(12V), 4G15(8V)	04/88 ⇒ 05/92
LANCER V 1.8 4WD	4G37	03/89 ⇒ 12/90
LANCER III/IV 1.2	4G16	08/86 ⇒ 04/88
GALANT VI 1.6	4G32	01/88 ⇒ 10/92
GALANT VI 1.8	4G37	11/87 ⇒ 10/92
L200 II 1.6	4G32	04/87 ⇒ 10/96
L200 II 2.6 4WD	G54B	11/89 ⇒ 05/95
MONTERO 2.6i [USA]	4G54	01/83 ⇒ 12/90
PAJERO 1.2.6	4G54	01/83 ⇒ 11/90
PAJERO 1.2.6 4WD	4G54	01/83 ⇒ 05/91
PAJERO II 2.6 4WD	4G54	03/91 ⇒ 10/97
SHOGUN I 2.6 4x4	4G54	01/84 ⇒ 02/91
STARION 2.0 Turbo ECi	4G63-T(ECI), 4G63-T/C	06/82 ⇒ 08/87
TRUCK 2.6 [USA]	G54B	01/86 ⇒

NISSAN

URVAN III 2.0	Z20	05/87 ⇒ 05/97
VANETTE II 1.5	A15	04/87 ⇒ 11/94

KW 931 030



ROTORS

Adatt./Suitable: **MITSUBISHI****BOSCH**

1 987 234 051

MITSUBISHIT13371
T880T13371**NISSAN**22157-23G15
22157-M5610⁰³ Supplied until depletion

- Fornibile fino ad esaurimento delle scorte
- Fourni jusqu'à épuisement du stock
- Lieferbar solange vorrat reicht
- Suministrado hasta el stock termina

**NISSAN**

NAVARA I 2.4	Z24i	06/92 ⇒ 02/97
SUNNY II 1.4 LX	GA14S	10/88 ⇒ 08/91
VANETTE II 2.0	Z20S	07/87 ⇒ 08/94

KW 931 107



ROTORS

Adatt./Suitable: **MITSUBISHI****BOSCH**

1 987 234 058

HYUNDAI27115-32500
27131-32810**MITSUBISHI**27131-32810
MD611151
T16571⁰³ Supplied until depletion

- Fornibile fino ad esaurimento delle scorte
- Fourni jusqu'à épuisement du stock
- Lieferbar solange vorrat reicht
- Suministrado hasta el stock termina

**HYUNDAI**

ELANTRA I 1.5 i GL	G4DJ	12/90 ⇒ 08/94
H-1 I 2.4	G4CS	06/97 ⇒ 04/04
H-1 I 2.4 4WD	G4CS	02/98 ⇒ 04/04
H100 2.4	G4CS	07/93 ⇒ 12/04
LANTRA I 1.5 i.e.	G4DJ	10/90 ⇒ 11/95
PONY 1.5 i	G15B, G4DJ	10/89 ⇒ 01/95
PONY / EXCEL 1.5 i	G15B, G4DJ	01/90 ⇒ 01/95
PORTER I 2.4	G4CS	03/96 ⇒ 04/04
PRECIS 1.5 i [USA]	G4DJ	01/89 ⇒
SANTAMO 2.0 16V	G4JP	05/99 ⇒ 12/02
SANTAMO 2.0 16V 4x4	G4CP-D	05/99 ⇒ 12/02
S COUPE 1.5 i	G4DJ	02/90 ⇒ 05/96
SONATA II 2.4 i	G4CS	09/88 ⇒ 08/91
SONATA III 1.8 GLS	G4DM	07/96 ⇒ 05/98
SONATA III 1.8 i	G4CM	05/93 ⇒ 06/98
SONATA III 2.0 i	G4CP, G4EP	06/94 ⇒ 06/98

MITSUBISHI

COLT III 1.5 GLXi	4G15(8V)	04/88 ⇒ 05/92
LANCER V 1.5	4G15(12V)	09/88 ⇒ 08/90
LANCER V 1.5 12V	4G15(12V)	05/89 ⇒ 05/92
LANCER V 1.5 GLS	4G15(12V)	08/89 ⇒ 08/92
LANCER V 1.8 4WD	4G37	09/89 ⇒ 06/92
GALANT IV 1.6 GLX	4G32	09/80 ⇒ 05/84
GALANT VI 2.0	4G63(SOHC8V)	11/87 ⇒ 12/92
GALANT VI 2.0 4WD	4G63(SOHC8V)	12/88 ⇒ 10/92
L200 II 2.4	4G64(12V)	06/90 ⇒ 10/96
L200 II 2.4 4WD	4G64(12V)	06/94 ⇒ 10/96
MONTERO 2.4 16V	4G64(12V)	04/91 ⇒
PAJERO II 2.4	4G64(12V)	04/91 ⇒ 04/00
PAJERO III 2.4	4G64(12V)	10/01 ⇒ 08/06
PAJERO III 2.4 4x4	4G64(12V)	10/01 ⇒ 12/06
PAJERO SPORT II 2.4	4G64(16V)	07/08 ⇒
PRECIS 1.5 i [USA]	G4DJ	01/89 ⇒ 12/94
TRUCK 2.4i [USA]	4G64	01/89 ⇒

MITSUBISHI

VALLEY 2.4 i 4G64 09/92 ⇒ 10/94

KW 931 108



ROTORS

Adatt./Suitable: **MITSUBISHI****BOSCH**1 987 234 056
F 005 X04 731**FORD**4 046 843
E8BZ-12200-A
FOJY-12200-A
KK 150 18 V05
XM34-12200-BA**GENERAL MOTORS**

96 056 629

HOLDEN

3331086240

KIAKK150-18V05
KK150-18-V05A**MAZDA**B303-18-V05
F829-18-V05
FE25-18-V05
G601-18-V05**MITSUBISHI**

T16871

MotorcraftDRE 383
DRE 388**SUZUKI**33310-82032
33310-82032-000
33310-86240
33310-86240-000**FORD**

RANGER IV 2.2	--	10/99 ⇒
---------------	----	---------

FORD AUSTRALIA

FESTIVA 1.3	--	01/91 ⇒
SPECTRON 2.0	OHC	01/84 ⇒

HOLDEN

BARINA 1.3 GL	410UF015G02	02/89 ⇒ 05/94
---------------	-------------	---------------

KIA

PRIDE 1.1 i	B1	01/91 ⇒ 10/00
PRIDE 1.3 [GBR]	--	01/90 ⇒
PRIDE 1.3 i	--	01/90 ⇒ 05/97

MAZDA

121 I 1.1	B1, B115, B116	10/87 ⇒ 01/91
121 I 1.3	B3	10/87 ⇒ 06/91
323 III 1.5	B505, B535, B536	09/89 ⇒ 09/93
323 IV 1.3	E3	09/81 ⇒ 10/85
323 V 1.3	B333, E3, E391, E393	08/85 ⇒ 05/89
323 V 1.3 i	B335	09/85 ⇒ 08/89
323 V 1.5	B5, B50, B53, E5	08/85 ⇒ 10/89
323 V 1.6	93AF1006, B6E	09/86 ⇒ 10/95
323 V 1.6 4x4	B65M, B6E	05/90 ⇒ 03/93
323 V 1.6 GT	93AF1006	01/86 ⇒ 10/89
323 V 1.6i 16v Formula 4	B6F2	08/87 ⇒ 05/89
626 IV 1.8	F8(12V)	09/87 ⇒ 05/92
626 IV 2.0	FE(12V)	09/87 ⇒ 10/90
626 IV 2.0 12V	FE(12V), FEEF, FEEK	09/87 ⇒ 05/92
626 IV 2.2 12V	F2	11/87 ⇒ 04/92
626 IV 2.2 12V 4WD	F2	11/87 ⇒ 07/90
929 III 2.0	FE(8V), FEFA	06/87 ⇒ 05/89
929 III 2.2	--	01/86 ⇒ 12/91
929 III 2.2 12V	F2, F21, F267, F2E	02/87 ⇒ 05/89
929 III 2.2 i	F2-EGI	05/87 ⇒ 12/88
929 III 2.2i 12v	F2E6, F2E7	06/89 ⇒ 09/92
E2000 2.0	FEBN, FECK, FEY7	11/87 ⇒ 05/95
E2000 2.0 4x4	FECK, FEY7	11/87 ⇒ 07/91
E2000 4WD	FEBN	10/88 ⇒ 09/89
MPV I [USA] 2.6 12V	--	01/89 ⇒ 12/94
MPV I [USA] 2.6 12V AWD	--	01/89 ⇒ 12/94

SUZUKI

SWIFT I / II / III 1.3 GTi SOHC	G13B	10/89 ⇒ 12/95
SWIFT I / II / III 1.6	G16B	11/89 ⇒ 12/91
SWIFT I / II / III 1.6 4WD	G16B	11/89 ⇒ 12/91

KW 931 109 

ROTORS
Adatt./Suitable: **MITSUBISHI**

- BOSCH**
F 005 X04 737
- CHRYSLER**
MD611 459
MD611 757
- HYUNDAI**
27115-35000
27131-35010
- MITSUBISHI**
MD611459
MD611757
T15672
T15673
- NISSAN**
22157-03P10



CHRYSLER		
LE BARON 3.0 iV6	6G72	01/90 ⇨ 12/96
VOYAGER I 3.0 i [USA]	EFA	10/84 ⇨ 07/90
VOYAGER 3.0 i	300, 6G72	01/91 ⇨ 09/95
VOYAGER 3.3	EGA	10/89 ⇨ 09/90
HYUNDAI		
GALLOPER 3.0 V6	G6AT	08/98 ⇨ 12/03
INNOVATION 3.0 V6	G6AT	05/00 ⇨
SONATA II 3.0 i V6 [USA]	G6AT	01/88 ⇨
SONATA III 3.0 i V6	G6AT	05/93 ⇨ 06/98
MITSUBISHI		
PAJERO I 3.0 i 4WD	6G72(SOHC12V)	05/88 ⇨ 05/91
PAJERO I 3.0 V6	6G72(SOHC12V)	11/88 ⇨ 11/90
PAJERO II 3.0 V6	6G72(SOHC12V)	12/90 ⇨ 12/95
PAJERO II 3.0 V6 4WD	6G72(SOHC12V)	12/90 ⇨ 12/95

KW 931 110 

ROTORS
Adatt./Suitable: **MITSUBISHI**

- BOSCH**
1 987 234 038
- MITSUBISHI**
T17371
- NISSAN**
22157-17B10
22157-27M15



NISSAN		
NX1600 1.6 [USA]	E16	01/87 ⇨ 12/90
PICK UP I 2.4 i [USA]	KA24E	01/89 ⇨
PICK UP I 2.4 i 12V	KA24E	04/92 ⇨ 02/98
PICK UP I 2.4 i 12V 4WD	KA24E	04/92 ⇨ 02/98
PULSAR NX 1.6 [USA]	E16	01/86 ⇨
SUNNY II 1.6 i	E16i	06/86 ⇨ 10/90
SUNNY II 1.6 i 12V	GA16i	06/86 ⇨ 06/91
SUNNY II 1.6 i 4x4	E16i	06/86 ⇨ 10/90
SUNNY III 1.4	GA14DS	10/90 ⇨ 06/95
SUNNY III 1.4 i	GA14DS	10/90 ⇨ 05/95

KW 931 113 

ROTORS
Adatt./Suitable: **MITSUBISHI**

- BOSCH**
1 987 234 033
- MAZDA**
F220-18-V05
- Motorcraft**
DRE 385



MAZDA		
323 VI C 1.3	B3E	09/89 ⇨ 07/94
323 VI C 1.8 16V 4WD	BP	11/91 ⇨ 12/93
323 VI C 1.8 16V GT	BP(DOHC)	09/89 ⇨ 03/93
323 VI C 1.8 16V Turbo 4WD	BPTurbo	09/90 ⇨ 12/92

KW 931 118 

ROTORS
Adatt./Suitable: **MITSUBISHI**

- BOSCH**
1 987 234 060
- NISSAN**
22157-1E410
22157-53F11



NISSAN		
240SX 2.4	KA24DE	04/93 ⇨ 09/94
SERENA 1.6	GA16DE	02/93 ⇨ 09/01
SERENA 2.0	SR20DE	11/92 ⇨ 09/01

KW 931 119 

ROTORS
Adatt./Suitable: **MITSUBISHI**

- BOSCH**
1 987 234 060
1 987 234 062
F 005 X04 739
- HOLDEN**
3331070B50
- MAZDA**
B61V-18-V05
- MITSUBISHI**
MD618284
T880T21572
- Motorcraft**
ADR 5052
- NISSAN**
22157-55K10
- SUBARU**
22157-KA060
- SUZUKI**
33310-70B50
33310-70B50-000



FORD AUSTRALIA		
LASER 1.6	B6(SOHC16V)	03/90 ⇨ 09/91

HOLDEN		
BARINA 1.3 GL	410UF015G02	02/89 ⇨ 05/94
MAZDA		
121 I 1.1	B115, B116	10/87 ⇨ 01/91
121 I 1.1 Unleaded Fuel	--	01/87 ⇨ 12/91
121 I 1.3	B3	10/87 ⇨ 06/91
121 I 1.3 Leaded Fuel	--	01/87 ⇨ 12/91
121 II 1.1	B1	11/90 ⇨ 10/93
323 III 1.5	B505, B535, B536	09/89 ⇨ 09/93
323 VI C 1.6	B6E	09/89 ⇨ 06/91
323 VI F 1.6	B6E	09/89 ⇨ 06/91
323 VI S 1.3	B383, B3E	09/89 ⇨ 06/91
323 VI S 1.3 16V	B3(16V)	04/91 ⇨ 07/94
323 VI S 1.6	B6E	09/89 ⇨ 06/91
323 VI S 1.6 16V	B6	08/89 ⇨ 10/96
323 VI 1.3 16V	B384, B386, B387	06/89 ⇨ 03/91
MITSUBISHI		
COLT III 1.3 12V	4G13(12V)	04/88 ⇨ 05/92
COLT III 1.3 GL	4G13(8V)	04/88 ⇨ 12/90
COLT V 1.5	301353C	09/95 ⇨ 09/03
COLT V 1.5 16V	301353C	10/99 ⇨ 09/03
LANCER V 1.3	4G13(8V), G13B	04/88 ⇨ 05/92
LANCER V 1.3 12V	4G13(12V)	07/90 ⇨ 07/93
LANCER V 1.5	4G15(12V), 4G15(8V)	04/88 ⇨ 05/92
L400 2.0	4G63(SOHC16V)	12/94 ⇨ 10/02
LANCER VI 1.5	4G15(12V)	09/92 ⇨ 07/96
LANCER VII 1.5	301353C	06/00 ⇨ 08/03
LANCER VII 1.5 16V	301353C	10/99 ⇨ 08/03
SPACE GEAR 2.0 16V	4G63(DOHC16V)	08/96 ⇨ 05/00
SUBARU		
LEGACY I 1.6	--	01/89 ⇨
LEGACY I 1.8	--	01/89 ⇨
M80 800	--	01/90 ⇨

KW 931 131 

ROTORS
Adatt./Suitable: **MITSUBISHI**

- BOSCH**
1 987 234 060
- CHEVROLET**
93740921
- DAEWOO**
93740921
TD200C01001
- FORD**
E32Z-12200-B
F32Z-12200-B
F52Z-12200-B
- GENERAL MOTORS**
96 064 787
96 067 826
- MAZDA**
FS07-18-V05
FS07-18-V05A
- MITSUBISHI**
MD618187
MD619272
- Motorcraft**
DRE 390
DRE 390 A
- NISSAN**
22157-50Y10
- SUZUKI**
33310-56B10
33310-56B10-000
33310-60C30
33310-60C30-000
33310-60C31
33310-60C31-000



CHEVROLET		
SPARK I 0.8	F8CV	09/00 ⇨ 12/06
DAEWOO		
MATIZ 0.8	F8CV	08/98 ⇨
MITSUBISHI		
L200 IV 2.4 i	4G64(16V)	11/05 ⇨ 12/15
EXPO 2.4 i [USA]	4G64	01/91 ⇨ 12/92
GALANT VI 2.0	4G63(SOHC8V)	11/87 ⇨ 12/92
GALANT VI 2.0 4WD	4G63(SOHC8V)	12/88 ⇨ 10/92
L200 III 2.0	4G63(SOHC16V)	06/96 ⇨ 12/07
L200 III 2.4 4WD	4G64(16V)	06/96 ⇨ 12/07
L400 2.0	4G63(SOHC16V)	12/94 ⇨ 10/02
L400 2.4	4G64(16V)	05/95 ⇨ 02/06
L400 2.4 i 4WD	4G64(16V)	05/95 ⇨ 05/00

MITSUBISHI		
LANCER V 1.8 4WD	4G37	03/89 ⇒ 06/92
LANCER V 1.8 GTi	4G37	06/92 ⇒ 07/93
LANCER VI 1.8 GTi	4G37	06/92 ⇒ 07/93
SPACE GEAR 2.0 16V	4G63(DOHC16V)	08/96 ⇒ 05/00
SPACE GEAR 2.4 i	4G64(16V)	05/95 ⇒ 05/00
NISSAN		
SUNNY III 1.4	GA14DS	10/90 ⇒ 06/95
SUNNY III 1.4 i	GA14DS	10/90 ⇒ 05/95
SUNNY III 1.6 i	GA16DE, GA16DS	10/90 ⇒ 03/00
SUZUKI		
SIDEKICK 1.6i [USA]	--	01/91 ⇒
SIDEKICK 1.6i 16V J1X 4x4	G16B	04/89 ⇒ 04/96
VITARA I 1.6 8V	--	01/90 ⇒ 12/98

KW 931 132



ROTORS

Adatt./Suitable: **MITSUBISHI****BOSCH**1 987 234 061
F 005 X12 697**FORD**3 993 623
F4BZ-12200-A
F52Z-12200-D**KIA**MB593-18V05
MB6BF-18V05**MAZDA**B593-18-V05
B6BF-18-V05**Motorcraft**

DRE 394



FORD		
PROBE 2.0 16V	A20LE-FS	01/93 ⇒ 09/97
FORD AUSTRALIA		
LASER 1.6 i	B6(DOHC16V)	10/94 ⇒ 03/99
LASER 1.8 i	BP(DOHC)	10/94 ⇒ 03/99
MAZDA		
323 VII C 1.3 16V	B3(16V)	08/94 ⇒ 09/98
323 VII C 1.5 16V	Z5-DE	08/94 ⇒ 09/98
323 VII C 1.8 16V	BP-ZE	08/94 ⇒ 09/98
323 VII 1.5 16V	Z5-DE	07/94 ⇒ 09/98
323 VII 1.8 16V	BP-ZE	08/94 ⇒ 09/98
323 VII P 1.3 16V	B3(16V)	10/96 ⇒ 09/98
323 VII P 1.5 16V	Z5-DE	10/96 ⇒ 09/98
323 VIII F 1.4	B3(16V)	01/01 ⇒ 05/04
323 VIII F 1.4 16V	B3ME	09/98 ⇒ 01/01
323 VIII S 1.3	B3(16V)	01/01 ⇒ 05/04
323 VIII S 1.3 16V	B3(16V)	08/94 ⇒ 01/01
323 VIII S 1.5 16V	Z5-DE	08/94 ⇒ 09/98
323 VIII S 1.8 16V	BP-ZE	08/94 ⇒ 09/98
626 V 1.8	FP, FP01LP	08/91 ⇒ 04/97
626 V 1.8 i	--, FP	08/91 ⇒ 06/97
626 V 2.0 i	FS	08/91 ⇒ 04/97
626 V 2.0 i 4WD	FS	04/92 ⇒ 04/97
DEMIO 1.3 16V	B3ME	08/98 ⇒ 07/03
DEMIO 1.5 16V	BSE	04/00 ⇒ 07/03
MX-3 1.6 i	B6D	11/93 ⇒ 09/98
MX-6 2.0	FS	02/92 ⇒ 02/97

KW 931 133



ROTORS

Adatt./Suitable: **MITSUBISHI****BOSCH**F 005 X04 747
F 005 X12 881**FORD**3 395 566
3 880 181
F32Z-12200-C
KL01-18V05-A**FORD AUSTRALIA**

K L01-18-V05 A

FORD USA

3 880 181

MAZDAKL01-18-V05
KL01-18-V05A**Motorcraft**

DRE 391

**FORD AUSTRALIA**

TELSTAR 2.5	KL-ZE	01/92 ⇒ 10/95
TELSTAR 2.5 TXS Efi	KL-ZE	10/94 ⇒ 11/96

FORD USA

PROBE II 2.5 V6 24V	KL	10/93 ⇒ 03/98
---------------------	----	---------------

MAZDA

626 V 2.5 24V	KL	01/92 ⇒ 04/97
626 V 2.5i V6 [USA]	--	01/94 ⇒
MX-3 1.8 i V6	K819	01/92 ⇒ 01/94
MX-6 2.5 24V	KL	02/92 ⇒ 09/97

KW 931 134



ROTORS

Adatt./Suitable: **MITSUBISHI****BOSCH**F 005 X12 882
F 005 X12 883
F 005 X12 894**FORD**3 891 726
F52Z-12200-A
F52Z-12200-C**FORD USA**

3 891 726

MAZDAKF34-18-V05
KF34-18-V05A**MITSUBISHI**

MD619274

Motorcraft

DRE 395

**FORD AUSTRALIA**

TELSTAR 2.5	KL-ZE	01/92 ⇒ 10/95
TELSTAR 2.5 TXS Efi	KL-ZE	10/94 ⇒ 11/96

FORD USA

PROBE II 2.5 V6 24V	KL	10/93 ⇒ 03/98
---------------------	----	---------------

MAZDA

323 VII 2.0 24V	KF	08/94 ⇒ 09/98
626 V 2.5 24V	KL	08/94 ⇒ 04/97
MILLENIA 2.5i [USA]	--	05/99 ⇒
MPV I 3.0	JE94	09/88 ⇒ 12/91
MPV I 3.0 i V6	JE94	11/88 ⇒ 09/99
MX-3 1.8 i V6	K838, K8-ZE	01/94 ⇒ 10/97
MX-6 2.5 24V	KL	02/92 ⇒ 09/97
MX-6 2.5 i 24V	KL	08/94 ⇒ 02/97
XEDOS 9 2.0	KF	08/98 ⇒ 08/00
XEDOS 9 2.0 24V	KF	08/93 ⇒ 01/00
XEDOS 9 2.5 24V	KL	07/93 ⇒ 07/00
XEDOS 9 2.5 V6	KL	07/00 ⇒ 09/02

MITSUBISHI

GALANT VIII 2.5 V6 24V	6A13	09/00 ⇒ 10/04
------------------------	------	---------------

KW 931 136



ROTORS

Adatt./Suitable: **MITSUBISHI****BOSCH**F 005 X12 629
F 00E 000 243
F 00E 140 440**GENERAL MOTORS**

91 172 825

INFINITI

22157-46N12

MITSUBISHIMD619000
MD619216
MD619354
MD619434
MD619637**NISSAN**22157-0M512
22157-0M810
22157-2J210
22157-46N11
22157-46N12**SUZUKI**33310-70E00
33310-70E00-000
33310-70E01
33310-70E01-000**INFINITI**

G20 2.0	SR20DE	01/90 ⇒ 12/97
---------	--------	---------------

MITSUBISHI

CARISMA 1.6	4G92(SOHC16V)	07/95 ⇒ 06/06
CARISMA 1.8	4G93(SOHC16V)	07/95 ⇒ 07/97
COLT IV 1.6 4WD	4G92(SOHC16V)	08/93 ⇒ 08/95
COLT IV 1.6 GLXi 16V	4G92(SOHC16V)	04/92 ⇒ 04/96
COLT V 1300 GL, GLX	4G13(12V)	05/96 ⇒ 06/00
LANCER VI 1.6 16V	4G92(SOHC16V)	06/92 ⇒ 10/03
LANCER VI 1.6 16V 4WD	4G92(SOHC16V)	06/92 ⇒ 10/03
LANCER VII 1.3 12V	4G13(12V)	12/95 ⇒ 08/03
SPACE RUNNER 1.8	4G93(SOHC16V)	10/91 ⇒ 08/99
SPACE RUNNER 1.8 4WD	4G93(SOHC16V)	10/91 ⇒ 08/99
SPACE STAR 1.3 16V	4G13(16V)	09/00 ⇒ 12/04

NISSAN

240SX 2.4	KA24DE	05/94 ⇒ 08/97
ALMERA I 2.0 GTi	SR20DE	07/96 ⇒ 03/00
ALMERA TINO 2.0	SR20DE	08/00 ⇒ 01/03
PRIMERA II 2.0	SR20DEL	10/97 ⇒ 06/99
PRIMERA II 2.0 16V	SR20DE	06/96 ⇒ 07/02
PRIMERA II 2.0 GT	SR20DEH	10/97 ⇒ 06/99
PRIMERA I 2.0	SR20DE	07/94 ⇒ 01/98

SUZUKI

SIDEKICK 1.6 JS [USA]	--	05/96 ⇒ 07/98
SIDEKICK 1.6 JX 4x4 [USA]	--	05/96 ⇒ 07/98
X-90 1.6 i 16V	G16B	09/95 ⇒ 12/97
X-90 1.6 i 16V 4x4	G16B	09/95 ⇒ 12/97

931 137

KW 931 137



1

ROTORS

Adatt./Suitable: **MITSUBISHI**

BOSCH

1 987 234 055

⁰³ Supplied until depletion

- Fornibile fino ad esaurimento delle scorte
- Fourni jusqu'à épuisement du stock
- Lieferbar solange vorrat reicht
- Suministrado hasta el stock termina

FORD

3 857 542
F32Z-12200-A
F42Z-12200-A
FS01-18V05-A

MAZDA

FS01-18-V05
FS01-18-V05A

MITSUBISHI

MD618556
MD619273

Motorcraft

DRE 389
DRE 389 A



FORD

PROBE 2.0 16V	A20LE-FS	01/93 ⇒ 09/97
---------------	----------	---------------

MAZDA

626 V 1.8	FP, FP01LP	08/91 ⇒ 04/97
626 V 1.8 i	-, FP	08/91 ⇒ 06/97
626 V 2.0 i	FS	08/91 ⇒ 04/97
626 V 2.0 i 4WD	FS	04/92 ⇒ 04/97

MITSUBISHI

COLT IV 1.6 4WD	4G92(SOHC16V)	08/93 ⇒ 08/95
COLT IV 1.6 GLXi 16V	4G92(SOHC16V)	04/92 ⇒ 04/96
EXPOLRV 2.4i [USA]	4G64	01/92 ⇒
GALANT VII 1.8 GLSi	4G93(SOHC16V)	11/92 ⇒ 08/96
GALANT VII 2.0 GLSi	4G63(SOHC16V)	11/92 ⇒ 08/96
GALANT VII 2.0 GLSi 4WD	4G63(SOHC16V)	11/92 ⇒ 08/96
LANCER V 1.6 16V	4G92(SOHC16V)	06/92 ⇒ 05/94
LANCER V 1.6 4WD	4G92(SOHC16V)	06/92 ⇒ 11/93
LANCER VI 1.6 16V	4G92(SOHC16V)	06/92 ⇒ 10/03
LANCER VI 1.6 16V 4WD	4G92(SOHC16V)	06/92 ⇒ 10/03
SPACE RUNNER 1.8	4G93(SOHC16V)	10/91 ⇒ 08/99
SPACE RUNNER 1.8 4WD	4G93(SOHC16V)	10/91 ⇒ 08/99
SPACE WAGON 1.8	4G93(SOHC16V)	10/91 ⇒ 10/98
SPACE WAGON 1.8 4WD	4G93(SOHC16V)	10/91 ⇒ 10/98
SPACE WAGON 2.0	4G63(SOHC16V)	10/92 ⇒ 10/98
SPACE WAGON 2.0 4WD	4G63(SOHC16V)	10/92 ⇒ 10/98

KW 931 138



3

ROTORS

Adatt./Suitable: **MITSUBISHI**

HYUNDAI

27131-02750



HYUNDAI

ATOS 1.0 i	G4HC	02/98 ⇒ 03/02
ATOS PRIME 1.0 i	G4HC	08/99 ⇒

KW 931 139



3

ROTORS

Adatt./Suitable: **DAC**

CHEVROLET

93740944

DAEWOO

329013
93740944

GENERAL MOTORS

93 740 944



CHEVROLET

SPARK 1.0.8	F8CV	09/00 ⇒ 12/06
-------------	------	---------------

DAEWOO

MATIZ 0.8	F8CV	08/98 ⇒
-----------	------	---------

KW 938 262R



1

ROTORS

Adatt./Suitable: **PAL**

SKODA

113 911 400

²¹² Resistance Rotor [Ohm] 5000

- Rotore resistenza [Ohm] 5000
- Résistance rotor [ohm] 5000
- Widerstand-Rotor [Ohm] 5000
- Resistencia rotor [ohm] 5000



SKODA

105,120 1.0	33*	08/76 ⇒ 12/89
105,120 1.0 105 S, L	742.10	08/76 ⇒ 12/90
105,120 1.0 105 S, L, GL	742.10	08/76 ⇒ 08/83
105,120 1.0 105 S, L, LS	742.10	10/83 ⇒ 12/90
105,120 1.2	37*, 55*	08/76 ⇒ 12/89
105,120 1.2 120 GLS	742.12X	02/83 ⇒ 12/90
105,120 1.2 120 L	742.12, 742.12X	08/76 ⇒ 12/90
105,120 1.2 120 LS	742.12X	08/76 ⇒ 12/90
130 1.3	43*	01/84 ⇒ 12/88
135 1.3	43*	01/87 ⇒ 12/89
136 1.3	46*	01/87 ⇒ 12/89
FAVORIT 1.3	781.135, OHC	08/91 ⇒ 06/97
FAVORIT 1.3 135	781.135	10/90 ⇒ 09/94
FAVORIT 1.3 135L	781.135	05/89 ⇒ 09/94
FAVORIT 1.3 136	136L	10/90 ⇒ 09/94
FELICIA 1.3	061GW4G15K, 135, 135L, 136L	10/94 ⇒ 03/98

KW 938 263R



1

ROTORS

Adatt./Suitable: **PAL**

SKODA

114 911 070
115 911 401

²¹² Resistance Rotor [Ohm] 1000

- Rotore resistenza [Ohm] 1000
- Résistance rotor [ohm] 1000
- Widerstand-Rotor [Ohm] 1000
- Resistencia rotor [ohm] 1000



SKODA

FAVORIT 1.3	135B, 136B, 781.135, 781.135E, OHC	08/91 ⇒ 06/97
FAVORIT 1.3 135	781.135	10/90 ⇒ 09/94
FAVORIT 1.3 135 X, LX, GLX	781.135E	01/90 ⇒ 09/94
FAVORIT 1.3 135L	781.135	05/89 ⇒ 09/94
FAVORIT 1.3 136	136L	10/90 ⇒ 09/94

KW 946 014R



3,5

ROTORS

Adatt./Suitable: **U.D.S.S.R.**

LADA

21010-3706020-10
21013-7060010-10 *C
2101-3706020
2101-3706020-10
2107-3706020-10
3037-06020
38-37060-20

^{*C} Available rotor only-not, the distributor assy

- Fornito solo distributore rotante, non lo spinterogeno completo
- Disponible seulement le rotor, non pas l'allumeur complet
- Erhältlich nur rotor, nicht der komplette verteiler
- Disponible solo el rotor, no el distribuidor completo

²¹² Resistance Rotor [Ohm] 5000

- Rotore resistenza [Ohm] 5000
- Résistance rotor [ohm] 5000
- Widerstand-Rotor [Ohm] 5000
- Resistencia rotor [ohm] 5000



LADA

LADA 1.2	--	01/80 ⇒
LADA 1.3	--	01/80 ⇒
LADA 1.5	--	01/80 ⇒
NIVA I 1600	BA32121, BA32121	12/76 ⇒ 12/93
RIVA 1.5	--	01/85 ⇒
RIVA 1.6	--	01/85 ⇒



ROTORS

Adatt./Suitable: U.D.S.S.R.

LADA

2108-3706020

⁰³ Supplied until depletion

- Fornibile fino ad esaurimento delle scorte
- Fourni jusqu'à épuisement du stock
- Lieferbar solange vorrat reicht
- Suministrado hasta el stock termina

²¹² Resistance Rotor [Ohm] 1000

- Rotore resistenza [Ohm] 1000
- Résistance rotor [ohm] 1000
- Widerstand-Rotor [Ohm] 1000
- Resistencia rotor [ohm] 1000

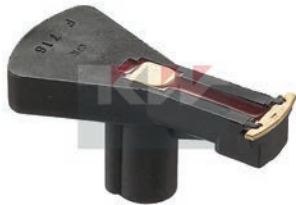

LADA

SAMARA 1.5	--	01/97 ⇨
SAMARA 1100	BA321081	02/88 ⇨ 12/94
SAMARA 1300	BA32108	01/86 ⇨ 12/94
SAMARA 1500	BA321083	09/87 ⇨ 12/96



IGNITION CABLE SETS

-SERIE CAVI ACCENSIONE COMPLETA -JEUX CABLES D'ALLUMAGE -ZÜNDKABELSÄTZE -JUEGOS DE CABLES DE ENCENDIDO

(A) P/NRS. - NOTES

- CODICI - NOTE
- RÉFS. - NOTES
- ARTIKEL-NR. - ANMERKUNGEN
- CODIGOS - NOTAS

360 904

07,5

IGNITION CABLE SETS

Adatt./Suitable:

GENERAL MOTORS

09 117 892
09 117 893
09 117 894
09 117 895
93 176 701

180 with marten protection

- con protezione contro roditori
- avec protection anti-mustélidés
- mit Marderschut
- con protección contra martas

OPEL

12 82 163
12 82 164
12 82 165
12 82 166
16 12 657

(B) PICTURE + TECHNICAL INFO

- FOTO + INFORMAZIONE TECNICA
- ILLUSTRATION + INFORMATION TECHNIQUE
- BILD + TECHNISCHE INFO
- FOTO + INFORMACIÓN TÉCNICA

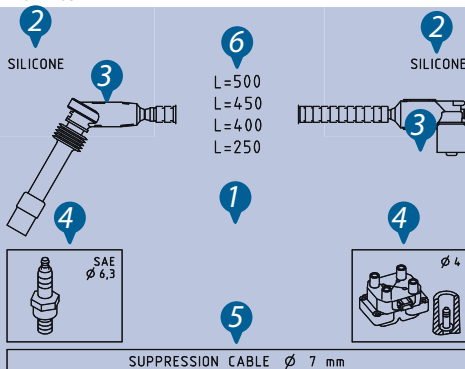

(C) APPLICATION LIST

- GUIDA APPLICAZIONI
- LISTE D'APPLICATIONS
- ANWENDUNGSTABELLE
- LISTA DE APLICACIONES

OPEL

ASTRA G 1.6	X16SZR, Z16SE	09/00 ⇒ 04/05
COMBO B 1.4	C14SE, X14SZ	07/94 ⇒ 10/01
COMBO C 1.6	Z16SE	10/01 ⇒
CORSA B 1.4	C14SE	04/93 ⇒ 08/94
CORSA B 1.4 i	X14SZ	03/93 ⇒ 09/00
CORSA B 1.4 Si	C14SE	03/93 ⇒ 09/00

(A)

1 # KW

2 OEM P/NRS.

- Codici originali
- Réfs. d'origine
- Originalteile-Nr.
- Codigos originales

3 PACKAGING SIZE

- Formato confezione
- Format du conditionnement
- Abpackensgroesse
- Tamaño del envase

4 PRODUCT AVAILABILITY DATE

- Data di disponibilità del prodotto
- DATE Disponibilité du produit
- Produktverfügbarkeitsdatum
- FECHA Disponibilidad artículo

5 NOTE

- Note
- Notes
- Bemerkungen
- Notas

(B)

1 PICTURE

- Foto - Photo - Bild - Foto

2 MATERIAL OF BOOTS

- Materiale dei gommini
- Matériel des capuchons
- Material der steckerüllen
- Material de los capuchones

3 SUPPRESSOR

- Soppressore antidisturbo
- Suppresseur anti-parasite
- Entstörstecker
- Supresor antiparasito

4 CONNECTOR, SEE PAGE

- Innesto, VEDERE PAGINA
- Connexion, VOIR PAGE
- Anschluss, SIEHE SEITE
- Anchufe, VÉASE PAGINA

5 DIAMETER AND TYPE OF WIRE

- Diametro e tipo di cavo
- Diamètre et type de cable
- Durchmesser und Kabeltyp
- Diametro y tipo de cable

6 LENGTH IN mm OF SINGLE CABLE MEASURED

AS SHOWN:

- Lunghezza in mm del singolo cavo così misurato:
- Longueur en mm de chaque cable mesuré comme suit:
- Einzelkabelänge in mm gemessen wie gezeigt:
- Largo en mm de cada cable MEDIDO COMO SIGUE:

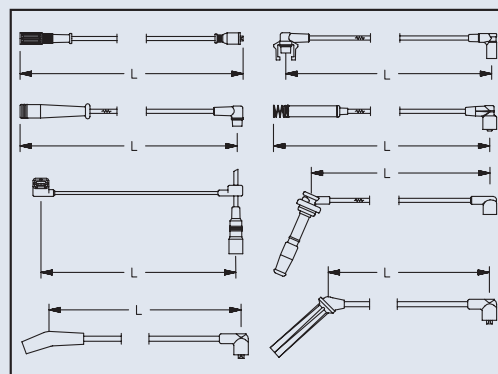



IGNITION CABLE SETS

-SERIE CAVI ACCENSIONE COMPLETA -JEUX CABLES D'ALLUMAGE -ZÜNDKABELSÄTZE -JUEGOS DE CABLES DE ENCENDIDO

ICON: CONNECTOR TYPES ON SPARK PLUGS - CAPS - COILS

- **ICONE:** INNESTI SU CANDELE - CALOTTE - BOBINE
- **ICONE:** CONNEXIONS SUR BOUGIES - TETES - BOBINES
- **BESTIMMUNG** DER STECKANSCHLÜSSE AUF ZÜNDKERZEN - VERTEILERKAPPEN - SPULEN
- **ICONAS:** ENCHUFES EN BUJIAS - TAPAS - BOBINAS

(B)

4

SPARK PLUG

- CANDELA
- BOUGIE
- KÜNDKERZE
- BUJIA

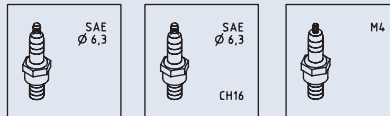

DISTRIBUTOR CAP

- CALOTTA
- TETE D'ALLUMEUR
- VERTEILERKAPPE
- TAPA DEL DISTRIBUIDOR

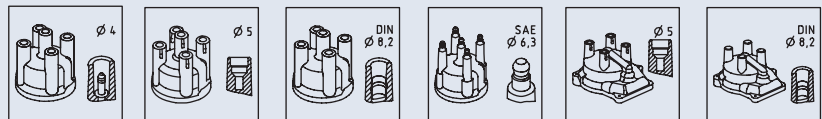

IGNITION COIL

- BOBINA
- BOBINE D'ALLUMAGE
- ZÜNDSPULE
- BOBINA DE ENCENDIDO

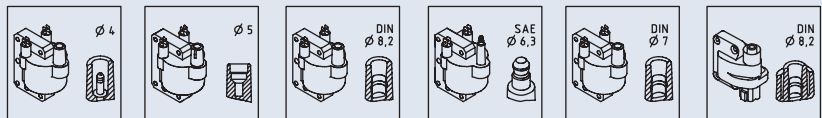

COIL FOR DISTRIBUTORLESS IGNITION

- BOBINA PER ACCENSIONE SENZA SPINTEROGENO
- BOBINE PUR ALLUMAGE SANS DISTRIBUTEUR
- SPULE FÜR VERTEILERLOSE ZÜNDSYSTEME
- BOBINA PARA ENCENDIDO SIN DISTRIBUIDOR

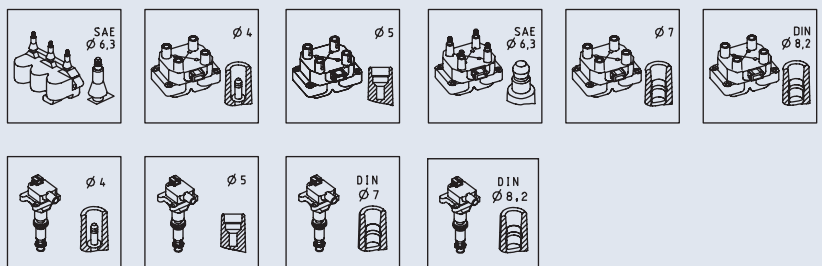

KW 358 004

07,5

IGNITION CABLE SETS

Adatt./Suitable:

03 Supplied until depletion

- Fornibile fino ad esaurimento delle scorte
- Fourni jusqu'à épuisement du stock
- Lieferbar solange vorrat reicht
- Suministrado hasta el stock termina

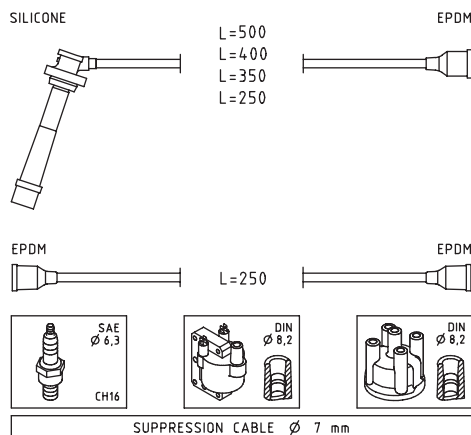

SUZUKI

SIDEKICK 1.6 JX 4x4	G16A(8V)	04/89 ⇒ 04/96
VITARA I 1.6	G16A(8V), G16B	07/88 ⇒ 03/98
VITARA I 1.6 i 16V	G16B	07/90 ⇒ 03/99
VITARA I 1.6 i 16V Trazione integrale	G16B	07/90 ⇒ 03/98
VITARA I 1.6 Trazione integrale	G16A(8V)	07/88 ⇒ 03/98

KW 358 005

05

IGNITION CABLE SETS

Adatt./Suitable:

BOSCH
0 986 357 263HITACHI
134987SUZUKI
33705-66D00
33705-66D00-000
33705M79F00
33705M79F00-000

00 Eliminated on 09-03-2022. Please verify the availability through our local distributors

- Eliminato il 09-03-2022. Verificare la disponibilità presso i nostri distributori
- Eliminé le 09-03-2022. Verifier la disponibilité auprès de nos distributeurs sur place
- Am 09-03-2022 gestrichen. Evtl. Verfügbarkeit bitte bei unseren Händlern prüfen
- Eliminado en fecha 09-03-2022. Verificar la disponibilidad a través de nuestros distribuidores locales

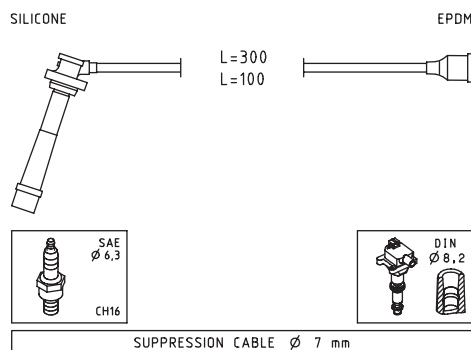

SUZUKI

ALTO VI 1.1	6AR02150, F10DN	09/04 ⇒ 12/08
BALENO 1.3 16V	G13BB	03/97 ⇒ 05/02
BALENO 1.3 i 16V	G13BB	07/95 ⇒ 05/02
BALENO 1.6 i 16V	G16B	07/95 ⇒ 05/02
BALENO 1.6 i 16V 4x4	G16B	07/95 ⇒ 05/02
CARRY 1.3	G13BB	03/99 ⇒
CARRY 1.3 16V	G13BB	03/00 ⇒
ESTEEM 1.6i [USA]	G16B	09/98 ⇒
GRAND VITARA I 1.6 4x4	G16B	02/00 ⇒ 09/02
JIMNY III 1.3 16V	G13BB	09/98 ⇒
JIMNY III 1.3 16V 4WD	G13BB	09/98 ⇒

SUZUKI

JIMNY III 1.3 4x4	G13BB	09/98 ⇒ 08/00
SWIFT III 1.3 [USA]	--	06/95 ⇒ 05/01
VITARA I 1.6 16V	G16B	10/99 ⇒ 10/02
VITARA II 1.6i [USA]	--	08/99 ⇒ 12/06
WAGON R+ II 1.3	G13BB, M13A	05/00 ⇒
WAGON R+ II 1.3 4WD	G13BB	10/01 ⇒

KW 358 006

07

IGNITION CABLE SETS

Adatt./Suitable:

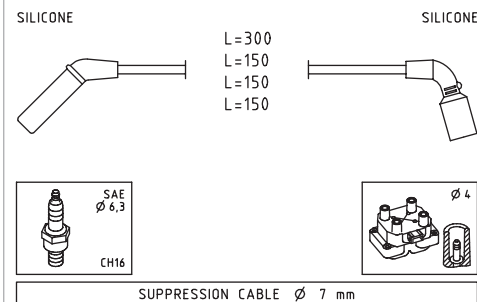
BOSCH
0 986 357 285CHEVROLET
96288956DAEWOO
96288956GENERAL MOTORS
96 288 956HITACHI
134260

CHEVROLET

AVEO I 1.2	B1251, F1253, LQ5, LY4	03/05 ⇒
KALOS 1.2	B1251	03/05 ⇒
MATIZ 1.0	B10S, B10S1, LQ4(61CUL4)	03/05 ⇒
MATIZ 1.0 LPG	B10S1	03/05 ⇒ 03/11
SPARK I 1.0	G10CV	11/02 ⇒ 12/04
SPARK II 1.0 LPG	B10S	05/05 ⇒
SPARK II 1.0 SX	B10S, B10S1, LA2	05/05 ⇒

DAEWOO

KALOS 1.2	B1251, F1253	04/03 ⇒
MATIZ 1.0	B10S	01/03 ⇒

KW 358 007

05

IGNITION CABLE SETS

Adatt./Suitable:

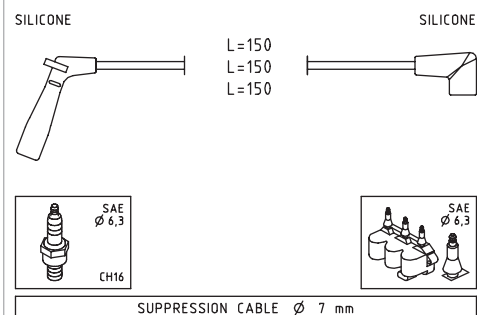
CHEVROLET
96291306DAEWOO
96291306GENERAL MOTORS
96 291 306HITACHI
134263

CHEVROLET

MATIZ 0.8	LBF(49CUL3), LQ2(49CUL3)	03/05 ⇒ 12/13
MATIZ 0.8 LPG	F8CV	03/05 ⇒ 12/07
SPARK I 0.8	F8CV	09/00 ⇒ 12/06
SPARK II 0.8	F8CV	05/05 ⇒ 02/10

DAEWOO

MATIZ 0.8	F8CV	08/98 ⇒
-----------	------	---------

KW 358 013

07

IGNITION CABLE SETS

Adatt./Suitable:

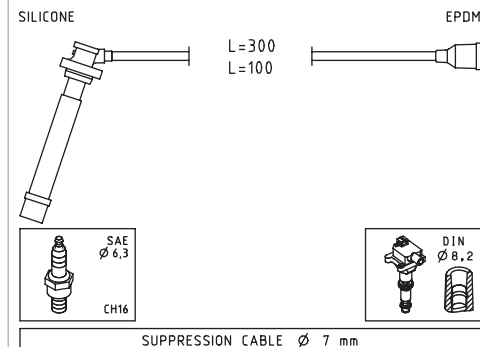
FIAT
71742423SUZUKI
33705-80G00-000
33705-86G00-000

FIAT

SEDCI 1.6 16V	M16A	06/06 ⇒ 10/14
SEDCI 1.6 16V 4x4	M16A	06/06 ⇒ 10/14

SUZUKI

GRAND VITARA II 1.6 4x4	M16A	09/05 ⇒ 02/15
GRAND VITARA II 1.6 Trazione integrale	M16A	04/05 ⇒ 02/15
SWIFT IV 1.3	M13A	02/05 ⇒
SWIFT IV 1.3 4x4	M13A	02/05 ⇒
SWIFT IV 1.5	M15A	02/05 ⇒
SWIFT IV 1.5 4x4	M15A	02/05 ⇒
SWIFT IV 1.6	M16A	05/06 ⇒
SWIFT IV 1.6 4x4	M16A	02/05 ⇒
IGNIS I 1.3	M13A	10/00 ⇒ 09/03
IGNIS I 1.3 4WD	M13A	10/00 ⇒ 09/03
IGNIS I 1.5 Sport	M15A	12/03 ⇒ 12/05
IGNIS II 1.3	M13A	09/03 ⇒
IGNIS II 1.3 4x4	M13A	09/03 ⇒
IGNIS II 1.5	M15A	09/03 ⇒
IGNIS II 1.5 4x4	M15A	09/03 ⇒
JIMNY III 1.3 16V	M13A	02/01 ⇒
JIMNY III 1.3 16V 4WD	M13A	02/01 ⇒
JIMNY III 1.3 16V 4x4	M13A	08/05 ⇒
JIMNY III 1.3 4WD	M13A	05/14 ⇒
LIANA 1.3	M13A	07/01 ⇒
LIANA 1.6	M16A	07/01 ⇒
LIANA 1.6 4WD	M16A	07/01 ⇒
LIANA 1.6 i	M16A	04/02 ⇒
LIANA 1.8 i	M18A	10/01 ⇒
SX4 I 1.5	M15A	06/06 ⇒ 07/10
SX4 I 1.5 VVT	M15A	07/10 ⇒
SX4 I 1.5 VVT 4x4	M15A	07/10 ⇒
SX4 I 1.6	M16A	06/06 ⇒
SX4 I 1.6 AWD	M16A	10/07 ⇒
SX4 I 1.6 VVT	M16A	06/06 ⇒
SX4 I 1.6 VVT 4x4	M16A	06/06 ⇒
WAGON R+ II 1.3	M13A	09/03 ⇒
WAGON R+ II 1.3 4WD	M13A	09/03 ⇒

KW 358 020



IGNITION CABLE SETS

Adatt./Suitable:

- HOLDEN**
3370083010
- SUZUKI**
33700-80001
33700-80001-000
33700-80012
33700-80012-000
33700-82610
33700-82610-000
33700-83010
33700-83010-000
33705-80040
33705-80040-000
33710-80010
33710-80010-000

- 03 Supplied until depletion**
- Fornibile fino ad esaurimento delle scorte
 - Fourni jusqu'à épuisement du stock
 - Lieferbar solange vorrat reicht
 - Suministrado hasta el stock termina

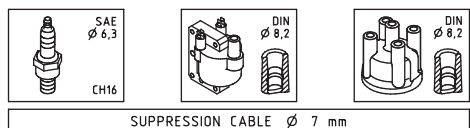
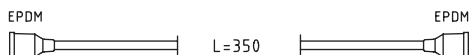
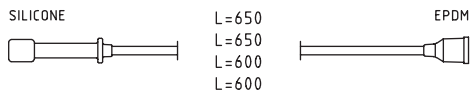

SUPPRESSION CABLE Ø 7 mm

HOLDEN		
DROVER QB 1.3	G13A	02/85 ⇒ 12/87
SUZUKI		
SA413 1.3	--	01/84 ⇒
SJ410 1.0	F10A	09/81 ⇒ 07/91
SJ413 1.3	G13A	09/84 ⇒ 08/90

KW 358 028



IGNITION CABLE SETS

Adatt./Suitable:

- 00 Eliminated on 22-02-2022. Please verify the availability through our local distributors**
- Eliminato il 22-02-2022. Verificare la disponibilità presso i nostri distributori
 - Éliminé le 22-02-2022. Vérifier la disponibilité auprès de nos distributeurs sur place
 - Am 22-02-2022 gestrichen. Evtl. Verfügbarkeit bitte bei unseren Händlern prüfen
 - Eliminado en fecha 22-02-2022. Verificar la disponibilidad a través de nuestros distribuidores locales

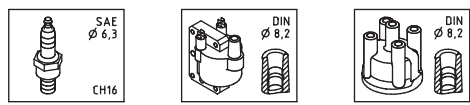
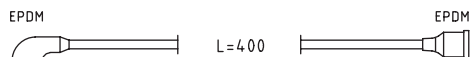
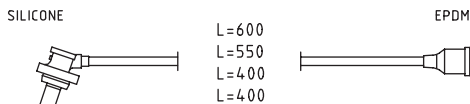

SUPPRESSION CABLE Ø 7 mm

SUZUKI		
WAGON R II 1.0	K10A	02/98 ⇒ 05/00
WAGON R II 1.2	K12A	02/98 ⇒ 05/00
WAGON R II 1.2 4WD	K12A	02/98 ⇒ 05/00

KW 358 049



IGNITION CABLE SETS

Adatt./Suitable:

- RENAULT**
82 00 122 243

- 03 Supplied until depletion**
- Fornibile fino ad esaurimento delle scorte
 - Fourni jusqu'à épuisement du stock
 - Lieferbar solange vorrat reicht
 - Suministrado hasta el stock termina

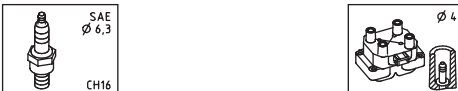
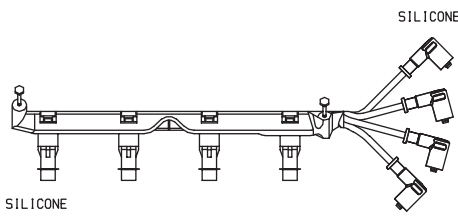

SUPPRESSION CABLE Ø 7 mm

RENAULT		
LAGUNA II 2.0 16V IDE	F5R700	04/01 ⇒ 09/07
MEGANE I 2.0 16V IDE	F5R740	11/99 ⇒ 08/03

KW 358 059



IGNITION CABLE SETS

Adatt./Suitable:

- HITACHI**
134958
- MAGNETI MARELLI**
941215240807
- VOLVO**
1275603

- 03 Supplied until depletion**
- Fornibile fino ad esaurimento delle scorte
 - Fourni jusqu'à épuisement du stock
 - Lieferbar solange vorrat reicht
 - Suministrado hasta el stock termina

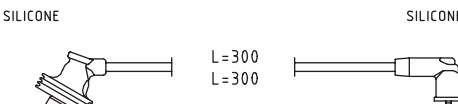

SUPPRESSION CABLE Ø 7 mm

VOLVO		
S40 I 1.6	B4164S2	03/99 ⇒ 12/03
S40 I 1.8	B4184S2, B4184S3, B4184S9	06/01 ⇒ 12/03
S40 I 1.8 16V	B4184S10	08/00 ⇒
S40 I 1.9T4	B4194T, B4194T2	05/97 ⇒ 07/00
S40 I 2.0	B4204S2	07/95 ⇒ 12/03
S40 I 2.0T	B4204T, B4204T2, B4204T3	06/01 ⇒ 12/03
S40 I 2.0T4	B4204T5	07/00 ⇒ 12/03
V40 I 1.6	B4164S2	03/99 ⇒ 06/04
V40 I 1.8	B4184S2, B4184S3, B4184S9	03/99 ⇒ 06/04
V40 I 1.8 16V	B4184S10	08/00 ⇒
V40 I 1.9T4	B4194T, B4194T2	05/97 ⇒ 07/00
V40 I 2.0	B4204S2	07/95 ⇒ 06/04
V40 I 2.0T	B4204T, B4204T2, B4204T3	06/01 ⇒ 06/04
V40 I 2.0T4	B4204T5	07/00 ⇒ 06/04

KW 358 061



IGNITION CABLE SETS

Adatt./Suitable:

- BOSCH**
0 986 357 238
- HITACHI**
134560
- RENAULT**
74 31 275 284
- VOLVO**
1275284
12752846

- 03 Supplied until depletion**
- Fornibile fino ad esaurimento delle scorte
 - Fourni jusqu'à épuisement du stock
 - Lieferbar solange vorrat reicht
 - Suministrado hasta el stock termina

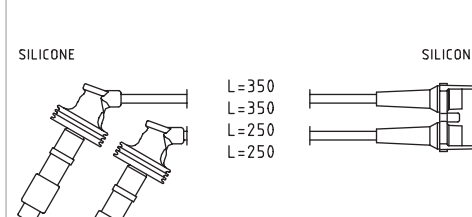

SUPPRESSION CABLE Ø 7 mm

RENAULT		
LAGUNA I 2.0	N7Q700, N7Q704	06/95 ⇒ 02/01
LAGUNA I 2.0 16V	N7Q700, N7Q704	06/95 ⇒ 03/01
SAFRANE II 2.0 16V	N7Q710, N7Q711	07/96 ⇒ 12/00

VOLVO		
S40 I 1.6	B4164S	09/95 ⇒ 08/99
S40 I 1.8	B4184S	07/95 ⇒ 08/99
S40 I 2.0	B4204S	07/95 ⇒ 08/99
V40 I 1.6	B4164S	12/95 ⇒ 08/99
V40 I 1.8	B4184S, B4184S3	07/95 ⇒ 08/99
V40 I 2.0	B4204S	07/95 ⇒ 08/99

KW 358 064



IGNITION CABLE SETS

Adatt./Suitable:

- 03 Supplied until depletion**
- Fornibile fino ad esaurimento delle scorte
 - Fourni jusqu'à épuisement du stock
 - Lieferbar solange vorrat reicht
 - Suministrado hasta el stock termina

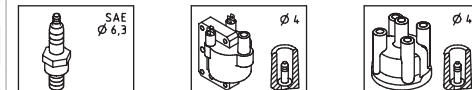
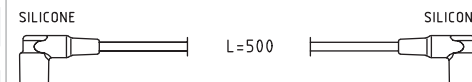
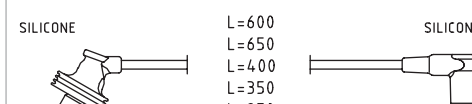

SUPPRESSION CABLE Ø 7 mm

RENAULT		
SAFRANE II 2.5 20V	N7U700, N7U701	07/96 ⇒ 12/00

VOLVO		
850 2.0	B5202S, B5204F, B5204FS	06/91 ⇒ 12/96
850 2.0 10V	B5202FS	08/94 ⇒ 12/97
850 2.0 Turbo	B5204FT, B5204T, B5204T2	02/93 ⇒ 10/97
850 2.3	B5234FS	01/96 ⇒ 10/96
850 2.3 T5	9M9T872	02/93 ⇒ 12/96
850 2.3 T5-R	B5234T4	08/95 ⇒ 12/96
850 2.3 Turbo R	B5234T5	06/95 ⇒ 10/97
850 2.4	B5252, B5252FS, B5254S	06/91 ⇒ 12/96
850 2.4 AWD	B5254T	04/96 ⇒ 12/96
850 2.4 GLE	B5254T	09/93 ⇒ 10/97

VOLVO		
850 2.5 10V	B5252FS	06/91 ⇒ 12/97
850 2.5 20V	B5254FS	08/91 ⇒ 12/97
C70 1.2.0	B5204T2	03/97 ⇒ 10/05
C70 1.2.0 T	B5204T3	03/97 ⇒ 10/05
C70 1.2.3 T5	B5234T3	03/98 ⇒ 10/05
C70 1.2.3 T-5	B5234T3	03/97 ⇒ 09/02
C70 1.2.4 T	B5254T	03/97 ⇒ 10/05
S70 2.0	B5202FS, B5202S, B5204T2	01/97 ⇒ 11/00
S70 2.0 Turbo	B5204T3	01/97 ⇒ 11/00
S70 2.3	B5234FS, B5234T7	01/97 ⇒ 07/99
S70 2.3 AWD	B5234T7	04/99 ⇒ 09/00
S70 2.3 T-5	B5234T3	01/97 ⇒ 11/00
S70 2.3 T5 AWD	B5234T4	07/97 ⇒ 09/00
S70 2.3 T5-R AWD	B5234T2	11/96 ⇒ 09/98
S70 2.3 Turbo	B5234FT+	01/97 ⇒ 11/00
S70 2.4	B5254S	06/98 ⇒ 11/00
S70 2.4 AWD	B5252FS	11/96 ⇒ 05/99
S70 2.4 Bifuel	GB5252S	10/98 ⇒ 11/00
S70 2.4 T5 AWD	B5254T	11/96 ⇒ 04/99
S70 2.4 Turbo	B5254T	01/97 ⇒ 11/00
S70 2.5 20V	B5254FS	01/97 ⇒ 12/98
S70 2.5 Bifuel	GB5252S2	01/99 ⇒ 12/99
V70 1.2.0	B5202FS, B5202S, B5204T2	12/95 ⇒ 03/00
V70 1.2.0 Turbo	B5204T3	11/96 ⇒ 12/00
V70 1.2.0 Turbo AWD	B5204T3	11/96 ⇒ 12/00
V70 1.2.3	B5234FS	01/97 ⇒ 07/99
V70 1.2.3 AWD	B5234T3, B5234T7	04/97 ⇒ 09/98
V70 1.2.3 T AWD	B5234FT+, B5234T4, B5234T6	04/97 ⇒ 12/98
V70 1.2.3 T-5	B5234T3	11/96 ⇒ 12/00
V70 1.2.3 T-5 AWD	B5234T3	01/97 ⇒ 12/00
V70 1.2.3 Turbo	B5234FT+, B5234T2, B5234T4	12/95 ⇒ 12/98
V70 1.2.4	B5254S	06/98 ⇒ 12/99
V70 1.2.4 Bifuel	GB5252S	05/98 ⇒ 12/99
V70 1.2.4 Turbo AWD	B5254T	04/96 ⇒ 12/00
V70 1.2.5	B5252FS	01/97 ⇒ 03/00
V70 1.2.5 20V	B5254FS	01/97 ⇒ 12/99
V70 1.2.5 Bifuel	GB5252S2	01/99 ⇒ 12/99

KW 358 100



IGNITION CABLE SETS

Adatt./Suitable:

00 Eliminated on 20-05-2019. Please verify the availability through our local distributors

- Eliminato il 20-05-2019. Verificare la disponibilità presso i nostri distributori
- Éliminé le 20-05-2019. Vérifier la disponibilité auprès de nos distributeurs sur place
- Am 20-05-2019 gestrichen. Evtl. Verfügbarkeit bitte bei unseren Händlern prüfen
- Eliminado en fecha 20-05-2019. Verificar la disponibilidad a través de nuestros distribuidores locales

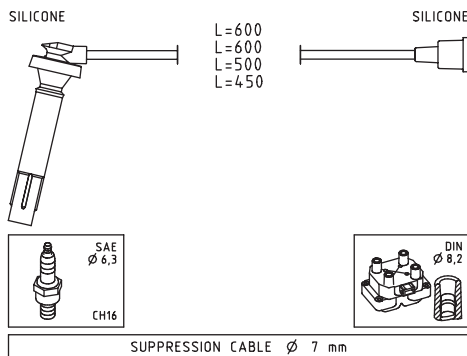

SUPPRESSION CABLE Ø 7 mm

SUBARU

LEGACY IV 2.0 AWD	EJ202	09/03 ⇒ 10/05
OUTBACK III 2.0	EJ202	09/03 ⇒ 10/05
OUTBACK III 2.0 AWD	EJ202	09/03 ⇒ 10/05

KW 358 106



IGNITION CABLE SETS

Adatt./Suitable:

00 Eliminated on 26-01-2021. Please verify the availability through our local distributors

- Eliminato il 26-01-2021. Verificare la disponibilità presso i nostri distributori
- Éliminé le 26-01-2021. Vérifier la disponibilité auprès de nos distributeurs sur place
- Am 26-01-2021 gestrichen. Evtl. Verfügbarkeit bitte bei unseren Händlern prüfen
- Eliminado en fecha 26-01-2021. Verificar la disponibilidad a través de nuestros distribuidores locales

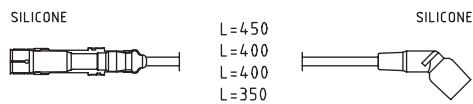

5 k.Ω



COPPER CORE CABLE Ø 7 mm

BMW

3 IV 316 Ci	M43B16(164E3)	04/00 ⇒ 07/06
3 IV 316 i	M43B16(164E3), M43B19(194E1)	04/00 ⇒ 02/05
3 IV 318 Ci	M43B19(194E1)	12/99 ⇒ 08/01
3 IV 318 i	M43B19(194E1)	12/97 ⇒ 09/01

KW 358 107



IGNITION CABLE SETS

Adatt./Suitable:

00 Eliminated on 22-02-2022. Please verify the availability through our local distributors

- Eliminato il 22-02-2022. Verificare la disponibilità presso i nostri distributori
- Éliminé le 22-02-2022. Vérifier la disponibilité auprès de nos distributeurs sur place
- Am 22-02-2022 gestrichen. Evtl. Verfügbarkeit bitte bei unseren Händlern prüfen
- Eliminado en fecha 22-02-2022. Verificar la disponibilidad a través de nuestros distribuidores locales

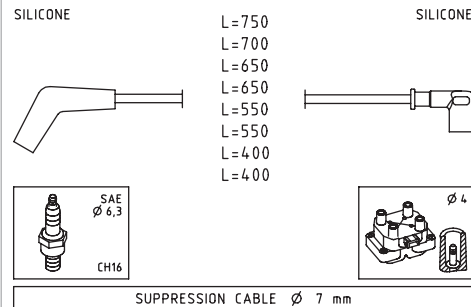

SUPPRESSION CABLE Ø 7 mm

LAND ROVER

DISCOVERY II 4.0 V8 4x4	35D, 56D, 94D	11/98 ⇒ 06/04
DISCOVERY II 4.6 V8 [USA]	--	01/03 ⇒ 06/04
RANGE ROVER II 3.9 4x4	42D	07/94 ⇒ 03/02
RANGE ROVER II 4.0 4x4	42D	01/95 ⇒ 03/02
RANGE ROVER II 4.6 4x4	46D	07/94 ⇒ 03/02

KW 358 111



IGNITION CABLE SETS

Adatt./Suitable:

HYUNDAI

27501-26A00
27501-26C00
27501-26D00

KIA

27501-26D00

03 Supplied until depletion

- Fornibile fino ad esaurimento delle scorte
- Fourni jusqu'à épuisement du stock
- Lieferbar solange vorrat reicht
- Suministrado hasta el stock termina

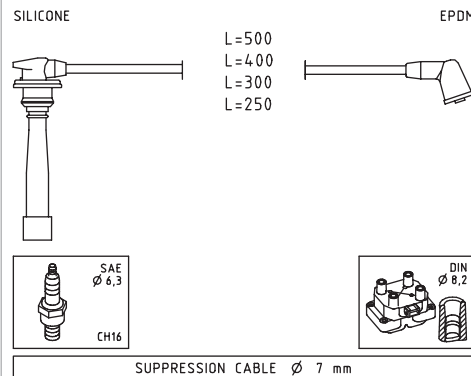

SUPPRESSION CABLE Ø 7 mm

HYUNDAI

ACCENT I 1.5 i 16V	G4ER	10/95 ⇒ 01/00
ACCENT II 1.5	G4EC-G	09/99 ⇒ 11/05
ACCENT II 1.6	G4ED-G	12/02 ⇒ 11/05
COUPE I 1.6 16V	G4GR	03/98 ⇒ 04/02
COUPE I 1.6i 16V	4G61	12/96 ⇒ 04/02
ELANTRA III 1.6	G4ED-G, G4GA, G4GR	06/00 ⇒ 07/06
EXCEL 1.5 i 16V GT	G4ER	10/96 ⇒ 08/99
GETZ 1.4 i	G4EE	08/05 ⇒ 12/10
GETZ 1.6	G4ED-G	09/02 ⇒ 06/09
LAVITA 1.6	--	01/07 ⇒
MATRIX 1.6	G4ED-G, G4ED-L	06/01 ⇒ 08/10
MATRIX 1.6 [TUR]	G4ED	04/08 ⇒
ACCENT III 1.4 GL	G4EE	11/05 ⇒ 11/10
ACCENT III 1.6 GLS	G4ED	11/05 ⇒ 11/10
COUPE II 1.6 16V	G4ED-G	03/02 ⇒ 08/09
VERNA I 1.5	G4EC-G	09/99 ⇒

HYUNDAI		
VERNA I 1.6	G4ED-G	12/02 ⇨
VERNA II 1.4 GL	--	11/05 ⇨
VERNA II 1.6 GLS	--	11/05 ⇨
KIA		
CERATO I 1.6	G4ED	04/04 ⇨ 12/09
RIO II 1.4 16V	G4EE	03/05 ⇨ 12/11
RIO II 1.6 16V	G4ED	03/05 ⇨ 12/11
RIO II 1.6 CVT	G4ED	03/05 ⇨ 12/11

KW 358 119

07

IGNITION CABLE SETS

Adatt./Suitable:

BOSCH
0 986 356 898
F 000 99C 609

HYUNDAI
27501-02H00
27501-22B00
27501-22B10

KIA
27501-02H00

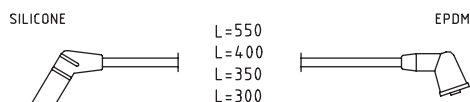

SUPPRESSION CABLE Ø 7 mm

HYUNDAI

ACCENT I 1.3	G4EH	10/94 ⇨ 01/00
ACCENT I 1.3 i 12V	G4EH	10/94 ⇨ 01/00
ACCENT I 1.5	G4EK	10/94 ⇨ 07/99
ACCENT I 1.5 i 12V	G4EK	10/94 ⇨ 01/00
ACCENT II 1.3	G4EA, G4EH	01/00 ⇨ 11/05
ACCENT II 1.5	G4EB, G4EK	01/00 ⇨ 11/05
ATOS 1.0 i	G4HC-E	03/01 ⇨ 07/03
ATOS 1.1	G4HD, G4HG	06/03 ⇨ 12/10
ATOS PRIME 1.0 i	G4HC-E	03/01 ⇨ 07/03
ATOS PRIME 1.1	G4HD, G4HG	08/03 ⇨ 12/08
EXCEL 1.3 i 12V	G4EH	09/94 ⇨ 08/99
EXCEL 1.5 i 12V	G4EK	09/94 ⇨ 08/99
GETZ 1.1	G4HD	09/02 ⇨ 09/05
GETZ 1.3	G4EA	09/03 ⇨ 06/09
GETZ 1.3 i	G4EA	09/02 ⇨ 03/04
LANTRA II 1.5 12V	G4EK	12/96 ⇨ 10/00
SANTRO 1.1	G4HD	01/03 ⇨
S COUPE 1.5 i	G4EK	04/92 ⇨ 05/96
S COUPE 1.5 i Turbo	G4EK-TC	04/91 ⇨ 05/96
VERNA I 1.3	G4EA	09/99 ⇨
VERNA I 1.5	G4EB	09/99 ⇨

KIA

PICANTO I 1.0	--, G4HE	04/04 ⇨
PICANTO I 1.1	G4HG	04/04 ⇨ 09/11

KW 358 120

07

IGNITION CABLE SETS

Adatt./Suitable:

BOSCH
0 986 356 990

HYUNDAI
27501-02A00

03 Supplied until depletion

- Fornibile fino ad esaurimento delle scorte
- Fourni jusqu'à épuisement du stock
- Lieferbar solange vorrat reicht
- Suministrado hasta el stock termina

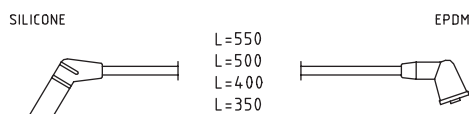

SUPPRESSION CABLE Ø 7 mm

HYUNDAI

ATOS 1.0 i	G4HC	02/98 ⇨ 03/02
ATOS PRIME 1.0 i	G4HC	08/99 ⇨

KW 358 159

07,5

IGNITION CABLE SETS

Adatt./Suitable:

00 Eliminated on 27-09-2021. Please verify the availability through our local distributors

- Eliminato il 27-09-2021. Verificare la disponibilità presso i nostri distributori
- Éliminé le 27-09-2021. Vérifier la disponibilité auprès de nos distributeurs sur place
- Am 27-09-2021 gestrichen. Evtl. Verfügbarkeit bitte bei unseren Händlern prüfen
- Eliminado en fecha 27-09-2021. Verificar la disponibilidad a través de nuestros distribuidores locales

03 Supplied until depletion

- Fornibile fino ad esaurimento delle scorte
- Fourni jusqu'à épuisement du stock
- Lieferbar solange vorrat reicht
- Suministrado hasta el stock termina

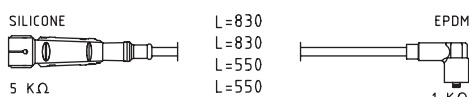

COPPER CORE CABLE Ø 7 mm

VW

TRANSPORTER III 1.9	DF, DG	08/82 ⇨ 07/92
TRANSPORTER III 1.9 Syncro	DG	11/84 ⇨ 07/92
TRANSPORTER III 2.1	DJ	08/84 ⇨ 07/92
TRANSPORTER III 2.1 Syncro	DJ	01/86 ⇨ 07/92

KW 358 170

07

IGNITION CABLE SETS

Adatt./Suitable:

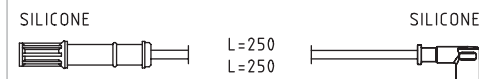
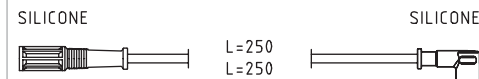

SUPPRESSION CABLE Ø 7 mm

ALFA ROMEO

MITO 1.4	04Y, 350A1.000, 955A9.000	08/08 ⇨
----------	---------------------------	---------

FIAT

500 1.2	169A4.000	07/07 ⇨
500 C 1.2	169A4.000	09/09 ⇨
PUNTO III EVO 1.2	169A4.000, 199A4.000	10/09 ⇨ 02/12
PUNTO III EVO 1.4	350A1.000, 858Y1	03/09 ⇨
PUNTO III EVO 1.4 LPG	350A1.000	06/09 ⇨ 02/12
PUNTO III EVO 1.4 Natural Power	350A1.000	10/09 ⇨ 02/12
500 MY12 1.2	--	01/12 ⇨
PUNTO III 1.2	169A4.000, 199B9.000	03/12 ⇨
PUNTO III 1.4	350A1.000	03/12 ⇨
PUNTO III 1.4 LPG	350A1.000	03/12 ⇨
PUNTO III 1.4 Natural Power	350A1.000	03/09 ⇨
FIORINO III 1.4	350A1.000, KFT, KVF	11/07 ⇨
FIORINO III 1.4 Natural Power	350A1.000	06/08 ⇨
DOBLO I 1.4	350A1.000	10/05 ⇨
PANDA III 1.2	169A4.000	02/12 ⇨
PANDA III 1.2 LPG	169A4.000	06/12 ⇨
IDEA 1.4	350A1.000	10/05 ⇨
LINEA 1.4	350A1.000	06/07 ⇨
PALIO 1.4	834A1.000	06/03 ⇨
PANDA II 1.2	169A4.000	03/10 ⇨
PANDA II 1.2 4x4	169A4.000	04/10 ⇨
PANDA II 1.2 Euro 5	--	04/09 ⇨
PANDA II 1.4 16V	--	11/10 ⇨
PANDA II 1.4 Natural Power	350A1.000	10/09 ⇨
PUNTO III / GRANDE PUNTO 1.2	169A4.000, 199A4.000	10/05 ⇨
PUNTO III / GRANDE PUNTO 1.2 [IND]	--	01/08 ⇨
PUNTO III / GRANDE PUNTO 1.2 Actual	--	09/09 ⇨
PUNTO III / GRANDE PUNTO 1.2 LPG	199A4.000	06/08 ⇨ 12/12
PUNTO III / GRANDE PUNTO 1.4	350A1.000, 858Y1	06/05 ⇨ 12/15
PUNTO III / GRANDE PUNTO 1.4 Actual	--	09/09 ⇨
PUNTO III / GRANDE PUNTO 1.4 LPG	350A1.000	12/08 ⇨
PUNTO III / GRANDE PUNTO 1.4 Natural Power	350A1.000	07/08 ⇨
QUBO 1.4	350A1.000, KFT, KVF	02/08 ⇨
QUBO 1.4 Natural Power	350A1.000	10/09 ⇨
500 MY15 1.2	--	01/15 ⇨
500 MY15 1.2 LPG	--	01/15 ⇨
SIENA 1.4	--	01/02 ⇨

FORD

KA II 1.2	FP4	10/08 ⇨ 05/16
-----------	-----	---------------

LANCIA

MUSA 1.4	350A1.000	09/05 ⇨ 09/12
MUSA 1.4 8V	--	01/11 ⇨ 12/12
YPSILON II 1.4	350A1.000	02/06 ⇨ 12/11
YPSILON II 1.4 LPG	350A1.000	11/10 ⇨ 12/11
YPSILON III 1.2	169A4.000	05/11 ⇨
YPSILON III 1.2 Bi-fuel	169A4.000	05/11 ⇨

KW 358 181

07,5

IGNITION CABLE SETS

Adatt./Suitable:

JEEP

4728190
4728190AC**00 Eliminated on 22-02-2022. Please verify the availability through our local distributors**

- Eliminato il 22-02-2022. Verificare la disponibilità presso i nostri distributori
- Éliminé le 22-02-2022. Vérifier la disponibilité auprès de nos distributeurs sur place
- Am 22-02-2022 gestrichen. Evtl. Verfügbarkeit bitte bei unseren Händlern prüfen
- Eliminado en fecha 22-02-2022. Verificar la disponibilidad a través de nuestros distribuidores locales

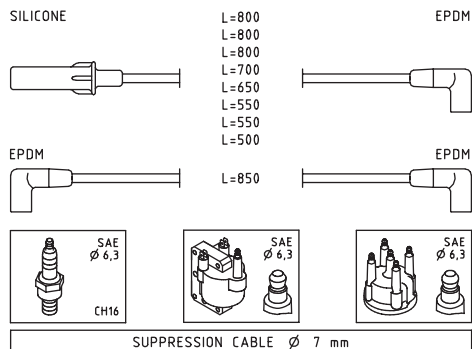

JEEP

GRAND CHEROKEE 5.2	ELF	10/96 ⇒ 09/98
GRAND CHEROKEE 5.2 4x4	ELF	10/96 ⇒ 09/98
GRAND CHEROKEE 5.2 i	EHY	10/90 ⇒ 09/96
GRAND CHEROKEE 5.9 i	EML	10/96 ⇒ 09/98

KW 358 195

07

IGNITION CABLE SETS

Adatt./Suitable:

00 Eliminated on 04-05-2020. Please verify the availability through our local distributors

- Eliminato il 04-05-2020. Verificare la disponibilità presso i nostri distributori
- Éliminé le 04-05-2020. Vérifier la disponibilité auprès de nos distributeurs sur place
- Am 04-05-2020 gestrichen. Evtl. Verfügbarkeit bitte bei unseren Händlern prüfen
- Eliminado en fecha 04-05-2020. Verificar la disponibilidad a través de nuestros distribuidores locales

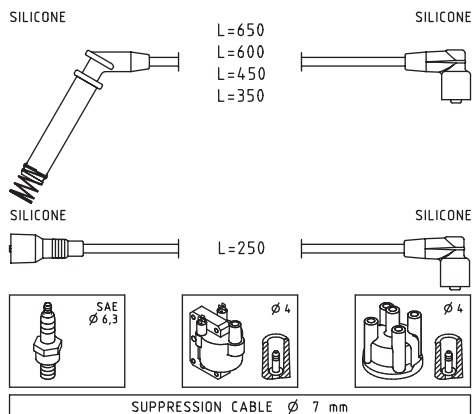

OPEL

COMBO B 1.2	C12NZ, X12SZ	07/94 ⇒ 10/01
COMBO B 1.4	C14NZ	07/94 ⇒ 10/01
CORSA B 1.2 i	12NZ, C12NZ, X12SZ	03/93 ⇒ 09/00
CORSA B 1.4 i	C14NZ	03/93 ⇒ 09/00

VAUXHALL

COMBO B 1.2	C12NZ, X12SZ	07/94 ⇒ 10/01
COMBO B 1.4	C14NZ	07/94 ⇒ 10/01

VAUXHALL

CORSA B 1.2 i	C12NZ, X12SZ	03/93 ⇒ 09/00
CORSA B 1.4 i	C14NZ	03/93 ⇒ 09/00
CORSAVAN I 1.4 i	C14NZ	01/94 ⇒ 09/00

KW 358 199

07

IGNITION CABLE SETS

Adatt./Suitable:

00 Eliminated on 22-02-2022. Please verify the availability through our local distributors

- Eliminato il 22-02-2022. Verificare la disponibilità presso i nostri distributori
- Éliminé le 22-02-2022. Vérifier la disponibilité auprès de nos distributeurs sur place
- Am 22-02-2022 gestrichen. Evtl. Verfügbarkeit bitte bei unseren Händlern prüfen
- Eliminado en fecha 22-02-2022. Verificar la disponibilidad a través de nuestros distribuidores locales

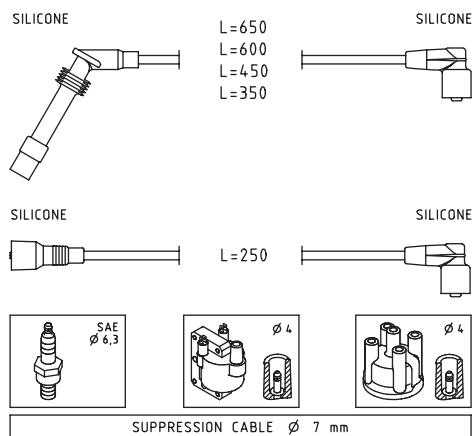

OPEL

COMBO B 1.2	C12NZ, X12SZ	07/94 ⇒ 10/01
COMBO B 1.4	C14NZ	07/94 ⇒ 10/01
CORSA B 1.2 i	12NZ, C12NZ, X12SZ	03/93 ⇒ 09/00
CORSA B 1.4 i	C14NZ	03/93 ⇒ 09/00

VAUXHALL

COMBO B 1.2	C12NZ, X12SZ	07/94 ⇒ 10/01
COMBO B 1.4	C14NZ	07/94 ⇒ 10/01
CORSA B 1.2 i	C12NZ, X12SZ	03/93 ⇒ 09/00
CORSA B 1.4 i	C14NZ	03/93 ⇒ 09/00
CORSAVAN I 1.4 i	C14NZ	01/94 ⇒ 09/00

KW 358 208

07

IGNITION CABLE SETS

Adatt./Suitable:

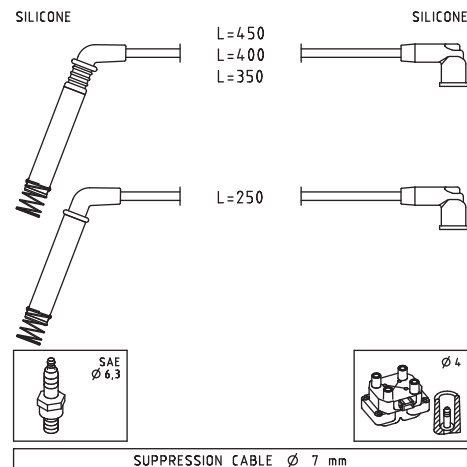

FORD

FIESTA V 1.3	A9JA, A9JB, BAJA	11/01 ⇒ 06/08
FOCUS I 1.6 16V Flexifuel	FYDH	01/02 ⇒ 11/04
FUSION 1.3	--, BAJA	08/02 ⇒
KA I 1.3 i	BAA	09/96 ⇒ 11/08
KA I 1.3 i ROCAM	A9A, A9B	08/02 ⇒ 11/08
KA I 1.6	CDB, CDC	09/00 ⇒ 11/08
KA I 1.6 i	CCA, CDB, CDC	02/01 ⇒ 11/08
STREET KA 1.6	CDRA, CDRB	05/03 ⇒ 07/05

KW 358 214

07,5

IGNITION CABLE SETS

Adatt./Suitable:

03 Supplied until depletion

- Fornibile fino ad esaurimento delle scorte
- Fourni jusqu'à épuisement du stock
- Lieferbar solange vorrat reicht
- Suministrado hasta el stock termina

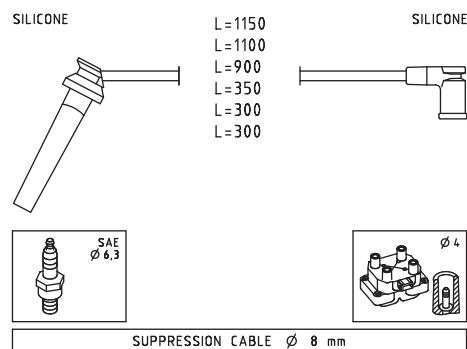

FORD

MONDEO II 3.0 V6 24V	REBA	09/04 ⇒ 03/07
MONDEO II ST220	MEBA	04/02 ⇒ 03/07

KW 358 223



07

IGNITION CABLE SETS

Adatt./Suitable:

VW

06A 905 409 N

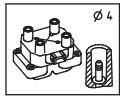
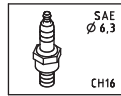
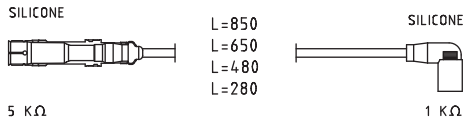

COPPER CORE CABLE Ø 7 mm

SKODA

OCTAVIA I 2.0	AZJ	04/99 ⇒ 05/07
OCTAVIA I 2.0 4x4	AZJ	08/00 ⇒ 09/04

VOLKSWAGEN (BR)

POLO 2.0	CFEA	01/09 ⇒
----------	------	---------

VW

BORA 2.0	AZJ	10/98 ⇒ 12/13
BORA 2.0 4motion	AZJ	04/00 ⇒ 05/05
CADDY III 2.0 EcoFuel	BSX	04/06 ⇒ 05/15
GOLF IV 2.0	AZG, AZJ	07/98 ⇒ 06/06
GOLF IV 2.0 4motion	AZJ	10/00 ⇒ 06/06
GOLF IV 2.0 Bi-Fuel	BEH	02/02 ⇒ 06/06
JETTA VI 2.0	CKJA	06/10 ⇒ 12/17
NEW BEETLE 2.0	AZG, AZJ, BDC, BEJ, BER, BEV, BGD, BHP	01/98 ⇒ 10/10
TOURAN I 2.0 EcoFuel	BSX	02/06 ⇒ 05/09

KW 358 229



07

IGNITION CABLE SETS

Adatt./Suitable:

RENAULT

82 00 575 895

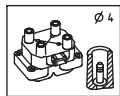
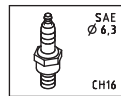
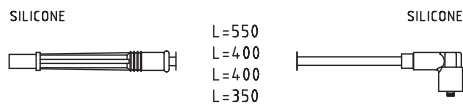

SUPPRESSION CABLE Ø 7 mm

RENAULT

CLIO III 1.2 16V	D4F784, D4F786	05/07 ⇒ 12/14
MODUS / GRAND MODUS 1.2	D4F786	04/11 ⇒
MODUS / GRAND MODUS 1.2 16V	D4F784	05/07 ⇒
TWINGO II 1.2 TcE 100	D4F780, D4F782	02/11 ⇒
TWINGO II 1.2 Turbo	D4F780, D4F782	03/07 ⇒ 09/14
WIND 1.2	D4F782	07/10 ⇒

KW 358 230



07

IGNITION CABLE SETS

Adatt./Suitable:

BOSCH

0 986 357 253

MAGNETI MARELLI

941318111315

NISSAN

22450-00Q0A

22450-00Q0C

22450-00QAA

RENAULT

82 00 486 877

82 00 805 133

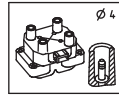
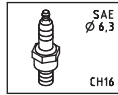
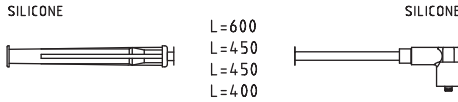

SUPPRESSION CABLE Ø 7 mm

NISSAN

KUBISTAR 1.2	D7F726, D7F744, D7F764	08/03 ⇒
--------------	------------------------	---------

RENAULT

TWINGO II 1.2	D7F800	03/07 ⇒ 09/14
---------------	--------	---------------

KW 358 231



07,5

IGNITION CABLE SETS

Adatt./Suitable:

SUZUKI

33700M70FA0

33700M70FA0-000

33710M70F30

33710M70F30-000

Eliminated on 22-02-2022. Please verify the availability through our local distributors

• Eliminato il 22-02-2022. Verificare la disponibilità presso i nostri distributori

• Éliminé le 22-02-2022. Vérifier la disponibilité auprès de nos distributeurs sur place

• Am 22-02-2022 gestrichen. Evtl. Verfügbarkeit bitte bei unseren Händlern prüfen

• Eliminado en fecha 22-02-2022. Verificar la disponibilidad a través de nuestros distribuidores locales

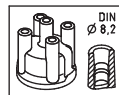
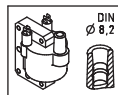
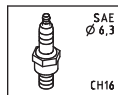
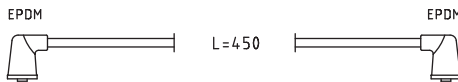
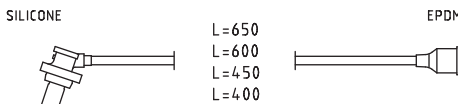

SUPPRESSION CABLE Ø 7 mm

SUZUKI

ALTO IV 1.0	G10BB	09/94 ⇒ 06/02
ALTO V 1.0	G10BB	01/00 ⇒ 06/02

KW 358 232



07

IGNITION CABLE SETS

Adatt./Suitable:

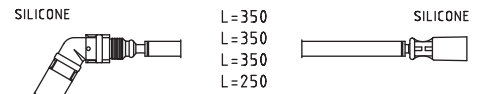

2 KΩ

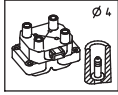
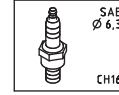

COPPER CORE CABLE Ø 7 mm

MERCEDES-BENZ

CLASSE A II A 200 TURBO	M266.980	09/05 ⇒ 06/12
CLASSE B I B 200 TURBO	M266.980	03/05 ⇒ 11/11

KW 358 234



07

IGNITION CABLE SETS

Adatt./Suitable:

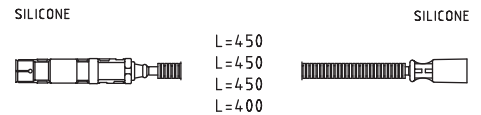

2 KΩ

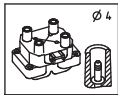
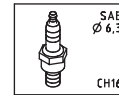

COPPER CORE CABLE Ø 7 mm

MERCEDES-BENZ

CLASSE A II A 150	M266.920	09/04 ⇒ 06/12
CLASSE A II A 160	M266.920	04/09 ⇒ 06/12
CLASSE A II A 170	M266.940	09/04 ⇒ 06/12
CLASSE A II A 180	M266.940	04/09 ⇒ 06/12
CLASSE A II A 200	M266.960	09/04 ⇒ 06/12
CLASSE B I B 150	M266.920	03/05 ⇒ 11/11
CLASSE B I B 160	M266.920	04/09 ⇒ 11/11
CLASSE B I B 170	M266.940	03/05 ⇒ 11/11
CLASSE B I B 170 NGT	M266.960	04/08 ⇒ 11/11
CLASSE B I B 180	M266.940	04/09 ⇒ 11/11
CLASSE B I B 180 NGT	M266.960	04/08 ⇒ 11/11
CLASSE B I B 200	M266.960	03/05 ⇒ 11/11

KW 358 235

07

IGNITION CABLE SETS

Adatt./Suitable:

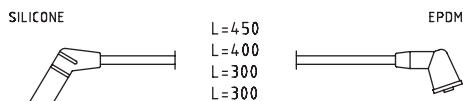
HYUNDAI
27501-02D00

SUPPRESSION CABLE Ø 7 mm

HYUNDAI

ATOS 1.0 i	G4HC, G4HC-E	03/01 ⇒ 07/03
ATOS PRIME 1.0 i	G4HC, G4HC-E	03/01 ⇒
GETZ 1.1	G4HD	09/02 ⇒ 06/09
I10 I 1.1	G4HG	12/07 ⇒ 12/13

KIA

PICANTO I 1.0	G4HE	09/07 ⇒ 04/11
PICANTO I 1.1	--	08/07 ⇒

KW 358 236

07,5

IGNITION CABLE SETS

Adatt./Suitable:

HYUNDAI
27501-37B00⁰³ Supplied until depletion

- Fornibile fino ad esaurimento delle scorte
- Fourni jusqu'à épuisement du stock
- Lieferbar solange vorrat reicht
- Suministrado hasta el stock termina

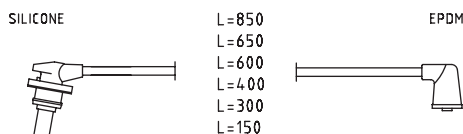

SUPPRESSION CABLE Ø 7 mm

HYUNDAI

SANTA FE I 2.7 V6 4x4	G6BA-G	02/01 ⇒ 03/06
COUPE II 2.7 V6	G6BA-G	01/01 ⇒ 08/09
TUCSON 2.7 Trazione integrale	G6BA-G	08/04 ⇒ 11/10

KIA

SPORTAGE II 2.7 V6 4WD	G6BA	09/04 ⇒
------------------------	------	---------

KW 358 239

07,5

IGNITION CABLE SETS

Adatt./Suitable:

HITACHI
134114⁰³ Supplied until depletion

- Fornibile fino ad esaurimento delle scorte
- Fourni jusqu'à épuisement du stock
- Lieferbar solange vorrat reicht
- Suministrado hasta el stock termina

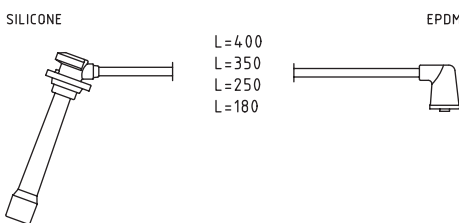
KIAOK30E-18140
OK30F-18140
27400-2X140

SUPPRESSION CABLE Ø 7 mm

KIA

RIO I 1.5 16V	A5D	08/00 ⇒ 02/05
RIO I 1.6 [CAN] [USA]	--	06/00 ⇒ 02/05
CARENS I 1.6	GA6D	07/02 ⇒
SHUMA I 1.6	GA6D	01/01 ⇒ 12/01
SHUMA II 1.6	GA6D	05/01 ⇒ 08/04
SPECTRA 1.6 i 16V	--	07/00 ⇒
SEPHIA 1.6 i 16V	--	07/00 ⇒

KW 358 241

07

IGNITION CABLE SETS

Adatt./Suitable:

BOSCH
0 986 356 991⁰³ Supplied until depletion

- Fornibile fino ad esaurimento delle scorte
- Fourni jusqu'à épuisement du stock
- Lieferbar solange vorrat reicht
- Suministrado hasta el stock termina

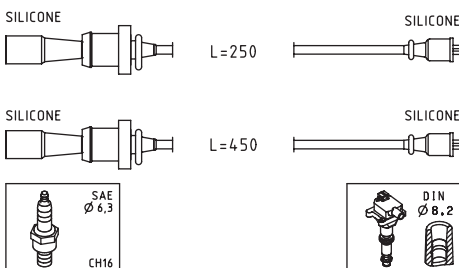
HITACHI
134376**HYUNDAI**
27501-38B00**KIA**
27501-38B00

SUPPRESSION CABLE Ø 7 mm

HYUNDAI

H-1 I 2.4	G4JS	11/01 ⇒ 04/04
HIGHWAY VAN 2.0 16V	G4JP	03/00 ⇒ 03/04
SANTA FE I 2.0	G4BP	08/01 ⇒ 03/06
SANTA FE I 2.4 16V	G4JS-G	02/01 ⇒ 03/06
SANTA FE I 2.4 16V 4x4	G4JS-G	02/01 ⇒ 03/06
SONATA IV 2.0 16V	G4JP-EG, G4JP-G	10/01 ⇒ 11/04
SONATA IV 2.4 16V	G4BS	03/98 ⇒ 10/01
SONATA V 2.0 [RUS]	--	01/05 ⇒ 04/06
TRAJET 2.0	G4GC, G4GC-G, G4JP-G	03/00 ⇒ 07/08
TRAJET 2.0 CRDi	D4EA	08/05 ⇒ 07/08

KIA

MAGENTIS I 2.0	G4JP	05/01 ⇒ 09/05
MAGENTIS I 2.4 [USA]	--	01/01 ⇒ 12/04

KW 358 242

07

IGNITION CABLE SETS

Adatt./Suitable:

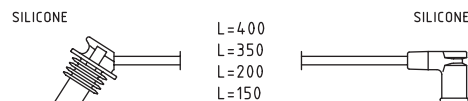
VOLVO
30731424

SUPPRESSION CABLE Ø 8 mm

FORD

B-MAX 1.4	SPJD	10/12 ⇒
B-MAX 1.4 LPG	RTJC	08/13 ⇒
B-MAX 1.6 Ti	IQJA	10/12 ⇒
C-MAX I 1.6	HWDA, HWDB, SHDA, SHDB, SHDC	02/07 ⇒ 09/10
C-MAX I 1.6 Ti-VCT	--	03/07 ⇒
C-MAX II 1.6	--	12/10 ⇒
C-MAX II 1.6 Ti	IQDA, IQDB, PNDA, XTDA	12/10 ⇒ 06/19
FIESTA V 1.25 16V	FUJA, FUJB, M7JA, M7JB	05/02 ⇒ 06/08
FIESTA V 1.4 16V	FXJA, FXJB	11/01 ⇒ 06/08
FIESTA V 1.6 16V	FYJA, FYJB	11/01 ⇒ 06/08
FIESTA VI 1.25	SNJA, SNJB, SNJC, SNJD, STJA, STJB	06/08 ⇒

FIESTA VI 1.4	--, 8MA1.77, SPJC	06/08 ⇒
FIESTA VI 1.4 LPG	RTJA, RTJB	01/09 ⇒ 04/17
FIESTA VI 1.6 Ti	--, 68GR-FKS, HXJB, IQJA, USJA	06/08 ⇒

FOCUS II 1.4	ASDA, ASDB	07/04 ⇒ 09/12
FOCUS II 1.6	HWDA, HWDB, SHDA, SHDB, SHDC	07/04 ⇒ 09/12

FOCUS II 1.6 Ti	HXDA, HXDB	07/04 ⇒ 09/12
FOCUS II 1.6 Ti-VCT	--	12/07 ⇒
FOCUS III 1.6 Flexifuel	MUDA	07/10 ⇒
FOCUS III 1.6 LPG	MUDA	02/12 ⇒
FOCUS III 1.6 Ti	IQDB, MUDA, PNDA, XTDA	07/10 ⇒
FOCUS III 1.6 Ti-VCT	--	07/10 ⇒

FOCUS C-MAX 1.6	HWDA, HWDB	10/03 ⇒ 03/07
FOCUS C-MAX 1.6 Ti	HXDA, SIDA	08/04 ⇒ 03/07
FUSION 1.25	--, FUJA, FUJB	10/02 ⇒
FUSION 1.4	--, FXJA, FXJB, FXJC	08/02 ⇒
FUSION 1.4 LPG	UTJA	01/10 ⇒ 12/12
FUSION 1.6	FYJA, FYJB, FYJC	08/02 ⇒ 11/09
GRAND C-MAX 1.6 Ti	IQDA, IQDB, PNDA	12/10 ⇒ 06/19
KA+ 1.2	B2KA	06/16 ⇒
KA+ 1.2 Ti-VCT	YSKD, YSKE	06/16 ⇒
MONDEO III 1.6 Ti	KGBA, PNBA, RHBA	03/07 ⇒ 01/15

MAZDA

2 I 1.2	FUJA	02/03 ⇒ 06/07
2 I 1.25	FUJA	04/03 ⇒ 06/07
2 I 1.3 L	ZJ-04	04/03 ⇒ 06/07
2 I 1.4	FXJA	02/03 ⇒ 06/07
2 I 1.5	ZY-VE	04/03 ⇒ 06/07
2 I 1.6	FYJA	02/03 ⇒ 06/07

VOLVO

C30 1.6	B416453	10/06 ⇒ 12/12
S40 II 1.6	B416453	01/05 ⇒ 12/12
V50 1.6	B416453	01/05 ⇒ 12/12

KW 358 244



07

IGNITION CABLE SETS

Adatt./Suitable:

BOSCH

0 986 MG0 980

DACIA

77 00 273 826
82 00 506 297

MAGNETI MARELLI

941318111002

NISSAN

22450-00Q0B
22450-00QAB

RENAULT

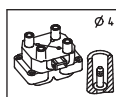
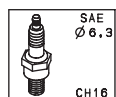
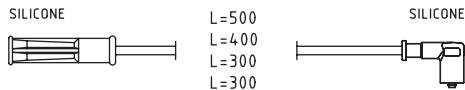
77 00 273 826
82 00 506 297

SUPPRESSION CABLE Ø 7 mm

DACIA

LOGAN I 1.4	K7J710	09/04 ⇒
LOGAN I 1.6	K7M710	09/04 ⇒
LOGAN I 1.6 Bifuel	K7M710	11/08 ⇒
SANDERO I 1.4	K7J710	06/08 ⇒

NISSAN

KUBISTAR 1.4	K7J700	08/03 ⇒ 10/09
--------------	--------	---------------

RENAULT

CLIO II 1.4	E7J634, E7J635, K7J700	09/98 ⇒
CLIO II 1.6	K7M746	10/99 ⇒
KANGOO I 1.4	E7J634, E7J635, K7J700, K7J701	08/97 ⇒
KANGOO I 1.6	K7M746	09/99 ⇒
LOGAN 1.4	K7J710	09/04 ⇒
LOGAN 1.6	K7M710	09/04 ⇒
MEGANE I 1.4	E7J626	09/96 ⇒ 08/03
MEGANE I 1.4 e	E7J626	01/96 ⇒ 08/03
MEGANE I 1.6	K7M704	02/00 ⇒ 09/00
MEGANE I 1.6 e	K7M702, K7M703	01/96 ⇒ 08/03
MEGANE I 1.6 i	K7M720	01/96 ⇒ 03/99
MEGANE SCÉNIC I 1.6 e	K7M702, K7M703	10/96 ⇒ 10/99
MEGANE SCÉNIC I 1.6 i	K7M720	01/97 ⇒ 09/99
SANDERO I 1.4	K7J710	02/09 ⇒
SANDERO I 1.6	K7M710	02/09 ⇒

KW 358 245



07

IGNITION CABLE SETS

Adatt./Suitable:

HITACHI

134955

MAGNETI MARELLI

941318111320

MAZDA

L813-18-140B
L813-18-140C

03 Supplied until depletion

- Fornibile fino ad esaurimento delle scorte
- Fourni jusqu'à épuisement du stock
- Lieferbar solange vorrat reicht
- Suministrado hasta el stock termina

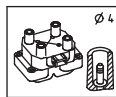
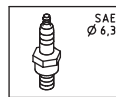
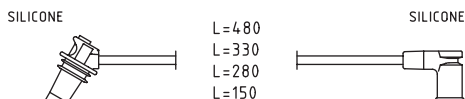

SUPPRESSION CABLE Ø 8 mm

MAZDA

611.8	L813, L823, L828	08/02 ⇒ 08/07
612.0	LF17, LF18	06/02 ⇒ 08/07
612.3	L3C1	01/02 ⇒ 02/08
612.3 AWD	L3C1	11/02 ⇒ 08/07

MAZDA

MPV II 2.3

L3

07/02 ⇒ 02/06

KW 358 246



07

IGNITION CABLE SETS

Adatt./Suitable:

BOSCH

F 000 99C 602

DACIA

82 00 713 680

NISSAN

24488-00QAA

RENAULT

82 00 713 680

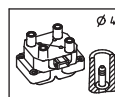
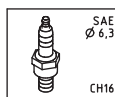
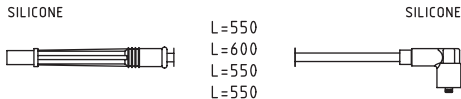

SUPPRESSION CABLE Ø 7 mm

DACIA

LOGAN I 1.0	D4D760	12/05 ⇒
LOGAN I 1.2 16V	D4F732	02/06 ⇒
SANDERO I 1.2 16V	D4F732	11/08 ⇒
SANDERO I 1.2 16V LPG	D4F732	11/08 ⇒

NISSAN

KUBISTAR 1.2 16V	D4F712, D4F730	04/06 ⇒
------------------	----------------	---------

RENAULT

CLIO II 1.2 16V	D4F722, D4F728	06/01 ⇒ 08/16
CLIO III 1.2	D4F764	10/05 ⇒ 12/12
CLIO III 1.2 16V	D4F740, D4F744, D4F764	06/05 ⇒
CLIO III 1.2 16V Hi-Flex	D4F740, D4F742	07/08 ⇒ 12/14
CLIO IV 1.2 16V	D4F744	11/12 ⇒
LOGAN 1.0	D4D760	12/05 ⇒
LOGAN 1.2 16V	D4F732	02/06 ⇒
MODUS / GRAND MODUS 1.2	D4F740, D4F742, D4F764	12/04 ⇒
MODUS / GRAND MODUS 1.2 16V Hi-Flex	D4F740	10/08 ⇒
SANDERO I 1.2 16V	D4F732	11/08 ⇒
THALIA I 1.2i 16V	D4F728	04/04 ⇒
TWINGO I 1.2 16V	D4F708	08/04 ⇒ 06/07
TWINGO II 1.2 16V	D4F764, D4F770, D4F772	03/07 ⇒

KW 358 247



07

IGNITION CABLE SETS

Adatt./Suitable:

03 Supplied until depletion

- Fornibile fino ad esaurimento delle scorte
- Fourni jusqu'à épuisement du stock
- Lieferbar solange vorrat reicht
- Suministrado hasta el stock termina

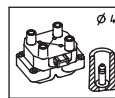
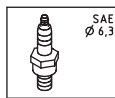
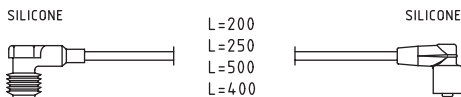

COPPER CORE CABLE Ø 7 mm

CHEVROLET

CAPTIVA 2.4	Z24SED	06/06 ⇒
CAPTIVA 2.4 4WD	Z24SED	06/06 ⇒ 02/11
CAPTIVA 2.4 LPG	Z24SED	01/07 ⇒
CAPTIVA 2.4 LPG 4WD	Z24SED	01/07 ⇒ 02/11

KW 358 248



07

IGNITION CABLE SETS

Adatt./Suitable:

SKODA

03F 905 409 A
03F 905 409 B
03F 905 409 C

VW

03F 905 409 B

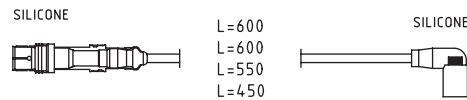

5 KΩ

1 KΩ

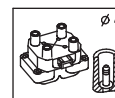
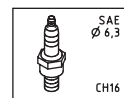

COPPER CORE CABLE Ø 7 mm

AUDI

A1 1.2 TFSI	CBZA	05/10 ⇒ 04/15
A3 II 1.2 TFSI	CBZB	03/10 ⇒ 05/13
A3 II 1.2 TSI	CBZB	04/10 ⇒ 03/13

SEAT

ALTEA 1.2 TSI	CBZB	04/10 ⇒
ALTEA XL 1.2 TSI	CBZB	04/10 ⇒
IBIZA IV 1.2 TSI	CBZA, CBZB	09/10 ⇒ 05/15
LEON II 1.2 TSI	CBZB	02/10 ⇒ 12/12
TOLEDO IV 1.2 TSI	CBZA, CBZB	07/12 ⇒ 06/15

SKODA

OCTAVIA II 1.2 TSI	CBZB	02/10 ⇒ 06/13
FABIA II 1.2 TSI	CBZA, CBZB	03/10 ⇒ 12/14
YETI 1.2 TSI	CBZB	09/09 ⇒ 05/15

VW

GOLF VI 1.2 TSi	CBZA, CBZB	11/08 ⇒
BEETLE 1.2 TSI	CBZB	07/11 ⇒ 07/19
CADDY III 1.2 TSI	CBZA, CBZB	09/10 ⇒ 05/15
JETTA VI 1.2 TSI	CBZB	10/10 ⇒ 12/17
POLO V 1.2 TSI	CBZB, CBZC	11/09 ⇒
TOURAN I 1.2 TSI	CBZB	05/10 ⇒ 05/15

KW 358 249



07

IGNITION CABLE SETS

Adatt./Suitable:

CHEVROLET

25183557
96651945
96984145

GENERAL MOTORS

25 183 557
96 984 145

HITACHI

134375

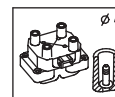
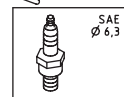
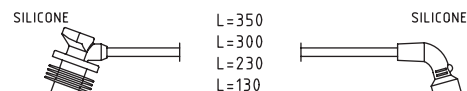

SUPPRESSION CABLE Ø 7 mm

CHEVROLET

AVEO I 1.2	B12D1, LMU	01/08 ⇒
AVEO I 1.2 LPG	B12D1, LMU	04/08 ⇒
AVEO I 1.5	LX6	05/05 ⇒
SPARK III 1.0	B10D1	03/10 ⇒
SPARK III 1.0 LPG	B10D1, LMT	03/10 ⇒
SPARK III 1.2	B12D1, LMU, Z12XE	03/10 ⇒
SPARK III 1.2 LPG	B12D1, LMU	03/10 ⇒

KW 358 251

05

IGNITION CABLE SETS

Adatt./Suitable:

HITACHI
134377MITSUBISHI
MD343245

03 Supplied until depletion

- Fornibile fino ad esaurimento delle scorte
- Fourni jusqu'à épuisement du stock
- Lieferbar solange vorrat reicht
- Suministrado hasta el stock termina

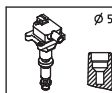
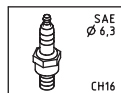
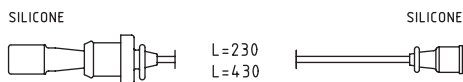
SUPPRESSION CABLE \varnothing 5 mm

MITSUBISHI

LANCER VII 2.0 16V EVO IV	4G63Turbo	08/96 \Rightarrow 06/97
LANCER VII EVO V	4G63Turbo	01/98 \Rightarrow 12/98
LANCER VII EVO VI	4G63Turbo	01/99 \Rightarrow 02/01
LANCER VIII 2.0	4G63(DOHC16V), 4G63-7	09/03 \Rightarrow
OUTLANDER I 2.0	4G63(DOHC16V)	05/03 \Rightarrow 10/06
OUTLANDER I 2.0 4WD	4G63(DOHC16V)	05/03 \Rightarrow 10/06
OUTLANDER I 2.0 Turbo 4WD	4G63-T(DOHC16V)	04/04 \Rightarrow 10/06
OUTLANDER I 2.0 Turbo-R 4WD	4G63Turbo	01/02 \Rightarrow 10/06

KW 358 252

05

IGNITION CABLE SETS

Adatt./Suitable:

BOSCH

0 986 357 256

DACIA

22 44 042 52R
82 00 943 801

RENAULT

82 00 943 801

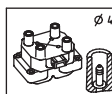
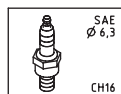
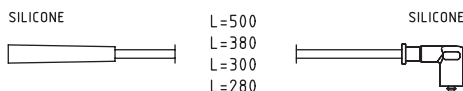
SUPPRESSION CABLE \varnothing 7 mm

DACIA

DOKKER 1.6	K7M812, K7M828	11/12 \Rightarrow
DOKKER 1.6 LPG	K7M812, K7M828	11/13 \Rightarrow
LODGY 1.6	K7M812, K7M828	03/12 \Rightarrow
LODGY 1.6 LPG	K7M812, K7M828	11/13 \Rightarrow
LOGAN I 1.4	K7J710	09/04 \Rightarrow
LOGAN I 1.4 MPI LPG	K7J710	02/06 \Rightarrow 12/12
LOGAN I 1.6	K7M710, K7M714	09/04 \Rightarrow
LOGAN I 1.6 Bifuel	K7M710	11/08 \Rightarrow
LOGAN I 1.6 MPI 85	K7M800	05/10 \Rightarrow
LOGAN II 1.6 16V	K7M764, K7M812	10/12 \Rightarrow
SANDERO I 1.4	K7J710	06/08 \Rightarrow
SANDERO I 1.6	K7M710, K7M718	06/08 \Rightarrow
SANDERO I 1.6 MPI 85	K7M800	05/10 \Rightarrow 06/13
SANDERO II 1.6	K7M812	11/12 \Rightarrow
SANDERO II 1.6 I	K7M764	10/12 \Rightarrow

RENAULT

KANGOO II 1.6	K7M750	02/08 \Rightarrow
LOGAN 1.4	K7J710	09/04 \Rightarrow
LOGAN 1.6	K7M710	09/04 \Rightarrow
LOGAN 1.6 MPI 85	K7M800	05/10 \Rightarrow
SANDERO I 1.4	K7J710	02/09 \Rightarrow

RENAULT

SANDERO I 1.6	K7M710	12/07 \Rightarrow
SANDERO I 1.6 MPI 85	K7M800	05/10 \Rightarrow
THALIA I 1.4	K7J700	05/00 \Rightarrow
THALIA I 1.6	K7M730, K7M734	01/01 \Rightarrow
THALIA II 1.4	K7J700	09/08 \Rightarrow 06/14

KW 358 255

07

IGNITION CABLE SETS

Adatt./Suitable:

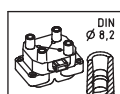
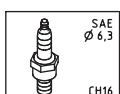
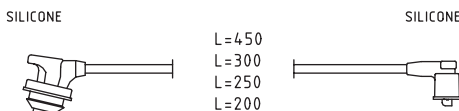
SUPPRESSION CABLE \varnothing 7 mm

HYUNDAI

I20 II 1.2	G4LA	11/14 \Rightarrow
I10 I 1.2	G4LA	11/08 \Rightarrow 12/13
I10 II 1.2	G4LA	12/13 \Rightarrow
I20 I 1.2	G4LA	09/08 \Rightarrow 12/15

KW 359 347

05

IGNITION CABLE SETS

Adatt./Suitable:

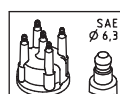
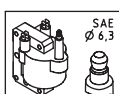
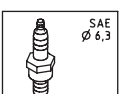
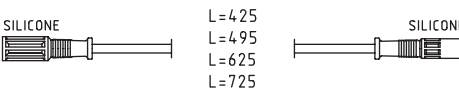
SUPPRESSION CABLE \varnothing 7 mm

FIAT

FIORINO II 1.0 iE	156A2.246	11/92 \Rightarrow 04/96
PALIO 1.1	178B9.033	07/97 \Rightarrow 10/03
PANDA I 1.1	156C.046	05/91 \Rightarrow 03/95
PANDA I 1000	156A2.100, 156A2.100, 156A3.000	01/85 \Rightarrow
PANDA I 1000 4x4	156A2.100, 156A2.246, 156A3.000	01/86 \Rightarrow 12/94
PANDA I 1000 CLX	156A2.000	05/91 \Rightarrow 12/94
PANDA I 1000 Fire	156A2.000	05/86 \Rightarrow 04/91
PANDA I 1000 Fire [CHE]	156A2.146	11/87 \Rightarrow 04/91
PANDA I 1000 Fire [DEU]	156A2.048	01/86 \Rightarrow 07/89
PANDA I 1000 i.e	156A2.246	08/92 \Rightarrow 02/04
PANDA I 1000 i.e. Cat	156A2.246	10/87 \Rightarrow 08/98
PANDA I 1100 Trekking 4x4	156C.046	10/91 \Rightarrow 07/04
PANDA I 750	156A4.000	01/86 \Rightarrow 10/03
PANDA I 750 Cat	156A4.048	01/95 \Rightarrow 10/03
PANDA I 750 Fire	156A4.048	11/88 \Rightarrow 04/91
TIPO I 1.1	160A3.000	01/88 \Rightarrow 10/91
UNO 45 1.0	156A2.000, 156A2.100	06/86 \Rightarrow 12/93
UNO 45 1.0 Fire	--	01/83 \Rightarrow 12/89
UNO 45 i.e. 1.0	156A2.246	10/84 \Rightarrow 10/95
UNO 50 1.1	156C.046	01/90 \Rightarrow 12/93

FIAT

UNO 50 i.e. 1.1	146C3.000	06/92 \Rightarrow 12/93
UNO 60 1.1	160A3.000	04/89 \Rightarrow 12/92
UNO Mondo 1.0	146A2.166	01/98 \Rightarrow
UNO Mondo 1.0 [IND]	146A2.166	01/98 \Rightarrow

LANCIA

Y10 1.0 Fire	156A2.100	06/85 \Rightarrow 06/91
Y10 1.0 Fire Catalytic-Conv	156A2.246	10/87 \Rightarrow 02/92
Y10 1.0 Fire Trazione integrale	156A2.000, 156A2.100	12/86 \Rightarrow 02/90
Y10 1.1 i.e Fire	156C.000	08/89 \Rightarrow 06/92
Y10 1.1 i.e. Fire	156C.046	07/89 \Rightarrow 09/95

KW 359 351

05

IGNITION CABLE SETS

Adatt./Suitable:

FIAT

7619338

03 Supplied until depletion

- Fornibile fino ad esaurimento delle scorte
- Fourni jusqu'à épuisement du stock
- Lieferbar solange vorrat reicht
- Suministrado hasta el stock termina

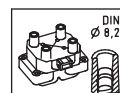
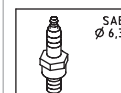
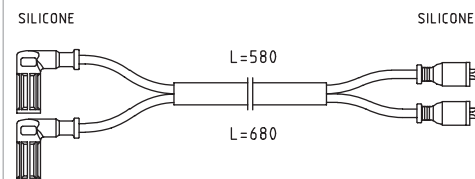
SUPPRESSION CABLE \varnothing 7 mm

FIAT

126 700	126A2.000, 126A2.048	09/87 \Rightarrow 06/96
---------	----------------------	---------------------------

KW 359 354

07

IGNITION CABLE SETS

Adatt./Suitable:

03 Supplied until depletion

- Fornibile fino ad esaurimento delle scorte
- Fourni jusqu'à épuisement du stock
- Lieferbar solange vorrat reicht
- Suministrado hasta el stock termina

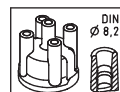
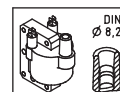
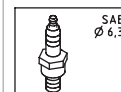
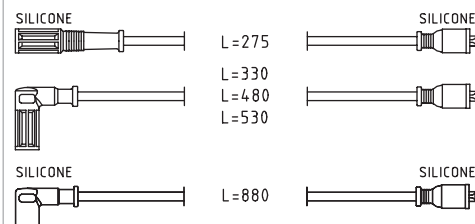
SUPPRESSION CABLE \varnothing 7 mm

FIAT

REGATA 1.1 60, 60 L	138B.000	10/83 \Rightarrow 08/86
REGATA 70 1.3	138B2.000, 149A3.000	09/83 \Rightarrow 07/89
TEMPRA 1.4 i.e.	159A2.000	04/90 \Rightarrow 08/96
TIPO I 1.4	160A1.000	07/87 \Rightarrow 12/89
TIPO I 1.4 i.e.	159A2.000	05/89 \Rightarrow 04/95
UNO 55 1.1	138B.000	01/83 \Rightarrow 08/89
UNO 60 1.1	146A4.048	02/88 \Rightarrow 02/92
UNO 60 1.1 SX	--	01/83 \Rightarrow 12/85
UNO 70 1.3	138B2.000	01/83 \Rightarrow 04/85

LANCIA

DELTA I 1.1	831B8.000	01/86 \Rightarrow 12/90
DELTA I 1.3	1831B.000, 3831B.000, 831A2.000, 831B.000	09/79 \Rightarrow 10/92
DELTA I 1.5	831A1.000, 831B1.000	09/79 \Rightarrow 12/92

LANCIA

PRISMA 1.3 831A2.000 01/83 ⇒ 12/89

KW 359 372

07,5

IGNITION CABLE SETS

Adatt./Suitable:

03 Supplied until depletion

- Fornibile fino ad esaurimento delle scorte
- Fourni jusqu'à épuisement du stock
- Lieferbar solange vorrat reicht
- Suministrado hasta el stock termina

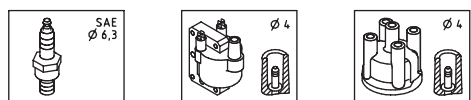
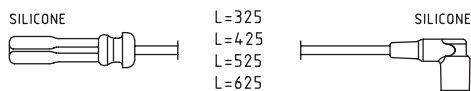

SUPPRESSION CABLE Ø 7 mm

VOLVO

960 I 2.3	B230GT	08/90 ⇒ 07/94
960 I 2.3 Turbo	B230FT	09/90 ⇒ 08/93
740 2.0	B200E, B200ET, B200G	01/85 ⇒ 07/92
740 2.0 Turbo	B200ET, B200FT	09/87 ⇒ 08/91
740 2.3	B230E, B230F, B230FB, B230G, B230K	08/84 ⇒ 12/92
740 2.3 GL	B230E	08/84 ⇒ 08/87
740 2.3 Turbo	B230ET, B230FT, B230GT	08/85 ⇒ 08/91
760 2.3	B230ET, B230FT, B230K	08/84 ⇒ 07/92
760 2.3 Turbo	B230ET, B230FT, B230GT	08/84 ⇒ 08/90
940 I 2.0	B200E, B200F, B200G	08/90 ⇒ 07/94
940 I 2.0 Turbo	B200FT	08/90 ⇒ 07/95
940 I 2.3	B230E, B230F, B230FB, B230FD, B230G	08/90 ⇒ 07/95
940 I 2.3 Turbo	B230FT	08/90 ⇒ 07/94
940 II 2.0 GLT	B200GT	10/94 ⇒ 05/97
940 II 2.0 Turbo	B200FT	04/96 ⇒ 10/98
940 II 2.3	B230FD, B230GK	08/94 ⇒ 05/97
940 II 2.3 ti	B230FK	01/95 ⇒ 10/98
940 II 2.3 Turbo	B230FT, B230GK	08/94 ⇒ 12/98

KW 359 386

07

IGNITION CABLE SETS

Adatt./Suitable:

03 Supplied until depletion

- Fornibile fino ad esaurimento delle scorte
- Fourni jusqu'à épuisement du stock
- Lieferbar solange vorrat reicht
- Suministrado hasta el stock termina

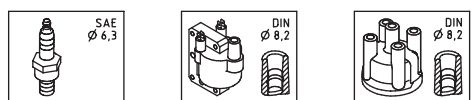
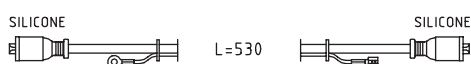
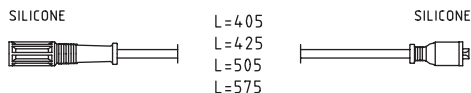

SUPPRESSION CABLE Ø 7 mm

FIAT

PANDA I 800	100GL6.000	02/81 ⇒ 12/85
PANDA I 950	A112B1.054	09/82 ⇒ 08/83
UNO 45 0.9 Trend	146A.048	09/89 ⇒ 09/92

PEUGEOT

309 II 1.4	TU3F2	07/91 ⇒ 12/93
------------	-------	---------------

KW 359 398

05

IGNITION CABLE SETS

Adatt./Suitable:

03 Supplied until depletion

- Fornibile fino ad esaurimento delle scorte
- Fourni jusqu'à épuisement du stock
- Lieferbar solange vorrat reicht
- Suministrado hasta el stock termina

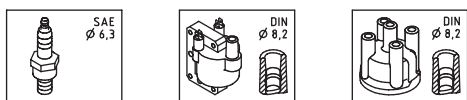
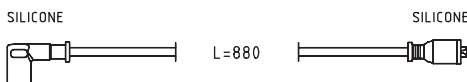
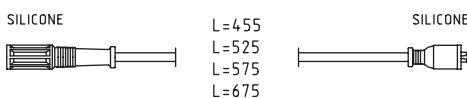

SUPPRESSION CABLE Ø 7 mm

FIAT

CROMA I 2000 CHT	154A1.000, 154C5.000	01/91 ⇒ 09/92
CROMA I 2000 i.e.	154C3.000, 154C3.046, 834B.048, 834B.146	03/86 ⇒ 12/96
CROMA I 2000 i.e. Turbo	154A2.000, 154C4.000, 154C4.046, 834C.146	12/85 ⇒ 08/96
TEMPRA 1.8 4x4	159A4.000	07/92 ⇒ 06/93
TEMPRA 1.8 i.e.	159A4.000, 159A4.046	03/90 ⇒ 08/96

LANCIA

DELTA I 1.6 GT i.e.	831B7.000	08/86 ⇒ 08/88
PRISMA 1.6	831B6.000	08/86 ⇒ 02/92
THEMA 2000 i.e.	834B1.000	09/88 ⇒ 05/92
THEMA 2000 i.e.	834B.146	09/87 ⇒ 05/92
THEMA 2000 i.e. Turbo	834C.146	07/86 ⇒ 05/90
THEMA 2000 Turbo	834C.146	12/88 ⇒ 03/92

KW 359 415

07

IGNITION CABLE SETS

Adatt./Suitable:

00 Eliminated on 22-02-2021. Please verify the availability through our local distributors

- Eliminato il 22-02-2021. Verificare la disponibilità presso i nostri distributori
- Éliminé le 22-02-2021. Vérifier la disponibilité auprès de nos distributeurs sur place
- Am 22-02-2021 gestrichen. Evtl. Verfügbarkeit bitte bei unseren Händlern prüfen
- Eliminado en fecha 22-02-2021. Verificar la disponibilidad a través de nuestros distribuidores locales

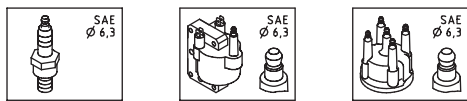
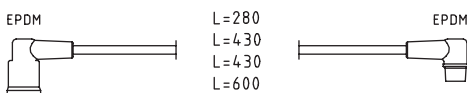

SUPPRESSION CABLE Ø 7 mm

RENAULT

19 I 1.7	F3N746	08/88 ⇒ 12/92
19 II 1.7	F3N743, F3N746	04/92 ⇒ 12/95
CLIO I 1.7	F2N770	01/91 ⇒ 12/93

VOLVO

440 1.6	B16F	09/88 ⇒ 12/96
440 1.7	B18E, B18EP, B18F, B18FP, B18K, B18KD, B18KP, B18KPD	08/88 ⇒ 12/96

VOLVO

440 1.8	B18U	08/91 ⇒ 12/96
440 2.0	B20F	08/92 ⇒ 07/96
460 1.6	B16F	07/92 ⇒ 07/96
460 1.7	B18EP, B18FP, B18K, B18KD, B18KP	09/88 ⇒ 07/96
460 1.8	B18U	08/91 ⇒ 07/96
460 2.0	B20F	08/92 ⇒ 07/96
480 1.7	B18E, B18ED, B18EP, B18F, B18FP	04/86 ⇒ 07/96
480 2.0	B20F	08/92 ⇒ 09/95

KW 359 417

07

IGNITION CABLE SETS

Adatt./Suitable:

00 Eliminated on 14-04-2020. Please verify the availability through our local distributors

- Eliminato il 14-04-2020. Verificare la disponibilità presso i nostri distributori
- Éliminé le 14-04-2020. Vérifier la disponibilité auprès de nos distributeurs sur place
- Am 14-04-2020 gestrichen. Evtl. Verfügbarkeit bitte bei unseren Händlern prüfen
- Eliminado en fecha 14-04-2020. Verificar la disponibilidad a través de nuestros distribuidores locales

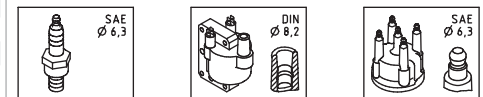
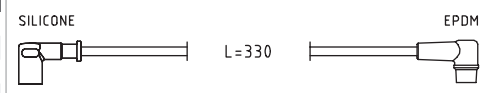
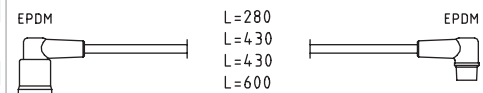

SUPPRESSION CABLE Ø 7 mm

VOLVO

440 1.7 Turbo	B18FT	08/88 ⇒ 12/96
460 1.7 Turbo	B18FT	08/89 ⇒ 07/96
480 1.7 Turbo	B18FT	08/87 ⇒ 07/96

KW 359 429

07

IGNITION CABLE SETS

Adatt./Suitable:

FIAT

4261590

00 Eliminated on 18-11-2019. Please verify the availability through our local distributors

- Eliminato il 18-11-2019. Verificare la disponibilità presso i nostri distributori
- Éliminé le 18-11-2019. Vérifier la disponibilité auprès de nos distributeurs sur place
- Am 18-11-2019 gestrichen. Evtl. Verfügbarkeit bitte bei unseren Händlern prüfen
- Eliminado en fecha 18-11-2019. Verificar la disponibilidad a través de nuestros distribuidores locales

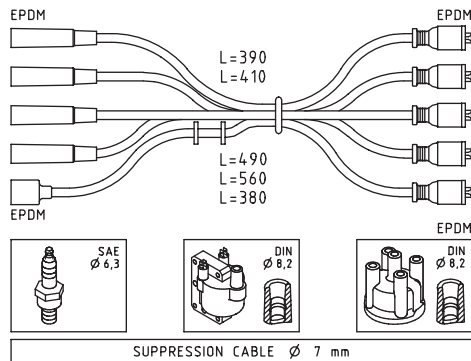

FIAT

127 0.9

100GL.000, 100GL.048

06/71 ⇒ 12/84

KW 359 432

07

IGNITION CABLE SETS

Adatt./Suitable:

FIAT

7540530

MAGNETI MARELLI

941094040575

03 Supplied until depletion

- Fornibile fino ad esaurimento delle scorte
- Fourni jusqu'à épuisement du stock
- Lieferbar solange vorrat reicht
- Suministrado hasta el stock termina

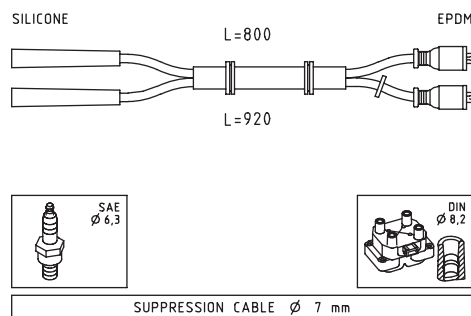

FIAT

126 650

126A1.048

07/77 ⇒ 09/87

KW 359 456

07

IGNITION CABLE SETS

Adatt./Suitable:

BOSCH

0 986 356 709

FIAT

7625943

7742689

LANCIA

7625943

7742689

00 Eliminated on 19-01-2021. Please verify the availability through our local distributors

- Eliminato il 19-01-2021. Verificare la disponibilità presso i nostri distributori
- Éliminé le 19-01-2021. Vérifier la disponibilité auprès de nos distributeurs sur place
- Am 19-01-2021 gestrichen. Evtl. Verfügbarkeit bitte bei unseren Händlern prüfen
- Eliminado en fecha 19-01-2021. Verificar la disponibilidad a través de nuestros distribuidores locales

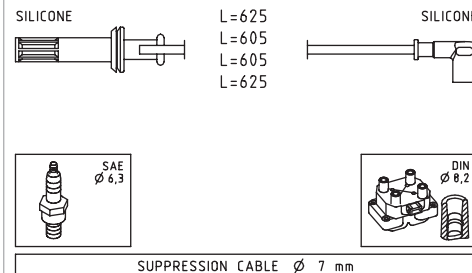

FIAT

COUPE 2.0 16V Turbo

175A1.000

11/93 ⇒ 08/96

LANCIA

DELTA II 2.0 16V Turbo

175A4.000, 836A2.000

06/93 ⇒ 08/99

THEMA 2000 16V Turbo

834C1.000

12/88 ⇒ 06/90

THEMA 2000 i.e. 16V

834B2.000, 834B2.246

05/88 ⇒ 08/92

THEMA 2000 i.e. 16V Turbo

834C1.000, 834C1.246

12/88 ⇒ 03/93

KW 359 466

07

IGNITION CABLE SETS

Adatt./Suitable:

03 Supplied until depletion

- Fornibile fino ad esaurimento delle scorte
- Fourni jusqu'à épuisement du stock
- Lieferbar solange vorrat reicht
- Suministrado hasta el stock termina

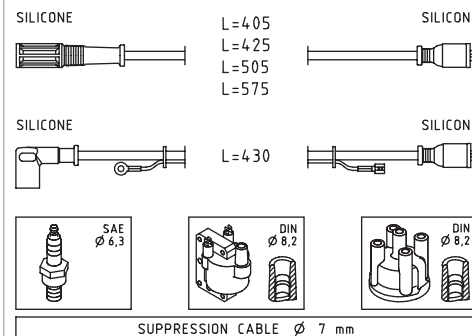

FIAT

PANDA I 750

141B.000

01/86 ⇒ 01/95

PANDA I 900

100GL3.000

10/80 ⇒ 06/94

PANDA I 900 CL

146A.048

01/86 ⇒ 12/92

KW 359 471

07

IGNITION CABLE SETS

Adatt./Suitable:

03 Supplied until depletion

- Fornibile fino ad esaurimento delle scorte
- Fourni jusqu'à épuisement du stock
- Lieferbar solange vorrat reicht
- Suministrado hasta el stock termina

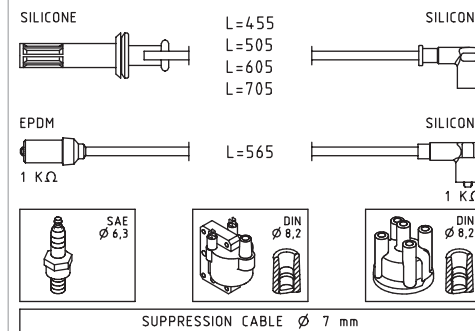

LANCIA

DELTA I 2.0 16V HF Evo

831E5.000

06/93 ⇒ 01/94

Integrale

DELTA I 2.0 16V HF Integrale

831D5.000

03/89 ⇒ 09/91

DELTA I 2.0 HF Integrale

831C5.046

12/86 ⇒ 12/92

KW 359 491

08

IGNITION CABLE SETS

Adatt./Suitable:

BOSCH

0 986 356 820

CITROËN

5967 K9

96 070 995

MAGNETI MARELLI

941318111091

PEUGEOT

5967 K9

00 Eliminated on 06-09-2021. Please verify the availability through our local distributors

- Eliminato il 06-09-2021. Verificare la disponibilità presso i nostri distributori
- Éliminé le 06-09-2021. Vérifier la disponibilité auprès de nos distributeurs sur place
- Am 06-09-2021 gestrichen. Evtl. Verfügbarkeit bitte bei unseren Händlern prüfen
- Eliminado en fecha 06-09-2021. Verificar la disponibilidad a través de nuestros distribuidores locales

03 Supplied until depletion

- Fornibile fino ad esaurimento delle scorte
- Fourni jusqu'à épuisement du stock
- Lieferbar solange vorrat reicht
- Suministrado hasta el stock termina

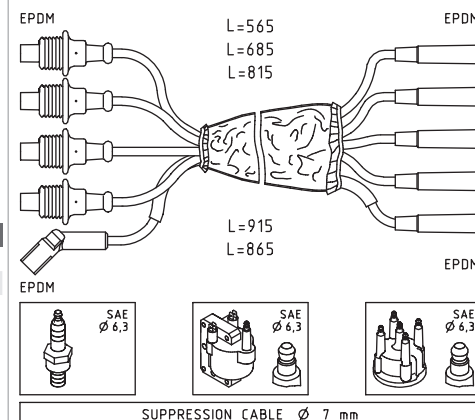

CITROËN

BX 1.6

182A, B6D, B6E

01/87 ⇒ 12/94

BX 16

180Z

03/86 ⇒ 12/94

ZX 1.9

D6E(XU9JA)

03/91 ⇒ 06/97

ZX 1.9 i

DKZ(XU9JA), XU9JA

03/91 ⇒ 06/97

PEUGEOT

205 I 1.6 GTI

B6D(XU5JA)

02/83 ⇒ 07/87

205 II 1.6 GTI

XU5JA

01/91 ⇒ 12/94

PEUGEOT		
205 II 1.9 GTI	D6B(XU9JA), DKZ(XU9JAZ)	10/87 ⇒ 09/98
309 II 1.6	XU5JA	07/89 ⇒ 12/93
309 II 1.6 GTi	--	09/89 ⇒ 10/93
309 II 1.9 GTI	DKZ(XU9JAZ)	07/89 ⇒ 12/93

KW 359 493



IGNITION CABLE SETS

Adatt./Suitable:

- 03 Supplied until depletion**
- Fornibile fino ad esaurimento delle scorte
 - Fourni jusqu'à épuisement du stock
 - Lieferbar solange vorrat reicht
 - Suministrado hasta el stock termina

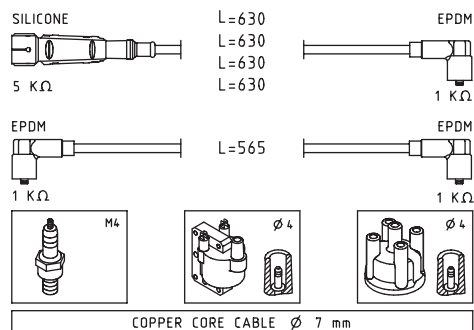

VW		
POLO II 1.0	AAK, GL, HZ	10/81 ⇒ 09/94
POLO II 1.0 Cat	AAK	08/89 ⇒ 09/94
POLO II 1.1	HB	10/81 ⇒ 09/89
POLO II 1.3	GK, GT, HH, HJ, HK, HW, MH	10/81 ⇒ 09/89
POLO II 1.3 Cat	ZG, MH, NZ	07/87 ⇒ 09/94
POLO II 1.3 G40	PY	01/87 ⇒ 08/90
JETTA II 1.0	HZ	08/85 ⇒ 10/91
JETTA II 1.3	GT, HK, MH	01/84 ⇒ 06/87
JETTA II 1.3 Cat	ZG, MH, NZ	06/87 ⇒ 12/91
GOLF II 1.0	HZ	08/85 ⇒ 10/91
GOLF II 1.3	GT, HK, MH	08/83 ⇒ 06/87
GOLF II 1.3 Cat	ZG, NZ	06/86 ⇒ 12/92
GOLF III 1.4	ABD	10/91 ⇒ 04/99
GOLF III 1.6	ABU	09/92 ⇒ 08/97
SCIROCCO II 1.3	HK	08/83 ⇒ 07/84
VENTO 1.4	ABD	11/91 ⇒ 09/98

KW 359 494



IGNITION CABLE SETS

Adatt./Suitable:

- BOSCH**
0 986 356 727
0 986 357 098
- CITROËN**
5967 L1
5967 L6
5967 L8
5967 N1
96 088 851
96 099 749
96 161 266

- 03 Supplied until depletion**
- Fornibile fino ad esaurimento delle scorte
 - Fourni jusqu'à épuisement du stock
 - Lieferbar solange vorrat reicht
 - Suministrado hasta el stock termina

FIAT
9617237080

HITACHI
134432

MAGNETI MARELLI
941085180570

PEUGEOT
5967 L1
5967 L6
5967 L8
5967 N1

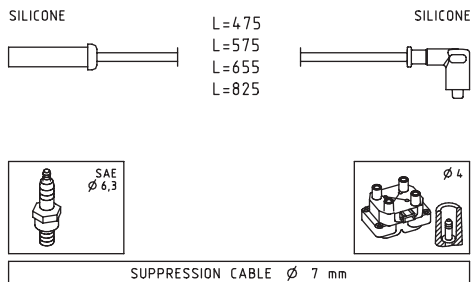

CITROËN		
XANTIA I 2.0	RFX(XU10J2C/ZL3)	03/93 ⇒ 05/95
XANTIA I 2.0 i	RFX(XU10J2C)	03/93 ⇒ 04/03
XANTIA I 2.0 Turbo	RGX(XU10J2TE)	06/95 ⇒ 04/03
EVASION 2.0	RFU(XU10J2/C)	06/94 ⇒ 07/02
EVASION 2.0 Turbo C.T.	RGX(XU10J2TE)	06/94 ⇒ 07/02
XM I 2.0 i	RDZ(XU10MZ), RFZ(XU10J2)	05/89 ⇒ 06/94
XM I 2.0 i Turbo	RGY(XU10J2TE/Z)	09/92 ⇒ 06/94
XM I 2.0 Turbo	RGY(XU10J2TE/Z)	09/92 ⇒ 04/94
XANTIA II 2.0 i	RFX(XU10J2C)	01/98 ⇒ 04/03
XANTIA II 2.0 Turbo	RGX(XU10J2TE)	01/98 ⇒ 04/03
XM II 2.0	XU10J2	08/94 ⇒ 07/99
XM II 2.0 Turbo	RGX(XU10J2TE), RGY(XU10J2TE/Z)	05/94 ⇒ 10/00
ZX 2.0	RFX(XU10J2C)	07/94 ⇒ 10/97
ZX 2.0 i	RFX(XU10J2C), XU10J2	07/92 ⇒ 10/97

FIAT		
ULYSSE I 2.0	RFU(XU10J2C)	06/94 ⇒ 08/02
ULYSSE I 2.0 Turbo	RGX(XU10J2CTE)	06/94 ⇒ 08/02

PEUGEOT		
306 2.0	RFX(XU10J2)	03/94 ⇒ 04/02
306 2.0 ST	RFX(XU10J2)	07/94 ⇒ 05/01
306 2.0 XSi	RFX(XU10J2)	05/93 ⇒ 05/01
405 II 2.0	RFX(XU10J2)	08/92 ⇒ 10/96
405 II 2.0 4x4	RFX(XU10J2)	08/92 ⇒ 10/96
405 II 2.0 X4	RFX(XU10J2)	08/92 ⇒ 10/95
406 2.0 Turbo	RGX(XU10J2TE)	04/96 ⇒ 10/04
605 2.0	RFZ(XU10J2Z)	06/89 ⇒ 09/99
605 2.0 Turbo	RGX(XU10J2TE), RGY(XU10J2TE)	07/91 ⇒ 09/99
806 2.0	RFU(XU10J2)	06/94 ⇒ 08/02
806 2.0 Turbo	RGX(XU10J2TE)	06/94 ⇒ 08/02

KW 359 507



IGNITION CABLE SETS

Adatt./Suitable:

FIAT
4380722
4830772
5888330

MAGNETI MARELLI
941094060576

- 03 Supplied until depletion**
- Fornibile fino ad esaurimento delle scorte
 - Fourni jusqu'à épuisement du stock
 - Lieferbar solange vorrat reicht
 - Suministrado hasta el stock termina

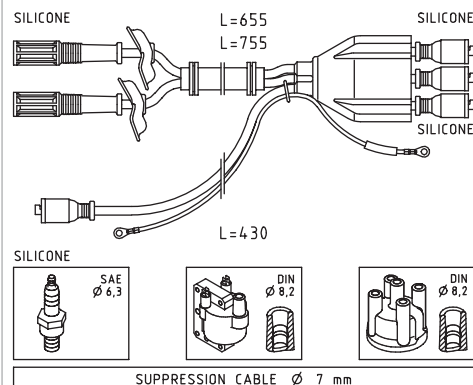

FIAT		
126 600	126A.000	09/72 ⇒ 06/77

KW 359 509



IGNITION CABLE SETS

Adatt./Suitable:

BOSCH
0 986 356 862

GENERAL MOTORS
90 113 411

MAGNETI MARELLI
941125070664

OPEL
16 12 434

- 03 Supplied until depletion**
- Fornibile fino ad esaurimento delle scorte
 - Fourni jusqu'à épuisement du stock
 - Lieferbar solange vorrat reicht
 - Suministrado hasta el stock termina

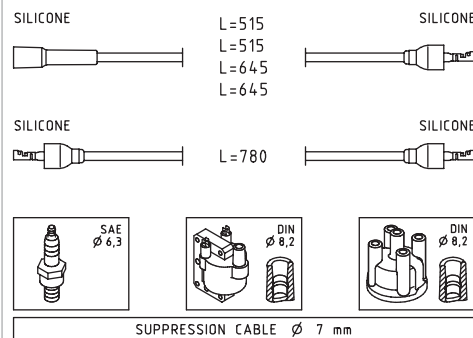

OPEL		
CORSA A 1.0	10S	09/82 ⇒ 03/93
CORSA A 1.2	12N, 12NC, E12GV	09/82 ⇒ 08/90
CORSA A 1.2 N	12NC, E12GV	01/85 ⇒ 10/87
KADETT E 1.2	12SC	09/84 ⇒ 07/86

KW 359 511

07

IGNITION CABLE SETS

Adatt./Suitable:

00 Eliminated on 22-02-2022. Please verify the availability through our local distributors

- Eliminato il 22-02-2022. Verificare la disponibilità presso i nostri distributori
- Éliminé le 22-02-2022. Vérifier la disponibilité auprès de nos distributeurs sur place
- Am 22-02-2022 gestrichen. Evtl. Verfügbarkeit bitte bei unseren Händlern prüfen
- Eliminado en fecha 22-02-2022. Verificar la disponibilidad a través de nuestros distribuidores locales

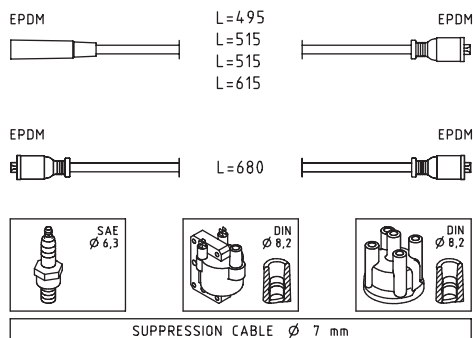

DACIA

ARO 10	--	01/72 \Rightarrow 12/80
LADA		
LADA 1.2	--	01/80 \Rightarrow
LADA 1.3	--	01/80 \Rightarrow
LADA 1.5	--	01/80 \Rightarrow
NIVA I 1600	BA32121	12/76 \Rightarrow 12/93

KW 359 513

07

IGNITION CABLE SETS

Adatt./Suitable:

BOSCH

0 986 356 723

GENERAL MOTORS

90 369 758

90 398 586

90 442 448

OPEL

16 12 523

16 12 527

16 12 532

16 12 545

00 Eliminated on 14-04-2020. Please verify the availability through our local distributors

- Eliminato il 14-04-2020. Verificare la disponibilità presso i nostri distributori
- Éliminé le 14-04-2020. Vérifier la disponibilité auprès de nos distributeurs sur place
- Am 14-04-2020 gestrichen. Evtl. Verfügbarkeit bitte bei unseren Händlern prüfen
- Eliminado en fecha 14-04-2020. Verificar la disponibilidad a través de nuestros distribuidores locales

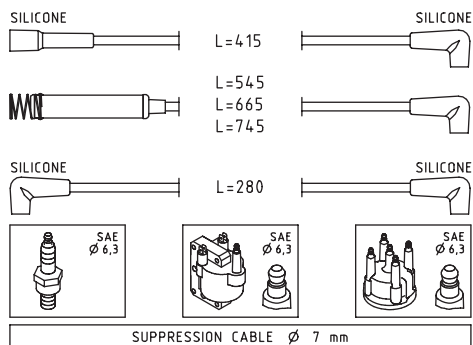

OPEL

VECTRA A 1.6 i	C16NZ, E16NZ	09/88 \Rightarrow 11/95
VECTRA A 1.6 i Cat	C16NZ	09/88 \Rightarrow 11/95

KW 359 514

07

IGNITION CABLE SETS

Adatt./Suitable:

BOSCH

0 986 356 723

GENERAL MOTORS

90 008 241

90 297 570

90 398 282

90 442 051

90 442 405

HITACHI

134202

MAGNETI MARELLI

941 125 180672

OPEL

16 12 459

16 12 479

16 12 524

16 12 539

16 12 542

03 Supplied until depletion

- Fornibile fino ad esaurimento delle scorte
- Fourni jusqu'à épuisement du stock
- Lieferbar solange vorrat reicht
- Suministrado hasta el stock termina

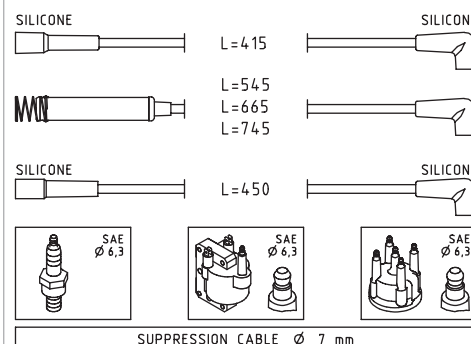

OPEL

ASCONA C 1.3 N	13N	09/81 \Rightarrow 08/86
ASCONA C 1.3 S	13S	09/81 \Rightarrow 08/88
ASCONA C 1.6	16SV	09/86 \Rightarrow 08/88
ASTRA F 1.6 i	C16NZ	09/91 \Rightarrow 09/98
CORSA A 1.6 GSI	C16NZ	08/88 \Rightarrow 09/92
KADETT D 1.2	12ST	08/82 \Rightarrow 08/84
KADETT E 1.2	12ST	09/84 \Rightarrow 08/88
KADETT E 1.3 i Cat	C13N	09/85 \Rightarrow 08/91
KADETT E 1.3 N	13N, 13NB	09/84 \Rightarrow 08/91
KADETT E 1.3 S	13S	09/84 \Rightarrow 02/93
KADETT E 1.6	16SV	09/86 \Rightarrow 12/91
KADETT E 1.6 i	16SV, C16NZ, E16NZ	09/86 \Rightarrow 07/94
KADETT E 1.6 i Cat	C16LZ, C16NZ	09/86 \Rightarrow 02/93
KADETT E 1.6 S	16SV	09/86 \Rightarrow 08/91
VECTRA A 1.6	16SV	09/88 \Rightarrow 05/93
VECTRA A 1.6 S	16SV	09/88 \Rightarrow 05/93

VAUXHALL

ASTRA III 1.6 i	C16NZ	09/91 \Rightarrow 12/98
ASTRAVAN I 1.6 i	C16NZ	10/91 \Rightarrow 08/98

KW 359 527

07

IGNITION CABLE SETS

Adatt./Suitable:

BOSCH

0 986 356 850

GENERAL MOTORS

90 350 555

90 442 064

OPEL

16 12 497

16 12 531

00 Eliminated on 22-02-2022. Please verify the availability through our local distributors

- Eliminato il 22-02-2022. Verificare la disponibilità presso i nostri distributori
- Éliminé le 22-02-2022. Vérifier la disponibilité auprès de nos distributeurs sur place
- Am 22-02-2022 gestrichen. Evtl. Verfügbarkeit bitte bei unseren Händlern prüfen
- Eliminado en fecha 22-02-2022. Verificar la disponibilidad a través de nuestros distribuidores locales

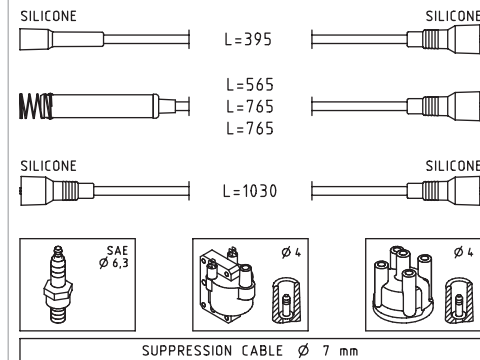

OPEL

FRONTERA A 2.0 i	C20NE	03/92 \Rightarrow 10/98
OMEGA A 1.8	18SEH, E18NVR, S18NV	09/86 \Rightarrow 03/94
OMEGA A 1.8 N	18NV	09/86 \Rightarrow 08/87
OMEGA A 1.8 S	18SV	09/86 \Rightarrow 03/94
OMEGA A 2.0	20SE, C20NE	09/86 \Rightarrow 04/94
OMEGA A 2.0 i	C20NE	09/86 \Rightarrow 04/94
OMEGA B 2.0	20SE	03/94 \Rightarrow 12/00

VAUXHALL

FRONTERA A 2.0	C20NE	04/95 \Rightarrow 08/98
FRONTERA A 2.0 i	C20NE	03/92 \Rightarrow 10/98
OMEGA B 2.0	20SE	09/95 \Rightarrow 09/96

KW 359 539

07

IGNITION CABLE SETS

Adatt./Suitable:

00 Eliminated on 14-02-2022. Please verify the availability through our local distributors

- Eliminato il 14-02-2022. Verificare la disponibilità presso i nostri distributori
- Éliminé le 14-02-2022. Vérifier la disponibilité auprès de nos distributeurs sur place
- Am 14-02-2022 gestrichen. Evtl. Verfügbarkeit bitte bei unseren Händlern prüfen
- Eliminado en fecha 14-02-2022. Verificar la disponibilidad a través de nuestros distribuidores locales

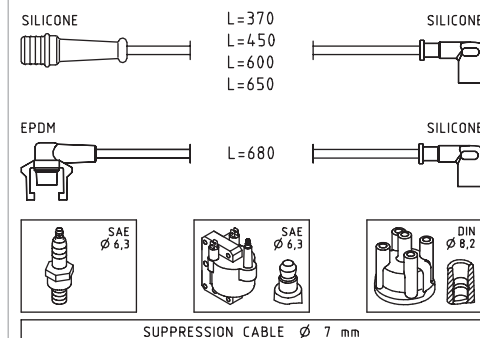

RENAULT

21 2.0	14ZR, J6R758, J6R793, J7R747, J7R750, J7R751	03/86 \Rightarrow 12/93
21 2.0 4x4	14ZR, J7R747	03/89 \Rightarrow 12/93

RENAULT		
21 2.0 Turbo	J7R752	04/87 ⇒ 03/90
21 2.0 Turbo 4x4	J7R752	08/89 ⇒ 10/93
21 2.2	J6T790, J6T791, J7T754, J7T755, J7T756	03/86 ⇒ 12/95
21 2.2 4x4	J7T754, J7T755	06/86 ⇒ 06/94
25 2.0	J7R722, J7R723	03/87 ⇒ 12/93
25 2.0 12V	7CYQD80D-E3, J7R721	06/88 ⇒ 12/93
25 2.2	04TNV88-C, 74G69-S4M, J7T706, J7T707, J7T708, J7T715, J7T730, J7T731, J7T732	04/84 ⇒ 12/92
ESPACE I 2.0 i	J7R760	01/89 ⇒ 12/90
ESPACE I 2.0 i Quadra	J7R760	03/88 ⇒ 12/92
ESPACE I 2.2	2QG15DE	07/86 ⇒ 12/90
ESPACE I 2.2 Quadra	2QG15DE	01/88 ⇒ 12/90
ESPACE II 2.0	J7R768	01/91 ⇒ 10/96
ESPACE II 2.2	J7T773, J7T776	01/91 ⇒ 10/96
ESPACE II 2.2 4x4	J7T773	03/91 ⇒ 12/96
TRAFIC I 2.2	J7T600, J7T780	05/89 ⇒ 04/98
TRAFIC I 2.2 4x4	J7T600, J7T780	05/89 ⇒ 04/98

KW 359 543

07

IGNITION CABLE SETS

Adatt./Suitable:

00 Eliminated on 14-02-2022. Please verify the availability through our local distributors

- Eliminato il 14-02-2022. Verificare la disponibilità presso i nostri distributori
- Éliminé le 14-02-2022. Vérifier la disponibilité auprès de nos distributeurs sur place
- Am 14-02-2022 gestrichen. Evtl. Verfügbarkeit bitte bei unseren Händlern prüfen
- Eliminado en fecha 14-02-2022. Verificar la disponibilidad a través de nuestros distribuidores locales

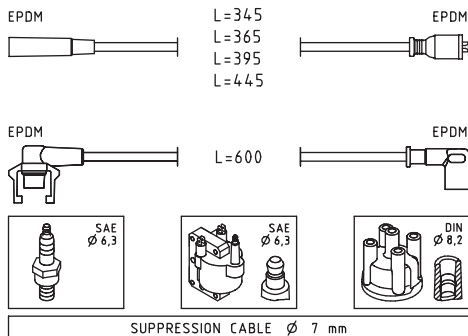
SUPPRESSION CABLE \varnothing 7 mm

RENAULT

19 I 1.2	C1G730	01/88 ⇒ 12/92
EXPRESS 1.2	C1G	01/85 ⇒ 10/90
EXPRESS 1.4	C1J, C2J	01/85 ⇒ 10/90
EXPRESS 1.4i	C3G/C3J	01/85 ⇒ 10/90

KW 359 572

07,5

IGNITION CABLE SETS

Adatt./Suitable:

BMW
12 12 1 705 697
BOSCH
0 356 901 808

00 Eliminated on 02-03-2020. Please verify the availability through our local distributors

- Eliminato il 02-03-2020. Verificare la disponibilità presso i nostri distributori
- Éliminé le 02-03-2020. Vérifier la disponibilité auprès de nos distributeurs sur place
- Am 02-03-2020 gestrichen. Evtl. Verfügbarkeit bitte bei unseren Händlern prüfen
- Eliminado en fecha 02-03-2020. Verificar la disponibilidad a través de nuestros distribuidores locales

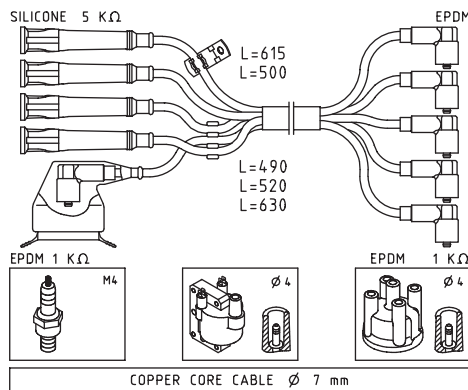
COPPER CORE CABLE \varnothing 7 mm

BMW

3 II 316	M10B18(184VC), M10B18(184VD)	09/83 ⇒ 06/88
3 II 316 i	M10B18(184KA)	08/87 ⇒ 08/88
3 II 318 i	M10B18(184EA), M10B18(184KA)	09/82 ⇒ 08/88
5 II 518	M10B18(184VC), M10B18(184VD)	06/81 ⇒ 09/84
5 II 518 i	M10B18(184EB)	05/81 ⇒ 12/87
5 I 518	M10B18(184VB)	07/74 ⇒ 05/81

KW 359 573

IGNITION CABLE SETS

Adatt./Suitable:

BMW
12 12 1 717 646
12 12 1 727 686

BOSCH
0 986 356 325

00 Eliminated on 14-04-2020. Please verify the availability through our local distributors

- Eliminato il 14-04-2020. Verificare la disponibilità presso i nostri distributori
- Éliminé le 14-04-2020. Vérifier la disponibilité auprès de nos distributeurs sur place
- Am 14-04-2020 gestrichen. Evtl. Verfügbarkeit bitte bei unseren Händlern prüfen
- Eliminado en fecha 14-04-2020. Verificar la disponibilidad a través de nuestros distribuidores locales

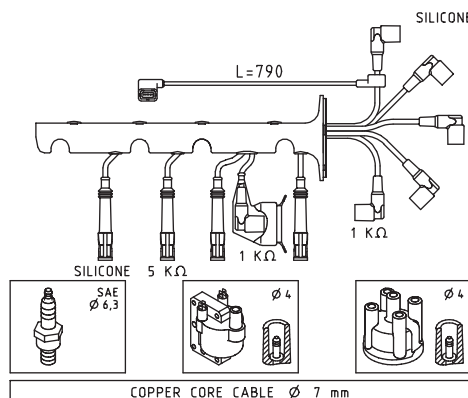
COPPER CORE CABLE \varnothing 7 mm

BMW

3 II 316 i	M40B16(164E1)	09/87 ⇒ 06/94
3 II 318 i	M40B18(184E1)	06/87 ⇒ 06/94

KW 359 578

07,5

IGNITION CABLE SETS

Adatt./Suitable:

BMW
12 12 1 722 253
BOSCH
0 356 901 814

00 Eliminated on 22-02-2022. Please verify the availability through our local distributors

- Eliminato il 22-02-2022. Verificare la disponibilità presso i nostri distributori
- Éliminé le 22-02-2022. Vérifier la disponibilité auprès de nos distributeurs sur place
- Am 22-02-2022 gestrichen. Evtl. Verfügbarkeit bitte bei unseren Händlern prüfen
- Eliminado en fecha 22-02-2022. Verificar la disponibilidad a través de nuestros distribuidores locales

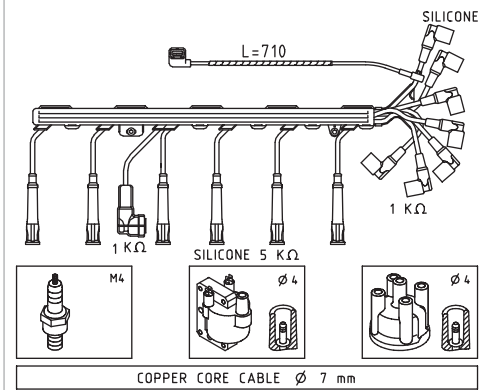
COPPER CORE CABLE \varnothing 7 mm

BMW

5 II 530 i	--	01/84 ⇒ 12/88
5 III 530 i	M30B30(306KA)	01/88 ⇒ 04/90
5 III 535 i	M30B34(346KB)	11/87 ⇒ 02/93
7 II 730 i, iL	M30B30(306EA), M30B30(306KA)	03/85 ⇒ 03/94
7 II 735 i, iL	M30B34(346KB), M30B35(Motronic, 9.2:1)	06/86 ⇒ 07/92

KW 359 587

IGNITION CABLE SETS

Adatt./Suitable:

BMW
12 12 1 720 529
BOSCH
0 986 356 323

00 Eliminated on 14-04-2020. Please verify the availability through our local distributors

- Eliminato il 14-04-2020. Verificare la disponibilità presso i nostri distributori
- Éliminé le 14-04-2020. Vérifier la disponibilité auprès de nos distributeurs sur place
- Am 14-04-2020 gestrichen. Evtl. Verfügbarkeit bitte bei unseren Händlern prüfen
- Eliminado en fecha 14-04-2020. Verificar la disponibilidad a través de nuestros distribuidores locales

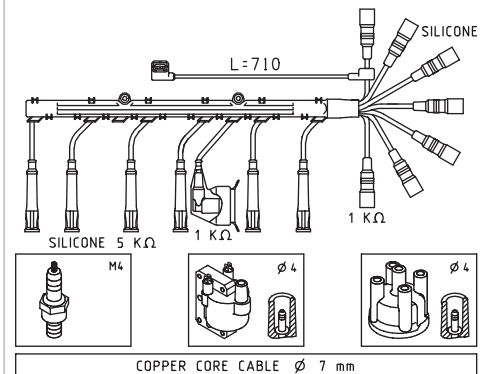
COPPER CORE CABLE \varnothing 7 mm

BMW

3 II 320 i	M20B20(206EB), M20B20(206KA)	09/82 ⇒ 11/93
3 II 325 i	M20B25(256E1), M20B25(256E2), M20B25(256EX), M20B25(256K1)	09/83 ⇒ 11/93

KW 359 597



IGNITION CABLE SETS

Adatt./Suitable:

BMW
12 12 1 726 037
BOSCH
0 356 901 819
0 986 356 362

⁰³ Supplied until depletion

- Fornibile fino ad esaurimento delle scorte
- Fourni jusqu'à épuisement du stock
- Lieferbar solange vorrat reicht
- Suministrado hasta el stock termina

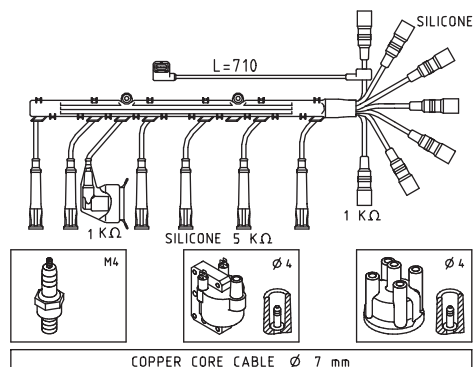
**BMW**

3 III 320 i	M20B20(206EB), M20B20(206KA)	09/82 ⇒ 11/93
3 III 325 i	M20B25(256E1), M20B25(256E2), M20B25(256EX), M20B25(256K1)	09/83 ⇒ 11/93
5 III 520 i	M20B20(206KA)	06/87 ⇒ 09/90
5 III 525 i	M20B25(256K1)	02/88 ⇒ 08/90

KW 359 605



IGNITION CABLE SETS

Adatt./Suitable:

BMW
12 12 1 727 855
BOSCH
0 986 356 325

⁰³ Supplied until depletion

- Fornibile fino ad esaurimento delle scorte
- Fourni jusqu'à épuisement du stock
- Lieferbar solange vorrat reicht
- Suministrado hasta el stock termina

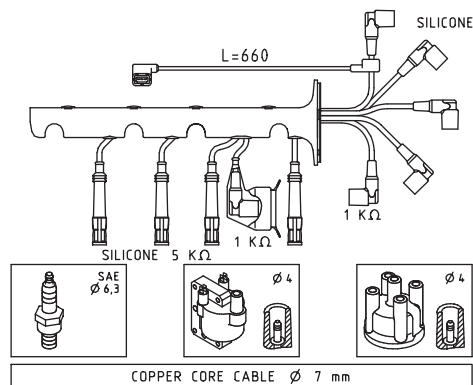
**BMW**

3 III 316 i	M40B16(164E1), M43B16(164E2)	09/90 ⇒ 09/93
3 III 318 i	M40B18(184E1)	09/90 ⇒ 08/93

KW 359 608



07,5

IGNITION CABLE SETS

Adatt./Suitable:

BOSCH
0 986 356 705
HITACHI
134276
NISSAN
22440-99B00
22440-99B05
22440-99B06

⁰³ Supplied until depletion

- Fornibile fino ad esaurimento delle scorte
- Fourni jusqu'à épuisement du stock
- Lieferbar solange vorrat reicht
- Suministrado hasta el stock termina

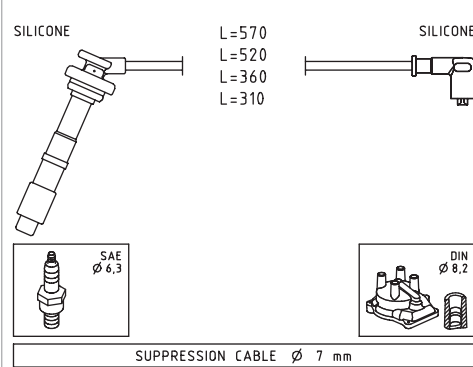
**NISSAN**

MICRA II 1.0 i 16V	CG10DE	08/92 ⇒ 07/00
MICRA II 1.3 i 16V	CG13DE	08/92 ⇒ 09/00

KW 359 609



08

IGNITION CABLE SETS

Adatt./Suitable:

NISSAN
22450-71J25

⁰⁰ Eliminated on 14-04-2020. Please verify the availability through our local distributors

- Eliminato il 14-04-2020. Verificare la disponibilità presso i nostri distributori
- Éliminé le 14-04-2020. Vérifier la disponibilité auprès de nos distributeurs sur place
- Am 14-04-2020 gestrichen. Evtl. Verfügbarkeit bitte bei unseren Händlern prüfen
- Eliminado en fecha 14-04-2020. Verificar la disponibilidad a través de nuestros distribuidores locales

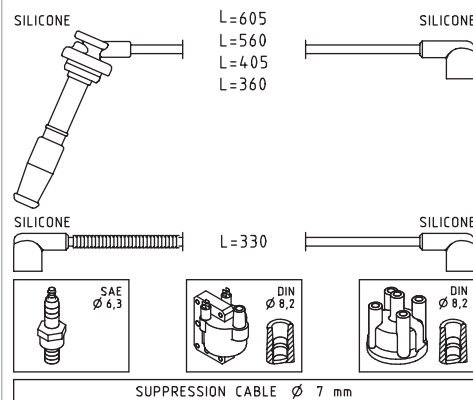
**NISSAN**

PRIMERA I 1.6	GA16DS	06/90 ⇒ 01/96
---------------	--------	---------------

KW 359 612



07

IGNITION CABLE SETS

Adatt./Suitable:

⁰⁰ Eliminated on 22-02-2022. Please verify the availability through our local distributors

- Eliminato il 22-02-2022. Verificare la disponibilità presso i nostri distributori
- Éliminé le 22-02-2022. Vérifier la disponibilité auprès de nos distributeurs sur place
- Am 22-02-2022 gestrichen. Evtl. Verfügbarkeit bitte bei unseren Händlern prüfen
- Eliminado en fecha 22-02-2022. Verificar la disponibilidad a través de nuestros distribuidores locales

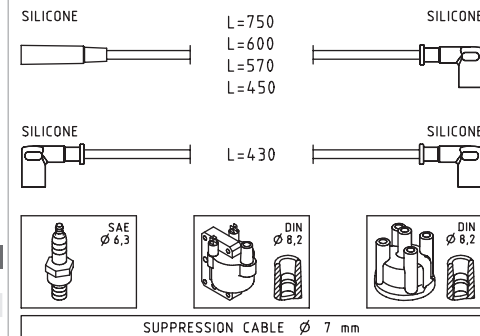
**SEAT**

IBIZA I 1.2	021A1000	11/84 ⇒ 12/93
IBIZA I 1.2 i	021C.1000	01/89 ⇒ 05/93
IBIZA I 1.5 i	021B.2000	10/86 ⇒ 05/93
MALAGA 1.2	021A1000	05/85 ⇒ 12/93
MALAGA 1.5	021A2000	05/85 ⇒ 12/93

KW 359 613



07

IGNITION CABLE SETS

Adatt./Suitable:

FIAT
7735100

⁰⁰ Eliminated on 04-08-2020. Please verify the availability through our local distributors

- Eliminato il 04-08-2020. Verificare la disponibilità presso i nostri distributori
- Éliminé le 04-08-2020. Vérifier la disponibilité auprès de nos distributeurs sur place
- Am 04-08-2020 gestrichen. Evtl. Verfügbarkeit bitte bei unseren Händlern prüfen
- Eliminado en fecha 04-08-2020. Verificar la disponibilidad a través de nuestros distribuidores locales

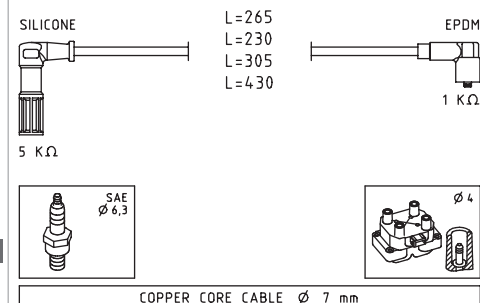
**FIAT**

PUNTO I 1.4 GT Turbo	176A4.000, 176B6.000	10/93 ⇒ 07/99
----------------------	----------------------	---------------

KW 359 615



IGNITION CABLE SETS

Adatt./Suitable:

- FIAT 7694366
- HITACHI 134484
- MAGNETI MARELLI 941095680607

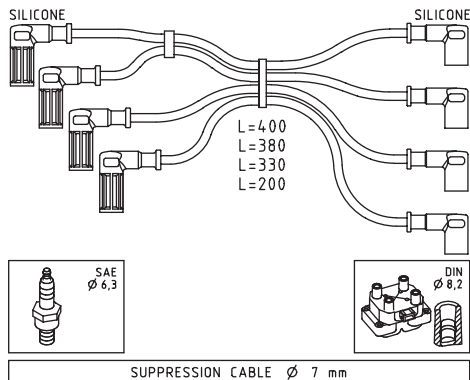

FIAT		
CINQUECENTO 0.9	170A1.000	07/91 \Rightarrow 12/93
CINQUECENTO 0.9 i.e.	170A1.046	07/91 \Rightarrow 09/94
CINQUECENTO 0.9 i.e. S	1170A1.000, 1170A1.046	07/91 \Rightarrow 07/99
PANDA I 900	1170A1.046	04/92 \Rightarrow 12/96
SEICENTO / 600 0.9	1170A1.046	11/97 \Rightarrow 01/10

KW 359 616



IGNITION CABLE SETS

Adatt./Suitable:

- BOSCH 0 986 356 754
- FIAT 7776810
- HITACHI 134467
- LANCIA 7776810
- MAGNETI MARELLI 941095130583 941095780616

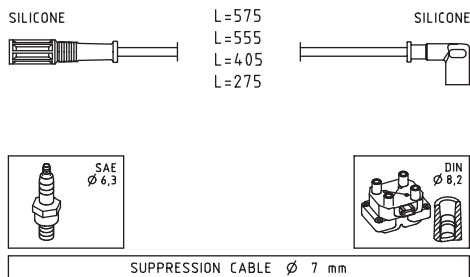

FIAT		
CINQUECENTO 1.1 Sporting	176B2.000	10/94 \Rightarrow 01/98
PUNTO I 1.1	176B2.000	04/96 \Rightarrow 02/00
PUNTO I 55 1.1	176A6.000, 176B2.000	09/93 \Rightarrow 09/99
PUNTO I 60 1.2	176A7.000, 176B1.000, 176B4.000	09/93 \Rightarrow 06/00
PUNTO I 75 1.2	176A8.000	10/93 \Rightarrow 09/99
PALIO 1.2	176A8.000, 178B5.000, 178B7.045, 178C4.066, 178E2.000, 188A4.000	04/96 \Rightarrow
PALIO 1.2 75	178B7.045	03/98 \Rightarrow
PALIO 1.2 MPI	178C4.066	01/02 \Rightarrow
PANDA I 1.1	156C.046	05/91 \Rightarrow 03/95
PANDA I 1000 4x4	141C2.000	05/86 \Rightarrow 12/94
PANDA I 1000 i.e	156A2.246	08/92 \Rightarrow 02/04
PANDA I 1000 i.e. Cat	141C2.000, 156A2.246	10/87 \Rightarrow 08/98
PANDA I 1100	156C.046, 176B2.000	05/91 \Rightarrow 12/99
PANDA I 1100 4x4	176B2.000	02/95 \Rightarrow 07/04
PANDA I 1100 Trekking 4x4	156C.046	10/91 \Rightarrow 07/04
SEICENTO / 600 1.1	176B2.000	01/98 \Rightarrow 01/10
SIENA 1.2	178B7.045	01/98 \Rightarrow
SIENA 1.3	178B5.000, 178C4.066, 188A4.000, 188A5.000	09/01 \Rightarrow 12/12
STRADA 1.2	178B5.000, 178B7.045, 188A4.000	04/03 \Rightarrow

FIAT		
STRADA 1.2 Trekking	--	11/05 \Rightarrow
UNO Mondo 1.2 i.e. [IND]	178D5.066	01/96 \Rightarrow
LANCIA		
YI 1.1	176B2.000	11/95 \Rightarrow 09/03
YI 1.2	840A3.000	03/96 \Rightarrow 09/03

KW 359 623



IGNITION CABLE SETS

Adatt./Suitable:

- ⁰³ Supplied until depletion
 - Fornibile fino ad esaurimento delle scorte
 - Fourni jusqu'à épuisement du stock
 - Lieferbar solange vorrat reicht
 - Suministrado hasta el stock termina

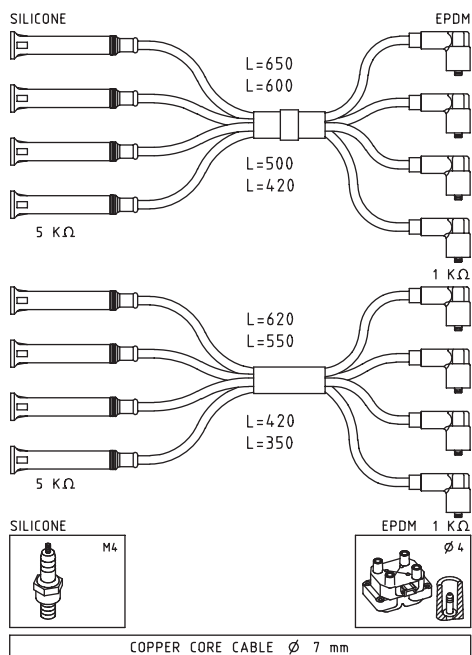

ALFA ROMEO		
155 1.7 T.S.	AR67103, AR67105	04/93 \Rightarrow 04/96
155 1.8 T.S.	AR67101	02/92 \Rightarrow 05/94
155 1.8 T.S. Sport	AR67101, AR67102	03/92 \Rightarrow 12/96
155 2.0 T.S.	AR67201, AR67202	02/92 \Rightarrow 05/95

KW 359 634



IGNITION CABLE SETS

Adatt./Suitable:

- BOSCH 0 986 357 063 0 986 357 124
- GENERAL MOTORS 90 442 404 90 486 611 90 486 612

- ⁰³ Supplied until depletion
 - Fornibile fino ad esaurimento delle scorte
 - Fourni jusqu'à épuisement du stock
 - Lieferbar solange vorrat reicht
 - Suministrado hasta el stock termina

- HITACHI 134258 134871
- MAGNETI MARELLI 941125190673
- OPEL 16 12 543 16 12 591 16 12 592 16 12 651

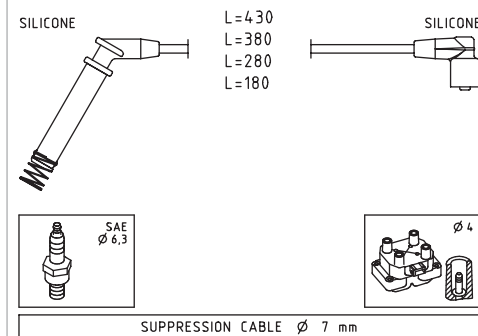

OPEL		
ASTRA F 1.4	14SE	09/92 \Rightarrow 09/98
ASTRA F 1.4 Si	C14SE	03/92 \Rightarrow 03/01
ASTRA F 1.6	16NZR	09/95 \Rightarrow 09/98
ASTRA F 1.6 i	X16SZ, X16SZR	09/91 \Rightarrow 01/05
ASTRA F 1.6 Si	C16SE	03/92 \Rightarrow 12/94
COMBO B 1.4	C14SE	07/94 \Rightarrow 10/01
CORSA A 1.4 Si	C14SE	09/91 \Rightarrow 03/93
CORSA B 1.4	C14SE	04/93 \Rightarrow 08/94
CORSA B 1.4 Si	C14SE	03/93 \Rightarrow 09/00
VECTRA A 1.6 i	X16SZ	09/93 \Rightarrow 11/95

VAUXHALL		
ASTRA III 1.4 i	C14SE	03/91 \Rightarrow 03/01
ASTRA III 1.6	C16SE	03/94 \Rightarrow 08/95
ASTRA III 1.6 i	C16SE, X16SZ, X16SZR	03/92 \Rightarrow 09/98
ASTRA III 1.6 Si	C16SE	03/91 \Rightarrow 12/94
ASTRAVAN I 1.6 i	X16SZ	09/94 \Rightarrow 08/96
COMBO B 1.4	C14SE	07/94 \Rightarrow 10/01
CORSA B 1.4 i S	C14SE	03/93 \Rightarrow 09/00

KW 359 650

07

IGNITION CABLE SETS

Adatt./Suitable:

00 Eliminated on 26-10-2020. Please verify the availability through our local distributors

- Eliminato il 26-10-2020. Verificare la disponibilità presso i nostri distributori
- Éliminé le 26-10-2020. Vérifier la disponibilité auprès de nos distributeurs sur place
- Am 26-10-2020 gestrichen. Evtl. Verfügbarkeit bitte bei unseren Händlern prüfen
- Eliminado en fecha 26-10-2020. Verificar la disponibilidad a través de nuestros distribuidores locales

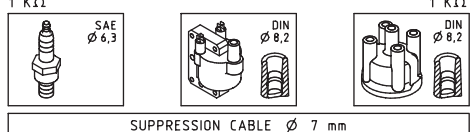
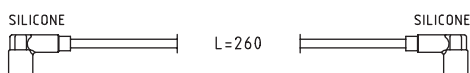
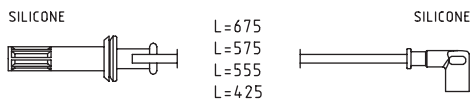

FIAT		
COUPE 2.0 16V	836A3.000	11/93 ⇒ 08/96
COUPE 2.0 16V [BRA]	836A3.011	11/93 ⇒ 08/96
TIPO I 2.0	836A3.011	03/93 ⇒ 04/95
TIPO I 2.0 16V	160A8.046	07/91 ⇒ 04/95
TIPO I 2.0 i.e. 16V Sport	836A3.000	03/93 ⇒ 04/95

FIAT (BR)		
COUPE 2.0i 16V	2.0Mpi	01/95 ⇒ 12/97
TIPO 2.0i 16V	2.0Mpi	01/94 ⇒ 12/95

LANCIA		
DEDRA 2.0 16V	836A3.000	07/94 ⇒ 07/99
DEDRA 2.0 Integrale	836A3.000	07/94 ⇒ 07/99
DELTA II 2.0 16V	836A3.000	06/93 ⇒ 08/99

KW 359 655

07

IGNITION CABLE SETS

Adatt./Suitable:

BOSCH
0 986 356 854

CITROËN
5967 N2

FIAT
7735397

INNOCENTI
7735397

LANCIA
7735397

MAGNETI MARELLI
941095770615

PEUGEOT
5967 N2

00 Eliminated on 04-05-2021. Please verify the availability through our local distributors

- Eliminato il 04-05-2021. Verificare la disponibilità presso i nostri distributori
- Éliminé le 04-05-2021. Vérifier la disponibilité auprès de nos distributeurs sur place
- Am 04-05-2021 gestrichen. Evtl. Verfügbarkeit bitte bei unseren Händlern prüfen
- Eliminado en fecha 04-05-2021. Verificar la disponibilidad a través de nuestros distribuidores locales

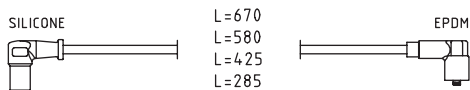

CITROËN		
JUMPY I 1.6	1580SPI, 220A2.000	10/95 ⇒ 08/00
JUMPY I 1.6 i	1580SPI, 220A2.000	10/95 ⇒ 08/00

FIAT		
ELBA 1.4	146D5.000	10/93 ⇒ 02/95

FIAT

FIORINO II 1.4	146C5.000	11/92 ⇒ 05/01
FIORINO II 1.6	146D6.000	01/94 ⇒ 05/01
FIORINO II 70 i.e. 1.4	146D5.000	05/94 ⇒ 05/01
FIORINO II 75 i.e. 1.6	146D6.000	10/93 ⇒ 05/01
SCUDO I 1.6	220A2.000	02/96 ⇒ 12/06
TEMPRA 1.4 i.e.	836A4.000	04/90 ⇒ 08/96
TEMPRA 1.6 i.e.	835C1.000	10/90 ⇒ 08/96
TIPO I 1.4 i.e.	836A4.000	05/89 ⇒ 04/95
TIPO I 1.6	835C1.000	03/93 ⇒ 10/95
TIPO I 1.6 i.e.	835C1.000	10/92 ⇒ 04/95
TIPO I 1.6 i.e. [BRA]	160E2.011	03/93 ⇒ 04/95

FIAT (BR)

TIPO 1.6i	1.65pi	01/93 ⇒ 12/95
-----------	--------	---------------

INNOCENTI

ELBA 1.4 i.e.	146D5.000	09/94 ⇒ 12/96
ELBA 1.6 i.e.	146D6.000	09/94 ⇒ 12/96

LANCIA

DEDRA 1.6 i.e.	835C1.000	04/93 ⇒ 07/99
DELTA II 1.4 i.e.	836A4.000	10/94 ⇒ 08/99
DELTA II 1.6 i.e.	835C1.000	06/93 ⇒ 08/99

PEUGEOT

EXPERT I 1.6	222A2(1580SPI)	02/96 ⇒ 09/00
--------------	----------------	---------------

KW 359 660

09

IGNITION CABLE SETS

Adatt./Suitable:

ALFA ROMEO
60534855
60573030

00 Eliminated on 12-01-2021. Please verify the availability through our local distributors

- Eliminato il 12-01-2021. Verificare la disponibilità presso i nostri distributori
- Éliminé le 12-01-2021. Vérifier la disponibilité auprès de nos distributeurs sur place
- Am 12-01-2021 gestrichen. Evtl. Verfügbarkeit bitte bei unseren Händlern prüfen
- Eliminado en fecha 12-01-2021. Verificar la disponibilidad a través de nuestros distribuidores locales

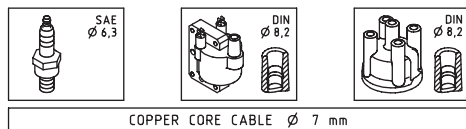
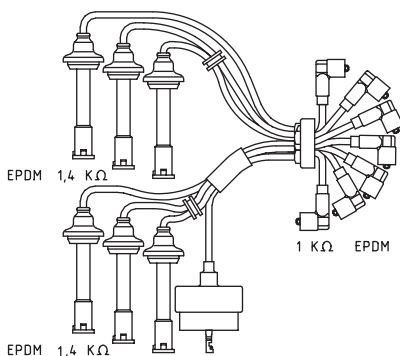

ALFA ROMEO

75 2.5 V6	AR01646, AR01648, AR01911	05/85 ⇒ 08/86
75 3.0 V6	AR06120, AR61503	01/87 ⇒ 02/92
75 3.0 V6 Cat	AR06124	01/87 ⇒ 02/92

KW 359 666

09

IGNITION CABLE SETS

Adatt./Suitable:

00 Eliminated on 15-01-2020. Please verify the availability through our local distributors

- Eliminato il 15-01-2020. Verificare la disponibilità presso i nostri distributori
- Éliminé le 15-01-2020. Vérifier la disponibilité auprès de nos distributeurs sur place
- Am 15-01-2020 gestrichen. Evtl. Verfügbarkeit bitte bei unseren Händlern prüfen
- Eliminado en fecha 15-01-2020. Verificar la disponibilidad a través de nuestros distribuidores locales

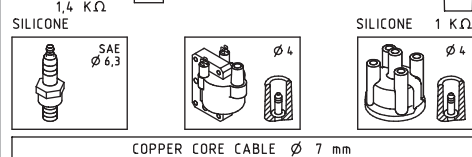
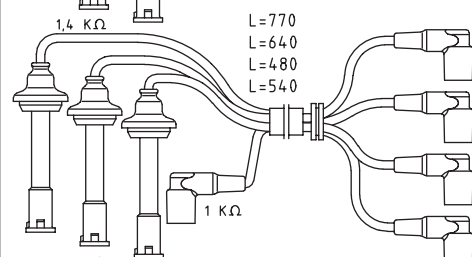
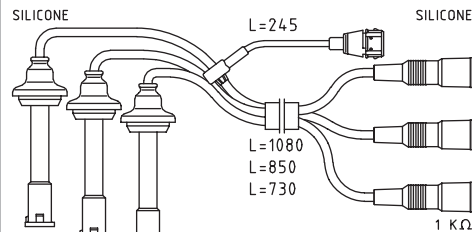

ALFA ROMEO

164 2.0 Turbo	AR64102	07/90 ⇒ 10/92
164 2.0 V6 Turbo	AR64101	03/91 ⇒ 09/92

KW 359 674



07

IGNITION CABLE SETS

Adatt./Suitable:

BOSCH
0 986 356 767
0 986 356 854
F 000 99C 097

- 03 Supplied until depletion**
- Fornibile fino ad esaurimento delle scorte
 - Fourni jusqu'à épuisement du stock
 - Lieferbar solange vorrat reicht
 - Suministrado hasta el stock termina

CITROËN
5967 L0
5967 L7
5967 N7
96 094 933
96 099 747

FIAT
9609493380
9619064880

HITACHI
134431

MAGNETI MARELLI
941135160703

PEUGEOT
5967 L0
5967 L7
5967 N7

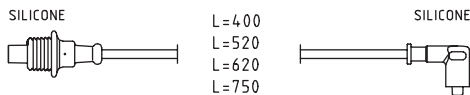

SUPPRESSION CABLE Ø 7 mm

CITROËN

XANTIA I 1.6 i	BFZ(XU5JP)	03/93 ⇒ 03/01
XANTIA I 1.8 i	LFX(XU7JB), LFZ(XU7JP)	03/93 ⇒ 01/98
BX 16	BDY(XU5M), BDZ(XU5M)	05/89 ⇒ 12/94
BX 16 E	BDY(XU5M), BDZ(XU5M)	05/89 ⇒ 02/93
XSARA 1.8 i	LFX(XU7JB), LFZ(XU7JP)	04/97 ⇒ 09/00
XSARA 1.8 i Aut.	LFZ(XU7JP)	04/97 ⇒ 09/00
EVASION 1.8	LFZ(XU7JP)	05/97 ⇒ 07/02
JUMPER I 2.0	RFW(XU10J2U)	02/94 ⇒ 04/02
JUMPER I 2.0 4x4	RFW(XU10J2U)	08/96 ⇒ 04/02
JUMPER II 2.0	XU10J2	04/02 ⇒
JUMPER II 2.0 bivalent	XU10J2	02/03 ⇒
BERLINGO I 1.8 i	LFX(XU7JB)	05/97 ⇒ 10/02
BERLINGO I 1.8 i 4WD	LFX(XU7JB)	04/97 ⇒ 10/01
XANTIA II 1.6 i SX	BFZ(XU5JP)	01/98 ⇒ 03/01
XANTIA II 1.8 i	LFX(XU7JB)	01/98 ⇒ 04/03
ZX 1.6	BDY(XU5M), BFZ(XU5JP)	07/94 ⇒ 10/97
ZX 1.6 i	BDY(XU5M), BFZ(XU5JP)	03/91 ⇒ 10/97
ZX 1.8	LFZ(XU7JP)	03/91 ⇒ 10/97
ZX 1.8 i	LFZ(XU7JP)	07/92 ⇒ 10/97
ZX 1.9	D6E(XU9JA)	03/91 ⇒ 06/97
ZX 1.9 i	DKZ(XU9JA), XU9JA	03/91 ⇒ 06/97

FIAT

DUCATO II 2.0	RFL(XU10J2U)	03/94 ⇒
DUCATO II 2.0 4x4	RFL(XU10J2U)	11/94 ⇒ 07/06
DUCATO II 2.0 Bipower	RFL(XU10J2U)	11/02 ⇒
DUCATO II 2.0 Panorama/Combinato	RFW	03/94 ⇒ 04/02
ULYSSE I 1.8	LFW(XU7JP)	05/97 ⇒ 08/02

PEUGEOT

205 II 1.6 i	BDZ(XU5M)	01/91 ⇒ 12/94
306 1.8	--, LFZ(XU7JP)	05/93 ⇒ 04/02
306 1.8 ST	LFZ(XU7JP)	06/94 ⇒ 05/01
BOXER I 2.0	RFL(XU10J2U)	04/02 ⇒
BOXER I 2.0 4x4	--	03/96 ⇒ 09/98
BOXER I 2.0 i	RFW(XU10J2)	03/94 ⇒ 04/02
BOXER I 2.0 i 4x4	RFW(XU10J2)	08/96 ⇒ 04/02
309 II 1.6	BDZ(XU5M)	07/89 ⇒ 12/93
405 I 1.6	BDY(XU5M2Z), BDY(XU5M3Z)	07/87 ⇒ 12/92
405 II 1.6	BDY(XU5M2Z), BDY(XU5M3Z), BDZ(XU5M), BFZ(XU5JP)	08/92 ⇒ 05/97
405 II 1.8	LFZ(XU7JP)	08/92 ⇒ 10/96
406 1.6	BFZ(XU5JP)	11/95 ⇒ 05/04
406 1.8	LFX(XU7JB), LFZ(XU7JP)	10/96 ⇒ 03/99
EXPERT I 1.8	L6B(XU7JP), LFZ(XU7JP)	09/96 ⇒
806 1.8	LFW(XU7JP)	07/95 ⇒ 08/02
PARTNER I 1.8	LFX(XU7JB)	03/97 ⇒ 12/02
RANCH 1.8	LFX(XU7JB)	05/97 ⇒

KW 359 688



07,5

IGNITION CABLE SETS

Adatt./Suitable:

BOSCH
0 986 356 778
0 986 357 237
F 005 X03 945
F 005 X04 028

- 03 Supplied until depletion**
- Fornibile fino ad esaurimento delle scorte
 - Fourni jusqu'à épuisement du stock
 - Lieferbar solange vorrat reicht
 - Suministrado hasta el stock termina

GENERAL MOTORS
90 384 308
90 384 310
90 443 584
90 443 687

HOLDEN
90443584
90443687

MAGNETI MARELLI
941125310683

OPEL
12 82 077
12 82 078
12 82 079
12 82 080
16 12 552
16 12 561

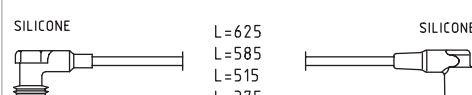

COPPER CORE CABLE Ø 7 mm

HOLDEN

BARINA 1.6	X16XE	05/97 ⇒ 08/00
BARINA_SB 1.6i	C16XE, X16XE	04/94 ⇒ 09/98
CALIBRA_YE 2.0i 16V	C20XE	09/91 ⇒ 07/95

OPEL

ASTRA F 1.6 i 16V	X16XEL	08/94 ⇒ 01/05
ASTRA F 2.0 GSI 16V	C20XE	09/91 ⇒ 01/98
ASTRA F 2.0 i 16V	C20XE	03/93 ⇒ 01/98
CALIBRA A 2.0 i 16V	C20XE	06/90 ⇒ 02/94
CALIBRA A 2.0 i 16V 4x4	C20XE	06/90 ⇒ 02/94
COMBO B 1.4 16V	X14XE	08/99 ⇒ 10/01
CORSA B 1.4 i 16V	C14SEL, X14XE	09/94 ⇒ 12/02
CORSA B 1.6 GSI 16V	C16XE	03/93 ⇒ 09/00
CORSA B 1.6 i 16V	C16SEL, X16XE	09/94 ⇒ 09/00
TIGRA A 1.4 16V	X14XE	07/94 ⇒ 12/00
TIGRA A 1.6 16V	C16SEL, X16XE	07/94 ⇒ 08/98
VECTRA A 2.0 i 16V	20XEJ	02/89 ⇒ 10/90
VECTRA A 2.0 i 16V 4x4	C20XE	08/89 ⇒ 08/95
VECTRA A 2.0 i 16V Cat	C20XE	02/90 ⇒ 11/95
VECTRA A 2000 16V 4x4	20XEJ	01/89 ⇒ 10/90
VECTRA A 2000/GT 16V	20XEJ	01/89 ⇒ 06/94
VECTRA A 2000/GT 16V Cat	C20XE	02/90 ⇒ 11/95
VECTRA A 2000/GT 16V Cat 4x4	C20XE	02/90 ⇒ 11/95
VECTRA B 1.6 i 16V	X16XEL	10/95 ⇒ 07/02

VAUXHALL

ASTRA III 1.6 i 16V	X16XEL	01/94 ⇒ 09/98
ASTRA III 2.0 i 16V	C20XE	09/91 ⇒ 02/98
CALIBRA 2.0 i 16V	C20XE	06/90 ⇒ 02/94
CALIBRA 2.0 i 16V 4x4	C20XE	06/90 ⇒ 02/94
COMBO B 1.4 16V	X14XE	08/99 ⇒ 10/01
CORSA B 1.4 i 16V	X14XE	09/94 ⇒ 09/00
CORSA B 1.6 GSI 16V	C16XE	03/93 ⇒ 09/00
CORSA B 1.6 i 16V	X16XE	09/94 ⇒ 09/00
TIGRA A 1.4 16V	X14XE	07/94 ⇒ 12/00
TIGRA A 1.6 16V	X16XE	07/94 ⇒ 12/00
VECTRA B 1.6 i 16V	X16XEL	08/95 ⇒ 03/02

KW 359 689



07,5

IGNITION CABLE SETS

Adatt./Suitable:

BOSCH
0 986 357 125
0 986 357 127
F 005 X03 944

- 03 Supplied until depletion**
- Fornibile fino ad esaurimento delle scorte
 - Fourni jusqu'à épuisement du stock
 - Lieferbar solange vorrat reicht
 - Suministrado hasta el stock termina

GENERAL MOTORS
90 443 692
90 443 693
90 443 694

HITACHI
134214

HOLDEN
90443692

OPEL
16 12 558
16 12 559
16 12 560

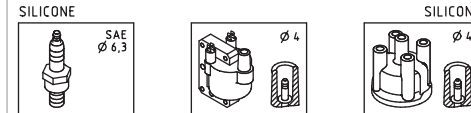
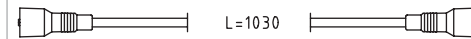
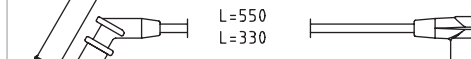
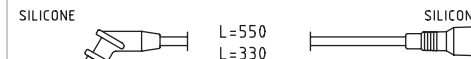

SUPPRESSION CABLE Ø 7 mm

HOLDEN

CALIBRA_YE 2.0i	C20NE	09/91 ⇒ 07/95
-----------------	-------	---------------

OPEL

ASTRA F 1.8 i	C18NZ	09/91 ⇒ 09/98
ASTRA F 2.0 i	C20NE	09/91 ⇒ 09/98
CALIBRA A 2.0 i	C20NE	08/89 ⇒ 12/96
CALIBRA A 2.0 i 4x4	C20NE	06/90 ⇒ 07/97
FRONTERA A 2.0 i	C20NE	03/92 ⇒ 10/98
KADETT E 1.8 i	S18NV	06/85 ⇒ 08/91
KADETT E 1.8 S	E18NV	09/87 ⇒ 08/91
KADETT E 2.0 GSI	20NE	09/86 ⇒ 08/91
KADETT E 2.0 GSI Cat	C20NE	09/86 ⇒ 08/91
KADETT E 2.0 i	20NE	10/86 ⇒ 02/93
KADETT E 2.0 i Cat	C20NE	10/86 ⇒ 02/93
OMEGA A 1.8	18SEH, E18NVR, S18NV	09/86 ⇒ 03/94
OMEGA A 1.8 N	18NV	09/86 ⇒ 08/87
OMEGA A 1.8 S	18SV	09/86 ⇒ 03/94
OMEGA A 2.0	20SE, C20NE	09/86 ⇒ 04/94
OMEGA A 2.0 i	C20NE	09/86 ⇒ 04/94
OMEGA B 2.0	20SE	03/94 ⇒ 12/00
VECTRA A 1.8 i	18SV	09/88 ⇒ 10/90
VECTRA A 1.8 i Cat	C18NZ	03/90 ⇒ 11/95
VECTRA A 1.8 S	18SV, E18NVR	09/88 ⇒ 10/90
VECTRA A 1.8 S 4x4	E18NVR	01/89 ⇒ 07/89
VECTRA A 2.0 i	20NE, 20SEH	09/88 ⇒ 09/92
VECTRA A 2.0 i 4x4	20NE, 20SEH	01/89 ⇒ 07/92
VECTRA A 2.0 i Cat	C20NE	09/88 ⇒ 11/95
VECTRA A 2.0 i Cat 4x4	C20NE	01/89 ⇒ 11/95
VECTRA A 2.0 i GT	20SEH	09/88 ⇒ 11/95

VAUXHALL

ASTRA III 1.8 i	C18NZ	09/91 ⇒ 09/98
ASTRA III 2.0 i	C20NE	09/91 ⇒ 09/98
CALIBRA 2.0 i	C20NE	06/90 ⇒ 07/97
CALIBRA 2.0 i 4x4	C20NE	06/90 ⇒ 07/97
FRONTERA A 2.0	C20NE	04/95 ⇒ 08/98
FRONTERA A 2.0 i	C20NE	03/92 ⇒ 10/98
OMEGA B 2.0	20SE	09/95 ⇒ 09/96

KW 359 692

07

IGNITION CABLE SETS

Adatt./Suitable:

00 Eliminated on 16-09-2019. Please verify the availability through our local distributors

- Eliminato il 16-09-2019. Verificare la disponibilità presso i nostri distributori
- Éliminé le 16-09-2019. Vérifier la disponibilité auprès de nos distributeurs sur place
- Am 16-09-2019 gestrichen. Evtl. Verfügbarkeit bitte bei unseren Händlern prüfen
- Eliminado en fecha 16-09-2019. Verificar la disponibilidad a través de nuestros distribuidores locales

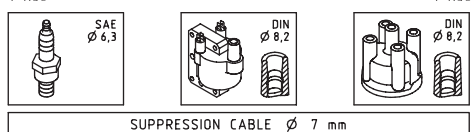
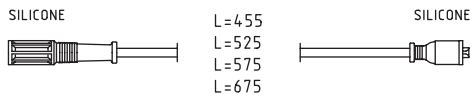

SUPPRESSION CABLE Ø 7 mm

FIAT		
TEMPRA 1.8 4x4	159A4.000	07/92 ⇒ 06/93
TEMPRA 1.8 i.e.	159A4.000, 159A4.046	03/90 ⇒ 08/96
TEMPRA 2.0	159A6.046	04/90 ⇒ 06/93
TEMPRA 2.0 i.e.	159A6.046	10/90 ⇒ 09/96
TEMPRA 2.0 i.e. [BRA]	159A6.011	04/93 ⇒ 12/96
TEMPRA 2.0 i.e. 4x4	159A6.046	03/92 ⇒ 03/95
TIPO I 1.8 i.e.	159A4.000, 159A4.046	10/90 ⇒ 06/93
TIPO I 2.0	159A5.046, 159A6.046	10/90 ⇒ 10/92
TIPO I 2.0 i.e.	159A5.046, 159A6.046	03/90 ⇒ 04/95
TIPO I 2.0 i.e. [BRA]	159A6.011	03/93 ⇒ 10/95

LANCIA		
DEDRA 1.8 i.e.	835A2.000, 835A2.046, 835C5.000	09/89 ⇒ 07/99
DEDRA 2.0 HF Integrale	835A7.046	11/90 ⇒ 07/94
DEDRA 2.0 i.e.	835A5.000, 835A5.046	09/89 ⇒ 07/99
DEDRA 2.0 i.e. Turbo	835A8.046	04/91 ⇒ 07/99
DEDRA 2.0 i.e. Turbo Integrale	835A7.000	04/90 ⇒ 08/91
DEDRA 2.0 Turbo	835A8.000	11/90 ⇒ 06/94

KW 359 694

07

IGNITION CABLE SETS

Adatt./Suitable:

FIAT

7742005

LANCIA

7742005

MAGNETI MARELLI

941095700609

03 Supplied until depletion

- Fornibile fino ad esaurimento delle scorte
- Fourni jusqu'à épuisement du stock
- Lieferbar solange vorrat reicht
- Suministrado hasta el stock termina

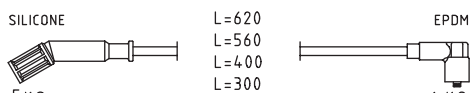

COPPER CORE CABLE Ø 7 mm

FIAT		
TIPO I 1.1 i.e.	156C.046	10/94 ⇒ 10/95
UNO Mondo 1.0 i.e.	146D8.000	01/96 ⇒

LANCIA		
Y10 1.1 Fire	176B2.000	01/95 ⇒ 12/95

LANCIA

Y10 1.1 Fire Trazione integrale	176B2.000	01/95 ⇒ 12/95
Y10 1.1 i.e. Fire Trazione integrale	156C.046	09/92 ⇒ 12/95

KW 359 700

07

IGNITION CABLE SETS

Adatt./Suitable:

BOSCH

0 986 356 892

FIAT

7703382

LANCIA

7703382

00 Eliminated on 06-07-2020. Please verify the availability through our local distributors

- Eliminato il 06-07-2020. Verificare la disponibilità presso i nostri distributori
- Éliminé le 06-07-2020. Vérifier la disponibilité auprès de nos distributeurs sur place
- Am 06-07-2020 gestrichen. Evtl. Verfügbarkeit bitte bei unseren Händlern prüfen
- Eliminado en fecha 06-07-2020. Verificar la disponibilidad a través de nuestros distribuidores locales

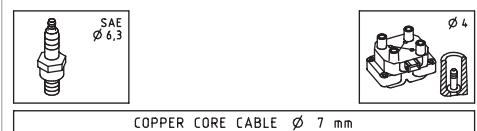
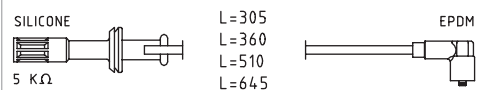

COPPER CORE CABLE Ø 7 mm

FIAT

CROMA I 2000 16V	154E1.000	08/92 ⇒ 08/96
CROMA I 2000 i.e. 16V	154E1.027	03/95 ⇒ 12/96

LANCIA

KAPPA 2.0 16V Turbo	834A4.000	02/95 ⇒ 10/01
THEMA 2000 16V	834F1.000	05/92 ⇒ 07/94
THEMA 2000 16V Turbo	834F2.000	10/92 ⇒ 07/94
THEMA 2000 Turbo 16V	834F2.000	11/92 ⇒ 07/94

KW 359 716

07

IGNITION CABLE SETS

Adatt./Suitable:

ALFA ROMEO

115 48 05 089 00

60522981

60569567

MAGNETI MARELLI

941044110501

03 Supplied until depletion

- Fornibile fino ad esaurimento delle scorte
- Fourni jusqu'à épuisement du stock
- Lieferbar solange vorrat reicht
- Suministrado hasta el stock termina

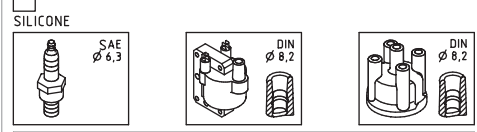
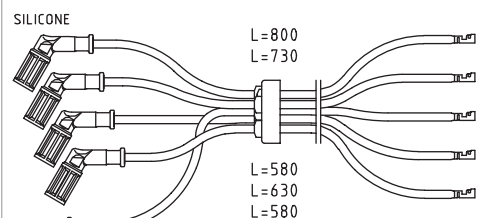

SUPPRESSION CABLE Ø 7 mm

ALFA ROMEO

75 1.6	AR06100	05/85 ⇒ 09/89
75 1.8	AR06202	09/85 ⇒ 06/89

KW 359 725

07

IGNITION CABLE SETS

Adatt./Suitable:

03 Supplied until depletion

- Fornibile fino ad esaurimento delle scorte
- Fourni jusqu'à épuisement du stock
- Lieferbar solange vorrat reicht
- Suministrado hasta el stock termina

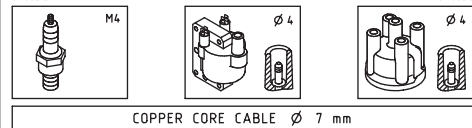
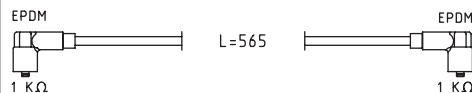
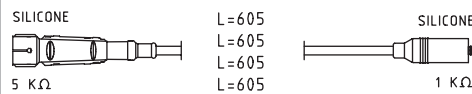

COPPER CORE CABLE Ø 7 mm

SEAT

IBIZA II 1.0	AAU	03/93 ⇒ 09/96
IBIZA II 1.3 i	AAV	03/93 ⇒ 08/99
TOLEDO I 1.6 i	ABN, EZ	05/91 ⇒ 03/99
TOLEDO I 1.8 16V	PL	05/91 ⇒ 03/99
TOLEDO I 1.8 i	ABS, ADZ, RP	05/91 ⇒ 12/96
TOLEDO I 2.0 i	2E	05/91 ⇒ 03/99

VW

JETTA II 1.6	ABN, EZ, EZA, HM, PN, RF	12/83 ⇒ 07/92
JETTA II 1.8	EV, GU, GX, PB, RD, RH, RV	01/84 ⇒ 10/91
JETTA II 1.8 Cat	GX, PF, RP	01/87 ⇒ 10/91
JETTA II 1.8 G60	PG	04/90 ⇒ 07/91
JETTA II 1.8 Syncro	3E82, GU, GX, RH, RP	08/85 ⇒ 07/91
JETTA II 1.8i GT	GZ	12/83 ⇒ 07/88
CADDY I 1.5	JB	08/82 ⇒ 07/83
CADDY I 1.6	EW, HN	01/83 ⇒ 07/92
CADDY I 1.8	JH	08/85 ⇒ 07/92
CORRADO 1.8 G60	PG	09/88 ⇒ 09/93
CORRADO 2.0 i	ADY	04/93 ⇒ 12/95
GOLF I 1.6	EW, HN	08/83 ⇒ 04/92
GOLF I 1.8	2H, DX, EX, JH, KT	08/82 ⇒ 04/93
GOLF II 1.0	GN	11/83 ⇒ 08/85
GOLF II 1.6	ABN, EZ, PN, RF	08/83 ⇒ 12/92
GOLF II 1.6 [CHE] [SWE]	HM	08/83 ⇒ 07/88
GOLF II 1.6 G	EZA, PN	08/86 ⇒ 07/91
GOLF II 1.8	GU, GX, RH, RV	08/84 ⇒ 10/91
GOLF II 1.8 [CHE] [SWE]	HV	04/84 ⇒ 07/87
GOLF II 1.8 GTI	EV, PB, RD	08/83 ⇒ 10/91
GOLF II 1.8 GTI Cat	PF	01/87 ⇒ 10/91
GOLF II 1.8 GTI G60	PG	04/90 ⇒ 07/91
GOLF II 1.8 GTI G60 Syncro	1H, PG	08/88 ⇒ 12/91
GOLF II 1.8 i	RP	08/87 ⇒ 07/91
GOLF II 1.8 i Cat	GX, RP	08/87 ⇒ 10/91
GOLF II 1.8 i Cat Syncro	RP	08/87 ⇒ 10/91
GOLF II 1.8 Rallye syncro	1H, PG	08/88 ⇒ 07/91
GOLF II 1.8 Syncro	3E82, GU, GX, RH	02/86 ⇒ 07/91
GOLF II 1.8i GTI [CHE] [SWE]	GZ	01/84 ⇒ 07/87
GOLF II 1.8i GTI [SWE]	GZ	08/87 ⇒ 07/88
PASSAT III 1.6	1F, ABN, EZ	04/88 ⇒ 07/92
PASSAT III 1.8	AAM, ABS, PB, PF, RP	02/88 ⇒ 05/97
PASSAT III 1.8 G60 Syncro	PG	08/88 ⇒ 05/97
PASSAT III 2.0	2E	02/90 ⇒ 05/97
PASSAT III 2.0 Syncro	2E	03/90 ⇒ 12/96
PASSAT III 2.0i	ACX	08/92 ⇒ 07/93
GOLF III 1.8	AAM, ABS, ADZ	08/91 ⇒ 04/99
GOLF III 1.8 Syncro	ABS	01/93 ⇒ 08/97
SCIROCCO II 1.6	EW, EWA, HN, RE	01/83 ⇒ 07/90
SCIROCCO II 1.8	DX, EX, JH, KT	08/82 ⇒ 07/92
VENTO 1.8	AAM, ABS	11/91 ⇒ 09/98
VENTO 2.0	AKR	11/91 ⇒ 09/98

IGNITION CABLE SETS

Adatt./Suitable:

00 Eliminated on 22-02-2022. Please verify the availability through our local distributors

- Eliminato il 22-02-2022. Verificare la disponibilità presso i nostri distributori
- Éliminé le 22-02-2022. Vérifier la disponibilité auprès de nos distributeurs sur place
- Am 22-02-2022 gestrichen. Evtl. Verfügbarkeit bitte bei unseren Händlern prüfen
- Eliminado en fecha 22-02-2022. Verificar la disponibilidad a través de nuestros distribuidores locales

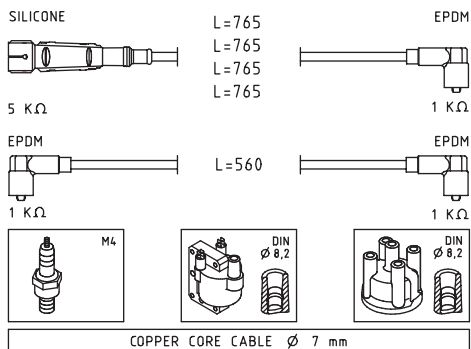

VW

JETTA II 1.3	GT, HK	01/84 ⇒ 06/87
JETTA II 1.6	EZ, HM	12/83 ⇒ 07/92
JETTA II 1.8	EV, GU, GX	01/84 ⇒ 10/91
JETTA II 1.8 Cat	GX	08/87 ⇒ 10/91
JETTA II 1.8 Syncro	GU	08/87 ⇒ 12/88
JETTA II 1.8i GT	GZ	12/83 ⇒ 07/88
CADDY I 1.5	JB	08/82 ⇒ 07/83
CADDY I 1.6	EW, HN	01/83 ⇒ 07/92
CADDY I 1.8	JH	08/85 ⇒ 07/92
GOLF I 1.3	HK	08/83 ⇒ 07/86
GOLF I 1.6	EW, HN	08/83 ⇒ 04/92
GOLF I 1.8	2H, DX, EX, JH, KT	08/82 ⇒ 04/93
GOLF II 1.0	GN	11/83 ⇒ 08/85
GOLF II 1.3	GT, HK	08/83 ⇒ 06/87
GOLF II 1.6	EZ	08/83 ⇒ 07/92
GOLF II 1.6 [CHE] [SWE]	HM	08/83 ⇒ 07/85
GOLF II 1.8	GU, GX	08/84 ⇒ 10/91
GOLF II 1.8 [CHE] [SWE]	HV	04/84 ⇒ 07/87
GOLF II 1.8 GTI	EV	08/83 ⇒ 10/91
GOLF II 1.8i Cat	GX	08/87 ⇒ 10/91
GOLF II 1.8i GTI [CHE] [SWE]	GZ	01/84 ⇒ 07/87
GOLF II 1.8i GTI [SWE]	GZ	08/87 ⇒ 07/88
SCIROCCO I 1.1	FA	04/74 ⇒ 07/79
SCIROCCO I 1.3	GF	08/79 ⇒ 07/80
SCIROCCO I 1.5	JB	08/77 ⇒ 07/80
SCIROCCO II 1.3	HK	08/83 ⇒ 07/84
SCIROCCO II 1.6	EW, EWA, HN	01/83 ⇒ 12/89
SCIROCCO II 1.8	DX, EX, JH, KT	08/82 ⇒ 07/92

IGNITION CABLE SETS

Adatt./Suitable:

03 Supplied until depletion

- Fornibile fino ad esaurimento delle scorte
- Fourni jusqu'à épuisement du stock
- Lieferbar solange vorrat reicht
- Suministrado hasta el stock termina

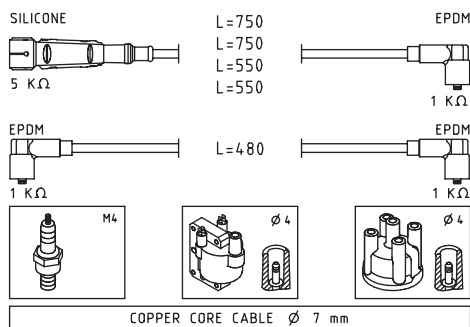

SEAT

CORDOBA I 1.6 i ABU 02/93 ⇒ 10/02

VW

VENTO 1.6 ABU 09/92 ⇒ 09/98

IGNITION CABLE SETS

Adatt./Suitable:

03 Supplied until depletion

- Fornibile fino ad esaurimento delle scorte
- Fourni jusqu'à épuisement du stock
- Lieferbar solange vorrat reicht
- Suministrado hasta el stock termina

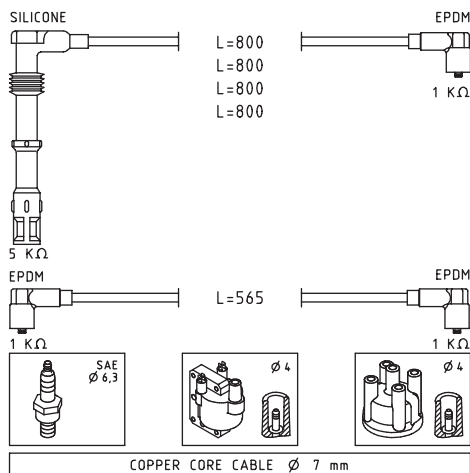

VW

JETTA II 1.8 16V	KR, PL	08/86 ⇒ 10/91
GOLF II 1.8 GTI 16V	KR, PL	02/86 ⇒ 10/91
SCIROCCO II 1.8 16V	KR, PL	10/85 ⇒ 07/92

IGNITION CABLE SETS

Adatt./Suitable:

00 Eliminated on 22-02-2022. Please verify the availability through our local distributors

- Eliminato il 22-02-2022. Verificare la disponibilità presso i nostri distributori
- Éliminé le 22-02-2022. Vérifier la disponibilité auprès de nos distributeurs sur place
- Am 22-02-2022 gestrichen. Evtl. Verfügbarkeit bitte bei unseren Händlern prüfen
- Eliminado en fecha 22-02-2022. Verificar la disponibilidad a través de nuestros distribuidores locales

BOSCH
0 986 357 128
CITROËN
95 659 596
97 534 955
PEUGEOT
5967 C3
5967 K7

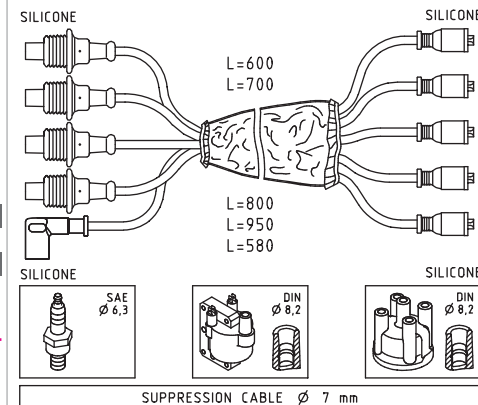

CITROËN

BX 1.6	182A, B6D, B6E	01/87 ⇒ 12/94
BX 1.9	159C, D6U, DKK	09/85 ⇒ 12/94
BX 1.9 GTi	D6D, D6K	01/87 ⇒ 01/92
BX 16	180Z	03/86 ⇒ 12/94
BX 19	D6A(XU9J2), DKZ(XU9JA)	07/86 ⇒ 12/94
BX 19 Cat	DFZ(XU9J1)	07/86 ⇒ 12/94
BX 19 GTi	D6A(XU9J2), DKZ(XU9JA)	07/86 ⇒ 02/93
BX 19 GTi 4x4	DKZ(XU9JA)	06/88 ⇒ 02/93

PEUGEOT

205 I 1.6	B1A(XU51C), B1E(XU51C), BAZ(XU5CP)	08/86 ⇒ 10/87
205 I 1.6 GTI	180A(XU5J), B6D(XU5JA), XU5J1	01/83 ⇒ 12/90
205 II 1.9 GTI	DFZ(XU9J1)	03/87 ⇒ 10/87
205 II 1.6	B1A(XU51C), B1E(XU51C), BAZ(XU5CP)	10/87 ⇒ 09/98
205 II 1.6 CTI	180A(XU5J), 180Z(XU5J)	03/86 ⇒ 10/90
205 II 1.6 GTI	180A(XU5J), 180Z(XU5J)	10/87 ⇒ 12/89
205 II 1.9 CTI	DFZ(XU9J1)	10/87 ⇒ 12/94
205 II 1.9 GTI Cat	DFZ(XU9J1)	10/87 ⇒ 07/94
309 I 1.6	--, 180Z(XU5J), B6B(XU5J), XU5JA	11/85 ⇒ 06/89
309 I 1.6 Cat	BAZ(XU5CP)	09/86 ⇒ 12/89
309 I 1.9	D2B(XU9S), DFZ(XU9J1), XU92C	10/85 ⇒ 07/89
309 II 1.6	XU5JA	07/89 ⇒ 12/93
309 II 1.6 GTi	--	09/89 ⇒ 10/93
309 II 1.9	XU92C	07/89 ⇒ 12/93
405 I 1.9	DFZ(XU9J1)	05/88 ⇒ 08/92
405 I 1.9 Injection	DFZ(XU9J1)	07/87 ⇒ 12/92
405 I 1.9 Trazione integrale	DFZ(XU9J1)	09/88 ⇒ 07/92

KW 359 748

07,5

IGNITION CABLE SETS

Adatt./Suitable:

PEUGEOT

5967 E5
5967 H5
5967 K4

Eliminated on 01-12-2020. Please verify the availability through our local distributors

- Eliminato il 01-12-2020. Verificare la disponibilità presso i nostri distributori
- Éliminé le 01-12-2020. Vérifier la disponibilité auprès de nos distributeurs sur place
- Am 01-12-2020 gestrichen. Evtl. Verfügbarkeit bitte bei unseren Händlern prüfen
- Eliminado en fecha 01-12-2020. Verificar la disponibilidad a través de nuestros distribuidores locales

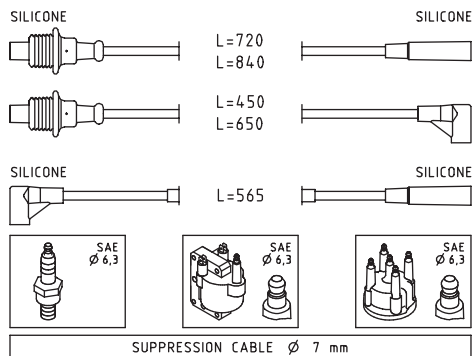

SUPPRESSION CABLE Ø 7 mm

PEUGEOT

205 I 1.6	B1A(XU51C), B1E(XU51C)	08/86 ⇒ 10/87
205 II 1.6	B1A(XU51C), B1E(XU51C)	10/87 ⇒ 09/98
309 II 1.6	18EM, BDZ(XU5M)	07/89 ⇒ 12/93
309 II 1.9	XU92C	07/89 ⇒ 12/93
405 I 1.6	—, 18EM, B1E(XU51C), BDZ(XU5M)	01/87 ⇒ 12/92
405 I 1.6 4x4	BDZ(XU5M)	04/88 ⇒ 07/92
405 I 1.6 SRi 4x4	BDZ(XU5M)	04/88 ⇒ 07/92
405 I 1.9	D2C(XU92C)	07/87 ⇒ 12/92
405 II 1.6	18EM	08/92 ⇒ 05/97
405 II 1.9	XU92C	01/93 ⇒ 12/96

KW 359 768

07

IGNITION CABLE SETS

Adatt./Suitable:

Eliminated on 21-01-2020. Please verify the availability through our local distributors

- Eliminato il 21-01-2020. Verificare la disponibilità presso i nostri distributori
- Éliminé le 21-01-2020. Vérifier la disponibilité auprès de nos distributeurs sur place
- Am 21-01-2020 gestrichen. Evtl. Verfügbarkeit bitte bei unseren Händlern prüfen
- Eliminado en fecha 21-01-2020. Verificar la disponibilidad a través de nuestros distribuidores locales

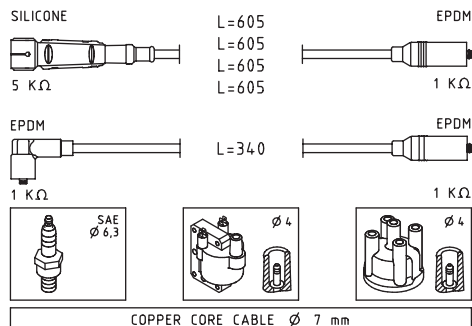

COPPER CORE CABLE Ø 7 mm

AUDI

80 II 1.3	EP	09/78 ⇒ 07/86
80 II 1.6	DT, JU, SA, WV	08/78 ⇒ 03/87
80 II 1.8	DS, JN, SF	01/83 ⇒ 08/86
80 II 1.8 CC quattro	JN, JV	08/84 ⇒ 08/86

AUDI

80 II 1.8 GTE	DZ, MU, PV	06/84 ⇒ 03/87
80 III 1.4	SE	08/86 ⇒ 07/88
80 III 1.6	ABB, PP, RN, RNA	09/86 ⇒ 10/91
80 III 1.8	RU, SD	09/86 ⇒ 01/90
80 III 1.8 E	DZ	06/86 ⇒ 08/91
80 III 1.8 E quattro	DZ	09/86 ⇒ 08/91
80 III 1.8 quattro	SD	09/86 ⇒ 08/90
80 III 1.8 S	JN, JV, NE, PM, SF	08/86 ⇒ 10/91
80 III 1.8 S quattro	JN, NE, PM, SF	09/86 ⇒ 09/91
80 III 2.0	AAD	10/90 ⇒ 08/91
80 III 2.0 E	3A	08/88 ⇒ 10/90
80 III 2.0 E quattro	3A	08/88 ⇒ 09/90
80 III 2.0 quattro	3A, AAD	08/88 ⇒ 08/91
80 IV 1.6	ABB, ABM	09/91 ⇒ 12/94
80 IV 1.6 E	ADA	06/93 ⇒ 01/96
80 IV 2.0	ABT	09/91 ⇒ 01/96
80 IV 2.0 E	ABK	09/91 ⇒ 01/96
80 IV 2.0 E quattro	ABK	09/91 ⇒ 12/94
80 IV 2.0 quattro	ADW	11/93 ⇒ 01/96
90 I 1.8	JN	06/84 ⇒ 03/87
100 III 1.8	DS, JW, NP, SH	08/83 ⇒ 12/90
100 III 1.8 Cat	4B, PH	03/85 ⇒ 11/90
100 III 1.8 Cat quattro	4B, PH	08/85 ⇒ 11/90
100 III 1.8 quattro	NP, SH	10/84 ⇒ 07/90
100 IV 1.6	ABB	03/92 ⇒ 07/93
100 IV 2.0	AAE	12/90 ⇒ 07/94
100 IV 2.0 E	AAD, AAE, ABK	12/90 ⇒ 07/94
100 IV 2.0 E quattro	AAD	12/90 ⇒ 07/92
A6 I 2.0	AAE, ABK, ADW	06/94 ⇒ 12/97
A4 I RS4 quattro	AZR	05/00 ⇒ 09/01
CABRIOLET 2.0 E	ABK	01/93 ⇒ 07/98
COUPE 1.8	DZ	08/89 ⇒ 07/91
COUPE 2.0	3A, AAD, ABK	05/89 ⇒ 12/96

KW 359 780

07

IGNITION CABLE SETS

Adatt./Suitable:

BOSCH

0 986 356 889

HITACHI

134471

MAGNETI MARELLI

941135120700

PEUGEOT

5967 K6

Supplied until depletion

- Fornibile fino ad esaurimento delle scorte
- Fourni jusqu'à épuisement du stock
- Lieferbar solange vorrat reicht
- Suministrado hasta el stock termina

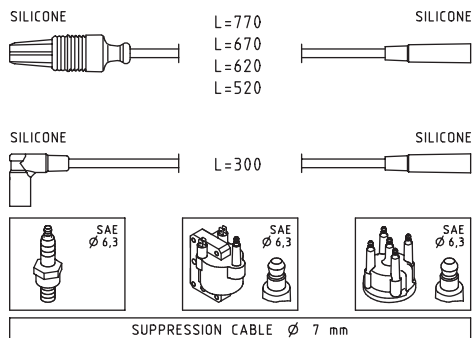

SUPPRESSION CABLE Ø 7 mm

PEUGEOT

106 I 1.0	TU9	09/91 ⇒ 03/01
106 I 1.1	H1B(TU1), HDZ(TU1M)	08/91 ⇒ 04/96
106 I 1.4	K5A(TU3), KDY(TU3M), TU3, TU3.2	08/91 ⇒ 04/96
106 II 1.1	H1B(TU1)	04/96 ⇒
205 I 1.4	TU3	01/83 ⇒ 12/90
205 II 1.0	TU9	10/87 ⇒ 09/98
205 II 1.1	H1B(TU1), HDZ(TU1M)	10/87 ⇒ 09/98
205 II 1.1 CJ	HDZ(TU1M)	10/89 ⇒ 12/94
205 II 1.4	K1D(TU3A), K2B(TU3S), KDY(TU3M), KDZ(TU3M)	06/87 ⇒ 09/98
205 II 1.4 Cat	KAY(TU3CP)	08/87 ⇒ 09/93
205 II 1.4 CJ	K1D(TU3A), KDY(TU3M), KDZ(TU3M)	03/89 ⇒ 12/94
205 II 1.4 CJ Cat	KAY(TU3CP)	01/89 ⇒ 09/93
306 1.4	TU3	01/93 ⇒ 04/02
309 I 1.4	K1D(TU3A), K2B(TU3S), KDY(TU3M), KDZ(TU3M)	08/88 ⇒ 08/89
309 II 1.1	H1B(TU1), HDZ(TU1M)	09/89 ⇒ 12/93
309 II 1.4	KDZ(TU3M), TU3, TU3F2	07/89 ⇒ 12/93
405 I 1.4	K5A(TU3), TU3A, TU3F2	01/87 ⇒ 12/92
405 II 1.4	TU3F2	01/93 ⇒ 12/96
RANCH 1.4	K5A(TU3.2)	09/96 ⇒ 08/02

KW 359 801

07,5

IGNITION CABLE SETS

Adatt./Suitable:

Supplied until depletion

- Fornibile fino ad esaurimento delle scorte
- Fourni jusqu'à épuisement du stock
- Lieferbar solange vorrat reicht
- Suministrado hasta el stock termina

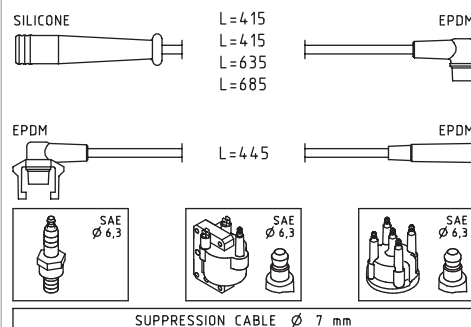

SUPPRESSION CABLE Ø 7 mm

RENAULT

19 I 1.2i	E7F	01/89 ⇒ 12/92
19 I 1.4	E6J700, E6J701, E7J700	01/88 ⇒ 12/92
19 II 1.2	E7F730	05/92 ⇒ 09/94
19 II 1.4	E6J706, E7J706, E7J707, E7J742, E7J745	01/92 ⇒ 12/95
CLIO I 1.2	ESF710, ESF716, E7F700, E7F706, E7F708, E7F750	05/90 ⇒ 09/98
CLIO I 1.4	E6J712, E6J713, E6J718, E7J601, E7J710, E7J711, E7J716, E7J718, E7J719, E7J754, E7J756, E7J757	01/90 ⇒ 09/98
EXPRESS 1.4	E6J/E7J	01/85 ⇒ 10/90
MEGANE I 1.4	E7J764	09/96 ⇒ 08/03
MEGANE I 1.4 e	E7J764	01/96 ⇒ 08/03
MEGANE I 1.4 Eco	E7J624	01/96 ⇒ 03/99
MEGANE SCÉNIC I 1.4 i	E7J764	01/97 ⇒ 09/99
RAPID 1.4	E6J738, E7J720, E7J724, E7J726, E7J728, E7J770, E7J771, E7J773	09/91 ⇒ 03/98
RAPID 1.4 RN	E6J734	09/91 ⇒ 08/93

KW 359 802

08

IGNITION CABLE SETS

Adatt./Suitable:

Supplied until depletion

- Fornibile fino ad esaurimento delle scorte
- Fourni jusqu'à épuisement du stock
- Lieferbar solange vorrat reicht
- Suministrado hasta el stock termina

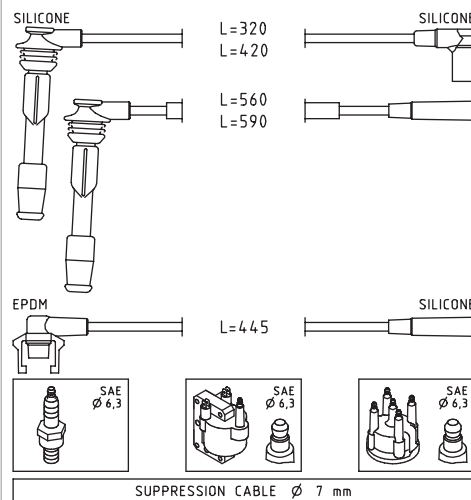

SUPPRESSION CABLE Ø 7 mm

RENAULT

19 I 1.8 16V	F7P700, F7P704	06/89 ⇒ 09/92
19 II 1.8 16V	F7P704	04/92 ⇒ 06/96
CLIO I 1.8 16V	F7P720, F7P722	01/91 ⇒ 03/96
CLIO I Williams	F7R700	01/94 ⇒ 09/98

KW 359 808



07

IGNITION CABLE SETS

Adatt./Suitable:

00 Eliminated on 28-06-2021. Please verify the availability through our local distributors

- Eliminato il 28-06-2021. Verificare la disponibilità presso i nostri distributori
- Éliminé le 28-06-2021. Vérifier la disponibilité auprès de nos distributeurs sur place
- Am 28-06-2021 gestrichen. Evtl. Verfügbarkeit bitte bei unseren Händlern prüfen
- Eliminado en fecha 28-06-2021. Verificar la disponibilidad a través de nuestros distribuidores locales

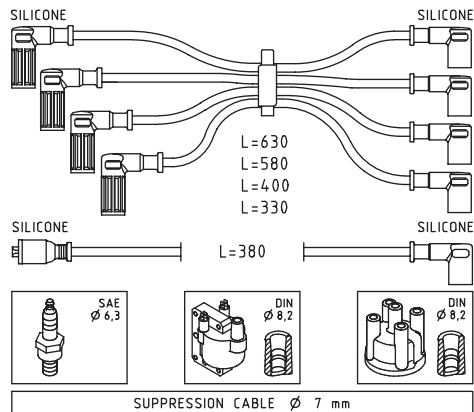

FIAT

TEMPRA 1.4 i.e.	160A1.046	04/90 ⇒ 08/96
TEMPRA 1.6	159A3.000, 159A3.048, 159A3.098	03/90 ⇒ 12/96
TEMPRA 1.6 i.e.	159A3.046, 159A3.048	06/90 ⇒ 08/96
TIPO I 1.4	160A1.048	07/87 ⇒ 12/89
TIPO I 1.4 i.e.	160A1.046	05/89 ⇒ 04/95
TIPO I 1.6	159A3.048, 160A2.000	01/88 ⇒ 10/95
TIPO I 1.6 i.e.	159A3.046, 159A3.048	07/90 ⇒ 04/95
TIPO I 1.6 SX DGT	159A3.000	05/89 ⇒ 10/95
UNO 1.4 Super	146C2.028	09/89 ⇒ 09/92
UNO 70 i.e. 1.4	146C1.000, 160A1.046	09/89 ⇒ 07/96
UNO 70 S 1.4	160A1.048	10/88 ⇒ 06/06
UNO 75 i.e. 1.5	149C1.000	10/85 ⇒ 12/93
UNO Mondo 1.4 Super	146C2.028	01/96 ⇒

KW 359 815



07

IGNITION CABLE SETS

Adatt./Suitable:

00 Eliminated on 21-12-2020. Please verify the availability through our local distributors

- Eliminato il 21-12-2020. Verificare la disponibilità presso i nostri distributori
- Éliminé le 21-12-2020. Vérifier la disponibilité auprès de nos distributeurs sur place
- Am 21-12-2020 gestrichen. Evtl. Verfügbarkeit bitte bei unseren Händlern prüfen
- Eliminado en fecha 21-12-2020. Verificar la disponibilidad a través de nuestros distribuidores locales

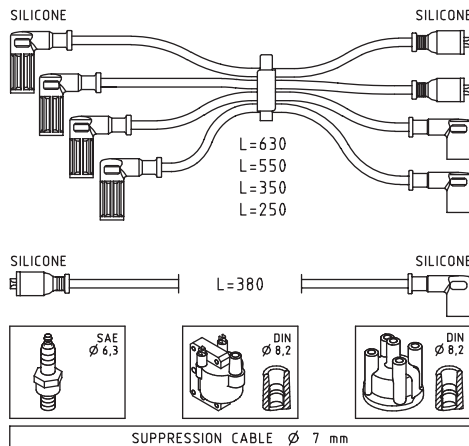

FIAT

TEMPRA 1.4 i.e.	160A1.046	04/90 ⇒ 08/96
TEMPRA 1.6	159A3.000, 159A3.048, 159A3.098	03/90 ⇒ 12/96
TEMPRA 1.6 i.e.	159A3.046, 159A3.048	06/90 ⇒ 08/96
TIPO I 1.4 i.e.	160A1.046	05/89 ⇒ 04/95
TIPO I 1.6	159A3.048	03/93 ⇒ 10/95
TIPO I 1.6 i.e.	159A3.046, 159A3.048	07/90 ⇒ 04/95
TIPO I 1.6 SX DGT	159A3.000	05/89 ⇒ 10/95

KW 359 839



07

IGNITION CABLE SETS

Adatt./Suitable:

00 Eliminated on 29-07-2019. Please verify the availability through our local distributors

- Eliminato il 29-07-2019. Verificare la disponibilità presso i nostri distributori
- Éliminé le 29-07-2019. Vérifier la disponibilité auprès de nos distributeurs sur place
- Am 29-07-2019 gestrichen. Evtl. Verfügbarkeit bitte bei unseren Händlern prüfen
- Eliminado en fecha 29-07-2019. Verificar la disponibilidad a través de nuestros distribuidores locales

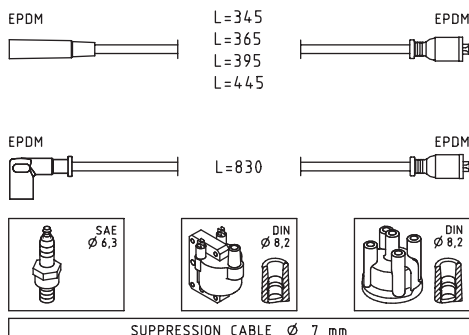

RENAULT

9 1.2	C1G700, C1G710	09/85 ⇒ 12/88
11 1.2	C1G700, C1G710	10/84 ⇒ 12/88

RENAULT

11 1.4	C2J720, C2J766, C2J767, C2J768	03/83 ⇒ 12/88
EXPRESS 1.1	C1E	01/85 ⇒ 10/90
EXPRESS 955	C1C	01/85 ⇒ 10/90
RAPID 1.0	C1C706	09/85 ⇒ 05/92
RAPID 1.1	C1E750, C1E752, C1E754, C1E756, C1E760, C1E762, C1E764, C1E792	07/85 ⇒ 10/97
SUPER 5 1.0	C1C700	10/84 ⇒ 10/88
SUPER 5 1.1	C1E750, C1E752, C1E754, C1E756, C1E760	10/84 ⇒ 12/96

KW 359 846



08

IGNITION CABLE SETS

Adatt./Suitable:

PEUGEOT
5967 79
5967 84

03 Supplied until depletion

- Fornibile fino ad esaurimento delle scorte
- Fourni jusqu'à épuisement du stock
- Lieferbar solange vorrat reicht
- Suministrado hasta el stock termina

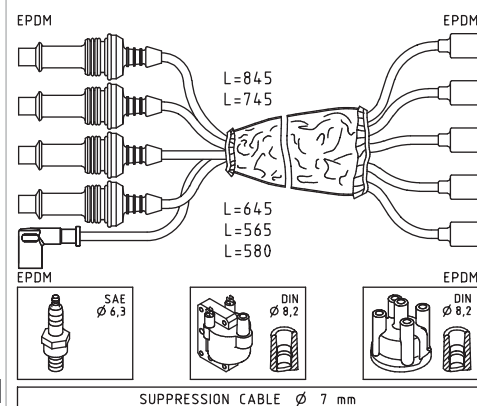

PEUGEOT

205 I 1.1	109F(XW7), 109N(XW7)	02/83 ⇒ 10/87
205 I 1.4	150(XY6B), 150B(XY8), 150D(XY7), 150G(XY7), 150H(XY8)	02/83 ⇒ 10/87
205 II 1.4	150C(XY7), 150H(XY8)	10/87 ⇒ 05/89
205 II 1.4 CJ	150D(XY7), 150G(XY7)	03/88 ⇒ 05/89
205 II 1.4 CT	150B(XY8), 150H(XY8)	04/86 ⇒ 12/88

KW 359 864



07

IGNITION CABLE SETS

Adatt./Suitable:

00 Eliminated on 11-11-2019. Please verify the availability through our local distributors

- Eliminato il 11-11-2019. Verificare la disponibilità presso i nostri distributori
- Éliminé le 11-11-2019. Vérifier la disponibilité auprès de nos distributeurs sur place
- Am 11-11-2019 gestrichen. Evtl. Verfügbarkeit bitte bei unseren Händlern prüfen
- Eliminado en fecha 11-11-2019. Verificar la disponibilidad a través de nuestros distribuidores locales

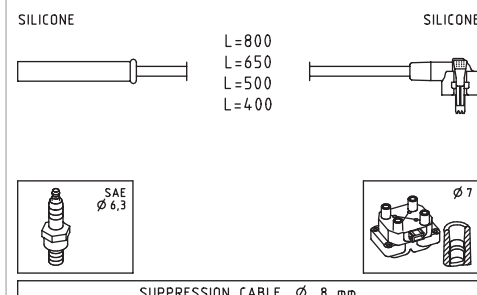

FORD

ESCORT IV 1.4	F4B, F6F, F6G	07/90 ⇒ 08/00
ESCORT V 1.4	F4B, F6F, F6G, FUH	07/90 ⇒ 01/95

FORD			
ESCORT V 1.4 i	F4B	07/93 ⇒ 01/95	
ESCORT V 1.6	LJF, LUJ, LUK	07/90 ⇒ 08/93	
ESCORT VI 1.4	F4B	01/95 ⇒ 12/99	
FIESTA III 1.4	FUG, FUJ	03/89 ⇒ 12/95	
FIESTA III 1.4 Cat	F4A	03/89 ⇒ 12/95	
FIESTA III 1.6	LUH	01/89 ⇒ 01/94	
ORION II 1.4	F6F, F6G, HL14L-FUH	07/90 ⇒ 12/93	
ORION II 1.6	LUJ, LUK	07/90 ⇒ 12/92	
ORION II 1.6 i	HL16EFI-LJE, LJF	07/90 ⇒ 09/92	

KW 359 884

07

IGNITION CABLE SETS

Adatt./Suitable:

BOSCH

0 986 357 241

HITACHI

134242

MAZDA

FP13-18-140A

FP13-18-140B

FS01-18-140

00 Eliminated on 22-02-2022. Please verify the availability through our local distributors

- Eliminato il 22-02-2022. Verificare la disponibilità presso i nostri distributori

- Éliminé le 22-02-2022. Vérifier la disponibilité auprès de nos distributeurs sur place

- Am 22-02-2022 gestrichen. Evtl. Verfügbarkeit bitte bei unseren Händlern prüfen

- Eliminado en fecha 22-02-2022. Verificar la disponibilidad a través de nuestros distribuidores locales

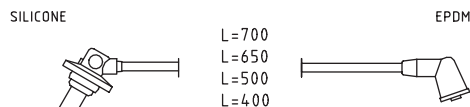

SUPPRESSION CABLE Ø 7 mm

MAZDA

626 V 1.8	FP, FP01LP	08/91 ⇒ 04/97
626 V 1.8 i	→, FP	08/91 ⇒ 06/97
626 V 2.0 i	FS	08/91 ⇒ 04/97
626 V 2.0 i 4WD	FS	04/92 ⇒ 04/97
MX-6 2.0	FS	02/92 ⇒ 02/97

KW 359 887

07

IGNITION CABLE SETS

Adatt./Suitable:

BOSCH

0 986 356 733

FIAT

7745367

03 Supplied until depletion

- Fornibile fino ad esaurimento delle scorte

- Fourni jusqu'à épuisement du stock

- Lieferbar solange vorrat reicht

- Suministrado hasta el stock termina

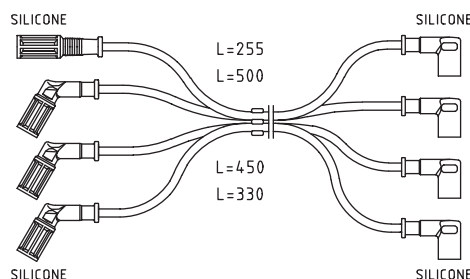

SUPPRESSION CABLE Ø 7 mm

FIAT

PANDA I 1.1	156C.046	05/91 ⇒ 03/95
-------------	----------	---------------

FIAT

PANDA I 1000 i.e	156A2.246	08/92 ⇒ 02/04
PANDA I 1000 i.e. Cat	156A2.246	10/87 ⇒ 08/98
PANDA I 1100	156C.046	05/91 ⇒ 12/99
PANDA I 1100 Trekking 4x4	156C.046	10/91 ⇒ 07/04

KW 359 888

07

IGNITION CABLE SETS

Adatt./Suitable:

BOSCH

0 986 356 738

FIAT

7785350

LANCIA

7785350

MAGNETI MARELLI

941095870625

03 Supplied until depletion

- Fornibile fino ad esaurimento delle scorte

- Fourni jusqu'à épuisement du stock

- Lieferbar solange vorrat reicht

- Suministrado hasta el stock termina

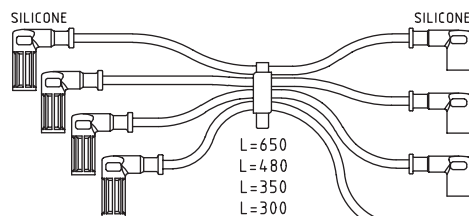

SUPPRESSION CABLE Ø 7 mm

FIAT

PUNTO I 1.6	176A9.000	01/94 ⇒ 04/97
PUNTO I 90 1.6	176A9.000	04/94 ⇒ 04/97
TEMPRA 1.6 i.e.	159B9.000	06/94 ⇒ 08/96

LANCIA

DEDRA 1.6	159B9.000	10/94 ⇒ 07/99
DEDRA 1.6 LE Cat	159B9.000	07/94 ⇒ 07/99

KW 359 889

07

IGNITION CABLE SETS

Adatt./Suitable:

FIAT

7787458

LANCIA

7787458

00 Eliminated on 14-04-2020. Please verify the availability through our local distributors

- Eliminato il 14-04-2020. Verificare la disponibilità presso i nostri distributori

- Éliminé le 14-04-2020. Vérifier la disponibilité auprès de nos distributeurs sur place

- Am 14-04-2020 gestrichen. Evtl. Verfügbarkeit bitte bei unseren Händlern prüfen

- Eliminado en fecha 14-04-2020. Verificar la disponibilidad a través de nuestros distribuidores locales

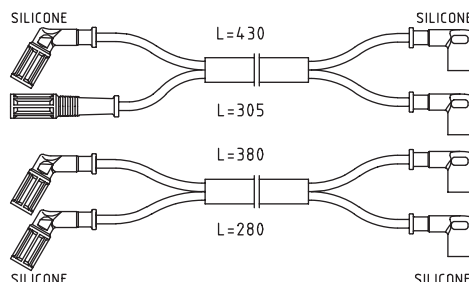

SUPPRESSION CABLE Ø 7 mm

FIAT

TEMPRA 1.8 i.e.	835C2.000, 835C4.000, 836A5.000	09/93 ⇒ 08/96
-----------------	---------------------------------	---------------

FIAT

TIPO I 1.8 i.e	836A5.000	03/93 ⇒ 04/95
TIPO I 1.8 i.e.	835C2.000, 835C4.000, 836A5.000, 836A6.000	03/93 ⇒ 10/95

LANCIA

DEDRA 1.8 i.e.	836A5.000	07/94 ⇒ 07/99
DELTA II 1.8 i.e.	835C2.000, 835C4.000, 836A5.000, 836A6.000, 836C4.000	06/93 ⇒ 08/99

KW 359 900

07

IGNITION CABLE SETS

Adatt./Suitable:

00 Eliminated on 13-09-2021. Please verify the availability through our local distributors

- Eliminato il 13-09-2021. Verificare la disponibilità presso i nostri distributori

- Éliminé le 13-09-2021. Vérifier la disponibilité auprès de nos distributeurs sur place

- Am 13-09-2021 gestrichen. Evtl. Verfügbarkeit bitte bei unseren Händlern prüfen

- Eliminado en fecha 13-09-2021. Verificar la disponibilidad a través de nuestros distribuidores locales

03 Supplied until depletion

- Fornibile fino ad esaurimento delle scorte

- Fourni jusqu'à épuisement du stock

- Lieferbar solange vorrat reicht

- Suministrado hasta el stock termina

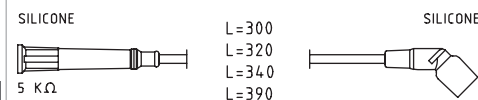

COPPER CORE CABLE Ø 7 mm

BMW

3 III 316 g	M43B16(164E2)	02/96 ⇒ 08/00
3 III 316 i	M43B16(164E2), M43B19(194E1)	09/93 ⇒ 08/00
3 III 318 i	M43B18(184E2)	09/93 ⇒ 11/99
Z3 1.8 i	M43B18(184E2)	10/95 ⇒ 10/98
Z3 1.9 i	M43B19(194E1)	07/98 ⇒ 01/03

KW 359 920

07

IGNITION CABLE SETS

Adatt./Suitable:

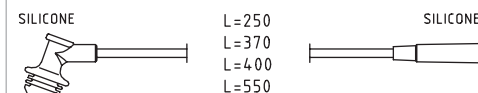

SUPPRESSION CABLE Ø 7 mm

RENAULT

LAGUNA I 1.8	F3P678, F3P720, F3P724	11/93 ⇒ 03/01
LAGUNA I 2.0	627U730, F3R722	11/93 ⇒ 03/01

KW 359 956

07,5

IGNITION CABLE SETS

Adatt./Suitable:

GENERAL MOTORS
90 350 560
OPEL
16 12 512

00 Eliminated on 14-04-2020. Please verify the availability through our local distributors

- Eliminato il 14-04-2020. Verificare la disponibilità presso i nostri distributori
- Éliminé le 14-04-2020. Vérifier la disponibilité auprès de nos distributeurs sur place
- Am 14-04-2020 gestrichen. Evtl. Verfügbarkeit bitte bei unseren Händlern prüfen
- Eliminado en fecha 14-04-2020. Verificar la disponibilidad a través de nuestros distribuidores locales

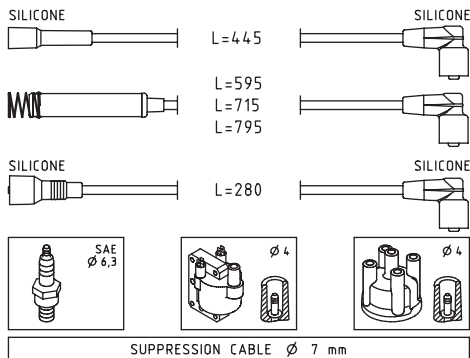

OPEL

VECTRA A 1.4 S | 14NV | 04/88 ⇒ 06/92

KW 359 965

07

IGNITION CABLE SETS

Adatt./Suitable:

03 Supplied until depletion

- Fornibile fino ad esaurimento delle scorte
- Fourni jusqu'à épuisement du stock
- Lieferbar solange vorrat reicht
- Suministrado hasta el stock termina

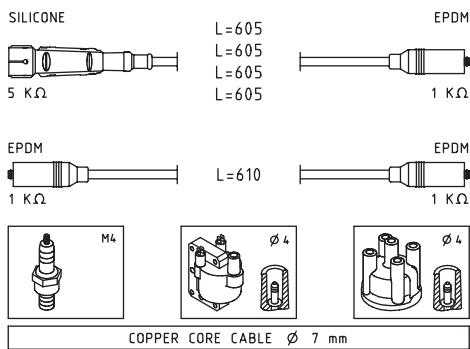

SEAT

CORDOBA I 1.6 i	1F	05/94 ⇒ 06/99
CORDOBA I 1.8 i	ABS, ACC, ADZ	02/93 ⇒ 09/02
CORDOBA I 2.0 i	2E, AGG	02/93 ⇒ 06/99
IBIZA II 1.6 i	1F	09/94 ⇒ 06/99
IBIZA II 1.8 i	ABS, ACC, ADZ	03/93 ⇒ 08/99
IBIZA II 2.0 i	2E, AGG	03/93 ⇒ 08/99
INCA 1.6 i	1F	11/95 ⇒ 05/98
TOLEDO I 1.6 i	1F, ABN, EZ	05/91 ⇒ 03/99
TOLEDO I 1.8 i	ABS, RP	05/91 ⇒ 12/96
TOLEDO I 2.0 i	2E, AGG	05/91 ⇒ 03/99

VW

CADDY II 1.6	1F	11/95 ⇒ 05/97
CADDY II 75 1.6	1F	11/95 ⇒ 05/97
CORRADO 2.0 i	2E	04/93 ⇒ 12/95
GOLF III 1.8	AAM	07/93 ⇒ 05/98
GOLF III 2.0	2E	11/91 ⇒ 04/99
PASSAT III 1.8	AAM, ABS, ADZ	02/88 ⇒ 05/97
PASSAT III 2.0	2E, ADY, AEP, AGG	02/90 ⇒ 05/97
PASSAT III 2.0 Syncro	2E, ADY, AGG	03/90 ⇒ 12/96
POLO III 75 1.6	1F	11/95 ⇒ 09/97

VW

VENTO 2.0 | 2E | 11/91 ⇒ 09/98

KW 360 007

07,5

IGNITION CABLE SETS

Adatt./Suitable:

03 Supplied until depletion

- Fornibile fino ad esaurimento delle scorte
- Fourni jusqu'à épuisement du stock
- Lieferbar solange vorrat reicht
- Suministrado hasta el stock termina

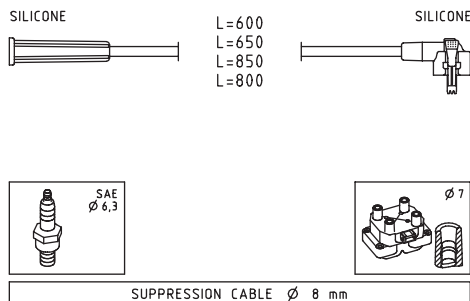

FORD

FIESTA III 1.0	TLB	03/89 ⇒ 12/95
FIESTA III 1.1	G6A, GUD, GUE	03/89 ⇒ 12/95
FIESTA III 1.3	J6B, JBB, JBC	03/89 ⇒ 02/96
FIESTA III 1.3 Cat	J6B	05/91 ⇒ 01/97
ESCORT IV 1.1	GSG	12/85 ⇒ 07/90
ESCORT V 1.3	J6A, JBE	07/90 ⇒ 01/95
ESCORT VI 1.3	BL13H-JBE, J6A	01/95 ⇒ 02/99
ESCORT III 1.1	GSG	05/86 ⇒ 07/90
ORION II 1.3	BL13H-JBE, J4B, J6A	07/90 ⇒ 12/94

KW 360 025

07

IGNITION CABLE SETS

Adatt./Suitable:

BOSCH
0 986 357 240

CITROËN
5967 L9

MAGNETI MARELLI
941135130701

PEUGEOT
5967 L9

03 Supplied until depletion

- Fornibile fino ad esaurimento delle scorte
- Fourni jusqu'à épuisement du stock
- Lieferbar solange vorrat reicht
- Suministrado hasta el stock termina

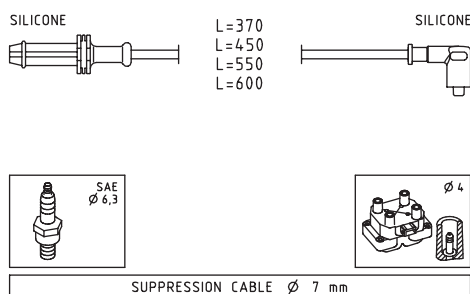

PEUGEOT

106 I 1.4 i	TU3FJ, TU3FMC	01/91 ⇒ 12/96
306 1.1	HDZ(TU1M)	05/93 ⇒ 05/01
306 1.4	KDX(TU3MC)	04/93 ⇒ 07/01
306 1.4 SL	KDX(TU3MC)	06/94 ⇒ 05/01
306 1.6	NFZ(TU5JP)	05/93 ⇒ 10/00
306 1.6 SR	NFZ(TU5JP)	06/94 ⇒ 10/00
405 II 1.4	TU3FM	01/93 ⇒ 12/96

KW 360 078

07

IGNITION CABLE SETS

Adatt./Suitable:

03 Supplied until depletion

- Fornibile fino ad esaurimento delle scorte
- Fourni jusqu'à épuisement du stock
- Lieferbar solange vorrat reicht
- Suministrado hasta el stock termina

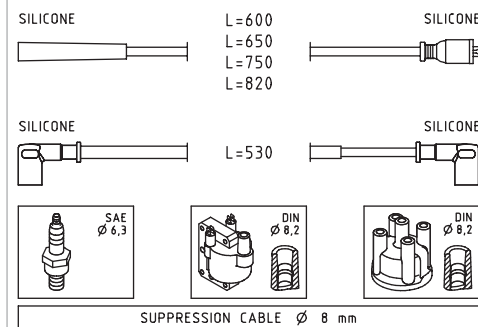

FORD

CORTINA 1300	KL13H	10/70 ⇒ 03/72
GRANADA 1.7	TV17LC	08/77 ⇒ 05/82
GRANADA 2.0	NEP	08/79 ⇒ 08/85
P 100 1.6	LCR	04/82 ⇒ 09/87
P 100 2.0	NAE	10/87 ⇒ 12/92
SCORPIO I 1.8	REC	04/85 ⇒ 02/92
SCORPIO I 2.0	TL20H-NE4, TL20H-NER	10/84 ⇒ 02/90
SCORPIO I 2.0 i	NRA, NRI	04/85 ⇒ 02/92
SIERRA I 1.3	JCT	08/82 ⇒ 12/86
TRANSIT II 1.6	LAC, LAT	09/85 ⇒ 09/92
TRANSIT II 2.0	N6T5, NAT, NAV, NAW	09/85 ⇒ 09/92
TRANSIT II 2.0 Cat	N6T	11/85 ⇒ 09/92
TRANSIT II 2.0 L	NAW, NAX	10/85 ⇒ 03/91

KW 360 138

07

IGNITION CABLE SETS

Adatt./Suitable:

BOSCH
0 986 357 161

SAAB
88 17 520

00 Eliminated on 14-04-2020. Please verify the availability through our local distributors

- Eliminato il 14-04-2020. Verificare la disponibilità presso i nostri distributori
- Éliminé le 14-04-2020. Vérifier la disponibilité auprès de nos distributeurs sur place
- Am 14-04-2020 gestrichen. Evtl. Verfügbarkeit bitte bei unseren Händlern prüfen
- Eliminado en fecha 14-04-2020. Verificar la disponibilidad a través de nuestros distribuidores locales

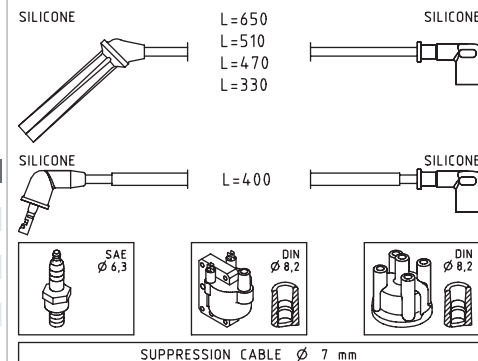

SAAB

900 I 2.0-16	5B6304GS, B202XI	01/86 ⇒ 12/93
900 I 2.0 Turbo-16	B202L, B202XL	11/85 ⇒ 06/94
900 I 2.0 Turbo-16 S	B202XL	02/84 ⇒ 12/88
900 I 2.0 Turbo-16 S Cat	B202XL	01/89 ⇒ 12/93
9000 2.0-16	5B6304GS, B202XI	12/85 ⇒ 01/93
9000 2.0-16 CS	5B6304GS	01/89 ⇒ 12/98
9000 2.0-16 Turbo	B202XL	09/84 ⇒ 08/93
9000 2.0-16 Turbo CD	B202XL	09/88 ⇒ 08/93

360 140

SAAB		
9000 2.3 -16 CD	B234I	08/89 ⇒ 12/98
9000 2.3 -16 CS	B234I	09/89 ⇒ 12/98

KW 360 140



IGNITION CABLE SETS

Adatt./Suitable:

SAAB
93 37 346

00 Eliminated on 22-02-2022. Please verify the availability through our local distributors

- Eliminato il 22-02-2022. Verificare la disponibilità presso i nostri distributori
- Éliminé le 22-02-2022. Vérifier la disponibilité auprès de nos distributeurs sur place
- Am 22-02-2022 gestrichen. Evtl. Verfügbarkeit bitte bei unseren Händlern prüfen
- Eliminado en fecha 22-02-2022. Verificar la disponibilidad a través de nuestros distribuidores locales

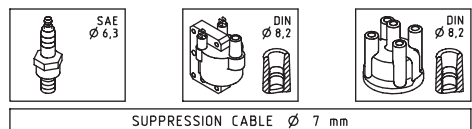
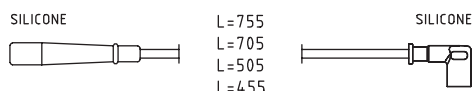

SAAB		
90 2.0	B20I	08/84 ⇒ 08/87
900 I 2.0 c	B201XC	09/79 ⇒ 12/88
900 I 2.0 i	OTLE4G15, B201XI	11/80 ⇒ 08/90
900 I 2.0 Turbo	B201XL	01/86 ⇒ 12/91

KW 360 145



IGNITION CABLE SETS

Adatt./Suitable:

03 Supplied until depletion

- Fornibile fino ad esaurimento delle scorte
- Fourni jusqu'à épuisement du stock
- Lieferbar solange vorrat reicht
- Suministrado hasta el stock termina

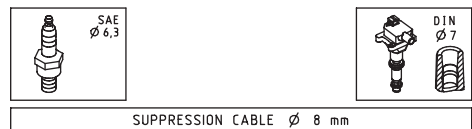
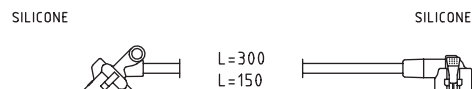

FORD		
ESCORT V RS 2000	N7A	05/91 ⇒ 01/95
ESCORT VI RS 2000	N7A	02/95 ⇒ 02/98
ESCORT VI RS 2000 4x4	N7A	02/95 ⇒ 10/98
GALAXY I 2.3 16V	YSB	01/97 ⇒ 05/06
SCORPIO II 2.0 i 16V	N3A	10/94 ⇒ 08/98
SCORPIO II 2.3 i 16V	YSA	06/96 ⇒ 08/98
TRANSIT III 2.3	ESFA, ESFC	08/00 ⇒ 03/06
TRANSIT III 2.3 16V	ESFA, ESFC	04/01 ⇒ 05/06
TRANSIT III 2.3 16V RWD	ESFA, ESFC	08/00 ⇒ 05/06

KW 360 209



IGNITION CABLE SETS

Adatt./Suitable:

BOSCH
0 986 356 928
F 005 X03 926HITACHI
134130HOLDEN
9091922327MAGNETI MARELLI
941318111274TOYOTA
90919-22327

03 Supplied until depletion

- Fornibile fino ad esaurimento delle scorte
- Fourni jusqu'à épuisement du stock
- Lieferbar solange vorrat reicht
- Suministrado hasta el stock termina

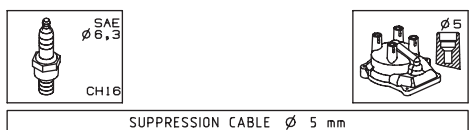
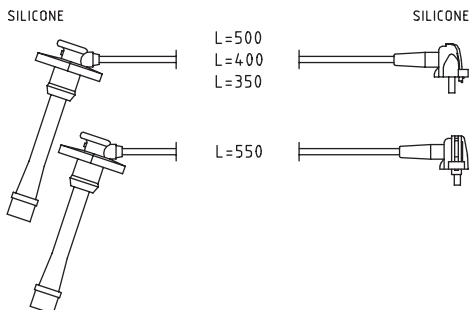

HOLDEN

NOVA_LF 1.8i Hatchback	7AFE	08/91 ⇒ 03/93
NOVA_LF 1.8i Sedan	7AFE	08/91 ⇒ 03/93
NOVA_LG 1.6i Hatchback	4AFE	09/94 ⇒ 09/96
NOVA_LG 1.6i Sedan	4AFE	09/94 ⇒ 09/96
NOVA_LG 1.8i Hatchback	7AFE	09/94 ⇒ 09/96
NOVA_LG 1.8i Sedan	7AFE	09/94 ⇒ 09/96

TOYOTA

AVENSIS I 1.6	4A-FE	09/97 ⇒ 10/00
CARINA E 1.6	4A-FE	04/92 ⇒ 09/97
CARINA E 1.6 16V	4A-FE	12/94 ⇒ 09/97
CARINA E 1.6 GLI	4A-FE	04/92 ⇒ 09/97
CARINA E 1.6 i	4A-FE	02/95 ⇒ 09/97
COROLLA VII 1.6 GLI	4A-FE	07/92 ⇒ 04/97
COROLLA VII 1.6 Si	4A-FE	07/92 ⇒ 04/97
COROLLA VII 1.8 16V 4WD	7A-FE	09/95 ⇒ 04/97
COROLLA VII 1.8 GT	7A-FE	11/92 ⇒ 05/95
COROLLA VIII 1.6	4A-FE	04/97 ⇒ 02/00
COROLLA VIII 1.6 Aut.	4A-FE	04/97 ⇒ 02/00
COROLLA VIII 1.8 4WD	7A-FE	04/97 ⇒ 10/01
CELICA VI 1.8 i 16V	7A-FE	11/93 ⇒ 11/99
CELICA VI 1.8 i 16V [USA] [CAN]	7A-FE	09/93 ⇒ 08/99

KW 360 231



IGNITION CABLE SETS

Adatt./Suitable:

BOSCH
0 986 357 149

MAZDA

B69F-18-140A
B69F-18-140B
B6BF-18-140A
B6BF-18-140B

00 Eliminated on 22-02-2021. Please verify the availability through our local distributors

- Eliminato il 22-02-2021. Verificare la disponibilità presso i nostri distributori
- Éliminé le 22-02-2021. Vérifier la disponibilité auprès de nos distributeurs sur place
- Am 22-02-2021 gestrichen. Evtl. Verfügbarkeit bitte bei unseren Händlern prüfen
- Eliminado en fecha 22-02-2021. Verificar la disponibilidad a través de nuestros distribuidores locales

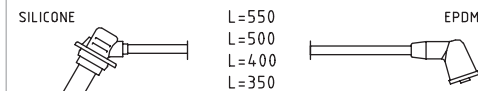

MAZDA

323 VII C 1.8 16V	BP-ZE	08/94 ⇒ 09/98
323 VII 1.8 16V	BP-ZE	08/94 ⇒ 09/98
323 VIII S 1.8 16V	BP-ZE	08/94 ⇒ 09/98
MX-3 1.6i	B6D	11/93 ⇒ 09/98
XEDOS 6 1.6 16V	B6(DOHC), B69	01/92 ⇒ 10/99

KW 360 237



IGNITION CABLE SETS

Adatt./Suitable:

BOSCH
0 986 356 747
0 986 357 127
0 986 357 148
0 986 357 156
F 005 X11 115

GENERAL MOTORS

90 442 406
90 442 410
90 443 690
90 443 691HITACHI
134296HOLDEN
90443690MAGNETI MARELLI
941125120666

OPEL

16 12 533
16 12 541
16 12 544
16 12 556
16 12 557
16 12 610

03 Supplied until depletion

- Fornibile fino ad esaurimento delle scorte
- Fourni jusqu'à épuisement du stock
- Lieferbar solange vorrat reicht
- Suministrado hasta el stock termina

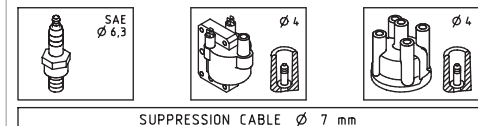
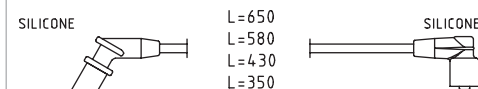

HOLDEN

BARINA 1.4i	C14NZ	04/94 ⇒ 07/97
-------------	-------	---------------

HOLDEN			
BARINA_SB 1.2i	C12NZ	04/94	⇒ 07/97
COMBO 1.4 i	C14NZ	03/96	⇒ 07/97
COMBO_SB 1.4i	C14NZ	04/94	⇒ 07/97

OPEL			
ASTRA F 1.4	14NV, 14SE	09/91	⇒ 09/98
ASTRA F 1.4 i	C14NZ	09/91	⇒ 01/05
ASTRA F 1.4 Si	C14SE	03/92	⇒ 03/01
COMBO B 1.2	C12NZ, X12SZ	07/94	⇒ 10/01
CORSA A 1.2 i	C12NZ	09/89	⇒ 03/93
CORSA A 1.4 i	C14NZ	01/85	⇒ 03/93
CORSA A 1.4 S	14NV	09/89	⇒ 03/93
CORSA A 1.4 Si	C14SE	09/91	⇒ 03/93
CORSA B 1.2 i	12NZ, C12NZ, X12SZ	03/93	⇒ 09/00
KADETT E 1.4 i	C14NZ	01/90	⇒ 07/94
KADETT E 1.4 S	14NV	07/89	⇒ 02/93
KADETT E 1.6	16SV	09/86	⇒ 12/91
KADETT E 1.6 i	16SV	07/89	⇒ 02/93
KADETT E 1.6 S	16SV	09/86	⇒ 08/91
VECTRA A 1.4 S	14NV	04/88	⇒ 06/92
VECTRA A 1.6	16SV	09/88	⇒ 05/93
VECTRA A 1.6 i	C16NZ, E16NZ	09/88	⇒ 11/95
VECTRA A 1.6 i Cat	C16NZ	09/88	⇒ 11/95
VECTRA A 1.6 S	16SV	09/88	⇒ 05/93

VAUXHALL			
ASTRA III 1.4	14NV	09/91	⇒ 09/93
ASTRA III 1.4 i	C14NZ, C14SE	03/91	⇒ 09/98
ASTRA III 1.4 S	14NV	09/91	⇒ 02/98
ASTRAVAN I 1.4 i	C14NZ	09/91	⇒ 08/95
COMBO B 1.2	C12NZ, X12SZ	07/94	⇒ 10/01
CORSA B 1.2 i	C12NZ, X12SZ	03/93	⇒ 09/00

KW 360 278

07,5

IGNITION CABLE SETS

Adatt./Suitable:

BOSCH

0 986 357 147

HITACHI

134279

MAGNETI MARELLI

941285030866

MITSUBISHI

MD183124

MD193015

MD198216

MD310297

MD315902

MD334017

MD334021

MD334026

MD334039

03 Supplied until depletion

- Fornibile fino ad esaurimento delle scorte
- Fourni jusqu'à épuisement du stock
- Lieferbar solange vorrat reicht
- Suministrado hasta el stock termina



SUPPRESSION CABLE Ø 7 mm

MITSUBISHI

COLT IV 1.6 4WD	4G92(SOHC16V)	08/93	⇒ 08/95
COLT IV 1.6 GLXi 16V	4G92(SOHC16V)	04/92	⇒ 04/96
GALANT VII 1.8	4G93(SOHC16V)	02/94	⇒ 08/96
GALANT VII 1.8 GLSi	4G93(SOHC16V)	11/92	⇒ 08/96
GALANT VII 2.0 GLSi	4G63(SOHC16V)	11/92	⇒ 08/96
GALANT VII 2.0 GLSi 4WD	4G63(SOHC16V)	11/92	⇒ 08/96
LANCER V 1.6 16V	4G92(SOHC16V)	06/92	⇒ 05/94
LANCER V 1.6 4WD	4G92(SOHC16V)	06/92	⇒ 11/93
LANCER VI 1.6	4G92(SOHC16V)	02/94	⇒ 12/96
LANCER VI 1.6 16V	4G92(SOHC16V)	06/92	⇒ 10/03
LANCER VI 1.6 16V 4WD	4G92(SOHC16V)	06/92	⇒ 10/03
LANCER VI 1.6 i	4G92(SOHC16V)	09/92	⇒ 07/96
SPACE RUNNER 1.8	4G93(SOHC16V)	10/91	⇒ 08/99
SPACE RUNNER 1.8 4WD	4G93(SOHC16V)	10/91	⇒ 08/99
SPACE WAGON 1.8	4G93(SOHC16V)	10/91	⇒ 10/98
SPACE WAGON 1.8 4WD	4G93(SOHC16V)	10/91	⇒ 10/98
SPACE WAGON 2.0	4G63(SOHC16V)	10/92	⇒ 10/98
SPACE WAGON 2.0 4WD	4G63(SOHC16V)	10/92	⇒ 10/98

KW 360 281

07

IGNITION CABLE SETS

Adatt./Suitable:

00 Eliminated on 02-12-2019. Please verify the availability through our local distributors

- Eliminato il 02-12-2019. Verificare la disponibilità presso i nostri distributori
- Éliminé le 02-12-2019. Vérifier la disponibilité auprès de nos distributeurs sur place
- Am 02-12-2019 gestrichen. Evtl. Verfügbarkeit bitte bei unseren Händlern prüfen
- Eliminado en fecha 02-12-2019. Verificar la disponibilidad a través de nuestros distribuidores locales

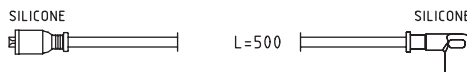
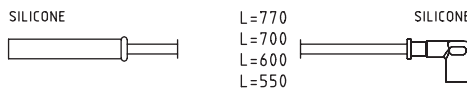

SUPPRESSION CABLE Ø 8 mm

FORD

ESCORT IV 1.4	F6D, FUC	01/86	⇒ 07/90
ESCORT IV 1.6 XR3i	LR2, LRB	01/86	⇒ 07/90
FIESTA II 1.4	FUB, FUD	10/85	⇒ 11/89
FIESTA II 1.6 XR2	LUB, LUD	03/84	⇒ 02/89
FIESTA III 1.4	F6E	03/89	⇒ 12/95
ESCORT III 1.4 i	F6D, FUC	02/86	⇒ 07/90
ORION I 1.4 Cat	F6D	02/87	⇒ 07/90
ORION I 1.6 i	LRB	03/86	⇒ 07/90

KW 360 300

07,5

IGNITION CABLE SETS

Adatt./Suitable:

03 Supplied until depletion

- Fornibile fino ad esaurimento delle scorte
- Fourni jusqu'à épuisement du stock
- Lieferbar solange vorrat reicht
- Suministrado hasta el stock termina

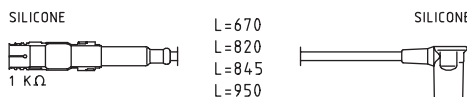

COPPER CORE CABLE Ø 7 mm

MERCEDES-BENZ

190 2.3	M102.985	09/87	⇒ 09/88
190 2.3 E	M102.985	10/82	⇒ 09/88
190 E 1.8	M102.910, M102.919	04/90	⇒ 12/93
190 E 2.0	M102.962	10/82	⇒ 08/93
190 E 2.3	M102.985	09/86	⇒ 08/93
KOMBI II 200 TE	M102.962	09/88	⇒ 12/89

KW 360 305

07,5

IGNITION CABLE SETS

Adatt./Suitable:

03 Supplied until depletion

- Fornibile fino ad esaurimento delle scorte
- Fourni jusqu'à épuisement du stock
- Lieferbar solange vorrat reicht
- Suministrado hasta el stock termina

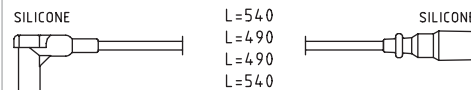

COPPER CORE CABLE Ø 7 mm

MERCEDES-BENZ

CLASSE C I C 180	M111.920	03/93	⇒ 05/00
CLASSE C I C 180 T	M111.920	06/96	⇒ 09/00
CLASSE C I C 200	M111.941	01/94	⇒ 05/00
CLASSE C I C 200 T	M111.941	06/96	⇒ 03/01

KW 360 323

09

IGNITION CABLE SETS

Adatt./Suitable:

00 Eliminated on 22-02-2022. Please verify the availability through our local distributors

- Eliminato il 22-02-2022. Verificare la disponibilità presso i nostri distributori
- Éliminé le 22-02-2022. Vérifier la disponibilité auprès de nos distributeurs sur place
- Am 22-02-2022 gestrichen. Evtl. Verfügbarkeit bitte bei unseren Händlern prüfen
- Eliminado en fecha 22-02-2022. Verificar la disponibilidad a través de nuestros distribuidores locales

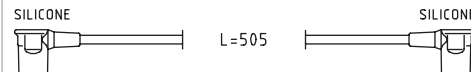
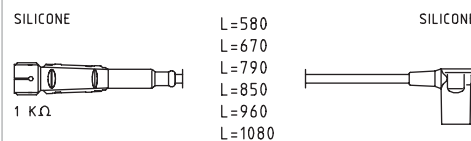

COPPER CORE CABLE Ø 7 mm

MERCEDES-BENZ

123 280 CE	M110.988	03/77	⇒ 11/85
CLASSE S II 280 SE, SEL	M110.989	10/79	⇒ 07/85
TRE VOLUMI I 280 E	M110.988	02/76	⇒ 11/85

KW 360 332

07

IGNITION CABLE SETS

Adatt./Suitable:

⁰³ Supplied until depletion

- Fornibile fino ad esaurimento delle scorte
- Fourni jusqu'à épuisement du stock
- Lieferbar solange vorrat reicht
- Suministrado hasta el stock termina

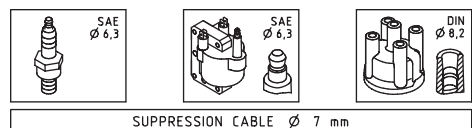
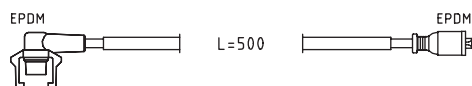
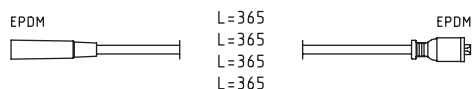

SUPPRESSION CABLE Ø 7 mm

RENAULT

TWINGO 1.2	C3G700, C3G702	03/93 ⇒ 10/96
VOLVO		
340-360 1.3	B13, B13.4E	08/88 ⇒ 12/90
340-360 1.4	B14.3E, B14.4E, B14.4ED, B14.40, B14.45	08/82 ⇒ 07/91

KW 360 343

07,5

IGNITION CABLE SETS

Adatt./Suitable:

BOSCH
0 986 357 248

CHRYSLER
4797685
SPW07685AA

⁰⁰ Eliminated on 09-12-2019. Please verify the availability through our local distributors

- Eliminato il 09-12-2019. Verificare la disponibilità presso i nostri distributori
- Éliminé le 09-12-2019. Vérifier la disponibilité auprès de nos distributeurs sur place
- Am 09-12-2019 gestrichen. Evtl. Verfügbarkeit bitte bei unseren Händlern prüfen
- Eliminado en fecha 09-12-2019. Verificar la disponibilidad a través de nuestros distribuidores locales

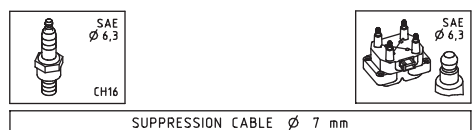
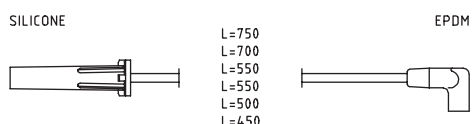

SUPPRESSION CABLE Ø 7 mm

CHRYSLER

VOYAGER II 3.3 i	R00	01/95 ⇒ 03/01
VOYAGER II 3.8 i AWD	EGH, L00	01/95 ⇒ 03/01

KW 360 344

07,5

IGNITION CABLE SETS

Adatt./Suitable:

MITSUBISHI
MD338249
MD371794
MD371980

⁰⁰ Eliminated on 07-10-2019. Please verify the availability through our local distributors

- Eliminato il 07-10-2019. Verificare la disponibilità presso i nostri distributori
- Éliminé le 07-10-2019. Vérifier la disponibilité auprès de nos distributeurs sur place
- Am 07-10-2019 gestrichen. Evtl. Verfügbarkeit bitte bei unseren Händlern prüfen
- Eliminado en fecha 07-10-2019. Verificar la disponibilidad a través de nuestros distribuidores locales

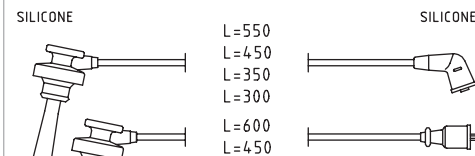

SUPPRESSION CABLE Ø 5 mm

MITSUBISHI

PAJERO III 3.0	6G72(SOHC24V)	10/01 ⇒ 12/06
PAJERO III 3.0 ZR	6G72(DOHC24V)	08/03 ⇒
PAJERO III 3.5	6G74(DOHC24V)	04/00 ⇒ 01/07
PAJERO III 3.5 i	6G74(DOHC24V), 6G74(SOHC24V)	09/03 ⇒ 10/06
PAJERO III 3.5 V6 GDI	6G74(GDI)	04/00 ⇒ 12/06
PAJERO II 3.0 V6 24V	6G72(SOHC24V)	06/94 ⇒ 04/00
PAJERO II 3.5 V6 24V	6G74(DOHC24V), 6G74(SOHC24V)	06/94 ⇒ 10/99
PAJERO SPORT I 3.0 4WD	6G72(SOHC24V)	09/96 ⇒ 12/01
PAJERO SPORT I 3.0 V6	6G72(SOHC24V)	06/00 ⇒
PAJERO SPORT I 3.0 V6 4WD	6G72(DOHC24V)	03/03 ⇒

KW 360 345

07,5

IGNITION CABLE SETS

Adatt./Suitable:

CHRYSLER
5019593AA

⁰³ Supplied until depletion

- Fornibile fino ad esaurimento delle scorte
- Fourni jusqu'à épuisement du stock
- Lieferbar solange vorrat reicht
- Suministrado hasta el stock termina

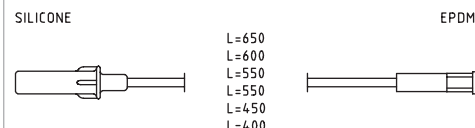

SUPPRESSION CABLE Ø 7 mm

CHRYSLER

VOYAGER III 3.3	EGA	02/00 ⇒ 12/08
VOYAGER III 3.3 AWD	EGA	02/00 ⇒ 12/08

KW 360 353

07

IGNITION CABLE SETS

Adatt./Suitable:

⁰⁰ Eliminated on 22-02-2022. Please verify the availability through our local distributors

- Eliminato il 22-02-2022. Verificare la disponibilità presso i nostri distributori
- Éliminé le 22-02-2022. Vérifier la disponibilité auprès de nos distributeurs sur place
- Am 22-02-2022 gestrichen. Evtl. Verfügbarkeit bitte bei unseren Händlern prüfen
- Eliminado en fecha 22-02-2022. Verificar la disponibilidad a través de nuestros distribuidores locales

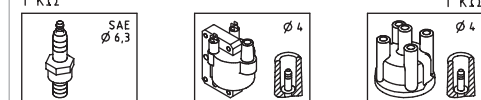
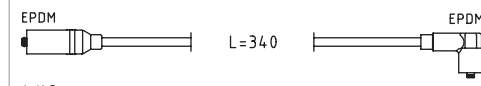
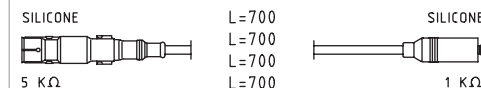

COPPER CORE CABLE Ø 7 mm

AUDI

A4 I 1.6	ADP	11/94 ⇒ 09/01
VW		
PASSAT IV 1.6	ADP	10/96 ⇒ 11/00

KW 360 356

08

IGNITION CABLE SETS

Adatt./Suitable:

⁰⁰ Eliminated on 22-02-2021. Please verify the availability through our local distributors

- Eliminato il 22-02-2021. Verificare la disponibilità presso i nostri distributori
- Éliminé le 22-02-2021. Vérifier la disponibilité auprès de nos distributeurs sur place
- Am 22-02-2021 gestrichen. Evtl. Verfügbarkeit bitte bei unseren Händlern prüfen
- Eliminado en fecha 22-02-2021. Verificar la disponibilidad a través de nuestros distribuidores locales

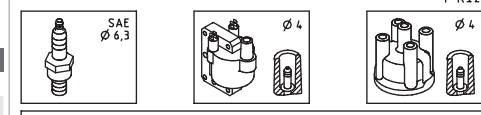
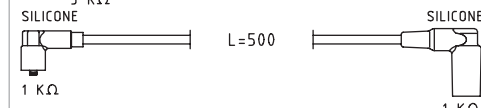
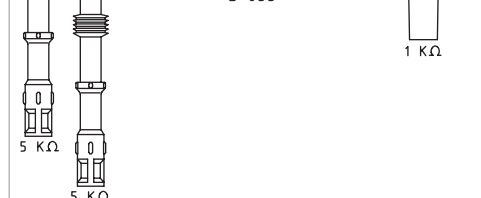
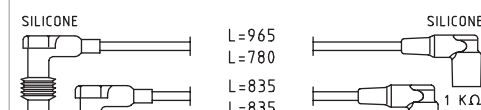

COPPER CORE CABLE Ø 7 mm

AUDI

100 IV 2.0 E 16V	ACE	01/92 ⇒ 07/94
100 IV 2.0 E 16V quattro	ACE	07/92 ⇒ 07/94
A6 I 2.0 16V	ACE	06/94 ⇒ 12/97
A6 I 2.0 16V quattro	ACE	06/94 ⇒ 12/97

KW 360 363



07

IGNITION CABLE SETS

Adatt./Suitable:

BOSCH

0 356 912 881

FIAT

7760523

HITACHI

134534

134758

IVECO

7760523

LANCIA

7760523

MAGNETI MARELLI

941095790617

03 Supplied until depletion

- Fornibile fino ad esaurimento delle scorte
- Fourni jusqu'à épuisement du stock
- Lieferbar solange vorrat reicht
- Suministrado hasta el stock termina

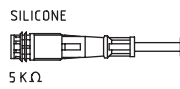

L = 580
L = 550
L = 480
L = 330

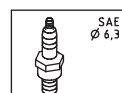
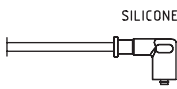
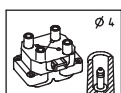
SAE
ø 6,3

ø 4

COPPER CORE CABLE ø 7 mm

FIAT			
BRAVA 1.4	182A5.000	10/95	⇒ 10/01
BRAVA 1.4 12V	182A3.000	10/95	⇒ 08/98
BRAVO I 1.4	182A3.000, 182A5.000	10/95	⇒ 10/01
MAREA 1.4 80 12V	182A3.000	09/96	⇒ 05/02
LANCIA			
YI 1.4 12V	840A2.000, 840A4.000	03/96	⇒ 09/03

KW 360 364



07

IGNITION CABLE SETS

Adatt./Suitable:

03 Supplied until depletion

- Fornibile fino ad esaurimento delle scorte
- Fourni jusqu'à épuisement du stock
- Lieferbar solange vorrat reicht
- Suministrado hasta el stock termina

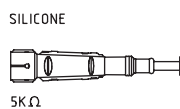

L = 630
L = 630
L = 630
L = 630

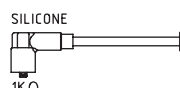
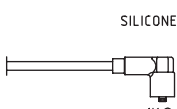

L = 495

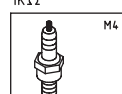
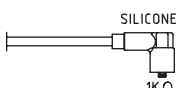

M4

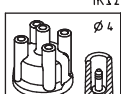
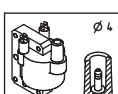

ø 4

COPPER CORE CABLE ø 7 mm

SEAT			
CORDOBA I 1.4 i	ABD	06/94	⇒ 10/02
CORDOBA I 1.6 i	ABU	02/93	⇒ 10/02
IBIZA II 1.4 i	ABD	09/93	⇒ 02/02
IBIZA II 1.6 i	ABU	03/93	⇒ 02/02
VW			
POLO II 1.0	AAU, HZ	01/85	⇒ 09/94
POLO II 1.0 Cat	AAU, ACM	08/89	⇒ 09/94
POLO II 1.3	3F	10/90	⇒ 09/94
POLO II 1.3 Cat	2G, 3F, AAV, MH, NZ	07/87	⇒ 09/94
POLO II 1.3 G40	PY	08/90	⇒ 09/94
GOLF III 1.6	ABU, AEA	09/92	⇒ 08/97
POLO III 45 1.0	AEV	10/94	⇒ 09/96
POLO III 50 1.0	AER	09/96	⇒ 10/99
POLO III 55 1.3	ADX	10/94	⇒ 04/97
POLO IV 1.0	AER	08/96	⇒ 12/01
VENTO 1.6	ABU	09/92	⇒ 09/98

KW 360 373



07

IGNITION CABLE SETS

Adatt./Suitable:

00 Eliminated on 22-02-2022. Please verify the availability through our local distributors

- Eliminato il 22-02-2022. Verificare la disponibilità presso i nostri distributori
- Éliminé le 22-02-2022. Vérifier la disponibilité auprès de nos distributeurs sur place
- Am 22-02-2022 gestrichen. Evtl. Verfügbarkeit bitte bei unseren Händlern prüfen
- Eliminado en fecha 22-02-2022. Verificar la disponibilidad a través de nuestros distribuidores locales

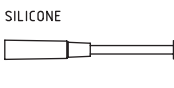

L = 300
L = 370
L = 400
L = 505

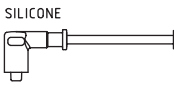
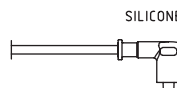

L = 380

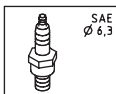
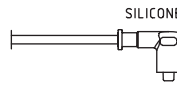

ø 4

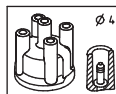
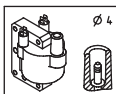

ø 4

SUPPRESSION CABLE ø 7 mm

SKODA			
FELICIA 1.3	135, 135L, 136I	10/94	⇒ 03/98

KW 360 374



07

IGNITION CABLE SETS

Adatt./Suitable:

BOSCH

0 986 357 240

CITROËN

5967 N6

5967 P1

PEUGEOT

5967 N6

5967 P1

00 Eliminated on 10-12-2021. Please verify the availability through our local distributors

- Eliminato il 10-12-2021. Verificare la disponibilità presso i nostri distributori
- Éliminé le 10-12-2021. Vérifier la disponibilité auprès de nos distributeurs sur place
- Am 10-12-2021 gestrichen. Evtl. Verfügbarkeit bitte bei unseren Händlern prüfen
- Eliminado en fecha 10-12-2021. Verificar la disponibilidad a través de nuestros distribuidores locales

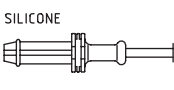

L = 280
L = 380
L = 500
L = 580

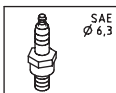
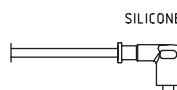

ø 4

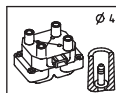

ø 4

SUPPRESSION CABLE ø 7 mm

CITROËN			
AX 1.4 GTi	KFY(TU3FJ2), KFZ(TU3FJ2)	06/91	⇒ 12/96
AX 10	CDY(TU9M), CDZ(TU9M)	07/86	⇒ 12/98
AX 11	HDZ(TU1M)	09/86	⇒ 12/97
AX 14	K6B(TU3FJ2), KDX(TU3M/Z), KDY(TU3FM)	04/87	⇒ 04/97
AX 14 4x4	KDY(TU3FM)	08/91	⇒ 12/96
XSARA 1.4 i	KFX(TU3JP)	04/97	⇒ 08/05
XSARA 1.6 i	NFZ(TU5JP)	04/97	⇒ 09/00
BERLINGO I 1.1 i	HDZ(TU1M)	07/96	⇒ 05/08
BERLINGO I 1.4 i	KFW(TU3JP), KFX(TU3JP)	07/96	⇒ 12/11
BERLINGO I 1.4 i bivalent	KFW(TU3JP)	04/03	⇒ 10/05
SAXO 1.0 X	CDZ(TU9M)	05/96	⇒ 11/98
SAXO 1.1 X, SX	HDZ(TU1M)	05/96	⇒ 09/03
SAXO 1.4 VTS	KFX(TU3JP)	05/96	⇒ 06/03
SAXO 1.6	NFT(TU5JP), NFZ(TU5JP)	02/01	⇒ 04/04
SAXO 1.6 VTL, VTR	NFZ(TU5JP)	05/96	⇒ 06/03

CITROËN

SAXO 1.6 VTS	NFT(TU5JP)	09/00	⇒ 09/03
ZX 1.1	HDZ(TU1M)	03/91	⇒ 06/97
ZX 1.4	KDZ(TU3M/Z)	03/91	⇒ 06/97
ZX 1.4 i	KDX(TU3M/Z), KDZ(TU3M/Z), KFX(TU3JP)	03/91	⇒ 10/97

PEUGEOT

106 I 1.0	CDY(TU9M), CDZ(TU9M)	09/91	⇒ 03/01
106 I 1.1	HDZ(TU1M)	09/91	⇒ 04/96
106 I 1.3	TU2J2	10/93	⇒ 04/96
106 I 1.4	KDX(TU3MC)	09/91	⇒ 04/96
106 I 1.4 i XSI	TU3J	09/91	⇒ 03/96
106 I 1.4 Le Mans	KFZ(TU3J2/Z)	09/91	⇒ 11/94
106 I 1.6	NFY(TU5J2), NFZ(TU5JP)	06/93	⇒ 04/96
106 II 1.0 i	CDY(TU9M), CDZ(TU9M)	04/96	⇒ 10/99
106 II 1.1 i	HDY(TU1M), HDZ(TU1M)	05/96	⇒ 07/04
106 II 1.4 i	KFW(TU3JP), KFX(TU3JP)	05/96	⇒ 07/04
106 II 1.6 i	NFW(TU5J2), NFY(TU5J2), NFZ(TU5JP)	05/96	⇒ 10/99
306 1.4	KFW(TU3JP), KFX(TU3JP)	04/93	⇒ 04/02
306 1.4 SL	KFW(TU3JP), KFX(TU3JP)	06/94	⇒ 05/01
306 1.6	NFZ(TU5JP)	05/93	⇒ 10/00
306 1.6 SR	NFZ(TU5JP)	06/94	⇒ 10/00
PARTNER I 1.1	HDY(TU1M), HDZ(TU1M)	06/96	⇒
PARTNER I 1.4	KFX(TU3JP), TU32	06/96	⇒ 12/15
RANCH 1.1	HDY(TU1M), HDZ(TU1M)	06/96	⇒
RANCH 1.4	KFX(TU3JP)	06/96	⇒

KW 360 376



07

IGNITION CABLE SETS

Adatt./Suitable:

CITROËN

5967 N9

00 Eliminated on 14-04-2020. Please verify the availability through our local distributors

- Eliminato il 14-04-2020. Verificare la disponibilità presso i nostri distributori
- Éliminé le 14-04-2020. Vérifier la disponibilité auprès de nos distributeurs sur place
- Am 14-04-2020 gestrichen. Evtl. Verfügbarkeit bitte bei unseren Händlern prüfen
- Eliminado en fecha 14-04-2020. Verificar la disponibilidad a través de nuestros distribuidores locales

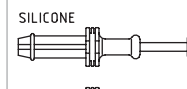

L = 485
L = 585
L = 640

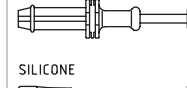
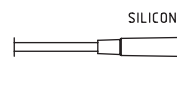

L = 740

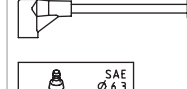
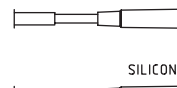

L = 300

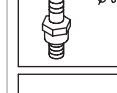
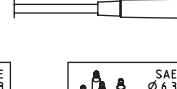

ø 6,3

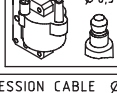

ø 6,3



ø 6,3

SUPPRESSION CABLE ø 7 mm

CITROËN			
AX 1.3 Sport	M4A	04/87	⇒ 12/88
AX 10	C1A	09/86	⇒ 06/92
AX 10 E	C3A	12/86	⇒ 12/88
AX 11	H1A, H1B, HDZ(TU1M)	09/86	⇒ 12/97
AX 11 4x4	H1A	06/91	⇒ 07/92
AX 11 Cat	HAZ(TU1CP)	09/88	⇒ 12/89
AX 14	K1A(TU3), K1B, K1F, K1G, K1J, K2A, K2B, K2D, KAY(TU3CP), KDX(TU3M/Z), KDY(TU3FM), KDY(TU3M), KDZ(TU3M/Z)	09/86	⇒ 04/97
AX 14 4x4	KD4, KDX(TU3M/Z), KDY(TU3FM), KDY(TU3M), KDZ(TU3M/Z)	06/91	⇒ 12/96
AX 14 GT	KDZ(TU3M/Z)	01/89	⇒ 12/91
BX 1.1	109LA, H1A	04/86	⇒ 06/91
BX 1.4	150C, K1F, K2D	07/86	⇒ 12/94
BX 1.4 E	150B(XY8), 150J, 150Y, K1F, KAZ	09/82	⇒ 12/94
BX 14	150C, KDY(TU3M), KDZ(TU3M/Z)	01/86	⇒ 02/93
BX 14 E	150A, 150C, K1G	10/82	⇒ 02/93
C15 1.0	108C(XV8), C1A, C1A(TU9/K), C1B(TU9/W), TU9	10/84	⇒ 12/97
C15 1.1	H1A, HDZ(TU1M), TU1	08/88	⇒ 07/96

CITROËN			
C15 1.1 i	HDZ(TU1M), TU1MZ	07/88 ⇒ 12/96	
C15 1.4	K1A, K1G, K1H(TU3A), KDY(TU3M)	07/87 ⇒ 12/96	
C15 1.4 E	K1F, K1J, K2D, K3A, KAZ	07/86 ⇒ 12/96	
C15 1.4 i	KDY(TU3FM), KDY(TU3M)	05/91 ⇒ 12/96	
BERLINGO I 1.4	TU32	07/96 ⇒ 10/98	
ZX 1.1	H1A, H1B, HDZ(TU1M), TU1	03/91 ⇒ 06/97	
ZX 1.4 i	KDY(TU3M)	10/93 ⇒ 10/97	

KW 360 385

07,5

IGNITION CABLE SETS

Adatt./Suitable:

HYUNDAI

27501-23A00
27501-23B01
27501-23B70

KIA

27501-23B70

03 Supplied until depletion

- Fornibile fino ad esaurimento delle scorte
- Fourni jusqu'à épuisement du stock
- Lieferbar solange vorrat reicht
- Suministrado hasta el stock termina

SILICONE

L=550
L=400
L=350
L=250

EPDM

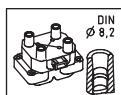
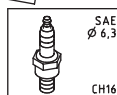
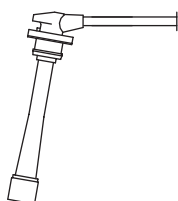

SUPPRESSION CABLE ø 7 mm

HYUNDAI

COUPE I 1.6 16V	G4GR	03/98 ⇒ 04/02
COUPE I 1.6 i 16V	4G61	12/96 ⇒ 04/02
COUPE I 2.0 16V	G4GF	08/96 ⇒ 04/02
ELANTRA II 1.6 i 16V	G4GR	06/95 ⇒ 05/00
ELANTRA II 1.8 i 16V	G4GM	05/95 ⇒ 05/00
ELANTRA II 2.0 i 16V	G4DF	06/97 ⇒ 05/00
ELANTRA III 1.8	G4BB, G4GB	06/00 ⇒ 07/06
ELANTRA III 2.0	G4GC, G4GC-G	06/00 ⇒ 07/06
ELANTRA IV 2.0 CVVT	G4GC	06/06 ⇒ 06/11
I30 I 2.0	G4GC, G4GC-G	10/07 ⇒ 06/12
LANTRA 1.8	G4GB	06/00 ⇒
LANTRA 2.0	G4GC-G	06/00 ⇒
LANTRA II 1.6 16V	4G61	11/95 ⇒ 10/00
LANTRA II 1.6 i	G4GR	11/95 ⇒ 10/00
LANTRA II 1.8 16V	G4GM	11/95 ⇒ 10/00
LANTRA II 2.0 16V	G4GF	11/95 ⇒ 10/00
LAVITA 1.8	--	01/07 ⇒
MATRIX 1.8	G4GB-G	06/01 ⇒ 08/10
MATRIX 1.8 [TUR]	G4GB	04/08 ⇒
SONATA V 2.0 i [RUS]	--	04/06 ⇒ 12/10
COUPE II 2.0	G4GC-G	08/01 ⇒ 08/09
COUPE II 2.0 GLS	G4GC-G	02/03 ⇒ 08/09
TIBURON 1.6 i 16V	G4GL, G4GR	08/00 ⇒
TIBURON 2.0 i 16V	G4DF	08/99 ⇒
TRAJET 2.0	G4GC, G4GC-G, G4JP-G	03/00 ⇒ 07/08
TRAJET 2.0 CRDi	D4EA	08/05 ⇒ 07/08
TUCSON 2.0	G4GC	08/04 ⇒
TUCSON 2.0 Trazione integrale	G4GC	08/04 ⇒ 11/10

KIA

CARENS I 2.0 CVVT	G4GC	08/04 ⇒
CEED I 2.0	G4GC	12/06 ⇒ 12/12
CERATO I 2.0	G4GC	03/04 ⇒ 05/07
PRO CEE'D I 2.0	G4GC	02/08 ⇒ 09/12
SPORTAGE II 2.0 16V 4WD	G4GC	09/04 ⇒
SPORTAGE II 2.0 i 16V	G4GC	09/04 ⇒
CERATO II 2.0 CVVT	--	01/09 ⇒

KW 360 393

05

IGNITION CABLE SETS

Adatt./Suitable:

BOSCH

0 986 357 171

TOYOTA

90919-22329

00 Eliminated on 04-05-2020. Please verify the availability through our local distributors

- Eliminato il 04-05-2020. Verificare la disponibilità presso i nostri distributori
- Éliminé le 04-05-2020. Vérifier la disponibilité auprès de nos distributeurs sur place
- Am 04-05-2020 gestrichen. Evtl. Verfügbarkeit bitte bei unseren Händlern prüfen
- Eliminado en fecha 04-05-2020. Verificar la disponibilidad a través de nuestros distribuidores locales

SILICONE

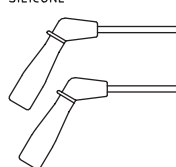
L=500
L=350

L=450

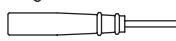

L=700

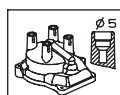
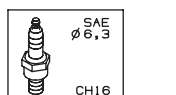

SUPPRESSION CABLE ø 5 mm

TOYOTA

COROLLA VII 1.3 12V	2E	07/92 ⇒ 04/97
COROLLA VIII 1.3	2E	05/97 ⇒ 10/01
STARLET 1.0	1E	12/89 ⇒ 12/92
TERCEL 1.5 i [USA]	3EE	01/93 ⇒

KW 360 398

07

IGNITION CABLE SETS

Adatt./Suitable:

MAZDA

8BBG-18-140
8BBY-18-140

00 Eliminated on 14-06-2021. Please verify the availability through our local distributors

- Eliminato il 14-06-2021. Verificare la disponibilità presso i nostri distributori
- Éliminé le 14-06-2021. Vérifier la disponibilité auprès de nos distributeurs sur place
- Am 14-06-2021 gestrichen. Evtl. Verfügbarkeit bitte bei unseren Händlern prüfen
- Eliminado en fecha 14-06-2021. Verificar la disponibilidad a través de nuestros distribuidores locales

SILICONE

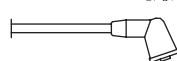
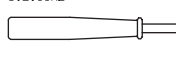
L=700
L=600
L=500
L=450

EPDM

L=500

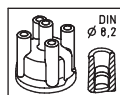
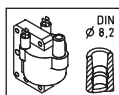
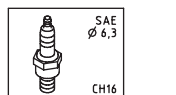
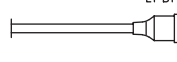
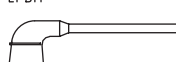

SUPPRESSION CABLE ø 7 mm

KIA

PRIDE 1.1 i	B1	01/91 ⇒ 10/00
PRIDE 1.3	B3, B3A5	01/90 ⇒ 09/01
PRIDE 1.3 [GBR]	--	01/90 ⇒
PRIDE 1.3 i	--	01/90 ⇒ 05/97
PRIDE 1.3 i [GBR]	--	01/90 ⇒
SEPHIA I 1.6 i	B6	09/93 ⇒ 10/97

MAZDA

323 VI C 1.6 16V	B6	03/91 ⇒ 10/94
323 VI F 1.6 16V	B6	03/91 ⇒ 10/94

MAZDA

323 VIF 1.8 16V	BP	08/89 ⇒ 07/94
323 VIF 1.8 16V GT	BP(DOHC)	08/89 ⇒ 07/94
323 VIF 1.8i 16v GRSi	BP31	06/89 ⇒ 03/91
323 VIS 1.3 16V	B3(16V)	04/91 ⇒ 07/94
323 VIS 1.6 16V	B6	08/89 ⇒ 10/96
323 VIS 1.8 16V	BP52	08/89 ⇒ 07/94
323 VIS 1.8 16V 4WD	BP52	09/91 ⇒ 07/94
PROTEGE 1.8i OHC [USA]	--	01/90 ⇒

KW 360 399

07

IGNITION CABLE SETS

Adatt./Suitable:

BOSCH

0 986 357 239

NISSAN

22440-57Y10
22440-73C00
22440-73C10

00 Eliminated on 22-02-2021. Please verify the availability through our local distributors

- Eliminato il 22-02-2021. Verificare la disponibilità presso i nostri distributori
- Éliminé le 22-02-2021. Vérifier la disponibilité auprès de nos distributeurs sur place
- Am 22-02-2021 gestrichen. Evtl. Verfügbarkeit bitte bei unseren Händlern prüfen
- Eliminado en fecha 22-02-2021. Verificar la disponibilidad a través de nuestros distribuidores locales

SILICONE

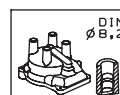
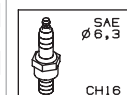
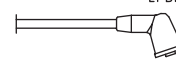
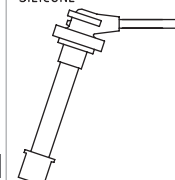
L=650
L=550
L=450
L=350

SUPPRESSION CABLE ø 7 mm

NISSAN

100NX 1.6 SR	GA16DE	09/93 ⇒ 10/94
ALMERA I 1.4	GA14DE	09/95 ⇒ 07/00
ALMERA I 1.4 GX, LX	GA14DE	09/95 ⇒ 07/00
ALMERA I 1.4 S, GX, LX	GA14DE	09/95 ⇒ 03/00
ALMERA I 1.6	GA16DE	07/95 ⇒ 07/00
ALMERA I 1.6 SLX	GA16DE	09/95 ⇒ 07/00
ALMERA I 1.6 SR, SLX	GA16DE	09/95 ⇒ 03/00
PRIMERA I 1.6 i	GA16DE	02/91 ⇒ 03/98
SUNNY III 1.6 i	GA16DE	10/90 ⇒ 03/00
SUNNY III 1.6 i 16V	GA16DE	10/92 ⇒ 05/95

KW 360 401

07

IGNITION CABLE SETS

Adatt./Suitable:

BOSCH
0 986 356 974
0 986 357 151

HYUNDAI
27501-33A00

KIA
27501-33A00

MITSUBISHI
MD134754
MD192995

00 Eliminated on 22-02-2022. Please verify the availability through our local distributors

• Eliminato il 22-02-2022. Verificare la disponibilità presso i nostri distributori

• Éliminé le 22-02-2022. Vérifier la disponibilité auprès de nos distributeurs sur place

• Am 22-02-2022 gestrichen. Evtl. Verfügbarkeit bitte bei unseren Händlern prüfen

• Eliminado en fecha 22-02-2022. Verificar la disponibilidad a través de nuestros distribuidores locales

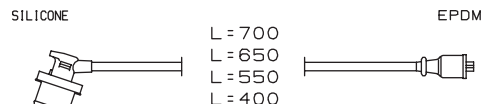
SUPPRESSION CABLE \varnothing 7 mm

HYUNDAI

ELANTRA I 1.5 i GL	G4DJ	12/90 \Rightarrow 08/94
ELANTRA I 1.6i 16V	G4CR	12/90 \Rightarrow 05/95
ELANTRA I 1.8i 16V	G4CN	06/92 \Rightarrow 12/95
LANTRA I 1.5 i.e.	G4DJ	10/90 \Rightarrow 11/95
LANTRA I 1.6 i.e. 16V	G4CR	10/90 \Rightarrow 11/95
LANTRA I 1.8 i.e. 16V	G4CN	10/90 \Rightarrow 11/95
SANTAMO 2.0 16V	G4JP	05/99 \Rightarrow 12/02
SANTAMO 2.0 16V 4x4	G4CP-D	05/99 \Rightarrow 12/02
SONATA II 2.0 i 16V	G4CP-D	01/91 \Rightarrow 10/93
SONATA III 2.0 i 16V	G4CP-D, G4CP-DM	05/93 \Rightarrow 06/98

KIA

JOICE 2.0	G4CP	02/00 \Rightarrow
-----------	------	---------------------

MITSUBISHI

COLT III 1.6 GTi 16V	4G61	04/88 \Rightarrow 05/90
COLT III 1.8 GTi 16V Cat	4G67	06/90 \Rightarrow 05/92
LANCERV 1.6 GTi	4G61	05/88 \Rightarrow 05/90
LANCERV 1.8 GTi 16V	4G67	11/89 \Rightarrow 05/92
ECLIPSE I 2.0 i 16V	4G63(DOHC16V)	04/91 \Rightarrow 11/95
ECLIPSE I 2.0 i 16V 4WD	4G63(DOHC16V)	04/91 \Rightarrow 11/95
ECLIPSE I 2.0 Turbo	4G63-T(DOHC16V)	12/89 \Rightarrow 03/94
ECLIPSE I 2.0 Turbo 4WD	4G63-T(DOHC16V)	12/89 \Rightarrow 03/94
GALANT VI 2.0 GTi 16V	4G63(DOHC16V)	11/87 \Rightarrow 10/92
GALANT VI 2.0 GTi 16V 4WD	4G63(DOHC16V)	06/88 \Rightarrow 10/92
GALANT VI 2.0 GTi 16V 4x4	4G63(DOHC16V)	07/89 \Rightarrow 12/92
GALANT VI 2.0 GTi 16V Cat 4WD	4G63(DOHC16V)	09/91 \Rightarrow 10/92

KW 360 411

07,5

IGNITION CABLE SETS

Adatt./Suitable:

BOSCH
0 986 357 239

HITACHI
134280

NISSAN
22440-2F200
22440-2J210

03 Supplied until depletion

• Fornibile fino ad esaurimento delle scorte

• Fourni jusqu'à épuisement du stock

• Lieferbar solange vorrat reicht

• Suministrado hasta el stock termina

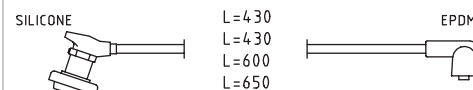
SUPPRESSION CABLE \varnothing 7 mm

NISSAN

ALMERA I 2.0 GTi	SR20DE	07/96 \Rightarrow 03/00
ALMERA TINO 2.0	SR20DE	08/00 \Rightarrow 01/03
PRIMERA II 2.0	SR20DEL	10/97 \Rightarrow 06/99
PRIMERA II 2.0 16V	SR20DE	06/96 \Rightarrow 07/02
PRIMERA II 2.0 GT	SR20DEH	10/97 \Rightarrow 06/99
PRIMERA I 2.0	SR20DE	07/94 \Rightarrow 01/98

KW 360 413

05

IGNITION CABLE SETS

Adatt./Suitable:

03 Supplied until depletion

• Fornibile fino ad esaurimento delle scorte

• Fourni jusqu'à épuisement du stock

• Lieferbar solange vorrat reicht

• Suministrado hasta el stock termina

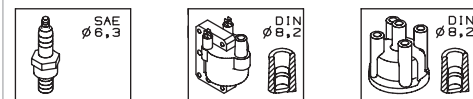
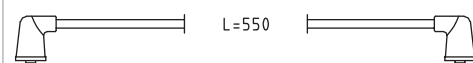
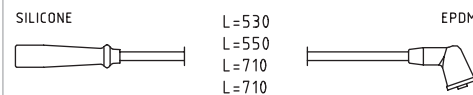
SUPPRESSION CABLE \varnothing 7 mm

SUZUKI

ALTO IV 1.0	G10BB	09/94 \Rightarrow 06/02
ALTO V 1.0	G10BB	01/00 \Rightarrow 06/02
SWIFT I / II / III 1.3	G13BA	03/89 \Rightarrow 10/96
SWIFT I / II / III 1.3 GTi SOHC	G13B	10/89 \Rightarrow 12/95
SWIFT I / II / III 1.3 i	G13BA	09/91 \Rightarrow 10/96
SJ410 1.0	F10A	09/81 \Rightarrow 07/91
SWIFT III 1.3 i	G13BA	06/96 \Rightarrow 03/01

KW 360 415

07

IGNITION CABLE SETS

Adatt./Suitable:

GENERAL MOTORS
96 058 494

SUZUKI
33700-60A10
33700-60A10-000
33700-60A20
33700-60A20-000

03 Supplied until depletion

• Fornibile fino ad esaurimento delle scorte

• Fourni jusqu'à épuisement du stock

• Lieferbar solange vorrat reicht

• Suministrado hasta el stock termina

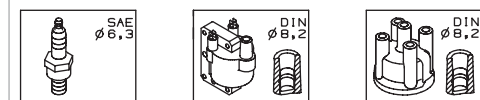
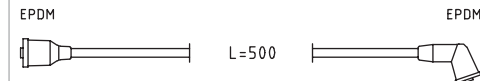
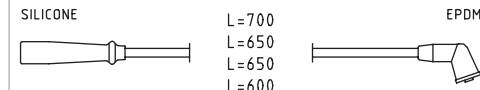
SUPPRESSION CABLE \varnothing 7 mm

SUZUKI

SIDEKICK 1.6i [USA]	--	01/89 \Rightarrow 12/91
VITARA I 1.6 8V	--	01/90 \Rightarrow 12/94

KW 360 417

07

IGNITION CABLE SETS

Adatt./Suitable:

SUZUKI
33700-83020
33700-83020-000
33705-83020
33705-83020-000
33710-83020
33710-83020-000

00 Eliminated on 25-11-2020. Please verify the availability through our local distributors

• Eliminato il 25-11-2020. Verificare la disponibilità presso i nostri distributori

• Éliminé le 25-11-2020. Vérifier la disponibilité auprès de nos distributeurs sur place

• Am 25-11-2020 gestrichen. Evtl. Verfügbarkeit bitte bei unseren Händlern prüfen

• Eliminado en fecha 25-11-2020. Verificar la disponibilidad a través de nuestros distribuidores locales

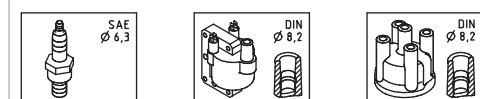
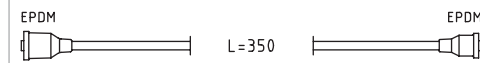
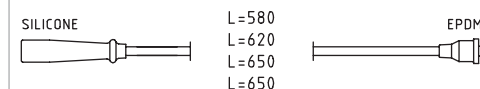
SUPPRESSION CABLE \varnothing 7 mm

SUZUKI

SIDEKICK 1.6i [USA]	--	01/91 \Rightarrow
---------------------	----	---------------------

KW 360 433

07

IGNITION CABLE SETS

Adatt./Suitable:

BOSCH
0 986 356 975
DAEWOO
NP1149

00 Eliminated on 14-04-2020. Please verify the availability through our local distributors

- Eliminato il 14-04-2020. Verificare la disponibilità presso i nostri distributori
- Éliminé le 14-04-2020. Vérifier la disponibilité auprès de nos distributeurs sur place
- Am 14-04-2020 gestrichen. Evtl. Verfügbarkeit bitte bei unseren Händlern prüfen
- Eliminado en fecha 14-04-2020. Verificar la disponibilidad a través de nuestros distribuidores locales

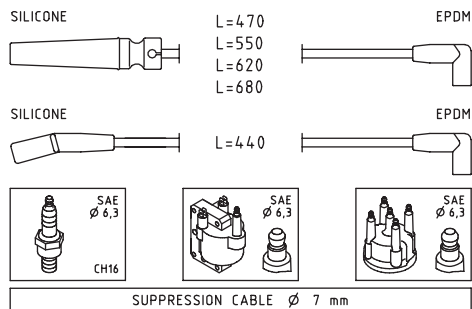

DAEWOO

ARANOS 1.5	V15L	01/95 ⇒ 11/97
ESPERO 1.5	G15MF	10/97 ⇒ 09/99
ESPERO 1.5 16V	A15MF	02/95 ⇒ 06/99
NEXIA 1.5 16V	A15MF	02/95 ⇒ 08/97

KW 360 434

07

IGNITION CABLE SETS

Adatt./Suitable:

SUZUKI
33705-51G20
33705-51G20-000

00 Eliminated on 14-04-2020. Please verify the availability through our local distributors

- Eliminato il 14-04-2020. Verificare la disponibilità presso i nostri distributori
- Éliminé le 14-04-2020. Vérifier la disponibilité auprès de nos distributeurs sur place
- Am 14-04-2020 gestrichen. Evtl. Verfügbarkeit bitte bei unseren Händlern prüfen
- Eliminado en fecha 14-04-2020. Verificar la disponibilidad a través de nuestros distribuidores locales

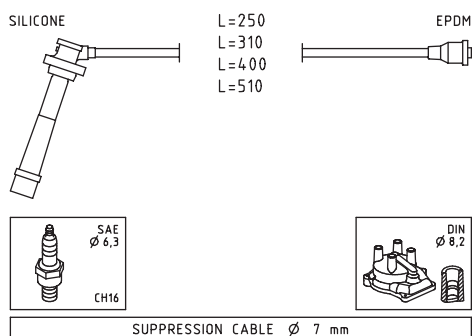

SUZUKI

BALENO 1.3 16V	G13BB	03/97 ⇒ 05/02
BALENO 1.3 i 16V	G13BB	07/95 ⇒ 05/02
BALENO 1.6 i 16V	G16B	07/95 ⇒ 05/02
BALENO 1.6 i 16V 4x4	G16B	07/95 ⇒ 05/02

KW 360 435

07

IGNITION CABLE SETS

Adatt./Suitable:

BOSCH
0 986 356 957
MAGNETI MARELLI
941318111188
TOYOTA
90919-22373

00 Eliminated on 22-02-2022. Please verify the availability through our local distributors

- Eliminato il 22-02-2022. Verificare la disponibilità presso i nostri distributori
- Éliminé le 22-02-2022. Vérifier la disponibilité auprès de nos distributeurs sur place
- Am 22-02-2022 gestrichen. Evtl. Verfügbarkeit bitte bei unseren Händlern prüfen
- Eliminado en fecha 22-02-2022. Verificar la disponibilidad a través de nuestros distribuidores locales

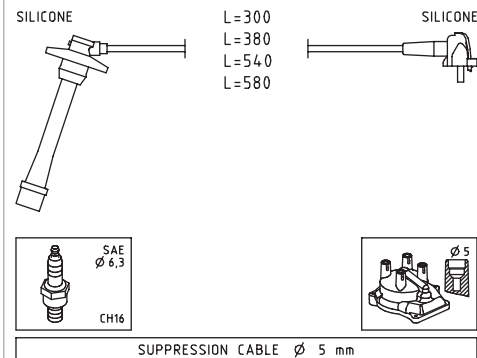

TOYOTA

COROLLA VII 1.3 XLI	4E-FE	07/92 ⇒ 04/97
COROLLA VII 1.3 XLI 16V	4E-FE	07/92 ⇒ 09/95
PASEO 1.5	5E-FE	06/90 ⇒ 06/99
STARLET 1.3	4E-FE	01/96 ⇒ 07/99

KW 360 436

05

IGNITION CABLE SETS

Adatt./Suitable:

BOSCH
0 986 357 222
DAIHATSU
19901-87B87-000

03 Supplied until depletion

- Fornibile fino ad esaurimento delle scorte
- Fourni jusqu'à épuisement du stock
- Lieferbar solange vorrat reicht
- Suministrado hasta el stock termina

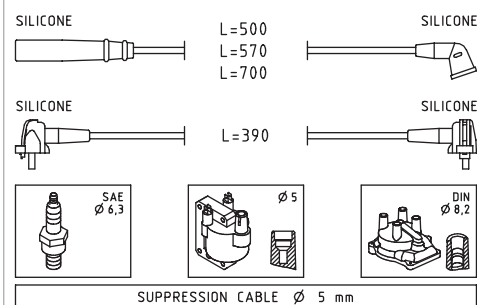

DAIHATSU

CUORE III 0.8	ED10K	10/90 ⇒ 12/94
CUORE IV 0.8	ED20	01/95 ⇒ 08/98
DOMINO 0.8i	ED20	08/90 ⇒ 10/98
DOMINO 850i	--	01/97 ⇒
MIRA 0.8i	ED20	12/94 ⇒ 02/97
MOVE 0.8	ED20	01/97 ⇒ 11/99

KW 360 443

07

IGNITION CABLE SETS

Adatt./Suitable:

RENAULT
77 00 273 226

00 Eliminated on 07-01-2020. Please verify the availability through our local distributors

- Eliminato il 07-01-2020. Verificare la disponibilità presso i nostri distributori
- Éliminé le 07-01-2020. Vérifier la disponibilité auprès de nos distributeurs sur place
- Am 07-01-2020 gestrichen. Evtl. Verfügbarkeit bitte bei unseren Händlern prüfen
- Eliminado en fecha 07-01-2020. Verificar la disponibilidad a través de nuestros distribuidores locales

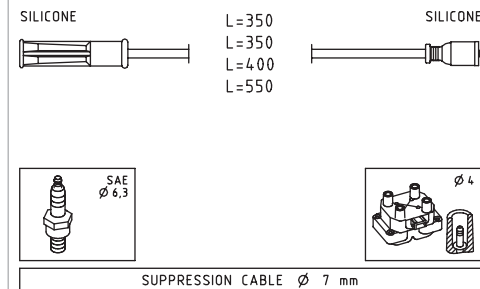

RENAULT

CLIO II 1.4	E7J780	09/98 ⇒ 05/05
CLIO II 1.6	K7M744, K7M745	09/98 ⇒ 05/05
KANGOO I 1.4	E7J780	08/97 ⇒
MEGANE I 1.6 e	K7M702, K7M703	01/96 ⇒ 08/03
MEGANE I 1.6 i	K7M720	01/96 ⇒ 03/99
MEGANE SCÉNIC I 1.6 e	K7M702, K7M703	10/96 ⇒ 10/99
MEGANE SCÉNIC I 1.6 i	K7M720	01/97 ⇒ 09/99

KW 360 446

07

IGNITION CABLE SETS

Adatt./Suitable:

BOSCH
0 986 357 211
0 986 357 252
HITACHI
134464
RENAULT
77 00 866 923

03 Supplied until depletion

- Fornibile fino ad esaurimento delle scorte
- Fourni jusqu'à épuisement du stock
- Lieferbar solange vorrat reicht
- Suministrado hasta el stock termina

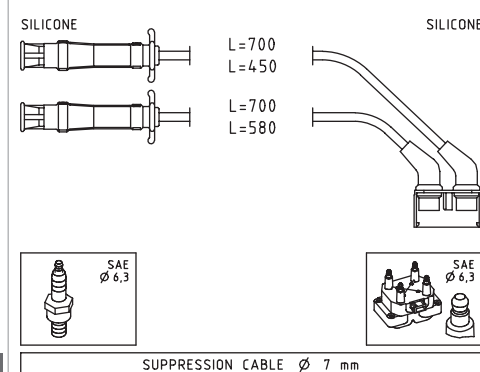

RENAULT

MEGANE I 1.6 e	K7M702, K7M703, K7M790	01/96 ⇒ 08/03
MEGANE I 1.6 i	K7M720	01/96 ⇒ 03/99
MEGANE SCÉNIC I 1.6 e	K7M702, K7M703	10/96 ⇒ 10/99
MEGANE SCÉNIC I 1.6 i	K7M720	01/97 ⇒ 09/99

KW **360 447**

07

IGNITION CABLE SETS

Adatt./Suitable:

RENAULT

77 00 107 662
77 00 874 109

00 Eliminated on 26-01-2021. Please verify the availability through our local distributors

- Eliminato il 26-01-2021. Verificare la disponibilità presso i nostri distributori
- Éliminé le 26-01-2021. Vérifier la disponibilité auprès de nos distributeurs sur place
- Am 26-01-2021 gestrichen. Evtl. Verfügbarkeit bitte bei unseren Händlern prüfen
- Eliminado en fecha 26-01-2021. Verificar la disponibilidad a través de nuestros distribuidores locales

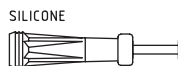
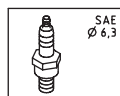
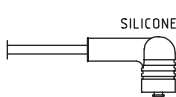
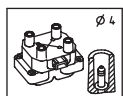
L = 600
L = 450
L = 400
L = 500SAE
ø 6,3

ø 4

SUPPRESSION CABLE ø 7 mm

RENAULT

CLIO I 1.2	D7F730	01/96 ⇨ 09/98
CLIO II 1.2	D7F710, D7F720, D7F722, D7F726, D7F766	09/98 ⇨
CLIO II 1.2 LPG	D7F722, D7F766	09/98 ⇨ 06/09
KANGOO I 1.2	D7F710, D7F720, D7F722, D7F726, D7F744, D7F746	08/97 ⇨
TWINGO I 1.2	D7F700, D7F701, D7F702, D7F703, D7F704, D7F706	05/96 ⇨

KW **360 451**

07

IGNITION CABLE SETS

Adatt./Suitable:

BOSCH

0 986 357 816

FIAT

46749624
55202897
55203737

HITACHI

134272

LANCIA

46749624
55202897

MAGNETI MARELLI

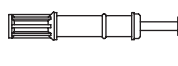
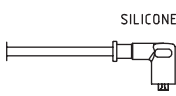
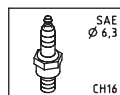
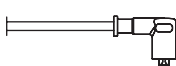
941095100582
941318111161L = 580
L = 280L = 600
L = 450SAE
ø 6,3

CH16

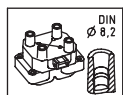
DIN
ø 8,2

SUPPRESSION CABLE ø 7 mm

FIAT

DOBLO I 1.2	223A5.000	03/01 ⇨
PALIO 1.0	178A1.000	04/96 ⇨ 10/03
PALIO 1.0 GLX	--	07/98 ⇨ 10/03
PALIO 1.1	187A1.000	06/06 ⇨
PALIO 1.2	176A8.000, 178B5.000, 178B7.045, 178C4.066, 178E2.000, 188A4.000	04/96 ⇨
PALIO 1.2 75	178B7.045	03/98 ⇨
PALIO 1.2 MPI	178C4.066	01/02 ⇨
PANDA I 1.1	187A1.000	09/00 ⇨ 02/04
PANDA I 1.1 AWD	187A1.000	09/00 ⇨ 02/04
PANDA I 1100	187A1.000	02/95 ⇨ 09/03
PANDA I 1100 i.e. 4x4	187A1.000	12/00 ⇨

FIAT

PANDA II 1.1	--	09/03 ⇨
PANDA II 1.2	188A4.000	09/03 ⇨
PANDA II 1.2 4x4	188A4.000	09/04 ⇨
PANDA II 1.2 Bi-Power / Natural Power	--	04/09 ⇨
PANDA II 1.2 Euro 4	--	04/09 ⇨
PANDA II 1.2 LPG	188A4.000	04/09 ⇨
PANDA II 1.2 Natural Power	188A4.000	01/07 ⇨ 12/11
PUNTO II 1.2 60	188A4.000	09/99 ⇨ 12/10
PUNTO II 1.2 Bifuel	188A4.000	08/07 ⇨ 03/12
PUNTO II 1.2 Natural Power	188A4.000	09/03 ⇨ 03/12
SEICENTO / 600 1.1	187A1.000	01/98 ⇨ 01/10
SIENA 1.2	178B7.045	01/98 ⇨
SIENA 1.3	178B5.000, 178C4.066, 188A4.000, 188A5.000	09/01 ⇨ 12/12
STRADA 1.2	178B5.000, 178B7.045, 188A4.000	04/03 ⇨
STRADA 1.2 Trekking	--	11/05 ⇨

LANCIA

YI 1.2	188A4.000	03/96 ⇨ 09/03
YPSILON II 1.2	169A4.000, 188A4.000	10/03 ⇨ 12/11

KW **360 479**

07

IGNITION CABLE SETS

Adatt./Suitable:

00 Eliminated on 19-01-2022. Please verify the availability through our local distributors

- Eliminato il 19-01-2022. Verificare la disponibilità presso i nostri distributori
- Éliminé le 19-01-2022. Vérifier la disponibilité auprès de nos distributeurs sur place
- Am 19-01-2022 gestrichen. Evtl. Verfügbarkeit bitte bei unseren Händlern prüfen
- Eliminado en fecha 19-01-2022. Verificar la disponibilidad a través de nuestros distribuidores locales

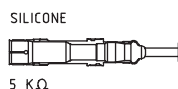
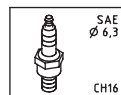
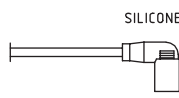
L = 700
L = 650
L = 480
L = 280SAE
ø 6,3

CH16

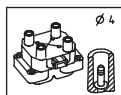

ø 4

COPPER CORE CABLE ø 7 mm

AUDI

A3 I 1.6	AEH, AKL	09/96 ⇨ 05/03
----------	----------	---------------

SKODA

OCTAVIA I 1.6	AEH, AKL	02/97 ⇨ 12/07
---------------	----------	---------------

VW

GOLF IV 1.6	AEH, AKL	05/01 ⇨ 05/04
-------------	----------	---------------

KW **360 484**

07

IGNITION CABLE SETS

Adatt./Suitable:

00 Eliminated on 18-11-2019. Please verify the availability through our local distributors

- Eliminato il 18-11-2019. Verificare la disponibilità presso i nostri distributori
- Éliminé le 18-11-2019. Vérifier la disponibilité auprès de nos distributeurs sur place
- Am 18-11-2019 gestrichen. Evtl. Verfügbarkeit bitte bei unseren Händlern prüfen
- Eliminado en fecha 18-11-2019. Verificar la disponibilidad a través de nuestros distribuidores locales

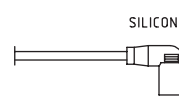
L = 600
L = 650
L = 480
L = 280

5 KΩ

1 KΩ

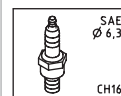
SAE
ø 6,3

CH16

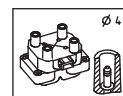

ø 4

COPPER CORE CABLE ø 7 mm

AUDI

A3 I 1.6	AEH, AKL, APF	09/96 ⇨ 05/03
----------	---------------	---------------

SEAT

CORDOBA I 1.6 i	AKL	07/96 ⇨ 10/02
-----------------	-----	---------------

IBIZA II 1.6 i	AKL	04/96 ⇨ 02/02
----------------	-----	---------------

LEON I 1.6	AEH, AKL	11/99 ⇨ 06/06
------------	----------	---------------

TOLEDO II 1.6	AEH, AKL, APF	10/98 ⇨ 07/04
---------------	---------------	---------------

SKODA

OCTAVIA I 1.6	AEH, AKL	02/97 ⇨ 12/07
---------------	----------	---------------

VOLKSWAGEN (BR)

GOLF A4 1.6i	AKL	10/99 ⇨
--------------	-----	---------

VW

BORA 1.6	AEH, AKL, APF	10/98 ⇨ 05/05
----------	---------------	---------------

GOLF IV 1.6	AEH, AKL, APF	05/01 ⇨ 05/04
-------------	---------------	---------------

POLO III 1.6	AEH, AKL	05/97 ⇨ 09/01
--------------	----------	---------------

POLO III 100 1.6	AEH, AKL	12/95 ⇨ 09/01
------------------	----------	---------------

KW **360 489**

09

IGNITION CABLE SETS

Adatt./Suitable:

03 Supplied until depletion

- Fornibile fino ad esaurimento delle scorte
- Fourni jusqu'à épuisement du stock
- Lieferbar solange vorrat reicht
- Suministrado hasta el stock termina

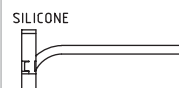
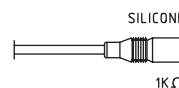
L = 820
L = 750
L = 750
L = 750

5KΩ

1KΩ

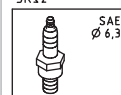
SAE
ø 6,3

CH16

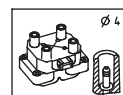

ø 4

COPPER CORE CABLE ø 7 mm

AUDI

A3 I 1.8	AGN, APG	09/96 ⇨ 05/03
----------	----------	---------------

360 491

SEAT		
LEON I 1.8 20V	AGN, APG	11/99 ⇒ 06/06
TOLEDO II 1.8 20V	AGN, APG	10/98 ⇒ 07/04
SKODA		
OCTAVIA I 1.8	AGN	09/96 ⇒ 07/00
OCTAVIA I 1.8 20V	AGN	07/98 ⇒ 07/00
VW		
BORA 1.8	AGN	10/98 ⇒ 05/05
BORA 1.8 4motion	AGN	02/99 ⇒ 05/05
GOLF IV 1.8	AGN	08/97 ⇒ 06/05
GOLF IV 1.8 4motion	AGN	05/98 ⇒ 06/06

KW 360 491



IGNITION CABLE SETS

Adatt./Suitable:

⁰³ Supplied until depletion

- Fornibile fino ad esaurimento delle scorte
- Fourni jusqu'à épuisement du stock
- Lieferbar solange vorrat reicht
- Suministrado hasta el stock termina

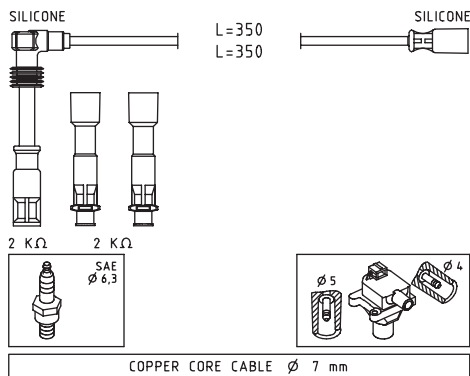

AUDI

A6 I 1.8 quattro	ADR	12/95 ⇒ 12/97
A4 I 1.8	ADR, AFY, APT, ARG, AVV	11/94 ⇒ 09/01
A4 I 1.8 quattro	ADR, AFY, APT, ARG	01/95 ⇒ 09/01
A6 II 1.8	AFY	05/97 ⇒ 01/05
CABRIOLET 1.8	ADR	01/97 ⇒ 08/00

VW

PASSAT IV 1.8	ADR, AFY, APT, ARG	10/96 ⇒ 03/05
PASSAT IV 1.8 Syncro/4motion	ADR, APT, ARG	12/96 ⇒ 11/00

KW 360 492



IGNITION CABLE SETS

Adatt./Suitable:

BOSCH
0 986 356 967

RENAULT
77 00 106 221

⁰⁰ Eliminated on 10-06-2019. Please verify the availability through our local distributors

- Eliminato il 10-06-2019. Verificare la disponibilità presso i nostri distributori
- Éliminé le 10-06-2019. Vérifier la disponibilité auprès de nos distributeurs sur place
- Am 10-06-2019 gestrichen. Evtl. Verfügbarkeit bitte bei unseren Händlern prüfen
- Eliminado en fecha 10-06-2019. Verificar la disponibilidad a través de nuestros distribuidores locales

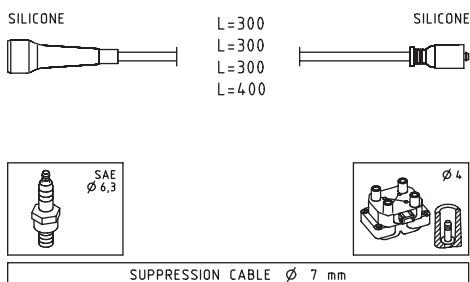

RENAULT

ESPACE III 2.0	F3R728, F3R729, F3R742, F3R768, F3R769	11/96 ⇒ 10/00
----------------	--	---------------

RENAULT

LAGUNA I 1.8	F3P670, F3P674, F3P676, F3P678	06/95 ⇒ 03/01
LAGUNA I 2.0	--, F3R611, F3R728, F3R729, F3R768, F3R769	11/93 ⇒ 03/01
MEGANE I 2.0	F3R750, F3R751, F3R752, F3R791, F3R796, F3R797, F3R798	04/97 ⇒ 08/03
MEGANE I 2.0 i	F3R750, F3R751, F3R752, F3R791, F3R796, F3R797, F3R798	01/96 ⇒ 08/03
MEGANE SCÉNIC I 2.0 i	F3R750, F3R751, F3R796	01/97 ⇒ 09/99
MEGANE SCÉNIC I 2.0 RXE 4x4	F3R750	05/97 ⇒ 10/99
SCÉNIC I 2.0	F3R791, F3R797, F3R798	09/99 ⇒ 08/03

KW 360 497



IGNITION CABLE SETS

Adatt./Suitable:

⁰³ Supplied until depletion

- Fornibile fino ad esaurimento delle scorte
- Fourni jusqu'à épuisement du stock
- Lieferbar solange vorrat reicht
- Suministrado hasta el stock termina

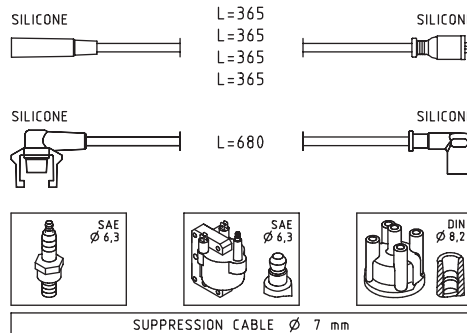

RENAULT

CLIO I 1.2	C3G720	06/94 ⇒ 02/98
------------	--------	---------------

KW 360 499



IGNITION CABLE SETS

Adatt./Suitable:

⁰³ Supplied until depletion

- Fornibile fino ad esaurimento delle scorte
- Fourni jusqu'à épuisement du stock
- Lieferbar solange vorrat reicht
- Suministrado hasta el stock termina

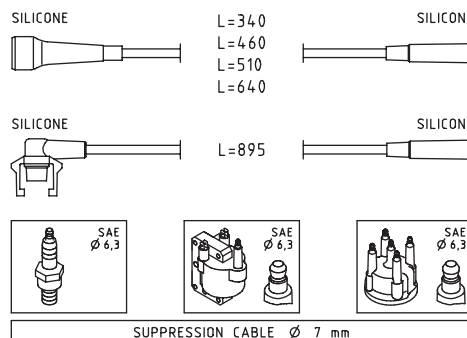

RENAULT

LAGUNA I 1.8	F3P678, F3P720, F3P724	11/93 ⇒ 03/01
LAGUNA I 2.0	6Z7U730, F3R722	11/93 ⇒ 03/01

KW 360 501



IGNITION CABLE SETS

Adatt./Suitable:

BOSCH
0 986 357 210

RENAULT
77 00 874 564

⁰⁰ Eliminated on 16-06-2020. Please verify the availability through our local distributors

- Eliminato il 16-06-2020. Verificare la disponibilità presso i nostri distributori
- Éliminé le 16-06-2020. Vérifier la disponibilité auprès de nos distributeurs sur place
- Am 16-06-2020 gestrichen. Evtl. Verfügbarkeit bitte bei unseren Händlern prüfen
- Eliminado en fecha 16-06-2020. Verificar la disponibilidad a través de nuestros distribuidores locales

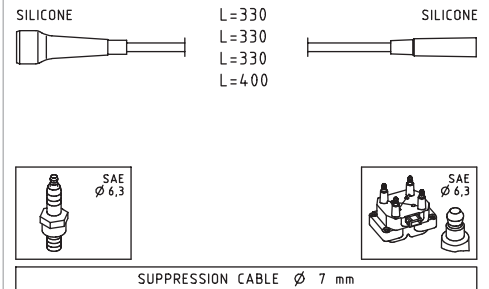

RENAULT

ESPACE III 2.0	F3R728, F3R768, F3R769	11/96 ⇒ 10/00
LAGUNA I 1.8	F3P670, F3P674, F3P676, F3P678	06/95 ⇒ 03/01
LAGUNA I 2.0	--, F3R728, F3R729, F3R768, F3R769	11/93 ⇒ 03/01
MEGANE I 2.0	F3R262, F3R264, F3R750, F3R751, F3R752, F3R791, F3R797, F3R798	01/97 ⇒ 08/03
MEGANE I 2.0 i	F3R750, F3R751, F3R752, F3R791, F3R797, F3R798	01/96 ⇒ 08/03
MEGANE SCÉNIC I 2.0 i	F3R750, F3R751	01/97 ⇒ 09/99
MEGANE SCÉNIC I 2.0 RXE 4x4	F3R750	05/97 ⇒ 10/99
SCÉNIC I 2.0	F3R791, F3R797, F3R798	09/99 ⇒ 08/03

KW 360 503



IGNITION CABLE SETS

Adatt./Suitable:

BOSCH
0 986 357 261

FIAT
46413088

HITACHI
134518

LANCIA
46413088

MAGNETI MARELLI
941095800618

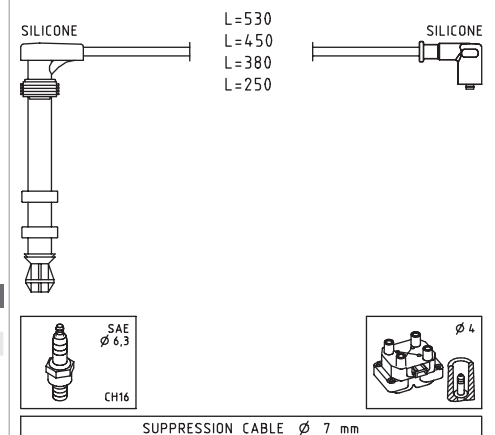

FIAT

BRAVA 1.6 16V	182A4.000, 182A4.027, 182A6.000, 182B6.000	10/95 ⇒ 12/02
BRAVO I 1.6	182B6.000	09/00 ⇒ 10/01
BRAVO I 1.6 16V	178A8.011, 182A4.000, 182A6.000	10/95 ⇒ 10/01
DOBLO I 1.6 Natural Power	182B6.000	09/02 ⇒

FIAT		
MAREA 1.6	182B6.000, 185A3.000	09/00 ⇒ 08/02
MAREA 1.6 100 16V	182A4.000	09/96 ⇒ 05/02
MAREA 1.6 100 16V Bipower	185A3.000	04/99 ⇒ 05/02
MAREA 1.6 16V	185A3.000	04/97 ⇒ 02/99
MAREA 1.6 SX	182B5.098	09/00 ⇒ 08/02
MULTIPLA 1.6	182B6.000	09/00 ⇒ 06/10
MULTIPLA 1.6 100 16V	182A4.000	04/99 ⇒ 06/10
MULTIPLA 1.6 16V	182B6.000	04/02 ⇒ 06/10
MULTIPLA 1.6 16V Bipower	182B6.000, 186A4.000	10/01 ⇒ 06/10
MULTIPLA 1.6 16V Blupower	186A3.000	04/99 ⇒ 06/10
MULTIPLA 1.6 16V GPL	182B6.000	10/01 ⇒ 06/10
PALIO 1.6	178D2.011	07/97 ⇒
PALIO 1.6 16V	178B3.000, 178C7.098, 178D2.011, 182B6.000	02/01 ⇒
SIENA 1.6	182B6.000	11/00 ⇒ 12/12
SIENA 1.6 16V	178B3.000	09/98 ⇒
STRADA 1.6 MPI	178D2.011	07/05 ⇒

FIAT (BR)		
BRAVA 1.6i 16v	1.6Mpi	01/00 ⇒
PALIO 1.6i	1.6Mpi	01/99 ⇒ 12/00
PALIO 1.6i 16v	1.6Mpi16v	01/96 ⇒
SIENA 1.6i 16v	1.6Mpi	01/98 ⇒ 12/99
STRADA 1.6i 16v	1.6Mpi	01/99 ⇒

LANCIA		
DEDRA 1.6 16V	182A4.000	01/96 ⇒ 07/99
DELTA II 1.6 i.e.	182A6.000	03/96 ⇒ 08/99
DELTA II 1.6 i.e. 16V	182A4.000	01/96 ⇒ 08/99
LYBRA 1.6	182B6.000	10/00 ⇒ 10/05
LYBRA 1.6 16V	182A4.000	07/99 ⇒ 10/05

KW 360 504



07,5

IGNITION CABLE SETS

Adatt./Suitable:

BOSCH
 0 986 357 258

FIAT
 46425912

HITACHI
 134332

LANCIA
 46425912

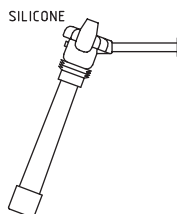
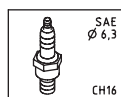
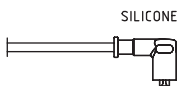
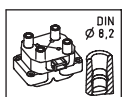
MAGNETI MARELLI
 941095910629

 L = 4,00
 L = 280
 L = 200
 L = 130

 SAE
 ø 6,3
 CH16

 DIN
 ø 6,2

SUPPRESSION CABLE ø 7 mm

FIAT		
PUNTO I 1.2 16V	176B9.000	04/97 ⇒ 09/99
PUNTO I 85 16V 1.2	176B9.000	04/97 ⇒ 06/00

LANCIA		
YI 1.2 16V	176B9.000	04/97 ⇒ 09/03

KW 360 505



07,5

IGNITION CABLE SETS

Adatt./Suitable:

BOSCH
 0 986 357 181
 F 000 99C 122

FIAT
 46474814
 46743086

HITACHI
 134333

LANCIA
 46474814

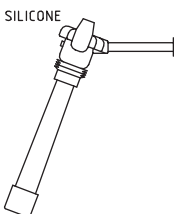
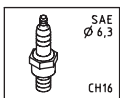
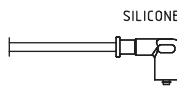
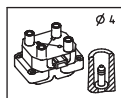
MAGNETI MARELLI
 941095980634

 L = 600
 L = 480
 L = 330
 L = 280

 SAE
 ø 6,3
 CH16

ø 4

SUPPRESSION CABLE ø 7 mm

FIAT		
BRAVA 1.2 16V	182B2.000	12/98 ⇒ 12/02
BRAVA 1.2 16V 80	182B2.000, 188A5.000	10/00 ⇒ 12/02
BRAVO I 1.2 16V 80	182B2.000, 188A5.000	10/00 ⇒ 10/01
MAREA 1.2 16V	182B2.000	10/98 ⇒ 05/02
PALIO 1.2	188A5.000	09/01 ⇒ 10/04
PALIO 1.2 16V	178D7.055	06/05 ⇒
PUNTO II 1.2 16V	188A5.000	06/03 ⇒
PUNTO II 1.2 16V 80	188A5.000	09/99 ⇒ 04/06
SIENA 1.2 16V	178D7.055	01/02 ⇒

FIAT (BR)		
PALIO 1.0i 16v	1.0Mpi16vFire	01/01 ⇒
PALIO 1.3i 16v	1.3Mpi16vFire	01/00 ⇒
SIENA 1.3i 16v	1.3MpiFire	01/00 ⇒ 12/00

LANCIA		
YI 1.2 16V	188A5.000	10/00 ⇒ 09/03

KW 360 506



07,5

IGNITION CABLE SETS

Adatt./Suitable:

GENERAL MOTORS
 09 119 169
 9 193 022

OPEL
 16 12 001
 16 12 013
 16 12 646

⁰⁰Eliminated on 22-02-2021. Please verify the availability through our local distributors

• Eliminato il 22-02-2021. Verificare la disponibilità presso i nostri distributori

• Éliminé le 22-02-2021. Vérifier la disponibilité auprès de nos distributeurs sur place

• Am 22-02-2021 gestrichen. Evtl. Verfügbarkeit bitte bei unseren Händlern prüfen

• Eliminado en fecha 22-02-2021. Verificar la disponibilidad a través de nuestros distribuidores locales

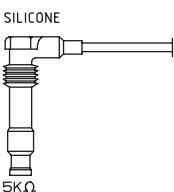
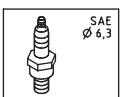
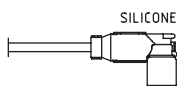
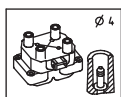
 L = 450
 L = 400
 L = 250
 L = 200

 SAE
 ø 6,3

ø 4

COPPER CORE CABLE ø 7 mm

OPEL		
ASTRA F 1.8 i 16V	C18SEL, C18XE, C18XEL, X18XE	06/93 ⇒ 03/01

OPEL		
ASTRA F 2.0 i 16V	X20XE	02/95 ⇒ 08/00
CALIBRA A 2.0 i 16V	X20XE	02/94 ⇒ 07/97
CALIBRA A 2.0 i 16V 4x4	X20XE	02/94 ⇒ 07/97
VECTRA B 1.8 i 16V	X18XE	10/95 ⇒ 09/00
VECTRA B 2.0 i 16V	C20SEL, X20XE	09/95 ⇒ 06/00

VAUXHALL		
ASTRA III 1.8	C18XE	09/94 ⇒ 08/96
ASTRA III 1.8 16V	C18XEL, X18XE	11/94 ⇒ 03/01
ASTRA III 1.8 i 16V	C18XE, C18XEL, X18XE	06/93 ⇒ 02/98
ASTRA III 2.0 i 16V	X20XE	01/94 ⇒ 09/98
CALIBRA 2.0 i 16V	X20XE	06/90 ⇒ 07/97
CALIBRA 2.0 i 16V 4x4	X20XE	02/94 ⇒ 07/97
VECTRA B 1.8 i 16V	X18XE	10/95 ⇒ 09/00
VECTRA B 2.0 i 16V	X20XE	10/95 ⇒ 01/01

KW 360 507



07,5

IGNITION CABLE SETS

Adatt./Suitable:

BOSCH
 0 986 357 270

CHRYSLER
 4883233
 4883233AB

⁰³Supplied until depletion

- Fornibile fino ad esaurimento delle scorte
- Fourni jusqu'à épuisement du stock
- Lieferbar solange vorrat reicht
- Suministrado hasta el stock termina

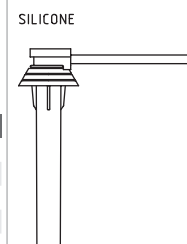
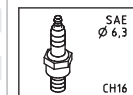
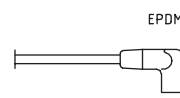
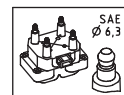
 L = 200
 L = 200
 L = 150
 L = 150

 SAE
 ø 6,3
 CH16

 SAE
 ø 6,3

SUPPRESSION CABLE ø 7 mm

CHRYSLER		
CIRRUS 2.0 LX	ECB	10/97 ⇒ 09/00
NEON I 1.8 16V	EBD	09/97 ⇒ 08/99
NEON I 2.0 16V	420H	05/94 ⇒ 08/99
NEON II 2.0 16V	420H	08/99 ⇒ 12/06
SEBRING I 2.0	ECB	05/95 ⇒ 09/00
SEBRING II 2.0	ECC	04/01 ⇒ 06/07
STRATUS 2.0 16V	ECB	12/95 ⇒ 04/01
STRATUS 2.0 LE	420X	12/95 ⇒ 04/01
VOYAGER II 2.0 i	C00	01/95 ⇒ 03/01

KW 360 508

07,5

IGNITION CABLE SETS

Adatt./Suitable:

BOSCH
0 986 357 270
CHRYSLER
4773841

00 Eliminated on 14-04-2020. Please verify the availability through our local distributors

- Eliminato il 14-04-2020. Verificare la disponibilità presso i nostri distributori
- Éliminé le 14-04-2020. Vérifier la disponibilité auprès de nos distributeurs sur place
- Am 14-04-2020 gestrichen. Evtl. Verfügbarkeit bitte bei unseren Händlern prüfen
- Eliminado en fecha 14-04-2020. Verificar la disponibilidad a través de nuestros distribuidores locales

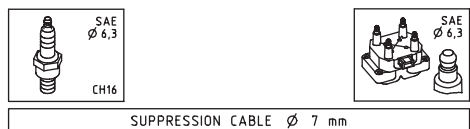
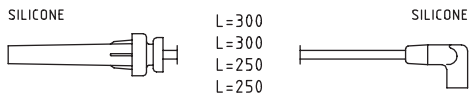

SUPPRESSION CABLE Ø 7 mm

CHRYSLER

CIRRUS 2.4 LX	EDZ	05/94 ⇒ 09/00
NEON I 2.0	ECC	10/96 ⇒ 09/00
NEON I 2.0 16V	420T, ECC	06/94 ⇒ 08/99
SEBRING I 2.4	EDZ	03/96 ⇒ 09/00
STRATUS 2.4 16V	EDZ	12/95 ⇒ 04/01
STRATUS 2.4 16V	EDZ	12/95 ⇒ 04/01
VOYAGER II 2.4 i	B00	01/95 ⇒ 03/01

KW 360 509

07,5

IGNITION CABLE SETS

Adatt./Suitable:

CHEVROLET
96450249
DAEWOO
96450249
HITACHI
134119

03 Supplied until depletion

- Fornibile fino ad esaurimento delle scorte
- Fourni jusqu'à épuisement du stock
- Lieferbar solange vorrat reicht
- Suministrado hasta el stock termina

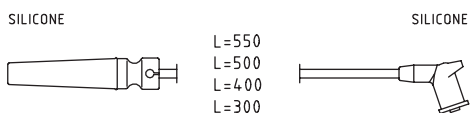

SUPPRESSION CABLE Ø 7 mm

CHEVROLET

LACETTI 1.4	F14D3	03/05 ⇒
LACETTI 1.4 16V	F14D3	03/05 ⇒ 03/13
LACETTI 1.6	F16D3	03/05 ⇒
NUBIRA 1.4	F14D3	01/05 ⇒ 12/08
NUBIRA 1.6	F16D3, LXT	03/05 ⇒
OPTRA 1.4 16V	F14D3	03/05 ⇒
OPTRA 1.6	F16D3, LXT	08/03 ⇒ 12/08
OPTRA 1.6 SRV	F16D3	06/06 ⇒

DAEWOO

LACETTI 1.4	F14D3	02/04 ⇒
LACETTI 1.6	F16D3	02/04 ⇒
NUBIRA II 1.4	F14D3	10/03 ⇒ 12/04
NUBIRA II 1.6	F16D3	07/03 ⇒

KW 360 511

07

IGNITION CABLE SETS

Adatt./Suitable:

CHRYSLER
5018394AE

03 Supplied until depletion

- Fornibile fino ad esaurimento delle scorte
- Fourni jusqu'à épuisement du stock
- Lieferbar solange vorrat reicht
- Suministrado hasta el stock termina

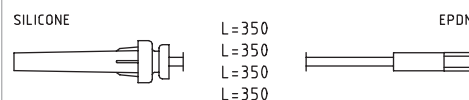

SUPPRESSION CABLE Ø 7 mm

CHRYSLER

PT CRUISER 2.0	ECC	06/00 ⇒ 09/04
PT CRUISER 2.4	EDZ	03/04 ⇒ 03/08
SEBRING II 2.0	ECC	04/01 ⇒ 06/07
SEBRING II 2.4	EDZ	04/01 ⇒ 06/07
VOYAGER III 2.4	EDZ	02/00 ⇒ 12/08

KW 360 518

07

IGNITION CABLE SETS

Adatt./Suitable:

00 Eliminated on 22-02-2022. Please verify the availability through our local distributors

- Eliminato il 22-02-2022. Verificare la disponibilità presso i nostri distributori
- Éliminé le 22-02-2022. Vérifier la disponibilité auprès de nos distributeurs sur place
- Am 22-02-2022 gestrichen. Evtl. Verfügbarkeit bitte bei unseren Händlern prüfen
- Eliminado en fecha 22-02-2022. Verificar la disponibilidad a través de nuestros distribuidores locales

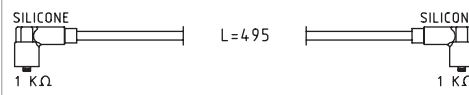
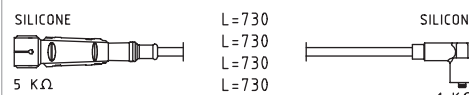

COPPER CORE CABLE Ø 7 mm

VW

POLO II 1.0	AAU, HZ	01/85 ⇒ 09/94
POLO II 1.0 Cat	AAU, ACM	08/89 ⇒ 09/94
POLO II 1.3	3F	10/90 ⇒ 09/94
POLO II 1.3 Cat	2G, 3F, AAV, MH, NZ	07/87 ⇒ 09/94
POLO II 1.3 G40	PY	08/90 ⇒ 09/94

KW 360 527

07

IGNITION CABLE SETS

Adatt./Suitable:

FIAT
46448661

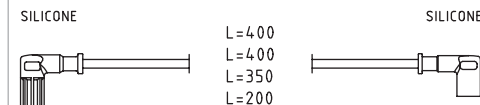

SUPPRESSION CABLE Ø 7 mm

FIAT

PANDA I 900	1170A1.046	04/92 ⇒ 12/96
PANDA I 900 i.e.	1170A1.046	01/98 ⇒

KW 360 529

07,5

IGNITION CABLE SETS

Adatt./Suitable:

GENERAL MOTORS
90 510 857
90 510 858
90 542 968

03 Supplied until depletion

- Fornibile fino ad esaurimento delle scorte
- Fourni jusqu'à épuisement du stock
- Lieferbar solange vorrat reicht
- Suministrado hasta el stock termina

HITACHI
134246

MAGNETI MARELLI
941125380688
941318111140

OPEL

16 12 606
16 12 607
16 12 639

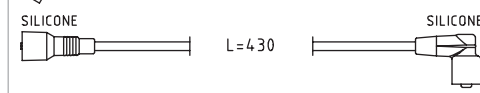
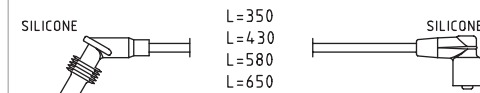

SUPPRESSION CABLE Ø 7 mm

OPEL

ASTRA F 1.4	14NV	09/91 ⇒ 09/93
ASTRA F 1.4 i	C14NZ	09/91 ⇒ 01/05
COMBO B 1.4	C14NZ	07/94 ⇒ 10/01
CORSA B 1.4 i	C14NZ	03/93 ⇒ 09/00

VAUXHALL

ASTRA III 1.4	14NV	09/91 ⇒ 09/93
ASTRA III 1.4 i	C14NZ	09/91 ⇒ 09/98
ASTRA III 1.4 S	14NV	09/91 ⇒ 02/98
ASTRAVAN I 1.4 i	C14NZ	09/91 ⇒ 08/95
COMBO B 1.4	C14NZ	07/94 ⇒ 10/01
CORSA B 1.4 i	C14NZ	03/93 ⇒ 09/00
CORSAVAN I 1.4 i	C14NZ	01/94 ⇒ 09/00

KW 360 531



IGNITION CABLE SETS

Adatt./Suitable:

BOSCH
0 986 357 226
GENERAL MOTORS
90 510 851

HITACHI
134234
134275

MAGNETI MARELLI
941125360686

OPEL
16 12 608

- 03 Supplied until depletion**
- Fornibile fino ad esaurimento delle scorte
 - Fourni jusqu'à épuisement du stock
 - Lieferbar solange vorrat reicht
 - Suministrado hasta el stock termina

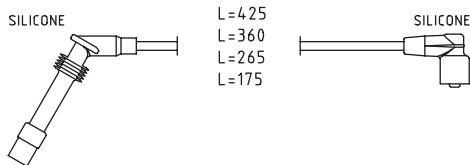

L = 425
L = 360
L = 265
L = 175

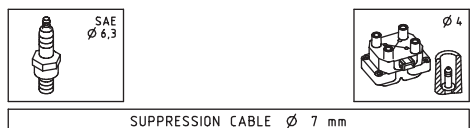

SUPPRESSION CABLE \varnothing 7 mm

OPEL

ASTRA F 1.4	14SE	09/92 \Rightarrow 09/98
ASTRA F 1.4 Si	C14SE	03/92 \Rightarrow 03/01
ASTRA F 1.6	16NZR	09/95 \Rightarrow 09/98
ASTRA F 1.6 i	X16SZ, X16SZR	09/91 \Rightarrow 01/05
ASTRA F 1.6 Si	C16SE	03/92 \Rightarrow 12/94
VECTRA A 1.6 i	X16SZ	09/93 \Rightarrow 11/95
VECTRA B 1.6 i	X16SZR	10/95 \Rightarrow 07/03

VAUXHALL

ASTRA III 1.4 i	C14SE	03/91 \Rightarrow 03/01
ASTRA III 1.6	C16SE	03/94 \Rightarrow 08/95
ASTRA III 1.6 i	C16SE, X16SZ, X16SZR	03/92 \Rightarrow 09/98
ASTRA III 1.6 Si	C16SE	03/91 \Rightarrow 12/94
ASTRAVAN I 1.6 i	X16SZ	09/94 \Rightarrow 08/96
VECTRA B 1.6 i	X16SZR	08/95 \Rightarrow 03/02

KW 360 549



IGNITION CABLE SETS

Adatt./Suitable:

- 00 Eliminated on 11-03-2021. Please verify the availability through our local distributors**
- Eliminato il 11-03-2021. Verificare la disponibilità presso i nostri distributori
 - Éliminé le 11-03-2021. Vérifier la disponibilité auprès de nos distributeurs sur place
 - Am 11-03-2021 gestrichen. Evtl. Verfügbarkeit bitte bei unseren Händlern prüfen
 - Eliminado en fecha 11-03-2021. Verificar la disponibilidad a través de nuestros distribuidores locales

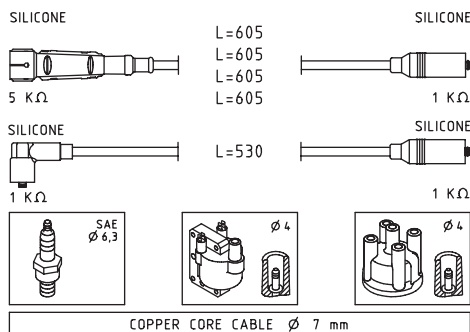

L = 605
L = 605
L = 605
L = 605

L = 530

COPPER CORE CABLE \varnothing 7 mm

SEAT

CORDOBA I 1.8 i	ACC	02/93 \Rightarrow 09/02
-----------------	-----	---------------------------

VW

GOLF III 1.8	AAM, ADZ	08/91 \Rightarrow 04/99
GOLF III 1.8 Syncro	ADZ	01/93 \Rightarrow 04/99
GOLF III 2.0	ADY, AEP, AGG, AKR	11/91 \Rightarrow 04/99

VW

GOLF III 2.0 GL	AEP	08/95 \Rightarrow 09/97
GOLF III 2.0 Syncro	AGG	08/95 \Rightarrow 04/99
GOLF IV 1.8	AAM, ANN, ANP	06/98 \Rightarrow 06/02
POLO III 90 1.8	ADD	01/97 \Rightarrow 09/01
VENTO 1.6	AEA	09/92 \Rightarrow 09/98
VENTO 1.8	AAM, ADZ, ANP	11/91 \Rightarrow 02/99
VENTO 2.0	ADY, AGG	11/91 \Rightarrow 09/98
VENTO 2.0 GL	AEP	05/96 \Rightarrow 12/97

KW 360 551



IGNITION CABLE SETS

Adatt./Suitable:

- 03 Supplied until depletion**
- Fornibile fino ad esaurimento delle scorte
 - Fourni jusqu'à épuisement du stock
 - Lieferbar solange vorrat reicht
 - Suministrado hasta el stock termina

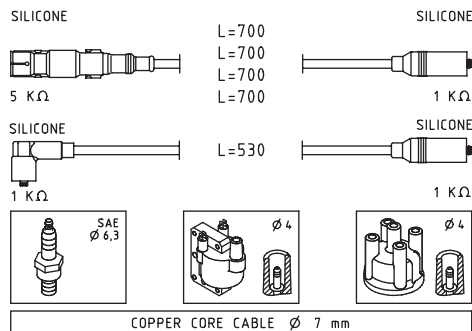

L = 700
L = 700
L = 700
L = 700

L = 530

COPPER CORE CABLE \varnothing 7 mm

VW

GOLF III 1.6	AEK	07/94 \Rightarrow 04/99
PASSAT III 1.6	AEK	07/94 \Rightarrow 08/96
POLO III 2.0	ADC	08/99 \Rightarrow 09/01
VENTO 1.6	AEK	10/94 \Rightarrow 09/98

KW 360 559



IGNITION CABLE SETS

Adatt./Suitable:

- 03 Supplied until depletion**
- Fornibile fino ad esaurimento delle scorte
 - Fourni jusqu'à épuisement du stock
 - Lieferbar solange vorrat reicht
 - Suministrado hasta el stock termina

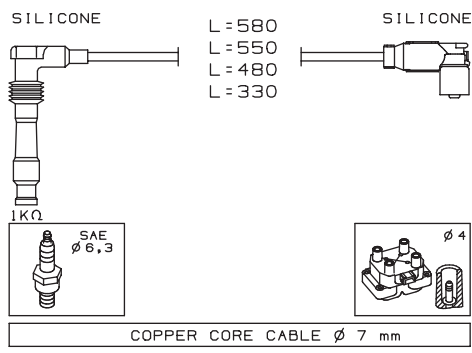

L = 580
L = 550
L = 480
L = 330

COPPER CORE CABLE \varnothing 7 mm

OPEL

ASTRA F 1.4 i 16V	X14XE	01/96 \Rightarrow 03/01
ASTRA F 1.6 i 16V	X16XEL	08/94 \Rightarrow 01/05
COMBO B 1.4 16V	X14XE	08/99 \Rightarrow 10/01
CORSA B 1.4 i 16V	C14SEL, X14XE	09/94 \Rightarrow 12/02
CORSA B 1.6 GSI 16V	C16XE	03/93 \Rightarrow 09/00
CORSA B 1.6 i 16V	C16SEL, X16XE	09/94 \Rightarrow 09/00
TIGRA A 1.4 16V	X14XE	07/94 \Rightarrow 12/00
TIGRA A 1.6 16V	C16SEL, X16XE	07/94 \Rightarrow 08/98

VAUXHALL

ASTRA III 1.4 i 16V	X14XE	01/96 \Rightarrow 03/01
ASTRA III 1.6 i 16V	X16XEL	01/94 \Rightarrow 09/98
COMBO B 1.4 16V	X14XE	08/99 \Rightarrow 10/01
CORSA B 1.4 i 16V	X14XE	09/94 \Rightarrow 09/00
CORSA B 1.6 GSI 16V	C16XE	03/93 \Rightarrow 09/00

VAUXHALL

CORSA B 1.6 i 16V	X16XE	09/94 \Rightarrow 09/00
TIGRA A 1.4 16V	X14XE	07/94 \Rightarrow 12/00
TIGRA A 1.6 16V	X16XE	07/94 \Rightarrow 12/00

KW 360 562



IGNITION CABLE SETS

Adatt./Suitable:

BOSCH
0 986 357 237
F 005 X04 029

GENERAL MOTORS
90 487 571

HOLDEN
90487571

OPEL
16 12 598

- 00 Eliminated on 22-02-2022. Please verify the availability through our local distributors**
- Eliminato il 22-02-2022. Verificare la disponibilità presso i nostri distributori
 - Éliminé le 22-02-2022. Vérifier la disponibilité auprès de nos distributeurs sur place
 - Am 22-02-2022 gestrichen. Evtl. Verfügbarkeit bitte bei unseren Händlern prüfen
 - Eliminado en fecha 22-02-2022. Verificar la disponibilidad a través de nuestros distribuidores locales

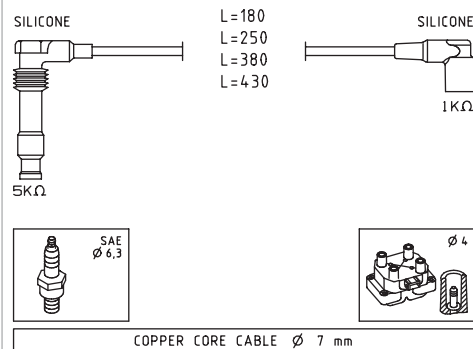

L = 180
L = 250
L = 380
L = 430

COPPER CORE CABLE \varnothing 7 mm

HOLDEN

ASTRA_TR 1.8i 16v Hatchback	C18SEL	09/96 \Rightarrow 09/98
ASTRA_TR 1.8i 16v Sedan	C18SEL	09/96 \Rightarrow 09/98
ASTRA_TR 2.0i 16v Hatchback	X20XE	09/96 \Rightarrow 09/98
CALIBRA_YE 2.0i 16V	X20XE	08/95 \Rightarrow 10/97

OPEL

ASTRA F 1.8	Z18XEL	02/03 \Rightarrow 07/04
ASTRA F 1.8 i 16V	C18SEL, C18XE, C18XEL, X18XE	06/93 \Rightarrow 03/01
ASTRA F 2.0 i 16V	X20XER, X20XE	02/95 \Rightarrow 08/00
ASTRA G 2.0 16V	X20XE	02/98 \Rightarrow 01/05
ASTRA G 2.0 16V OPC	X20XER	11/99 \Rightarrow 09/02
CALIBRA A 2.0 i 16V	X20XE	02/94 \Rightarrow 07/97
CALIBRA A 2.0 i 16V 4x4	X20XE	02/94 \Rightarrow 07/97
OMEGA B 2.0 16V	X20XE	03/94 \Rightarrow 09/99
SINTRA 2.2 i 16V	X22XE	11/96 \Rightarrow 04/99
VECTRA A 2.0 i 16V	X20XE	08/92 \Rightarrow 08/95
VECTRA A 2.0 i 16V 4x4	X20XE	06/94 \Rightarrow 11/95
VECTRA B 1.8 i 16V	X18XE	10/95 \Rightarrow 09/00
VECTRA B 2.0 i 16V	C20SEL, X20XE	09/95 \Rightarrow 06/00

VAUXHALL

ASTRA III 1.8	C18XE	09/94 \Rightarrow 08/96
ASTRA III 1.8 16V	C18XEL, X18XE	11/94 \Rightarrow 03/01
ASTRA III 1.8 i 16V	C18XE, C18XEL, X18XE	06/93 \Rightarrow 02/98
ASTRA III 2.0 i 16V	X20XE	01/94 \Rightarrow 09/98
ASTRA IV 2.0	X20XER	10/99 \Rightarrow 08/00
ASTRA IV 2.0 16V	X20XE	02/98 \Rightarrow 05/05
CALIBRA 2.0 i 16V	X20XE	06/90 \Rightarrow 07/97
CALIBRA 2.0 i 16V 4x4	X20XE	02/94 \Rightarrow 07/97
OMEGA B 2.0 16V	X20XE	03/94 \Rightarrow 07/01
SINTRA 2.2 i 16V	X22XE	11/96 \Rightarrow 04/99
VECTRA B 1.8 i 16V	X18XE	10/95 \Rightarrow 09/00
VECTRA B 2.0 i 16V	X20XE	10/95 \Rightarrow 01/01

KW 360 568

07

IGNITION CABLE SETS

Adatt./Suitable:

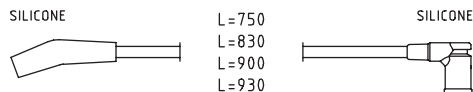
SUPPRESSION CABLE \varnothing 8 mm

FORD

ESCORT VI 1.3	J4B	01/95 \Rightarrow 02/99
FIESTA IV 1.0 i	0EAL	04/96 \Rightarrow 09/99
FIESTA IV 1.3	J4C	02/96 \Rightarrow 08/03
FIESTA IV 1.3 i	J4C, J4J, J4L, J4Q, J4R, J4T, J4C, J4A, J4C, J4E, J4J, J4K, J4M	08/95 \Rightarrow 01/02
IKON 1.3 EFI	--	01/00 \Rightarrow
KA I 1.3 i	J4D, J4K, J4M, J4N, J4P, J4S, J4B, J4D, J4F, J4G, J4H, J4L	09/96 \Rightarrow 11/08

KW 360 569

07

IGNITION CABLE SETS

Adatt./Suitable:

⁰³ Supplied until depletion

- Fornibile fino ad esaurimento delle scorte
- Fourni jusqu'à épuisement du stock
- Lieferbar solange vorrat reicht
- Suministrado hasta el stock termina

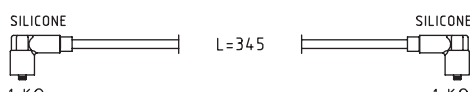
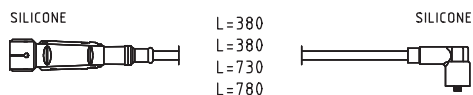
COPPER CORE CABLE \varnothing 7 mm

SEAT

AROSA 1.0	ALL	05/97 \Rightarrow 06/04
SKODA		
FELICIA 1.6	6A16XHT	06/97 \Rightarrow 04/02
FELICIA 1.6 GLX	6A16XHT	08/95 \Rightarrow 03/98
FELICIA 1.6 LX	6A16XHT	08/95 \Rightarrow 03/98

KW 360 575

07

IGNITION CABLE SETS

Adatt./Suitable:

VW

036 905 409 K

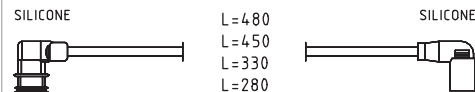
COPPER CORE CABLE \varnothing 7 mm

AUDI

A2 1.4	AUA	02/00 \Rightarrow 08/05
--------	-----	---------------------------

SEAT

AROSA 1.4 16V	0P11C-VE, AQQ, AUB	01/00 \Rightarrow 06/04
CORDOBA I 1.4 16V	2CJXE, AUA	06/99 \Rightarrow 12/02
IBIZA II 1.4 16V	2CJXE, AUA	05/00 \Rightarrow 02/02
IBIZA II 1.4 i 16V	AQQ	06/97 \Rightarrow 02/02
IBIZA III 1.4 16V	AUB	02/02 \Rightarrow 11/09
INCA 1.4 16V	AUA	04/00 \Rightarrow 06/03
LEON I 1.4 16V	2CJXE, AHW, AXP	11/99 \Rightarrow 06/06
LEON I 1.6 16V	AUS	09/00 \Rightarrow 06/06
TOLEDO II 1.4 16V	2CJXE, AHW, AXP	01/00 \Rightarrow 05/02
TOLEDO II 1.6 16V	AUS	06/00 \Rightarrow 05/06

SKODA

FABIA I 1.4 16V	AUA, AUB, BBY, BBZ	10/99 \Rightarrow 03/08
OCTAVIA I 1.4 16V	AXP, BCA	08/00 \Rightarrow 12/10

VOLKSWAGEN (BR)

POLO 1.0	ARA	07/02 \Rightarrow 01/04
----------	-----	---------------------------

VW

BORA 1.4 16V	AHW, AKQ, APE, AXP	03/00 \Rightarrow 05/05
BORA 1.6 16V	ATN, AUS	02/00 \Rightarrow 05/05
CADDY II 1.4	AUA	08/00 \Rightarrow 01/04
CADDY II 1.4 16V	AUA	08/00 \Rightarrow 01/04
GOLF IV 1.4 16V	AHW, AKQ, APE, AXP	10/97 \Rightarrow 06/06
GOLF IV 1.6 16V	ATN, AUS	02/00 \Rightarrow 06/06
POLO IV 1.0	ARA	02/03 \Rightarrow 10/03
POLO IV 1.4 16V	AUA	10/01 \Rightarrow 05/08
LUPO 1.4 16V	AFK, AHW, AKQ, APE, AQQ, AUA, AUB	09/98 \Rightarrow 07/05
LUPO 1.6 GTI	AVY	09/00 \Rightarrow 07/05
POLO III 1.4 16V	AFK, AHW, APE, AUA, AUB	10/99 \Rightarrow 09/01
POLO III 1.6 16V GTI	ARC, AVY	10/99 \Rightarrow 09/01
POLO III 120 1.6 16V GTI	AJV	09/98 \Rightarrow 10/99
POLO III 75 1.4 16V	APE, AUA	10/99 \Rightarrow 09/01

KW 360 580

07

IGNITION CABLE SETS

Adatt./Suitable:

⁰³ Supplied until depletion

- Fornibile fino ad esaurimento delle scorte
- Fourni jusqu'à épuisement du stock
- Lieferbar solange vorrat reicht
- Suministrado hasta el stock termina

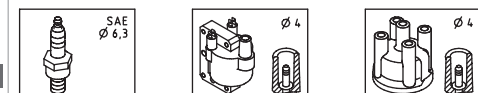
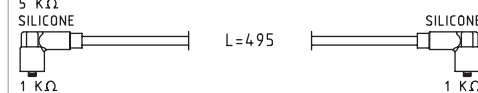
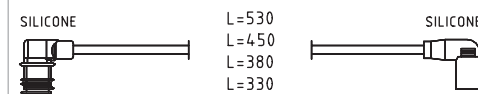
COPPER CORE CABLE \varnothing 7 mm

VW

POLO III 100 1.4 16V	AFH	04/96 \Rightarrow 10/99
----------------------	-----	---------------------------

KW 360 585

07

IGNITION CABLE SETS

Adatt./Suitable:

VW

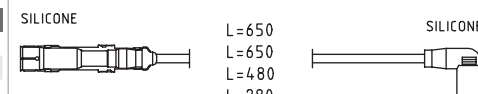
06A 905 409 L
06A 905 409 PCOPPER CORE CABLE \varnothing 7 mm

AUDI

A3 I 1.6	AEH, AVU, BFQ	08/00 \Rightarrow 05/03
A3 II 1.6	BGU, BSE, BSF	05/03 \Rightarrow 03/13
A3 II 1.6 E-Power	CCSA, CMXA	01/11 \Rightarrow 03/13
A4 II 1.6	ALZ	11/00 \Rightarrow 12/04
A4 I 1.6	OD6-280I-A, AHL, ALZ, ANA	07/00 \Rightarrow 09/01
A4 III 1.6	ALZ	11/04 \Rightarrow 06/08

SEAT

ALTEA 1.6	BGU, BSE, BSF, CCSA, CMXA	03/04 \Rightarrow
ALTEA 1.6 LPG	CHGA	09/09 \Rightarrow
ALTEA XL 1.6	BSE, BSF, CCSA, CMXA	10/06 \Rightarrow
ALTEA XL 1.6 LPG	CHGA	09/09 \Rightarrow
ALTEA XL 1.6 Multifuel	CCSA	10/06 \Rightarrow 11/10
EXEO 1.6	ALZ	03/09 \Rightarrow 09/10
IBIZA III 2.0	AZL, BBX	04/02 \Rightarrow 11/09
CORDOBA II 2.0	AZL, BBX	09/02 \Rightarrow 11/09
IBIZA IV 2.0	CEKA	10/08 \Rightarrow 05/15
ALHAMBRA I / II 2.0 i	ATM	04/96 \Rightarrow 03/10
LEON I 1.6	BFQ	10/05 \Rightarrow 06/06
LEON II 1.6	BSE, BSF, CCSA, CMXA	07/05 \Rightarrow 12/12
LEON II 1.6 LPG	CHGA	12/09 \Rightarrow 12/12
LEON II 1.6 MultiFuel	BSE, CMXA	07/05 \Rightarrow 08/13
TOLEDO III 1.6	BGU, BSE, BSF	10/04 \Rightarrow 05/09

SKODA

FABIA I 2.0	AZL	12/99 \Rightarrow 03/08
SUPERB I 2.0	AZM	12/01 \Rightarrow 03/08
OCTAVIA I 1.6	AVU, BFQ	09/00 \Rightarrow 12/10
OCTAVIA I 2.0	AEG, APK, AQQ, AZH	04/99 \Rightarrow 05/07
OCTAVIA I 2.0 4x4	AZH	08/00 \Rightarrow 09/04

SKODA		
OCTAVIA II 1.6	BGU, BSE, BSF, CCSA, CMXA	06/04 ⇒ 06/13
OCTAVIA II 1.6 LPG	CHGA	08/09 ⇒ 11/12
OCTAVIA II 1.6 MultiFuel	CCSA, CMXA	01/08 ⇒ 06/13
OCTAVIA II 2.0 [CHN]	BXX., CGZA.	04/07 ⇒
VOLKSWAGEN (BR)		
GOLF A4 2.0i	APK	08/99 ⇒
POLO 2.0	BBX	05/02 ⇒
VW		
PASSAT IV 1.6	AHL, ALZ, ANA, ARM	10/96 ⇒ 05/05
PASSAT IV 2.0	AZM, BFF	11/00 ⇒ 05/05
PASSAT IV 2.0 [CHN]	BFF, BNL	06/03 ⇒
PASSAT IV 2.0 4motion	AZM	11/00 ⇒ 05/05
GOLF VI 1.6	BSE, BSF, CCSA, CMXA	10/08 ⇒
GOLF VI 1.6 BiFuel	CHGA	03/09 ⇒
GOLF VI 1.6 MultiFuel	CCSA, CHGA, CMXA	10/08 ⇒
BORA 1.6	AVU, BFQ	08/00 ⇒ 05/05
BORA 2.0	APK, AQY, AZH	10/98 ⇒ 12/13
BORA 2.0 4motion	AZH	04/00 ⇒ 05/05
GOLF V 1.6	BGU, BSE, BSF, CCSA, CHGA	01/04 ⇒
GOLF V 1.6 MultiFuel	CCSA	10/07 ⇒ 12/13
GOLF V 2.0	BHY	01/05 ⇒ 11/08
CADDY III 1.6	BGU, BRY, BSE, BSF	04/04 ⇒ 05/15
CADDY III 1.6 BiFuel	CHGA	05/11 ⇒ 05/15
JETTA V 1.6	BSE, BSF, CCSA	09/04 ⇒ 10/10
JETTA V 1.6 [CHN]	BJG	01/05 ⇒
JETTA V 1.6 MultiFuel	CCSA	01/08 ⇒ 10/10
PASSAT V 1.6	BSE, BSF	05/05 ⇒ 11/10
GOLF IV 1.6	AVU, BFQ	08/00 ⇒ 06/06
GOLF IV 2.0	APK, AQY	07/98 ⇒ 06/06
GOLF IV 2.0 4motion	AZH	10/00 ⇒ 06/06
JETTA VI 2.0	CBPA	06/10 ⇒ 12/17
POLO IV 2.0	BBX	09/02 ⇒
POLO III 1.6	APF, AUR	05/97 ⇒ 09/01
POLO III 100 1.6	APF, AUR	12/95 ⇒ 09/01
MULTIVAN 2.0	AXA	11/03 ⇒ 08/15
NEW BEETLE 1.6	AWH, AYD, BFS	06/00 ⇒ 09/10
NEW BEETLE 2.0	AEG, APK, AQY, BER, BHP, CBPA	01/98 ⇒ 10/10
SHARAN I 2.0	ATM	09/95 ⇒ 03/10
SHARAN I 2.0 LPG	ATM	04/06 ⇒ 03/10
TOURAN I 1.6	BGU, BSE, BSF	07/03 ⇒ 05/10
TOURAN I 2.0 FSI	BJZ	10/04 ⇒ 05/10
TOURAN I 2.0 TDI [CHN]	CGZA	04/09 ⇒
TRANSPORTER V 2.0	AXA	11/03 ⇒ 08/15

KW 360 595



IGNITION CABLE SETS

Adatt./Suitable:

00 Eliminated on 13-09-2021. Please verify the availability through our local distributors

- Eliminato il 13-09-2021. Verificare la disponibilità presso i nostri distributori
- Éliminé le 13-09-2021. Vérifier la disponibilité auprès de nos distributeurs sur place
- Am 13-09-2021 gestrichen. Evtl. Verfügbarkeit bitte bei unseren Händlern prüfen
- Eliminado en fecha 13-09-2021. Verificar la disponibilidad a través de nuestros distribuidores locales

03 Supplied until depletion

- Fornibile fino ad esaurimento delle scorte
- Fourni jusqu'à épuisement du stock
- Lieferbar solange vorrat reicht
- Suministrado hasta el stock termina

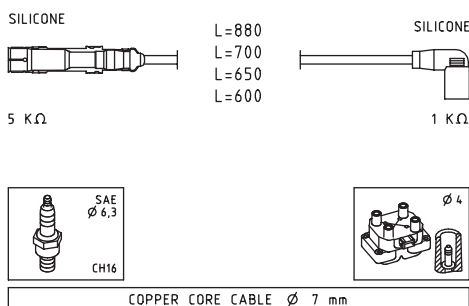

SEAT

AROSA 1.0	ALD, ANV	05/97 ⇒ 06/04
AROSA 1.4	4A20NFT	05/97 ⇒ 06/04

VW

LUPO 1.0	ALD, ANV	09/98 ⇒ 07/05
----------	----------	---------------

KW 360 601



IGNITION CABLE SETS

Adatt./Suitable:

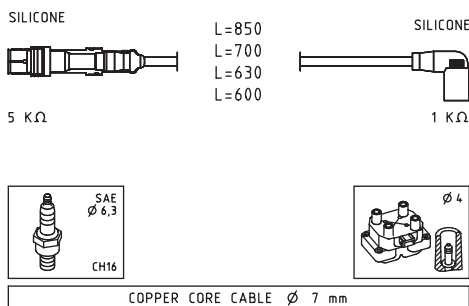

SEAT

AROSA 1.0	AUC	05/97 ⇒ 06/04
AROSA 1.4	AUD	05/97 ⇒ 06/04
IBIZA II 1.0 i	AUC	09/96 ⇒ 02/02
IBIZA II 1.4 i	AUD	09/93 ⇒ 02/02
INCA 1.4 i	AUD	11/95 ⇒ 06/03

VW

CADDY II 1.4	AUD	11/95 ⇒ 06/03
CADDY II 60 1.4	AUD	11/95 ⇒ 01/04
LUPO 1.0	AUC	09/98 ⇒ 07/05
LUPO 1.4	AUD	10/00 ⇒ 07/05
POLO III 1.0	ALD, AUC	10/99 ⇒ 09/01
POLO III 1.4	AKK, AKP, ANW, AUD	05/97 ⇒ 09/01
POLO III 60 1.4	AKK, ANW, AUD	12/95 ⇒ 09/01

KW 360 607



IGNITION CABLE SETS

Adatt./Suitable:

00 Eliminated on 31-08-2021. Please verify the availability through our local distributors

- Eliminato il 31-08-2021. Verificare la disponibilità presso i nostri distributori
- Éliminé le 31-08-2021. Vérifier la disponibilité auprès de nos distributeurs sur place
- Am 31-08-2021 gestrichen. Evtl. Verfügbarkeit bitte bei unseren Händlern prüfen
- Eliminado en fecha 31-08-2021. Verificar la disponibilidad a través de nuestros distribuidores locales

03 Supplied until depletion

- Fornibile fino ad esaurimento delle scorte
- Fourni jusqu'à épuisement du stock
- Lieferbar solange vorrat reicht
- Suministrado hasta el stock termina

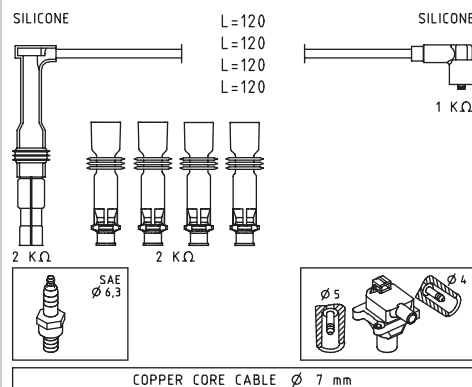

ALFA ROMEO

147 1.6 16V T.SPARK	AR32104	01/01 ⇒ 03/10
147 1.6 16V T.SPARK ECO	AR37203	01/01 ⇒ 03/10
147 2.0 16V T.SPARK	AR32310	01/01 ⇒ 03/10
156 1.6 16V T.SPARK	AR32103, AR32104	09/97 ⇒ 09/05
156 1.6 16V T.SPARK.	AR32103, AR32104	05/00 ⇒ 05/06
156 2.0 16V T.SPARK	AR32310	05/00 ⇒ 06/02
166 2.0 T.SPARK	AR36301	10/00 ⇒ 06/07
GT 1.8 TS	AR32205	11/03 ⇒ 09/10
GTV 2.0 T.SPARK 16V	AR32310	06/95 ⇒ 10/05
SPIDER II 2.0 T.SPARK 16V	AR32310	06/95 ⇒ 04/05

KW 360 608



07,5

IGNITION CABLE SETS

Adatt./Suitable:

00 Eliminated on 14-06-2021. Please verify the availability through our local distributors

- Eliminato il 14-06-2021. Verificare la disponibilità presso i nostri distributori
- Éliminé le 14-06-2021. Vérifier la disponibilité auprès de nos distributeurs sur place
- Am 14-06-2021 gestrichen. Evtl. Verfügbarkeit bitte bei unseren Händlern prüfen
- Eliminado en fecha 14-06-2021. Verificar la disponibilidad a través de nuestros distribuidores locales

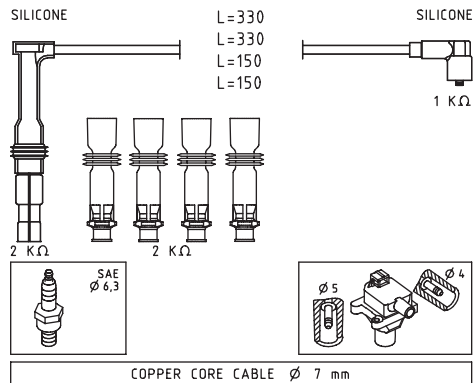

KW 360 609



07

IGNITION CABLE SETS

Adatt./Suitable:

03 Supplied until depletion

- Fornibile fino ad esaurimento delle scorte
- Fourni jusqu'à épuisement du stock
- Lieferbar solange vorrat reicht
- Suministrado hasta el stock termina

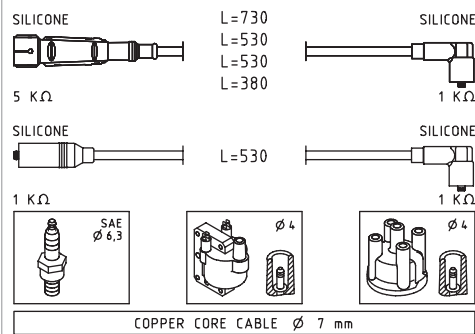

SKODA

OCTAVIA I 1.6 6A16XHT 09/96 ⇨ 09/04

VW

GOLF III 1.6 AEE 09/92 ⇨ 08/97

VENTO 1.6 AEE 09/92 ⇨ 09/98

KW 360 614



07

IGNITION CABLE SETS

Adatt./Suitable:

03 Supplied until depletion

- Fornibile fino ad esaurimento delle scorte
- Fourni jusqu'à épuisement du stock
- Lieferbar solange vorrat reicht
- Suministrado hasta el stock termina

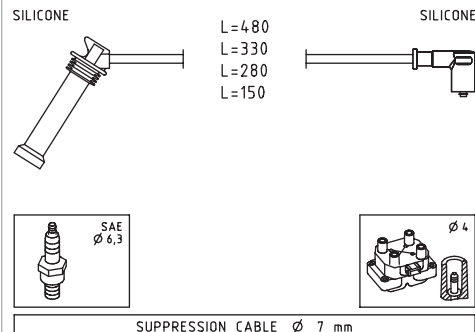

KW 360 619



07

IGNITION CABLE SETS

Adatt./Suitable:

03 Supplied until depletion

- Fornibile fino ad esaurimento delle scorte
- Fourni jusqu'à épuisement du stock
- Lieferbar solange vorrat reicht
- Suministrado hasta el stock termina

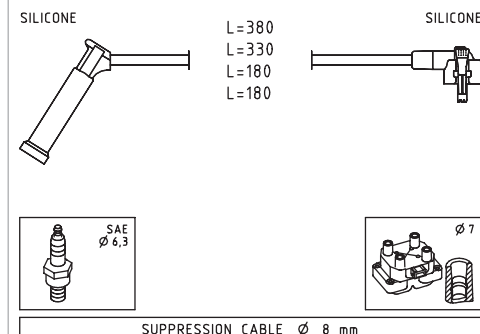

FORD

FIESTA IV 1.25 i 16V DHA, DHB, DHC, DHD, DHE, DHE, DHG 08/95 ⇨ 01/02

FIESTA IV 1.4 i 16V FHA, FHE 04/96 ⇨ 01/02

PUMA 1.4 16V FHD, FHF 11/97 ⇨ 10/00

PUMA 1.7 16V MHA, MHB 03/97 ⇨ 06/02

ALFA ROMEO

145 1.4 i.e. 16V T.S.	AR33503	12/96 ⇨ 01/01
145 1.6 16V T.S.	AR32102	09/97 ⇨ 12/00
145 1.8 i.e. 16V	AR32201	03/98 ⇨ 01/01
145 1.8 i.e. 16V T.S.	AR67106	12/96 ⇨ 12/98
145 1.8 i.e. 16V T.S. [BRA]	AR67199	10/96 ⇨ 02/99
145 2.0 16V	AR32301	03/98 ⇨ 01/01
145 2.0 16V T.S.	AR67204	10/95 ⇨ 01/01
145 2.0 16V T.SPARK [BRA]	AR67299	10/96 ⇨ 02/99
146 1.4 i.e. 16V T.S.	AR33503	11/96 ⇨ 01/01
146 1.6 16V T.S.	AR32102	09/97 ⇨ 12/00
146 1.6 i.e. 16V T.S.	AR67601	11/96 ⇨ 10/01
146 1.8 i.e. 16V T.S.	AR32201, AR67106	11/96 ⇨ 01/01
146 2.0 16V	AR32301	03/97 ⇨ 10/01
146 2.0 16V T.S.	AR67204	10/95 ⇨ 01/01
155 1.6 16V T.S.	AR67601	05/96 ⇨ 12/97
155 1.7 T.S. 16V	AR67106	05/96 ⇨ 12/97
155 2.0 T.S. 16V	AR67204, AR67299	03/95 ⇨ 12/97
156 1.6 16V T.SPARK	AR32102, AR67601	09/97 ⇨ 09/05
156 1.6 16V T.SPARK.	AR32102, AR67601	05/00 ⇨ 05/06
156 1.8 16V T.SPARK	AR32201	09/97 ⇨ 10/00
156 2.0 16V T.SPARK	AR32301	09/97 ⇨ 06/02
166 2.0 T.SPARK	AR34103	09/98 ⇨ 10/00
GTV 1.8 16V	AR32201	05/98 ⇨ 10/05
GTV 2.0 T.SPARK 16V	AR16201, AR32301	06/95 ⇨ 10/05
SPIDER II 1.8 16V	AR32201	05/98 ⇨ 04/05
SPIDER II 2.0 T.SPARK 16V	AR16201, AR32301	06/95 ⇨ 04/05

KW 360 624



07

IGNITION CABLE SETS

Adatt./Suitable:

03 Supplied until depletion

- Fornibile fino ad esaurimento delle scorte
- Fourni jusqu'à épuisement du stock
- Lieferbar solange vorrat reicht
- Suministrado hasta el stock termina

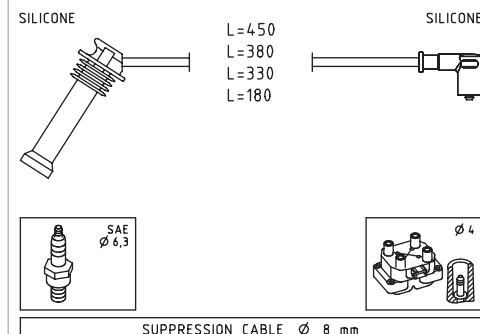

FORD

COUGAR 2.0 16V EDDB, EDDB, EDBC, EDBD 08/98 ⇨ 12/01

FOCUS I 1.6 16V -- 02/01 ⇨ 11/04

FOCUS I 1.8 16V EYDB, EYDC, EYDD, EYDE, EYDF, EYDG, EYDI, EYDJ, EYDL 10/98 ⇨ 11/04

FOCUS I 1.8 BiFuel EYDL 02/03 ⇨ 01/05

FOCUS I 2.0 16V EDDB, EDDC, EDDD, EDDF 10/98 ⇨ 11/04

FOCUS I RS HMDA 10/02 ⇨ 11/04

FOCUS I ST170 ALDA 03/02 ⇨ 11/04

MAVERICK 2.0 16V YF 02/01 ⇨

MONDEO I 1.6 i L1J 08/96 ⇨ 09/00

MONDEO I 1.6 i 16V L1L, L1N, L1Q 05/98 ⇨ 09/00

MONDEO I 1.8 i RKB, RKF, RKH, RKJ, RKK 08/96 ⇨ 09/00

MONDEO I 2.0 i NGA, NGB, NGC, NGD 08/96 ⇨ 09/00

TOURNEO CONNECT I 1.8 16V EYPA, EYPC, EYPD 06/02 ⇨ 12/13

TRANSIT CONNECT I 1.8 16V EYPA, EYPC, EYPD 06/02 ⇨ 12/13

TRANSIT CONNECT I 1.8 16V LPG EYPC 06/02 ⇨ 12/13

KW 360 625

07

IGNITION CABLE SETS

Adatt./Suitable:

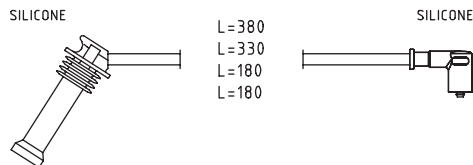

SUPPRESSION CABLE Ø 8 mm

FORD

FIESTA V 1.25 16V	FUJA, FUJB, M7JA, M7JB	05/02 ⇒ 06/08
FIESTA V 1.4 16V	FXJA, FXJB	11/01 ⇒ 06/08
FIESTA V 1.6 16V	FYJA, FYJB	11/01 ⇒ 06/08
FIESTA IV 1.25 i 16V	DHA, DHB, DHC, DHD, DHE, DHF, DHG	08/95 ⇒ 01/02
FIESTA IV 1.4 i 16V	FHA, FHE	04/96 ⇒ 01/02
FIESTA IV 1.6 16V Sport	L1T, L1V	02/00 ⇒ 01/02
FOCUS I 1.4 16V	FXDA, FXDB, FXDC, FXDD	10/98 ⇒ 11/04
FOCUS I 1.6 16V	FYDA, FYDB, FYDC, FYDD, FYDH	10/98 ⇒ 11/04
FOCUS II 1.4	ASDA, ASDB	07/04 ⇒ 09/12
FOCUS II 1.6	HWDA, HWDB, SHDA, SHDB, SHDC	07/04 ⇒ 09/12
FOCUS II 1.6 Ti	HXDA, HXDB	07/04 ⇒ 09/12
FOCUS C-MAX 1.6	HWDA, HWDB	10/03 ⇒ 03/07
FOCUS C-MAX 1.6 Ti	HXDA, SIDA	08/04 ⇒ 03/07
FUSION 1.25	-, FUJA, FUJB	10/02 ⇒
FUSION 1.4	-, FXJA, FXJB, FXJC	08/02 ⇒
FUSION 1.6	FYJA, FYJB, FYJC	08/02 ⇒ 11/09
MONDEO III 1.6 Ti	KGBA, PNBA, RHBA	03/07 ⇒ 01/15
PUMA 1.4 16V	FHD, FHF	11/97 ⇒ 10/00
PUMA 1.6 16V	L1W	08/00 ⇒ 06/02
PUMA 1.7 16V	MHA, MHB	03/97 ⇒ 06/02

KW 360 630

07

IGNITION CABLE SETS

Adatt./Suitable:

⁰³ Supplied until depletion

- Fornibile fino ad esaurimento delle scorte
- Fourni jusqu'à épuisement du stock
- Lieferbar solange vorrat reicht
- Suministrado hasta el stock termina

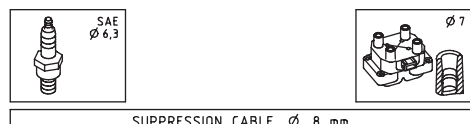
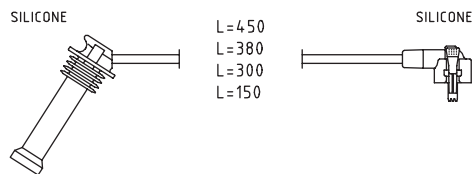

SUPPRESSION CABLE Ø 8 mm

FORD

ESCORT IV 1.6 16V	L1E	10/98 ⇒ 07/00
ESCORT V 1.6 16V XR3i	L1E	12/92 ⇒ 01/95
ESCORT V 1.6 i 16V	L1E, L1H, L1K	09/92 ⇒ 01/95
ESCORT V 1.8 16V	RDA	02/92 ⇒ 01/95
ESCORT V 1.8 16V XR3i	99BFR1740, RDA	02/92 ⇒ 01/95
ESCORT V 1.8 i 16V	99BFR1740	09/92 ⇒ 01/95
ESCORT V 1.8 XR3i 16V 4x4	99BFR1740, RDA	08/93 ⇒ 01/95
ESCORT VI 1.6 16V	L1E	01/95 ⇒ 07/00
ESCORT VI 1.6 16V 4x4	L1E	01/95 ⇒ 10/98
ESCORT VI 1.6 16V XR3i	L1E, L1H	02/95 ⇒ 09/99

FORD

ESCORT VI 1.6 i 16V	L1E, L1H, L1K	01/95 ⇒ 02/99
ESCORT VI 1.8 16V	RDA, RKC	01/95 ⇒ 02/99
ESCORT VI 1.8 16V XR3i	RDA, RKC	02/95 ⇒ 08/98
FIESTA III 1.6 i 16V	L1G	01/94 ⇒ 12/95
FIESTA III 1.8 16V	RDB	02/92 ⇒ 12/95
FIESTA III 1.8 XR2i 16V	RQC	02/92 ⇒ 12/95
MONDEO I 1.6 i	L1J	08/96 ⇒ 09/00
MONDEO I 1.6 i 16V	L1F, L1J, L1L, L1N, L1Q	02/93 ⇒ 09/00
MONDEO I 1.8 4x4	RKA	02/93 ⇒ 08/96
MONDEO I 1.8 i	RKB, RKF, RKH, RKJ, RKK	08/96 ⇒ 09/00
MONDEO I 1.8 i 16V	RKA, RKB	02/93 ⇒ 08/96
MONDEO I 1.8 i 16V 4x4	RKA	02/93 ⇒ 08/96
MONDEO I 2.0 i	NGA, NGB, NGC, NGD	08/96 ⇒ 09/00
MONDEO I 2.0 i 16V	NGA	01/93 ⇒ 08/96
MONDEO I 2.0 i 16V 4x4	NGA	02/93 ⇒ 08/96
ORION II 1.6 i 16V	L1E, L1K	07/92 ⇒ 12/93
ORION II 1.8 i 16V	99BFR1740, RDA	01/92 ⇒ 12/93

KW 360 634

07

IGNITION CABLE SETS

Adatt./Suitable:

BOSCH

0 986 356 988

CHEVROLET

96256433

96518123

DAEWOO

96256433

96518123

GENERAL MOTORS

96 518 123

HITACHI

134227

⁰³ Supplied until depletion

- Fornibile fino ad esaurimento delle scorte
- Fourni jusqu'à épuisement du stock
- Lieferbar solange vorrat reicht
- Suministrado hasta el stock termina

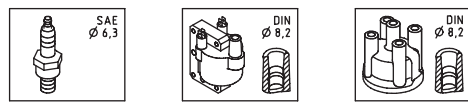
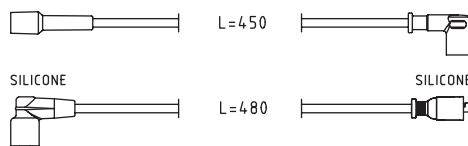
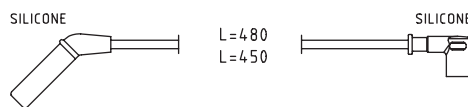

SUPPRESSION CABLE Ø 7 mm

CHEVROLET

MATIZ 0.8	LBF(49CUL3), LQZ(49CUL3)	03/05 ⇒ 12/13
MATIZ 0.8 LPG	F8CV	03/05 ⇒ 12/07
SPARK I 0.8	F8CV	09/00 ⇒ 12/06
SPARK II 0.8	F8CV	05/05 ⇒ 02/10
DAEWOO		
MATIZ 0.8	F8CV	08/98 ⇒

KW 360 639

07

IGNITION CABLE SETS

Adatt./Suitable:

⁰³ Supplied until depletion

- Fornibile fino ad esaurimento delle scorte
- Fourni jusqu'à épuisement du stock
- Lieferbar solange vorrat reicht
- Suministrado hasta el stock termina

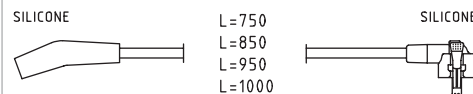

SUPPRESSION CABLE Ø 8 mm

FORD

ESCORT VI 1.3	J4B	01/95 ⇒ 02/99
FIESTA IV 1.0 i	0EAL	04/96 ⇒ 09/99
FIESTA IV 1.3	J4C	02/96 ⇒ 08/03
FIESTA IV 1.3 i	J4C, J4J, J4L, J4Q, J4R, J4T, J4C, J4A, J4C, J4E, J4J, J4K, J4M	08/95 ⇒ 01/02
KA I 1.3 i	J4D, J4K, J4M, J4N, J4P, J4S, J4B, J4D, J4F, J4G, J4H, J4L	09/96 ⇒ 11/08

KW 360 640

07

IGNITION CABLE SETS

Adatt./Suitable:

⁰³ Supplied until depletion

- Fornibile fino ad esaurimento delle scorte
- Fourni jusqu'à épuisement du stock
- Lieferbar solange vorrat reicht
- Suministrado hasta el stock termina

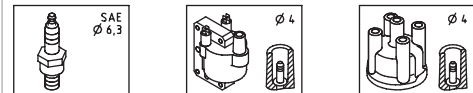
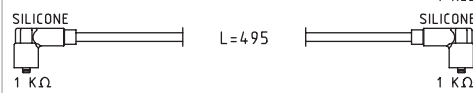
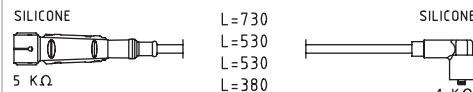

COPPER CORE CABLE Ø 7 mm

SEAT

CORDOBA I 1.0 i	AER	09/96 ⇒ 10/02
CORDOBA I 1.4	ANX	12/97 ⇒ 04/99
CORDOBA I 1.4 i	AEX, AKV, APQ	06/94 ⇒ 12/02
CORDOBA I 1.6 i	AEE, ALM	02/93 ⇒ 12/02
IBIZA II 1.0 i	AER	09/96 ⇒ 02/02
IBIZA II 1.4	ANX	12/97 ⇒ 04/99
IBIZA II 1.4 i	AEX, AKV, APQ	09/93 ⇒ 02/02
IBIZA II 1.6 i	AEE, ALM	03/93 ⇒ 02/02

VW

POLO III 1.4	AEX, AKV, ANX, APQ	05/97 ⇒ 09/01
POLO III 1.6	AEE, ALM	05/97 ⇒ 09/01
POLO III 54 1.4	ANX	01/98 ⇒ 08/99
POLO III 55 1.4	AEX	08/95 ⇒ 10/99
POLO III 60 1.4	AEX, AKV, APQ	07/95 ⇒ 09/01
POLO III 75 1.6	AEE, ALM	10/94 ⇒ 09/01
VENTO 1.4	AEX	11/91 ⇒ 09/98

KW 360 641

07

IGNITION CABLE SETS

Adatt./Suitable:

03 Supplied until depletion

- Fornibile fino ad esaurimento delle scorte
- Fourni jusqu'à épuisement du stock
- Lieferbar solange vorrat reicht
- Suministrado hasta el stock termina

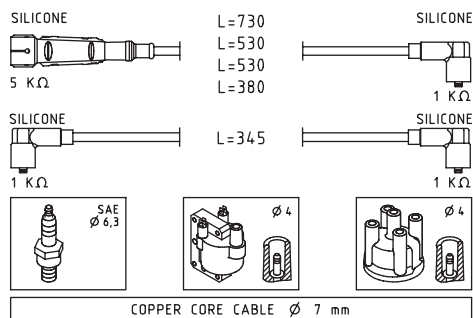

SEAT

AROSA 1.0	AER	05/97 ⇒ 06/04
AROSA 1.4	AEX, AKV, APQ	05/97 ⇒ 06/04

VW

CADDY II 1.6	AEE	06/96 ⇒ 12/00
LUPU 1.0	AER, ALL	09/98 ⇒ 07/05
POLO III 1.4	AEX	05/97 ⇒ 09/01
POLO III 50 1.0	AER, ALL	09/96 ⇒ 10/99
POLO III 55 1.4	AEX	08/95 ⇒ 10/99
POLO III 60 1.4	AEX, AKV	07/95 ⇒ 09/01
POLO III 75 1.6	AEE, AHS	10/94 ⇒ 09/01
POLO IV 1.0	AER	08/96 ⇒ 12/01

KW 360 643

07

IGNITION CABLE SETS

Adatt./Suitable:

BOSCH
0 356 912 975HITACHI
134952SMART
Q 0002576V002000000

03 Supplied until depletion

- Fornibile fino ad esaurimento delle scorte
- Fourni jusqu'à épuisement du stock
- Lieferbar solange vorrat reicht
- Suministrado hasta el stock termina

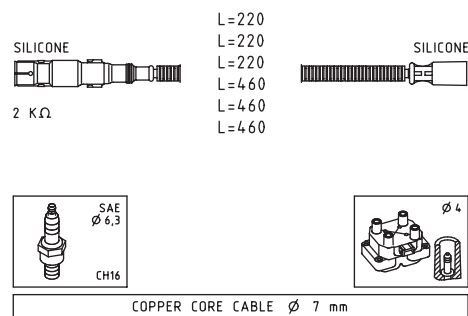

SMART

CABRIO 0.6	M160E6ALB03, M160E-6ALB05, M160.910, M160.920	03/00 ⇒ 01/04
CABRIO 0.7	M160.910	01/03 ⇒ 01/04
CITY-COUPÉ 0.6	M160E6ALB03, M160E-6ALB04, M160E6ALB05, M160.920	01/01 ⇒ 01/04
CITY-COUPÉ 0.7	M160.910	01/03 ⇒ 01/04
CROSSBLADE 0.6	M160.920	06/02 ⇒ 12/03
FORTWO I 0.7	M160.910	01/04 ⇒ 01/07
ROADSTER 0.7	M160.921, M160.922	04/03 ⇒ 11/05
ROADSTER 0.7 Brabus	M160.923	12/03 ⇒ 11/05

KW 360 649

07,5

IGNITION CABLE SETS

Adatt./Suitable:

03 Supplied until depletion

- Fornibile fino ad esaurimento delle scorte
- Fourni jusqu'à épuisement du stock
- Lieferbar solange vorrat reicht
- Suministrado hasta el stock termina

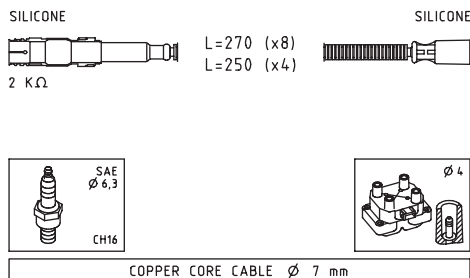

MERCEDES-BENZ

CLASSE C I C 240	M112.910	06/97 ⇒ 05/00
CLASSE C I C 240 T	M112.910, M112.915	09/00 ⇒ 03/01
CLASSE C I C 280	M112.920	06/97 ⇒ 05/00
CLASSE C I C 280 T	M112.920	06/97 ⇒ 03/01
CLASSE C II C 240	M112.912	05/00 ⇒ 08/07
CLASSE C II C 240 4-matic	M112.916	07/02 ⇒ 08/07
CLASSE C II C 32 AMG Kompressor	M112.961	02/01 ⇒ 08/07
CLASSE C II C 320	M112.946	05/00 ⇒ 05/08
CLASSE C II C 320 4-matic	M112.953	07/02 ⇒ 08/07
CLASSE CLK I 320	M112.940	06/97 ⇒ 06/02
CLASSE CLK II 240	M112.912	06/02 ⇒ 05/09
CLASSE CLK II 320	M112.955	06/02 ⇒ 05/09
CLASSE CLK II CLK 240	M112.912	02/03 ⇒ 03/10
CLASSE CLK II CLK 320	M112.955	02/03 ⇒ 03/10
CLASSE E II E 240	M112.911, M112.914	08/00 ⇒ 03/02
CLASSE E II E 240 T	M112.911, M112.914	08/00 ⇒ 03/03
CLASSE E II E 280	M112.921	12/96 ⇒ 03/02
CLASSE E II E 280 4-matic	M112.921	12/96 ⇒ 03/02
CLASSE E II E 280 T	M112.921	12/96 ⇒ 03/03
CLASSE E II E 280 T 4-matic	M112.921	12/96 ⇒ 03/03
CLASSE E II E 320	M112.941	06/97 ⇒ 03/02
CLASSE E II E 320 4-matic	M112.941	06/97 ⇒ 03/02
CLASSE E II E 320 T	M112.941	12/96 ⇒ 03/03
CLASSE E II E 320 T 4-matic	M112.941	12/96 ⇒ 03/03
CLASSE E III E 240	M112.913	03/02 ⇒ 12/08
CLASSE E III E 240 4-matic	M112.917	03/03 ⇒ 12/08
CLASSE E III E 240 T	M112.913	03/03 ⇒ 07/09
CLASSE E III E 240 T 4-matic	M112.917	07/03 ⇒ 07/09
CLASSE E III E 320	M112.949	03/02 ⇒ 12/08
CLASSE E III E 320 4-matic	M112.954	03/03 ⇒ 12/08
CLASSE E III E 320 T	M112.949	03/03 ⇒ 07/09
CLASSE E III E 320 T 4-matic	M112.954	07/03 ⇒ 07/09
CLASSE G II G 320	M112.945	06/97 ⇒ 11/97
CLASSE M I ML 320	M112.942	02/98 ⇒ 08/02
CLASSE M I ML 350	M112.970	08/02 ⇒ 06/05
CLASSE S IV S 280	M112.922	10/98 ⇒ 08/05
CLASSE S IV S 320	M112.944	10/98 ⇒ 08/05
CLASSE S IV S 350	M112.972	09/02 ⇒ 08/05
CLASSE S IV S 350 4-matic	M112.975	06/03 ⇒ 08/05
CLASSE SL IV 280	M112.923	05/98 ⇒ 10/01
CLASSE SL IV 320	M112.943	05/98 ⇒ 10/01
CLASSE SL V 350	M112.973	03/03 ⇒ 01/12
CLASSE SLK I 32 AMG Kompressor	M112.960	03/01 ⇒ 04/04
CLASSE SLK I 320	M112.947	03/00 ⇒ 04/04
VIANO 3.2	M112.951	09/03 ⇒
VIANO 3.7	M112.976	06/04 ⇒
VITO II 119	M112.951	09/03 ⇒
VITO II 122	M112.951	09/03 ⇒
VITO II 123	M112.976	06/04 ⇒ 07/08

KW 360 654

07

IGNITION CABLE SETS

Adatt./Suitable:

00 Eliminated on 23-03-2021. Please verify the availability through our local distributors

- Eliminato il 23-03-2021. Verificare la disponibilità presso i nostri distributori
- Éliminé le 23-03-2021. Vérifier la disponibilité auprès de nos distributeurs sur place
- Am 23-03-2021 gestrichen. Evtl. Verfügbarkeit bitte bei unseren Händlern prüfen
- Eliminado en fecha 23-03-2021. Verificar la disponibilidad a través de nuestros distribuidores locales

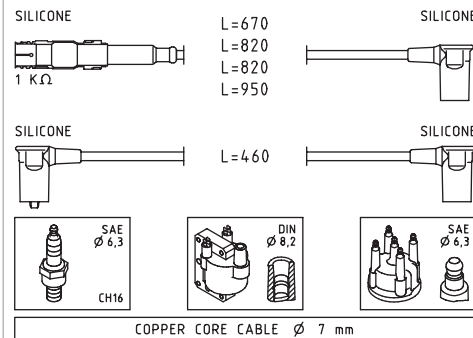

MERCEDES-BENZ

124 200 CE	M102.963	09/89 ⇒ 06/93
124 230 CE	M102.982	03/87 ⇒ 12/92
124 230 CE Cat	M102.982	06/89 ⇒ 12/92
190 2.0	M102.924	08/83 ⇒ 05/90
CLASSE G I 200 GE	M102.964	02/80 ⇒ 08/92
CLASSE G I 230 GE	M102.981, M102.987	04/82 ⇒ 08/92
CLASSE G II 230 GE	M102.981	04/92 ⇒
KOMBI II 200 T	M102.922	09/85 ⇒ 05/90
KOMBI II 200 TE	M102.963	09/88 ⇒ 08/92
KOMBI II 230 E Chassis	M102.982	09/86 ⇒ 06/93
KOMBI II 230 TE	M102.982	09/85 ⇒ 08/92
KOMBI II 230 TE Cat	M102.982	06/89 ⇒ 08/92
T1 210 2.3	M102.942, M102.945	04/77 ⇒ 02/96
T1 310 2.3	M102.942, M102.945	08/82 ⇒ 02/96
T1 410 2.3	M102.942, M102.945	08/82 ⇒ 06/95
T2/LN1 510	M102.946	04/86 ⇒ 12/94
TRE VOLUMI II 200	M102.922	12/85 ⇒ 10/92
TRE VOLUMI II 200 E	M102.963	09/88 ⇒ 08/93
TRE VOLUMI II 230 E	M102.982	12/84 ⇒ 06/93
TRE VOLUMI II 230 E Cat	M102.982	06/89 ⇒ 06/93

PUCH

G-MODELL 230 GE	M102.981, M102.987	03/79 ⇒ 12/91
-----------------	--------------------	---------------

KW 360 657

07,5

IGNITION CABLE SETS

Adatt./Suitable:

00 Eliminated on 30-09-2019. Please verify the availability through our local distributors

- Eliminato il 30-09-2019. Verificare la disponibilità presso i nostri distributori
- Éliminé le 30-09-2019. Vérifier la disponibilité auprès de nos distributeurs sur place
- Am 30-09-2019 gestrichen. Evtl. Verfügbarkeit bitte bei unseren Händlern prüfen
- Eliminado en fecha 30-09-2019. Verificar la disponibilidad a través de nuestros distribuidores locales

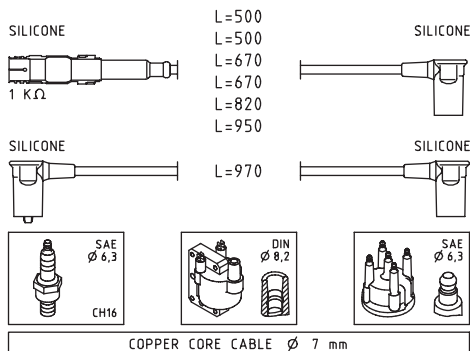

MERCEDES-BENZ

CLASSE E I E 300 4-matic	M103.985	06/93 ⇒ 06/95
CLASSE E I E 300 T 4-matic	M103.985	06/93 ⇒ 06/96
124 300 CE	M103.983	03/87 ⇒ 05/93
CLASSE G II 300 GE	M103.987	09/89 ⇒ 09/97
CLASSE SL III 300 SL	M103.982	09/85 ⇒ 08/89
CLASSE SL IV 300 SL	M103.984	03/89 ⇒ 08/93
KOMBI II 300 TE	M103.983	01/86 ⇒ 08/92
KOMBI II 300 TE 4-matic	M103.985	09/86 ⇒ 06/93
TRE VOLUMI II 260 E	M103.940	09/85 ⇒ 08/92
TRE VOLUMI II 260 E 4-matic	M103.943	09/86 ⇒ 08/92
TRE VOLUMI II 300 E	M103.983	08/85 ⇒ 08/92
TRE VOLUMI II 300 E 4-matic	M103.983, M103.985	09/86 ⇒ 06/93

PUCH

G-MODELL 300 GE	M103.987	06/89 ⇒ 08/93
-----------------	----------	---------------

KW 360 658

08

IGNITION CABLE SETS

Adatt./Suitable:

BOSCH
0 986 357 239
NISSAN
22440-86J00
22440-86J10

00 Eliminated on 07-04-2021. Please verify the availability through our local distributors

- Eliminato il 07-04-2021. Verificare la disponibilità presso i nostri distributori
- Éliminé le 07-04-2021. Vérifier la disponibilité auprès de nos distributeurs sur place
- Am 07-04-2021 gestrichen. Evtl. Verfügbarkeit bitte bei unseren Händlern prüfen
- Eliminado en fecha 07-04-2021. Verificar la disponibilidad a través de nuestros distribuidores locales

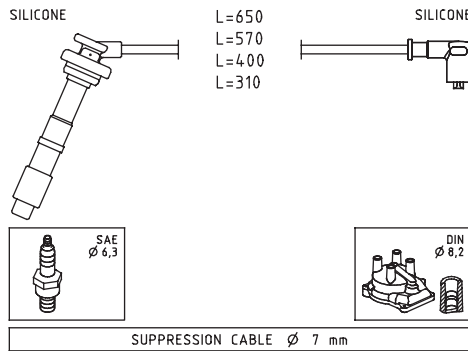

NISSAN

PRIMERA II 1.6 16V	GA16DE	09/96 ⇒ 07/02
PRIMERA I 1.6	GA16DE	06/93 ⇒ 01/96

KW 360 660

07

IGNITION CABLE SETS

Adatt./Suitable:

03 Supplied until depletion

- Fornibile fino ad esaurimento delle scorte
- Fourni jusqu'à épuisement du stock
- Lieferbar solange vorrat reicht
- Suministrado hasta el stock termina

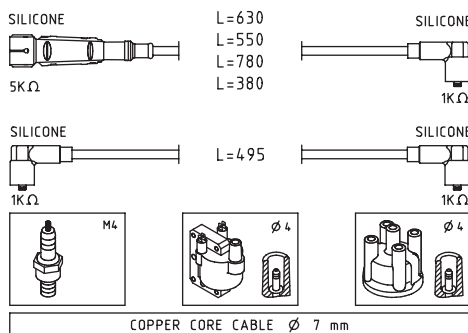

SEAT

INCA 1.4 i	AEX, AKV, APQ	11/95 ⇒ 06/03
INCA 1.6 i	AEE	06/97 ⇒ 09/00

VW

CADDY II 1.4	AEX, AKV, APQ	11/95 ⇒ 06/03
CADDY II 1.6	AEE	06/97 ⇒ 09/00
CADDY II 60 1.4	AEX, APQ	11/95 ⇒ 01/04
CADDY II 75 1.6	AEE	11/95 ⇒ 09/00
VENTO 1.4	APQ	12/97 ⇒ 05/98

KW 360 667

07

IGNITION CABLE SETS

Adatt./Suitable:

00 Eliminated on 22-02-2022. Please verify the availability through our local distributors

- Eliminato il 22-02-2022. Verificare la disponibilità presso i nostri distributori
- Éliminé le 22-02-2022. Vérifier la disponibilité auprès de nos distributeurs sur place
- Am 22-02-2022 gestrichen. Evtl. Verfügbarkeit bitte bei unseren Händlern prüfen
- Eliminado en fecha 22-02-2022. Verificar la disponibilidad a través de nuestros distribuidores locales

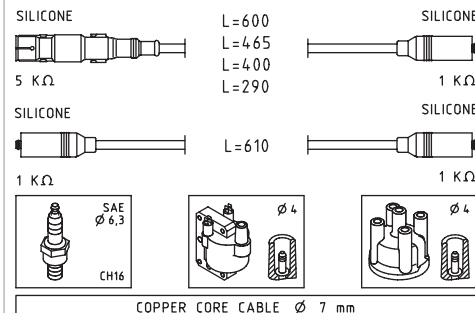

SEAT

ALHAMBRA I / II 2.0 i	ADY	04/96 ⇒ 03/10
-----------------------	-----	---------------

VW

SHARAN I 2.0	ADY	09/95 ⇒ 03/10
--------------	-----	---------------

KW 360 671

07

IGNITION CABLE SETS

Adatt./Suitable:

00 Eliminated on 22-02-2022. Please verify the availability through our local distributors

- Eliminato il 22-02-2022. Verificare la disponibilità presso i nostri distributori
- Éliminé le 22-02-2022. Vérifier la disponibilité auprès de nos distributeurs sur place
- Am 22-02-2022 gestrichen. Evtl. Verfügbarkeit bitte bei unseren Händlern prüfen
- Eliminado en fecha 22-02-2022. Verificar la disponibilidad a través de nuestros distribuidores locales

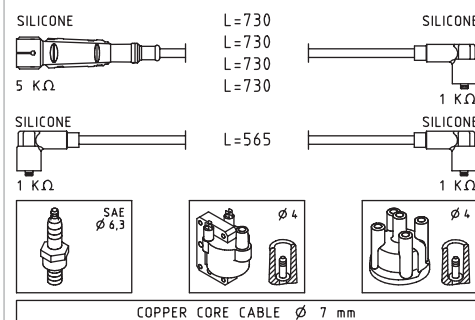

VW

JETTA II 1.3	MH, NU	01/84 ⇒ 12/87
JETTA II 1.3 Cat	MH, NZ	06/87 ⇒ 12/91
GOLF II 1.0	HZ	08/85 ⇒ 10/91
GOLF II 1.3	MH, NU	08/83 ⇒ 12/87
GOLF II 1.3 Cat	NZ	06/86 ⇒ 12/92
GOLF III 1.4	AEX	10/91 ⇒ 04/99
TRANSPORTER IV 1.8	5K7M710	12/90 ⇒ 07/92
TRANSPORTER IV 2.0	AAC	07/90 ⇒ 04/03

KW 360 677

07,5

IGNITION CABLE SETS

Adatt./Suitable:

BOSCH
0 986 356 986**CHEVROLET**
96190263
96460220**DAEWOO**
96190263
96460220**GENERAL MOTORS**
96 460 220**00 Eliminated on 22-02-2022. Please verify the availability through our local distributors**

- Eliminato il 22-02-2022. Verificare la disponibilità presso i nostri distributori

- Éliminé le 22-02-2022. Vérifier la disponibilité auprès de nos distributeurs sur place

- Am 22-02-2022 gestrichen. Evtl. Verfügbarkeit bitte bei unseren Händlern prüfen

- Eliminado en fecha 22-02-2022. Verificar la disponibilidad a través de nuestros distribuidores locales

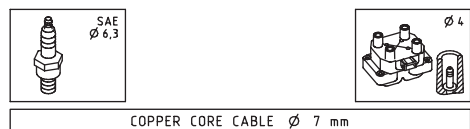
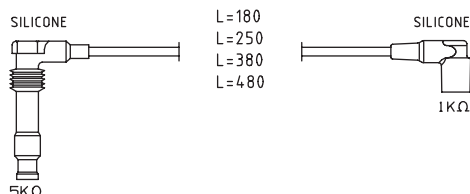

CHEVROLET

EPICA 2.0	T20SED	01/05 ⇒ 12/06
EVANDA 2.0	X20SED	03/05 ⇒ 12/06
LACETTI 1.8	T18SED	03/05 ⇒
LACETTI 2.0	U20SED	03/05 ⇒
LEGANZA 2.0	--	01/98 ⇒
LEGANZA 2.2	--	01/98 ⇒
NUBIRA 1.8	T18SED	03/05 ⇒ 12/09
OPTRA 1.8	T18SED	08/03 ⇒ 12/08
OPTRA 1.8 SRV	T18SED	06/06 ⇒
OPTRA 2.0	U20SED	06/99 ⇒
REZZO 2.0	T20SED	03/05 ⇒
TACUMA 2.0	X20SED	02/05 ⇒
VIVANT 2.0	X20SED	08/00 ⇒
VIVANT 2.0 CX	T20SED	01/05 ⇒

DAEWOO

EVANDA 2.0	L88, X20SED	08/02 ⇒
LACETTI 1.8	T18SED	02/04 ⇒
LEGANZA 2.0 16V	T20SED, X20SED	07/00 ⇒ 04/04
LEGANZA 2.2 16V	T22SED	04/99 ⇒ 12/02
NUBIRA I 2.0 16V	T20SED, X20SED, Z20L	12/00 ⇒
NUBIRA I 2.0 CDX	T20SED	08/02 ⇒ 07/03
NUBIRA II 1.8	T18SED	07/03 ⇒
REZZO 2.0	T20SED, X20SED	09/00 ⇒
TACUMA 2.0	X20SED	09/00 ⇒ 01/05

KW 360 680

07

IGNITION CABLE SETS

Adatt./Suitable:

BOSCH
0 986 356 987**CHEVROLET**
96211948
96497773**DAEWOO**
96211948
96497773**GENERAL MOTORS**
96 497 773**HITACHI**
134236**MAGNETI MARELLI**
941365030926**03 Supplied until depletion**

- Fornibile fino ad esaurimento delle scorte

- Fourni jusqu'à épuisement du stock

- Lieferbar solange vorrat reicht

- Suministrado hasta el stock termina

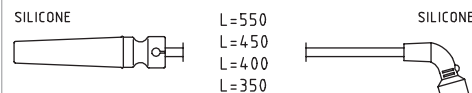

CHEVROLET

AVEO I 1.4	F14D3, L14	03/05 ⇒ 05/13
AVEO I 1.4 16V	F14D3	05/03 ⇒ 05/08
AVEO I 1.4 CNG	L95	01/10 ⇒
AVEO I 1.6	A16DMS, F16D3, LXT, LVX	09/03 ⇒
CRUZE 1.6	F16D3, LXT	05/09 ⇒
KALOS 1.4 16V	F14D3	03/05 ⇒
LANOS 1.6 16V	A16DMS	11/05 ⇒
REZZO 1.6	A16DMS	03/05 ⇒
TACUMA 1.6	A16DMS	02/05 ⇒
VIVANT 1.6	A16DMS	08/01 ⇒

DAEWOO

KALOS 1.4	F14D3	05/03 ⇒ 12/04
KALOS 1.4 16V	F14D3	04/03 ⇒
LANOS 1.6 16V	A16DMS	02/97 ⇒
NUBIRA I 1.6 16V	A16DMS	05/97 ⇒
REZZO 1.6	A16DMS	09/00 ⇒
TACUMA 1.6	A16DMS	09/00 ⇒ 01/05

KW 360 681

07,5

IGNITION CABLE SETS

Adatt./Suitable:

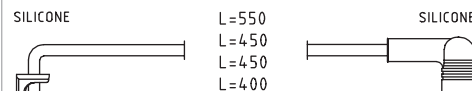
MAGNETI MARELLI
941318111287**RENAULT**
77 00 114 549

RENAULT

CLIO II 1.0	D7D760	02/00 ⇒ 05/01
CLIO II 1.2	D7F710, D7F720, D7F722, D7F726, D7F744, D7F746, D7F764, D7F766	03/98 ⇒

RENAULT

CLIO II 1.2 LPG	D7F722, D7F764, D7F766	09/98 ⇒ 06/09
KANGOO I 1.0	D7D700, D7D760	09/98 ⇒
KANGOO I 1.2	D7F710, D7F720, D7F722, D7F726, D7F744, D7F746	08/97 ⇒
TWINGO I 1.0	D7D740	01/00 ⇒
TWINGO I 1.2	D7F700, D7F701, D7F702, D7F703, D7F704, D7F706	05/96 ⇒

KW 360 682

07

IGNITION CABLE SETS

Adatt./Suitable:

00 Eliminated on 22-02-2022. Please verify the availability through our local distributors

- Eliminato il 22-02-2022. Verificare la disponibilità presso i nostri distributori

- Éliminé le 22-02-2022. Vérifier la disponibilité auprès de nos distributeurs sur place

- Am 22-02-2022 gestrichen. Evtl. Verfügbarkeit bitte bei unseren Händlern prüfen

- Eliminado en fecha 22-02-2022. Verificar la disponibilidad a través de nuestros distribuidores locales

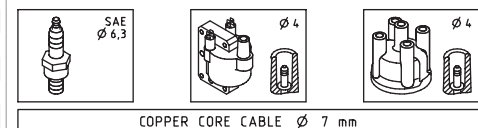
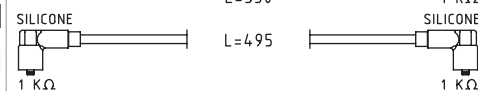
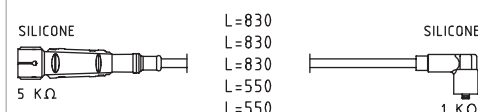

AUDI

80 II 2.0	HP, JS	10/83 ⇒ 09/84
80 II 2.0 quattro	JS	10/83 ⇒ 09/84
80 IV 2.3 E	NG	09/91 ⇒ 01/96
80 IV 2.3 E quattro	NG	09/91 ⇒ 12/94
90 I 2.0	HP, JL, JS, SK	10/84 ⇒ 03/87
90 I 2.0 quattro	JS	08/84 ⇒ 08/86
90 I 2.2	9C54, HY	10/84 ⇒ 03/87
90 I 2.2 E quattro	9C54	11/84 ⇒ 03/87
90 II 2.0	PS	07/88 ⇒ 09/91
90 II 2.2 E	9C54	04/87 ⇒ 07/91
90 II 2.2 E quattro	9C54	04/87 ⇒ 09/91
90 II 2.3 E	NG	04/87 ⇒ 09/91
90 II 2.3 E quattro	NG	04/87 ⇒ 09/91
100 III 2.0	KP	08/84 ⇒ 12/87
100 III 2.0 Cat	RT	01/88 ⇒ 11/90
100 III 2.0 E	KP	01/85 ⇒ 12/87
100 III 2.0 E Cat	RT	01/88 ⇒ 11/90
100 III 2.2 Cat	KU	06/89 ⇒ 11/90
100 III 2.2 Cat quattro	KU	06/89 ⇒ 11/90
100 III 2.2 E Turbo quattro	MC	08/86 ⇒ 11/90
100 III 2.2 Turbo	MC	08/86 ⇒ 11/90
100 III 2.2 Turbo quattro	MC	08/86 ⇒ 11/90
100 III 2.3	NF	08/86 ⇒ 11/90
100 III 2.3 E	NF	10/86 ⇒ 11/90
100 III 2.3 E quattro	NF	08/86 ⇒ 11/90
100 III 2.3 quattro	NF	01/90 ⇒ 11/90
100 IV 2.3 E	7M15A-FKS	12/90 ⇒ 07/94
100 IV 2.3 E quattro	7M15A-FKS	12/90 ⇒ 07/94
A6 I 2.3	7M15A-FKS	06/94 ⇒ 12/95
CABRIOLET 2.3 E	NG	05/91 ⇒ 07/94
COUPE 2.2	9C54	11/88 ⇒ 07/91
COUPE 2.2 quattro	9C54	11/88 ⇒ 07/91
COUPE 2.3	NG	10/88 ⇒ 12/96
COUPE 2.3 quattro	NG	11/88 ⇒ 12/96

KW 360 686

07

IGNITION CABLE SETS

Adatt./Suitable:

BOSCH
0 986 356 721
HONDA
32700-P1J-E01

00 Eliminated on 22-02-2022. Please verify the availability through our local distributors

- Eliminato il 22-02-2022. Verificare la disponibilità presso i nostri distributori
- Éliminé le 22-02-2022. Vérifier la disponibilité auprès de nos distributeurs sur place
- Am 22-02-2022 gestrichen. Evtl. Verfügbarkeit bitte bei unseren Händlern prüfen
- Eliminado en fecha 22-02-2022. Verificar la disponibilidad a través de nuestros distribuidores locales

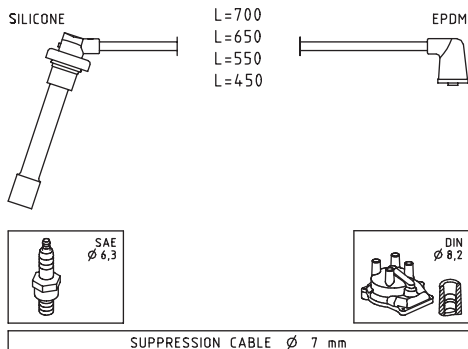

HONDA

CIVICVI 1.4 16V	D14A7, D14A8	01/97 ⇒ 02/01
CIVICVI 1.4 i	D14A8	06/95 ⇒ 02/01
CIVICVI 1.4i	D14A6	01/99 ⇒
CIVICVI 1.4i 16V	D14Z3, D14Z4	11/98 ⇒ 12/00
CIVICVI 1.4i 16V Vtec	D14Z4	01/99 ⇒
CIVICVI 1.5 16V	D15Z8	01/97 ⇒ 02/01
CIVICVI 1.6	D16W4	11/98 ⇒ 03/01
CIVICVI 1.6 16V	D16B2	01/97 ⇒ 02/01
CIVICVI 1.6i 16V	D16W3	11/98 ⇒ 12/00

KW 360 691

07

IGNITION CABLE SETS

Adatt./Suitable:

03 Supplied until depletion

- Fornibile fino ad esaurimento delle scorte
- Fourni jusqu'à épuisement du stock
- Lieferbar solange vorrat reicht
- Suministrado hasta el stock termina

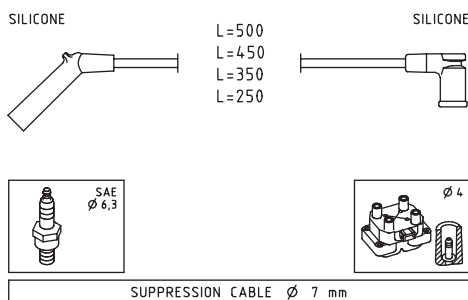

FORD

IKON 1.3 Rocam	--	10/00 ⇒
IKON 1.6 EFI Rocam	--	11/99 ⇒

FORD (BR)

FIESTA 1.0i	ZL10	07/99 ⇒
FIESTA 1.6i	ZL16	07/99 ⇒

KW 360 699

07

IGNITION CABLE SETS

Adatt./Suitable:

BOSCH
0 986 356 721
HONDA
32700-PEL-004

03 Supplied until depletion

- Fornibile fino ad esaurimento delle scorte
- Fourni jusqu'à épuisement du stock
- Lieferbar solange vorrat reicht
- Suministrado hasta el stock termina

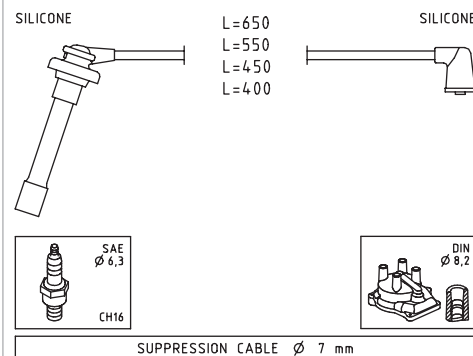

HONDA

HR-V 1.6 16V	350Y	03/99 ⇒
HR-V 1.6 16V 4WD	350Y, D16W5	03/99 ⇒
HR-V 1.6i 16V	D16W2	04/99 ⇒

KW 360 702

07

IGNITION CABLE SETS

Adatt./Suitable:

BOSCH
0 986 356 721

HONDA
32722-P2A-000
32722-P2A-003
32722-P2A-J00
32722-P2A-J01
32722-P2F-A02
32722-P2F-A03

03 Supplied until depletion

- Fornibile fino ad esaurimento delle scorte
- Fourni jusqu'à épuisement du stock
- Lieferbar solange vorrat reicht
- Suministrado hasta el stock termina

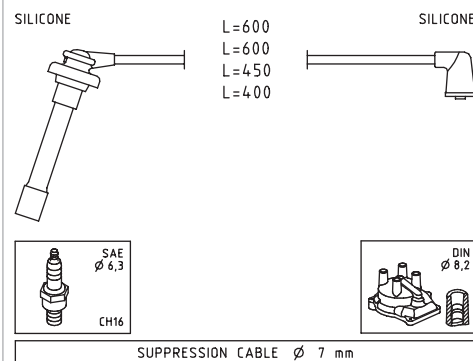

HONDA

BALLADE 1.5	D15Z4	01/97 ⇒
BALLADE 1.6i	D16Y9	01/96 ⇒ 02/01
CIVIC VI 1.4	D14A4	11/95 ⇒ 10/98
CIVIC VI 1.4 i	D14A3, D14A4, D14Z1, D14Z2	11/95 ⇒ 02/01
CIVIC VI 1.4 i S	D14A4, D14Z2	11/95 ⇒ 02/01
CIVIC VI 1.4i 16V	D14Z1	11/98 ⇒ 03/01
CIVIC VI 1.5 i	D15Z6	11/95 ⇒ 02/01
CIVIC VI 1.6	--	05/96 ⇒ 04/99
CIVIC VI 1.6 i	D16Y5	11/95 ⇒ 02/01
CIVIC VI 1.6 i Vtec	D16Y6, D16Y8	11/95 ⇒ 02/01
CIVIC VI 1.6 VTi	B16A2	11/95 ⇒ 02/01
CIVIC VI 1.6i 16V	D16Y7	01/96 ⇒
CIVIC VI 1.6i 16V Vtec	D16Y8	01/96 ⇒ 09/99
CIVIC V 1.6 i	D16Y7	01/94 ⇒ 11/95
CIVIC V 1.6i Vtec	D16Y6	01/94 ⇒ 03/96

KW 360 709

07

IGNITION CABLE SETS

Adatt./Suitable:

BOSCH
0 986 357 150
HONDA
32700-PHK-003
32722-P75-A01

00 Eliminated on 24-05-2021. Please verify the availability through our local distributors

- Eliminato il 24-05-2021. Verificare la disponibilità presso i nostri distributori
- Éliminé le 24-05-2021. Vérifier la disponibilité auprès de nos distributeurs sur place
- Am 24-05-2021 gestrichen. Evtl. Verfügbarkeit bitte bei unseren Händlern prüfen
- Eliminado en fecha 24-05-2021. Verificar la disponibilidad a través de nuestros distribuidores locales

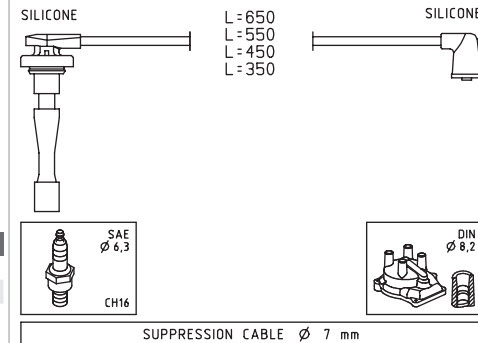

HONDA

BALLADE 1.8 i	B18B4	01/96 ⇒ 02/01
CR-V I 2.0	B20Z1	04/99 ⇒ 02/02
CR-V I 2.0 16V 4WD	B20B, B20Z1	10/95 ⇒ 02/02
CR-V I 2.0 i 16V	B20B3, B20B4, B20B9, B20Z3	02/97 ⇒ 04/99
INTEGRA 1.8 i	B18B1	01/98 ⇒

KW 360 711

07,5

IGNITION CABLE SETS

Adatt./Suitable:

BOSCH
0 986 356 776
0 986 AM0 039

HONDA
32700-POD-000
32700-P0K-G00
32700-P5K-003
32700-P5N-G01
32700-PT0-000
32700-PT0-G00
32701-P14-A00
32701-PT0-000
32702-P14-A00
32702-PT0-000
32703-P14-A00
32703-PT0-000
32704-P14-A00
32704-PT0-000
32722-PT3-A00

03 Supplied until depletion

- Fornibile fino ad esaurimento delle scorte
- Fourni jusqu'à épuisement du stock
- Lieferbar solange vorrat reicht
- Suministrado hasta el stock termina

MAGNETI MARELLI
941315020889

ROVER
GHT274

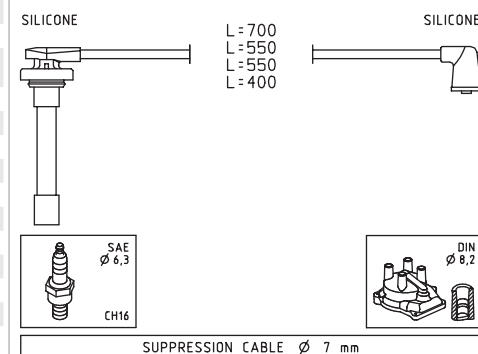

HONDA

ACCORD IV 1.8	--	01/90 ⇒ 12/91
ACCORD IV 2.0 16V	F20A2, F20A3, F20A5, F20A6	01/90 ⇒ 12/93
ACCORD IV 2.0 i 16V	F20A4, F20A7, F20A8, F20Z3	01/90 ⇒ 12/93

HONDA			
ACCORD IV 2.2	F22A6	05/92 ⇒ 12/93	
ACCORD IV 2.2 i 16V	F22A3, F22A7, F22A8	01/90 ⇒ 12/93	
ACCORD IV 2.2 i 16V Automatik	F22A3	01/90 ⇒ 03/93	
ACCORD V 1.8 16V	F18A3	01/94 ⇒ 12/95	
ACCORD V 1.9 i	F18A3	02/96 ⇒ 10/98	
ACCORD V 2.0	F20B3	09/93 ⇒ 12/97	
ACCORD V 2.0 i	F20Z2	03/93 ⇒ 01/96	
ACCORD V 2.0 i LS	F20Z1	02/96 ⇒ 10/98	
ACCORD V 2.0 i LS 16V	F20B3	09/93 ⇒ 02/98	
ACCORD V 2.0 i S	F20Z1	03/93 ⇒ 01/96	
ACCORD V 2.2 16V	F22Z1	01/96 ⇒ 09/98	
ACCORD V 2.2 i [USA]	--	01/94 ⇒ 12/95	
ACCORD V 2.2 i 16V	F22B4	08/95 ⇒ 12/97	
ACCORD V 2.2 i ES	F22B5	09/93 ⇒ 02/98	
ODYSSEY 2.2	F22B6	01/95 ⇒ 12/97	
PRELUDE IV 2.0 i 16V	F20A4	02/92 ⇒ 09/96	
PRELUDE V 2.0 16V	F20A4	10/96 ⇒ 10/00	
PRELUDE V 2.2 i 16V	F22A2	10/96 ⇒ 10/01	
SHUTTLE 2.2 16V	F22B8	10/94 ⇒ 02/98	
ROVER			
600 618 i/Si	F18A3	03/96 ⇒ 02/99	
600 620 i	F20Z2	08/93 ⇒ 06/96	
600 620 Si	F20Z1	08/93 ⇒ 02/99	

KW 360 719

07,5

IGNITION CABLE SETS

Adatt./Suitable:

MINI
82 11 0 393 996
82 11 0 404 488

03 Supplied until depletion

- Fornibile fino ad esaurimento delle scorte
- Fourni jusqu'à épuisement du stock
- Lieferbar solange vorrat reicht
- Suministrado hasta el stock termina

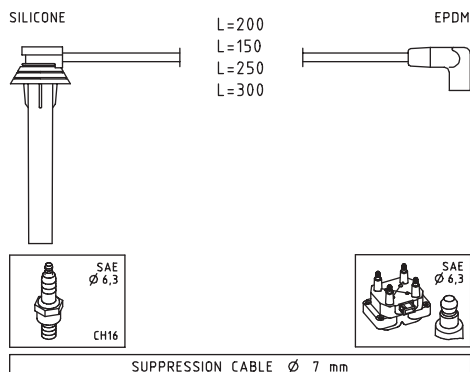

CHRYSLER

NEON II 1.6	EJD	11/01 ⇒ 12/06	
PT CRUISER 1.6	EJD	11/01 ⇒ 12/10	
MINI			
MINI I Cooper	W10B16A	06/01 ⇒ 07/08	
MINI I Cooper S	W11B16A	03/02 ⇒ 11/07	
MINI I John Cooper Works	W11B16A	07/04 ⇒ 11/07	
MINI I One	W10B14A, W10B16A	06/01 ⇒ 11/07	
MINI I Works	W11B16A	11/03 ⇒ 09/06	



MAZDA			
323 VIII F 1.5 16V	ZL05, ZL06	09/98 ⇒ 01/01	
323 VIII F 1.6	ZM	01/01 ⇒ 05/04	
323 VIII S 1.5 16V	ZL05, ZL06	09/98 ⇒ 01/01	
323 VIII S 1.6	ZM	01/01 ⇒ 05/04	
PROTEGE 1.6i [USA]	--	06/98 ⇒	

KW 360 723

07

IGNITION CABLE SETS

Adatt./Suitable:

03 Supplied until depletion

- Fornibile fino ad esaurimento delle scorte
- Fourni jusqu'à épuisement du stock
- Lieferbar solange vorrat reicht
- Suministrado hasta el stock termina

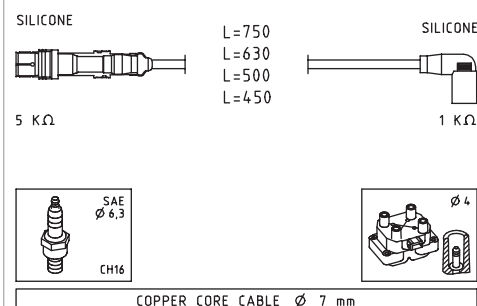

SEAT

IBIZA III 1.6	BAH	02/03 ⇒ 11/09	
CORDOBA II 1.6	BAH	04/03 ⇒ 11/09	

VOLKSWAGEN (BR)

POLO 1.6	BAH, BPA, CCRA	02/02 ⇒	
----------	----------------	---------	--

VW

FOX 1.0	--, AQZ, BNX, CCNA	10/03 ⇒	
FOX 1.0 Alcohol	BJE, BNX	10/03 ⇒	
FOX 1.0 Total Flex	CCNA	03/08 ⇒	
FOX 1.4	BKR	04/05 ⇒ 12/09	
FOX 1.6	BAH, BLH, BPA, CCRA, CFZA	10/03 ⇒ 08/14	
FOX 1.6 Alcohol	--	10/03 ⇒	
FOX 1.6 Total Flex	BJA, BPA, CCRA	10/03 ⇒ 08/14	
POLO IV 1.4	BLM	08/02 ⇒ 08/10	
POLO IV 1.6	BAH, BPA	08/02 ⇒	
POLO IV 1.6 Flex	BPA	12/04 ⇒ 10/14	
POLO IV 1.6 Total Flex	BPA	10/04 ⇒ 06/06	
SPACEFOX / SPACE CROSS 1.6	BAH, BLH	03/06 ⇒	
SPACEFOX / SPACE CROSS 1.6 FSI	BPA, CCRA, CFZA	03/06 ⇒	
SPACEFOX / SPACE CROSS 1.6 Total Flex	BPA, CCRA, CFZA	03/06 ⇒	

KW 360 729

05

IGNITION CABLE SETS

Adatt./Suitable:

BOSCH
0 986 357 266HITACHI
134953MAZDA
ZL01-18-140A

00 Eliminated on 07-06-2021. Please verify the availability through our local distributors

- Eliminato il 07-06-2021. Verificare la disponibilità presso i nostri distributori
- Éliminé le 07-06-2021. Vérifier la disponibilité auprès de nos distributeurs sur place
- Am 07-06-2021 gestrichen. Evtl. Verfügbarkeit bitte bei unseren Händlern prüfen
- Eliminado en fecha 07-06-2021. Verificar la disponibilidad a través de nuestros distribuidores locales

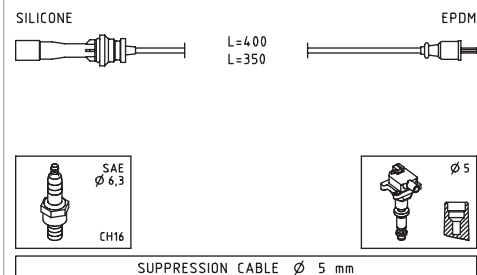

MAZDA			
323 VIII F 1.5 16V	ZL05, ZL06	09/98 ⇒ 01/01	
323 VIII F 1.6	ZM	01/01 ⇒ 05/04	
323 VIII S 1.5 16V	ZL05, ZL06	09/98 ⇒ 01/01	
323 VIII S 1.6	ZM	01/01 ⇒ 05/04	
PROTEGE 1.6i [USA]	--	06/98 ⇒	

KW 360 730

07

IGNITION CABLE SETS

Adatt./Suitable:

CHEVROLET
96342284DAEWOO
96342284GENERAL MOTORS
96 342 284

03 Supplied until depletion

- Fornibile fino ad esaurimento delle scorte
- Fourni jusqu'à épuisement du stock
- Lieferbar solange vorrat reicht
- Suministrado hasta el stock termina

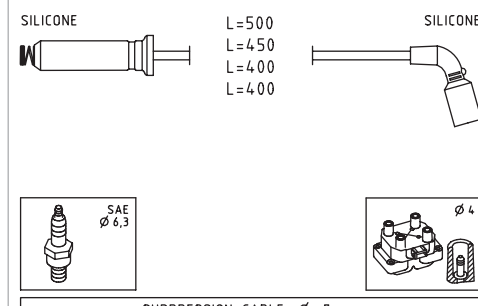

CHEVROLET

VIVANT 1.8	F18S2	05/00 ⇒	
------------	-------	---------	--

DAEWOO

REZZO 1.8	--, A18DMS, F18D2	09/00 ⇒	
-----------	-------------------	---------	--

TACUMA 1.8	F18S2	09/00 ⇒	
------------	-------	---------	--

KW 360 731

07

IGNITION CABLE SETS

Adatt./Suitable:

BOSCH
0 986 356 980CHEVROLET
96305387DAEWOO
96305387HITACHI
134239

03 Supplied until depletion

- Fornibile fino ad esaurimento delle scorte
- Fourni jusqu'à épuisement du stock
- Lieferbar solange vorrat reicht
- Suministrado hasta el stock termina

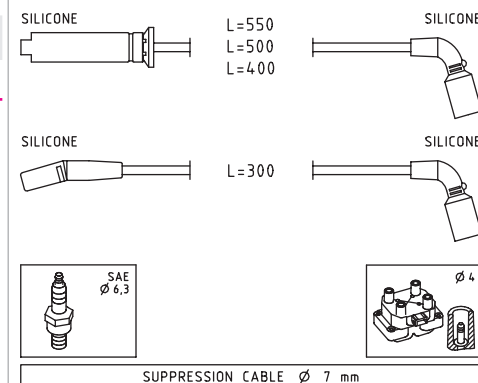

CHEVROLET

AVEO I 1.4	F14S3	03/05 ⇒	
------------	-------	---------	--

AVEO I 1.5	F15S3	01/05 ⇒	
------------	-------	---------	--

LANOS 1.3	--	01/97 ⇒	
-----------	----	---------	--

LANOS 1.5	A15SMS	11/05 ⇒	
-----------	--------	---------	--

DAEWOO

KALOS 1.4	F14S3	09/02 ⇒	
-----------	-------	---------	--

LANOS 1.3	A14SMS	05/97 ⇒	
-----------	--------	---------	--

LANOS 1.5	A15SMS	05/97 ⇒	
-----------	--------	---------	--

KW 360 732

07,5

IGNITION CABLE SETS

Adatt./Suitable:

BOSCH
0 986 357 277**DAIHATSU**
19901-87186-000
19901-87196-000
90048-66019-000⁰³ Supplied until depletion

- Fornibile fino ad esaurimento delle scorte
- Fourni jusqu'à épuisement du stock
- Lieferbar solange vorrat reicht
- Suministrado hasta el stock termina

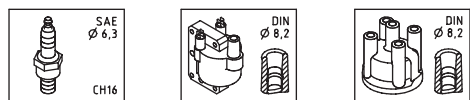
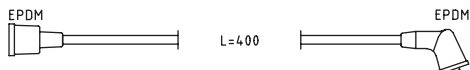
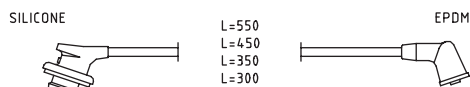
SUPPRESSION CABLE \varnothing 7 mm**DAIHATSU**

FEROZA 1.6 16V	HD-C	10/88 \Rightarrow 12/99
FEROZA 1.6 16V 4x4	HD-C	10/88 \Rightarrow 12/99
FEROZA 1.6 i 16V	HD-E	10/88 \Rightarrow 12/99
FEROZA 1.6 i 16V 4x4	HD-E	10/88 \Rightarrow 12/99
FEROZA 1.6i	--	01/90 \Rightarrow
ROCKY 2.0i [USA]	--	01/89 \Rightarrow
SPORTRACK 1.6 16v 4x4	HD-C	10/88 \Rightarrow 08/93

KW 360 738

07,5

IGNITION CABLE SETS

Adatt./Suitable:

BOSCH
0 986 357 149**HITACHI**
134298**MAZDA**
Z501-18-140
Z501-18-140A⁰⁰ Eliminated on 22-02-2022. Please verify the availability through our local distributors

- Eliminato il 22-02-2022. Verificare la disponibilità presso i nostri distributori
- Éliminé le 22-02-2022. Vérifier la disponibilité auprès de nos distributeurs sur place
- Am 22-02-2022 gestrichen. Evtl. Verfügbarkeit bitte bei unseren Händlern prüfen
- Eliminado en fecha 22-02-2022. Verificar la disponibilidad a través de nuestros distribuidores locales

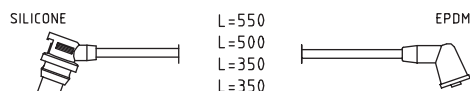
SUPPRESSION CABLE \varnothing 7 mm**MAZDA**

323 VII C 1.5 16V	Z5-DE	08/94 \Rightarrow 09/98
323 VII 1.5 16V	Z5-DE	07/94 \Rightarrow 09/98
323 VII P 1.5 16V	Z5-DE	10/96 \Rightarrow 09/98
323 VIII S 1.5 16V	Z5-DE	08/94 \Rightarrow 09/98

KW 360 739

08

IGNITION CABLE SETS

Adatt./Suitable:

HITACHI
134273**MAZDA**
FSD7-18-140B⁰³ Supplied until depletion

- Fornibile fino ad esaurimento delle scorte
- Fourni jusqu'à épuisement du stock
- Lieferbar solange vorrat reicht
- Suministrado hasta el stock termina

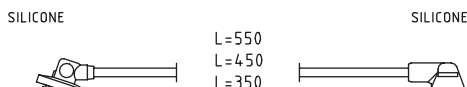
SUPPRESSION CABLE \varnothing 7 mm**MAZDA**

626 VI 1.8	FP, FP9A, FPY3	05/97 \Rightarrow 10/02
626 VI 2.0	FS, FS2C	05/97 \Rightarrow 10/02
626 VI 2.0 H.P.	FS2C	02/98 \Rightarrow 10/02

KW 360 740

07,5

IGNITION CABLE SETS

Adatt./Suitable:

MAZDAFP39-18-140
FP39-18-140A⁰³ Supplied until depletion

- Fornibile fino ad esaurimento delle scorte
- Fourni jusqu'à épuisement du stock
- Lieferbar solange vorrat reicht
- Suministrado hasta el stock termina

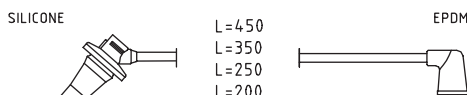
SUPPRESSION CABLE \varnothing 7 mm**MAZDA**

323 VIII F 1.9 16V	FP, FP55	09/98 \Rightarrow 01/01
323 VIII S 1.9 16V	FP, FP55	09/98 \Rightarrow 05/04
PROTEGE 1.8i [USA]	--	06/98 \Rightarrow

KW 360 741

07

IGNITION CABLE SETS

Adatt./Suitable:

BOSCH
0 986 357 195**MAZDA**
B33G-18-140A
B33G-18-140B⁰⁰ Eliminated on 25-11-2020. Please verify the availability through our local distributors

- Eliminato il 25-11-2020. Verificare la disponibilità presso i nostri distributori
- Éliminé le 25-11-2020. Vérifier la disponibilité auprès de nos distributeurs sur place
- Am 25-11-2020 gestrichen. Evtl. Verfügbarkeit bitte bei unseren Händlern prüfen
- Eliminado en fecha 25-11-2020. Verificar la disponibilidad a través de nuestros distribuidores locales

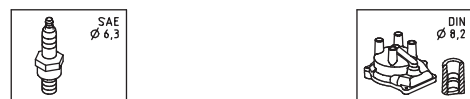
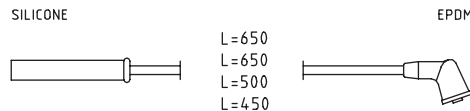
SUPPRESSION CABLE \varnothing 7 mm**MAZDA**

323 VIII F 1.4	B3(16V)	01/01 \Rightarrow 05/04
323 VIII F 1.4 16V	B3ME	09/98 \Rightarrow 01/01
323 VIII S 1.3	B3(16V)	01/01 \Rightarrow 05/04
323 VIII S 1.3 16V	B3ME	09/98 \Rightarrow 01/01

KW 360 745

07,5

IGNITION CABLE SETS

Adatt./Suitable:

BOSCH
0 986 356 742**HITACHI**
134286**MAZDA**
B61P-18-140C
B6MC-18-140B
BPE8-18-140
BPE8-18-140A⁰³ Supplied until depletion

- Fornibile fino ad esaurimento delle scorte
- Fourni jusqu'à épuisement du stock
- Lieferbar solange vorrat reicht
- Suministrado hasta el stock termina

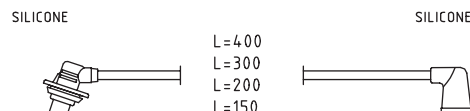
SUPPRESSION CABLE \varnothing 7 mm**MAZDA**

MIATA 1.6i 16v	CE16i	03/90 \Rightarrow 08/93
MIATA 1.6i 16v GT	CE16T	11/90 \Rightarrow 08/93
MIATA 1.8i [USA]	--	01/94 \Rightarrow
MX-5 I 1.6	8AN1, B64F	05/90 \Rightarrow 04/98
MX-5 I 1.8	BPF1	01/93 \Rightarrow 04/98
MX-5 II 1.6 16V	B6D	05/98 \Rightarrow 10/05
MX-5 II 1.8	BP6j, BPD	08/02 \Rightarrow 10/05
MX-5 II 1.8 16V	BPD, BP-ZE	11/00 \Rightarrow 10/05

KW 360 753

07

IGNITION CABLE SETS

Adatt./Suitable:

BOSCH

0 986 357 157

MAGNETI MARELLI

941285120871

MITSUBISHI

MD332343

03 Supplied until depletion

- Fornibile fino ad esaurimento delle scorte
- Fourni jusqu'à épuisement du stock
- Lieferbar solange vorrat reicht
- Suministrado hasta el stock termina

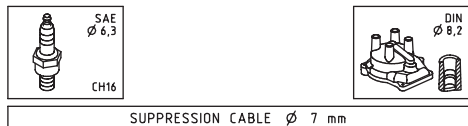
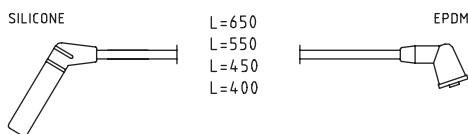

MITSUBISHI

COLT V 1.5	301353C	09/95 ⇒ 09/03
COLT V 1.5 16V	301353C	10/99 ⇒ 09/03
COLT V 1300 GL, GLX	4G13(12V)	05/96 ⇒ 06/00
LANCER VII 1.3 12V	4G13(12V)	12/95 ⇒ 08/03
LANCER VII 1.5	301353C	06/00 ⇒ 08/03
LANCER VII 1.5 16V	301353C	10/99 ⇒ 08/03

KW 360 760

09

IGNITION CABLE SETS

Adatt./Suitable:

BOSCH

0 986 356 966

MAZDA

0000-18-135A

88GP-18-140

88GP-18-140A

88GP-18-140B

88GP-18-140C

K834-18-140A

KF33-18-140C

KF33-18-140D

KF33-18-140E

KL01-18-140C

KL47-18-140B

KL47-18-140C

00 Eliminated on 22-02-2022. Please verify the availability through our local distributors

- Eliminato il 22-02-2022. Verificare la disponibilità presso i nostri distributori
- Éliminé le 22-02-2022. Vérifier la disponibilité auprès de nos distributeurs sur place
- Am 22-02-2022 gestrichen. Evtl. Verfügbarkeit bitte bei unseren Händlern prüfen
- Eliminado en fecha 22-02-2022. Verificar la disponibilidad a través de nuestros distribuidores locales

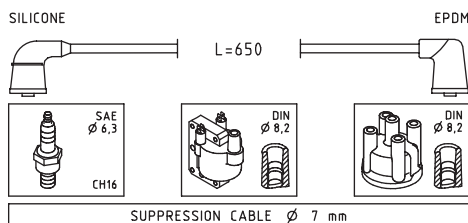
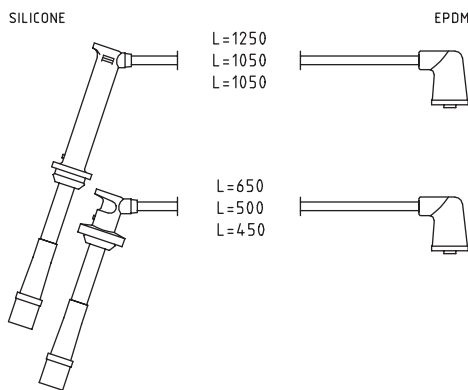

MAZDA

323 VII 2.0 24V	KF	08/94 ⇒ 09/98
626 V 2.5 24V	KL	01/92 ⇒ 04/97
MX-3 1.8 iV6	K838, K8-ZE	01/94 ⇒ 10/97
MX-6 2.5 24V	KL	02/92 ⇒ 09/97
MX-6 2.5 i 24V	KL	08/94 ⇒ 02/97
XED05 6 2.0 V6	KF1	01/92 ⇒ 10/99

MAZDA

XED05 9 2.0	KF	08/98 ⇒ 08/00
XED05 9 2.0 24V	KF	08/93 ⇒ 01/00
XED05 9 2.5 24V	KL	07/93 ⇒ 07/00

KW 360 764

07

IGNITION CABLE SETS

Adatt./Suitable:

CHRYSLER

MD338 624

HITACHI

134613

MITSUBISHI

MD334043

MD336862

MD338624

00 Eliminated on 07-06-2021. Please verify the availability through our local distributors

- Eliminato il 07-06-2021. Verificare la disponibilità presso i nostri distributori
- Éliminé le 07-06-2021. Vérifier la disponibilité auprès de nos distributeurs sur place
- Am 07-06-2021 gestrichen. Evtl. Verfügbarkeit bitte bei unseren Händlern prüfen
- Eliminado en fecha 07-06-2021. Verificar la disponibilidad a través de nuestros distribuidores locales

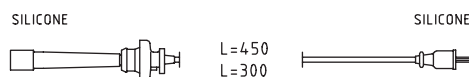

CHRYSLER

SEBRING II 2.4	EDZ, EY7	10/00 ⇒
MITSUBISHI		
CARISMA 1.6	4G92(SOHC16V)	09/00 ⇒ 06/06
CARISMA 1.8	4G93(SOHC16V)	07/95 ⇒ 09/97
COLT V 1600	4G92(SOHC16V)	09/00 ⇒ 09/03
COLT V 1600 GLX	4G92(SOHC16V)	05/96 ⇒ 09/00
GRANDIS 2.0	4G63(SOHC8V)	04/04 ⇒
SPACE WAGON 2.0 16V	4G63(DOHC16V)	06/00 ⇒
SPACE WAGON 2.4 GDI	4G64(GDI)	07/98 ⇒
SPACE WAGON 2.4 GDI GLX	4G64(GDI)	08/00 ⇒ 05/03
GALANT VIII 2.0	4G63(SOHC16V)	09/00 ⇒ 10/04
LANCER VII 1.6 16V	4G92(SOHC16V)	12/95 ⇒ 08/03
MONTERO IO 1.8 GDI	4G93(SOHC16V)	08/99 ⇒
PAJERO PININ 1.8	4G93(SOHC16V)	11/01 ⇒ 06/07
PAJERO PININ 1.8 GDI	4G93(GDI)	10/99 ⇒ 10/01
SPACE RUNNER 2.0	→, 4G63(SOHC16V)	01/92 ⇒ 08/02
SPACE STAR 1.8 GDI	4G93(GDI)	06/98 ⇒ 12/04
SPACE STAR 1.8 MPI	4G93(DOHC16V)	10/02 ⇒ 12/04

KW 360 767

07

IGNITION CABLE SETS

Adatt./Suitable:

03 Supplied until depletion

- Fornibile fino ad esaurimento delle scorte
- Fourni jusqu'à épuisement du stock
- Lieferbar solange vorrat reicht
- Suministrado hasta el stock termina

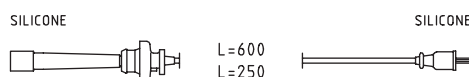

MAZDA

323 VIII F 1.8 Astina	BP(DOHC)	09/98 ⇒ 05/04
323 VIII F 2.0	FS, FS7E, FS7G	02/00 ⇒ 09/04
323 VIII S 1.8 Protege	BP(DOHC)	05/98 ⇒ 05/04

MAZDA

323 VIII S 2.0	FS, FS7E, FS7G	02/00 ⇒ 05/04
MPV II 2.0	FS-DS	09/99 ⇒ 08/00
PREMACY 1.9	FP	07/99 ⇒ 03/05

KW 360 789

07

IGNITION CABLE SETS

Adatt./Suitable:

FORD

1 960 394

1 961 207

NISSAN

22440-1S700

22440-1S710

22440-8B000

00 Eliminated on 27-09-2021. Please verify the availability through our local distributors

- Eliminato il 27-09-2021. Verificare la disponibilità presso i nostri distributori
- Éliminé le 27-09-2021. Vérifier la disponibilité auprès de nos distributeurs sur place
- Am 27-09-2021 gestrichen. Evtl. Verfügbarkeit bitte bei unseren Händlern prüfen
- Eliminado en fecha 27-09-2021. Verificar la disponibilidad a través de nuestros distribuidores locales

03 Supplied until depletion

- Fornibile fino ad esaurimento delle scorte
- Fourni jusqu'à épuisement du stock
- Lieferbar solange vorrat reicht
- Suministrado hasta el stock termina

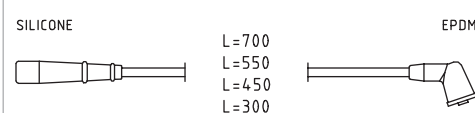

FORD

MAVERICK 2.4 i	KA24	09/96 ⇒ 04/98
NISSAN		
PICK UP II 2.4 i	KA24E	02/98 ⇒ 04/05
PICK UP II 2.4 i 4WD	KA24E	02/98 ⇒ 04/05
TERRANO II 2.4 4WD	KA24E	05/96 ⇒ 09/07
TERRANO II 2.4 i 12V 4WD	KA24E	02/93 ⇒ 12/97

KW 360 792

07,5

IGNITION CABLE SETS

Adatt./Suitable:

TOYOTA
90919-22387

00 Eliminated on 22-02-2022. Please verify the availability through our local distributors

- Eliminato il 22-02-2022. Verificare la disponibilità presso i nostri distributori
- Éliminé le 22-02-2022. Vérifier la disponibilité auprès de nos distributeurs sur place
- Am 22-02-2022 gestrichen. Evtl. Verfügbarkeit bitte bei unseren Händlern prüfen
- Eliminado en fecha 22-02-2022. Verificar la disponibilidad a través de nuestros distribuidores locales

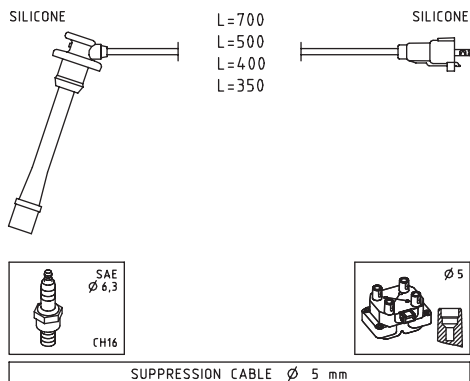

TOYOTA		
4 RUNNER 2.7 16V	3RZ-FE	11/95 ⇨ 08/00
4 RUNNER 2.7 i	3RZ-FE	11/95 ⇨ 03/96
COASTER 2.7	3RZFE	07/99 ⇨
DYNA 200 2.7	3RZ-FE	06/95 ⇨ 07/01
HIACE IV 2.7	3RZ-FE	04/98 ⇨ 12/06
HIACE IV 2.7 4WD	3RZ-FE	04/98 ⇨ 08/06
HILUX VI 2.4 i 4WD	2RZ-FE	08/97 ⇨ 10/05
LAND CRUISER 2.7	3RZ-FE	09/02 ⇨ 08/04
T100 2.7 i [USA]	3RZFE	10/93 ⇨ 07/98
TACOMA 2.4 i [USA]	2RZFE	01/95 ⇨
TACOMA 2.7 i [USA]	3RZFE	02/98 ⇨

KW 360 793

07,5

IGNITION CABLE SETS

Adatt./Suitable:

BOSCH
0 986 AM0 035
HOLDEN
9091922370TOYOTA
90919-22369
90919-22370

00 Eliminated on 16-12-2020. Please verify the availability through our local distributors

- Eliminato il 16-12-2020. Verificare la disponibilità presso i nostri distributori
- Éliminé le 16-12-2020. Vérifier la disponibilité auprès de nos distributeurs sur place
- Am 16-12-2020 gestrichen. Evtl. Verfügbarkeit bitte bei unseren Händlern prüfen
- Eliminado en fecha 16-12-2020. Verificar la disponibilidad a través de nuestros distribuidores locales

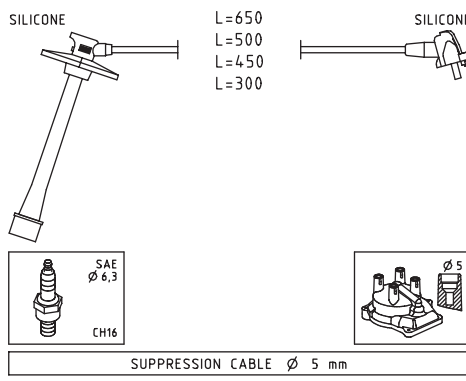

HOLDEN		
APOLLO 2.2 i	08GR-FXS	03/93 ⇨ 05/97
TOYOTA		
CAMRY 2.2	5S-FE	06/91 ⇨ 07/96
CARINA E 2.0	3S-FE	01/93 ⇨ 09/97
CARINA E 2.0 GLI	3S-FE	04/92 ⇨ 09/97
CARINA E 2.0 GTi	3S-GE	04/92 ⇨ 12/95
CARINA E 2.0 GTi 16V	3S-GE	03/94 ⇨ 09/97
CARINA E 2.0 i	3S-FE	12/92 ⇨ 09/97
CELICA V 2.2	5S-FE	10/89 ⇨ 12/94
FUNCRUISER 2.0 i 16V 4WD	3SFE	04/94 ⇨
MR 2 II 2.2 16V	5S-FE	01/90 ⇨ 06/95
CELICA VI 2.2 GT	5S-FE	11/93 ⇨ 08/99
RAV 4 I 2.0	3S-FE	06/97 ⇨ 09/99
RAV 4 I 2.0 4WD	3S-FE	01/94 ⇨ 06/00

KW 360 813

07,5

IGNITION CABLE SETS

Adatt./Suitable:

03 Supplied until depletion

- Fornibile fino ad esaurimento delle scorte
- Fourni jusqu'à épuisement du stock
- Lieferbar solange vorrat reicht
- Suministrado hasta el stock termina

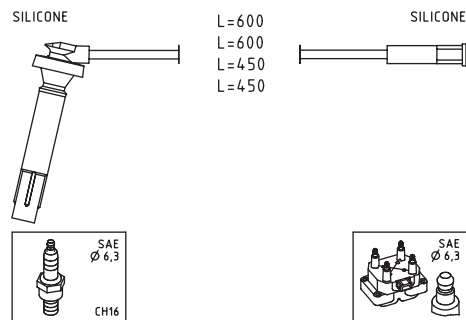

SUBARU		
IMPREZA I 1.8 i	EJ181	08/92 ⇨ 12/00
IMPREZA I 2.0	EJ201	09/98 ⇨ 09/00
IMPREZA I 2.0 i	EJ201	09/98 ⇨ 09/00
IMPREZA I 2.0 i 16V AWD	EJ20, EJ20E	06/98 ⇨ 12/00
IMPREZA I 2.0 i AWD	EJ201	06/98 ⇨ 12/00
IMPREZA I 2.2 i	EJ22E, EJ22EZ	11/93 ⇨ 08/98
IMPREZA I 2.5 i	EJ253	11/93 ⇨ 08/98

SUBARU

IMPREZA II 2.0 AWD	EJ20	12/00 ⇨ 12/07
IMPREZA II 2.0 i AWD	EJ201	12/00 ⇨ 06/09
IMPREZA II 2.5 AWD	EJ25	03/01 ⇨ 09/05
IMPREZA II 2.5 i AWD	EJ251	12/02 ⇨ 09/05
FORESTER II 2.0 AWD	EJ20, EJ201	06/02 ⇨ 05/05
FORESTER II 2.5	EJ251	02/02 ⇨
LEGACY III 2.0	EJ201	12/98 ⇨ 08/03
LEGACY III 2.0 AWD	EJ201	12/98 ⇨ 08/03
LEGACY III 2.5	EJ251	10/98 ⇨ 08/03
LEGACY III 2.5 AWD	EJ25	10/98 ⇨ 08/03
OUTBACK II 2.5 AWD	EJ25	10/00 ⇨ 08/03
FORESTER I 2.0 AWD	EJ202	08/97 ⇨ 09/02

KW 360 817

07,5

IGNITION CABLE SETS

Adatt./Suitable:

00 Eliminated on 16-12-2019. Please verify the availability through our local distributors

- Eliminato il 16-12-2019. Verificare la disponibilità presso i nostri distributori
- Éliminé le 16-12-2019. Vérifier la disponibilité auprès de nos distributeurs sur place
- Am 16-12-2019 gestrichen. Evtl. Verfügbarkeit bitte bei unseren Händlern prüfen
- Eliminado en fecha 16-12-2019. Verificar la disponibilidad a través de nuestros distribuidores locales

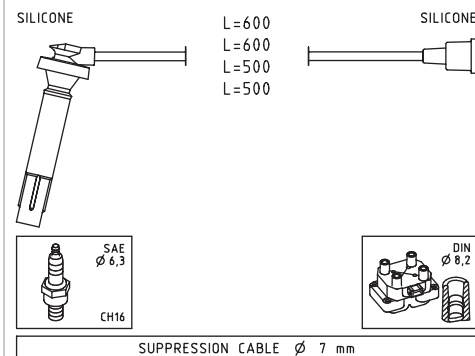

SUBARU

FORESTER I 2.0 AWD	EJ202	08/97 ⇨ 09/02
--------------------	-------	---------------

KW 360 819

07,5

IGNITION CABLE SETS

Adatt./Suitable:

03 Supplied until depletion

- Fornibile fino ad esaurimento delle scorte
- Fourni jusqu'à épuisement du stock
- Lieferbar solange vorrat reicht
- Suministrado hasta el stock termina

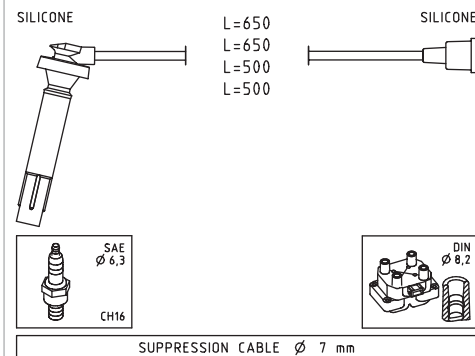

SUBARU

IMPREZA I 1.6	EJ161	09/98 ⇨ 09/00
IMPREZA I 1.6 i	EJ161	06/98 ⇨ 12/00
IMPREZA I 1.6 i AWD	EJ161	06/98 ⇨ 12/00
IMPREZA II 1.6 AWD	8F140GA, EJ161	12/00 ⇨ 06/09

KW 360 823

07

IGNITION CABLE SETS

Adatt./Suitable:

TOYOTA
90919-22209
90919-22210

03 Supplied until depletion

- Fornibile fino ad esaurimento delle scorte
- Fourni jusqu'à épuisement du stock
- Lieferbar solange vorrat reicht
- Suministrado hasta el stock termina

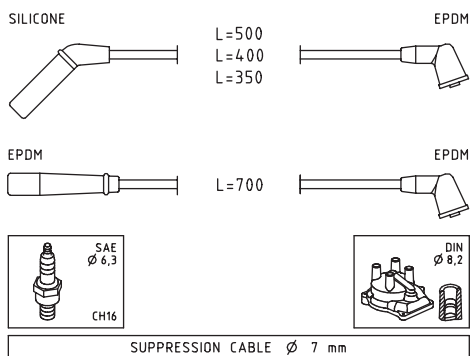

SUPPRESSION CABLE Ø 7 mm

TOYOTA

COROLLA VI 1.3	2E	05/87 ⇒ 06/92
COROLLA VI 1.3 i	2E, 2E-E	08/87 ⇒ 06/92
STARLET 1.3 12V	2E, 2E-E	12/89 ⇒ 12/92
STARLET 1.3 12V Cat	2E-E	12/89 ⇒ 03/96
STARLET 1.3 XL	2E	12/89 ⇒ 12/91

KW 360 835

07,5

IGNITION CABLE SETS

Adatt./Suitable:

03 Supplied until depletion

- Fornibile fino ad esaurimento delle scorte
- Fourni jusqu'à épuisement du stock
- Lieferbar solange vorrat reicht
- Suministrado hasta el stock termina

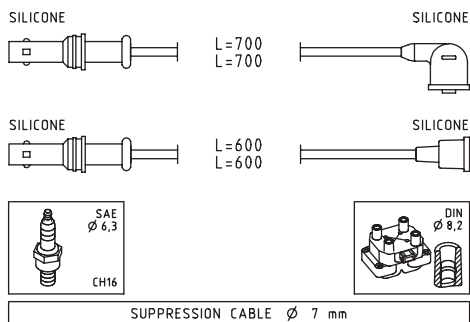

SUPPRESSION CABLE Ø 7 mm

SUBARU

IMPREZA I 1.6	EJ16E	01/93 ⇒ 12/00
IMPREZA I 1.6 i	8F140GA	08/92 ⇒ 12/00
IMPREZA I 1.6 i AWD	8F140GA	08/92 ⇒ 12/00
IMPREZA I 1.8	EJ18	01/93 ⇒ 10/95
IMPREZA I 1.8 i	EJ18E	11/95 ⇒ 06/96
IMPREZA I 1.8 i AWD	EJ18, EJ18E	08/92 ⇒ 12/00
LEGACY II 1.8 4WD	EJ18E	05/96 ⇒ 09/98
LEGACY II 2.0 i	EJ20EMPI	09/94 ⇒ 03/99
LEGACY II 2.0 i 4WD	EJ201, EJ20E	09/94 ⇒ 03/99
FORESTER I 2.0	EJ20J	08/97 ⇒ 09/02

KW 360 841

05

IGNITION CABLE SETS

Adatt./Suitable:

03 Supplied until depletion

- Fornibile fino ad esaurimento delle scorte
- Fourni jusqu'à épuisement du stock
- Lieferbar solange vorrat reicht
- Suministrado hasta el stock termina

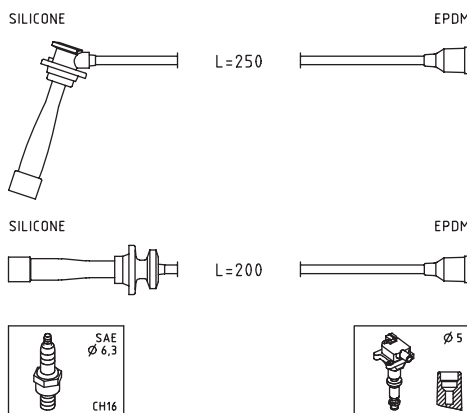

SUPPRESSION CABLE Ø 7 mm

KIA

CARENS I 1.8	TB	07/02 ⇒
CARENS I 1.8 i	T8	11/00 ⇒ 07/02
CLARUS 1.8 i 16V	T8	07/96 ⇒
SEPHIA I 1.5 i	B5	02/96 ⇒ 10/97
SEPHIA I 1.8 i 16V	--, OK24N, OK26Y	01/95 ⇒ 10/97
SHUMA I 1.5	OK280	03/96 ⇒ 12/98
SHUMA I 1.5 i 16V	BFD, ZY-VE	10/97 ⇒ 10/01
SHUMA I 1.8 i 16V	T8	10/97 ⇒ 03/01
SHUMA II 1.8	T8	05/01 ⇒ 08/04
SPECTRA 1.5 i	--	09/97 ⇒
SPECTRA 1.5 i 16V	--	09/97 ⇒
SPECTRA 1.8 i 16V	--	09/97 ⇒
SEPHIA 1.5 i 16V	--	09/97 ⇒
SEPHIA 1.8 i 16V	--	09/97 ⇒

KW 360 851

07

IGNITION CABLE SETS

Adatt./Suitable:

KIA
OK30A-18-140A
OK30B-18140
27401-2X000

03 Supplied until depletion

- Fornibile fino ad esaurimento delle scorte
- Fourni jusqu'à épuisement du stock
- Lieferbar solange vorrat reicht
- Suministrado hasta el stock termina

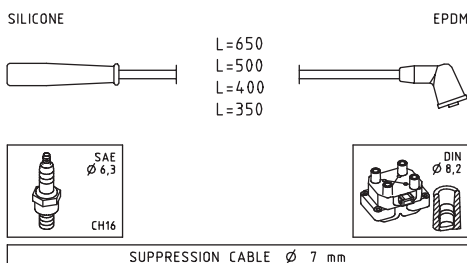

SUPPRESSION CABLE Ø 7 mm

KIA

RIO I 1.3	A3E	08/00 ⇒ 02/05
-----------	-----	---------------

KW 360 856

07,5

IGNITION CABLE SETS

Adatt./Suitable:

BOSCH
0 986 AMO 063
TOYOTA
90919-22386
90919-22400

03 Supplied until depletion

- Fornibile fino ad esaurimento delle scorte
- Fourni jusqu'à épuisement du stock
- Lieferbar solange vorrat reicht
- Suministrado hasta el stock termina

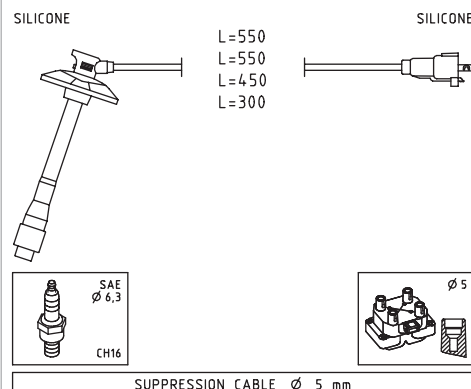

SUPPRESSION CABLE Ø 5 mm

TOYOTA

AVENSIS I 2.0	3S-FE	09/97 ⇒ 10/00
CAMRY 2.2	5S-FE, 5S-FNE	08/96 ⇒
CAMRY SOLARA I 2.2	5S-FE	06/98 ⇒ 11/02
FUNCRUISER 2.0 i 16V 4WD	3SFE	04/94 ⇒
PICNIC I 2.0	3S-FE	06/00 ⇒ 12/01
PICNIC I 2.0 16V	3S-FE	08/96 ⇒ 09/00
RAV 4 I 2.0	3S-FE	06/97 ⇒ 09/99
RAV 4 I 2.0 4WD	3S-FE	01/94 ⇒ 06/00

KW 360 879

07,5

IGNITION CABLE SETS

Adatt./Suitable:

TOYOTA
90998-99001
90998-99002

00 Eliminated on 16-09-2019. Please verify the availability through our local distributors

- Eliminato il 16-09-2019. Verificare la disponibilità presso i nostri distributori
- Éliminé le 16-09-2019. Vérifier la disponibilité auprès de nos distributeurs sur place
- Am 16-09-2019 gestrichen. Evtl. Verfügbarkeit bitte bei unseren Händlern prüfen
- Eliminado en fecha 16-09-2019. Verificar la disponibilidad a través de nuestros distribuidores locales

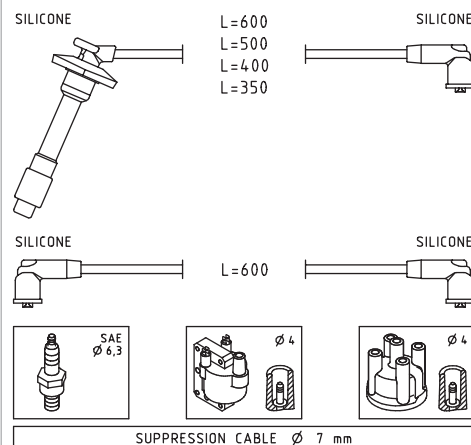

SUPPRESSION CABLE Ø 7 mm

TOYOTA

AVENSIS I 1.6	4A-FE	09/97 ⇒ 10/00
CARINA E 1.6	4A-FE	04/92 ⇒ 09/97
CARINA E 1.6 GLV	4A-FE	12/94 ⇒ 09/97
CARINA E 1.6 GLI	4A-FE	04/92 ⇒ 09/97
CARINA E 1.6 i	4A-FE	02/95 ⇒ 09/97
CARINA E 1.8	7A-FE	04/92 ⇒ 09/97
CARINA E 1.8 i	7A-FE	02/95 ⇒ 09/97

TOYOTA		
CARINA E 1.8 i 16V	7A-FE	01/95 ⇒ 09/97

KW **360 880**

07

IGNITION CABLE SETS

Adatt./Suitable:

BOSCH
0 986 357 259
HITACHI
134132
TOYOTA
90919-22395

- 03 Supplied until depletion**
- Fornibile fino ad esaurimento delle scorte
 - Fourni jusqu'à épuisement du stock
 - Lieferbar solange vorrat reicht
 - Suministrado hasta el stock termina

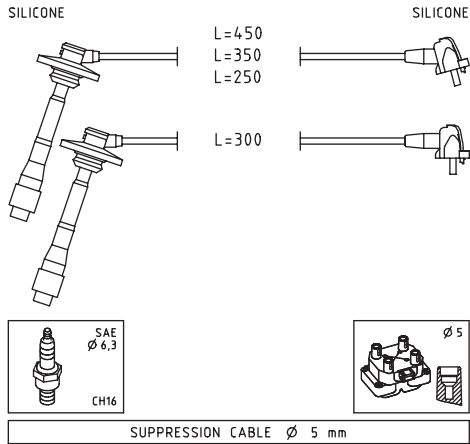

TOYOTA		
COROLLA VIII 1.4	4E-FE	04/97 ⇒ 02/00

KW **360 882**

07,5

IGNITION CABLE SETS

Adatt./Suitable:

BOSCH
0 986 357 272
MITSUBISHI
MD362276

- 00 Eliminated on 19-01-2022. Please verify the availability through our local distributors**
- Eliminato il 19-01-2022. Verificare la disponibilità presso i nostri distributori
 - Éliminé le 19-01-2022. Vérifier la disponibilité auprès de nos distributeurs sur place
 - Am 19-01-2022 gestrichen. Evtl. Verfügbarkeit bitte bei unseren Händlern prüfen
 - Eliminado en fecha 19-01-2022. Verificar la disponibilidad a través de nuestros distribuidores locales

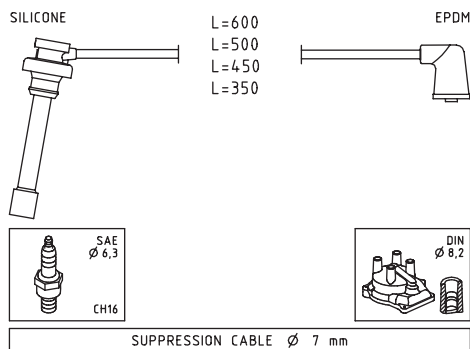

MITSUBISHI		
SPACE STAR 1.3 16V	4G13(16V)	09/00 ⇒ 12/04

KW **360 883**

07

IGNITION CABLE SETS

Adatt./Suitable:

BOSCH
0 986 357 273
HITACHI
134619
MITSUBISHI
MD365102

- 03 Supplied until depletion**
- Fornibile fino ad esaurimento delle scorte
 - Fourni jusqu'à épuisement du stock
 - Lieferbar solange vorrat reicht
 - Suministrado hasta el stock termina

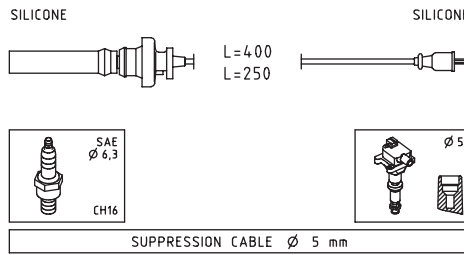

MITSUBISHI		
CARISMA 1.3 16V	4G13(16V)	09/00 ⇒ 10/04
COLT V 1.3	4G19	08/02 ⇒ 09/03
COLT V 1300	4G13(16V)	06/00 ⇒ 09/03
COLT V 1300 GL, GLX	4G13(12V)	05/96 ⇒ 06/00
LANCER VIII 1.3	4G13(16V)	09/03 ⇒ 12/13
LANCER VIII 1.6	4G18	09/03 ⇒ 12/13
SPACE STAR 1.3 16V	4G13(16V)	09/00 ⇒ 12/04
SPACE STAR 1.6 16V	4G18	01/01 ⇒ 12/04

KW **360 887**

07,5

IGNITION CABLE SETS

Adatt./Suitable:

- 03 Supplied until depletion**
- Fornibile fino ad esaurimento delle scorte
 - Fourni jusqu'à épuisement du stock
 - Lieferbar solange vorrat reicht
 - Suministrado hasta el stock termina

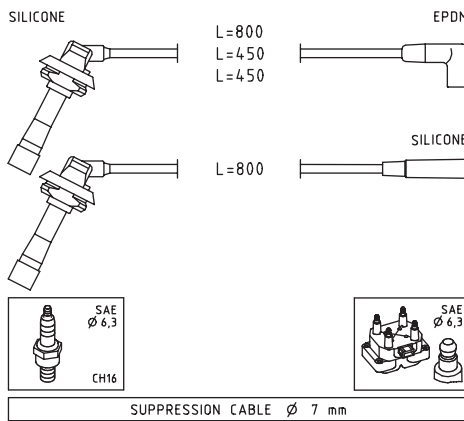

SUBARU		
IMPREZA I 2.0 Turbo GT AWD	EJ205	06/98 ⇒ 12/00
FORESTER I 2.0 S Turbo AWD	EJ20	06/98 ⇒ 04/01

KW **360 888**

07,5

IGNITION CABLE SETS

Adatt./Suitable:

BOSCH
0 986 356 731
HITACHI
134287
ROVER
GHT284
NGC000090

- 03 Supplied until depletion**
- Fornibile fino ad esaurimento delle scorte
 - Fourni jusqu'à épuisement du stock
 - Lieferbar solange vorrat reicht
 - Suministrado hasta el stock termina

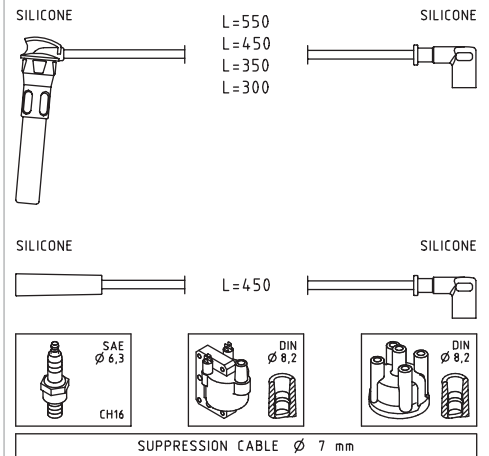

MG		
MGF 1.8 i 16V	18K4F	03/95 ⇒ 03/02
MG TF 115	16K4F	03/02 ⇒ 12/09
MG TF 120	18K4F	03/02 ⇒ 12/09
MG TF 135	18K4F	03/02 ⇒ 12/09
MG ZR 105	14K4F	06/01 ⇒ 04/05
MG ZR 120	18K4F	06/01 ⇒ 04/05

ROVER		
25 1.4 16V	14K4F, 14K4M	10/99 ⇒ 05/05
25 1.6 16V	16K4F	10/99 ⇒ 05/05
25 1.8 16V	18K4F	10/99 ⇒ 05/05
200 II 216	16K4F	01/96 ⇒ 12/97
200 II 216 1.6i 16V	16K4F	01/96 ⇒ 11/99
200 III 214 Si	14K4F	11/95 ⇒ 03/00
200 III 216 Si	16K4F	11/95 ⇒ 06/99
400 II 414 Si	14K4F	05/95 ⇒ 03/00
400 II 416 Si	16K4F, D16Y2	03/95 ⇒ 03/00
400 I 1.6 i	16K4F, D16A8	05/94 ⇒ 11/98
COUPE 1.6 16V	16K4F	03/96 ⇒ 11/99

KW **360 889**

07

IGNITION CABLE SETS

Adatt./Suitable:

ROVER
NGC000040

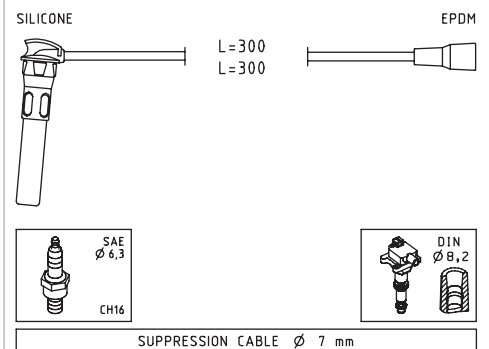

LAND ROVER		
FREELANDER 1.8 16V 4x4	18K4F	04/98 ⇒ 10/06
FREELANDER 1.8 i 16V 4x4	18K4F	02/98 ⇒ 10/06

MG		
MGF 1.8 i 16V	18K4F	03/95 ⇒ 03/02
MG TF 115	16K4F	03/02 ⇒ 12/09
MG TF 120	18K4F	03/02 ⇒ 12/09
MG TF 135	18K4F	03/02 ⇒ 12/09
MG ZR 105	14K4F	06/01 ⇒ 04/05

360 900

MG		
MG ZR 120	18K4F	06/01 ⇒ 04/05
MG ZS 120	18K4F	07/01 ⇒ 10/05
ROVER		
25 1.4 16V	14K4F, 14K4M	10/99 ⇒ 05/05
25 1.6 16V	16K4F	10/99 ⇒ 05/05
25 1.8 16V	18K4F	10/99 ⇒ 05/05
45 1.4	14K4F	02/00 ⇒ 05/05
45 1.6	16K4F	02/00 ⇒ 05/05
45 1.8	18K4F	02/00 ⇒ 05/05
75 1.8	K1.8	02/99 ⇒ 05/05
75 1.8 Turbo	--	05/03 ⇒ 05/05
200 III 214 Si	14K4F	11/95 ⇒ 03/00
200 III 216 Si	16K4F	11/95 ⇒ 06/99

KW 360 900

07,5

IGNITION CABLE SETS

Adatt./Suitable:

⁰³ Supplied until depletion

- Fornibile fino ad esaurimento delle scorte
- Fourni jusqu'à épuisement du stock
- Lieferbar solange vorrat reicht
- Suministrado hasta el stock termina

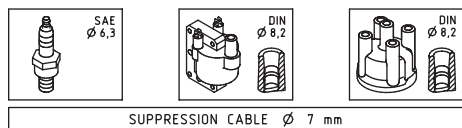
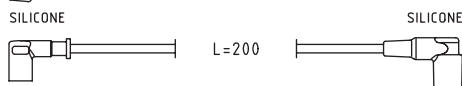
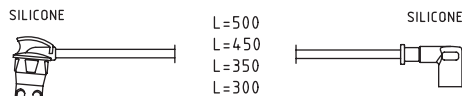

LAND ROVER

FREELANDER 1.8 16V 4x4	18K4F	04/98 ⇒ 10/06
FREELANDER 1.8 i 16V 4x4	18K4F	02/98 ⇒ 10/06

KW 360 904

07,5

IGNITION CABLE SETS

Adatt./Suitable:

GENERAL MOTORS

09 117 892
09 117 893
09 117 894
09 117 895
93 176 701

⁰³ Supplied until depletion

- Fornibile fino ad esaurimento delle scorte
- Fourni jusqu'à épuisement du stock
- Lieferbar solange vorrat reicht
- Suministrado hasta el stock termina

OPEL

12 82 163
12 82 164
12 82 165
12 82 166
16 12 657

¹⁸⁰ with marten protection

- con protezione contro roditori
- avec protection anti-mustélidés
- mit Marderschutz
- con protección contra martas

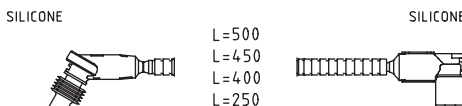

OPEL

ASTRA G 1.6	X16SZR, Z16SE	09/00 ⇒ 04/05
COMBO B 1.4	C14SE, X14SZ	07/94 ⇒ 10/01

OPEL

COMBO C 1.6	Z16SE	10/01 ⇒
CORSA B 1.4	C14SE	04/93 ⇒ 08/94
CORSA B 1.4 i	X14SZ	03/93 ⇒ 09/00
CORSA B 1.4 Si	C14SE	03/93 ⇒ 09/00
CORSA C 1.6	Z16SE	09/00 ⇒
MERIVA A 1.6	Z16SE	05/03 ⇒ 05/10
VECTRA B 1.6 i	X16SZR	10/95 ⇒ 07/03

VAUXHALL

ASTRA IV 1.6	X16SZR, Z16SE	03/98 ⇒ 05/05
ASTRAVAN II 1.6 i	X16SZR, Z16SE	09/00 ⇒ 08/06
COMBO B 1.4	C14SE	07/94 ⇒ 10/01
COMBO C 1.6	Z16SE	09/01 ⇒ 11/11
CORSA B 1.4 i	X14SZ	03/93 ⇒ 09/00
CORSA B 1.4 i S	C14SE	03/93 ⇒ 09/00
MERIVA I 1.6 i	Z16SE	01/03 ⇒ 06/10
VECTRA B 1.6 i	X16SZR	08/95 ⇒ 03/02

KW 360 914

07

IGNITION CABLE SETS

Adatt./Suitable:

BOSCH

0 986 357 153

ROVER

GHT287

NGC000060

⁰³ Supplied until depletion

- Fornibile fino ad esaurimento delle scorte
- Fourni jusqu'à épuisement du stock
- Lieferbar solange vorrat reicht
- Suministrado hasta el stock termina

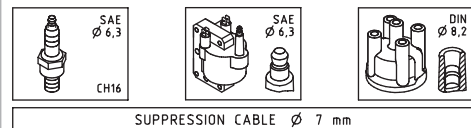
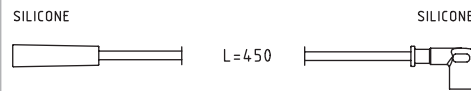
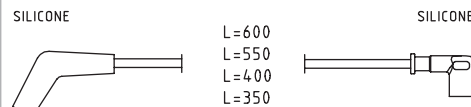

ROVER

200 III 211	11K2D	01/98 ⇒ 03/00
200 III 214 i	14K2F	11/95 ⇒ 03/00

KW 360 921

07,5

IGNITION CABLE SETS

Adatt./Suitable:

⁰⁰ Eliminated on 18-11-2019. Please verify the availability through our local distributors

- Eliminato il 18-11-2019. Verificare la disponibilità presso i nostri distributori
- Éliminé le 18-11-2019. Vérifier la disponibilité auprès de nos distributeurs sur place
- Am 18-11-2019 gestrichen. Evtl. Verfügbarkeit bitte bei unseren Händlern prüfen
- Eliminado en fecha 18-11-2019. Verificar la disponibilidad a través de nuestros distribuidores locales

¹⁸⁰ with marten protection

- con protezione contro roditori
- avec protection anti-mustélidés
- mit Marderschutz
- con protección contra martas

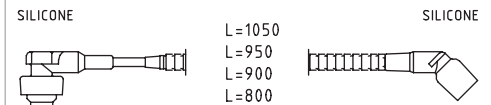

BMW

3 III 318 is	M42B18(18451), M44B19(19451)	01/92 ⇒ 04/99
3 III 318 ti	M42B18(18451), M44B19(19451)	09/94 ⇒ 08/99
Z3 1.9 i	M44B19(19451)	11/95 ⇒ 03/99

KW 360 932

07

IGNITION CABLE SETS

Adatt./Suitable:

⁰³ Supplied until depletion

- Fornibile fino ad esaurimento delle scorte
- Fourni jusqu'à épuisement du stock
- Lieferbar solange vorrat reicht
- Suministrado hasta el stock termina

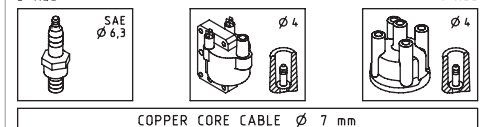
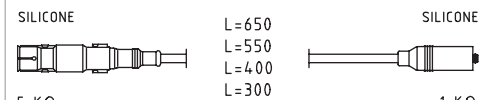

SEAT

CORDOBA I 1.6 i	AFT	07/96 ⇒ 12/02
IBIZA II 1.6 i	AFT	04/96 ⇒ 02/02

VW

GOLF IV 1.6	AFT, AKS	06/98 ⇒ 06/02
POLO III 1.6	AFT	05/97 ⇒ 09/01
POLO III 100 1.6	AFT	12/95 ⇒ 09/01
PASSAT III 1.6	AFT	07/94 ⇒ 08/96

KW 360 933

07

IGNITION CABLE SETS

Adatt./Suitable:

00 Eliminated on 13-09-2021. Please verify the availability through our local distributors

- Eliminato il 13-09-2021. Verificare la disponibilità presso i nostri distributori
- Éliminé le 13-09-2021. Vérifier la disponibilité auprès de nos distributeurs sur place
- Am 13-09-2021 gestrichen. Evtl. Verfügbarkeit bitte bei unseren Händlern prüfen
- Eliminado en fecha 13-09-2021. Verificar la disponibilidad a través de nuestros distribuidores locales

03 Supplied until depletion

- Fornibile fino ad esaurimento delle scorte
- Fourni jusqu'à épuisement du stock
- Lieferbar solange vorrat reicht
- Suministrado hasta el stock termina

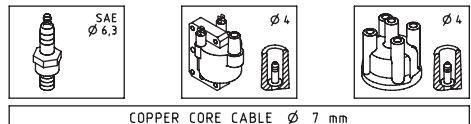
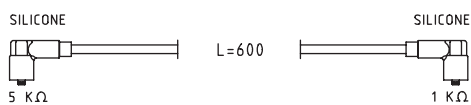
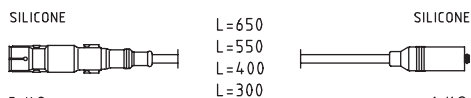

VW		
GOLF III 1.6	AFT	07/94 ⇒ 04/99
POLO III 1.6	AFT	05/97 ⇒ 09/01
POLO III 100 1.6	AFT	12/95 ⇒ 09/01
VENTO 1.6	AFT	10/94 ⇒ 09/98

KW 360 937

07

IGNITION CABLE SETS

Adatt./Suitable:

03 Supplied until depletion

- Fornibile fino ad esaurimento delle scorte
- Fourni jusqu'à épuisement du stock
- Lieferbar solange vorrat reicht
- Suministrado hasta el stock termina

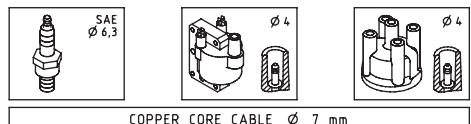
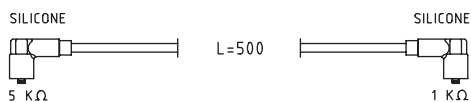
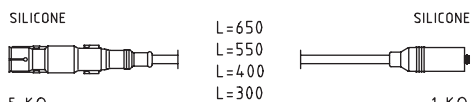

SEAT		
TOLEDO I 1.6 i	AFT	11/96 ⇒ 03/99

VW		
GOLF III 1.6	AFT, AKS	07/94 ⇒ 04/99
VENTO 1.6	AFT, AKS	10/94 ⇒ 02/99

KW 360 942

07

IGNITION CABLE SETS

Adatt./Suitable:

BOSCH
0 986 356 723
0 986 356 972

DAEWOO
NP1332

GENERAL MOTORS
90 297 423

OPEL
16 12 477

00 Eliminated on 14-04-2020. Please verify the availability through our local distributors

- Eliminato il 14-04-2020. Verificare la disponibilità presso i nostri distributori
- Éliminé le 14-04-2020. Vérifier la disponibilité auprès de nos distributeurs sur place
- Am 14-04-2020 gestrichen. Evtl. Verfügbarkeit bitte bei unseren Händlern prüfen
- Eliminado en fecha 14-04-2020. Verificar la disponibilidad a través de nuestros distribuidores locales

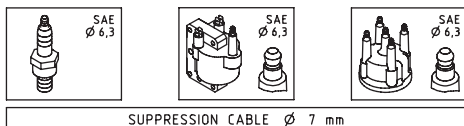
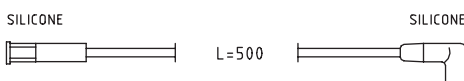
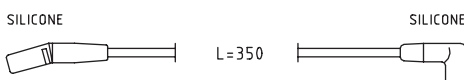
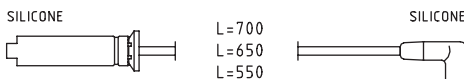

DAEWOO		
NEXIA 1.5	G15MF	02/95 ⇒ 08/97

OPEL		
ASCONA C 1.6 i	E16NZ	09/87 ⇒ 08/88
ASCONA C 1.6 i Cat	C16LZ, C16NZ	09/86 ⇒ 08/88
KADETT E 1.6 i	C16NZ	09/86 ⇒ 07/94
KADETT E 1.6 i Cat	C16LZ, C16NZ	09/86 ⇒ 02/93

KW 360 947

07

IGNITION CABLE SETS

Adatt./Suitable:

03 Supplied until depletion

- Fornibile fino ad esaurimento delle scorte
- Fourni jusqu'à épuisement du stock
- Lieferbar solange vorrat reicht
- Suministrado hasta el stock termina

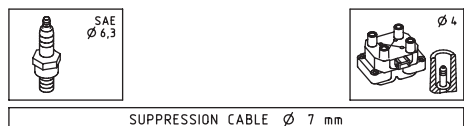
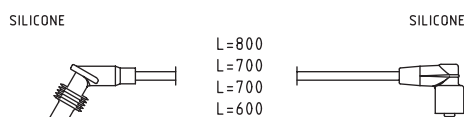

HOLDEN		
FRONTERA UT 2.0i	X20SE	10/95 ⇒ 03/99

OPEL		
FRONTERA A 2.0 i	X20SE	03/92 ⇒ 10/98

VAUXHALL		
FRONTERA A 2.0	X20SE	04/95 ⇒ 08/98
FRONTERA A 2.0 i	X20SE	03/92 ⇒ 10/98

KW 360 976

07,5

IGNITION CABLE SETS

Adatt./Suitable:

00 Eliminated on 22-02-2021. Please verify the availability through our local distributors

- Eliminato il 22-02-2021. Verificare la disponibilità presso i nostri distributori
- Éliminé le 22-02-2021. Vérifier la disponibilité auprès de nos distributeurs sur place
- Am 22-02-2021 gestrichen. Evtl. Verfügbarkeit bitte bei unseren Händlern prüfen
- Eliminado en fecha 22-02-2021. Verificar la disponibilidad a través de nuestros distribuidores locales

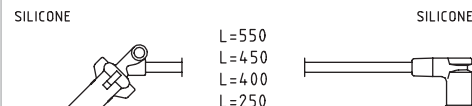

FORD		
GALAXY I 2.3 16V	ESSA, ESSB	09/01 ⇒ 05/06

KW 360 984

07

IGNITION CABLE SETS

Adatt./Suitable:

00 Eliminated on 22-02-2022. Please verify the availability through our local distributors

- Eliminato il 22-02-2022. Verificare la disponibilità presso i nostri distributori
- Éliminé le 22-02-2022. Vérifier la disponibilité auprès de nos distributeurs sur place
- Am 22-02-2022 gestrichen. Evtl. Verfügbarkeit bitte bei unseren Händlern prüfen
- Eliminado en fecha 22-02-2022. Verificar la disponibilidad a través de nuestros distribuidores locales

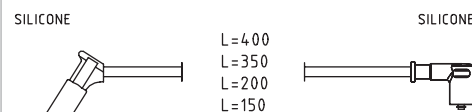

KW 360 990

 07,5

IGNITION CABLE SETS

Adatt./Suitable:

00 Eliminated on 22-02-2022. Please verify the availability through our local distributors

- Eliminato il 22-02-2022. Verificare la disponibilità presso i nostri distributori
- Éliminé le 22-02-2022. Vérifier la disponibilité auprès de nos distributeurs sur place
- Am 22-02-2022 gestrichen. Evtl. Verfügbarkeit bitte bei unseren Händlern prüfen
- Eliminado en fecha 22-02-2022. Verificar la disponibilidad a través de nuestros distribuidores locales

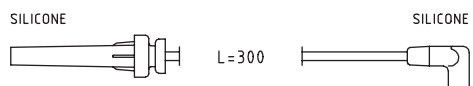
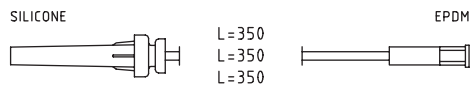

SUPPRESSION CABLE Ø 7 mm

CHRYSLER

PT CRUISER 2.4 GT	EDV	03/04 ⇔ 03/08
PT CRUISER GT 2.4	EDV	08/03 ⇔ 12/10



PICK-UPS

-IMPULSORI -CAPTEURS -IMPULSGEBER -CAPTADORES

(A) P/NRS. - NOTES

- CODICI - NOTE
- RÉFS. - NOTES
- ARTIKEL-NR. - ANMERKUNGEN
- CODIGOS - NOTAS

(B) PICTURE + TECHNICAL INFO

- FOTO + INFORMAZIONE TECNICA
- ILLUSTRATION + INFORMATION TECHNIQUE
- BILD + TECHNISCHE INFO
- FOTO + INFORMACIÓN TÉCNICA

(C) APPLICATION LIST

- GUIDA APPLICAZIONI
- LISTE D'APPLICATIONS
- ANWENDUNGSTABELLE
- LISTA DE APLICACIONES

430 161/1 3,5

PICK-UPS

Adatt./Suitable: **MARELLI**

ABARTH 9939762

FIAT 9934729 9939762

LANCIA 9934729

MAGNETI MARELLI 071319801010 610 800 24 *N 712 160 01 713 198 01

*N Available only pick-up coil, not the distributor assy

- Fornito solo l'impulsore, non lo spinterogeno completo
- Disponible seulement capteur, sans allumeur
- Erhältlich nur Impulsgeber, ohne Zündverteiler
- Disponible solamente captador sin didtribuidor

L	ohm	Pick-Up	
700	730	Coil	

ABARTH		
RITMO 125 TC 2.0	138AR1.000	11/81 ⇔ 12/87
FIAT		
132 2.0	132C2.000	01/76 ⇔ 06/81
RITMO II 105 1.6	138AR.000	01/83 ⇔ 12/87
LANCIA		
A 112 1.0 Abarth	A112A2.000, A112A2.000	03/78 ⇔ 02/84

(A)

- 1 # KW
- 2 OEM P/NRS.
 - CODICI ORIGINALI
 - RÉFS. D'ORIGINE
 - ORIGINALTEILE-NR.
 - CODIGOS ORIGINALES
- 3 PACKAGING SIZE
 - FORMATO CONFEZIONE
 - FORMAT DU CONDITIONNEMENT
 - ABPACKENSGROSSE
 - TAMAÑO DEL ENVASE
- 4 NOTE
 - NOTE
 - NOTES
 - BERMERKUNGEN
 - NOTAS

(B)

1 PICTURE

- FOTO
- PHOTO
- BILD
- FOTO

2 CABLE LENGHT IN "mm" MEASURED AS SHOWN:

- LUNGHEZZA IN "mm" DEL CAVO COSÌ MISURATO:
- LONGUEUR EN "mm" DU CABLE MESURÉ COMME SUIT:
- KABELLÄNGE IN "mm" GEMESSEN WIE GEZEIGT:
- LARGO EN "mm" DEL CABLE MEDIDO DE LA MANERA ILUSTRADA:

3 RESISTANCE BETWEEN THE TERMINALS

- RESISTENZA TRA I TERMINALI
- RESISTANCE ENTRE LES CONNEXIONS
- WIDERSTAND ZWISCHEN DEN ANSCHLÜSSEN
- RESISTENCIA ENTRE LOS ENCHUFES

4 PICK-UP COIL

- IMPULSORI
- CAPTEUR
- IMPULSGEBER
- CAPTADOR

HALL PICK-UP COIL

- IMPULSORI SISTEMA HALL
- CAPTEUR DU SYSTEME HALL
- HALL-IMPULSGEBER
- CAPTADOR DEL SISTEMA HALL

5 TYPE OF CONNECTION

- TIPO DI CONNESSIONE
- TYPE DE CONNEXION
- ANSCHLUSSART
- TIPO DE ENCHUFE

KW 406 153 

PICK-UPS

Adatt./Suitable: **BOSCH**

ALFA ROMEO

705 420
9938953
9950055

00 Eliminated on 27-01-2021. Please verify the availability through our local distributors

BOSCH

0 237 002 109 *N
1 234 211 018
1 234 211 218
1 237 031 123 *S

FIAT

7073905 *S
7080461
9938953

FORD

3 241 724
3 243 330
6 147 957 *S
84AU-12A09-3A

PEUGEOT

5904 06
5905 09

TALBOT

0013 56 6600

VOLVO

1276620

VW

035 905 205
035 905 205 A *N
035 905 205 B *N
035 905 205 C *N
035 905 205 D *N
035 905 205 E *N
035 905 205 Q *N
035 905 315
047 905 205 C *N
325 905 209 2
477 905 206

- Eliminato il 27-01-2021. Verificare la disponibilità presso i nostri distributori
- Éliminé le 27-01-2021. Vérifier la disponibilité auprès de nos distributeurs sur place
- Am 27-01-2021 gestrichen. Evtl. Verfügbarkeit bitte bei unseren Händlern prüfen
- Eliminado en fecha 27-01-2021. Verificar la disponibilidad a través de nuestros distribuidores locales

***N Available pick-up coil only-not the distributor assy**

- Fornito solo impulsore, no lo spinterogeno completo
- Disponible seulement capteur, sans l'allumeur
- Erhältlich nur impulsgeber, ohne Zündverteiler
- Disponible solamente captador sin distribuidor

***S Available pick-up coil only-not base**

- Fornito solo impulsore, no base
- Disponible seulement capteur, sans base
- Erhältlich nur Impulsgeber, ohne Grundplatte
- Disponible solamente captador, sin base

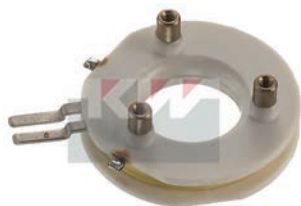

L	ohm	Pick-Up
---	1.100	Coil

TALBOT

TAGORA 2.1 SN2 06/80 ⇨ 12/83

VOLVO

240 2.0 B19ET 10/82 ⇨ 08/84
240 2.1 Turbo B21ET, B21FT 08/80 ⇨ 07/85

KW 406 159 

PICK-UPS

Adatt./Suitable: **BOSCH**

BOSCH

0 237 024 038 *N
0 237 035 001 *N
1 237 011 073

PEUGEOT

5904 25

SEAT

050 905 205 A *N
051 905 205 *N

VW

026 905 205 AA *N
026 905 205 AB *N
026 905 205 AC *N
026 905 205 AD *N
026 905 205 AF *N
026 905 205 AG *N
026 905 205 AH *N
026 905 205 AJ *N
026 905 205 AK *N
026 905 205 G *N
026 905 205 H *N
026 905 205 J *N
026 905 205 L *N
026 905 205 N *N
026 905 205 P *N
026 905 205 Q *N
026 905 206
026 905 206 A *N
026 905 206 AC *N
026 905 206 AD *N
026 905 206 B *N
026 905 206 C *N
026 905 206 E *N
026 905 206 F *N
026 905 206 G *N
026 905 206 H *N
026 905 206 J *N
026 905 206 K *N
026 905 206 T *N
027 905 205 F *N
027 905 205 H *N
027 905 205 M *N
027 905 205 Q *N
027 905 205 R *N
049 905 206 D *N
049 905 206 F *N
049 905 206 G *N
050 905 205
050 905 205 A *N
050 905 205 B *N
050 905 205 C *N
050 905 205 D *N
050 905 205 E *N
050 905 205 F *N
050 905 205 H *N
050 905 205 J *N
050 905 205 K *N
051 905 205 *N
056 905 205 L
175 905 206 A *N

***N Available pick-up coil only-not the distributor assy**

- Fornito solo impulsore, no lo spinterogeno completo
- Disponible seulement capteur, sans l'allumeur
- Erhältlich nur impulsgeber, ohne Zündverteiler
- Disponible solamente captador sin distribuidor

KW 406 160 

PICK-UPS

Adatt./Suitable: **BOSCH**

BOSCH

1 230 500 221
9 231 087 552

VW

040 905 359 1

03 Supplied until depletion

- Fornibile fino ad esaurimento delle scorte
- Fourni jusqu'à épuisement du stock
- Lieferbar solange vorrat reicht
- Suministrado hasta el stock termina



L	ohm	Pick-Up
---	---	Hall 

VOLKSWAGEN (BR)

GOL 1.6	504, 505	09/94 ⇨ 01/97
GOL 1.8	521, 522	04/94 ⇨ 01/97
GOL 2.0i	528, 529	09/94 ⇨ 01/97
LOGUS 1.6	504, 505	10/94 ⇨ 12/96
LOGUS 1.8	524, 525, 599	12/92 ⇨ 12/96
LOGUS 2.0	653	11/93 ⇨ 05/94
LOGUS 2.0i	526, 527	05/94 ⇨ 12/96
PARATI 1.6	504, 505	08/95 ⇨ 01/97
PARATI 1.8	521, 522	08/95 ⇨ 01/97
PARATI 2.0i	528, 529	08/95 ⇨ 01/97
POINTER 1.8	524, 525, 599	11/93 ⇨ 12/96
POINTER 2.0	653	12/92 ⇨ 05/94
POINTER 2.0i	526, 527	05/94 ⇨ 12/96

ALFA ROMEO

33 I 1.3	AR30168	10/84 ⇨ 12/89
33 I 1.3 i.e.	AR30168	05/83 ⇨ 12/89
33 I 1.5 4x4	AR30508	12/86 ⇨ 03/89
75 1.6	AR06100	05/85 ⇨ 09/89
75 1.8	AR06202	09/85 ⇨ 06/89
90 1.8	AR06202	10/84 ⇨ 07/87
90 2.0 i.e.	AR06210	10/84 ⇨ 07/87
ALFASUD 1.5 ti	AR30128	05/80 ⇨ 06/84
ALFETTA 1.6	AR01600	01/75 ⇨ 12/84
ALFETTA 1.8	AR01608	10/79 ⇨ 12/84
GIULIETTA I 1.6	AR01600	10/77 ⇨ 04/85
GIULIETTA I 1.8	AR01678	04/79 ⇨ 04/85
GIULIETTA I 2.0	AR01655	06/80 ⇨ 04/85
SPIDER I 1600	AR00526, AR01563	03/76 ⇨ 12/93

FIAT

UNO 70 1.3i SX	--	01/83 ⇨ 12/89
UNO 75 i.e. 1.5	138C2.048	10/85 ⇨ 12/93

FIAT (BR)

PREMIO 1.3	--	01/85 ⇨
PREMIO 1.5	--	01/85 ⇨
UNO 1.5	1.5	01/91 ⇨ 12/93
UNO 1.5R	1.5	01/87 ⇨ 12/89
UNO 1.6R	1.6	01/90 ⇨ 12/93
UNO CS 1.5	1.5	01/89 ⇨ 12/93
UNO CS 1.5 Furgoneta	1.5	01/91 ⇨ 12/93
UNO CSL 1.6	1.6	01/91 ⇨ 12/93
UNO MILLE 1.0	1.0	01/91 ⇨ 04/93

PEUGEOT

309 I 1.3	G1A, G2S	10/85 ⇨ 08/89
505 2.0Ti, STI	829(ZEJ)	08/79 ⇨ 10/86



L	ohm	Pick-Up
---	---	Hall 

PEUGEOT

505 2.1 i	XN9T	01/83 ⇨ 12/88
505 2.2	851(ZDJ), 851X(ZDJL)	05/81 ⇨ 12/93
505 2.2 GTI	851B(ZDJL)	08/83 ⇨ 12/93

SEAT

TOLEDO I 1.6 i	1F	05/91 ⇨ 03/99
TOLEDO I 1.8 i	RP	05/91 ⇨ 12/96

VW

JETTA II 1.6	PN	10/86 ⇨ 10/91
GOLF II 1.6	PN	10/86 ⇨ 12/92
GOLF II 1.6 G	PN	08/86 ⇨ 07/91
GOLF II 1.8 [CHE] [SWE]	HV	04/84 ⇨ 07/86

KW 406 193



PICK-UPS

Adatt./Suitable: **BOSCH**

BOSCH
0 237 037 010 *N
1 237 011 076
1 237 011 111

SAAB
74 86 822

SEAT
030 998 065
SE 021914.016A

VW
030 905 205 *N
030 905 205 A *N
030 905 205 B *N
030 905 205 D *N
030 905 205 J *N
030 998 065

*N Available pick-up coil only-not the distributor assy

- Fornito solo impulsore, no lo spinterogeno completo
- Disponible seulement capteur, sans l'allumeur
- Erhältlich nur impulsgeber, ohne Zündverteiler
- Disponible solamente captador sin distribuidor



L	ohm	Pick-Up	
---	---	Hall	

SAAB			
900 I 2.0 c	B201XC	09/79	⇒ 12/88
900 I 2.0 i	01LE4G15, B201XI	11/80	⇒ 08/90
900 I 2.0 Turbo	B201XL	01/86	⇒ 12/91

SEAT			
IBIZA I 1.2	021A1000	11/84	⇒ 12/93
MALAGA 1.2	021A1000	05/85	⇒ 12/93
MALAGA 1.5	021A2000	05/85	⇒ 12/93

VW			
POLO II 1.0	AAK, HZ	01/85	⇒ 09/94
POLO II 1.0 Cat	AAK	08/89	⇒ 09/94
POLO II 1.3	MH	08/83	⇒ 07/88
POLO II 1.3 Cat	2G, MH, NZ	07/87	⇒ 09/94
JETTA II 1.0	HZ	08/85	⇒ 10/91
JETTA II 1.3	MH, NU	01/84	⇒ 12/87
JETTA II 1.3 Cat	2G, MH, NZ	06/87	⇒ 12/91
DERBY 1.3	HK	08/83	⇒ 12/84
GOLF II 1.0	HZ	08/85	⇒ 10/91
GOLF II 1.3	MH, NU	08/83	⇒ 12/87
GOLF II 1.3 Cat	2G, NZ	06/86	⇒ 12/92

KW 406 219



PICK-UPS

Adatt./Suitable: **BOSCH**

AUDI
034 998 065

BOSCH
1 237 011 081
1 237 011 116

VW
034 998 065
035 998 065 A



L	ohm	Pick-Up	
---	---	Hall	

AUDI			
80 II 1.3	EP	09/78	⇒ 07/86
80 II 1.6	DT, JU, SA, WV	08/78	⇒ 03/87
80 II 1.8	DS, JN, SF	01/83	⇒ 08/86
80 II 1.8 CC quattro	JN, JV	08/84	⇒ 08/86
80 II 1.8 GTE	DZ, MU	06/84	⇒ 03/87
80 II 2.0	JS	10/83	⇒ 09/84
80 II 2.0 quattro	JS	10/83	⇒ 09/84
80 III 1.4	SE	08/86	⇒ 07/88
80 III 1.6	ABB, PP, RN, RNA	09/86	⇒ 10/91
80 III 1.8	RU	10/86	⇒ 01/90
80 III 1.8 E	DZ	06/86	⇒ 08/91
80 III 1.8 S	JN, JV, NE, PM, SF	08/86	⇒ 10/91
90 I 1.8	JN	06/84	⇒ 03/87
90 I 2.0	JL, JS	10/84	⇒ 03/87
90 I 2.0 quattro	JS	08/84	⇒ 08/86
90 I 2.2	9C54, KX	10/84	⇒ 03/87
90 I 2.2 E quattro	9C54	11/84	⇒ 03/87
90 II 2.0	PS	07/88	⇒ 09/91
90 II 2.2 E	9C54	04/87	⇒ 07/91
90 II 2.2 E quattro	9C54	04/87	⇒ 09/91
100 III 1.8	DS, JW, NP, SH	08/83	⇒ 12/90
100 III 1.8 Cat	4B, PH	03/85	⇒ 11/90
100 III 1.8 Cat quattro	4B	08/85	⇒ 11/90
100 III 1.8 quattro	NP, SH	10/84	⇒ 07/90
100 III 2.0 Cat	RT	01/88	⇒ 11/90
100 III 2.0 E Cat	RT	01/88	⇒ 11/90
COUPE 1.8	DZ	08/89	⇒ 07/91
COUPE 2.2	9C54	11/88	⇒ 07/91
COUPE 2.2 quattro	9C54	11/88	⇒ 07/91
COUPE 2.3 quattro	NG	01/87	⇒ 12/87

VW			
PASSAT II 2.0	JS	08/83	⇒ 03/88
PASSAT II 2.0 Syncro	JS	05/84	⇒ 03/88
JETTA II 1.6	ABN, EZ, EZA, HM, PN, RF	12/83	⇒ 07/92
JETTA II 1.8	EV, GU, GX, RH	01/84	⇒ 10/91
JETTA II 1.8 Cat	GX, RP	08/87	⇒ 10/91
JETTA II 1.8 Syncro	GU, RP	08/87	⇒ 12/88
JETTA II 1.8i GT	GZ	12/83	⇒ 07/88
CADDY I 1.8	JH	08/85	⇒ 07/92
GOLF I 1.6	EW, HN	08/83	⇒ 04/92
GOLF I 1.8	DX, EX, JH, KT	08/82	⇒ 04/93
GOLF II 1.6	ABN, EZ, PN, RF	08/83	⇒ 12/92
GOLF II 1.6 [CHE] [SWE]	HM	08/83	⇒ 07/88
GOLF II 1.6 G	EZA, PN	08/86	⇒ 07/91
GOLF II 1.8	GU, GX, RH	08/84	⇒ 10/91
GOLF II 1.8 [CHE] [SWE]	HV	08/86	⇒ 07/87
GOLF II 1.8 GTI	EV	08/83	⇒ 10/91
GOLF II 1.8 i	RP	08/87	⇒ 07/91
GOLF II 1.8 i Cat	GX, RP	08/87	⇒ 10/91
GOLF II 1.8 i Cat Syncro	RP	08/87	⇒ 10/91

VW

GOLF II 1.8 Syncro	GU, GX	02/86	⇒ 07/91
GOLF II 1.8i GTI [CHE] [SWE]	GZ	01/84	⇒ 07/87
GOLF II 1.8i GTI [SWE]	GZ	08/87	⇒ 07/88
PASSAT III 1.6	1F, EZ	04/88	⇒ 07/92
PASSAT III 1.8	RP	02/88	⇒ 05/97
QUANTUM 1.7	--	01/85	⇒ 12/87
SANTANA 2.0	JS	08/83	⇒ 12/84
SCIROCCO II 1.6	EW, EWA, HN, RE	01/83	⇒ 07/90
SCIROCCO II 1.8	DX, EX, JH, KT	08/82	⇒ 07/92

KW 406 222



PICK-UPS

Adatt./Suitable: **BOSCH**

VOLVO
1346792
13467923



L	ohm	Pick-Up
---	---	Hall

VOLVO			
740 2.0	B200E, B200G, B200K	08/85	⇒ 07/92
740 2.3	B230E, B230F, B230K	08/84	⇒ 12/92
740 2.3 GL	B230E	08/84	⇒ 08/87
740 2.3 Turbo	B230FT	08/86	⇒ 08/91
760 2.3	B230FT, B230K	08/84	⇒ 07/92
760 2.3 Turbo	B230FT	08/84	⇒ 08/90
940 12.0	B200E	09/90	⇒ 09/93
940 I 2.3	B230E	08/90	⇒ 12/94

KW 406 223



3,5

PICK-UPS

Adatt./Suitable: BOSCH

AUDI

030 905 065
030 905 065 B

BOSCH

0 237 522 011 *N
1 237 010 027
1 237 010 039
1 237 011 122
1 237 011 124
1 237 031 296

SEAT

030 905 065
030 905 065 B
037 905 205 M *N
050 905 205 AH *N

SKODA

030 905 065

VW

030 905 065
030 905 065 A
030 905 065 B
035 905 206 AF *N
037 905 205 M *N
050 905 205 AH *N
050 905 205 AL *N
050 905 205 BA *N
052 998 065

*N Available pick-up coil only-not the distributor assy

- Fornito solo impulsore, no lo spinterogeno completo
- Disponible seulement capteur, sans l'allumeur
- Erhältlich nur impulsgeber, ohne Zündverteiler
- Disponible solamente captador sin distribuidor



L	ohm	Pick-Up	
---	---	Hall	

AUDI

80 IV 1.6 E	ADA	06/93 ⇒ 01/96
A4 I 1.6	ADP	11/94 ⇒ 09/01

SEAT

AROSA 1.0	AER, ALL	05/97 ⇒ 06/04
AROSA 1.4	AEX, AKV, APQ	05/97 ⇒ 06/04
CORDOBA I 1.0 i	AER	09/96 ⇒ 10/02
CORDOBA I 1.4	ANX	12/97 ⇒ 04/99
CORDOBA I 1.4 i	AEX, AKV, APQ	06/94 ⇒ 12/02
CORDOBA I 1.4 i 16V	AFH	09/96 ⇒ 10/02
CORDOBA I 1.6 i	1F, AEE, AFT, ALM	02/93 ⇒ 06/99
CORDOBA I 1.8 i	ABS, ACC, ADZ	02/93 ⇒ 09/02
CORDOBA I 1.8 i 16V	148D	10/93 ⇒ 08/96
CORDOBA I 2.0 i	AGG	02/93 ⇒ 06/99
IBIZA II 1.0 i	AER	09/96 ⇒ 02/02
IBIZA II 1.4	ANX	12/97 ⇒ 04/99
IBIZA II 1.4 i	ABD, AEX, AKV, APQ	09/93 ⇒ 02/02
IBIZA II 1.4 i 16V	AFH	06/97 ⇒ 02/02
IBIZA II 1.6 i	1F, AEE, AFT, ALM	03/93 ⇒ 06/99
IBIZA II 1.8 i	ABS, ADZ	03/93 ⇒ 08/99
IBIZA II 1.8 i 16V	148D	11/93 ⇒ 08/96
IBIZA II 2.0 i	AGG	03/93 ⇒ 08/99
INCA 1.4 i	AEX, AKV, APQ	11/95 ⇒ 06/03
INCA 1.6 i	1F, AEE	11/95 ⇒ 05/98
ALHAMBRA I / II 2.0 i	ADY	04/96 ⇒ 03/10
TOLEDO I 1.6 i	1F, AFT	05/91 ⇒ 03/99
TOLEDO I 1.8 i	ABS, RP	05/91 ⇒ 12/96
TOLEDO I 2.0 i	AGG	05/91 ⇒ 03/99
TOLEDO I 2.0 i 16V	ABF	11/93 ⇒ 03/99

SKODA

FELICIA 1.6	6A16XHT	06/97 ⇒ 04/02
FELICIA 1.6 GLX	6A16XHT	08/95 ⇒ 03/98
FELICIA 1.6 LX	6A16XHT	08/95 ⇒ 03/98
OCTAVIA I 1.6	6A16XHT	09/96 ⇒ 09/04

VW

PASSAT IV 1.6	ADP	10/96 ⇒ 11/00
POLO II 1.0	AAU	01/85 ⇒ 09/94
POLO II 1.0 Cat	AAU	08/89 ⇒ 09/94
POLO II 1.3	AAV	09/82 ⇒ 07/94
POLO II 1.3 Cat	AAV	07/87 ⇒ 09/94
JETTA II 1.8 16V	KR, PL	08/86 ⇒ 10/91
CADDY II 1.4	AEX, AKV, APQ	11/95 ⇒ 06/03
CADDY II 1.6	1F, AEE	11/95 ⇒ 12/00
CADDY II 60 1.4	AEX, APQ	11/95 ⇒ 01/04
CADDY II 75 1.6	1F, AEE	11/95 ⇒ 05/97

VW

CADDY III 1.8 [ARG]	BUR	10/05 ⇒
CORRADO 1.8 16V	KR	04/89 ⇒ 07/92
CORRADO 2.0 i 16V	7T2220XS560	08/91 ⇒ 12/95
DERBY 1.3	GK	09/82 ⇒ 12/84
GOLF II 1.8 GTI 16V	KR, PL	02/86 ⇒ 10/91
GOLF III 1.4	ABD, AEX	10/91 ⇒ 04/99
GOLF III 1.6	ABU, AEA, AEE, AEK, AFT, AKS	09/92 ⇒ 04/99
GOLF III 1.8	AAM, ABS, ADZ	08/91 ⇒ 04/99
GOLF III 2.0	ADY, AEP, AGG, AKR	11/91 ⇒ 04/99
GOLF III 2.0 GL	AEP	08/95 ⇒ 09/97
GOLF III 2.0 GTI 16V	ABF	08/92 ⇒ 08/97
GOLF III 2.0 Syncro	AGG	08/95 ⇒ 04/99
GOLF IV 1.6	AFT, AKS	06/98 ⇒ 06/02
GOLF IV 2.0	AGG, AKR, AWF, AWG	06/98 ⇒ 06/02
LUPU 1.0	AER, ALL	09/98 ⇒ 07/05
POLO III 1.4	AEX, AKV, ANX, APQ	05/97 ⇒ 09/01
POLO III 1.6	AEA, AEE, AFT, ALM	09/94 ⇒ 09/01
POLO III 100 1.4 16V	AFH	04/96 ⇒ 10/99
POLO III 100 1.6	AFT	12/95 ⇒ 09/01
POLO III 45 1.0	AEV	10/94 ⇒ 09/96
POLO III 50 1.0	AER, ALL	09/96 ⇒ 10/99
POLO III 54 1.4	ANX	01/98 ⇒ 08/99
POLO III 55 1.3	ADX	10/94 ⇒ 04/97
POLO III 55 1.4	AEX	08/95 ⇒ 10/99
POLO III 60 1.4	AEX, AKV, APQ	07/95 ⇒ 09/01
POLO III 75 1.6	AEA, AEE, AHS, ALM	10/94 ⇒ 09/01
POLO III 75 1.6 4motion	AEA	08/95 ⇒ 10/99
PASSAT III 1.8	KR	08/91 ⇒ 09/93
PASSAT III 1.8 16V	KR	04/88 ⇒ 12/89
PASSAT III 1.8 GL	KR	08/91 ⇒ 09/93
POLO IV 1.0	AER	08/96 ⇒ 12/01
SCIROCCO II 1.8 16V	KR, PL	10/85 ⇒ 07/92
TRANSPORTER IV 2.5	ACU, AET, AEU, APL, AVT	11/90 ⇒ 04/03
TRANSPORTER IV 2.5 Syncro	ACU, AET, AEU, APL, AVT	08/92 ⇒ 04/03
VENTO 1.4	ABD	11/91 ⇒ 09/98
VENTO 1.6	AEA, AEK, AFT, AKS	09/92 ⇒ 02/99

KW 406 231



3,5

PICK-UPS

Adatt./Suitable: BOSCH

VW

035 998 065 A*
035 998 065 A***

L	ohm	Pick-Up	
---	---	Hall	

AUDI

80 II 1.6	VV	08/78 ⇒ 07/86
80 III 1.8 quattro	SD	09/86 ⇒ 08/90
80 III 1.8 S quattro	JN	09/86 ⇒ 09/91

VW

SANTANA 1.6	DT	08/81 ⇒ 12/84
SANTANA 1.8	DS	01/83 ⇒ 12/84

KW 406 233



3,5

PICK-UPS

Adatt./Suitable: BOSCH

ALFA ROMEO

60534261 *S

BOSCH

0 237 521 047 *N
1 237 010 033
1 237 011 114
1 237 031 180

FORD

6 125 612 *S
6 182 576 *N
6 182 577 *N
845F-12100-BA *N
895F-12100-JA *N

Motorcraft

EDR 309 *S

SEAT

026 905 359 2
051 905 205 C *N

VW

026 905 359 2
030 998 065 A *S
051 905 205 B *N
051 905 205 C *N

*N Available pick-up coil only-not the distributor assy

- Fornito solo impulsore, no lo spinterogeno completo
- Disponible seulement capteur, sans l'allumeur
- Erhältlich nur impulsgeber, ohne Zündverteiler
- Disponible solamente captador sin distribuidor

*S Available pick-up coil only-not base

- Fornito solo impulsore, no base
- Disponible seulement capteur, sans base
- Erhältlich nur Impulsgeber, ohne Grundplatte
- Disponible solamente captador, sin base

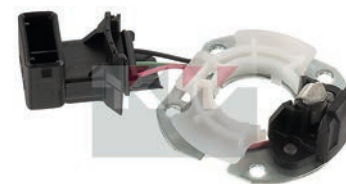

L	ohm	Pick-Up	
---	---	Hall	

FORD

ESCORT IV 1.6 Turbo RS	LNB	01/86 ⇒ 07/90
------------------------	-----	---------------

SEAT

CORDOBA I 1.0 16V	AST, AVZ	05/00 ⇒ 10/02
IBIZA II 1.0 16V	AST, AVZ	10/99 ⇒ 02/02
TOLEDO I 1.8 16V	KR, PL	05/91 ⇒ 03/99
TOLEDO I 1.8 GT	KR	05/91 ⇒ 11/92

VOLKSWAGEN (BR)

CADDY 1.6i	MY4	11/98 ⇒
GOL 1.0i	510	11/96 ⇒
GOL 1.0i 16v	511	09/97 ⇒
GOL 1.6i	540, 541	10/96 ⇒
GOL 1.8i	542, 543	10/96 ⇒
GOL 2.0i	546, 547	10/96 ⇒
PARATI 1.0i 16v	511	09/97 ⇒
PARATI 1.6i	540, 541	10/96 ⇒
PARATI 1.8i	542	10/96 ⇒
PARATI 2.0i	546, 547	10/96 ⇒
POLO 1.6	MJ3, MY4	07/00 ⇒
POLO 1.8	MJ2, MY5, MY6	12/96 ⇒
SAVEIRO 1.6i	540, 541	10/96 ⇒
SAVEIRO 1.8i	542, 543	10/96 ⇒
SAVEIRO 2.0i	546, 547	10/96 ⇒

VW

CADDY III 1.6 [ARG]	UVC	10/05 ⇒
POLO II 1.3	3F	10/90 ⇒ 09/94
POLO II 1.3 Cat	3F	10/89 ⇒ 09/94
POLO II 1.3 G40	PY	01/87 ⇒ 09/94

KW 406 234

3,5

PICK-UPS

Adatt./Suitable: **BOSCH****BOSCH**
0 237 021 074 *N
1 237 011 119**SEAT**
030 998 065 B**VW**
030 998 065 B

*N Available pick-up coil only-not the distributor assy

- Fornito solo impulsore, no lo spinterogeno completo
- Disponible seulement capteur, sans l'allumeur
- Erhältlich nur impulsgeber, ohne Zündverteiler
- Disponible solamente captador sin distribuidor



L	ohm	Pick-Up	
---	---	Hall	

SEAT			
IBIZA II 1.3 i	8C20HD0D	03/93 ⇨	08/99

VW			
POLO II 1.0	HZ	01/85 ⇨	09/94
POLO II 1.0 Cat	ACM	08/89 ⇨	09/94
POLO II 1.3 Cat	2G	07/87 ⇨	09/94
JETTA II 1.0	HZ	08/85 ⇨	10/91
JETTA II 1.3 Cat	2G, NZ	06/87 ⇨	12/91
GOLF II 1.0	HZ	08/85 ⇨	10/91
GOLF II 1.3 Cat	2G, NZ	06/86 ⇨	12/92

KW 406 244

3,5

PICK-UPS

Adatt./Suitable: **BOSCH****BOSCH**
0 237 520 054 *N
0 237 521 024
1 237 031 093
1 237 031 339**HYUNDAI**
27180-22000**SAAB**
88 57 617 *N

*N Available pick-up coil only-not the distributor assy

- Fornito solo impulsore, no lo spinterogeno completo
- Disponible seulement capteur, sans l'allumeur
- Erhältlich nur impulsgeber, ohne Zündverteiler
- Disponible solamente captador sin distribuidor



L	ohm	Pick-Up	
---	---	Hall	

HYUNDAI			
S COUPE 1.5 i	G4EK	04/92 ⇨	05/96
S COUPE 1.5 i Turbo	G4EK-TC	04/91 ⇨	05/96

SAAB			
900 I 2.0 S Turbo-16	B202S	07/91 ⇨	06/94

SAAB

900 I 2.0 Turbo-16	B202L, B202XL	11/85 ⇨	06/94
900 I 2.0 Turbo-16 S	B202XL	01/84 ⇨	06/94
900 I 2.0 Turbo-16 S Cat	B202XL	01/89 ⇨	12/93

KW 412 010

3,5

PICK-UPS

Adatt./Suitable: **DELCO REMY****GENERAL MOTORS**
1 978 503**OPEL**
12 12 126

*3 Supplied until depletion

- Fornibile fino ad esaurimento delle scorte
- Fourni jusqu'à épuisement du stock
- Lieferbar solange vorrat reicht
- Suministrado hasta el stock termina



L	ohm	Pick-Up
---	800	Coil

KW 412 011

3,5

PICK-UPS

Adatt./Suitable: **DELCO REMY****DELCO REMY**
1 103 516 *N
1 103 549 *N
GENERAL MOTORS
1 979 511**OPEL**
12 12 125

*N Available pick-up coil only-not the distributor assy

- Fornito solo impulsore, no lo spinterogeno completo
- Disponible seulement capteur, sans l'allumeur
- Erhältlich nur impulsgeber, ohne Zündverteiler
- Disponible solamente captador sin distribuidor

*3 Supplied until depletion

- Fornibile fino ad esaurimento delle scorte
- Fourni jusqu'à épuisement du stock
- Lieferbar solange vorrat reicht
- Suministrado hasta el stock termina



L	ohm	Pick-Up
---	800	Coil

OPEL			
ASCONA C 1.3 N	13N	09/81 ⇨	08/86
ASCONA C 1.6	165V	09/86 ⇨	08/88
CORSA A 1.2	12S, 12ST	09/82 ⇨	08/90
CORSA A 1.2 N	12NV	01/90 ⇨	03/93
CORSA A 1.2 S	12S, 12ST	09/82 ⇨	03/93
CORSA A 1.3	13NB, 13SB	09/85 ⇨	10/89
CORSA A 1.3 GL	13S	09/82 ⇨	03/93
CORSA A 1.3 S	13SB	09/82 ⇨	10/89
KADETT D 1.2	12ST	08/82 ⇨	08/84
KADETT E 1.3 N	13N, 13NB	09/84 ⇨	08/91
KADETT E 1.3 S	13S	09/84 ⇨	02/93
KADETT E 1.6	165V	09/86 ⇨	12/91
KADETT E 1.6 i	165V	07/89 ⇨	02/93
KADETT E 1.6 S	165V	09/86 ⇨	08/91

KW 415 017



3,5

PICK-UPS

Adatt./Suitable: **DUCELLIER**

CITROËN

5904 K3
95 624 952

DUCELLIER

2 525 683 A *N
2 525 683 B *N
2 590 264
2 590 938

PEUGEOT

5904 K3
5904 K9

*N Available pick-up coil only-not the distributor assy

- Fornito solo impulsore, no lo spinterogeno completo
- Disponible seulement capteur, sans l'allumeur
- Erhältlich nur impulsgeber, ohne Zündverteiler
- Disponible solamente captador sin distribuidor

03 Supplied until depletion

- Fornibile fino ad esaurimento delle scorte
- Fourni jusqu'à épuisement du stock
- Lieferbar solange vorrat reicht
- Suministrado hasta el stock termina

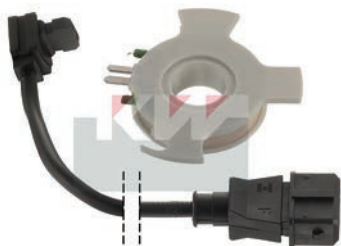

L	ohm	Pick-Up	
265	370	Coil	

CITROËN

BX 1.6	B2C	02/88 ⇨ 12/94
BX 1.9	159B, 159C, D6U, DKK	05/85 ⇨ 12/94
BX 1.9 GTi	D6D, D6K	01/87 ⇨ 01/92
BX 15	B1E(XU51C)	01/87 ⇨ 05/92
BX 16	171A, 171B, 171C, 171D, 23DH, B1E(XU51C), BAY(XU5CP), BAZ(XU5CP)	10/82 ⇨ 12/94
BX 19	159A, D2A(XU92C), D2C(XU92C), D2E, D6A(XU9J2), DKZ(XU9JA)	09/84 ⇨ 12/94
BX 19 Cat	DFZ(XU9J1)	07/86 ⇨ 12/94
BX 19 E 4x4	D2F	04/89 ⇨ 02/93
BX 19 GTi	D6A(XU9J2), DKZ(XU9JA)	07/86 ⇨ 02/93
BX 19 GTi 4x4	DKZ(XU9JA)	06/88 ⇨ 02/93

PEUGEOT

205 I 1.6	B1A(XU51C), B1E(XU51C), BAZ(XU5CP)	08/86 ⇨ 10/87
205 I 1.9 GTi	DFZ(XU9J1)	03/87 ⇨ 10/87
205 II 1.6	B1A(XU51C), B1E(XU51C), BAZ(XU5CP)	10/87 ⇨ 09/98
205 II 1.9 CTI	DFZ(XU9J1)	10/87 ⇨ 12/94
205 II 1.9 GTi Cat	DFZ(XU9J1)	10/87 ⇨ 07/94
309 I 1.6	B1A(XU51C), B1D(XU51C), B1E(XU51C)	10/85 ⇨ 07/89
309 I 1.6 Cat	BAZ(XU5CP)	09/86 ⇨ 12/89
309 I 1.9	D2B(XU9S), DFZ(XU9J1), XU92C	10/85 ⇨ 07/89
309 II 1.9	XU92C	07/89 ⇨ 12/93
405 I 1.9	DFZ(XU9J1)	05/88 ⇨ 08/92
405 I 1.9 Antipollution	XU92C	01/87 ⇨ 12/92
405 I 1.9 Injection	DFZ(XU9J1)	07/87 ⇨ 12/92
405 I 1.9 Trazione integrale	DFZ(XU9J1)	09/88 ⇨ 07/92

KW 415 019



3

PICK-UPS

Adatt./Suitable: **DUCELLIER**

CITROËN

5900 F1
5900 F6
5900 F7
5900 F8
5900 F9
5900 G2
5900 H5
5900 J3
5900 K1
5900 K7
5900 K8
5904 K8
95 624 987
95 643 723
96 001 914 *N
96 002 856 *N
96 004 266 *N
96 014 242 *N
96 020 587 *N
96 039 183 *N

DUCELLIER

2 525 765 A *N
2 590 945

FIAT

9564372380

PEUGEOT

5900 H1
5900 H7
5900 H9
5900 J1
5900 K3
5900 K6
5900 K7
5904 K8
5904 L3
5904 P5

*N Available pick-up coil only-not the distributor assy

- Fornito solo impulsore, no lo spinterogeno completo
- Disponible seulement capteur, sans l'allumeur
- Erhältlich nur impulsgeber, ohne Zündverteiler
- Disponible solamente captador sin distribuidor

03 Supplied until depletion

- Fornibile fino ad esaurimento delle scorte
- Fourni jusqu'à épuisement du stock
- Lieferbar solange vorrat reicht
- Suministrado hasta el stock termina



L	ohm	Pick-Up	
---	370	Coil	

CITROËN

AX 1.3 Sport	M4A	04/87 ⇨ 12/88
AX 10	C1A	09/86 ⇨ 06/92
AX 10 E	C3A	12/86 ⇨ 12/88
AX 11	H1A, H1B, HDZ(TU1M)	09/86 ⇨ 12/97
AX 11 4x4	H1A	06/91 ⇨ 07/92
AX 11 Cat	HAZ(TU1CP)	09/88 ⇨ 12/89
AX 14	K1A(TU3), K1B, K1F, K1G, K1J, K2A, K2B, K2D, KAY(TU3CP), KDX(TU3M/Z), KDY(TU3FM), KDZ(TU3M/Z)	09/86 ⇨ 04/97
AX 14 4x4	KD4, KDX(TU3M/Z), KDY(TU3FM), KDZ(TU3M), KDZ(TU3M/Z)	06/91 ⇨ 12/96
AX 14 GT	KDZ(TU3M/Z)	01/89 ⇨ 12/91
BX 1.1	109LA, H1A	04/86 ⇨ 06/91
BX 1.4	150C, K1F, K2D	07/86 ⇨ 12/94
BX 1.4 E	150B(XY8), 150J, 150Y, K1F, KAZ	09/82 ⇨ 12/94
BX 1.6	B2C	02/88 ⇨ 12/94
BX 1.9	159B, 159C, D6U, DKK	05/85 ⇨ 12/94
BX 1.9 GTi	D6D, D6K	01/87 ⇨ 01/92
BX 14	150C, KDY(TU3M), KDZ(TU3M/Z)	01/86 ⇨ 02/93
BX 14 E	150A, 150C, K1G	10/82 ⇨ 02/93
BX 15	B1E(XU51C)	01/87 ⇨ 05/92
BX 16	171A, 171B, 171C, 171D, 23DH, B1E(XU51C), BAY(XU5CP), BAZ(XU5CP)	10/82 ⇨ 12/94
BX 19	159A, D2A(XU92C), D2C(XU92C), D2E, D6A(XU9J2), DKZ(XU9JA)	09/84 ⇨ 12/94
BX 19 Cat	DFZ(XU9J1)	07/86 ⇨ 12/94
BX 19 E 4x4	D2F	04/89 ⇨ 02/93
BX 19 GTi	D6A(XU9J2), DKZ(XU9JA)	07/86 ⇨ 02/93
BX 19 GTi 4x4	DKZ(XU9JA)	06/88 ⇨ 02/93
C15 1.0	108C(XV8), C1A, C1A(TU9/K), C1B(TU9/W), TU9	10/84 ⇨ 12/97
C15 1.1	H1A, HDZ(TU1M), TU1	08/88 ⇨ 07/96
C15 1.1 i	HDZ(TU1M), TU1M2	07/88 ⇨ 12/96

CITROËN

C15 1.4	K1A, K1G, K1H(TU3A), KDY(TU3M)	07/87 ⇨ 12/96
C15 1.4 E	K1F, K1J, K2D, K3A, KAZ	07/86 ⇨ 12/96
C15 1.4 i	KDY(TU3FM), KDY(TU3M)	05/91 ⇨ 12/96
JUMPER I 2.0	XU102C	02/94 ⇨ 02/02
XM I 2.0	--	05/89 ⇨ 04/94
XM I 2.0 i	RFZ(XU10J2)	05/89 ⇨ 06/94
BERLINGO I 1.4	TU32	07/96 ⇨ 10/98
ZX 1.1	H1A, H1B, HDZ(TU1M), TU1	03/91 ⇨ 06/97
ZX 1.4 i	KDY(TU3M)	10/93 ⇨ 10/97

FIAT

DUCATO II 2.0	--, R5B	03/94 ⇨ 12/95
---------------	---------	---------------

PEUGEOT

106 I 1.0	TU9	09/91 ⇨ 03/01
106 I 1.1	H1B(TU1), HDZ(TU1M)	08/91 ⇨ 04/96
106 I 1.4	K5A(TU3), KDY(TU3M), TU3.2	08/91 ⇨ 04/96
106 II 1.1	H1B(TU1)	04/96 ⇨
205 I 1.4	TU3	01/83 ⇨ 12/90
205 I 1.6	B1A(XU51C), B1E(XU51C)	08/86 ⇨ 10/87
205 II 1.0	TU9	10/87 ⇨ 09/98
205 II 1.1	H1B(TU1), HDZ(TU1M)	10/87 ⇨ 09/98
205 II 1.1 CJ	HDZ(TU1M)	10/89 ⇨ 12/94
205 II 1.4	K1D(TU3A), K2B(TU3S), KDY(TU3M), KDZ(TU3M)	06/87 ⇨ 09/98
205 II 1.4 CJ	K1D(TU3A), KDY(TU3M)	03/89 ⇨ 12/94
205 II 1.6	B1A(XU51C), B1E(XU51C)	10/87 ⇨ 09/98
306 1.4	TU3	01/93 ⇨ 04/02
309 I 1.4	K1D(TU3A), K2B(TU3S), KDY(TU3M), KDZ(TU3M)	08/88 ⇨ 08/89
309 II 1.1	H1B(TU1), HDZ(TU1M)	09/89 ⇨ 12/93
309 II 1.4	KDZ(TU3M), TU3, TU3F2	07/89 ⇨ 12/93
309 II 1.6	18EM, BDZ(XU5M)	07/89 ⇨ 12/93
309 II 1.9	DDZ(XU9M), XU92C	07/89 ⇨ 12/93
405 I 1.4	K5A(TU3), TU3A, TU3F2	01/87 ⇨ 12/92
405 I 1.6	--, 18EM, B1E(XU51C)	01/87 ⇨ 12/92
405 I 1.9	D2C(XU92C)	07/87 ⇨ 12/92
405 II 1.4	TU3F2	01/93 ⇨ 12/96
405 II 1.6	18EM	08/92 ⇨ 05/97
405 II 1.9	XU92C	01/93 ⇨ 12/96
605 2.0	R5A(XU102C)	06/89 ⇨ 09/99
BOXER I 2.0	R5B(XU102C)	02/94 ⇨ 02/02
RANCH 1.4	K5A(TU3.2)	09/96 ⇨ 08/02

KW 428 202



3,5

PICK-UPS

Adatt./Suitable: **LUCAS**

GENERAL MOTORS

90 346 324 *N

OPEL

12 11 006 *N

*N Available pick-up coil only-not the distributor assy

- Fornito solo impulsore, no lo spinterogeno completo
- Disponible seulement capteur, sans l'allumeur
- Erhältlich nur impulsgeber, ohne Zündverteiler
- Disponible solamente captador sin distribuidor



L	ohm	Pick-Up
---	---	Hall

OPEL

ASTRA F 1.4 i	C14NZ	09/91 ⇨ 01/05
CORSA A 1.2 i	C12NZ	09/89 ⇨ 03/93
CORSA A 1.6 GSI	E16SE	05/88 ⇨ 03/92

VAUXHALL

ASTRA III 1.4 i	C14NZ	09/91 ⇨ 09/98
ASTRAVAN I 1.4 i	C14NZ	09/91 ⇨ 08/95

KW 430 161/1



04

PICK-UPS

Adatt./Suitable: **MARELLI****ABARTH**
9939762

*N Available pick-up coil only-not the distributor assy

FIAT
9934729
9939762

• Fornito solo impulsore, no lo spinterogeno completo

LANCIA
9934729

• Disponible seulement capteur, sans l'allumeur

MAGNETI MARELLI
071319801010610 800 24 *N
712 160 01
713 198 01• Erhältlich nur impulsgeber, ohne Zündverteiler
• Disponible solamente captador sin distribuidor

03 Supplied until depletion

- Fornibile fino ad esaurimento delle scorte
- Fourni jusqu'à épuisement du stock
- Lieferbar solange vorrat reicht
- Suministrado hasta el stock termina



L	ohm	Pick-Up
700	730	Coil

ABARTH

RITMO 125 TC 2.0 138AR1.000 11/81 ⇨ 12/87

FIAT

132 2.0 132C2.000 01/76 ⇨ 06/81

RITMO II 105 1.6 138AR.000 01/83 ⇨ 12/87

LANCIA

A 112 1.0 Abarth A112A2.000 03/78 ⇨ 02/84

KW 430 163/1



3,5

PICK-UPS

Adatt./Suitable: **MARELLI****FIAT**
9936331

*N Available pick-up coil only-not the distributor assy

LANCIA
9936331

• Fornito solo impulsore, no lo spinterogeno completo

MAGNETI MARELLI
071319804010712 160 03
713 198 04
SM 807 AX *N

• Disponible seulement capteur, sans l'allumeur

• Erhältlich nur impulsgeber, ohne Zündverteiler

• Disponible solamente captador sin distribuidor

03 Supplied until depletion

- Fornibile fino ad esaurimento delle scorte
- Fourni jusqu'à épuisement du stock
- Lieferbar solange vorrat reicht
- Suministrado hasta el stock termina



L	ohm	Pick-Up
780	730	Coil

FIAT

124 Spider, Sport [USA] -- 01/79 ⇨ 12/86

131 2.0 Brava [USA] -- 01/79 ⇨ 12/84

LANCIA

BETA 1600 828B.000 08/73 ⇨ 07/82

KW 430 176M



3,5

PICK-UPS

Adatt./Suitable: **MARELLI****FIAT**
9939788
9941231
9941693

*N Available pick-up coil only-not the distributor assy

INNOCENTI
9941693**LANCIA**
9939788**MAGNETI MARELLI**
713 284 01
713 473 01
713 491 01

• Fornito solo impulsore, no lo spinterogeno completo

• Disponible seulement capteur, sans l'allumeur

• Erhältlich nur impulsgeber, ohne Zündverteiler

• Disponible solamente captador sin distribuidor

03 Supplied until depletion

- Fornibile fino ad esaurimento delle scorte
- Fourni jusqu'à épuisement du stock
- Lieferbar solange vorrat reicht
- Suministrado hasta el stock termina

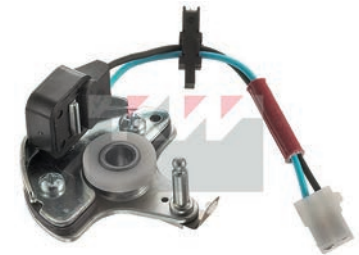

L	ohm	Pick-Up
---	830	Coil

FIAT

DUNA 60 1.1 146A6.000 01/87 ⇨ 12/91

DUNA 70 1.3 146A5.000 01/87 ⇨ 12/91

ELBA 1.3 146A5.000 04/91 ⇨ 02/95

FIORINO I 1.1 60 146A9.000 11/86 ⇨ 04/88

FIORINO I 1.3 146A5.000 12/87 ⇨ 08/93

FIORINO II 1.3 146A5.000 01/88 ⇨ 12/94

FIORINO II 60 1.1 146A9.000 05/88 ⇨ 12/93

FIORINO II 70 1.3 146A5.000 01/88 ⇨ 12/94

REGATA 70 1.3 138B2.000, 149A3.000 09/83 ⇨ 07/89

RITMO I 1.3 149A3.000 11/83 ⇨ 08/85

TEMPRA 1.4 i.e. 159A2.000 04/90 ⇨ 08/96

TIPO I 1.4 160A1.000 07/87 ⇨ 12/89

TIPO I 1.4 i.e. 159A2.000 05/89 ⇨ 04/95

UNO 60 1.1 146A4.048, 146A6.000 02/88 ⇨ 02/92

UNO 60 1.1 SX -- 01/85 ⇨ 12/89

UNO CS 1.1 146A6.000 09/87 ⇨ 09/91

FIAT (BR)

UNO CS 1116 -- 01/88 ⇨

INNOCENTI

ELBA 1.3 146A5.000 08/91 ⇨ 12/96

LANCIA

DELTA I 1.1 831B8.000 01/86 ⇨ 12/90

DELTA I 1.3 1831B.000, 3831B.000, 831A2.000, 831B.000 09/79 ⇨ 10/92

PRISMA 1.3 831A2.000 01/83 ⇨ 12/89

KW 430 177/1



3

PICK-UPS

Adatt./Suitable: MARELLI

FIAT

9940429

FORD

1 641 614

INNOCENTI

9940429

LANCIA

9940429

MAGNETI MARELLI

610 453 24 *N

713 269 01

*N Available pick-up coil only-not the distributor assy

- Fornito solo impulsore, no lo spinterogeno completo

- Disponible seulement capteur, sans l'allumeur

- Erhältlich nur impulsgeber, ohne Zündverteiler

- Disponible solamente captador sin distribuidor

03 Supplied until depletion

- Fornibile fino ad esaurimento delle scorte

- Fourni jusqu'à épuisement du stock

- Lieferbar solange vorrat reicht

- Suministrado hasta el stock termina

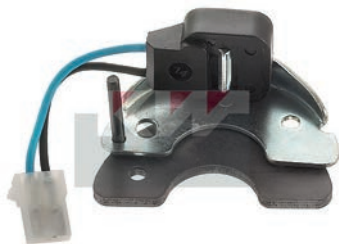

L	ohm	Pick-Up
---	830	Coil

LANCIA

DELTA I 2.0 16V HF Evo Integrale	831E5.000	06/93 ⇒ 01/94
DELTA I 2.0 16V HF Integrale	831D5.000	03/89 ⇒ 09/91
DELTA I 2.0 HF Integrale	831B5.000, 831C5.000, 831C5.046	11/86 ⇒ 12/92
DELTA II 1.4 i.e.	160A1.046	10/94 ⇒ 08/99
DELTA II 2.0 16V	836A3.000	06/93 ⇒ 08/99
PRISMA 1.6 i.e.	831B7.000	05/86 ⇒ 12/89
PRISMA 2.0 i.e. Trazione integrale	831B4.000	04/86 ⇒ 12/89

KW 430 178M



04

PICK-UPS

Adatt./Suitable: MARELLI

PEUGEOT

5904 F1

03 Supplied until depletion

- Fornibile fino ad esaurimento delle scorte

- Fourni jusqu'à épuisement du stock

- Lieferbar solange vorrat reicht

- Suministrado hasta el stock termina

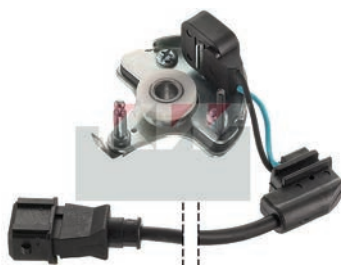

L	ohm	Pick-Up
800	830	Coil



PEUGEOT

505 2.0 | 106E(XN1A) | 09/85 ⇒ 09/95

KW 430 180M



3,5

PICK-UPS

Adatt./Suitable: MARELLI

FIAT

9939786

9941720

LANCIA

9939786

MAGNETI MARELLI

611 101 03 *N

611 101 26 *N

713 277 01

713 474 01

PIAGGIO

498325

*N Available pick-up coil only-not the distributor assy

- Fornito solo impulsore, no lo spinterogeno completo

- Disponible seulement capteur, sans l'allumeur

- Erhältlich nur impulsgeber, ohne Zündverteiler

- Disponible solamente captador sin distribuidor

03 Supplied until depletion

- Fornibile fino ad esaurimento delle scorte

- Fourni jusqu'à épuisement du stock

- Lieferbar solange vorrat reicht

- Suministrado hasta el stock termina



L	ohm	Pick-Up
---	830	Coil

FIAT

FIORINO II 1.0 iE	156A2.246	11/92 ⇒ 04/96
PALIO 1.1	178B9.033	07/97 ⇒ 10/03
PANDA I 1.1	156C.046	05/91 ⇒ 03/95
PANDA I 1000	156A2.100, 156A3.000	01/85 ⇒ 12/92
PANDA I 1000 4x4	156A2.100, 156A2.246, 156A3.000	01/86 ⇒ 12/94
PANDA I 1000 Fire [CHE]	156A2.146	11/87 ⇒ 04/91
PANDA I 1000 Fire [DEU]	156A2.048	01/86 ⇒ 07/89
PANDA I 1000 i.e.	156A2.246	08/92 ⇒ 02/04
PANDA I 1000 i.e. Cat	156A2.246	10/87 ⇒ 08/98
PANDA I 1100 i.e.	156C.046	01/86 ⇒ 04/91
PANDA I 1100 Trekking 4x4	156C.046	10/91 ⇒ 07/04
PANDA I 750 Cat	156A4.048	01/95 ⇒ 10/03
PANDA I 750 Fire	156A4.048	11/88 ⇒ 04/91
TIPO I 1.1	160A3.000	01/88 ⇒ 10/91
UNO 1.0	146A2.166	11/94 ⇒ 08/00
UNO 45 1.0	156A2.000, 156A2.100	06/86 ⇒ 12/93
UNO 45 1.0 Fire	--	01/83 ⇒ 12/89
UNO 45 i.e. 1.0	156A2.246	10/84 ⇒ 10/95
UNO 50 1.1	156C.046	01/90 ⇒ 12/93
UNO 50 i.e. 1.1	146C3.000	06/92 ⇒ 12/93
UNO 60 1.1	160A3.000	04/89 ⇒ 12/92
UNO Mondo 1.0	146A2.166	01/98 ⇒
UNO Mondo 1.0 [IND]	146A2.166	01/98 ⇒

LANCIA

Y10 1.0 Fire	156A2.100	06/85 ⇒ 06/91
Y10 1.0 Fire Catalytic-Conv	156A2.246	10/87 ⇒ 02/92
Y10 1.0 Fire Trazione integrale	156A2.000, 156A2.100, 156A2.246	12/86 ⇒ 02/92
Y10 1.1 i.e. Fire	156C.000	08/89 ⇒ 06/92
Y10 1.1 i.e. Fire Trazione integrale	156C.000	08/89 ⇒ 06/92
Y10 1.1 i.e. Fire	156C.046	07/89 ⇒ 09/95

KW 430 182

 3,5

PICK-UPS

Adatt./Suitable: **MARELLI****MAGNETI MARELLI**
DT 458 BX *N**SEAT**

030 905 205 AE *N

VW

030 905 205 AE *N

***N Available pick-up coil only-not the distributor assy**

- Fornito solo impulsore, no lo spinterogeno completo
- Disponible seulement capteur, sans l'allumeur
- Erhältlich nur impulsgeber, ohne Zündverteiler
- Disponible solamente captador sin distribuidor

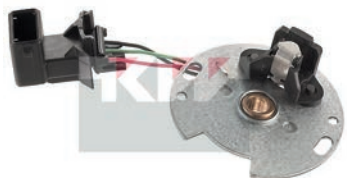

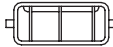
L	ohm	Pick-Up	
---	---	Hall	

SEAT

CORDOBA 1.0 i	AER	09/96 ⇨ 10/02
CORDOBA 1.4	ANX	12/97 ⇨ 04/99
CORDOBA 1.4 i	AKV, APQ	06/94 ⇨ 12/02
CORDOBA 1.4 i 16V	AFH	09/96 ⇨ 10/02
CORDOBA 1.6 i	AEE, ALM	02/93 ⇨ 12/02

VW

GOLF III 1.4	AEX, AEX	10/91 ⇨ 04/99
GOLF III 1.6	AEE	09/92 ⇨ 08/97





MODULES

-MODULI -MODULES -MODULE -MODULOS

(A) P/NRS. - NOTES

- CODICI - NOTE
- RÉFS. - NOTES
- ARTIKEL-NR. - ANMERKUNGEN
- CODIGOS - NOTAS

465 076  **3,5**

IGNITION MODULES

Adatt./Suitable:

AUDI
4D0 905 351

BOSCH
0 227 100 030
0 227 100 211
0 227 100 212

SEAT
4D0 905 351

SKODA
4D0 905 351

VW
4D0 905 351

03 Supplied until depletion

- Fornibile fino ad esaurimento delle scorte
- Fourni jusqu'à épuisement du stock
- Lieferbar solange vorrat reicht
- Suministrado hasta el stock termina

1114 Supplied with heat conducting silicone grease capsule

- Fornito con capsula di grasso termico al silicone
- Fourni avec capsule contenant graisse thermique au silicone
- Geliefert mit Thermo-Silikonfettkapsel
- Suministrado con capsula de grasa termica de silicona

(A)

1 # KW

2 OEM P/NRS.

- CODICI ORIGINALI
- RÉFS. D'ORIGINE
- ORIGINALTEILE-NR.
- CODIGOS ORIGINALES

3 PACKAGING SIZE

- FORMATO CONFEZIONE
- FORMAT DU CONDITIONNEMENT
- ABPACKENSGROESSE
- TAMAÑO DEL ENVASE

4 NOTE

- NOTE
- NOTES
- BERMERKUNGEN
- NOTAS

(B) PICTURE + TECHNICAL INFO

- FOTO + INFORMAZIONE TECNICA
- ILLUSTRATION + INFORMATION TECHNIQUE
- BILD + TECHNISCHE INFO
- FOTO + INFORMACIÓN TÉCNICA



(C) APPLICATION LIST

- GUIDA APPLICAZIONI
- LISTE D'APPLICATIONS
- ANWENDUNGSTABELLE
- LISTA DE APLICACIONES

AUDI		
A3 I 1.8 T	AGU	12/96 ⇨ 05/03
A3 I 1.8 T quattro	AGU	12/96 ⇨ 05/03
A4 I 1.8 T	AEB	01/95 ⇨ 09/01
A4 I 1.8 T quattro	AEB	01/95 ⇨ 09/01
A4 II 1.8 T	AVJ	11/00 ⇨ 07/02
A4 II 1.8 T quattro	AVJ	11/00 ⇨ 07/02
A6 I S6 Plus quattro	AHK	04/96 ⇨ 12/97
A6 II 1.8 T	AEB	01/97 ⇨ 01/05
A6 II 1.8 T quattro	AEB	02/97 ⇨ 01/05
A8 I 3.7	AEW, AKJ	07/95 ⇨ 12/98
A8 I 3.7 quattro	AEW, AKJ	07/95 ⇨ 11/98
A8 I 4.2 quattro	ABZ, AEM, AGH, AKG	03/94 ⇨ 11/98
A8 I S8 quattro	AHC, AKH	07/96 ⇨ 06/99
SEAT		
ALHAMBRA I / II 1.8 T 20V	AJH	10/97 ⇨ 03/10
LEON I 1.8 20V T	APP	11/99 ⇨ 06/06
SKODA		
OCTAVIA I 1.8 T	AGU, ARX, AUM	08/97 ⇨ 12/10
OCTAVIA I 1.8 T 4x4	ARX	05/01 ⇨ 05/06
OCTAVIA I RS 1.8 T	AUQ	05/01 ⇨ 01/06

(B)

1 PICTURE

- FOTO
- PHOTO
- BILD
- FOTO

KW 465 004



3,5

IGNITION MODULES

Adatt./Suitable:

AUDI

211 905 351

BMW

12 14 1 244 089
12 14 1 244 191
12 14 1 244 477

BOSCH

0 227 100 100
0 227 100 101
0 227 100 103
0 227 100 104
0 227 100 113
0 227 100 118
0 227 100 137
0 227 100 138
0 227 100 139
1 227 022 008

GENERAL MOTORS

90 008 145
90 114 676
90 140 187

LADA

2108-3734910-10
3700-3118583

MAGNETI MARELLI

940038500010

OPEL

12 08 241
12 08 246

SAAB

93 90 220

SCANIA

2573826

SEAT

SE 021913.010A

SIEMENS

2576 12.70.01
5WK 6105

TELEFUNKEN

318 738
335 622
339 109

VAUXHALL

90006145
90114676
90140187

VW

211 905 351
211 905 351 A
211 905 351 B
211 905 351 D
211 905 351 E

1114 Supplied with heat conducting silicone grease capsule

- Fornito con capsula di grasso termico al silicone
- Fourni avec capsule contenant graisse termique au silicone
- Geliefert mit Thermo-Silikonfettkapsel
- Suministrado con capsula de grasa termica de silicona



HALL TYPE MODULE

AUDI

80 II 1.6	WV	08/78 ⇒ 07/86
80 III 1.8 quattro	SD	09/86 ⇒ 08/90
80 III 1.8 S quattro	JN	09/86 ⇒ 09/91
90 II 2.2 E quattro	9C54	04/87 ⇒ 09/91
100 III 1.8	DR	08/82 ⇒ 12/87
100 III 1.9	WH	08/82 ⇒ 07/84
100 III 2.2	KZ	10/84 ⇒ 09/86
200 II 2.2	KU	08/84 ⇒ 07/85
COUPE 2.2 GT	9C54	09/84 ⇒ 10/88
COUPE 2.2 quattro	9C54, JT	10/84 ⇒ 10/88

OPEL

KADETT E 1.6 S	16S	09/84 ⇒ 08/86
KADETT E 1.8	18SE	01/86 ⇒ 08/91
KADETT E 1.8 GSI	18E	09/84 ⇒ 08/86
KADETT E 1.8 i	18E	09/84 ⇒ 08/86

SAAB

90 2.0	B20I	08/84 ⇒ 08/87
900 I 2.0-16	B202XI	01/86 ⇒ 12/88
900 I 2.0 c	B201XC	09/79 ⇒ 12/88
900 I 2.0 i	0TLE4G15, B201XI	11/80 ⇒ 08/90
900 I 2.0 Turbo	B201XL	01/86 ⇒ 12/91
900 I 2.0 Turbo-16	B202L, B202XL	11/85 ⇒ 06/94
900 I 2.0 Turbo-16 S	B202XL	01/84 ⇒ 06/94
900 I 2.0 Turbo-16 S Cat	B202XL	01/89 ⇒ 12/93
9000 2.0-16 Turbo	B202XL	09/84 ⇒ 08/93
9000 2.0-16 Turbo CD	B202XL	09/88 ⇒ 08/93

VW

PASSAT II 1.3	79SU16	08/80 ⇒ 07/86
PASSAT II 1.6	DT	08/80 ⇒ 03/88
PASSAT II 1.8	DS	01/83 ⇒ 03/88
PASSAT II 1.8 Syncro	DS	01/86 ⇒ 03/88
PASSAT II 1.9	WN	01/81 ⇒ 07/83
PASSAT II 2.0	JS	08/83 ⇒ 03/88
PASSAT II 2.0 Syncro	JS	05/84 ⇒ 03/88
PASSAT II 2.2	KX	01/85 ⇒ 03/88
POLO II 1.0	HZ	01/85 ⇒ 09/94
POLO II 1.3	MH	08/83 ⇒ 07/88
POLO II 1.3 Cat	MH, NZ	07/87 ⇒ 09/94
DERBY 1.3	GK, HK	09/82 ⇒ 12/84
QUANTUM 2.1	--	01/81 ⇒ 12/89
SANTANA 1.6	DT	08/81 ⇒ 12/84
SANTANA 1.8	DS	01/83 ⇒ 12/84
SANTANA 1.9	WN	08/81 ⇒ 07/83
SANTANA 2.0	JS	08/83 ⇒ 12/84
SCIROCCO II 1.3	GF	08/80 ⇒ 12/83

KW 465 005



3,5

IGNITION MODULES

Adatt./Suitable:

ALFA ROMEO

60750065

BMW

12 14 1 266 702
12 14 1 273 217
12 14 1 273 298
12 14 1 274 698

BOSCH

0 227 100 102
0 227 100 110
0 227 100 111
0 227 100 112
0 227 100 123

CITROËN

5945 48
91 504 912
91 506 338
97 522 876
97 530 125
97 531 922
97 532 831

DUCELLIER

521 008
521 013
594 525
2 528 008 A
7 350 370 2

FIAT

9753012580
9753283180
9753293180

GENERAL MOTORS

90 295 499

MAGNETI MARELLI

648 330 20
BKL 2 A
MTR 01

OPEL

12 08 248

PEUGEOT

5927 90
5945 02
5945 03
5945 25
5945 31
5945 33
5945 39
5945 48

SIEMENS

17-5607

TALBOT

0057 18 9700
9150 49 1280
9150 63 3880

ALFA ROMEO

33 I 1.3	AR30168	10/84 ⇒ 12/89
33 I 1.3 i.e.	AR30168	05/83 ⇒ 12/89
33 I 1.5 4x4	AR30508	12/86 ⇒ 03/89

BMW

3 II 316	M10B18(184VC), M10B18(184VD)	09/83 ⇒ 06/88
3 II 323 i	M20B23(236EC)	09/82 ⇒ 09/86
3 I 315	M10B16(164VB)	03/81 ⇒ 03/84
5 II 518	M10B18(184VC), M10B18(184VD)	06/81 ⇒ 09/84



BMW

5 II 520 i	M20B20(206EA), M20B20(206KA)	06/81 ⇒ 12/87
5 II 525 i	M30B25(256EA)	06/81 ⇒ 12/87
5 II 528 i	M30B28(286EA)	06/81 ⇒ 12/87
5 II 528 i [USA]	--	01/81 ⇒ 12/87
5 I 518	M10B18(184VB)	07/74 ⇒ 05/81
6 I 628 CSi	M30B28	09/79 ⇒ 08/87
6 I 633 CSi	05U18	10/75 ⇒ 08/84
6 I 635 CSi	M30B35(Motronic, 9.3:1)	06/78 ⇒ 04/82
7 I 728	M30B28	05/77 ⇒ 08/79
7 I 728 i	M30B28	09/77 ⇒ 08/86
7 I 730	M30B30	05/77 ⇒ 08/79

CITROËN

AXEL 11	--	01/84 ⇒ 03/91
BX 1.1	109LA, H1A	04/86 ⇒ 06/91
BX 1.4	150C, K1F, K2D	07/86 ⇒ 12/94
BX 1.4 E	150B(XY8), 150J, 150Y, K1F, KAZ	09/82 ⇒ 12/94
BX 1.6	182A, B2C, B6D, B6E	01/87 ⇒ 12/94
BX 1.9	159B, 159C, D6U, DKK	05/85 ⇒ 12/94
BX 1.9 GTi	D6D, D6K	01/87 ⇒ 01/92
BX 1.9 GTi 16V	159K, DFK	01/87 ⇒ 12/94
BX 14	150C	01/86 ⇒ 02/93
BX 14 E	150A, 150C, K1G	10/82 ⇒ 02/93
BX 15	B1E(XU51C)	01/87 ⇒ 05/92
BX 16	171A, 171B, 171C, 171D, 180Z, 23DH, B1E(XU51C), BAZ(XU5CP), BAZ(XU5CP)	10/82 ⇒ 12/94
BX 19	159A, D2A(XU92C), D2C(XU92C), D2E, D6A(XU9J2), DKZ(XU9JA)	09/84 ⇒ 12/94
BX 19 Cat	DFZ(XU9J1)	07/86 ⇒ 12/94
BX 19 E 4x4	D2F	04/89 ⇒ 02/93
BX 19 GTi	D6A(XU9J2), DKZ(XU9JA)	07/86 ⇒ 02/93
BX 19 GTi 16V	D6C(XU9JA), DFU(XU9JA)	09/87 ⇒ 02/93
BX 19 GTi 4x4	DKZ(XU9JA)	06/88 ⇒ 02/93
C15 1.0	108C	10/84 ⇒ 07/88
C15 1.0 E	TU9K	11/92 ⇒ 07/96
C15 1.1	109K, E1A, XW7	10/84 ⇒ 12/96
C15 1.3	G1A	07/87 ⇒ 05/88
C15 1.4	150D(XY7)	05/87 ⇒ 10/92
C15 1.4 E	150D(XY7)	05/87 ⇒ 12/96
CX II 20 RE	829A5	08/85 ⇒ 12/92
CX II 22 TRS	J6TA500	07/85 ⇒ 12/92
GS A 1.3	G13/625	07/78 ⇒ 07/86
XMI 2.0 i	RDZ(XU10MZ)	05/89 ⇒ 04/94
LNA 1.1	109/5E	07/82 ⇒ 04/85
VISA 11 E	109K	09/78 ⇒ 06/88
ZX 1.9	D6E(XU9JA)	03/91 ⇒ 06/97
ZX 1.9 i	DKZ(XU9JA), XU9JA	03/91 ⇒ 06/97

FIAT

DUCATO I 1.8	169B	01/82 ⇒ 12/88
DUCATO I 2.0	170B, 170D, 170C(XN1T), XN1T	01/82 ⇒ 05/94
DUCATO I 2.0 4x4	170D	06/90 ⇒ 05/94
TALENTO 2.0	170B	03/89 ⇒ 03/94

OPEL

ASTRA F 1.4	14NV	09/91 ⇒ 09/93
CORSA A 1.2	12NC, E12GV	09/82 ⇒ 08/90
CORSA A 1.2 N	12NC, E12GV	01/85 ⇒ 10/87
CORSA A 1.4 S	14NV	09/89 ⇒ 03/93
KADETT E 1.4 S	14NV	07/89 ⇒ 02/93
VECTRA A 1.4 S	14NV	04/88 ⇒ 06/92

PEUGEOT

104 1.0	108C(XV8)	09/83 ⇒ 06/88
205 I 1.0	108C(XV8)	02/83 ⇒ 12/90
205 I 1.1	109F(XW7), 109N(XW7)	02/83 ⇒ 10/87
205 I 1.3	G1A	02/84 ⇒ 10/87
205 I 1.4	150(XY6B), 150B(XY8), 150D(XY7), 150G(XY7), 150H(XY8), J2	01/83 ⇒ 12/90
205 I 1.5	Y2/K	02/84 ⇒ 10/87
205 I 1.6	B1A(XU51C), B1E(XU51C), BAZ(XU5CP)	08/86 ⇒ 10/87
205 I 1.6 GTI	180A(XU5J), B6D(XU5JA), XU5J1	01/83 ⇒ 12/90
205 I 1.9 GTI	D6B(XU9JA), DFZ(XU9J1)	10/86 ⇒ 10/87
205 II 1.1	109N(XW7)	10/87 ⇒ 10/90
205 II 1.1 XA	E1	07/87 ⇒ 10/88
205 II 1.2	F1	01/87 ⇒ 12/90
205 II 1.3	G1A	08/90 ⇒ 07/92
205 II 1.4	150(XY6B), 150B(XY8), 150D(XY7), 150G(XY7), 150H(XY8), J2	01/87 ⇒ 12/94
205 II 1.4 CJ	150D(XY7), 150G(XY7)	03/88 ⇒ 05/89
205 II 1.4 CT	150B(XY8), 150H(XY8)	04/86 ⇒ 12/88
205 II 1.6	B1A(XU51C), B1E(XU51C), BAZ(XU5CP)	10/87 ⇒ 09/98
205 II 1.6 CTI	180A(XU5J), 180Z(XU5J)	03/86 ⇒ 10/90
205 II 1.6 GTI	180A(XU5J), 180Z(XU5J), XU5JA	10/87 ⇒ 12/94
205 II 1.9 CTI	DFZ(XU9J1)	10/87 ⇒ 12/94

PEUGEOT		
205 II 1.9 GTI	D6B(XU9JA), DKZ(XU9JAZ)	10/87 ⇒ 09/98
205 II 1.9 GTI Cat	DFZ(XU9J1)	10/87 ⇒ 07/94
305 1.5	117(XRS5)	05/80 ⇒ 09/82
309 I 1.1	E1	10/85 ⇒ 07/89
309 I 1.3	G1A, G2S	10/85 ⇒ 08/89
309 I 1.3 XL	--	09/86 ⇒ 08/89
309 I 1.5	Y2/K	06/87 ⇒ 12/89
309 I 1.6	--, 180Z(XU5J), B1A(XU51C), B1D(XU51C), B1E(XU51C), B6B(XU5J), J2, XU5JA	10/85 ⇒ 07/89
309 I 1.6 Cat	BAZ(XU5CP)	09/86 ⇒ 12/89
309 I 1.9	D2B(XU9S), DFZ(XU9J1), XU92C	10/85 ⇒ 07/89
309 I 1.9 GTI	D6B(XU9JA)	10/86 ⇒ 07/89
309 II 1.6	18EM, J2, XU5JA	07/89 ⇒ 12/93
309 II 1.6 GTI	--	09/89 ⇒ 10/93
309 II 1.9	XU92C	07/89 ⇒ 12/93
309 II 1.9 GTI	DKZ(XU9JAZ)	07/89 ⇒ 12/93
309 II 1.9 GTI 16V	D6C(XU9J4)	08/89 ⇒ 07/90
405 I 1.6	B1E(XU51C), BDZ(XU5M)	07/87 ⇒ 12/92
405 I 1.6 4x4	BDZ(XU5M)	04/88 ⇒ 07/92
405 I 1.6 SRI 4x4	BDZ(XU5M)	04/88 ⇒ 07/92
405 I 1.9	D6C(XU9J4), DFZ(XU9J1), DKZ(XU9JAZ), XU9J2, XU9J2/D6D	01/87 ⇒ 12/92
405 I 1.9 4x4	D6C(XU9J4), DKZ(XU9JAZ)	06/87 ⇒ 07/92
405 I 1.9 Antipollution	XU92C	01/87 ⇒ 12/92
405 I 1.9 Injection	DFZ(XU9J1)	07/87 ⇒ 12/92
405 I 1.9 Sport MI-16	D6C(XU9J4), DFW(XU9J4Z)	06/87 ⇒ 11/92
405 I 1.9 Sport MI-16 4x4	DFW(XU9J4Z)	06/87 ⇒ 07/92
405 I 1.9 Trazione integrale	D6C(XU9J4), DFZ(XU9J1)	06/87 ⇒ 07/92
505 2.0	106E(XN1A)	09/85 ⇒ 09/95
505 2.0 TI, STI	829(ZEJ)	08/79 ⇒ 10/86
505 2.1 i	XN9T	01/83 ⇒ 12/88
505 2.2	851(ZDJ), 851X(ZDJL)	05/81 ⇒ 12/93
505 2.2 GTI	851B(ZDJL)	08/83 ⇒ 12/93
J5 1.8	169B(XM7T)	01/83 ⇒ 11/88
J9 2.0	XN1P	03/80 ⇒ 06/87
VAUXHALL		
ASTRA III 1.4	14NV	09/91 ⇒ 09/93
ASTRA III 1.4 S	14NV	09/91 ⇒ 02/98

KW 465 007  **3,5**

IGNITION MODULES

Adatt./Suitable:

AUDI

191 905 351 B

BOSCH

0 227 100 142

0 227 100 143

0 227 100 147

SAAB

89 80 534

SEAT

191 905 351 B

TELEFUNKEN

339 373

VW

191 905 351 A

191 905 351 B

Eliminated on 28-06-2021. Please verify the availability through our local distributors

• Eliminato il 28-06-2021. Verificare la disponibilità presso i nostri distributori

• Eliminé le 28-06-2021. Vérifier la disponibilité auprès de nos distributeurs sur place

• Am 28-06-2021 gestrichen. Evtl. Verfügbarkeit bitte bei unseren Händlern prüfen

• Eliminado en fecha 28-06-2021. Verificar la disponibilidad a través de nuestros distribuidores locales



HALL TYPE MODULE

AUDI		
80 II 1.3	DT, JU, SA	09/78 ⇒ 07/86
80 II 1.6	DS, JN, SF	01/83 ⇒ 08/86
80 II 1.8	JN, JV	08/84 ⇒ 08/86
80 II 1.8 CC quattro	DZ, MU, PV	06/84 ⇒ 03/87
80 II 1.8 GTE	HP, JS	10/83 ⇒ 09/84

AUDI		
80 II 2.0 quattro	JS	10/83 ⇒ 09/84
80 III 1.4	SE	08/86 ⇒ 07/88
80 III 1.6	ABB, PP, RN, RNA	09/86 ⇒ 10/91
80 III 1.8	RU, SD	09/86 ⇒ 01/90
80 III 1.8 E	DZ	06/86 ⇒ 08/91
80 III 1.8 S	JN, JV, NE, PM, SF	08/86 ⇒ 10/91
80 III 2.0	AAD	10/90 ⇒ 08/91
80 III 2.0 E	3A	08/88 ⇒ 10/90
80 III 2.0 E 16V	6A	03/90 ⇒ 09/91
80 IV 1.6	ABB	03/92 ⇒ 05/93
90 I 1.8	JN	06/84 ⇒ 03/87
90 I 2.0	HP, JL, JS, SK	10/84 ⇒ 03/87
90 I 2.0 quattro	JS	08/84 ⇒ 08/86
90 I 2.2	9C54, HY, KX	10/84 ⇒ 03/87
90 I 2.2 E quattro	9C54	11/84 ⇒ 03/87
90 II 2.0	PS	07/88 ⇒ 09/91
90 II 2.0 20V	NM	08/89 ⇒ 07/91
90 II 2.2 E	9C54	04/87 ⇒ 07/91
90 II 2.3 E	NG	04/87 ⇒ 09/91
90 II 2.3 E 20V	7A	08/88 ⇒ 07/91
100 III 1.8	DS, JW, NP, SH	08/83 ⇒ 12/90
100 III 1.8 Cat	4B, PH	03/85 ⇒ 11/90
100 III 1.8 Cat quattro	4B	08/85 ⇒ 11/90
100 III 1.8 quattro	NP, SH	10/84 ⇒ 07/90
100 III 2.0	KP	08/84 ⇒ 12/87
100 III 2.0 E	KP	01/85 ⇒ 12/87
100 III 2.2 Cat	KU	06/89 ⇒ 11/90
100 III 2.2 Cat quattro	KU	06/89 ⇒ 11/90
100 IV 1.6	ABB	03/92 ⇒ 07/93
COUPE 1.8	DZ	08/89 ⇒ 07/91
COUPE 2.2	9C54	11/88 ⇒ 07/91
COUPE 2.2 GT	9C54	09/84 ⇒ 10/88
COUPE 2.2 quattro	9C54, JT	10/84 ⇒ 07/91

SAAB		
900 I 2.0 -16	5B6304G5	01/89 ⇒ 06/94
900 I 2.0 i	0TLE4G15, B201XI	11/80 ⇒ 08/90
900 I 2.0 S Turbo-16	B202S	07/91 ⇒ 06/94
900 I 2.0 Turbo	B201XL	01/86 ⇒ 12/91
900 I 2.0 Turbo-16	B202L, B202XL	11/85 ⇒ 06/94
900 I 2.0 Turbo-16 S	B202XL	01/84 ⇒ 06/94
900 I 2.0 Turbo-16 S Cat	B202XL	01/89 ⇒ 12/93

SEAT		
TOLEDO I 1.6 i	1F	05/91 ⇒ 03/99
TOLEDO I 1.8 16V	PL	05/91 ⇒ 03/99
TOLEDO I 1.8 i	RP	05/91 ⇒ 12/96

VW		
POLO II 1.0	AAK, HZ	01/85 ⇒ 09/94
POLO II 1.0 Cat	AAK	08/89 ⇒ 09/94
POLO II 1.3	3F, MH	08/83 ⇒ 09/94
POLO II 1.3 Cat	2G, 3F, MH, NZ	07/87 ⇒ 09/94
POLO II 1.3 G40	PY	01/87 ⇒ 08/90
JETTA II 1.0	HZ	08/85 ⇒ 10/91
JETTA II 1.3	MH	01/84 ⇒ 06/87
JETTA II 1.3 Cat	2G, MH, NZ	06/87 ⇒ 12/91
JETTA II 1.6	ABN, EZ, EZA, HM, PN, RF	12/83 ⇒ 07/92
JETTA II 1.8	EV, GU, GX, PB, RD, RH, RV	01/84 ⇒ 10/91
JETTA II 1.8 16V	KR, PL	08/86 ⇒ 10/91
JETTA II 1.8 Cat	GX, PF, RP	01/87 ⇒ 10/91
JETTA II 1.8 G60	PG	04/90 ⇒ 07/91
JETTA II 1.8 Syncro	3E82, GU, GX, RH, RP	08/85 ⇒ 07/91
JETTA II 1.8i GT	GZ	12/83 ⇒ 07/88
CADDY I 1.8	JH	08/85 ⇒ 07/92
CORRADO 1.8 16V	KR	04/89 ⇒ 07/92
CORRADO 1.8 G60	PG	09/88 ⇒ 09/93
CORRADO 2.0 i	ADY	04/93 ⇒ 12/95
CORRADO 2.0i 16V	7TZ220XS560	08/91 ⇒ 12/95
CORRADO 2.9 VR6	ABV	08/91 ⇒ 12/95
GOLF I 1.6	EW, HN	08/83 ⇒ 04/92
GOLF I 1.8	2H, DX, EX, JH, KT	08/82 ⇒ 04/93
GOLF II 1.0	HZ	08/85 ⇒ 10/91
GOLF II 1.3	MH	08/83 ⇒ 06/87
GOLF II 1.3 Cat	2G, NZ	06/86 ⇒ 12/92
GOLF II 1.6	ABN, EZ, PN, RF	08/83 ⇒ 12/92
GOLF II 1.6 [CHE] [SWE]	HM	08/83 ⇒ 07/88
GOLF II 1.6 G	EZA, PN	08/86 ⇒ 07/91
GOLF II 1.8	GU, GX, RH, RV	08/84 ⇒ 10/91
GOLF II 1.8 [CHE] [SWE]	HV	04/84 ⇒ 07/87
GOLF II 1.8 GTI	EV, PB, RD	08/83 ⇒ 10/91
GOLF II 1.8 GTI 16V	KR, PL	02/86 ⇒ 10/91
GOLF II 1.8 GTI Cat	PF	01/87 ⇒ 10/91
GOLF II 1.8 GTI G60	PG	04/90 ⇒ 07/91
GOLF II 1.8 GTI G60 Syncro	1H, PG	08/88 ⇒ 12/91
GOLF II 1.8 i	RP	08/87 ⇒ 07/91
GOLF II 1.8 i Cat	GX, RP	08/87 ⇒ 10/91
GOLF II 1.8 i Cat Syncro	RP	08/87 ⇒ 10/91
GOLF II 1.8 Rallye syncro	1H, PG	08/88 ⇒ 07/91
GOLF II 1.8 Syncro	3E82, GU, GX, RH	02/86 ⇒ 07/91
GOLF II 1.8i GTI [CHE] [SWE]	GZ	01/84 ⇒ 07/87

VW		
GOLF II 1.8i GTI [SWE]	GZ	08/87 ⇒ 07/88
PASSAT III 1.6	1F, EZ	04/88 ⇒ 07/92
PASSAT III 1.8	KR, PB, PF	04/88 ⇒ 09/93
PASSAT III 1.8 16V	KR	04/88 ⇒ 12/89
PASSAT III 1.8 GL	KR	08/91 ⇒ 09/93
SCIROCCO II 1.6	EW, HN	01/83 ⇒ 12/89
SCIROCCO II 1.8	DX, EX, JH, KT	08/82 ⇒ 07/92
SCIROCCO II 1.8 16V	KR, PL	10/85 ⇒ 07/92
TRANSPORTER III 1.9	DF, DG	08/82 ⇒ 07/92
TRANSPORTER III 1.9 Syncro	DG	11/84 ⇒ 07/92
TRANSPORTER III 2.1	DJ, MV, SR	08/84 ⇒ 07/92
TRANSPORTER III 2.1 Cat	MV	06/89 ⇒ 07/92
TRANSPORTER III 2.1 i	SS	07/89 ⇒ 07/92
TRANSPORTER III 2.1 Syncro	DJ, MV, SR	08/85 ⇒ 07/92

KW 465 020  **3,5**

IGNITION MODULES

Adatt./Suitable:

FIAT

9940095

INNOCENTI

9940095

LANCIA

9940095

MAGNETI MARELLI

064833040010

581701070000

648 330 40

BKL 4 A

PIAGGIO

498327



FIAT		
DUNA 60 1.1	146A6.000	01/87 ⇒ 12/91
DUNA 70 1.3	146A5.000	01/87 ⇒ 12/91
ELBA 1.3	146A5.000	04/91 ⇒ 02/95
FIORINO I 1.1 60	146A9.000	11/86 ⇒ 04/88
FIORINO I 1.3	146A5.000	12/87 ⇒ 08/93
FIORINO II 1.0 IE	156A2.246	11/92 ⇒ 04/96
FIORINO II 1.3	146A5.000	01/88 ⇒ 12/94
FIORINO II 60 1.1	146A9.000	05/88 ⇒ 12/93
FIORINO II 70 1.3	146A5.000	01/88 ⇒ 12/94
PALIO 1.1	178B9.033	07/97 ⇒ 10/03
PANDA I 1.1	156C.046	05/91 ⇒ 03/95
PANDA I 1000	156A2.100, 156A3.000	01/85 ⇒ 12/92
PANDA I 1000 4x4	156A2.100, 156A2.246, 156A3.000	01/86 ⇒ 12/94
PANDA I 1000 Fire [CHE]	156A2.146	11/87 ⇒ 04/91
PANDA I 1000 Fire [DEU]	156A2.048	01/86 ⇒ 07/89
PANDA I 1000 i.e	156A2.246	08/92 ⇒ 02/04
PANDA I 1000 i.e. Cat	156A2.246	10/87 ⇒ 08/98
PANDA I 1100 i.e.	156C.046	01/86 ⇒ 04/91
PANDA I 1100 Trekking 4x4	156C.046	10/91 ⇒ 07/04
PANDA I 750 Cat	156A4.048	01/95 ⇒ 10/03
PANDA I 750 Fire	156A4.048	11/88 ⇒ 04/91
REGATA 70 1.3	138B2.000, 149A3.000	09/83 ⇒ 07/89
RITMO I 1.3	149A3.000	11/83 ⇒ 08/85
TEMPRA 1.4 i.e.	159A2.000	04/90 ⇒ 08/96
TIPO I 1.1	160A3.000	01/88 ⇒ 10/91
TIPO I 1.4	160A1.000	07/87 ⇒ 12/89
TIPO I 1.4 i.e.	159A2.000	05/89 ⇒ 04/95
UNO 1.0	146A2.166	11/94 ⇒ 08/00
UNO 45 1.0	156A2.000, 156A2.100	06/86 ⇒ 12/93
UNO 45 1.0 Fire	--	01/83 ⇒ 12/89
UNO 45 i.e. 1.0	156A2.246	10/84 ⇒ 10/95
UNO 50 1.1	156C.046	01/90 ⇒ 12/93
UNO 50 i.e. 1.1	146C3.000	06/92 ⇒ 12/93
UNO 60 1.1	146A4.048, 146A6.000, 160A3.000	02/88 ⇒ 12/92
UNO 60 1.1 SX	--	01/85 ⇒ 12/89
UNO CS 1.1	146A6.000	09/87 ⇒ 09/91
UNO Mondo 1.0	146A2.166	01/98 ⇒
UNO Mondo 1.0 [IND]	146A2.166	01/98 ⇒
FIAT (BR)		
UNO CS 1116	--	01/88 ⇒

INNOCENTI			
ELBA 1.3	146A5.000	08/91	⇒ 12/96
LANCIA			
DELTA I 1.1	831B8.000	01/86	⇒ 12/90
DELTA I 1.3	1831B.000, 3831B.000, 831A2.000, 831B.000	09/79	⇒ 10/92
PRISMA 1.3	831A2.000	01/83	⇒ 12/89
Y10 1.0 Fire	156A2.100	06/85	⇒ 06/91
Y10 1.0 Fire Catalytic-Conv	156A2.246	10/87	⇒ 02/92
Y10 1.0 Fire Trazione integrale	156A2.000, 156A2.100, 156A2.246	12/86	⇒ 02/92
Y10 1.1 i.e Fire	156C.000	08/89	⇒ 06/92
Y10 1.1 i.e Fire Trazione integrale	156C.000	08/89	⇒ 06/92
Y10 1.1 i.e Fire	156C.046	07/89	⇒ 09/95

KW 465 025



IGNITION MODULES

Adatt./Suitable:

DELCO REMY

1 601 0892
1 977 958
1 979 107
D-1957
D-1958
D-1961

GENERAL MOTORS

1 977 958
1 979 107
1 979 571
1 985 342
10 482 824
16 140 049
16 158 829

ISUZU

8-01979571-0
8-16140049-0

OPEL

12 11 582
12 11 591
12 37 504
62 37 753

03 Supplied until depletion

- Fornibile fino ad esaurimento delle scorte
- Fourni jusqu'à épuisement du stock
- Lieferbar solange vorrat reicht
- Suministrado hasta el stock termina

1114 Supplied with heat conducting silicone grease capsule

- Fornito con capsula di grasso termico al silicone
- Fourni avec capsule contenant graisse termique au silicone
- Geliefert mit Thermo-Silikonfettkapsel
- Suministrado con capsula de grasa termica de silicona

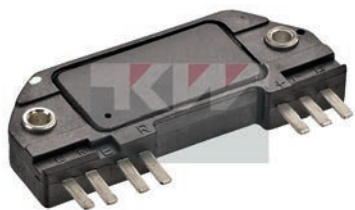

ISUZU

PICK-UP 3.1i V6 [USA]	LG6	01/90	⇒
RODEO 3.1i V6 [USA]	LG6	01/90	⇒ 12/92
TROOPER 3.2i V6 [USA]	--	01/88	⇒ 12/91

OPEL

ASCONA C 1.6 i Cat	C16LZ, C16NZ	09/86	⇒ 08/88
ASTRA F 1.6 i	C16NZ	09/91	⇒ 09/98
CORSA A 1.3	C13N	09/85	⇒ 10/87
CORSA A 1.3 i	C13N	09/86	⇒ 09/90
KADETT E 1.3 i Cat	C13N	09/85	⇒ 08/91
KADETT E 1.6 i	C16NZ	09/86	⇒ 07/94
KADETT E 1.6 i Cat	C16LZ, C16NZ	09/86	⇒ 02/93
VECTRA A 1.6 i	C16NZ, E16NZ, X16SZ	09/88	⇒ 11/95
VECTRA A 1.6 i Cat	C16NZ	09/88	⇒ 11/95

VAUXHALL

ASTRA III 1.6 i	C16NZ	09/91	⇒ 12/98
ASTRAVAN I 1.6 i	C16NZ	10/91	⇒ 08/98

KW 465 029



IGNITION MODULES

Adatt./Suitable:

DUCELLIER

2 528 001 A
7 350 260 2

FIAT

9942040

LANCIA

9942040

03 Supplied until depletion

- Fornibile fino ad esaurimento delle scorte
- Fourni jusqu'à épuisement du stock
- Lieferbar solange vorrat reicht
- Suministrado hasta el stock termina

1114 Supplied with heat conducting silicone grease capsule

- Fornito con capsula di grasso termico al silicone
- Fourni avec capsule contenant graisse termique au silicone
- Geliefert mit Thermo-Silikonfettkapsel
- Suministrado con capsula de grasa termica de silicona



FIAT

PANDA I 750 Cat	156A4.048	01/95	⇒ 10/03
PANDA I 750 Fire	156A4.048	11/88	⇒ 04/91
TIPO I 1.1	160A3.000	01/88	⇒ 10/91
UNO 45 1.0	156A2.000, 156A2.100	06/86	⇒ 12/93
UNO 45 1.0 Fire	--	01/83	⇒ 12/89
UNO 60 1.1	160A3.000	04/89	⇒ 12/92

LANCIA

Y10 1.0 Fire Trazione integrale	156A2.000	12/87	⇒ 02/90
Y10 1.1 i.e Fire	156C.000	08/89	⇒ 06/92
Y10 1.1 i.e Fire Trazione integrale	156C.000	08/89	⇒ 06/92

KW 465 034



IGNITION MODULES

Adatt./Suitable:

BOSCH

0 227 100 124
1 227 010 003
1 227 010 039

CITROËN

5945 51
96 048 070

GENERAL MOTORS

90 006 499

IVECO

7612955

OPEL

12 08 243

PEUGEOT

5945 51

PORSCHE

928 602 706 01

SAAB

40 23 149
59 60 059
75 03 600

SCANIA

4023149
5960059

VOLVO

1332584
13325840

03 Supplied until depletion

- Fornibile fino ad esaurimento delle scorte
- Fourni jusqu'à épuisement du stock
- Lieferbar solange vorrat reicht
- Suministrado hasta el stock termina

1114 Supplied with heat conducting silicone grease capsule

- Fornito con capsula di grasso termico al silicone
- Fourni avec capsule contenant graisse termique au silicone
- Geliefert mit Thermo-Silikonfettkapsel
- Suministrado con capsula de grasa termica de silicona



CITROËN

XM I 3.0	UFZ(ZPJ/Z)	05/89	⇒ 05/94
XM I 3.0 V6	SFZ(ZPJ/Z), UFZ(ZPJ/Z)	05/89	⇒ 06/94
XM I 3.0 V6 24V	SKZ(ZPJ4/Z), UKZ(ZPJ4/Z)	07/90	⇒ 06/94

CITROËN

XM II 3.0 V6	SFZ(ZPJ/Z), UFZ(ZPJ/Z)	05/94	⇒ 10/00
XM II 3.0 V6 24V	SKZ(ZPJ4/Z), UKZ(ZPJ4/Z)	05/94	⇒ 10/00

OPEL

KADETT E 1.6 S	16S	09/84	⇒ 08/86
KADETT E 1.8	18SE	01/86	⇒ 08/91
KADETT E 1.8 GSI	18E	09/84	⇒ 08/86
KADETT E 1.8 i	18E	09/84	⇒ 08/86
OMEGA A 3.0	3ONE	03/87	⇒ 09/90

PEUGEOT

605 3.0	UFZ(ZPJ), UKZ(ZPJ4/Z)	08/89	⇒ 09/99
605 3.0 SV 24	UKZ(ZPJ4/Z)	08/89	⇒ 09/99

PORSCHE

911 II 3.6 Carrera	M64.01, M64.02	12/88	⇒ 05/94
911 II 3.6 Carrera 4	M64.01	12/88	⇒ 05/94
911 II 3.6 Carrera RS	M64.03	06/91	⇒ 09/93
928 5.4 GTS	M28.49, M28.50	08/91	⇒ 11/95

SAAB

900 1.2.0 -16	5B6304GS	01/89	⇒ 06/94
9000 2.0 -16	5B6304GS, B202XI	12/85	⇒ 01/93
9000 2.0 -16 CS	5B6304GS	01/89	⇒ 12/98
9000 2.3 -16 CD	B234I	08/89	⇒ 12/98
9000 2.3 -16 CS	B234I	09/89	⇒ 12/98

KW 465 036



IGNITION MODULES

Adatt./Suitable:

GENERAL MOTORS

90 243 618 *J
90 360 314 *J
90 360 315 *J

HOLDEN

90243618 *J

OPEL

12 37 334 *J
12 37 464 *J

*J Supplied module only, without bracket

- Fornito solo il modulo, no la flangia
- Fourni le module seul, sans bride
- Geliefert nur das Modul, ohne Montageflansch
- Suministrado solo el módulo, sin base de montaje

03 Supplied until depletion

- Fornibile fino ad esaurimento delle scorte
- Fourni jusqu'à épuisement du stock
- Lieferbar solange vorrat reicht
- Suministrado hasta el stock termina

1114 Supplied with heat conducting silicone grease capsule

- Fornito con capsula di grasso termico al silicone
- Fourni avec capsule contenant graisse termique au silicone
- Geliefert mit Thermo-Silikonfettkapsel
- Suministrado con capsula de grasa termica de silicona



HOLDEN

BARINA 1.4 i	C14NZ	04/94	⇒ 07/97
BARINA_SB 1.2i	C12NZ	04/94	⇒ 07/97
COMBO 1.4 i	C14NZ	03/96	⇒ 07/97
COMBO_SB 1.4i	C14NZ	04/94	⇒ 07/97

OPEL

ASTRA F 1.4	14SE	09/92	⇒ 09/98
ASTRA F 1.4 i	C14NZ	09/91	⇒ 01/05
ASTRA F 1.4 Si	C14SE	03/92	⇒ 03/01
ASTRA F 1.6	16LZ2, 16NZ2	09/94	⇒ 09/98
ASTRA F 1.8 i	C18NZ	09/91	⇒ 09/98
COMBO B 1.2	C12NZ	07/94	⇒ 10/01
COMBO B 1.4	C14NZ	07/94	⇒ 10/01
CORSA A 1.2 i	C12NZ	09/89	⇒ 03/93
CORSA A 1.4 i	C14NZ	01/85	⇒ 03/93
CORSA A 1.4 Si	C14SE	09/91	⇒ 03/93
CORSA A 1.6 GSI	E16SE	05/88	⇒ 03/92
CORSA B 1.2 i	12NZ, C12NZ	03/93	⇒ 09/00
CORSA B 1.4 i	C14NZ	03/93	⇒ 09/00
KADETT E 1.4 i	C14NZ	01/90	⇒ 07/94
KADETT E 1.6	16SV	09/86	⇒ 12/91
KADETT E 1.6 i	16SV	07/89	⇒ 02/93
KADETT E 1.6 S	16SV	09/86	⇒ 08/91

OPEL			
OMEGA A 1.8 S	18SV	09/86 ⇒	03/94
VECTRA A 1.6	16SV, C16LZ2	09/88 ⇒	07/93
VECTRA A 1.6 i	C16NZ2	09/88 ⇒	11/95
VECTRA A 1.6 i Cat	C16NZ2	09/88 ⇒	11/95
VECTRA A 1.6 S	16SV	09/88 ⇒	05/93
VECTRA A 1.8 i	18SV	09/88 ⇒	10/90
VECTRA A 1.8 i Cat	C18NZ	03/90 ⇒	11/95
VECTRA A 1.8 S	18SV	09/89 ⇒	10/90
VECTRA B 1.6 i	16LZ2	10/95 ⇒	07/03
VAUXHALL			
ASTRA III 1.4 i	C14NZ, C14SE	03/91 ⇒	09/98
ASTRA III 1.8 i	C18NZ	09/91 ⇒	09/98
ASTRAVAN I 1.4 i	C14NZ	09/91 ⇒	08/95
COMBO B 1.2	C12NZ	07/94 ⇒	10/01
COMBO B 1.4	C14NZ	07/94 ⇒	10/01
CORSA B 1.2 i	C12NZ	03/93 ⇒	09/00
CORSA B 1.4 i	C14NZ	03/93 ⇒	09/00
CORSAVAN I 1.4 i	C14NZ	01/94 ⇒	09/00

KW 465 051



3,5

IGNITION MODULES

Adatt./Suitable:

AUDI

4A0 905 351

HITACHI

DIS4-05

VW

4A0 905 351

⁰³ Supplied until depletion

- Fornibile fino ad esaurimento delle scorte
- Fourni jusqu'à épuisement du stock
- Lieferbar solange vorrat reicht
- Suministrado hasta el stock termina

¹¹¹⁴ Supplied with heat conducting silicone grease capsule

- Fornito con capsula di grasso termico al silicone
- Fourni avec capsule contenant graisse thermique au silicone
- Geliefert mit Thermo-Silikonfettkapsel
- Suministrado con capsula de grasa termica de silicona



AUDI			
80 IV 2.6	ABC	07/92 ⇒	01/96
80 IV 2.6 E	ACZ	05/93 ⇒	05/95
80 IV 2.6 E quattro	ACZ	11/93 ⇒	05/95
80 IV 2.6 quattro	ABC, ACZ	06/92 ⇒	01/96
80 IV 2.8	AAH	09/91 ⇒	01/96
80 IV 2.8 quattro	AAH	09/91 ⇒	07/95
100 IV 2.6	ABC, ACZ	03/92 ⇒	07/94
100 IV 2.6 E quattro	ACZ	08/93 ⇒	07/94
100 IV 2.6 quattro	ABC	04/92 ⇒	07/94
100 IV 2.8 E	AAH	12/90 ⇒	07/94
100 IV 2.8 E quattro	AAH	12/90 ⇒	07/94
A6 I 2.4	AFM	07/95 ⇒	12/97
A6 I 2.6	ABC, ACZ	06/94 ⇒	12/97
A6 I 2.6 quattro	ABC, ACZ	06/94 ⇒	12/97
A6 I 2.8	AAH, AEJ	06/94 ⇒	12/97
A6 I 2.8 quattro	AAH, AEJ	06/94 ⇒	12/97
A4 I 2.4	AFM	07/95 ⇒	07/97
A4 I 2.6	ABC	01/95 ⇒	09/01
A4 I 2.6 quattro	ABC	01/95 ⇒	09/01
A4 I 2.8	AAH	09/95 ⇒	07/97
A4 I 2.8 quattro	AAH	01/95 ⇒	07/97
A8 I 2.8	AAH, AEJ	03/94 ⇒	03/96
A8 I 2.8 quattro	AAH, AEJ	03/94 ⇒	03/96
CABRIOLET 2.6	ABC, ACZ	06/93 ⇒	08/00
CABRIOLET 2.8	AAH	11/92 ⇒	08/00
COUPE 2.6	ABC	08/92 ⇒	12/96
COUPE 2.6 quattro	ABC	08/92 ⇒	12/96
COUPE 2.8	AAH	09/91 ⇒	12/96
COUPE 2.8 quattro	AAH	08/91 ⇒	12/96

KW 465 052



3,5

IGNITION MODULES

Adatt./Suitable:

ACURA

06302-PT2-000
06302-PT2-A00

HONDA

06302-PT2-000
06302-PT2-A00
06302-PT3-000
06302-PT3-A00
06302-PT-A00
30120-PM-A01
30120-PR3-003
30120-PT2-004
30120-PT3-003
30120-PT3-004
30130-P54-006
30130-PR3-006
30130-PT2-006

ROVER

NJL100030
NJL100040
NJW100030

ACURA			
INTEGRA I 1.6	D16A1	01/85 ⇒	12/90
INTEGRA I 1.6 i	D16A8	01/85 ⇒	12/90
INTEGRA II 1.8	F18A2	10/90 ⇒	09/93
HONDA			
ACCORD IV 2.0 16V	F20A5	01/90 ⇒	12/93
ACCORD IV 2.0 i 16V	F20A4, F20A7, F20A8, F20Z3	01/90 ⇒	12/93
ACCORD IV 2.2	F22A6	05/92 ⇒	12/93
ACCORD IV 2.2 i 16V	F22A3, F22A7, F22A8	01/90 ⇒	12/93
ACCORD IV 2.2 i 16V Automatic	F22A3	01/90 ⇒	03/93
ACCORD V 2.0	F20B3	09/93 ⇒	12/97
ACCORD V 2.0 i	F20Z2	03/93 ⇒	01/96
ACCORD V 2.0 i LS 16V	F20B3	09/93 ⇒	02/98
ACCORD V 2.0 i S	F20Z1	03/93 ⇒	01/96
ACCORD V 2.2 i [USA]	--	01/94 ⇒	12/95
ACCORD V 2.2 i 16V	F22B4	08/95 ⇒	12/97
ACCORD V 2.2 i ES	F22B5	09/93 ⇒	02/98
CIVIC V 1.5	D15B2	01/92 ⇒	12/92
CIVIC V 1.5 i 16V	D15B2, D15Z1	10/91 ⇒	11/95
CIVIC V 1.6 16V Vtec	D16Z6, D16Z7	10/91 ⇒	11/95
CIVIC V 1.6 4x4	D16Z7	01/92 ⇒	10/95
CIVIC V 1.6 i Vtec	B16A2	01/94 ⇒	11/95
CIVIC V 1.6 Vti	B16A2	10/91 ⇒	11/95
CIVIC V 1.6 Vti 16V	B16A2	10/91 ⇒	11/95
CIVIC IV 1.5	D15B1	01/88 ⇒	12/89
CIVIC IV 1.5 i 16V	D15B2	10/87 ⇒	09/91
CIVIC IV 1.6 16V 4x4	D16A6	11/87 ⇒	09/91
CIVIC IV 1.6 i 16V	D16A6, D16A9, D16Z2	09/87 ⇒	09/91
CIVIC IV 1.6 i 16V 4x4	D16A6, D16Z2	01/89 ⇒	12/91
CIVIC IV 1.6 i	--	01/90 ⇒	12/91
CIVIC IV 1.6 i 16V	D16A1, D16A7, D16A8, D16A9	01/88 ⇒	05/92
CIVIC IV 1.6 i 16V 4WD	D16A1, D16Z2	01/88 ⇒	12/91
CIVIC IV SHUTTLE 1.5 i 16V	D15B2	01/88 ⇒	11/91
CIVIC IV SHUTTLE 1.6 4x4	D16A, D16A7	01/88 ⇒	12/92
CIVIC IV SHUTTLE 1.6 i 16V 4WD	D16A6	01/88 ⇒	02/95
CIVIC IV SHUTTLE 1.6 i	--	01/88 ⇒	12/91
CIVIC IV SHUTTLE 1.6 i 16V 4WD	D16Z2	01/88 ⇒	12/92
CONCERTO 1.5 i 16V	D15B2	08/89 ⇒	05/95
CONCERTO 1.6 16V	D16Z2	08/89 ⇒	03/95
CONCERTO 1.6 i 16V	D16A8, D16Z2	08/89 ⇒	03/95
CONCERTO 1.6 i DOHC	--	01/90 ⇒	12/91
CRX II 1.6 i 16V	D16A9, D16Z5	10/87 ⇒	02/92
CRX II 1.6 i 16V Vtec	B16A1	10/89 ⇒	02/92
CRX III 1.6 ESi	D16Y8, D16Z6	03/92 ⇒	12/98
CRX III 1.6 i Vti	B16A2	03/92 ⇒	12/98
PRELUDE IV 2.0 i 16V	F20A4	02/92 ⇒	09/96
PRELUDE IV 2.2 i 16V Vtec	H22A2	02/93 ⇒	09/96
PRELUDE IV 2.3 i 16V	H23A2	02/92 ⇒	09/96
ROVER			
200 II 216	D16A8	10/92 ⇒	06/99

ROVER			
200 II 216 1.6i	D16A8	01/92 ⇒	11/99
200 II 216 GSi	1GH5E-180	01/90 ⇒	12/95
200 II 216 GTi	D16A8	01/90 ⇒	10/95
600 618 i/Si	F18A3	03/96 ⇒	02/99
600 620 i	F20Z2	08/93 ⇒	06/96
600 620 Si	F20Z1	08/93 ⇒	02/99
600 623 Si	H23A3	08/93 ⇒	06/99
400 I 416 GSi	1GH5E-180	04/90 ⇒	04/95
400 I 416 GSi/GSE	D16A7	04/90 ⇒	04/95
400 I 416 GTI	D16A8	04/90 ⇒	04/95

KW 465 072



3,5

IGNITION MODULES

Adatt./Suitable:

AUDI

8D0 905 351

HITACHI

DIS4-08

VW

8D0 905 351

⁰³ Supplied until depletion

- Fornibile fino ad esaurimento delle scorte
- Fourni jusqu'à épuisement du stock
- Lieferbar solange vorrat reicht
- Suministrado hasta el stock termina

¹¹¹⁴ Supplied with heat conducting silicone grease capsule

- Fornito con capsula di grasso termico al silicone
- Fourni avec capsule contenant graisse thermique au silicone
- Geliefert mit Thermo-Silikonfettkapsel
- Suministrado con capsula de grasa termica de silicona



AUDI			
A4 I 1.8 T	1HN9, AJL, ANB, APU, ARK	01/95 ⇒	09/01
A4 I 1.8 T quattro	1HN9, AJL, ANB, APU, ARK	01/95 ⇒	09/01
A6 II 1.8 T	1HN9, AJL, ANB, APU, ARK	01/97 ⇒	01/05
A6 II 1.8 T quattro	1HN9, AJL, ANB, APU, ARK	02/97 ⇒	01/05
VW			
PASSAT IV 1.8 T	AEB, ANB, APU	10/96 ⇒	11/00
PASSAT IV 1.8 T Syncro	AEB	11/96 ⇒	08/00

KW 465 073



IGNITION MODULES

Adatt./Suitable:

MAZDA
B541-18-V20 *J
MITSUBISHI
J170

00 Eliminated on 04-05-2020. Please verify the availability through our local distributors

- Eliminato il 04-05-2020. Verificare la disponibilità presso i nostri distributori
- Éliminé le 04-05-2020. Vérifier la disponibilité auprès de nos distributeurs sur place
- Am 04-05-2020 gestrichen. Evtl. Verfügbarkeit bitte bei unseren Händlern prüfen
- Eliminado en fecha 04-05-2020. Verificar la disponibilidad a través de nuestros distribuidores locales

***J Supplied module only, without bracket**

- Fornito solo il modulo, no la flangia
- Fourni le module seul, sans bride
- Geliefert nur das Modul, ohne Montageflansch
- Suministrase solo el módulo, sin base de montaje

1114 Supplied with heat conducting silicone grease capsule

- Fornito con capsula di grasso termico al silicone
- Fourni avec capsule contenant graisse termique au silicone
- Geliefert mit Thermo-Silikonfettkapsel
- Suministrado con capsula de grasa termica de silicona



MAZDA

121 I 1.1	B115, B116	10/87 ⇒ 01/91
121 I 1.1 Unleaded Fuel	--	01/87 ⇒ 12/91
121 I 1.3	B3	04/89 ⇒ 10/90
121 I 1.3 Leaded Fuel	--	01/87 ⇒ 12/91
121 II 1.1	B1	11/90 ⇒ 10/93
323 III 1.5	B505, B535, B536	09/89 ⇒ 09/93
323 VI C 1.6	B6E	09/89 ⇒ 06/91
323 VI C 1.6 16V	B6	03/91 ⇒ 10/94
323 VI F 1.6	B6E	09/89 ⇒ 06/91
323 VI F 1.6 16V	B6	03/91 ⇒ 10/94
323 VI S 1.3	B383, B3E	09/89 ⇒ 06/91
323 VI S 1.3 16V	B3(16V)	04/91 ⇒ 07/94
323 VI S 1.6	B6E	09/89 ⇒ 06/91
323 VI S 1.6 16V	B6	08/89 ⇒ 10/96
323 VI 1.3 16V	B384, B386, B387	06/89 ⇒ 03/91

KW 465 074



IGNITION MODULES

Adatt./Suitable:

SEAT
071 905 143
TELEFUNKEN
311886

VW
071 905 143

03 Supplied until depletion

- Fornibile fino ad esaurimento delle scorte
- Fourni jusqu'à épuisement du stock
- Lieferbar solange vorrat reicht
- Suministrado hasta el stock termina



SEAT

LEON I 2.3 V5	AGZ	10/98 ⇒ 11/00
TOLEDO II 2.3 V5	AGZ	10/98 ⇒ 11/00

VW

PASSAT IV 2.3 VR5	AGZ	10/96 ⇒ 11/00
PASSAT IV 2.3 VR5 Syncro/4motion	AGZ	10/97 ⇒ 11/00
BORA 2.3 V5	AGZ	10/98 ⇒ 10/00
BORA 2.3 V5 4motion	AGZ	12/98 ⇒ 10/00
GOLF IV 2.3 V5	AGZ	08/97 ⇒ 06/06
GOLF IV 2.3 V5 4motion	AGZ	12/98 ⇒ 06/06

KW 465 076



IGNITION MODULES

Adatt./Suitable:

AUDI
4D0 905 351

BOSCH
0 227 100 030
0 227 100 211
0 227 100 212

SEAT
4D0 905 351

SKODA
4D0 905 351

VW
4D0 905 351

03 Supplied until depletion

- Fornibile fino ad esaurimento delle scorte
- Fourni jusqu'à épuisement du stock
- Lieferbar solange vorrat reicht
- Suministrado hasta el stock termina

1114 Supplied with heat conducting silicone grease capsule

- Fornito con capsula di grasso termico al silicone
- Fourni avec capsule contenant graisse termique au silicone
- Geliefert mit Thermo-Silikonfettkapsel
- Suministrado con capsula de grasa termica de silicona



AUDI

A3 I 1.8 T	AGU	12/96 ⇒ 05/03
A3 I 1.8 T quattro	AGU	12/96 ⇒ 05/03
A4 II 1.8 T	AVJ	11/00 ⇒ 07/02
A4 II 1.8 T quattro	AVJ	11/00 ⇒ 07/02
A6 I S6 Plus quattro	AHK	04/96 ⇒ 12/97
A4 I 1.8 T	1HN9	01/95 ⇒ 09/01
A4 I 1.8 T quattro	1HN9	01/95 ⇒ 09/01
A6 II 1.8 T	1HN9	01/97 ⇒ 01/05
A6 II 1.8 T quattro	1HN9	02/97 ⇒ 01/05
A8 I 3.7	AEW, AKJ	07/95 ⇒ 12/98
A8 I 3.7 quattro	AEW, AKJ	07/95 ⇒ 11/98
A8 I 4.2 quattro	ABZ, AEM, AGH, AKG	03/94 ⇒ 11/98
A8 I S8 quattro	ZC2CNG, AKH	07/96 ⇒ 06/99

SEAT

ALHAMBRA I / II 1.8 T 20V	AJH	10/97 ⇒ 03/10
LEON I 1.8 20V T	APP	11/99 ⇒ 06/06

SKODA

OCTAVIA I 1.8 T	AGU, ARX, AUM	08/97 ⇒ 12/10
-----------------	---------------	---------------



COILS

-BOBINE -BOBINES -ZÜNDSPULEN -BOBINAS

(A) P/NRS. - NOTES

- CODICI - NOTE
- RÉFS. - NOTES
- ARTIKEL-NR. - ANMERKUNGEN
- CODIGOS - NOTAS

(B) PICTURE + TECHNICAL INFO

- FOTO + INFORMAZIONE TECNICA
- ILLUSTRATION + INFORMATION TECHNIQUE
- BILD + TECHNISCHE INFO
- FOTO + INFORMACIÓN TÉCNICA

(C) APPLICATION LIST

- GUIDA APPLICAZIONI
- LISTE D'APPLICATIONS
- ANWENDUNGSTABELLE
- LISTA DE APLICACIONES

470 607  **05,5**

IGNITION COILS

Adatt./Suitable:

BMW

- 12 13 7 559 842
- 12 13 7 571 644
- 12 13 7 582 627
- 12 13 7 594 935
- 12 13 7 638 477
- 7 559 842
- 7 594 935
- 7 638 477

BOSCH

- 0 221 504 471
- 0 221 504 472



NEW - ITEM NOW AVAILABLE FROM PRODUCTION

- NUOVO - ARTICOLO ORA DISPONIBILE PER LA VENDITA
- NOUVEAU - ARTICLE DISPONIBLE EN PRODUCTION COURANTE
- NEU - JETZT ZUM VERKAUF VERFÜGBARER ARTIKEL
- NUEVO - ARTICULO AHORA DISPONIBLE EN PRODUCCION

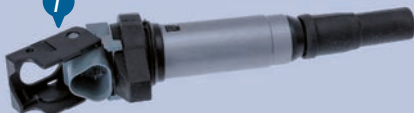
MARKET DIFFUSION: MEDIUM



2 **3** **4** **5** **6**

	ohm		ohm	
- +	0,55		---	

BMW		
3 SERIES 320i Touring	N43B20A	06/07 ⇌ 10/12
1 1 116 i	N43B16A, N43B20A	03/07 ⇌ 12/11
1 1 118 d	M47D20(204D4)	11/03 ⇌ 02/07
1 1 118 i	N43B20A	09/06 ⇌ 12/13
1 1 120 i	N43B20A, N46B20BD	11/03 ⇌ 12/13
3 V 316 i	N43B16A, N43B16AA	09/07 ⇌ 12/13
3 V 318 i	N43B20A	02/07 ⇌ 12/13
3 V 320 i	N43B20A	09/06 ⇌ 12/13

(A)

1 # KW

- 2 OEM P/NRS.**
- CODICI ORIGINALI
 - RÉFS. D'ORIGINE
 - ORIGINALTEILE-NR.
 - CODIGOS ORIGINALES

- 3 PACKAGING SIZE**
- FORMATO CONFEZIONE
 - FORMAT DU CONDITIONNEMENT
 - ABPACKENSGROESSE
 - TAMAÑO DEL ENVASE

- 4 PRODUCT AVAILABILITY DATE**
- DATA DI DISPONIBILITÀ DEL PRODOTTO
 - DATE DISPONIBILITÉ DU PRODUIT
 - PRODUKTVERFUEGBARKEITSDATUM
 - FECHA DISPONIBILIDAD ARTÍCULO

- 5 NOTE**
- NOTE
 - NOTES
 - BERMERKUNGEN
 - NOTAS

(B)

- 1 PICTURE**
- FOTO
 - PHOTO
 - BILD
 - FOTO

- 2 LOW TENSION CONNECTION TYPE**
- TIPO CONNESSIONE BASSA TENSIONE
 - TYPE CONNECTION BAISSE TENSION
 - ANSCHLUSSTYP NIEDERSpannung
 - TIPO CONNECCION BAJA TENSION

- 3 PRIMARY RESISTANCE**
- RESISTENZA PRIMARIO
 - RESISTANCE PRIMAIRE
 - WIDERSTAND PRIMÄRSPULE
 - RESISTENCIA DEL PRIMARIO

- 4 HIGH TENSION CONNECTION TYPE**
- TIPO CONNESSIONE ALTA TENSIONE
 - TYPE CONNECTION HAUTE TENSION
 - ANSCHLUSSTYP HOCHSPANNUNG
 - TIPO CONNECCION ALTA TENSION

- 5 SECONDARY RESISTANCE (IT CAN BE MEASURED ONLY IF IT IS WITHOUT DIODE)**
- RESISTENZA SECONDARIO (MISURABILE SOLO SE NON È PRESENTE IL DIODO)
 - RESISTANCE SECONDAIRE (MESURABLE SEULEMENT S'IL Y A LE DIODE)
 - WIDERSTAND SEKUNDÄRSPULE, NUR WENN DIE DIODE ABWESEND IST
 - RESISTENCIA DEL SECONDARIO (MENSURABLE SOLAMENTE SI HAY EL DIODO)

- 6 SYMBOL OF DIODE (IF PRESENT)**
- RAPPRESENTAZIONE DIODO (SOLO SE PRESENTE)
 - SYMBOL DU DIODE (S'IL Y A)
 - ABBILDUNG DER DIODE, NUR WENN SIE ANWESEND IST.
 - REPRESENTACION DEL DIODO (SI HAY)



470 XXX/490 XXX IGNITION COILS

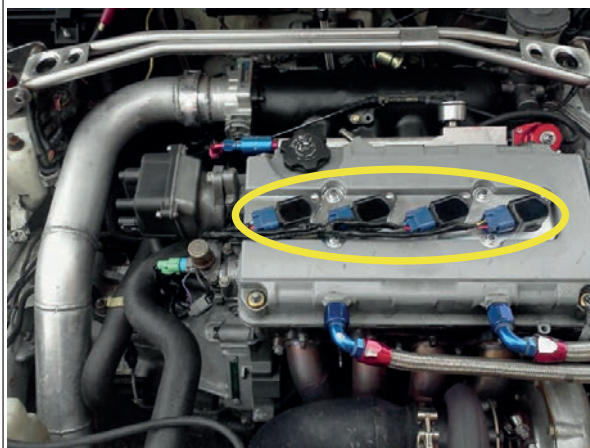

The ignition coils are transformers that are able to provide high voltage pulses. The purpose of these pulses is to generate a spark (arc) between the electrodes of the spark plugs on the internal combustion engine that is of sufficient intensity and duration to start the internal combustion of the air-fuel mixture successfully.

The main causes of failure of the product are:

- short circuit due to overheating
- insufficient power supply
- cable breakage
- low battery
- mechanical, electrical and chemical stress
- humidity

Signs of malfunctions:

- failure to start the engine
- problems of acceleration and power loss
- emergency operation of the control unit
- the engine control light comes on
- NOX emissions
- damage to the catalytic converter

The ignition coils are designed and built to withstand critical mounting conditions in the engine compartment. In particular they must meet the following requirements:

- operating temperature:
 - from -40°C to $+125^{\circ}\text{C}$ for devices mounted on the head and motor (typically, Pencil Coil); the parts in contact with the candle must withstand 180°C .

The coils are subjected to rigorous qualification and durability tests to determine if the product is suitable for being built and sold:

- Electromagnetic immunity test
- Proof of resistance to rapid temperature cycles
- Free discharge dielectric strength test
- Duration test
- Vibration resistance test

Pass these tests and allow the approval to produce during assembly the product undergoes strict control cycles which provide **100% testing**.

Structural components and operating principles

The main elements of construction of a modern ignition coil are:

- primary electrical circuit (copper wire wound around the primary iron core)
- secondary electrical circuit (copper wire wound around the secondary iron core)
- the magnetic circuit (pack)
- the electronic circuit
- the case (containing all the other elements coated in epoxy resin)
- various elements (incorporated only in some models): the interference suppressor, the high voltage diode, the electronic power switch, etc. The primary winding is piloted by the electronic power switch until it reaches the required current. The moment the current is switched off, a high voltage, typically between 20 and 30 kV, is generated on the secondary output, to ensure ignition of the spark. Since the high voltage is generated by releasing the induction energy stored by the primary inductance, these ignition systems are also called "inductive discharge".

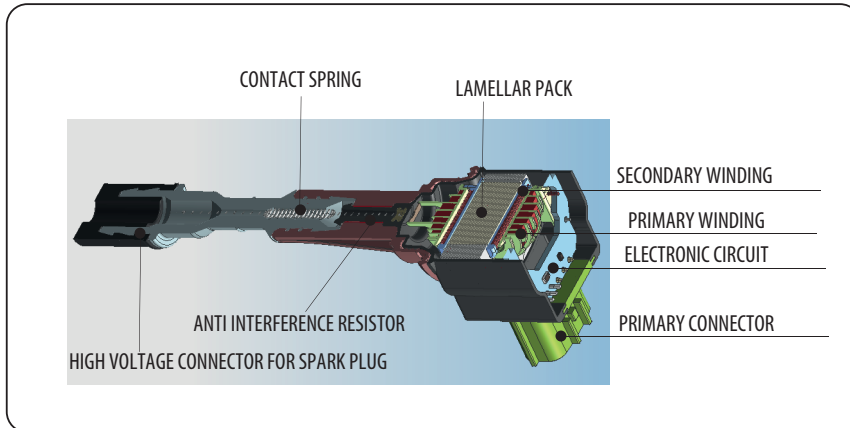

• Mechanical distribution coils:

These are individual coils and the high voltage is "distributed" to the spark plugs through special H.V. cables (abbreviation for High Voltage), by a rotor fitted on the distributor under the "cap". In mechanical distribution ignition systems, the high voltage supplied by the coil is transferred by special high voltage cables and "distributed" to the spark plugs by means of a "commutator rotor" under the distributor "cap", moved by the engine shaft. After a few micro-seconds, when the high voltage exceeds about 15 kV (as an absolute value), the spark is ignited between the electrodes of the spark plug.

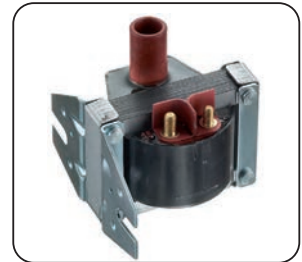

• Wasted spark coil (second generation):

This type of coil is called wasted spark because during the compression stroke there is a normal ignition spark, but during the exhaust stroke, when the gases have different electrical characteristics before and after combustion, there is a spark of lower intensity and therefore a small waste of energy.

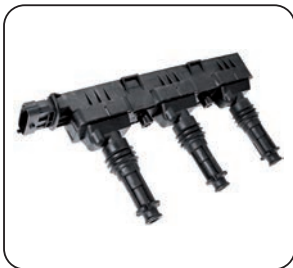

• Direct ignition coil (third generation):

The negative output on the secondary winding is connected directly to a single spark plug, while the other end is connected to an earthing point through a low voltage connection, or to the positive terminal of the primary winding (+ battery) inside the coil. There is therefore a coil for each spark plug.





470 XXX/490 XXX BOBINE DI ACCENSIONE

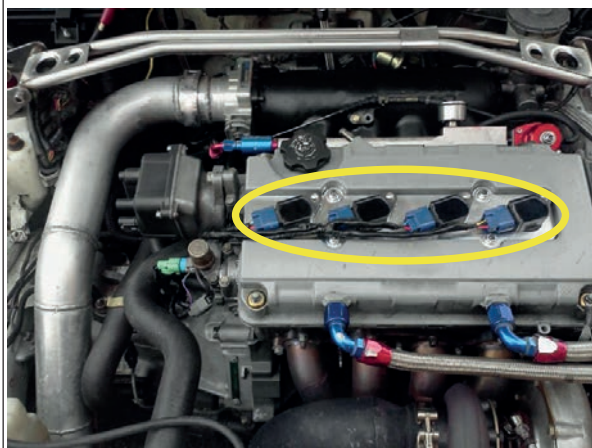

Le bobine d'accensione consentono di accumulare una carica nel sistema elettrico a bassa tensione del veicolo, immagazzinata e fatta scoppiare con una scintilla elettrica prodotta dalla candela per fare accendere in modo ottimale la miscela aria/carburante in modo che si verifichi la combustione completa nei motori a scoppio.

Principali cause malfunzionamento:

- corto circuito per surriscaldamento
- alimentazione insufficiente
- rottura cavo
- batteria scarica
- stress meccanici, elettrici e chimici
- umidità

Effetti malfunzionamento:

- mancato avviamento del motore
- problemi di accelerazione e calo di potenza
- funzionamento di emergenza della centralina
- accensione della spia di controllo motore
- emissioni NOX
- danni al convertitore catalitico

Le bobine di accensione sono progettate e costruite per sopportare le condizioni critiche di montaggio nel vano motore. In particolare devono soddisfare i seguenti requisiti:

- temperatura di funzionamento:
 - da - 40°C a + 125°C per i dispositivi montati sulla testa del motore (tipicamente, Pencil Coil); le parti a contatto con la candela devono resistere a 180°C.

Le bobine sono sottoposte a **rigorose prove di qualificazione e di durata** per stabilire se il prodotto è idoneo per essere costruito e venduto:

- Prova di immunità elettromagnetica
- Prova di resistenza ai cicli rapidi di temperatura
- Prova di rigidità dielettrica a scarica libera
- Prova di durata
- Prova di resistenza alle vibrazioni

Superate tali prove e concesso il benessere a produrre, durante l'assemblaggio il prodotto viene sottoposto a severi cicli di controllo che prevedono il **collaudo al 100%**.

Elementi costruttivi e principio di funzionamento

Gli elementi costruttivi principali di una bobina moderna sono:

- circuito elettrico primario (filo di rame avvolto sul rocchetto primario)
 - circuito elettrico secondario (filo di rame avvolto sul rocchetto secondario)
 - il circuito magnetico (pacco lamellare)
 - circuito elettronico
 - il vassoio (contenente gli altri elementi inglobati in resina epossidica)
 - elementi vari (incorporati solamente in alcuni modelli): il soppressore di disturbi, il diodo ad alta tensione, l'interruttore elettronico di potenza, ecc.
- L'avvolgimento primario viene pilotato dall'interruttore elettronico fino a raggiungere la corrente richiesta. Nell'istante di interruzione della corrente, sull'uscita secondaria viene generata l'alta tensione tipicamente compresa tra 20 e 30 kV per garantire l'innesco della scintilla. Poiché l'alta tensione è generata liberando l'energia induttiva immagazzinata dall'induttanza del primario, questi sistemi di accensione vengono anche chiamati "a scarica induttiva".

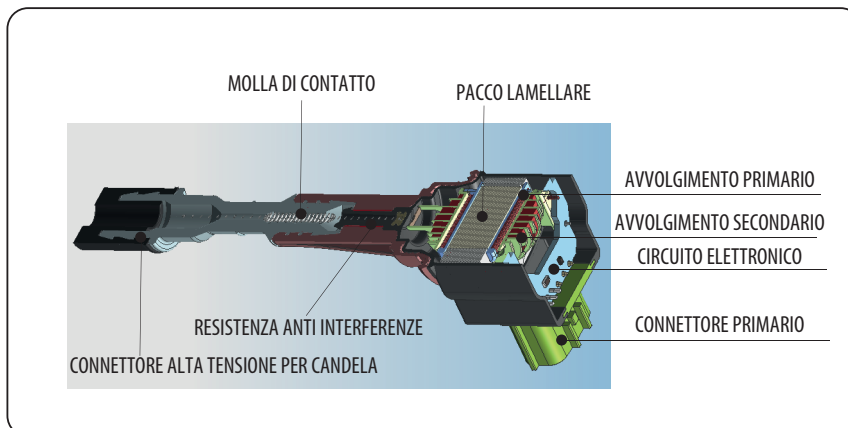

• Bobine per distribuzione meccanica:

Si tratta di bobine singole e l'alta tensione viene "distribuita" alle candele, tramite appositi cavi A.T. (abbreviazione di Alta Tensione), da un distributore rotante montato sullo spinterogeno, all'interno della "calotta". Nei sistemi di accensione a distribuzione meccanica, l'alta tensione erogata dalla bobina viene trasportata tramite appositi cavi ad alta tensione e "distribuita" alle candele tramite un "commutatore rotante" posto nella "calotta" (distributore) e mosso dall'albero motore. Dopo pochi microsecondi, quando l'alta tensione supera (come valore assoluto) i 15 kV circa, si innesca la scintilla tra gli elettrodi della candela.

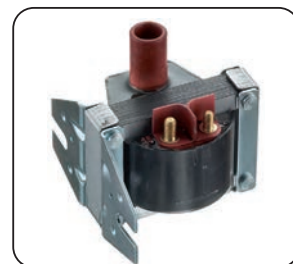

• Bobine a scintilla persa (seconda generazione):

Questo tipo di bobina viene chiamato a scintilla persa perché, mentre nel cilindro in fase di compressione si ha la normale scintilla di accensione, grazie alle diverse caratteristiche elettriche dei gas prima e dopo la combustione, nel cilindro in fase di scarico si ha una scintilla di piccola intensità e quindi una piccola perdita di energia.

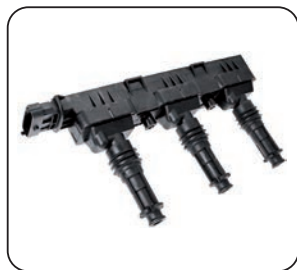

• Bobine dirette (terza generazione):

L'uscita negativa del secondario è collegata ad una sola candela direttamente, l'altro capo è collegato a massa con una connessione a bassa tensione, oppure al terminale positivo del primario (+ batteria) all'interno della bobina. Abbiamo quindi una bobina per ogni candela.





470 XXX/490 XXX BOBINES D'ALLUMAGE

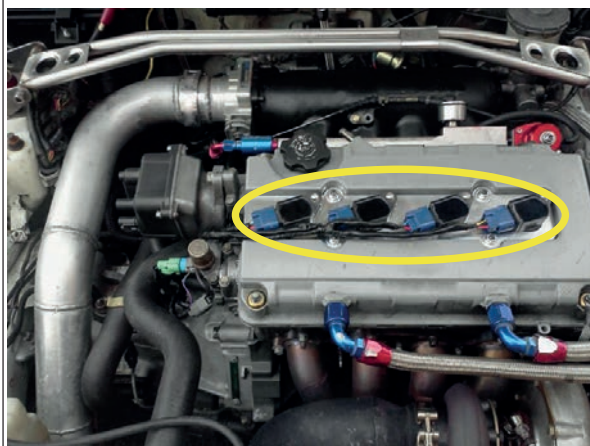

Les bobines d'allumage permettent d'accumuler de l'énergie dans le système électrique à basse tension du véhicule. Stockée, celle-ci permet aux bougies de créer l'étincelle électrique afin d'allumer de manière optimale le mélange air/carburant garantissant ainsi une combustion complète sur les moteurs à combustion.

Principales causes de dysfonctionnement:

- court-circuit dû à une surchauffe
- alimentation insuffisante
- rupture câble
- batterie à plat
- stress mécaniques, électriques et chimiques
- humidité

Conséquences du dysfonctionnement:

- le moteur ne s'allume pas
- problèmes d'accélération et baisse de puissance
- le boîtier électronique fonctionne en urgence
- voyant de contrôle moteur allumé
- émissions NOX
- dommages sur le convertisseur catalytique

Les bobines d'allumage sont conçues et construites pour supporter des conditions difficiles de montage sous le capot. Elles doivent notamment respecter les critères suivants :

- température de fonctionnement :
 - de - 40°C à + 125°C pour les dispositifs montés sur la tête du moteur (habituellement, bobines-crayon);
 - les parties au contact de la bougie doivent résister à 180°C.

Les bobines sont soumises à des tests **rigoureux de qualité et de longévité** garantissant un produit adapté à la construction et à la vente :

- Test d'immunité électromagnétique
- Test de résistance aux cycles rapides de température
- Test de rigidité diélectrique à décharge libre
- Test de durée
- Test de résistance aux vibrations

Si ces tests sont réussis et le feu vert pour la production est donné, lors de l'assemblage, le produit est à nouveau soumis à des cycles de contrôle qui prévoient son **inspection à 100 %**.

Éléments et principes de fonctionnement

Les éléments principales d'une bobine moderne sont :

- circuit électrique primaire (fil de cuivre enroulé autour du bobinage primaire)
- circuit électrique secondaire (fil de cuivre enroulé autour du bobinage secondaire)
- le circuit magnétique (paquet magnétique)
- le plateau (contenant les autres éléments englobés en résine époxy)
- éléments divers (présents seulement sur certains modèles) : l'antiparasite, la diode à haute tension, l'interrupteur électronique de puissance, etc. Le bobinage primaire est piloté par l'interrupteur électronique jusqu'à ce que le courant requis soit atteint. Au moment de l'interruption du courant, une haute tension, habituellement comprise entre 20 et 30 kV, est générée sur la sortie secondaire pour garantir l'étincelle. Puisque la haute tension est générée en libérant l'énergie inductive stockée par l'inductance du circuit primaire, ces systèmes d'allumage sont également appelés « à décharge inductive ».

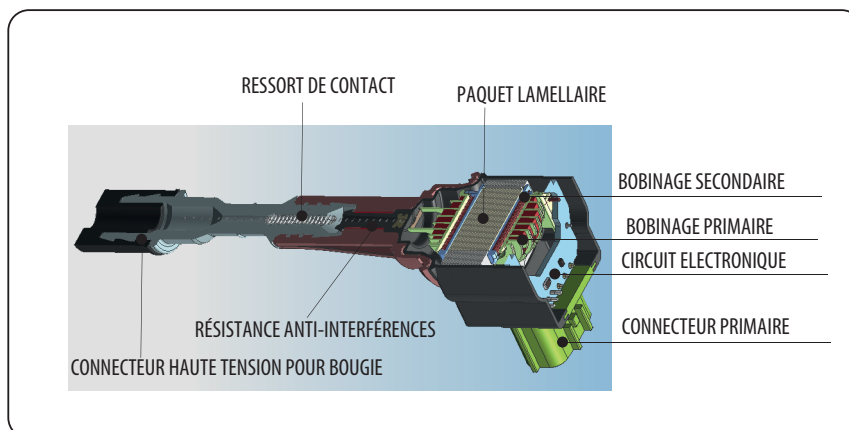

• Bobines pour distribution mécanique:

Il s'agit de bobines simples et la haute tension est distribuée aux bougies avec des câbles H.T. (abréviation de haute tension), par un distributeur tournant monté sur l'allumeur, à l'intérieur de la tête de delco. Sur les systèmes d'allumage à distribution mécanique, la haute tension fournie par la bobine est transportée par des câbles à haute tension et distribuée aux bougies avec un commutateur tournant placé dans la tête de delco (distributeur) et mis en mouvement par l'arbre moteur. Après quelques microsecondes, lorsque la haute tension dépasse (en valeur absolue) les 15 kV environ, l'étincelle est produite sur les électrodes de la bougie.

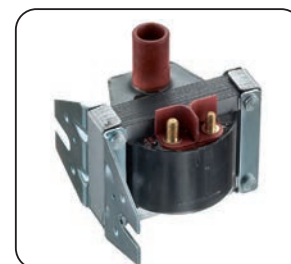

• Bobine à étincelle perdue (seconde génération):

Ce type de bobine est appelée de la sorte, car tandis que dans le cylindre en phase de compression l'on obtient une étincelle d'allumage normale, avec les différentes caractéristiques électriques des gaz avant et après la combustion, dans le cylindre en phase de déchargement, l'on obtient une étincelle de faible intensité et donc une perte d'énergie moindre. Elles peuvent être des typologies suivantes : Bobines avec 2 sorties H.T.



• Bobinas directas (tercera generación):

La sortie négative du bobinage secondaire est directement branchée sur une seule bougie, l'autre extrémité étant reliée à la masse avec une connexion à basse tension, ou au pôle positif du circuit primaire (+ batterie) à l'intérieur de la bobine. Nous avons donc une bobine pour chaque bougie.





470 XXX/490 XXX ZÜNDSPULEN

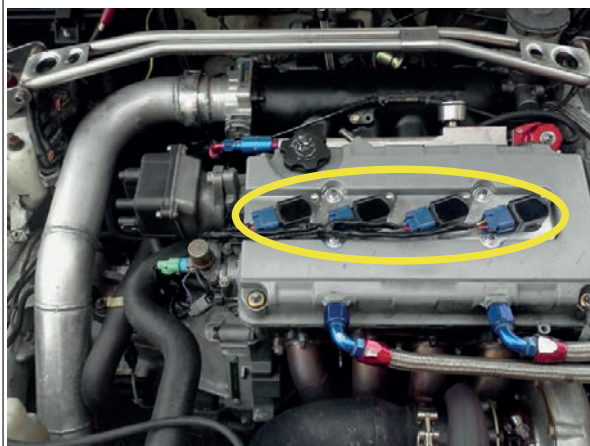

Die Zündspulen dienen als Transformatoren, indem sie für Hochspannungsimpulse sorgen.

Der Zweck dieser Impulse ist es, einen Funken (Lichtbogen) zwischen den Elektroden der Zündkerzen des Verbrennungsmotors zu erzeugen, dessen Intensität und Dauer ausreicht, um die Verbrennung des Gemischs aus Luft und Treibstoff im Inneren richtig in Gang zu setzen.

Wichtigste Störungsursachen:

- Kurzschluss durch Überhitzen
- unzureichende Versorgung
- Kabelbruch
- entladene Batterie
- mechanische, elektrische und chemische Beanspruchungen
- Feuchtigkeit

Störungsauswirkungen:

- nicht erfolgtes Anspringen des Motors
- Beschleunigungsprobleme und Leistungsabfall
- Notbetrieb des Steuergeräts
- Aufleuchten der Motorkontrollanzeige
- NOX-Emissionen
- Schäden am Katalysator

Die Zündspulen wurden so entwickelt und gebaut, dass sie den kritischen Bedingungen der Montage im Motorraum standhalten. Insbesondere müssen sie die folgenden Anforderungen erfüllen:

- Betriebstemperatur:
 - von - 40°C bis + 125°C für auf dem Motorkopf montierte Vorrichtungen (normalerweise Pencil Coil); die mit der Zündkerze in Kontakt geratenden Teile müssen 180°C standhalten.

Die Zündspulen werden **strengen Prüfungen hinsichtlich Qualifizierung und Beständigkeit unterzogen**, um festzustellen, ob das Produkt sich für die Herstellung und den Verkauf eignet:

- Prüfung der elektromagnetischen Störfestigkeit
- Prüfung der Beständigkeit bei schnellen Temperaturwechseln
- Prüfung der Durchschlagfestigkeit bei freier Entladung
- Dauerversuch
- Prüfung der Schwingungsfestigkeit

Nachdem es diese Prüfungen bestanden und die Produktionsgenehmigung erhalten hat, wird das Produkt strengen Kontrollzyklen unterzogen, die die **100 % Endabnahme vorsehen**.

Bauteile und Funktionsprinzip

Die wichtigsten baulichen Elemente einer modernen Zündspule umfassen:

- Primärstromkreis (auf die Primärspule gewickelter Kupferdraht)
- Sekundärstromkreis (auf die Sekundärspule gewickelter Kupferdraht)
- Magnetischer Kreis (Paket)
- das Tablett (das die anderen in Epoxidharz eingeschlossenen Elemente enthält)
- verschiedene Elemente (nur in einige Modelle eingebaut): den Störungsunterdrücker, die Hochspannungsdiode, den elektronischen Leistungsschalter, usw. Die Primärwicklung wird von dem elektronischen Schalter bis zum Erreichen des gewünschten Stroms gesteuert. Im Moment der Stromunterbrechung wird auf dem Sekundärausgang die normalerweise zwischen 20 und 30 kV liegende Hochspannung erzeugt, um den Funkenschlag zu garantieren. Da die Hochspannung durch das Freisetzen von von der Induktanz des Primärstromkreises gespeicherter induktiver Energie erzeugt wird, werden diese Zündsysteme auch „Systeme mit induktiver Entladung“ genannt.

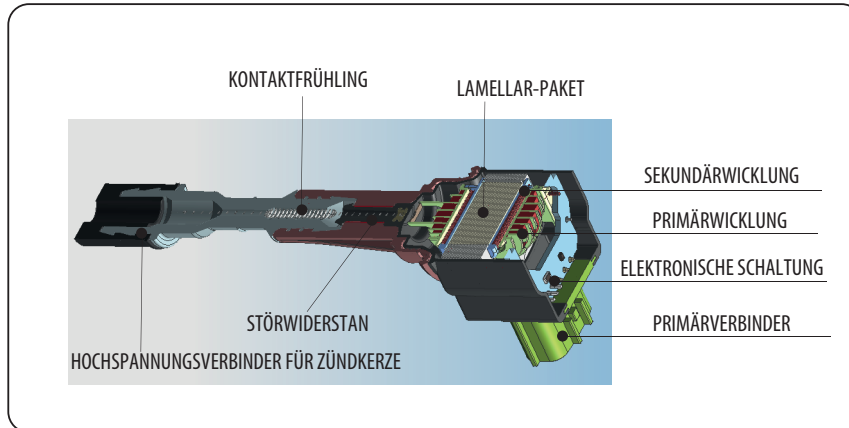

• Zündspulen zur mechanischen Verteilung:

Es handelt sich um Einzelspulen und die Hochspannung wird an die Zündkerzen über entsprechende HS-Kabel „verteilt“ (Abkürzung von Hochspannung), und zwar über einen im Inneren der „Haube“ auf dem Zündverteiler montierten Drehverteiler. In Zündsystemen mit mechanischer Verteilung wird die von der Zündspule abgegebene Hochspannung mit Hilfe entsprechender Hochspannungskabel befördert und an die Kerzen über einen in der „Haube“ (Verteiler) positionierten und von der Motorwelle angetriebenen „Drehkommutator“ verteilt. Nach wenigen Mikrosekunden wird, wenn die Hochspannung (als absoluten Wert) ca. 15 kV übersteigt, der Funke zwischen den Elektroden der Zündkerze gezündet.

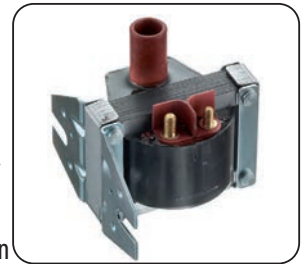

• Doppelfunkenzündspulen (zweite generation)

Dieser Spulentyp wird als Doppelfunkenzündspule bezeichnet, da bei Zylinder in Kompressionsphase der normale Zündfunke erzeugt wird, aufgrund der unterschiedlichen elektrischen Eigenschaften der Gase vor und nach der Verbrennung wird im Zylinder beim Entladen ein Funke geringer Intensität erzeugt und damit ein geringer Energieverlust. Es gibt die folgenden Typen: Spulen mit zwei HS-Ausgängen.



• Direkte Zündspulen (dritte Generation):

Der negative Ausgang des Sekundärstromkreises ist an nur eine Kerze direkt angeschlossen, das andere Ende ist mit einem Niederspannungsanschluss an die Masse angeschlossen bzw. an die positive Klemme des Primärstromkreises (+ Batterie) im Inneren der Spule. Wir haben also eine Spule für jede Kerze.





470 XXX/490 XXX BOBINAS DE ENCENDIDO

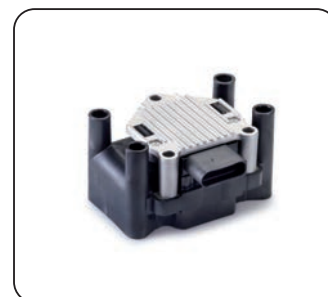
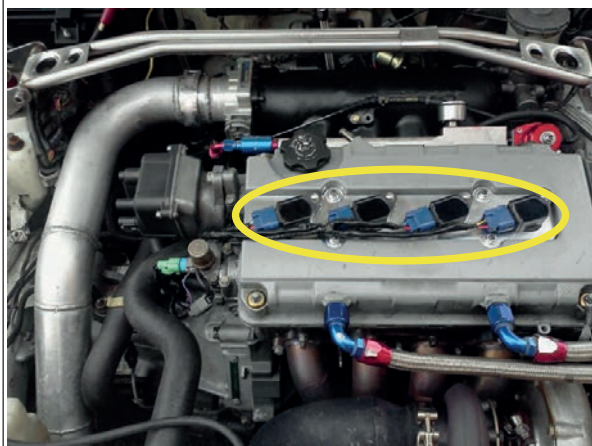

Las bobinas de encendido permiten acumular una carga en el sistema eléctrico de baja tensión del vehículo, que se almacena y se hace explotar con una chispa eléctrica generada por la bujía para encender de forma óptima la mezcla de aire/combustible y para que se produzca la combustión completa en los motores de explosión.

Causas principales de mal funcionamiento:

- cortocircuito por recalentamiento
- alimentación insuficiente
- rotura del cable
- batería descargada
- estrés mecánico, eléctrico y químico
- humedad

Efectos de un mal funcionamiento:

- falta de arranque del motor
- problemas de aceleración y disminución de potencia
- funcionamiento de emergencia de la centralita
- encendido del testigo de control del motor
- emisiones NOX
- daños al convertidor catalítico

Las bobinas de encendido están diseñadas y fabricadas para soportar las condiciones críticas de montaje en el compartimento del motor. En especial, deben cumplir los siguientes requisitos:

- temperatura de funcionamiento:
 - de - 40°C a + 125°C para los dispositivos montados en el cabezal del motor (típicamente, Pencil Coil); las partes en contacto con la bujía deben resistir 180°C.

Las bobinas se someten a **rigurosas pruebas de cualificación y de duración** para determinar si el producto es apto para la fabricación y la venta:

- Prueba de inmunidad electromagnética
- Prueba de resistencia a los ciclos rápidos de temperatura
- Prueba de rigidez dieléctrica de descarga libre
- Prueba de duración
- Prueba de resistencia a las vibraciones

Tras superar esas pruebas, y con la aprobación para la producción, durante el ensamblaje el producto se somete a severos ciclos de control que constituyen el **ensayo al 100%**.

Elementos constructivos y principio de funcionamiento

Los elementos constructivos principales de una bobina moderna son:

- circuito eléctrico primario (alambre de cobre envuelto en el carretel primario)
- circuito eléctrico secundario (alambre de cobre envuelto en el carretel secundario)
- el circuito magnético (paquete)
- la bandeja (que contiene los otros elementos englobados en resina epoxy)
- elementos varios (incorporados solamente en algunos modelos): el supresor de disturbios, el diodo de alta tensión, el interruptor electrónico de potencia, etc. El bobinado primario está controlado por el interruptor electrónico hasta que alcanza la corriente prevista. En el instante de interrupción de la corriente, en la salida secundaria se genera la alta tensión que típicamente es de 20 a 30 kV, para garantizar el encendido de la chispa. Como la alta tensión se genera liberando la energía inductiva almacenada por la inductancia del primario, estos sistemas de encendido también se llaman "de descarga inductiva".

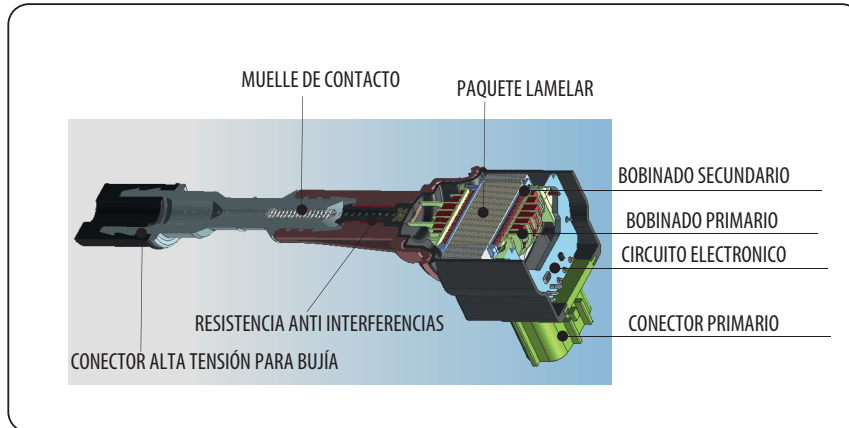

• Bobinas para distribución mecánica:

Se trata de bobinas individuales, y la alta tensión se "distribuye" a las bujías mediante los correspondientes cables A.T. (abreviatura de Alta Tensión) mediante un distribuidor giratorio montado en el distribuidor de encendido, en el interior de la "tapa". En los sistemas de encendido de distribución mecánica, la alta tensión distribuida por la bobina se transporta mediante los correspondientes cables de alta tensión y se "distribuye" a las bujías mediante un "conmutador giratorio" presente en la "tapa" (distribuidor) y movido por el árbol motor. Después de pocos microsegundos, cuando la alta tensión supera (como valor absoluto) los 15 kV aproximadamente, se enciende la chispa entre los electrodos de la bujía.

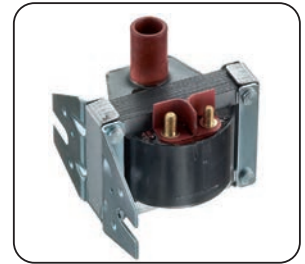

• Bobinas de chispa perdida (segunda generación):

Este tipo de bobina se llama de chispa perdida porque, mientras en el cilindro en fase de compresión se tiene la chispa normal de encendido, gracias a las distintas características eléctricas de los gases antes y después de la combustión, en el cilindro en fase de descarga se tiene una chispa de baja intensidad y, por lo tanto, una pequeña pérdida de energía. Pueden ser de los siguientes tipos: Bobinas con 2 salidas A.T.



• Bobinas directas (tercera generación):

La salida negativa del secundario está conectada a una sola bujía directamente, el otro extremo está conectado a masa con una conexión de baja tensión, o al terminal positivo del primario (+ batería) dentro de la bobina. Por lo tanto, tenemos una bobina por cada bujía.



KW 470 101D



07

COILS

Adatt./Suitable:

ALFA ROMEO

510 897
116 42 65 079 00
60744199

BMW

12 13 1 357 296
12 13 1 359 637

CITROËN

DM 212 08B

DAF

316447

FIAT

39322140
4071394
4158493

HITACHI

CI2500
CI2500E

INNOCENTI

39322140

ISUZU

981360005
981360007
982511535
982513508
9-82513508-0
982513509
9-82513509-0

LADA

2101-3705000-02
21013-7050560
2101-3705060-00

LANCIA

4158493

LAND ROVER

PRC9858
RTC5629

MAGIRUS-DEUTZ

41912606

MERCEDES-BENZ

A 000 158 00 03
A 000 158 38 03

PEUGEOT

5970 11
5970 28

RENAULT

77 00 552 370
77 00 562 370
77 01 348 252

ROVER

GCL110
RTC3433

SAAB

85 22 328

SEAT

SE 141915.000A

TALBOT

0055 50 5600

VOLVO

3638411
36384113

VW

043 905 115 A
043 905 115 C
052 905 105
221 100 019

1116 Universal coil (except for electronic ignition)

- Bobina universale (esclusa accensione elettronica)
- Bobine universelle (sauf système d'allumage électronique)
- Universalzündspulen (nicht für elektronische Zündsysteme)
- Bobina universal (con excepción del encendido electrónico)

960 Dry (epoxy) coil replacing original oil-bath coil version

- Bobina (resinizzata) sostitutiva originale a bagno d'olio
- Bobine seche, remplaçant la bobine d'origine à bain d'huile
- Trockenspule, die die Originale im Ölbad ersetzt
- Bobina seca, sustituye modelo original con baño de aceite

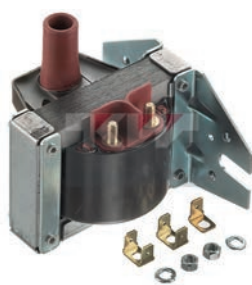

		ohm			ohm
-	+	1,75			10500
M5	M5				

ALFA ROMEO

ALFASUD 1.2	AR30102	06/72 ⇒ 09/84
ALFETTA 1.8	AR01608X	07/74 ⇒ 04/82
GIULIETTA I 1.3	AR01644	10/77 ⇒ 06/83

DACIA

1210 1.2	--	01/69 ⇒
1310 1.3	810-02/-99	05/83 ⇒ 07/04
1410 1.4	--	01/69 ⇒

FIAT

124 1200	124A.000	07/66 ⇒ 10/73
124 1400 Special	124B2.000	12/68 ⇒ 12/72

FIAT

124 1600 Special T	132AC.000	01/73 ⇒ 07/75
126 600	126A.000	09/72 ⇒ 06/77
127 0.9	100GL.000, 100GL.048	06/71 ⇒ 12/84
127 1.0	127A.000	01/77 ⇒ 12/86
128 1.1	128A.000	03/69 ⇒ 12/84
131 1.3 Mirafiori	131A6.000	10/74 ⇒ 09/81
132 1.6	132C.000	05/77 ⇒ 09/82
242 1.6	124B3.000	10/75 ⇒ 07/82
500 0.5	110F.000, 120.000	01/60 ⇒ 12/75
500 0.6	111A000	08/68 ⇒ 01/76
DUCATO I 1.8	169B	01/82 ⇒ 12/88
600 0.6	--	03/55 ⇒ 05/61
850 0.8	100G.000	07/64 ⇒ 10/72
ARGENTA 1600	132D.000	04/81 ⇒ 12/85
ARGENTA 1600 i.e	132D.000	04/81 ⇒ 12/85
FIORINO I 1.0	127A.000	01/80 ⇒ 12/87
FIORINO I 1050	127A.000	01/80 ⇒ 12/87
FIORINO I 900	100GL.000	10/77 ⇒ 10/86
PANDA I 1000	156A2.000	12/93 ⇒
PANDA I 1000 CLX	156A2.000	05/91 ⇒ 12/94
PANDA I 1000 Fire	156A2.000	05/86 ⇒ 04/91
PANDA I 1000 Fire [DEU]	156A2.048	01/86 ⇒ 07/89
PANDA I 750	141B.000, 156A4.000	01/86 ⇒ 01/95
PANDA I 800	100GL6.000	02/81 ⇒ 12/85
PANDA I 900	100GL3.000	10/80 ⇒ 06/94
PANDA I 900 CL	146A.048	01/86 ⇒ 12/92
PANDA I 950	A112B1.054	09/82 ⇒ 08/83
PANDA I 950 4x4	A112B1.054	09/83 ⇒ 12/86
REGATA 1.1 60, 60 L	138B.000	10/83 ⇒ 08/86
REGATA 1.6	149A.000	10/84 ⇒ 06/89
REGATA 70 1.3	138B2.000, 149A3.000	09/83 ⇒ 07/89
REGATA 85 1.6	149A.000	10/83 ⇒ 06/90
RITMO I 1.1	146A4.048	04/85 ⇒ 12/87
RITMO I 1.3	149A3.000	11/83 ⇒ 08/85
RITMO II 75 1.5	138A2.000	09/85 ⇒ 12/88
UNO 45 0.9	146A.000, 146A1.000	03/83 ⇒ 07/96
UNO 45 0.9 Trend	146A.048	09/89 ⇒ 09/92
UNO 60 1.1 SX	--	01/83 ⇒ 12/85
X 1/9 1.3	128AS.000	10/75 ⇒ 06/78

FSO

126P 0.6	--	09/72 ⇒ 07/77
POLONEZ I 1.5	AA	10/77 ⇒ 08/88

INNOCENTI

MINI 120	--	01/75 ⇒ 12/83
----------	----	---------------

LADA

NIVA I 1600	BA32121	12/76 ⇒ 12/93
-------------	---------	---------------

LANCIA

A 112 0.9 Junior	A112A5.000	03/81 ⇒ 06/86
------------------	------------	---------------

LAND ROVER

90 2.5 4x4	17H	09/85 ⇒ 08/90
110/127 2.5 4x4	17H	10/85 ⇒ 07/90
DEFENDER 2.25	--	01/87 ⇒
DEFENDER 2.5 90, 110	--	08/90 ⇒ 09/01

MERCEDES-BENZ

0 309	M115.921, M115.952	01/68 ⇒ 02/89
-------	--------------------	---------------

PEUGEOT

305 1.5	117(XR5S)	05/80 ⇒ 09/82
505 1.8	105(XM7)	06/81 ⇒ 10/85

RENAULT

4 0.8	80001	09/71 ⇒ 12/88
5 1.3	810719, 810726	09/76 ⇒ 09/84
5 1.4 Alpine A5	840725	09/77 ⇒ 09/81
9 1.2	C1G700, C1G710	09/85 ⇒ 12/88
11 1.1	C1E715, C1E720	03/83 ⇒ 06/86
11 1.2	C1G700, C1G710	10/84 ⇒ 12/88
20 2.0	829700, 829701, 829702, 829703, 829.01	10/77 ⇒ 12/83

SEAT

FURA 0.9	100GL3000	01/82 ⇒ 06/86
IBIZA I 0.9	146A000	08/86 ⇒ 05/93
MARBELLA 0.8	5K9K718	08/86 ⇒ 12/93
MARBELLA 0.9	09NCA	01/87 ⇒ 12/93
PANDA 0.9	100GL3000	10/80 ⇒ 12/86
PANDA 34 850	--	01/80 ⇒ 12/83
PANDA 35 850	--	01/80 ⇒ 12/83
PANDA 45	--	01/82 ⇒ 12/85
TERRA 0.9	09NCA	02/87 ⇒ 12/96

TALBOT

TAGORA 2.1	5N2	06/80 ⇒ 12/83
------------	-----	---------------

ZASTAVA

101 1.1	128A.000, 128A.064	06/73 ⇒ 12/93
101 1.1 Super	128AC5.000	07/79 ⇒ 09/81

KW 470 102



07,5

COILS

Adatt./Suitable:

BOSCH

0 986 221 028

DUCELLIER

2 526 015
2 526 015 A

FIAT

7588435

MAGNETI MARELLI

060705404010
607 056 01
BAE 506 A

03 Supplied until depletion

- Fornibile fino ad esaurimento delle scorte
- Fourni jusqu'à épuisement du stock
- Lieferbar solange vorrat reicht
- Suministrado hasta el stock termina



		ohm			ohm
		0,75			6000
6.4					

FIAT

CROMA I 2000 CHT	154A1.000	12/85 ⇒ 02/89
FIORINO I 1.5	149C1.000	01/88 ⇒ 08/93
FIORINO II 1.5 iE	149C1.000	01/88 ⇒ 10/92
FIORINO II 75 i.e. 1.5	149C1.000	05/88 ⇒ 12/93
REGATA 70 1.3	138B2.000, 149A3.000	09/83 ⇒ 07/89
REGATA 85 1.5	149A5.000	05/85 ⇒ 12/87
RITMO I 1.3	149A3.000	11/83 ⇒ 08/85
RITMO I 1.5	138C2.048	10/85 ⇒ 05/87
UNO 45 1.0 Fire	--	01/83 ⇒ 12/89
UNO 60 1.1 SX	--	01/85 ⇒ 12/89

KW 470 103



07,5

COILS

Adatt./Suitable:

BOSCH

0 221 119 030
0 221 122 012

FIAT

4386221
4460205

LANCIA

4386221
4460205

MAGNETI MARELLI

607 029 02
607 029 03
BAE 209 B
BAE 209 C

03 Supplied until depletion

- Fornibile fino ad esaurimento delle scorte
- Fourni jusqu'à épuisement du stock
- Lieferbar solange vorrat reicht
- Suministrado hasta el stock termina



		ohm			ohm
		0,35			6000
6.4					

FIAT

ARGENTA 2000 i.e.	132C3.000	06/81 ⇒ 07/86
CROMA I 1600	154A.048	12/85 ⇒ 12/90

FIAT			
CROMA I 2000 CHT	154A1.000	12/85 ⇒	02/89
FIORINO I 1.5	149C1.000	01/88 ⇒	08/93
FIORINO II 1.5 iE	149C1.000	01/88 ⇒	10/92
FIORINO II 75 i.e. 1.5	149C1.000	05/88 ⇒	12/93
REGATA 1.6	--	09/86 ⇒	06/89
REGATA 100 Super 1.6	149A2.000	10/83 ⇒	12/90
REGATA 85 1.5	149A5.000	05/85 ⇒	12/87
RITMO I 1.6	149A4.000	01/83 ⇒	12/87
RITMO II 75 1.5	138A2.000	09/85 ⇒	12/88
UNO 70 1.3i SX	--	01/83 ⇒	12/89
UNO 75 i.e. 1.5	138C2.048	10/85 ⇒	12/93

LANCIA			
BETA 1600	828B.000	08/73 ⇒	07/82
DELTA I 1.5	831A1.000, 831B1.000	09/79 ⇒	12/92
PRISMA 1.5	831B1.000	05/86 ⇒	07/89
PRISMA 1.6	831B6.000	08/86 ⇒	02/92

KW 470 105



05

COILS

Adatt./Suitable:

BOSCH

F 000 ZS0 114

CITROËN

5970 43

96 010 513

97 530 780

DUCELLIER

520 073

520 073 A

HITACHI

138754

2508754

MAGNETI MARELLI

060717014012

PEUGEOT

5970 43



	ohm		ohm
	0,68	Ø 6,3	6800

CITROËN

AX 1.3 Sport	M4A	04/87 ⇒	12/88
AX 10	C1A	09/86 ⇒	06/92
AX 10 E	C3A	12/86 ⇒	12/88
AX 11	H1A, H1B, HDZ(TU1M)	09/86 ⇒	12/97
AX 11 4x4	H1A	06/91 ⇒	07/92
AX 11 Cat	HAZ(TU1CP)	09/88 ⇒	12/89
AX 14	K1A(TU3), K1B, K1F, K1G, K1J, K2A, K2B, K2D, KAY(TU3CP), KDX(TU3M/Z), KDY(TU3FM)	09/86 ⇒	04/97
AX 14 4x4	KDY(TU3FM)	08/91 ⇒	12/96
AX 14 GT	KDZ(TU3M/Z)	01/89 ⇒	12/91
BX 1.1	109LA, H1A	04/86 ⇒	06/91
BX 1.4	150C, K1F, K2D	07/86 ⇒	12/94
BX 1.4 E	150B(XY8), 150J, 150Y, K1F, KAZ	09/82 ⇒	12/94
BX 1.6	182A, B6D, B6E	01/87 ⇒	12/94
BX 1.9	159C, D6U, DKK	09/85 ⇒	12/94
BX 1.9 GTi	D6D, D6K	01/87 ⇒	01/92
BX 14	150C, KDY(TU3M), KDZ(TU3M/Z)	01/86 ⇒	02/93
BX 14 E	150A, 150C, K1G	10/82 ⇒	02/93
BX 16	180Z	03/86 ⇒	12/94
BX 19	D6A(XU9J2), DKZ(XU9JA)	07/86 ⇒	12/94
BX 19 Cat	DFZ(XU9J1)	07/86 ⇒	12/94
BX 19 GTi	D6A(XU9J2), DKZ(XU9JA)	07/86 ⇒	02/93
BX 19 GTi 4x4	DKZ(XU9JA)	06/88 ⇒	02/93

CITROËN

C15 1.0	108C(XV8), C1A, C1A(TU9/K), C1B(TU9/W), TU9	10/84 ⇒	12/97
C15 1.1	H1A, HDZ(TU1M), TU1	08/88 ⇒	07/96
C15 1.1 i	HDZ(TU1M), TU1M2	07/88 ⇒	12/96
C15 1.4	K1A, K1G, K1H(TU3A), KDY(TU3M)	07/87 ⇒	12/96
C15 1.4 E	K1F, K1J, K2D, K3A, KAZ	07/86 ⇒	12/96
C15 1.4 i	KDY(TU3FM), KDY(TU3M)	05/91 ⇒	12/96

PEUGEOT

205 I 1.4	TU3	01/83 ⇒	12/90
205 I 1.6 GTI	XU5J1	01/83 ⇒	12/90
205 I 1.9 GTI	D6B(XU9JA)	10/86 ⇒	10/87
205 II 1.0	TU9	10/87 ⇒	09/98
205 II 1.1	H1B(TU1), HDZ(TU1M)	10/87 ⇒	09/98
205 II 1.1 CJ	HDZ(TU1M)	10/89 ⇒	12/94
205 II 1.3	TU24	01/91 ⇒	12/94
205 II 1.3 Rallye	TU24	10/87 ⇒	10/90
205 II 1.4	K1D(TU3A), K2B(TU3S), KDY(TU3M), KDZ(TU3M)	06/87 ⇒	09/98
205 II 1.4 Cat	KAY(TU3CP)	08/87 ⇒	09/93
205 II 1.4 CJ	K1D(TU3A), KDY(TU3M), KDZ(TU3M)	03/89 ⇒	12/94
205 II 1.4 CJ Cat	KAY(TU3CP)	01/89 ⇒	09/93
205 II 1.6 GTI	XU5JA	01/91 ⇒	12/94
205 II 1.9 GTI	DFZ(XU9J1)	10/87 ⇒	12/94
205 II 1.9 GTI	D6B(XU9JA), DKZ(XU9JAZ)	10/87 ⇒	09/98
205 II 1.9 GTI Cat	DFZ(XU9J1)	10/87 ⇒	07/94
309 I 1.4	K1D(TU3A), K2B(TU3S), KDY(TU3M), KDZ(TU3M)	08/88 ⇒	08/89
309 II 1.1	H1B(TU1), HDZ(TU1M)	09/89 ⇒	12/93
309 II 1.4	KDZ(TU3M), TU3, TU3F2	07/89 ⇒	12/93
309 II 1.6	XU5JA	07/89 ⇒	12/93
309 II 1.6 GTi	--	09/89 ⇒	10/93
309 II 1.9 GTI	DKZ(XU9JAZ)	07/89 ⇒	12/93
405 I 1.4	K5A(TU3), TU3A, TU3F2	01/87 ⇒	12/92
405 I 1.9	DKZ(XU9JAZ)	06/87 ⇒	08/92
405 I 1.9 4x4	DKZ(XU9JAZ)	06/87 ⇒	07/92

KW 470 106



07

COILS

Adatt./Suitable:

BOSCH

F 000 ZS0 113

CITROËN

5970 42

97 531 206

DUCELLIER

2 526 009

2 526 009 A

MAGNETI MARELLI

060705738010

060717015012

607 057 01

607 057 38

BAE 507 AK

PEUGEOT

5970 42



	ohm		ohm
	0,68	Ø 6,3	6800

CITROËN

BX 1.6	B2C	02/88 ⇒	12/94
BX 1.9	159B, 159C, D6U, DKK	05/85 ⇒	12/94
BX 1.9 GTi	D6D, D6K	01/87 ⇒	01/92
BX 1.9 GTi 16V	159K, DFK	01/87 ⇒	12/94
BX 15	B1E(XU51C)	01/87 ⇒	05/92
BX 16	171A, 171B, 171C, 171D, 23DH, B1E(XU51C), BAY(XU5CP), BAZ(XU5CP), BDY(XU5M), BDZ(XU5M)	10/82 ⇒	12/94
BX 16 E	BDY(XU5M), BDZ(XU5M)	05/89 ⇒	02/93

CITROËN

BX 19	159A, D2A(XU92C), D2C(XU92C), D2E, D6A(XU9J2), DKZ(XU9JA)	09/84 ⇒	12/94
BX 19 Cat	DFZ(XU9J1)	07/86 ⇒	12/94
BX 19 E 4x4	D2F	04/89 ⇒	02/93
BX 19 GTi	D6A(XU9J2), DKZ(XU9JA)	07/86 ⇒	02/93
BX 19 GTi 16V	D6C(XU9J4), DFW(XU9J4)	09/87 ⇒	02/93
BX 19 GTi 4x4	DKZ(XU9JA)	06/88 ⇒	02/93
C15 1.1	E1A	10/84 ⇒	12/96
C15 1.3	G1A	07/87 ⇒	05/88

PEUGEOT

205 I 1.3	G1A	02/84 ⇒	10/87
205 I 1.4	J2	01/83 ⇒	12/90
205 I 1.5	Y2/K	02/84 ⇒	10/87
205 II 1.1 XA	E1	07/87 ⇒	10/88
205 II 1.2	F1	01/87 ⇒	12/90
205 II 1.3	G1A	08/90 ⇒	07/92
205 II 1.4	J2	01/91 ⇒	12/94
309 I 1.1	E1	10/85 ⇒	07/89
309 I 1.3	G1A, G2S	10/85 ⇒	08/89
309 I 1.3 XL	--	09/86 ⇒	08/89
309 I 1.5	Y2/K	06/87 ⇒	12/89
309 I 1.6	--, J2	01/86 ⇒	07/89
309 II 1.6	18EM, BDZ(XU5M), J2	07/89 ⇒	12/93
309 II 1.9	XU92C	07/89 ⇒	12/93
309 II 1.9 GTI 16V	D6C(XU9J4)	08/89 ⇒	07/90
405 I 1.6	--, 18EM, B1E(XU51C), BDZ(XU5M)	01/87 ⇒	12/92
405 I 1.6 4x4	BDZ(XU5M)	04/88 ⇒	07/92
405 I 1.6 SRi 4x4	BDZ(XU5M)	04/88 ⇒	07/92
405 I 1.9	D2C(XU92C), D6A(XU9J2), D6C(XU9J4), XU9J2/D6D	01/87 ⇒	12/93
405 I 1.9 4x4	D6C(XU9J4)	06/87 ⇒	07/92
405 I 1.9 Antipollution	XU92C	01/87 ⇒	12/92
405 I 1.9 Sport MI-16	D6C(XU9J4), DFW(XU9J4Z)	06/87 ⇒	11/92
405 I 1.9 Sport MI-16 4x4	DFW(XU9J4Z)	06/87 ⇒	07/92
405 I 1.9 Trazione integrale	D6C(XU9J4)	06/87 ⇒	07/92
405 II 1.6	18EM	08/92 ⇒	05/97
405 II 1.9	XU92C	01/93 ⇒	12/96

KW 470 107



05

COILS

Adatt./Suitable:

BOSCH

F 000 ZS0 115

CHRYSLER

T1031135

DUCELLIER

520 064

2 526 023

2 526 023 A

2 526 048 A

JEEP

T1031135

MAGNETI MARELLI

BAE 504 B

RENAULT

77 01 031 135

VOLVO

3287677

32876773

⁰⁰ Eliminated on 25-11-2020. Please verify the availability through our local distributors

- Eliminato il 25-11-2020. Verificare la disponibilità presso i nostri distributori
- Éliminé le 25-11-2020. Vérifier la disponibilité auprès de nos distributeurs sur place
- Am 25-11-2020 gestrichen. Evtl. Verfügbarkeit bitte bei unseren Händlern prüfen
- Eliminado en fecha 25-11-2020. Verificar la disponibilidad a través de nuestros distribuidores locales



	ohm		ohm
	0,47	Ø 6,3	6000

ALPINE

V6 TURBO Z7U730, Z7U732, Z7U734 01/88 ⇒ 12/90

JEEP

CHEROKEE II 2.5 EPE, U150, Y246 10/83 ⇒ 09/90

JEEP		
CHEROKEE II 2.5 4x4	EPE	10/86 ⇒ 09/90
CHEROKEE II 4.0 i	1Z7K	10/86 ⇒ 09/01
COMANCHE 2.5	EPE	10/86 ⇒ 09/90
COMANCHE 4.0 i	1Z7K	10/87 ⇒ 09/90
GRAND WAGONEER 4.0 i	1Z7K	10/86 ⇒ 09/90
WAGONEER 2.5	EPE	10/83 ⇒ 09/90
WAGONEER 4.0 i	1Z7K	10/86 ⇒ 09/90
WRANGLER 4.0	1Z7K	10/86 ⇒ 09/90
RENAULT		
18 1.4	847720, 847722	04/78 ⇒ 07/86
18 1.6 TS	A6M725, A6M726	05/82 ⇒ 07/86
18 2.0	J6R716	05/82 ⇒ 07/86
19 1.1.2	C1G730	01/88 ⇒ 12/92
19 1.1.2i	E7F	01/89 ⇒ 12/92
19 1.1.4	C2J772, C2J776, C3J710, E6J700, E6J701, E7J700	01/88 ⇒ 05/93
19 1.1.4 Cat	C3J710	01/89 ⇒ 04/92
19 1.1.7	F2N720, F2N721, F2N722, F2N724, F3N740, F3N741, F3N742, F3N743, F3N746	07/88 ⇒ 12/92
19 1.1.8 16V	F7P700, F7P704	06/89 ⇒ 09/92
19 11 1.2	E7F730	05/92 ⇒ 09/94
19 11 1.4	C3J710, E6J706, E7J706, E7J742, E7J745	01/92 ⇒ 12/95
19 11 1.7	F2N720, F2N721, F2N726, F2N727, F3N740, F3N741, F3N742, F3N743, F3N746	09/90 ⇒ 12/95
19 11 1.8	5F140FE, 8NA20S, F3P682, F3P704, F3P705, F3P706, F3P707, F3P708, F3P764, F3P765	04/92 ⇒ 06/96
19 11 1.8 16V	F7P704	04/92 ⇒ 06/96
21 1.4	C2J770, C2L714, C2L717	06/88 ⇒ 12/95
21 1.6	C2L	01/87 ⇒ 12/94
21 1.7	F2N710, F2N711, F2N712, F2N722, F2N750, F2N752, F2N754, F2N758, F2N786, F3N722, F3N723, F3N726	03/86 ⇒ 12/95
21 1.7 Cat	F3N726	05/88 ⇒ 06/93
21 2.0	14ZR, F2R702, J6R758, J6R793, J7R740, J7R747, J7R750, J7R751	03/86 ⇒ 06/94
21 2.0 4x4	14ZR, J7R740, J7R747	03/89 ⇒ 02/94
21 2.0 Turbo	J7R752, J7R756	04/87 ⇒ 10/92
21 2.0 Turbo 4x4	J7R752, J7R756	08/89 ⇒ 10/93
21 2.0 TXi	15CRMP10U1, J7R740	07/89 ⇒ 05/93
21 2.2	J6T790, J6T791, J7T754, J7T755, J7T756	03/86 ⇒ 12/95
21 2.2 4x4	J7T754, J7T755	06/86 ⇒ 06/94
25 2.0	08A, J6R706, J6R707, J6R763, J7R722, J7R723	04/84 ⇒ 12/93
25 2.0 12V	74AR-FXE, 7CYQD80D-E3, J7R721	06/88 ⇒ 12/93
25 2.2	04TNV88-C, 74G69-S4M, J7T706, J7T707, J7T708, J7T715, J7T730, J7T731, J7T732	04/84 ⇒ 12/92
25 2.4 V6 Turbo	Z7U702	10/84 ⇒ 05/90
25 2.5 V6 Turbo	Z7U700	01/90 ⇒ 12/92
25 2.8 V6	Z7W700, Z7W701	06/87 ⇒ 02/90
25 2.8 V6 Injection	Z7W706, Z7W707, Z7W709	06/87 ⇒ 12/92
CLIO I 1.2	E5F710, E5F716, E7F700, E7F706, E7F708, E7F750	05/90 ⇒ 09/98
CLIO I 1.4	E6J712, E6J713, E6J718, E7J601, E7J710, E7J711, E7J716, E7J718, E7J719, E7J754, E7J756, E7J757	01/90 ⇒ 09/98
CLIO I 1.7	F2N770	01/91 ⇒ 12/93
CLIO I 1.8	OHR10DE, F3P710, F3P714, F3P754	08/90 ⇒ 09/98
CLIO I 1.8 16V	F7P720, F7P722	01/91 ⇒ 03/96
CLIO I 1.8 Rsi	F3P712, F3P758	01/93 ⇒ 09/98
CLIO I Williams	F7R700	01/94 ⇒ 09/98
ESPACE I 2.0	53AZ-FXE, J6R234, J6R236	07/84 ⇒ 12/90
ESPACE I 2.0 i	J7R760	01/89 ⇒ 12/90
ESPACE I 2.0 i Quadra	J7R760	03/88 ⇒ 12/92
ESPACE II 2.0	J7R768	01/91 ⇒ 10/96
ESPACE II 2.2	J7T772, J7T773, J7T776	01/91 ⇒ 10/96
ESPACE II 2.2 4x4	J7T772, J7T773	03/91 ⇒ 12/96
ESPACE II 2.8 V6	Z7W712, Z7W713, Z7W717	01/91 ⇒ 10/96
EXPRESS 1.2	C1G	01/85 ⇒ 10/90
EXPRESS 1.4	C1J, C2J, E6J/E7J	01/85 ⇒ 10/90
FUEGO 1.6 [USA] R136B	A7L	01/84 ⇒ 12/86
LAGUNA I 1.8	F3P678, F3P720, F3P724	11/93 ⇒ 03/01
LAGUNA I 2.0	G27U730, F3R722	11/93 ⇒ 03/01
MASTER I 2.0	J5R718, J5R728	06/85 ⇒ 12/95
MASTER I 2.2	J7T788	08/93 ⇒ 02/98
MASTER I 28-35 2.0	J5R718	10/86 ⇒ 07/98
MASTER I 30 2.2	J7T782, J7T788	08/80 ⇒ 07/98
MEGANE I 1.4	E7J764	09/96 ⇒ 08/03
MEGANE I 1.4 e	E7J764	01/96 ⇒ 08/03
MEGANE I 1.4 Eco	E7J624	01/96 ⇒ 03/99
MEGANE SCÉNIC I 1.4 i	E7J764	01/97 ⇒ 09/99
RAPID 1.2	C1G726	09/91 ⇒ 08/93

RENAULT		
RAPID 1.4	C1J768, C1J780, C2J784, E6J738, E7J720, E7J724, E7J726, E7J728, E7J770, E7J771, E7J773	07/85 ⇒ 03/98
RAPID 1.4 Cat	C3J702, C3J760, C3J762	08/88 ⇒ 03/98
RAPID 1.4 RN	E6J734	09/91 ⇒ 08/93
SAFRANE I 2.0	0LJY, J7R732, J7R738, J7R739	08/92 ⇒ 09/96
SAFRANE I 2.0 12V	J7R734, J7R735	04/92 ⇒ 07/96
SAFRANE I 2.2	1MR4790B, J7T761, J7T762	04/92 ⇒ 07/96
SAFRANE I 3.0	Z7X723	02/93 ⇒ 06/96
SAFRANE I 3.0 Biturbo 4x4	Z7X726	02/93 ⇒ 07/96
SAFRANE I 3.0 V6	Z7X721, Z7X722, Z7X723, Z7X753	12/92 ⇒ 07/96
SAFRANE I 3.0 V6 4x4	Z7X721, Z7X722, Z7X723	12/92 ⇒ 07/96
SAFRANE II 3.0 V6	6216K4FU, Z7X755	07/96 ⇒ 12/00
SUPER 5 1.2	C1G702, C1G720, C1G722	01/87 ⇒ 12/96
SUPER 5 1.4	C1J768, C1J780, C1J788, C2J700, C2J780, C2J781, C2J782, C2J784, C2J788, C2J789, C2J798, C3J700	10/84 ⇒ 08/90
SUPER 5 1.4 Cat	C3J700, C3J702, C3J760	10/85 ⇒ 12/96
SUPER 5 1.4 Turbo	C1J782, C1J784, C1J788	04/85 ⇒ 08/90
SUPER 5 1.7	F2N740, F2N742, F3N716, F3N717	10/86 ⇒ 03/95
SUPER 5 1.7 i	F3N702	10/86 ⇒ 08/91
TRAFIC I 1.7	F1N720	05/89 ⇒ 08/94
TRAFIC I 2.0	J5R716	05/89 ⇒ 08/90
TRAFIC I 2.0 RWD	J5R726	05/89 ⇒ 10/97
TRAFIC I 2.2	J7T600, J7T780	05/89 ⇒ 04/98
TRAFIC I 2.2 4x4	J7T600, J7T780	05/89 ⇒ 04/98
VOLVO		
340-360 1.3	B13, B13.4E	08/88 ⇒ 12/90
340-360 1.4	B14.3E, B14.4E, B14.4ED, B14.40, B14.45	08/82 ⇒ 07/91
340-360 1.7	B172K	08/85 ⇒ 07/91
340-360 2.0	B200E, B200EA, B200F, B200K	08/84 ⇒ 07/90
440 1.6	B16F	09/88 ⇒ 12/96
440 1.7	B18E, B18EP, B18F, B18FP, B18K, B18KD, B18KP, B18KPD	08/88 ⇒ 12/96
440 1.8	B18U	08/91 ⇒ 12/96
440 2.0	B20F	08/92 ⇒ 07/96
460 1.6	B16F	07/92 ⇒ 07/96
460 1.7	B18EP, B18FP, B18K, B18KD, B18KP	09/88 ⇒ 07/96
460 1.8	B18U	08/91 ⇒ 07/96
460 2.0	B20F	08/92 ⇒ 07/96
480 1.7	B18E, B18ED, B18EP, B18F, B18FP	04/86 ⇒ 07/96
480 2.0	B20F	08/92 ⇒ 09/95

KW	470 108	07
----	---------	----

COILS

Adatt./Suitable:

BOSCH

0 986 221 027

FIAT

7582152

7663177

7698431

7746152

7746154

LANCIA

7663177

MAGNETI MARELLI

060705604010



060717017012

607 056 04

BAE 506

BAE 506 D

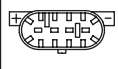

	ohm	ohm
	0,75	
		3500

FIAT

FIORINO II 1.0 iE	156A2.246	11/92 ⇒ 04/96
PALIO 1.1	178B9.033	07/97 ⇒ 10/03
PANDA I 1.1	156C.046	05/91 ⇒ 03/95
PANDA I 1000 4x4	141C2.000, 156A2.246	05/86 ⇒ 12/94
PANDA I 1000 Fire [CHE]	156A2.146	11/87 ⇒ 04/91
PANDA I 1000 i.e	156A2.246	08/92 ⇒ 02/04
PANDA I 1000 i.e. Cat	141C2.000, 156A2.246	10/87 ⇒ 08/98
PANDA I 1100 i.e.	156C.046	01/86 ⇒ 04/91
PANDA I 1100 Trekking 4x4	156C.046	10/91 ⇒ 07/04
TEMPRA 1.4 i.e.	159A2.000, 160A1.046	04/90 ⇒ 08/96
TIPO I 1.1	160A3.000	01/88 ⇒ 10/91
TIPO I 1.4	160A1.000	07/87 ⇒ 12/89
TIPO I 1.4 i.e.	159A2.000	05/89 ⇒ 04/95
UNO 45 1.0	156A2.000, 156A2.100	06/86 ⇒ 12/93
UNO 45 i.e. 1.0	156A2.246	10/84 ⇒ 10/95
UNO 50 1.1	156C.046	01/90 ⇒ 12/93
UNO 50 i.e. 1.1	146C3.000	06/92 ⇒ 12/93
UNO 60 1.1	146A4.048, 146A6.000, 160A3.000	02/88 ⇒ 12/92
UNO Mondo 1.0	146A2.166	01/98 ⇒
UNO Mondo 1.0 [IND]	146A2.166	01/98 ⇒
LANCIA		
Y10 1.0 Fire	156A2.100	06/85 ⇒ 06/91
Y10 1.0 Fire Catalytic-Conv	156A2.246	10/87 ⇒ 02/92
Y10 1.0 Fire Trazione integrale	156A2.000, 156A2.100, 156A2.246	12/86 ⇒ 02/92
Y10 1.1 i.e. Fire	156C.000	08/89 ⇒ 06/92
Y10 1.1 i.e. Fire Trazione integrale	156C.000	08/89 ⇒ 06/92
Y10 1.1 i.e. Fire	156C.046	07/89 ⇒ 09/95

KW 470 109



07

COILS

Adatt./Suitable:

DELCO REMY
3 474 227

GENERAL MOTORS
03 474 227
3 474 227
OPEL

12 08 035

00 Eliminated on 23-02-2022. Please verify the availability through our local distributors

- Eliminato il 23-02-2022. Verificare la disponibilità presso i nostri distributori
- Éliminé le 23-02-2022. Vérifier la disponibilité auprès de nos distributeurs sur place
- Am 23-02-2022 gestrichen. Evtl. Verfügbarkeit bitte bei unseren Händlern prüfen
- Eliminado en fecha 23-02-2022. Verificar la disponibilidad a través de nuestros distribuidores locales



	ohm		ohm
	0,68		8300

OPEL

ASCONA C 1.6	16N	09/81 ⇨ 09/87
ASCONA C 1.6 S	16SH	09/81 ⇨ 08/86
ASCONA C 1.8 i	18E	09/82 ⇨ 08/86
KADETT E 1.8 i	18E	09/84 ⇨ 08/86

KW 470 110



07

COILS

Adatt./Suitable:

00 Eliminated on 24-02-2021. Please verify the availability through our local distributors

- Eliminato il 24-02-2021. Verificare la disponibilità presso i nostri distributori
- Éliminé le 24-02-2021. Vérifier la disponibilité auprès de nos distributeurs sur place
- Am 24-02-2021 gestrichen. Evtl. Verfügbarkeit bitte bei unseren Händlern prüfen
- Eliminado en fecha 24-02-2021. Verificar la disponibilidad a través de nuestros distribuidores locales

1000 After depletion of stock this part is replaced by:

- Esaurite le scorte questo pezzo sarà sostituito da:
- Après épuisement du stock, cette pièce est remplacée par:
- Nach Vorraterschöpfung wird ersetzt durch:
- Despues agotamiento stock, sera sustituido por:

470 341



	ohm		ohm
	0,41		5000

KW 470 111



07

COILS

Adatt./Suitable:

DELCO REMY
3 474 221

GENERAL MOTORS

3 474 221

OPEL

12 08 036

03 Supplied until depletion

- Fornibile fino ad esaurimento delle scorte
- Fourni jusqu'à épuisement du stock
- Lieferbar solange vorrat reicht
- Suministrado hasta el stock termina



	ohm		ohm
	0,41		5000

OPEL

ASCONA C 1.3 N	13N	09/81 ⇨ 08/86
ASCONA C 1.3 S	13S	09/81 ⇨ 08/88
ASCONA C 1.6	16SV	09/86 ⇨ 08/88
ASCONA C 1.6 i Cat	C16LZ, C16NZ	09/86 ⇨ 08/88

KW 470 112



07

COILS

Adatt./Suitable:

BMW
1 720 166
1 720 877
12 13 1 720 166
12 13 1 720 877
12 13 1 742 925
17 20 1 66.2
BOSCH

0 221 502 009



	ohm		ohm
	0,36		9000

BMW

5 II 530 i	--	01/84 ⇨ 12/88
5 III M5	S38B36(36651)	09/88 ⇨ 03/92
5 III M5 Cat	S38B36(36651)	09/88 ⇨ 03/92
7 II 750 i, iL V12	M70B50(5012A)	09/87 ⇨ 09/94
8 850 CSi	S70B56(56121)	11/92 ⇨ 12/96
8 850 i, Ci	M70B50(5012A)	01/90 ⇨ 08/94
Z1 2.5	M20B25(256K1)	06/88 ⇨ 06/91

KW 470 125



07

COILS

Adatt./Suitable:

AUDI

211 905 115 D
251 905 115 A

BOSCH

0 221 122 349
0 221 122 350
0 221 122 386

SEAT

211 905 115 D

VW

211 905 115 D
251 905 115 A

960 Dry (epoxy) coil replacing original oil-bath coil version

- Bobina (resinizzata) sostituyente originale a bagno d'olio
- Bobine seche, remplaçant la bobine d'origine à bain d'huile
- Trockenspule, die die Originale im Ölbad ersetzt
- Bobina seca, sustituye modelo original con baño de aceite



-	+	ohm	ohm
M5	M5	0,63	3500
			∅ 4

AUDI

80 II 1.3	EP	09/78 ⇒ 07/86
80 II 1.6	DT, JU, SA, WV	08/78 ⇒ 03/87
80 II 1.8	DS, JN, SF	01/83 ⇒ 08/86
80 II 1.8 CC quattro	JN, JV	08/84 ⇒ 08/86
80 II 1.8 GTE	DZ, MU, PV	06/84 ⇒ 03/87
80 II 2.0	HP, JS	10/83 ⇒ 09/84
80 II 2.0 quattro	JS	10/83 ⇒ 09/84
90 I 1.8	JN	06/84 ⇒ 03/87
90 I 2.0	HP, JL, JS, SK	10/84 ⇒ 03/87
90 I 2.0 quattro	JS	08/84 ⇒ 08/86
90 I 2.2	9C54, HY, KX	10/84 ⇒ 03/87
90 I 2.2 E quattro	9C54	11/84 ⇒ 03/87
90 II 2.2 E quattro	9C54	04/87 ⇒ 09/91
100 III 2.0	KP	08/84 ⇒ 12/87
100 III 2.0 E	KP	01/85 ⇒ 12/87
100 III 2.2	KZ	10/84 ⇒ 09/86
200 II 2.2	KU	08/84 ⇒ 07/85
COUPE 2.2 GT	9C54	09/84 ⇒ 10/88
COUPE 2.2 quattro	9C54, JT	10/84 ⇒ 10/88

SEAT

TOLEDO I 1.8 16V	KR, PL	05/91 ⇒ 03/99
TOLEDO I 1.8 GT	KR	05/91 ⇒ 11/92
TOLEDO I 1.8 i	RP	05/91 ⇒ 12/96

VW

PASSAT II 1.6	DT	08/80 ⇒ 03/88
PASSAT II 1.8	DS	01/83 ⇒ 03/88
PASSAT II 1.8 Syncro	DS	01/86 ⇒ 03/88
PASSAT II 2.0	JS	08/83 ⇒ 03/88
PASSAT II 2.0 Syncro	JS	05/84 ⇒ 03/88
POLO II 1.0	AAK, HZ	01/85 ⇒ 09/94
POLO II 1.0 Cat	AAK	08/89 ⇒ 09/94
POLO II 1.3	3F, GK	09/82 ⇒ 09/94
POLO II 1.3 Cat	2G, 3F, MH, NZ	07/87 ⇒ 09/94
POLO II 1.3 G40	PY	01/87 ⇒ 08/90
JETTA II 1.0	HZ	08/85 ⇒ 10/91
JETTA II 1.3	MH, NU	01/84 ⇒ 12/87
JETTA II 1.3 Cat	2G, MH, NZ	06/87 ⇒ 12/91
JETTA II 1.6	ABN, EZ, EZA, HM, PN, RF	12/83 ⇒ 07/92
JETTA II 1.8	EV, GU, GX, PB, RD, RH, RV	01/84 ⇒ 10/91
JETTA II 1.8 16V	KR, PL	08/86 ⇒ 10/91
JETTA II 1.8 Cat	GX, PF, RP	01/87 ⇒ 10/91
JETTA II 1.8 G60	PG	04/90 ⇒ 07/91
JETTA II 1.8 Syncro	3E82, GU, GX, RH, RP	08/85 ⇒ 07/91
JETTA II 1.8i GT	GZ	12/83 ⇒ 07/88
CADDY I 1.8	JH	08/85 ⇒ 07/92
CORRADO 1.8 G60	PG	09/88 ⇒ 09/93
DERBY 1.3	GK, HK	09/82 ⇒ 12/84
GOLF I 1.6	EW, HN	08/83 ⇒ 04/92
GOLF I 1.8	2H, DX, EX, JH, KT	08/82 ⇒ 04/93

VW

GOLF II 1.0	HZ	08/85 ⇒ 10/91
GOLF II 1.3	MH, NU	08/83 ⇒ 12/87
GOLF II 1.3 Cat	2G, NZ	06/86 ⇒ 12/92
GOLF II 1.6	ABN, EZ, PN, RF	08/83 ⇒ 12/92
GOLF II 1.6 [CHE] [SWE]	HM	08/83 ⇒ 07/88
GOLF II 1.6 G	EZA, PN	08/86 ⇒ 07/91
GOLF II 1.8	GU, GX, RH, RV	08/84 ⇒ 10/91
GOLF II 1.8 [CHE] [SWE]	EV, PB, RD	04/84 ⇒ 07/87
GOLF II 1.8 GTI	HM	08/83 ⇒ 10/91
GOLF II 1.8 GTI 16V	KR, PL	02/86 ⇒ 10/91
GOLF II 1.8 GTI Cat	PF	01/87 ⇒ 10/91
GOLF II 1.8 GTI G60	PG	04/90 ⇒ 07/91
GOLF II 1.8 GTI G60 Syncro	1H, PG	08/88 ⇒ 12/91
GOLF II 1.8 i	RP	08/87 ⇒ 07/91
GOLF II 1.8 i Cat	GX, RP	08/87 ⇒ 10/91
GOLF II 1.8 i Cat Syncro	RP	08/87 ⇒ 10/91
GOLF II 1.8 Rallye syncro	1H, PG	08/88 ⇒ 07/91
GOLF II 1.8 Syncro	3E82, GU, GX, RH	02/86 ⇒ 07/91
GOLF II 1.8i GTI [CHE] [SWE]	GZ	01/84 ⇒ 07/87
GOLF II 1.8i GTI [SWE]	GM	08/87 ⇒ 07/88
LT I 2.4 i	1E	08/89 ⇒ 06/96
PASSAT III 1.6	1F, EZ	04/88 ⇒ 07/92
PASSAT III 1.8	KR, PB, PF, RP	02/88 ⇒ 05/97
PASSAT III 1.8 16V	KR	04/88 ⇒ 12/89
PASSAT III 1.8 G60 Syncro	PG	08/88 ⇒ 05/97
PASSAT III 1.8 GL	KR	08/91 ⇒ 09/93
QUANTUM 2.1	--	01/85 ⇒ 12/87
QUANTUM 2.1	--	01/81 ⇒ 12/84
SANTANA 1.6	DT	08/81 ⇒ 12/84
SANTANA 1.8	DS	01/83 ⇒ 12/84
SANTANA 2.0	JS	08/83 ⇒ 12/84
SCIROCCO II 1.6	EW, EWA, HN, RE	01/83 ⇒ 07/90
SCIROCCO II 1.8	DX, EX, JH, KT	08/82 ⇒ 07/92
SCIROCCO II 1.8 16V	KR, PL	10/85 ⇒ 07/92
TRANSPORTER III 1.9	DF, DG	08/82 ⇒ 07/92
TRANSPORTER III 1.9 Syncro	DG	11/84 ⇒ 07/92
TRANSPORTER III 2.1	DJ, MV, SR	08/84 ⇒ 07/92
TRANSPORTER III 2.1 Cat	MV	06/89 ⇒ 07/92
TRANSPORTER III 2.1 i	SS	07/89 ⇒ 07/92
TRANSPORTER III 2.1 Syncro	DJ, MV, SR	08/85 ⇒ 07/92

KW 470 126



07

COILS

Adatt./Suitable:

AUDI

035 905 105 A

BOSCH

0 221 118 398
0 221 122 334
0 221 122 357
0 221 122 358
0 221 122 399
0 221 122 400

FIAT

7612954

LANCIA

7612954

VW

035 905 105 A
191 905 115 A

960 Dry (epoxy) coil replacing original oil-bath coil version

- Bobina (resinizzata) sostituyente originale a bagno d'olio
- Bobine seche, remplaçant la bobine d'origine à bain d'huile
- Trockenspule, die die Originale im Ölbad ersetzt
- Bobina seca, sustituye modelo original con baño de aceite



-	+	ohm	ohm
M5	M5	0,68	7200
			∅ 4

AUDI

200 II 2.2 Turbo quattro	MC	01/85 ⇒ 12/91
--------------------------	----	---------------

LANCIA

THEMA 2850 V6 i.e.	834E.146	06/88 ⇒ 05/92
THEMA 8.32	F105L	09/87 ⇒ 05/89

VW

POLO II 1.0	HZ	01/85 ⇒ 09/94
POLO II 1.3	GK	09/82 ⇒ 09/89
POLO II 1.3 Cat	2G, MH, NZ	07/87 ⇒ 09/94
JETTA II 1.0	HZ	08/85 ⇒ 10/91
JETTA II 1.3	MH	01/84 ⇒ 06/87
JETTA II 1.3 Cat	2G, MH, NZ	06/87 ⇒ 12/91
JETTA II 1.6	EZ, PN, RF	01/84 ⇒ 07/92
JETTA II 1.8 16V	PL	08/86 ⇒ 10/91
JETTA II 1.8 Syncro	3E82, GU	08/87 ⇒ 07/91
CADDY I 1.8	JH	08/85 ⇒ 07/92
CORRADO 1.8 16V	KR	04/89 ⇒ 07/92
GOLF I 1.6	EW, HN	08/83 ⇒ 04/92
GOLF I 1.8	2H, DX, EX, JH, KT	08/82 ⇒ 04/93
GOLF II 1.0	HZ	08/85 ⇒ 10/91
GOLF II 1.3	MH	08/83 ⇒ 06/87
GOLF II 1.3 Cat	2G, NZ	06/86 ⇒ 12/92
GOLF II 1.6	EZ, PN, RF	08/84 ⇒ 12/92
GOLF II 1.6 G	PN	08/86 ⇒ 07/91
GOLF II 1.8	GU	08/84 ⇒ 10/91
GOLF II 1.8 GTI 16V	PL	02/86 ⇒ 10/91
GOLF II 1.8 Syncro	3E82, GU	02/86 ⇒ 07/91
PASSAT III 1.6	1F, EZ	04/88 ⇒ 07/92
PASSAT III 1.8	KR	08/91 ⇒ 09/93
PASSAT III 1.8 16V	KR	04/88 ⇒ 12/89
PASSAT III 1.8 GL	KR	08/91 ⇒ 09/93
QUANTUM 2.1	--	01/85 ⇒ 12/89
SCIROCCO II 1.6	EW, RE	01/83 ⇒ 07/90
SCIROCCO II 1.8	DX, EX, JH, KT	08/82 ⇒ 07/92
SCIROCCO II 1.8 16V	KR, PL	10/85 ⇒ 07/92
TRANSPORTER III 1.9	DF, DG	08/82 ⇒ 07/92
TRANSPORTER III 1.9 Syncro	DG	11/84 ⇒ 07/92
TRANSPORTER III 2.1	DJ	08/84 ⇒ 07/92
TRANSPORTER III 2.1 Syncro	DJ	01/86 ⇒ 07/92

KW 470 127



07

COILS

Adatt./Suitable:

AUDI

811 905 115

BOSCH

0 221 122 379
0 221 122 380

VW

811 905 115

960 Dry (epoxy) coil replacing original oil-bath coil version

- Bobina (resinizzata) sostituyente originale a bagno d'olio
- Bobine seche, remplaçant la bobine d'origine à bain d'huile
- Trockenspule, die die Originale im Ölbad ersetzt
- Bobina seca, sustituye modelo original con baño de aceite

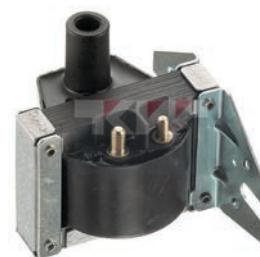

+	-	ohm	ohm
M6	M5	0,63	3500
			∅ 4

AUDI

80 II 1.3	EP	09/78 ⇒ 07/86
80 II 1.6	DT, JU, SA	08/78 ⇒ 03/87
80 II 1.8	DS, JN, SF	01/83 ⇒ 08/86
80 II 1.8 CC quattro	JN, JV	08/84 ⇒ 08/86
80 II 1.8 GTE	DZ, MU, PV	06/84 ⇒ 03/87
80 II 2.0	HP, JS	10/83 ⇒ 09/84
80 II 2.0 quattro	JS	10/83 ⇒ 09/84
80 III 1.4	SE	08/86 ⇒ 07/88
80 III 1.6	ABB, PP, RN, RNA	09/86 ⇒ 10/91
80 III 1.8	RU, SD	09/86 ⇒ 01/90
80 III 1.8 E	DZ	06/86 ⇒ 08/91
80 III 1.8 E quattro	DZ	09/86 ⇒ 08/91
80 III 1.8 quattro	SD	09/86 ⇒ 08/90
80 III 1.8 S	JN, JV, NE, PM, SF	08/86 ⇒ 10/91
80 III 1.8 S quattro	JN, NE, PM, SF	09/86 ⇒ 09/91
80 III 2.0	AAD	10/90 ⇒ 08/91

AUDI			
80 IV 1.6	ABB	03/92 ⇒ 05/93	
90 I 1.8	JN	06/84 ⇒ 03/87	
90 I 2.0	HP, JL, JS, SK	10/84 ⇒ 03/87	
90 I 2.0 quattro	JS	08/84 ⇒ 08/86	
90 I 2.2	9C54, HY, KX	10/84 ⇒ 03/87	
90 I 2.2 E quattro	9C54	11/84 ⇒ 03/87	
90 II 2.0	PS	07/88 ⇒ 09/91	
90 II 2.2 E	9C54	04/87 ⇒ 07/91	
90 II 2.2 E quattro	9C54	04/87 ⇒ 09/91	
100 III 1.8	DS, JW, NP, SH	08/83 ⇒ 12/90	
100 III 1.8 Cat	4B, PH	03/85 ⇒ 11/90	
100 III 1.8 Cat quattro	4B, PH	08/85 ⇒ 11/90	
100 III 1.8 quattro	NP, SH	10/84 ⇒ 07/90	
100 III 2.0	KP	08/84 ⇒ 12/87	
100 III 2.0 E	KP	01/85 ⇒ 12/87	
100 III 2.2 Cat	KU	06/89 ⇒ 11/90	
100 III 2.2 Cat quattro	KU	06/89 ⇒ 11/90	
100 IV 1.6	ABB	03/92 ⇒ 07/93	
COUPE 1.8	DZ	08/89 ⇒ 07/91	
COUPE 2.2	9C54	11/88 ⇒ 07/91	
COUPE 2.2 GT	9C54	09/84 ⇒ 10/88	
COUPE 2.2 quattro	9C54, JT	10/84 ⇒ 07/91	

VW			
POLO II 1.3	GK	09/82 ⇒ 09/89	
SANTANA 1.9	WN	08/81 ⇒ 07/83	
SCIROCCO II 1.3	GF	08/80 ⇒ 12/83	
SCIROCCO II 1.6	EW, EWA, HN	01/83 ⇒ 12/89	
SCIROCCO II 1.8	DX, EX, JH, KT	08/82 ⇒ 07/92	
SCIROCCO II 1.8 16V	KR	10/85 ⇒ 07/89	

KW 470 135  **07**

COILS

Adatt./Suitable:

BOSCH
F 000 Z50 212

DENSO
029700-6700

FORD
1 649 067
6 503 279
6 503 280
885F-12029A-1A
885F-12029A-2A
928F-12029-CA
96BF-12024A-1B
E8TZ-12029-A
E9TF-12029-AA

HITACHI
138803

MAGNETI MARELLI
060717036012

MAZDA
FSD7-18-100

Motorcraft
DG 435
EDG 43

⁰³ Supplied until depletion

- Fornibile fino ad esaurimento delle scorte
- Fourni jusqu'à épuisement du stock
- Lieferbar solange vorrat reicht
- Suministrado hasta el stock termina

KW 470 132  **07**

COILS

Adatt./Suitable:

AUDI
211 905 115 B

BOSCH
0 221 102 088
0 221 122 022
0 221 122 023

VW
211 905 115 B
211 905 115 C



⁰³ Supplied until depletion

- Fornibile fino ad esaurimento delle scorte
- Fourni jusqu'à épuisement du stock
- Lieferbar solange vorrat reicht
- Suministrado hasta el stock termina

⁹⁶⁰ Dry (epoxy) coil replacing original oil-bath coil version

- Bobina (resinizzata) sostituyente originale a bagno d'olio
- Bobine sèche, remplaçant la bobine d'origine à bain d'huile
- Trockenspule, die die Originale im Ölbad ersetzt
- Bobina seca, sustituye modelo original con baño de aceite





	ohm		ohm
	0,63	∅ 8,2	3500

AUDI			
80 II 1.6	WV	08/78 ⇒ 07/86	
100 III 1.8	DR	08/82 ⇒ 12/87	
100 III 1.9	WH	08/82 ⇒ 07/84	

VW			
PASSAT II 1.3	79SU16	08/80 ⇒ 07/86	
PASSAT II 1.6	DT	08/80 ⇒ 03/88	
PASSAT II 1.9	WN	01/81 ⇒ 07/83	
PASSAT II 2.2	KX	01/85 ⇒ 03/88	
JETTA II 1.8	EV, GU, GX	01/84 ⇒ 10/91	
JETTA II 1.8 Cat	GX	08/87 ⇒ 10/91	
JETTA II 1.8i GT	GZ	12/83 ⇒ 07/88	
GOLF I 1.6	EW, HN	08/83 ⇒ 04/92	
GOLF I 1.8	2H, DX, EX, JH, KT	08/82 ⇒ 04/93	
GOLF II 1.8	GU, GX	08/84 ⇒ 10/91	
GOLF II 1.8 [CHE] [SWE]	HV	04/84 ⇒ 07/85	
GOLF II 1.8 GTI	EV	08/83 ⇒ 10/91	
GOLF II 1.8i Cat	GX	08/87 ⇒ 10/91	
GOLF II 1.8i GTI [CHE] [SWE]	GZ	01/84 ⇒ 07/87	
GOLF II 1.8i GTI [SWE]	GZ	08/87 ⇒ 07/88	



	ohm		ohm
	0,50	∅ 7	13000

FORD

ESCORT IV 1.3	J6A, JBD	01/95 ⇒ 08/97	
ESCORT IV 1.4	F4B, F6F, F6G	07/90 ⇒ 08/00	
ESCORT V 1.4	F4B, F6F, F6G, FUH	07/90 ⇒ 01/95	
ESCORT V 1.4 i	F4B	07/93 ⇒ 01/95	
ESCORT V 1.6	LJF, LUJ, LUK	07/90 ⇒ 08/93	
ESCORT VI 1.4	F4B, F6B, F6D, FUH	01/95 ⇒ 12/99	
FIESTA III 1.4	FUG, FUJ	03/89 ⇒ 12/95	
FIESTA III 1.4 Cat	F4A	03/89 ⇒ 12/95	
FIESTA III 1.6	LUH	01/89 ⇒ 01/94	
FIESTA III 1.6 Turbo	LHA	03/90 ⇒ 10/92	
FIESTA III 1.6 XR2i	LJC, LJD	03/89 ⇒ 01/94	
ORION II 1.4	F6F, F6G, HL14L-FUH	07/90 ⇒ 12/93	
ORION II 1.6	LUJ, LUK	07/90 ⇒ 12/92	
ORION II 1.6 i	HL16EFH-LJE, LJF	07/90 ⇒ 09/92	
SIERRA II 1.6 i	L6B	10/89 ⇒ 02/93	
SIERRA II 1.8 i	HL18CFI-R6A	01/92 ⇒ 12/93	

MAZDA

626 VI 1.8	FP, FP9A, FPY3	05/97 ⇒ 10/02	
626 VI 2.0	FS	05/97 ⇒ 10/02	

KW 470 140  **07**

COILS

Adatt./Suitable:

BOSCH
F 000 Z50 111

DUCELLIER
2 526 049 A

GENERAL MOTORS
03 474 283
3 474 283
90 449 739
90 510 386

HITACHI
138780
2508780

HOLDEN
90449739



MAGNETI MARELLI
060717011012

OPEL
12 08 003
12 08 054
12 08 070
3474283
90449739
90510386

⁰³ Supplied until depletion

- Fornibile fino ad esaurimento delle scorte
- Fourni jusqu'à épuisement du stock
- Lieferbar solange vorrat reicht
- Suministrado hasta el stock termina



	ohm		ohm
6,4	0,41	∅ 4	5000

HOLDEN

BARINA 1.4 i	C14NZ	04/94 ⇒ 07/97	
BARINA_SB 1.2i	C12NZ	04/94 ⇒ 07/97	
COMBO 1.4 i	C14NZ	03/96 ⇒ 07/97	
COMBO_SB 1.4i	C14NZ	04/94 ⇒ 07/97	

OPEL

ASTRA F 1.4	14SE	09/92 ⇒ 09/98	
ASTRA F 1.4 i	C14NZ	09/91 ⇒ 01/05	
ASTRA F 1.4 Si	C14SE	03/92 ⇒ 03/01	
ASTRA F 1.6	16LZ2, 16NZ2	09/94 ⇒ 09/98	
ASTRA F 1.8 i	C18NZ	09/91 ⇒ 09/98	
COMBO B 1.2	C12NZ	07/94 ⇒ 10/01	
COMBO B 1.4	C14NZ	07/94 ⇒ 10/01	
CORSA A 1.2 i	C12NZ	09/89 ⇒ 03/93	
CORSA A 1.4 i	C14NZ	01/85 ⇒ 03/93	
CORSA A 1.4 Si	C14SE	09/91 ⇒ 03/93	
CORSA A 1.6 GSi	E16SE	05/88 ⇒ 03/92	
CORSA B 1.2 i	12NZ, C12NZ	03/93 ⇒ 09/00	
CORSA B 1.4 i	C14NZ	03/93 ⇒ 09/00	
KADETT E 1.4 i	C14NZ	01/90 ⇒ 07/94	
KADETT E 1.6	16SV	09/86 ⇒ 12/91	
KADETT E 1.6 i	16SV	07/89 ⇒ 02/93	
KADETT E 1.6 S	16S, 16SV	09/84 ⇒ 08/91	
KADETT E 1.8	18SE	01/86 ⇒ 08/91	
KADETT E 1.8 i	C18NZ	06/85 ⇒ 05/92	
OMEGA A 1.8	18SEH	09/86 ⇒ 03/94	
OMEGA A 1.8 S	18SV	09/86 ⇒ 03/94	
VECTRA A 1.6	16SV, C16LZ2	09/88 ⇒ 07/93	
VECTRA A 1.6 i	C16NZ2	09/88 ⇒ 11/95	
VECTRA A 1.6 i Cat	C16NZ2	09/88 ⇒ 11/95	
VECTRA A 1.6 S	16SV	09/88 ⇒ 05/93	
VECTRA A 1.8 i	18SV	09/88 ⇒ 10/90	
VECTRA A 1.8 i Cat	C18NZ	03/90 ⇒ 11/95	
VECTRA A 1.8 S	18SV	09/89 ⇒ 10/90	
VECTRA B 1.6 i	16LZ2	10/95 ⇒ 07/03	

VAUXHALL

ASTRA III 1.4 i	C14NZ, C14SE	03/91 ⇒ 09/98	
ASTRA III 1.8 i	C18NZ	09/91 ⇒ 09/98	
ASTRAVAN I 1.4 i	C14NZ	09/91 ⇒ 08/95	
COMBO B 1.2	C12NZ	07/94 ⇒ 10/01	
COMBO B 1.4	C14NZ	07/94 ⇒ 10/01	

VAUXHALL		
CORSA B 1.2 i	C12NZ	03/93 ⇒ 09/00
CORSA B 1.4 i	C14NZ	03/93 ⇒ 09/00
CORSAVAN I 1.4 i	C14NZ	01/94 ⇒ 09/00

KW 470 146



05

COILS

Adatt./Suitable:

ALFA ROMEO

46548037
60805420
60809492

BOSCH

F 000 Z50 103

CHAMPION

BAE 800 B

FIAT

46543562
46548037
60805420
60809492
60815150
7626232
7672018

HITACHI

138730
2508730

INNOCENTI

46543562

LANCIA

46543562
46548037
60805420
60809492
7626232
7672018

MAGNETI MARELLI

060708038010
060717029012
060780002010
607 080 38
BAE 800 AK
BAE 800 B
BAE 800 DK

	ohm		ohm
	0,54		7500

ALFA ROMEO

33 II 1.4 i.e.	AR30753	06/91 ⇒ 09/94
145 1.4 i.e.	AR33501	07/94 ⇒ 12/96
146 1.4 i.e.	AR33501	12/94 ⇒ 12/96
155 2.0 16V Turbo Q4	AR67203	01/92 ⇒ 12/97

FIAT

CINQUECENTO 0.7	170A.000, 171A.000	12/91 ⇒ 02/98
CINQUECENTO 0.7 i	170A.046	07/94 ⇒ 01/98
CINQUECENTO 0.9	170A1.000	07/91 ⇒ 12/93
CINQUECENTO 0.9 i.e.	170A1.046	07/91 ⇒ 09/94
CINQUECENTO 0.9 i.e. S	1170A1.000, 1170A1.046	07/91 ⇒ 07/99
CINQUECENTO 1.1 Sporting	176B2.000	10/94 ⇒ 01/98
COUPE 2.0 16V Turbo	175A1.000	11/93 ⇒ 08/96
DOBLO I 1.2	223A5.000	03/01 ⇒
PUNTO I 1.1	176B2.000	04/96 ⇒ 02/00
PUNTO I 1.2 16V	176B9.000	04/97 ⇒ 09/99
PUNTO I 155 1.1	176A6.000, 176B2.000	09/93 ⇒ 09/99
PUNTO I 60 1.2	176A7.000, 176B1.000, 176B4.000	09/93 ⇒ 06/00
PUNTO I 75 1.2	176A8.000	10/93 ⇒ 09/99
PUNTO I 85 16V 1.2	176B9.000	04/97 ⇒ 06/00
FIORINO II 1.2 MPI	178E8.011	01/04 ⇒
PALIO 1.0	178A1.000	04/96 ⇒ 10/03
PALIO 1.0 GLX	--	07/98 ⇒ 10/03
PALIO 1.1	187A1.000	06/06 ⇒
PALIO 1.2	176A8.000, 178B5.000, 178B7.045, 178C4.066, 178E2.000, 188A4.000	04/96 ⇒
PALIO 1.2 75	178B7.045	03/98 ⇒
PALIO 1.2 MPI	178C4.066	01/02 ⇒
PALIO 1.4	178B2.000, 178B2.016	04/96 ⇒ 10/02

FIAT

PALIO 1.4 Cat	178B2.000, 178B2.016	04/96 ⇒ 08/01
PALIO 1.5	178E5.022	02/02 ⇒
PALIO 1.5 MPI	178E5.027	08/01 ⇒
PALIO 1.6 16V 100	178C8.098	01/98 ⇒
PANDA I 1.1	156C.046, 187A1.000	09/00 ⇒ 03/95
PANDA I 1.1 AWD	187A1.000	09/00 ⇒ 02/04
PANDA I 1000 4x4	141C2.000	05/86 ⇒ 12/94
PANDA I 1000 i.e	156A2.246	08/92 ⇒ 02/04
PANDA I 1000 i.e. Cat	141C2.000, 156A2.246	10/87 ⇒ 08/98
PANDA I 1100	156C.046, 176B2.000, 187A1.000	05/91 ⇒ 12/99
PANDA I 1100 4x4	176B2.000	02/95 ⇒ 07/04
PANDA I 1100 i.e. 4x4	187A1.000	12/00 ⇒
PANDA I 1100 Trekking 4x4	156C.046	10/91 ⇒ 07/04
PANDA I 900	1170A1.046	04/92 ⇒ 12/96
PANDA I 900 i.e.	1170A1.046	01/98 ⇒
PANDA II 1.1	--	09/03 ⇒
PANDA II 1.2	188A4.000	09/03 ⇒
PANDA II 1.2 4x4	188A4.000	09/04 ⇒
PANDA II 1.2 Bipower	188A4.000	09/04 ⇒ 12/11
PANDA II 1.2 Bi-Power / Natural Power	--	04/09 ⇒
PANDA II 1.2 Euro 4	--	04/09 ⇒
PANDA II 1.2 LPG	188A4.000	04/09 ⇒
PANDA II 1.2 Natural Power	188A4.000, 188A4000CNG	01/07 ⇒ 12/11
PUNTO II 1.2 60	188A4.000	09/99 ⇒ 12/10
PUNTO II 1.2 Bifuel	188A4.000	08/07 ⇒ 03/12
PUNTO II 1.2 Bipower	188A4.000	08/01 ⇒ 05/03
PUNTO II 1.2 Natural Power	188A4.000, 188A4000CNG	01/03 ⇒ 03/12
SEICENTO / 600 0.9	1170A1.046	11/97 ⇒ 01/10
SEICENTO / 600 1.1	176B2.000, 187A1.000	01/98 ⇒ 01/10
SIENA 1.2	178B7.045	01/98 ⇒
SIENA 1.3	178B5.000, 178C4.066, 188A4.000	09/01 ⇒ 12/12
SIENA 1.4	178B2.000, 178B2.016	04/96 ⇒ 12/09
SIENA 1.4 Cat	178B2.000, 178B2.016	04/96 ⇒ 12/09
SIENA 1.5	178E5.022, 178E5.027	09/02 ⇒
SIENA 1.7 [CHN]	--	01/06 ⇒
STRADA 1.2	178B5.000, 178B7.045, 188A4.000	04/03 ⇒
STRADA 1.2 Trekking	--, 178B7.045	11/05 ⇒
TEMPRA 1.8 i.e.	835C2.000, 835C4.000, 836A5.000	09/93 ⇒ 08/96
TIPO I 1.8 i.e	836A5.000	03/93 ⇒ 04/95
TIPO I 1.8 i.e.	835C2.000, 835C4.000, 836A5.000, 836A6.000	03/93 ⇒ 10/95
UNO 1.0	156A2.000	06/89 ⇒ 02/92
UNO 1.0 i.e.	146C7.000	09/89 ⇒ 03/94
UNO Mondo 1.2 i.e. [IND]	178D5.066	01/96 ⇒

FIAT (BR)

PALIO 1.0i	1.0Mpi	01/96 ⇒
PALIO 1.5i	1.5Mpi	01/96 ⇒ 12/00
PALIO 1.6i	1.6Spi	01/99 ⇒ 12/99
SIENA 1.0i	1.0Mpi	01/99 ⇒ 12/00
SIENA 1.5i	1.5Mpi	01/99 ⇒ 12/00
SIENA 1.6i	1.6Mpi	01/98 ⇒ 12/00
STRADA 1.5i	1.5Mpi	01/99 ⇒ 12/01
STRADA 1.6i 8v	1.6Mpi	01/99 ⇒ 12/00
UNO 1.5i	1.5Spi	01/92 ⇒ 12/96
UNO 1.5i Furgoneta	1.5Mpi	01/92 ⇒
UNO CS 1.5i	1.5Spi	01/92 ⇒ 12/96
UNO MILLE 1.0	1.0	05/93 ⇒ 12/95
UNO MILLE 1.0i	1.0Mpi	01/96 ⇒

INNOCENTI

MILLE 1.0	146C7.000	07/95 ⇒ 05/97
MILLE 1.0i	146C7.000	02/93 ⇒ 02/98

LANCIA

DEDRA 1.8 i.e.	836A5.000	07/94 ⇒ 07/99
DELTA I 2.0 16V HF Evo Integrale	831E5.046	06/93 ⇒ 01/94
DELTA II 1.8 i.e.	835C2.000, 835C4.000, 836A5.000, 836A6.000, 836C4.000	06/93 ⇒ 08/99
DELTA II 2.0 16V Turbo	175A4.000, 836A2.000	06/93 ⇒ 08/99
THEMA 2000 16V Turbo	834C1.000	12/88 ⇒ 06/90
THEMA 2000 i.e. 16V	834B2.000, 834B2.246	05/88 ⇒ 08/92
THEMA 2000 i.e. 16V Turbo	834C1.000, 834C1.246	12/88 ⇒ 03/93
Y I 1.1	176B2.000	11/95 ⇒ 09/03
Y I 1.2	188A4.000, 840A3.000	03/96 ⇒ 09/03
Y I 1.2 16V	176B9.000	04/97 ⇒ 09/03
YPSILON II 1.2	169A4.000, 188A4.000	10/03 ⇒ 12/11

KW 470 148



07

COILS

Adatt./Suitable:

BOSCH

0 986 221 037

FIAT

7746151

INNOCENTI

7746151

LANCIA

7746151

MAGNETI MARELLI

060705404010

607 054 04

BAE 504 D



	ohm		ohm
	0,45		5000

FIAT

CROMA I 2000 CHT	154A1.000, 154C5.000	01/91 ⇒ 09/92
CROMA I 2000 i.e.	154C3.000, 154C3.046, 834B.146	10/87 ⇒ 12/96
ELBA 1.5	149C1.000	01/92 ⇒ 12/96
FIORINO II 1.6	146C6.000	01/94 ⇒ 05/01
FIORINO II 70 i.e. 1.4	146C5.000	05/94 ⇒ 05/01
FIORINO II 75 i.e. 1.6	146C6.000	10/93 ⇒ 05/01
TEMPRA 1.4 i.e.	160A1.046	04/90 ⇒ 08/96
TEMPRA 1.6	159A3.000, 159A3.048, 159A3.098	03/90 ⇒ 12/96
TEMPRA 1.6 i.e.	159A3.046, 159A3.048	06/90 ⇒ 08/96
TIPO I 1.4	160A1.048	07/87 ⇒ 12/89
TIPO I 1.4 i.e.	160A1.046	05/89 ⇒ 04/95
TIPO I 1.6	159A3.048, 160A2.000	01/88 ⇒ 10/95
TIPO I 1.6 i.e.	159A3.046, 159A3.048	07/90 ⇒ 04/95
TIPO I 1.6 SX DGT	159A3.000	05/89 ⇒ 10/95
UNO 1.4 Super	146C2.028	09/89 ⇒ 09/92
UNO 70 i.e. 1.4	146C1.000, 160A1.046	09/89 ⇒ 07/96
UNO 70 S 1.4	160A1.048	10/88 ⇒ 06/06
UNO 75 i.e. 1.5	149C1.000	10/85 ⇒ 12/93
UNO Mondo 1.4 Super	146C2.028	01/96 ⇒

INNOCENTI

ELBA 1.4 i.e.	146C5.000	09/94 ⇒ 12/96
ELBA 1.5 i.e.	149C1.000	08/92 ⇒ 09/94
ELBA 1.6 i.e.	146C6.000	09/94 ⇒ 12/96
MILLE 1.4	160A1046	07/95 ⇒ 05/97

LANCIA

DEDRA 1.6 i.e.	835A1.046	08/89 ⇒ 03/93
DELTA II 1.4 i.e.	160A1.046	10/94 ⇒ 08/99
THEMA 2000 i.e	834B1.000	09/88 ⇒ 05/92
THEMA 2000 i.e.	834B.146	09/87 ⇒ 05/92
THEMA 2000 i.e. Turbo	834C.146	07/86 ⇒ 05/90
THEMA 2000 Turbo	834C.146	12/88 ⇒ 03/92
Y10 1.3 i.e.	146A5.046, 156B.000	11/87 ⇒ 12/95

KW 470 155



05

COILS

Adatt./Suitable:

BOSCH
0 986 221 029

CITROËN
5970 45
96 035 284

DUCELLIER
2 526 026 A

HITACHI
138752
2508752

MAGNETI MARELLI
060705754010
060717009012

PEUGEOT
5970 45
96 035 284

03 Supplied until depletion

- Fornibile fino ad esaurimento delle scorte
- Fourni jusqu'à épuisement du stock
- Lieferbar solange vorrat reicht
- Suministrado hasta el stock termina



	ohm		ohm
	0,68	Ø 6.3	6800

CITROËN

AX 1.3 Sport	M4A	04/87 ⇒ 12/88
AX 10	C1A	09/86 ⇒ 06/92
AX 10 E	C3A	12/86 ⇒ 12/88
AX 11	H1A, H1B, HDZ(TU1M)	09/86 ⇒ 12/97
AX 11 4x4	H1A	06/91 ⇒ 07/92
AX 11 Cat	HAZ(TU1CP)	09/88 ⇒ 12/89
AX 14	K1A(TU3), K1B, K1F, K1G, K1J, K2A, K2B, K2D, KAY(TU3CP), KDX(TU3M/Z), KDY(TU3FM), KDY(TU3M), KDZ(TU3M/Z)	09/86 ⇒ 04/97
AX 14 4x4	KD4, KDX(TU3M/Z), KDY(TU3FM), KDY(TU3M), KDZ(TU3M/Z)	06/91 ⇒ 12/96
XM I 2.0 i	RDZ(XU10M/Z), RFZ(XU10J2)	05/89 ⇒ 06/94
BERLINGO I 1.4	TU32	07/96 ⇒ 10/98
ZX 1.1	H1A, H1B, HDZ(TU1M), TU1	03/91 ⇒ 06/97
ZX 1.4 i	KDY(TU3M)	10/93 ⇒ 10/97
ZX 1.9	D6E(XU9JA)	03/91 ⇒ 06/97
ZX 1.9 i	DKZ(XU9JA), XU9JA	03/91 ⇒ 06/97

PEUGEOT

106 I 1.0	TU9	09/91 ⇒ 04/96
106 I 1.1	H1B(TU1), HDZ(TU1M)	08/91 ⇒ 04/96
106 I 1.4	K5A(TU3), KDY(TU3M), TU3, TU3.2	08/91 ⇒ 04/96
106 II 1.1	H1B(TU1)	04/96 ⇒
205 II 1.0	TU9	10/87 ⇒ 09/98
205 II 1.1	H1B(TU1)	01/91 ⇒ 12/94
306 1.4	TU3	01/93 ⇒ 04/02
405 II 1.4	TU3F2	01/93 ⇒ 12/96
PARTNER I 1.4	TU32	06/96 ⇒ 12/15
RANCH 1.4	K5A(TU3.2)	09/96 ⇒ 08/02

KW 470 158



07

COILS

Adatt./Suitable:

BOSCH
0 986 221 028

FIAT
7553120
7646974
7746153

INNOCENTI
7746153

LANCIA
7646974

MAGNETI MARELLI
060705606010
607 056 06
BAE 506 F

	ohm		ohm
6.4	0,75	Ø 8.2	3500

FIAT

DUNA 60 1.1	146A6.000	01/87 ⇒ 12/91
DUNA 70 1.3	146A5.000	01/87 ⇒ 12/91
ELBA 1.3	146A5.000	04/91 ⇒ 02/95
FIORINO I 1.1 60	146A9.000	11/86 ⇒ 04/88
FIORINO I 1.3	146A5.000	12/87 ⇒ 08/93
FIORINO II 1.3	146A5.000	01/88 ⇒ 12/94
FIORINO II 60 1.1	146A9.000	05/88 ⇒ 12/93
FIORINO II 70 1.3	146A5.000	01/88 ⇒ 12/94
PANDA I 1000	156A2.100, 156A3.000	01/85 ⇒ 12/92
PANDA I 1000 4x4	156A2.100, 156A2.246, 156A3.000	01/86 ⇒ 12/94
PANDA I 750 Cat	156A4.048	01/95 ⇒ 10/03
PANDA I 750 Fire	156A4.048	11/88 ⇒ 04/91
UNO CS 1.1	146A6.000	09/87 ⇒ 09/91

FIAT (BR)

UNO CS 1116 -- 01/88 ⇒

INNOCENTI

ELBA 1.3 146A5.000 08/91 ⇒ 12/96

LANCIA

 DELTA I 1.1 831B8.000 01/86 ⇒ 12/90
 DELTA I 1.3 1831B.000, 3831B.000, 831A2.000, 831B.000 09/79 ⇒ 10/92

COILS

Adatt./Suitable:

BOSCH
0 986 221 002
MAGNETI MARELLI
060717005012

SEAT
867 905 105 A

VW
867 905 105 A

00 Eliminated on 23-02-2022. Please verify the availability through our local distributors

- Eliminato il 23-02-2022. Verificare la disponibilità presso i nostri distributori
- Éliminé le 23-02-2022. Vérifier la disponibilité auprès de nos distributeurs sur place
- Am 23-02-2022 gestrichen. Evtl. Verfügbarkeit bitte bei unseren Händlern prüfen
- Eliminado en fecha 23-02-2022. Verificar la disponibilidad a través de nuestros distribuidores locales



	ohm		ohm
M5	0,56	Ø 4	3300

SEAT

IBIZA II 1.8 i	ADZ	03/93 ⇒ 08/99
IBIZA II 2.0 i	2E	03/93 ⇒ 08/99
TOLEDO I 1.6 i	1F, ABN, EZ	05/91 ⇒ 03/99
TOLEDO I 1.8 i	ABS	11/93 ⇒ 12/96
TOLEDO I 2.0 i	2E	05/91 ⇒ 03/99
TOLEDO I 2.0 i 16V	ABF	11/93 ⇒ 03/99

VW

PASSAT III 1.6	1F, EZ	04/88 ⇒ 07/92
PASSAT III 2.0	2E	02/90 ⇒ 05/97

KW 470 162S



05

COILS

Adatt./Suitable:

BMW

1 317 232
1 703 359
1 703 360
1 726 177
1 727 108
1 730 520
1 730 766
1 734 468
12 13 1 317 232
12 13 1 317 585
12 13 1 402 440
12 13 1 402 713
12 13 1 404 102
12 13 1 703 359
12 13 1 726 177
12 13 1 726 178
12 13 1 727 108
12 13 1 729 842
12 13 1 730 765
12 13 1 730 766
12 13 1 731 884
12 13 1 734 468
12 13 1 748 394
12 13 1 748 395
12 13 7 599 218
7 599 218

BOSCH

1 227 030 082

03 Supplied until depletion

- Fornibile fino ad esaurimento delle scorte
- Fourni jusqu'à épuisement du stock
- Lieferbar solange vorrat reicht
- Suministrado hasta el stock termina

255 without spark plug connector

- senza cappuccio candela d'accensione
- sans cosse de bougie d'allumage
- ohne Zündkerzenstecker
- sin conector de bujía de encendido

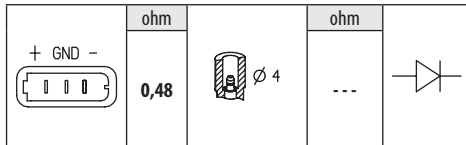

BMW		
3 III 318 is	M42B18(18451)	01/92 ⇒ 12/95
3 III 320 i	M50B20(20651), M50B20(20652), M52B20(20653)	01/91 ⇒ 11/99
3 III 325 i	M50B25(25651), M50B25(25652)	09/90 ⇒ 12/95
3 III M3 3.0	S50B30(30651)	11/92 ⇒ 07/95
3 II 318 is	M42B18(18451)	09/89 ⇒ 08/91
5 III 520 i	M50B20(20651), M50B20(20652)	07/91 ⇒ 07/96
5 III 520 i 24V	M50B20(20651), M50B20(20652)	04/90 ⇒ 08/95
5 III 525 i	M50B25(25651), M50B25(25652)	07/91 ⇒ 07/96
5 III 525 i 24V	M50B25(25652)	03/90 ⇒ 08/95
5 III 525 ix	M50B25(25651)	01/92 ⇒ 03/96
5 III 525 ix 24V	M50B25(25651), M50B25(25652)	10/91 ⇒ 08/95
5 III 530 i	M60B30(30851)	09/92 ⇒ 07/96
5 III 530 i V8	M60B30(30851)	09/92 ⇒ 12/95
5 III 540 i	M60B40(40851)	09/93 ⇒ 07/96
5 III 540 i V8	M60B40(40851)	09/92 ⇒ 12/95
5 III M5	S38B38(38651)	01/92 ⇒ 07/95
7 II 730 i, iL V8	M60B30(30851)	04/92 ⇒ 09/94
7 II 740 i, iL V8	M60B40(40851)	05/92 ⇒ 03/94
7 III 730 i, iL	M60B30(30851)	03/94 ⇒ 02/96
7 III 740 i, iL	M60B40(40851)	03/94 ⇒ 02/96
8 840 i	M60B40(40851)	03/93 ⇒ 02/96

KW 470 168



07

COILS

Adatt./Suitable:

ALFA ROMEO

60558152
60586072
60809606

BOSCH

0 221 503 407
0 221 503 457

CITROËN

5970 53

FIAT

60558152
60586072
60809606
7648797

HITACHI

138793

2508793

HONDA

30520-PDF-E01

IVECO

76487970

KIA

OK011-18100

LANCIA

7648797

LAND ROVER

ERR6045

ERR6566 *1

060717037012

PEUGEOT

5970 53

ROVER

ERR6045

VW

048 905 105 1

*1 Without fastening clamp

- Senza staffa di fissaggio
- sans bride de fixation
- ohne Befestigungsbügel
- sin estribo de sujeción

245 without fastening clamp

- senza staffa fissaggio
- sans bride de fixation
- ohne Befestigungsbügel
- sin estribo de sujeción

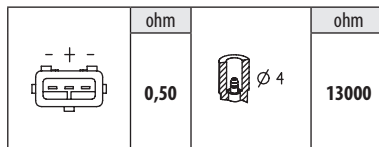

ALFA ROMEO

33 II 1.5 i.e.	AR30738	09/91 ⇒ 12/95
33 II 1.7 i.e.	AR30740	09/91 ⇒ 12/95
145 1.6 i.e.	AR33201	10/94 ⇒ 12/96
145 1.7 i.e. 16V	AR33401	10/94 ⇒ 12/96
146 1.7 i.e. 16V	AR33401	12/94 ⇒ 12/96
155 1.7 T.S.	AR67103, AR67105	04/93 ⇒ 04/96
155 1.8 T.S.	AR67101	02/92 ⇒ 05/94
155 1.8 T.S. Sport	AR67101, AR67102	03/92 ⇒ 12/96
155 2.0 T.S.	AR67201, AR67202	02/92 ⇒ 05/95
164 2.0 T.S.	AR64103	09/92 ⇒ 09/98

CITROËN

JUMPY I 1.6	1580SPI, 220A2.000	10/95 ⇒ 08/00
JUMPY I 1.6 i	1580SPI, 220A2.000	10/95 ⇒ 08/00

FIAT

BRAVA 1.2 16V	182B2.000	12/98 ⇒ 12/02
BRAVA 1.2 16V 80	182B2.000, 188A5.000	10/00 ⇒ 12/02
BRAVA 1.4	182A5.000	10/95 ⇒ 10/01
BRAVA 1.4 12V	182A3.000	10/95 ⇒ 08/98
BRAVO I 1.2 16V 80	182B2.000, 188A5.000	10/00 ⇒ 10/01
BRAVO I 1.4	182A3.000, 182A5.000	10/95 ⇒ 10/01
CROMA I 2000 16V	154E1.000	08/92 ⇒ 08/96
CROMA I 2000 i.e. 16V	154E1.027	03/95 ⇒ 12/96
FIORINO II 1.4	146C5.000	11/92 ⇒ 05/01
FIORINO II 1.6	146D6.000	01/94 ⇒ 05/01
FIORINO II 70 i.e. 1.4	146D5.000	05/94 ⇒ 05/01
FIORINO II 75 i.e. 1.6	146D6.000	10/93 ⇒ 05/01
MAREA 1.2 16V	182B2.000	10/98 ⇒ 05/02
MAREA 1.4 80 12V	182A3.000	09/96 ⇒ 05/02
PALIO 1.2	178D6.011, 188A5.000	03/00 ⇒ 10/04
PUNTO I 1.4 GT Turbo	176A4.000, 176B6.000	10/93 ⇒ 07/99
SCUDO I 1.6	220A2.000	02/96 ⇒ 12/06

FIAT

PUNTO II 1.2 16V	188A5.000	06/03 ⇒
PUNTO II 1.2 16V 80	188A5.000	09/99 ⇒ 04/06
SIENA 1.3	188A5.000	09/01 ⇒ 12/09
TEMPRA 1.4 i.e.	836A4.000	04/90 ⇒ 08/96
TEMPRA 1.6 i.e.	835C1.000	10/90 ⇒ 08/96
TIPO I 1.1 i.e.	156C.046	10/94 ⇒ 10/95
TIPO I 1.4 i.e.	836A4.000	05/89 ⇒ 04/95
TIPO I 1.6	835C1.000	03/93 ⇒ 10/95
TIPO I 1.6 i.e.	835C1.000	10/92 ⇒ 04/95
TIPO I 1.6 i.e. [BRA]	160E2.011	03/93 ⇒ 04/95
UNO Mondo 1.0 i.e.	146D8.000	01/96 ⇒

FIAT (BR)

TIPO 1.6i	1.6Mpi	01/93 ⇒ 12/97
UNO 1.6i	1.6Mpi	01/95 ⇒ 12/96

HONDA

ACCORD 1.6	D16B7	10/98 ⇒ 12/01
ACCORD VI 1.6	D16B6	12/99 ⇒ 12/02
ACCORD VI 1.6 i	D16B6	10/98 ⇒ 12/02
ACCORD VI 1.6 LS	D16B7	10/98 ⇒ 12/02

KIA

SPORTAGE I 2.0 4WD	FE(8V)	06/95 ⇒ 11/98
SPORTAGE I 2.0 i 4WD	FE(8V)	04/94 ⇒ 08/99

LANCIA

DEDRA 1.6 i.e.	835C1.000	04/93 ⇒ 07/99
DELTA II 1.4 i.e.	836A4.000	10/94 ⇒ 08/99
DELTA II 1.6 i.e.	835C1.000	06/93 ⇒ 08/99
KAPPA 2.0 16V Turbo	834A4.000, 838A4.000	02/95 ⇒ 10/01
THEMA 2000 16V	834F1.000	05/92 ⇒ 07/94
THEMA 2000 16V Turbo	834F2.000	10/92 ⇒ 07/94
THEMA 2000 Turbo 16V	834F2.000	11/92 ⇒ 07/94
Y I 1.2 16V	176B9.000, 188A5.000	10/00 ⇒ 09/03
Y I 1.4 12V	840A2.000, 840A4.000	03/96 ⇒ 09/03
Y10 1.1 Fire	176B2.000	01/95 ⇒ 12/95
Y10 1.1 Fire Trazione integrale	176B2.000	01/95 ⇒ 12/95
Y10 1.1 i.e. Fire Trazione integrale	156C.046	09/92 ⇒ 12/95

LAND ROVER

DISCOVERY II 4.0 V8 4x4	35D, 56D, 94D	11/98 ⇒ 06/04
DISCOVERY II 4.6 V8 [USA]	--	01/03 ⇒ 06/04
RANGE ROVER II 3.9 4x4	42D	07/94 ⇒ 03/02
RANGE ROVER II 4.0 4x4	42D, 46698710	01/95 ⇒ 03/02
RANGE ROVER II 4.6 4x4	46D, 48D, 60D	07/94 ⇒ 03/02

PEUGEOT

EXPERT 1.6	222A2(1580SPI)	02/96 ⇒ 09/00
------------	----------------	---------------

VOLKSWAGEN (BR)

GOL 2.0i 16V	112	10/95 ⇒
PARATI 2.0i 16V	112	02/96 ⇒

KW 470 169



07

COILS

Adatt./Suitable:

BOSCH

0 221 122 008
0 221 122 031
0 221 122 450

FORD

1 027 283
6 077 429
79BB-12024-AA
92GB-12024-AA

HITACHI

138803

MERCURY

E73Z12029A

Motorcraft

EDG 27

VW

046 905 105

⁹⁶⁰ Dry (epoxy) coil replacing original oil-bath coil version

• Bobina (resinizzata) sostitutiva originale a bagno d'olio

• Bobine seche, remplaçant la bobine d'origine à bain d'huile

• Trockenspule, die die Originale im Ölbad ersetzt

• Bobina seca, sustituye modelo original con baño de aceite

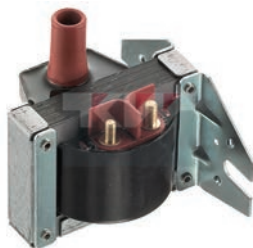

-	+	ohm	ohm
		0,75	7200

FORD

ESCORT III 1.3	JPA	09/80 ⇒ 02/86
ESCORT III 1.4 i	F6B, F6D, FUC	02/86 ⇒ 07/90
ESCORT III 1.6	LP1, LPA	09/80 ⇒ 12/85
ESCORT III 1.6 i	LR1	09/83 ⇒ 12/85
ESCORT III 1.6 XR3i	LR1, LRA	10/82 ⇒ 12/85
ESCORT IV 1.4	F6B, F6D, FUA, FUC	01/86 ⇒ 07/90
ESCORT IV 1.6 Turbo RS	LNB	01/86 ⇒ 07/90
ESCORT IV 1.6 XR3i	LR2, LRB	01/86 ⇒ 07/90
ESCORT V RS Cosworth 4x4	NSF	10/91 ⇒ 01/95
FIESTA II 1.4	FUB, FUD	10/85 ⇒ 11/89
FIESTA II 1.6 XR2	LUB, LUD	03/84 ⇒ 02/89
FIESTA III 1.4	F6E	03/89 ⇒ 12/95
GRANADA 1.7	TV17LC	08/77 ⇒ 05/82
GRANADA 2.0	NEP	08/79 ⇒ 08/85
SIERRA I 1.3	JCT	08/82 ⇒ 12/86
SIERRA I 1.8	REB	10/84 ⇒ 12/86
SIERRA I 2.0	NET	08/82 ⇒ 12/86
SIERRA I 2.0 i	NR2	03/85 ⇒ 12/86
ORION I 1.3	JPA	07/83 ⇒ 03/86
ORION I 1.4	FUA, FUC	12/85 ⇒ 07/90
ORION I 1.4 Cat	F6B, F6D	02/87 ⇒ 07/90
ORION I 1.6	LP1, LPA	07/83 ⇒ 03/86
ORION I 1.6 i	LR1, LRA, LRB	07/83 ⇒ 07/90
SCORPIO I 1.8	REC	04/85 ⇒ 02/92
SCORPIO I 2.0	TL20H-NE4, TL20H-NER	10/84 ⇒ 02/90
SCORPIO I 2.0 i	N9B, N9D, N9F, NRA, NRI	04/85 ⇒ 09/94
SCORPIO I 2.4 i	ARC	09/86 ⇒ 09/88
SCORPIO I 2.9 i	BRC, BRD, BRE, BRF	09/86 ⇒ 12/94
SCORPIO I 2.9 i 4x4	BRC, BRD, BRE, BRF	09/86 ⇒ 10/94
SCORPIO I 2.9 i Cat	BRE	10/87 ⇒ 09/94
SCORPIO II 2.9 i	BRG	02/95 ⇒ 08/98
SIERRA II 1.8	R2C, R6A	05/88 ⇒ 02/93
SIERRA II 2.0	N8C, NES	01/87 ⇒ 02/93
SIERRA II 2.0 i	N4A, N4I, N9B	01/87 ⇒ 02/93
TRANSIT II 1.6	LAC, LAT	09/85 ⇒ 09/92
TRANSIT II 2.0	NGTS, NAT, NAV, NAW, NBA, NCA, NSF, NSG, NSH	09/85 ⇒ 03/00
TRANSIT II 2.0 Cat	NGT	11/85 ⇒ 09/92
TRANSIT II 2.0 EFI	--	08/91 ⇒ 08/94
TRANSIT II 2.0 i	NCA	09/91 ⇒ 07/94
TRANSIT II 2.0 L	NAW, NAX	10/85 ⇒ 03/91
TRANSIT II 2.9 i	BRT	01/91 ⇒ 09/94
TRANSIT 2.0	NSHCNG	06/94 ⇒ 03/00
TRANSIT TOURNEO 2.0	NSF, NSG, NSH	11/94 ⇒ 12/00

KW 470 170



07,5

COILS

Adatt./Suitable:

DENSO

029700-6760
029700-7180
029700-7910

FORD

5 008 196
6 489 415
6 630 365
6 958 305
919F-12029-AA
E95F-12029-AA
E95Z-12029-A
F15U-12029-AA
F55U-12029-AA
F55U-12029-AB

FORD AUSTRALIA

6 958 305
F55U-12029-AA
F55Z-12029-A

FORD USA

5 008 196
6 958 305
F55U-12029-AA
F55U-12029-AB

JAGUAR

LNA 1508AA

MAGNETI MARELLI

060717048012

Motorcraft

DG 440
DGE-456

⁰³ Supplied until depletion

• Fornibile fino ad esaurimento delle scorte

• Fourni jusqu'à épuisement du stock

• Lieferbar solange vorrat reicht

• Suministrado hasta el stock termina



- - - +	ohm	ohm
	0,50	13000

FORD

COUGAR 2.5 ST 200	SGA	01/00 ⇒ 12/01
COUGAR 2.5 ST 200 24V	MABB	08/98 ⇒
COUGAR 2.5 V6 24V	JP25LCBD, LCBA, LCBB, LCBC, LCBE	06/00 ⇒ 12/01
MONDEO I 2.5 24V	SEA, SEB, SEC	08/96 ⇒ 09/00
MONDEO I 2.5 i 24V	SEA	07/94 ⇒ 08/96
MONDEO I 2.5 ST 200	SGA	05/99 ⇒ 09/00
SCORPIO I 2.9 24V	BOA	08/93 ⇒ 09/94
SCORPIO I 2.9 i 24V	BOA	04/91 ⇒ 09/94
SCORPIO II 2.9 i 24V	BOB	10/94 ⇒ 08/98
WINDSTAR 3.0 i 12V	99U	04/95 ⇒ 07/97
WINDSTAR 3.0 i 12V S	99U	08/97 ⇒

FORD AUSTRALIA

TAURUS 3.0i V6 -- 01/96 ⇒

FORD USA

WINDSTAR 3.0 V6 --, 99U30 01/95 ⇒ 02/99

JAGUAR

XJ 12 6.0 8E 09/94 ⇒ 09/97

KW 470 178



07

COILS

Adatt./Suitable:

BOSCH

0 221 118 329
0 221 502 431

HITACHI

138716

2508716

MERCEDES-BENZ

A 000 158 45 03
A 000 158 48 03
A 000 158 50 03
A 000 158 53 03
A 000 158 54 03
A 000 158 61 03
A 000 158 62 03



+	-	ohm	ohm
		0,38	10500

MERCEDES-BENZ

CLASSE E I E 300 4-matic	M103.985	06/93 ⇒ 06/95
CLASSE E I E 300 T 4-matic	M103.985	06/93 ⇒ 06/96
CLASSE E I E 420	M119.975	06/93 ⇒ 06/95
CLASSE E I E 500	M119.974	06/93 ⇒ 06/95
CLASSE E I E 60 AMG	M119.974(AMG6.0)	05/94 ⇒ 06/95
124 200 CE	M102.963	09/89 ⇒ 06/93
124 230 CE	M102.982	03/87 ⇒ 12/92
124 230 CE Cat	M102.982	06/89 ⇒ 12/92
124 300 CE	M103.983	03/87 ⇒ 05/93
190 2.0	M102.924	08/83 ⇒ 05/90
190 2.3	M102.985	09/87 ⇒ 09/88
190 2.3 E	M102.985	10/82 ⇒ 09/88
190 2.6	M103.942	10/82 ⇒ 09/88
190 E 1.8	M102.910, M102.919	04/90 ⇒ 12/93
190 E 2.0	M102.962	10/82 ⇒ 08/93
190 E 2.3	M102.985	09/86 ⇒ 08/93
190 E 2.3-16	M102.983	04/84 ⇒ 08/88
190 E 2.5-16	M102.990	09/88 ⇒ 08/93
190 E 2.5-16 Evolution	M102.991	03/89 ⇒ 08/93
190 E 2.5-16 Evolution II	M102.992	05/90 ⇒ 08/93
190 E 2.6	M103.942	09/86 ⇒ 08/93
190 E 3.2 AMG	M103.983	01/88 ⇒
CLASSE G II 200 GE	M102.965	01/90 ⇒ 07/93
CLASSE G II 230 GE	M102.979, M102.989, M102.996, M102.997	09/89 ⇒ 07/96
CLASSE G II 300 GE	M103.987	09/89 ⇒ 09/97
CLASSE S II 260 SE	M103.941	09/85 ⇒ 06/91
CLASSE S II 300 SE, SEL	M103.981	09/85 ⇒ 06/91
CLASSE S II 380 SE, SEL	M116.963	10/81 ⇒ 08/85
CLASSE S II 380 SEC	M116.963	10/81 ⇒ 07/85
CLASSE S II 500 SE, SEL	M117.961, M117.963	12/79 ⇒ 08/85
CLASSE S II 500 SEC	M117.963	08/80 ⇒ 08/85
CLASSE S III 400 SE, SEL/S420	M119.971	02/91 ⇒ 10/98
CLASSE S III 500 SE, SEL	M119.970	02/91 ⇒ 10/98
CLASSE S III 500 SEC / CL 500	M119.970	10/92 ⇒ 12/99
CLASSE S III S 420	M119.971	01/93 ⇒ 10/98
CLASSE S III S 500	M119.970	01/93 ⇒ 10/98
CLASSE S III SEC/CL 420	M119.971	10/94 ⇒ 02/99
CLASSE SL III 300 SL	M103.982	09/85 ⇒ 08/89
CLASSE SL IV 300 SL	M103.984	03/89 ⇒ 08/93
CLASSE SL IV 500 SL	M119.960	09/89 ⇒ 08/92
KOMBI II 200 T	M102.922	09/85 ⇒ 05/90
KOMBI II 200 TE	M102.962, M102.963	09/88 ⇒ 08/92
KOMBI II 230 E Chassis	M102.982	09/86 ⇒ 06/93
KOMBI II 230 TE	M102.982	09/85 ⇒ 08/92
KOMBI II 230 TE Cat	M102.982	06/89 ⇒ 08/92
KOMBI II 260 TE FGST.	M103.940	09/89 ⇒ 08/92
KOMBI II 300 TE	M103.983	01/86 ⇒ 08/92

MERCEDES-BENZ

KOMBI II 300 TE 4-matic	M103.985	09/86 ⇒ 06/93
TRE VOLUMI II 200	M102.922	12/85 ⇒ 10/92
TRE VOLUMI II 200 E	M102.963	09/88 ⇒ 08/93
TRE VOLUMI II 230 E	M102.982	12/84 ⇒ 06/93
TRE VOLUMI II 230 E Cat	M102.982	06/89 ⇒ 06/93
TRE VOLUMI II 260 E	M103.940	09/85 ⇒ 08/92
TRE VOLUMI II 260 E 4-matic	M103.943	09/86 ⇒ 08/92
TRE VOLUMI II 300 E	M103.983	06/85 ⇒ 08/92
TRE VOLUMI II 300 E 4-matic	M103.943, M103.983, M103.985	01/86 ⇒ 12/93
TRE VOLUMI II 400 E 4.2	M119.975	10/92 ⇒ 06/93
TRE VOLUMI II 500 E	M119.974	01/91 ⇒ 06/93
TRE VOLUMI II 500 E AMG 6.0	M119.974(AMG6.0)	01/92 ⇒ 06/93

PUCH

G-MODELL 230 GE	M102.989	07/89 ⇒ 07/00
G-MODELL 300 GE	M103.987	06/89 ⇒ 08/93

KW 470 179



07

COILS

Adatt./Suitable:

BOSCH

0 221 502 433

HITACHI

138744

2508744

MERCEDES-BENZ

A 000 158 56 03

A 000 158 58 03

A 000 158 64 03

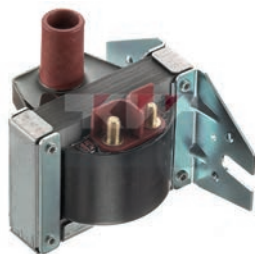

+	-	ohm		ohm
M6	M5	0,25	Ø 8.2	10500

MERCEDES-BENZ

124 300 CE-24	M104.980	09/89 ⇒ 06/93
CLASSE E I E 420	M119.975	06/93 ⇒ 06/95
CLASSE E I E 500	M119.974	06/93 ⇒ 06/95
CLASSE E I E 60 AMG	M119.974(AMG6.0)	05/94 ⇒ 06/95
CLASSE G II 500 GE	M117.965	09/93 ⇒ 12/94
CLASSE S II 420 SEL	M116.965	10/85 ⇒ 06/91
CLASSE S II 420 SEC	M116.965	10/85 ⇒ 06/91
CLASSE S II 500 SEL	M117.965	09/85 ⇒ 06/91
CLASSE S II 500 SEC	M117.965	06/89 ⇒ 06/91
CLASSE S II 500 SEC Cat	M117.965	09/85 ⇒ 06/91
CLASSE S II 500 SEC	M117.965	06/89 ⇒ 06/91
CLASSE S II 560 SE, SEL	M117.968	10/85 ⇒ 06/91
CLASSE S II 560 SEC	M117.968	10/85 ⇒ 06/91
CLASSE S III 600 SE, SEL	M120.980	04/91 ⇒ 12/92
CLASSE S III S 600	M120.980	01/93 ⇒ 10/98
CLASSE S III SEC/CL 600	M120.980	09/92 ⇒ 02/99
CLASSE SL IV 500	M119.972	09/92 ⇒ 10/01
CLASSE SL IV 600	M120.981	07/92 ⇒ 10/01
CLASSE SL IV 600 SL	M120.981	02/92 ⇒ 08/94
KOMBI II 300 TE-24	M104.980	09/89 ⇒ 08/92
TRE VOLUMI II 300 E-24	M104.980	09/88 ⇒ 08/92
TRE VOLUMI II 400 E 4.2	M119.975	10/92 ⇒ 06/93
TRE VOLUMI II 500 E	M119.974	01/91 ⇒ 06/93
TRE VOLUMI II 500 E AMG 6.0	M119.974(AMG6.0)	01/92 ⇒ 06/93

KW 470 180



07

COILS

Adatt./Suitable:

BOSCH

0 221 118 307

MERCEDES-BENZ

A 000 158 40 03

ROLLS-ROYCE

UD70828

960 Dry (epoxy) coil replacing original oil-bath coil version

- Bobina (resinizzata) sostituyente originale a bagno d'olio

- Bobine seche, remplaçant la bobine d'origine à bain d'huile
- Trockenspule, die die Originale im Ölbad ersetzt

- Bobina seca, sustituye modelo original con baño de aceite

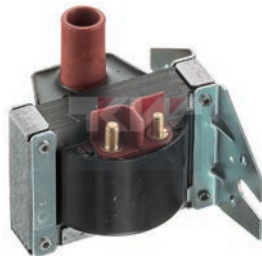

+	-	ohm		ohm
M6	M5	0,56	Ø 8.2	9000

MERCEDES-BENZ

124 200 CE	M102.963	09/89 ⇒ 06/93
124 230 CE	M102.982	03/87 ⇒ 12/92
124 230 CE Cat	M102.982	06/89 ⇒ 12/92
190 2.0	M102.921, M102.924	10/82 ⇒ 05/90
190 2.3	M102.985	09/87 ⇒ 09/88
190 2.3 E	M102.985	10/82 ⇒ 09/88
190 E 2.0	M102.962	10/82 ⇒ 08/93
190 E 2.3	M102.985	09/86 ⇒ 08/93
CLASSE G I 200 GE	M102.964	02/80 ⇒ 08/92
CLASSE G I 230 GE	M102.981, M102.987, M102.998	04/82 ⇒ 08/92
CLASSE G I 280 GE	M110.994	11/79 ⇒ 08/89
KOMBI I 200 T	M102.920, M102.939	11/80 ⇒ 11/85
KOMBI II 200 T	M102.922	09/85 ⇒ 05/90
KOMBI II 200 TE	M102.962, M102.963	09/88 ⇒ 08/92
KOMBI II 230 E Chassis	M102.982	09/86 ⇒ 06/93
KOMBI II 230 TE	M102.982	09/85 ⇒ 08/92
KOMBI II 230 TE Cat	M102.982	06/89 ⇒ 08/92
O 309	M102.943	01/68 ⇒ 02/89
T1 210 2.3	M102.942, M102.945	04/77 ⇒ 02/96
T1 310 2.3	M102.942, M102.945	08/82 ⇒ 02/96
T1 410 2.3	M102.942, M102.945	08/82 ⇒ 06/95
T2/LN1 510	M102.946	04/86 ⇒ 12/94
TRE VOLUMI I 280 E	M110.984, M110.988	02/76 ⇒ 11/85
TRE VOLUMI II 200	M102.922	12/85 ⇒ 10/92
TRE VOLUMI II 200 E	M102.963	09/88 ⇒ 08/93
TRE VOLUMI II 230 E	M102.982	12/84 ⇒ 06/93
TRE VOLUMI II 230 E Cat	M102.982	06/89 ⇒ 06/93

PUCH

G-MODELL 230 GE	M102.981, M102.987	03/79 ⇒ 12/91
G-MODELL 280 GE	M110.994	01/86 ⇒ 12/91

KW 470 188



07

COILS

Adatt./Suitable:

BOSCH

0 221 503 004

0 221 503 025

F 01R 00A 025

CITROËN

5970 48

5970 60

5970 70

96 074 054

96 228 897

DUCELLIER

2 526 037 A

2 526 040 A

FIAT

9607405480

9622889780

HITACHI

138760

2508760

INNOCENTI

9622889780

LANCIA

9607405480

9622889780

MAGNETI MARELLI

060717043012

PEUGEOT

5970 48

5970 70

96 228 897

SAGEM

2 526 040 A



- - + +	ohm		ohm
	0,70	Ø 4	9000

CITROËN

XANTIA I 1.6 i	BFZ(XU5JP)	03/93 ⇒ 03/01
XANTIA I 1.8 i	LFZ(XU7JB), LFZ(XU7JP)	03/93 ⇒ 01/98
XANTIA I 2.0	RFXX(U10J2C/ZL3)	03/93 ⇒ 05/95
XANTIA I 2.0 i	RFZ(XU10J2C)	03/93 ⇒ 04/03
XANTIA I 2.0 Turbo	RGX(XU10J2TE)	06/95 ⇒ 04/03
BX 1.9	159C, D6U, DKK	09/85 ⇒ 12/94
BX 1.9 GTi	D6D, D6K	01/87 ⇒ 01/92
BX 16	BDY(XU5M), BDZ(XU5M)	05/89 ⇒ 12/94
BX 16 E	BDY(XU5M), BDZ(XU5M)	05/89 ⇒ 02/93
BX 19	D6A(XU9J2), DKZ(XU9JA)	07/86 ⇒ 12/94
BX 19 Cat	DFZ(XU9J1)	07/86 ⇒ 12/94
BX 19 GTi	D6A(XU9J2), DKZ(XU9JA)	07/86 ⇒ 02/93
BX 19 GTi 4x4	DKZ(XU9JA)	06/88 ⇒ 02/93
XSARA 1.4 i	KFW(TU3JP), KFX(TU3JP)	04/97 ⇒ 08/05
XSARA 1.4 LPG	KFW(TU3JP)	05/98 ⇒ 08/00
XSARA 1.6 i	NFZ(TU5JP)	04/97 ⇒ 09/00
XSARA 1.8 i	LFZ(XU7JB), LFZ(XU7JP)	04/97 ⇒ 09/00
XSARA 1.8 i Aut.	LFZ(XU7JP)	04/97 ⇒ 09/00
EVASION 1.8	LFZ(XU7JP)	02/96 ⇒ 12/96
EVASION 2.0	RFU(XU10J2/C)	06/94 ⇒ 07/02
EVASION 2.0 Turbo C.T.	RGX(XU10J2TE)	06/94 ⇒ 07/02
JUMPER I 2.0	RFW(XU10J2U)	02/94 ⇒ 04/02
JUMPER I 2.0 4x4	RFW(XU10J2U)	08/96 ⇒ 04/02
XMI 1.2 0 i	RDZ(XU10MZ), RFZ(XU10J2)	05/89 ⇒ 06/94
XMI 1.2 0 i Turbo	RGY(XU10J2TE/Z)	09/92 ⇒ 06/94
XMI 1.2 0 Turbo	RGY(XU10J2TE/Z)	09/92 ⇒ 04/94
JUMPER II 2.0	XU10J2	04/02 ⇒
JUMPER II 2.0 bivalent	XU10J2	02/03 ⇒
BERLINGO I 1.1 i	HDZ(TU1M)	07/96 ⇒ 05/08
BERLINGO I 1.4 BiFuel	KFW(TU3JP)	07/96 ⇒ 10/02
BERLINGO I 1.4 i	KFW(TU3JP), KFX(TU3JP)	07/96 ⇒ 12/11
BERLINGO I 1.4 i bivalent	KFW(TU3JP)	04/03 ⇒ 10/05
BERLINGO I 1.8 i	LFZ(XU7JB)	05/97 ⇒ 10/02
BERLINGO I 1.8 i 4WD	LFZ(XU7JB)	04/97 ⇒ 10/01
SAXO 1.0	CDZ(TU9M)	10/97 ⇒ 06/03

CITROËN			
SAXO 1.0 X	CDY(TU9M), CDZ(TU9M)	05/96 ⇒	11/98
SAXO 1.1 BiFuel	HDZ(TU1M)	07/00 ⇒	06/03
SAXO 1.1 X, SX	HDZ(TU1M)	05/96 ⇒	09/03
SAXO 1.4 VTS	KFW(TU3JP), KFX(TU3JP)	05/96 ⇒	06/03
SAXO 1.6	NFT(TU5JP), NFZ(TU5JP)	02/01 ⇒	04/04
SAXO 1.6 VTL, VTR	NFZ(TU5JP)	05/96 ⇒	06/03
SAXO 1.6 VTS	NFT(TU5JP)	09/00 ⇒	09/03
XANTIA II 1.6 i SX	BFZ(XU5JP)	01/98 ⇒	03/01
XANTIA II 1.8 i	LFX(XU7JB)	01/98 ⇒	04/03
XANTIA II 2.0 i	RFX(XU10J2C)	01/98 ⇒	04/03
XANTIA II 2.0 Turbo	RGX(XU10J2TE)	01/98 ⇒	04/03
XM II 2.0	XU10J2	08/94 ⇒	07/99
XM II 2.0 Turbo	RGX(XU10J2TE), RGY(XU10J2TE/Z)	05/94 ⇒	10/00
ZX 1.4 i	KFX(TU3JP)	03/91 ⇒	10/97
ZX 1.6	BDY(XU5M), BFZ(XU5JP)	07/94 ⇒	10/97
ZX 1.6 i	BDY(XU5M), BFZ(XU5JP)	03/91 ⇒	10/97
ZX 1.8	LFZ(XU7JP)	03/91 ⇒	10/97
ZX 1.8 i	LFZ(XU7JP)	07/92 ⇒	10/97
ZX 1.9	D6E(XU9JA)	03/91 ⇒	06/97
ZX 1.9 i	DKZ(XU9JA), XU9JA	03/91 ⇒	06/97
ZX 2.0	RFX(XU10J2C)	07/94 ⇒	10/97
ZX 2.0 i	RFX(XU10J2C), XU10J2	07/92 ⇒	10/97

FIAT			
DUCATO II 2.0	RFL	03/94 ⇒	
DUCATO II 2.0 4x4	RFL	11/94 ⇒	07/06
DUCATO II 2.0 Bipower	RFL	11/02 ⇒	
DUCATO II 2.0 LPG	RFL	11/02 ⇒	07/06
DUCATO II 2.0 Panorama/ Combinato	RFW	03/94 ⇒	04/02
ELBA 1.4	146D5.000	10/93 ⇒	02/95
ULYSSE I 1.8	LFW(XU7JP)	05/97 ⇒	08/02
ULYSSE I 2.0	RFU(XU10J2C)	06/94 ⇒	08/02
ULYSSE I 2.0 Turbo	RGX(XU10J2CTE)	06/94 ⇒	08/02

INNOCENTI			
ELBA 1.4 i.e.	146D5.000	09/94 ⇒	12/96
ELBA 1.6 i.e.	146D6.000	09/94 ⇒	12/96

LANCIA			
ZETA 2.0 Turbo	RGX(XU10J2TE)	05/95 ⇒	09/02

PEUGEOT			
106 I 1.0	CDY(TU9M), TU9	04/96 ⇒	03/01
106 II 1.0 i	CDY(TU9M), CDZ(TU9M)	04/96 ⇒	10/99
106 II 1.1 BiFuel	HDZ(TU1M+)	04/96 ⇒	03/01
106 II 1.1 i	HDY(TU1M+), HDZ(TU1M)	05/96 ⇒	07/04
106 II 1.4 i	KFW(TU3JP), KFX(TU3JP)	05/96 ⇒	07/04
106 II 1.6 i	NFZ(TU5JP)	05/96 ⇒	10/99
205 II 1.6 i	BDZ(XU5M)	01/91 ⇒	12/94
306 1.4	KFW(TU3JP), KFX(TU3JP)	04/93 ⇒	04/02
306 1.4 SL	KFW(TU3JP), KFX(TU3JP)	06/94 ⇒	05/01
306 1.6	NFZ(TU5JP)	05/93 ⇒	10/00
306 1.6 SR	NFZ(TU5JP)	06/94 ⇒	10/00
306 1.8	-, LFZ(XU7JP)	05/93 ⇒	04/02
306 1.8 ST	LFZ(XU7JP)	06/94 ⇒	05/01
306 2.0	RFX(XU10J2)	03/94 ⇒	04/02
306 2.0 ST	RFX(XU10J2)	07/94 ⇒	05/01
306 2.0 XSi	RFX(XU10J2)	05/93 ⇒	05/01

BOXER I 2.0	RFL(XU10J2U)	12/01 ⇒	
BOXER I 2.0 4x4	-	03/96 ⇒	09/98
BOXER I 2.0 i	RFW(XU10J2)	03/94 ⇒	04/02
BOXER I 2.0 i 4x4	RFW(XU10J2)	08/96 ⇒	04/02
309 II 1.6	BDZ(XU5M)	07/89 ⇒	12/93
405 II 1.6	BDY(XU5M2Z), BDY(XU5M3Z), BDZ(XU5M), BFZ(XU5JP)	08/92 ⇒	05/97
405 II 1.8	LFZ(XU7JP)	08/92 ⇒	10/96
405 II 1.9	XU9J2/D6D	01/93 ⇒	12/96
405 II 2.0	RFX(XU10J2)	08/92 ⇒	10/96
405 II 2.0 4x4	RFX(XU10J2)	08/92 ⇒	10/96
405 II 2.0 X4	RFX(XU10J2)	08/92 ⇒	10/95
406 1.6	BFZ(XU5JP)	11/95 ⇒	05/04
406 1.8	L6A(XU7JP), LFX(XU7JB), LFZ(XU7JP)	10/96 ⇒	03/99
406 2.0 Turbo	RGX(XU10J2TE)	04/96 ⇒	10/04
EXPERT I 1.8	L6B(XU7JP), LFZ(XU7JP)	09/96 ⇒	
605 2.0	RFZ(XU10J2Z)	06/89 ⇒	09/99
605 2.0 Turbo	RGX(XU10J2TE), RGY(XU10J2TE)	07/91 ⇒	09/99

806 1.8	LFW(XU7JP)	07/95 ⇒	08/02
806 2.0	RFU(XU10J2)	06/94 ⇒	08/02
806 2.0 Turbo	RGX(XU10J2TE)	06/94 ⇒	08/02
PARTNER I 1.1	HDY(TU1M), HDZ(TU1M)	06/96 ⇒	
PARTNER I 1.4	KFX(TU3JP)	06/96 ⇒	12/15
PARTNER I 1.8	LFX(XU7JB)	03/97 ⇒	12/02
RANCH 1.1	HDY(TU1M), HDZ(TU1M)	06/96 ⇒	
RANCH 1.4	KFX(TU3JP)	06/96 ⇒	
RANCH 1.8	LFX(XU7JB)	05/97 ⇒	



COILS

Adatt./Suitable:

BOSCH

0 221 503 003
0 221 503 006
0 221 503 024

CITROËN

5970 49
96 062 288

DUCELLIER

2 526 035 A

HITACHI

138756

2508756

MAGNETI MARELLI

060717129012

PEUGEOT

5970 49

96 062 288

ROVER

GCL204

NEC100710

903 Supplied until depletion

- Fornibile fino ad esaurimento delle scorte
- Fourni jusqu'à épuisement du stock
- Lieferbar solange vorrat reicht
- Suministrado hasta el stock termina



	ohm		ohm
	0,70		9000

CITROËN

AX 1.4 GTi	KFY(TU3FJ2), KFZ(TU3FJ2)	06/91 ⇒	12/96
AX 10	CDY(TU9M), CDZ(TU9M)	07/86 ⇒	12/98
AX 11	HDZ(TU1M)	09/86 ⇒	12/97
AX 14	K6B(TU3FJ2), KDX(TU3M/Z), KDY(TU3FM)	04/87 ⇒	04/97
AX 14 4x4	KDY(TU3FM)	08/91 ⇒	12/96
ZX 1.1	HDZ(TU1M)	03/91 ⇒	06/97
ZX 1.4	KDZ(TU3M/Z)	03/91 ⇒	06/97
ZX 1.4 i	KDX(TU3M/Z), KDZ(TU3M/Z)	03/91 ⇒	10/97

PEUGEOT

106 I 1.0	CDY(TU9M), CDZ(TU9M)	09/91 ⇒	04/96
106 I 1.1	HDZ(TU1M)	09/91 ⇒	04/96
106 I 1.3	TU2J2	10/93 ⇒	04/96
106 I 1.4	KDX(TU3MC)	09/91 ⇒	04/96
106 I 1.4 i	TU3FJ, TU3FMC	01/91 ⇒	12/96
106 I 1.4 i XSi	TU3J	09/91 ⇒	03/96
106 I 1.4 Le Mans	KFZ(TU3J2/Z)	09/91 ⇒	11/94
106 I 1.6	NFY(TU5J2), NFZ(TU5JP)	06/93 ⇒	04/96
106 II 1.6 i	NFW(TU5J2), NFY(TU5J2)	05/96 ⇒	01/01
205 II 1.0	CDZ(TU9M)	08/92 ⇒	05/97
205 II 1.1	HDZ(TU1M)	07/89 ⇒	09/98
205 II 1.4	KDX(TU3MC)	07/88 ⇒	09/98
306 1.1	HDZ(TU1M)	05/93 ⇒	05/01
306 1.4	KDX(TU3MC)	04/93 ⇒	07/01
306 1.4 SL	KDX(TU3MC)	06/94 ⇒	05/01
306 1.6	NFZ(TU5JP)	05/93 ⇒	10/00
306 1.6 SR	NFZ(TU5JP)	06/94 ⇒	10/00
405 II 1.4	TU3FM	01/93 ⇒	12/96

ROVER

400 II 420 Si Lux	1CA46A15-01, 20M4F	12/95 ⇒	03/00
600 620 Ti Vitesse	20T4G	05/94 ⇒	08/98
800 820 I/SI	1CA46A15-01	01/91 ⇒	02/99
400 I 2.0 i	1CA46A15-01	05/94 ⇒	11/98
MINI 1300	12A2A, 12A2B, 12A2D, 12A2E, 12A2L	01/91 ⇒	04/95



COILS

Adatt./Suitable:

BOSCH

0 221 122 402
0 221 122 403
1 227 020 029

GENERAL MOTORS

90 277 970

OPEL

12 08 047

VAUXHALL

90277970

900 Eliminated on 23-02-2022. Please verify the availability through our local distributors

- Eliminato il 23-02-2022. Verificare la disponibilità presso i nostri distributori
- Éliminé le 23-02-2022. Vérifier la disponibilité auprès de nos distributeurs sur place
- Am 23-02-2022 gestrichen. Evtl. Verfügbarkeit bitte bei unseren Händlern prüfen
- Eliminado en fecha 23-02-2022. Verificar la disponibilidad a través de nuestros distribuidores locales

900 Dry (epoxy) coil replacing original oil-bath coil version

- Bobina (resinizzata) sostitutive originale a bagno d'olio
- Bobine seche, remplaçant la bobine d'origine à bain d'huile
- Trockenspule, die die Originale im Ölbad ersetzt
- Bobina seca, sustituye modelo original con baño de aceite

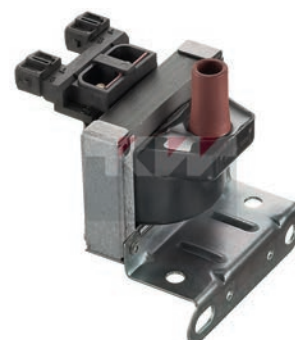

	ohm		ohm
	0,68		7200

OPEL

CALIBRA A 2.0 i	C20NE	08/89 ⇒	12/96
CALIBRA A 2.0 i 4x4	C20NE	06/90 ⇒	07/97
KADETT E 1.8 i	S18NV	06/85 ⇒	08/91
KADETT E 1.8 S	E18NV	09/87 ⇒	08/91
KADETT E 2.0 GSI	Z0NE, Z0SEH	09/86 ⇒	08/91
KADETT E 2.0 GSI Cat	C20NE	09/86 ⇒	08/91
KADETT E 2.0 i	Z0NE	10/86 ⇒	02/93
KADETT E 2.0 i Cat	C20NE	10/86 ⇒	02/93
OMEGA A 1.8	E18NVR, S18NV	09/86 ⇒	03/94
OMEGA A 1.8 N	18NV	09/86 ⇒	08/87
OMEGA A 2.0	Z0SE, C20NE	09/86 ⇒	04/94
OMEGA A 2.0 i	C20NE	09/86 ⇒	04/94
OMEGA A 2.4 i	C24NE	09/88 ⇒	03/94
OMEGA A 3.0	C30LE, C30NE	03/87 ⇒	03/94
OMEGA A 2.0 i Cat	C30NE	03/87 ⇒	03/94
OMEGA B 2.0	Z0SE	03/94 ⇒	12/00
SENATOR B 3.0	C30LE	09/87 ⇒	09/93
SENATOR B 3.0 i Cat	C30NE	01/88 ⇒	09/93
VECTRA A 1.8 S	E18NVR	09/88 ⇒	07/89
VECTRA A 1.8 S 4x4	E18NVR	01/89 ⇒	07/89
VECTRA A 2.0 i	Z0NE, Z0SEH	09/88 ⇒	09/92
VECTRA A 2.0 i 4x4	Z0NE, Z0SEH	01/89 ⇒	07/92
VECTRA A 2.0 i Cat	C20NE	09/88 ⇒	11/95
VECTRA A 2.0 i Cat 4x4	C20NE	01/89 ⇒	11/95
VECTRA A 2.0 i GT	Z0SEH	09/88 ⇒	11/95

VAUXHALL

CALIBRA 2.0 i	C20NE	06/90 ⇒	07/97
CALIBRA 2.0 i 4x4	C20NE	06/90 ⇒	07/97
OMEGA B 2.0	Z0SE	09/95 ⇒	09/96

KW 470 192



07

COILS

Adatt./Suitable:

BOSCH

0 221 122 408
0 221 122 409
1 220 522 019
1 221 122 409
F 000 Z50 001

GENERAL MOTORS

30 584 237
90 350 021

OPEL

12 08 053

SAAB

12 08 053
30 584 237
42 26 031
51 71 111
90 350 021
90 350 987
90 369 434

SCANIA

30584237
4226031
5171111



	ohm		ohm
	0,68	∅ 4	7200

OPEL

ASTRA F 1.6	16LZ2, 16NZ2	09/94 ⇒ 09/98
ASTRA F 1.8 i	C18NZ	09/91 ⇒ 09/98
ASTRA F 1.8 i 16V	18SE	09/95 ⇒ 09/96
ASTRA F 2.0 i	C20NE	09/91 ⇒ 09/98
CALIBRA A 2.0 i	C20NE	08/89 ⇒ 12/96
CALIBRA A 2.0 i 4x4	C20NE	06/90 ⇒ 07/97
FRONTERA A 2.0 i	C20NE	03/92 ⇒ 10/98
FRONTERA A 2.4 i	C24NE	03/92 ⇒ 10/98
KADETT E 1.8 i	S18NV	06/85 ⇒ 08/91
KADETT E 1.8 S	E18NV	09/87 ⇒ 08/91
KADETT E 2.0 GSI	20NE, 20SEH	09/86 ⇒ 08/91
KADETT E 2.0 GSI Cat	C20NE	09/86 ⇒ 08/91
KADETT E 2.0 i	20NE	10/86 ⇒ 02/93
KADETT E 2.0 i Cat	C20NE	10/86 ⇒ 02/93
OMEGA A 1.8	E18NVR, S18NV	09/86 ⇒ 03/94
OMEGA A 1.8 N	18NV	09/86 ⇒ 08/87
OMEGA A 2.0	20SE, C20NE	09/86 ⇒ 04/94
OMEGA A 2.0 i	C20NE	09/86 ⇒ 04/94
OMEGA A 2.4 i	C24NE	09/88 ⇒ 03/94
OMEGA A 2.6 i	C26NE	09/90 ⇒ 03/94
OMEGA A 3.0	C30LE, C30NE	03/87 ⇒ 03/94
OMEGA A 3.0 24V	C30SE	09/89 ⇒ 03/94
OMEGA A 3.0 24V Omega 3000	C30SE	09/88 ⇒ 04/94
OMEGA A 3.0 Cat	C30NE	03/87 ⇒ 03/94
OMEGA B 2.0	20SE	03/94 ⇒ 12/00
SENATOR B 3.0	C30LE	09/87 ⇒ 09/93
SENATOR B 3.0 24V	C30SE	09/89 ⇒ 09/93
SENATOR B 3.0 i Cat	C30NE	01/88 ⇒ 09/93
VECTRA A 1.8 S	E18NVR	09/88 ⇒ 07/89
VECTRA A 1.8 S 4x4	E18NVR	01/89 ⇒ 07/89
VECTRA A 2.0 i	20NE, 20SEH	09/88 ⇒ 09/92
VECTRA A 2.0 i 4x4	20NE, 20SEH	01/89 ⇒ 07/92
VECTRA A 2.0 i Cat	C20NE	09/88 ⇒ 11/95
VECTRA A 2.0 i Cat 4x4	C20NE	01/89 ⇒ 11/95
VECTRA A 2.0 i GT	20SEH	09/88 ⇒ 11/95

SAAB

9-3 2.0 i	B204I	02/98 ⇒ 08/03
9-3 2.0 SE Turbo	B204R	02/98 ⇒ 08/03
9-3 2.0 Turbo	B204E, B204L, B205E, B205L, B205R	02/98 ⇒ 08/03
9-3 2.3	B235R	09/99 ⇒ 01/02
9-3 2.3 i	B234I	02/98 ⇒ 08/03

SAAB

900 II 2.0 i	B204I, B206I	07/93 ⇒ 02/98
900 II 2.3 -16	B234I	07/93 ⇒ 02/98

VAUXHALL

ASTRA III 1.8 i	C18NZ	09/91 ⇒ 09/98
ASTRA III 1.8 i 16V	18SE	09/95 ⇒ 02/98
ASTRA III 2.0 i	C20NE	09/91 ⇒ 09/98
CALIBRA 2.0 i	C20NE	06/90 ⇒ 07/97
CALIBRA 2.0 i 4x4	C20NE	06/90 ⇒ 07/97
FRONTERA A 2.0	C20NE	04/95 ⇒ 08/98
FRONTERA A 2.0 i	C20NE	03/92 ⇒ 10/98
FRONTERA A 2.4 i	C24NE	03/92 ⇒ 10/98
OMEGA B 2.0	20SE	09/95 ⇒ 09/96

KW 470 194



07

COILS

Adatt./Suitable:

BOSCH

0 221 122 369

GENERAL MOTORS

90 240 252

OPEL

12 08 041

VAUXHALL

90240252

⁰³ Supplied until depletion

- Fornibile fino ad esaurimento delle scorte
- Fourni jusqu'à épuisement du stock
- Lieferbar solange vorrat reicht
- Suministrado hasta el stock termina

⁹⁶⁰ Dry (epoxy) coil replacing original oil-bath coil version

- Bobina (resinizzata) sostituyente originale a bagno d'olio
- Bobine seche, remplaçant la bobine d'origine à bain d'huile
- Trockenspule, die die Originale im Ölbad ersetzt
- Bobina seca, sustituye modelo original con baño de aceite



	ohm		ohm
6.4 ∅ 4	0,72	∅ 8.2	7200

OPEL

ASCONA C 1.8	E18NV	09/87 ⇒ 08/88
ASCONA C 1.8 E	S18NV	01/85 ⇒ 08/86
ASCONA C 2.0 i	20NE	09/86 ⇒ 08/88
ASCONA C 2.0 i Cat	C20NE	09/86 ⇒ 08/88
ASCONA C 2.0 i GT	20SEH	03/87 ⇒ 08/88
KADETT E 1.8 i	S18NV	06/85 ⇒ 08/91
KADETT E 1.8 S	E18NV	09/87 ⇒ 08/91
KADETT E 2.0 GSI	20NE, 20SEH	09/86 ⇒ 08/91
KADETT E 2.0 GSI Cat	C20NE	09/86 ⇒ 08/91
KADETT E 2.0 i	20NE	10/86 ⇒ 02/93
KADETT E 2.0 i Cat	C20NE	10/86 ⇒ 02/93
OMEGA A 1.8	E18NVR, S18NV	09/86 ⇒ 03/94
OMEGA A 1.8 N	18NV	09/86 ⇒ 08/87
OMEGA A 2.0	20SE, C20NE	09/86 ⇒ 04/94
OMEGA A 2.0 i	C20NE	09/86 ⇒ 04/94
OMEGA A 3.0	C30LE, C30NE	03/87 ⇒ 03/94
OMEGA A 3.0 Cat	C30NE	03/87 ⇒ 03/94
OMEGA B 2.0	20SE	03/94 ⇒ 12/00
SENATOR B 3.0	C30LE	09/87 ⇒ 09/93
SENATOR B 3.0 i Cat	C30NE	01/88 ⇒ 09/93

VAUXHALL

OMEGA B 2.0	20SE	09/95 ⇒ 09/96
-------------	------	---------------

KW 470 196



05

COILS

Adatt./Suitable:

BOSCH

0 986 221 033

HITACHI

138738
2508738

MAGNETI MARELLI

060708049010
060708149010
060717051012
BAE 800 EK
BAE 801 EK

RENAULT

77 00 107 269

SEAT

SE 028915.000B



	ohm		ohm
	0,54	∅ 4	7500

RENAULT

ESPACE III 2.0	F3R728, F3R729, F3R742, F3R768, F3R769	11/96 ⇒ 10/00
LAGUNA I 1.8	F3P670, F3P674, F3P676, F3P678	06/95 ⇒ 03/01
LAGUNA I 2.0	---, F3R611, F3R728, F3R729, F3R768	11/93 ⇒ 03/01
MEGANE I 2.0	F3R262, F3R264, F3R750, F3R791	01/97 ⇒ 08/03
MEGANE I 2.0 i	F3R750, F3R751, F3R752, F3R791, F3R796, F3R797, F3R798	01/96 ⇒ 08/03
MEGANE I 2.0 RT	F3R750, F3R751, F3R752, F3R791, F3R796, F3R797, F3R798	10/96 ⇒ 02/99
MEGANE SCÉNIC I 2.0 i	F3R750, F3R751, F3R791, F3R796, F3R797, F3R798	01/97 ⇒ 09/99
MEGANE SCÉNIC I 2.0 RXE 4x4	F3R750	05/97 ⇒ 10/99
SCÉNIC I 2.0	F3R791, F3R797, F3R798	09/99 ⇒ 08/03

SEAT

MARBELLA 0.9 Cat	08NCB	11/96 ⇒ 10/98
TERRA 0.9 Cat	09NCB	02/92 ⇒ 12/94

KW 470 197



05

COILS

Adatt./Suitable:

BOSCH
F 005 X11 771
DENSO
029700-5430
GENERAL MOTORS
94 840 127
HOLDEN
9091902135
TOYOTA
90919-02135

00 Eliminated on 23-02-2022. Please verify the availability through our local distributors

- Eliminato il 23-02-2022. Verificare la disponibilità presso i nostri distributori
- Éliminé le 23-02-2022. Vérifier la disponibilité auprès de nos distributeurs sur place
- Am 23-02-2022 gestrichen. Evtl. Verfügbarkeit bitte bei unseren Händlern prüfen
- Eliminado en fecha 23-02-2022. Verificar la disponibilidad a través de nuestros distribuidores locales



M4	M4	ohm	ohm
		0,45	8500

HOLDEN			
APOLLO 2.0 i	3S-FE	08/89	⇒ 02/93
TOYOTA			
CAMRY 2.0	3S-FE	03/83	⇒ 02/93
CAMRY 2.0 4WD	3S-FE	03/83	⇒ 06/91
CARINA II 2.0	3S-FE	12/87	⇒ 04/92
CARINA II 2.0 GLi	3S-FE	12/87	⇒ 03/92
COROLLA V 1.6	4A-C, 4A-LC	08/84	⇒ 05/89
COROLLA V 1.6 SR	4A-C	08/83	⇒ 04/85
COROLLA VI 1.6	4A-FE	08/89	⇒ 04/92
COROLLA VI 1.6 i	4A-FE	05/87	⇒ 05/92
COROLLA VI 1.6 i 4WD	4A-FE	10/87	⇒ 08/90
COROLLA VI 1.6 XLI	4A-FE	11/89	⇒ 06/92
LITEACE 2.2	4Y-EC	01/92	⇒ 01/95
MODEL F 2.2	4Y-EC	08/85	⇒ 01/90
CELICA IV 2.0i [USA]	2SEL, 3S-FE	01/85	⇒ 12/87
TERCEL 1.5	3A-C	08/83	⇒ 05/85
TERCEL 1.5 4WD	3A-C	09/82	⇒ 01/88
TERCEL 1.5 i [USA]	3EE	01/89	⇒ 12/90
VAN 2.0 [USA]	3YEC	01/83	⇒ 12/90
VAN 2.2 [USA]	4YEC	01/83	⇒ 12/90

KW 470 198



05

COILS

Adatt./Suitable:

BOSCH
F 000 Z50 121
HITACHI
138866
2508866
HOLDEN
9091902163
TOYOTA
90919-02163

03 Supplied until depletion

- Fornibile fino ad esaurimento delle scorte
- Fourni jusqu'à épuisement du stock
- Lieferbar solange vorrat reicht
- Suministrado hasta el stock termina



M4	M4	ohm	ohm
		0,45	12200

HOLDEN		
APOLLO 2.2 i	08GR-FXS	03/93 ⇒ 05/97
TOYOTA		
4 RUNNER 2.7 4WD	3RZ-FE	11/95 ⇒ 08/02
CAMRY 2.2	5S-FE	06/91 ⇒ 07/96
CARINA E 2.0	3S-FE	01/93 ⇒ 09/97
CARINA E 2.0 GLI	3S-FE	04/92 ⇒ 09/97
CARINA E 2.0 GTi	3S-GE	04/92 ⇒ 12/95
CARINA E 2.0 GTi 16V	3S-GE	03/94 ⇒ 09/97
CARINA E 2.0 i	3S-FE	12/92 ⇒ 09/97
CELICA V 2.2	5S-FE	10/89 ⇒ 12/94
COROLLA VIII 1.8 4WD	7A-FE	04/97 ⇒ 10/01
DYNA 200 2.7	3RZ-FE	06/95 ⇒ 07/01
FUNCRUISER 2.0 i 16V 4WD	3SFE	04/94 ⇒
MR 2 II 2.2 16V	5S-FE	01/90 ⇒ 06/95
HIACE IV 2.4	5YTD050W07	08/89 ⇒ 08/03
HIACE IV 2.4 4WD	5YTD050W07	08/89 ⇒ 08/95
CELICA VI 1.8 i 16V [USA] [CAN]	7A-FE	09/93 ⇒ 08/99
CELICA VI 2.2 GT	5S-FE	11/93 ⇒ 08/99
LAND CRUISER 90 2.7	3RZ-FE	06/95 ⇒ 08/02
PASEO 1.5	5E-FE	06/90 ⇒ 08/95
RAV 4 1.2.0	3S-FE	06/97 ⇒ 09/99
RAV 4 1.2.0 4WD	3S-FE	01/94 ⇒ 06/00
T100 2.7 i [USA]	3RZFE	10/93 ⇒ 07/98
TACOMA 2.4 i [USA]	2RZFE	01/95 ⇒
TERCEL 1.5 [USA]	3E	01/86 ⇒ 12/90
TERCEL 1.5 i [USA]	3EE	01/91 ⇒

KW 470 199



05

COILS

Adatt./Suitable:

BOSCH
F 000 Z50 117
GENERAL MOTORS
94 404 545
94 853 695
HITACHI
138865
2508865
HOLDEN
9091902164
ISUZU
8-94404545-0
MAGNETI MARELLI
060717025012
TOYOTA
90919-02164

00 Eliminated on 02-08-2021. Please verify the availability through our local distributors

- Eliminato il 02-08-2021. Verificare la disponibilità presso i nostri distributori
- Éliminé le 02-08-2021. Vérifier la disponibilité auprès de nos distributeurs sur place
- Am 02-08-2021 gestrichen. Evtl. Verfügbarkeit bitte bei unseren Händlern prüfen
- Eliminado en fecha 02-08-2021. Verificar la disponibilidad a través de nuestros distribuidores locales



M4	M4	ohm	ohm
		1,32	12200

HOLDEN		
APOLLO 2.0	3S-FC	08/89 ⇒ 08/91
NOVA_LE 1.4 Hatchback	6AFC	07/89 ⇒ 07/91
NOVA_LE 1.6 Hatchback	4AFC	07/89 ⇒ 07/91
NOVA_LE 1.6 Sedan	4AFC	07/89 ⇒ 07/91
NOVA_LF 1.8i Hatchback	7AFE	08/91 ⇒ 03/93
NOVA_LF 1.8i Sedan	7AFE	08/91 ⇒ 03/93
NOVA_LG 1.6i Hatchback	4AFE	09/94 ⇒ 09/96
NOVA_LG 1.6i Sedan	4AFE	09/94 ⇒ 09/96
NOVA_LG 1.8i Hatchback	7AFE	09/94 ⇒ 09/96
NOVA_LG 1.8i Sedan	7AFE	09/94 ⇒ 09/96
TOYOTA		
CARINA II 1.6	4A-F	12/87 ⇒ 08/90
CARINA E 1.6	4A-FE	04/92 ⇒ 09/97
CARINA E 1.6 16V	4A-FE	12/94 ⇒ 09/97
CARINA E 1.6 GLI	4A-FE	04/92 ⇒ 09/97
CARINA E 1.6 i	4A-FE	02/95 ⇒ 09/97
CELICA IV 1.6	4A-L	04/86 ⇒ 08/89
COROLLA VI 1.3	2E	05/87 ⇒ 06/92
COROLLA VI 1.3 i	2E, 2E-E	08/87 ⇒ 06/92
COROLLA VI 1.6	4A-F	05/87 ⇒ 12/92
COROLLA VI 1.6 4WD	4A-F	08/87 ⇒ 08/89
COROLLA VI 1.6 GL 4WD	4A-F	10/87 ⇒ 08/90
COROLLA VI 1.6 XL	4A-F	09/89 ⇒ 04/92
COROLLA VII 1.3 12V	2E	07/92 ⇒ 04/97
COROLLA VII 1.3 XLI	4E-FE	07/92 ⇒ 04/97
COROLLA VII 1.3 XLI 16V	4E-FE	07/92 ⇒ 09/95
COROLLA VII 1.6 GLI	4A-FE	07/92 ⇒ 04/97
COROLLA VII 1.6 Si	4A-FE	07/92 ⇒ 04/97
COROLLA VII 1.8 16V 4WD	7A-FE	09/95 ⇒ 04/97
COROLLA VII 1.8 GT	7A-FE	11/92 ⇒ 05/95
COROLLA VIII 1.3	2E	05/97 ⇒ 10/01
COROLLA VIII 1.6	4A-FE	04/97 ⇒ 02/00
COROLLA VIII 1.6 Aut.	4A-FE	04/97 ⇒ 02/00
COROLLA VIII 1.8	7A-FE	10/97 ⇒ 10/01
COROLLA 1.6	4A-FE	05/97 ⇒ 09/99
HIACE 2.4 LPG	2RZE	08/95 ⇒ 06/99
HIACE IV 2.0	1RZ, 1RZ-E	08/89 ⇒ 08/04
HIACE IV 2.4	2RZ, 2RZE, 5YTD050W07	08/89 ⇒ 12/04
HIACE IV 2.4 4WD	2RZE	08/95 ⇒ 04/98
CELICA VI 1.8 i 16V	7A-FE	11/93 ⇒ 11/99
CELICA VI 1.8 i 16V [USA] [CAN]	7A-FE	09/93 ⇒ 08/99
PASEO 1.5	5E-FE	08/95 ⇒ 06/99
PASEO 1.5 Efi	5E-FE	01/97 ⇒ 12/99
STARLET 1.0	1E	12/89 ⇒ 12/92
STARLET 1.3	2E	01/96 ⇒ 07/99
STARLET 1.3 12V	2E, 2E-E	12/89 ⇒ 12/92
STARLET 1.3 12V Cat	2E-E	12/89 ⇒ 03/96
STARLET 1.3 XL	2E	12/89 ⇒ 12/91

KW 470 201



05

COILS

Adatt./Suitable:

SUZUKI

33410-57B10
33410-57B10-000
33410-80C10
33410-80C10-000

00 Eliminated on 02-03-2020. Please verify the availability through our local distributors

- Eliminato il 02-03-2020. Verificare la disponibilità presso i nostri distributori
- Éliminé le 02-03-2020. Vérifier la disponibilité auprès de nos distributeurs sur place
- Am 02-03-2020 gestrichen. Evtl. Verfügbarkeit bitte bei unseren Händlern prüfen
- Eliminado en fecha 02-03-2020. Verificar la disponibilidad a través de nuestros distribuidores locales



	ohm		ohm
	0,98	Ø 8,4	12000

SUZUKI

SIDEKICK 1.6 JX 4x4	G16A(8V)	04/89 ⇨ 04/96
SIDEKICK 1.6i 16V JX 4x4	G16B	04/89 ⇨ 04/96
VITARA I 1.6	G16A(8V), G16B	07/88 ⇨ 03/98
VITARA I 1.6 i 16V	G16B	07/90 ⇨ 03/99
VITARA I 1.6 i 16V Trazione integrale	G16B	07/90 ⇨ 03/98
VITARA I 1.6 Trazione integrale	G16A(8V)	07/88 ⇨ 03/98

KW 470 202



05

COILS

Adatt./Suitable:

DENSO

029700-6820

LEXUS

90919-02185

TOYOTA

90919-02185

03 Supplied until depletion

- Fornibile fino ad esaurimento delle scorte
- Fourni jusqu'à épuisement du stock
- Lieferbar solange vorrat reicht
- Suministrado hasta el stock termina



	ohm		ohm
	0,47	Ø 8,4	12000

LEXUS

ES 250 2VZ-FE 12/89 ⇨ 12/91

TOYOTA

4 RUNNER 3.0	3VZ-E	08/88 ⇨ 11/95
4 RUNNER 3.0 [USA]	3VZ-E	01/88 ⇨ 12/91
CAMRY 2.5	2VZ-FE	10/86 ⇨ 06/91
MR 2 II 2.0 16V	3S-GE	12/89 ⇨ 09/99
MR 2 II 2.0 Turbo	3S-GTE	12/89 ⇨ 07/99
HILUX V 3.0 4WD	3VZ-E	08/89 ⇨ 11/95
LAND CRUISER 80 4.0	3F-E	01/90 ⇨ 10/92
TRUCK 3.0	3VZ-E	08/88 ⇨ 11/95
TRUCK 3.0 i [USA]	3VZ-E	01/88 ⇨ 12/90

KW 470 203



05

COILS

Adatt./Suitable:

BOSCH

F 00E 140 278

DENSO

029700-7050

029700-7051 *U

HITACHI

138868

2508868

LEXUS

90919-02197

90919-02208

MAGNETI MARELLI

060717123012

TOYOTA

19500-74040 *U

90919-02197

90919-02208

VW

J90 919 021 97

00 Supplied only the coil, not the mounting bracket, not the module

- Fornita solo la bobina, non la staffa di fissaggio, non il modulo
- Fourni seule la bobine, non pas le support de montage, et non pas le module
- nur die Spule geliefert wird, nicht die Montagehalterung, nicht das Modul
- Suministra sólo la bobina, no el soporte de montaje, no el módulo

03 Supplied until depletion

- Fornibile fino ad esaurimento delle scorte
- Fourni jusqu'à épuisement du stock
- Lieferbar solange vorrat reicht
- Suministrado hasta el stock termina



	ohm		ohm
	0,47	Ø 5	12000

LEXUS

GS 300	2JZ-GE	01/93 ⇨ 08/97
LS I 400	1UZ-FE	12/89 ⇨ 12/95
LS II 400	1UZ-FE	12/94 ⇨ 08/97
SC 400 4.0i	1UZFE	01/91 ⇨

TOYOTA

4 RUNNER 2.4	22RE	08/88 ⇨ 11/95
4 RUNNER 2.4 i [USA]	22RE	01/89 ⇨ 12/93
4 RUNNER 3.0	3VZ-E	08/88 ⇨ 11/95
4 RUNNER 3.0 [USA]	3VZ-E	01/88 ⇨ 12/91
CELICA V 2.0	3S-GE	09/89 ⇨ 01/94
CELICA V 2.0 4WD	3S-GTE	10/89 ⇨ 01/94
MR 2 II 2.0	3S-FE	12/89 ⇨ 08/92
MR 2 II 2.0 16V	3S-GE	12/89 ⇨ 09/99
MR 2 II 2.0 Turbo	3S-GTE	12/89 ⇨ 07/99
MR 2 II 2.2 16V	5S-FE	01/90 ⇨ 06/95
HILUX IV 2.4 4WD	22R	10/88 ⇨ 12/97
HILUX V 2.4 4WD	22R	10/88 ⇨ 08/97
HILUX V 2.4 i 4WD	22RE	01/89 ⇨ 07/97
HILUX V 3.0 4WD	3VZ-E	08/89 ⇨ 11/95
LITEACE 1.5	5K	01/92 ⇨ 01/95
SUPRA 3.0 i	2JZ-GE	05/93 ⇨ 07/02
T100 3.0 i [USA]	3VZE	08/92 ⇨ 08/94
TRUCK 2.4	22RE	08/88 ⇨ 11/95
TRUCK 2.4 i [USA]	22RE	01/92 ⇨
TRUCK 3.0	3VZ-E	08/88 ⇨ 11/95
TRUCK 3.0 i [USA]	3VZ-E	01/91 ⇨

VW

TARO 2.4 i 4x4 22R 06/89 ⇨ 03/97

KW 470 211



05

COILS

Adatt./Suitable:

HONDA
30520-PH7-006
30520-PH7-016

ROVER
GCL145
GCL146

00 Eliminated on 23-02-2022. Please verify the availability through our local distributors

- Eliminato il 23-02-2022. Verificare la disponibilità presso i nostri distributori
- Éliminé le 23-02-2022. Vérifier la disponibilité auprès de nos distributeurs sur place
- Am 23-02-2022 gestrichen. Evtl. Verfügbarkeit bitte bei unseren Händlern prüfen
- Eliminado en fecha 23-02-2022. Verificar la disponibilidad a través de nuestros distribuidores locales



	ohm		ohm
	0,88		12000
		Ø 8,2	

HONDA			
LEGEND I 2.7 i 24V	C27A1	10/87	⇒ 12/90
ROVER			
800 827 24V	C27A1	08/92	⇒ 02/99
800 827 24V I/SI Cat	C27A1	01/92	⇒ 02/99
800 827 SI/Sterling	82RZ-FE	02/88	⇒ 12/91
800 827 SI/Sterling Catalytic-Conv	C27A1	02/88	⇒ 02/99
800 827 Vitesse Catalytic-Conv	C27A1	10/88	⇒ 12/91
800 827 Vitesse/SLI	82RZ-FE	10/88	⇒ 12/91

KW 470 212



05

COILS

Adatt./Suitable:

ACURA
30500-PE0-006

BOSCH
F 00E 140 011
F 00E 140 012

HONDA
30500-PE0-006
30500-PH1-026

00 Eliminated on 17-02-2020. Please verify the availability through our local distributors

- Eliminato il 17-02-2020. Verificare la disponibilità presso i nostri distributori
- Éliminé le 17-02-2020. Vérifier la disponibilité auprès de nos distributeurs sur place
- Am 17-02-2020 gestrichen. Evtl. Verfügbarkeit bitte bei unseren Händlern prüfen
- Eliminado en fecha 17-02-2020. Verificar la disponibilidad a través de nuestros distribuidores locales



	ohm		ohm
	1,38		13000
		Ø 8,2	

ACURA			
INTEGRA I 1.6	D16A1	01/85	⇒ 12/90
INTEGRA I 1.6 i	D16A8	01/85	⇒ 12/90
HONDA			
CIVIC III 1.3 [USA]	--	01/85	⇒ 12/87
CIVIC III 1.5 i Si [USA]	--	01/84	⇒ 12/87

KW 470 213



05

COILS

Adatt./Suitable:

ACURA
30500-PM5-A02

HONDA
30500-PM5-A02
30500-PM5-A03

MAGNETI MARELLI
060717024012

ROVER
GCL161

03 Supplied until depletion

- Fornibile fino ad esaurimento delle scorte
- Fourni jusqu'à épuisement du stock
- Lieferbar solange vorrat reicht
- Suministrado hasta el stock termina



	ohm		ohm
	0,43		11500
		Ø 7	

ACURA			
INTEGRA I 1.6	D16A1	01/85	⇒ 12/90
INTEGRA I 1.6 i	D16A8	01/85	⇒ 12/90

HONDA

CIVIC IV 1.5 i 16V	D15B2	10/87	⇒ 09/91
CIVIC IV 1.6 16V 4x4	D16A6	11/87	⇒ 09/91
CIVIC IV 1.6 i 16V	D16A6, D16A9	09/87	⇒ 09/91
CIVIC IV 1.6 i 16V 4x4	D16A6	10/89	⇒ 09/91
CIVIC IV 1.6 i 16V	D16A7, D16A8, D16A9	01/88	⇒ 05/92
CIVIC IV 1.6 i 16V 4WD	D16A1, D16Z2	01/88	⇒ 12/91
CIVIC IV SHUTTLE 1.5 i 16V	D15B2	01/88	⇒ 11/91
CIVIC IV SHUTTLE 1.6 4x4	D16A, D16A7	01/88	⇒ 12/92
CIVIC IV SHUTTLE 1.6 i 16V 4WD	D16A6	01/88	⇒ 02/95
CIVIC IV SHUTTLE 1.6i	--	01/88	⇒ 12/91
CONCERTO 1.6 16V	D16Z2	08/89	⇒ 03/95
CONCERTO 1.6 i 16V	D16A8, D16Z2	08/89	⇒ 03/95
CONCERTO 1.6i DOHC	--	01/90	⇒ 12/91
CONCERTO 1.6i SOHC	--	01/90	⇒ 12/91
CRX II 1.6 i 16V	D16A9, D16Z5	10/87	⇒ 02/92

ROVER

200 II 216	D16A8	10/92	⇒ 06/99
200 II 216 1.6i	D16A8	01/92	⇒ 11/99
200 II 216 GSi	1GH5E-180, D16A7	10/89	⇒ 12/95
200 II 216 GTi	D16A8, D16A9	01/90	⇒ 10/95
400 I 416 GSi	1GH5E-180	04/90	⇒ 04/95
400 I 416 GSi/GSE	D16A7	04/90	⇒ 04/95
400 I 416 GTI	D16A8	04/90	⇒ 04/95
400 I 416 GTI/GTE	D16A9	04/90	⇒ 04/95

KW 470 214



05

COILS

Adatt./Suitable:

ACURA
30510-P73-A01
30510-PT2-006

BOSCH
F 000 Z50 116
F 00E 140 018

HITACHI
138812
2508812

HONDA
30510-P73-A01
30510-P73-A02
30510-PT2-006

MAGNETI MARELLI
060717022012

ROVER
GCL195
NEC100530

03 Supplied until depletion

- Fornibile fino ad esaurimento delle scorte
- Fourni jusqu'à épuisement du stock
- Lieferbar solange vorrat reicht
- Suministrado hasta el stock termina



	ohm		ohm
	0,83		18000
		M4 M4	

ACURA

INTEGRA II 1.8	F18A2	10/90	⇒ 09/93
INTEGRA III 1.8 GS-R	F18C2	10/93	⇒ 09/01
INTEGRA III 1.8 LS	F18C1	10/93	⇒ 09/01
INTEGRA III 1.8 Sport	F18C1	10/93	⇒ 09/01

HONDA

ACCORD IV 2.0 16V	F20A5	01/90	⇒ 12/93
ACCORD IV 2.0 i 16V	F20A4, F20A7, F20A8, F20Z3	01/90	⇒ 12/93
ACCORD IV 2.2	F22A6	05/92	⇒ 12/93
ACCORD IV 2.2 i 16V	F22A3, F22A7, F22A8	01/90	⇒ 12/93
ACCORD IV 2.2 i 16V Automatic	F22A3	01/90	⇒ 03/93
ACCORD V 1.8 16V	F18A3	01/94	⇒ 12/95
ACCORD V 2.0	F20B3	09/93	⇒ 12/97
ACCORD V 2.0 i	F20Z2	03/93	⇒ 01/96
ACCORD V 2.0 i LS 16V	F20B3	09/93	⇒ 02/98

HONDA		
ACCORD V 2.0 i S	F20Z1	03/93 ⇒ 01/96
ACCORD V 2.2 i 16V	F22B4	08/95 ⇒ 12/97
ACCORD V 2.2 i ES	F22B5	09/93 ⇒ 02/98
ACCORD V 2.3 i SR	H23A3	03/93 ⇒ 01/96
ACCORD VI 2.2 Type-R	H22A7	02/99 ⇒ 12/02
CIVIC V 1.5	D15B7	08/93 ⇒ 12/95
CIVIC V 1.5 i 16V	D15B2, D15Z1	10/91 ⇒ 11/95
CIVIC V 1.5 i LSi	D15B7	08/93 ⇒ 11/95
CIVIC V 1.6 16V Vtec	D16Z6, D16Z7	10/91 ⇒ 11/95
CIVIC V 1.6 4x4	D16Z7	01/92 ⇒ 10/95
CIVIC V 1.6 EX	D16A7	08/93 ⇒ 10/95
CIVIC V 1.6 i	D16Y7	01/94 ⇒ 11/95
CIVIC V 1.6 i Vtec	B16A2, D16Z9	01/94 ⇒ 03/96
CIVIC V 1.6 VTi	B16A2	10/91 ⇒ 11/95
CIVIC V 1.6 VTi 16V	B16A2	10/91 ⇒ 11/95
BALLADE 1.6i	B16A6	01/97 ⇒ 02/01
BALLADE 1.8 i	B18B4	01/96 ⇒ 02/01
CIVIC IV 1.6i	--	01/90 ⇒ 12/91
CIVIC VI 1.4 i	D14A2, D14A3, D14Z1, D14Z2, D14Z4	06/95 ⇒ 02/01
CIVIC VI 1.4 i S	D14A2, D14Z2, D14Z4	11/95 ⇒ 02/01
CIVIC VI 1.4i 16V	D14Z1	11/98 ⇒ 03/01
CIVIC VI 1.5	D15Z3	11/95 ⇒ 12/96
CIVIC VI 1.5 16V	D15Z6, D15Z8	01/97 ⇒ 02/01
CIVIC VI 1.5 i	D15Z6, D15Z8	11/95 ⇒ 02/01
CIVIC VI 1.5 i Vtec-E	D15Z3	09/94 ⇒ 01/97
CIVIC VI 1.6	--, D16Y2	10/95 ⇒ 03/01
CIVIC VI 1.6 16V	D16B2, D16W3	01/97 ⇒ 02/01
CIVIC VI 1.6 i	D16Y3	09/94 ⇒ 03/00
CIVIC VI 1.6 i Vtec	B16A2, D16Y2, D16Y8	09/94 ⇒ 02/01
CIVIC VI 1.6 VTi	B16A2	11/95 ⇒ 02/01
CIVIC VI 1.6i 16V	D16Y7	01/96 ⇒
CIVIC VI 1.6i 16V Vtec	D16Y8	01/96 ⇒ 09/99
CIVIC VI 1.8 16V	B18C4	01/97 ⇒ 02/01
CIVIC VI 1.8 i 16V VTi Vtec	D18C4	01/97 ⇒ 12/98
CR-V 1.2.0	B20Z1	04/99 ⇒ 02/02
CR-V 1.2.0 16V 4WD	B20B, B20B3, B20B9, B20Z1, B20Z3	10/95 ⇒ 02/02
CR-V 1.2.0 i 16V	B20B3, B20B4, B20B9, B20Z3	02/97 ⇒ 04/99
CRX III 1.6 Esi	D16Y8, D16Z6	03/92 ⇒ 12/98
CRX III 1.6 i VTi	B16A2	03/92 ⇒ 12/98
HR-V 1.6 16V	D16W1	03/99 ⇒
HR-V 1.6 16V 4WD	D16W1, D16W5	03/99 ⇒
HR-V 1.6i 16V	D16W2	04/99 ⇒
INTEGRA 1.8 i	B18B1, B18C3	01/98 ⇒
INTEGRA 1.8 Type-R	B18C6	11/97 ⇒ 10/01
LOGO 1.3	D13B7	03/99 ⇒ 03/02
PRELUDE IV 2.0 i 16V	F20A4	02/92 ⇒ 09/96
PRELUDE IV 2.2 i 16V Vtec	H22A2	02/93 ⇒ 09/96
PRELUDE IV 2.3 i 16V	H23A2	02/92 ⇒ 09/96
PRELUDE V 2.0 16V	F20A4	10/96 ⇒ 10/00
PRELUDE V 2.2 16V	H22A5, H22A8	10/96 ⇒ 10/00
PRELUDE V 2.2 i 16V	F22A2	10/96 ⇒ 10/01
PRELUDE V 2.2 i 16V VTi-R	H22A8	10/98 ⇒ 12/01
PRELUDE V 2.2 Si	F22Z6	03/97 ⇒ 07/02
SHUTTLE 2.2 16V	F22B8	10/94 ⇒ 02/98

ROVER		
400 II 416 Si	D16Y2, D16Y3, D16B2	03/95 ⇒ 03/00
600 618 i/Si	F18A3	03/96 ⇒ 02/99
600 620 i	F20Z2	08/93 ⇒ 06/96
600 620 Si	F20Z1	08/93 ⇒ 02/99
600 623 Si	H23A3	08/93 ⇒ 06/99

KW 470 215



05

COILS

Adatt./Suitable:

ACURA

30500-PR4-A02

BOSCH

F 00E 140 015

HONDA

30500-PR4-A02

MAGNETI MARELLI

060717023012

03 Supplied until depletion

- Fornibile fino ad esaurimento delle scorte
- Fourni jusqu'à épuisement du stock
- Lieferbar solange vorrat reicht
- Suministrado hasta el stock termina



		ohm			ohm
M4	-	0,69			11500
M4	+				

ACURA

INTEGRA II 1.8

F18A2

10/90 ⇒ 09/93

HONDA

CIVIC IV 1.5

D15B1

01/88 ⇒ 12/89

CIVIC IV 1.5 i 16V

D15B2

10/87 ⇒ 09/91

CIVIC IV 1.6 i 16V

D16Z2

10/87 ⇒ 09/91

CIVIC IV 1.6 i 16V 4x4

D16Z2

01/89 ⇒ 12/91

CIVIC IV 1.6i

--

01/90 ⇒ 12/91

CIVIC IV 1.6i 16V

D16A1

01/88 ⇒ 12/91

CIVIC IV SHUTTLE 1.5 i 16V

D15B2

01/88 ⇒ 11/91

CIVIC IV SHUTTLE 1.6i

--

01/88 ⇒ 12/91

CIVIC IV SHUTTLE 1.6i 16V

D16Z2

01/88 ⇒ 12/92

4WD

CIVIC V 1.5

D15B2

01/92 ⇒ 12/92

CONCERTO 1.5 i

--

01/90 ⇒ 12/91

CONCERTO 1.5 i 16V

D15B2

08/89 ⇒ 05/95

CRX II 1.6 i 16V Vtec

B16A1

10/89 ⇒ 02/92

KW 470 216

05

COILS

Adatt./Suitable:

HITACHI

CM1T-209B

CM1T-217

HONDA

30500-PO1-005

30500-PM3-005

30500-PM3-015

30500-PT0-005

00 Eliminated on 17-05-2021. Please verify the availability through our local distributors

- Eliminato il 17-05-2021. Verificare la disponibilità presso i nostri distributori
- Éliminé le 17-05-2021. Vérifier la disponibilité auprès de nos distributeurs sur place
- Am 17-05-2021 gestrichen. Evtl. Verfügbarkeit bitte bei unseren Händlern prüfen
- Eliminado en fecha 17-05-2021. Verificar la disponibilidad a través de nuestros distribuidores locales

		ohm			ohm
-	4.8	0,65			16000
+					

HONDA

ACCORD IV 1.8

--

01/90 ⇒ 12/91

ACCORD IV 2.0 16V

F20A2, F20A3, F20A6

01/90 ⇒ 03/93

CIVIC V 1.3

D13B2

01/92 ⇒ 12/92

CIVIC V 1.3 16V

D13B2

10/91 ⇒ 11/95

CIVIC IV 1.2

D12B1

01/88 ⇒ 12/91

CIVIC IV 1.3

D13B1

10/87 ⇒ 12/89

CIVIC IV 1.3 [USA]

--

09/87 ⇒ 12/89

CIVIC IV 1.3 16V Cat

D13B2

09/89 ⇒ 09/91

CIVIC IV 1.4 L

D14A1

10/87 ⇒ 12/89

CIVIC IV 1.4i 16V

D14A1

01/90 ⇒ 12/91

CIVIC IV 1.6 16V 4x4

D16A6

11/87 ⇒ 09/91

CIVIC IV 1.6i 16V

D16A6

10/87 ⇒ 09/91

CIVIC IV 1.6i 16V 4x4

D16A6

10/89 ⇒ 09/91

CIVIC IV 1.6i 16V 4WD

D16A1, D16Z2

01/88 ⇒ 12/91

CIVIC IV SHUTTLE 1.4 i 16V

D14A1

01/88 ⇒ 12/92

CIVIC IV SHUTTLE 1.6 i 16V

D16A6

01/88 ⇒ 02/95

4WD

CONCERTO 1.4

D14A1

08/89 ⇒ 10/92

CONCERTO 1.6i

D16A

01/90 ⇒ 12/91

1180

facet@facet.it

KW 470 219



05

COILS

Adatt./Suitable:

BOSCH

F 005 X03 219
F 00E 140 476

DAEWOO

96320818 *U
96336522 *U

DENSU

DIC-0116

GENERAL MOTORS

94 136 766

HITACHI

CM1T-205

HOLDEN

2243342L00
2243342L10

HYUNDAI

AA100-18100B *1

ISUZU

8-94136766-0

KIA

AA100-18-100B *1

MAGNETI MARELLI

060717106012

NISSAN

22433-18R10
22433-42L10

OPEL

42 94 029

*1 Without fastening clamp

- Senza staffa di fissaggio
- sans bride de fixation
- ohne Befestigungsbügel
- sin estribo de sujeción

*U Supplied only the coil, not the mounting bracket, not the module

- Fornita solo la bobina, non la staffa di fissaggio, non il modulo
- Fourni seule la bobine, non pas le support de montage, et non pas le module
- nur die Spule geliefert wird, nicht die Montagehalterung, nicht das Modul
- Suministra sólo la bobina, no el soporte de montaje, no el módulo

*3 Supplied until depletion

- Fornibile fino ad esaurimento delle scorte
- Fourni jusqu'à épuisement du stock
- Lieferbar solange vorrat reicht
- Suministrado hasta el stock termina

*245 without fastening clamp

- senza staffa fissaggio
- sans bride de fixation
- ohne Befestigungsbügel
- sin estribo de sujeción



	ohm		ohm
6.4	1,2	Ø 8.2	9300

CHEVROLET

SPARK I 0.8 F8CV 09/00 ⇨ 12/06

DAEWOO

MATIZ 0.8 F8CV 08/98 ⇨

HOLDEN

CALAIS 3.0 Executive -- 10/88 ⇨ 09/90

CALAIS_VL 2.0i 2.0PFI 01/86 ⇨ 07/88

CALAIS_VL 3.0i Turbo 3.0EFITURBO 01/86 ⇨ 07/88

COMMODORE 3.0 EFi 255263088 03/86 ⇨ 09/88

COMMODORE 3.0 EFi Turbo RB30ET 01/86 ⇨ 08/88

COMMODORE_VL 2.0i 2.0PFI 01/86 ⇨ 07/88

COMMODORE_VL 2.0i Wagon 2.0PFI 01/86 ⇨ 07/88

ISUZU

AMIGO 2.3i [USA] LW3 01/88 ⇨

PICK-UP 2.3i [USA] LW3 01/88 ⇨

TROOPER 2.3 4ZD1 11/85 ⇨ 12/91

KIA

TOWNER 0.8 Gasoline -- 10/97 ⇨

OPEL

MIDI 2.0 i 20PET 09/92 ⇨ 08/94

MIDI 2.0 i 4x4 20PET 09/92 ⇨ 08/94

KW 470 228



07

COILS

Adatt./Suitable:

BOSCH

9 220 081 505

HITACHI

138735
2508735

MAGNETI MARELLI

060705409010

060717020012

607 054 09

BAE 504 L

RENAULT

77 00 749 450

*3 Supplied until depletion

- Fornibile fino ad esaurimento delle scorte
- Fourni jusqu'à épuisement du stock
- Lieferbar solange vorrat reicht
- Suministrado hasta el stock termina

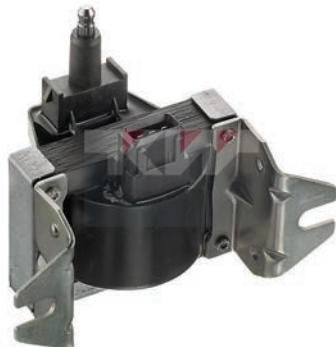

	ohm		ohm
	0,47	Ø 6.3	5000

RENAULT

19 II 1.8 8NA20S, F3P708 04/92 ⇨ 06/96

CLIO I 1.2 C3G720 06/94 ⇨ 02/98

EXPRESS 1.2 C3G710, C3G712 07/95 ⇨ 10/99

EXPRESS 1.4i C3G/C3J 01/85 ⇨ 10/90

RAPID 1.2 C3G710, C3G712 09/91 ⇨ 03/98

TWINGO I 1.2 C3G700, C3G702 03/93 ⇨ 10/96

KW 470 233



05

COILS

Adatt./Suitable:

BOSCH

F 00E 140 248

FORD

F1CZ-12029-A

MAZDA

B6S7-18-10XA

B6S8-18-10XA

Motorcraft

DGE-447

*3 Supplied until depletion

- Fornibile fino ad esaurimento delle scorte
- Fourni jusqu'à épuisement du stock
- Lieferbar solange vorrat reicht
- Suministrado hasta el stock termina

*246 with fastening clamp

- con staffa fissaggio
- avec bride de fixation/boulon en U/étrier
- mit Befestigungsbügel
- con estribo de sujeción



	ohm		ohm
	1	Ø 8.2	14500

MAZDA

323 VI C 1.6 B6E 09/89 ⇨ 06/91

323 VI C 1.6 16V B6 03/91 ⇨ 10/94

323 VI F 1.6 B6E 09/89 ⇨ 06/91

323 VI F 1.6 16V B6 03/91 ⇨ 10/94

323 VI F 1.8 16V BP 08/89 ⇨ 07/94

323 VI F 1.8 16V GT BP(DOHC) 08/89 ⇨ 07/94

323 VI F 1.8i 16v GRSi BP31 06/89 ⇨ 03/91

323 VI S 1.3 16V B3(16V) 04/91 ⇨ 07/94

323 VI S 1.6 B6E 09/89 ⇨ 06/91

323 VI S 1.6 16V B6 08/89 ⇨ 10/96

323 VI S 1.8 16V BP52 08/89 ⇨ 07/94

323 VI S 1.8 16V 4WD BP52 09/91 ⇨ 07/94

323 VI S 1.8 16V Turbo 4WD BPTurbo 01/91 ⇨ 07/94

323 VI 1.3 16V B384, B386, B387 06/89 ⇨ 03/91

323 VI 1.8i 16v 4x4 BP51 06/89 ⇨ 03/91

323 VI 1.8i 16v GRSi BP22 06/89 ⇨ 03/91

323 VI 1.8i 16v GT Formula 4 BP55 04/91 ⇨ 04/94

323 VI 1.8i 16v GT-R BP5J 04/91 ⇨ 04/94

Formula 4

323 VI 1.8i 16v Turbo 4x4 BP55 06/89 ⇨ 03/91

MX-3 1.6 B69 05/91 ⇨ 10/93

PROTEGE 1.8i DOHC [USA] -- 01/90 ⇨

PROTEGE 1.8i OHC [USA] -- 01/90 ⇨

KW 470 252



05

COILS

Adatt./Suitable:

DAIHATSU

90048-52072-000
90048-52095-000**00 Eliminated on 09-09-2019. Please verify the availability through our local distributors**

- Eliminato il 09-09-2019. Verificare la disponibilità presso i nostri distributori
- Éliminé le 09-09-2019. Vérifier la disponibilité auprès de nos distributeurs sur place
- Am 09-09-2019 gestrichen. Evtl. Verfügbarkeit bitte bei unseren Händlern prüfen
- Eliminado en fecha 09-09-2019. Verificar la disponibilidad a través de nuestros distribuidores locales

240 with fastening clamp

- con staffa fissaggio
- avec bride de fixation/boulon en U/étrier
- mit Befestigungsbügel
- con estribo de sujeción



	ohm		ohm
	1,5		25500

DAIHATSU

CHARADE III 1.0i	G102	01/88 ⇒
CHARADE III 1.3	HC-C	09/88 ⇒ 02/93
CHARADE III 1.3 i	HC-E	06/88 ⇒ 12/92
CHARADE III 1.3 i 4WD	HC-E	06/88 ⇒ 01/93
HJET II 1.3 i 16V	HC-E	05/98 ⇒ 10/05

KW 470 265



05

COILS

Adatt./Suitable:

HITACHI

CM12-100

SUBARU

22433-AA230
22433-AA360

	ohm		ohm
	0,78		14000

SUBARU

IMPREZA I 1.6	EJ16E	01/93 ⇒ 12/00
IMPREZA I 1.6 i	8F140GA	08/92 ⇒ 12/00

SUBARU

IMPREZA I 1.6 i AWD	8F140GA	08/92 ⇒ 12/00
IMPREZA I 1.8	EJ18	01/93 ⇒ 10/95
IMPREZA I 1.8 i	EJ18E	11/95 ⇒ 06/96
IMPREZA I 1.8 i AWD	EJ18, EJ18E	08/92 ⇒ 12/00
LEGACY I 2.0	EJ20E	08/91 ⇒ 12/93
LEGACY I 2.0i 16V	EJ20E	08/91 ⇒ 12/93
LEGACY I 2.2i	--	01/90 ⇒
LEGACY I 2.2i [USA]	--	01/90 ⇒
LEGACY I 2.2i 16v	EJ22E	08/89 ⇒ 10/91
LEGACY I 2.2i Turbo [USA]	--	01/90 ⇒
LEGACY I 2000	EJ20EMPI	09/91 ⇒ 12/93
LEGACY I 2000 4WD	EJ20EMPI	08/91 ⇒ 07/94
LEGACY I 2200 4WD	EJ22EMPI	01/89 ⇒ 07/94
LEGACY I 2200 Super 4WD	EJ22EMPI	01/89 ⇒ 07/94
LEGACY II 1.8 4WD	EJ18E	05/96 ⇒ 09/98

KW 470 266



05

COILS

Adatt./Suitable:

HITACHI

138737
2508737

SUBARU

22433-AA240
22433-AA370

	ohm		ohm
	0,78		20000

SUBARU

IMPREZA I 2.0	EJ20E	09/96 ⇒ 08/98
IMPREZA I 2.0 AWD	EJ20E	12/95 ⇒ 12/00
IMPREZA I 2.0 i	EJ20E	11/95 ⇒ 09/00
IMPREZA I 2.0 i AWD	EJ20	10/95 ⇒ 12/00
IMPREZA I 2.0 i Turbo AWD	EJ20(Turbo)	03/94 ⇒ 12/00
IMPREZA I 2.0 Turbo AWD	EJ20G	12/96 ⇒ 12/00
IMPREZA I 2.0 Turbo GT AWD	EJ20(Turbo)	03/94 ⇒ 12/00
IMPREZA I 2.2 i	EJ22E	11/93 ⇒ 08/98
LEGACY II 2.0 i	EJ20EMPI	09/94 ⇒ 03/99
LEGACY II 2.0 i 4WD	EJ201, EJ20E	09/94 ⇒ 03/99
LEGACY II 2.2	2LF479Q3	07/94 ⇒ 11/98
LEGACY II 2.2 i 4WD	EJ22EMPI	02/94 ⇒ 03/99
LEGACY II 2.5	EJ25D	01/96 ⇒ 12/99
LEGACY II 2.5 i 4WD	EJ25D	06/96 ⇒ 03/99
LEGACY I 2.2i	--	01/90 ⇒
LEGACY I 2.2i [USA]	--	01/90 ⇒
LEGACY I 2.2i Turbo [USA]	--	01/90 ⇒

KW 470 269



05

COILS

Adatt./Suitable:

BOSCH

1 227 030 051
1 227 030 052

MAGNETI MARELLI

060717006012

VW

357 905 105

03 Supplied until depletion

- Fornibile fino ad esaurimento delle scorte
- Fourni jusqu'à épuisement du stock
- Lieferbar solange vorrat reicht
- Suministrado hasta el stock termina



	ohm		ohm
	0,47		8500

VW

CORRADO 2.9 VR6	ABV	08/91 ⇒ 12/95
GOLF III 2.8 VR6	AAA	01/92 ⇒ 09/97
PASSAT III 2.8 VR6	AAA	06/91 ⇒ 05/97
VENTO 2.8 VR6	AAA	01/92 ⇒ 09/98

KW 470 272



07

COILS

Adatt./Suitable:

BOSCH

0 221 503 700
0 986 221 093

DUCELLIER

2 526 055 A

GENERAL MOTORS

90 458 250

HITACHI

138762
2508762

HOLDEN

90458250

MAGNETI MARELLI

060717044012

OPEL

12 08 071
90458250

SAGEM

2 526 055 A

SIEMENS

5WK 90611

VAUXHALL

90458250

03 Supplied until depletion

- Fornibile fino ad esaurimento delle scorte
- Fourni jusqu'à épuisement du stock
- Lieferbar solange vorrat reicht
- Suministrado hasta el stock termina



	ohm		ohm
	0,7	∅ 4	9000

HOLDEN

ASTRA TR 1.8i 16v Hatchback	C18SEL	09/96 ⇒ 09/98
ASTRA TR 1.8i 16v Sedan	C18SEL	09/96 ⇒ 09/98
ASTRA TR 2.0i 16v Hatchback	X20XEV	09/96 ⇒ 09/98
CALIBRA YE 2.0i 16V	X20XEV	08/95 ⇒ 10/97

OPEL

ASTRA F 1.8	Z18XEL	02/03 ⇒ 07/04
ASTRA F 1.8i 16V	C18SEL, C18XE, C18XEL, X18XE	06/93 ⇒ 03/01
ASTRA F 2.0i 16V	X20XER, X20XEV	02/95 ⇒ 08/00
ASTRA G 2.0 16V	X20XEV	02/98 ⇒ 01/05
ASTRA G 2.0 16V OPC	X20XER	11/99 ⇒ 09/02
CALIBRA A 2.0i 16V	X20XEV	02/94 ⇒ 07/97
CALIBRA A 2.0i 16V 4x4	X20XEV	02/94 ⇒ 07/97
OMEGA B 2.0 16V	X20XEV	03/94 ⇒ 09/99
VECTRA 2.0	C20SEL	10/95 ⇒ 04/02
VECTRA A 2.0i 16V	X20XEV	08/92 ⇒ 08/95
VECTRA A 2.0i 16V 4x4	X20XEV	06/94 ⇒ 11/95
VECTRA B 1.8 FlexFuel	X18XE	01/99 ⇒ 09/00
VECTRA B 1.8i 16V	X18XE	10/95 ⇒ 09/00
VECTRA B 2.0i 16V	C20SEL, X20XEV	09/95 ⇒ 07/03
VECTRA B 2.2i 16V	C22SEL	07/00 ⇒ 07/02

VAUXHALL

ASTRA III 1.8	C18XE	09/94 ⇒ 08/96
ASTRA III 1.8 16V	C18XEL, X18XE	11/94 ⇒ 03/01
ASTRA III 1.8i 16V	C18XE, C18XEL, X18XE	06/93 ⇒ 02/98
ASTRA III 2.0i 16V	X20XEV	01/94 ⇒ 09/98
ASTRA IV 2.0	X20XER	10/99 ⇒ 08/00
ASTRA IV 2.0 16V	X20XEV	02/98 ⇒ 05/05
CALIBRA 2.0i 16V	X20XEV	06/90 ⇒ 07/97
CALIBRA 2.0i 16V 4x4	X20XEV	02/94 ⇒ 07/97
OMEGA B 2.0 16V	X20XEV	03/94 ⇒ 07/01
VECTRA B 1.8i 16V	X18XE	09/95 ⇒ 09/00
VECTRA B 2.0 Dualfuel	X20XEV	05/98 ⇒ 01/01
VECTRA B 2.0i 16V	X20XEV	10/95 ⇒ 01/01

KW 470 273



07

COILS

Adatt./Suitable:

BOSCH

0 221 503 001

GENERAL MOTORS

90 443 900

HITACHI

138790
2508790

HOLDEN

90443900

MAGNETI MARELLI

060717066012

OPEL

12 08 065
90443900
90449572

00 Eliminated on 23-02-2022. Please verify the availability through our local distributors

- Eliminato il 23-02-2022. Verificare la disponibilità presso i nostri distributori
- Éliminé le 23-02-2022. Vérifier la disponibilité auprès de nos distributeurs sur place
- Am 23-02-2022 gestrichen. Evtl. Verfügbarkeit bitte bei unseren Händlern prüfen
- Eliminado en fecha 23-02-2022. Verificar la disponibilidad a través de nuestros distribuidores locales



	ohm		ohm
	0,5	∅ 4	13000

HOLDEN

CALIBRA YE 2.0i 16V	C20XE	09/91 ⇒ 07/95
FRONTERA UT 2.0i	X20SE	10/95 ⇒ 03/99

OPEL

ASTRA F 2.0 GSI 16V	C20XE	09/91 ⇒ 01/98
ASTRA F 2.0i 16V	C20XE	03/93 ⇒ 01/98
CALIBRA A 2.0i 16V	C20XE	06/90 ⇒ 02/94
CALIBRA A 2.0i 16V 4x4	C20XE	06/90 ⇒ 02/94
FRONTERA A 2.0i	X20SE	03/92 ⇒ 10/98
FRONTERA A 2.2i	X22XE	03/95 ⇒ 10/98
OMEGA B 2.0	X20SE	03/94 ⇒ 09/99
VECTRA B 2.0i	Z0NEJ	10/95 ⇒ 04/02

VAUXHALL

ASTRA III 2.0i 16V	C20XE	09/91 ⇒ 02/98
CALIBRA 2.0i 16V	C20XE	06/90 ⇒ 02/94
CALIBRA 2.0i 16V 4x4	C20XE	06/90 ⇒ 02/94
FRONTERA A 2.0	X20SE	04/95 ⇒ 08/98
FRONTERA A 2.0i	X20SE	03/92 ⇒ 10/98
FRONTERA A 2.2i	X22XE	03/95 ⇒ 10/98
OMEGA B 2.0	X20SE	03/94 ⇒ 09/99
VECTRA B 2.0i	Z0NEJ	10/95 ⇒ 03/02

KW 470 275



05

COILS

Adatt./Suitable:

BOSCH

0 986 221 089

HITACHI

138736
2508736

MAGNETI MARELLI

060717070012

607 081 38

RENAULT

77 00 854 306

77 00 872 265



	ohm		ohm
	0,73	∅ 6.3	8000

RENAULT

Z1 2.0 Turbo	J7R756	02/90 ⇒ 10/92
Z1 2.0 Turbo 4x4	J7R756	02/90 ⇒ 10/92
ESPACE III 2.0	F3R728, F3R729, F3R768, F3R769	11/96 ⇒ 10/00
ESPACE III 3.0	Z7X775	11/96 ⇒ 10/98
LAGUNA I 1.8	F3P670, F3P674, F3P676, F3P678	06/95 ⇒ 03/01
LAGUNA I 2.0	..., F3R611, F3R728, F3R729, F3R768	11/93 ⇒ 03/01
LAGUNA I 3.0	Z7X760, Z7X765, Z7X767	11/93 ⇒ 03/01
MEGANE I 2.0	F3R262, F3R264, F3R750, F3R751, F3R752, F3R796, F3R797, F3R798	01/97 ⇒ 08/03
MEGANE I 2.0i	F3R750, F3R751, F3R752, F3R791, F3R796, F3R797, F3R798	01/96 ⇒ 08/03
MEGANE I 2.0 RT	F3R752	10/96 ⇒ 02/99
MEGANE SCÉNIC I 2.0 RXE 4x4	F3R750	05/97 ⇒ 10/99
SCÉNIC I 2.0	F3R791, F3R797, F3R798	09/99 ⇒ 08/03

KW 470 276



05

COILS

Adatt./Suitable:

MAGNETI MARELLI607 081 54
BAE 801 BK**RENAULT**77 00 854 307
77 00 872 692**00 Eliminated on 22-02-2021. Please verify the availability through our local distributors**

- Eliminato il 22-02-2021. Verificare la disponibilità presso i nostri distributori
- Éliminé le 22-02-2021. Vérifier la disponibilité auprès de nos distributeurs sur place
- Am 22-02-2021 gestrichen. Evtl. Verfügbarkeit bitte bei unseren Händlern prüfen
- Eliminado en fecha 22-02-2021. Verificar la disponibilidad a través de nuestros distribuidores locales



	ohm		ohm
	0,73	Ø 6,3	8000

RENAULT

21 2.0 Turbo	J7R756	02/90 ⇒ 10/92
21 2.0 Turbo 4x4	J7R756	02/90 ⇒ 10/92
ESPACE III 3.0	Z7X775	11/96 ⇒ 10/98
LAGUNA I 3.0	Z7X760, Z7X765, Z7X767	11/93 ⇒ 03/01

KW 470 285



07

COILS

Adatt./Suitable:

00 Eliminated on 09-09-2019. Please verify the availability through our local distributors

- Eliminato il 09-09-2019. Verificare la disponibilità presso i nostri distributori
- Éliminé le 09-09-2019. Vérifier la disponibilité auprès de nos distributeurs sur place
- Am 09-09-2019 gestrichen. Evtl. Verfügbarkeit bitte bei unseren Händlern prüfen
- Eliminado en fecha 09-09-2019. Verificar la disponibilidad a través de nuestros distribuidores locales



	ohm		ohm
	0,5	Ø 5	12500

KW 470 285S



05

COILS

Adatt./Suitable:

BOSCH

F 000 Z50 117

DENSO

029700-7700

TOYOTA

19070-74170

19080-66010

19500-74090

19500-74091

19500-74100

19500-74120

90919-02209

***U Supplied only the coil, not the mounting bracket, not the module**

- Fornita solo la bobina, non la staffa di fissaggio, non il modulo
- Fourni seule la bobine, non pas le support de montage, et non pas le module
- nur die Spule geliefert wird, nicht die Montagehalterung, nicht das Modul
- Suministra sólo la bobina, no el soporte de montaje, no el módulo



	ohm		ohm
	0,5	Ø 5	12500

TOYOTA

CARINA E 1.6	4A-FE	04/92 ⇒ 09/97
CARINA E 1.6 16V	4A-FE	12/94 ⇒ 09/97
CARINA E 1.6 GLI	4A-FE	04/92 ⇒ 09/97
CARINA E 1.6 i	4A-FE	02/95 ⇒ 09/97
CELICA V 2.2	5S-FE	10/89 ⇒ 12/94
CELICA VI 2.0 GTi	3S-GE	08/94 ⇒ 08/99
CELICA VI 2.0 i 16V	3S-GE	11/93 ⇒ 11/99
CELICA VI 2.0 i Turbo 4WD	3S-GTE	02/94 ⇒ 11/99
CELICA VI 2.2 GT	5S-FE	11/93 ⇒ 08/99
FUNCRUISER 2.0 i 16V 4WD	3SFE	04/94 ⇒
LAND CRUISER 80 4.5	1FZ-FE	08/92 ⇒ 01/98
LAND CRUISER 80 4.5 24V	1FZ-FE	08/92 ⇒ 12/97
RAV 4 1 2.0	3S-FE	06/97 ⇒ 09/99
RAV 4 1 2.0 4WD	3S-FE	01/94 ⇒ 06/00

KW 470 289



07,5

COILS

Adatt./Suitable:

BOSCH

F 005 X11 773

DENSO

029700-6770

029700-6780

029700-7531

FORD

6 383 157

90TF-12029A-1A

E9DF-12029-AA

E9DZ-12029-A

F0TZ-12029-A

F57U-12029-AA

F57Z-12029-A

F82U-12029-AA

FORD USA

6 383 157

F0TZ-12029-A

MAGNETI MARELLI

060717047012

MAZDA

KLG4-18-100A

ZZL0-18-100

ZZM7-18-100

Motorcraft

DG 438

DG 459

DGE-446

00 Eliminated on 23-02-2022. Please verify the availability through our local distributors

- Eliminato il 23-02-2022. Verificare la disponibilità presso i nostri distributori
- Éliminé le 23-02-2022. Vérifier la disponibilité auprès de nos distributeurs sur place
- Am 23-02-2022 gestrichen. Evtl. Verfügbarkeit bitte bei unseren Händlern prüfen
- Eliminado en fecha 23-02-2022. Verificar la disponibilidad a través de nuestros distribuidores locales



	ohm		ohm
	0,5	Ø 7	13000

FORD

ENDEAVOUR 4.0 EFI V6	--	11/03 ⇒
EVEREST 4.0 EFI V6	--	11/03 ⇒
RANGER IV 4.0	--	10/05 ⇒ 06/06
RANGER IV 4.0 4x4	--	10/05 ⇒ 06/06

FORD USA

EXPLORER 4.0 V6 4WD	--	01/93 ⇒ 12/01
MUSTANG 4.0 V6	--	12/04 ⇒ 12/10

MAZDA

NAVAJO 4.0i [USA]	--	01/91 ⇒
-------------------	----	---------

KW 470 296



05

COILS

Adatt./Suitable:

BOSCH

F 00E 140 024

NISSAN



22433-1E400

22448-1E400

⁰³ Supplied until depletion

- Fornibile fino ad esaurimento delle scorte
- Fourni jusqu'à épuisement du stock
- Lieferbar solange vorrat reicht
- Suministrado hasta el stock termina



	ohm		ohm
	1		14500

NISSAN

ALTIMA 2.4	KA24DE	06/93 ⇨ 09/01
STANZA 2.4i [USA]	KA24DE	01/92 ⇨

KW 470 299



08

COILS

Adatt./Suitable:

BOSCH

F 000 Z50 212

FORD

6 823 318

6 860 288

MAGNETI MARELLI

060717036012

MAZDA

1E05-18-100

1E05-18-100A



⁰⁰ Eliminated on 23-02-2022. Please verify the availability through our local distributors

- Eliminato il 23-02-2022. Verificare la disponibilità presso i nostri distributori
- Éliminé le 23-02-2022. Vérifier la disponibilité auprès de nos distributeurs sur place
- Am 23-02-2022 gestrichen. Evtl. Verfügbarkeit bitte bei unseren Händlern prüfen
- Eliminado en fecha 23-02-2022. Verificar la disponibilidad a través de nuestros distribuidores locales

²⁴⁰ with fastening clamp

- con staffa fissaggio
- avec bride de fixation/boulon en U/étrier
- mit Befestigungsbügel
- con estribo de sujeción



	ohm		ohm
	0,5		13000

FORD

ESCORT V 1.6 16V XR3i	L1E	12/92 ⇨ 01/95
ESCORT V 1.6 i 16V	L1E, L1H, L1K	09/92 ⇨ 01/95
ESCORT V 1.8 16V	RDA	02/92 ⇨ 01/95
ESCORT V 1.8 16V XR3i	99BFR1740, RDA	02/92 ⇨ 01/95
ESCORT V 1.8 i 16V	99BFR1740	09/92 ⇨ 01/95
ESCORT V 1.8 XR3i 16V 4x4	99BFR1740, RDA	08/93 ⇨ 01/95
FIESTA III 1.6 i 16V	L1G	01/94 ⇨ 12/95
FIESTA III 1.8 16V	RDB	02/92 ⇨ 12/95
FIESTA III 1.8 XR2i 16V	RQC	02/92 ⇨ 12/95
MONDEO I 1.6 i 16V	L1F, L1J	02/93 ⇨ 08/96
MONDEO I 1.8 4x4	RKA	02/93 ⇨ 08/96
MONDEO I 1.8 i 16V	RKA, RKB	02/93 ⇨ 08/96
MONDEO I 1.8 i 16V 4x4	RKA	02/93 ⇨ 08/96
MONDEO I 2.0 i 16V	NGA	01/93 ⇨ 08/96
MONDEO I 2.0 i 16V 4x4	NGA	02/93 ⇨ 08/96
ORION II 1.6 i 16V	L1E, L1K	07/92 ⇨ 12/93
ORION II 1.8 i 16V	99BFR1740, RDA	01/92 ⇨ 12/93

MAZDA

121 III 1.25	1E05, DHF, DHG	03/96 ⇨ 04/03
--------------	----------------	---------------

KW 470 299S



07

COILS

Adatt./Suitable:

BOSCH

F 000 Z50 212

FORD

5 008 193

6 860 289

928F-12029-CB

938F-12024-DA

F5RZ-12029-C

FORD AUSTRALIA

938F-12024-DA

MAZDA

1E06-18-100

Motorcraft

DG 458



⁰⁰ Eliminated on 23-02-2022. Please verify the availability through our local distributors

- Eliminato il 23-02-2022. Verificare la disponibilità presso i nostri distributori
- Éliminé le 23-02-2022. Vérifier la disponibilité auprès de nos distributeurs sur place
- Am 23-02-2022 gestrichen. Evtl. Verfügbarkeit bitte bei unseren Händlern prüfen
- Eliminado en fecha 23-02-2022. Verificar la disponibilidad a través de nuestros distribuidores locales

²⁴⁵ without fastening clamp

- senza staffa fissaggio
- sans bride de fixation
- ohne Befestigungsbügel
- sin estribo de sujeción



	ohm		ohm
	0,5		13000

FORD

FIESTA IV 1.25 i 16V	DHA, DHB, DHC, DHD, DHE, DHF, DHG	08/95 ⇨ 01/02
FIESTA 1.2	DHA, DHB, DHC, DHD, DHF, DHG	01/96 ⇨ 04/02
PUMA 1.4 16V	FHD, FHF	11/97 ⇨ 10/00
PUMA 1.7 16V	MHA, MHB	03/97 ⇨ 06/02
PUMA Racing ST 160	MHA	06/99 ⇨ 06/02

KW 470 312



07

COILS

Adatt./Suitable:

FORD

F1VU-12029A-1A
F1VY-12029-A
F50U-12029-AA
F50U-12029-BA
F50Y-12029-A
F50Y-12029-B

MAGNETI MARELLI

060801006010
BAE 680 D

Motorcraft

DG 449
DG 460
DG 461

00 Eliminated on 22-02-2021. Please verify the availability through our local distributors

• Eliminato il 22-02-2021. Verificare la disponibilità presso i nostri distributori

• Éliminé le 22-02-2021. Vérifier la disponibilité auprès de nos distributeurs sur place

• Am 22-02-2021 gestrichen. Evtl. Verfügbarkeit bitte bei unseren Händlern prüfen

• Eliminado en fecha 22-02-2021. Verificar la disponibilidad a través de nuestros distribuidores locales

1187 Without ignition firing nrs., it can be used in the place of:

• Senza numeri dell'ordine d'accensione, può sostituire:

• Sans nos. de sequence d'allumage, peut être utilisé au lieu:

• Ohne Zündfolge-Nr. verwendbar als Ersatz von:
• Sin nos. de secuencia de ignición puede utilizarse en lugar:

470 135



	ohm		ohm
	0,5	Ø 7	13000

FORD

ESCORT III 1.4 i	F6B, F6D, FUC	02/86 ⇒ 07/90
ORION I 1.4	FUA	12/85 ⇒ 07/90
ORION II 1.3	J4B, J6A	07/90 ⇒ 12/93
ORION II 1.4	F6F, F6G, FUH	07/90 ⇒ 12/93
ORION II 1.6	LUJ, LUK	07/90 ⇒ 12/92
ORION II 1.6 i	LJF	07/90 ⇒ 09/92
ORION II 1.6 i 16V	L1E, L1K	07/92 ⇒ 12/93
ORION II 1.8 i 16V	99BFR1740, RDA	01/92 ⇒ 12/93
SIERRA II 1.6 i	L6B	10/89 ⇒ 02/93
SIERRA II 1.8	R2C, R6A	05/88 ⇒ 02/93

MAZDA

121 III 1.25	DHF, DHG	03/96 ⇒ 04/03
626 VI 2.0	FS	05/97 ⇒ 10/02

KW 470 313



07

COILS

Adatt./Suitable:

ALFA ROMEO

60562701
60810690

BOSCH

0 221 504 456

FIAT

60562701
60810690

IVECO

8024220

LANCIA

60562701
60810690

00 Eliminated on 09-04-2019. Please verify the availability through our local distributors

• Eliminato il 09-04-2019. Verificare la disponibilità presso i nostri distributori

• Éliminé le 09-04-2019. Vérifier la disponibilité auprès de nos distributeurs sur place

• Am 09-04-2019 gestrichen. Evtl. Verfügbarkeit bitte bei unseren Händlern prüfen

• Eliminado en fecha 09-04-2019. Verificar la disponibilidad a través de nuestros distribuidores locales



	ohm		ohm	
	0,52		...	

KW 470 314



07,5

COILS

Adatt./Suitable:

BOSCH

0 221 504 006

FIAT

46403328

HITACHI

133865
2503865

LANCIA

46403328

MAGNETI MARELLI

060810245010

03 Supplied until depletion

• Fornibile fino ad esaurimento delle scorte

• Fourni jusqu'à épuisement du stock

• Lieferbar solange vorrat reicht

• Suministrado hasta el stock termina



	ohm		ohm	
	0,45		...	

FIAT

BRAVO I 2.0 HGT 20V 182A1.000 10/95 ⇒ 07/98

COUPE 2.0 20V 182A1.000 08/96 ⇒ 09/98

COUPE 2.0 20V Turbo 175A3.000 08/96 ⇒ 08/00

MAREA 2.0 150 20V 182A1.000 09/96 ⇒ 04/99

MAREA 2.0i 20v [BRA] 182A1.011 10/96 ⇒ 04/99

FIAT (BR)

MAREA 2.0i 20v 2.0Mpi 01/99 ⇒ 12/00

LANCIA

KAPPA 2.0 20V 838A1.000, 838A6.000 10/94 ⇒ 10/01

KAPPA 2.0 20V Turbo 175A3.000 06/98 ⇒ 10/01

KAPPA 2.4 20V 838A2.000, 838A2.027 08/94 ⇒ 10/01

FORD

FIESTA III 1.1	G6A, GUD, GUE	03/89 ⇒ 12/95
FIESTA III 1.3	J6B	03/89 ⇒ 02/96
FIESTA III 1.3 Cat	J6B	05/91 ⇒ 01/97
FIESTA III 1.4	F6E, FUG, FUJ	03/89 ⇒ 12/95
FIESTA III 1.4 Cat	F4A	03/89 ⇒ 12/95
FIESTA III 1.6	LUH	01/89 ⇒ 01/94
FIESTA III 1.6 i 16V	L1G	01/94 ⇒ 12/95
FIESTA III 1.6 Turbo	LHA	03/90 ⇒ 10/92
FIESTA III 1.6 XR2i	LJC, LJD	03/89 ⇒ 01/94
FIESTA III 1.8 16V	RDB	02/92 ⇒ 12/95
FIESTA III 1.8 XR2i 16V	RQC	02/92 ⇒ 12/95
ESCORT IV 1.3	JBA	07/88 ⇒ 12/94
ESCORT IV 1.4	F6B, F6D, F6F, F6G, FUA, FUC	01/86 ⇒ 12/94
ESCORT IV 1.6	LUG	04/89 ⇒ 07/90
ESCORT IV 1.6 i	L4B	01/86 ⇒ 07/90
ESCORT IV 1.6 Turbo RS	LNB	01/86 ⇒ 07/90
ESCORT IV 1.6 XR3i	LR2, LRB	01/86 ⇒ 07/90
ESCORT V 1.3	J4B, J6A	07/90 ⇒ 01/95
ESCORT V 1.4	F4B, F6F, F6G, FUH	07/90 ⇒ 01/95
ESCORT V 1.4 i	F4B	07/93 ⇒ 01/95
ESCORT V 1.6	LJF, LUJ, LUK	07/90 ⇒ 08/93
ESCORT V 1.6 16V XR3i	L1E	12/92 ⇒ 01/95
ESCORT V 1.6 i 16V	L1E, L1H, L1K	09/92 ⇒ 01/95
ESCORT V 1.8 16V XR3i	99BFR1740	09/92 ⇒ 01/95
ESCORT V 1.8 i 16V	99BFR1740	09/92 ⇒ 01/95
ESCORT V 1.8 XR3i 16V 4x4	99BFR1740	08/93 ⇒ 01/95
ESCORT VI 1.3	J6A	01/95 ⇒ 02/99
ESCORT VI 1.4	F4B	01/95 ⇒ 02/99
FIESTA II 1.4	F6A, F6C	10/86 ⇒ 02/89
FIESTA IV 1.3 i	JBC	08/95 ⇒ 01/02
MONDEO I 1.6 i 16V	L1F, L1J	02/93 ⇒ 08/96
MONDEO I 1.8 i 16V	RKA, RKB	02/93 ⇒ 08/96
MONDEO I 1.8 i 16V 4x4	RKA	02/93 ⇒ 08/96
MONDEO I 2.0 i 16V	NGA	02/93 ⇒ 08/96
MONDEO I 2.0 i 16V 4x4	NGA	04/93 ⇒ 08/96
ESCORT III 1.3	JBA	07/88 ⇒ 07/90

ALFA ROMEO

147 3.2 GTA	932A.000	02/03 ⇒ 03/10
156 2.5 V6 24V	AR32401, AR32405	02/97 ⇒ 05/06
156 2.5 V6 24V [BRA]	AR32402	10/97 ⇒ 12/01
156 3.2 GTA	932A.000	03/02 ⇒ 05/06
164 3.0	AR64304	04/93 ⇒ 02/95
164 3.0 24V	AR66301, AR66302	09/92 ⇒ 09/98
164 3.0 24V Q4	AR64307, AR64308, AR66304	09/92 ⇒ 10/98
164 3.0 24V QV	AR64304	09/92 ⇒ 09/98
164 3.0 24V QV [USA]	AR64308	04/93 ⇒ 02/95
164 3.0 24V QV Trazione integrale	AR64307	11/92 ⇒ 10/97
164 3.0i 24V Super [BRA]	64306	09/92 ⇒ 10/98
164 3.0i 24V Super Q4	AR66304	03/95 ⇒ 12/98
166 2.5 V6 24V	AR34201, AR36201	10/00 ⇒ 06/07
166 3.0 V6 24V	AR34301, AR36101	10/00 ⇒ 06/07
166 3.0 V6 24V [BRA]	AR34302	08/98 ⇒ 09/00
166 3.2 V6 24V	936A.000	10/03 ⇒ 06/07
GT 3.2 GTA	936A.000	11/03 ⇒ 09/10
GTV 3.0 V6 24V	AR16102, AR16105	10/00 ⇒ 10/05
GTV 3.2 V6 24V	936A6.000	04/03 ⇒ 10/05
SPIDER II 3.0 V6	AR16105	09/94 ⇒ 04/05
SPIDER II 3.0 V6 24V	AR16102	01/99 ⇒ 10/03
SPIDER II 3.2 V6 24V	936A6.000	04/03 ⇒ 04/05

LANCIA

KAPPA 3.0 24V	838B.000	10/94 ⇒ 10/01
THESIS 3.0 V6	841A.000	07/02 ⇒ 07/09
THESIS 3.2 V6	841L.000	05/03 ⇒ 07/09

KW 470 316



05

COILS

Adatt./Suitable:

BOSCH

0 221 506 002
0 221 506 003
0 221 506 444
0 221 506 445

DAEWOO

0001587003
0001587503

MERCEDES-BENZ

A 000 150 02 80
A 000 158 70 03
A 000 158 71 03
A 000 158 75 03

PUCH

000 158 71 03
A 000 150 02 80

SSANGYONG

0001587003
0001587103
0001587503
1621580103

VW

00A 905 105

00 Eliminated on 27-01-2021. Please verify the availability through our local distributors

- Eliminato il 27-01-2021. Verificare la disponibilità presso i nostri distributori
- Éliminé le 27-01-2021. Vérifier la disponibilité auprès de nos distributeurs sur place
- Am 27-01-2021 gestrichen. Evtl. Verfügbarkeit bitte bei unseren Händlern prüfen
- Eliminado en fecha 27-01-2021. Verificar la disponibilidad a través de nuestros distribuidores locales

250 without spark plug connector

- senza cappuccio candela d'accensione
- sans cosse de bougie d'allumage
- ohne Zündkerzenstecker
- sin conector de bujía de encendido



	ohm		ohm
	0,35		7500

DAEWOO

KORANDO 2.0	E20	12/98 ⇒ 02/01
KORANDO 2.0 16V	E20, M161.950	02/99 ⇒
KORANDO 2.3	E23, M161.970	01/99 ⇒
KORANDO 3.2 4x4	E32, M104.995	01/99 ⇒
MUSSO 2.3	M111.970	01/99 ⇒
MUSSO 3.2 4x4	M104.992, M162E32	01/99 ⇒
REXTON 3.2 V6	M162.992	04/02 ⇒

MERCEDES-BENZ

100 LI 2.3	M161.971	11/96 ⇒
CLASSE E I E 280	M104.942	06/93 ⇒ 06/95
CLASSE E I E 280 T	M104.942	06/93 ⇒ 06/96
CLASSE E I E 320	M104.992	06/93 ⇒ 03/98
CLASSE E I E 320 T	M104.992	06/93 ⇒ 06/96
CLASSE E I E 36 AMG	M104.992(AMG3.6)	06/93 ⇒ 03/98
CLASSE E I E 36 T AMG	M104.992(AMG3.6)	05/94 ⇒ 06/96
124 320 CE	M104.992	10/92 ⇒ 05/93
CLASSE C I C 180	M111.921	03/93 ⇒ 05/00
CLASSE C I C 180 T	M111.921	06/96 ⇒ 09/00
CLASSE C I C 200	M111.945	01/94 ⇒ 05/00
CLASSE C I C 200 Kompressor	M111.944	10/95 ⇒ 05/00
CLASSE C I C 200 T	M111.945	06/96 ⇒ 03/01
CLASSE C I C 200 T Kompressor	M111.944	11/96 ⇒ 03/01
CLASSE C I C 230	M111.974	06/96 ⇒ 06/97
CLASSE C I C 230 Kompressor	M111.975	10/95 ⇒ 05/00
CLASSE C I C 230 T	M111.974	06/96 ⇒ 06/98
CLASSE C I C 230 T Kompressor	M111.975	06/97 ⇒ 09/00
CLASSE C I C 280	M104.941	05/93 ⇒ 05/00
CLASSE C I C 36 AMG	M104.941(AMG3.6)	05/94 ⇒ 05/00
SPRINTER I 214	M111.979, M111.984	02/95 ⇒ 05/06
SPRINTER I 214 NGT	M111.984, M111979NGT, M111984NGT	02/95 ⇒ 05/06
SPRINTER I 314	M111.979, M111.984	02/95 ⇒ 05/06
SPRINTER I 314 4x4	M111.984	08/02 ⇒ 05/06
SPRINTER I 314 NGT	M111.984, M111979NGT, M111984NGT	02/95 ⇒ 05/06
SPRINTER I 414	M111.979, M111.984	02/95 ⇒ 05/06
SPRINTER I 414 4x4	M111.979, M111.984	05/97 ⇒ 05/06
SPRINTER I 414 NGT	M111.979, M111.984, M111979NGT, M111984NGT	02/95 ⇒ 05/06
CLASSE CLK I 200	M111.945	06/97 ⇒ 06/02

MERCEDES-BENZ

CLASSE CLK I 200 Kompressor	M111.944	06/97 ⇒ 06/00
CLASSE CLK I 230 Kompressor	M111.975	06/97 ⇒ 06/00
CLASSE E II E 200	M111.942	06/95 ⇒ 08/00
CLASSE E II E 200 Kompressor	M111.947	06/97 ⇒ 03/02
CLASSE E II E 200 T	M111.942	06/96 ⇒ 08/00
CLASSE E II E 200 T Kompressor	M111.947	06/97 ⇒ 03/03
CLASSE E II E 230	M111.970	06/95 ⇒ 06/97
CLASSE E II E 230 T	M111.970	06/96 ⇒ 06/97
CLASSE E II E 280	M104.945	01/96 ⇒ 06/97
CLASSE E II E 320	M104.995	06/95 ⇒ 06/97
CLASSE E II E 36 AMG	M104.995AMG	04/96 ⇒ 01/98
CLASSE G II 320 GE	M104.996	09/94 ⇒ 11/97
CLASSE G II G 320	M104.996	09/94 ⇒ 12/97
CLASSE G II G 36 AMG	M104.996(AMG3.6)	01/95 ⇒ 07/98
CLASSE V V 200	M111.948, M111.950	02/97 ⇒ 07/03
CLASSE V V 230	M111.978, M111.980	10/96 ⇒ 07/03
CLASSE M I ML 230	M111.977	02/98 ⇒ 06/05
CLASSE S III 300 SE 2.8	M104.944	01/93 ⇒ 10/98
CLASSE S III 300 SE, SEL/S320	M104.994	03/91 ⇒ 10/98
CLASSE S III S 280	M104.944	02/93 ⇒ 10/98
CLASSE SL IV 280	M104.943	08/93 ⇒ 10/01
CLASSE SL IV 320	M104.991	09/93 ⇒ 10/01
CLASSE SLK I 200	M111.946	09/96 ⇒ 03/00
CLASSE SLK I 200 Kompressor	M111.943	10/96 ⇒ 03/00
CLASSE SLK I 230 Kompressor	M111.973	09/96 ⇒ 03/00
KOMBI II 280 TE	M104.942	10/92 ⇒ 06/93
KOMBI II 320 TE	M104.992	10/92 ⇒ 06/93
TRE VOLUMI II 280 E	M104.942	10/92 ⇒ 06/93
TRE VOLUMI II 320 E	M104.992	10/92 ⇒ 06/93
VITO I 113 2.0	M111.948, M111.950	02/96 ⇒ 07/03
VITO I 114 2.3	M111.978	12/96 ⇒ 07/03

PUCH

G-MODELL G 320	M104.996	02/94 ⇒ 12/97
G-MODELL G 36 AMG	M104.952(AMG3.6)	01/95 ⇒ 04/98

SSANGYONG

CHAIRMAN 3.2	G32D	07/11 ⇒
KORANDO 2.0	E20, E20M160, E20M161, M111E20	05/97 ⇒ 10/02
KORANDO 2.3	--, E23, M111.970, M111E23, M111E23-143	05/97 ⇒ 11/06
KORANDO 3.2	E32, M104.992, M104.995	12/96 ⇒ 11/06
KYRON 3.2 M320 4x4	G32D	03/08 ⇒
MUSSO 2.0	E20, M111E20	10/96 ⇒ 05/05
MUSSO 3.2	M104.992	06/96 ⇒ 09/04
REXTON I 3.2 RX320 4x4	G32D	04/02 ⇒
RODIUS 3.2	M162E32	05/05 ⇒
RODIUS 3.2 4WD	G32D	07/07 ⇒

VW

LT II 2.3	AGL	05/96 ⇒ 07/06
-----------	-----	---------------

KW 470 316K



05

COILS

Adatt./Suitable:

00 Eliminated on 16-09-2019. Please verify the availability through our local distributors

- Eliminato il 16-09-2019. Verificare la disponibilità presso i nostri distributori
- Éliminé le 16-09-2019. Vérifier la disponibilité auprès de nos distributeurs sur place
- Am 16-09-2019 gestrichen. Evtl. Verfügbarkeit bitte bei unseren Händlern prüfen
- Eliminado en fecha 16-09-2019. Verificar la disponibilidad a través de nuestros distribuidores locales

250 incl. spark plug connector

- con cappuccio candela accensione
- Cosse de bougie d'allumage comprise
- inkl. Zündkerzenstecker
- incl. conector bujías



	ohm		ohm
	0,35		7500

MERCEDES-BENZ

100 LI 2.3	M161.971	11/96 ⇒
CLASSE E I E 280	M104.942	06/93 ⇒ 06/95
CLASSE E I E 280 T	M104.942	06/93 ⇒ 06/96
CLASSE E I E 320	M104.992	06/93 ⇒ 03/98
CLASSE E I E 320 T	M104.992	06/93 ⇒ 06/96
CLASSE E I E 36 AMG	M104.992(AMG3.6)	06/93 ⇒ 03/98
CLASSE E I E 36 T AMG	M104.992(AMG3.6)	05/94 ⇒ 06/96
124 320 CE	M104.992	10/92 ⇒ 05/93
CLASSE C I C 180	M111.921	03/93 ⇒ 05/00
CLASSE C I C 180 T	M111.921	06/96 ⇒ 09/00
CLASSE C I C 200	M111.945	01/94 ⇒ 05/00
CLASSE C I C 200 Kompressor	M111.944	10/95 ⇒ 05/00
CLASSE C I C 200 T	M111.945	06/96 ⇒ 03/01
CLASSE C I C 200 T Kompressor	M111.944	11/96 ⇒ 03/01
CLASSE C I C 230	M111.974	06/96 ⇒ 06/97
CLASSE C I C 230 Kompressor	M111.975	10/95 ⇒ 05/00
CLASSE C I C 230 T	M111.974	06/96 ⇒ 06/98
CLASSE C I C 230 T Kompressor	M111.975	06/97 ⇒ 09/00
CLASSE C I C 280	M104.941	05/93 ⇒ 05/00
CLASSE C I C 36 AMG	M104.941(AMG3.6)	05/94 ⇒ 05/00
SPRINTER I 214 NGT	M111.984	02/95 ⇒ 05/06
SPRINTER I 314 NGT	M111.984	02/95 ⇒ 05/06
SPRINTER I 414	M111.979	02/96 ⇒ 05/06
SPRINTER I 414 4x4	M111.979	05/97 ⇒ 05/06
CLASSE G II 320 GE	M104.996	09/94 ⇒ 11/97
CLASSE G II G 320	M104.996	09/94 ⇒ 12/97
CLASSE G II G 36 AMG	M104.996(AMG3.6)	01/95 ⇒ 07/98
CLASSE S III 300 SE 2.8	M104.944	01/93 ⇒ 10/98
CLASSE S III 300 SE, SEL/S320	M104.994	03/91 ⇒ 10/98
CLASSE S III S 280	M104.944	02/93 ⇒ 10/98
CLASSE SL IV 280	M104.943	08/93 ⇒ 10/01
CLASSE SL IV 320	M104.991	09/93 ⇒ 10/01
KOMBI II 280 TE	M104.942	10/92 ⇒ 06/93
KOMBI II 320 TE	M104.992	10/92 ⇒ 06/93
TRE VOLUMI II 280 E	M104.942	10/92 ⇒ 06/93
TRE VOLUMI II 320 E	M104.992	10/92 ⇒ 06/93

PUCH

G-MODELL G 320	M104.996	02/94 ⇒ 12/97
G-MODELL G 36 AMG	M104.952(AMG3.6)	01/95 ⇒ 04/98

KW 470 317



07

COILS

Adatt./Suitable:

BOSCH
0 221 505 437
0 221 505 438

HITACHI
138711
2508711

MAGNETI MARELLI
060717098012

MERCEDES-BENZ
A 000 150 04 80
A 000 150 05 80
A 000 158 68 03

00 Eliminated on 26-04-2021. Please verify the availability through our local distributors

- Eliminato il 26-04-2021. Verificare la disponibilità presso i nostri distributori
- Éliminé le 26-04-2021. Vérifier la disponibilité auprès de nos distributeurs sur place
- Am 26-04-2021 gestrichen. Evtl. Verfügbarkeit bitte bei unseren Händlern prüfen
- Eliminado en fecha 26-04-2021. Verificar la disponibilidad a través de nuestros distribuidores locales



		ohm		ohm
M5	M5	0,4	∅ 4	9200

MERCEDES-BENZ

CLASSE E I E 200	M111.940	06/93 ⇒ 03/98
CLASSE E I E 200 T	M111.940	06/93 ⇒ 06/96
CLASSE E I E 220	M111.960	06/93 ⇒ 03/98
CLASSE E I E 220 T	M111.960	06/93 ⇒ 06/96
124 220 CE	M111.960	10/92 ⇒ 05/93
CLASSE C I C 180	M111.920	03/93 ⇒ 05/00
CLASSE C I C 180 T	M111.920	06/96 ⇒ 09/00
CLASSE C I C 200	M111.941	01/94 ⇒ 05/00
CLASSE C I C 200 T	M111.941	06/96 ⇒ 03/01
CLASSE C I C 220	M111.961	03/93 ⇒ 05/00
KOMBI II 200 TE	M111.940	05/86 ⇒ 06/93
KOMBI II 220 TE	M111.960	10/92 ⇒ 05/93
TRE VOLUMI II 200 E	M111.940	10/92 ⇒ 06/93
TRE VOLUMI II 220 E	M111.960	10/92 ⇒ 06/93

KW 470 322



05

COILS

Adatt./Suitable:

DENSO
029700-7301

TOYOTA
90919-02200

03 Supplied until depletion

- Fornibile fino ad esaurimento delle scorte
- Fourni jusqu'à épuisement du stock
- Lieferbar solange vorrat reicht
- Suministrado hasta el stock termina



	ohm		ohm
- +	0,5	∅ 8.4	12500

TOYOTA

PREVIA I 2.4	2TZ-FE	05/90 ⇒ 08/00
PREVIA I 2.4 4WD	2TZ-FE, 2TZ-FZE	01/90 ⇒ 12/99

KW 470 341



07

COILS

Adatt./Suitable:

BOSCH
F 000 ZS0 112

DELCO REMY
3 474 232
3 474 282

DUCELLIER
2 526 050 A

GENERAL MOTORS
03 474 232
03 474 282
90 449 740
90 510 387

OPEL
12 08 002
12 08 004
12 08 048

03 Supplied until depletion

- Fornibile fino ad esaurimento delle scorte
- Fourni jusqu'à épuisement du stock
- Lieferbar solange vorrat reicht
- Suministrado hasta el stock termina



	ohm		ohm
6.4	0,45	∅ 6.3	5700

OPEL

ASTRA F 1.6 i	C16NZ	09/91 ⇒ 09/98
CORSA A 1.2	12S, 12ST	09/82 ⇒ 08/90

OPEL

CORSA A 1.2 N	12NV	01/90 ⇒ 03/93
CORSA A 1.2 S	12S, 12ST	09/82 ⇒ 03/93
CORSA A 1.3	13NB, 13SB, C13N	09/85 ⇒ 10/89
CORSA A 1.3 GL	13S	09/82 ⇒ 03/93
CORSA A 1.3 i	C13N	09/86 ⇒ 09/90
CORSA A 1.3 S	13SB	09/82 ⇒ 10/89
CORSA A 1.6 GSI	C16NZ	08/88 ⇒ 09/92
KADETT D 1.2	12ST	08/82 ⇒ 08/84
KADETT E 1.3 i Cat	C13N	09/85 ⇒ 08/91
KADETT E 1.3 N	13N, 13NB	09/84 ⇒ 08/91
KADETT E 1.3 S	13S	09/84 ⇒ 02/93
KADETT E 1.6	16SV	09/86 ⇒ 12/91
KADETT E 1.6 i	16SV, C16NZ, E16NZ	09/86 ⇒ 07/94
KADETT E 1.6 i Cat	C16LZ, C16NZ	09/86 ⇒ 02/93
KADETT E 1.6 S	16S, 16SV	09/84 ⇒ 08/91
VECTRA A 1.6 i	C16NZ, E16NZ	09/88 ⇒ 11/95
VECTRA A 1.6 i Cat	C16NZ	09/88 ⇒ 11/95

VAUXHALL

ASTRA III 1.6 i	C16NZ	09/91 ⇒ 12/98
ASTRAVAN I 1.6 i	C16NZ	10/91 ⇒ 08/98

KW 470 345



07,5

COILS

Adatt./Suitable:

BOSCH
0 986 221 003

CHAMPION
BAE 920 A
BAE 920 AX

FIAT
46446039
46472440
46480361
500309816
7789346

HITACHI
138739
2508739

IVECO
500309816

LANCIA
46446039
46472440
46480361
7789346

MAGNETI MARELLI

060717067012
060792001010
BAE 920 A
BAE 920 AX



	ohm		ohm
- + -	0,55	∅ 4	4500

FIAT

BRAVA 1.6 16V	182A4.000, 182A4.027, 182A6.000, 182B6.000	10/95 ⇒ 12/02
BRAVO I 1.6	182B6.000	09/00 ⇒ 10/01
BRAVO I 1.6 16V	178A8.011, 182A4.000, 182A6.000	10/95 ⇒ 10/01
DOBLO I 1.6 Natural Power	182B6.000, 182B6000CNG	09/02 ⇒
MAREA 1.6	182B6.000, 185A3.000	09/00 ⇒ 08/02
MAREA 1.6 100 16V	182A4.000	09/96 ⇒ 05/02
MAREA 1.6 100 16V Bipower	182A4.000, 185A3.000	04/99 ⇒ 05/02
MAREA 1.6 16V	185A3.000	04/97 ⇒ 02/99
MAREA 1.6 SX	182B5.098	09/00 ⇒ 08/02
MULTIPLA 1.6	182B6.000	09/00 ⇒ 06/10
MULTIPLA 1.6 100 16V	182A4.000	04/99 ⇒ 06/10
MULTIPLA 1.6 16V	182B6.000	04/02 ⇒ 06/10
MULTIPLA 1.6 16V Bipower	182B6.000, 186A4.000	10/01 ⇒ 06/10
MULTIPLA 1.6 16V Blupower	186A3.000, 186A3000CNG	04/99 ⇒ 06/10
MULTIPLA 1.6 16V GPL	182B6.000	10/01 ⇒ 06/10
MULTIPLA 1.6 Natural Power	182B6000CNG	11/08 ⇒ 06/10
MULTIPLA VAN 1.6	182B6.000	09/00 ⇒ 06/10

FIAT			
MULTIPLA VAN Bipower	182B6.000	10/01 ⇒ 06/10	
PALIO 1.6	178C7.098, 178D2.011	07/97 ⇒	
PALIO 1.6 16V	178B3.000, 178C7.098, 178D2.011, 182B6.000	02/01 ⇒	
PALIO 1.6 16V Sport	178E7.000	10/01 ⇒	
SIENA 1.6	182B6.000	11/00 ⇒ 12/12	
SIENA 1.6 16V	178B3.000	09/98 ⇒	
STRADA 1.6 MPI	178D2.011	07/05 ⇒	

FIAT (BR)			
BRAVA 1.6i 16v	1.6Mpi	01/00 ⇒	
PALIO 1.6i	1.6Mpi	01/99 ⇒ 12/00	
PALIO 1.6i 16v	1.6Mpi16v	01/96 ⇒	
SIENA 1.6i 16v	1.6Mpi	01/98 ⇒ 12/99	
STRADA 1.6i 16v	1.6Mpi	01/99 ⇒	

IVECO			
DAILY II 2.8 CNG	8149.03	05/99 ⇒ 07/07	
DAILY II 50 C 11 Natural Power	8149.03	05/99 ⇒ 04/06	
DAILY III 50 C 11 Natural Power	8149.03	05/02 ⇒ 05/06	
DAILY 2.8 CNG	8149.03	07/99 ⇒ 12/06	

LANCIA			
DEDRA 1.6 16V	182A4.000	01/96 ⇒ 07/99	
DELTA II 1.6 i.e.	182A6.000	03/96 ⇒ 08/99	
DELTA II 1.6 i.e. 16V	182A4.000	01/96 ⇒ 08/99	
LYBRA 1.6	182B6.000	10/00 ⇒ 10/05	
LYBRA 1.6 16V	182A4.000	07/99 ⇒ 10/05	

KW 470 347



05

COILS

Adatt./Suitable:

HITACHI
138810
2508810
CM1T-228
CM1T-228 A
CM1T-228 B
CM1T-228 C

03 Supplied until depletion

- Fornibile fino ad esaurimento delle scorte
- Fourni jusqu'à épuisement du stock
- Lieferbar solange vorrat reicht
- Suministrado hasta el stock termina

HONDA
30500-P0A-A01
30500-P0H-A01
30500-PAA-A01
30500-PCA-003
30500-PDA-E01

ISUZU
5-86206161-0
5-86207198-0

MAGNETI MARELLI
060717021012

ROVER
GCL207
NEC100750



4, 8		ohm	ohm
-	+	0,49	28000

HONDA			
ACCORD VI 2.3 i 16V Vtec	F23Z5	11/00 ⇒	
ACCORD VI 2.3 VTi	F23A3	02/98 ⇒ 10/02	
CIVIC VI 1.4 16V	D14A7, D14Z3	04/98 ⇒ 02/01	
CIVIC VI 1.4 i	D14A3, D14A5, D14A7, D14Z1, D14Z3, D14Z4	06/95 ⇒ 02/01	
CIVIC VI 1.4 i S	D14Z4	11/95 ⇒ 02/01	
CIVIC VI 1.4 LPG	D14A4, D14Z4	01/97 ⇒ 02/01	
CIVIC VI 1.4i 16V	D14Z3, D14Z4	11/98 ⇒ 12/00	
CIVIC VI 1.4i 16V Vtec	D14Z4	01/99 ⇒	
CIVIC VI 1.5 16V	D15Z8	01/97 ⇒ 02/01	
CIVIC VI 1.5 i	D15Z8	11/95 ⇒ 02/01	
CIVIC VI 1.6	D16W4, D16Y2	10/95 ⇒ 03/01	
CIVIC VI 1.6 16V	D16B2, D16W3, D16W4	01/97 ⇒ 02/01	
CIVIC VI 1.6 i	D16Y5	11/95 ⇒ 02/01	
CIVIC VI 1.6 i Vtec	D16Y6	11/95 ⇒ 02/01	
CIVIC VI 1.6i 16V	D16W3	11/98 ⇒ 12/00	
CIVIC VI 1.8 16V	B18C4	01/97 ⇒ 02/01	
CIVIC V 1.6i Vtec	D16Y6	01/94 ⇒ 03/96	
ODYSSEY 2.2	F22B6	01/95 ⇒ 12/97	
ODYSSEY 2.3	F23A	10/97 ⇒ 09/03	
ODYSSEY 2.3 4x4	F23A	10/97 ⇒ 09/03	
ODYSSEY 2.3 i 16V Vtec	F23A8	01/98 ⇒	
SHUTTLE 2.3 16V	F23A7, F23A8	10/97 ⇒ 06/04	

ROVER			
400 II 416 Si	16K4F, D16Y2, D16Y3, D16B2	03/95 ⇒ 03/00	
600 618 i/Si	F18A3	03/96 ⇒ 02/99	
600 620 i	F20Z2	08/93 ⇒ 06/96	
600 620 Si	F20Z1	08/93 ⇒ 02/99	

KW 470 352



05

COILS

Adatt./Suitable:

BMW
1 703 227
1 748 017
1 748 018
12 13 1 703 228
12 13 1 703 825
12 13 1 748 017
12 13 1 748 018
12 13 7 599 219
12 13 9 067 830
7 599 219

BOSCH
0 221 504 004
0 221 504 029
1 227 030 081

LAND ROVER
1748018
LR022494
NEC000040
NEC101000L

00 Eliminated on 23-03-2021. Please verify the availability through our local distributors

- Eliminato il 23-03-2021. Verificare la disponibilità presso i nostri distributori
- Éliminé le 23-03-2021. Vérifier la disponibilité auprès de nos distributeurs sur place
- Am 23-03-2021 gestrichen. Evtl. Verfügbarkeit bitte bei unseren Händlern prüfen
- Eliminado en fecha 23-03-2021. Verificar la disponibilidad a través de nuestros distribuidores locales



+ GND -		ohm	ohm
		0,56	...

BMW			
3 III 320 i	M50B20(20651), M50B20(20652), M52B20(20653)	01/91 ⇒	11/99
3 III 323 i	M52B25(25653)	05/95 ⇒	11/99
3 III 323 ti	M52B25(25653)	09/97 ⇒	08/00
3 III 328 i	M52B28(28651)	01/95 ⇒	11/99
3 III M3 3.2	S50B32(32651)	10/95 ⇒	09/99
3 IV 320 Ci	M52B20(20654), M52B20654, M54B22(22651), M54B22651	01/00 ⇒	12/07
3 IV 320 i	4F8Q636, M52B20(20654), M52B20654, M54B22(22651), M54B22651	09/00 ⇒	02/05
3 IV 323 Ci	0LF8, 8CLS, M52B25(25654), M52B25654	04/99 ⇒	09/00

BMW			
3 IV 323 i	-(24653), M52B25(25654), M52B25654	03/98 ⇒	12/03
3 IV 325 Ci	4CCS, M54B25(25655), M54B25655, M5625656	09/00 ⇒	
3 IV 325 i	-(24654), M54B25(25655), M54B25655, M5625656	09/00 ⇒	
3 IV 325 ti	M54B25(25655), M54B25655	04/01 ⇒	12/04
3 IV 325 xi	M54B25(25655), M54B25655	09/00 ⇒	02/05
3 IV 328 Ci	M52B28(28652), M52B28652	12/98 ⇒	05/00
3 IV 328 i	1LGX, M52B28(28652), M52B28652	02/98 ⇒	06/00
3 IV 330 Ci	7ACR, M54B30(30653), M54B30653	06/00 ⇒	08/06
3 IV 330 i	M54B30(30653), M54B30653	06/00 ⇒	04/05
3 IV 330 xi	M54B30(30653), M54B30653	06/00 ⇒	07/06
5 IV 520 i	6BJT, 8TJ3760E, M52B20653, M52B20654, M54B22(22651), M54B22651	09/00 ⇒	12/03
5 IV 523 i	1LDS, 4M18A, 6GW491Q-E, 8K7M818, M52B25(25653), M52B25653	09/95 ⇒	08/00
5 IV 525 i	8CUG, M54B25(25655), M54B25655	09/00 ⇒	05/04
5 IV 528 i	9D0836LE501, M52B28(28651), M52B28(28652), M52B28652	09/95 ⇒	08/00
5 IV 530 i	2CBL, M54B30(30653), M54B30653	09/00 ⇒	12/03
5 IV 535 i	1H4B410, 6DAM15B, M62B35(35852)	06/96 ⇒	08/98
5 IV 540 i	0JL465QH, 54A915, 9K20C3, M62B44(44851), M62B44(44852), M62B44852	03/96 ⇒	12/03
5 IV M5	8D0836LF40, S62B50(50851)	10/98 ⇒	06/03
7 III 728 i, iL	M52B28(28651), M52B28(28652)	08/95 ⇒	11/01
7 III 728i X	M52B28(28651)	11/95 ⇒	09/01
7 III 735 i, iL	M62B35(35851)	03/96 ⇒	08/98
7 III 740 i, iL	M62B44(44851), M62B44(44852)	02/96 ⇒	07/01
8 840 Ci	M62B44(44851)	03/96 ⇒	06/99
Z3 2.0 i	M52B20(20654)	04/99 ⇒	01/03
Z3 2.2 i	M54B22(22651)	08/00 ⇒	01/03
Z3 2.8 i	M52B28(28651), M52B28(28652)	01/96 ⇒	07/00
Z3 3.0 i	M54B30(30653)	06/00 ⇒	06/03
Z3 M	S50B32(32651)	02/98 ⇒	06/01
Z3 M 3.2	S50B32(32651)	01/97 ⇒	06/00
Z8 4.9	S62B50(50851)	01/00 ⇒	12/03
X5 I 3.0 i	M54B30(30653)	04/00 ⇒	12/06
X5 I 4.4 i	M62B44(44852), M62B44852	01/00 ⇒	09/03
X5 I 4.6 iS	M62B46(46851), M62B46851	10/01 ⇒	09/03

LAND ROVER

DEFENDER 2.8 90, 110	--	09/00 ⇒	
FREELANDER 2.5 V6 4x4	25KV6	11/00 ⇒	10/06
RANGE ROVER III 4.4 4x4	448PN, 445DEX, M62B44	03/02 ⇒	08/12

KW 470 354



COILS

Adatt./Suitable:

- 03 Supplied until depletion**
- Fornibile fino ad esaurimento delle scorte
 - Fourni jusqu'à épuisement du stock
 - Lieferbar solange vorrat reicht
 - Suministrado hasta el stock termina

- 250 incl. spark plug connector**
- con cappuccio candela accensione
 - Cosse de bougie d'allumage comprise
 - inkl. Zündkerzenstecker
 - incl. conector bujias

- 302 Paired article numbers**
- N° articolo appaiato
 - Numéro d'article en paire
 - paarige Artikelnummer
 - Referencia artículo par

470 354S

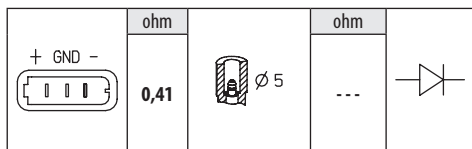

VOLKSWAGEN (BR)		
GOLF A4 1.8i Turbo 20v	AGU	10/99 ⇨
VW		
PASSAT IV 1.8 T Syncro	AEB	11/96 ⇨ 08/00

KW 470 354S



COILS

Adatt./Suitable:

- AUDI**
- 058 905 101
 - 058 905 105
- BOSCH**
- 0 986 221 011
 - 0 986 22A 203

- HITACHI**
- 133805
 - 2503805

- SEAT**
- 058 905 105

- SKODA**
- 058 905 101
 - 058 905 105

- VW**
- 058 905 101
 - 058 905 105

- 03 Supplied until depletion**
- Fornibile fino ad esaurimento delle scorte
 - Fourni jusqu'à épuisement du stock
 - Lieferbar solange vorrat reicht
 - Suministrado hasta el stock termina

- 255 without spark plug connector**
- senza cappuccio candela d'accensione
 - sans cosse de bougie d'allumage
 - ohne Zündkerzenstecker
 - sin conector de bujia de encendido

- 301 Paired article numbers**
- N° articolo appaiato
 - Numéro d'article en paire
 - paarige Artikelnummer
 - Referencia artículo par

470 354

470 422

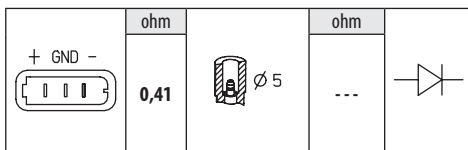

AUDI		
A3 I 1.8 T	AGU	12/96 ⇨ 05/03
A3 I 1.8 T quattro	AGU	12/96 ⇨ 05/03
A6 I S6 Plus quattro	AHK	04/96 ⇨ 12/97
A4 I 1.8 T	AEB, AJL, ANB, APU, ARK	01/95 ⇨ 09/01
A4 I 1.8 T quattro	AEB, AJL, ANB, APU, ARK, AWT	01/95 ⇨ 09/01
A4 I RS4 quattro	ASJ, AZR	05/00 ⇨ 09/01
A4 I S4 quattro	AGB, AZB	09/97 ⇨ 09/01
A6 II 1.8 T	AEB, AJL, ANB, APU, ARK	01/97 ⇨ 01/05
A6 II 1.8 T quattro	AEB, AJL, ANB, APU, ARK	02/97 ⇨ 01/05
A6 II 2.7 T	AJK	02/99 ⇨ 01/05
A6 II 2.7 T quattro	AJK, ARE, AZA	08/01 ⇨ 01/05
A8 I 3.7	AKJ	06/97 ⇨ 12/98
A8 I 4.2 quattro	ABZ, AEM, AGH, AKG, AQF, AUW	03/94 ⇨ 11/98
A8 I S8 quattro	AHC, AKH	07/96 ⇨ 06/99
ALLROAD 2.7 T quattro	1457L77, ARE	05/00 ⇨ 08/05

SEAT		
ALHAMBRA I / II 1.8 T 20V	AJH	10/97 ⇨ 03/10

SKODA		
OCTAVIA I 1.8 T	AGU	08/97 ⇨ 12/10

VOLKSWAGEN (BR)		
GOLF A4 1.8i Turbo 20v	AGU	10/99 ⇨

VW		
PASSAT IV 1.8 T	AEB, ANB, APU	10/96 ⇨ 11/00
PASSAT IV 1.8 T Syncro	AEB	11/96 ⇨ 08/00
BORA 1.8 T	AGU	05/00 ⇨ 05/05
GOLF IV 1.8 T	AGU	08/97 ⇨ 06/06
SHARAN I 1.8 T 20V	AJH	09/97 ⇨ 03/10

KW 470 355



COILS

Adatt./Suitable:

- BOSCH**
- 0 986 221 030

- DUCELLIER**
- 2 526 051 A
 - 2 526 110 A

- HITACHI**
- 138757
 - 2508757

- MAGNETI MARELLI**
- 060717073012

- RENAULT**
- 77 00 863 020
 - 77 01 041 607

- SAGEM**
- 2 526 051 A
 - 2 526 110 A

- VOLVO**
- 70863020
 - 708630207

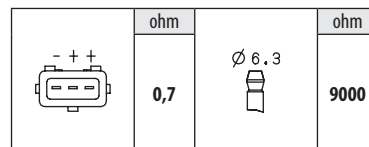

RENAULT		
LAGUNA I 2.0	N7Q700, N7Q704	06/95 ⇨ 02/01
LAGUNA I 2.0 16V	N7Q700, N7Q704	06/95 ⇨ 03/01
MEGANE I 1.6 e	K7M702, K7M703, K7M790	01/96 ⇨ 08/03
MEGANE I 1.6 i	K7M720, K7M790	01/96 ⇨ 03/99
MEGANE I 1.6 LPG	K7M702	08/95 ⇨ 03/99
MEGANE SCÉNIC I 1.6 e	K7M702, K7M703	10/96 ⇨ 10/99
MEGANE SCÉNIC I 1.6 i	K7M720	01/97 ⇨ 09/99
MEGANE 1.6 BiFuel	K7M702	10/96 ⇨ 10/99
SAFRANE II 2.0 16V	N7Q710, N7Q711	07/96 ⇨ 12/00

VOLVO		
S40 I 1.6	B4164S	09/95 ⇨ 08/99
S40 I 1.8	B4184S	07/95 ⇨ 08/99
S40 I 2.0	B4204S, B4204S2	07/95 ⇨ 08/99
V40 I 1.6	B4164S	12/95 ⇨ 08/99
V40 I 1.8	B4184S	07/95 ⇨ 08/99
V40 I 2.0	B4204S	07/95 ⇨ 08/99

KW 470 356



05

COILS

Adatt./Suitable:

BOSCH

0 986 221 031

DUCELLIER

2 526 052 A
2 526 111 A

HITACHI

138758
2508758

MAGNETI MARELLI

060717071012

RENAULT

77 00 863 021
77 01 041 608

SAGEM

2 526 052 A
2 526 111 A

VOLVO

70863021
708630215

	ohm		ohm
	0,7	∅ 6,3	9000

RENAULT

LAGUNA I 2.0	N7Q700, N7Q704	06/95 ⇒ 02/01
LAGUNA I 2.0 16V	N7Q700, N7Q704	06/95 ⇒ 03/01
MEGANE I 1.6 e	K7M702, K7M703, K7M790	01/96 ⇒ 08/03
MEGANE I 1.6 i	K7M720, K7M790	01/96 ⇒ 03/99
MEGANE I 1.6 LPG	K7M702	08/95 ⇒ 03/99
MEGANE SCÉNIC I 1.6 e	K7M702, K7M703	10/96 ⇒ 10/99
MEGANE SCÉNIC I 1.6 i	K7M720	01/97 ⇒ 09/99
MEGANE 1.6 BiFuel	K7M702	10/96 ⇒ 10/99
SAFRANE II 2.0 16V	N7Q710, N7Q711	07/96 ⇒ 12/00

VOLVO

S40 I 1.6	B4164S	09/95 ⇒ 08/99
S40 I 1.8	B4184S	07/95 ⇒ 08/99
S40 I 2.0	B4204S, B4204S2	07/95 ⇒ 08/99
V40 I 1.6	B4164S	12/95 ⇒ 08/99
V40 I 1.8	B4184S	07/95 ⇒ 08/99
V40 I 2.0	B4204S	07/95 ⇒ 08/99

KW 470 364



07

COILS

Adatt./Suitable:

BOSCH

F 000 Z50 212

FORD

1 008 886
1 008 887
1 018 139
1 018 140
96FB-12257-AB
A96BF-12024-A1B

HITACHI

138803

MAGNETI MARELLI

060717036012

⁰⁰ Eliminated on 23-02-2022. Please verify the availability through our local distributors

- Eliminato il 23-02-2022. Verificare la disponibilità presso i nostri distributori
- Éliminé le 23-02-2022. Vérifier la disponibilité auprès de nos distributeurs sur place
- Am 23-02-2022 gestrichen. Evtl. Verfügbarkeit bitte bei unseren Händlern prüfen
- Eliminado en fecha 23-02-2022. Verificar la disponibilidad a través de nuestros distribuidores locales

³⁰⁰ Paired article numbers

- N° articolo appaiato
- Numéro d'article en paire
- paarige Artikelnummer
- Referencia artículo par

470 135



	ohm		ohm
	0,5	∅ 7	13000

FORD

FIESTA III 1.0	TLB	03/89 ⇒ 12/95
FIESTA III 1.1	G6A, GUD, GUE	03/89 ⇒ 12/95
FIESTA III 1.3	J6B, JBB, JBC	03/89 ⇒ 02/96
FIESTA III 1.3 Cat	J6B	05/91 ⇒ 01/97
ESCORT V 1.3	J4B, J6A, JBE	07/90 ⇒ 01/95
ESCORT VI 1.3	BL13H-JBE	01/95 ⇒ 02/99
FIESTA IV 1.0 i	OEAL	04/96 ⇒ 09/99
FIESTA IV 1.3 i	JBC	08/95 ⇒ 01/02
ORION II 1.3	BL13H-JBE, J4B, J6A	07/90 ⇒ 12/94

COILS

Adatt./Suitable:

HITACHI

138765
2508765

MAGNETI MARELLI

060717072012

RENAULT

77 00 872 449
77 00 872 834
82 00 141 149

SAGEM

2 526 078 A
2 526 078 B

	ohm		ohm
	0,7	∅ 4	9000

RENAULT

CLIO I 1.2	D7F730	01/96 ⇒ 09/98
CLIO II 1.2	D7F710, D7F720, D7F722, D7F726	09/98 ⇒
CLIO II 1.2 LPG	D7F722	03/99 ⇒ 05/01
CLIO II 2.0 16V Sport	F4R730, F4R732, F4R736, F4R738	02/00 ⇒ 06/09
KANGOO 1.2 BiFuel	D7F710, D7F722, D7F744, D7F764, D7F766	06/97 ⇒ 06/03
KANGOO I 1.2	D7F710, D7F720, D7F722, D7F726, D7F744, D7F746, D7F764, D7F766	08/97 ⇒
KANGOO I 1.2 BiFuel	D7F710, D7F744	07/98 ⇒ 07/01
LAGUNA II 2.0 16V IDE	FSR700, FSR701	04/01 ⇒ 09/07
MEGANE I 2.0 16V	F4R746	01/02 ⇒ 08/03
MEGANE I 2.0 16V IDE	F4R746, FSR740	11/99 ⇒ 08/03
TWINGO I 1.2	D7F700, D7F701, D7F702, D7F703, D7F704, D7F706	05/96 ⇒

KW 470 366S



05

COILS

Adatt./Suitable:

BOSCH

F 005 X11 775

FORD

4 132 292
B6S7 18100
XM34-4608-CA

FORD USA

4 132 292
XM34-4608-CA

MAZDA

B6S7-18-100
FEJK-18-10X**00 Eliminated on 23-02-2022. Please verify the availability through our local distributors**

- Eliminato il 23-02-2022. Verificare la disponibilità presso i nostri distributori
- Éliminé le 23-02-2022. Vérifier la disponibilité auprès de nos distributeurs sur place
- Am 23-02-2022 gestrichen. Evtl. Verfügbarkeit bitte bei unseren Händlern prüfen
- Eliminado en fecha 23-02-2022. Verificar la disponibilidad a través de nuestros distribuidores locales

1193 Paired article numbers

- N° articolo appaiato
- Numéro d'article en paire
- paarige Artikelnummer
- Referencia artículo par

470 233**245 without fastening clamp**

- senza staffa fissaggio
- sans bride de fixation
- ohne Befestigungsbügel
- sin estribo de sujeción



	ohm		ohm
	1	Ø 8.2	14500

FORD

ENDEAVOUR 2.6 EFI	--	08/03 ⇒
EVEREST 2.6 EFI	--	08/03 ⇒
RANGER IV 2.2	F2D6	03/02 ⇒ 09/05
RANGER IV 2.6	--	10/02 ⇒ 09/04
RANGER IV 2.6 EFI	--	10/06 ⇒

MAZDA

E2000 2.0i 12v	FERW, FEY9	04/97 ⇒
E2000 2.0i 12v 4x4	FEJM, FEY9	09/90 ⇒ 08/99

KW 470 374



07,5

COILS

Adatt./Suitable:

DUCELLIER

2 526 073 A

LAND ROVER

NEC100630

MAGNETI MARELLI

060717131012

MG

NEC100630

ROVER

GCL201
NEC100630
NEC100630SLP
NEC100631

	ohm		ohm
	0,75	Ø 6.3	5600

LAND ROVER

FREELANDER 1.8 16V 4x4	18K4F	04/98 ⇒ 10/06
FREELANDER 1.8 4x4	18K4F	10/00 ⇒ 10/06
FREELANDER 1.8 i 16V 4x4	18K4F	02/98 ⇒ 10/06

MG

EXPRESS 1.4	14K4F	03/03 ⇒ 05/05
MG TF 115	16K4F	03/02 ⇒ 12/09
MG TF 135	18K4F	03/02 ⇒ 12/09
MG TF 160	18K4K	03/02 ⇒ 12/09
MG ZR 105	14K4F	06/01 ⇒ 04/05
MG ZR 120	18K4F	06/01 ⇒ 04/05

ROVER

25 1.1	11K4F, 11K2F	09/99 ⇒ 05/05
25 1.1 16V	11K4F	01/04 ⇒ 05/05
25 1.4	14K4M	01/03 ⇒ 12/05
25 1.4 16V	14K4F, 14K4M	10/99 ⇒ 05/05
25 1.6 16V	16K4F	10/99 ⇒ 05/05
25 1.8 16V	18K4F	10/99 ⇒ 05/05
200 II 214 GSi/Si	14K4C	01/90 ⇒ 10/95
200 II 216 1.6i 16V	16K4F	01/96 ⇒ 11/99
200 III 1.4	14K4D	01/96 ⇒ 12/97
200 III 211	11K2D	01/98 ⇒ 03/00
200 III 214 i	14K2F	11/95 ⇒ 03/00
200 III 214 Si	14K4F	11/95 ⇒ 03/00
200 III 216 Si	16K4F	11/95 ⇒ 06/99
400 II 414	14K2F	03/96 ⇒ 12/99
400 II 414 Si	14K4F	05/95 ⇒ 03/00
400 II 416 Si	16K4F, D16V2	03/95 ⇒ 03/00
400 I 1.6 i	16K4F, D16A8	05/94 ⇒ 11/98
400 I 414	14K4C	01/93 ⇒ 04/95
STREETWISE 1.4	14K4F, 14K4M	08/03 ⇒ 05/05
STREETWISE 1.6	16K4F	01/04 ⇒ 05/05

KW 470 376



05

COILS

Adatt./Suitable:

BOSCH

0 986 221 025

HITACHI

138759
2508759

MAGNETI MARELLI

060717068012

RENAULT

77 00 100 589

SAGEM

2 526 114 A

03 Supplied until depletion

- Fornibile fino ad esaurimento delle scorte
- Fourni jusqu'à épuisement du stock
- Lieferbar solange vorrat reicht
- Suministrado hasta el stock termina



	ohm		ohm
	0,7	Ø 4	9000

RENAULT

CLIO II 1.4	E7J780	09/98 ⇒ 05/05
CLIO II 1.6	K7M744, K7M745	09/98 ⇒ 05/05
KANGOO I 1.4	E7J780	08/97 ⇒
MEGANE I 1.6 e	K7M702, K7M703, K7M790	01/96 ⇒ 08/03
MEGANE I 1.6 i	K7M720	01/96 ⇒ 03/99
MEGANE I 1.6 LPG	K7M702	08/95 ⇒ 03/99
MEGANE SCÉNIC I 1.6 e	K7M702, K7M703	10/96 ⇒ 10/99
MEGANE SCÉNIC I 1.6 i	K7M720	01/97 ⇒ 09/99
MEGANE 1.6 BiFuel	K7M702	10/96 ⇒ 10/99

KW **470 377**

07

COILS

Adatt./Suitable:

- 00 Eliminated on 16-11-2021. Please verify the availability through our local distributors**
- Eliminato il 16-11-2021. Verificare la disponibilità presso i nostri distributori
 - Éliminé le 16-11-2021. Vérifier la disponibilité auprès de nos distributeurs sur place
 - Am 16-11-2021 gestrichen. Evtl. Verfügbarkeit bitte bei unseren Händlern prüfen
 - Eliminado en fecha 16-11-2021. Verificar la disponibilidad a través de nuestros distribuidores locales

RB Replaced by

- Sostituito da
- Remplacé par
- Ersetzt durch
- Reemplazado por

470 596

	ohm		ohm
	0,7		9000

KW **470 378**

05

COILS

Adatt./Suitable:

BOSCH
0 986 221 026

HITACHI
138766
2508766

MAGNETI MARELLI
060717069012

RENAULT
77 00 100 643

SAGEM
2 526 115 A

03 Supplied until depletion

- Fornibile fino ad esaurimento delle scorte
- Fourni jusqu'à épuisement du stock
- Lieferbar solange vorrat reicht
- Suministrado hasta el stock termina



	ohm		ohm
	0,7		9000

RENAULT

CLIO II 1.4	E7J780	09/98 ⇨ 05/05
CLIO II 1.6	K7M744, K7M745	09/98 ⇨ 05/05
KANGOO I 1.4	E7J780	08/97 ⇨
MEGANE I 1.6 e	K7M702, K7M703, K7M790	01/96 ⇨ 08/03
MEGANE I 1.6 i	K7M720	01/96 ⇨ 03/99
MEGANE I 1.6 LPG	K7M702	08/95 ⇨ 03/99
MEGANE SCÉNIC I 1.6 e	K7M702, K7M703	10/96 ⇨ 10/99
MEGANE SCÉNIC I 1.6 i	K7M720	01/97 ⇨ 09/99
MEGANE 1.6 BiFuel	K7M702	10/96 ⇨ 10/99

KW **470 384**

05,5

COILS

Adatt./Suitable:

FIAT
46473849

HITACHI
133926
2503926
CM11-202

LANCIA
46473849

MAGNETI MARELLI
060810090010



	ohm		ohm	
	

FIAT

BARCETTA 1.8 16V	183A1.000, 188A6.000	04/95 ⇨ 05/05
BRAVO I 1.8 GT	182A2.000	10/95 ⇨ 10/01
COUPE 1.8 16V	183A1.000	03/96 ⇨ 08/00
PUNTO II 1.8 130 HGT	183A1.000, 188A6.000	09/99 ⇨ 03/12
PUNTO II 1.8 16V	188A6.000	06/03 ⇨
STILO 1.8 16V	192A4.000	10/01 ⇨ 08/08

FIAT (BR)

BRAVA 1.8i 16v	1.8Mpi	01/00 ⇨
MAREA 1.8i 16v	1.8Mpi	01/00 ⇨ 12/01

LANCIA

DELTA II 1.8 i.e. 16V GT	183A1.000	03/96 ⇨ 08/99
LYBRA 1.8 16V	839A4.000, 839A7.000, 839A9.000	07/99 ⇨ 10/05

KW **470 386**

05

COILS

Adatt./Suitable:

ALFA ROMEO
71711984
7793212

BOSCH
1 227 030 059

255 without spark plug connector

- senza cappuccio candela d'accensione
- sans cosse de bougie d'allumage
- ohne Zündkerzenstecker
- sin conector de bujía de encendido

301 Paired article numbers

- N° articolo appaiato
- Numéro d'article en paire
- paarige Artikelnummer
- Referencia artículo par

470 386K

	ohm		ohm
	0,33		7500

ALFA ROMEO

145 1.4 i.e. 16V T.S.	AR33503	12/96 ⇨ 01/01
145 1.6 i.e. 16V T.S.	AR32102, AR67601	12/96 ⇨ 01/01
145 1.6 LPG	AR32102	01/98 ⇨ 01/01
145 1.8 i.e. 16V T.S.	AR67106	12/96 ⇨ 12/98
145 1.8 i.e. 16V T.S. [BRA]	AR67199	10/96 ⇨ 02/99
145 2.0 16V T.S.	AR67204	10/95 ⇨ 01/01
145 2.0 16V T.SPARK [BRA]	AR67299	10/96 ⇨ 02/99
146 1.4 i.e. 16V T.S.	AR33503	11/96 ⇨ 01/01
146 1.6 i.e. 16V T.S.	AR32102, AR67601	11/96 ⇨ 10/01
146 1.8 i.e. 16V T.S.	AR67106	11/96 ⇨ 01/01
146 2.0 16V T.S.	AR67204	10/95 ⇨ 01/01
155 1.6 16V T.S.	AR67601	05/96 ⇨ 12/97
155 1.7 T.S. 16V	AR67106	05/96 ⇨ 12/97
155 2.0 T.S. 16V	AR67204, AR67299	03/95 ⇨ 12/97
156 1.6 16V T.SPARK	AR67601	09/97 ⇨ 09/05
156 1.6 16V T.SPARK.	AR67601	05/00 ⇨ 05/06
GTV 2.0 T.SPARK 16V	AR16201	06/95 ⇨ 10/05
SPIDER II 2.0 T.SPARK 16V	AR16201	06/95 ⇨ 04/05

KW 470 386K



05

COILS

Adatt./Suitable:

ALFA ROMEO
60605306 *1
BOSCH
0 221 506 001

*1 Without fastening clamp

- Senza staffa di fissaggio
- sans bride de fixation
- ohne Befestigungsbügel
- sin estribo de sujeción

245 without fastening clamp

- senza staffa fissaggio
- sans bride de fixation
- ohne Befestigungsbügel
- sin estribo de sujeción

250 incl. spark plug connector

- con cappuccio candela accensione
- Cosse de bougie d'allumage comprise
- inkl. Zündkerzenstecker
- incl. conector bujias

302 Paired article numbers

- N° articolo appaiato
- Numéro d'article en paire
- paarige Artikelnummer
- Referencia artículo par

470 386



	ohm		ohm
	0,33	Ø 4 Ø 5	7500

ALFA ROMEO

145 1.8 i.e. 16V T.S. [BRA]	AR67199	10/96 ⇒ 02/99
145 2.0 16V T.SPARK [BRA]	AR67299	10/96 ⇒ 02/99
145 2.0 16V T.SPARK Q.V. [BRA]	AR67299	10/95 ⇒ 09/96
155 1.6 16V T.S.	AR67601	05/96 ⇒ 12/97
155 1.7 T.S. 16V	AR67106	05/96 ⇒ 12/97
155 2.0 T.S. 16V	AR67204, AR67299	03/95 ⇒ 12/97

KW 470 387



05

COILS

Adatt./Suitable:

ALFA ROMEO
46469863
BOSCH
1 227 030 062
HITACHI
133861
2503861

255 without spark plug connector

- senza cappuccio candela d'accensione
- sans cosse de bougie d'allumage
- ohne Zündkerzenstecker
- sin conector de bujia de encendido

301 Paired article numbers

- N° articolo appaiato
- Numéro d'article en paire
- paarige Artikelnummer
- Referencia artículo par

470 387K



	ohm		ohm
	0,33	Ø 4 Ø 5	7500

ALFA ROMEO

145 1.4 i.e. 16V T.S.	AR33503	12/96 ⇒ 01/01
145 1.6 16V T.S.	AR32102	09/97 ⇒ 12/00
145 1.6 i.e. 16V T.S.	AR32102, AR67601	12/96 ⇒ 01/01
145 1.6 LPG	AR32102	01/98 ⇒ 01/01
145 1.8 i.e. 16V	AR32201	03/98 ⇒ 01/01
145 2.0 16V	AR32301	03/98 ⇒ 01/01
146 1.4 i.e. 16V T.S.	AR33503	11/96 ⇒ 01/01
146 1.6 16V T.S.	AR32102	09/97 ⇒ 12/00
146 1.6 i.e. 16V T.S.	AR32102, AR67601	11/96 ⇒ 10/01
146 1.8 i.e. 16V T.S.	AR32201	03/98 ⇒ 01/01
146 2.0 16V	AR32301	03/97 ⇒ 10/01
146 2.0 16V T.S.	AR67204	10/95 ⇒ 01/01
156 1.6 16V T.SPARK	AR32102, AR67601	09/97 ⇒ 09/05
156 1.6 16V T.SPARK.	AR32102, AR67601	05/00 ⇒ 05/06
156 1.8 16V T.SPARK	AR32201, AR32205	09/97 ⇒ 05/06
156 2.0 16V T.SPARK	AR32301, AR32310	05/00 ⇒ 06/02
156 2.0 Twin Spark	AR32303	11/97 ⇒ 04/00
166 2.0 T.SPARK	AR34103	09/98 ⇒ 10/00
GTV 1.8 16V	AR32201	05/98 ⇒ 10/05
GTV 2.0 T.SPARK 16V	AR16201, AR32301	06/95 ⇒ 10/05
SPIDER II 1.8 16V	AR32201	05/98 ⇒ 04/05
SPIDER II 2.0 T.SPARK 16V	AR32301	05/98 ⇒ 08/00

KW 470 387K



05

COILS

Adatt./Suitable:

250 incl. spark plug connector

- con cappuccio candela accensione
- Cosse de bougie d'allumage comprise
- inkl. Zündkerzenstecker
- incl. conector bujias

302 Paired article numbers

- N° articolo appaiato
- Numéro d'article en paire
- paarige Artikelnummer
- Referencia artículo par

470 387



	ohm		ohm
	0,33	Ø 4 Ø 5	7500

ALFA ROMEO

156 1.6 16V T.SPARK.	AR32102	05/00 ⇒ 05/06
----------------------	---------	---------------

KW 470 389



07

COILS

Adatt./Suitable:

BOSCH
0 221 503 011
GENERAL MOTORS
90 506 102
OPEL
12 08 076
90506102
VAUXHALL
90506102

03 Supplied until depletion

- Fornibile fino ad esaurimento delle scorte
- Fourni jusqu'à épuisement du stock
- Lieferbar solange vorrat reicht
- Suministrado hasta el stock termina



	ohm		ohm
	0,7	Ø 4	9000

OPEL

SINTRA 2.2 i 16V	X22XE	11/96 ⇒ 04/99
VAUXHALL		
SINTRA 2.2 i 16V	X22XE	11/96 ⇒ 04/99

KW 470 394



05

COILS

Adatt./Suitable:

HYUNDAI
27301-02502 *U

¹⁰ Supplied only the coil, not the mounting bracket, not the module

- Fornita solo la bobina, nol la staffa di fissaggio, non il modulo
- Fourni seule la bobine, non pas le support de montage, et non pas le module
- nur die Spule geliefert wird, nicht die Montagehalterung, nicht das Modul
- Suministra sólo la bobina, no el soporte de montaje, no el módulo

⁰³ Supplied until depletion

- Fornibile fino ad esaurimento delle scorte
- Fourni jusqu'à épuisement du stock
- Lieferbar solange vorrat reicht
- Suministrado hasta el stock termina



	ohm		ohm
	0,85		11500

HYUNDAI

ATOS 1.0 i	G4HC	02/98 ⇨ 12/00
------------	------	---------------

KW 470 397



05

COILS

Adatt./Suitable:

ALFA ROMEO
46755605

BOSCH
1 227 030 071

HITACHI
133841
2503841

²⁵⁵ without spark plug connector

- senza cappuccio candela d'accensione
- sans cosse de bougie d'allumage
- ohne Zündkerzenstecker
- sin conector de bujia de encendido

³⁰¹ Paired article numbers

- N° articolo appaiato
- Numéro d'article en paire
- paarige Artikelnummer
- Referencia artículo par

470 397K



	ohm		ohm
	0,33		13500

ALFA ROMEO

147 1.6 16V T.SPARK	AR32104	01/01 ⇨ 03/10
147 1.6 16V T.SPARK ECO	AR37203	01/01 ⇨ 03/10
147 1.6 LPG	AR32104, AR37203	03/01 ⇨ 03/10
147 2.0 16V T.SPARK	AR32310	01/01 ⇨ 03/10
156 1.6 16V T.SPARK	AR32103, AR32104	09/97 ⇨ 09/05
156 1.6 16V T.SPARK.	AR32103, AR32104	05/00 ⇨ 05/06
156 1.8 16V T.SPARK	AR32201, AR32205	09/97 ⇨ 05/06
156 2.0 16V T.SPARK	AR32301, AR32310	05/00 ⇨ 06/02
156 2.0 Twin Spark	AR32303	11/97 ⇨ 04/00
166 2.0 T.SPARK	AR36301	10/00 ⇨ 06/07
GT 1.8 TS	AR32205	11/03 ⇨ 09/10
GTV 2.0 T.SPARK 16V	AR32310	06/95 ⇨ 10/05
SPIDER II 2.0 T.SPARK 16V	AR32310	06/95 ⇨ 04/05

KW 470 397K



05

COILS

Adatt./Suitable:

²⁵⁰ incl. spark plug connector

- con cappuccio candela accensione
- Cosse de bougie d'allumage comprise
- inkl. Zündkerzenstecker
- incl. conector bujias

³⁰² Paired article numbers

- N° articolo appaiato
- Numéro d'article en paire
- paarige Artikelnummer
- Referencia artículo par

470 397



	ohm		ohm
	0,33		13500

ALFA ROMEO

156 1.6 16V T.SPARK.	AR32103	05/00 ⇨ 05/06
156 2.0 16V T.SPARK	AR32310	09/97 ⇨ 06/02

KW 470 398



08,5

COILS

Adatt./Suitable:

- BOSCH**
0 221 503 014
0 221 503 471
- GENERAL MOTORS**
90 543 059
93 180 806
- HITACHI**
133815
133866
2503815
2503866
- MAGNETI MARELLI**
060717081012
060810208010
- OPEL**
12 08 028
12 08 306
90543059
93180806
- VAUXHALL**
90543059
93180806

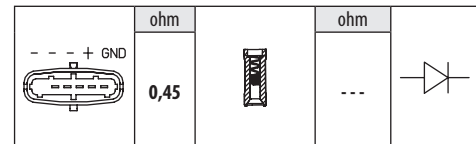

OPEL			
AGILA A 1.0	Z10XEP	08/03	⇒ 12/07
AGILA A 1.0 12V	Z10XE	09/00	⇒ 12/07
CORSA B 1.0 i 12V	X10XE	11/96	⇒ 09/00
CORSA C 1.0	1K10CT, Z10XEP	09/00	⇒ 12/09
CORSA D 1.0	Z10XEP	07/06	⇒ 08/14
VAUXHALL			
AGILA A 1.0 12V	Z10XE, Z10XEP	02/00	⇒ 11/06
CORSA B 1.0 i 12V	X10XE	11/96	⇒ 09/00
CORSA C 1.0 12V	Z10XE, Z10XEP	09/00	⇒ 10/06
CORSA D 1.0	Z10XEP	08/06	⇒ 08/14

KW 470 399



08,6

COILS

Adatt./Suitable:

- BOSCH**
0 986 221 039
- GENERAL MOTORS**
19 005 212
- HITACHI**
133809
2503809
- MAGNETI MARELLI**
060717052012
- OPEL**
12 08 307
19005212
- VAUXHALL**
19005212

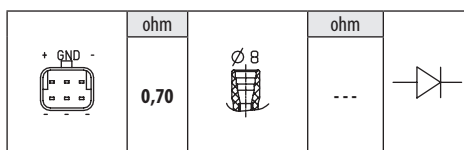

OPEL			
ASTRA G 1.4	X14XE, Z14XE	09/98	⇒ 04/05
ASTRA G 1.4 16V	X14XE, Z14XE	02/98	⇒ 01/05
ASTRA G 1.4 LPG	X14XE, Z14XE	02/98	⇒ 01/05
ASTRA G 1.6	C16SEL, Z16XE, Z16XEP	09/98	⇒ 05/04
ASTRA G 1.6 16V	X16XEL, Z16XE	02/98	⇒ 10/05
ASTRA G 1.6 CNG	Z16YNG	03/03	⇒ 07/04
ASTRA G 1.6 LPG	X16XEL, Z16XE	03/98	⇒ 01/05
ASTRA H 1.4 16V	Z14XE	05/04	⇒ 07/09
ASTRA H 1.6	Z16XE	06/04	⇒ 02/06
ASTRA H 1.6 16V	Z16XE	03/04	⇒ 01/08
ZAFIRA B 1.6 CNG	Z16YNG	07/05	⇒ 04/15
ZAFIRA B 1.6 CNG VAN	Z16YNG	07/05	⇒ 04/15
COMBO C 1.6 CNG	Y16YNG, Z16YNG	04/05	⇒ 12/11
COMBO C 1.6 CNG 16V	Y16YNG, Z16YNG	04/05	⇒
CORSA C 1.4	Z14XE	09/00	⇒ 12/09
CORSA C 1.6 CNG	Y16YNG	05/03	⇒ 12/09
CORSA C 1.6 X	Z16YNG	08/05	⇒
MERIVA A 1.6 16V	Z16XE	05/03	⇒ 01/06
VECTRA B 1.6 i 16V	X16XEL, Y16XE, Z16XE	10/95	⇒ 07/02
VECTRA C 1.6	Z16XE	08/05	⇒ 08/08
VECTRA C 1.6 16V	Z16XE	06/04	⇒ 10/05
ZAFIRA A 1.6 16V	X16XEL, Z16XE, Z16YNG	09/02	⇒ 06/05
ZAFIRA A 1.6 CNG	Z16YNG	09/01	⇒ 06/05
ZAFIRA A 1.6 LPG	X16XEL, Z16XE	10/03	⇒ 06/05
VAUXHALL			
ASTRA IV 1.4 16V	X14XE, Z14XE	02/98	⇒ 05/05
ASTRA IV 1.4 16V Dualfuel	X14XE, Z14XE	09/99	⇒ 06/03
ASTRA IV 1.6 16V	X16XEL, Z16XE	02/98	⇒ 10/05
ASTRA IV 1.6 Dualfuel	X16XEL, Z16XE	03/98	⇒ 05/05
ZAFIRA A 1.6 16V	X16XEL, Z16XE	04/99	⇒ 08/05
ZAFIRA A 1.6 CNG	Z16YNG	09/01	⇒ 06/05
ZAFIRA A 1.6 Dualfuel	X16XEL	11/98	⇒ 08/05
ASTRAVAN II 1.4 16V	Z14XE	09/00	⇒ 05/05
ASTRAVAN II 1.6 Dualfuel	Z16XE	07/00	⇒ 08/05
COMBO C 1.4 16V	Z14XE	10/01	⇒ 05/07
COMBO C 1.6 CNG	Z16YNG	04/05	⇒ 02/12
COMBO C 1.6 CNG 16V	Y16YNG, Z16YNG	04/05	⇒ 02/12
CORSA C 1.4 16V	Z14XE	09/00	⇒ 10/06
MERIVA I 1.6 i 16V	Z16XE	01/03	⇒ 09/05
VECTRA B 1.6 i 16V	X16XEL, Y16XE, Z16XE	08/95	⇒ 03/02
VECTRA C 1.6 16V	Z16XE	06/04	⇒ 07/08
ZAFIRA B 1.6 CNG	Z16YNG	07/05	⇒ 11/14

KW 470 400



08,5

COILS

Adatt./Suitable:

- BOSCH**
0 221 503 015
0 221 503 472
- GENERAL MOTORS**
24 420 584
90 543 253
93 177 212
- HITACHI**
133816
133839
2503816
2503839
- MAGNETI MARELLI**
060717065012
060717133012
- OPEL**
12 08 012
12 08 020
90543253
93177212
- VAUXHALL**
90543253
93177212

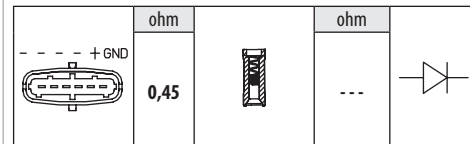

OPEL			
AGILA A 1.2 16V	Z12XE	09/00	⇒ 12/07
AGILA A 1.2 16V Twinport	Z12XEP	07/04	⇒ 12/07
ASTRA G 1.2	X12XE	09/98	⇒ 08/00
ASTRA G 1.2 16V	X12XE, Z12XE	09/00	⇒ 01/05
ASTRA G 1.4	Z14XEP	09/07	⇒ 12/09
ASTRA H 1.2	Z12XEP	08/05	⇒ 10/10
ASTRA H 1.4	Z14XEL, Z14XEP	03/04	⇒ 10/10
ASTRA H 1.4 EcoTec	Z14XEP	12/04	⇒ 12/12
ASTRA H 1.4 LPG	Z14XEP	08/09	⇒ 10/10
ASTRA J 1.4	Z14XEP	01/09	⇒
COMBO C 1.4	Z14XEP	10/04	⇒ 12/11
COMBO C 1.4 16V	Z14XEP	08/05	⇒
CORSA B 1.2 i 16V	X12XE	03/98	⇒ 09/00
CORSA C 1.2	Z12XE	09/00	⇒ 12/09
CORSA C 1.2 16V	Z12XE	09/00	⇒ 07/03
CORSA C 1.2 Twinport	Z12XEP	07/04	⇒ 12/09
CORSA C 1.4	Z14XEP	08/03	⇒ 06/12
CORSA C 1.4 Twinport	Z14XEP	06/03	⇒ 12/09
CORSA D 1.2	Z12XEP	07/06	⇒ 08/14
CORSA D 1.2 LPG	Z12XEP	08/06	⇒ 08/14
CORSA D 1.4	Z14XEP	07/06	⇒ 08/14
CORSA D 1.4 LPG	Z14XEP	08/06	⇒ 12/11
MERIVA A 1.4 16V Twinport	Z14XEP	07/04	⇒ 05/10
MERIVA A 1.4 16V Twinport LPG	Z14XEP	07/04	⇒ 05/10
TIGRA B 1.4	Z14XEP	06/04	⇒ 12/10
VAUXHALL			
AGILA A 1.2 16V	Z12XE	09/00	⇒ 03/08
AGILA A 1.2 16V Twinport	Z12XEP	07/04	⇒ 11/06
ASTRA IV 1.2 16V	X12XE, Z12XE	09/00	⇒ 05/05
ASTRA V 1.2	Z12XEP	08/05	⇒ 10/10
ASTRA V 1.4	Z14XEL, Z14XEP	01/04	⇒ 10/10
ASTRA V 1.4 i 16V	Z14XEP	03/05	⇒ 11/10
COMBO C 1.4	Z14XEP	10/04	⇒ 09/10
COMBO C 1.4 i 16V	Z14XEP	01/04	⇒ 11/11
CORSA B 1.2 i 16V	X12XE	03/98	⇒ 09/00
CORSA C 1.2 16V	Z12XE	09/00	⇒ 10/06
CORSA C 1.2 16V Dualfuel	Z12XE	08/01	⇒ 10/06
CORSA C 1.2 Twinport	Z12XEP	07/04	⇒ 10/06
CORSA C 1.4 Twinport	Z14XEP	06/03	⇒ 10/06
CORSA D 1.2	Z12XEP	08/06	⇒ 08/14
CORSA D 1.2 LPG	Z12XEP	09/09	⇒ 08/14
CORSA D 1.4	Z14XEP	08/06	⇒ 08/14
CORSA D 1.4 LPG	Z14XEP	07/06	⇒ 08/14
CORSAVAN II 1.2 16V	Z12XE, Z12XEP	09/00	⇒ 11/06

VAUXHALL		
CORSAVAN II 1.2 16V Dualfuel	Z12XE, Z12XEP	08/01 ⇨ 06/06
CORSAVAN II 1.4	Z14XEP	11/03 ⇨ 06/06
CORSAVAN III 1.2	Z12XEP	07/09 ⇨
ASTRAVAN III 1.4 i	Z14XEP	03/05 ⇨
MERIVA I 1.4 16V Twinport	Z14XEP	01/03 ⇨ 06/10
TIGRA B 1.4	Z14XEP	06/04 ⇨ 08/09

KW 470 405  **08,6**

COILS
Adatt./Suitable:
BOSCH
0 986 221 035
0 986 221 084
CITROËN
5970 78
5970 79
5970 90
5970 97
5970 A8
96 358 647 80
96 358 649 80
96 548 144 80

ELECTRICFIL
15 43 02
FIAT
9467511580
9654347080

HITACHI
133818
2503818

MAGNETI MARELLI
060717030012

PEUGEOT
5970 78
5970 79
5970 90
5970 97
5970 A8
5979 A8

SAGEM
26951960-3

KW 470 403  **08,5**

COILS
Adatt./Suitable:
BOSCH
0 986 221 034

CITROËN
5970 72
5970 74
5970 A9
96 246 755 80
96 281 585 80

ELECTRICFIL
15 43 01



HITACHI
133817
2503817

MAGNETI MARELLI
060717031012



PEUGEOT
5970 72
5970 74
5970 A9
96 246 755 80
96 281 585 80

SAGEM
2 526 117 A



	ohm		ohm
	0,53		12000



	ohm		ohm
	0,65		21000

CITROËN		
XSARA 1.4	KFX(TU3JP)	05/98 ⇨ 10/04
XSARA 1.4 i	KFW(TU3JP), KFX(TU3JP)	04/97 ⇨ 08/05
XSARA 1.4 LPG	KFW(TU3JP), KFX(TU3JP)	05/98 ⇨ 08/00
XSARA 1.6 i	NFZ(TU5JP)	04/97 ⇨ 09/00
BERLINGO I 1.4 BiFuel	KFW(TU3JP)	07/96 ⇨ 10/02
BERLINGO I 1.4 bivalent	KFW(TU3JP)	11/02 ⇨ 12/11
BERLINGO I 1.4 i	KFW(TU3JP), KFX(TU3JP)	07/96 ⇨ 12/11
BERLINGO I 1.4 i bivalent	KFW(TU3JP)	04/03 ⇨ 10/08
SAXO 1.4 VTS	KFW(TU3JP), KFX(TU3JP)	05/96 ⇨ 06/03
SAXO 1.6	NFZ(TU5JP)	02/96 ⇨ 06/03
SAXO 1.6 VTL, VTR	NFZ(TU5JP)	05/96 ⇨ 06/03
XSARA PICASSO 1.6	NFZ(TU5JP)	06/02 ⇨ 08/05

PEUGEOT		
106 II 1.4 i	KFW(TU3JP), KFX(TU3JP)	05/96 ⇨ 07/04
206 1.1	HFX(TU1JP)	08/98 ⇨ 02/07
206 1.1 i	HFX(TU1JP), HFZ(TU1JP)	09/98 ⇨ 02/07
206 1.4 i	K6C(TU3JP), KFX(TU3JP)	09/98 ⇨
206 1.6 8V	NFZ(TU5JP)	05/99 ⇨ 10/03
206 1.6 i	NFZ(TU5JP)	09/98 ⇨ 12/00
306 1.4	KFW(TU3JP), KFX(TU3JP)	04/93 ⇨ 04/02
306 1.4 SL	KFW(TU3JP), KFX(TU3JP)	06/94 ⇨ 05/01
306 1.6	NFZ(TU5JP)	05/93 ⇨ 10/00
306 1.6 SR	NFZ(TU5JP)	06/94 ⇨ 10/00
RANCH 1.4	K6C(TU3JP), KFX(TU3JP)	06/96 ⇨

CITROËN		
C2 1.1	HFX(TU1JP)	09/03 ⇨ 09/12
C2 1.4	KFW(TU3JP)	09/03 ⇨ 12/09
C3 I PLURIEL 1.4	KFW(TU3A), KFX(TU3JP)	05/03 ⇨
C3 I PLURIEL 1.4 Hybrid	KFW(TU3JP)	05/05 ⇨
C3 II 1.1 BiFuel	HFX(TU1A)	11/10 ⇨
C3 II 1.1 i	HFV(TU1A), HFX(TU1A)	09/09 ⇨ 01/13
C3 II 1.4	K6E(TU3A), KFT(TU3A), KFT(TU3AE5), TU3AE5	11/09 ⇨
C3 II 1.4 LPG	KFT(TU3A)	07/10 ⇨
C3 I 1.1 i	HFX(TU1A), HFX(TU1JP)	02/02 ⇨
C3 I 1.1 LPG	HFX(TU1A)	06/06 ⇨ 12/09
C3 I 1.4 BiFuel	KFW(TU3JP)	09/08 ⇨ 12/09
C3 I 1.4 i	KFW(TU3A), KFX(TU3JP)	02/02 ⇨ 11/10
C3 I 1.4 i Bivalent	KFW(TU3JP)	02/02 ⇨
XSARA 1.4	KFX(TU3JP)	05/98 ⇨ 03/05
XSARA 1.4 i	KFW(TU3JP), KFX(TU3JP)	04/97 ⇨ 08/05
BERLINGO I 1.1 i	HFX(TU1JP)	07/96 ⇨ 05/08
BERLINGO I 1.4	K6D(TU3A), KFW(TU3A), KFW(TU3JP)	11/02 ⇨
BERLINGO I 1.4 BiFuel	KFW(TU3JP)	07/96 ⇨ 10/02
BERLINGO I 1.4 bivalent	KFW(TU3JP)	11/02 ⇨ 12/11
BERLINGO I 1.4 CNG	KFW(TU3JP)	11/02 ⇨ 03/08
BERLINGO I 1.4 GNC	KFW(TU3JP)	11/02 ⇨
BERLINGO I 1.4 Hybrid	KFW(TU3JP)	05/05 ⇨
BERLINGO I 1.4 i	KFW(TU3JP), KFX(TU3JP)	07/96 ⇨ 12/11
BERLINGO I 1.4 i bivalent	KFW(TU3JP)	04/03 ⇨ 10/08
NEMO 1.4	KFT(TU3A), KFX(TU3A), TU3AE5	02/08 ⇨
SAXO 1.1 X, SX	HFX(TU1JP)	05/96 ⇨ 09/03
SAXO 1.4 VTS	KFW(TU3JP), KFX(TU3JP)	05/96 ⇨ 06/03
SAXO 1.6	NFT(TU5JP)	02/01 ⇨ 04/04
SAXO 1.6 VTS	NFT(TU5JP)	09/00 ⇨ 09/03
XSARA PICASSO 1.6	NFV(TU5JP)	12/99 ⇨ 12/10
XSARA PICASSO 1.6 Chrono	NFV(TU5JP)	04/01 ⇨ 10/04
FIAT		
FIORINO III 1.4	KFT, KFX	11/07 ⇨
QUBO 1.4	KFT, KFX	02/08 ⇨
PEUGEOT		
106 II 1.1 i	HFX(TU1JP)	05/96 ⇨ 07/04

PEUGEOT		
106 II 1.4 i	KFW(TU3JP), KFX(TU3JP)	05/96 ⇨ 07/04
206 1.1	HFX(TU1JP)	08/98 ⇨ 02/07
206 1.1 i	HFX(TU1JP), HFZ(TU1JP)	09/98 ⇨ 02/07
206 1.4	KFW(TU3A), KFX(TU3JP)	07/02 ⇨
206 1.4 CNG	KFW(TU3A)	05/06 ⇨ 09/07
206 1.4 i	K6D(TU3A), K6D(TU3JP), KFW(TU3A), KFW(TU3JP), TU3AF	04/05 ⇨
206 1.4 LPG	KFW(TU3JP)	07/02 ⇨ 09/07
207 1.4	KFT(TU3A), KFT(TU3AE5), KFW(TU3A), KFW(TU3A)	02/06 ⇨ 12/15
207 1.4 BiFuel	KFW(TU3A)	08/07 ⇨ 12/13
207 1.4 Flex	KFW(TU3A)	11/08 ⇨ 12/14
207 1.4 LPG	KFW(TU3A)	08/07 ⇨ 12/12
306 1.4	KFW(TU3JP), KFX(TU3JP)	04/93 ⇨ 04/02
306 1.4 SL	KFW(TU3JP), KFX(TU3JP)	06/94 ⇨ 05/01
306 1.6	NFT(TU5JP)	10/00 ⇨ 04/02
307 1.4	K6D(TU3JP), KFW(TU3JP)	08/00 ⇨
206+ 1.1	HFX(TU1A)	01/09 ⇨ 06/13
206+ 1.1 LPG	HFX(TU1A), HFX(TU1JP)	04/09 ⇨ 06/13
206+ 1.4 i	K6D(TU3A), KFT(TU3AE5), KFW(TU3A), TU3AE5	01/09 ⇨
1007 1.4	KFW(TU3A), KFX(TU3JP)	04/05 ⇨
BIPPER 1.4	KFW(TU3A), TU3AE5	02/08 ⇨
BIPPER TEPEE 1.4	KFW(TU3A)	04/08 ⇨
PARTNER I 1.1	HDZ(TU1M), HFX(TU1JP)	06/96 ⇨ 10/02
PARTNER I 1.4	K6D(TU3A), KFW(TU3JP)	11/02 ⇨
PARTNER I 1.4 BiFuel	KFW(TU3JP)	04/03 ⇨ 10/06
PARTNER ORIGIN 1.4	KFW(TU3JP)	07/08 ⇨ 12/15
RANCH 1.1	HFX(TU1JP)	06/96 ⇨
RANCH 1.4	K6D(TU3A), K6D(TU3JP), KFW(TU3A), KFW(TU3JP)	04/05 ⇨
RANCH 1.4 BiFuel	KFW(TU3JP)	04/03 ⇨

KW 470 407  **08,6**

COILS
Adatt./Suitable:
CITROËN
5970 80
5970 99
96 363 378 80



HITACHI
133819
2503819

MAGNETI MARELLI
060717082012

PEUGEOT
5970 80
5970 99

SAGEM
2 526 182 A
2 526 182 B



	ohm		ohm
	0,54		18600

CITROËN		
C2 1.6	NFU(TU5JP4)	07/03 ⇨ 10/10
C2 1.6 VTS	NFS(TU5JP4S)	10/04 ⇨ 12/09
C3 I PLURIEL 1.6	NFU(TU5JP4)	05/03 ⇨
C4 I 1.6 16V	NFU(TU5JP4)	11/04 ⇨ 07/11
C4 I 1.6 16V Bio-Flex	N6A(TU5JP4), NFU(TU5JP4)	09/07 ⇨
C4 I 1.6 16V Flex Fuel	N6A(TU5JP4)	02/09 ⇨
C4 I 1.6 Flex	--	02/09 ⇨ 07/11
C3 II 1.6 Flex	NFX(TU5JP4)	11/09 ⇨
C4 II 1.6 Flex	NFX(TU5JP4)	11/09 ⇨
C3 I 1.6 16V	N6A(TU5JP4), NFU(TU5JP4)	02/02 ⇨
XSARA 1.6 16V	NFU(TU5JP4)	09/00 ⇨ 08/05
BERLINGO II 1.6	N6A(TU5JP4), NFR(TU5JP4B), NFU(TU5JP4)	04/08 ⇨
BERLINGO I 1.6 16V	NFU(TU5JP4)	10/00 ⇨ 12/11

470 408

CITROËN		
XSARA PICASSO 1.6 16V	NGA(TU5JP4), NFU(TU5JP4)	03/05 →
PEUGEOT		
206 1.6	NFU(TU5JP4)	09/01 → 12/08
206 1.6 16V	NGA(TU5JP4), NFU(TU5JP4)	07/00 →
206 1.6 BiFuel	NFU(TU5JP4)	07/00 → 04/09
206 1.6 LPG	NFU(TU5JP4)	07/02 →
207 1.6	NGA(TU5JP4)	08/08 →
207 1.6 16V	NFU(TU5JP4)	02/06 → 10/13
207 1.6 Bioflex	NGA(TU5JP4)	01/08 → 12/13
308 I 1.6 16V	NGA(TU5JP4)	07/08 →
308 I 1.6 Bioflex	NGA(TU5JP4), NFU(TU5JP4)	04/08 →
307 1.6	NFU(TU5JP4)	07/06 → 04/12
307 1.6 16V	NGA(TU5JP4), NFU(TU5JP4)	08/00 →
307 1.6 BioFlex	-, NGA(TU5JP4), NFU(TU5JP4)	07/06 →
206+ 1.6 16V	NFU(TU5JP4)	07/10 →
1007 1.6 16V	NFU(TU5JP4)	04/05 →
PARTNER I 1.6	NGA(TU5JP4)	09/00 →
PARTNER I 1.6 16V	NFU(TU5JP4)	07/01 → 03/08
PARTNER I 1.6 Bioflex	NFU(TU5JP4)	09/00 → 10/02
PARTNER I 1.6 Flexfuel	NFU(TU5JP4)	09/00 → 10/02
PARTNER II 1.6	NFR(TU5JP4B), NFU(TU5JP4)	04/08 →
PARTNER II TEEPEE 1.6 VTi	NFR(TU5JP4B), NFU(TU5JP4)	04/08 →
PARTNER ORIGIN 1.6	NFU(TU5JP4)	09/11 → 12/15
PARTNER ORIGIN 1.6 16V	NFU(TU5JP4)	09/11 → 12/13
RANCH 1.6 16V	NGA(TU5JP4), NFU(TU5JP4)	07/01 →

KW 470 408  **08,7**

COILS
Adatt./Suitable:

BOSCH
0 986 22A 206

CITROËN
5970 75
5970 98
8970 98
96 341 314 80

FIAT
9463264180
9634131380

HITACHI
133883
2503883

LANCIA
9463264180
9634131380

MAGNETI MARELLI
060717104012

PEUGEOT
5970 75
5970 98

SAGEM
2 526 118 A

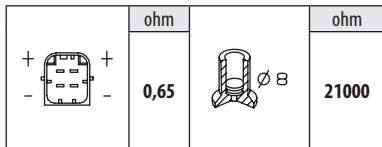

CITROËN		
C4 I 2.0 16V	RFN(EW10J4)	11/04 → 07/07
XSARA 2.0 16V	RFN(EW10J4)	09/00 → 08/05
C5 I 1.8	6FZ(EW7J4)	09/04 → 08/05
C5 I 1.8 16V	6FZ(EW7J4)	03/01 →
C5 I 2.0 16V	RFN(EW10J4)	03/01 → 08/04
C8 2.0	RFN(EW10J4)	07/02 →
EVASION 2.0 16V	RFN(EW10J4)	05/00 → 07/02
JUMPY I 2.0	RFN(EW10J4)	04/00 → 12/06
JUMPY I 2.0 i 16V	RFN(EW10J4)	03/00 → 10/06
XSARA PICASSO 1.8 16V	6FZ(EW7J4)	02/00 → 08/05
XSARA PICASSO 2.0	RFN(EW10J4)	02/04 → 10/04
XSARA PICASSO 2.0 16V	RFN(EW10J4)	01/03 → 06/12

FIAT		
ULYSSE I 2.0 16V	RFN(EW10J4)	09/00 → 08/02
SCUDO 2.0	RFN	09/99 → 10/06
SCUDO I 2.0	RFN, RFN(EW10J4)	05/00 → 12/06
SCUDO I 2.0 16V	RFN, RFN(EW10J4)	06/00 → 12/06
ULYSSE II 2.0	RFN, RFN(EW10J4)	08/02 → 06/11
LANCIA		
PHEDRA 2.0	RFN, RFN(EW10J4)	09/02 → 11/10
PEUGEOT		
206 2.0 16V	RFN(EW10J4)	07/02 → 02/07
206 2.0 516	RFN(EW10J4), RFR(DEW10J4), RFR(EW10J4)	04/99 → 12/07
307 2.0	RFN(EW10J4)	03/02 → 06/05
307 2.0 16V	RFN(EW10J4)	08/00 → 04/08
406 1.8 16V	6FZ(EW7J4)	10/00 → 10/04
406 1.8 BiFuel	6FZ(EW7J4)	09/00 → 05/04
406 2.0 16V	RFN(EW10J4), RFR(DEW10J4), RFR(EW10J4), RFV(XU10J4R)	08/00 → 12/04
EXPERT I 2.0	RFN(EW10J4)	07/00 → 12/06
407 1.8	6FZ(EW7J4)	03/04 → 07/05
407 1.8 16V	6FY(EW7A)	08/05 → 12/10
407 2.0	RFN(EW10J4)	03/04 → 07/05
607 2.0	RFN(EW10J4)	02/00 → 08/05
806 2.0	RFN(EW10J4)	05/00 → 02/03
806 2.0 16V	RFN(EW10J4)	09/00 → 08/02
807 2.0	RFN(EW10J4)	06/02 →

KW 470 412  **05**

COILS
Adatt./Suitable:

BOSCH
0 221 504 410
0 221 504 474

00 Eliminated on 17-11-2020. Please verify the availability through our local distributors

- Eliminato il 17-11-2020. Verificare la disponibilità presso i nostri distributori
- Éliminé le 17-11-2020. Vérifier la disponibilité auprès de nos distributeurs sur place
- Am 17-11-2020 gestrichen. Evtl. Verfügbarkeit bitte bei unseren Händlern prüfen
- Eliminado en fecha 17-11-2020. Verificar la disponibilidad a través de nuestros distribuidores locales

- 250 incl. spark plug connector**
- con cappuccio candela accensione
 - Cousse de bougie d'allumage comprise
 - inkl. Zündkerzenstecker
 - incl. conector bujías

- 302 Paired article numbers**
- N° articolo appaiato
 - Numéro d'article en paire
 - paarige Artikelnummer
 - Referencia artículo par

470 1625

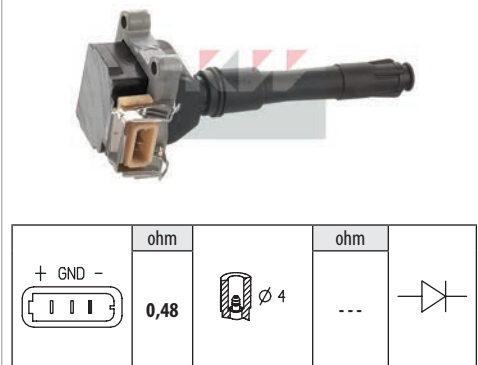

BMW		
3 III 320 i	M50B20(206S1), M50B20(206S2), M52B20(206S3)	01/91 → 11/99
3 III 325 i	M50B25(256S1), M50B25(256S2)	09/90 → 12/95
3 III M3 3.0	S50B30(306S1)	11/92 → 07/95
5 III 520 i	M50B20(206S1), M50B20(206S2)	07/91 → 07/96
5 III 520 i 24V	M50B20(206S1), M50B20(206S2)	04/90 → 08/95

BMW		
5 III 525 i	M50B25(256S1), M50B25(256S2)	07/91 → 07/96
5 III 525 i 24V	M50B25(256S2)	03/90 → 08/95
5 III 525 ix	M50B25(256S1)	01/92 → 03/96
5 III 525 ix 24V	M50B25(256S1), M50B25(256S2)	10/91 → 08/95
5 III 530 i	M60B30(308S1)	09/92 → 07/96
5 III 530 i V8	M60B30(308S1)	09/92 → 12/95
5 III 540 i	M60B40(408S1)	09/93 → 07/96
5 III 540 i V8	M60B40(408S1)	09/92 → 12/95
7 III 730 i, iL V8	M60B30(308S1)	04/92 → 09/94
7 III 740 i, iL V8	M60B40(408S1)	05/92 → 03/94
7 III 730 i, iL	M60B30(308S1)	03/94 → 02/96
7 III 740 i, iL	M60B40(408S1)	03/94 → 02/96
8 840 i	M60B40(408S1)	03/93 → 02/96

KW 470 413  **05**

COILS
Adatt./Suitable:

LAND ROVER
NEC101010L

MG
NEC101000
NEC101010

ROVER
NEC101000
NEC10100SLP
NEC101010

00 Eliminated on 17-11-2020. Please verify the availability through our local distributors

- Eliminato il 17-11-2020. Verificare la disponibilità presso i nostri distributori
- Éliminé le 17-11-2020. Vérifier la disponibilité auprès de nos distributeurs sur place
- Am 17-11-2020 gestrichen. Evtl. Verfügbarkeit bitte bei unseren Händlern prüfen
- Eliminado en fecha 17-11-2020. Verificar la disponibilidad a través de nuestros distribuidores locales

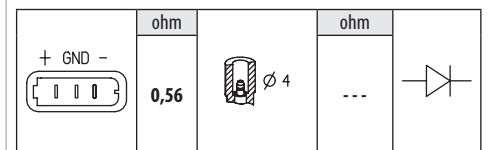

BMW		
3 III 320 i	M50B20(206S1), M50B20(206S2), M52B20(206S3)	01/91 → 11/99
3 III 323 i	M52B25(256S3)	05/95 → 11/99
3 III 323 ti	M52B25(256S3)	09/97 → 08/00
3 III 328 i	M52B28(286S1)	01/95 → 11/99
3 III M3 3.2	S50B32(326S1)	10/95 → 09/99
3 IV 320 Ci	M52B20(206S4), M54B22(226S1)	01/00 → 12/07
3 IV 320 i	M52B20(206S4), M54B22(226S1)	09/00 → 02/05
3 IV 323 Ci	M52B25(256S4)	04/99 → 09/00
3 IV 323 i	-(246S3), M52B25(256S4)	03/98 → 12/03
3 IV 325 Ci	M54B25(256S5)	09/00 →
3 IV 325 i	-(246S4), M54B25(256S5), M56256S6	09/00 →
3 IV 325 ti	M54B25(256S5)	04/01 → 12/04
3 IV 325 xi	M54B25(256S5)	09/00 → 02/05
3 IV 328 Ci	M52B28(286S2)	12/98 → 05/00
3 IV 328 i	M52B28(286S2)	02/98 → 06/00
3 IV 330 Ci	M54B30(306S3)	06/00 → 08/06
3 IV 330 i	M54B30(306S3)	06/00 → 02/05
3 IV 330 xi	M54B30(306S3)	06/00 → 07/06
5 IV 520 i	M54B22(226S1)	09/00 → 12/03
5 IV 523 i	M52B25(256S3)	09/95 → 08/00
5 IV 525 i	M54B25(256S5)	09/00 → 05/04
5 IV 528 i	M52B28(286S1), M52B28(286S2)	09/95 → 08/00
5 IV 530 i	M54B30(306S3)	09/00 → 12/03
5 IV 535 i	M62B35(358S2)	06/96 → 08/98
5 IV 540 i	M62B44(448S1), M62B44(448S2)	03/96 → 12/03
5 IV M5	S62B50(508S1)	10/98 → 06/03
7 III 728 i, iL	M52B28(286S1), M52B28(286S2)	08/95 → 11/01
7 III 728i X	M52B28(286S1)	11/95 → 09/01
7 III 735 i, iL	M62B35(358S1)	03/96 → 08/98

BMW		
7 III 740 i, iL	M62B44(44851), M62B44(44852)	02/96 ⇨ 07/01
8 840 Ci	M62B44(44851)	03/96 ⇨ 06/99
Z3 2.0 i	M52B20(20654)	04/99 ⇨ 01/03
Z3 2.2 i	M54B22(22651)	08/00 ⇨ 01/03
Z3 2.8 i	M52B28(28651), M52B28(28652)	01/96 ⇨ 07/00
Z3 3.0 i	M54B30(30653)	06/00 ⇨ 06/03
Z3 M	S50B32(32651)	02/98 ⇨ 06/01
Z3 M 3.2	S50B32(32651)	01/97 ⇨ 06/00
Z8 4.9	S62B50(50851)	01/00 ⇨ 12/03
X5 I 3.0 i	M54B30(30653)	04/00 ⇨ 12/06
X5 I 4.4 i	M62B44(44852)	01/00 ⇨ 09/03
X5 I 4.6 is	M62B46(46851)	10/01 ⇨ 09/03

LAND ROVER		
DEFENDER 2.8 90, 110	--	09/00 ⇨
FREELANDER 2.5 V6 4x4	25KV6	11/00 ⇨ 10/06

MG		
MG ZS 180	25K4F	07/01 ⇨ 10/05

ROVER		
45 2.0V6	20K4F	02/00 ⇨ 05/05

KW 470 414

05

COILS

Adatt./Suitable:

BOSCH

0 221 503 022

MERCEDES-BENZ

A 000 158 77 03

A 160 158 77 03

SMART

Q 0003100V004000000

Q 0003100V005000000

Eliminated on 16-12-2019. Please verify the availability through our local distributors

• Eliminato il 16-12-2019. Verificare la disponibilità presso i nostri distributori

• Éliminé le 16-12-2019. Vérifier la disponibilité auprès de nos distributeurs sur place

• Am 16-12-2019 gestrichen. Evtl. Verfügbarkeit bitte bei unseren Händlern prüfen

• Eliminado en fecha 16-12-2019. Verificar la disponibilidad a través de nuestros distribuidores locales



	ohm		ohm	
	0,45		...	

SMART

CABRIO 0.6	M160E6ALB03, M160E6ALB05, M160.910, M160.920	03/00 ⇨ 01/04
CABRIO 0.7	M160.910, M160.920	01/03 ⇨ 01/04
CITY COUPE 0.6	M160.910	12/99 ⇨ 04/03
CITY-COUPE 0.6	M160E6ALB03, M160E6ALB04, M160E6ALB05, M160.910, M160.920	01/01 ⇨ 01/04
CITY-COUPE 0.7	M160.910, M160.920	01/03 ⇨ 01/04
CROSSBLADE 0.6	M160.910, M160.920	06/02 ⇨ 12/03
FORTWO I 0.6	M160.910	01/04 ⇨ 02/07
FORTWO I 0.7	M160.910, M160.920	01/04 ⇨ 01/07
ROADSTER 0.7	M160.921, M160.922	04/03 ⇨ 11/05
ROADSTER 0.7 Brabus	M160.923	12/03 ⇨ 11/05

KW 470 416

07

COILS

Adatt./Suitable:

BOSCH

F 000 Z50 206 *4

F 000 Z50 207

FIAT

46752948 *4

HITACHI

138878

2508878

Eliminated on 23-02-2022. Please verify the availability through our local distributors

• Eliminato il 23-02-2022. Verificare la disponibilità presso i nostri distributori

• Éliminé le 23-02-2022. Vérifier la disponibilité auprès de nos distributeurs sur place

• Am 23-02-2022 gestrichen. Evtl. Verfügbarkeit bitte bei unseren Händlern prüfen

• Eliminado en fecha 23-02-2022. Verificar la disponibilidad a través de nuestros distribuidores locales

***Supplied coil only-not alu cast**

• Fornita solo la bobina, non la fusione in alluminio

• Fourni seulement la bobine, non pas la fusion en alu

• Nur Zündspule alleine geliefert-ohne Gussteil

• Suministrada solamente bobina, no la fundición



	ohm		ohm
	0,5		13000

FIAT

PALIO 1.0 MPI	178F1.011	11/03 ⇨ 07/05
PALIO 1.2 16V	178D7.055	06/05 ⇨
SIENA 1.2 16V	178D7.055	01/02 ⇨
SIENA 1.3	188A5.000	09/01 ⇨ 12/09

FIAT (BR)

PALIO 1.0i 16v	1.0Mpi16vFire	01/01 ⇨
PALIO 1.3i 16v	1.3Mpi16vFire	01/00 ⇨
SIENA 1.3i 16v	1.3MpiFire	01/00 ⇨ 12/00

KW 470 417

05

COILS

Adatt./Suitable:

BOSCH

0 221 503 035

0 221 503 036

CHRYSLER

5098138AA

HITACHI

138709

2508709

MAGNETI MARELLI

060717163012

MAN

51.25919-0016

MERCEDES-BENZ

A 000 158 73 03

A 000 158 78 03

SCANIA

1789358



	ohm		ohm	
	0,53		...	

CHRYSLER

CROSSFIRE 3.2	EGX	07/03 ⇨ 12/08
CROSSFIRE SRT-6	EGZ	09/04 ⇨ 12/07

MAN

LION'S CITY	D0826LUH, E2876LUH02, E2876LUH03	05/07 ⇨
NG	E2866DUH01, E2876LUH02	05/07 ⇨ 07/99
NL	E2866DUH01, E2866DUH02, E2866DUH03, E2866LUH02, E2876LUH02	05/07 ⇨ 07/99

MERCEDES-BENZ

CITARO	M476.930, M476.932, M476.933, M476.934	04/00 ⇨
CLASSE A II A 150	M266.920	09/04 ⇨ 06/12
CLASSE A II A 160	M266.920	04/09 ⇨ 06/12
CLASSE A II A 170	M266.940	09/04 ⇨ 06/12
CLASSE A II A 180	M266.940	04/09 ⇨ 06/12
CLASSE A II A 200	M266.960	09/04 ⇨ 06/12
CLASSE A II A 200 TURBO	M266.980	09/05 ⇨ 06/12
CLASSE B I B 150	M266.920	03/05 ⇨ 11/11
CLASSE B I B 160	M266.920	04/09 ⇨ 11/11
CLASSE B I B 170	M266.940	03/05 ⇨ 11/11
CLASSE B I B 170 NGT	M266.960, M266960NGT	04/08 ⇨ 11/11
CLASSE B I B 180	M266.940	04/09 ⇨ 11/11
CLASSE B I B 180 NGT	M266.960, M266960NGT	04/08 ⇨ 11/11
CLASSE B I B 200	M266.960	03/05 ⇨ 11/11
CLASSE B I B 200 TURBO	M266.980	03/05 ⇨ 11/11
CLASSE C I C 240	M112.910	06/97 ⇨ 05/00
CLASSE C I C 240 T	M112.910, M112.915	09/00 ⇨ 03/01
CLASSE C I C 280	M112.920	06/97 ⇨ 05/00
CLASSE C I C 280 T	M112.920	06/97 ⇨ 03/01
CLASSE C I C 43 AMG	M113.944	08/97 ⇨ 03/01
CLASSE C II C 240	M112.912	05/00 ⇨ 08/07
CLASSE C II C 240 4-matic	M112.916	07/02 ⇨ 08/07
CLASSE C II C 32 AMG Kompressor	M112.961	02/01 ⇨ 08/07
CLASSE C II C 320	M112.946	05/00 ⇨ 05/08
CLASSE C II C 320 4-matic	M112.953	07/02 ⇨ 08/07
CLASSE C II C 55 AMG	M113.988	02/04 ⇨ 08/07
CLASSE CLK I 320	M112.940	06/97 ⇨ 06/02
CLASSE CLK I 430	M113.943	07/98 ⇨ 06/02
CLASSE CLK I 55 AMG	M113.984	01/00 ⇨ 12/03
CLASSE CLK II 240	M112.912	06/02 ⇨ 05/09
CLASSE CLK II 320	M112.955	06/02 ⇨ 05/09
CLASSE CLK II 500	M113.968	06/02 ⇨ 05/09
CLASSE CLK II 55 AMG	M113.987	09/02 ⇨ 05/09
CLASSE CLK II CLK 240	M112.912	02/03 ⇨ 03/10
CLASSE CLK II CLK 320	M112.955	02/03 ⇨ 03/10
CLASSE CLK II CLK 500	M113.968	02/03 ⇨ 03/10

MERCEDES-BENZ

CLASSE CLK II CLK 55 AMG	M113.987	06/02 → 03/10
CLASSE CLS I CLS 500	M113.967	10/04 → 12/10
CLASSE CLS I CLS 55 AMG	M113.990	01/05 → 12/10
CLASSE E II E 240	M112.911, M112.914	08/00 → 03/02
CLASSE E II E 240 T	M112.911, M112.914	08/00 → 03/03
CLASSE E II E 280	M112.921	12/96 → 03/02
CLASSE E II E 280 4-matic	M112.921	12/96 → 03/02
CLASSE E II E 280 T	M112.921	12/96 → 03/03
CLASSE E II E 280 T 4-matic	M112.921	12/96 → 03/03
CLASSE E II E 320	M112.941	06/97 → 03/02
CLASSE E II E 320 4-matic	M112.941	06/97 → 03/02
CLASSE E II E 320 T	M112.941	12/96 → 03/03
CLASSE E II E 320 T 4-matic	M112.941	12/96 → 03/03
CLASSE E II E 430	M113.940	06/97 → 03/02
CLASSE E II E 430 4-matic	M113.940	05/99 → 03/02
CLASSE E II E 430 T	M113.940	06/97 → 03/03
CLASSE E II E 430 T 4-matic	M113.940	05/99 → 03/03
CLASSE E II E 55 AMG	M113.980	08/97 → 03/02
CLASSE E II E 55 T AMG	M113.980	08/97 → 03/03
CLASSE E III E 240	M112.913	03/02 → 12/08
CLASSE E III E 240 4-matic	M112.917	03/03 → 12/08
CLASSE E III E 240 T	M112.913	03/03 → 07/09
CLASSE E III E 240 T 4-matic	M112.917	07/03 → 07/09
CLASSE E III E 320	M112.949	03/02 → 12/08
CLASSE E III E 320 4-matic	M112.954	03/03 → 12/08
CLASSE E III E 320 T	M112.949	03/03 → 07/09
CLASSE E III E 320 T 4-matic	M112.954	07/03 → 07/09
CLASSE E III E 500	M113.967	03/02 → 12/08
CLASSE E III E 500 4-matic	M113.969	10/03 → 12/08
CLASSE E III E 500 T	M113.967	10/03 → 07/09
CLASSE E III E 500 T 4-matic	M113.969	10/03 → 07/09
CLASSE E III E 55 AMG	M113.990	10/02 → 12/08
Kompressor		
CLASSE E III E 55 T AMG	M113.990	07/03 → 07/09
Kompressor		
CLASSE E E 280	M112.921	07/99 → 11/02
CLASSE G II G 320	M112.945	06/97 → 11/97
CLASSE G II G 500	M113.962	04/98 →
CLASSE G II G 55 AMG	M113.962, M113.982, M113.993	04/98 →
CLASSE M I ML 320	M112.942	02/98 → 08/02
CLASSE M I ML 350	M112.970	08/02 → 06/05
CLASSE M I ML 430	M113.942	02/98 → 06/05
CLASSE M I ML 500	M113.965	09/01 → 06/05
CLASSE M I ML 55 AMG	M113.981	02/00 → 06/05
CLASSE M II ML 500 4-matic	M113.964	07/05 → 12/11
CLASSE R R 500 4-matic	M113.971	08/05 → 12/14
CLASSE S IV S 280	M112.922	10/98 → 08/05
CLASSE S IV S 320	M112.944	10/98 → 08/05
CLASSE S IV S 350	M112.972	09/02 → 08/05
CLASSE S IV S 350 4-matic	M112.975	06/03 → 08/05
CLASSE S IV S 430	M113.941	10/98 → 08/05
CLASSE S IV S 430 4-matic	M113.948	09/02 → 08/05
CLASSE S IV S 500	M113.960	10/98 → 08/05
CLASSE S IV S 500 4-matic	M113.966	09/02 → 08/05
CLASSE S IV S 55 AMG	M113.986	04/99 → 08/05
CLASSE S IV S 55 AMG	M113.991	06/02 → 08/05
Kompressor		
CLASSE SL IV 280	M112.923	05/98 → 10/01
CLASSE SL IV 320	M112.943	05/98 → 10/01
CLASSE SL IV 500	M113.961	05/98 → 10/01
CLASSE SL V 350	M112.973	03/03 → 01/12
CLASSE SL V 500	M113.963	10/01 → 01/12
CLASSE SL V 55 AMG	M113.992, M113.995	10/01 → 01/12
CLASSE SL V 55 AMG	M113.992	06/02 → 01/12
Kompressor		
CLASSE SLK I 32 AMG	M112.960	03/01 → 04/04
Kompressor		
CLASSE SLK I 320	M112.947	03/00 → 04/04
CLASSE SLK II 55 AMG	M113.989	06/04 → 12/11
SLR MCLAREN 5.4	M155.980	04/04 →
SLR MCLAREN 5.4 722 Edition	M155.980	10/06 →
SLR MCLAREN 5.5	M155.980	09/04 →
SLR MCLAREN 5.5 SLR McLaren	M155.980	04/07 → 12/09
VIANO 3.2	M112.951	09/03 →
VIANO 3.7	M112.976	06/04 →
VITO II 119	M112.951	09/03 →
VITO II 122	M112.951	09/03 →
VITO II 123	M112.976	06/04 → 07/08
PUCH		
G-MODELL G 500	M113.962	12/97 → 11/00
G-MODELL G 55 AMG	M113.982	04/99 → 03/01

KW 470 419



07,5

COILS

Adatt./Suitable:

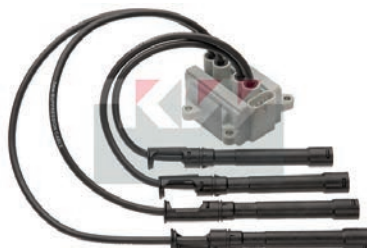
BOSCH
0 986 221 036**HITACHI**
138712
2508712**NISSAN**
22448-00QAD**RENAULT**
82 00 025 256
82 00 084 401

- + + -	ohm		ohm
	0,39		11000

NISSAN

KUBISTAR 1.2 16V | D4F712 | 04/06 →

RENAULT

CLIO II 1.0 16V	D4D700	01/01 →
CLIO II 1.2 16V	D4F706, D4F712, D4F714	06/01 → 08/16
CLIO III 1.2 16V	D4F706	06/05 → 12/14
KANGOO 1.2	D4F712, D4F714	07/01 → 10/03
KANGOO 1.0	D4D700, D4D720	01/02 → 01/07
KANGOO I 1.0 16V	59CH23N17, D4D700	03/98 →
KANGOO I 1.2 16V	D4F712, D4F714, D4F716	06/01 →
TWINGO I 1.0 16V	D4D712	01/01 →
TWINGO I 1.2 16V	D4F702	01/01 → 06/07

KW 470 420



05,5

COILS

Adatt./Suitable:

BOSCH
0 986 221 066
0 986 22A 201**HITACHI**
134066
134089
2504066
2504089**MAGNETI MARELLI**
060717183012

MERCEDES-BENZ

A 000 150 15 80
A 000 150 25 80
A 000 150 29 80

+ GND -	ohm		ohm	
	0,42		...	

MERCEDES-BENZ

CLASSE C II C 160 Kompressor | M271.921 | 05/02 → 05/08

MERCEDES-BENZ

CLASSE C II C 180 Kompressor	M271.946	05/02 → 05/08
CLASSE C II C 200 CGI Kompressor	M271.942	03/03 → 05/08
CLASSE C II C 200 Kompressor	M271.940	05/02 → 05/08
CLASSE C II C 220	M271.948	05/02 → 05/08
CLASSE C II C 230 Kompressor	M271.948	05/02 → 05/08
CLASSE C III C 180	M271.820	06/11 →
CLASSE C III C 180 CGI	M271.820, M271.952	01/07 → 08/14
CLASSE C III C 180 Kompressor	M271.820, M271.910, M271.952	01/07 → 08/14
CLASSE C III C 200	M271.820	05/11 → 01/14
CLASSE C III C 200 CGI	M271.820, M271.860, M271.950	01/07 →
CLASSE C III C 200 Kompressor	M271.820, M271.860, M271.950	01/07 → 08/14
CLASSE C III C 250	M271.860	06/11 →
CLASSE C III C 250 CGI	M271.860	07/09 → 08/14
CLASSE CLC CLC 160	M271.911, M271.921	02/09 → 06/11
CLASSE CLC CLC 180 Kompressor	M271.940, M271.946	05/08 → 06/11
CLASSE CLC CLC 200 Kompressor	M271.957	05/08 → 06/11
CLASSE CLK II 200 CGI	M271.942	07/03 → 05/09
CLASSE CLK II 200 Kompressor	M271.940, M271.955	09/02 → 05/09
CLASSE CLK II CLK 200 CGI	M271.942	07/03 → 03/10
CLASSE CLK II CLK 200 Kompressor	M271.940, M271.955	02/03 → 03/10
CLASSE E III E 200 Kompressor	M271.941, M271.956	11/02 → 07/09
CLASSE E III E 200 NGT	M271.941, M271.941NGT	03/04 → 12/08
CLASSE E III E 200 T Kompressor	M271.941	03/03 → 07/09
CLASSE E IV E 200 CGI	M271.820, M271.860	08/09 → 12/16
CLASSE E IV E 200 NGT	M271.958, M271.958NGT	03/11 → 12/15
CLASSE E IV E 250 CGI	M271.860	01/09 → 12/16
SPRINTER II 216	M271.951	09/08 →
SPRINTER II 316	M271.951	09/08 →
SPRINTER II 316 LGT	271951	09/08 →
SPRINTER II 316 NGT	M271.951, M271.951NGT	09/08 →
SPRINTER II 516	M271.951	09/08 →
SPRINTER II 516 NGT	M271.951, M271.951NGT	09/08 →
CLASSE SLK II 200 Kompressor	M271.944, M271.954	03/04 → 02/11
CLASSE SLK III 200	M271.861	02/11 →
CLASSE SLK III 250	M271.861	02/11 →

KW 470 422



07

COILS

Adatt./Suitable:

03 Supplied until depletion

- Fornibile fino ad esaurimento delle scorte
- Fourni jusqu'à épuisement du stock
- Lieferbar solange vorrat reicht
- Suministrado hasta el stock termina

250 incl. spark plug connector

- con cappuccio candela accensione
- Cosse de bougie d'allumage comprise
- inkl. Zündkerzenstecker
- incl. conector bujías

302 Paired article numbers

- N° articolo appaiato
- Numéro d'article en paire
- paarige Artikelnummer
- Referencia artículo par

470 354S

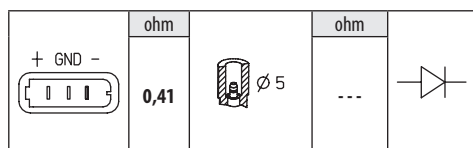

AUDI

A6 I S6 Plus quattro	AHK	04/96 ⇨ 12/97
A8 I 3.7	AKJ	06/97 ⇨ 12/98
A8 I 4.2 quattro	AGH	07/95 ⇨ 09/98

ALFA ROMEO		
MITO 1.4	350A1.000, 955A9.000	03/11 ⇨ 10/18
CHRYSLER		
YPSILON 1.2	169A4.000	05/11 ⇨
FIAT		
500 1.2	169A4.000	07/07 ⇨
500 1.2 LPG	169A4.000	12/10 ⇨
500 C 1.2	169A4.000	09/09 ⇨
PUNTO III EVO 1.2	169A4.000, 199A4.000	10/09 ⇨ 02/12
PUNTO III EVO 1.4	199A7000, 350A1.000	03/09 ⇨
PUNTO III EVO 1.4 LPG	350A1.000	06/09 ⇨ 02/12
PUNTO III EVO 1.4 Natural Power	350A1.000, 350A1000CNG	10/09 ⇨ 02/12
500 MY12 1.2	--	01/12 ⇨
PUNTO III 1.2	169A4.000, 199B9.000	03/12 ⇨
PUNTO III 1.4	199A7000, 350A1.000	03/12 ⇨
PUNTO III 1.4 Bifuel	350A1.000	03/12 ⇨
PUNTO III 1.4 Natural Power	350A1.000, 350A1000CNG	03/09 ⇨
FIORINO III 1.4	350A1.000	10/09 ⇨
FIORINO III 1.4 CNG	350A1000CNG	06/08 ⇨
FIORINO III 1.4 Natural Power	350A1.000, 350A1000CNG	06/08 ⇨
DOBLO I 1.4	350A1.000	10/05 ⇨
GRANDE PUNTO 1.4	350A1.000	02/06 ⇨ 06/13
GRANDE PUNTO 1.4 LPG	350A1.000	03/09 ⇨ 12/12
GRANDE PUNTO 1.4 Natural Power	350A1000CNG	03/09 ⇨ 12/12
PANDA III 1.2	169A4.000	02/12 ⇨
PANDA III 1.2 LPG	169A4.000	06/12 ⇨
IDEA 1.4	350A1.000	10/05 ⇨
IDEA 1.4 LPG	350A1.000	03/09 ⇨
LINEA 1.4	350A1.000	06/07 ⇨
PALIO 1.4	350A1.000, 834A1.000	10/02 ⇨
PANDA II 1.2	169A4.000	03/10 ⇨
PANDA II 1.2 4x4	169A4.000	04/10 ⇨
PANDA II 1.2 Euro 5	--	04/09 ⇨
PANDA II 1.2 LPG	169A4.000	09/10 ⇨
PANDA II 1.2 Natural Power	188A4000CNG	01/07 ⇨ 11/09
PANDA II 1.4 16V	--	01/10 ⇨
PANDA II 1.4 Natural Power	350A1.000, 350A1000CNG	10/09 ⇨

KW 470 423



09

COILS

Adatt./Suitable:

ALFA ROMEO

55200112
55208723

BOSCH

0 986 221 065

CHAMPION

BAE 940 A

CHRYSLER

55208723

FIAT

55200112
55200486
55208723

FORD

1 535 713
1 671 690
9S51-12029-AA
9S51-12029-AB

HITACHI

138727
138769
2508727
2508769

LANCIA

55200112
55208723

MAGNETI MARELLI

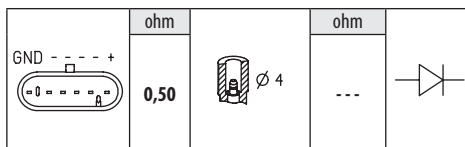
060717135012
060794001010
BAE 940 A

ALFA ROMEO

MITO 1.4 350A1.000, 955A9.000 03/11 ⇨ 10/18

CHRYSLER

YPSILON 1.2 169A4.000 05/11 ⇨

FIAT

500 1.2	169A4.000	07/07 ⇨
500 1.2 LPG	169A4.000	12/10 ⇨
500 C 1.2	169A4.000	09/09 ⇨
PUNTO III EVO 1.2	169A4.000, 199A4.000	10/09 ⇨ 02/12
PUNTO III EVO 1.4	199A7000, 350A1.000	03/09 ⇨
PUNTO III EVO 1.4 LPG	350A1.000	06/09 ⇨ 02/12
PUNTO III EVO 1.4 Natural Power	350A1.000, 350A1000CNG	10/09 ⇨ 02/12
500 MY12 1.2	--	01/12 ⇨
PUNTO III 1.2	169A4.000, 199B9.000	03/12 ⇨
PUNTO III 1.4	199A7000, 350A1.000	03/12 ⇨
PUNTO III 1.4 Bifuel	350A1.000	03/12 ⇨
PUNTO III 1.4 Natural Power	350A1.000, 350A1000CNG	03/09 ⇨
FIORINO III 1.4	350A1.000	10/09 ⇨
FIORINO III 1.4 CNG	350A1000CNG	06/08 ⇨
FIORINO III 1.4 Natural Power	350A1.000, 350A1000CNG	06/08 ⇨
DOBLO I 1.4	350A1.000	10/05 ⇨
GRANDE PUNTO 1.4	350A1.000	02/06 ⇨ 06/13
GRANDE PUNTO 1.4 LPG	350A1.000	03/09 ⇨ 12/12
GRANDE PUNTO 1.4 Natural Power	350A1000CNG	03/09 ⇨ 12/12
PANDA III 1.2	169A4.000	02/12 ⇨
PANDA III 1.2 LPG	169A4.000	06/12 ⇨
IDEA 1.4	350A1.000	10/05 ⇨
IDEA 1.4 LPG	350A1.000	03/09 ⇨
LINEA 1.4	350A1.000	06/07 ⇨
PALIO 1.4	350A1.000, 834A1.000	10/02 ⇨
PANDA II 1.2	169A4.000	03/10 ⇨
PANDA II 1.2 4x4	169A4.000	04/10 ⇨
PANDA II 1.2 Euro 5	--	04/09 ⇨
PANDA II 1.2 LPG	169A4.000	09/10 ⇨
PANDA II 1.2 Natural Power	188A4000CNG	01/07 ⇨ 11/09
PANDA II 1.4 16V	--	01/10 ⇨
PANDA II 1.4 Natural Power	350A1.000, 350A1000CNG	10/09 ⇨

FIAT

PUNTO III / GRANDE PUNTO 1.2	169A4.000, 199A4.000	10/05 ⇨
PUNTO III / GRANDE PUNTO 1.2 (IND)	--	01/08 ⇨
PUNTO III / GRANDE PUNTO 1.2 Actual	--	09/09 ⇨
PUNTO III / GRANDE PUNTO 1.2 LPG	199A4.000	06/08 ⇨ 12/12
PUNTO III / GRANDE PUNTO 1.4	199A7000, 350A1.000	06/05 ⇨ 12/15
PUNTO III / GRANDE PUNTO 1.4 Actual	--	09/09 ⇨
PUNTO III / GRANDE PUNTO 1.4 LPG	350A1.000	12/08 ⇨
PUNTO III / GRANDE PUNTO 1.4 Natural Power	350A1.000, 350A1000CNG	07/08 ⇨
QUBO 1.4	350A1.000	10/09 ⇨
QUBO 1.4 Natural Power	350A1.000, 350A1000CNG	10/09 ⇨
500 MY15 1.2	--	01/15 ⇨
500 MY15 1.2 LPG	--	01/15 ⇨
SIENA 1.4	--	01/02 ⇨

FORD

KA II 1.2 169A4000, FP4 10/08 ⇨ 05/16

LANCIA

MUSA 1.4	350A1.000	09/05 ⇨ 09/12
MUSA 1.4 8V	--	01/11 ⇨ 12/12
MUSA 1.4 LPG	350A1.000	11/10 ⇨ 09/12
YPSILON II 1.2	169A4.000, 188A4.000	10/03 ⇨ 12/11
YPSILON II 1.4	350A1.000	02/06 ⇨ 12/11
YPSILON II 1.4 LPG	350A1.000	11/10 ⇨ 12/11
YPSILON III 1.2	169A4.000	05/11 ⇨
YPSILON III 1.2 Bi-fuel	169A4.000	05/11 ⇨

KW 470 425



05,5

COILS

Adatt./Suitable:

BOSCH

0 986 221 054

VW

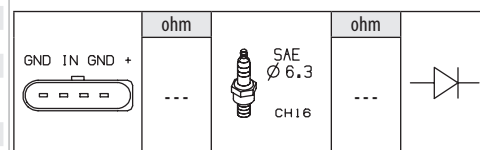
077 905 115 AA
077 905 115 G
077 905 115 J
077 905 115 M
077 905 115 R
077 905 115 S

VW

PHAETON 4.2 V8 4motion	BGH, BGJ	05/03 ⇨ 03/16
TOUAREG I 4.2 V8	AXQ	12/02 ⇨ 11/06

KW 470 426

05,5

COILS

Adatt./Suitable:

AUDI

06F 905 115 C
06F 905 115 E
06F 905 115 F
06H 905 115
06H 905 115 A
06H 905 115 B
07K 905 715 A
07K 905 715 C
07K 905 715 D
07K 905 715 F
07K 905 715 G

BOSCH

0 221 604 115
0 221 604 116

HITACHI

133836
2503836

MAGNETI MARELLI

060717108012
060810196010

SEAT

06F 905 115 A
06F 905 115 B
06F 905 115 C
06F 905 115 E
06F 905 115 F
06H 905 115
06H 905 115 A
06H 905 115 B
07K 905 715 A
07K 905 715 B
07K 905 715 C
07K 905 715 D
07K 905 715 F
07K 905 715 G

SKODA

06F 905 115 C
06F 905 115 F
06H 905 115
06H 905 115 A
06H 905 115 B
07K 905 715 A
07K 905 715 B
07K 905 715 C
07K 905 715 D
07K 905 715 F
07K 905 715 G

VW

06F 905 115
06F 905 115 A
06F 905 115 B
06F 905 115 C
06F 905 115 E
06F 905 115 F
06H 905 115
06H 905 115 A
06H 905 115 B
07K 905 715
07K 905 715 A
07K 905 715 B
07K 905 715 C
07K 905 715 D
07K 905 715 E
07K 905 715 F
07K 905 715 G

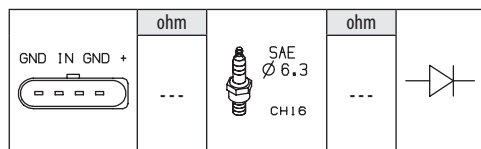

AUDI

A1 2.0 TFSI quattro	CDLH	03/12 ⇒ 11/12
A4 IV 1.8 TFSI	CABA, CABB, CDHA, CDHB	11/07 ⇒ 12/15
A4 IV 1.8 TFSI quattro	CDHB	09/08 ⇒ 03/12
A4 IV 2.0 TFSI	CAEA, CAEB, CAED, CDNB, CDNC, CFKA	06/08 ⇒ 12/15
A4 IV 2.0 TFSI flexible fuel	CFKA	11/09 ⇒ 12/15
A4 IV 2.0 TFSI flexible fuel quattro	CFKA	11/09 ⇒ 12/15
A4 IV 2.0 TFSI quattro	CAEB, CAED, CDNC, CFKA, CPMA, CPMB	06/08 ⇒ 12/15
A4 IV RS4 quattro	CFA	05/12 ⇒ 08/15
A3 II 1.8 TFSI	BYT, BZB, CDAA	11/06 ⇒ 05/13
A3 II 1.8 TFSI quattro	CDAA	07/08 ⇒ 03/13
A3 II 2.0 FSI	AXW, BLR, BLX, BLY, BMB, BVY, BVZ	05/03 ⇒ 06/08
A3 II 2.0 TFSI	AXX, BPY, BWA, CAWB, CBFA, CCZA	09/04 ⇒ 05/13
A3 II 2.0 TFSI quattro	AXX, BPY, BWA, CCTA, CCZA	09/04 ⇒ 03/13

AUDI

A3 II RS3 quattro	CEPA	01/11 ⇒ 12/12
A3 II S3 quattro	BHZ, BZC, CDLA, CDLC	11/06 ⇒ 03/13
A3 III RS3 quattro	CZGB	03/15 ⇒
A4 III 2.0 TFSI	BGB, BPG, BPI, BUL, BWE, BWT, BYK	11/04 ⇒ 06/08
A4 III 2.0 TFSI 16V	BWE, BWT	01/06 ⇒ 03/09
A4 III 2.0 TFSI quattro	BGB, BUL, BWE, BWT	11/04 ⇒ 03/09
A4 III RS4 quattro	BNS	09/05 ⇒ 12/08
A5 I 1.8 TFSI	CABD, CDHB	10/07 ⇒ 01/17
A5 I 2.0 TFSI	CAEA, CAEB, CAED, CDNB, CDNC	06/08 ⇒ 12/14
A5 I 2.0 TFSI quattro	CAEB, CAED, CDNC, CPMA, CPMB	06/08 ⇒ 01/17
A5 I RS5 quattro	CFA	03/10 ⇒ 01/17
A4 IV ALLROAD 2.0 TFSI quattro	CDNC, CPMA, CPMB	04/09 ⇒ 05/16
A6 III 2.0 TFSI	BPI, BYK	06/05 ⇒ 08/11
A6 IV 2.0 TFSI	CAEB, CAED, CDNB	03/11 ⇒
A6 IV 2.0 TFSI hybrid	CHJA	11/11 ⇒ 09/18
A6 IV 2.0 TFSI quattro	CAEB	05/12 ⇒ 05/13
A8 III 2.0 TFSI hybrid	CHJA	02/12 ⇒ 11/15
Q3 2.0 TFSI	CCTA	10/13 ⇒
Q3 2.0 TFSI quattro	CCTA, CCZC, CPFA	06/11 ⇒ 10/18
Q3 RS 2.5 quattro	CTSA, CZGA	05/13 ⇒ 10/18
Q3 RS performance 2.5 quattro	CZGB	01/15 ⇒ 10/18
Q5 I 2.0 Hybrid quattro	CHJA	09/12 ⇒ 05/16
Q5 I 2.0 TFSI	CDNA	11/08 ⇒
Q5 I 2.0 TFSI Hybrid quattro	CHJA	06/11 ⇒ 06/16
Q5 I 2.0 TFSI quattro	CAEB, CDNB, CDNC, CPMA, CPMB	11/08 ⇒ 05/17
Q5 I 2.0 TFSI quattro [CHN]	CADA	09/09 ⇒
R8 5.2 FSI quattro	CPMA	11/10 ⇒ 07/15
TT II 1.8 TFSI	CDAA	06/08 ⇒ 06/14
TT II 2.0 TFSI	BPY, BWA, CCTA, CESA	08/06 ⇒ 06/14
TT II 2.0 TFSI quattro	BWA, CCZA, CESA, CETA	06/08 ⇒ 06/14
TT II 2.0 TFSI quattro	CDLA, CDLB, CDMA	05/08 ⇒ 06/14
TT II 2.5 RS quattro	CEPA, CEPB	07/09 ⇒ 06/14

SEAT

ALTEA 1.8 TFSI	BYT, BZB, CDAA	01/07 ⇒
ALTEA 2.0 FSI	BLR, BLY, BVY, BVZ	05/04 ⇒ 03/09
ALTEA 2.0 TFSI	BWA	04/06 ⇒ 05/09
ALTEA XL 1.8 TFSI	BYT, BZB, CDAA	01/07 ⇒
ALTEA XL 2.0 FSI	BVY, BVZ	10/06 ⇒ 03/09
ALTEA XL 2.0 TFSI	BWA, CCZB	10/06 ⇒
ALTEA XL 2.0 TFSI 4x4	BWA, CCZB	06/07 ⇒
EXEO 1.8 TFSI	CDHA, CDHB	05/10 ⇒ 05/13
EXEO 2.0 TFSI	BWE, CDND	03/09 ⇒ 05/13
ALHAMBRA III 1.8 TFSI	CDAA	11/12 ⇒
ALHAMBRA III 2.0 TFSI	CCZA	11/10 ⇒ 05/12
LEON II 1.8 TFSI	BZB, CDAA	06/07 ⇒ 12/12
LEON II 2.0 Cupra R	CDLA	09/09 ⇒ 12/12
LEON II 2.0 FSI	BLR, BLY, BVY, BVZ	07/05 ⇒ 05/10
LEON II 2.0 TFSI	BWA, BWJ, CDLD	05/05 ⇒ 05/11
TOLEDO III 1.8 TFSI	BYT, BZB, CDAA	01/07 ⇒ 05/09
TOLEDO III 2.0 FSI	BLR, BLY, BVY, BVZ	10/04 ⇒ 05/09
TOLEDO III 2.0 TFSI	BWA	11/05 ⇒ 05/09

SKODA

OCTAVIA II 1.8 TFSI	BZB, CDAA, CDAB	06/07 ⇒ 06/13
OCTAVIA II 1.8 TFSI 4x4	CDAA, CDAB	11/08 ⇒ 02/13
OCTAVIA II 2.0 4x4	CCZA	11/08 ⇒
OCTAVIA II 2.0 FSI	BLR, BLY, BVY, BVZ	11/04 ⇒ 10/08
OCTAVIA II 2.0 FSI 4x4	BLX, BLY, BVX	11/04 ⇒ 04/09
OCTAVIA II 2.0 TFSI	BWA, CCZA	10/05 ⇒ 02/13
SUPERB II 1.8 TFSI	BZB, CDAA, CDAB	03/08 ⇒ 05/15
SUPERB II 1.8 TFSI 4x4	CDAA, CDAB	11/08 ⇒ 05/15
SUPERB II 2.0 TFSI	CCZA	05/10 ⇒ 05/15
YETI 1.2 TFSI	CBZB	09/09 ⇒ 05/15
YETI 1.8	CDAB	02/11 ⇒
YETI 1.8 TFSI 4x4	CDAA, CDAB	05/09 ⇒ 12/17

VW

AMAROK 2.0 TSI	CFPA	12/10 ⇒ 10/16
GOLF VI 1.8 TFSI	CDAA	06/09 ⇒ 01/11
GOLF VI 2.0	CDLF	05/11 ⇒
GOLF VI 2.0 GTi	CBFA, CCTA, CCZB, CDLG	02/09 ⇒ 05/16
GOLF VI 2.0 R	CDLA	01/13 ⇒ 05/16
GOLF VI 2.0 R 4motion	CDLC, CDLF	11/09 ⇒ 11/13
GOLF VI 2.0 TFSI	CCZA	07/09 ⇒
GOLF VI 2.0 TFSI Gti	CBFA, CCTA, CCZB, CDLG	05/11 ⇒
GOLF VI 2.0 TFSI	CDLC	01/13 ⇒
GOLF VI 2.0 TFSI R 4motion	CDLF	11/09 ⇒ 11/12
GOLF VI 2.5	CBTA, CBUA	07/09 ⇒
BEETLE 2.0 TFSI	CBFA, CCTA, CCZA	04/11 ⇒ 07/16
BEETLE 2.5	CBTA, CBUA, CCA	04/11 ⇒ 07/19
GOLF V 2.0 FSI	AXW, BLR, BLX, BLY, BVX, BVY, BVZ	01/04 ⇒ 11/08
GOLF V 2.0 FSI 4motion	BLX, BVX	08/04 ⇒ 11/08
GOLF V 2.0 GTI	AXX, BPY, BWA, BYD, CAWB, CBFA	10/04 ⇒ 02/09
GOLF V 2.0 TFSI	BWA, CAWB	06/07 ⇒ 07/09

VW

GOLF V 2.5	CBTA, CBUA	05/07 ⇒ 11/08
CALIFORNIA 2.0 TSI	CJKA, CJKB	05/11 ⇒ 07/19
CALIFORNIA 2.0 TSI 4motion	CJKA	07/11 ⇒ 07/19
CAMPMOBILE 2.0 TFSI	CJKA, CJKB	05/11 ⇒ 08/15
CAMPMOBILE 2.0 TFSI BlueMotion	CJKA, CJKB	04/15 ⇒ 07/19
CC 1.8 TSI	CDAA, CDAB	11/11 ⇒ 12/16
CC 2.0 TFSI	CBFA, CCTA	11/11 ⇒ 12/16
CC 2.0 TSI	CBFA, CCTA, CCZB	11/11 ⇒
EOS 2.0 FSI	BVY, BVZ	03/06 ⇒ 05/08
EOS 2.0 TFSI	BPY, BWA, CAWB, CBFA, CCZA	03/06 ⇒ 08/15
EOS 2.0 TSI	CCZB	11/09 ⇒ 08/15
JETTA V 2.0 FSI	BLR, BLY, BVY, BVZ	08/05 ⇒ 10/10
JETTA V 2.0 TFSI	BPY, BWA, CAWB, CBFA, CCTA, CCZA	10/05 ⇒ 10/10
JETTA V 2.5	BGP, BGQ, BTK, CBTA, CCZA	01/05 ⇒
PASSAT V 1.8 TFSI	BZB, CDAA, CDAB, CGYA	05/07 ⇒ 12/14
PASSAT V 2.0 FSI	BLR, BLY, BVY, BVZ, CCTB	03/05 ⇒ 11/10
PASSAT V 2.0 FSI 4motion	BLX, BLY, BVX	09/05 ⇒ 11/10
PASSAT V 2.0 TFSI	AXX, BPY, BWA, CAWB	07/05 ⇒ 11/10
PASSAT V 2.0 TSI	CCZB	11/10 ⇒ 12/15
PASSAT V 2.0 TSI 4motion	CCZB	01/12 ⇒ 12/14
PASSAT V 2.5 SRE	CBTA, CBUA, CCA	01/11 ⇒
JETTA VI 2.0 TFSI	CBFA, CCTA, CCZA	12/10 ⇒
JETTA VI 2.5	CBTA, CBUA, CCA	04/10 ⇒
MULTIVAN 2.0 TSI	CJKA, CJKB	05/11 ⇒ 07/19
MULTIVAN 2.0 TSI 4motion	CJKA	07/11 ⇒ 07/19
NEW BEETLE 2.5	BPR, BPS	07/05 ⇒ 09/10
POLO V 2.0 R WRC	CDLJ	08/13 ⇒ 05/14
PASSAT 1.8 TFSI	CDAA	08/10 ⇒ 12/14
PASSAT 2.0 TFSI	CCZB	11/10 ⇒ 12/14
SCIROCCO III 2.0 R	CDLA, CDLC, CDLK	11/09 ⇒ 11/17
SCIROCCO III 2.0 TFSI	CAWB	05/08 ⇒ 05/14
SCIROCCO III 2.0 TSI	CCZB	11/09 ⇒ 11/17
SHARAN II 1.8 TFSI	CDAA	11/11 ⇒
SHARAN II 2.0 TFSI	CCZA	12/10 ⇒ 11/15
SHARAN II 2.0 TSI	CCZA	12/10 ⇒ 11/15
PASSAT CC 1.8 TFSI	BZB, CDAA, CDAB, CGYA	06/08 ⇒ 01/12
PASSAT CC 2.0 TFSI	CAWB, CBFA, CCTA, CCZA	06/08 ⇒ 01/12
PASSAT CC 2.0 TSI	CCZB	11/10 ⇒ 01/12
TIGUAN I 2.0 TFSI	CAWB, CCTA, CCTB	11/07 ⇒
TIGUAN I 2.0 TFSI 4motion	CAWA, CAWB, CCTA, CCTB, CCZA, CCZC	09/07 ⇒ 07/18
TIGUAN I 2.0 TSI 4motion	CCZA, CCZB, CCZC, CCZD	11/09 ⇒ 07/18
TOUAREG I 4.2 V8 FSI	BAR	06/06 ⇒ 05/10
TOURAN I 2.0 FSI	AXW, BLR, BLX, BLY, BVY, BVZ	10/03 ⇒ 01/07
TRANSPORTER V 2.0 TSI	CJKA, CJKB	05/11 ⇒ 08/15
TRANSPORTER V 2.0 TSI 4motion	CJKA	07/11 ⇒ 08/15
TRANSPORTER VI 2.0 TSI	CJKA, CJKB	04/15 ⇒ 07/19
TRANSPORTER VI 2.0 TSI 4motion	CJKA	06/15 ⇒ 07/19

KW 470 427

05,5

COILS

Adatt./Suitable:

AUDI

06D 905 115
06D 905 115 A
06D 905 115 C
06D 905 115 D
06D 905 115 F
06D 905 115 G
06D 905 115 J
06D 905 115 K
06E 905 115
06E 905 115 A
06E 905 115 B
06E 905 115 C
06E 905 115 D
06E 905 115 E
06E 905 115 F
06E 905 115 G
07L 905 115
07L 905 115 A
07L 905 115 B

BOSCH

0 221 604 800

HITACHI

133831
2503831
2503835

MAGNETI MARELLI

060717175012

PORSCHE

958 602 102 00

VW

06D 905 115
06D 905 115 A
06D 905 115 C
06D 905 115 D
06D 905 115 F
06D 905 115 G
06D 905 115 K
06E 905 115
06E 905 115 A
06E 905 115 B
06E 905 115 C
06E 905 115 D
06E 905 115 E
06E 905 115 F
06E 905 115 G

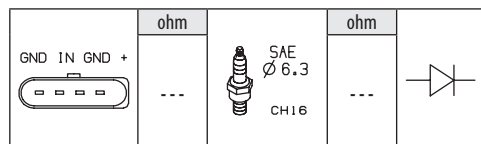

AUDI

A4 IV 3.0 TFSI quattro	CMUA, CRED	02/12 ⇒ 12/15
A4 IV 3.2 FSI	CALA	09/08 ⇒ 03/12
A4 IV 3.2 FSI quattro	CALA	11/07 ⇒ 03/12
A4 IV S4 quattro	CAKA, CCBA, CGWC, CGXC, CREC, CTUB	11/08 ⇒ 12/15
A4 II 2.0 FSI	AWA	07/02 ⇒ 12/04
A4 III 3.2 FSI	AUK	01/05 ⇒ 03/09
A4 III 3.2 FSI quattro	AUK, BKH	01/05 ⇒ 03/09
A5 I 3.0 TFSI quattro	CHMB, CMUA, CRED	08/11 ⇒
A5 I 3.2 FSI	CALA	06/07 ⇒ 03/12
A5 I 3.2 FSI quattro	CALA	06/07 ⇒ 03/12
A5 I S5 quattro	CAKA, CAUA, CCBA, CGWC, CGXC, CREC, CTDA, CTUB	06/07 ⇒ 01/17
A6 III 2.4	BDW	05/04 ⇒ 10/08
A6 III 2.4 [CHN]	BDW	04/05 ⇒
A6 III 2.4 quattro	BDW	01/05 ⇒ 10/08
A6 III 2.8 FSI	BDX, CCDA, CCEA	11/06 ⇒ 08/11
A6 III 2.8 FSI quattro	BDX, CCDA, CCEA	06/07 ⇒ 08/11
A6 III 3.0 TFSI quattro	CAJA, CCAA	10/08 ⇒ 08/11
A6 III 3.2 FSI	AUK, BKH, CALA	05/04 ⇒ 03/11
A6 III 3.2 FSI quattro	AUK, BKH, BYU	05/04 ⇒ 10/08
A6 III 4.2 FSI quattro	BVJ	05/06 ⇒ 08/11
A6 III RS6 quattro	BUH	04/08 ⇒ 08/10
A6 III S6 quattro	BXA	03/06 ⇒ 08/11
A6 IV 2.8 FSI	CHVA	11/10 ⇒ 04/15
A6 IV 2.8 FSI quattro	CHVA, CVPA	11/10 ⇒ 09/18
A6 IV 3.0 TFSI	CREH	09/14 ⇒
A6 IV 3.0 TFSI quattro	CGWB, CGWD, CGXB, CREC, CREH, CTUA	11/10 ⇒ 09/18
A7 SPORTBACK 2.0 TFSI quattro	CYNB	05/15 ⇒ 05/18

AUDI

A7 SPORTBACK 2.5 FSI	CLXB	05/12 ⇒
A7 SPORTBACK 2.8 FSI	CHVA	02/11 ⇒ 03/15
A7 SPORTBACK 2.8 FSI quattro	CHVA, CNYA, CVPA	10/10 ⇒ 05/18
A7 SPORTBACK 2.8 TFSI	CVPA	09/14 ⇒
A7 SPORTBACK 3.0 TFSI	CREH	05/14 ⇒
A7 SPORTBACK 3.0 TFSI quattro	CGWB, CGWD, CGXB, CHMA, CREC, CTTA, CTUA	10/10 ⇒ 05/18
A8 II 2.8 FSI	BDX, CJBA	08/07 ⇒ 07/10
A8 II 3.2 FSI	BPK	06/05 ⇒ 07/10
A8 II 3.2 FSI quattro	BPK	06/05 ⇒ 07/10
A8 II 4.2 FSI quattro	BVJ	06/06 ⇒ 07/10
A8 II S8 quattro	BSM	06/06 ⇒ 07/10
Q7 I 3.0 TFSI quattro	CREC	01/15 ⇒ 12/19
A8 III 2.5 TFSI	CPAA, CVBA	07/12 ⇒ 06/16
A8 III 3.0 TDI quattro	CPNA, CPNB	11/12 ⇒ 06/16
A8 III 3.0 TFSI quattro	CGWA, CGWD, CGXC, CMDA, CREA, CREC, CREG, CTDA, CTUB	06/10 ⇒ 01/18
A8 III 4.2 FSI quattro	CDRA	11/09 ⇒ 12/12
Q5 I 3.0 TFSI quattro	CTUC, CTVA	06/12 ⇒ 05/17
Q5 I 3.2 FSI quattro	CALB	11/08 ⇒ 12/12
Q5 I SQ5 TFSI quattro	CTUD, CTXA	05/13 ⇒ 05/17
Q7 I 3.0 TFSI quattro	CJTB, CJTC, CJWB, CJWC, CJWE, CNA A, CTWA, CTWB	05/10 ⇒ 08/15
Q7 I 4.2 FSI quattro	BAR	03/06 ⇒ 05/10
Q7 I 4.2 quattro	BAR	03/06 ⇒ 12/10
R8 4.2 FSI quattro	BYH, CNDA	04/07 ⇒ 07/15
R8 5.2 FSI	CTPA, CTPB, DKAB, DKAC	07/12 ⇒
R8 5.2 FSI quattro	BUJ, CSP A, CSPB, CTPA, CTPB, CTYA, DKAA, DKAC, DMWA	04/09 ⇒

PORSCHE

CAYENNE 3.0 S Plug-in Hybrid Supercharged	MCG.EA, MCG.FA	01/15 ⇒
CAYENNE II 3.0 S E-Hybrid	M06.EC, MCG.EA, MCG.FA	10/14 ⇒
PANAMERA 3.0 S E-Hybrid	MCG.EA, MCG.FA	03/11 ⇒ 10/16

VW

TOUAREG I 4.2 V8	AXQ	12/02 ⇒ 11/06
TOUAREG I 4.2 V8 FSI	BAR	06/06 ⇒ 05/10
TOUAREG II 3.0 TFSI	CYJA	01/15 ⇒
TOUAREG II 3.0 V6 TSI	CJTA	08/10 ⇒ 03/18
TOUAREG II 3.0 V6 TSI Hybrid	CGEA, CGFA	04/10 ⇒ 03/18
TOUAREG II 4.2 V8 FSI	CGNA	01/11 ⇒ 03/18

KW 470 429

05,5

COILS

Adatt./Suitable:

AUDI

06A 905 115
06A 905 115 A
06A 905 115 B
06A 905 115 C
06A 905 115 D
06B 905 115 D
06B 905 115 G
06B 905 115 H
06B 905 115 J
06B 905 115 L
06B 905 115 M
06B 905 115 N
06B 905 115 P
06B 905 115 Q
06B 905 115 R
06B 905 115 S
06C 905 115 C

BOSCH

0 986 221 024

HITACHI

133806
2503806

MAGNETI MARELLI

060717053012

SEAT

06A 905 115
06A 905 115 A
06A 905 115 B
06A 905 115 C
06A 905 115 D
06B 905 115 D
06B 905 115 G
06B 905 115 H
06B 905 115 J
06B 905 115 L
06B 905 115 M
06B 905 115 N
06B 905 115 P
06B 905 115 Q
06B 905 115 R
06C 905 115 C

SKODA

06A 905 115
06A 905 115 A
06A 905 115 B
06A 905 115 C
06A 905 115 D
06B 905 115 D
06B 905 115 G
06B 905 115 H
06B 905 115 J
06B 905 115 L
06B 905 115 M
06B 905 115 N
06B 905 115 P
06B 905 115 Q
06B 905 115 R
06C 905 115 C

VW

06A 905 115
06A 905 115 A
06A 905 115 B
06A 905 115 C
06A 905 115 D
06B 905 115 D
06B 905 115 G
06B 905 115 H
06B 905 115 J
06B 905 115 L
06B 905 115 M
06B 905 115 N
06B 905 115 P
06B 905 115 Q
06B 905 115 R
06B 905 115 S
06C 905 115 C

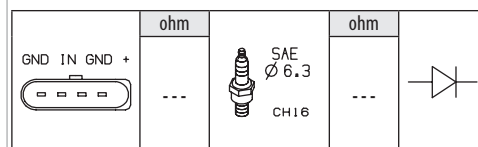

AUDI

A3 I 1.8 T	AGU, ARY, AUM, AUQ	12/96 ⇒ 05/03
A3 I 1.8 T quattro	ARX, ARY	12/96 ⇒ 05/03
A3 I S3 quattro	AMK, APY, AUL, BAM	10/01 ⇒ 05/03
A4 II 1.8 T	AMB, AVJ, BEX, BFB	11/00 ⇒ 12/04
A4 II 1.8 T quattro	AMB, AVJ, BEX, BFB	11/00 ⇒ 12/04
A4 III 1.8 T	BFB	07/02 ⇒ 03/09
A4 III 1.8 T quattro	BFB	05/03 ⇒ 06/08
A4 III 2.0	ALT	11/04 ⇒ 06/08
A4 I 1.8 T	AWT	01/95 ⇒ 09/01
A4 I 1.8 T quattro	AWT	01/95 ⇒ 11/00
A6 II 1.8 T	AWT	01/97 ⇒ 01/05
A6 II 1.8 T quattro	AWT	02/97 ⇒ 01/05

AUDI		
A6 II 2.7 T quattro	1457L77	08/01 ⇒ 01/05
ALLROAD 2.7 T quattro	1457L77, ARE	05/00 ⇒ 08/05
TT I 1.8 T	AJQ, APP, ATC, AUM, AUQ, BVP, BVR	01/01 ⇒ 06/06
TT II 1.8 T quattro	AJQ, APX, ARY, ATC, AUQ, BAM, BFV, BVR	02/00 ⇒ 06/06

SEAT		
EXEO 1.6	ALZ	03/09 ⇒ 09/10
EXEO 1.8 T	CFMA	12/08 ⇒ 05/10
IBIZA II 1.8 T 20V Cupra	AYP	07/00 ⇒ 02/02
IBIZA III 1.8 T Cupra R	BBU, BLZ	01/04 ⇒ 02/08
IBIZA III 1.8 T FR	BJX, BKV	12/03 ⇒ 05/08
LEON I 1.8 20V T	AUQ	11/99 ⇒ 06/06
LEON I 1.8 20V T 4	ARY	11/99 ⇒ 06/06
LEON I 1.8 T Cupra R	AMK, BAM	02/02 ⇒ 06/06
LEON I 1.8 Turbo 4x4	AMK	05/02 ⇒ 05/03
TOLEDO II 1.8 20VT	APP	09/00 ⇒ 07/04

SKODA		
SUPERB I 1.8 T	AWT	12/01 ⇒ 03/08
OCTAVIA I 1.8 T	ARZ	08/97 ⇒ 12/10
OCTAVIA I 1.8 T 4x4	ARX	05/01 ⇒ 05/06
OCTAVIA I RS 1.8 T	AUQ	05/01 ⇒ 01/06

VW		
BORA 1.8 T	AUM, AUQ	05/00 ⇒ 05/05
GOLF IV 1.8 T	AUM	08/97 ⇒ 06/06
GOLF IV 1.8 T GTI	AUQ	08/01 ⇒ 06/05
POLO IV 1.8 GTI	BJX	09/05 ⇒ 11/09
POLO IV 1.8 GTI Cup Edition	BBU	05/06 ⇒ 11/09
NEW BEETLE 1.8 T	AGU, APH, AVC, AWP, AWU, AWW, BKF, BNU	11/01 ⇒ 09/10
PASSAT IV 1.8 [CHN]	AWL, BGC, CED	06/01 ⇒
PASSAT IV 1.8 4motion	AWM	03/01 ⇒ 05/05
PASSAT IV 1.8 T	AWM	02/01 ⇒ 11/05
PASSAT IV 1.8 T 20V	AWL, AWT	11/00 ⇒ 05/05
PASSAT IV 1.8 T 4motion	AWM	11/03 ⇒ 05/05
PASSAT IV 2.0	ALT	11/01 ⇒ 05/05

KW 470 431  **05,5**

COILS

Adatt./Suitable:

BOSCH
0 986 221 047

HITACHI
133812
2503812

MAGNETI MARELLI
060717130012
060810167010

SEAT
03D 905 115 F
03D 905 115 G
03D 905 715 A

SKODA
03D 905 115
03D 905 115 A
03D 905 115 B
03D 905 115 C
03D 905 115 D
03D 905 115 E
03D 905 115 F
03D 905 115 G
03D 905 715 A

VW
03D 905 115
03D 905 115 A
03D 905 115 B
03D 905 115 C
03D 905 115 D
03D 905 115 E
03D 905 115 F
03D 905 115 G
03D 905 715 A

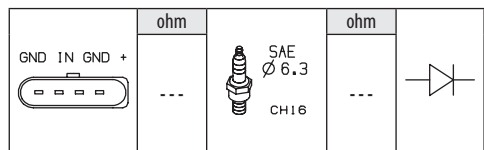

SEAT		
IBIZA III 1.2	BBM	06/07 ⇒ 05/08
SKODA		
FABIA I 1.2	AWY, BMD	07/01 ⇒ 12/07
FABIA II 1.2	BBM, CHFA	12/06 ⇒ 12/14

SKODA		
FABIA II 1.2 LPG	CHFA	03/09 ⇒ 11/11
VW		
FOX 1.2	BMD, CHFA, CHFB	04/05 ⇒ 12/11
POLO IV 1.2	AWY, BBM, BMD	01/02 ⇒ 11/09

KW 470 432  **05,5**

COILS

Adatt./Suitable:

BOSCH
0 986 221 001
0 986 221 045

DACIA
22 43 325 97R
22 43 335 29R
77 00 107 177
77 00 113 357
82 00 208 611
82 00 380 267
82 00 405 098
82 00 568 671
82 00 765 882

DENSO
029700-8240
029700-8291

GENERAL MOTORS
91 159 920
91 159 996
93 161 188
93 161 948

HITACHI
133800

LADA
82 00 765 882

MAGNETI MARELLI
060717035012
060810070010

NISSAN
22433-3529R
22448-00A0C
22448-00Q0A
22448-00Q0B
22448-00Q0C
22448-00Q0G
22448-00QAA
22448-00QAB
22448-00QAE
22448-00QAH
77001-07177
82006-72564

OPEL

44 08 283
44 08 389
44 13 233
44 32 202
91159996
93161188
93161948

RENAULT

22 43 325 97R
22 43 335 29R
77 00 107 177
77 00 113 357
77 00 113 357 A
77 00 875 000
82 00 035 420
82 00 154 186
82 00 154 186 A
82 00 208 611
82 00 380 267
82 00 405 098
82 00 568 671
82 00 672 564
82 00 765 882
89 00 568 671
H77 00 875 000

SAGEM
2 526 180 A
21595273-2

VAUXHALL
91159996
93161188
93161948

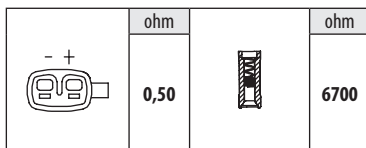

DACIA		
DUSTER 1.6	K4M642, K4M646, K4M694, K4M842, K4M884	04/10 ⇒
DUSTER 1.6 16V	K4M490, K4M606, K4M616, K4M694, K4M696, K4M842, K4M896	04/10 ⇒
DUSTER 1.6 16V 4x4	K4M490, K4M606, K4M646, K4M690	06/10 ⇒

DACIA		
DUSTER 1.6 16V Hi-Flex	K4M696	08/10 ⇒
DUSTER 1.6 16V LPG	K4M616, K4M642, K4M696	04/11 ⇒ 01/18
DUSTER 2.0	F4R400, F4R401, F4R402, F4R403, F4R404, F4R405, F4R408, F4R410, F4R412, F4R414, F4R416	04/10 ⇒
LODGY 1.6	K4M845	03/12 ⇒
LOGAN I 1.6 16V	K4M690, K4M694, K4M696, K4M697, K4M698	12/05 ⇒
LOGAN I 1.6 16V Flexifuel	K4M696	07/10 ⇒
LOGAN I 1.6 16V Hi-Flex	K4M690, K4M696	11/09 ⇒
LOGAN II 1.6 16V	K4M842, K4M845	10/12 ⇒
LOGAN II 2.0	F4R412, F4R416	10/12 ⇒
SANDERO I 1.6 16V	K4M690, K4M694	07/11 ⇒
SANDERO I 1.6 16V Bifuel	K4M690, K4M696	01/11 ⇒
SANDERO II 1.6 16V	K4M842, K4M845	01/13 ⇒
SANDERO II 2.0	F4R416	10/12 ⇒
SANDERO II 2.0 LPG	F4R412	10/12 ⇒

LADA		
LARGUS 1.6	21129, K4M	03/12 ⇒

NISSAN		
ALMERA 1.6	K4M	11/12 ⇒
KUBISTAR 1.6 16V	K4M750, K4M752, K4M753, K4M753	08/03 ⇒
PRIMASTAR 2.0	F4R720, F4R722, F4R820, F4R726	03/01 ⇒
TERRANO III 1.6	K4M, K4M606, K4M690	09/13 ⇒
TERRANO III 1.6 4x4	K4M606, K4M690	03/14 ⇒
TERRANO III 2.0	F4R	09/13 ⇒
TERRANO III 2.0 4x4	F4R	03/14 ⇒

OPEL		
VIVARO A 2.0 16V	F4R720	08/01 ⇒ 07/06
VIVARO A 2.0 ECOTEC	F4R820	08/06 ⇒ 07/14

RENAULT

AVANTIME 2.0 16V Turbo	F4R760, F4R761	11/01 ⇒ 05/03
CLIO II 1.4 16V	K4J700, K4J710, K4J711, K4J712, K4J713, K4J715	02/00 ⇒
CLIO II 1.6	K4M746	11/03 ⇒
CLIO II 1.6 16V	K4M708, K4M734, K4M740, K4M742, K4M743, K4M744, K4M745, K4M746, K4M748	09/98 ⇒
CLIO II 1.6 Hi-Flex	K4M748	01/05 ⇒ 02/10
CLIO II 1.6i	K4M736	11/04 ⇒
CLIO II 2.0 16V	F4R732	06/01 ⇒
CLIO III 1.4 16V	K4J780	06/05 ⇒ 12/12
CLIO III 1.6 16V	K4M800, K4M801, K4M804, K4M862	06/05 ⇒ 12/14
CLIO III 1.6 16V GT	K4M862	06/09 ⇒ 12/14
CLIO III 2.0 16V Sport	-, F4R830, F4R832	02/06 ⇒
MEGANE III 1.6 16V	K4M848, K4M858, K4M866	11/08 ⇒
MEGANE III 1.6 16V BiFuel	K4M858	11/08 ⇒
MEGANE III 1.6 16V Hi-Flex	K4M866	11/08 ⇒ 08/15
MEGANE III 1.6 BiFuel	K4M866	11/08 ⇒
MEGANE III 2.0 R.S.	F4R874	11/08 ⇒
MEGANE III 2.0 TCe	F4R872, F4R870, F4R874	11/08 ⇒
MEGANE III 2.0 TCe 220	F4R874	11/13 ⇒
KANGOO II 1.6	K4M830, K4M831	02/09 ⇒ 12/12
KANGOO II 1.6 16V	K4M830, K4M831, K4M834, K4M835, K4M836	02/08 ⇒
KANGOO II 1.6 16V FLEX	K4M834	02/08 ⇒
KANGOO II 1.6 16V LPG	K4M834, K4M835, K4M836	02/08 ⇒
CLIO 1.6	K4M734	07/00 ⇒ 10/03
DUSTER 1.6 16V	K4M616	02/12 ⇒
DUSTER 1.6 16V 4x4	K4M490, K4M606, K4M646, K4M690	06/11 ⇒ 05/15
DUSTER 2.0	F4R403, F4R405	02/12 ⇒
DUSTER 2.0 4x4	F4R400, F4R402, F4R410, F4R412, F4R401	10/11 ⇒
ESPACE III 2.0	F4R700, F4R701	09/01 ⇒ 10/02
ESPACE III 2.0 16V	F4R700, F4R701	10/98 ⇒ 10/02
ESPACE IV 2.0	F4R790, F4R792, F4R794, F4R795, F4R796, F4R797, F4R896, F4R897	11/02 ⇒
ESPACE IV 2.0 Turbo	F4R794, F4R795, F4R796, F4R797	11/02 ⇒
FLUENCE 1.6 16V	K4M838, K4M839	02/10 ⇒
FLUENCE 1.6 LPG 16V	K4M839	01/12 ⇒
GRAND SCÉNIC II 1.6	K4M761, K4M764, K4M782, K4M788, K4M812, K4M813	04/04 ⇒ 11/08
GRAND SCÉNIC II 1.6 Flex	K4M766	06/06 ⇒ 06/09
GRAND SCÉNIC II 2.0	F4R770, F4R771, F4R776	04/04 ⇒ 06/09
MEGANE II 1.4	K4J730, K4J732, K4J740	08/03 ⇒
MEGANE II 1.4 16V	K4J730, K4J732, K4J740	11/02 ⇒ 02/08
MEGANE II 1.6	K4M760, K4M761, K4M762, K4M768, K4M788, K4M812, K4M813, K4M680	08/03 ⇒

RENAULT		
MEGANE II 1.6 16V	K4M760, K4M761, K4M762, K4M764, K4M768, K4M812, K4M813, K4M856	11/02 →
MEGANE II 1.6 16V Hi-Flex	K4M856	02/08 → 07/09
MEGANE II 1.6 Bifuel	K4M788	06/05 → 02/08
MEGANE II 1.6 Flex-Fuel	K4M856	01/07 → 02/08
MEGANE II 1.6 LPG 16V	K4M760	01/06 → 08/09
MEGANE II 2.0	F4R770, F4R771, F4R774	08/03 →
MEGANE II 2.0 16V	F4R770, F4R771	11/02 → 02/08
MEGANE II 2.0 16V Turbo	F4R776	05/04 → 03/09
MEGANE II 2.0 Renault Sport	F4R774, F4R774	05/04 → 10/09
GRAND SCÉNIC III 1.6 16V	K4M858	02/09 →
GRAND SCÉNIC III 1.6 16V Bifuel	K4M866	02/09 →
GRAND SCÉNIC III 1.6 E85	K4M866	02/09 →
KANGOO 1.6	K4M836	03/13 →
KANGOO 1.6 BiFuel	K4M750	06/05 → 06/08
KANGOO 1.6 CNG	K4M830	10/07 →
KANGOO I 1.6	K4M730	09/01 →
KANGOO I 1.6 16V	K4M708, K4M730, K4M732, K4M750, K4M752, K4M753, K4M754	06/01 →
KANGOO I 1.6 16V 4x4	K4M708, K4M750, K4M752, K4M753, K4M754	02/01 →
KANGOO I 1.6 16V bivalent	K4M850CNG	06/05 →
KANGOO I 1.6 Flex	K4M850	03/07 → 12/18
KAPTUR 2.0 4WD	F4R410	03/16 →
LAGUNA I 1.6 16V	K4M720, K4M724	11/97 → 03/01
LAGUNA I 1.8 16V	F4P760	04/98 → 03/01
LAGUNA I 2.0	F4R780	09/99 → 02/01
LAGUNA I 2.0 16V	F4R780	09/99 → 03/01
LAGUNA II 1.6	K4M710	03/01 → 10/05
LAGUNA II 1.6 16V	K4M710, K4M714, K4M716	03/01 → 12/07
LAGUNA II 1.6 Bifuel	K4M714	06/05 → 12/07
LAGUNA II 1.6 LPG	K4M714	03/01 → 05/05
LAGUNA II 1.8 16V	F4P770, F4P771, F4P772, F4P773, F4P774, F4P775	03/01 →
LAGUNA II 2.0 16V	F4R712, F4R713, F4R714, F4R715, F4R784, F4R786, F4R787, F4R886, F4R887	08/02 → 12/07
LAGUNA II 2.0 16V Turbo	F4R764, F4R765, F4R786, F4R787	01/03 → 08/05
LAGUNA III 1.6 16V	K4M824	10/07 → 12/15
LAGUNA III 2.0	F4R813	02/08 →
LAGUNA III 2.0 16V Turbo	F4R811, F4R813	10/07 → 12/15
LAGUNA III 2.0 GT	F4R800, F4R802	03/08 → 12/15
LOGAN 1.6	K4M690, K4M694, K4M696, K4M697, K4M845	04/07 →
LOGAN 1.6 16V	K4M694	12/05 →
LOGAN/STEPWAY 1.6	K4M842, K4M845	04/14 →
MEGANE 1.4	K4J714, K4J750	04/01 → 07/03
MEGANE 1.6	K4M701, K4M708, K4M709, K4M700	04/01 → 07/03
MEGANE 1.6 BiFuel	K4M704, K4M712	04/01 → 07/03
MEGANE 1.8	F4P722	04/01 → 07/03
MEGANE 2.0	F4R740, F4R746	08/95 → 02/99
MEGANE I 1.4 16V	K4J700, K4J710, K4J711, K4J712, K4J713, K4J714, K4J732, K4J750	03/99 → 08/03
MEGANE I 1.6 16V	K4M701, K4M704, K4M706, K4M708, K4M709, K4M710, K4M712, K4M714, K4M720, K4M724, K4M730, K4M734, K4M740, K4M742, K4M743, K4M744	05/00 →
MEGANE I 1.6 Bifuel	K4M712	03/99 → 09/00
MEGANE I 1.6 LPG	K4M704, K4M712	10/00 → 08/02
MEGANE I 1.8 16V	F4P720, F4P722, F4P760, F4P770, F4P771, F4P772, F4P774, F4P775	07/00 → 08/03
MEGANE I 2.0 16V	F4R276, F4R700, F4R701, F4R712, F4R713, F4R720, F4R730, F4R732, F4R736, F4R746, F4R760, F4R761, F4R762, F4R763, F4R767, F4R770	05/00 →
MEGANE I 2.0 RT	F4R740, F4R741, F4R746, F4R747	03/01 → 08/03
MEGANE SCÉNIC I 1.6 16V	K4M701, K4M704, K4M708, K4M700	04/98 → 10/99
MODUS / GRAND MODUS 1.4	K4J770, K4J780	12/04 →
MODUS / GRAND MODUS 1.6	K4M790, K4M791, K4M792, K4M794, K4M800, K4M801	12/04 →
SANDERO I 1.6	K4M697	12/07 →
SANDERO II 1.6 16V	K4M842, K4M845	04/14 →
SCÉNIC I 1.4 16V	K4J714, K4J750	09/99 → 08/03
SCÉNIC I 1.6	K4M701, K4M706, K4M707, K4M708, K4M709, K4M776, K4M700	03/01 → 09/03
SCÉNIC I 1.6 16V	K4M712	05/00 → 08/03
SCÉNIC I 1.6 BiFuel	K4M704, K4M712	03/01 → 08/03
SCÉNIC I 1.8 16V	F4P720, F4P722	01/01 → 08/03

RENAULT		
SCÉNIC I 1.8 4x4	F4P722	07/00 → 04/01
SCÉNIC I 2.0 16V	F4R740, F4R741, F4R744, F4R746, F4R747	07/00 → 08/03
SCÉNIC I 2.0 16V RX4	F4R744, F4R746	06/00 → 08/03
SCÉNIC II 1.4	K4J730, K4J740	06/03 → 11/08
SCÉNIC II 1.6	K4M761, K4M782, K4M788, K4M812, K4M813	06/03 → 11/08
SCÉNIC II 1.6 16V	K4M764, K4M766, K4M812, K4M813	05/03 →
SCÉNIC II 1.6 BiFuel	K4M764	08/03 → 05/06
SCÉNIC II 1.6 Hi-Flex	K4M766	03/05 → 07/10
SCÉNIC II 2.0	F4R770, F4R771	06/03 → 07/10
SCÉNIC II 2.0 16V Turbo	F4R776	05/04 → 11/08
SCÉNIC III 1.6 16V	K4M858	02/09 →
SCÉNIC III 1.6 16V BiFuel	K4M866	02/09 →
SCÉNIC III 1.6 E85	K4M866	02/09 →
SCÉNIC 1.6 VVT	K4M858	01/13 →
THALIA I 1.4 16V	K4J713	08/00 →
THALIA I 1.6	K4M670, K4M674, K4M744, K4M745	01/01 →
THALIA II 1.4	K4J712, K4J713	01/09 → 12/11
THALIA II 1.6 16V	K4M670, K4M674, K4M744	09/08 →
TRAFIC II 2.0	F4R720, F4R722	03/01 →
TRAFIC II 2.0 16V	F4R820	08/06 →
TWINGO II 1.6 RS	K4M854	05/08 → 09/14
VEL SATIS 2.0 16 V Turbo	F4R766, F4R767	04/04 →
VEL SATIS 2.0 16V Turbo	F4R762, F4R763	06/02 → 08/09
VEL SATIS 2.0 Turbo	F4R767, F4R867	04/05 →
WIND 1.6	K4M854	07/10 →
MEGANE CC 1.6 16V	K4M858	06/10 →
MEGANE CC 1.6 16V Hi-Flex	K4M866	06/10 →
MEGANE CC 2.0 Tce	8XTDM10, F4R872	06/10 →
MEGANE CC 2.0 Turbo	8AR90212	10/11 →

KW 470 433  **05,5**

COILS

Adatt./Suitable:

AUDI

- 077 905 115 B
- 077 905 115 C
- 077 905 115 E
- 077 905 115 F
- 077 905 115 H
- 077 905 115 K
- 077 905 115 P
- 077 905 115 Q
- 077 905 115 T

BOSCH

0 986 221 054

HITACHI

133845

2503845

MAGNETI MARELLI

060717169012

VW

- 077 905 115 B
- 077 905 115 C
- 077 905 115 E
- 077 905 115 F
- 077 905 115 H
- 077 905 115 K
- 077 905 115 P
- 077 905 115 Q
- 077 905 115 T

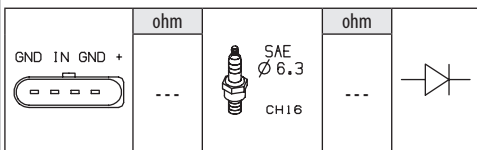

AUDI

A4 II S4 quattro	BBK	03/03 → 12/04
A4 III S4 quattro	BBK, BHF	03/04 → 03/09
A6 III 4.2 quattro	BAT	05/04 → 05/06
A8 II 3.7 quattro	BFL	10/02 → 05/06
A8 II 4.2 quattro	BFM	10/02 → 07/10
ALLROAD 4.2 V8 quattro	BAS	07/02 → 08/05

KW 470 434  **05,5**

COILS

Adatt./Suitable:

AUDI

- 022 905 100 P
- 022 905 715 B
- 022 905 715 D

BOSCH

0 986 221 051

HITACHI

133847

2503847

MAGNETI MARELLI

060717102012

PORSCHE

- 955 602 101 00
- 955 602 101 01
- 955 602 101 02
- 955 602 101 03
- 955 602 101 04
- 955 602 101 05
- 958 602 101 00
- PAB 905 715

SEAT

- 022 905 100 E
- 022 905 100 H
- 022 905 100 P
- 022 905 715

SKODA

022 905 715

VW

- 022 905 100 B
- 022 905 100 E
- 022 905 100 H
- 022 905 100 L
- 022 905 100 P
- 022 905 100 S
- 022 905 100 T
- 022 905 715
- 022 905 715 B
- 022 905 715 D

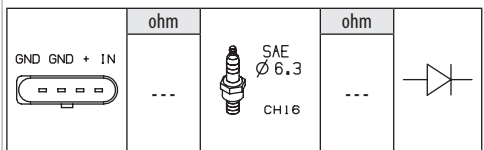

AUDI

A3 I [USA] 3.2 24V	CBRA	07/08 → 05/09
A3 I [USA] 3.2 24V AWD	--	01/06 → 12/09
A3 II 3.2 V6 quattro	BDB, BMJ, BUB	07/03 → 05/09
TT I 3.2 VR6 quattro	BHE, BPF	07/03 → 06/06
TT II 3.2 V6 quattro	BUB	08/06 → 06/10

PORSCHE

CAYENNE I 3.2	M02.2Y	08/03 → 09/07
CAYENNE I 3.6	M55.01	02/07 → 09/10
CAYENNE II 3.6	M55.02, MCE.YA	06/10 →

SEAT

LEON I 2.8	BDE	05/02 → 06/04
LEON I 2.8 Cupra 4	AUE, BDE	02/01 → 06/06

VW

EOS 3.2 V6	BUB, CBRA	06/06 → 05/09
PASSAT V 3.2 FSI 4motion	AXZ	11/05 → 11/10
PASSAT V 3.6 FSI	BLV	06/05 → 11/10
PASSAT V 3.6 FSI 4motion	BLV	09/05 → 11/10
PASSAT V 3.6 R36 4motion	BWS	04/07 → 11/10
GOLF IV 3.2 R32 4motion	BFH, BML	09/02 → 06/05
GOLF V 3.2 R32 4motion	BUB	11/05 → 11/08
MULTIVAN 3.2 V6	BDL, BKK, CFLA	02/04 → 12/09
MULTIVAN 3.2 V6 4motion	BKK, CFLA	07/04 → 12/09
PHAETON 3.2 V6	AYT, BKL	04/02 → 05/05
PHAETON 3.2 V6 4motion	BKL, BRK	02/04 → 11/08
TOUAREG I 3.2 V6	AZZ, BAA, BKJ, BMV, BMX, BRJ	10/02 → 11/06
TOUAREG I 3.6 V6 FSI	BHL	10/05 → 05/10
TRANSPORTER V 3.2 4motion	BDL, BKK, CFLA	11/03 → 11/09
TRANSPORTER V 3.2 V6	BDL, BKK, CFLA	04/03 → 11/09
TRANSPORTER V 3.2 V6 4motion	BDL, BKK, CFLA	04/03 → 12/09

KW 470 435



05,5

COILS

Adatt./Suitable:

BOSCH

0 986 221 073

FORD

1 120 169
1 252 407
1 331 283
1 362 718
1 673 468
6M21-12029-AA
YM21-12029-AA
YM21-12029-AB
YM21-12029-AC
YM21-12029-AD

HITACHI

133848
2503848

MAGNETI MARELLI

060717143012
060717160012

SEAT

022 905 100 A
022 905 100 D
022 905 100 G
022 905 100 K
022 905 100 N
022 905 715 C

VW

022 905 100 A
022 905 100 AC
022 905 100 D
022 905 100 G
022 905 100 K
022 905 100 N
022 905 715 C

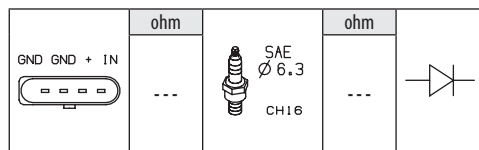

FORD			
GALAXY I 2.8	AAA, AYL	05/00 ⇒	03/06
GALAXY I 2.8 iV6	AAA, AMY	11/95 ⇒	04/00
GALAXY I 2.8 V6	AYL	04/00 ⇒	05/06

SEAT			
ALHAMBRA I / II 2.8 V6	AUE, AYL	06/00 ⇒	03/10
ALHAMBRA I / II 2.8 V6 4motion	AUE, AYL	06/00 ⇒	03/10
LEON I 2.3 VR5	AQN	09/00 ⇒	11/03
TOLEDO II 2.3 V5 20V	AQN	09/00 ⇒	11/03

VW			
BORA 2.3 V5	AQN	10/00 ⇒	05/05
BORA 2.3 V5 4motion	AQN	10/00 ⇒	05/05
BORA 2.8 V6 4motion	AUE, BDE	03/99 ⇒	05/05
BORA 2.8 VR6	AUE	03/00 ⇒	05/00
GOLF IV 2.3 V5	AQN	10/00 ⇒	06/06
GOLF IV 2.3 V5 4motion	AQN	10/00 ⇒	06/06
GOLF IV 2.8 V6 4motion	AUE, BDE	05/99 ⇒	06/06
GOLF IV 2.8 VR6 4motion	AUE, BDE	03/99 ⇒	06/05
NEW BEETLE 2.3 V5	AQN	10/00 ⇒	09/10
NEW BEETLE 3.2 RSI 4motion	AXJ	04/00 ⇒	05/01
SHARAN I 2.8 V6 24V	AYL	04/00 ⇒	03/10
SHARAN I 2.8 V6 24V 4motion	AYL	04/00 ⇒	03/10
SHARAN I 2.8 VR6	AYL	08/01 ⇒	05/03

KW 470 436



05,5

COILS

Adatt./Suitable:

AUDI

06C 905 115 A
06C 905 115 B
06C 905 115 D
06C 905 115 E
06C 905 115 F
06C 905 115 G
06C 905 115 H
06C 905 115 J
06C 905 115 K
06C 905 115 L
06C 905 115 M

BOSCH

0 986 221 053

HITACHI

133834
2503834

MAGNETI MARELLI

060717167012

VW

06C 905 115 A
06C 905 115 B
06C 905 115 D
06C 905 115 E
06C 905 115 F
06C 905 115 G
06C 905 115 H
06C 905 115 K
06C 905 115 L
06C 905 115 M

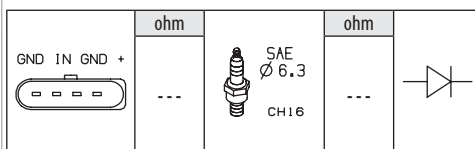

AUDI

A6 III 3.0	BBJ	08/04 ⇒	05/06
A6 III 3.0 [CHN]	BBJ	04/05 ⇒	
A6 III 3.0 quattro	BBJ	05/04 ⇒	05/06
A4 II 2.0	ALT	11/00 ⇒	12/04
A4 II 3.0	ASN, AVK, BBJ	11/00 ⇒	12/04
A4 II 3.0 quattro	ASN, AVK, BBJ	11/00 ⇒	12/04
A6 II 2.0	ALT	08/01 ⇒	01/05
A6 II 3.0	ASN, BBJ	06/01 ⇒	01/05
A6 II 3.0 quattro	ASN, BBJ	06/01 ⇒	01/05
A8 III 3.0	ASN, BBJ	07/03 ⇒	05/06
A8 III 3.0 quattro	ASN, BBJ	07/03 ⇒	05/05
A4 III 2.0	ALT	09/04 ⇒	12/05
A4 III 3.0	ASN, BBJ	04/02 ⇒	05/06
A4 III 3.0 quattro	ASN	05/03 ⇒	07/06

KW 470 437



05,5

COILS

Adatt./Suitable:

BOSCH

0 986 221 055

VW

066 905 100
066 905 100 B
066 905 100 C
066 905 100 D
066 905 100 G
066 905 715

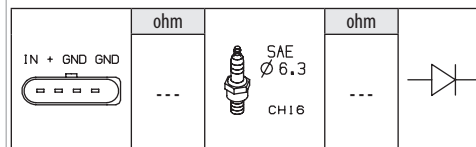

VW

PASSAT IV 2.3 V5	AZX	11/00 ⇒	05/05
PASSAT IV 2.3 V5 4motion	AZX	11/00 ⇒	05/05
PASSAT IV 2.3 VR5	AZX	11/00 ⇒	05/05
PASSAT IV 2.3 VR5 4motion	AZX	11/00 ⇒	05/05

KW 470 442



05,5

COILS

Adatt./Suitable:

ABARTH

4677288
55246099

ALFA ROMEO

4677288
55246099

BOSCH

0 986 221 043
0 986 22A 204

CHAMPION

BAE 403 C

FIAT

4677288
504142675
55246099

GENERAL MOTORS

95 512 934

HITACHI

133801
2503801

IVECO

504142675

LANCIA

4677288
55246099

MAGNETI MARELLI

060717202012
060740303010

OPEL

12 08 108
95512934

VAUXHALL

95512934

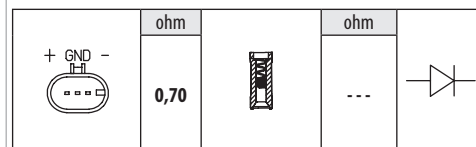

ALFA ROMEO

MITO 1.4	199A6.000, 955A1000	08/08 ⇒	08/13
FIAT			
500 0.9	312A4.000, 312A6.000	09/12 ⇒	

FIAT		
500 1.4	169A3.000	10/07 →
500 C 0.9	312A4.000, 312A6.000	09/12 →
500 C 1.4	169A3.000, EAB	09/09 →
500 MY12 0.9	--	01/12 →
500 MY12 1.4	--	01/12 →
500L 1.4	843A1.000	09/12 →
BRAVO II 1.4	192B2.000	04/07 → 12/14
BRAVO II 1.4 16V	--	04/07 →
BRAVO II 1.4 LPG	--	12/08 →
BRAVO II 1.4 T-Jet	198A1.000, 198A4.000	09/07 → 12/14
DOBLO II 1.4	843A1.000	02/10 →
DOBLO II 1.4 Natural Power	198A4000CNG	06/10 →
DUCATO III 140 Natural Power	F1CE0441A, F1CFA401A, F1CFA401C	04/09 →
PANDA III 0.9	312A4.000, 312A5.000, 312A6.000, 312A7.000	02/12 →
PANDA III 0.9 4x4	312A2.000	06/14 →
IDEA 1.2	--	01/08 →
IDEA 1.2 16V	188A5.000	01/04 →
IDEA 1.4	192B2.000	12/03 →
IDEA 1.4 16V	--, 843A1.000	01/04 →
LINEA 1.4 16V [IND]	--	06/07 →
LINEA 1.4 T-Jet	198A4.000	05/07 →
PANDA II 1.4	--	10/06 →
PUNTO III / GRANDE PUNTO 1.4 16V	199A6.000	10/05 → 08/11
PUNTO III / GRANDE PUNTO 1.4 16V [IND]	--	01/08 →
500 MY15 0.9	--	01/15 →
500 MY15 1.4	--	01/15 →
PUNTO II 1.4	199A6.000, 843A1.000	09/03 →
STILO 1.2 16V	188A5.000	02/02 → 11/06
STILO 1.4	843A1.000	01/04 → 08/08
STILO 1.4 16V	192B2.000, 843A1.000	10/03 → 08/08
TIPO II 1.4	843A1.000	10/15 →
IVECO		
DAILY IV 35C14 G, 35C14 G/P, 35S14 G, 35S14 G/P, 35C14 GD...	F1CE0441A	07/07 → 08/11
DAILY IV 35C14 GV, 35C14 GV/P, 35S14 GV, 35S14 GV/P	F1CE0441A	07/07 → 08/11
DAILY IV 40C14 G, 40C14 G/P	F1CE0441A	07/07 → 08/11
DAILY IV 40C14 GV, 40C14 GV/P	F1CE0441A	07/07 → 08/11
DAILY IV 50C14 G, 50C14 G/P, 50C14 GD, 50C14 GD/P	F1CE0441A	07/07 → 08/11
DAILY IV 50C14 GV, 50C14 GV/P	F1CE0441A	07/07 → 08/11
DAILY IV 65C14 G, 65C14 G/P, 65C14 GD, 65C14 GD/P	F1CE0441A	07/07 → 08/11
DAILY IV Natural Power 35S14, 35C14, 40C14, 50C14, 65C14, 70C14	F1CE0441A	09/11 → 02/14
DAILY IV Natural Power 35S14, 35C14, 40C14, 50C14, 60C14, 65C14..	F1CE0441A	09/11 → 02/14
DAILY V Natural Power 35S14, 35C14, 40C14, 50C14, 60C14, 65C14,...	F1CFA401A	03/14 →
DAILY V Natural Power 40C14, 50C14, 60C14	F1CFA401A, F1CFA401C	03/14 →
DAILY 3.0 CNG	F1CE0441A	06/06 → 02/14
LANCIA		
MUSA 1.4	192B2.000, 843A1.000	10/04 → 09/12
MUSA 1.4 16V	--	01/11 → 12/12
YPSILON II 1.2	188A5.000	10/03 → 12/11
YPSILON II 1.4 16V	843A1.000	10/03 → 12/11
OPEL		
COMBO D 1.4	A14FP	02/12 →
VAUXHALL		
COMBO D 1.4	A14FP	11/11 →

KW 470 445



COILS

Adatt./Suitable:

AUDI

06B 905 115
06B 905 115 B
06B 905 115 E

HITACHI

133828
2503828
CM11-201

MAGNETI MARELLI

060717158012

SEAT

06B 905 115 B
06B 905 115 E

SKODA

06B 905 115 B
06B 905 115 E

VW

06B 905 115
06B 905 115 B
06B 905 115 E

	ohm		ohm	
	---		---	

AUDI

A3 I 1.8 T	AJQ, APP, ARZ	12/96 → 05/03
A3 I 1.8 T quattro	AJQ, AQA	12/96 → 05/03
A3 I S3 quattro	AMK, APY, AUL	03/99 → 04/02
A6 II 1.8	AJP, AQE, ARH	07/97 → 01/05
A6 II 4.2 quattro	ARS, ASG	11/98 → 01/05
A6 II RS6 plus quattro	BRV	04/04 → 01/05
A6 II RS6 quattro	BCY	07/02 → 01/05
A6 II S6 quattro	ANK, AQJ	09/99 → 01/05
A8 I 3.7	AKC, AQG	11/98 → 09/02
A8 I 3.7 quattro	AKC, AQG	11/98 → 09/02
A8 I 4.2 quattro	ABZ, AKB, AQF, ARU, AUW	03/94 → 12/99
A8 I S8 quattro	AQH, AVP, AYS, BCS	09/00 → 09/02
TT I 1.8 T	AJQ, APP, ATC, AUQ	10/98 → 06/06
TT I 1.8 T quattro	AJQ, APX, ARY, ATC, AUQ, BAM	10/98 → 06/06

SEAT

CORDOBA I 1.8 T 20V Cupra	AQX	07/00 → 10/02
IBIZA II 1.8 T 20V Cupra	AQX	07/00 → 02/02
ALHAMBRA I / II 1.8 T 20V	AWC	10/97 → 03/10
LEON I 1.8 20V T	APP	11/99 → 06/06
LEON I 1.8 20V T 4	AJQ	11/99 → 06/06
TOLEDO II 1.8 20V T	AUQ	09/00 → 07/04
TOLEDO II 1.8 4x4	AJQ	05/01 → 04/04

SKODA

OCTAVIA I 1.8 T	ARX, AUM	08/97 → 12/10
-----------------	----------	---------------

VW

GOLF IV 1.8 T	ARZ, AUM	08/97 → 06/06
GOLF IV 1.8 T GTI	AUQ	08/01 → 06/05
NEW BEETLE 1.8 T	AGU, APH, AVC, AWU, AWV	10/99 → 09/10
PASSAT IV 1.8 [CHN]	ANQ	03/00 → 12/03
SHARAN I 1.8 T 20V	AWC	09/97 → 03/10

KW 470 448



COILS

Adatt./Suitable:

BOSCH

0 221 604 001
0 221 604 008

HITACHI

133870
2503870

VOLVO

30713416
9125601

	ohm		ohm	
	---		---	

VOLVO

C70 I 2.0 T	B5204T3, B5204T4	03/00 → 10/05
C70 I 2.3 T5	B5234T3, B5234T9	07/02 → 10/05
C70 I 2.3 T-5	B5234T3	03/97 → 09/02
C70 I 2.4	B5244S, B5254S, B5254SDENS	06/98 → 10/05
C70 I 2.4 T	B5244T, B5244T7, B5254T	03/97 → 10/05
S60 I 2.0 T	B5204T5	07/00 → 04/10
S60 I 2.3 T5	B5234T7	07/00 → 09/02
S60 I 2.4	B5244S, B5244S2, B5244T4	07/00 → 04/10
S60 I 2.4 Bifuel	B5244SG, B5244SG2	07/01 → 04/10
S60 I 2.4 T	B5244T3	07/00 → 04/10
S60 I 2.4 T AWD	B5244T3	06/01 → 04/10
S60 I 2.4 T5	B5244T5	04/04 → 04/10
S60 I 2.5 T	B5254T2	01/03 → 04/10
S60 I 2.5 T AWD	B5254T2	07/02 → 04/10
S60 I R 2.5 T AWD	B5254T4	01/03 → 04/10
S60 I T5	B5234T3	07/00 → 04/10
S70 2.0	B5204T4	01/97 → 11/00
S70 2.3	B5234FS, B5234T7	01/97 → 07/99
S70 2.3 AWD	B5234T7	04/99 → 09/00
S70 2.4	B5244S, B5244S2, B5244SG, B5254S, B5254SDENS	01/97 → 11/00
S70 2.4 AWD	B5244S, B5244S2, B5254SDENS	10/98 → 05/99
S70 2.4 Bifuel	B5244SG, B5244SG2	07/99 → 11/00
S70 2.4 Blu-Fuel	B5244S2, B5244SG	07/97 → 09/00
S70 2.4 T5 AWD	B5254T	11/96 → 04/99
S70 2.4 Turbo	B5244T	01/97 → 11/00
S80 I 2.0	B5204T4	06/98 → 07/06
S80 I 2.0 T	B5204T3, B5204T5	06/98 → 07/06
S80 I 2.3 R	B5234T7	04/00 → 08/05
S80 I 2.4	B5244S, B5244S2	01/99 → 07/06
S80 I 2.4 Bifuel	B5244SG, B5244SG2	09/01 → 07/06
S80 I 2.4 T	B5244T3	06/00 → 07/06
S80 I 2.4 T5 AWD	B5244T3	04/00 → 09/03
S80 I 2.5 T	B5254T2	03/03 → 07/06
S80 I 2.5 T AWD	B5254T2	07/03 → 07/06
S80 I 2.8 T6	B6284T	05/98 → 12/01
S80 I 2.9	B6294S, B6294S2, B6304S3	05/98 → 02/08
S80 I 2.9 T6	B6294T	06/01 → 07/06
S80 I 3.0	B6294S2	06/01 → 07/06
S80 I 3.0 T6	B6294T	06/01 → 07/06
V70 2.4 LPG	B5244SG2	07/97 → 03/00
V70 I 2.0	B5204T4	01/97 → 12/00
V70 I 2.3	B5234FS	01/97 → 07/99
V70 I 2.3 AWD	B5234T7, B5234T8	12/98 → 02/00
V70 I 2.4	B5244S, B5244S2, B5244SG2, B5254S, B5254SDENS	12/95 → 12/99
V70 I 2.4 AWD	B5254SDENS	06/98 → 12/99
V70 I 2.4 Bifuel	B5244SG, B5244SG2	08/99 → 12/00
V70 I 2.4 Turbo	B5244T	04/96 → 12/00
V70 I 2.4 Turbo AWD	B5244T, B5244T2	04/96 → 12/00

470 450

VOLVO		
V70 II 2.3	B5234T7	10/00 → 09/04
V70 II 2.3 AWD	B5234T7	10/00 → 09/04
V70 II 2.3 T5	B5234T3	11/99 → 12/04
V70 II 2.4	B5244S, B5244S2	03/00 → 08/07
V70 II 2.4 Bifuel	B5244S6, B5244S62	09/01 → 08/07
V70 II 2.4 T	B5244T3	11/99 → 08/03
V70 II 2.4 T AWD	B5244T3	09/01 → 08/02
V70 II 2.5 AWD	B5254T2	09/02 → 12/04
XC70 II 2.3 T XC AWD	B5234T7	01/01 → 07/04
XC70 II 2.5 T XC AWD	B5254T2	09/02 → 08/07
XC90 II 2.5 T AWD	B5254T2, B5254T9	10/02 → 09/14
XC90 II 6 AWD	B6294T	10/02 → 12/06

KW 470 450

08,6

COILS

Adatt./Suitable:

ALFA ROMEO

71739725
71744369
71779115

BOSCH

0 986 221 104

FIAT

71739725
71744369
71779115

GENERAL MOTORS

1 104 082
10 458 316
95 517 924

HITACHI

133832
2503832

MAGNETI MARELLI

060717156012

OPEL

10458316
12 08 021
12 08 120
95517924

SAAB

10 458 316

VAUXHALL

10458316
95517924

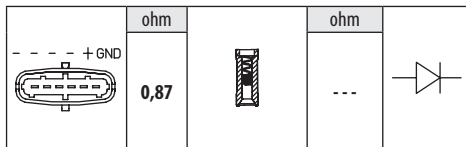

ALFA ROMEO

159 1.8 MPI	939A4.000	06/05 → 11/11
-------------	-----------	---------------

FIAT

CROMA II 1.8 16V	939A4.000	12/05 →
STILO 1.6	192B3.000	04/05 → 08/08
STILO 1.6 16V	192B3.000	03/05 → 12/07

OPEL

ZAFIRA TOURER 1.6 CNG	A16XNT, B16XNT	10/11 →
ASTRA G 1.6	Z16XEP	11/02 → 12/09
ASTRA G 1.6 16V	Z16XEP	03/00 → 05/05
ASTRA G 1.6 LPG	Z16XEP	06/02 → 06/07
ASTRA H 1.6	A16XER, Z16XE1, Z16XEP, Z16XER	03/04 → 05/14
ASTRA H 1.6 EcoTec	Z16XEP, Z16XER	02/04 → 12/10
ASTRA H 1.6 LPG	Z16XER	08/09 → 10/10
ASTRA H 1.6 Turbo	A16LET, Z16LET	02/07 → 10/10
ASTRA H 1.8	A18XER, Z18XER	08/05 → 05/14
ZAFIRA B 1.6	A16XER, Z16XE1, Z16XEP, Z16XER	07/05 → 04/15
ZAFIRA B 1.6 CNG Turbo	A16XNT, Z16XNT	04/10 → 04/15
ZAFIRA B 1.6 CNG Turbo VAN	A16XNT, Z16XNT	02/09 → 04/15
ZAFIRA B 1.6 FlexFuel	Z16XER	08/08 → 12/12
ZAFIRA B 1.8	A18XER, Z18XER	07/05 → 04/15
ZAFIRA B 1.8 LPG	Z18XER	07/09 → 04/15
ZAFIRA B 1.8 VAN	A18XER, Z18XER	07/05 → 04/15
ASTRA J 1.6	Z16XER	12/06 →
ASTRA J 1.8	Z18XER	02/07 →
CORSA D 1.6	Z16LER	07/12 → 08/14

OPEL

CORSA D 1.6 Turbo	A16LER, A16LER, A16LES, B16LER, Z16LER, Z16LER	11/06 → 08/14
INSIGNIA A 1.6 Turbo	A16LET	07/08 → 03/17
MERIVA A 1.6	Z16XEP	01/06 → 05/10
MERIVA A 1.6 Turbo	Z16LET	09/05 → 05/10
SIGNUM 1.8	Z18XER	09/05 → 12/08
VECTRA C 1.6	Z16XEP	08/05 → 08/08
VECTRA C 1.8	Z18XER	08/05 → 08/08
ZAFIRA A 1.6	Z16XEP	10/03 → 06/05
ZAFIRA A 1.6 16V	Z16XEP	10/03 → 06/05

SAAB

9-5 1.6 Turbo	A16LET	05/10 → 01/12
---------------	--------	---------------

VAUXHALL

ASTRA IV 1.6	Z16XEP	12/02 → 05/05
ASTRA IV 1.6 16V	Z16XEP	09/98 → 10/05
ASTRA V 1.6	A16LET, A16XER, Z16LET, Z16XE1, Z16XEP, Z16XER	01/04 → 03/11
ASTRA V 1.6 i 16V	A16XER, Z16XER	10/06 → 08/11
ASTRA V 1.6 Turbo	A16LET, Z16LET	09/06 → 09/09
ASTRA V 1.8	A18XER, Z18XER	01/04 → 11/10
ASTRA V 1.8 i 16V	A18XER, Z18XER	03/07 → 11/10
ASTRAVAN II 1.6 Dualfuel	Z16XE, Z16XEP	07/00 → 08/05
ASTRAVAN II 1.6 Dualfuel 16V	Z16XEP	10/04 → 12/05
CORSA D 1.6 SRi	A16LER, Z16LER	05/07 → 08/14
CORSA D 1.6 VXR	A16LER, A16LES, B16LER, Z16LER	11/06 → 08/14
INSIGNIA 1.6 Turbo	A16LET	01/09 → 05/17
ASTRAVAN III 1.6	Z16XE1, Z16XEP	03/05 →
MERIVA I 1.6 i 16V Twinport	Z16XEP	05/03 → 06/10
MERIVA I 1.6 Turbo	Z16LET	05/06 → 06/10
SIGNUM 1.8	Z18XER	08/05 → 05/08
VECTRA C 1.6 16V	Z16XEP	01/06 → 07/08
VECTRA C 1.8	Z18XER	01/06 → 07/08
ZAFIRA B 1.6	A16XER, Z16XE1, Z16XEP, Z16XER	07/05 → 11/14
ZAFIRA B 1.6 CNG Turbo	A16XNT, Z16XNT	02/09 → 11/14
ZAFIRA B 1.8	A18XER, Z18XER	04/05 → 11/14
ZAFIRA C 1.6 CNG	A16XNT	10/11 → 08/18

KW 470 457

05,5

COILS

Adatt./Suitable:

BOSCH

F 005 X11 800

DENSO

099 700-061
099 700-072
099 700-114
DIC-0144

HITACHI

133913
2503913
CM11-207A

HONDA

30520-P8E-A01
30520-P8E-S01
30520-P8F-A01
30520-P8F-A02
30520-PGK-A01
30520-PVF-A01
30520-PVJ-A01
30520-RCA-A01
30520-RCA-A02
30520-RCA-S01
30520-RJA-A01

MAGNETI MARELLI

060717088012
060810231010

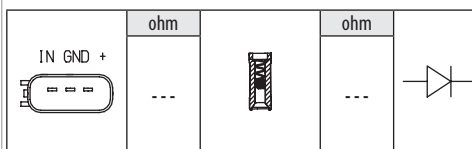

HONDA

ACCORD VI 3.0 V6 24V	J30A1	02/98 → 06/03
ACCORD VI 3.0 Vtec	J30A1	03/97 → 12/03
CIVIC VII 1.4	D14Z5	12/00 → 09/05
CIVIC VII 1.4 i	D14Z6	02/01 → 09/05

HONDA

CIVIC VII 1.4 iS	D14Z5, D14Z6	02/01 → 09/05
CIVIC VII 1.4i 16V	D14Z6	02/01 →
CIVIC VII 1.5	D15Y3	02/03 → 09/05
CIVIC VII 1.5 i 16V	D15Y2, D15Y3	01/01 →
CIVIC VII 1.6	D16V1, D16W7	02/01 → 09/05
CIVIC VII 1.6 i	D16V1, D16W7	02/01 → 12/05
CIVIC VII 1.6i 16V	D16W7	04/01 →
CIVIC VII 1.6i 16V Vtec	D16V3	04/01 →
CIVIC VII 1.7	D17A6	01/00 → 09/05
CIVIC VII 1.7 i	D17A8	05/01 → 12/05
CIVIC VII 1.7 i 16V VTi	D17A5, D17Z4	02/01 →
CIVIC VII 1.7 i VTEC	D17A5, D17A9	05/01 → 12/05
FR-V 1.7	D17A2	08/04 →
LEGEND IV 3.5 i	J35A8	10/04 →
LEGEND IV 3.5 V6 4WD	J35A8	05/06 → 12/12
LEGEND IV 3.5 VTEC V6	C35A8	10/04 → 06/09
LEGEND IV 3.7 VTEC V6 4WD	J37A3	08/08 → 12/13
MR-V 3.5	J35A4, J35A6, J35A9	01/03 →
ODYSSEY 3.5	J35A2, J35A4, J35A6	01/00 →
STREAM 1.7 16V	D17A2	05/01 → 09/06

KW 470 458

05,5

COILS

Adatt./Suitable:

BOSCH

0 986 AGO 508
F 005 X11 793

DENSO

DIC-0134

HITACHI

133874
2503874

LEXUS

90919-02248
90919-02260

MAGNETI MARELLI

060717086012

TOYOTA

90919-02247
90919-02248
90919-02260
90919-A2001
90919-A2006
90919-C2002
90919-C2006
90919-T2001
90919-T2005
90919-T2008

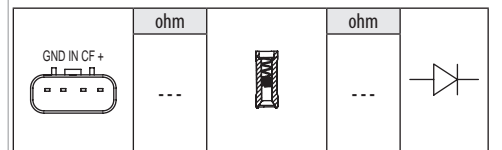

LEXUS

GS F	2UR-GSE	09/15 →
LC 500	2UR-GSE	11/16 →
RC F	2UR-GSE	08/14 →

TOYOTA

COROLLA X 1.5	1NZ-FE	09/06 →
COROLLA X 1.5 4WD	1NZ-FE	09/06 →
COROLLA X 2.4	2AZ-FE	01/08 →
AVENSIS I 2.0	1AZ-FSE	10/00 → 02/03
AVENSIS I 2.0 VVT-i	1AZ-FSE	10/00 → 02/03
AVENSIS II 2.0	1AZ-FSE	03/03 → 11/08
AVENSIS II 2.0 VVTi	1AZ-FE, 1AZ-FSE	01/03 → 11/08
AVENSIS II 2.4	2AZ-FSE	09/03 → 11/08
CAMRY 2.0	1AZ-FE	05/06 →
CAMRY 2.4	2AZ-FE	09/01 → 09/11
CAMRY 2.4 [CHN]	3AZ-FXE	03/10 →
CAMRY 2.4 Hybrid	2AZ-FXE	01/06 → 09/11
CAMRY SOLARA II 2.4	2AZ-FE	07/03 → 11/08
COROLLA XI 1.5	1NZ-FE	05/12 →
COROLLA XI 1.5 4WD	1NZ-FE	05/12 →
LAND CRUISER 200 4.0	1GR-FE	01/10 →
FJ CRUISER 4.0	1GR-FE	06/05 → 12/11
FJ CRUISER 4.0 4WD	1GR-FE	06/05 → 01/18
FORTUNER 2.7 4x4	2TR-FE	05/15 →
HIACE IV 2.7	2TR-FE	01/05 →

TOYOTA		
HIACE IV 2.7 VVTi	2TR-FE	01/05 ⇨
LAND CRUISER 2.7	2TR-FE	08/04 ⇨
LAND CRUISER 4.0	1GR-FE	01/03 ⇨ 08/09
LAND CRUISER 120 2.7	2TR-FE	11/03 ⇨ 02/10
LAND CRUISER 120 4.0	1GR-FE	09/02 ⇨ 12/10
LAND CRUISER 120 4.0 V6 VVT-i	1GR-FE	01/03 ⇨ 07/09
MATRIX 2.4	2AZ-FE	01/08 ⇨ 05/14
RAV 4 III 2.0 VVT-i [CHN]	1AZ-FE	03/09 ⇨
RAV 4 III 2.4 VVTi [CHN]	2AR-FE	03/09 ⇨
TARAGO MPV / SPACE 2.4 VVTi	2AZ-FE	02/00 ⇨ 12/05
HILUX VII 2.0	1TR-FE	06/05 ⇨ 05/15
HILUX VII 2.7	2TR-FE	02/05 ⇨
HILUX VII 2.7 4WD	2TR-FE	08/05 ⇨ 05/15
HILUX VII 4.0	1GR-FE	02/05 ⇨
HILUX VII 4.0 4WD	1GR-FE	02/05 ⇨

TOYOTA		
YARIS III 1.3	2NZ-FE	12/11 ⇨
YARIS III 1.5	1NZ-FE	12/10 ⇨
YARIS III 1.5 Hybrid	1NZ-FXE	03/12 ⇨
YARIS VERSO 1.3	2NZ-FE	11/02 ⇨ 09/05
YARIS VERSO 1.3 VVTi	2NZ-FE	03/00 ⇨ 09/05
YARIS VERSO 1.5	1NZ-FE	01/00 ⇨ 09/05
YARIS VERSO 1.5 VVTi	1NZ-FE	03/00 ⇨ 03/03

TOYOTA		
COROLLA VERSO II 1.6	3ZZ-FE	04/04 ⇨ 03/09
COROLLA VERSO II 1.8	1ZZFE	04/04 ⇨ 03/09
MR 2 III 1.8 16V VT-i	1ZZFE	10/99 ⇨ 06/07
RAV 4 II 1.8	1ZZFE	08/00 ⇨ 11/05
VIOS / YARIS 1.0	1KR-FE	09/05 ⇨ 10/13
YARIS II 1.0 GPL	1KR-FE	01/06 ⇨ 12/11
YARIS II 1.0 VVT-i	1KR-FE	08/05 ⇨ 12/11
YARIS III 1.0	1KR-FE	12/10 ⇨

KW 470 459  **05,5**

COILS

Adatt./Suitable:

BOSCH
0 986 AG0 502

CITROËN
16 115 478 80

DENSO
DIC-0101
DIC-0146

HITACHI
133844
2503844

MAGNETI MARELLI
060717078012

PEUGEOT
16 115 478 80

TOYOTA
90080-19021
90919-02229
90919-02240
90919-02265
90919-02270
90919-W2002

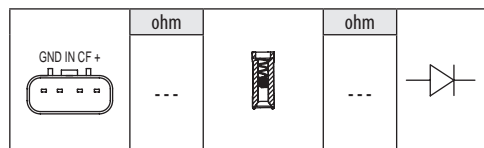

CITROËN		
C1 II 1.0 VTi 68	CFB(1KR)	04/14 ⇨
C1 II 1.0 VTi 72	CFB(1KR)	06/18 ⇨
PEUGEOT		
108 1.0 VTi	1KR-FE, CFB(1KR)	05/14 ⇨
108 1.0 VTi 72	CFB(1KR)	05/18 ⇨
TOYOTA		
AQUA 1.5 Hybrid	1NZ-FXE	12/11 ⇨
COROLLA X 1.3 VVT-i	2NZ-FE	03/08 ⇨
COROLLA X 1.5	1NZ-FE	09/06 ⇨
COROLLA X 1.5 4WD	1NZ-FE	09/06 ⇨
AYGO II 1.0	1KR-FE	05/14 ⇨
AYGO II 1.0 VVTi	1KR-FE	03/18 ⇨
COROLLA XI 1.5 Hybrid	1NZ-FXE	10/14 ⇨
ECHO 1.5 i 16V [USA]	1NZFE	08/99 ⇨
IQ 1.0	1KR-FE	01/09 ⇨ 12/15
PRIUS I 1.5 Hybrid	1NZ-FXE	05/00 ⇨ 01/04
PRIUS II 1.5 Hybrid	1NZ-FXE	09/03 ⇨ 12/09
PRIUS C 1.5 Hybrid	1NZ-FXE	12/11 ⇨
VIOS / YARIS 1.3	2NZ-FE, 2SZ-FE	09/05 ⇨ 10/13
VIOS / YARIS 1.3 4WD	2NZ-FE	09/05 ⇨ 04/13
VIOS / YARIS 1.5	1NZ-FE	08/07 ⇨
YARIS I 1.0	1SZ-FE	03/03 ⇨ 09/05
YARIS I 1.3	2NZ-FE, 2SZ-FE	04/02 ⇨ 11/05
YARIS I 1.5	1NZ-FE	03/00 ⇨ 11/05
YARIS II 1.3 4WD	2NZ-FE	08/07 ⇨ 11/10
YARIS II 1.3 VVT-i	2NZ-FE, 2SZ-FE	08/05 ⇨ 12/12
YARIS II 1.5	1NZ-FE	11/05 ⇨
YARIS III 1.0 VVTi	1KR-FE	07/14 ⇨

KW 470 461  **05,5**

COILS

Adatt./Suitable:

BOSCH
0 986 AG0 503
F 005 X11 783

CITROËN
5970 88
5970 C0
5970 C1

DAIHATSU
90919-02262

DENSO
DIC-0100

HITACHI
133846
2503846

MAGNETI MARELLI
060717126012

PEUGEOT
5970 88
5970 C0
5970 C1

TOYOTA
90080-19015
90080-19019
90919-02239
90919-02262
90919-T2002
90919-T2006
90919-W2001

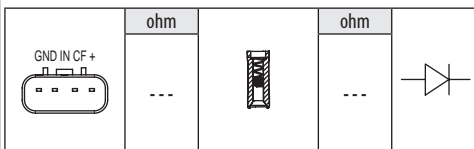

CITROËN		
C1 I 1.0	384F, CFA(384F), CFB(1KR)	06/05 ⇨
DAIHATSU		
CUORE VII 1.0 LPG	1KR-FE	09/11 ⇨ 12/12
PEUGEOT		
107 1.0	CFA(384F), CFB(1KR)	06/05 ⇨ 05/14
TOYOTA		
COROLLA X 1.4 VVT-i	4ZZFE	11/06 ⇨ 11/13
COROLLA X 1.6 VVTi	3ZZ-FE	08/07 ⇨ 06/13
COROLLA X 1.8 16V	2CJXG	08/07 ⇨
COROLLA X 1.8 CNG	2CJXG	06/09 ⇨
COROLLA X 1.8 FlexFuel [BRA]	1ZZ-FBE	03/08 ⇨
AURIS I 1.4	85HFC4GB	03/07 ⇨ 09/12
AVENSIS I 1.6	3ZZ-FE	07/00 ⇨ 02/03
AVENSIS I 1.6 VVT-i	3ZZ-FE	10/00 ⇨ 02/03
AVENSIS I 1.8	1ZZFE	10/00 ⇨ 02/03
AVENSIS I 1.8 VVT-i	1ZZFE	10/00 ⇨ 02/03
AVENSIS II 1.6 VVT-i	3ZZ-FE	04/03 ⇨ 11/08
AVENSIS III 1.8	1ZZFE	03/03 ⇨ 11/08
AYGO I 1.0	1KR-FE	07/05 ⇨ 05/14
AYGO I 1.0 GPL	1KR-FE	07/05 ⇨ 05/14
AYGO I 1.0 VVTi	1KR-FE	07/05 ⇨ 05/14
CELICA VII 1.8 16V VT-i	1ZZFE	08/99 ⇨ 07/05
COROLLA VIII 1.6	3ZZ-FE	10/99 ⇨ 01/02
COROLLA VIII 1.6 16V	3ZZ-FE	10/99 ⇨ 12/01
COROLLA IX 1.4 VVT-i	02224	10/01 ⇨ 02/07
COROLLA IX 1.6 VVT-i	3ZZ-FE	10/01 ⇨ 03/08
COROLLA IX 1.8	1ZZFE	12/01 ⇨ 12/07
COROLLA VERSO I 1.6 VVT-i	3ZZ-FE	08/01 ⇨ 05/04
COROLLA VERSO I 1.8 VVT-i	1ZZFE	12/01 ⇨ 05/04
COROLLA VERSO I 1.8 VVTi 4WD	2CJXG	07/01 ⇨ 02/04

KW 470 466  **05,5**

COILS

Adatt./Suitable:

BOSCH
0 986 AG0 506
F 005 X11 794

DENSO
DIC-0102

HITACHI
134010
2504010

LEXUS
90919-02244
90919-02266

MAGNETI MARELLI
060717119012

TOYOTA
90080-19023
90919-02243
90919-02244
90919-02266

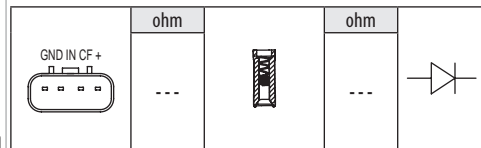

LEXUS		
HS 250h	2AZ-FXE	07/09 ⇨ 01/18
TOYOTA		
COROLLA X 2.4	2AZ-FE	01/08 ⇨
AVENSIS II 2.0	1AZ-FE	08/01 ⇨ 11/09
AVENSIS II 2.0 VVTi	1AZ-FE	01/03 ⇨ 11/08
AVENSIS II 2.4	2AZ-FE	08/01 ⇨ 08/07
AVENSIS II 2.4 4WD	2AZ-FE	11/03 ⇨ 08/06
AVENSIS III 2.0	1AZ-FE	11/08 ⇨ 04/11
CAMRY 2.0	1AZ-FE	08/01 ⇨ 11/06
CAMRY 2.4	2AZ-FE	09/01 ⇨ 09/11
CAMRY 2.4 Hybrid	2AZ-FXE	01/06 ⇨ 09/11
CAMRY 2.4 VVTi LE	2AZ-FE	01/06 ⇨ 11/06
CAMRY SOLARA II 2.4	2AZ-FE	07/03 ⇨ 11/08
MATRIX 2.4	2AZ-FE	01/08 ⇨ 05/14
MATRIX 2.4 4WD	2AZ-FE	01/09 ⇨ 12/10
PICNIC II 2.0 VVTi	1AZ-FE	05/01 ⇨ 08/06
PICNIC II 2.4 VVTi	2AZ-FE	11/03 ⇨ 08/06
PREVIA II 2.4	2AZ-FE	02/00 ⇨ 02/06
RAV 4 II 2.0	1AZ-FE	09/00 ⇨ 12/03
RAV 4 II 2.0 4WD	1AZ-FE	05/00 ⇨ 11/05
RAV 4 II 2.4 4WD	2AZ-FE	08/03 ⇨ 11/05
RAV 4 III 2.0 4WD	1AZ-FE	02/06 ⇨ 06/13
RAV 4 III 2.4	2AZ-FE	11/05 ⇨ 12/13
RAV 4 III 2.4 4WD	2AZ-FE	11/05 ⇨ 06/13
PREVIA III 2.4	2AZ-FE	10/05 ⇨
TARAGO MPV / SPACE 2.4 VVTi	2AZ-FE	02/00 ⇨ 12/05

KW 470 474

05,5

COILS

Adatt./Suitable:

AUDI

036 905 100 A
036 905 100 B
036 905 100 C
036 905 100 D
036 905 715
036 905 715 A
036 905 715 C
036 905 715 E
036 905 715 F
036 905 715 G
036 905 715 H

BOSCH

0 986 221 023

HITACHI

133807

2503807

MAGNETI MARELLI

060717062012

SEAT

036 905 100 A
036 905 100 B
036 905 100 C
036 905 100 D
036 905 715
036 905 715 A
036 905 715 C
036 905 715 E
036 905 715 F
036 905 715 G
036 905 715 H

SKODA

036 905 100 A
036 905 100 B
036 905 100 C
036 905 100 D
036 905 715
036 905 715 A
036 905 715 C
036 905 715 E
036 905 715 F
036 905 715 G
036 905 715 H

VW

036 905 100 A
036 905 100 B
036 905 100 C
036 905 100 D
036 905 715
036 905 715 A
036 905 715 C
036 905 715 E
036 905 715 F
036 905 715 G
036 905 715 H

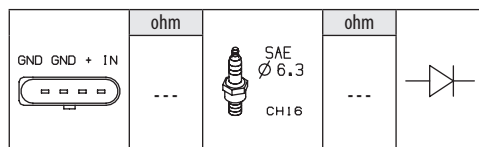

AUDI

A1 1.4 TFSI	CAVG, CAXA, CNVA, CTHG	05/10 ⇒ 04/15
A2 1.4	BBY	02/00 ⇒ 08/05
A2 1.6 FSI	BAD	05/02 ⇒ 08/05
A3 II 1.4 TFSI	CAXC, CMSA	09/07 ⇒ 05/13
A3 II 1.6 FSI	BAG, BLF, BLP	08/03 ⇒ 09/07

SEAT

ALTEA 1.4 16V	BXW, CGGB	05/06 ⇒
ALTEA 1.4 TFSI	CAXC	05/10 ⇒ 04/11
ALTEA 1.4 TSI	CAXC	11/07 ⇒
ALTEA XL 1.4 16V	BXW, CGGB	10/06 ⇒
ALTEA XL 1.4 TSI	CAXC	11/07 ⇒
ALHAMBRA III 1.4 TSI	CAVA, CTHA	06/10 ⇒
IBIZA III 1.2	AZQ, BME	02/02 ⇒ 06/06
IBIZA III 1.2 12V	BXV	05/06 ⇒ 11/09
IBIZA III 1.4 16V	AUB, BBY, BBZ, BKY, BXW	02/02 ⇒ 11/09
IBIZA III 1.6 16V	BTS	11/06 ⇒ 11/09
CORDOBA II 1.2	AZQ, BME	10/02 ⇒ 06/06
CORDOBA II 1.2 12V	BXV	05/06 ⇒ 11/09
CORDOBA II 1.4 16V	BBY, BBZ, BKY, BUD, BXW	09/02 ⇒
CORDOBA II 1.6 16V	BTS	11/06 ⇒ 11/09
IBIZA IV 1.2	BZG, CGPA, CGPB, CLB	03/08 ⇒ 05/15
IBIZA IV 1.2 LPG	BZG	03/08 ⇒ 05/11
IBIZA IV 1.4	BXW, CGGB	03/08 ⇒ 05/15
IBIZA IV 1.4 LPG	BXW	03/08 ⇒ 05/11
IBIZA IV 1.4 TSI	CAVF, CNUB, CTHF, CTJB	01/09 ⇒ 05/15
IBIZA IV 1.4 TSI Cupra	CAVE, CTHE, CTJC	06/09 ⇒ 05/15

SEAT

IBIZA IV 1.6	BTS	05/08 ⇒ 05/15
IBIZA IV 1.6 LPG	CNKA	05/11 ⇒ 05/15
IBIZA 1.2	BZG, CGPA, CGPB	04/08 ⇒ 05/15
IBIZA 1.4	BXW, CGGB	07/08 ⇒ 05/15
IBIZA 1.6	BTS	07/08 ⇒ 05/15
LEON I 1.4 16V	BCA	11/99 ⇒ 06/06
LEON I 1.6 16V	AZD, BCB	09/00 ⇒ 06/06
LEON II 1.4 16V	BXW	06/06 ⇒ 12/12
LEON II 1.4 TSI	CAXC	11/07 ⇒ 12/12
LEON II 2.0 TFSI	CCZB	06/09 ⇒ 12/12
TOLEDO II 1.4 16V	BCA	01/00 ⇒ 05/02
TOLEDO II 1.6 16V	AZD, BCB	06/00 ⇒ 05/06
TOLEDO III 1.4 16V	BXW	05/06 ⇒ 05/09
TOLEDO IV 1.2	CGPC	07/12 ⇒ 06/15
TOLEDO IV 1.4 TSI	CAXA	07/12 ⇒ 06/15
TOLEDO IV 1.6	CFNA	07/13 ⇒ 06/15

SKODA

FABIA I 1.2	AZQ, BME	01/03 ⇒ 03/08
FABIA I 1.4	BKY	05/04 ⇒ 12/07
FABIA I 1.4 16V	AUB, BBY, BBZ, BKY, BUD	12/99 ⇒ 03/08
OCTAVIA I 1.4 16V	BCA	08/00 ⇒ 12/10
OCTAVIA II 1.4	BCA, BUD, CGGA	05/04 ⇒ 06/13
OCTAVIA II 1.4 [CHN]	CFBA.	03/10 ⇒
OCTAVIA II 1.4 TSI	CAXA	11/08 ⇒ 06/13
OCTAVIA II 1.6 [CHN]	CDFA, CLRA, CPJA	09/07 ⇒
OCTAVIA II 1.6 FSI	BLF	02/04 ⇒ 10/08
RAPID 1.2	CGPC	07/12 ⇒ 06/15
RAPID 1.2 LPG	CGPC	07/12 ⇒ 06/15
RAPID 1.4 TSI	CAXA	07/12 ⇒ 06/15
RAPID 1.6	CFNA	07/12 ⇒ 06/15
ROOMSTER 1.2	BME, BZG, CGPA	05/06 ⇒ 05/15
ROOMSTER 1.2 LPG	CGPA	03/09 ⇒ 05/15
ROOMSTER 1.4	BXW, CGGB	09/06 ⇒ 05/15
ROOMSTER 1.4 LPG	BXW, CGGB	03/10 ⇒ 05/15
ROOMSTER 1.6	BTS, CFNA	09/06 ⇒ 05/15
ROOMSTER 1.6 LPG	BTS	06/06 ⇒ 07/10
FABIA II 1.2	BZG, CEVA, CGPA, CHTA	01/07 ⇒ 12/14
FABIA II 1.2 [IND]	CJLA	09/10 ⇒
FABIA II 1.2 12V	CGPB	11/11 ⇒ 12/14
FABIA II 1.2 LPG	CGPA	07/07 ⇒ 11/14
FABIA II 1.4	BXW, CGGB	01/07 ⇒ 12/14
FABIA II 1.4 [CHN]	CDDA	12/08 ⇒
FABIA II 1.4 LPG	BXW, CGGB	01/07 ⇒ 11/14
FABIA II 1.4 TSI RS	CAVE, CTHE	05/10 ⇒ 12/14
FABIA II 1.6	BTS, CFNA, CLSA	04/07 ⇒ 12/14
FABIA II 1.6 [CHN]	CDEA	12/08 ⇒
SUPERB II 1.4 [CHN]	CFBA.	03/10 ⇒
SUPERB II 1.4 TSI	CAXC	07/08 ⇒ 05/15
YETI 1.4 TSI	CAXA	06/10 ⇒ 05/15

VOLKSWAGEN (BR)

POLO 1.4	BKY	07/06 ⇒
POLO 1.4 16V	BBY	09/02 ⇒

VW

GOLF VI 1.4	BUD, CGGA, CNWA	10/08 ⇒
GOLF VI 1.4 16V	BUD, CGGA	01/09 ⇒ 05/11
GOLF VI 1.4 TSI	CAVD, CAXA, CNWA, CTHD, CTKA	10/08 ⇒
GOLF VI TSi	CAXA	10/08 ⇒ 11/12
BEETLE 1.4 TSI	CAVD, CNWA, CTHD, CTKA	10/11 ⇒ 07/16
BORA 1.4 16V	BCA	03/00 ⇒ 05/05
BORA 1.6 16V	AZD, BCB	02/00 ⇒ 05/05
BORA 1.6 FSI	BAD	01/02 ⇒ 05/05
GOLF V 1.4	BUD	06/07 ⇒ 07/09
GOLF V 1.4 16V	BCA, BUD, CGGA	10/03 ⇒ 12/13
GOLF V 1.4 FSI	BKG, BLN	10/03 ⇒ 11/06
GOLF V 1.4 TSI	BLG, BMY, CAVD, CAXA, CNWA, CTHD	11/05 ⇒ 12/13
GOLF V 1.6 FSI	BAG, BLF, BLP	10/03 ⇒ 07/08
CADDY III 1.4	BCA, BUD	03/04 ⇒ 08/10
CC 1.4 TSI	CTHD	11/11 ⇒ 12/16
CC 1.4 TSI MultiFuel	CKMA	11/11 ⇒ 12/16
EOS 1.4 TSI	CAVD, CAXA, CTHD	11/07 ⇒ 08/15
EOS 1.6 FSI	BLF	06/06 ⇒ 05/08
EOS 2.0 TFSI	BPY, BWA, CAWB, CBFA, CCTA, CCZA	03/06 ⇒ 08/15
JETTA V 1.4 TSI	BLG, BMY, CAVD, CAXA	07/06 ⇒ 10/10
JETTA V 1.6 FSI	BLF	09/05 ⇒ 10/10
PASSAT V 1.4 TSI	CAXA, CTHD	05/07 ⇒ 12/14
PASSAT V 1.4 TSI EcoFuel	CDGA	01/09 ⇒ 12/14
PASSAT V 1.4 TSI MultiFuel	CKMA	11/10 ⇒ 12/14
PASSAT V 1.6 FSI	BLF	03/05 ⇒ 06/08
GOLF IV 1.4	BCA	05/00 ⇒ 06/06
GOLF IV 1.4 16V	BCA	10/97 ⇒ 06/06
GOLF IV 1.6	AZD, BCB	05/00 ⇒ 06/06
GOLF IV 1.6 16V	AZD, BCB	02/00 ⇒ 06/06
GOLF IV 1.6 FSI	BAD, BAG	01/02 ⇒ 06/06
GOLF PLUS 1.4 TSi	CAVD, CAXA	01/09 ⇒ 08/14
JETTA VI 1.4 TSI	CAVA, CAVD, CAXA, CMSB, CTHA, CTHD	04/11 ⇒

VW

JETTA VI 1.6	CFNA, CFNB, CLRA	12/11 ⇒
POLO IV 1.2 12V	AZQ, BME, BZG	10/01 ⇒ 11/09
POLO IV 1.4	BBY, BBZ, BKY, BMG, CDD.	11/02 ⇒
POLO IV 1.4 16V	AUB, BBY, BBZ, BKY, BUD	10/01 ⇒ 11/09
POLO IV 1.4 BiFuel	BUD	05/06 ⇒ 11/09
POLO IV 1.4 FSI	AXU	02/02 ⇒ 07/06
POLO IV 1.6	BMH, CDE.	03/06 ⇒
POLO IV 1.6 16V	BTS	05/06 ⇒ 11/09
LUPO 1.4 16V	BBY	09/98 ⇒ 07/05
NEW BEETLE 1.4	BCA	11/01 ⇒ 09/10
POLO V 1.2	CGPA, CGPB	03/09 ⇒
POLO V 1.2 [IND]	CJLA	08/11 ⇒
POLO V 1.2 BlueMotion	CGPA	03/09 ⇒ 05/14
POLO V 1.4	CDDA, CGGB, CLPA	03/09 ⇒ 05/14
POLO V 1.4 BiFuel	CMAA	03/10 ⇒ 01/11
POLO V 1.4 GTI	CAVE, CTHE	05/10 ⇒
POLO V 1.6	CFNA, CFNB, CLSA	01/10 ⇒
POLO V 1.6 BiFuel	CNKA	01/11 ⇒ 05/14
PASSAT 1.4 TSi BlueMotion	CAXA	08/10 ⇒ 12/14
SCIROCCO III 1.4 TSI	CAVD, CAXA, CMSB, CNWA, CTHD, CTKA	05/08 ⇒ 11/17
SHARAN II 1.4 TSI	CAVA, CTHA	05/10 ⇒
PASSAT CC 1.4 TSi MultiFuel	CKMA	01/11 ⇒ 01/12
TIGUAN I 1.4 [CHN]	CFBA.	11/11 ⇒
TIGUAN I 1.4 TSI	BWK, CAVA, CAVD, CAXA, CTHD	05/08 ⇒ 07/18
TIGUAN I 1.4 TSI 4motion	BWK, CAVA, CAVD, CTHD	09/07 ⇒ 07/18
TOURAN I 1.4 [CHN]	CFBA.	04/09 ⇒
TOURAN I 1.4 TSI	BLG, BMY, CAVB, CAVC, CTHB, CTHC	02/06 ⇒ 05/15
TOURAN I 1.4 TSi EcoFuel	CDGA	05/09 ⇒ 05/15
TOURAN I 1.6 FSI	BAG, BLF, BLP	02/03 ⇒ 01/07
TOURAN I FSI	BAG, BLF, BLP	02/03 ⇒ 11/06

KW 470 475



COILS

Adatt./Suitable:

- BMW**
 12 13 0 148 594
 12 13 0 390 064
 12 13 1 712 219
 12 13 1 712 223
 12 13 5 A06 753
 12 13 7 523 345
 12 13 7 548 553
 12 13 7 550 012
 12 13 7 551 049
 12 13 7 551 260
 12 13 7 562 744
 12 13 7 571 643
 12 13 7 575 010
 12 13 7 594 596
 12 13 7 594 936
 12 13 7 594 937
 12 13 7 594 938
 12 13 8 611 236
 12 13 8 616 153
 12 13 8 647 689
 12 13 8 657 273
 5 575 010
 7 548 553
 7 551 049
 7 571 643
 7 594 596
 7 594 936
 8 611 236
 8 616 153
 8 647 689

- BOSCH**
 0 221 504 100
 0 221 504 463
 0 221 504 464
 0 221 504 465
 0 221 504 467
 0 221 504 470
 0 221 504 800

- CITROËN**
 5970 64
 5970 91
 98 067 027 80
 98 078 418 80

- DS**
 5970 91
GENERAL MOTORS
 3 648 847

- HITACHI**
 133825
 133875
 134046
 134047
 134049
 2503825
 2503875
 2504046
 2504047
 2504049

- MAGNETI MARELLI**
 060717114012
 060717115012
 060717116012
 060717152012

- MINI**
 12 13 5 A06 753
 12 13 7 550 012
 12 13 7 551 049
 12 13 7 562 744
 12 13 7 571 643
 12 13 7 575 010
 12 13 7 594 596
 12 13 7 594 937
 12 13 7 594 938
 12 13 8 616 153
 12 13 8 657 273
 7 571 643

- OPEL**
 3648847
 5 97 091

- PEUGEOT**
 5970 64
 5970 91
 98 067 027 80
 98 078 418 80

- ROLLS-ROYCE**
 12 13 5 A06 753
 12 13 7 571 643
 12 13 7 594 937
 12 13 7 594 938
 12 13 8 616 153
 12 13 8 647 689
 12 13 8 657 273

- VAUXHALL**
 5 97 091

ALPINA		
B6 4.4 Biturbo 4x4 [USA]	N63M20A	03/14 ⇨
B7 4.4 Biturbo [USA]	N63M20A	01/11 ⇨
B7 4.4 Biturbo 4x4 [USA]	N63M20A	01/12 ⇨
B7 BITURBO	N63M10A	03/09 ⇨ 06/12
B7 BITURBO Trazione integrale	N63M10A	09/10 ⇨ 06/12
BMW		
11 116 i	N45B16A	06/04 ⇨ 12/11
11 118 i	N46B20B	07/04 ⇨ 12/13
11 120 i	N46B20B, N46B20BD, N46B20C	06/04 ⇨ 12/13
11 125 i	N52B30A, N52B30B, N52B30BF	10/07 ⇨
11 128 i	N51B30A, N52B30A	12/07 ⇨
11 130 i	N52B30A, N52B30B, N52B30BF	09/05 ⇨ 12/11
11 135 i	N54B30A, N55B30A	10/07 ⇨ 12/13
11 M	N54B30A	03/11 ⇨ 06/12
3VI 316 i	N13B16A	07/12 ⇨ 08/16
3VI 316 Li [CHN]	N13B16A	10/12 ⇨
3VI 320 i	N13B16A, N20B20A, N20B20B	03/12 ⇨ 10/18
3VI 320 i xDrive	N20B20A, N20B20B	07/12 ⇨ 10/18
3VI 320 Li [CHN]	--	02/12 ⇨
3VI 328 i	N20B20A, N26B20A	11/11 ⇨ 10/18
3VI 328 i xDrive	N20B20A, N26B20A	07/12 ⇨ 08/16
3VI 328 i xDrive [USA]	--	10/11 ⇨
3VI 328 Li [CHN]	N20B20A	10/11 ⇨
3VI 328 Li xDrive [CHN]	--	10/11 ⇨
3VI 328i	N20B20A	11/11 ⇨ 06/15
3VI 335 i	N55B30A	11/11 ⇨ 06/16
3VI 335 i xDrive	N55B30A	07/12 ⇨ 06/16
3VI ActiveHybrid	N55B30A	07/12 ⇨ 06/15
3VI M3	S55B30A	03/14 ⇨ 10/18
3VI M3 Competition	S55B30A	03/16 ⇨ 10/18
3VI M3 CS	S55B30A	01/18 ⇨ 10/18
111 114 i	N13B16A	12/11 ⇨
111 116 i	N13B16A	07/11 ⇨
111 118 i	N13B16A	07/11 ⇨
111 120 i	N13B16A	03/15 ⇨
111 125 i	N20B20A	12/11 ⇨
111 125 i Active Flex	N20B20A	11/14 ⇨ 11/17
111 M 135 i	N55B30A	12/11 ⇨
111 M 135 i xDrive	N55B30A	02/12 ⇨
2220 i	N20B20A, N20B20B	10/13 ⇨
2228 i	N20B20A	07/14 ⇨
2 M 235 i	N55B30A	10/13 ⇨
2 M 235 i xDrive	N55B30A	07/14 ⇨
2 M2	N55B30A	11/15 ⇨ 06/18
2 M2 Competition	S55B30A	06/18 ⇨
2 M2 CS	S55B30A	11/19 ⇨
3V 316 i	N45B16A	09/05 ⇨ 10/11
3V 318 i	N46B20B	09/05 ⇨ 03/12
3V 320 i	N46B20A, N46B20B, N46B20C, N46B20CB	12/04 ⇨ 12/13
3V 320 si	N45B20A	09/05 ⇨ 08/06
3V 323 i	N52B25A, N52B25B, N52B25BE, N52B25BF, N52B25B, N52B25BE, N52B25BF	09/05 ⇨
3V 325 i	N52B25A, N52B25AF, N52B25B, N52B25BF, N52B25B	12/04 ⇨
3V 325 i xDrive	N52B25A	03/10 ⇨ 04/13
3V 325 xi	N52B25A, N52B30A	01/05 ⇨
3V 328 i	N51B30A, N52B30A, N52NB30A	07/05 ⇨
3V 328 xi	N51B30A, N52B30A	09/06 ⇨
3V 330 i	N52B30A, N52B30B, N52B30BF, N53B30A	12/04 ⇨ 10/13
3V 330 xi	N52B30A	09/05 ⇨ 02/10
3V 335 i	N54B30A, N54B30B, N55B30A	03/06 ⇨ 10/13
3V 335 i xDrive	N54B30A, N55B30A	05/08 ⇨ 12/13
3V 335 xi	N54B30A, N55B30A	09/06 ⇨ 02/10
3 SERIES 325i xDrive	N52B25A	09/08 ⇨ 10/11
4420 i	N20B20A, N20B20B	11/13 ⇨ 02/17
4420 i xDrive	N20B20A, N20B20B	11/13 ⇨ 02/16
4428 i	N20B20A, N26B20A	07/13 ⇨ 02/17
4428 i xDrive	N20B20A, N26B20A	07/13 ⇨ 02/16
4435 i	N55B30A	07/13 ⇨ 02/16
4435 i xDrive	N55B30A	07/13 ⇨ 02/16
4 M4	S55B30A	03/14 ⇨
4 M4 Competition	S55B30A	03/16 ⇨
4 M4 CS	S55B30A	07/17 ⇨ 06/19
4 M4 GTS	S55B30A	03/16 ⇨ 02/17
X5 III M	S63B44B	12/14 ⇨ 07/18
X5 III sDrive 35 i [USA]	N55B30A	01/13 ⇨
X5 III xDrive 28 i	N20B20A	06/15 ⇨ 07/18
X5 III xDrive 35 i	N55B30A	12/13 ⇨ 07/18
X5 III xDrive 40e	N20B20A	08/15 ⇨ 07/18
X5 III xDrive 50 i	N63B44B	08/13 ⇨ 07/18

BMW		
X5 III xDrive 50i	N63B40A	07/13 ⇨
3 IV 316 Ci	N40B16A, N45B16A	10/01 ⇨
3 IV 316 i	N40B16A, N42B18A, N45B16A, N46B18A	02/02 ⇨ 02/05
3 IV 316 ti	N40B16A, N42B18A, N45B16A, N46B18A	06/01 ⇨ 02/05
3 IV 318 Ci	N42B20A, N46B20A, N46B20B, N46B20C	12/00 ⇨ 12/07
3 IV 318 i	N42B20A, N46B20A, N46B20C	09/01 ⇨ 07/05
3 IV 318 ti	N42B20A, N46B20A	03/01 ⇨ 12/04
3 IV 320 Ci	M52B20(22654), M54B22(22651), M54B22651	01/00 ⇨ 12/07
3 IV 320 i	4F8Q0636, M52B20(20654), M54B22(22651), M54B22651	09/00 ⇨ 02/05
3 IV 325 Ci	4CS5, M54B25(25655), M54B25655, M5625656	09/00 ⇨
3 IV 325 i	-(24654), M54B25(25655), M54B25655, M5625656	09/00 ⇨
3 IV 325 ti	M54B25(25655), M54B25655	04/01 ⇨ 12/04
3 IV 325 xi	M54B25(25655), M54B25655	09/00 ⇨ 02/05
3 IV 330 Ci	7ACR, M54B30(30653), M54B30653	06/00 ⇨ 08/06
3 IV 330 i	M54B30(30653), M54B30653	06/00 ⇨ 04/05
3 IV 330 xi	M54B30(30653), M54B30653	06/00 ⇨ 07/06
3 IV M3	S54B32(32654), S54B32654	07/00 ⇨ 08/06
3 IV M3 CSL	S54B32(32654), S54B32654	05/03 ⇨ 12/03
5 IV 520 i	M54B22(22651), M54B22651	09/00 ⇨ 12/03
5 IV 525 i	8CUG, M54B25(25655), M54B25655	09/00 ⇨ 05/04
5 IV 530 i	2CBL, M54B30(30653), M54B30653	09/00 ⇨ 12/03
5 VII M 550 i xDrive	N63B44C	03/17 ⇨ 06/19
5 VII M5	S63B44B	09/17 ⇨
5 VII M5 Competition	S63B44B	07/18 ⇨
5 VII M5 CS	S63B44B	03/21 ⇨
5 VI 520 i	N20B16A, N20B20A, N20B20B	10/10 ⇨ 02/17
5 VI 520Li [CHN]	N20B20D	01/09 ⇨
5 VI 523 i	N52B25A, N52B25AF, N52B25B, N52B25BF	11/09 ⇨ 08/11
5 VI 523Li [CHN]	N52B25AF	01/09 ⇨
5 VI 525 d	N47D20D(N4751)	09/11 ⇨ 10/16
5 VI 525Li [CHN]	N20B20A	09/11 ⇨
5 VI 528 i	N20B20A, N52B30BF	03/10 ⇨
5 VI 528 i xDrive	N20B20A	09/11 ⇨ 02/17
5 VI 528Li [CHN]	N20B20C	09/10 ⇨
5 VI 530 Hybrid [CHN]	--	01/13 ⇨
5 VI 530 i	N52B30A, N52B30AF, N52B30BF	03/10 ⇨ 06/13
5 VI 530Li [CHN]	N52B30AF	09/10 ⇨
5 VI 535 i	N55B30A	01/10 ⇨ 02/17
5 VI 535 i xDrive	N55B30A	03/11 ⇨ 02/17
5 VI 535Li [CHN]	N55B30A	01/09 ⇨
5 VI 550 i	N63B44A, N63B44B	03/10 ⇨ 02/17
5 VI 550 i xDrive	N63B44A, N63B44B	08/10 ⇨ 10/16
5 VI ActiveHybrid	N55B30A	12/11 ⇨ 10/16
5 VI M5	S63B44B	09/11 ⇨ 10/16
5 VI M5 30th Anniversary	S63B44B	07/14 ⇨ 10/16
5 VI M5 Competition	S63B44B	02/13 ⇨ 10/16
X3 II sDrive 20 i	N20B16A, N20B20A	04/14 ⇨ 08/17
X3 II sDrive 28 i [USA]	N20B20A	01/13 ⇨
X3 II xDrive 20 i	N20B20A	10/11 ⇨ 08/17
X3 II xDrive 28 i	N20B20A, N52B30A, N52B30AF, N52B30BF	01/11 ⇨ 08/17
X3 II xDrive 35 i	N55B30A	09/10 ⇨ 08/17
6 II 630 i	N52B30A, N52B30B, N52B30BF	09/04 ⇨ 08/10
6 II 645 Ci	N62B44A	09/03 ⇨ 08/05
6 II 650 i	N62B48B	09/05 ⇨ 08/10
5 V 520 i	M5422651, M54B22(22651), M54B22651, N46B20B	07/03 ⇨
5 V 520Li	N46B20B, N46B20C	09/07 ⇨
5 V 523 i	N52B25A, N52B25B, N52B25BE, N52B25BF, N52B25B	10/04 ⇨
5 V 523Li	N52B25A, N52B25B, N52B25BE	07/05 ⇨
5 V 525 i	M54B25(25655), M54B25655, N52B25A, N52B25B, N52B25BF, N52B30A, N52B30B, N52B30BF, N52B25B	09/03 ⇨
5 V 525 xi	N52B25A, N52B30A, N53B30A	04/05 ⇨
5 V 525Li	N52B25A, N52B25BF, N52B25B	07/05 ⇨
5 V 528 xi	N52B30A	03/07 ⇨

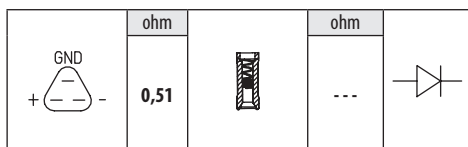

BMW		
5V 530 i	3CA4GB16, M54306S3, M54B30(306S3), N52B30A, N52B30BF, N53B30A	12/01 →
5V 530 xi	N52B30A	09/04 → 05/10
5V 530Li	N52B30A, N52B30B, N52B30BF	07/05 →
5V 535 i	N54B30A	04/06 → 12/09
5V 535xi	N54B30A	03/07 →
5V 540 i	N62B40A	09/05 → 12/09
5V 545 i	N62B44A	09/03 → 12/10
5V 550 i	N62B48A, N62B48B	07/05 → 12/10
6 III 640 i	N55B30A	07/11 → 10/18
6 III 640 i xDrive	N55B30A	03/13 → 10/18
6 III 650 i	N63B44A, N63B44B	12/10 → 10/18
6 III 650 i xDrive	N63B40A, N63B44A, N63B44B	09/11 →
6 III 650 i xDrive 4.0	N63B40A	06/11 →
6 III M6	S63B44B	03/12 → 10/18
6 III M6 Competition	S63B44B	07/13 → 10/18
Z4 II sDrive30i	N52B30B, N52B30BF	05/09 →
7V 730 i, Li	N52B30A, N52B30AF, N52B30BF	09/09 → 06/15
7V 740 i, Li	N54B30A, N55B30A	09/08 → 12/15
7V 740 i, Li xDrive	N55B30A	07/12 → 12/15
7V 750 i, Li	N63B44A, N63B44B	09/08 → 06/15
7V 750 i, Li xDrive	N63B44A, N63B44B	09/09 → 06/15
7V 750Li xDrive	N63B40A	01/11 →
7V 760 i, Li	N74B60A	09/09 → 12/15
7V ActiveHybrid 7	N55B30A, N63B44A	04/10 → 06/15
8 M8	S63B44B	07/19 →
8 M8 Competition	S63B44B	07/19 →
X3 I 2.0 i	N46B20B	07/05 → 08/08
X3 I 2.5 i	M54B25(256S5), M54B256S5	03/04 → 07/06
X3 I 2.5 si	N52B25A, N52B25AF, N52B25BF	08/06 → 08/08
X3 I 2.5 si xDrive	N52B25A, N52B25AF, N52B25BF	08/06 → 08/08
X3 I 3.0 i xDrive	M54B30(306S3), M54B306S3	09/03 → 07/06
X3 I 3.0 si	N52B30A, N52B30BF, N52KB30	08/06 → 08/08
X3 I xDrive 2.5si	N52B25BF	09/06 →
X3 I xDrive 20 i	N46B20B	09/08 → 08/11
X3 I xDrive 25 i	N52B25A, N52B25AF, N52B25BF	09/08 → 08/10
X3 I xDrive 3.0si	N52B30B	09/06 →
X3 I xDrive 30 i	N52B30A, N52B30BF	09/08 → 08/10
7 IV 730 i, Li	1CYA, M54B30(306S3), N52B30A, N52B30BF	03/03 → 08/08
7 IV 730 i, Li	N52B30B	03/05 →
7 IV 735 i, Li	N62B36A	11/01 → 02/05
7 IV 740 i, Li	N62B40A	03/05 → 08/08
7 IV 745 i, Li	N62B44A	07/01 → 03/05
7 IV 750 i, Li	N62B48B	03/05 → 08/08
7 IV 760 i, Li	N73B60A, N73B60B	01/03 → 08/08
7 IV B7 Alpina	H1	01/06 →
X6 II 35 i [USA]	N55B30A	08/14 →
X6 II M	S63B44B	12/14 → 07/19
X6 II xDrive 35 i	N55B30A	08/14 → 07/19
X6 II xDrive 50 i	N63B40A, N63B44B	08/14 →
X6 II xDrive 50 i [USA]	N63B44B	08/14 →
X1 I sDrive 16 i	N20B16A	03/13 → 06/15
X1 I sDrive 18 i	N46B20B, N46B20BD	03/10 → 06/15
X1 I sDrive 18 i [CHN]	N20B20C	01/13 →
X1 I sDrive 20 i	N20B20A	09/11 → 06/15
X1 I sDrive 28 i [USA]	N20B20A	01/09 →
X1 I xDrive 20 i	N20B20A	09/11 → 06/15
X1 I xDrive 25 i	N52B30A	03/10 → 08/11
X1 I xDrive 28 i	N20B20A, N52B30A	09/09 → 06/15
X1 I xDrive 35 i	N55B30A	03/11 → 06/15
7 VI 750 i, Li	N63B44C	11/15 → 02/19
7 VI 750 i, Li xDrive	N63B44C	09/15 → 02/19
7 VI 750 Li xDrive	N63B40B	03/16 →
7 VI M 760 i, Li xDrive	N74B66C	12/16 → 02/19
7 VI M 760 Li xDrive	N74B66C	03/19 →
X4 I M 40 i	N55B30A	12/15 → 03/18
X4 I xDrive 20 i	N20B20A	04/14 → 03/18
X4 I xDrive 28 i	N20B20A	04/14 → 03/18
X4 I xDrive 35 i	N55B30A	04/14 → 03/18
X5 II 3.0 si	N52B30A, N52B30AF, N52B30B, N52B30BF	10/06 → 09/08
X5 II 4.8 i xDrive	N62B48B	10/06 → 09/08
X5 II M	S63B44A	07/09 → 07/13
X5 II xDrive 30 i	N52B30A	02/07 → 12/12
X5 II xDrive 35 i	N55B30A	04/10 → 07/13
X5 II xDrive 40 i	N55B30A	01/12 → 06/13
X5 II xDrive 48 i	N62B48B	10/08 → 03/10
X5 II xDrive 50 i	N63B44A	04/10 → 07/13
X5 IV M	S63B44B	12/19 →
X5 IV M Competition	S63B44B	12/19 →
X5 IV xDrive 50 i	N63B44D	08/18 →

BMW		
X6 I 35 i	N54B30A	05/08 → 08/08
X6 I 50 i	N63B44A	05/08 → 06/14
X6 I ActiveHybrid	N63B44A	01/09 → 10/11
X6 I ActiveHybrid xDrive	N63B44A	01/09 → 10/11
X6 I M	S63B44A	07/09 → 07/14
X6 I xDrive 35 i	N54B30A, N55B30A	06/07 → 07/14
X6 I xDrive 40 i	N55B30A	01/12 →
X6 I xDrive 50 i	N63B44A	10/07 → 07/14
X6 III M	S63B44B	12/19 →
X6 III M Competition	S63B44B	12/19 →
X7 xDrive M 50 i	N63B44D	07/19 →
Z3 M	S54B32(326S4)	06/01 → 06/03
Z3 M 3.2	S54B32(326S4)	06/01 → 01/03
Z4 I 2.0 i	N46B20A	03/05 → 02/09
Z4 I 2.2 i	M54B22(226S1)	10/03 → 10/05
Z4 I 2.5 i	M54B25(256S5), N52B25B	12/02 →
Z4 I 2.5 si	N52B25B	01/06 →
Z4 I 3.0 i	M54B30(306S3), N52B30A	12/02 →
Z4 I 3.0 si	N52B30B	01/06 →
Z4 I M	S54B32(326S4)	01/06 → 08/08
5 VI GT 528 i	N20B20A	07/13 → 02/17
5 VI GT 535 i	N55B30A	01/09 → 02/17
5 VI GT 535 i xDrive	N55B30A	09/10 → 02/17
5 VI GT 550 i	N63B44A, N63B44B	08/09 → 02/17
5 VI GT 550 i xDrive	N63B40A, N63B44A, N63B44B	06/10 → 02/17
X5 I 3.0 i	5CNG, M54B30(306S3)	04/00 → 12/06
X5 I 4.4 i	N62B44A, N62B44A	10/03 → 10/06
X5 I 4.8 is	N62B48A	04/04 → 09/06

CITROËN		
C4 PICASSO II 1.6 THP 150	5FX(EP6DT)	09/14 →
C4 PICASSO II 1.6 THP 155	5FV(EP6CDT)	02/13 →
C4 PICASSO II 1.6 THP 165	5GZ(EP6FDT)	07/14 →
C4 PICASSO II 1.6 VTi 120	5FS(EP6C)	02/13 →
C4 PICASSO II THP 155	5FV(EP6CDT)	02/13 →
C4 PICASSO II VTi 120	5FS(EP6C)	02/13 →
C4 PICASSO I 1.6 16V	5FX(EP6DT)	07/08 → 08/13
C4 PICASSO I 1.6 THP 140	5FT(EP6DT)	07/08 → 08/13
C4 PICASSO I 1.6 THP 155	5FV(EP6CDT)	09/10 → 08/13
C4 PICASSO I 1.6 VTi 120	5FW(EP6)	07/08 →
C3 PICASSO 1.4	EP3C	02/09 →
C3 PICASSO 1.4 VTi 95	8FN(EP3), 8FP(EP3C), 8FS(EP3)	02/09 →
C3 PICASSO 1.4 VTi 95 LPG	8FN(EP3)	01/12 →
C3 PICASSO 1.6 VTi	5FP(EP6)	07/09 →
C3 PICASSO 1.6 VTi 120	5FS(EP6C), 5FW(EP6)	02/09 →
C4 I 1.6 THP	5FT(EP6DT)	06/08 → 07/11
C4 I 1.6 THP 140	5FT(EP6DT)	07/08 → 07/11
C4 I 1.6 THP 150	5FX(EP6DT)	07/08 → 07/11
C4 I 1.6 VTi 120	5FW(EP6)	07/08 → 07/11
C3 II 1.4 16V	EP3C	11/09 →
C3 II 1.4 LPG	8FN(EP3)	06/13 →
C3 II 1.4 VTi	8FR(EP3)	11/09 →
C3 II 1.4 VTi 95	8FP(EP3C)	11/09 →
C3 II 1.6 VTi 120	5FS(EP6C)	11/09 →
C4 II 1.4 16V	EP3C	11/09 →
C4 II 1.4 VTi 95	8FP(EP3C)	11/09 →
C4 II 1.6 16V	EP6FDTX	10/10 →
C4 II 1.6 THP 155	5FV(EP6CDT)	11/09 → 12/16
C4 II 1.6 VTi 120	5FS(EP6C)	11/09 → 12/16
C4 II 1.6 VTi 120 LPG	5FS(EP6C)	09/11 →
C4 III 1.6 THP 165	5GZ(EP6FDT)	04/18 →
C5 II 1.6 THP 150	5FN(EP6CDT)	04/09 →
C5 II 1.6 THP 155	5FV(EP6CDT)	04/09 →
C5 II 1.6 VTi 120	5FS(EP6C)	07/10 →
BERLINGO II 1.6 VTi 120	5FS(EP6C)	11/09 →
BERLINGO II 1.6 VTi 95	5FK(EP6CB)	07/10 →
C5 AIRCROSS 1.6 Hybrid	5GF(EP6FADTXD)	04/20 →
C5 AIRCROSS 1.6 PureTech 180	5GF(EP6FADTXD)	11/18 →
C5 AIRCROSS 1.6 THP 150	5GX(EP6FDTM)	09/19 →
C5 AIRCROSS 1.6 THP 165	5GV(EP6FDTM)	05/19 →
C4 GRAND PICASSO I 1.6 16V	5FT(EP6DT), 5FX(EP6DT), EP6C	07/08 →
C4 GRAND PICASSO I 1.6 THP 155	5FV(EP6CDT)	09/10 → 08/13
C4 GRAND PICASSO I 1.6 VTi 120	5FW(EP6)	07/08 → 08/13
C4 GRAND PICASSO II 1.6 THP 150	5FX(EP6DT)	09/14 →
C4 GRAND PICASSO II 1.6 THP 155	5FV(EP6CDT)	09/13 →
C4 GRAND PICASSO II 1.6 THP 165	5GZ(EP6FDT)	07/14 →
C4 GRAND PICASSO II 1.6 VTi 120	5FS(EP6C)	09/13 →
DS3 1.4 VTi 95	8FP(EP3C)	04/10 → 07/15
DS3 1.4 VTi 95 LPG	8FR(EP3C)	08/12 → 07/15

CITROËN		
DS3 1.4 VTi 98	8FR(EP3C)	11/09 → 07/15
DS3 1.6	5GM(EP6FDTX)	02/11 → 07/15
DS3 1.6 Racing	5FD(EP6DTS), 5FF(EP6DTS)	02/11 → 07/15
DS3 1.6 THP 150	5FN(EP6CDT), 5FX(EP6DT)	01/10 → 07/15
DS3 1.6 THP 155	5FR(EP6DT), 5FV(EP6CDT)	04/10 → 07/15
DS3 1.6 THP 165	5GZ(EP6FDT)	10/14 → 07/15
DS3 1.6 VTi 120	5FS(EP6C)	04/10 → 07/15
DS4 1.6 THP 150	5FE(EP6CDTMD)	04/11 → 07/15
DS4 1.6 THP 155	5FV(EP6CDT)	04/11 → 07/15
DS4 1.6 THP 160	5FM(EP6CDTM)	04/12 → 07/15
DS4 1.6 THP 165	5FM(EP6CDTM), 5FM(EP6DT), 5GZ(EP6FDT)	01/12 → 07/15
DS4 1.6 THP 200	5FU(EP6DTX)	04/11 → 07/15
DS4 1.6 THP 210	5GM(EP6FDTX)	07/15 → 07/15
DS4 1.6 VTi 120	5FS(EP6C)	04/11 → 07/15
DS5 1.6 THP 150	5FE(EP6CDTMD)	11/11 → 07/15
DS5 1.6 THP 155	5FV(EP6CDT)	11/11 → 07/15
DS5 1.6 THP 165	5FM(EP6CDTM), 5FM(EP6DT), 5GZ(EP6FDT)	01/12 → 07/15
DS5 1.6 THP 165 Hybrid	5GZ(EP6FDT)	06/12 → 07/15
DS5 1.6 THP 200	5FU(EP6DTX)	11/11 → 07/15
DS5 1.6 THP 210	5GM(EP6FDTX)	11/14 → 07/15
GRAND C4 SPACETOUREUR 1.6 PureTech 180	5GF(EP6FADTXD)	04/18 →
GRAND C4 SPACETOUREUR 1.6 THP 165	5GX(EP6FDTM), 5GZ(EP6FDT)	04/18 →

DS		
DS 4 PureTech 180	5GF(EP6FADTXD)	10/21 →
DS 5 1.6 THP 165	5GZ(EP6FDT)	07/15 → 12/18
DS 5 1.6 THP 210	5GM(EP6FDTX)	04/15 → 12/18
DS 7 1.6 PureTech 180	5GF(EP6FADTXD)	04/18 →
DS 7 1.6 PureTech 225	5GC(EP6FADTX)	09/17 →
DS 7 E-TENSE	5GQ(EP6FADTXHP)	10/19 →
DS 7 E-TENSE 225	5GQ(EP6FADTXHP)	05/21 →
DS 7 E-TENSE 4x4	5GB(EP6FADTXHP)	05/19 →
DS3 1.6 THP	5GW(EP6FDT), 5GX(EP6FDTMD), 5GZ(EP6FDT)	07/15 → 07/19
DS3 1.6 THP 165	5GZ(EP6FDT)	07/15 → 07/19
DS3 1.6 THP 208	5GR(EP6FDTX)	09/15 → 07/19
DS4 / DS4 CROSSBACK 1.6 THP 150	5FE(EP6CDTMD)	10/16 → 12/18
DS4 / DS4 CROSSBACK 1.6 THP 160	5FM(EP6CDTM)	07/15 → 12/18
DS4 / DS4 CROSSBACK 1.6 THP 165	5GZ(EP6FDT)	07/15 → 12/18
DS4 / DS4 CROSSBACK 1.6 THP 210	5GM(EP6FDTX)	07/15 → 12/18

MINI		
MINI II Cooper	N12B16A, N12B16BA, N16B16A	09/06 → 10/16
MINI II Cooper ALL4	N16B16A, N18B16A	11/12 → 10/16
MINI II Cooper S	N14B16A, N14B16AB, N18B16A	10/06 → 10/16
MINI II Cooper S ALL4	N18B16A	08/10 → 10/16
MINI II Cooper S JCW	N18B16A	12/10 → 04/15
MINI II Cooper S John Cooper Works	N14B16AB, N14B16C, N18B16A	11/06 → 11/13
MINI II John Cooper Works	N14B16C, N18B16C	11/07 → 05/15
MINI II John Cooper Works ALL4	N18B16C	11/12 → 10/16
MINI II John Cooper Works GP	N14B16C, N18B16C	09/12 → 11/13
MINI II John Cooper Works ALL4	N18B16C	11/12 →
MINI II One	N12B14A, N16B16A	11/06 → 10/16
MINI II One LPG	N12B14A	03/09 → 03/10

OPEL		
GRANDLAND / GRANDLAND X 1.6 Turbo	A16XHL(EP6FDTM), D16XHT(EP6FADTXD)	09/18 →
GRANDLAND / GRANDLAND X 1.6 Turbo Hybrid	F16XHR(EP6FADTXD)	12/19 →
GRANDLAND / GRANDLAND X 1.6 Turbo Hybrid4	F16XHR(EP6FADTXD)	06/19 →

PEUGEOT		
207 1.4 16V	8FR(EP3), 8FS(EP3), EP3C	06/07 → 10/13
207 1.6 16V	5FS(EP6C), 5FW(EP6), EP6	06/07 → 10/13
207 1.6 16V RC	5FY(EP6DTS)	02/07 → 12/12
207 1.6 16V Turbo	5FR(EP6DT), 5FX(EP6DT)	02/06 → 10/13
207 1.6 16V VTi	5FS(EP6C), 5FW(EP6), EP6	02/07 → 12/12
207 1.6 VTi	5FW(EP6)	03/07 → 12/12
207 CC 1.6 16V	5FS(EP6C), 5FW(EP6), EP6	02/07 → 10/13
207 CC 1.6 16V Turbo	5FR(EP6DT), 5FV(EP6CDT), 5FX(EP6DT)	02/07 → 12/13
308 I 1.4 16V	8FR(EP3), 8FS(EP3), EP3C	09/07 →
308 I 1.6 16V	5FS(EP6C), 5FT(EP6DT), 5FV(EP6CDT), 5FW(EP6), 5FX(EP6DT), 5FY(EP6DTS), EP6, EP6C	09/07 →
308 I 1.6 GTi	EP6CDTX	07/10 → 10/14

PEUGEOT		
308 I 1.6 THP	EP6CDTM, EP6CDTMD, EP6CDTX	10/10 →
308 I 1.6 THP 16V	5FV(EP6CDT)	10/09 → 10/14
208 I 1.4 GPL	EP3C	10/13 →
208 I 1.4 VTi	8FS(EP3), EP3C	03/12 →
208 I 1.6	5FS(EP6C), 5FV(EP6CDT), 5GZ(EP6FDT)	02/12 →
208 I 1.6 GTi	5FU(EP6CDTX), 9H92	08/12 →
208 I 1.6 THP 165	5GZ(EP6FDT)	03/15 →
208 I 1.6 THP 210	5GM(EP6FDTX)	04/15 →
308 II 1.6	5GZ(EP6FDT)	01/12 →
308 II 1.6 GT 205	3AC	06/14 → 06/21
308 II 1.6 GTi	5GN(EP6FDTR), 6AAS	06/15 → 06/21
308 II 1.6 GTi PureTech 263	EGX(EP6FADTR)	07/18 → 06/21
308 II 1.6 PureTech 225	5GG(EP6FADTX)	01/18 → 06/21
308 II 1.6 THP	5FV(EP6CDT), 5GX(EP6FDTMD)	09/13 → 06/21
308 II 1.6 THP 125	5FA(EP6CDT)	09/13 → 06/21
308 II 1.6 THP 150	5GX(EP6FDTMD)	03/14 → 06/21
308 II 1.6 THP 155	5FV(EP6CDT)	03/14 → 06/21
308 II 1.6 THP 163	5FM(EP6CDTM)	06/14 → 06/21
308 II 1.6 THP 210	5GM(EP6FDTX)	04/15 →
508 I 1.6	5GZ(EP6FDT)	02/12 → 12/18
508 I 1.6 THP	5FE(EP6CDTM), 5FN(EP6CDT), 5FV(EP6CDT), 5GZ(EP6FDT), EP6CDTM	11/10 →
508 I 1.6 VTi	5FH(EP6C), 5FS(EP6C)	11/10 → 12/18
508 II 1.6 PureTech 180	5GF(EP6FADTXD)	09/18 →
508 II 1.6 PureTech 225	5GG(EP6FADTX)	09/18 →
508 II 1.6 THP 150	5GX(EP6FDTMD)	09/18 →
508 II 1.6 THP 165	5GY(EP6FDTM)	09/18 →
508 II Hybrid 224	5GQ(EP6FADTXHPD)	08/19 →
508 II Hybrid 225	5GQ(EP6FADTXHPD)	08/19 →
2008 I 1.6 VTi	5FS(EP6C)	03/13 →
3008 I 1.6 THP	5FE(EP6CDTM), 5FE(EP6CDTMD), 5FM(EP6CDTM), 5FV(EP6CDT), 5FX(EP6DT), EP6CDTM, EP6CDTMD	06/09 →

3008 I 1.6 VTi	EP6	06/09 → 08/16
3008 II 1.6 PureTech 180	5GF(EP6FADTXD)	07/18 →
3008 II 1.6 THP 150	5GX(EP6FDTMD)	11/17 →
3008 II 1.6 THP 165	5GY(EP6FDTM), 5GZ(EP6FDT)	05/16 →
3008 II Hybrid	5GQ(EP6FADTXHPD)	10/19 →
3008 II Hybrid4	5GB(EP6FADTXHPA)	10/19 →
5008 I 1.6 16V	5FS(EP6C), 5FV(EP6CDT), 5FW(EP6), EP6	09/09 → 03/17
5008 I 1.6 THP 150	5FX(EP6DT)	02/12 → 03/17
5008 I 1.6 THP 163	5GZ(EP6FDT)	02/12 → 03/17
5008 I 1.6 THP 165	5GZ(EP6FDT)	02/12 → 03/17
5008 II 1.6	5GX(EP6FDTMD)	07/18 →
5008 II 1.6 PureTech 180	5GF(EP6FADTXD)	07/18 →
5008 II 1.6 THP 165	5GY(EP6FDTM), 5GZ(EP6FDT)	12/16 →
PARTNER II 1.6	5FK(EP6CB), 5FS(EP6C)	04/10 →
PARTNER II TEPEE 1.6 VTi	5FK(EP6CB), 5FS(EP6C)	09/09 →
RCZ 1.6 16V	5FM(EP6CDTM), 5FV(EP6CDT), EP6CDTX	03/10 → 12/15
RCZ 1.6 THP 150	5FE(EP6CDTMD)	03/11 → 12/15
RCZ 1.6 THP 270	5FG(EP6CDTR)	06/13 → 12/15

ROLLS-ROYCE

CULLINAN V12	N74B68A	08/18 →
DAWN V12	N74B66A	02/16 →
GHOST V12	N74B66A, N74B68A	12/09 →
GHOST V-Specification	N74B66A	01/14 → 06/14
PHANTOM 6.75 V12	N73B68A	06/07 → 07/17
PHANTOM V12	N73B68A	01/03 → 07/17
PHANTOM V12, V12 EWB	N74B68A	09/17 →
WRAITH V12	N74B66A	08/13 →

VAUXHALL

GRANDLAND X 1.6 Turbo Hybrid	D16XHT(EP6FADTXHP)	12/19 →
GRANDLAND X 1.6 Turbo Hybrid4	D16XHT(EP6FADTXHP)	06/19 →

KW 470 476

08,7

COILS

Adatt./Suitable:

BOSCH
0 986 221 088**CITROËN**
5970 87
5970 A0
96 566 957 80
96 582 279 80**HITACHI**
133842
2503842**MAGNETI MARELLI**
060717207012**PEUGEOT**
5970 87
5970 92
5970 A0
5970 A6
96 566 957 80**SAGEM**
21597716-4
21603800-7

	ohm		ohm	
---	0,79	---	---	---

CITROËN

C4 PICASSO I 1.8 Bifuel	6FY(EW7A)	01/09 → 10/12
C4 PICASSO I 1.8 i 16V	6FY(EW7A)	02/07 → 12/11
C4 PICASSO I 2.0 i 16V	RFJ(EW10A)	09/07 → 08/13
C4 I 2.0 16V	RFJ(EW10A)	11/04 → 07/11
C4 I 2.0 VTR	RFJ(EW10A)	10/06 → 12/07
C4 II 2.0 Flex	RFJ(EW10A)	11/09 →
C5 I 1.8 16V	6FY(EW7A)	09/05 →
C5 I 2.0	RFJ(EW10A)	11/04 → 01/08
C5 I 2.0 16V	RFJ(EW10A)	09/04 →
C5 II 1.8 16V	6FY(EW7A)	02/08 →
C5 II 2.0 16V	RFJ(EW10A)	02/08 →
C5 II 2.0 16V BioFlex	RFJ(EW10A)	02/08 →
C8 2.0	RFJ(EW10A)	06/04 → 12/11
C8 2.0 16V	RFJ(EW10A)	09/05 →
C4 GRAND PICASSO I 1.8 i 16V	6FY(EW7A)	10/06 → 12/10
C4 GRAND PICASSO I 1.8 i 16V Flex	6FY(EW7A)	06/09 → 01/13
C4 GRAND PICASSO I 2.0 i 16V	RFJ(EW10A)	10/06 → 08/13
JUMPY II 2.0 i	RFH(EW10A), RFJ(EW10A)	01/07 → 03/16

PEUGEOT

EXPERT II TEPEE 2.0 16V	RFH(EW10A), RFJ(EW10A)	01/07 → 03/16
308 I 2.0 Bioflex	RFJ(EW10A)	01/08 → 12/12
308 I 2.0 CVVT	RFJ(EW10A)	07/09 → 12/14
307 2.0 16V	RFJ(EW10A), RFK(EW10J4S)	10/03 → 04/09
407 2.0 16V	RFJ(EW10A)	08/05 → 12/10
407 2.0 Bioflex	RFJ(EW10A)	09/07 → 02/11
407 2.0 Flex	RFJ(EW10A)	10/05 → 02/11
607 2.2 16V	3FY(EW12J4), 3FZ(EW12J4)	02/00 → 06/10
807 2.0 16V	RFJ(EW10A)	09/05 →
EXPERT II 2.0 16V	RFH(EW10A), RFJ(EW10A)	01/07 →

KW 470 478

05,5

COILS

Adatt./Suitable:

BOSCH
0 221 604 010**FORD**
1 371 601
6M5G-12029-AA**HITACHI**
133889
2503889**VOLVO**
30713417
8677837

	ohm		ohm	
---	---	---	---	---

FORD

FOCUS II 2.5 RS	JZDA	01/09 → 07/11
FOCUS II 2.5 RS 500	JZDA	05/10 → 07/11
FOCUS II 2.5 ST	HYDA	10/05 → 09/12
GALAXY II 2.5 ST	HUWA	05/06 →
KUGA I 2.5	HYDB, HYDC	02/08 → 11/12
KUGA I 2.5 4x4	HYDB	02/08 → 11/12
MONDEO III 2.5	HUBA	03/07 → 01/15
S-MAX I 2.5 ST	HUWA	05/06 → 12/14

VOLVO

C30 2.4 i	B524454	10/06 → 12/12
C30 T5	B5254T3, B5254T7	10/06 → 12/13
C70 II 2.4	B524455	03/06 → 10/09
C70 II 2.4 i	B524454	03/06 → 10/09
C70 III T5	B5254T3, B5254T7	03/06 → 06/13
S40 II 2.4	B524454, B524455	01/04 → 12/12
S40 III T5	B5254T3, B5254T7	01/04 → 12/12
S40 III T5 AWD	B5254T3, B5254T7	04/04 → 12/10
S60 I 2.0 T	B5204T5	07/00 → 04/10
S60 I 2.4 AWD	B5244T5	02/04 → 04/10
S60 I 2.5 AWD	B5254T4	09/03 → 04/10
S60 II 2.0 T	B5204T8	05/12 → 12/15
S60 II 2.5 T	B5254T14	01/13 →
S60 II 2.5 T5	B5254T5	09/11 → 12/15
S60 II 2.5 T5 AWD	B5254T14, B5254T5	09/12 → 12/18
S60 III T	B5204T9	04/14 →
S60 III T5 AWD	B5254T12	08/15 → 12/18
S80 2.5 T	B5254T6	01/08 →
S80 2.5 T5	B5254T12	01/12 →
S80 T4	B5204T8	01/12 →
S80 I 2.0 T	B5204T5	12/99 → 07/06
S80 I 2.4 LTP	B5244T4	06/04 → 07/06
S80 II 2.5 T	B5254T10, B5254T12, B5254T14, B5254T6	03/06 → 12/16
S80 II 2.5 T AWD	B5254T6	10/06 → 04/09
S80 II 2.5 T FlexFuel	B5254T11, B5254T8	05/08 → 12/11
V40 II T4	B5204T8	07/13 → 12/15
V40 II T4 AWD	B5204T8	07/13 →
V40 II T5	B5204T9, B5254T12, B5254T14	12/12 →
V40 II T5 AWD	B5204T9, B5254T12, B5254T14	01/13 →
V50 2.4	B524454, B524455	04/04 → 12/10
V50 2.4 AWD	B524454	08/06 → 12/09
V50 T5	B5254T3, B5254T7	04/04 → 12/12
V50 T5 AWD	B5254T3, B5254T7	04/04 → 12/10
V60 I 2.0 BiFuel	B5204T9	03/14 → 12/15
V60 I 2.0 T	B5204T8	01/14 → 07/18
V60 I T5	B5204T9	10/13 → 05/18
V60 I T5 AWD	B5254T12, B5254T14	03/15 → 05/18
V70 II 2.0 T	B5204T5	11/99 → 08/07
V70 II 2.4 T	B5244T4	01/05 → 12/05
V70 II 2.4 T5	B5244T5	04/04 → 08/07
V70 II 2.5 R Sport	B5254T4	12/02 → 08/07

470 480

VOLVO		
V70 II 2.5 T	B5254T2	07/01 → 08/07
V70 II 2.5 T AWD	B5254T2	07/02 → 08/07
V70 II R 2,5 T AWD	B5254T4	03/03 → 08/07
V70 III 2.0 BiFuel	B5204T9, B5204T9CNG	03/13 → 12/15
V70 III 2.0 GDI	B5204T9	04/12 → 12/15
V70 III 2.5 T	B5254T10, B5254T6	08/07 → 12/12
V70 III 2.5 T FlexiFuel	B5254T11, B5254T8	05/08 → 12/11
XC60 I T5 AWD	B5254T12	04/14 → 02/17
XC70 I 2.4 XC AWD	B5244T4	01/05 → 12/06
XC70 II T5 AWD	B5254T12	08/15 → 12/16
XC70 II T6 AWD	B5254T14	03/15 → 12/16

KW 470 480



05,5

COILS

Adatt./Suitable:

BOSCH
0 221 504 702

FORD
1 224 925
1 314 271
1 322 402
1 578 771
4M5E-12A366-AA
4M5G-12A366-BA
4M5G-12A366-BB
4M5G-12A366-BC
4M5G-12A366-BD
5 047 437

HITACHI
133852
2503852

MAGNETI MARELLI
060717105012
060810269010

MAZDA
LF16-18-100
LF16-18-100A
LF16-18-100B

MERCURY
4M5Z12029B

VOLVO
30711786
31375294
869474
8694741



	ohm		ohm
	0,60		6500

FORD		
C-MAX I 1.8	QQDA, QQDB, QQDC	02/07 → 09/10
C-MAX I 1.8 Flexifuel	Q7DA	02/07 → 09/10
C-MAX I 2.0	AODA, AODB, AODE, SYDA	02/07 → 09/10
C-MAX I 2.0 CNG	SYDA	04/09 → 09/10
C-MAX I 2.0 LPG	SYDA	06/08 → 09/10
ECOSPORT 2.0 4x4	C20HDEA	08/12 →
FOCUS II 1.8	Q7DA, QQDA, QQDB	03/06 → 09/12
FOCUS II 1.8 Flexifuel	--, 1LQ4(364CIV8), 4LQ2(122CUL4), Q7DA, QQDA, QQDB, QQDD	12/05 → 09/12
FOCUS II 2.0	AODA, AODB, AODE, SYDA	07/04 → 09/12
FOCUS II 2.0 CNG	SYDA	04/09 → 07/11
FOCUS II 2.0 Flex	SYDA	10/08 → 03/10
FOCUS II 2.0 LPG	SYDA	06/08 → 07/11
FOCUS C-MAX 1.8	CSDA, CSDB, Q7DA, QQDA, QQDB, QQDC	10/03 → 03/07
FOCUS C-MAX 1.8 Flexifuel	Q7DA	01/06 → 03/07
FOCUS C-MAX 2.0	AODA, AODB, AODE, SYDA	03/04 → 03/07
GALAXY II 2.0	AOWA, AOWB, TBWA, TBWB	05/06 → 06/15
GALAXY II 2.0 Flexifuel	TBWA, TBWB	05/06 → 06/15
MAVERICK 2.3	--	05/06 →
MAVERICK 2.3 16V	GZ, ZH23HYU	03/04 →
MONDEO III 2.0	AOBA, AOBC, TBBA, TBBC	03/07 → 01/15
MONDEO III 2.0 Flexifuel	TBBA, TBBC	03/09 → 01/15
MONDEO III 2.0 LPG	TBBA, TBBC	07/09 → 01/15
MONDEO IV 2.0	AOBC	03/07 → 09/14
S-MAX I 2.0	AODA, AODB, AODE, AOWA, AOWB	05/06 → 12/14

FORD		
S-MAX I 2.0 Flexifuel	TBWA, TBWB	05/06 → 12/14
TRANSIT III 2.3 16V CNG RWD	GZFC	04/06 → 08/14
TRANSIT III 2.3 16V LPG RWD	GZFC	04/06 → 08/14
TRANSIT III 2.3 16V RWD	GZFA, GZFB, GZFC	04/06 → 08/14

MAZDA		
3 2.0	LF17	09/03 → 06/06
3 I 2.0	LF17, LF50, LF72, LFN7, LFN8	10/03 → 12/09
TRIBUTE 2.3 AWD	L3-VE	04/04 → 05/08
TRIBUTE 2.3 GX	L3-VE	12/03 → 10/04

VOLVO		
C30 1.8	B4184511	10/06 → 12/12
C30 1.8 FlexFuel	B418458	01/07 → 12/12
C30 2.0	B420453	10/06 → 12/12
C30 2.0 FlexFuel	B420454	01/10 → 12/12
S40 II 1.8	B4184511	04/04 → 12/10
S40 II 1.8 FlexFuel	B418458	01/06 → 12/10
S40 II 2.0	B420453	10/06 → 12/12
S40 II 2.0 F	B420454	10/09 → 12/12
S80 II 2.0	B420453	01/08 → 09/12
S80 II 2.0 FlexFuel	B420454	01/08 → 12/11
V50 1.8	B4184511	04/04 → 12/10
V50 1.8 BiFuel	B418458	01/09 → 09/10
V50 1.8 FlexFuel	B418458	01/05 → 12/10
V50 2.0	B420453	10/06 → 12/12
V50 2.0 FlexFuel	B420454	01/10 → 12/12
V70 III 2.0	B420453	10/07 → 12/11
V70 III 2.0 FlexiFuel	B420454	01/08 → 12/11

KW 470 481



07

COILS

Adatt./Suitable:

BOSCH
0 221 503 485
0 221 503 486
0 221 503 487

FORD
1 350 562
1 350 567
1 458 400
1 459 278
1 727 629
1 754 514
1 823 596
4M5G-12029-ZA
4M5G-12029-ZB
4S7G-12029-AA
4S7G-12029-AB
CM5G-12029-FA
CM5G-12029-FB
CM5G-12029-FC

HITACHI
138808
138809
2508808
2508809

MAGNETI MARELLI
060717036012
060717038012
060717146012
060810209010
060810270010

MAZDA
C401-18-100
C401-18-100A

VOLVO
30731419
31216444
31422170
9487221



	ohm		ohm
	0,53		11800

FORD		
B-MAX 1.4	SPJD, SPJE	10/12 →

FORD		
B-MAX 1.4 LPG	RTJC	10/12 →
B-MAX 1.6 Ti	IQJA, IQJC	10/12 →
C-MAX I 1.6	HWDA, HWDB, HXDA, HXDB, SHDA, SHDB, SHDC, SIDA	02/07 → 09/10
C-MAX I 1.6 Ti-VCT	--	03/07 →
C-MAX II 1.6	--	12/10 →
C-MAX II 1.6 CNG	MUDA	01/13 → 12/14
C-MAX II 1.6 Flexifuel	MUDA, MUDD	02/11 → 06/19
C-MAX II 1.6 LPG	MUDA, MUDD	02/12 → 06/19
C-MAX II 1.6 Ti	IQDA, IQDB, MUDD, MUDD, PNDA, PNDD, XTDA, XTDB	10/10 → 06/19
FIESTA V 1.25 16V	FUJA, FUJB, M7JA, M7JB	05/02 → 06/08
FIESTA V 1.3	A9JA, A9JB, BAJA	11/01 → 08/08
FIESTA V 1.4	FXJA	05/02 → 09/05
FIESTA V 1.4 16V	FXJA, FXJB	11/01 → 06/08
FIESTA V 1.6 16V	FYJA, FYJB	11/01 → 06/08
FIESTA V ST150	N4JB	03/05 → 06/08
ECOSPORT 1.5 Ti	UEJB, UEJE	10/13 →
ECOSPORT 1.5 Ti-VCT	UEJB, UEJE	10/13 →
ECOSPORT 1.6 Ti-VCT	HXJD, IQJB	08/12 →
FIESTA VI 1.25	SNJA, SNJB, SNJC, SNJD, STJA, STJB, STJC, STJD	06/08 →
FIESTA VI 1.4	--, 24KH1CT5H1, RTJA, SPJA, SPJC, SPJE	06/08 →
FIESTA VI 1.4 LPG	RTJA, RTJB, RTJD, SPJA, SPJC, SPJE	01/09 → 04/17
FIESTA VI 1.6	XTJA	03/15 →
FIESTA VI 1.6 Ti	--, 68GR-FKS, HXJA, HXJB, HXJE, IQJA, IQJC, IQJE, RVJA, USJA	06/08 →
FIESTA VI 1.6 Ti-VCT	HXJA, HXJB	10/08 → 12/12
FOCUS II 1.4	ASDA, ASDB	07/04 → 09/12
FOCUS II 1.6	HWDA, HWDB, SHDA, SHDB, SHDC	07/04 → 09/12
FOCUS II 1.6 LPG	SIDA	10/09 → 09/12
FOCUS II 1.6 Ti	HXDA, HXDB, SIDA	07/04 → 09/12
FOCUS II 1.6 Ti-VCT	--, HXDA, HXDB, SIDA	09/05 →
FOCUS III 1.6 Flexifuel	MUDA, MUDD	07/10 →
FOCUS III 1.6 LPG	MUDA, MUDD	02/12 →
FOCUS III 1.6 Ti	IQDA, IQDB, IQDC, MUDD, MUDD, PNDA, PNDD, XTDA, XTDB	07/10 →
FOCUS III 1.6 Ti-VCT	--	07/10 →
FOCUS C-MAX 1.6	HWDA, HWDB, SHDA, SHDB, SHDC	10/03 → 03/07
FOCUS C-MAX 1.6 Ti	HXDA, HXDB, SIDA	08/04 → 03/07
FUSION 1.25	--, FUJA, FUJB	10/02 →
FUSION 1.3	--, BAJA	08/02 →
FUSION 1.4	--, FXJA, FXJB, FXJC	08/02 →
FUSION 1.4 LPG	UTJA	01/10 → 12/12
FUSION 1.6	FYJA, FYJB, FYJC	08/02 → 11/09
FUSION 2.0	--	11/04 →
GRAND C-MAX 1.6 Ti	IQDA, IQDB, PNDA, PNDD, XTDA	12/10 → 06/19
KA+ 1.2	B2KA, YSKD, YSKE	06/16 →
KA+ 1.2 Ti-VCT	YSKD, YSKE	06/16 →
KA I 1.3 i	BAA, J4D, J4K, J4M, J4N, J4P, J4S	09/96 → 11/08
KA I 1.3 i ROCAM	A9A, A9B	08/02 → 11/08
KA I 1.6 i	CDB, CDC, HL16SL9B	02/01 → 11/08
MONDEO II 1.8 16V	CGBA, CGBB, CHBA, CHBB	10/00 → 03/07
MONDEO II 2.0 16V	CJBA, CJBB	10/00 → 03/07
MONDEO III 1.6 Ti	KGBA, PNBA, RHBA	03/07 → 01/15

MAZDA		
2 I 1.2	FUJA	02/03 → 06/07
2 I 1.25	FUJA	04/03 → 06/07
2 I 1.3 L	ZJ-04	04/03 → 06/07
2 I 1.4	FXJA	02/03 → 06/07
2 I 1.5	ZY-VE	04/03 → 06/07
2 I 1.6	FYJA	02/03 → 06/07

VOLVO		
C30 1.6	B416453	10/06 → 12/12
S40 II 1.6	B416453	01/05 → 12/12
V50 1.6	B416453	01/05 → 12/12

KW 470 483



08,5

COILS

Adatt./Suitable:

BOSCH

0 986 22A 205

CITROËN

5970 85

96 517 106 80

GENERAL MOTORS

1 104 091

HITACHI

133854

2503854

MAGNETI MARELLI

060717157012

PEUGEOT

5970 85



	ohm		ohm	
	0,83		...	

CITROËN

C2 1.4 16V	KFU(ET3J4)	04/05 ⇨ 12/09
C4 1.4 16V	KFU(ET3J4)	11/04 ⇨ 07/11
C3 1.4 16V	KFU(ET3J4)	12/03 ⇨

PEUGEOT

206 1.4 16V	KFU(ET3J4)	10/03 ⇨
207 1.4 16V	KFU(ET3J4)	02/06 ⇨ 10/13
307 1.4 16V	KFU(ET3J4)	11/03 ⇨ 07/07
1007 1.4 16V	KFU(ET3J4)	10/05 ⇨

KW 470 487



07,5

COILS

Adatt./Suitable:

BOSCH

0 986 221 058

HITACHI

134041

2504041

MAGNETI MARELLI

060717144012

MERCEDES-BENZ

A 000 150 19 80

A 000 150 26 80

A 000 150 27 80

A 272 906 00 60



	ohm		ohm	
	

MERCEDES-BENZ

CLASSE C II C 230	M272.920	01/05 ⇨ 05/08
CLASSE C II C 280	M272.940	01/05 ⇨ 08/07
CLASSE C II C 280 4-matic	M272.941	01/05 ⇨ 08/07
CLASSE C II C 350	M272.960	01/05 ⇨ 05/08
CLASSE C II C 350 4-matic	M272.970	01/05 ⇨ 08/07
CLASSE C III C 230	M272.921	01/07 ⇨ 08/14
CLASSE C III C 230 4-matic	M272.911	07/07 ⇨ 01/14

MERCEDES-BENZ

CLASSE C III C 250	M272.921	01/07 ⇨
CLASSE C III C 250 4-matic	M272.911	07/07 ⇨
CLASSE C III C 280	M272.947	01/07 ⇨ 08/14
CLASSE C III C 280 4-matic	M272.948	07/07 ⇨ 01/14
CLASSE C III C 300	M272.947	08/07 ⇨ 08/14
CLASSE C III C 300 4-matic	M272.948	07/07 ⇨ 01/14
CLASSE C III C 350	M272.961	01/07 ⇨ 08/14
CLASSE C III C 350 4-matic	M272.971	07/07 ⇨ 01/14
CLASSE CLC CLC 230	M272.920	05/08 ⇨ 06/11
CLASSE CLC CLC 250	M272.920	06/09 ⇨ 06/11
CLASSE CLC CLC 350	M272.960	05/08 ⇨ 06/11
CLASSE CLK II 280	M272.940	01/05 ⇨ 05/09
CLASSE CLK II 350	M272.960	01/05 ⇨ 05/09
CLASSE CLK II 500	M273.967	06/06 ⇨
CLASSE CLK II 550	M273.967	06/06 ⇨
CLASSE CLK II CLK 280	M272.940	01/05 ⇨ 03/10
CLASSE CLK II CLK 350	M272.960	01/05 ⇨ 03/10
CLASSE CLK II CLK 500	M273.967	06/06 ⇨ 03/10
CLASSE CLS I CLS 280	M272.943	07/08 ⇨ 12/10
CLASSE CLS I CLS 300	M272.943	04/09 ⇨ 12/10
CLASSE CLS I CLS 350	M272.964	10/04 ⇨ 12/10
CLASSE CLS I CLS 500	M273.960	04/06 ⇨ 12/10
CLASSE CLS I CLS 550	M273.960	04/06 ⇨ 02/11
CLASSE E III 350 CGI	M272.985	05/06 ⇨ 07/09
CLASSE E III E 230	M272.922	09/07 ⇨ 12/08
CLASSE E III E 230 T	M272.922	05/07 ⇨ 07/09
CLASSE E III E 250	M272.922	09/07 ⇨ 12/08
CLASSE E III E 280	M272.943	03/05 ⇨ 12/08
CLASSE E III E 280 4-matic	9930.61, M272944	03/05 ⇨ 12/08
CLASSE E III E 280 T	M272.943	03/05 ⇨ 07/09
CLASSE E III E 280 T 4-matic	9930.61, M272944	03/05 ⇨ 07/09
CLASSE E III E 300	M272.943	03/05 ⇨ 12/08
CLASSE E III E 300 T 4-matic	9930.61	03/05 ⇨ 07/09
CLASSE E III E 350	M272.964	03/05 ⇨ 12/08
CLASSE E III E 350 4-matic	M272.972	08/04 ⇨ 12/08
CLASSE E III E 350 CGI	M272.985	09/07 ⇨ 12/08
CLASSE E III E 350 T	M272.964	03/05 ⇨ 07/09
CLASSE E III E 350 T 4-matic	M272.972	03/05 ⇨ 07/09
CLASSE E III E 500	M273.960	04/06 ⇨ 12/08
CLASSE E III E 500 4-matic	M273.962	04/06 ⇨ 12/08
CLASSE E III E 500 T	M273.960	04/06 ⇨ 07/09
CLASSE E III E 500 T 4-matic	M273.962	04/06 ⇨ 07/09
CLASSE E III E 550 4-matic	M273.962	04/06 ⇨ 12/08
CLASSE E III E 550 T 4-matic	M273.962	04/06 ⇨ 07/09
CLASSE E IV E 250	M272.923	01/10 ⇨
CLASSE E IV E 300	M272.952, M272.980	01/09 ⇨
CLASSE E IV E 350	M272.961, M272.980, M272.988	01/09 ⇨
CLASSE E IV E 350 4-matic	M272.977	01/09 ⇨ 12/11
CLASSE E IV E 500	M273.966	01/09 ⇨ 12/16
CLASSE E IV E 500 4-matic	M273.970	01/09 ⇨ 12/11
CLASSE E IV E 550 [USA]	M273.966	01/09 ⇨
CLASSE E IV E 550 [USA] [CAN] [JPN]	M273.971	01/09 ⇨
CLASSE E IV E 550 4-matic [USA] [CAN]	M273.970	01/09 ⇨
CLASSE G II G 500	M273.963, M273.969	01/07 ⇨
CLASSE G II G 500 GUARD	M273.963	06/10 ⇨
CLASSE G II G 550	M273.963, M273.969	06/10 ⇨
CLASSE GL I GL 450 4-matic	M273.923	09/06 ⇨ 08/12
CLASSE GL I GL 500 4-matic	M273.963	09/06 ⇨ 12/12
CLASSE GL I GL 550 4-matic	M273.963	09/06 ⇨
CLASSE GLK 280 4-matic	M272.948	06/08 ⇨ 06/09
CLASSE GLK 300 4-matic	M272.948	07/09 ⇨ 12/15
CLASSE GLK 350	M272.991	04/09 ⇨ 06/15
CLASSE GLK 350 4-matic	M272.971	06/08 ⇨ 04/11
CLASSE M II ML 300	M272.945	07/09 ⇨
CLASSE M II ML 300 4-matic	M272.945	03/10 ⇨ 12/11
CLASSE M II ML 350	M272.967	07/05 ⇨
CLASSE M II ML 350 4-matic	M272.967	02/05 ⇨ 12/11
CLASSE M II ML 450 4-matic Hybrid	M272.973	07/05 ⇨
CLASSE M II ML 500 4-matic	M273.963	12/07 ⇨ 12/11
CLASSE M II ML 550 4-matic	M273.963	12/07 ⇨
CLASSE R R 280	M272.945	01/07 ⇨ 12/14
CLASSE R R 280 4-matic	M272.945	05/07 ⇨ 12/11
CLASSE R R 300	M272.945	07/09 ⇨ 12/14
CLASSE R R 300 4-matic	M272.945	07/09 ⇨
CLASSE R R 350	M272.967	01/07 ⇨ 12/12
CLASSE R R 350 4-matic	M272.967	08/05 ⇨ 12/12
CLASSE R R 500 4-matic	M273.963	05/07 ⇨ 12/14
CLASSE R R 550 4-matic	M273.963	01/07 ⇨
CLASSE SV CL 550 [JPN]	M273.961	06/06 ⇨
CLASSE SV CL 550 [USA]	M273.961	06/06 ⇨
CLASSE SV CL 550 4-matic [JPN]	M273.968	02/08 ⇨
CLASSE SV CL 550 4-matic [USA]	M273.968	02/08 ⇨
CLASSE SV S 280	M272.946	08/06 ⇨ 12/13

MERCEDES-BENZ

CLASSE SV S 300	M272.946	08/06 ⇨ 12/13
CLASSE SV S 350	M272.965	10/05 ⇨ 12/13
CLASSE SV S 350 4-matic	M272.975	02/08 ⇨ 12/13
CLASSE SV S 400 Hybrid	M272.974	01/09 ⇨ 12/13
CLASSE SV S 450	M273.922	12/05 ⇨ 12/13
CLASSE SV S 450 4-matic	M273.924	12/05 ⇨ 12/13
CLASSE SV S 500	M273.961	10/05 ⇨ 12/13
CLASSE SV S 500 4-matic	M273.968	10/05 ⇨ 12/13
CLASSE SV S 550 [JPN]	M273.961	10/05 ⇨
CLASSE SV S 550 [USA]	M273.961	10/05 ⇨
CLASSE SV S 550 4-matic [JPN]	M273.968	10/05 ⇨
CLASSE SV S 550 4-matic [USA]	M273.968	10/05 ⇨
SPRINTER II 224	M272.979	06/06 ⇨
SPRINTER II 324	M272.979	06/06 ⇨ 12/13
SPRINTER II 424	M272.979	06/06 ⇨ 12/13
SPRINTER II 524	M272.979	06/06 ⇨ 12/13
CLASSE SLV 280	M272.949	03/08 ⇨ 01/12
CLASSE SLV 300	M272.949	04/09 ⇨ 01/12
CLASSE SLV 350	M272.966, M272.968	03/06 ⇨ 01/12
CLASSE SLV 500	M273.965	03/06 ⇨ 01/12
CLASSE SLV 550	M273.965	03/06 ⇨ 01/12
CLASSE SLK II 280	M272.942	01/05 ⇨ 02/11
CLASSE SLK II 300	M272.942	04/09 ⇨ 02/11
CLASSE SLK II 350	M272.963, M272.969	06/04 ⇨ 02/11
VIANO 3.5	M272.978	09/07 ⇨
VIANO 3.7	M112.976	06/04 ⇨ 07/07
VITO II 123	M112.976	06/04 ⇨ 07/08
VITO II 126	M272.978	09/07 ⇨

KW 470 489



05,5

COILS

Adatt./Suitable:

BOSCH

0 221 604 014

HITACHI

133863

2503863

MAGNETI MARELLI

060810187010

NISSAN

22448-ED800

22448-ED80A

RENAULT

77 01 065 086



	ohm		ohm	
	

NISSAN

MICRA III 160 SR	HR16DE	05/05 ⇨ 06/10
MICRA C+C 1.6 160 SR	HR16DE	08/05 ⇨
NOTE I 1.6	HR16DE	03/06 ⇨ 06/12
QASHQAI / QASHQAI +2 1.6 CVTC	HR16DE	03/13 ⇨ 04/14
QASHQAI I 1.6	HR16DE	02/07 ⇨ 12/13
QASHQAI I 1.6 LPG	HR16DE	11/10 ⇨ 12/13
QASHQAI I 2.0	MR20DE	02/07 ⇨ 12/13
QASHQAI I 2.0 Trazione integrale	MR20DE	02/07 ⇨ 12/13
TIIDA I 1.6	HR16DE	09/07 ⇨ 12/12
TIIDA I 1.8	MR18DE	05/04 ⇨ 12/12
X-TRAIL II 2.0	MR20DE	06/08 ⇨ 02/14
X-TRAIL II 2.0 4x4	MR20DE	06/07 ⇨ 11/13
X-TRAIL II 2.0 FWD	MR20DE	03/07 ⇨ 11/13

RENAULT

CLIO III 2.0 16V	M4R700, M4R701	09/06 ⇨ 12/14
LAGUNA III 2.0 16V	M4R704	10/07 ⇨ 12/15
LAGUNA III 2.0 16V Hi-Flex	M4R704	10/07 ⇨ 12/15

KW 470 492



05,5

COILS

Adatt./Suitable:

HITACHI

134006
2504006

HYUNDAI

27301-3C000

KIA

27301-3C000

MAGNETI MARELLI

060717148012



	ohm		ohm
	0,72		7160

HYUNDAI

EQUUS / CENTENNIAL II 3.8	--	01/13 →
GENESIS 3.0 GDI	G6DG	06/14 →
GENESIS 3.0 GDI 4WD	G6DG	06/14 →
GENESIS 3.8	G6DA	09/09 →
GENESIS 3.8 GDI	G6DJ	06/14 →
GENESIS 3.8 GDI 4WD	G6DJ	06/14 →
GENESIS 3.8 V6	G6DA, G6DJ	01/08 →
GRANDEUR 3.3	G6DB	04/05 → 12/11
GRAND SANTA FE 3.0 GDi	G6DG	07/13 →
Trazione integrale		
GRAND SANTA FE 3.3	G6DF	01/14 →
GRAND SANTA FE 3.3	G6DF	02/14 →
Trazione integrale		
IX55 3.8 V6	G6DA	01/11 →
IX55 3.8 V6 4WD	G6DA	01/07 →
NF 2.0 CVVT	G4BPE	05/05 → 12/10
SANTA FE II 3.3	G6DB	07/07 → 11/08
SANTA FE II 3.3 Dynamic 4x4	G6DB	03/06 → 12/12
SANTA FE II 3.5	--	01/10 →
SANTA FE II 3.5 4x4	G6DC	08/11 → 12/12
SANTA FE IV 3.5 MPI AWD	G6DC	07/19 →
SONATA V 2.0 VVTi GLS	G4KA	05/05 → 12/10
SONATA V 2.4	G4KC	01/05 → 12/10
SONATA V 3.3	G6DB	01/05 → 12/10
SONICA 3.3 CVVT	G6DB	03/09 → 12/10

KIA

BORREGO 3.8	--	06/08 → 12/13
CADENZA 3.5 CVVT	G6DC	01/10 →
CARENS II 2.0 CVVT	G4KA	09/06 →
MOHAVE 3.8	--	12/08 →
OPIRUS 3.8 V6	G6DA	10/06 →
OPTIMA II 2.0	G4KA	05/08 →
QUORIS 3.8	G6DK	01/13 →
QUORIS 3.8 GDI	G6DJ	04/15 →
MAGENTIS II 2.0	G4JP, G4KA	11/05 →
SORENTO I 3.3 V6	--	12/06 →
SORENTO I 3.3 V6 4WD	G6DB	02/07 → 12/11
SORENTO III 3.5 D-CVVT	G6DC	12/18 →
SORENTO III 3.5 D-CVVT 4WD	G6DC	12/18 →
SORENTO II 3.3 GDI	--	10/12 →
SORENTO II 3.5	G6DC	11/09 →
SORENTO II 3.5 4WD	G6DC	11/09 →

KW 470 495



05,5

COILS

Adatt./Suitable:

BOSCH

0 986 221 062

HITACHI

134045
2504045

HYUNDAI

27301-2B000

KIA

27301-2B000

MAGNETI MARELLI

060717111012



	ohm		ohm
	0,81		5640

HYUNDAI

ELANTRA IV 1.6 CVVT	G4FC	06/06 → 06/11
I30 I 1.4	G4FA	10/07 → 06/12
I30 I 1.4 LPG	G4FA	01/09 → 06/12
I30 I 1.6	G4FC	10/07 → 06/12

KIA

CEED I 1.4	G4FA	12/06 → 12/12
CEED I 1.6	G4FC	09/07 → 12/12
CEED I 1.6 LPG	G4FC	06/07 → 12/11
CERATO I 1.6	G4ED, G4FC, G4GR	04/04 →
PRO CEE'D I 1.4	G4FA	02/08 → 09/12
PRO CEE'D I 1.6	G4FC	02/08 → 09/12
PRO CEE'D I 1.6 CVVT	G4FC	02/08 → 09/12

KW 470 496



05

COILS

Adatt./Suitable:

BOSCH

0 986 221 005

HITACHI

138746

HYUNDAI

27301-02600 *5
27301-02630 *5
27301-02800 *5
27310-02620
27310-02630

*5 Supplied single coil only, without fastening clamp

- Fornita bobina singola senza staffa
- Fourni seulement la bobine individuelle, sans étrier
- Nur Zündspule geliefert, ohne Befestigungsbügel
- Suministrada solamente la bobina individual, sin brida

470 496

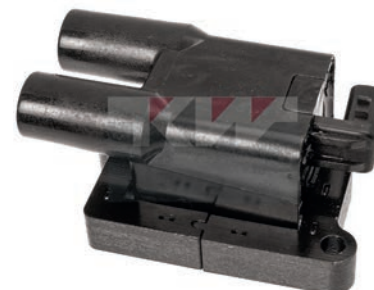

	ohm		ohm
	0,9		13200

HYUNDAI

ATOS 1.0 i	G4HC	03/01 → 07/03
ATOS 1.1	G4HD, G4HG	06/03 → 12/10
ATOS PRIME 1.0 i	G4HC-E	03/01 → 07/03
ATOS PRIME 1.1	G4HD, G4HG	08/03 → 12/08
I10 I 1.1	G4HG	12/07 → 12/13
I10 I 1.1 LPG	G4HG	01/09 → 12/13
SANTRO 1.1	G4HD	01/03 →

KW 470 497



05,5

COILS

Adatt./Suitable:

CITROËN

5970 96

HITACHI

134083
2504083

MITSUBISHI

1832A016

PEUGEOT

5970 96



	ohm		ohm

CITROËN

C4 AIRCROSS 2.0	4B11	04/12 →
C4 AIRCROSS 2.0 AWC	4B11	04/12 →
C-CROSSER 2.0	4B11	11/10 →
C-CROSSER 2.0 Trazione integrale	4B11	11/10 →

CITROËN		
C-CROSSER 2.4 16V	SFZ(4B12MMC)	08/08 →
C-CROSSER ENTERPRISE 2.4 16V	4B12	01/09 →
MITSUBISHI		
ASX 1.8	4B10	02/10 →
ASX 1.8 4WD	6B4204T30	02/10 →
ASX 2.0 i	4B11	06/10 →
ASX 2.0 i 4WD	4B11	01/10 →
ASX 2.0 MIVEC	4B11, 4J11	06/10 →
ASX 2.0 MIVEC 4WD	4B11, 4J11	06/10 →
DELICA D5 2.4 4WD	4B12	06/07 →
LANCER 1.8 i	--	10/07 →
LANCER IX 1.8	4B10, 4J10	02/08 →
LANCER IX 1.8 Bifuel	4B10	01/10 →
LANCER IX 1.8 Flex	4B10	03/09 →
LANCER IX 1.8 Flexfuel	4B10, 6B4204T30	03/09 →
LANCER IX 1.8 MIVEC	4B10, 4J10	03/09 →
LANCER IX 2.0	4B11	04/08 →
LANCER IX 2.0 i	4B11	04/07 →
LANCER IX 2.0 i 4WD	4B11	03/07 →
OUTLANDER I 2.4 4WD	4G64(16V)	05/03 → 10/06
OUTLANDER I 2.4 HDD Mivec	4G69	03/01 → 12/06
OUTLANDER II 2.0	4B11	11/06 → 11/12
OUTLANDER II 2.0 4WD	4B11	11/06 → 11/12
OUTLANDER II 2.4	4B12	11/06 → 11/12
OUTLANDER II 2.4 4WD	4B12	09/07 → 11/12
OUTLANDER II 2.4 Flex 4WD	4B12	09/07 → 11/12
OUTLANDER II 3.0 4WD	6B31	11/06 → 12/12
OUTLANDER II 3.0 AWD	6B31	11/06 → 12/10
OUTLANDER II 3.0 FWD	6B31	11/06 → 11/12
OUTLANDER III 3.0	6B31	08/12 →
OUTLANDER III 3.0 4WD	6B31	03/14 →
OUTLANDER III 3.0 GT 4WD	6B31	08/12 →
PAJERO SPORT II 3.0	6B31	09/08 →
PAJERO SPORT II 3.0 4WD	6B31	09/08 →
LANCER VIII 1.8 SEI Limited	4G93(GDI)	09/03 → 03/07
PEUGEOT		
4007 2.0	4B11	11/10 → 03/13
4007 2.0 4x4	4B11	11/10 → 03/13
4007 2.4 16V	SFY(4B12-MMC), SFZ(4B12-MMC)	02/07 → 03/13
4008 2.0	4B11	05/13 →
4008 2.0 AWC	4B11	05/12 →

KW 470 503

05,5

COILS

Adatt./Suitable:

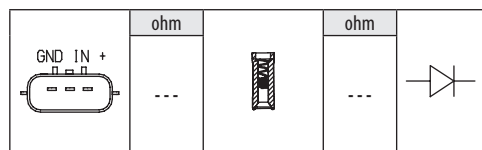
HITACHI
134086
2504086MITSUBISHI
1832A028SMART
A 132 158 00 03

MITSUBISHI

I 0.7 3B20 02/07 →

SMART

FORTWO II 1.0 M132.910 01/07 →

FORTWO II 1.0 Brabus M132.930 01/08 →

FORTWO II 1.0 Turbo M132.930 01/07 →

FORTWO II 1.0 Turbo Brabus M132.930 07/10 →

KW 470 505

05,5

COILS

Adatt./Suitable:

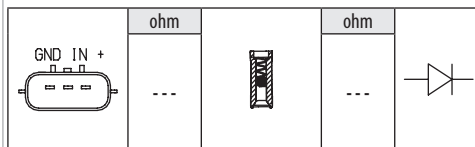
CITROËN
16 075 767 80HITACHI
134087
2504087MITSUBISHI
MN195805PEUGEOT
16 075 767 80

CITROËN

C4 AIRCROSS 1.6 4A92, NKZ(4A92) 04/12 →

MITSUBISHI

ASX 1.6 LPG 4A92 06/10 →

ASX 1.6 MIVEC 4A92 05/10 →

COLT VI 1.1 3A91 10/04 → 06/12

COLT VI 1.1 LPG 3A91 10/04 → 06/12

COLT VI 1.3 4A90 06/04 →

COLT VI 1.3 4WD 4A90 08/04 →

COLT VI 1.3 LPG 4A90 06/04 → 06/12

LANCER IX 1.5 4A91 06/08 →

LANCER IX 1.5 Bifuel 4A91 02/10 →

LANCER IX 1.6 MIVEC 4A92 05/10 →

PEUGEOT

4008 1.6 --, 4A92, MMC 05/12 →

KW 470 507

08,6

COILS

Adatt./Suitable:

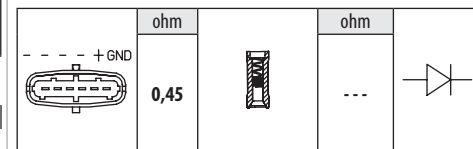
BOSCH
0 221 503 468GENERAL MOTORS
9 198 834
90 424 480HITACHI
133879
2503879MAGNETI MARELLI
060717185012OPEL
62 35 037
91 98 834VAUXHALL
9198834

OPEL

ASTRA G 2.0 16V Turbo Z20LET 09/00 → 10/05

ASTRA G 2.0 OPC Z20LET 03/02 → 10/05

ASTRA H 2.0 Turbo Z20LEH, Z20LEL, Z20LER 03/04 → 10/10

ZAFIRA B 2.0 Z20LEH, Z20LER 07/05 → 12/10

ZAFIRA B 2.0 VAN Z20LER 07/05 → 12/10

SPEEDSTER 2.0 Z20LET 10/03 → 08/06

SPEEDSTER 2.0 Turbo Z20LET 08/02 → 08/06

ZAFIRA A 2.0 OPC Z20LET 09/01 → 06/05

VAUXHALL

ASTRA IV 2.0 Z20LET 08/02 → 10/05

ASTRA IV 2.0 16V Turbo Z20LET 09/00 → 08/05

ASTRA IV 2.0 SRI Turbo Z20LET 11/01 → 05/05

ASTRA IV 2.0 Turbo Z20LET 03/02 → 10/05

ZAFIRA A 2.0 Z20LET 06/02 → 06/05

ZAFIRA A 2.0 GSI Turbo Z20LET 09/01 → 06/05

ASTRA V 2.0 Z20LEL 02/06 → 11/10

ASTRA V 2.0 Turbo Z20LEH, Z20LEL, Z20LER 01/04 → 11/10

ASTRA V 2.0 VXR Z20LEH 02/09 → 11/10

SPEEDSTER 2.0 Turbo Z20LET 03/01 → 09/06

SPEEDSTER VXR20 Z20LET 03/01 → 09/06

VX220 2.0 i Turbo Z20LET 03/01 → 07/05

VX220 2.0 VXR Z20LET 10/03 → 07/05

ZAFIRA B 2.0 Z20LEH, Z20LER 07/05 → 11/14

03

Supplied until depletion

- Fornibile fino ad esaurimento delle scorte
- Fourni jusqu'à épuisement du stock
- Lieferbar solange vorrat reicht
- Suministrado hasta el stock termina

KW 470 508  **08,8**

COILS
 Adatt./Suitable:
GENERAL MOTORS
 9 119 567
 90 536 194
HITACHI
 133810
 2503810
MAGNETI MARELLI
 060717064012
OPEL
 12 08 008
 91 19 567
SAAB
 91 19 567
SAGEM
 2 526 116 A
SIEMENS
 5WK9 3171
VAUXHALL
 9119567

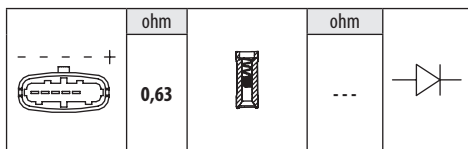

OPEL		
ASTRA F 1.8 i	X18XE1	03/98 ⇨ 08/00
ASTRA G 1.8	Z18XEL	02/03 ⇨ 07/04
ASTRA G 1.8 16V	X18XE1, Z18XE	03/00 ⇨ 10/05
ASTRA H 1.8	Z18XE	01/04 ⇨ 10/10
CORSA C 1.8	Z18XE	09/00 ⇨ 12/09
MERIVA A 1.8	Z18XE	05/03 ⇨ 05/10
SIGNUM 1.8	Z18XE	05/03 ⇨ 07/05
TIGRA B 1.8	Z18XE	06/04 ⇨ 12/10
VECTRA B 1.8 i 16V	X18XE1, Z18XE, Z18XEL	09/00 ⇨ 07/03
VECTRA C 1.8	Z18XE	04/02 ⇨ 07/08
VECTRA C 1.8 16V	Z18XE, Z18XEL	04/02 ⇨ 09/08
ZAFIRA A 1.8	Z18XEL	02/03 ⇨ 06/05
ZAFIRA A 1.8 16V	X18XE1, Z18XE	09/00 ⇨ 06/05

SAAB		
9-3 1.8 i	Z18XE	01/04 ⇨ 02/15

VAUXHALL		
ASTRA IV 1.8 16V	X18XE1, Z18XE	02/98 ⇨ 10/05
ASTRA IV 1.8 16V Dualfuel	Z18XE	07/02 ⇨ 08/05
ZAFIRA A 1.8 16V	X18XE1, Z18XE	09/00 ⇨ 08/05
ZAFIRA A 1.8 Dualfuel	Z18XE	09/00 ⇨ 08/05
ASTRA V 1.8	Z18XE	01/04 ⇨ 11/10
CORSA C 1.8 16V	Z18XE	08/00 ⇨ 09/06
MERIVA I 1.8 i 16V	Z18XE	05/03 ⇨ 06/10
SIGNUM 1.8	Z18XE	06/03 ⇨ 07/05
TIGRA B 1.8	Z18XE	06/04 ⇨ 08/09
VECTRA B 1.8 Dualfuel	Z18XE	09/00 ⇨ 07/03
VECTRA B 1.8 i 16V	X18XE1, Z18XE, Z18XEL	09/00 ⇨ 07/03
VECTRA C 1.8	Z18XEL	04/02 ⇨ 07/08
VECTRA C 1.8 16V	Z18XE	04/02 ⇨ 07/08
VECTRA C 1.8 16V Dualfuel	Z18XE	04/02 ⇨ 07/08

KW 470 509  **08,7**

COILS
 Adatt./Suitable:
CITROËN
 5970 84
 5970 A5
 96 351 725 80
 96 453 331 80
HITACHI
 133843
 2503843
PEUGEOT
 5970 76
 5970 84
 5970 A5
SAGEM
 2 526 131 A

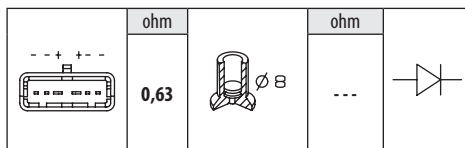
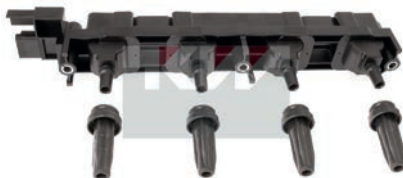

CITROËN		
C4 I 2.0 16V	RFK(EW10J4S)	11/04 ⇨ 12/10
C8 2.2	3FZ(EW12J4)	07/02 ⇨
PEUGEOT		
206 2.0 RC	RFK(EW10J4S)	07/03 ⇨ 12/07
307 2.0 16V	RFK(EW10J4S)	10/03 ⇨ 04/09
406 2.2	3FZ(EW12J4)	07/00 ⇨ 12/04
407 2.2	3FZ(EW12J4)	03/04 ⇨ 10/06
407 2.2 16V	3FY(EW12J4)	08/05 ⇨
607 2.2 16V	3FY(EW12J4), 3FZ(EW12J4)	02/00 ⇨ 06/10
807 2.2	3FZ(EW12J4)	06/02 ⇨

KW 470 514  **05,5**

COILS
 Adatt./Suitable:
BOSCH
 0 986 221 091
HITACHI
 133939
 2503939
MAZDA
 ZJ01-18-100
 ZJ01-18-100A

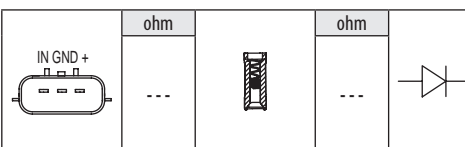
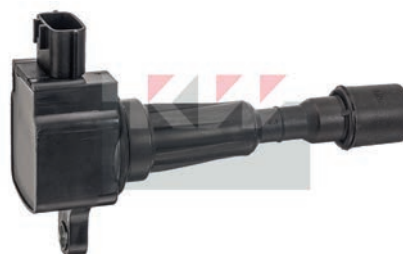

MAZDA		
2 II 1.3	ZJ-46	10/07 ⇨ 06/15
2 II 1.3 BiFuel	ZJ-46	05/11 ⇨ 11/14
2 II 1.5	ZY66	07/07 ⇨ 06/15
3 I 1.3	ZJ07, ZJ30, ZJ-VE	10/03 ⇨ 06/09
3 I 1.4	FXJA	02/04 ⇨ 06/09
3 I 1.6	B6ZE, Z6, Z601, Z627	10/03 ⇨ 06/09

MAZDA
 3 II 1.6 MZR | Z668, Z682, Z683 | 12/08 ⇨ 09/14

KW 470 516  **05,5**

COILS
 Adatt./Suitable:
BOSCH
 0 986 221 092
HITACHI
 133936
 2503936
MAGNETI MARELLI
 060717176012
MAZDA
 ZJ20-18-100
 ZJ20-18-100A

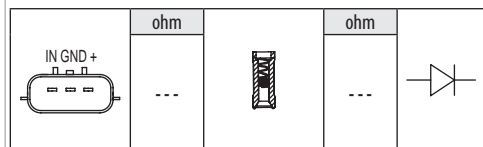

MAZDA		
2 II 1.3	ZJ-46, ZJ-VE	07/07 ⇨ 06/15
2 II 1.3 BiFuel	ZJ-46	05/11 ⇨ 11/14
2 II 1.3 MZR	ZJ-46, ZJ-VE	01/10 ⇨ 06/15
2 II 1.5	ZY06, ZY66, ZY-DE, ZY-VE	07/07 ⇨ 06/15
2 II 1.5 i	ZY-DE	05/10 ⇨ 06/15
2 II 1.5 MZR	ZY05, ZY66	06/11 ⇨ 06/15
3 I 1.3	ZJ-VE	10/03 ⇨ 06/09
3 I 1.4	FXJA	02/04 ⇨ 06/09
3 I 1.6	B6ZE, Z6, Z601, Z627	10/03 ⇨ 06/09
3 II 1.6 MZR	Z6	12/08 ⇨ 09/14
3 III 1.6	Z6Y1, Z6Y3	09/13 ⇨

KW 470 518



07

COILS

Adatt./Suitable:

BOSCH

0 986 221 046

DACIA

82 00 702 693

HITACHI

138713

1548719

2508713

MAGNETI MARELLI

060717101012

060717190012

NISSAN

22462-00Q0A

RENAULT

82 00 702 693



	ohm		ohm
	0,41	∅ 4	5200

DACIA

LOGAN I 1.0	D4D760	12/05 →
LOGAN I 1.0 Hi-Flex	D4D760	01/11 → 10/12
LOGAN I 1.2 16V	D4F732	02/06 →
LOGAN I 1.2 16V LPG	D4F734	02/06 →
LOGAN II 1.0	D4D754	10/12 →
LOGAN II 1.2	D4F732, D4F734	10/12 →
LOGAN II 1.2 LPG	D4F732, D4F734	10/12 →
LOGAN II MCV 1.2	D4F732	02/13 →
LOGAN II MCV 1.2 LPG	D4F732, D4F734	02/13 →
SANDERO I 1.0 Hi-Flex	D4D760	01/11 → 12/12
SANDERO I 1.2 16V	D4F732	11/08 →
SANDERO I 1.2 16V LPG	D4F732, D4F734	11/08 →
SANDERO II 1.0	D4D754	10/12 →
SANDERO II 1.2	D4F732, D4F734	10/12 →
SANDERO II 1.2 LPG	D4F732, D4F734	10/12 →

NISSAN

KUBISTAR 1.2 16V	D4F730	04/06 →
------------------	--------	---------

RENAULT

CLIO 1.2	D4F728	08/98 →
CLIO II 1.2 16V	D4F722, D4F728	06/01 → 08/16
CLIO III 1.2	D4F740	10/05 → 12/14
CLIO III 1.2 16V	D4F740, D4F744, D4F764	06/05 →
CLIO III 1.2 16V Hi-Flex	D4F740, D4F742, D4F744	11/07 → 12/14
CLIO III 1.2 Ethanol	D4F742	07/08 → 12/12
CLIO III 1.2 Hi-Flex	D4F742	11/07 → 12/09
CLIO IV 1.2 16V	D4F740, D4F744	11/12 →
CLIO IV 1.2 16V LPG	D4F744	01/14 →
CLIO IV 1.2 LPG	D4F744	01/14 →
CLIO IV 1.2 LPG 16V	D4F744	11/12 → 06/15
KANGOO I 1.2 16V	D4F730	06/01 →
LOGAN 1.0	D4D760	12/05 →
LOGAN 1.2 16V	D4F732, D4F734	02/06 →
LOGAN 1.2 16V LPG	D4F732, D4F734	12/13 →
LOGAN/STEPWAY 1.2	D4F732, D4F734	11/13 →
LOGAN/STEPWAY 1.2 16V LPG	D4F732, D4F734	11/13 →
MODUS / GRAND MODUS 1.2	D4F740, D4F742, D4F744, D4F764	12/04 →
MODUS / GRAND MODUS 1.2 16V Hi-Flex	D4F742	10/08 →
MODUS / GRAND MODUS 1.2 GPL	D4F744	05/08 → 12/12
SANDERO I 1.2 16V	D4F732	11/08 →
SANDERO II 1.2 16V	D4F732, D4F734	12/13 →
SANDERO II 1.2 16V LPG	D4F734	12/13 →
THALIA I 1.2i 16V	D4F728	04/04 →
THALIA II 1.2 16V	D4F728, D4F736	09/08 → 06/14
TWINGO I 1.2 16V	D4F708	08/04 → 06/07
TWINGO II 1.2	D4F770	09/10 → 09/14
TWINGO II 1.2 16V	D4F764, D4F770, D4F772	03/07 →

KW 470 522



05,5

COILS

Adatt./Suitable:

DENSO

099 700-101

DIC-0143

HITACHI

134044

2504044

HONDA

30520-RNA-A01

MAGNETI MARELLI

060717150012

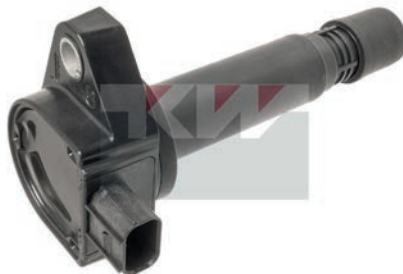

	ohm		ohm	
	---		---	

HONDA

ACCORD VIII 2.0 i	R20A3	06/08 → 06/15
CIVIC VIII 1.6	R16A1, R16A2	09/05 →
CIVIC VIII 1.8	R18A1, R18A2	09/05 →
CIVIC VIII 1.8 EXS Flex	R18A1	11/06 →
CR-V II 2.0	R20A1	06/04 →
CR-V III 2.0 i	R20A2	01/07 →
CR-V III 2.0 i-VTEC	R20A2	01/07 → 06/12
CR-V III 2.0 i-VTEC 4WD	R20A2	10/06 → 06/12
CR-V IV 2.0	R20A9	01/12 →
FR-V 1.8	R18A1	01/07 →

KW 470 527



05,5

COILS

Adatt./Suitable:

HITACHI

133944

2503944

CM11-118

HONDA

30521-RBJ-003

30521-RBJ-013

30521-RBJ-S01



	ohm		ohm	
	---		---	

HONDA

INSIGHT 1.3 IMA	LDA3	04/09 →
JAZZ III 1.3 HYBRID	LDA3	04/11 →

KW 470 529



05,5

COILS

Adatt./Suitable:

BOSCH

0 986 JG1 225

HITACHI

133910

2503910

CM11-109

CM11-112

HONDA

30520-PWA-003

30520-PWA-013

30520-PWA-S01

30520-REA-Z01

MAGNETI MARELLI

060810229010

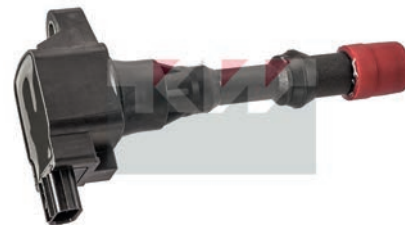

	ohm		ohm	
	---		---	

HONDA

JAZZ II 1.2	L12A4	01/06 →
JAZZ II 1.4	L13A6	01/06 →
CITY 1.2	L12A2	05/03 →
CITY 1.3	L13A3	10/05 → 07/08
CITY 1.5 i i-DSI	L15A2	11/02 →
CIVIC VII 1.3 IMA	LDA1	10/03 → 09/05
JAZZ I 1.2 i-DSI	L12A1, L12A3, L12A4	03/02 → 07/08
JAZZ I 1.3 iDSi	L13A1, L13A6	03/02 → 07/08
JAZZ I 1.4	L13A5	04/05 → 07/08
JAZZ I 1.4 iDSI	L13A1, L13A6	12/06 → 10/08
CIVIC VIII 1.3 IMA	LDA2	01/06 →
CIVIC VIII 1.4	L13A7	09/05 →

KW 470 532

07

COILS

Adatt./Suitable:

BOSCH
0 221 503 490
0 221 503 491

*1 Without fastening clamp

- Senza staffa di fissaggio
- sans bride de fixation
- ohne Befestigungsbügel
- sin estribo de sujeción

FORD

1 053 904 *1
1 066 102 *1
1 067 601
1 075 786
1 111 212
1 111 213 *1
1 119 835
1 130 402
1 317 972
1 319 788
1 319 929
1 517 813
1 619 343
157G-12029-AB
157G-12029-AC
157G-12029-AD
988F-12024-AB *1
988F-12029-AB
988F-12029-AC
988F-12029-AD
988F-12029-AE
988F-12029-BA
988F-12257-AB *1
9BBF-10029-BA
YM2F-12024-AC
YM2F-12024-AD
YM2F-12029-AA
YM2F-12029-AB

245 without fastening clamp

- senza staffa fissaggio
- sans bride de fixation
- ohne Befestigungsbügel
- sin estribo de sujeción

HITACHI

138800
138803
138809
138811
2508800
2508803
2508809
2508811

MAGNETI MARELLI

060717036012
060717038012
060717178012
060801005010
BAE 680 C

MAZDA

1E03-18-10X *1
1E03-18-10XA *1
1E04-18-10X
1E05-18-100B
1F20-18-100
1F20-18-100A
C201-18-100
C201-18-100A
C201-18-100B
LF01-18-100
LF01-18-100A
YF09-18-10X

VOLVO

30735759
31359976



	ohm		ohm
	0,53	∅ 4	11800

FORD

FIESTA V 1.25 16V	FUJA, FUJB, M7JA, M7JB	05/02 ⇨ 06/08
FIESTA V 1.3	A9JA, A9JB, BAJA	11/01 ⇨ 08/08
FIESTA V 1.4	FXJA	05/02 ⇨ 09/05
FIESTA V 1.4 16V	FXJA, FXJB	11/01 ⇨ 06/08
FIESTA V 1.6 16V	FYJA, FYJB	11/01 ⇨ 06/08
FIESTA V ST150	N4JB	03/05 ⇨ 06/08
COUGAR 2.0 16V	EDBA, EDBB, EDBC, EDBD	08/98 ⇨ 12/01
ESCORT-NOMADE 1.6	8LH7(98CUL4), ZH16L1E	01/95 ⇨ 04/00
ESCORT-NOMADE 1.8	0LW2(273CUL8)	01/95 ⇨ 04/00
ESCORT IV 1.6 16V	L1E, L1K	10/98 ⇨ 07/00
ESCORT VI 1.3	J4B, J6A	01/95 ⇨ 02/99
ESCORT VI 1.6 16V	L1E, L1K	01/95 ⇨ 07/00
ESCORT VI 1.6 16V 4x4	L1E	01/95 ⇨ 10/98
ESCORT VI 1.6 16V XR3i	L1E, L1H, L1K	02/95 ⇨ 09/99
ESCORT VI 1.6 i 16V	L1E, L1H, L1K	01/95 ⇨ 02/99
ESCORT VI 1.8 16V	RDA, RKC	01/95 ⇨ 02/99

FORD

ESCORT VI 1.8 16V XR3i	RDA, RKC, RQB	02/95 ⇨ 08/98
FIESTA IV 1.0 i	OEAL	04/96 ⇨ 09/99
FIESTA IV 1.25 i 16V	DHA, DHB, DHC, DHD, DHE, DHF, DHG	08/95 ⇨ 01/02
FIESTA IV 1.3 i	J4C, J4J, J4L, J4Q, J4R, J4T, JBC, JJA, JJC, JJE, JJJ, JJK, JJM	08/95 ⇨ 01/02
FIESTA IV 1.4	FHA	08/98 ⇨ 04/02
FIESTA IV 1.4 i 16V	FHA, FHE	04/96 ⇨ 01/02
FIESTA IV 1.6 16V Sport	L1T, L1V	02/00 ⇨ 01/02
FIESTA 1.2	DHA, DHB, DHC, DHD, DHF, DHG	01/96 ⇨ 04/02
FIESTA 1.3	J4C, J4J, J4R	09/95 ⇨ 08/03
FOCUS I 1.4	FXDA, FXDB, FXDC, FXDD	04/99 ⇨ 03/05
FOCUS I 1.4 16V	FXDA, FXDB, FXDC, FXDD	10/98 ⇨ 11/04
FOCUS I 1.6	FYDA, FYDB, FYDC, FYDD	04/99 ⇨ 03/05
FOCUS I 1.6 16V	--, FYDA, FYDB, FYDC, FYDD, FYDH	02/99 ⇨ 11/04
FOCUS I 1.6 16V Flexifuel	FYDH	01/02 ⇨ 11/04
FOCUS I 1.8	EYDB, EYDC, EYDD, EYDE, EYDF, EYDG	04/99 ⇨ 03/05
FOCUS I 1.8 16V	EYDB, EYDC, EYDD, EYDE, EYDF, EYDG, EYDI, EYDJ, EYDL	10/98 ⇨ 11/04
FOCUS I 1.8 16V BiFuel	EYDD, EYDG, EYDI	09/02 ⇨ 07/04
FOCUS I 1.8 BiFuel	EYDL	02/03 ⇨ 01/05
FOCUS I 2.0 16V	EDDB, EDDC, EDDD, EDDF	10/98 ⇨ 11/04
FOCUS I RS	HMDA	10/02 ⇨ 11/04
FOCUS I ST170	ALDA	03/02 ⇨ 11/04
FOCUS II 1.4	ASDA, ASDB	07/04 ⇨ 09/12
FOCUS II 1.6	HWDA, HWDB, SHDA, SHDB, SHDC	07/04 ⇨ 09/12
FOCUS II 1.6 Ti	HXDA, HXDB, SIDA	07/04 ⇨ 09/12
FOCUS C-MAX 1.6	HWDA, HWDB, SHDA, SHDB, SHDC	10/03 ⇨ 03/07
FOCUS C-MAX 1.6 Ti	HXDA, HXDB, SIDA	08/04 ⇨ 03/07
FUSION 1.25	--, FUJA, FUJB	10/02 ⇨
FUSION 1.3	--, BAJA	08/02 ⇨
FUSION 1.4	--, FXJA, FXJB, FXJC	08/02 ⇨
FUSION 1.6	FYJA, FYJB, FYJC	08/02 ⇨ 11/09
FUSION 2.0	--	11/04 ⇨
GALAXY 1.2.0	ZVSA	03/96 ⇨ 03/06
GALAXY 1.2.0 i	NSE, ZVSA	11/95 ⇨ 05/06
GALAXY 1.2.3	ESSA, ESSB	05/00 ⇨ 03/06
GALAXY 1.2.3 16V	ESSA, ESSB, YSB	09/01 ⇨ 05/06
IKON 1.3 Rocam	--	10/00 ⇨
KA I 1.3	A9A, A9B	09/02 ⇨ 03/04
KA I 1.3 i	BAA, J4D, J4K, J4M, J4N, J4P, J4S, JJB, JJD, JJF, JJG, JJH, JJJ	09/96 ⇨ 11/08
KA I 1.3 i ROCAM	A9A, A9B	08/02 ⇨ 11/08
KA I 1.6 i	CCA, CDB, CDC, HL16SL9B	02/01 ⇨ 11/08
MAVERICK 2.0 16V	YF	02/01 ⇨
MAVERICK 2.0 16V FWD	YF	02/01 ⇨
MONDEO I 1.6 i	L1J	08/96 ⇨ 09/00
MONDEO I 1.6 i 16V	L1L, L1N, L1Q	05/98 ⇨ 09/00
MONDEO I 1.8 i	RKA, RKB, RKF, RKH, RKJ, RKK	08/96 ⇨ 09/00
MONDEO I 2.0 i	NGA, NGB, NGC, NGD	08/96 ⇨ 09/00
MONDEO II 1.8 16V	CGBA, CGBB, CHBA, CHBB	10/00 ⇨ 03/07
MONDEO II 2.0 16V	CJBA, CJBB	10/00 ⇨ 03/07
PUMA 1.4 16V	FHD, FHF	11/97 ⇨ 10/00
PUMA 1.6 16V	L1W	08/00 ⇨ 06/02
PUMA 1.7 16V	MHA, MHB	03/97 ⇨ 06/02
PUMA Racing ST 160	MHA	06/99 ⇨ 06/02
STREET KA 1.6	CDRA, CDRB	05/03 ⇨ 07/05
TOURNEO 1.8 BiFuel	EYPCNG	08/05 ⇨ 12/06
TOURNEO 1.8 LPG	EYPC	08/05 ⇨ 12/06
TOURNEO CONNECT I 1.8 16V	EYPA, EYPC, EYPD	06/02 ⇨ 12/13
TRANSIT 1.8 CNG	EYPCNG	05/02 ⇨ 12/13
TRANSIT CONNECT I 1.8 16V	EYPA, EYPC, EYPD	06/02 ⇨ 12/13
TRANSIT CONNECT I 1.8 16V LPG	EYPA, EYPC, EYPD	06/02 ⇨ 12/13

FORD (BR)

FIESTA 1.0i	ZL10	07/99 ⇨
FIESTA 1.6i	ZL16	07/99 ⇨

MAZDA

121 1.3	1E03, 1E04	01/96 ⇨ 05/97
121 III 1.25	1E05	03/96 ⇨ 04/03
121 III 1.3	1E03, 1E04, 1E09, J4R, J4T, JJK, JJM	03/96 ⇨ 04/03
21 1.2	FUJA	02/03 ⇨ 06/07
21 1.25	FUJA	04/03 ⇨ 06/07
21 1.3 L	ZJ-04	04/03 ⇨ 06/07
21 1.4	FXJA	02/03 ⇨ 06/07
21 1.5	ZY-VE	04/03 ⇨ 06/07
21 1.6	FYJA	02/03 ⇨ 06/07
TRIBUTE 2.0	0L65(396CUL8)	03/00 ⇨ 05/08
TRIBUTE 2.0 4WD	1L33(425CUL8)	03/00 ⇨ 05/08
TRIBUTE 2.0i [USA]	B	05/00 ⇨
TRIBUTE 2.0i 4x4 [USA]	B	05/00 ⇨

VOLVO

S40 II 1.6	B416453	01/05 ⇨ 12/12
------------	---------	---------------

VOLVO

V50 1.6	B416453	01/05 ⇨ 12/12
---------	---------	---------------

KW 470 533

05,5

COILS

Adatt./Suitable:

HITACHI
2503902

INFINITI
22448-JA10C
22448-JA11C

NISSAN
22448-JA10A
22448-JA10C
22448-JA11C

RENAULT
22 44 8JA 10C



	ohm		ohm	
IN GND +	...	∅ 4	...	

INFINITI

EX35 3.5 V6	VQ35HR	04/08 ⇨
FX 35	VQ35HR	07/08 ⇨ 12/11
FX 35 AWD	VQ35HR	07/08 ⇨ 12/10
M 25	VQ25HR	07/10 ⇨
M 35h	VQ35HR	04/11 ⇨
G SERIES 3.5 V6	VQ35HR	12/06 ⇨
G 25	VQ25HR	01/11 ⇨
G 35 X	VQ35HR	01/07 ⇨ 12/08
JX 3.5 AWD	VQ35DE	11/12 ⇨ 09/13
M35 3.5	VQ35HR	09/08 ⇨ 12/10
M35 3.5 h	VQ35HR	01/10 ⇨
M35 3.5 X	VQ35HR	09/08 ⇨ 12/10
Q50 50 Hybrid	VQ35HR	04/13 ⇨
Q50 50 Hybrid AWD	VQ35HR	04/13 ⇨
Q70 2.5	VQ25HR	05/15 ⇨
Q70 3.5 Hybrid	VQ35HR	03/13 ⇨
QX50 2.5 AWD	VQ25HR	02/14 ⇨
QX60 3.5 AWD	VQ35DE	10/13 ⇨

NISSAN

MURANO 3.5 CVTC 4x4	VQ35DE	03/13 ⇨ 09/14
MURANO III 3.5 V6	VQ35DE	01/16 ⇨
MURANO III 3.5 V6 ALL MODE 4x4-i	VQ35DE	10/14 ⇨
MURANO II 3.5	VQ35DE	11/07 ⇨ 09/14
MURANO II 3.5 4x4	VQ35DE	11/07 ⇨ 09/14
TEANA II 2.5	VQ25DE	07/08 ⇨ 09/13
TEANA II 3.5	VQ35DE	07/08 ⇨ 09/13
TEANA III 3.5	VQ35DE	01/14 ⇨
TEANA III 3.5 CVTC	VQ35DE	01/14 ⇨
PATHFINDER IV 3.5 4WD	VQ35DE	09/12 ⇨

RENAULT

LAGUNA III 3.5 V6	8T2150XSG15	04/08 ⇨ 12/15
LATITUDE 2.5 V6	2ZV604	05/11 ⇨
LATITUDE 3.5	5ZV604	05/11 ⇨

KW 470 535



07,5

COILS

Adatt./Suitable:

HITACHI

2503947

MAGNETI MARELLI

060717159012

SUZUKI

33400-65G00
33400-65G00-000
33400-65G01
33400-65G01-000
33400-65G02
33400-65G02-000

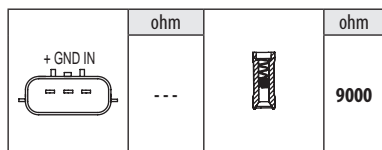
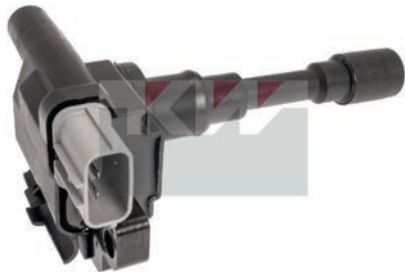

SUZUKI

Model	Code	Year
ALTO VI 1.1	F10D, F10DN	09/04 → 12/08
BALENO 1.6	G16B	07/96 → 01/99
BALENO 1.6 i 16V	G16B	07/95 → 05/02
BALENO 1.6 i 16V 4x4	G16B	07/95 → 05/02
CARRY 1.3	G13BB	02/99 → 12/06
CARRY 1.3 16V	G13BB	03/00 →
ESTEEM 1.6i [USA]	G16B	09/98 →
GRAND VITARA II 1.6	M16A	10/05 →
GRAND VITARA II 1.6 4x4	M16A	09/05 → 02/15
GRAND VITARA II 1.6 Trazione integrale	M16A	04/05 → 02/15
SWIFT IV 1.3	M13A	02/05 →
SWIFT IV 1.3 4x4	M13A	02/05 →
SWIFT IV 1.3 LPG	M13A	09/08 → 12/10
SWIFT IV 1.5	M15A	02/05 →
SWIFT IV 1.5 4x4	M15A	02/05 →
SWIFT IV 1.6	M16A	05/06 →
SWIFT IV 1.6 4x4	M16A	02/05 →
IGNIS I 1.3	M13A	10/00 → 09/03
IGNIS I 1.3 4WD	M13A	10/00 → 09/03
IGNIS I 1.5 Sport	M15A	12/03 → 12/05
JIMNY III 1.3 4WD	M13A	03/13 →
LIANA 1.3	M13A	07/01 →
LIANA 1.6	M16A	07/01 →
LIANA 1.6 4WD	M16A	07/01 →
LIANA 1.6 i	M16A	04/02 →
LIANA 1.8 i	M18A	10/01 →
SX4 I 1.5	M15A	06/06 → 07/10
SX4 I 1.5 VVT	M15A	07/10 →
SX4 I 1.5 VVT 4x4	M15A	07/10 →
SX4 I 1.5 VVTi	M15A	07/07 → 12/15
SX4 I 1.6	M16A	10/07 →
SX4 I 1.6 AWD	M16A	10/07 →
SX4 I 1.6 LPG	M16A	06/06 → 12/12
SX4 I 1.6 VVT	M16A	06/06 →
SX4 I 1.6 VVT 4x4	M16A	06/06 →
WAGON R+ II 1.3	G13BB, M13A	05/00 →
WAGON R II 1.3	G13BB	04/99 → 10/00

KW 470 536



05,5

COILS

Adatt./Suitable:

LEXUS

90919-02258

TOYOTA

90919-02252

90919-02258

- NEW - ITEM NOW AVAILABLE FROM PRODUCTION

- NUOVO - ARTICOLO ORA DISPONIBILE PER LA VENDITA
- NOUVEAU - ARTICLE DISPONIBLE EN PRODUCTION COURANTE
- NEU - JETZT ZUM VERKAUF VERFÜGBARER ARTIKEL
- NUEVO - ARTICULO AHORA DISPONIBLE EN PRODUCCION

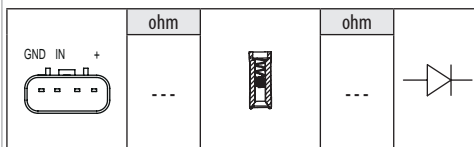

LEXUS

CT 200h	2ZR-FXE	12/10 →
NX 200	3ZR-FAE	11/14 →
NX 200 AWD	3ZR-FAE	11/14 →

TOYOTA

COROLLA X 1.6	1ZR-FAE, 1ZR-FE	11/06 → 11/13
COROLLA X 1.6 Dual VVTi	1ZR-FE	01/07 → 07/14
COROLLA X 1.6 VVTi	1ZR-FE	03/07 → 05/14
COROLLA X 1.8	2ZR-FAE, 2ZR-FE	09/06 →
COROLLA X 1.8 4WD	2ZR-FAE	09/06 →
COROLLA X 1.8 VVTi	2ZR-FBE, 2ZR-FE	08/10 →
COROLLA X 2.0	3ZR-FE	04/10 →
COROLLA X 2.0 FlexFuel	3ZR-FBE	04/10 →
COROLLA X 2.0 VVTi	3ZR-FE	08/10 →
AURIS I 1.6	1ZR-FAE, 1ZR-FE	03/07 → 09/12
AURIS I 1.8	2ZR-FAE, 2ZR-FE	10/06 → 09/12
AURIS I 1.8 4WD	2ZR-FAE	10/06 → 10/09
AURIS I 1.8 Hybrid	2ZR-FXE	09/10 → 09/12
AURIS II 1.6	1ZR-FAE	10/12 → 12/18
AURIS II 1.8 Hybrid	2ZR-FXE	10/12 → 12/18
AVENSIS III 1.6	1ZR-FAE	11/08 → 10/18
AVENSIS III 1.8	2ZR-FAE	11/08 → 10/18
AVENSIS III 2.0	3ZR-FAE, 3ZR-FE	11/08 → 10/18
C-HR 2.0	3ZR-FAE	11/16 →
COROLLA IX 1.6	1ZR-FE	11/06 → 07/07
COROLLA XI 1.6	1ZR-FAE, 1ZR-FE	06/13 → 12/18
COROLLA XI 1.6 BiFuel	1ZR-FE	06/13 →
COROLLA XI 1.8	2ZR-FAE	05/12 →
COROLLA XI 1.8 [USA] [CAN]	2ZR-FAE	08/13 →
COROLLA XI 1.8 VVTi	2ZR-FE	06/13 → 08/19
COROLLA XI 1.8 VVT-i	2ZR-FE	12/13 →
COROLLA XI 2.0 VVT-i CNG	3ZRFEENG	10/13 → 12/18
COROLLA 1.6 VVTi	1ZR-FAE, 1ZR-FE	01/19 →
MATRIX 1.8	2ZR-FE	01/08 → 05/14
RAV 4 IV 2.0	3ZR-FE	12/12 →
RAV 4 IV 2.0 4WD	3ZR-FAE, 3ZR-FE	12/12 →
PRIUS III 1.8 Hybrid	2ZR-FXE, 5ZR-FXE	06/08 →
PRIUS 1.8 Plug-In Hybrid	2ZR-FXE	01/12 →
PRIUS PLUS 1.8 Hybrid	2ZR-FXE	11/14 →
RAV 4 2.0 VVTi 4WD	3ZR-FAE	12/12 → 11/18
RAV 4 III 2.0	3ZR-FAE	12/08 → 06/13
RAV 4 III 2.0 4WD	3ZR-FAE	12/08 → 06/13
VERSO 1.6	1ZR-FAE	04/09 → 08/18
VERSO 1.8	2ZR-FAE	04/09 → 08/18
VERSO VVTi	1ZR-FAE, 2ZR-FAE	04/09 → 08/18
YARIS II 1.6 [CHN]	1ZR-FE	05/08 →
YARIS II 1.8 VVTi	2ZR-FE	01/07 → 12/11
YARIS III 1.8 GRMN	2ZR-FE	09/17 →

COILS

Adatt./Suitable:

ASTON MARTIN

9091902257

BOSCH

0 986 AGO 501

F 005 X11 797

DAIHATSU

90919-02257

DENSO

DIC-0132

DIC-0147

HITACHI

134038

2504038

LEXUS

90919-02250

90919-02256

90919-A2003

90919-A2005

90919-C2004

SUBARU

90919-02257

TOYOTA

90919-02250

90919-02256

90919-02257

90919-A2003

90919-A2005

90919-A2008

90919-C2004

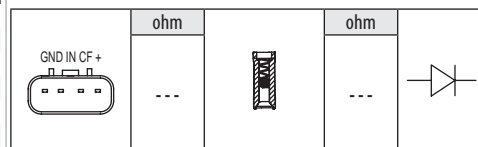

ASTON MARTIN

CYGNET 1.3	1NR-FE	04/11 → 10/13
------------	--------	---------------

DAIHATSU

CHARADEVI 1.33 16V	1NR-FE	05/11 →
--------------------	--------	---------

LEXUS

ES 200	6AR-FSE	08/15 →
ES 250	2AR-FE	06/12 → 06/18
ES 300h	2AR-FXE	06/12 → 06/18
GS 250	4GR-FSE	01/12 →
GS 3.5 450h	2GR-FXE	03/12 → 09/18
GS 3.5 VVTi	2GR-FSE	04/05 → 12/12
GS 300	3GR-FE, 3GR-FSE	04/05 → 11/11
GS 300h	2AR-FSE	10/13 →
GS 350	2GR-FSE	09/06 →
GS 350 AWD	2GR-FKS, 2GR-FSE	09/06 →
GS 450h	2GR-FSE, 2GR-FXE	02/06 →
GX 460 4WD	1UR-FE	01/10 →
IS II 250	4GR-FSE	08/05 →
IS II 250 AWD	4GR-FSE	10/05 → 03/13
IS II 350	2GR-FSE	01/08 →
IS III 250	4GR-FSE	04/13 →
IS III 300h	2AR-FSE	04/13 →
LS IV 460	1UR-FE, 1UR-FE-E4, 1UR-FE-E5, 1UR-FSE-E4, 1UR-FSE-E5	04/06 →
LS IV 460 4WD	1UR-FSE	08/06 →
LS IV 460 AWD	1UR-FE-E4, 1UR-FSE	12/08 →
LS IV 600h AWD	2UR-FSE, 2URFSE-E4, 2UR-FSE-E5	04/07 →
LX 570	3UR-FE	08/07 →
NX 300h	2AR-FXE	07/14 →
NX 300h AWD	2AR-FXE	07/14 →
RC 300h	2AR-FSE	09/14 →
RC 350	2GR-FSE	08/14 →
RX III 270	1AR-FE	12/08 → 10/15
RX III 450h AWD	2GR-FXE, 2GRFXE(299H)-E4	12/08 → 10/15

SUBARU

TREZIA 1.3	1NR-FE	03/11 →
------------	--------	---------

TOYOTA

COROLLA X 1.33	1NR-FE	12/08 → 07/14
AURIS I 1.33 Dual-VVTi	1NR-FE	05/09 → 09/12
AURIS II 1.3	1NR-FE	10/12 → 12/18

470 538

TOYOTA		
CAMRY 2.0	6ARFSE	12/14 →
CAMRY 2.5	2AR-FE	01/10 →
CAMRY 2.5 [CHN]	5AR-FE	12/11 →
CAMRY 2.5 Hybrid	2AR-FXE	09/11 →
CAMRY 2.5 Hybrid [CHN]	4AR-FXE	05/12 →
COROLLA XI 1.3	1NR-FE	05/12 →
LAND CRUISER 200 4.0	1GR-FE	01/10 →
LAND CRUISER 200 4.6 V8	1UR-FE	09/10 →
LAND CRUISER 200 5.7 V8	3UR-FE	08/07 →
FJ CRUISER 4.0	1GR-FE	06/05 → 06/14
FJ CRUISER 4.0 4WD	1GR-FE	06/05 → 01/18
HIGHLANDER / KLUGER 2.7	1AR-FE	09/16 →
IQ 1.33	1NR-FE	01/09 →
LAND CRUISER 4.0 V6 VVTi	1GR-FE	08/09 →
LAND CRUISER 150 4.0 V6 Dual VVTi	1GR-FE	08/09 →
LAND CRUISER 150 4.0 V6 VVTi	1GR-FE	08/09 →
LAND CRUISER 150 4.0 V6 VVT-i	1GR-FE	08/09 →
RAV 4 IV 2.5	2AR-FE	12/12 → 11/18
RAV 4 IV 2.5 4WD	2AR-FE	12/12 →
RAV 4 IV 2.5 Hybrid	2AR-FXE	10/15 → 11/18
RAV 4 IV 2.5 Hybrid 4WD	2AR-FXE	10/15 → 12/18
RAV 4 III 2.5	2AR-FE	12/08 →
SIENNA 2.7	1AR-FE	09/10 → 07/13
URBAN CRUISER 1.33	1NR-FE	01/09 → 03/16
VENZA 2.7	1AR-FE	11/08 → 11/16
VENZA 2.7 4WD	1AR-FE	11/08 → 11/16
VERSO S 1.33	1NR-FE	11/10 → 10/16
YARIS II 1.33 VVT-i	1NR-FE	11/08 → 12/11
YARIS III 1.3	1NR-FE	09/11 →
YARIS III 1.3 4WD	1NR-FE	12/10 →
YARIS III 1.3 VVTi	1NR-FE	10/12 →
YARIS III 1.5	2NR-FKE	03/17 →
YARIS III 1.5 VVTi	2NR-FKE	03/17 →

KW 470 538 05,5

COILS

Adatt./Suitable:

LEXUS

90919-02251
90919-02255
90919-A2004
90919-A2007

NEW - ITEM NOW AVAILABLE FROM PRODUCTION

- NUOVO - ARTICOLO ORA DISPONIBILE PER LA VENDITA
- NOUVEAU - ARTICLE DISPONIBLE EN PRODUCTION COURANTE
- NEU - JETZT ZUM VERKAUF VERFÜGBARER ARTIKEL
- NUEVO - ARTICULO AHORA DISPONIBLE EN PRODUCCION

TOYOTA

90919-02251
90919-02255
90919-A2002
90919-A2004
90919-A2007



	ohm		ohm	
	

LEXUS

ES 3.5	2GR-FE	05/06 → 06/12
ES 350	2GR-FE	06/12 → 06/18
RX II 350	2GR-FE	01/06 → 12/08
RX II 350 AWD	2GR-FE, 2GR-FE(276)	02/06 → 12/08
RX III 350	2GR-FE	01/09 → 09/15
RX III 350 AWD	2GR-FE	12/08 → 08/15
RX III 450h	2GR-FXE	12/08 → 10/15
RX III 450h AWD	2GR-FXE	12/08 → 10/15

TOYOTA

AURION 3.5	2GR-FE	03/06 →
CAMRY 3.5	2GR-FE	01/06 →
HIGHLANDER / KLUGER 3.5 AWD	2GR-FE, 2GR-FKS	09/14 →
RAV 4 III 3.5 AWD	2GR-FE	11/05 →
SIENNA 3.5	2GR-FE	01/10 →
SIENNA 3.5 4WD	2GR-FE	01/10 →
PREVIA III 3.5	2GR-FE	01/06 →

TOYOTA

PREVIA III 3.5 4WD	2GR-FE	01/06 →
VENZA 3.5	2GR-FE	11/08 → 11/16
VENZA 3.5 4WD	2GR-FE	11/08 → 11/16

KW 470 543 05,5

COILS

Adatt./Suitable:

BOSCH

0 986 221 063

HITACHI

134035
2504035

HYUNDAI

27301-2B010

KIA

27301-2B010



	ohm		ohm
	0,81		5640

HYUNDAI

ACCENT 1.4 CVVT	G4FA	11/10 →
CRETA 1.6	G4FG	01/16 →
CRETA 1.6 4WD	G4FG	08/16 →
ELANTRA V 1.6	G4FG	04/11 →
ACCENT IV 1.4	G4FA	11/10 →
ACCENT IV 1.6	G4FC	11/10 →
I20 I 1.4	G4FA	09/08 → 12/15
I20 I 1.4 LPG	G4FA	12/08 → 12/12
I20 I 1.6	G4FC	09/08 → 12/12
I30 I 1.4	G4FA	10/07 → 06/12
I30 I 1.4 LPG	G4FA	01/09 → 06/12
I30 I 1.6	G4FC	10/07 → 06/12
I30 II 1.4	G4FA, G4LC	12/11 →
I30 II 1.4 LPG	G4FA	01/13 →
I30 II 1.6	G4FC, G4FG	12/11 →
I30 II 1.6 MPI	G4FC	06/14 →
IX20 1.4	G4FA	11/10 →
IX20 1.4 LPG	G4FA	11/10 →
IX20 1.6	G4FC	11/10 →
IX20 1.6 LPG	G4FC	11/10 →
SB 11 1.4	--	01/11 →
SB 11 1.6	--	01/11 →
SOLARIS 1.4 16V	--	01/11 →
SOLARIS 1.4 VVTi	G4FA	11/10 →
SOLARIS 1.6	G4FG	01/17 →
SOLARIS 1.6 16V	--	01/11 →
VELOSTER 1.6	G4FG	06/11 →
VELOSTER 1.6 MPI	G4FC	04/11 → 12/17

KIA

CARENS II 1.6 CVVT	G4FC	08/09 →
CEED I 1.4	G4FA	12/06 → 12/12
CEED I 1.4 CVVT	G4FA, G4FA-L	07/09 → 12/12
CEED I 1.4 LPG	G4FA	01/09 → 04/12
CEED I 1.6	G4FC	12/06 → 12/12
CEED I 1.6 CVVT	G4FC	06/09 → 12/12
CEED I 1.6 LPG	G4FC	06/07 → 09/12
CEED II 1.4 CVVT	G4FA, G4FA-L	05/12 → 07/18
CEED II 1.4 LPG	G4FA	05/12 → 07/18
CEED II 1.6 CVVT	G4FC	05/12 →
CEED III 1.6	G4FG	03/18 →
CERATO I 1.6	G4FC	05/06 →
CERATO II 1.6	G4FC	01/10 → 06/13
CERATO II 1.6 CVVT	G4FC	02/09 →
CERATO III 1.6	--	07/12 →
CERATO III 1.6 CVVT	G4FC	07/16 →
CERATO III 1.6 MPI	G4FG	06/13 →
FORTE 1.6	--	07/12 →
PRO CEE'D I 1.4	G4FA	02/08 → 09/12
PRO CEE'D I 1.4 CVVT	G4FA, G4FA-L	06/10 → 09/12

KIA

PRO CEE'D I 1.6	G4FC	02/08 → 09/12
PRO CEE'D I 1.6 CVVT	G4FC	02/08 → 02/13
PRO CEE'D II 1.4 CVVT	G4FA	03/13 → 07/18
PRO CEE'D II 1.4 MPI	G4LC	07/13 → 07/18
PRO CEE'D II 1.6 CVVT	G4FC	03/13 → 07/18
PRO CEE'D 1.4 CVVT	G4FA	05/12 → 07/18
RIO III 1.4 CVVT	G4FA	06/11 →
RIO III 1.6 CVVT	G4FC	06/12 → 12/17
RIO IV 1.6	G4FG	01/17 →
SOUL I 1.6	G4FC	09/09 → 12/14
SOUL I 1.6 CVVT	G4FC	02/09 → 12/14
SOUL I 1.6 Flex	--	01/11 →
SOUL I 1.6 LPG	G4FC	02/09 → 12/14
SOUL II 1.6 CVVT	G4FG	02/14 →
SOUL II 1.6 LPG	G4FG	12/14 →
SOUL III 1.6 MPI	G4FG	01/19 →
VENGA 1.4 CVVT	G4FA, G4FA-L	02/10 →
VENGA 1.4 LPG	G4FA	02/10 →
VENGA 1.6 CVVT	G4FC	02/10 →
VENGA CVVT	G4FA, G4FC	02/15 →

KW 470 545 08,6

COILS

Adatt./Suitable:

BOSCH

0 986 221 098
0 986 221 109

CHEVROLET

25186687
55561655
55584404
96476983

GENERAL MOTORS

25 186 687
55 561 655
55 584 404
96 476 983

OPEL

12 08 086
12 08 098
55561655
55584404

SIEMENS

5WK 9397

VAUXHALL

55561655
55584404

NEW - AVAILABLE FROM:

- NUOVO - DISPONIBILE DA:
- NOUVEAU - DISPONIBLE EN:
- NEU - VERFUEGBAR AB:
- NUEVO - DISPONIBLE EN:

22/04



	ohm		ohm	
	

CHEVROLET

AVEO II 1.6	LDE	03/11 →
CRUZE 1.6	LDE	06/11 →
TRAX 1.6	LDE	12/12 →
TRAX 1.8	2HO	03/13 →
TRAX 1.8 AWD	2HO	03/13 →

OPEL

ASTRA J 1.6	A16LET, A16XER, B16XER	12/09 →
ASTRA J 1.6 LPG	A16XER	10/12 → 10/15
ASTRA J 1.6 Turbo	A16LET	12/09 →
ASTRA J 1.8	A18XER	10/11 → 10/15
ZAFIRA TOURER 1.8	A18XEL, A18XER	10/11 →
ZAFIRA TOURER 1.8 LPG	A18XER	10/11 →
CORSA E 1.6 Turbo	B16LER, B16LES	03/15 →
INSIGNIA A 1.4	B18XER	04/11 →
INSIGNIA A 1.6	A16XER	07/08 → 03/17
INSIGNIA A 1.8	A18XER, B18XER	07/08 → 03/17
MOKKA 1.6	A16XER, B16XER, D16XER	06/12 →
MOKKA 1.8	A18XER	01/13 →
MOKKA 1.8 4x4	A18XER	01/13 →
ZAFIRA B 1.8	A18XEL	06/13 → 04/15

VAUXHALL

ASTRA V 1.6	A16XER	08/04 → 03/11
-------------	--------	---------------

VAUXHALL		
ASTRA V 1.8	A18XER	12/05 → 10/10
ASTRA VI 1.6	A16LET, A16XER, B16XER	12/09 → 10/15
ASTRA VI 1.6 Turbo	A16LET	12/09 → 10/15
CORSA E 1.6 VXR	B16LES	04/15 →
INSIGNIA 1.6	A16XER	07/08 → 05/17
INSIGNIA 1.8	A18XER, B18XER	07/08 → 05/17
MOKKA / MOKKA X 1.6	A16XER, B16XER, D16XER	06/12 →
ZAFIRA B 1.8	A18XEL	04/13 → 11/14
ZAFIRA C 1.8	A18XEL, A18XER	10/11 →

KW 470 547  **08,5**

COILS

Adatt./Suitable:

BOSCH
0 221 503 800
0 986 221 096

CHEVROLET
25195107
25198623
25200553
55575499
55577898
55579072
95528319

GENERAL MOTORS

25 195 107
25 198 623
55 573 735
55 575 499
55 577 898
55 579 072
95 528 319

HITACHI
134048
2504048

MAGNETI MARELLI
060717137012

OPEL
12 08 092
12 08 093
12 08 096
12 08 123
25195107
25198623
55573735
55577898
55579072
95528319

VAUXHALL
25195107
25198623
55573735
55577898
55579072
95528319

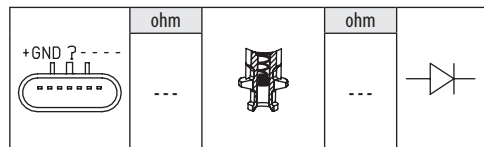

CHEVROLET		
AVEO I 1.4	A14XER	04/08 →
AVEO II 1.2	LDC, LWD	03/11 →
AVEO II 1.2 LPG	LDC	11/12 → 12/15
AVEO II 1.4	LDD	03/11 →
AVEO II 1.4 Turbo	A14NET	08/13 →
CRUZE 1.4	A14NET, A14XER, LDD, LUJ	09/10 →
ORLANDO 1.4	LUJ	06/12 →
TRAX 1.4	A14NET	12/12 →
TRAX 1.4 AWD	A14NET	12/12 →
TRAX 1.4 LPG	A14NET	04/13 →
VOLT EV 150	LUU	11/11 →

OPEL		
ADAM 1.2	A12XEL, B12XEL, D12XEL	10/12 → 02/19
ADAM 1.4	A14XEL, A14XER, B14XEL, B14XER, D14XEL, D14XER	10/12 → 02/19
ADAM 1.4 LPG	A14XEL, B14XEL, D14XEL	07/13 → 11/18
ADAM 1.4 S	B14NEH, D14NEH	11/14 → 01/19
AMPERA EV 150	A14XFL	11/11 → 03/15
ASTRA J 1.4	A14NEL, A14NET, A14XEL, A14XER, B14NEL, B14NET, B14XER	12/09 →
ASTRA J 1.4 LPG	A14NET	12/11 →

OPEL		
ASTRA J 1.4 Turbo	A14NEL, A14NET, B14NEL, B14NET	12/09 →
ZAFIRA TOURER 1.4	A14NEL, A14NET, B14NEL, B14NET	10/11 →
ZAFIRA TOURER 1.4 LPG	A14NET, B14NET	10/11 →
CASCADA 1.4	A14NEL, B14NEL	03/13 →
CASCADA 1.4 Turbo	A14NET, B14NET	03/13 →
CORSA D 1.2	A12XEL, A12XER	12/09 → 08/14
CORSA D 1.2 LPG	A12XER	06/11 → 08/14
CORSA D 1.4	A14NEL, A14XEL, A14XER	09/09 → 08/14
CORSA D 1.4 LPG	A14XEL	09/09 → 08/14
CORSA E 1.2	B12XEL	09/14 →
CORSA E 1.4	B14XEJ, B14XEL, D14XEL	09/14 →
CORSA E 1.4 LPG	B14XEL	03/15 →
CORSA E 1.4 Turbo	B14NEH, B14NEJ, D14NEH, D14NEJ	09/14 →
INSIGNIA A 1.4	A14NET, B14NET	04/11 → 03/17
INSIGNIA A 1.4 LPG	A14NET, B14NET	07/12 → 03/17
MERIVA B 1.4	A14NEL, A14NET, A14XER, B14NEL, B14NET, B14XER	06/10 → 03/17
MERIVA B 1.4 LPG	A14NEL, B14NEL	06/11 → 03/17
MERIVA 1.4 ECOTEC	A14XER	01/13 → 03/17
MOKKA 1.4	A14NET, B14NET, D14NET	04/13 →
MOKKA 1.4 4x4	A14NET, B14NET, D14NET	06/12 →
MOKKA 1.4 LPG	A14NET, B14NET, D14NET	04/13 →

VAUXHALL		
ADAM 1.2	A12XEL, B12XEL, D12XEL	10/12 → 04/19
ADAM 1.4	A14XEL, A14XER, B14XEL, B14XER, D14XEL	10/12 → 02/19
ADAM 1.4 LPG	A14XEL	07/13 →
ADAM 1.4 S	B14NEH	11/14 → 01/19
AMPERA EV 150	4ET50, A14XFL	03/12 →
CASCADA 1.4	A14NEL, A14NET, B14NET	02/13 →
ASTRA VI 1.4	A14NEL, A14NET, A14XEL, A14XER, B14NEL, B14NET, B14XER	12/09 → 10/15
ASTRA VI 1.4 Turbo	A14NEL, A14NET, B14NET	12/09 →
CORSA D 1.2	A12XEL	06/10 → 08/14
CORSA D 1.2 i 16V	A12XER	12/09 → 08/14
CORSA D 1.2 LPG	A12XER	06/11 → 08/14
CORSA D 1.4	A14NEL, A14XEL, A14XER	09/09 → 08/14
CORSA D 1.4 LPG	A14XEL	09/09 → 08/14
CORSA E 1.2	B12XEL	08/14 →
CORSA E 1.4	B14NEH, B14XEJ, B14XEL, B14NEJ, D14NEJ, D14XEL	08/14 →
CORSA E 1.4 LPG	B14XEL	08/14 →
CORSAVAN III 1.2	A12XEL	01/10 →
CORSAVAN IV 1.2	B12XEL	10/14 →
CORSAVAN IV 1.4	B14XEJ	10/14 →
INSIGNIA 1.4	A14NET, B14NET	04/11 → 05/17
INSIGNIA 1.4 LPG	A14NET	07/12 → 05/17
MERIVA II 1.4	A14NEL, A14NET, A14XER, B14NEL, B14NET, B14XER	06/10 →
MERIVA II 1.4 LPG	A14NEL, B14NEL	06/11 →
MOKKA / MOKKA X 1.4	A14NET, B14NET, D14NET	04/13 →
MOKKA / MOKKA X 1.4 4x4	A14NET, B14NET, D14NET	06/12 →
ZAFIRA C 1.4	A14NEL, A14NET, B14NET	10/11 → 08/18
ZAFIRA C 1.4 LPG	A14NET	10/11 → 08/18

KW 470 549  **05,5**

COILS
Adatt./Suitable:

ABARTH
55224110
55229959

ALFA ROMEO
46337742
55214926
55224110
55229959
55263679
55267630
55270217

BOSCH
0 221 504 026
0 221 504 036

CHRYSLER
55214926
55229959

FIAT
46337742
55214926
55224110
55229959
55263679
55270217

JEEP
46337742
55224110
55229959
55263679
55270217
68298269AA
K68298228AA
K68298269AA
K68436928AA

LANCIA
55214926
55229959

MAGNETI MARELLI
060810224010

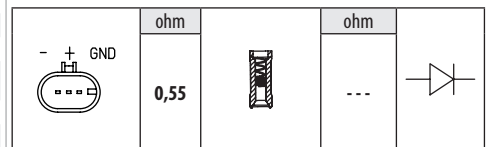

ABARTH		
PUNTO 1.4	955A8.000	03/12 →
PUNTO 1.4 SUPERSPORT	199A8.000, 955A8.000	03/12 →
PUNTO EVO 1.4	955A8.000	10/09 → 02/12
ALFA ROMEO		
159 1.8 Tbi	939B1.000	05/09 → 12/12
4C 1.8	960A1.000	03/13 → 12/20
BRERA 1.8 Tbi	939B1.000	05/09 → 06/10
GIULIETTA II 1.4	940A2.000	04/11 → 12/20
GIULIETTA II 1.4 TB	940A2.000, 940C2.000, 955A8.000	04/10 → 10/18
GIULIETTA II 1.8	940A1.000	04/11 → 02/16
GIULIETTA II 1.8 Tbi	940A1.000, 940B2.000, 960A1.000	04/10 → 10/18
MITO 1.4 MultiAir	940A2.000	09/09 → 10/18
MITO 1.4 TB	955B1.000	12/13 → 10/18
MITO 1.4 Turbo MultiAir	955A2.000, 955A7.000, 955A8.000	10/09 → 10/18
SPIDER III 1.8 Tbi	939B1.000	05/09 → 03/11

CHRYSLER		
DELTA 1.4 16V	198A7.000	08/11 →

FIAT		
PUNTO III EVO 1.4 16V	955A2.000	10/09 → 02/12
PUNTO III 1.4 Turbo Multi Air	955A2.000	03/12 →
500X 1.4	55263624	09/14 →
500X 1.4 4x4	55263623	02/15 →
500X 1.4 LPG	55277701	03/17 →
BRAVO II 1.4 16V	-, 198A7.000	04/07 →

JEEP		
COMPASS 1.4 MultiAir	EAQ(55263624)	03/17 →
COMPASS 1.4 MultiAir Trazione integrale	EAQ(55263623)	03/17 →
RENEGADE 1.4	55263624, EAM, EAM(55263624)	07/14 →
RENEGADE 1.4 4x4	EAM, EAM(55263623)	07/14 →

LANCIA		
DELTA III 1.4 16V	198A7.000	07/10 → 08/14
DELTA III 1.8	939B1.000	01/09 → 08/14

KW 470 551  **05,5**

COILS

Adatt./Suitable:

HITACHI
133929
2503929

NISSAN
22448-1KCOA

RENAULT
22 44 81K COA

NEW - ITEM NOW AVAILABLE FROM PRODUCTION

- NUOVO - ARTICOLO ORA DISPONIBILE PER LA VENDITA
- NOUVEAU - ARTICLE DISPONIBLE EN PRODUCTION COURANTE
- NEU - JEITZ ZUM VERKAUF VERFÜGBARER ARTIKEL
- NUEVO - ARTICULO AHORA DISPONIBLE EN PRODUCCION

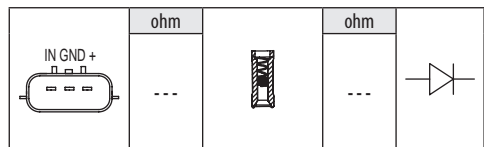
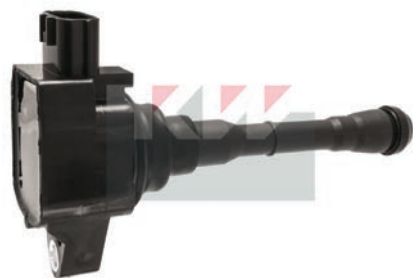

NISSAN

JUKE I 1.6	MR16DDT	03/13 →
JUKE I 1.6 DIG-T	MR16DDT	06/10 →
JUKE I 1.6 DIG-T 4x4	MR16DDT	06/10 →
JUKE I 1.6 DIG-T NISMO	MR16DDT	03/13 → 07/14
JUKE I 1.6 DIG-T NISMO 4x4	MR16DDT	02/13 → 07/14
JUKE I 1.6 DIG-T NISMO RS	MR16DDT	08/14 →
JUKE I 1.6 DIG-T NISMO RS 4x4	MR16DDT	08/14 →
X-TRAIL III 1.6 DIG-T	MR16DDT	06/15 →
X-TRAIL III 2.0	MR20DD	09/14 →
X-TRAIL III 2.0 ALL MODE 4x4-i	MR20DD	09/14 →
PULSAR 1.6 DIG-T	MR16DDT	02/15 →
SENTRA VII 1.6 DIG-T	MR16DDT	07/12 →
SYLPHY III 1.6 DIG-T	MR16DDT	07/12 →
QASHQAI II 1.6 DIG-T	MR16DDT	10/14 →
QASHQAI II 2.0	MR20DD	06/14 →
QASHQAI II 2.0 ALL MODE 4x4-i	MR20DD	10/15 →
TIIDA II 1.6	MR16DDT	02/13 →
TIIDA II 1.6 DIG-T	MR16DDT	08/11 →
X-TRAIL 2.0	MR20DD	12/14 →
X-TRAIL 2.0 ALL MODE 4x4-i	MR20DD	12/14 →

RENAULT

CLIO IV 1.6 RS	M5M400, M5M401	03/13 →
CLIO IV 1.6 RS Trophy	M5M401	03/15 →
MEGANE IV 1.6 Tce 165	M5M450	07/17 →
MEGANE IV 1.6 Tce 205	M5M450	11/15 →
MEGANE IV 1.8 RS 300	M5P404	09/18 →
MEGANE IV 1.8 RS Tce 280	M5P402, M5P404	10/17 →
ESPACEV 1.6 Tce 200	M5M450	02/15 →
ESPACEV 1.8 Tce 225	5T2175X15DYA, M5P403	10/16 →
KADJAR 1.6 Tce 165	M5M460	11/16 →
KOLEOS 2.0 Tce	M5R402	08/16 →
LATITUDE 1.6 RS	M5M400	04/14 →
TALISMAN 1.6 Tce 150	M5M450	11/15 →
TALISMAN 1.6 Tce 200	M5M450	11/15 →
TALISMAN 1.8 Tce 225	M5P403	09/18 →

KW 470 552  **05,5**

COILS

Adatt./Suitable:

BOSCH
0 986 221 090

DACIA
22 43 327 34R

HITACHI
133901
2503901

INFINITI
22448-JA00C

MAGNETI MARELLI
060717203012

NISSAN
22448-1KTOA
22448-1KT1A
22448-3RCOA
22448-ED000
22448-JA00A
22448-JA00C

RENAULT
22 43 327 34R
22 43 392 77R
22 44 81K TOA
22 44 83R COA
22 44 8JA 00C

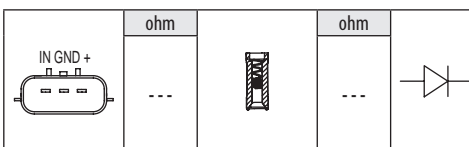

DACIA

DUSTER 1.0 LPG	H4D450, H4D460	01/19 →
DUSTER 1.0 Tce 100	H4D450, H4D460	01/19 →
DUSTER 1.0 Tce 100 4x4	H4D450, H4D460	01/19 →
DUSTER 1.0 Tce 90	H4D470	05/21 →
LOGAN II MCV 1.0 LPG	H4D450, H4D460	11/19 →
LOGAN II MCV 1.0 Tce 100	H4D450, H4D460	11/19 →
SANDERO II 1.0 LPG	H4D450, H4D460	11/19 →
SANDERO II 1.0 Tce 100	H4D450, H4D460	11/19 →
SANDERO II 1.0 Tce 90 GPF	H4D470	01/21 →
SANDERO 1.0 Tce 100	H4D480	01/21 →
SANDERO 1.0 Tce 100 ECO-G	H4D480	01/21 →
SANDERO 1.0 Tce 90	H4D470	01/21 →
SANDERO 1.0 Tce 90 ECO-G	H4D470	01/21 →

INFINITI

FX 50 AWD	VK50VE	10/08 →
M 56	VK56VD	03/10 →
M 56 X	VK56VD	03/10 →
Q70 5.6 AWD	VK56VD	01/15 →
QX70 50 AWD	VK50VE	08/13 →

NISSAN

CUBE 1.6 16V	HR16DE	08/09 →
FRONTIER 2.5 i	QR25DE	11/14 →
JUKE I 1.5	HR15DE	10/13 →
JUKE I 1.6	HR16DE	06/10 →
JUKE I 1.6 CVTC	HR16DE	08/14 →
JUKE I 1.6 LPG	HR16DE	01/12 →
JUKE I CVTC	HR16DE	03/13 →
MICRA IV 1.2	HR12DE	05/10 →
MICRA IV 1.2 4WD	HR12DE	05/10 →
MICRA IV 1.2 LPG	HR12DE	05/10 → 09/15
X-TRAIL III 2.5	QR25DE	12/13 →
X-TRAIL III 2.5 ALL MODE 4x4-i	QR25DE	12/13 →
MURANO III 2.5 HEV ALL MODE 4x4-i	QR25DER	01/16 →
NAVARA III 2.5	QR25DE	07/14 →
NAVARA III 2.5 DDTi	YD25DDTi	01/15 →
NOTE II 1.2	HR12DE	06/13 →
NOTE II 1.2 4WD	HR12DE	06/13 →
NOTE II 1.2 LPG	HR12DE	03/15 →
ALMERA III 1.2 i	HR12DE	09/11 →
NP300 2.5 i	QR25DE	06/14 →
NV200 / EVALIA 2.0	MR20DE	07/10 →
QASHQAI / QASHQAI +2.2.0	MR20DE	03/13 → 04/14

NISSAN

QASHQAI / QASHQAI +2.2.0 Trazione integrale	MR20DE	03/13 → 04/14
QASHQAI I 1.6 LPG	HR16DE	11/10 → 12/13
QASHQAI I 2.0	MR20DE	02/07 → 04/14
QASHQAI I 2.0 Trazione integrale	MR20DE	02/07 → 04/14
SENTRA VII 1.8	MRA8DE	08/12 →
SENTRA VII 1.8 [TWN]	MRA8DE	08/13 →
SENTRA VII 1.8 i	MRA8DE	07/12 →
SYLPHY III 1.8	MRA8DE	08/12 →
TEANA II 2.5 FOUR Trazione integrale	QR25DE	06/08 → 12/12
TEANA III 2.5	QR25DE	09/13 →
TIIDA II 1.6 [RUS]	HR16DE	01/15 →
TIIDA II 1.6 CVTC	HR16DE	08/12 →
TIIDA II 1.8	MRA8DE	08/12 →
PATHFINDER IV 2.5 Hybrid	QR25DER	10/13 →
PATHFINDER IV 2.5 Hybrid 4WD	QR25DER	10/13 →
X-TRAIL 2.5 ALL MODE 4x4-i	QR25DE	04/16 →
X-TRAIL II 2.5	QR25DE	09/07 → 11/13
X-TRAIL II 2.5 4x4	QR25DE	06/07 → 07/14

RENAULT

CAPTUR 1.0 Tce 90 ECO-G	H4D470	01/21 →
CAPTUR LPG	H4D460	01/20 →
CAPTUR Tce 100	H4D450	01/20 →
CAPTUR Tce 90	H4D470	09/20 →
CLIO V 1.0 LPG	H4D450, H4D452, H4D460	06/19 →
CLIO V 1.0 Tce 100	H4D450, H4D452, H4D460	06/19 →
CLIO V Tce 90	H4D450, H4D470	08/20 →
FLUENCE 1.6	H4M729	01/13 →
KOLEOS 2.5	2TR700, 2TR701, 2TR703, 2TR705, 2TR702	09/08 →
KOLEOS 2.5 4x4	2TR700, 2TR701, 2TR703, 2TR705, 2TR702	09/08 →
KOLEOS 2.5 Sce 4WD	2TR707	08/16 →
TWINGO III 0.9 Tce 95	H4B453	03/19 →

KW 470 556  **05,5**

COILS

Adatt./Suitable:

BOSCH
0 986 221 114

HYUNDAI
27300-3F100

KIA
27300-3F100

MAGNETI MARELLI
060717149012

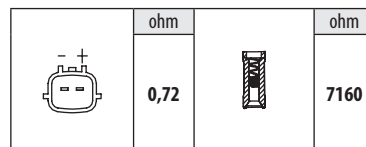

HYUNDAI

AZERA (USA) 2.4	--	09/10 →
EQUUS / CENTENNIAL II 4.6 V8	G8BA	03/09 →
GENESIS 2.0	G4KF	01/13 →
GENESIS 2.0 CVVT	G4KF	06/08 → 02/14
GENESIS 2.0T	G4KF	01/08 → 12/14
GENESIS 2.0Tci	--	01/11 →
GRANDEUR 2.4	G4KE	07/11 →
H-1 II 2.4	--, G4KC	02/08 →
H-1 II 2.4 i	G4KC	02/08 →
H1 2.4 CVVT	G4KC	01/10 →
IX35 2.0	G4KD	01/10 →
IX35 2.0 4WD	G4KD	01/10 →
IX35 2.0 CVVT	G4KD	08/09 → 07/13
IX35 2.0 CVVT AWD	G4KD	08/09 → 07/13

HYUNDAI			
IX35 2.4 DCVVT-I 4WD	G4KE	07/10	⇒ 12/13
IX35 2.4 GDI 4WD	G4KJ	01/13	⇒
NF 2.0 CVVT	G4BPE	05/05	⇒ 12/10
SANTA FE II 2.4	G4KE	11/10	⇒ 12/12
SANTA FE II 2.4 4x4	G4KE	07/10	⇒ 12/12
SANTA FE III 2.4	G4KJ	09/12	⇒ 12/15
SANTA FE III 2.4 4WD	G4KJ	09/12	⇒
SANTA FE III 2.4 CCVT	G4KE	09/12	⇒
SANTA FE III 2.4 CCVT AWD	G4KE	09/12	⇒
SANTA FE III 2.4 GDI 4WD	G4KJ	05/15	⇒
SANTA FE IV 2.4 AWD	G4KE	07/18	⇒
SANTA FE IV 2.4 GDI AWD	G4KJ	07/18	⇒
SONATA V 2.0 GLSI	G4KD	07/08	⇒ 12/10
SONATA V 2.0 VVTi GLS	G4KA, G4KD	05/05	⇒ 12/10
SONATA V 2.4	G4KC, G4KE	01/05	⇒ 12/10
SONATA VI 2.0	G4KD	06/09	⇒ 06/14
SONATA VI 2.0 i	G4KD	01/11	⇒ 06/14
SONATA VI 2.4	G4KC	06/09	⇒ 12/15

KIA			
BORREGO 4.6	G8BA	09/08	⇒ 12/11
CERATO II 1.6	G4FC	01/10	⇒
CERATO II 2.0	G4KD	01/09	⇒
CERATO II 2.0 CVVT	G4KD	01/09	⇒
CERATO 2.0 CVVT	G4KD	07/09	⇒ 02/14
MOHAVE 4.6	--	09/08	⇒
OPTIMA III 2.0	--	03/10	⇒
OPTIMA III 2.0 CVVL	G4KD	03/12	⇒
OPTIMA III 2.0 CVVT	G4KD	01/11	⇒ 12/15
OPTIMA III 2.4	--, G4KC, G4KE, G4KJ	03/10	⇒
OPTIMA III 2.4 CVVT	G4KE, G4KJ	01/12	⇒
OPTIMA III 2.4 Hybrid	G4KC	09/11	⇒
OPTIMA IV 2.4 MPi	G4KE	09/15	⇒
QUORIS 5.0 GDI	G8BE	05/15	⇒
MAGENTIS II 2.0	G4KD	09/09	⇒ 12/10
SORENTO II 2.4 CVVT	G4KE, G4KJ	11/09	⇒ 12/15
SORENTO II 2.4 CVVT 4WD	G4KE, G4KJ	11/09	⇒ 12/15
SORENTO II 2.4 GDI	G4KJ	10/12	⇒ 12/15
SORENTO II 2.4 GDI 4WD	G4KJ	10/12	⇒ 12/15
SORENTO II 2.4 LPG	G4KE	04/10	⇒ 12/15
SORENTO II 2.4 LPG 4WD	G4KE	04/10	⇒ 12/15
SORENTO II CVVT	G4KE	06/09	⇒ 12/15
SORENTO II CVVT 4WD	G4KE	06/09	⇒ 12/15
SPORTAGE III 2.0 CVVT	G4KD	06/10	⇒
SPORTAGE III 2.0 CVVT AWD	G4KD, G4NC	06/10	⇒
SPORTAGE III 2.4 i 4WD	G4KE	08/10	⇒

KW 470 557

05,5

COILS

Adatt./Suitable:

BOSCH
0 986 221 001
0 986 22A 000

HITACHI
133860
2503860

NISSAN
22448-6N000
22448-6N002
22448-6N010
22448-6N011
22448-6N012
22448-6N015
22448-95FOA

*3 Supplied until depletion

- Fornibile fino ad esaurimento delle scorte
- Fourni jusqu'à épuisement du stock
- Lieferbar solange vorrat reicht
- Suministrado hasta el stock termina



	ohm		ohm

NISSAN

ALMERA I 1.8	QG18DE	07/95	⇒ 05/00
ALMERA II 1.5	QG15DE	03/00	⇒
ALMERA II 1.5 XL	QG15DE	03/01	⇒
ALMERA II 1.8	QG18DE	01/00	⇒

NISSAN			
ALMERA III 1.5	QG15DE	01/06	⇒
ALMERA III 1.6	QG16	01/06	⇒
ALMERA III 1.6 16V	QG16, QG16DE	03/06	⇒
ALMERA TINO 1.8	QG18DE	08/00	⇒ 02/06
PRIMERA II 1.6 16V	QG16DE	06/96	⇒ 07/02
PRIMERA II 1.6 16V LPG	QG16DE	09/00	⇒ 07/02
PRIMERA II 1.8 16V	QG18DE	08/99	⇒ 07/02
PRIMERA II 1.8 16V LPG	QG18DE	08/99	⇒ 12/01
PRIMERA 1.6 LPG	QG16DE	09/96	⇒ 07/02
PRIMERA 1.8 LPG	QG18DE	08/99	⇒ 07/02
PRIMERA III 1.6	QG16DE	01/02	⇒ 08/08
PRIMERA III 1.6 Visia	QG16DE	01/02	⇒ 04/06
PRIMERA III 1.8	QG18DE	03/02	⇒ 10/08
PRIMERA III 1.8 LPG	QG18DE	03/02	⇒

KW 470 570

07,5

COILS

Adatt./Suitable:

BOSCH
0 986 22A 207

FIAT
71742420

HITACHI
2503947

MAGNETI MARELLI
060717159012

SUBARU
33400-62J00
33400-83E10

SUZUKI
33400-62J00
33400-62J00-000
33400-83E10
33400-83E10-000
33400M79F00
33400M79F00-000
33400M83E10
33400M83E10-000



	ohm		ohm
	...		9000

FIAT

SEDICI 1.6 16V	M16A	06/06	⇒ 10/14
SEDICI 1.6 16V 4x4	M16A	06/06	⇒ 10/14

SUBARU

JUSTY II 1.3 4x4	G13BB	04/01	⇒ 11/03
JUSTY III 1.3 AWD	M13A	09/03	⇒
JUSTY III 1.5 AWD	M15A	09/03	⇒

SUZUKI

ALTO VI 1.1	F10DN	09/04	⇒ 12/08
SWIFT IV 1.3	M13A	02/05	⇒
SWIFT IV 1.3 4x4	M13A	02/05	⇒
SWIFT IV 1.3 LPG	M13A	09/08	⇒ 12/10
SWIFT IV 1.5	M15A	02/05	⇒
SWIFT IV 1.6	M16A	05/06	⇒
IGNIS II 1.3	M13A	09/03	⇒
IGNIS II 1.3 4x4	M13A	09/03	⇒
IGNIS II 1.5	M15A	09/03	⇒
IGNIS II 1.5 4x4	M15A	09/03	⇒
WAGON R III 1.3	M13A	09/03	⇒ 12/10
SX4 I 1.5	M15A	06/06	⇒ 07/10
SX4 I 1.5 VVT	M15A	07/10	⇒
SX4 I 1.5 VVT 4x4	M15A	07/10	⇒
SX4 I 1.5 VVTi	M15A	07/07	⇒ 12/15
SX4 I 1.6	M16A	06/06	⇒
SX4 I 1.6 AWD	M16A	10/07	⇒ 12/11
SX4 I 1.6 VVT	M16A	06/06	⇒
SX4 I 1.6 VVT 4x4	M16A	06/06	⇒
WAGON R+ II 1.3	G13BB, M13A	05/00	⇒
WAGON R+ II 1.3 4WD	G13BB, M13A	10/01	⇒

SUZUKI			
WAGON R II 1.3	G13BB	04/99	⇒ 10/00

KW 470 579

05

COILS

Adatt./Suitable:

HITACHI

138856

2508856

HYUNDAI

27301-03000 *5

27301-03010 *5

27301-03015 *5

27310-03035 *5

27310-03010

27310-03020

27310-37110

KIA

27301-03010 *5

27301-03100 *5

27310-03010

27310-03020

*5 Supplied single coil only, without fastening clamp

- Fornita bobina singola senza staffa
- Fourni seulement la bobine individuelle, sans étrier
- Nur Zündspule geliefert, ohne Befestigungsbügel
- Suministrada solamente la bobina individual, sin brida

470 579



	ohm		ohm
	0,9		13200

HYUNDAI

I20 II 1.2	G4LA	11/14	⇒
I20 II 1.2 LPGI	G4LA	11/14	⇒
I20 II 1.2 MPI	G4LA	05/15	⇒
I10 I 1.2	G4LA	11/08	⇒
I10 I 1.2 LPG	G4LA	01/10	⇒ 12/13
I10 II 1.2	G4LA	12/13	⇒
I20 I 1.2	G4AG, G4LA	09/08	⇒ 12/15
I20 I 1.2 LPG	G4LA	01/09	⇒ 08/14
SANTA FE 1.2.7 V6 4x4	G6BA, G6BA-G	02/01	⇒ 03/06

KIA

PICANTO II 1.2	G4LA	09/11	⇒ 03/17
RIO III 1.2	G4LA	09/11	⇒ 12/17
RIO III 1.2 CVVT	G4LA	11/14	⇒ 12/17
RIO III 1.25 CVVT	G4LA	06/11	⇒ 12/17
RIO III 1.25 LPG	G4LA	09/11	⇒ 12/17

KW 470 580



05

COILS

Adatt./Suitable:

HYUNDAI
27310-02610
27310-37130
KIA
27310-02610



	ohm		ohm
	1,05	Ø 8.2	13200

470 589		
470 580	470 587	470 589

HYUNDAI		
SANTA FE I 2.7 4x4	G6BA	09/02 ⇨ 12/04
SANTA FE I 2.7 V6 4x4	G6BA, G6BA-G	02/01 ⇨ 03/06
KIA		
PICANTO I 1.0	--, G4HE	04/04 ⇨
PICANTO I 1.0 LPG	G4HE	01/09 ⇨ 04/11
PICANTO I 1.1	--, G4HG	04/04 ⇨
PICANTO I 1.1 LPG	G4HG	01/09 ⇨ 04/11

KW 470 581



05

COILS

Adatt./Suitable:

BOSCH
0 986 221 080
DENSO
DIC-0113
DIC-0114
HYUNDAI
27301-23700 *5
27301-23710 *5
27301-23900 *5
KIA
27301-23700 *5
27301-23710 *5
27301-23720 *5
27301-23900 *5

*5 Supplied single coil only, without fastening clamp

- Fornita bobina singola senza staffa
- Fourni seulement la bobine individuelle, sans étrier
- Nur Zündspule geliefert, ohne Befestigungsbügel
- Sumministrada solamente la bobina individual, sin brida

470 581

MAGNETI MARELLI
060717155012
060717172012

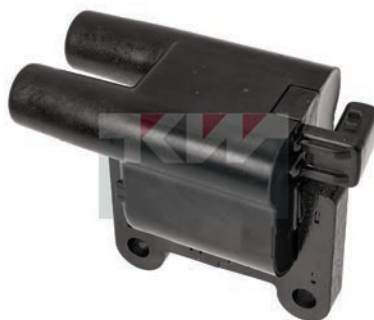

	ohm		ohm
	0,68	Ø 8.2	9200

HYUNDAI		
ELANTRA III 1.8	G4BB, G4GB	06/00 ⇨ 07/06
ELANTRA III 2.0	G4GC, G4GC-G	06/00 ⇨ 07/06
ELANTRA IV 2.0 CVVT	G4GC	06/06 ⇨ 06/11
I30 I 2.0	G4GC, G4GC-G	10/07 ⇨ 06/12
LANTRA 1.8	G4GB	06/00 ⇨
LANTRA 2.0	G4GC-G	06/00 ⇨
LAVITA 1.8	--	01/07 ⇨
MATRIX 1.8	G4GB, G4GB-G	06/01 ⇨ 08/10
MATRIX 1.8 [TUR]	G4GB	04/08 ⇨
SONATA V 2.0 i [RUS]	--	04/06 ⇨ 12/10
COUPE II 2.0	G4GC, G4GC-G	08/01 ⇨ 08/09
COUPE II 2.0 GLS	G4GC, G4GC-G	02/03 ⇨ 08/09
TRAJET 2.0	G4GC, G4GC-G, G4JP-G	03/00 ⇨ 07/08
TRAJET 2.0 CRDi	D4EA	08/05 ⇨ 07/08
TRAJET CVVT	G4GC	01/04 ⇨ 07/08
TUCSON 2.0	G4GC	08/04 ⇨
TUCSON 2.0 LPG	G4GC	06/04 ⇨ 03/10
TUCSON 2.0 LPG Trazione integrale	G4GC	06/09 ⇨ 03/10
TUCSON 2.0 Trazione integrale	G4GC	08/04 ⇨ 11/10
TUCSON CVVT	G4GC	06/04 ⇨ 03/10
KIA		
CARENS I 2.0 CVVT	G4GC	08/04 ⇨
CEED I 2.0	G4GC	12/06 ⇨ 12/12
CERATO I 2.0	G4GC	03/04 ⇨ 05/07
PRO CEE'D I 2.0	G4GC	02/08 ⇨ 09/12
PRO CEE'D I 2.0 LPG	G4GC	01/09 ⇨ 12/09
SPORTAGE II 2.0	G4KD	01/09 ⇨ 05/10
SPORTAGE II 2.0 16V 4WD	G4GC	09/04 ⇨
SPORTAGE II 2.0 i 16V	G4GC	09/04 ⇨
SPORTAGE II 2.0 LPG	G4GC	06/09 ⇨ 05/10
CERATO II 2.0 CVVT	--	01/09 ⇨

KW 470 582



05

COILS

Adatt./Suitable:

HYUNDAI
27310-22600
KIA
27310-22600



	ohm		ohm
	1,05	Ø 8.2	13200

470 585		
470 582	470 583	470 585

470 586		
470 582	470 584	470 586

HYUNDAI		
ACCENT II 1.3	G4EH	08/02 ⇨ 11/05
ACCENT II 1.5	G4EK	09/99 ⇨ 10/02
ACCENT II 1.6	G4ED-G	12/02 ⇨ 11/05
ELANTRA III 1.6	G4ED-G, G4GA	06/00 ⇨ 07/06
GETZ 1.3	G4EA	09/03 ⇨ 06/09
GETZ 1.3 i	G4EA	09/02 ⇨ 03/04
GETZ 1.4 i	G4EE	08/05 ⇨ 12/10
GETZ 1.6	G4ED, G4ED-G	09/02 ⇨ 06/09
LAVITA 1.6	--	01/07 ⇨
MATRIX 1.6	G4ED, G4ED-G, G4ED-L	06/01 ⇨ 08/10
MATRIX 1.6 [TUR]	G4ED	04/08 ⇨
ACCENT III 1.4 GL	G4EE	11/05 ⇨ 11/10
COUPE II 1.6 16V	G4ED-G	03/02 ⇨ 08/09
VERNA I 1.3	G4EA	09/99 ⇨
VERNA I 1.5	G4EB, G4EC-G	09/99 ⇨
VERNA I 1.6	G4ED-G	12/02 ⇨
VERNA II 1.4 GL	--	11/05 ⇨
VERNA II 1.6 GLS	--	11/05 ⇨
KIA		
RIO II 1.4	G4EE	01/10 ⇨ 12/11
RIO II 1.4 16V	G4EE	03/05 ⇨ 12/11

KW 470 583



05

COILS

Adatt./Suitable:

HYUNDAI
27310-22610
⁰³ Supplied until depletion

- Fornibile fino ad esaurimento delle scorte
- Fourni jusqu'à épuisement du stock
- Lieferbar solange vorrat reicht
- Suministrado hasta el stock termina



	ohm		ohm
	1,05	Ø 8.2	13200

470 585



HYUNDAI

ACCENT II 1.3	G4EA, G4EH	01/00 ⇒ 11/05
ACCENT II 1.5	G4EB, G4EK	01/00 ⇒ 12/06
GETZ 1.3	G4EA	09/03 ⇒ 06/09
GETZ 1.3 i	G4EA	09/02 ⇒ 03/04
VERNA I 1.3	G4EA	09/99 ⇒
VERNA I 1.5	G4EB	09/99 ⇒

KW 470 584



05

COILS

Adatt./Suitable:

HYUNDAI
27310-26600

KIA
27310-26600

	ohm		ohm
	1,05	Ø 8.2	13200

470 586



HYUNDAI

ACCENT II 1.5	G4FK	09/99 ⇒ 10/02
ACCENT II 1.6	G4ED-G	12/02 ⇒ 11/05
ELANTRA III 1.6	G4ED-G, G4GA	06/00 ⇒ 07/06
GETZ 1.4 i	G4EE	08/05 ⇒ 12/10
GETZ 1.6	G4ED, G4ED-G	09/02 ⇒ 06/09
LAVITA 1.6	--	01/07 ⇒
MATRIX 1.6	G4ED-G, G4ED-L	06/01 ⇒ 08/10
MATRIX 1.6 [TUR]	G4ED	04/08 ⇒
ACCENT III 1.4 GL	G4EE	11/05 ⇒ 11/10
COUPE II 1.6 16V	G4ED-G	03/02 ⇒ 08/09
VERNA I 1.5	G4EC-G	09/99 ⇒
VERNA I 1.6	G4ED-G	12/02 ⇒
VERNA II 1.4 GL	--	11/05 ⇒
VERNA II 1.6 GLS	--	11/05 ⇒

KIA

RIO II 1.4	G4EE	01/10 ⇒ 12/11
RIO II 1.4 16V	G4EE	03/05 ⇒ 12/11

KW 470 585



07

COILS

Adatt./Suitable:

CHEVROLET
96453420 *1

DAEWOO
96453420 *1

HYUNDAI
27301-22600 *1
^{*1} Without fastening clamp

- Senza staffa di fissaggio
- sans bride de fixation
- ohne Befestigungsbügel
- sin estribo de sujeción

²⁴⁵ without fastening clamp

- senza staffa fissaggio
- sans bride de fixation
- ohne Befestigungsbügel
- sin estribo de sujeción

470 582

470 583



CHEVROLET

LACETTI 1.4	F14D3	03/05 ⇒
LACETTI 1.4 16V	L14(85CUL4)	03/05 ⇒ 03/13
LACETTI 1.4 LPG	L14(85CUL4)	01/05 ⇒ 12/12
LACETTI 1.6	LXT	03/05 ⇒
LACETTI 1.6 LPG	LXT	06/09 ⇒ 12/11
LACETTI 1.8	LDA	03/05 ⇒
NUBIRA 1.4	L14(85CUL4)	01/05 ⇒ 12/08
NUBIRA 1.6	L44(96CUL4), LXT	03/05 ⇒
NUBIRA 1.6 LPG	L44(96CUL4), LXT	03/05 ⇒ 12/10
NUBIRA 1.8	LDA	03/05 ⇒ 12/11
OPTRA 1.4 16V	F14D3	03/05 ⇒
OPTRA 1.6	F16D3, LXT	08/03 ⇒ 12/08
OPTRA 1.6 SRV	F16D3	06/06 ⇒

DAEWOO

LACETTI 1.6	F16D3	02/04 ⇒
NUBIRA II 1.4	F14D3	10/03 ⇒ 12/04
NUBIRA II 1.6	F16D3	07/03 ⇒

HYUNDAI

ACCENT II 1.3	G4EA, G4EH	01/00 ⇒ 11/05
ACCENT II 1.5	G4EB, G4EC-G, G4EK, G4FK	01/00 ⇒ 12/06
GETZ 1.3	G4EA	09/04 ⇒ 06/09
VERNA I 1.3	G4EA	09/99 ⇒
VERNA I 1.5	G4EB	09/99 ⇒

KW 470 586



07

COILS

Adatt./Suitable:

HYUNDAI

27301-26600 *1

KIA

27301-26600 *1

*1 Without fastening clamp

- Senza staffa di fissaggio
- sans bride de fixation
- ohne Befestigungsbügel
- sin estribo de sujeción

245 without fastening clamp

- senza staffa fissaggio
- sans bride de fixation
- ohne Befestigungsbügel
- sin estribo de sujeción



470 582

470 584

HYUNDAI

ACCENT II 1.6	G4ED, G4ED-G	12/02 ⇨ 11/05
COUPE I 1.6 16V	G4GR	03/98 ⇨ 04/02
COUPE I 1.6 i 16V	4G61, G4GR	12/96 ⇨ 04/02
ELANTRA III 1.6	G4ED, G4ED-G, G4GA, G4GR	06/00 ⇨ 07/06
GETZ 1.6	G4ED-G	09/02 ⇨ 06/09
LAVITA 1.6	--	01/07 ⇨
MATRIX 1.6	G4ED-G, G4ED-L	06/01 ⇨ 08/10
MATRIX 1.6 [TUR]	G4ED	04/08 ⇨
COUPE II 1.6 16V	G4ED, G4ED-G	03/02 ⇨ 08/09
VERNA I 1.5	G4EC-G	09/99 ⇨
VERNA I 1.6	G4ED-G	12/02 ⇨
VERNA II 1.4 GL	--	11/05 ⇨
VERNA II 1.6 GLS	--	11/05 ⇨

KIA

CERATO I 1.6	G4ED	04/04 ⇨ 12/09
--------------	------	---------------

KW 470 587



05

COILS

Adatt./Suitable:

HYUNDAI

27301-02100 *5

27310-02611

27310-02612

27310-37120

KIA

27310-02611

*5 Supplied single coil only, without fastening clamp

- Fornita bobina singola senza staffa
- Fourni seulement la bobine individuelle, sans étrier
- Nur Zündspule geliefert, ohne Befestigungsbügel
- Suministrada solamente la bobina individual, sin brida

470 587

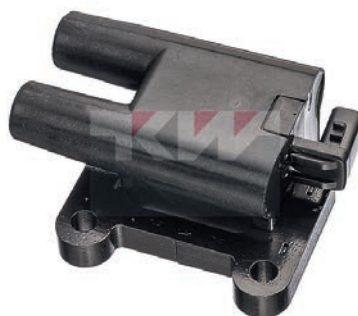

	ohm		ohm
	1,05		13200

470 589



470 587

470 589

470 580

HYUNDAI

GETZ 1.1	G4HD	09/02 ⇨ 06/09
SANTA FE I 2.7 4x4	G6BA	09/02 ⇨ 12/04
SANTA FE I 2.7 V6 4x4	G6BA, G6BA-G	02/01 ⇨ 03/06

KIA

PICANTO I 1.0	--, G4HE	04/04 ⇨
PICANTO I 1.0 LPG	G4HE	01/09 ⇨ 04/11
PICANTO I 1.1	--, G4HG	04/04 ⇨
PICANTO I 1.1 LPG	G4HG	01/09 ⇨ 04/11

KW 470 589



07

COILS

Adatt./Suitable:

KIA

27301-02700 *1

27301-02710 *1

*1 Without fastening clamp

- Senza staffa di fissaggio
- sans bride de fixation
- ohne Befestigungsbügel
- sin estribo de sujeción

245 without fastening clamp

- senza staffa fissaggio
- sans bride de fixation
- ohne Befestigungsbügel
- sin estribo de sujeción



470 580

470 587

KIA

PICANTO I 1.0	--, G4HE	04/04 ⇨
PICANTO I 1.1	--, G4HG	04/04 ⇨

KW 470 591



07,5

COILS

Adatt./Suitable:

HITACHI

133963

2503963

MAGNETI MARELLI

060717093012

SUZUKI

33410-66D00
33410-66D00-000
33410-66D01
33410-66D01-000
33410-66D10
33410-66D10-000



	ohm		ohm
	---		9000

SUZUKI

GRAND VITARA I 1.6 4x4	G16B	03/98 ⇨ 09/05
JIMNY III 1.3	M13A	08/04 ⇨
JIMNY III 1.3 16V	G13BB, M13A	02/01 ⇨
JIMNY III 1.3 16V 4WD	G13BB, M13A	09/98 ⇨
JIMNY III 1.3 16V 4x4	M13A	08/05 ⇨
JIMNY III 1.3 4x4	G13BB	09/98 ⇨ 08/00
SWIFT III 1.3 [USA]	--	06/95 ⇨ 05/01
VITARA I 1.6 16V	G16B	10/99 ⇨ 10/02
VITARA II 1.6i [USA]	--	08/99 ⇨ 12/06

KW **470 596**



COILS

Adatt./Suitable:

BOSCH
0 986 221 001
0 986 221 060
0 986 221 060

DACIA
22 43 361 34R
60 01 543 604
77 00 274 008

HITACHI
133800
138764
138764

LADA
22 43 361 34R

MAGNETI MARELLI
060717035012
060717055012
060810070010

NISSAN
22448-00Q0E
22448-00QAC

RENAULT
22 43 361 34R
60 01 543 604
77 00 274 008
H77 00 873 701

SAGEM
2 526 151 A

NEW - ITEM NOW AVAILABLE FROM PRODUCTION

- NUOVO - ARTICOLO ORA DISPONIBILE PER LA VENDITA
- NOUVEAU - ARTICLE DISPONIBLE EN PRODUCTION COURANTE
- NEU - JETZT ZUM VERKAUF VERFÜGBARER ARTIKEL
- NUEVO - ARTICULO AHORA DISPONIBLE EN PRODUCCION

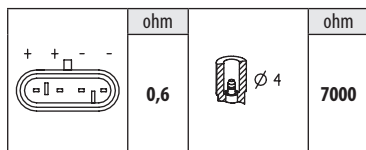

DACIA		
DOKKER 1.6	K7M812, K7M828	11/12 ⇨
DOKKER 1.6 LPG	K7M812, K7M828	11/13 ⇨
LODGY 1.6	K7M812, K7M828	03/12 ⇨
LODGY 1.6 LPG	K7M812, K7M828	11/13 ⇨
LOGAN I 1.4	K7J710	09/04 ⇨
LOGAN I 1.4 MPI LPG	K7J710, K7J714	02/06 ⇨ 12/12
LOGAN I 1.6	K7M710, K7M714	09/04 ⇨
LOGAN I 1.6 Bifuel	K7M710, K7M718, K7M800, K7M818	11/08 ⇨
LOGAN I 1.6 LPG	K7M718	08/04 ⇨ 12/12
LOGAN I 1.6 MPI 85	K7M800	05/10 ⇨
LOGAN II 1.6	K7M812	06/13 ⇨ 08/16
LOGAN II 1.6 16V	K7M764, K7M812	10/12 ⇨
LOGAN II MCV 1.6	K7M812	06/13 ⇨
SANDERO I 1.4	K7J710	06/08 ⇨
SANDERO I 1.4 MPI LPG	K7J714	01/09 ⇨
SANDERO I 1.6	K7M710, K7M718	06/08 ⇨
SANDERO I 1.6 Hi-Flex	K7M732	06/08 ⇨ 12/12
SANDERO I 1.6 LPG	K7M718, K7M818	06/08 ⇨ 12/12
SANDERO I 1.6 MPI 85	K7M800	05/10 ⇨ 06/13
SANDERO II 1.6	K7M812	11/12 ⇨
SANDERO II 1.6 I	K7M764	10/12 ⇨
SOLENZA 1.4	E7J262	02/03 ⇨ 10/05

LADA		
LARGUS 1.6	11189, K7M	03/12 ⇨

NISSAN		
KUBISTAR 1.2	D7F726, D7F744, D7F764, D7F726	08/03 ⇨
KUBISTAR 1.2 LPG	D7F764	10/03 ⇨ 08/05
KUBISTAR 1.4	K7J700, K7J701	08/03 ⇨ 10/09
KUBISTAR 1.6 16V	K4M752, K4M753	08/03 ⇨ 10/09

RENAULT		
CLIO II 1.0	D7D760	02/00 ⇨ 05/01
CLIO II 1.2	D7F710, D7F720, D7F722, D7F726, D7F744, D7F746, D7F764, D7F766	03/98 ⇨
CLIO II 1.2 LPG	D7F744, D7F764, D7F766	09/98 ⇨ 06/09
CLIO II 1.4	E7J634, E7J635, K7J700	09/98 ⇨
CLIO II 1.6	K7M746	09/98 ⇨
CLIO III 1.2	D4F784	11/07 ⇨ 12/11

RENAULT			
CLIO III 1.2 16V	D4F784, D4F786	05/07 ⇨	12/14
KANGOO II 1.6	K7M750	02/08 ⇨	
CLIO 1.2 BiFuel	D7F722	03/98 ⇨	10/01
DOKKER 1.6	K7M812	12/13 ⇨	
KANGOO 1.2	D7F746	12/01 ⇨	06/03
KANGOO 1.2 BiFuel	D7F710, D7F722, D7F744, D7F764, D7F766	06/97 ⇨	06/03
KANGOO I 1.0	D7D700, D7D760	09/98 ⇨	
KANGOO I 1.0 RN	D7D700, D7D760	01/02 ⇨	01/07
KANGOO I 1.2	D7F710, D7F720, D7F722, D7F726, D7F744, D7F746, D7F764, D7F766	08/97 ⇨	
KANGOO I 1.2 BiFuel	D7F710, D7F744	07/98 ⇨	07/01
KANGOO I 1.4	E7J634, E7J635, K7J700, K7J701	08/97 ⇨	
KANGOO I 1.6	K7M746	09/99 ⇨	
LODGY 1.6	K7M812, K7M828	07/13 ⇨	
LOGAN 1.4	K7J710	09/04 ⇨	
LOGAN 1.4 LPG	K7J714	02/08 ⇨	10/13
LOGAN 1.6	K7M710	09/04 ⇨	
LOGAN 1.6 MPI 85	K7M800	05/10 ⇨	
LOGAN EXPRESS 1.6	K7M710	04/07 ⇨	
LOGAN/STEPWAY 1.6	K7M812	11/13 ⇨	
MEGANE I 1.4	E7J626	09/96 ⇨	08/03
MEGANE I 1.4 e	E7J626	01/96 ⇨	08/03
MEGANE I 1.6	K7M704	02/00 ⇨	09/00
MEGANE I 1.6 e	K7M702, K7M703, K7M790	01/96 ⇨	08/03
MEGANE I 1.6 i	K7M720	01/96 ⇨	03/99
MEGANE I 1.6 LPG	K7M702	08/95 ⇨	03/99
MEGANE I 2.0 16V	F5R740	01/02 ⇨	08/03
MEGANE I 2.0 16V IDE	F4R746, F5R740	11/99 ⇨	08/03
MEGANE SCÉNIC I 1.6 e	K7M702, K7M703	10/96 ⇨	10/99
MEGANE SCÉNIC I 1.6 i	K7M720	01/97 ⇨	09/99
MEGANE 1.6 BiFuel	K7M702	10/96 ⇨	10/99
MODUS / GRAND MODUS 1.2	D4F786	04/11 ⇨	
MODUS / GRAND MODUS 1.2 16V	D4F784	05/07 ⇨	
SANDERO I 1.4	K7J710	02/09 ⇨	
SANDERO I 1.4 LPG	K7J714	02/09 ⇨	
SANDERO I 1.6	K7M710	12/07 ⇨	
SANDERO I 1.6 MPI 85	K7M800	05/10 ⇨	
SANDERO II 1.6	K7M812	11/13 ⇨	
THALIA I 1.4	K7J718	05/00 ⇨	02/09
THALIA I 1.6	K7M730, K7M734	01/01 ⇨	
THALIA II 1.4	K7J700	09/08 ⇨	06/14
TWINGO I 1.0	D7D740	01/00 ⇨	
TWINGO I 1.2	D7F700, D7F701, D7F702, D7F703, D7F704, D7F706	05/96 ⇨	
TWINGO II 1.2	D7F800	03/07 ⇨	09/14
TWINGO II 1.2 TCe 100	D4F780, D4F782	02/11 ⇨	
TWINGO II 1.2 Turbo	D4F780, D4F782	03/07 ⇨	09/14
WIND 1.2	D4F782	07/10 ⇨	
WIND 1.2 TCe 100	D4F782	02/11 ⇨	

KW **470 599**



COILS

Adatt./Suitable:

AUDI
04C 905 110 D
04C 905 110 E
04C 905 110 H
04C 905 110 J
04C 905 110 L
04E 905 110 B
04E 905 110 D
04E 905 110 E
04E 905 110 K
04E 905 110 M
04E 905 110 P

NEW - ITEM NOW AVAILABLE FROM PRODUCTION

- NUOVO - ARTICOLO ORA DISPONIBILE PER LA VENDITA
- NOUVEAU - ARTICLE DISPONIBLE EN PRODUCTION COURANTE
- NEU - JETZT ZUM VERKAUF VERFÜGBARER ARTIKEL
- NUEVO - ARTICULO AHORA DISPONIBLE EN PRODUCCION

BOSCH
0 986 221 057
0 986 221 072

CUPRA
04E 905 110 K
04E 905 110 P

HITACHI
2503894
2504033

MAGNETI MARELLI
060717199012

SEAT
04C 905 110 B
04C 905 110 D
04C 905 110 E
04C 905 110 H
04C 905 110 J
04C 905 110 L
04E 905 110 A
04E 905 110 B
04E 905 110 E
04E 905 110 K
04E 905 110 M
04E 905 110 P

SKODA
04C 905 110 A
04C 905 110 B
04C 905 110 D
04C 905 110 E
04C 905 110 H
04C 905 110 J
04C 905 110 L
04E 905 110 A
04E 905 110 B
04E 905 110 E
04E 905 110 K
04E 905 110 M
04E 905 110 P

VW
04C 905 110 A
04C 905 110 B
04C 905 110 D
04C 905 110 E
04C 905 110 H
04C 905 110 J
04C 905 110 L
04E 905 110 A
04E 905 110 B
04E 905 110 E
04E 905 110 H
04E 905 110 K
04E 905 110 L
04E 905 110 P

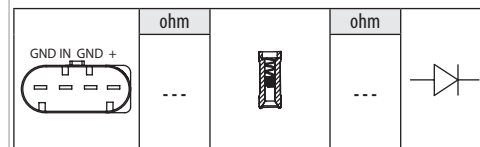

AUDI		
A1 1.0 TFSI	CHZB, CHZE, DKLD	03/15 ⇨ 10/18
A1 1.4 TFSI	CPTA, CZCA, CZDD	04/12 ⇨ 10/18
A1 1.4 TSI	CZEA	11/14 ⇨ 10/18
A1 25 TFSI	DKLA, DLAC	11/18 ⇨
A1 30 TFSI	DKJA, DKRF, DLAA	07/18 ⇨
A3 III 1.0 TFSI	CHZD, DKRF	07/16 ⇨ 10/20
A3 III 1.2 TFSI	CJZA, CYVB	02/13 ⇨
A3 III 1.4 TFSI	CMBA, CPTA, CXSA, CXSB, CZCA, CZCC	04/12 ⇨
A3 III 1.4 TFSI e-tron	CUKB, CXUA, DGEA	05/14 ⇨ 10/20
A3 III 1.4 TFSI g-tron	CPWA	11/13 ⇨ 10/20
A3 III 1.4 TSI	CZEA	05/14 ⇨ 10/20
A3 III 30 TFSI	CHZD, DKRF	07/18 ⇨ 10/20
A3 IV 30 TFSI	DLAA	06/20 ⇨
A3 IV 30 TFSI Mild Hybrid	DLAA	06/20 ⇨

AUDI		
A3 IV 40 TFSIe	DGEA	06/20 →
A3 IV 45 TFSIe	DGEA	07/21 →
A4 V 1.4 TFSI	CVNA	08/15 → 11/19
A5 II 1.4 TFSI	CVNA	11/16 → 02/20
Q2 1.0 TFSI	CHZJ, DKRF	10/16 → 10/20
Q2 1.4 TFSI	CZEA	06/16 → 08/18
Q2 30 TFSI	CHZJ, DKRF, DLAA	07/18 →
Q3 1.4 TFSI	CZDB	07/16 → 10/18
Q3 1.4 TSI	CHPB, CZDA, CZEA	10/13 → 10/18

CUPRA		
FORMENTOR 1.4 e-Hybrid	DGEA	01/21 →
FORMENTOR VZ 1.4 e-Hybrid	DGEA	02/21 →
LEON 1.4 e-HYBRID	DGEA	09/20 →
LEON VZ 1.4 e-HYBRID	DGEA	09/20 →

SEAT		
ALHAMBRA III 1.4 TSI	CZDA, DJKA	05/15 →
ALHAMBRA III TSI	CZDA	05/15 →
ARONA 1.0 TGI	DBYA	11/18 →
ARONA 1.0 TSI	CHZJ, CHZL, DKJA, DKLA, DKRF, DLAA	07/17 →
ARONA 1.6 SRE	CWVA	07/17 →
ATECA 1.0 TSI	CHZJ, DKRF	05/16 →
ATECA 1.4 TSI	CZEA	06/16 →
ATECA 1.4 TSI 4Drive	CZEA	06/16 →
IBIZA IV 1.0	CHYB	05/15 → 06/17
IBIZA IV 1.0 TSI	CHZB, CHZC	05/15 → 06/17
IBIZA IV 1.2 TSI	CJZC, CJZD	05/15 → 06/17
IBIZA IV 1.4 TSI	CPTA, CZEA	10/13 → 06/17
IBIZA IV 1.6	CWVA	07/15 → 06/17
IBIZA IV 1.6 SRE	CWVA, CWVB	07/15 →
IBIZA IV 1.8 TSI Cupra	DAJA	11/15 → 12/16
IBIZA V 1.0	CHYB, CHYC	01/17 →
IBIZA V 1.0 TGI	DBYA	11/17 →
IBIZA V 1.0 TSI	CHZJ, CHZL, DKJA, DKLA, DKRF, DLAA, DLAC	01/17 →
IBIZA V 1.6	CWVA	05/17 →
IBIZA 1.0 SRE	CHYB	05/15 → 12/16
IBIZA 1.6 SRE	CWVA	07/15 → 12/16
LEON III 1.0 TSI	CHZD, DKLB	05/15 →
LEON III 1.2 TSI	CJZA, CJZB, CYVA, CYVB	12/12 →
LEON III 1.4 TGI	CPWA	02/13 →
LEON III 1.4 TSI	CHPA, CMBA, CXSA, CZCA, CZDA, CZEA	09/12 →
LEON III 1.6 TSI	CWVA	05/15 →
LEON IV 1.0 TSI	DLAA, DLAB	03/20 →
LEON IV 1.0 TSI Mild Hybrid	DLAA	08/20 →
LEON IV 1.4 TSI e-Hybrid	DGEA	05/20 →
MII 1.0	CHYA, CHYB	10/11 → 07/19
MII 1.0 EcoFuel	CPGA	10/12 → 07/19
TARRACO 1.4 e-HYBRID	DGEA	02/21 →
TARRACO 1.4 TSI Plug in Hybrid	DGEA	02/21 →
TOLEDO IV 1.0 TSI	CHZB, CHZC, DKLD, DKRC	05/17 → 04/19
TOLEDO IV 1.2 TSI	CJZC, CJZD	05/15 → 05/17
TOLEDO IV 1.4 TSI	CZCA	05/15 → 04/19
TOLEDO IV 1.6	CWVA	05/15 → 04/19

SKODA		
CITIGO 1.0	CHYA, CHYB	10/11 → 08/19
CITIGO 1.0 CNG	CPGA	11/12 → 08/19
FABIA 1.0 TSI	DLAA, DLAC	06/21 →
KAMIQ 1.0 TGI CNG	DBYA	11/19 →
KAMIQ 1.0 TSI	DKJA, DKLA, DKRF	07/19 →
KAMIQ 1.6 SRE	CWVA	07/19 →
KAROQ 1.0 TSI	CHZJ, DKRF	07/17 →
KAROQ 1.4 TSI	CZEA, DJKA	07/17 →
KODIAQ 1.4 TSI	CZCA, CZDA, CZEA	10/16 →
KODIAQ 1.4 TSI 4x4	CZDA, CZEA	10/16 →
OCTAVIA III 1.0 TSI	CHZD, DKRA, DKRF	05/16 →
OCTAVIA III 1.2 TSI	CJZA, CJZB, CYVA, CYVB	11/12 →
OCTAVIA III 1.4 TSI	CHPA, CHPB, CZDA	11/12 →
OCTAVIA III 1.4 TSI G-TEC	CPWA	11/13 →
OCTAVIA III 1.6	CWVA	01/14 →
OCTAVIA IV 1.0 TSI	DLAA	06/20 →
OCTAVIA IV 1.0 TSI e-TEC	DLAA	06/20 →
RAPID 1.0 TSI	CHZB, CHZC, DKLD	06/17 → 12/19
RAPID 1.2 TSI	CJZC, CJZD	05/15 → 12/19
RAPID 1.4 TSI	CZCA	05/15 →
RAPID 1.6	CWVA	05/15 →
RAPID 1.6 SRE	CWVA	05/15 →
SCALA 1.0 TGI CNG	DBYA	11/19 →
SCALA 1.0 TSI	DKJA, DKLA, DKRF, DLAA, DLAC	02/19 →
SCALA 1.6 SRE	CWVA	02/19 →
FABIA III 1.0	CHYA, CHYB, CHYE	08/14 →
FABIA III 1.0 TSI	CHZB, CHZC, DKLD, DKRC	08/14 →
FABIA III 1.2 TSI	CJZC, CJZD	08/14 →
FABIA III 1.4 TSI R5	CZCA	02/18 →
FABIA III 1.6	CWVA, CWVB	01/15 →
SUPERB III 1.4 TSI	CZCA, CZDA, CZEA	03/15 →

SKODA		
SUPERB III 1.4 TSI 4x4	CZDA, CZEA	03/15 →
SUPERB III 1.4 TSI iv	DGEB	08/19 →
YETI 1.2 TSI	CYVB	05/15 → 12/17
YETI 1.4 TSI	CZCA	05/15 → 12/17
YETI 1.4 TSI 4x4	CZDA	05/15 → 12/17
YETI 1.6	CWVA	04/14 → 12/17

VW		
ARTEON 1.4 eHybrid	DGEB	11/20 →
BEETLE 1.2 TSI 16V	CYVD	12/14 → 07/19
BEETLE 1.4 TSI	CZDA	12/14 → 07/19
CADDY III 1.0 TSI	CHZG, DKRD, DKRE	11/15 →
CADDY III 1.2 TSI	CYVC	06/15 →
CADDY III 1.4 TGI CNG	CPWA	06/15 →
CADDY III 1.4 TSI	CZCB, DJKD	05/15 →
CADDY III 1.6	CWVA	11/15 → 09/20
CADDY III 1.6 SRE	CWVA	11/15 → 09/20
POLO VI 1.0	CHYB, CHYC, DFNB	06/17 → 08/21
POLO VI 1.0 TGI	DBYA	09/17 →
POLO VI 1.0 TSI	CHZJ, CHZL, DKJA, DKLA, DKRF, DLAA, DLAC	06/17 →
CADDY IV 1.6 SRE	DWYA	02/21 →
CC 1.4 TSI	CZDA	05/15 → 12/16
T-CROSS 1.0 TSI	CHZL, DKJA, DKLA, DKRF, DLAA, DLAC	12/18 →
GOLF VI 1.2 TSI 16V	CJZA, CYVD	11/13 → 05/16
GOLF VI 1.4 TSI	CZCA, CZDA	11/13 → 05/16
GOLF VII 1.0 TSI	CHZC, CHZD, CHZK, DKLB, DKRF	05/15 →
GOLF VII 1.2 TSI	CJZA, CJZB, CYVA, CYVB	08/12 →
GOLF VII 1.2 TSI BlueMotion	CJZA, CJZB, CYVA	08/12 →
GOLF VII 1.4 GTE Hybrid	CUKC, DGEA	05/14 →
GOLF VII 1.4 TGI CNG	CPWA, CZBA	06/13 →
GOLF VII 1.4 TSI	CHPA, CHPB, CMBA, CPTA, CPVA, CPVB, CXSA, CZCA, CZDA, CZDD, CZEA	08/12 →

GOLF VII 1.4 TSI BlueMotion	CHPA, CXSA	08/12 →
GOLF VII 1.4 TSI MultiFuel	CPVA, CPVB	04/13 →
GOLF VII 1.6	CWVA	05/14 →
PASSAT VI 1.4 GTE Hybrid	CUKC, DGEB	06/15 →
PASSAT VI 1.4 TSI	CZCA, CZDA, CZEA	11/14 →
PASSAT VI 1.4 TSI 4motion	CZEA	02/15 →
GOLF VIII 1.0 eTSI	DLAA	06/20 →
GOLF VIII 1.0 TSI	DLAA, DLAB	02/20 →
GOLF VIII 1.4 GTE Plug-in Hybrid	DGEA	07/20 →
GOLF VIII 1.4 TSI eHybrid	DGEA	07/20 →
JETTA VI 1.2 TSI	CYVD	02/11 →
JETTA VI 1.2 TSI 16V	CYVD	08/14 → 12/17
JETTA VI 1.4 TSI	CZCA, CZDA, CZTA	08/14 →
JETTA VI 1.4 TSI Hybrid	CNLA	04/11 →
JETTA VI 1.6	CWVA	09/15 →
JETTA VI 1.6 [RUS]	CWVA, CWVB	01/15 →
JETTA VI 1.6 MPI	CWVB	09/15 → 04/18
MULTIVAN 1.4 e-Hybrid	DGEA	08/21 →
POLO V 1.0	CHYA, CHYB	01/14 →
POLO V 1.0 TSI	CHZB, CHZC	11/14 →
POLO V 1.2 TSI	CJZC, CJZD	01/14 →
POLO V 1.2 TSI 16V	CJZC	02/14 → 10/17
POLO V 1.4 TSI	CPTA, CZCA, CZEA	10/12 →
POLO V 1.4 TSI [RUS]	CZCA	05/14 →
POLO V 1.6	CWVA, CWVB	07/14 →
T-ROC 1.0 TSI	CHZJ, DKRF, DLAA	07/17 →
SCIROCCO III 1.4 TSI	CZCA, CZDA, CZDC	11/13 →
SHARAN II 1.4 TSI	CZDA, DJKA	05/15 →
TAIGO 1.0 TSI	DLAA, DLAC	09/21 →
TAOS 1.4 TSI	DJKA	10/20 →
TAOS 1.4 TSI 4motion	DJKA	05/21 →
TAOS 1.6 MPI	DWYA	07/21 →
TIGUAN I 1.4 TSI	CZDA, CZDB	05/15 → 07/18
TIGUAN II 1.4 TSI	CZCA, CZDA, CZDB, CZEA, DJVA	01/16 →
TIGUAN II 1.4 TSI 4motion	CZDA, CZEA	05/16 → 07/18
TOURAN II 1.0 TSI	DKRB	12/18 →
TOURAN II 1.2 TSI	CYVB	05/15 →
TOURAN II 1.4 TSI	CZDA	05/15 →
UP 1.0	-- CHYA, CHYB, CHYE, DAFa	08/11 →
UP 1.0 EcoFuel	CPGA	11/12 →
UP 1.0 GTI	DKRA	11/17 →
UP 1.0 TSI	CHZA, DKLC	05/16 → 09/18

COILS

Adatt./Suitable:

HITACHI
133909
2503909MAGNETI MARELLI
060717164012
060810160010NISSAN
22448-AX001

NEW - ITEM NOW AVAILABLE FROM PRODUCTION

- NUOVO - ARTICOLO ORA DISPONIBILE PER LA VENDITA
- NOUVEAU - ARTICLE DISPONIBLE EN PRODUCTION COURANTE
- NEU - JETZ ZUM VERKAUF VERFÜGBARER ARTIKEL
- NUEVO - ARTICULO AHORA DISPONIBLE EN PRODUCCION

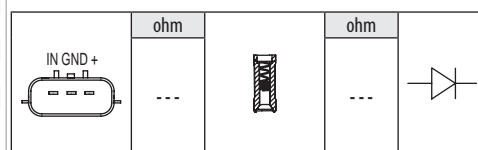
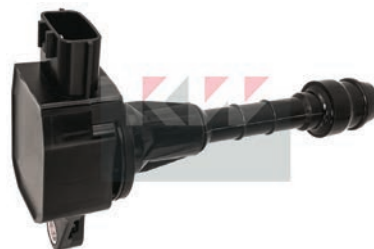

NISSAN

MICRA III 1.0 16V	CG10DE	01/03 → 06/10
MICRA III 1.2	CR12DE	10/03 → 06/10
MICRA III 1.2 16V	CG12DE, CR12DE	01/03 → 06/10
MICRA III 1.2 LPG	CG12DELPG, CR12DE	10/02 → 06/10
MICRA III 1.3	CGA3DE	08/04 →
MICRA III 1.4 16V	CR14DE	01/03 → 06/10
MICRA C+C 1.4 16V	CR14DE	08/05 →
NOTE I 1.4	CR14DE	03/06 → 06/12
NOTE I 1.4 LPG	CR14DE	01/06 → 08/13

COILS

Adatt./Suitable:

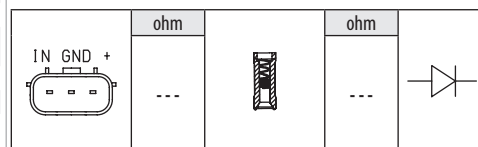
HITACHI
134003
2504003
CM11-116HONDA
30520-RB0-003
30520-RB0-013
30520-RB0-S01

HONDA

CITY 1.4 i-VTEC	L13Z1	09/08 →
CITY 1.5 i-VTEC	L15-A7	08/09 →
CIVIC VIII 1.4	L13Z1	10/08 →
CIVIC IX 1.4 i-VTEC	L13Z4	02/12 →
CR-Z 1.5 IMA	LEA1, LEA3	06/10 →
JAZZ III 1.2	L12B1, L12B2	07/08 →
JAZZ III 1.3 i	L13Z1, L13Z2	07/08 →

HONDA		
JAZZ III 1.4	L13Z1	11/08 ⇨
JAZZ III 1.5 i-VTEC	L15-A7	07/08 ⇨ 06/14

KW 470 607



05,5

COILS

Adatt./Suitable:

BMW

12 13 7 559 842
12 13 7 571 644
12 13 7 582 627
12 13 7 594 935
12 13 7 638 477
7 559 842
7 594 935
7 638 477

BOSCH

0 221 504 471
0 221 504 472
0 221 504 801

HITACHI

133876
2503876

MAGNETI MARELLI

060717113012

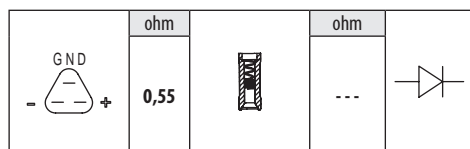

BMW

11 116 i	N43B16A, N43B16AA, N43B20A	03/07 ⇨ 12/11
11 118 d	M47D20(204D4)	06/04 ⇨ 02/07
11 118 i	N43B20A	09/06 ⇨ 12/13
11 120 i	N43B20A, N46B20BD	03/07 ⇨ 12/13
3 V 316 i	N43B16A, N43B16AA	09/07 ⇨ 06/13
3 V 318 i	N43B20A	05/07 ⇨ 12/13
3 V 320 i	N43B20A	09/05 ⇨ 12/13
3 V 325 i	N53B30A	10/06 ⇨ 12/13
3 V 325 i xDrive	N53B30A	09/08 ⇨ 12/13
3 V 325 xi	N53B30A	09/07 ⇨ 08/08
3 V 330 i	N52B30A, N52B30BF, N53B30A	09/06 ⇨ 10/13
3 V 330 i xDrive	N53B30A	09/07 ⇨ 06/13
3 V 330 xi	N53B30A	09/06 ⇨ 06/12
5 V 523 i	N53B30A	06/09 ⇨ 08/11
5 V 528 i	N53B30A	11/09 ⇨ 08/11
5 V 530 i	N53B30A	05/11 ⇨ 06/13
6 II 630 i	N53B30A	09/07 ⇨ 08/10
5 V 520 i	N43B20A	12/06 ⇨ 12/10
5 V 523 i	N53B25A	01/07 ⇨ 12/10
5 V 525 i	N53B30A	01/07 ⇨ 12/10
5 V 525 i xDrive	N53B30A	09/08 ⇨ 12/10
5 V 525 xi	N53B30A	01/07 ⇨ 12/10
5 V 530 i	N53B30A	09/06 ⇨ 12/10
5 V 530 i xDrive	N53B30A	09/08 ⇨ 05/10
5 V 530 xi	N53B30A	09/06 ⇨ 05/10

KW 470 608



05,5

COILS

Adatt./Suitable:

BOSCH

0 986 JG1 224

HITACHI

133930
2503930
CM11-108
CM11-111

HONDA

30521-PWA-003
30521-PWA-013
30521-PWA-S01
30521-REA-Z01

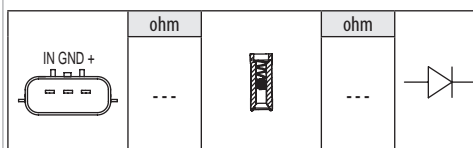

HONDA

JAZZ II 1.2	L12A4	01/06 ⇨
JAZZ II 1.4	L13A6	01/06 ⇨
CITY 1.2	L12A2	05/03 ⇨
CITY 1.3	L13A3	10/05 ⇨ 07/08
CITY 1.5 i-DSI	L15A2	11/02 ⇨
CIVIC VII 1.3 IMA	LDA1	10/03 ⇨ 09/05
JAZZ I 1.2 i-DSI	L12A1, L12A3, L12A4	03/02 ⇨ 07/08
JAZZ I 1.3 iDSi	L13A1, L13A6	03/02 ⇨ 07/08
JAZZ I 1.4	L13A5	04/05 ⇨ 07/08
JAZZ I 1.4 iDSi	L13A1, L13A6	12/06 ⇨ 10/08
CIVIC VIII 1.3 IMA	LDA2	01/06 ⇨
CIVIC VIII 1.4	L13A7	09/05 ⇨

KW 470 609



05,5

COILS

Adatt./Suitable:

BOSCH

0 986 221 101

CITROËN

96 712 145 80

DS

96 712 145 80

GENERAL MOTORS

3 639 500

HITACHI

134051
2504051

MAGNETI MARELLI

060717188012

OPEL

3639500
9671214580

PEUGEOT

96 712 145 80

TOYOTA

SU001-01125

VAUXHALL

3639500
9671214580

NEW - ITEM NOW AVAILABLE FROM PRODUCTION

- NUOVO - ARTICOLO ORA DISPONIBILE PER LA VENDITA
- NOUVEAU - ARTICLE DISPONIBLE EN PRODUCTION COURANTE
- NEU - JETZT ZUM VERKAUF VERFÜGBARER ARTIKEL
- NUEVO - ARTICULO AHORA DISPONIBLE EN PRODUCCION

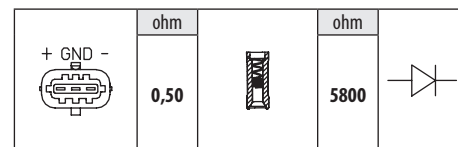

CITROËN

C1 II 1.2 VTi 82	177L, HMT(EB2D), HMZ(EB2F)	04/14 ⇨
C3 III 1.2 PureTech 82	HMR(EB2FA)	05/18 ⇨
C3 III 1.2 PureTech 82 LPG	HMR(EB2FA)	05/18 ⇨
C3 III 1.2 VTi 68	HMM(EB2FAD), HMP(EB2FB)	07/16 ⇨
C3 III 1.2 VTi 82	HMZ(EB2F)	07/16 ⇨
C3 III 1.2 VTi 82 LPG	HMZ(EB2F)	07/16 ⇨
C3 III PureTech 82	HMR(EB2FA)	03/19 ⇨
C3 AIRCROSS 1.2 PureTech 82	HMR(EB2FA), HMZ(EB2F)	06/17 ⇨
C3 AIRCROSS PureTech 82	HMZ(EB2F)	05/19 ⇨
C3 II 1.0 VTi 68	ZMZ(EBO)	08/12 ⇨
C3 II 1.2 VTi 82	177L, HMZ(EB2F)	06/12 ⇨ 09/16
C4 CACTUS 1.2 VTi 75 / PureTech 75	HMU(EB2D), HMU(EB2FD)	09/14 ⇨
C4 CACTUS 1.2 VTi 82	HMZ(EB2F)	09/14 ⇨
C4 CACTUS PureTech 82	177L	05/19 ⇨
C-ELYSEE 1.2 PureTech 82	HMR(EB2FA)	02/18 ⇨
C-ELYSEE 1.2 VTi 72	HMY(EB2M)	11/12 ⇨
C-ELYSEE 1.2 VTi 82	177L, EB2F, HMZ(EB2F)	12/14 ⇨
DS3 1.2 VTi 82	177L, HMZ(EB2F)	01/13 ⇨ 07/15

DS

DS3 1.2 VTi 82	HMZ(EB2), HMZ(EB2F)	04/15 ⇨ 07/19
----------------	---------------------	---------------

OPEL

CORSA F 1.2	F12XEL(EB2FAD)	07/19 ⇨
CROSSLAND X 1.2	F12XE(EB2FA)	07/19 ⇨

PEUGEOT

108 1.2	HMT(EB2D), HMZ(EB2), HMZ(EB2F)	05/14 ⇨
108 1.2 VTi	HMZ(EB2)	05/14 ⇨
108 108 1.2	HMZ(EB2F)	05/14 ⇨
208 I 1.0	ZMZ(EBO)	03/12 ⇨
208 I 1.2 GPL	HMZ(EB2F)	06/15 ⇨
208 I 1.2 PureTech 82	HMR(EB2FA), HMZ(EB2F)	03/18 ⇨
208 I 1.2 VTi	HMZ(EB2)	09/13 ⇨
208 I 1.2 VTi 68 / PureTech 68	HMM(EB2FAD), HMP(EB2FB)	06/15 ⇨
208 I 1.2 VTi 82	HMZ(EB2), HMZ(EB2F)	03/12 ⇨
208 I 1.2 VTi 82 / PureTech 82	HMR(EB2FA), HMZ(EB2), HMZ(EB2F)	06/15 ⇨
208 II 1.2 PureTech 75	HMM(EB2FAD)	06/19 ⇨
301 1.2	HMZ(EB2F)	11/12 ⇨
301 1.2 PureTech 82	HMR(EB2FA)	02/18 ⇨
301 1.2 VTi 72	HMY(EB2M)	11/12 ⇨
301 1.2 VTi 82	HMZ(EB2F)	12/14 ⇨
308 II 1.2 VTi 72	HMZ(EB2), HMZ(EB2F)	09/13 ⇨

470 611

PEUGEOT		
2008 I 1.2 PureTech 82	HMR(EB2FA)	01/18 ⇨ 12/19
2008 I 1.2 VTi	HMZ(EB2), HMZ(EB2F)	03/13 ⇨
TOYOTA		
AYGO II 1.2	1PP	05/14 ⇨
VAUXHALL		
CORSA 1.2	F12XL(EB2FAD)	07/19 ⇨
CROSSLAND X 1.2	B12XE(EB2F), D12XE(EB2FA), F12XE(EB2FA)	03/17 ⇨

KW 470 611

05,5

COILS

Adatt./Suitable:

BOSCH

0 986 221 078

DENSO

DIC-0207

HITACHI

134080

2504080

HYUNDAI

27301-2B100

KIA

27301-2B100

MAGNETI MARELLI

060717193012

ITEM NOW AVAILABLE FROM PRODUCTION

- ARTICOLO ORA DISPONIBILE PER LA VENDITA
- ARTICLE DISPONIBLE EN PRODUCTION COURANTE
- JETZT ZUM VERKAUF VERFÜGBARER ARTIKEL
- ARTICULO AHORA DISPONIBLE EN PRODUCCION



	ohm		ohm
	0,81		5640

HYUNDAI

I30 II 1.6	G4FC, G4FD, G4FG	12/11 ⇨ 12/16
I30 II 1.6 GDI	G4FD	12/11 ⇨
I40 1.6 GDI	G4FD	07/11 ⇨
IX35 1.6	G4FD	11/10 ⇨
IX35 GDi	G4FD	05/15 ⇨ 12/15
TUCSON 1.6 GDi	G4FD	06/15 ⇨ 09/20
VELOSTER 1.6 GDI	G4FD	03/11 ⇨ 12/17

KIA

CARENS III 1.6 GDi	G4FD	03/13 ⇨
CEED II 1.6 GDi	G4FD	05/12 ⇨ 07/18
PRO CEE'D II 1.6 GDI	G4FD	03/13 ⇨ 07/18
PRO CEE'D 1.6 GDI	G4FD	04/15 ⇨ 07/18
SOUL I 1.6 Flex	--	01/11 ⇨
SOUL I 1.6 GDI	G4FD	06/11 ⇨ 12/14
SOUL II 1.6 GDI	G4FD	02/14 ⇨
SPORTAGE III 1.6 GDI	G4FD	02/11 ⇨
SPORTAGE III 1.6 LPG	G4FD	01/14 ⇨ 12/15
SPORTAGE IV 1.6 GDI	G4FD	09/15 ⇨
SPORTAGE IV 1.6 LPG	G4FD	07/20 ⇨

KW 470 612

05,5

COILS

Adatt./Suitable:

BOSCH

0 986 221 076

HITACHI

134079

2504079

HYUNDAI

27301-03110

KIA

27301-03110

MAGNETI MARELLI

060717187012

ITEM NOW AVAILABLE FROM PRODUCTION

- ARTICOLO ORA DISPONIBILE PER LA VENDITA
- ARTICLE DISPONIBLE EN PRODUCTION COURANTE
- JETZT ZUM VERKAUF VERFÜGBARER ARTIKEL
- ARTICULO AHORA DISPONIBLE EN PRODUCCION



	ohm		ohm
	0,81		5640

HYUNDAI

I20 II 1.2	G4LA	11/14 ⇨
I20 II 1.2 LPG	G4LA	01/19 ⇨
I20 II 1.2 LPGI	G4LA	11/14 ⇨
I20 II 1.2 MPI	G4LA	05/15 ⇨
I20 I 1.2	G4LA	03/12 ⇨ 12/15

KIA

PICANTO II 1.2	G4LA	09/11 ⇨ 03/17
PICANTO III 1.2	G4LA	03/17 ⇨
RIO III 1.2 CVT	G4LA	11/14 ⇨ 12/17
RIO III 1.25 CVT	G4LA	06/11 ⇨ 12/17
RIO III 1.25 LPG	G4LA	09/11 ⇨ 12/17
RIO IV 1.25	G4LA	01/17 ⇨
STONIC 1.2 CVT	G4LA	07/17 ⇨

KW 470 613

05,5

COILS

Adatt./Suitable:

BOSCH

0 986 221 079

DACIA

22 43 324 28R

HITACHI

134058

2504058

LADA

22 43 324 28R

MAGNETI MARELLI

060810258010

MERCEDES-BENZ

A 281 906 00 00

NISSAN

22448-00Q0F

RENAULT

22 43 324 28R

H82 01 154 128

SMART

A 281 906 00 00

NEW - ITEM NOW AVAILABLE FROM PRODUCTION

- NUOVO - ARTICOLO ORA DISPONIBILE PER LA VENDITA
- NOUVEAU - ARTICLE DISPONIBLE EN PRODUCTION COURANTE
- NEU - JETZT ZUM VERKAUF VERFÜGBARER ARTIKEL
- NUEVO - ARTICULO AHORA DISPONIBLE EN PRODUCCION

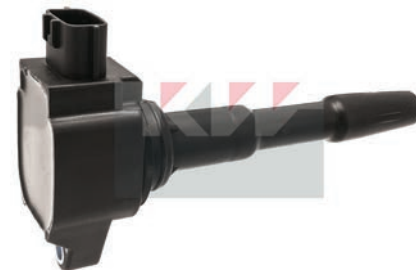

	ohm		ohm	
	---		---	

DACIA

DOKKER 1.2 TCe	H5F402, H5F408	11/12 ⇨
DOKKER 1.2 TCe 115	--, H5F402, H5F408	12/12 ⇨
DOKKER 1.6	H4M738, H4M740	11/12 ⇨
DOKKER 1.6 LPG	H4M740	04/15 ⇨
DUSTER 1.2 TCe 125	H5F404, H5F408	01/12 ⇨
DUSTER 1.2 TCe 125 4x4	H5F404	10/13 ⇨
DUSTER 1.6 SCe 115	H4M438, H4M738	06/15 ⇨
DUSTER 1.6 SCe 115 4x4	H4M430, H4M730, H4M738	06/15 ⇨
DUSTER 1.6 SCe 115 LPG	H4M740	06/15 ⇨
LODGY 1.2 TCe	H5F402, H5F408	03/12 ⇨
LODGY 1.6	H4M738	03/12 ⇨
LODGY 1.6 LPG	H4M740	04/15 ⇨
LODGY 1.6 SCe 100	H4M738, H4M740	06/15 ⇨
LOGAN II TCe 90	H4B400, H4B408, H4B410	10/12 ⇨
LOGAN II TCe 90 LPG	H4B410	09/15 ⇨
LOGAN II MCV TCe 90	H4B400, H4B408	02/13 ⇨
LOGAN II MCV TCe 90 LPG	H4B410	09/15 ⇨
SANDERO II TCe 90	--, H4B400, H4B408	10/12 ⇨
SANDERO II TCe 90 LPG	H4B410	09/15 ⇨

LADA

VESTA 1.6	H4M	11/19 ⇨
-----------	-----	---------

MERCEDES-BENZ

CITAN 112	M200.711	06/13 ⇨ 08/21
-----------	----------	---------------

NISSAN

JUKE I 1.2 DIG-T	HR12DDT, HRA2DDT	05/14 ⇨
MICRA V 0.9 IG-T	HR09DET	12/16 ⇨
MICRA V 0.9 LPG	HR09DET	03/19 ⇨
PULSAR 1.2 DIG-T	HRA2DDT	10/14 ⇨
TERRANO III 1.6	H4M	12/15 ⇨
TERRANO III 1.6 4x4	H4M	12/15 ⇨
QASHQAI II 1.2 DIG-T	HR12DDT, HRA2DDT	11/13 ⇨

RENAULT

MEGANE IV 1.2 TCe 100	H5F408	11/15 ⇨
MEGANE IV 1.2 TCe 130	H5F408	11/15 ⇨
MEGANE IV 1.6 16V	H4M738, H4M750	11/15 ⇨
MEGANE IV 1.6 SCe	H4M738, H4M750	10/16 ⇨
CAPTUR 0.9 TCe 90	H4B400, H4B408	06/13 ⇨
CAPTUR 1.2 T	H5F403	06/13 ⇨
CAPTUR 1.2 TCe	H5F408	02/18 ⇨
CAPTUR 1.2 TCe 120	H5F403, H5F408, H5F412	06/13 ⇨
MEGANE III 1.2 TCe	H5F400, H5F404, H5F405, H5F408, H5F412	03/12 ⇨
KANGOO II 1.2 TCe 115	H5F400, H5F408, H5F412	07/13 ⇨
CLIO IV 0.9 TCe 75	H4B408	05/18 ⇨

RENAULT		
CLIO IV 0.9 TCe 90	H4B400, H4B408	11/12 →
CLIO IV 0.9 TCe 90 LPG	H4B410	08/15 →
CLIO IV 1.2 TCe 120	H5F403, H5F408, H5F412	03/13 →
DUSTER 1.6 16V	H4M438	06/15 →
DUSTER 1.6 16V 4x4	H4M430	06/15 →
GRAND SCÉNIC III 1.2 TCe	H5F400, H5F404, H5F408	04/12 →
GRAND SCÉNIC IV 1.2 TCe 115	H5F408	09/16 →
GRAND SCÉNIC IV 1.2 TCe 130	H5F408	09/16 →
KADJAR 1.2 TCe 130	H5F408	06/15 →
KAPTUR 1.6	H4M429, H4M438	03/16 →
LOGAN/STEPWAY 1.6	H4M429, H4M438	09/16 →
SANDERO II 1.6	H4M429, H4M438	09/16 →
SANDERO II TCe 90	H4B400, H4B408, H4B410, H4B411	09/15 →
SCÉNIC III 1.2 TCe	H5F400, H5F404, H5F408	04/12 →
SCÉNIC IV 1.2 TCe 115	H5F408	09/16 →
SCÉNIC IV 1.2 TCe 130	H5F408	09/16 →
TWINGO III 0.9 TCe 110	H4B401	11/16 →
TWINGO III 0.9 TCe 90	H4B401	09/14 →
TWINGO III 0.9 TCe 90 LPG	H4B451	08/18 →
TWINGO III 1.0 SCe 70	H4D400	09/14 →
MEGANE CC 1.2 TCe	H5F400, H5F404	09/12 →

SMART		
FORFOUR III 0.9	M281.910	11/14 →
FORFOUR III 0.9 Brabus	M281.910	07/16 →
FORFOUR III 1.0	M281.920	07/14 →
FORTWO III 0.9	M281.910	09/14 →
FORTWO III 0.9 Brabus	M281.910	07/16 →
FORTWO III 1.0	M281.920	07/14 →

KW 470 614



05,5

COILS

Adatt./Suitable:

BOSCH

0 986 221 075

DENSO

DIC-0209

HITACHI

134081

2504081

HYUNDAI

27301-04000

KIA

27301-04000

ITEM NOW AVAILABLE FROM PRODUCTION

- ARTICOLO ORA DISPONIBILE PER LA VENDITA
- ARTICLE DISPONIBLE EN PRODUCTION COURANTE
- JETZT ZUM VERKAUF VERFÜGBARER ARTIKEL
- ARTICULO AHORA DISPONIBLE EN PRODUCCION



	ohm		ohm
	0,81		5640

HYUNDAI

I10 I 1.0	G3LA	01/11 → 12/17
I10 II 1.0	G3LA	08/13 →
I10 II 1.0 LPG	B3LA	02/14 →

KIA

PICANTO II 1.0	G3LA	05/11 → 03/17
PICANTO II 1.0 Bi-Fuel	B3LA	05/11 → 10/14
PICANTO II 1.0 LPG	B3LA	08/13 → 03/17

KW 470 619



05,5

COILS

Adatt./Suitable:

FORD

1 760 593

1 776 803

1 827 901

CM5G-12A366-BA

CM5G-12A366-CA

CM5G-12A366-CB

FORD USA

CM5G-12A366-BA

HITACHI

134085

2504085

MAGNETI MARELLI

060717173012

- NEW - ITEM NOW AVAILABLE FROM PRODUCTION

- NUOVO - ARTICOLO ORA DISPONIBILE PER LA VENDITA

- NOUVEAU - ARTICLE DISPONIBLE EN PRODUCTION COURANTE

- NEU - JETZT ZUM VERKAUF VERFÜGBARER ARTIKEL

- NUEVO - ARTICULO AHORA DISPONIBLE EN PRODUCCION



	ohm		ohm
	---		---

FORD

B-MAX 1.0 EcoBoost	M1JA, M1JE, M1JH, SFJA, SFJB, SFJC, SFJD, YYJC	08/12 →
C-MAX II 1.0 EcoBoost	--, M1DA, M1DD, M2DA, M2DC, SFDA	10/12 →
ECOSPORT 1.0 EcoBoost	M1JC, M1JJ, M1JU, SFJL, YYJD, YYJF	10/13 →
FIESTA VI 1.0	P4JA, P4JB, P4JC, P4JD, XMJA, XMJB, XMJC, XMJD	10/12 →
FIESTA VI 1.0 EcoBoost	M1JE, M1JH, SFJA, SFJB, SFJC, SFJD, YYJA, YYJB	09/12 →
FIESTA VI 1.0 Sport	YYJA, YYJB	05/14 → 04/17
FIESTA VII 1.0 EcoBoost	M1JL, M1JM, M1JP, QOJA, QOJB, QOJC, QOJD, SEJE, SEJF, SEJH, SEJJ, SFJK, SFJL, SFJP, YYJE, YYJG	05/17 →
FIESTA VII 1.0 EcoBoost Active	M1JL, M1JM, M1JP, SEJE, SEJF, SEJH, SEJJ, SFJK, SFJL, SFJP, YYJE, YYJG	04/18 →
FIESTA VII 1.0 EcoBoost mHEV	BZJA	07/20 →
FIESTA VII 1.0 EcoBoost mHEV Active	BZJA	01/21 →
FOCUS III 1.0 EcoBoost	M1DA, M1DC, M1DD, M1DH, M2DA, M2DB, M2DC, SFDA, SFDB	02/12 →
GRAND C-MAX 1.0 EcoBoost	M1DA, M1DD, M2DA, M2DC, SFDA	10/12 → 06/19
MONDEO IV 1.0 EcoBoost	M1CA, M1CB	02/15 →
TOURNEO COURIER 1.0 EcoBoost	SFCA, SFCB, SFCC, SFCD, SFCE, SFCF	02/14 →
TOURNEO CUSTOM 1.0 EcoBoost PHEV	M1FA	04/20 →
TRANSIT CONNECT II 1.0 EcoBoost	M2GA, M2GB	02/13 →
TRANSIT COURIER 1.0 EcoBoost	SFCA, SFCB, SFCC, SFCD, SFCE, SFCF	02/14 →
TRANSIT CUSTOM 1.0 EcoBoost PHEV	M1FA	04/20 →

KW 470 620



05,5

COILS

Adatt./Suitable:

BOSCH

0 986 221 102

CITROËN

96 753 909 80

DS

96 753 909 80

GENERAL MOTORS

3 639 845

HITACHI

133962

2503962

OPEL

3639845

9675390980

PEUGEOT

96 753 909 80

VAUXHALL

3639845

9675390980

- NEW - ITEM NOW AVAILABLE FROM PRODUCTION

- NUOVO - ARTICOLO ORA DISPONIBILE PER LA VENDITA

- NOUVEAU - ARTICLE DISPONIBLE EN PRODUCTION COURANTE

- NEU - JETZT ZUM VERKAUF VERFÜGBARER ARTIKEL

- NUEVO - ARTICULO AHORA DISPONIBLE EN PRODUCCION



	ohm		ohm
	0,55		---

CITROËN

C4 PICASSO II 1.2 THP 130	HNY(EB2DTS)	04/14 →
C3 III PureTech 110	HNZ(EB2DT)	03/19 →
C3 AIRCROSS PureTech 82	HNZ(EB2DT)	05/19 →
C3 PICASSO 1.2 THP 110	HNZ(EB2DT)	01/15 →
C3 II 1.2 THP 110	HNZ(EB2DT)	10/14 →
C4 II 1.2 THP 110	8D4HH, HNZ(EB2DT)	02/15 → 12/17
C4 II 1.2 THP 130	HNY(EB2DTS)	04/14 →
C4 III 1.2 PureTech 110	HNX(EB2DTS)	04/18 →
C4 III PureTech 130	HNY(EB2DTS)	05/19 →
C4 CACTUS PureTech 130	HNY(EB2DTS)	05/19 →
BERLINGO II 1.2 PureTech 110	--, EB2DT, HNZ(EB2DT)	02/16 →
C4 GRAND PICASSO II 1.2 THP 130	HNY(EB2DTS)	04/14 →
DS3 1.2 THP 110	HNZ(EB2DT)	10/14 → 07/15
DS4 1.2 THP 130	HNY(EB2DTS)	07/14 → 07/15
GRAND C4 SPACETOURER PureTech 130	HNY(EB2DTS)	05/19 →

DS

DS3 1.2 THP 110 / PureTech 110	HNP(EB2ADT), HNZ(EB2DT)	04/15 → 07/19
DS3 1.2 THP 130	HNY(EB2DTS)	09/15 → 07/19
DS4 / DS4 CROSSBACK 1.2 THP 130	HNY(EB2DTS)	07/15 → 12/18

OPEL

GRANDLAND / GRANDLAND X 1.2	B12XHT(EB2DTS)	06/17 →
308 II 1.2 THP 130	HNY(EB2DTS)	03/14 → 06/21
2008 I 1.2 THP 130 / PureTech 130	HNS(EB2ADTS), HNY(EB2DTS)	01/15 →
2008 I PureTech 130	HNS(EB2ADTS), HNY(EB2DTS)	01/18 →
3008 I 1.2	HNY(EB2DTS)	01/15 → 08/16
3008 II 1.2 THP / PureTech 130	HNS(EB2ADTS), HNY(EB2DTS)	05/16 →
3008 II PureTech 130	HNY(EB2DTS)	05/16 →
5008 I 1.2	HNY(EB2DTS)	01/15 → 03/17
PARTNER II 1.2 THP	HNZ(EB2DT)	02/16 →
PARTNER II TEPEE 1.2 THP	HNV(EB2DTM), HNZ(EB2DT)	02/16 →

VAUXHALL

CROSSLAND X 1.2	B12XHL(EB2DT), B12XHT(EB2DTS)	03/17 →
GRANDLAND X 1.2 Turbo	B12XHT(EB2DTS)	06/17 →

KW 470 621



05,5

COILS

Adatt./Suitable:

SUZUKI

33400-60R00
33400-60R00-000
33400-78P00
33400-78P00-000
33400-81P00
33400-81P00-000
33400M68P10
33400M68P10-000

NEW - ITEM NOW AVAILABLE FROM PRODUCTION

- NUOVO - ARTICOLO ORA DISPONIBILE PER LA VENDITA
- NOUVEAU - ARTICLE DISPONIBLE EN PRODUCTION COURANTE
- NEU - JETZT ZUM VERKAUF VERFÜGBARER ARTIKEL
- NUEVO - ARTICULO AHORA DISPONIBLE EN PRODUCCION

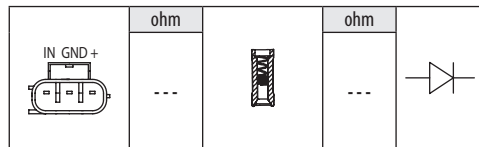

SUZUKI

BALENO 1.0	K10CT	02/16 ⇄
BALENO 1.2	K12C	02/16 ⇄
BALENO 1.2 Hybrid	K12C	02/16 ⇄
IGNIS III 1.2	K12C	10/16 ⇄
IGNIS III 1.2 AllGrip	K12C	10/16 ⇄
IGNIS III 1.2 Hybrid	K12C	10/16 ⇄
IGNIS III 1.2 Hybrid AllGrip	K12C	10/16 ⇄
SWIFT V 1.2	K12B	08/12 ⇄
SWIFT V 1.2 4WD	K12B	08/12 ⇄
SWIFT VI 1.0	K10C	04/17 ⇄
SWIFT VI 1.0 SHVS	K10C	04/17 ⇄
SWIFT VI 1.2	K12C	04/17 ⇄
SWIFT VI 1.2 AllGrip	K12C	04/17 ⇄
SWIFT VI 1.2 SHVS	K12C	04/17 ⇄
SWIFT VI 1.2 SHVS AllGrip	K12C	04/17 ⇄
SWIFT VI 1.4 Sport	K14C	09/17 ⇄
SX4 II 1.0	K10C	08/16 ⇄
SX4 II 1.0 AllGrip	K10C	08/16 ⇄
SX4 II 1.4 T	K14C	08/16 ⇄
SX4 II 1.4 T AllGrip	K14C	08/16 ⇄
VITARA IV 1.0	K10C	10/18 ⇄
VITARA IV 1.0 AllGrip	K10C	10/18 ⇄
VITARA IV 1.4 T	K14C	09/15 ⇄
VITARA IV 1.4 T AllGrip	K14C	09/15 ⇄

KW 470 622



05,5

COILS

Adatt./Suitable:

HYUNDAI

27301-03200

KIA

27301-03200

NEW - ITEM NOW AVAILABLE FROM PRODUCTION

- NUOVO - ARTICOLO ORA DISPONIBILE PER LA VENDITA
- NOUVEAU - ARTICLE DISPONIBLE EN PRODUCTION COURANTE
- NEU - JETZT ZUM VERKAUF VERFÜGBARER ARTIKEL
- NUEVO - ARTICULO AHORA DISPONIBLE EN PRODUCCION

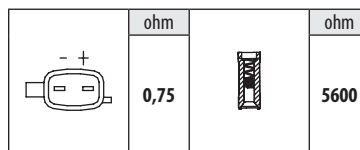

HYUNDAI

ACCENT V 1.4	G4LC	07/18 ⇄
BAYON 1.4 MPI	G4LC	05/21 ⇄
ACCENT IV 1.4	G4LC	11/10 ⇄
ACCENT IV 1.4 CVT	--	11/10 ⇄
I20 II 1.4	G4LC	11/14 ⇄
I20 II 1.4 MPi	G4LC	05/15 ⇄
I30 II 1.4	G4LC	12/14 ⇄
I30 II 1.4 MPI	G4LC	05/15 ⇄
I30 III 1.4 MPI	G4LC	11/16 ⇄
SOLARIS 1.4	G4LC	01/17 ⇄
KIA		
CEED II 1.4 MPI	G4LC	04/15 ⇄ 07/18
CEED III 1.4	G4LC	03/18 ⇄
CEED III 1.4 LPG	G4LC	12/18 ⇄
PRO CEE'D II 1.4 MPI	G4LC	07/13 ⇄ 07/18
RIO IV 1.4	G4LC	01/17 ⇄
STONIC 1.4 CVVT	G4LC	07/17 ⇄
STONIC 1.4 LPG	G4LC	11/18 ⇄

KW 470 623



05,5

COILS

Adatt./Suitable:

FORD

1 800 554
1 836 729
DS7G-12A366-BA
DS7G-12A366-BB

HITACHI

133956

NEW - ITEM NOW AVAILABLE FROM PRODUCTION

- NUOVO - ARTICOLO ORA DISPONIBILE PER LA VENDITA
- NOUVEAU - ARTICLE DISPONIBLE EN PRODUCTION COURANTE
- NEU - JETZT ZUM VERKAUF VERFÜGBARER ARTIKEL
- NUEVO - ARTICULO AHORA DISPONIBLE EN PRODUCCION

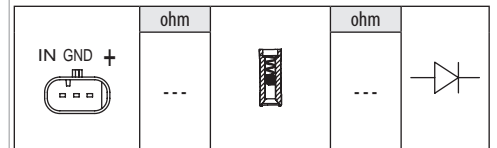

FORD

C-MAX II 1.5 16V	--	03/15 ⇄
C-MAX II 1.5 EcoBoost	M8DB, M8DF, M9DB	03/15 ⇄ 06/19
FOCUS III 1.5 EcoBoost	M8DA, M8DB, M8DD, M8DE, M9DA, M9DB	09/14 ⇄
GALAXY III 1.5 EcoBoost	C15HDTX, UNCL, UNCK	01/15 ⇄
GRAND C-MAX 1.5 EcoBoost	M8DB, M8DF, M9DB	03/15 ⇄ 06/19
KUGA II 1.5 16V	--	03/13 ⇄
KUGA II 1.5 EcoBoost	BNMA, M8MA, M8MB, M8MC, M8MD, M8ME	09/14 ⇄
KUGA II 1.5 EcoBoost 4x4	OCEAA, 285ZV604, 37F3P674K, 65M4R730, M8MA, M8MB, M8MD, M9MA, M9MC, M9ME	09/14 ⇄
MONDEO IV 1.5 EcoBoost	UNCA, UNCB, UNCE, UNCF, UNCN	09/14 ⇄
MONDEO IV 1.5 GTDI	--	09/14 ⇄
S-MAX II 1.5 EcoBoost	6CF4G15, C15HDTX, UNCL, UNCL, UNCK	01/15 ⇄

KW **470 626**



07,5

COILS

Adatt./Suitable:

INFINITI
22448-2V70A
22448-HG00A
22448-HG00B
22448-HG00C
22448-HG00E

MERCEDES-BENZ
A 274 906 06 00
A 274 906 07 00
A 274 906 14 00

NEW - ITEM NOW AVAILABLE FROM PRODUCTION

- NUOVO - ARTICOLO ORA DISPONIBILE PER LA VENDITA
- NOUVEAU - ARTICLE DISPONIBLE EN PRODUCTION COURANTE
- NEU - JETZT ZUM VERKAUF VERFÜGBARER ARTIKEL
- NUEVO - ARTICULO AHORA DISPONIBLE EN PRODUCCION

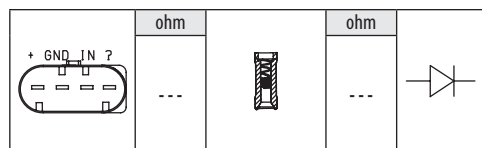

INFINITI

Q30 2.0 T	270920	11/15 ⇄
Q30 2.0 T AWD	270920	11/15 ⇄
Q50 2.0 T	M274	04/14 ⇄
Q60 2.0 T	M274	09/16 ⇄
QX30 2.0 AWD	270920	09/16 ⇄

MERCEDES-BENZ

CLASSE CLS II CLS 250	M274.920	05/14 ⇄
CLASSE B II B 160	M270.910	07/15 ⇄ 12/18
CLASSE B II B 180	M270.910	11/11 ⇄ 12/18
CLASSE B II B 200	M270.910	11/11 ⇄ 12/18
CLASSE B II B 200 Natural Gas Drive / B 200 c	M270.920, M270920NGT	11/12 ⇄ 12/17
CLASSE B II B 220 4-matic	M270.920	05/13 ⇄ 12/18
CLASSE B II B 250	M270.920	05/12 ⇄ 12/18
CLASSE B II B 250 4-matic	M270.920	08/14 ⇄ 12/18
CLASSE C III C 180	M274.910	02/12 ⇄
CLASSE C III C 180 CGI	M274.910	01/08 ⇄ 01/14
CLASSE C IV C 160	M274.910	04/15 ⇄
CLASSE C IV C 180	M274.910	03/14 ⇄
CLASSE C IV C 200	M274.920	12/13 ⇄ 08/18
CLASSE C IV C 200 4-matic	M274.920	04/15 ⇄ 08/18
CLASSE C IV C 250	M274.920	03/14 ⇄ 05/18
CLASSE C IV C 300	M274.920	09/15 ⇄ 12/18
CLASSE C IV C 300 4-matic	M274.920	12/13 ⇄ 08/18
CLASSE C IV C 300 e	M274.920	07/19 ⇄
CLASSE C IV C 300 e 4-matic	M274.920	07/19 ⇄
CLASSE C IV C 350 e	M274.920	02/15 ⇄ 08/18
CLASSE CLA AMG CLA 45 4-matic	M133.980	07/15 ⇄ 03/19
CLASSE CLA CLA 180	M270.910	01/13 ⇄ 03/19
CLASSE CLA CLA 200	M270.910	01/13 ⇄ 03/19
CLASSE CLA CLA 220 4-matic	M270.910, M270.920	01/15 ⇄
CLASSE CLA CLA 250	M270.920	01/13 ⇄ 03/19
CLASSE CLA CLA 250 4-matic	M270.920	07/13 ⇄ 03/19
CLASSE CLA CLA 45 AMG 4-matic	M133.980	07/13 ⇄ 03/19
CLASSE E IV E 180	M274.910	12/12 ⇄
CLASSE E IV E 200	M274.920	11/12 ⇄ 12/16
CLASSE E IV E 200 NGT	M274.920, M274920NGT	07/13 ⇄ 12/15
CLASSE E IV E 250	M274.920	11/12 ⇄ 12/16
CLASSE E V E 180	M274.910	01/17 ⇄
CLASSE E V E 200	M274.920	01/16 ⇄
CLASSE E V E 200 4-matic	M274.920	07/16 ⇄
CLASSE E V E 250	M274.920	07/16 ⇄
CLASSE E V E 300	M274.920	07/16 ⇄
CLASSE E V E 300 e	M274.920	11/18 ⇄
CLASSE E V E 300 e 4-matic	M274.920	07/20 ⇄
CLASSE E V E 350 e	M274.920	07/16 ⇄
CLASSE GLA AMG GLA 45 4-matic	M133.980	07/15 ⇄
CLASSE GLA GLA 180	M270.910	02/15 ⇄
CLASSE GLA GLA 200	M270.910	12/13 ⇄
CLASSE GLA GLA 220 4-matic	M270.920	01/17 ⇄

MERCEDES-BENZ

CLASSE GLA GLA 250	M270.920	12/13 ⇄
CLASSE GLA GLA 250 4-matic	M270.920	12/13 ⇄
CLASSE GLA GLA 250 Flex	M270.920	01/15 ⇄
CLASSE GLA GLA 45 AMG 4-matic	M133.980	05/14 ⇄
CLASSE GLC 250 4-matic	M274.920	06/15 ⇄ 04/19
CLASSE GLC 300 4-matic	M274.920	07/15 ⇄ 04/19
CLASSE GLC 300 e 4-matic	M274.920	11/19 ⇄
CLASSE GLC 350 e 4-matic	M274.920	01/16 ⇄ 04/19
CLASSE GLK 200	M274.920	08/13 ⇄ 06/15
CLASSE GLK 250	M274.920	08/13 ⇄ 06/15
CLASSE GLK 250 4-matic	M274.920	08/13 ⇄ 06/15
CLASSE SLC 180	M274.910	01/16 ⇄
CLASSE SLC 200	M274.920	01/16 ⇄
CLASSE SLC 300	M274.920	01/16 ⇄
CLASSE SLK III 200	M274.920	04/15 ⇄
CLASSE SLK III 300	M274.920	07/15 ⇄
GLE GLE 350 e 4-matic	M274.920	06/20 ⇄
CLASSE A III A 160	M270.910	07/15 ⇄ 05/18
CLASSE A III A 180	M270.910	09/12 ⇄ 05/18
CLASSE A III A 200	M270.910	06/12 ⇄ 05/18
CLASSE A III A 220 4-matic	M270.920	05/14 ⇄ 05/18
CLASSE A III A 250	M270.920	06/12 ⇄ 05/18
CLASSE A III A 250 4-matic	M270.920	06/13 ⇄ 05/18
CLASSE A III A 45 AMG 4-matic	M133.980	06/13 ⇄ 05/18
CLASSE A III AMG A 45 4-matic	M133.980	07/15 ⇄ 05/18

KW **470 627**



05,5

COILS

Adatt./Suitable:

HITACHI
133965

MAZDA
P51B-18-100
PE01-18-100
PE20-18-100
PE20-18-100A
PYF5-18-100

NEW - ITEM NOW AVAILABLE FROM PRODUCTION

- NUOVO - ARTICOLO ORA DISPONIBILE PER LA VENDITA
- NOUVEAU - ARTICLE DISPONIBLE EN PRODUCTION COURANTE
- NEU - JETZT ZUM VERKAUF VERFÜGBARER ARTIKEL
- NUEVO - ARTICULO AHORA DISPONIBLE EN PRODUCCION

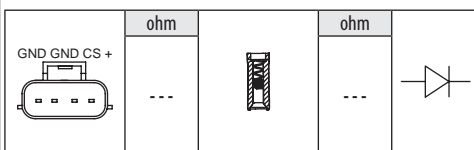

MAZDA

2 III 1.5	P5X0, P5X2, P5Y4, P5Y5, P5Y6, P5Y8, P5Z7, P5Z8, P5Z9	08/14 ⇄
2 III 1.5 SKYACTIV-G	P5X0, P5X2, P5Y5, P5Y6, P5Y8, P5Z2, P5Z3, P5Z7, P5Z8, P5Z9	08/14 ⇄
3 III 1.5	P5-VPS, P5Y1, P5Y4, P5Y5, P5Z3	09/13 ⇄
3 III 2.0	LFX, PEX2, PEXL, PEY5, PEY7	07/13 ⇄
3 III 2.0 Hybrid	--, PE-VPH	10/14 ⇄
3 IV 1.5 SKYACTIV-G	P5X4	11/18 ⇄
3 IV 2.0 SKYACTIV-G	PEXN, PEXP	11/18 ⇄
3 IV 2.0 SKYACTIV-G M Hybrid	PEXN	11/18 ⇄
3 IV 2.0 SKYACTIV-X M Hybrid	HFY7	02/21 ⇄
3 IV SKYACTIV-X M Hybrid	HFY7	02/21 ⇄
3 IV SKYACTIV-X M Hybrid AWD	HFY7	02/21 ⇄
6 III 2.0	PE-VPR, PEXB, PEXL, PEY5, PEY7	12/12 ⇄
6 III 2.5	PYY1, PYY3, PY-Y8, PYZ4, PYZ8, PY-ZA, PYZC	12/12 ⇄

MAZDA

CX-3 2.0 SKYACTIV-G	PEX3, PEXB, PEXT	05/15 ⇄
CX-3 2.0 SKYACTIV-G AWD	PEX3, PEXB, PEXT	05/15 ⇄
CX-5 2.0	PE-VPS, PEX3, PEXB, PEXP, PEY4, PEY5, PEY6, PEY7	11/11 ⇄
CX-5 2.0 AWD	PE-VPS, PEX3, PEXB, PEXP, PEY4, PEY5, PEY6, PEY7	11/11 ⇄
CX-5 2.0 SKYACTIV-G	PEXB, PEXP	03/18 ⇄
CX-5 2.0 SKYACTIV-G AWD	PEXB, PEXP	03/18 ⇄
CX-5 2.5	PY-VPS, PYY1, PYZ8, PYZC	02/13 ⇄
CX-5 2.5 4WD	PY-VPS	07/14 ⇄
CX-5 2.5 AWD	PYY1, PY-Y8, PYZ8, PY-ZA, PYZC	02/15 ⇄
CX-5 SKYACTIV-G	PEY7	04/15 ⇄ 02/17
CX-5 SKYACTIV-G AWD	PEY7, PYY1	04/15 ⇄ 02/17
CX-9 2.5 T AWD	PYZ4	06/16 ⇄
CX-30 e-SKYACTIV-X M Hybrid	HFY7	06/21 ⇄
CX-30 e-SKYACTIV-X M Hybrid AWD	HFY7	06/21 ⇄
CX-30 SKYACTIV-G M Hybrid	PEXN, PEXW	07/19 ⇄
CX-30 SKYACTIV-G M Hybrid AWD	PEXN, PEXW	07/19 ⇄
CX-30 SKYACTIV-X M Hybrid	HFY1	07/19 ⇄
CX-30 SKYACTIV-X M Hybrid AWD	HFY1	07/19 ⇄
MX-5 IV 1.5	P5-VPR, P5X1, P5Z1	06/15 ⇄
MX-5 IV 2.0	PEX4, PEX6, PEXF	06/15 ⇄

KW **470 631**



07

COILS

Adatt./Suitable:

GENERAL MOTORS

12 635 672
12 670 053
12 697 989

HITACHI

134093
2504093

OPEL

12 08 117
12635672
12670053
12697989

VAUXHALL

12635672
12670053
12697989

NEW - ITEM NOW AVAILABLE FROM PRODUCTION

- NUOVO - ARTICOLO ORA DISPONIBILE PER LA VENDITA
- NOUVEAU - ARTICLE DISPONIBLE EN PRODUCTION COURANTE
- NEU - JETZT ZUM VERKAUF VERFÜGBARER ARTIKEL
- NUEVO - ARTICULO AHORA DISPONIBLE EN PRODUCCION

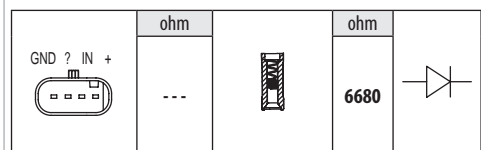

OPEL

ADAM 1.0	B10XFL, B10XFT, D10XFL, D10XFT	07/14 ⇄ 11/18
ASTRA K 1.0	D10XFL	05/18 ⇄
ASTRA K 1.0 Turbo	B10XFL, D10XFL	06/15 ⇄
ASTRA K 1.4	D14XFT	06/18 ⇄
ASTRA K 1.4 CNG	B14XNT	10/17 ⇄
ASTRA K 1.4 Turbo	B14XFL, B14XFT, D14XFT, D14XFL	06/15 ⇄
CORSA E 1.0	B10XFL, B10XFT, D10XFL, F10XFL	09/14 ⇄
INSIGNIA B 1.5	B15SFL, B15SFT, D15SFL, D15SFT	03/17 ⇄
MOKKA 1.4 4x4	B14XFT	06/16 ⇄

VAUXHALL

ADAM 1.0	B10XFL, B10XFT, D10XFT	07/14 ⇄
ASTRA VII 1.0	B10XFL, D10XFL	07/15 ⇄
ASTRA VII 1.4 Turbo	B14XFL, B14XFT	07/15 ⇄
CORSA E 1.0	B10XFL, B10XFT, D10XFL, D10XFT, F10XFL	08/14 ⇄
INSIGNIA 1.5	B15SFL, B15SFT, D15SFL, D15SFT, D15XHT	03/17 ⇄
MOKKA / MOKKA X 1.4 4x4	B14XFT	06/16 ⇄

KW 470 632

05,5

COILS

Adatt./Suitable:

BMW

12 13 7 619 385
12 13 8 615 991
12 13 8 643 360
12 13 8 647 463
12 13 8 678 438
8 643 360

BOSCH

0 986 221 124

HITACHI

134090
2504090

MINI

12 13 7 619 385
12 13 8 615 991
12 13 8 643 360
12 13 8 647 463
12 13 8 678 438
8 643 360
8 647 463

TOYOTA

90118-WA474

NEW - ITEM NOW AVAILABLE FROM PRODUCTION

- NUOVO - ARTICOLO ORA DISPONIBILE PER LA VENDITA
- NOUVEAU - ARTICLE DISPONIBLE EN PRODUCTION COURANTE
- NEU - JETZT ZUM VERKAUF VERFÜGBARER ARTIKEL
- NUEVO - ARTICULO AHORA DISPONIBLE EN PRODUCCION



- GND + 	ohm		ohm	
	0,45		...	

BMW

3 VI 318 i	B38B15A	07/15 → 06/19
3 VI 320 i	B48B20A	07/15 →
3 VI 320 i xDrive	B48B20A	07/15 →
3 VI 330 e	B48B20A	11/15 → 10/18
3 VI 330 i	B46B20B, B48B20B	07/15 →
3 VI 330 i xDrive	B48B20B	07/15 →
3 VI 340 i	B58B30A	07/15 →
3 VI 340 i xDrive	B58B30A	07/15 →
1 II 116 i	B38B15A	03/15 →
1 II 118 i	B38B15A	03/15 →
1 II 120 i	B48B20A	07/16 →
1 II 125 i	B48B20B	10/15 →
1 II M 140 i	B58B30A	10/15 →
1 II M 140 i xDrive	B58B30A	09/15 →
1 III 116 i	B38A15A	11/20 →
1 III 118 i	B38A15A	07/19 →
1 III 120 i	B48A20A, B48A20F	11/20 →
1 III 128 ti	B48A20B, B48A20E	11/20 →
1 III M 135 i xDrive	B48A20E	07/19 →
2 216 i	B38A15A	09/14 →
2 218 i	B38A15A, B38B15A	07/14 →
2 220 i	B48A20A, B48A20F, B48B20A	03/14 →
2 220 i xDrive	B48A20A	03/21 →
2 225 i	B48A20B	11/13 →
2 225 i xDrive	B48A20B	03/14 →
2 225 xe Plug-in-Hybrid	B38A15A	11/14 →
2 230 i	B48B20B	07/16 →
2 M 235 i xDrive	B48A20E	11/19 →
2 M 240 i	B58B30A	09/15 →
2 M 240 i xDrive	B58B30A	09/15 →
3 III 320 i	B46B20B, B48B20A	11/19 →
3 III 330 i	B48B20B	07/19 →
3 III M 340 i xDrive	B58B30B	11/19 →
3 VII 318 i	B48B20A	03/20 →
3 VII 320 e Plug-in-Hybrid	B48B20A	07/20 →
3 VII 320 e Plug-in-Hybrid xDrive	B48B20A	03/21 →
3 VII 320 i	B46B20B, B48B20A, B48B20B	03/19 →
3 VII 320 i 1.6	B48B16A	03/19 →
3 VII 320 i xDrive	B48B20A	07/19 →
3 VII 330 e Plug-in-Hybrid	B46B20B, B48B20A	07/19 →
3 VII 330 e Plug-in-Hybrid xDrive	B48B20A	07/20 →
3 VII 330 i	B48B20B	11/18 →
3 VII 330 i xDrive	B46B20B, B48B20B	11/18 →

BMW

3 VII M 340 i Mild-Hybrid xDrive	B58B30B	11/20 →
3 VII M 340 i xDrive	B58B30B	03/19 →
3 VII M3	S58B30B	11/20 →
3 VII M3 Competition	S58B30A	11/20 →
3 VII M3 Competition xDrive	S58B30A	05/21 →
4 418 i	B38B15A	07/15 →
4 420 i	B46B20B, B48B20A	03/16 →
4 420 i 1.6	B48B16A	11/20 →
4 420 i xDrive	B48B20A	03/16 →
4 430 i	B46B20B, B48B20B	03/16 →
4 430 i xDrive	B48B20B	03/16 →
4 440 i	B58B30A	03/16 →
4 440 i xDrive	B58B30A	03/16 →
4 M 440 i Mild-Hybrid	B58B30B	07/21 →
4 M 440 i Mild-Hybrid xDrive	B58B30B	07/20 →
4 M4	S58B30B	11/20 →
4 M4 Competition	S58B30A	11/20 →
4 M4 Competition M xDrive	S58B30A	07/21 →
4 SERIES M440i xDrive Coupe Mild-Hybrid	B58B30B	11/20 →
5 VII 520 E PLUG-IN-HYBRID	B48B20A	03/21 →
5 VII 520 i	B48B16A, B48B20A, B48B20B	07/17 →
5 VII 520 i Mild-Hybrid	B48B20A	07/20 →
5 VII 530 e Plug-in-Hybrid	B46B20B, B48B20A	03/17 →
5 VII 530 e Plug-in-Hybrid xDrive	B46B20B, B48B20A	03/17 →
5 VII 530 i	B46B20B, B48B20B	09/16 →
5 VII 530 i Mild-Hybrid	B48B20B	07/20 →
5 VII 530 i Mild-Hybrid xDrive	B48B20B	07/20 →
5 VII 530 i xDrive	B46B20B, B48B20B	09/16 →
5 VII 540 i	B58B30A	09/16 → 06/20
5 VII 540 i Mild-Hybrid	B58B30C	07/20 →
5 VII 540 i Mild-Hybrid xDrive	B58B30C	07/20 →
5 VII 540 i xDrive	B58B30A	09/16 →
5 VII 545 e Plug-in-Hybrid xDrive	B58B30C	11/20 →
6 IV GT 630 i	B48B20B	06/17 → 06/20
6 IV GT 630 i Mild-Hybrid	B48B20B	07/20 →
6 IV GT 630 i xDrive	B58B30C	07/19 →
6 IV GT 640 i	B58B30A, B58B30C	06/17 → 06/20
6 IV GT 640 i Mild-Hybrid	B58B30C	07/20 →
6 IV GT 640 i Mild-Hybrid xDrive	B58B30C	07/20 →
6 IV GT 640 i xDrive	B58B30A, B58B30C	06/17 → 06/20
8 840 i	B58B30C	07/19 →
8 840 i xDrive	B58B30C	07/19 →
X1 I sDrive 18 i	B38A15A	11/15 →
X1 I sDrive 20 i	B48A20A, B48A20F	07/15 →
X1 I xDrive 20 i	B48A20A, B48A20B, B48A20F	07/15 →
X1 II xDrive 25 e Plug-in-Hybrid	B38A15A	03/20 →
X1 II xDrive 25 i	B46A20B, B48A20B	07/15 →
7 VI 730 i	B48B20B	11/15 →
7 VI 730 i, Li	B48B20B	11/15 →
7 VI 740 e, Le	B48B20B	07/16 → 02/19
7 VI 740 i, Li	B58B30A, B58B30C	07/15 →
7 VI 740 Le xDrive	B48B20B	07/16 → 02/19
7 VI 740 Li xDrive	B58B30A, B58B30C	03/16 →
7 VI 745 e, Le Plug-in-Hybrid	B58B30C	03/19 →
7 VI 745 Le Plug-in-Hybrid xDrive	B58B30C	03/19 →
X2 M35 i	B48A20E	11/18 →
X2 sDrive 18 i	B32515A, B38A15A	03/18 →
X2 sDrive 20 i	B42520A, B48A20A, B48A20F	11/17 →
X2 xDrive 20 i	B48A20A	03/18 →
X2 xDrive 25 e Plug-in-Hybrid	B38A15A	03/20 →
X3 III M	S58B30A	03/19 →
X3 III M Competition	S58B30A	03/19 →
X3 III sDrive 20 i	B48B20A	12/17 →
X3 III sDrive 20 i 1.6	B48B16A	12/17 →
X3 III xDrive 20 i	B48B20A	12/17 →
X3 III xDrive 20 i Mild Hybrid	B48B20B	08/21 →
X3 III xDrive 30 e Plug-in-Hybrid	B46B20B, B48B20A	12/19 →
X3 III xDrive 30 i	B46B20B, B48B20B	08/17 →
X3 III xDrive 30 i Mild Hybrid	B48B20B	08/21 →
X3 III xDrive M40 i	B58B30A, B58B30B	08/17 →
X4 II M	S58B30A	03/19 →
X4 II M Competition	S58B30A	03/19 →
X4 II M40 i xDrive	B58B30A, B58B30B	04/18 →
X4 II xDrive 20 i	B48B20A	04/18 →
X4 II xDrive 20 i Mild Hybrid	B46B20B, B48B20A	08/21 →
X4 II xDrive 30 i	B48B20B	04/18 →
X4 II xDrive 30 i Mild Hybrid	B46B20B, B48B20B	07/21 →
X5 IV xDrive 40 i	B58B30C	08/18 →

BMW

X5 IV xDrive 40 i Mild-Hybrid	B58B30C	12/20 →
X5 IV xDrive 45 e Plug-in-Hybrid	B58B30C	06/19 →
X6 III xDrive 40 i	B58B30C	08/19 →
X6 III xDrive 40 i Mild-Hybrid	B58B30C	12/20 →
X7 xDrive 40 i	B58B30C	03/19 →
X7 xDrive 40 i Mild-Hybrid	B58B30C	12/20 →
MINI		
MINI III Cooper	B36A15A, B38A15A, B38A15F	09/13 →
MINI III Cooper ALL4	B38A15A, B38A15F	10/16 →
MINI III Cooper S	B46A20A, B48A20A, B48A20F	09/13 →
MINI III Cooper S ALL4	B46A20A, B48A20A, B48A20F	04/15 →
MINI III Cooper S JCW	B46A20A, B48A20A, B48A20F	09/13 →
MINI III Cooper S JCW ALL4	B48A20A	11/14 →
MINI III Cooper SE ALL4	B38A15A	01/17 →
MINI III John Cooper Works	B46A20B, B48A20B, B48A20E	03/15 →
MINI III John Cooper Works ALL4	B48A20B, B48A20E	03/17 →
MINI III John Cooper Works GP	B48A20E	03/20 →
MINI III One	B38A12A, B38A15A	04/14 →
MINI III One First	B38A12A, B38A15A	06/14 →
TOYOTA		
SUPRA 2.0	B48H, B48L	06/19 →
SUPRA 3.0 GR	B58	03/19 →

KW 470 636



05,5

COILS

Adatt./Suitable:

- AUDI**
- 06H 905 110 D
- 06H 905 110 E
- 06H 905 110 F
- 06H 905 110 G
- 06H 905 110 H
- 06H 905 110 L
- 06K 905 110 K
- 06L 905 110 C
- 06L 905 110 D
- 06L 905 110 E
- 06L 905 110 F
- 06L 905 110 H
- 06L 905 110 K

- BENTLEY**
- 06H 905 110 G
- 06H 905 110 L

- BOSCH**
- 0 986 221 072

- CUPRA**
- 06H 905 110 L
- 06L 905 110 K

- HITACHI**
- 134052
- 2504052

- MAGNETI MARELLI**
- 060717182012
- 060717200012

- PORSCHE**
- 958 905 110 00
- 958 905 110 01
- PAC 905 110
- PAC 905 110 A

- SEAT**
- 06H 905 110 D
- 06H 905 110 E
- 06H 905 110 F
- 06H 905 110 G
- 06H 905 110 H
- 06H 905 110 L
- 06L 905 110 B
- 06L 905 110 C
- 06L 905 110 D
- 06L 905 110 E
- 06L 905 110 F
- 06L 905 110 H
- 06L 905 110 K

- SKODA**
- 06H 905 110 D
- 06H 905 110 E
- 06H 905 110 F
- 06H 905 110 G
- 06H 905 110 H
- 06H 905 110 L
- 06L 905 110 C
- 06L 905 110 D
- 06L 905 110 E
- 06L 905 110 F
- 06L 905 110 H
- 06L 905 110 K

- VW**
- 06H 905 110 D
- 06H 905 110 E
- 06H 905 110 F
- 06H 905 110 G
- 06H 905 110 H
- 06H 905 110 L
- 06K 905 110 K
- 06L 905 110 A
- 06L 905 110 B
- 06L 905 110 C
- 06L 905 110 D
- 06L 905 110 E
- 06L 905 110 F
- 06L 905 110 H
- 06L 905 110 K

NEW - ITEM NOW AVAILABLE FROM PRODUCTION

- NUOVO - ARTICOLO ORA DISPONIBILE PER LA VENDITA
- NOUVEAU - ARTICLE DISPONIBLE EN PRODUCTION COURANTE
- NEU - JETZ ZUM VERKAUF VERFÜGBARER ARTIKEL
- NUEVO - ARTICULO AHORA DISPONIBLE EN PRODUCCION

AUDI		
A3 III 2.0 TFSI	CZPB, DKZA	05/16 → 10/20
A3 III 2.0 TFSI quattro	CZPB, DKZA	05/16 → 10/20
A3 III 40 TFSI	CZPB, DKZA	07/18 → 10/20
A3 III 40 TFSI quattro	CZPB, DKZA	07/18 → 10/20
A3 III S3 quattro	CJXD, CJXG, DJHA, DJHB, DNUÉ	11/12 → 10/20
A3 IV S3 quattro	DNFB	06/20 →
A4 V 2.0 TFSI	CYMC, CYRB, CYRC	05/15 → 11/19
A4 V 2.0 TFSI Mild Hybrid	DDWA	05/17 → 11/19
A4 V 2.0 TFSI Mild Hybrid quattro	DDWA	05/17 →
A4 V 2.0 TFSI quattro	CYMC, CYRB, CYRC	05/15 →
A4 V 35 TFSI Mild Hybrid	DLVB, DMSB	12/18 →
A4 V 40 TFSI Mild Hybrid	DMSA	06/20 →
A4 V 40 TFSI Mild Hybrid quattro	DMSA	06/20 →
A4 V 45 TFSI Mild Hybrid	DKNA	07/18 → 11/19
A4 V 45 TFSI Mild Hybrid quattro	DKNA, DMTA	07/18 →
A4 V ALLROAD 2.0 TFSI Mild Hybrid quattro	DDWA	11/18 → 10/19
A4 V ALLROAD 2.0 TFSI quattro	CYMC, CYRB, CYRC	01/16 →
A4 V ALLROAD 45 TFSI Mild Hybrid quattro	DKNA, DMTA	07/18 →
A5 I 1.8 TFSI	CJEB, CJED, CJEE	10/07 → 01/17
A5 I 2.0 TFSI	CNCD	05/13 → 05/16
A5 I 2.0 TFSI quattro	CNCD	05/13 → 05/16
A4 IV ALLROAD 2.0 TFSI quattro	CNCD	05/13 → 05/16
A5 II 2.0 TFSI	CYRB	11/16 → 02/20
A5 II 2.0 TFSI Mild Hybrid	DDWA	05/17 → 02/20
A5 II 2.0 TFSI Mild Hybrid quattro	DDWA, DLHB	05/17 →
A5 II 2.0 TFSI quattro	CYMC, CYRB, CYRC	06/16 →
A5 II 35 TFSI Mild Hybrid	DLVB, DMSB	08/18 →
A5 II 40 TFSI Mild Hybrid	DMSA	05/20 →
A5 II 40 TFSI Mild Hybrid quattro	DMSA	06/20 →
A5 II 45 TFSI Mild Hybrid	DKNA	07/18 → 02/20
A5 II 45 TFSI Mild Hybrid quattro	DKNA, DMTA, DPAA	07/18 →
A6 IV 1.8 TFSI	CYGA	09/14 → 09/18
A6 IV 2.0 TFSI	CYNB, CYP A	09/14 → 09/18
A6 IV 2.0 TFSI quattro	CYNB, CYP A	05/14 → 09/18
A6 V 40 TFSI	DMTC	09/20 →
A6 V 45 TFSI Mild Hybrid	DKNA, DLHA, DMTA	08/18 →
A6 V 45 TFSI Mild Hybrid quattro	DKNA, DLHA, DMTA	08/18 →
A6 V 50 TFSI e quattro	DLGA, DRYA	11/19 →
A6 V 55 TFSI e quattro	DLGA, DRYA	11/19 →
A7 SPORTBACK 2.0 TFSI	CYP A	09/14 → 05/18
A7 2.0 50 TFSI e	DLGA	11/19 →
A7 45 TFSI Mild Hybrid	DKNA, DLHA	07/18 →
A7 45 TFSI Mild hybrid quattro	DKNA, DLHA	07/18 →
A7 55 TFSI e quattro	DLGA	07/19 →
Q7 II 2.0 TFSI	CVJA	08/15 →
Q7 II 2.0 TFSI quattro	CYRB	08/15 →
Q2 2.0 TFSI quattro	CZPB, DKZA	05/17 →
Q2 S02 TFSI quattro	DNFC, DNUÉ	08/18 →
Q5 1.2.0 TFSI quattro	CNCB, CNCD	08/09 → 05/17
Q5 II 2.0 TFSI quattro	DAXB, DAXC, DAYB	06/16 →
Q5 II 35 TDI	DTNA	10/21 →
Q5 II 45 TFSI Mild Hybrid quattro	DNTA, DPUA, DPVA	12/18 →
Q5 II 45 TFSI quattro	DPVA	11/20 →
Q5 II 50 TFSI e quattro	DLGA	04/19 →
Q5 II 55 TFSI e quattro	DLGA	08/19 → 11/20
Q8 45 TFSI	DMFA, DNEA	07/20 →
Q8 45 TFSI quattro	DMFA, DNEA	10/19 →
TT III 1.8 TFSI	CJSA, CJSB	07/15 → 08/18
TT III 2.0 TFSI quattro	CJXF, CJXG, CYFB, DNUF	11/14 →
TT III 40 TFSI	DKZB, DNNB	07/18 →

BENTLEY		
BENTAYGA 3.0 Hybrid	DCBE	08/18 →
BENTAYGA 4.0	DCUA	01/18 →

CUPRA		
FORmentor 2.0 TSI	DNPA	03/21 →
FORmentor 2.0 TSI 4Drive	DNFB, DNNA	07/20 →
LEON 2.0 TSI	DNFC	06/21 →
LEON 2.0 TSI 4Drive	DNFB	06/21 →

PORSCHE		
CAYENNE III 2.9 S AWD	DCAB, MDC.AB	05/17 →
CAYENNE III 3.0 AWD	DCBE, MDC.BE	05/17 →
CAYENNE III 3.0 E-Hybrid AWD	DCBE, MDC.BE	05/17 →
CAYENNE III 4.0 Turbo AWD	DCUA, MDC.UA	05/17 →
CAYENNE III 4.0 Turbo GT AWD	DWNA	06/21 →

PORSCHE		
CAYENNE III 4.0 Turbo S E-Hybrid AWD	DCUA	10/19 →
MACAN 2.0	DKNA, DLHB, MCN.CC, MCV.NA, MCV.PA	07/14 →
MACAN 2.9 Turbo AWD	DGRC	05/18 →
MACAN 3.0 S	DLZB	05/18 →
PANAMERA 2.9 4	MDG.PA	05/16 →
PANAMERA 2.9 4 E-Hybrid	DGPA, MDG.PA	05/16 →
PANAMERA 2.9 4S	MCS.ZA	05/16 →
PANAMERA 2.9 4S E-Hybrid	CSZA, DGPA	08/20 →
PANAMERA 3.0	MCX.TA	05/16 →
PANAMERA 3.0 4	MCX.TA	05/16 →
PANAMERA 4.0 GTS	CVDD	01/18 →
PANAMERA 4.0 Turbo	MCV.DA	05/16 →
PANAMERA 4.0 Turbo S E-Hybrid	CVDA, MCV.DA	05/17 →

SEAT		
LEON III 1.8 TFSI	CJSA	02/13 →
LEON III 1.8 TSI	CJSA	02/13 →
LEON III 1.8 TSI 4Drive	CJSA, CJSB	11/14 →
LEON III 2.0 TSI	DKZA	09/18 →
LEON III 2.0 TSI 4Drive	DKZA	09/18 →
LEON IV 2.0 TFSI	DNNA	03/21 →
TARRACO 2.0 TFSI 4Drive	DNPA	01/21 →
TARRACO 2.0 TSI 4Drive	DKZA	11/18 →

SKODA		
KAROQ 2.0 TSI 4x4	DKZA, DNNA	04/19 →
KODIAQ 2.0 TSI 4x4	CZPA, DKZA, DNNA	10/16 →
OCTAVIA III 1.8 TSI	CJSA, CJSB	11/12 →
OCTAVIA III 1.8 TSI 4x4	CJSA, CJSB	11/12 →
OCTAVIA III 2.0 TSI	DKZA	02/17 →
OCTAVIA III 2.0 TSI 4x4	DKZA	02/19 →
SUPERB III 1.8 TSI	CJSA, CJSC	03/15 →

VW		
ARTEON 2.0 TSI	CZPB, DKZA, DNNA	05/17 →
ARTEON 2.0 TSI 4motion	DJHC, DLRB	06/20 →
BEETLE 2.0 TSI	CPLA, CPPA, CULC	12/12 → 07/19
POLO VI 2.0 GTI	CZPC, DKZC	11/17 →
GOLF VII 1.8 TSI 4motion	CJSB	12/14 →
GOLF VII 2.0 GTI	CXCA, CXDA	04/13 →
GOLF VII 2.0 GTI TCR	CJXH, DNUC	11/18 →
GOLF VII 2.0 R 4motion	CJXC, CJXD, CJXG, DJHA, DJHB, DNUC, DNUÉ	11/13 →
PASSAT VI 1.8 TSI	CJSA, CJSC	02/15 →
PASSAT VI 2.0 TSI	CXDA, CZPB, DKZA, DRFA	08/14 →
GOLF VIII 2.0 GTI	DNPA	09/20 →
GOLF VIII 2.0 GTI Clubsport	DNFC	10/20 →
GOLF VIII 2.0 TSI R 4motion	DNFG, DSFE, DSFF	09/20 →
JETTA VI 1.8 TSI	CPKA, CPRA	07/14 →
JETTA VI 2.0 TSI	CPLA, CPPA	12/12 → 12/17
MULTIVAN 2.0 TSI	DRNB	10/21 →
POLO V 1.8 GTI	DAJA, DAJB	11/14 →
PASSAT V 1.8 TSI	CPKA, CPRA	06/13 →
T-ROC 2.0 R 4motion	DNFC, DNUÉ	09/19 →
T-ROC 2.0 TSI 4motion	CZPB, DKZA, DNNA	07/17 →
TIGUAN II 2.0 TSI	DGUA, DTEA	04/17 →
TIGUAN II 2.0 TSI 4motion	CXDA, CZPA, DGUA, DGVA, DKZA, DNJA, DNLA, DNNA, DNPA, DTEA	01/16 →
TIGUAN II 2.0 TSI R 4motion	DNFG	11/20 →
TOUAREG II 2.0 TFSI 4motion	CYRC	05/18 →
TOURAN II 1.8 TSI	CJSA	11/15 →

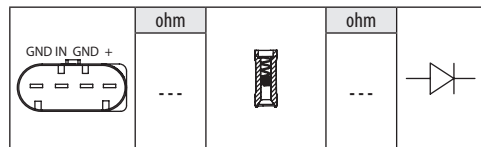

AUDI			
A1 1.8 TFSI	DAJB	02/15 →	10/18
A1 40 TFSI	CZPC, DKZC, DNND	09/18 →	
A4 IV 1.8 TFSI	CJEB	11/11 →	12/15
A4 IV 1.8 TFSI quattro	CJEB	11/11 →	12/15
A4 IV 2.0 TFSI	CNCD	05/13 →	12/15
A4 IV 2.0 TFSI quattro	CNCD	05/13 →	12/15
A3 III 1.8 TFSI	CJSA, CJSB, CNSB	04/12 →	
A3 III 1.8 TFSI quattro	CJSB	08/12 →	

KW 470 638



05,5

COILS

Adatt./Suitable:

HYUNDAI
27301-04110
KIA
27301-04110

NEW - ITEM NOW AVAILABLE FROM PRODUCTION

- NUOVO - ARTICOLO ORA DISPONIBILE PER LA VENDITA
- NOUVEAU - ARTICLE DISPONIBLE EN PRODUCTION COURANTE
- NEU - JETZT ZUM VERKAUF VERFÜGBARER ARTIKEL
- NUEVO - ARTICULO AHORA DISPONIBLE EN PRODUCCION

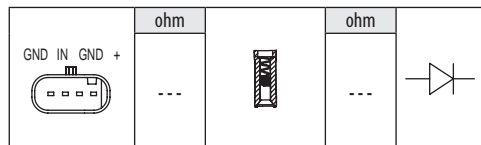

HYUNDAI

I20 II 1.0 T-GDi	G3LC	09/15 →
I30 III 1.0 T-GDi	G3LC	11/16 →
KONA 1.0 T-GDi	G3LC	07/17 →

KIA

CEED II 1.0 T-GDi	G3LC	04/15 → 07/18
CEED III 1.0 T-GDi	G3LC	03/18 →
CEED III T-GDi	G3LC	03/18 →
PICANTO III 1.0	G3LA, G3LD	03/17 →
PICANTO III 1.0 LPG	G3LA	11/18 →
PICANTO III 1.0 T-GDi	G3LC	03/17 →
PROCEED 1.0 T-GDi	G3LC	10/18 →
PRO CEE'D II 1.0 T-GDi	G3LC	07/15 → 07/18
RIO IV 1.0 T-GDi 100	G3LC, G3LE	01/17 →
RIO IV 1.0 T-GDi 100 Eco-Dynamics+	G3LF	02/17 →
RIO IV 1.0 T-GDi 120	G3LC	01/17 →
STONIC 1.0 T-GDi	G3LC	07/17 →
XCEED 1.0 T-GDi	G3LC	06/19 →

KW 470 645



05,5

COILS

Adatt./Suitable:

TOYOTA
90919-02271

NEW - ITEM NOW AVAILABLE FROM PRODUCTION

- NUOVO - ARTICOLO ORA DISPONIBILE PER LA VENDITA
- NOUVEAU - ARTICLE DISPONIBLE EN PRODUCTION COURANTE
- NEU - JETZT ZUM VERKAUF VERFÜGBARER ARTIKEL
- NUEVO - ARTICULO AHORA DISPONIBLE EN PRODUCCION

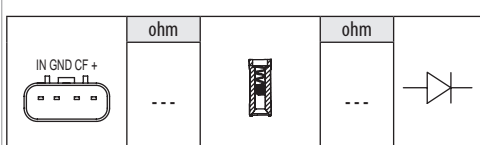

TOYOTA

AURIS II 1.2	8NR-FTS	03/15 → 12/18
C-HR 1.2	8NR-FTS	10/16 →
C-HR 1.2 4WD	8NR-FTS	10/16 →
COROLLA 1.2	8NR-FTS	01/19 →

KW 470 647



05,5

COILS

Adatt./Suitable:

HYUNDAI
27301-03HA0
KIA
27301-03HA0

NEW - ITEM NOW AVAILABLE FROM PRODUCTION

- NUOVO - ARTICOLO ORA DISPONIBILE PER LA VENDITA
- NOUVEAU - ARTICLE DISPONIBLE EN PRODUCTION COURANTE
- NEU - JETZT ZUM VERKAUF VERFÜGBARER ARTIKEL
- NUEVO - ARTICULO AHORA DISPONIBLE EN PRODUCCION

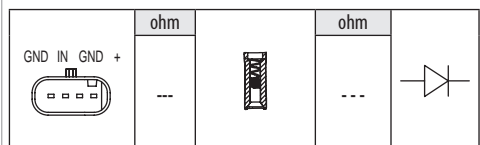
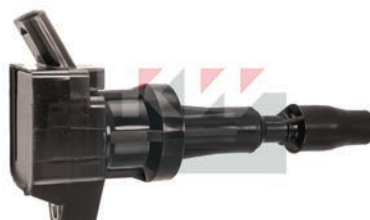

HYUNDAI

IONIQ 1.6 GDi Hybrid	G4LE	03/16 →
IONIQ 1.6 GDi Plug-in Hybrid	G4LE	03/16 →
KONA 1.6 GDi Hybrid	G4LE	06/19 →

KIA

CEED III 1.6 GDi Hybrid	G4LE	12/19 →
CEED III GDi Hybrid	G4LE	12/19 →
NIRO 1.6 GDi Hybrid	G4LE	09/16 →
NIRO GDi Hybrid	G4LE	09/16 →
XCEED 1.6 GDi Hybrid	G4LE	12/19 →

KW 490 303



07,5

COILS

Adatt./Suitable:

FIAT
7588436
7746226
LANCIA
7588436
MAGNETI MARELLI
064825072010
581700540000
581700540010
648 250 72
AEI 600 C
AEI 600 F

Supplied until depletion

- Fornibile fino ad esaurimento delle scorte
- Fourni jusqu'à épuisement du stock
- Lieferbar solange vorrat reicht
- Suministrado hasta el stock termina

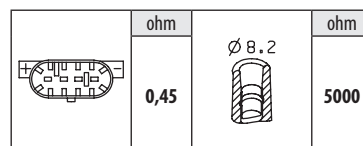

FIAT

COUPE 2.0 16V	836A3.000	11/93 → 08/96
COUPE 2.0 16V [BRA]	836A3.011	11/93 → 08/96
CROMA I 2000 i.e.	154C3.000, 834B.000	03/87 → 09/92
CROMA I 2000 i.e. Turbo	154C4.000, 154C4.046, 834C.146	11/86 → 08/96
TEMPRA 1.8 4x4	159A4.000	07/92 → 06/93
TEMPRA 1.8 i.e.	159A4.000, 159A4.046	03/90 → 08/96
TEMPRA 2.0	159A6.046	04/90 → 06/93
TEMPRA 2.0 i.e.	159A6.046	10/90 → 09/96
TEMPRA 2.0 i.e. [BRA]	159A6.011	04/93 → 12/96
TEMPRA 2.0 i.e. 4x4	159A6.046	03/92 → 03/95
TIPO I 1.8 i.e.	159A4.000, 159A4.046	10/90 → 06/93
TIPO I 1.8 i.e. 16V Sport	160A5.000	11/89 → 06/92
TIPO I 2.0	159A5.046, 159A6.046, 836A3.011	10/90 → 04/95
TIPO I 2.0 16V	160A8.046	07/91 → 04/95
TIPO I 2.0 i.e.	159A5.046, 159A6.046	03/90 → 04/95
TIPO I 2.0 i.e. [BRA]	159A6.011	03/93 → 10/95
TIPO I 2.0 i.e. 16V Sport	836A3.000	03/93 → 04/95
UNO 1.3 Turbo i.e.	146A2.000, 146A2.246	04/85 → 03/91
UNO 1.4 Turbo i.e.	146A8.000, 146A8.046	09/89 → 12/96

FIAT (BR)

COUPE 2.0i 16V	2.0Mpi	01/95 → 12/97
TIPO 2.0i 16V	2.0Mpi	01/94 → 12/95
TIPO 2.0i 8v	2.0Mpi	01/94 → 12/95
UNO 1.4i Turbo	1.4Mpi	01/94 → 12/96

LANCIA

DEDRA 1.6	835A1000	07/94 → 02/97
DEDRA 1.6 i.e.	835A1.000	08/89 → 06/94
DEDRA 1.8 i.e.	835A2.000, 835A2.046, 835C5.000	09/89 → 07/99
DEDRA 2.0 16V	836A3.000	07/94 → 07/99
DEDRA 2.0 HF Integrale	835A7.046	11/90 → 07/94
DEDRA 2.0 i.e.	835A5.000, 835A5.046	09/89 → 07/99
DEDRA 2.0 i.e. Turbo	835A8.046	04/91 → 07/99
DEDRA 2.0 i.e. Turbo Integrale	835A7.000	04/90 → 08/91
DEDRA 2.0 Integrale	836A3.000	07/94 → 07/99
DEDRA 2.0 Turbo	835A8.000	11/90 → 06/94
DELTA I 2.0 16V HF Integrale	831D5.000	03/89 → 09/91
DELTA I 2.0 HF Integrale	831C5.046	12/86 → 12/92
DELTA II 2.0 16V	836A3.000	06/93 → 08/99
THEMA 8.32	F105L, F105L.046	09/87 → 05/92

KW 490 414



07

COILS

Adatt./Suitable:

AUDI

6N0 905 104
867 905 352

BOSCH

0 986 221 000
1 227 022 030
1 227 030 030

DENSO

DIC-0200

HITACHI

138419
138701
2508419

MAGNETI MARELLI

060717004012
060717005012
060717007012
060717008012

SEAT

6N0 905 104
867 905 352

SKODA

004 050 014
004 050 016
6N0 905 104

TELEFUNKEN

311 354
339 700

VW

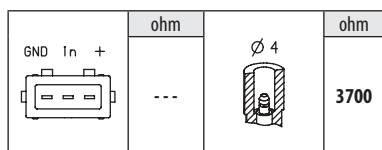
6N0 905 104
867 905 352

AUDI			
80 IV 2.0 E	ABK	09/91 ⇨	01/96
80 IV 2.0 E quattro	ABK	09/91 ⇨	12/94
CABRIOLET 2.0 E	ABK	01/93 ⇨	07/98
COUPE 2.0	ABK	05/89 ⇨	12/96

SEAT			
ALHAMBRA I / II 2.0	ADY	03/96 ⇨	03/10
ALHAMBRA I / II 2.0 i	ADY	04/96 ⇨	03/10
AROSA 1.0	AER, ALL	05/97 ⇨	06/04
AROSA 1.4	AEX, AKV, APQ	05/97 ⇨	06/04
CORDOBA I 1.0 16V	AST, AVZ	05/00 ⇨	10/02
CORDOBA I 1.0 CL	AAU	02/93 ⇨	06/96
CORDOBA I 1.0 i	AER	09/96 ⇨	10/02
CORDOBA I 1.3	AAV	02/93 ⇨	08/94
CORDOBA I 1.4	ANX	12/97 ⇨	04/99
CORDOBA I 1.4 i	ABD, AEX, AKV, APQ	06/94 ⇨	12/02
CORDOBA I 1.4 i 16V	AFH	09/96 ⇨	10/02
CORDOBA I 1.6 i	1F, ABU, AEE, AFT, ALM	02/93 ⇨	06/99
CORDOBA I 1.8 i	ABS, ACC, ADZ	02/93 ⇨	09/02
CORDOBA I 1.8 i 16V	148D	10/93 ⇨	08/96
CORDOBA I 2.0 i	2E, AGG	02/93 ⇨	06/99
CORDOBA I 2.0 i 16V	ABF	08/96 ⇨	06/99
IBIZA II 1.0	AAU	03/93 ⇨	09/96
IBIZA II 1.0 16V	AST, AVZ	10/99 ⇨	02/02
IBIZA II 1.0 i	AER	09/96 ⇨	02/02
IBIZA II 1.3 i	AAV	03/93 ⇨	08/99
IBIZA II 1.4 i	ABD, AEX	09/93 ⇨	02/02
IBIZA II 1.4 i 16V	AFH	06/97 ⇨	02/02
IBIZA II 1.6 i	1F, ABU, AEE, AFT, ALM	03/93 ⇨	06/99
IBIZA II 1.8 i	ABS, ACC, ADZ	03/93 ⇨	08/99
IBIZA II 1.8 i 16V	148D	11/93 ⇨	08/96
IBIZA II 2.0 i	2E, AGG	03/93 ⇨	08/99
IBIZA II 2.0 i 16V	ABF	08/96 ⇨	08/99
INCA 1.4 i	AEX, AKV, APQ	11/95 ⇨	06/03
INCA 1.6 i	1F, AEE	11/95 ⇨	05/98
TOLEDO I 1.6 i	1F, ABN, AFT, EZ	05/91 ⇨	03/99
TOLEDO I 1.8 i	ABS, ADZ	11/93 ⇨	12/96

SEAT			
TOLEDO I 2.0 i	2E, AGG	05/91 ⇨	03/99
TOLEDO I 2.0 i 16V	ABF	11/93 ⇨	03/99
SKODA			
FAVORIT 1.3	135B, 136B, 781.135E	09/91 ⇨	06/97
FAVORIT 1.3 135 X, LX, GLX	781.135E	01/90 ⇨	09/94
FELICIA 1.3	061GW4G15K, 135, 135I, 136I, 136B	10/94 ⇨	04/02
FELICIA 1.3 LXI	136I	08/95 ⇨	03/98
FELICIA 1.6	AEE	06/97 ⇨	04/02
FELICIA 1.6 GLX	AEE	08/95 ⇨	03/98
FELICIA 1.6 LX	AEE	08/95 ⇨	03/98
OCTAVIA I 1.6	AEE	09/96 ⇨	09/04
VOLKSWAGEN (BR)			
CADDY 1.6i	MY4	11/98 ⇨	
POLO 1.6	MJ3, MY4	07/00 ⇨	
POLO 1.8	MJ2, MYS, MY6	12/96 ⇨	
VW			
POLO II 1.0	AAU, HZ	01/85 ⇨	09/94
POLO II 1.0 Cat	AAU, ACM	08/89 ⇨	09/94
POLO II 1.3	3F	10/90 ⇨	09/94
POLO II 1.3 Cat	2G, 3F, AAV, MH, NZ	07/87 ⇨	09/94
POLO II 1.3 G40	PY	08/90 ⇨	09/94
CADDY II 1.4	AEX, APQ	11/95 ⇨	06/03
CADDY II 1.6	1F, AEE	11/95 ⇨	12/00
CADDY II 60 1.4	AEX, APQ	11/95 ⇨	01/04
CADDY II 75 1.6	1F, AEE	11/95 ⇨	05/97
CADDY III 1.6 [ARG]	UVC	10/05 ⇨	
CORRADO 2.0 i	2E, ADY	04/93 ⇨	12/95
PASSAT III 1.6	1F, ABN, AEK, AFT, EZ	04/88 ⇨	08/96
PASSAT III 1.8	AAM, ABS, ADZ, RP	02/88 ⇨	05/97
PASSAT III 2.0	2E, ADY, AEP, AGG	02/90 ⇨	05/97
PASSAT III 2.0 16V	ABF	01/94 ⇨	05/97
PASSAT III 2.0 Syncro	2E, ADY, AGG	03/90 ⇨	12/96
PASSAT III 2.0i	ACX	08/92 ⇨	12/96
GOLF III 1.4	ABD, AEX	10/91 ⇨	04/99
GOLF III 1.6	ABU, AEA, AEE, AEK, AFT, AKS	09/92 ⇨	04/99
GOLF III 1.8	AAM, ABS, ACC, ADZ	08/91 ⇨	04/99
GOLF III 1.8 Syncro	ABS, ADZ	01/93 ⇨	04/99
GOLF III 2.0	2E, ADY, AEP, AGG, AKR	11/91 ⇨	04/99
GOLF III 2.0 GL	AEP	08/95 ⇨	09/97
GOLF III 2.0 GTI 16V	ABF	08/92 ⇨	08/97
GOLF III 2.0 Syncro	AGG	08/95 ⇨	04/99
GOLF IV 1.6	AFT, AKS	06/98 ⇨	06/02
GOLF IV 1.8	AAM, ADZ, ANN, ANP	06/98 ⇨	06/02
GOLF IV 2.0	AGG, AKR, ATU, AWF, AWG	06/98 ⇨	06/02
LUPO 1.0	AER, ALL	09/98 ⇨	07/05
POLO III 1.0	AER, AEV, ALD, ALL, AUC	10/94 ⇨	05/02
POLO III 1.4	AEX, AKV, ANX, APQ	05/97 ⇨	09/01
POLO III 1.4 16V	AFH	10/99 ⇨	09/01
POLO III 1.6	AEA, AEE, AFT, ALM	09/94 ⇨	09/01
POLO III 100 1.4 16V	AFH	04/96 ⇨	10/99
POLO III 100 1.6	AFT	12/95 ⇨	09/01
POLO III 2.0	ADC	08/99 ⇨	09/01
POLO III 45 1.0	AEV	10/94 ⇨	09/96
POLO III 50 1.0	AER, ALD, ALL, AUC	09/96 ⇨	10/99
POLO III 54 1.4	ANX	01/98 ⇨	08/99
POLO III 55 1.3	ADX	10/94 ⇨	04/97
POLO III 55 1.4	AEX, ANX	08/95 ⇨	10/99
POLO III 60 1.4	AEX, AKV, APQ	07/95 ⇨	09/01
POLO III 75 1.6	1F, AEA, AEE, AHS, ALM	10/94 ⇨	10/99
POLO III 90 1.8	ADD	01/97 ⇨	09/01
POLO IV 1.0	AER	08/96 ⇨	12/01
SHARAN 2.0	ADY	09/95 ⇨	03/10
TRANSPORTER IV 2.0	AAC	07/90 ⇨	04/03
TRANSPORTER IV 2.5	AAF, ACU, AET, AEU, APL, AVT	09/90 ⇨	06/03
TRANSPORTER IV 2.5 Syncro	AAF, ACU, AET, AEU, APL, AVT	08/92 ⇨	04/03
VENTO 1.4	ABD, AEX, APQ	11/91 ⇨	09/98
VENTO 1.6	ABU, AEA, AEE, AEK, AFT, AKS	09/92 ⇨	02/99
VENTO 1.8	AAM, ABS, ADZ, ANP	11/91 ⇨	02/99
VENTO 2.0	2E, ADY, AGG, AKR	11/91 ⇨	09/98
VENTO 2.0 GL	AEP	05/96 ⇨	12/97

KW 490 416



07

COILS

Adatt./Suitable:

BOSCH

0 986 221 002

SEAT

701 905 104 A

TELEFUNKEN

310 481

VW

701 905 104 A

⁰⁰ Eliminated on 23-02-2022. Please verify the availability through our local distributors

- Eliminato il 23-02-2022. Verificare la disponibilità presso i nostri distributori
- Éliminé le 23-02-2022. Vérifier la disponibilité auprès de nos distributeurs sur place
- Am 23-02-2022 gestrichen. Evtl. Verfügbarkeit bitte bei unseren Händlern prüfen
- Eliminado en fecha 23-02-2022. Verificar la disponibilidad a través de nuestros distribuidores locales

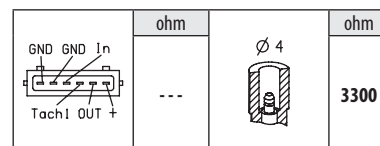

SEAT			
CORDOBA I 1.3	8C20HD0D	02/93 ⇨	08/94
IBIZA II 1.3 i	8C20HD0D	03/93 ⇨	08/99
TOLEDO I 1.8 i	ADZ	11/93 ⇨	12/96
TOLEDO I 2.0 i	AGG	05/91 ⇨	03/99
VW			
POLO II 1.0	HZ	01/85 ⇨	09/94
POLO II 1.0 Cat	ACM	08/89 ⇨	09/94
POLO II 1.3 Cat	2G, MH, NZ	07/87 ⇨	09/94
PASSAT III 1.6	1F, ABN, EZ	04/88 ⇨	07/92
PASSAT III 1.8	AAM, RP	02/88 ⇨	05/97
TRANSPORTER IV 1.8	5K7M710	12/90 ⇨	07/92

KW 490 420



07

COILS

Adatt./Suitable:

AUDI

032 905 106
032 905 106 B
032 905 106 D
032 905 106 E
032 905 106 F

BOSCH

0 221 603 010
0 986 221 048
F 000 Z50 210

HITACHI

138425
138704
2508425
2508704

MAGNETI MARELLI

060717041012
060717042012

SEAT

032 905 106
032 905 106 B
032 905 106 D
032 905 106 E
032 905 106 F

SKODA

032 905 106
032 905 106 B
032 905 106 D
032 905 106 E
032 905 106 F

TELEFUNKEN

311 740

VW

032 905 106
032 905 106 B
032 905 106 D
032 905 106 E
032 905 106 F
06B 905 106 A

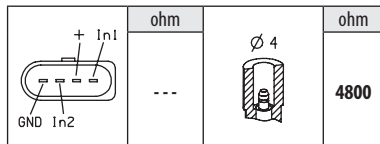

AUDI

A1 1.2 TFSI	CBZA	05/10 ⇒ 04/15
A2 1.4	AUA	02/00 ⇒ 08/05
A3 1.6	AEH, AKL, APF, AVU, BFQ	08/00 ⇒ 05/03
A3 1.8	AGN, APG	09/96 ⇒ 05/03
A3 II 1.2 TFSI	CBZB	03/10 ⇒ 05/13
A3 II 1.2 TSI	CBZB	04/10 ⇒ 03/13
A3 II 1.6	BGU, BSE, BSF, CCSA	05/03 ⇒ 03/13
A3 II 1.6 E-Power	CCSA, CMXA	01/11 ⇒ 03/13
A4 II 1.6	ALZ	11/00 ⇒ 12/04
A4 I 1.6	AHL, ALZ, ANA, ARM	07/00 ⇒ 09/01
A4 III 1.6	ALZ	11/04 ⇒ 06/08

SEAT

ALHAMBRA I / II 2.0	ATM	03/96 ⇒ 03/10
ALHAMBRA I / II 2.0 i	ATM	04/96 ⇒ 03/10
ALTEA 1.2 TSI	CBZB	04/10 ⇒
ALTEA 1.6	BGU, BSE, BSF, CCSA	03/04 ⇒
ALTEA 1.6 LPG	CHGA	09/09 ⇒
ALTEA 1.6 Multifuel	CMXA	11/10 ⇒ 05/11
ALTEA XL 1.2 TSI	CBZB	04/10 ⇒
ALTEA XL 1.6	BGU, BSE, BSF, CCSA	10/06 ⇒
ALTEA XL 1.6 LPG	CHGA	09/09 ⇒
ALTEA XL 1.6 Multifuel	BSE, BSF, CCSA, CMXA	10/06 ⇒ 11/10
AROSA 1.0	ALD, ANV, AUC	05/97 ⇒ 06/04
AROSA 1.4	AKK, ANW, AUD	05/97 ⇒ 06/04
AROSA 1.4 16V	AFK, AQQ, AUB	01/00 ⇒ 06/04
CORDOBA I 1.4 16V	2CJXE, AUA	06/99 ⇒ 12/02
CORDOBA I 1.6 i	AKL	07/96 ⇒ 10/02
EXEO 1.6	ALZ	03/09 ⇒ 09/10
EXEO 1.8 T	CFMA	12/08 ⇒ 05/10
IBIZA II 1.0 i	AUC	09/96 ⇒ 02/02

SEAT

IBIZA II 1.4 16V	2CJXE, AUA	05/00 ⇒ 02/02
IBIZA II 1.4 i	AUD	09/93 ⇒ 02/02
IBIZA II 1.4 i 16V	AQQ	06/97 ⇒ 02/02
IBIZA II 1.6 i	AKL	04/96 ⇒ 02/02
IBIZA III 1.4 16V	AUB	02/02 ⇒ 11/09
IBIZA III 1.6	BAH	02/03 ⇒ 11/09
IBIZA III 2.0	AZL, BBX	04/02 ⇒ 11/09
CORDOBA II 1.6	BAH	04/03 ⇒ 11/09
CORDOBA II 2.0	AZL, BBX	09/02 ⇒ 11/09
IBIZA IV 1.2 TSI	CBZA, CBZB	09/10 ⇒ 05/15
IBIZA IV 2.0	CEKA	10/08 ⇒ 05/15
INCA 1.4 16V	AUA	04/00 ⇒ 06/03
INCA 1.4 i	AUD	11/95 ⇒ 06/03
LEON I 1.4 16V	2CJXE, AHW, AXP	11/99 ⇒ 06/06
LEON I 1.6	AEH, AKL, BFQ	10/05 ⇒ 06/06
LEON I 1.6 16V	AUS	09/00 ⇒ 06/06
LEON I 1.8 20V	AGN, APG	11/99 ⇒ 06/06
LEON II 1.2 TSI	CBZB	02/10 ⇒ 12/12
LEON II 1.6	BSE, BSF, CCSA	07/05 ⇒ 12/12
LEON II 1.6 LPG	CHGA	12/09 ⇒ 12/12
LEON II 1.6 MultiFuel	BSE, CCSA, CMXA	07/05 ⇒ 08/13
TOLEDO II 1.4 16V	2CJXE, AHW, AXP	01/00 ⇒ 05/02
TOLEDO II 1.6	AEH, AKL, APF	10/98 ⇒ 07/04
TOLEDO II 1.6 16V	AUS	06/00 ⇒ 05/06
TOLEDO II 1.8 20V	AGN, APG	10/98 ⇒ 07/04
TOLEDO III 1.6	BGU, BSE, BSF, CCSA	10/04 ⇒ 05/09
TOLEDO IV 1.2 TSI	CBZA, CBZB	07/12 ⇒ 06/15

SKODA

FABIA I 1.4 16V	AUA, AUB, BBY, BBZ	10/99 ⇒ 03/08
FABIA I 2.0	AZL	12/99 ⇒ 03/08
SUPERB I 2.0	AZM	12/01 ⇒ 03/08
OCTAVIA I 1.4 16V	AXP	08/00 ⇒ 12/10
OCTAVIA I 1.6	AEH, AKL, AVU, BFQ	09/00 ⇒ 12/10
OCTAVIA I 1.8	AGN	09/96 ⇒ 07/00
OCTAVIA I 1.8 20V	AGN	07/98 ⇒ 07/00
OCTAVIA I 2.0	AEG, APK, AQY	04/99 ⇒ 05/07
OCTAVIA I 2.0 4x4	AZH	08/00 ⇒ 09/04
OCTAVIA II 1.2 TSI	CBZB	02/10 ⇒ 06/13
OCTAVIA II 1.6	BGU, BSE, BSF, CCSA, CMXA	06/04 ⇒ 06/13
OCTAVIA II 1.6 LPG	BSE, CHGA	08/09 ⇒ 11/12
OCTAVIA II 1.6 MultiFuel	CCSA	01/08 ⇒ 06/13
OCTAVIA II 2.0 [CHN]	BXX., CGZA.	04/07 ⇒
RAPID 1.2 LPG	CBZA	07/12 ⇒ 05/15
RAPID 1.2 TSI	CBZA, CBZB	07/12 ⇒ 05/15
ROOMSTER 1.2 TSI	CBZA, CBZB	03/10 ⇒ 05/15
FABIA II 1.2 TSI	CBZA, CBZB	03/10 ⇒ 12/14
YETI 1.2 TSI	CBZB	09/09 ⇒ 05/15

VOLKSWAGEN (BR)

GOL 1.0i 16v Turbo	512	06/00 ⇒
GOLF A4 1.6i	AKL	10/99 ⇒
GOLF A4 2.0i	APK	08/99 ⇒
PARATI 1.0i 16v Turbo	512	06/00 ⇒
POLO 1.6	BAH, BPA, CCRA	02/02 ⇒
POLO 2.0	BBX	05/02 ⇒

VW

PASSAT IV 1.6	AHL, ALZ, ANA, ARM	10/96 ⇒ 05/05
PASSAT IV 2.0	AZM, BFF	11/00 ⇒ 05/05
PASSAT IV 2.0 [CHN]	BFF, BNL	06/03 ⇒
PASSAT IV 2.0 4motion	AZM	11/00 ⇒ 05/05
GOLF VI 1.2 TSI	CBZA, CBZB	11/08 ⇒
GOLF VI 1.2 TSI BlueMotion	CBZB	05/09 ⇒ 11/12
GOLF VI 1.6	BSE, BSF, CCSA, CMXA	10/08 ⇒
GOLF VI 1.6 BiFuel	BSF	03/09 ⇒
GOLF VI 1.6 MultiFuel	CCSA, CHGA, CMXA	10/08 ⇒
BEETLE 1.2 TSI	CBZB	07/11 ⇒ 07/19
BORA 1.4 16V	AHW, AKQ, APE, AXP	03/00 ⇒ 05/05
BORA 1.6	AEH, AKL, APF, AVU, BFQ	08/00 ⇒ 05/05
BORA 1.6 16V	ATN, AUS	02/00 ⇒ 05/05
BORA 1.8 4motion	AGN	02/99 ⇒ 05/05
BORA 2.0	APK, AQY, AZH	10/98 ⇒ 12/13
BORA 2.0 4motion	AZH	04/00 ⇒ 05/05
CADDY II 1.4	AUA	11/95 ⇒ 01/04
CADDY II 1.4 16V	AUA	08/00 ⇒ 01/04
CADDY II 60 1.4	AUD	11/95 ⇒ 01/04
GOLF V 1.2 TSI	CBZA, CBZB	11/09 ⇒ 12/13
GOLF V 1.6	BGU, BSE, BSF, CCSA, CHGA, CMXA	01/04 ⇒
GOLF V 1.6 BiFuel	CHGA	05/09 ⇒ 12/13
GOLF V 1.6 MultiFuel	CCSA, CMXA	10/07 ⇒ 12/13
GOLF V 2.0	BHY	01/05 ⇒ 11/08
CADDY III 1.2 TSI	CBZA, CBZB	09/10 ⇒ 05/15
CADDY III 1.6	BGU, BRY, BSE, BSF	04/04 ⇒ 05/15
CADDY III 1.6 BiFuel	CHGA	05/11 ⇒ 05/15
FOX 1.0	--, AQZ, BNX, CCNA	10/03 ⇒
FOX 1.0 Alcohol	BJE, BNX	10/03 ⇒
FOX 1.0 Total Flex	CCNA	03/08 ⇒
FOX 1.4	BKR	04/05 ⇒ 12/09

VW

FOX 1.6	BAH, BLH, BPA, CCRA, CFZA	10/03 ⇒ 08/14
FOX 1.6 Alcohol	--	10/03 ⇒
FOX 1.6 Total Flex	BJA, BPA, CCRA	10/03 ⇒ 08/14
JETTA V 1.6	BSE, BSF, CCSA	09/04 ⇒ 10/10
JETTA V 1.6 [CHN]	BJG	01/05 ⇒
JETTA V 1.6 MultiFuel	CCSA	01/08 ⇒ 10/10
PASSAT V 1.6	BSE, BSF	05/05 ⇒ 11/10
GOLF IV 1.4	AXP	05/00 ⇒ 06/06
GOLF IV 1.4 16V	AHW, AKQ, APE, AXP	10/97 ⇒ 06/06
GOLF IV 1.6	AEH, AKL, APF, AUS, AVU, BFQ	05/00 ⇒ 06/06
GOLF IV 1.6 16V	ATN, AUS	02/00 ⇒ 06/06
GOLF IV 1.8	AGN	08/97 ⇒ 06/05
GOLF IV 1.8 4motion	AGN	05/98 ⇒ 06/06
GOLF IV 2.0	APK, AQY	07/98 ⇒ 06/06
GOLF IV 2.0 4motion	AZH	10/00 ⇒ 06/06
GOLF PLUS 1.2 TSI	CBZB	11/09 ⇒ 08/14
JETTA VI 1.2 TSI	CBZB	10/10 ⇒ 12/17
JETTA VI 2.0	CBPA	06/10 ⇒ 12/17
POLO IV 1.4	BLM	08/02 ⇒ 08/10
POLO IV 1.4 16V	AUA	10/01 ⇒ 05/08
POLO IV 1.6	BAH, BPA	08/02 ⇒
POLO IV 1.6 Flex	BPA	12/04 ⇒ 10/14
POLO IV 1.6 Total Flex	BPA	10/04 ⇒ 06/06
POLO IV 2.0	BBX	09/02 ⇒
LUPU 1.0	ALD, ANV, AUC	09/98 ⇒ 07/05
LUPU 1.4	AUD	10/00 ⇒ 07/05
LUPU 1.4 16V	AFK, AHW, AKQ, ANM, APE, AQQ, AUA, AUB	09/98 ⇒ 07/05
LUPU 1.6 GTI	AVY	09/00 ⇒ 07/05
POLO III 1.0	ALD, AUC	05/99 ⇒ 05/02
POLO III 1.4	AKK, AKP, ANW, AUA, AUD	05/97 ⇒ 09/01
POLO III 1.4 16V	AFK, AHW, APE, AUA, AUB	10/99 ⇒ 09/01
POLO III 1.6	AEH, AKL, APF, AUR	05/96 ⇒ 09/01
POLO III 1.6 16V GTI	ARC, AVY	10/99 ⇒ 09/01
POLO III 100 1.4 16V	AFK, AUB	04/96 ⇒ 10/99
POLO III 100 1.6	AEH, AKL, APF, AUR	12/95 ⇒ 09/01
POLO III 120 1.6 16V GTI	AJV	09/98 ⇒ 10/99
POLO III 50 1.0	ALD, AUC	09/96 ⇒ 10/99
POLO III 55 1.4	AKP	08/95 ⇒ 10/99
POLO III 60 1.4	AKK, ANW, AUD	07/95 ⇒ 09/01
POLO III 75 1.4 16V	APE, AUA	10/99 ⇒ 09/01
MULTIVAN 2.0	AXA	11/03 ⇒ 08/15
NEW BEETLE 1.6	AHW, AYD, BFS	06/00 ⇒ 09/10
NEW BEETLE 2.0	AEG, APK, AQY, BER	01/98 ⇒ 10/10
POLO V 1.2 TSI	CBZB, CBZC	11/09 ⇒
POLO V 1.2 TSI BlueMotion	CBZB	11/09 ⇒ 05/14
SHARAN I 2.0	ATM	09/95 ⇒ 03/10
SHARAN I 2.0 LPG	ATM	04/06 ⇒ 03/10
SPACEFOX / SPACE CROSS 1.6	BAH, BLH	03/06 ⇒
SPACEFOX / SPACE CROSS 1.6 FSI	BPA, CCRA, CFZA	03/06 ⇒
SPACEFOX / SPACE CROSS 1.6 Total Flex	BPA, CCRA, CFZA	03/06 ⇒
TOURAN I 1.2 TSI	CBZB	05/10 ⇒ 05/15
TOURAN I 1.6	BGU, BSE, BSF	07/03 ⇒ 05/10
TOURAN I 1.6 BiFuel	BSF	11/06 ⇒ 05/10
TOURAN I 2.0 FSI	BJZ	10/04 ⇒ 05/10
TOURAN I 2.0 TDI [CHN]	CGZA	04/09 ⇒
TRANSPORTER V 1.4 Brasile	BTJ	12/05 ⇒
TRANSPORTER V 2.0	AXA	11/03 ⇒ 08/15
TRANSPORTER V 2.0 BiFuel	AXA	05/11 ⇒ 08/15
TRANSPORTER V 2.0 CNG	AXACNG	11/03 ⇒ 08/15

KW **490 423**

07

COILS

Adatt./Suitable:

BOSCH
0 221 601 012**RENAULT**
74 01 275 174**VOLVO**
1275174**Eliminated on 12-01-2021. Please verify the availability through our local distributors**

- Eliminato il 12-01-2021. Verificare la disponibilità presso i nostri distributori
- Éliminé le 12-01-2021. Vérifier la disponibilité auprès de nos distributeurs sur place
- Am 12-01-2021 gestrichen. Evtl. Verfügbarkeit bitte bei unseren Händlern prüfen
- Eliminado en fecha 12-01-2021. Verificar la disponibilidad a través de nuestros distribuidores locales

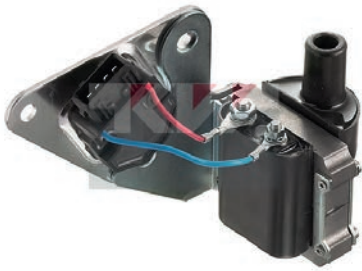

	ohm		ohm
	0,53		8600

RENAULT		
SAFRANE II 2.5 20V	N7U700, N7U701	07/96 ⇨ 12/00
VOLVO		
850 2.0	B5202S, B5204F, B5204FS	06/91 ⇨ 12/96
850 2.0 10V	B5202FS	08/94 ⇨ 12/97
850 2.0 Turbo	B5204FT, B5204T, B5204T2	02/93 ⇨ 10/97
850 2.3	B5234FS	01/96 ⇨ 10/96
850 2.3 T5	9M9T872	02/93 ⇨ 12/96
850 2.3 T5-R	B5234T4	08/95 ⇨ 12/96
850 2.3 Turbo R	B5234T5	06/95 ⇨ 10/97
850 2.4	B5252, B5252FS, B5254S	06/91 ⇨ 12/96
850 2.4 AWD	B5254T	04/96 ⇨ 12/96
850 2.4 GLE	B5254T	09/93 ⇨ 10/97
850 2.5 10V	B5252FS	06/91 ⇨ 12/97
850 2.5 20V	B5254FS	08/91 ⇨ 12/97
C70 I 2.0	B5204T2	03/97 ⇨ 10/05
C70 I 2.4 T	B5254T	03/98 ⇨ 10/05
S70 2.0	B5202FS, B5202S, B5204T2	01/97 ⇨ 11/00
S70 2.0 Turbo	B5204T2, B5204T3	01/97 ⇨ 11/00
S70 2.3	B5234FS, B5234T3	11/96 ⇨ 07/99
S70 2.3 AWD	B5234T7	04/99 ⇨ 09/00
S70 2.3 T-5	B5234T3	01/97 ⇨ 11/00
S70 2.3 T5 AWD	B5234T3, B5234T4	11/96 ⇨ 09/98
S70 2.3 T5-R AWD	B5234T2	11/96 ⇨ 09/98
S70 2.3 Turbo	B5234FT+, B5234T4	01/97 ⇨ 11/00
S70 2.4	B5252FS, B5254FS, B5254S	01/97 ⇨ 11/00
S70 2.4 AWD	B5252FS	11/96 ⇨ 05/99
S70 2.4 Bifuel	GB5252S	10/98 ⇨ 11/00
S70 2.4 T5 AWD	B5254T	11/96 ⇨ 04/99
S70 2.4 Turbo	B5254T	01/97 ⇨ 11/00
S70 2.5 20V	B5254FS	01/97 ⇨ 12/98
S70 2.5 Bifuel	GB5252S2	01/99 ⇨ 12/99
V70 I 2.0	B5202FS, B5202S, B5204T2	12/95 ⇨ 03/00
V70 I 2.0 Turbo	B5204T2, B5204T3	12/95 ⇨ 12/00
V70 I 2.0 Turbo AWD	B5204T3	11/96 ⇨ 12/00
V70 I 2.3	B5234FS, B5234T3	11/96 ⇨ 07/99
V70 I 2.3 AWD	B5234T3, B5234T7	04/97 ⇨ 09/98
V70 I 2.3 T AWD	B5234FT+, B5234T4, B5234T6	04/97 ⇨ 12/98
V70 I 2.3 T-5	B5234T3	11/96 ⇨ 12/00
V70 I 2.3 T-5 AWD	B5234T3	01/97 ⇨ 12/00
V70 I 2.3 Turbo	B5234FT+, B5234T2, B5234T4	12/95 ⇨ 12/98
V70 I 2.4	B5252FS, B5254S	12/95 ⇨ 12/99
V70 I 2.4 Bifuel	GB5252S	05/98 ⇨ 12/99
V70 I 2.4 Turbo	B5254T	04/96 ⇨ 12/00

VOLVO

V70 I 2.4 Turbo AWD	B5254T	04/96 ⇨ 12/00
V70 I 2.5	B5252FS	01/97 ⇨ 03/00
V70 I 2.5 20V	B5254FS	01/97 ⇨ 12/99
V70 I 2.5 Bifuel	GB5252S2	01/99 ⇨ 12/99



CROSS REFERENCE LIST OEM/OES

KW-IGN22Q1

- TABELLA COMPARATIVA OEM/OES - TABLE DE COMPARAISON OEM/OES - VERGLEICHSTABELLE OEM/OES - TABLA DE EQUIVALENCIAS OEM/OES

MANUFACTURER	MANUFACTURER	MANUFACTURER	MANUFACTURER
A	F	M	T
ABARTH	FACET	MARUTI	TALBOT
ACURA	FIAT	MASERATI	TOYOTA
ALFA ROMEO	FIAT (YV)	MAZDA	V
ASTON MARTIN	FORD	MERCEDES-BENZ	VALEO
AUDI	FORD AUSTRALIA	MG	VAUXHALL
B	FORD USA	MINI	VOLVO
BENTLEY	G	MITSUBISHI	VW
BMW	GENERAL MOTORS	N	Y
BOSCH	H	NISSAN	YUGO
C	HITACHI	O	Z
CHEVROLET	HOLDEN	OPEL	ZASTAVA
CHRYSLER	HONDA	P	
CITROËN	HYUNDAI	PEUGEOT	
CUPRA	I	PIAGGIO	
D	INFINITI	PORSCHE	
DACIA	INNOCENTI	PUCH	
DAEWOO	ISUZU	R	
DAF	IVECO	RELIANT	
DAIHATSU	J	RENAULT	
DELPHI	JAGUAR	ROLLS-ROYCE	
DENSO	JEEP	ROVER	
DS	K	S	
DUCATI	KIA	SAAB	
E	L	SEAT	
EFI AUTOMOTIVE	LADA	SKODA	
EPS	LANCIA	SMART	
	LAND ROVER	SOLO	
	LEXUS	SSANGYONG	
		STERLING	
		SUBARU	
		SUZUKI	



MANUFACTURER'S NAMES AND PART NUMBERS ARE QUOTED FOR REFERENCE PURPOSE ONLY.

- I nomi dei fabbricanti e i loro numeri sono menzionati unicamente per facilitare la ricerca della nostra corrispondente parte di ricambio.
- Les noms et références des fabricants sont mentionnées seulement pour faciliter la recherche de nos références.
- Die Namen und Teile-Nr. der Hersteller dienen nur zur Erleichterung bei der Suche unserer Teile-Nr.
- Los nombres de los fabricantes y sus códigos sirven únicamente para la individuación de nuestros productos.



CROSS REFERENCE LIST OEM/OES

KW-IGN22Q1

- TABELLA COMPARATIVA OEM/OES - TABLE DE COMPARAISON OEM/OES - VERGLEICHSTABELLE OEM/OES - TABLA DE EQUIVALENCIAS OEM/OES

AUDI

022 905 100 P	470 434
022 905 715 B	470 434
023 905 207	806 231 ^A
026 905 207 A	815 068
026 905 209	806 129
026 905 225	906 116R
026 905 225 K	915 099R
027 905 207	806 094
027 905 207 A	806 266
030 905 065	406 223
030 905 065 B	406 223
030 905 207	806 094
032 905 106	490 420
032 905 106 B	490 420
032 905 106 D	490 420
032 905 106 E	490 420
032 905 106 F	490 420
034 905 207 B	806 231 ^A
034 998 065	406 219
035 905 105 A	470 126
035 905 207 A	806 093
035 905 225	906 116R
035 905 225 B	906 055R
035 905 225 C	906 059R
036 905 715 A	470 474
036 905 715 F	470 474
036 905 715 G	470 474
043 905 207	806 079
051 905 207	806 266
051 905 225	906 121R
052 905 225 C	906 121R



806 231



DISTRIBUTOR CAPS

Adatt./Suitable: **BOSCH**

AUDI

023 905 207
034 905 207 B

BOSCH

0 290 004 032
0 290 004 035
1 235 522 369
1 235 522 371
1 235 522 385
1 235 522 404
1 235 522 405

VW

023 905 207
034 905 207
034 905 207 A
034 905 207 B
035 905 209 B

^Awithout cover

- senza copertura
- sans revêtement
- ohne Abdeckung
- sin cubierta



AUDI

80 II 2.0	HP, JS	10/83 ⇨ 09/84
80 II 2.0 quattro	JS	10/83 ⇨ 09/84
80 IV 2.3 E	NG	09/91 ⇨ 01/96
80 IV 2.3 E quattro	NG	09/91 ⇨ 11/94
90 I 2.0	HP, JL, JS, SK	10/84 ⇨ 03/87
90 I 2.0 quattro	JS	08/84 ⇨ 08/86
90 I 2.2	HY, KV, KX	10/84 ⇨ 03/87
90 I 2.2 E quattro	KV	11/84 ⇨ 03/87
90 II 2.0	PS	07/88 ⇨ 09/91
90 II 2.0 20 V quattro	NM	08/88 ⇨ 09/91
90 II 2.2 E	KV	04/87 ⇨ 07/91
90 II 2.2 E quattro	KV	04/87 ⇨ 09/91
90 II 2.3 E	NG	04/87 ⇨ 09/91
90 II 2.3 E 20V quattro	7A	06/88 ⇨ 09/91
90 II 2.3 E quattro	NG	04/87 ⇨ 09/91
100 III 2.0	KP	08/84 ⇨ 12/87
100 III 2.0 Cat	RT	01/88 ⇨ 11/90
100 III 2.0 E	KP	01/85 ⇨ 12/87
100 III 2.0 E Cat	RT	01/88 ⇨ 11/90
100 III 2.2 Cat	KU	06/89 ⇨ 11/90
100 III 2.2 Cat quattro	KU	06/89 ⇨ 11/90
100 III 2.2 E Turbo quattro	MC	08/86 ⇨ 11/90
100 III 2.2 Turbo	MC	08/86 ⇨ 11/90
100 III 2.3	NF	08/86 ⇨ 11/90
100 III 2.3 E	NF	10/86 ⇨ 11/90
100 III 2.3 E quattro	NF	08/86 ⇨ 11/90
100 III 2.3 quattro	NF	01/90 ⇨ 11/90
100 IV 2.3 E	AAR	12/90 ⇨ 07/94
100 IV 2.3 E quattro	AAR	12/90 ⇨ 07/94
200 II 2.2	KU	08/84 ⇨ 07/85
200 II 2.2 Turbo	1B, MC	08/85 ⇨ 09/91

ABARTH

46777288	470 442
55224110	470 549
55229959	470 549
55246099	470 442
9937767	930 054R
9939762	430 161/1

ACURA

06302-PT2-000	465 052
06302-PT2-A00	465 052
30102-P54-006	822 068
30102-PM5-A02	822 069
30102-PT2-006	822 068
30102-PV1-A05	822 084
30103-P08-003	922 095
30103-PAI-732	922 056
30103-PM5-A04	922 082
30103-PW0-G02	922 097R
30500-PE0-006	470 212
30500-PM5-A02	470 213
30500-PR4-A02	470 215
30510-P73-A01	470 214
30510-PT2-006	470 214

ALFA ROMEO

510 897	470 101D
700 216	806 079
700 218	906 012R
700 220	706 034HVS
700 291	815 049
700 295	915 091
700 299	615 034
701 707	630 117
705 390	930 051R
705 410	806 079
705 420	406 153
705 559	815 054
105 02 05 011 00/03	730 127
105 48 05 011 00/01	906 012R
105 48 05 011 04/03	730 139
105 48 05 011 06/01	806 076
105 48 05 011 08/02	806 079
115 44 05 011 00/02	906 055R
115 48 05 089 00	359 716
116 34 05 011 00/03	730 139
116 36 05 011 01/01	906 025R
116 42 65 079 00	470 101D
116 55 05 011 00/02	806 079
116 55 05 011 01/01	930 042R
116 55 05 011 01/09	630 117
116 55 05 011 03/01	915 083R
116 55 05 011 03/02	715 055
116 55 05 011 03/04	615 023
116 58 05 011 00/02	930 054R
116 69 05 011 00/02	906 113R
116 97 05 011 00/04	906 061R
119 00 05 011 04/02	806 081
119 11 05 011 00/02	906 024R
130 85 50 06/07	806 062
140 20 05 011 00/01	706 034HVS
140 20 05 011 00/03	906 012R
165 55 05 011 00/02	806 079
195 05 05 011 02/01	906 121R
195 17 05 011 00/02	906 121R
195 32 05 021 00/00	806 236 ^A
195 32 05 023 00/00	906 119R
46337742	470 549
46469863	470 387
46469919	360 608
46469920	360 608
46548037	470 146
46755605	470 397

ALFA ROMEO

46755606	360 607
46756506	360 608
46777288	470 442
46786044	360 608
55200112	470 423
55208723	470 423
55214926	470 549
55224110	470 549
55229959	470 549
55246099	470 442
55263679	470 549
55267630	470 549
55270217	470 549
60513050	806 236 ^A
60513052	906 119R
60522981	359 716
60534261	406 233 ^S
60534855	359 660
60558152	470 168
60562701	470 313
60566481	359 623
60566483	359 623
60567866	359 666
60569567	359 716
60573030	359 660
60573733	359 666
60586072	470 168
60605306	470 386K ¹
60710643	730 127
60714274	730 139
60714282	806 076
60714284	806 079
60723008	906 055R
60727364	730 139
60730437	930 042R
60730444	630 117
60730445	715 055
60731801	930 054R
60732287	906 113R
60735405	806 081
60735860	906 024R
60739126	706 034HVS
60739128	906 012R
60743670	906 121R
60743768	906 121R
60744199	470 101D
60748373	815 049
60748377	915 091
60748381	615 034
60749285	630 117
60749769	930 051R
60749869	815 054
60750065	465 005
60752000	906 055R
60755007	906 061R
60755091	906 123R
60801306	806 079
60805420	470 146
60809492	470 146
60809606	470 168
60810690	470 313
71711984	470 386
71713719	360 607
71713719	360 608
71739725	470 450
71744369	470 450
71779115	470 450
7789742	360 608
7789743	360 608
7793212	470 386
82305237	806 079
96586846	806 079
9916117	915 083R
9927967	906 025R
9938173	930 055R
9938953	406 153

ALFA ROMEO

9940437	906 061R
9950021	906 025R
9950047	930 055R
9950051	830 098
9950055	406 153
9950142	930 059
9950152	615 034
9950519	830 115

ASTON MARTIN

9091902257	470 537
------------	---------

AUDI

022 905 100 P	470 434
022 905 715 B	470 434
022 905 715 D	470 434
023 905 207	806 231 ^A
026 905 207 A	815 068
026 905 209	806 129
026 905 225	906 116R
026 905 225 K	915 099R
027 905 207	806 094
027 905 207 A	806 266
030 905 065	406 223
030 905 065 B	406 223
030 905 207	806 094
032 905 106	490 420
032 905 106 B	490 420
032 905 106 D	490 420
032 905 106 E	490 420
032 905 106 F	490 420
034 905 207 B	806 231 ^A
034 998 065	406 219
035 905 105 A	470 126
035 905 207 A	806 093
035 905 225	906 116R
035 905 225 B	906 055R
035 905 225 C	906 059R
036 905 100 A	470 474
036 905 100 B	470 474
036 905 100 C	470 474
036 905 100 D	470 474
036 905 715	470 474
036 905 715 A	470 474
036 905 715 C	470 474
036 905 715 E	470 474
036 905 715 F	470 474
036 905 715 G	470 474
036 905 715 H	470 474
043 905 207	806 079
04C 905 110 D	470 599
04C 905 110 E	470 599
04C 905 110 H	470 599
04C 905 110 J	470 599
04C 905 110 L	470 599
04E 905 110 B	470 599
04E 905 110 D	470 599
04E 905 110 E	470 599
04E 905 110 K	470 599
04E 905 110 M	470 599
04E 905 110 P	470 599
051 905 207	806 266
051 905 225	906 121R
052 905 225 C	906 121R
055 905 225 B	906 055R
058 905 101	470 354S
058 905 105	470 354S
06A 905 115	470 429
06A 905 115 A	470 429
06A 905 115 B	470 429
06A 905 115 C	470 429

AUDI

06A 905 115 D	470 429
06B 905 115	470 445
06B 905 115 B	470 445
06B 905 115 D	470 429
06B 905 115 E	470 445
06B 905 115 G	470 429
06B 905 115 H	470 429
06B 905 115 J	470 429
06B 905 115 L	470 429
06B 905 115 M	470 429
06B 905 115 N	470 429
06B 905 115 P	470 429
06B 905 115 Q	470 429
06B 905 115 R	470 429
06B 905 115 S	470 429
06C 905 115 A	470 436
06C 905 115 B	470 436
06C 905 115 C	470 429
06C 905 115 D	470 436
06C 905 115 E	470 436
06C 905 115 F	470 436
06C 905 115 G	470 436
06C 905 115 H	470 436
06C 905 115 J	470 436
06C 905 115 K	470 436
06C 905 115 L	470 436
06C 905 115 M	470 436
06D 905 115	470 427
06D 905 115 A	470 427
06D 905 115 C	470 427
06D 905 115 D	470 427
06D 905 115 F	470 427
06D 905 115 G	470 427
06D 905 115 J	470 427
06D 905 115 K	470 427
06E 905 115	470 427
06E 905 115 A	470 427
06E 905 115 B	470 427
06E 905 115 C	470 427
06E 905 115 D	470 427
06E 905 115 E	470 427
06E 905 115 F	470 427
06E 905 115 G	470 427
06F 905 115 C	470 426
06F 905 115 E	470 426
06F 905 115 F	470 426
06H 905 110 D	470 636
06H 905 110 E	470 636
06H 905 110 F	470 636
06H 905 110 G	470 636
06H 905 110 H	470 636
06H 905 110 L	470 636
06H 905 115	470 426
06H 905 115 A	470 426
06H 905 115 B	470 426
06K 905 110 K	470 636
06L 905 110 C	470 636
06L 905 110 D	470 636
06L 905 110 E	470 636
06L 905 110 F	470 636
06L 905 110 H	470 636
06L 905 110 K	470 636
077 905 115 B	470 433
077 905 115 C	470 433
077 905 115 E	470 433
077 905 115 F	470 433
077 905 115 H	470 433
077 905 115 K	470 433
077 905 115 P	470 433
077 905 115 Q	470 433
077 905 115 T	470 433
077 905 205	806 248 ^A
077 905 207	806 248 ^A
07K 905 715 A	470 426
07K 905 715 C	470 426
07K 905 715 D	470 426

AUDI

07K 905 715 F	470 426
07K 905 715 G	470 426
07L 905 115	470 427
07L 905 115 A	470 427
07L 905 115 B	470 427
191 905 351 B	465 007
211 905 115 B	470 132
211 905 115 D	470 125
211 905 351	465 004
251 905 115 A	470 125
4A0 905 351	465 051
4D0 905 351	465 076
6N0 905 104	490 414
811 905 115	470 127
867 905 352	490 414
8D0 905 351	465 072

BENTLEY

06H 905 110 G	470 636
06H 905 110 L	470 636

BMW

1 317 232	470 162S
1 703 227	470 352
1 703 359	470 162S
1 703 360	470 162S
1 715 903	806 238
1 720 166	470 112
1 720 877	470 112
1 726 177	470 162S
1 727 108	470 162S
1 730 520	470 162S
1 730 766	470 162S
1 734 468	470 162S
1 748 017	470 352
1 748 018	470 352
12 11 1 243 843	706 034HVS
12 11 1 267 391	706 034HVS
12 11 1 267 392	706 062
12 11 1 267 393	706 034HVS
12 11 1 267 394	706 049HDVS
12 11 1 267 464	906 024R
12 11 1 271 656	806 062
12 11 1 271 657	806 081
12 11 1 271 687	706 062
12 11 1 272 144	906 055R
12 11 1 272 300	906 061R
12 11 1 276 277	906 112R
12 11 1 284 372	806 121
12 11 1 284 446	906 119R
12 11 1 285 058	806 238 ^A
12 11 1 286 110	906 115R
12 11 1 286 111	906 112R
12 11 1 289 425	806 247
12 11 1 289 519	806 121
12 11 1 304 909	906 117R
12 11 1 326 765	806 094
12 11 1 328 430	906 117R
12 11 1 351 446	806 072
12 11 1 351 447	906 012R
12 11 1 353 117	806 072
12 11 1 354 449	806 079
12 11 1 354 499	806 062
12 11 1 354 501	806 072
12 11 1 354 502	706 034HVS
12 11 1 354 503	906 012R
12 11 1 354 584	706 049HDVS
12 11 1 354 999	806 062
12 11 1 355 211	906 027R
12 11 1 355 624	706 062
12 11 1 355 626	806 081

BMW

12 11 1 356 919	706 049HDVS
12 11 1 357 720	906 115R
12 11 1 359 704	606 212
12 11 1 359 705	706 034HVS
12 11 1 359 706	806 081
12 11 1 359 873	706 034HVS
12 11 1 359 874	806 079
12 11 1 360 305	906 027R
12 11 1 360 306	906 024R
12 11 1 360 648	706 034HVS
12 11 1 361 760	706 034HVS
12 11 1 362 221	906 027R
12 11 1 363 191	806 079
12 11 1 363 291	806 079
12 11 1 363 292	806 081
12 11 1 363 422	806 081
12 11 1 363 423	806 079
12 11 1 706 122	806 094
12 11 1 707 263	906 060R
12 11 1 710 735	906 115R
12 11 1 720 124	806 238
12 11 1 722 649	806 238
12 11 1 725 070	806 238
12 11 1 734 109	806 247 ^A
12 11 1 734 110	906 119R
12 11 8 630 144	906 012R
12 11 8 630 146	806 062
12 11 8 730 024	706 034HVS
12 11 8 730 055	806 062
12 12 1 247 362	359 900
12 12 1 247 363	359 900
12 12 1 247 364	359 900
12 12 1 247 365	359 900
12 12 1 247 511	360 921
12 12 1 247 512	360 921
12 12 1 247 513	360 921
12 12 1 247 514	360 921
12 12 1 247 523	360 921
12 12 1 247 524	360 921
12 12 1 247 525	360 921
12 12 1 247 526	360 921
12 12 1 355 211	906 027R
12 12 1 705 697	359 572
12 12 1 709 206	358 069
12 12 1 709 207	358 069
12 12 1 709 208	358 069
12 12 1 709 209	358 069
12 12 1 717 646	359 573
12 12 1 720 529	359 587
12 12 1 722 253	359 578
12 12 1 726 037	359 597
12 12 1 727 686	359 573
12 12 1 727 855	359 605
12 13 0 148 594	470 475
12 13 0 390 064	470 475
12 13 1 317 232	470 162S
12 13 1 317 585	470 162S
12 13 1 357 296	470 101D
12 13 1 359 637	470 101D
12 13 1 402 440	470 162S
12 13 1 402 713	470 162S
12 13 1 404 102	470 162S
12 13 1 703 228	470 352
12 13 1 703 359	470 162S
12 13 1 703 825	470 352
12 13 1 712 219	470 475
12 13 1 712 223	470 475
12 13 1 720 166	470 112
12 13 1 720 877	470 112
12 13 1 726 177	470 162S
12 13 1 726 178	470 162S
12 13 1 727 108	470 162S
12 13 1 729 842	470 162S
12 13 1 730 765	470 162S
12 13 1 730 766	470 162S
12 13 1 731 884	470 162S

BMW

12 13 1 734 468	470 162S
12 13 1 742 925	470 112
12 13 1 748 017	470 352
12 13 1 748 018	470 352
12 13 1 748 394	470 162S
12 13 1 748 395	470 162S
12 13 5 A06 753	470 475
12 13 7 523 345	470 475
12 13 7 548 553	470 475
12 13 7 550 012	470 475
12 13 7 551 049	470 475
12 13 7 551 260	470 475
12 13 7 559 842	470 607
12 13 7 562 744	470 475
12 13 7 571 643	470 475
12 13 7 571 644	470 607
12 13 7 575 010	470 475
12 13 7 582 627	470 607
12 13 7 594 596	470 475
12 13 7 594 935	470 607
12 13 7 594 936	470 475
12 13 7 594 937	470 475
12 13 7 594 938	470 475
12 13 7 599 218	470 162S
12 13 7 599 219	470 352
12 13 7 619 385	470 632
12 13 7 638 477	470 607
12 13 8 611 236	470 475
12 13 8 615 991	470 632
12 13 8 616 153	470 475
12 13 8 643 360	470 632
12 13 8 647 463	470 632
12 13 8 647 689	470 475
12 13 8 657 273	470 475
12 13 8 678 438	470 632
12 13 9 066 468	470 162S
12 13 9 067 830	470 352
12 14 1 244 089	465 004
12 14 1 244 191	465 004
12 14 1 244 477	465 004
12 14 1 266 702	465 005
12 14 1 273 217	465 005
12 14 1 273 298	465 005
12 14 1 274 698	465 005
17 20 1 66.2	470 112
5 575 010	470 475
7 548 553	470 475
7 551 049	470 475
7 559 842	470 607
7 571 643	470 475
7 594 596	470 475
7 594 935	470 607
7 594 936	470 475
7 599 218	470 162S
7 599 219	470 352
7 638 477	470 607
8 611 236	470 475
8 616 153	470 475
8 643 360	470 632
8 647 689	470 475

BOSCH

0 221 102 088	470 132
0 221 102 090	470 101D
0 221 102 091	470 101D
0 221 118 307	470 180
0 221 118 329	470 178
0 221 118 398	470 126
0 221 119 008	470 101D
0 221 119 018	470 101D
0 221 119 025	470 101D
0 221 119 027	470 101D
0 221 119 035	470 101D
0 221 119 048	470 101D

BOSCH

0 221 122 008	470 169
0 221 122 012	470 103
0 221 122 022	470 132
0 221 122 023	470 132
0 221 122 031	470 169
0 221 122 349	470 125
0 221 122 350	470 125
0 221 122 357	470 126
0 221 122 358	470 126
0 221 122 369	470 194
0 221 122 379	470 127
0 221 122 380	470 127
0 221 122 386	470 125
0 221 122 399	470 126
0 221 122 400	470 126
0 221 122 402	470 191
0 221 122 403	470 191
0 221 122 408	470 192
0 221 122 409	470 192
0 221 123 007	470 101D
0 221 502 009	470 112
0 221 502 431	470 178
0 221 502 433	470 179
0 221 503 001	470 273
0 221 503 003	470 189
0 221 503 004	470 188
0 221 503 006	470 189
0 221 503 011	470 389
0 221 503 014	470 398
0 221 503 022	470 414
0 221 503 024	470 189
0 221 503 025	470 188
0 221 503 035	470 417
0 221 503 036	470 417
0 221 503 407	470 168
0 221 503 457	470 168
0 221 503 468	470 507
0 221 503 471	470 398
0 221 503 485	470 481
0 221 503 486	470 481
0 221 503 487	470 481
0 221 503 491	470 532
0 221 504 004	470 352
0 221 504 006	470 314
0 221 504 026	470 549
0 221 504 029	470 352
0 221 504 036	470 549
0 221 504 100	470 475
0 221 504 410	470 412
0 221 504 456	470 313
0 221 504 463	470 475
0 221 504 467	470 475
0 221 504 471	470 607
0 221 504 472	470 607
0 221 504 474	470 412
0 221 505 437	470 317
0 221 505 438	470 317
0 221 506 002	470 316
0 221 506 003	470 316
0 221 506 444	470 316
0 221 506 445	470 316
0 221 601 012	490 423
0 221 604 001	470 448
0 221 604 008	470 448
0 221 604 010	470 478
0 221 604 014	470 489
0 221 604 115	470 426
0 221 604 116	470 426
0 227 100 030	465 076
0 227 100 100	465 004
0 227 100 101	465 004
0 227 100 102	465 005
0 227 100 103	465 004
0 227 100 104	465 004
0 227 100 110	465 005
0 227 100 111	465 005

BOSCH		BOSCH		BOSCH		BOSCH	
0 986 221 027	470 108	1 234 332 279	906 060R	1 234 332 861	912 096	1 235 522 323	806 092
0 986 221 029	470 155	1 234 332 280	906 027R	1 234 332 902	906 012R	1 235 522 324	806 090
0 986 221 030	470 355	1 234 332 281	906 115R	1 234 332 903	906 014R	1 235 522 325	806 117^{FA}
0 986 221 031	470 356	1 234 332 282	906 049R	1 234 332 904	906 018R	1 235 522 326	806 108
0 986 221 033	470 196	1 234 332 284	906 117R	1 234 332 906	906 021R	1 235 522 327	806 108^{FA}
0 986 221 034	470 403	1 234 332 285	906 026R	1 234 332 907	906 021R	1 235 522 329	806 123
0 986 356 345	358 223	1 234 332 288	906 115R	1 234 332 908	906 025R	1 235 522 330	806 123^{FA}
1 217 013 001	706 060	1 234 332 291	906 067R	1 234 332 918	912 093R	1 235 522 332	806 124
1 217 013 002	706 060	1 234 332 296	906 060R	1 234 335 082	906 014R	1 235 522 333	806 121
1 217 013 003	706 060	1 234 332 300	906 055R	1 234 335 215	906 025R	1 235 522 356	806 079
1 217 013 006	706 060	1 234 332 301	906 055R	1 234 335 216	906 026R	1 235 522 357	806 094
1 217 013 009	706 064	1 234 332 303	906 067R	1 234 335 280	906 027R	1 235 522 361	806 121
1 217 013 015	706 060	1 234 332 305	906 059R	1 234 335 300	906 055R	1 235 522 362	806 081^{FA}
1 217 013 020	706 083	1 234 332 309	906 055R	1 234 335 305	906 059R	1 235 522 364	806 238
1 217 013 021	706 068	1 234 332 313	906 112R	1 234 335 801	912 093R	1 235 522 365	806 238^{FA}
1 217 013 022	706 068	1 234 332 317	906 117R	1 234 335 802	915 091	1 235 522 366	806 127
1 217 013 025	706 083	1 234 332 332	906 024R	1 234 335 805	915 083R	1 235 522 368	806 123
1 217 013 103	706 060	1 234 332 333	906 070R	1 234 335 845	915 088R	1 235 522 369	806 231
1 217 031 015	706 068	1 234 332 337	906 049R	1 235 522 040	806 081	1 235 522 370	806 129
1 220 522 019	470 192	1 234 332 340	906 114R	1 235 522 041	806 081	1 235 522 371	806 231
1 221 122 409	470 192	1 234 332 341	906 122R	1 235 522 050	806 076	1 235 522 372	806 261
1 227 010 003	465 034	1 234 332 343	906 115R	1 235 522 051	806 072	1 235 522 374	806 235
1 227 010 039	465 034	1 234 332 344	906 112R	1 235 522 053	806 081	1 235 522 375	806 266
1 227 020 029	470 191	1 234 332 346	906 113R	1 235 522 056	806 079	1 235 522 380	806 234^{FA}
1 227 022 008	465 004	1 234 332 347	906 119R	1 235 522 058	806 076	1 235 522 381	806 234
1 227 022 030	490 414	1 234 332 348	906 116R	1 235 522 059	806 076	1 235 522 382	806 127^{FA}
1 227 030 030	490 414	1 234 332 349	906 118R	1 235 522 060	806 072	1 235 522 384	806 237
1 227 030 051	470 269	1 234 332 350	906 121R	1 235 522 074	806 092	1 235 522 385	806 231^{FA}
1 227 030 052	470 269	1 234 332 351	906 112R	1 235 522 075	806 081	1 235 522 387	806 236
1 227 030 059	470 386	1 234 332 353	906 117R	1 235 522 103	806 072	1 235 522 388	806 236^{FA}
1 227 030 062	470 387	1 234 332 359	906 055R	1 235 522 107	806 062	1 235 522 390	806 233
1 227 030 071	470 397	1 234 332 360	906 121R	1 235 522 109	806 072	1 235 522 391	806 239
1 230 500 221	406 160	1 234 332 364	906 122R	1 235 522 134	806 062	1 235 522 392	806 239^{FA}
1 230 591 003	806 080	1 234 332 365	906 125R	1 235 522 141	806 076	1 235 522 395	806 128^{FA}
1 230 591 040	806 266	1 234 332 366	906 121R	1 235 522 144	806 076	1 235 522 396	806 247^{FA}
1 234 211 018	406 153	1 234 332 370	906 123R	1 235 522 145	806 076	1 235 522 397	806 247
1 234 211 218	406 153	1 234 332 371	906 122R	1 235 522 146	806 072	1 235 522 399	806 240
1 234 332 024	906 018R	1 234 332 374	906 121R	1 235 522 147	806 072	1 235 522 400	806 240^{FA}
1 234 332 029	906 018R	1 234 332 381	906 127R	1 235 522 154	806 072	1 235 522 401	806 241
1 234 332 030	906 018R	1 234 332 382	906 126R	1 235 522 155	806 079	1 235 522 404	806 231
1 234 332 033	906 012R	1 234 332 387	906 121R	1 235 522 157	806 062	1 235 522 405	806 231^{FA}
1 234 332 062	906 018R	1 234 332 390	906 147R	1 235 522 158	806 072	1 235 522 408	806 260^{FA}
1 234 332 072	906 018R	1 234 332 393	906 121R	1 235 522 159	806 072	1 235 522 409	806 080^{FA}
1 234 332 074	906 012R	1 234 332 395	906 140R	1 235 522 167	806 076	1 235 522 417	806 251^{FA}
1 234 332 076	906 014R	1 234 332 399	906 121R	1 235 522 169	806 076	1 235 522 418	806 251
1 234 332 082	906 014R	1 234 332 401	906 061R	1 235 522 171	806 072	1 235 522 419	806 248
1 234 332 087	906 018R	1 234 332 402	906 121R	1 235 522 173	806 076	1 235 522 420	806 248^{FA}
1 234 332 088	906 018R	1 234 332 408	906 146R	1 235 522 175	806 076	1 235 522 421	806 238
1 234 332 089	906 014R	1 234 332 414	906 121R	1 235 522 176	806 072	1 235 522 423	806 253
1 234 332 106	906 021R	1 234 332 417	906 125R	1 235 522 177	806 072	1 235 522 424	806 080
1 234 332 107	906 021R	1 234 332 421	906 148R	1 235 522 179	806 076	1 235 522 426	806 233
1 234 332 109	906 021R	1 234 332 422	906 146R	1 235 522 181	806 072	1 235 522 434	806 257
1 234 332 144	906 067R	1 234 332 426	906 149R	1 235 522 183	806 079	1 235 522 435	806 257^{FA}
1 234 332 158	906 067R	1 234 332 800	912 093	1 235 522 185	806 079	1 235 522 436	806 249
1 234 332 162	906 067R	1 234 332 801	912 093R	1 235 522 188	806 079	1 235 522 437	806 256
1 234 332 173	906 024R	1 234 332 802	915 091	1 235 522 189	806 079	1 235 522 438	806 258
1 234 332 177	906 023R	1 234 332 803	915 081	1 235 522 193	806 079	1 235 522 439	806 258^{FA}
1 234 332 197	906 024R	1 234 332 805	915 083R	1 235 522 195	806 081	1 235 522 442	806 252^{FA}
1 234 332 200	906 113R	1 234 332 808	930 037	1 235 522 196	806 080	1 235 522 443	806 094
1 234 332 204	906 034R	1 234 332 809	930 037R	1 235 522 198	806 081	1 235 522 444	806 266
1 234 332 208	906 027R	1 234 332 810	930 037	1 235 522 199	806 079	1 235 522 447	806 260
1 234 332 209	906 067R	1 234 332 811	930 037R	1 235 522 201	806 079	1 235 522 449	806 233^{FA}
1 234 332 213	906 025R	1 234 332 812	930 037	1 235 522 202	806 080	1 235 522 453	806 263
1 234 332 215	906 025R	1 234 332 813	930 037R	1 235 522 203	806 079	1 235 522 454	806 263^{FA}
1 234 332 216	906 026R	1 234 332 814	930 036R	1 235 522 208	806 090	1 235 522 456	806 079
1 234 332 220	906 115R	1 234 332 827	913 014	1 235 522 213	806 094	1 235 522 465	806 094
1 234 332 236	906 024R	1 234 332 828	913 014	1 235 522 218	806 093	1 235 522 496	806 080
1 234 332 237	906 024R	1 234 332 836	906 014R	1 235 522 219	806 079	1 235 522 801	812 066
1 234 332 242	906 116R	1 234 332 838	915 088R	1 235 522 227	806 079	1 235 522 803	815 049
1 234 332 261	906 025R	1 234 332 841	915 088R	1 235 522 229	806 081	1 235 522 804	815 041
1 234 332 271	906 061R	1 234 332 845	915 088R	1 235 522 256	806 079	1 235 522 805	815 045
1 234 332 272	906 117R	1 234 332 848	928 012	1 235 522 290	806 081	1 235 522 806	815 045
1 234 332 273	906 056R	1 234 332 849	930 042R	1 235 522 295	806 081	1 235 522 807	830 069
1 234 332 275	906 061R	1 234 332 850	915 083R	1 235 522 307	806 099	1 235 522 810	830 081
1 234 332 276	906 112R	1 234 332 859	946 014R	1 235 522 315	806 079	1 235 522 812	842 043
1 234 332 277	906 117R	1 234 332 860	915 094	1 235 522 322	806 109	1 235 522 816	822 003

BOSCH		BOSCH		BOSCH		BOSCH	
1 235 522 819	822 003	1 237 013 079	706 062	1 237 013 821	742 054	1 987 233 012	831 003/001
1 235 522 822	819 083	1 237 013 081	706 034HVS	1 237 013 824	730 123	1 987 233 020	831 003/001
1 235 522 829	830 086	1 237 013 082	706 049HDVS	1 237 013 826	713 011HV	1 987 233 022	813 093
1 235 522 831	828 075	1 237 013 083	706 034HVS	1 237 013 827	715 076	1 987 233 030	813 262
1 235 522 832	815 059	1 237 013 086	706 062	1 237 013 828	715 111U	1 987 233 032	813 122
1 235 522 835	847 025	1 237 013 087	706 034HVS	1 237 013 831	730 142	1 987 233 033	813 092
1 235 522 836	830 069	1 237 013 088	706 034HVS	1 237 013 832	722 056HV	1 987 233 036	822 011
1 235 522 837	817 014	1 237 013 090	706 034HVS	1 237 013 835	730 127	1 987 233 037	822 022
1 235 522 843	828 078	1 237 013 091	706 062	1 237 013 837	746 071	1 987 233 043	831 118
1 235 522 844	830 090	1 237 013 094	706 034HVS	1 237 013 838	715 086	1 987 233 044	831 121
1 235 522 845	815 054	1 237 013 096	706 034HVS	1 237 013 840	715 102	1 987 233 047	822 057
1 235 522 863	812 073	1 237 013 098	706 034HVS	1 237 013 842	712 055HVS	1 987 233 051	822 040
1 235 522 901	806 076	1 237 013 101	706 047	1 237 013 846	712 055HVS	1 987 233 052	822 046
1 235 522 902	806 072	1 237 013 102	706 029HV	1 237 013 848	715 103	1 987 233 054	813 123
1 235 522 903	806 076	1 237 013 103	706 029HV	1 237 013 901	706 047	1 987 233 055	813 107
1 235 522 904	806 072	1 237 013 105	706 032HV	1 237 013 902	706 029HV	1 987 233 908	822 003
1 235 522 905	806 079	1 237 013 106	706 034HVS	1 237 013 904	706 032HV	1 987 233 912	831 003/001
1 235 522 907	806 062	1 237 013 107	706 040	1 237 013 906	706 034HVS	1 987 234 001	913 014
1 235 522 908	806 079	1 237 013 108	706 062	1 237 013 907	706 040	1 987 234 003	913 014
1 235 522 930	812 066	1 237 013 109	706 034HVS	1 237 013 910	715 055	1 987 234 009	931 023
1 235 522 931	806 080	1 237 013 110	706 034HVS	1 237 013 911	742 054	1 987 234 015	922 052
1 235 525 056	806 079	1 237 013 111	706 034HVS	1 237 013 912	706 049HDVS	1 987 234 021	913 014
1 235 525 059	806 076	1 237 013 112	706 062	1 237 013 913	706 034HVS	1 987 234 024	931 023
1 235 525 196	806 080	1 237 013 113	706 049HDVS	1 237 013 914	706 034HVS	1 987 234 025	913 027
1 235 525 801	812 066	1 237 013 114	706 034HVS	1 237 013 915	706 049HDVS	1 987 234 027	913 029
1 235 525 803	815 049	1 237 013 115	706 062	1 237 013 916	706 034HVS	1 987 234 031	922 073
1 235 525 806	815 045	1 237 013 116	706 034HVS	1 237 013 917	706 034HVS	1 987 234 033	931 113
1 235 525 812	842 043	1 237 013 117	706 034HVS	1 237 013 918	712 055HVS	1 987 234 038	931 110
1 237 000 065	806 241 ^A	1 237 013 119	706 034HVS	1 237 013 919	730 132	1 987 234 041	913 028
1 237 010 027	406 223	1 237 013 121	706 049HDVS	1 237 013 920	730 139	1 987 234 042	922 056
1 237 010 033	406 233	1 237 013 122	706 062	1 237 013 921	730 140	1 987 234 901	913 014
1 237 010 039	406 223	1 237 013 123	706 034HVS	1 237 013 923	706 034HVS	1 987 234 909	931 023
1 237 011 073	406 159	1 237 013 124	706 034HVS	1 237 013 924	712 055HVS	2 207 013 002	706 064
1 237 011 076	406 193	1 237 013 125	706 034HVS	1 237 015 802	712 055HVS	2 207 013 003	706 064
1 237 011 081	406 219	1 237 013 129	706 049HDVS	1 237 015 804	730 132	2 207 013 004	706 071
1 237 011 111	406 193	1 237 013 130	706 034HVS	1 237 015 805	730 139	2 207 013 005	706 071
1 237 011 114	406 233	1 237 013 138	706 034HVS	1 237 015 806	730 140	2 207 013 007	706 064
1 237 011 119	406 234	1 237 013 139	706 062	1 237 015 808	715 055	2 207 110 007	706 071
1 237 011 122	406 223	1 237 013 140	706 034HVS	1 237 015 821	742 054	2 207 330 011	606 030
1 237 011 124	406 223	1 237 013 143	706 062	1 237 015 848	715 103	2 207 330 041	606 180
1 237 013 000	706 047	1 237 013 144	706 034HVS	1 237 031 093	406 244	2 207 330 050	606 180
1 237 013 001	706 047	1 237 013 145	706 034HVS	1 237 031 123	406 153 ^S	9 220 332 702	470 101D
1 237 013 002	706 034HVS	1 237 013 146	706 049HDVS	1 237 031 180	406 233	9 230 087 016	406 153 ^N
1 237 013 003	706 047	1 237 013 147	706 049HDVS	1 237 031 296	406 223	9 230 087 019	406 153 ^N
1 237 013 006	706 029HV	1 237 013 150	706 034HVS	1 237 031 339	406 244	9 230 087 030	406 153 ^N
1 237 013 007	706 029HV	1 237 013 151	706 049HDVS	1 237 330 035	606 030	9 230 087 036	406 153 ^N
1 237 013 008	706 021	1 237 013 152	706 049HDVS	1 237 330 036	606 030	9 230 087 038	406 153 ^N
1 237 013 009	706 029HV	1 237 013 157	706 049HDVS	1 237 330 039	606 030	9 230 087 039	406 153 ^N
1 237 013 010	706 029HV	1 237 013 158	706 049HDVS	1 237 330 307	606 212	9 230 087 044	406 153 ^N
1 237 013 025	706 029HV	1 237 013 300	715 106	1 237 330 310	606 196	9 230 087 046	406 153 ^N
1 237 013 027	706 021	1 237 013 302	715 106	1 237 330 316	606 195	9 230 087 056	406 153 ^N
1 237 013 029	706 029HV	1 237 013 305	715 105	1 237 330 340	606 212	9 230 087 062	406 153 ^N
1 237 013 039	706 032HV	1 237 013 307	736 045	1 237 330 348	606 257	9 230 087 065	406 153 ^N
1 237 013 041	706 021	1 237 013 600	722 056HV	1 237 330 353	606 212	9 231 064 336	906 131
1 237 013 042	706 021	1 237 013 710	706 029HV	1 237 330 801	615 023	9 231 064 346	906 131
1 237 013 044	706 034HVS	1 237 013 712	706 034HVS	1 237 330 803	615 023	9 231 065 501	806 112
1 237 013 045	706 029HV	1 237 013 713	730 120	1 237 330 805	615 034	9 231 065 502	806 072
1 237 013 047	706 021	1 237 013 714	730 132	1 237 330 806	615 034	9 231 065 503	806 072
1 237 013 049	706 029HV	1 237 013 715	719 043HV	1 237 330 810	642 056	9 231 065 504	806 072
1 237 013 051	706 034HVS	1 237 013 717	715 061	1 237 330 811	642 056	9 231 065 506	806 112
1 237 013 052	706 049HDVS	1 237 013 718	715 064	1 237 330 828	630 117	9 231 065 516	806 112
1 237 013 053	706 029HV	1 237 013 719	728 083MHV	1 987 231 000	713 011HV	9 231 065 529	806 244
1 237 013 055	706 032HV	1 237 013 720	715 056	1 987 231 001	713 011HV	9 231 067 027	706 034HVS
1 237 013 056	706 029HV	1 237 013 724	719 044HV	1 987 231 004	722 056HV	9 231 081 319	806 098
1 237 013 057	706 040	1 237 013 728	719 043HV	1 987 231 006	731 084	9 231 081 413	806 098
1 237 013 059	706 049HDVS	1 237 013 802	712 055HVS	1 987 231 015	731 084	9 231 081 628	906 045R
1 237 013 060	706 047	1 237 013 803	730 120	1 987 231 020	713 022HV	9 231 081 678	806 098
1 237 013 061	706 049HDVS	1 237 013 804	730 132	1 987 231 032	731 084	9 231 086 370	806 094
1 237 013 062	706 049HDVS	1 237 013 805	730 139	1 987 231 033	731 085	9 231 087 552	406 160
1 237 013 063	706 034HVS	1 237 013 806	730 140	1 987 231 900	713 011HV	9 231 087 677	906 121R
1 237 013 065	706 034HVS	1 237 013 808	715 055	1 987 231 904	722 056HV	9 231 140 245	806 079
1 237 013 066	706 034HVS	1 237 013 809	715 061	1 987 231 915	731 084	9 231 337 005	717 024
1 237 013 068	706 040	1 237 013 811	715 064	1 987 231 932	731 084	9 231 337 005 706	717 024
1 237 013 074	706 034HVS	1 237 013 812	715 067	1 987 231 933	731 085	9 231 337 041	730 132
1 237 013 075	706 062	1 237 013 814	715 111U	1 987 233 003	831 003/001	9 231 337 072	717 024
1 237 013 077	706 034HVS	1 237 013 819	728 083MHV	1 987 233 008	822 003	9 231 337 072 706	717 024

BOSCH

9 231 337 074	717 026
9 232 081 442	806 094
9 232 337 354	617 097
9 232 337 354 706	617 097
9 233 335 511	817 014
F 000 ZSO 001	470 192
F 000 ZSO 111	470 140
F 000 ZSO 206	470 416*
F 000 ZSO 207	470 416

CHEVROLET

10495411	912 098
25183557	358 249
25186687	470 545
25195107	470 547
25198623	470 547
25200553	470 547
55561655	470 545
55575499	470 547
55577898	470 547
55579072	470 547
55584404	470 545
93740920	831 139
93740921	931 131
93740943	831 172
93740944	931 139
95528319	470 547
96190263	360 677
96211948	360 680
96256433	360 634
96288956	358 006
96291306	358 007
96305387	360 731
96342284	360 730
96450249	360 509
96453420	470 585
96460220	360 677
96460221	358 247
96460222	358 247
96460223	358 247
96460224	358 247
96476983	470 545
96497773	360 680
96518123	360 634
96651945	358 249
96984145	358 249

CHRYSLER

4773841	360 508
4797685	360 343
4883233	360 507
4883233AB	360 507
5018394AE	360 511
5019593AA	360 345
5033216AC	360 719
5033217AC	360 719
5033218AC	360 719
5033219AC	360 719
5033233AB	360 511
5033233AB	360 990
5033266AA	360 990
5098138AA	470 417
5226535	910 179
55208723	470 423
55214926	470 549
55229959	470 549
56 027 075	919 092
83 300 121	815 059
83 300 122	815 054
83 300 123	815 065
83 300 124	815 063
83 300 126	915 091

CHRYSLER

83 300 127	915 088
83 300 128	915 094
83 300 129	915 097
83 300 133	715 086
83 300 134	715 055
MD338 624	360 764
MD61 9050	831 161
MD611 459	931 109
MD611 526	831 116
MD611 757	931 109
SPW07685AA	360 343
T0267693	906 119R
T0267694	806 236*
T1020357	915 088
T1031135	470 107
T1407311	815 059
T1407311	915 088

CITROËN

16 075 767 80	470 505
16 115 478 80	470 459
2L 548 622 2Y	930 042R
2L 548 635 8B	630 117
54 283 90	915 083R
54 283 90P	915 083R
54 463 39M	715 056
54 524 17C	615 023
54 524 19Z	815 045
54 524 21	915 091
54 524 21W	915 091
54 524 22G	715 055
54 656 04	815 059
54 656 04P	815 059
54 747 41	715 064
54 862 20	630 117
54 862 21M	730 142
54 862 24	830 090
55 081 70	915 091
5900 F1	415 019^N
5900 F6	415 019^N
5900 F7	415 019^N
5900 F8	415 019^N
5900 F9	415 019^N
5900 G2	415 019^N
5900 H5	415 019^N
5900 J3	415 019^N
5900 K1	415 019^N
5900 K7	415 019^N
5900 K8	415 019^N
5904 K3	415 017
5904 K8	415 019
5937 42	906 119R
5940 57	815 087
5941 47	806 252*
5945 48	465 005
5945 51	465 034
5967 K9	359 491
5967 L0	359 674
5967 L1	359 494
5967 L6	359 494
5967 L7	359 674
5967 L8	359 494
5967 L9	360 025
5967 N1	359 494
5967 N2	359 655
5967 N6	360 374
5967 N7	359 674
5967 N9	360 376
5967 P1	360 374
5970 42	470 106
5970 43	470 105
5970 45	470 155
5970 48	470 188

CITROËN

5970 49	470 189
5970 53	470 168
5970 60	470 188
5970 64	470 475
5970 70	470 188
5970 72	470 403
5970 74	470 403
5970 75	470 408
5970 78	470 405
5970 79	470 405
5970 80	470 407
5970 84	470 509
5970 85	470 483
5970 87	470 476
5970 88	470 461
5970 90	470 405
5970 91	470 475
5970 96	470 497
5970 97	470 405
5970 98	470 408
5970 99	470 407
5970 A0	470 476
5970 A5	470 509
5970 A8	470 405
5970 A9	470 403
5970 C0	470 461
5970 C1	470 461
75 520 155	815 058
75 524 767	815 059
75 531 089	630 117
77 002 676 93	906 119R
79 015 927 44	715 076
79 015 927 83	715 103
79 015 937 22	915 088
79 015 948 11	615 034
8970 98	470 408
91 504 912	465 005
91 506 338	465 005
91 538 999	815 077
91 539 003	815 078^M
91 541 615	815 078^M
94 059 373 08	915 096R
94 059 413 28	806 124
95 534 910	815 054
95 534 913	715 086
95 538 865	930 042R
95 539 165	815 058
95 539 596	915 083R
95 547 732	615 034
95 559 241	915 094
95 602 185	906 056R
95 610 822	815 059
95 610 822	915 091
95 611 732	915 094
95 618 396	815 067
95 619 491	806 241
95 624 952	415 017
95 624 985	815 074
95 624 987	415 019
95 643 723	415 019
95 651 019	915 102R
95 659 596	359 747
95 659 654	806 241*
96 001 914	415 019^N
96 002 856	415 019^N
96 004 266	415 019^N
96 010 513	470 105
96 014 242	415 019^N
96 020 587	415 019^N
96 035 284	470 155
96 038 183	815 078^M
96 038 185	815 078^M
96 039 183	415 019^N
96 048 070	465 034
96 054 877	806 252
96 062 288	470 189

CITROËN

96 070 995	359 491
96 074 054	470 188
96 074 954	815 077
96 088 851	359 494
96 094 933	359 674
96 099 747	359 674
96 099 749	359 494
96 161 266	359 494
96 228 897	470 188
96 246 755 80	470 403
96 281 585 80	470 403
96 341 314 80	470 408
96 351 725 80	470 509
96 358 647 80	470 405
96 358 649 80	470 405
96 363 378 80	470 407
96 453 331 80	470 509
96 517 106 80	470 483
96 548 144 80	470 405
96 566 957 80	470 476
96 582 279 80	470 476
96 712 145 80	470 609
96 753 909 80	470 620
97 522 876	465 005
97 530 125	465 005
97 530 780	470 105
97 531 206	470 106
97 531 922	465 005
97 532 831	465 005
97 534 955	359 747
98 067 027 80	470 475
98 078 418 80	470 475
AZ 211-17	715 064
DM 211-15	815 049
DM 211-16	915 091
DM 211-17	715 055
DM 212 08B	470 101D
DM21 18	615 023
DX 211-202A	615 023
DX 211-215A	815 045
GX 061 800 1A	815 045
GX 061 850 1A	615 034

CUPRA

04E 905 110 K	470 599
04E 905 110 P	470 599
06H 905 110 L	470 636
06L 905 110 K	470 636

DACIA

0.0323_GA	615 023
22 43 324 28R	470 613
22 43 325 97R	470 432
22 43 327 34R	470 552
22 43 335 29R	470 432
22 43 361 34R	470 596
22 44 042 52R	358 252
60 01 543 604	470 596
77 00 107 177	470 432
77 00 113 357	470 432
77 00 273 826	358 244
77 00 274 008	470 596
82 00 208 611	470 432
82 00 380 267	470 432
82 00 405 098	470 432
82 00 506 297	358 244
82 00 568 671	470 432
82 00 702 693	470 518
82 00 713 680	358 246
82 00 765 882	470 432
82 00 943 801	358 252

DAEWOO

0001587003	470 316
0001587503	470 316
10467543	812 075
10495411	912 098
10496278	812 075
329010	831 172
329013	931 139
33321-78B40-000	831 139
93740920	831 139
93740921	931 131
93740943	831 172
93740944	931 139
96190263	360 677
96211948	360 680
96256433	360 634
96288956	358 006
96291306	358 007
96305387	360 731
96320818	470 219^U
96336522	470 219^U
96342284	360 730
96450249	360 509
96453420	470 585
96460220	360 677
96497773	360 680
96518123	360 634
NP1149	360 433
NP1332	360 942
TD200C01001	931 131
TS100C00601	831 139

DAF

22 12 12	706 029HV
22 45 64	706 034HVS
22 45 66	906 021R
22 48 85	915 091
22 48 86	715 055
22 48 87	615 023
22 48 88	815 049
52 84 20	906 018R
57 32 24 887	615 023

DAIHATSU

02935-00200	713 011HV
19101-1516	813 262
19101-15160-000	813 262
19101-2507	813 093
19101-25070-000	813 093
19101-87103-000	813 258
19101-87105-000	813 258
19101-87207-000	813 128
19101-87301	822 003
19101-87601-000	813 257
19101-87703	813 094
19101-87703-000	813 094
19102-26150-000	913 014
19102-33012-000	913 014
19102-38210-000	913 027
19102-87101-000	913 028
19102-87102-000	913 028
19102-87204-000	913 014
19102-87206-000	913 030
19102-87207-000	913 034
19102-87701-000	913 014
19102-87703-000	913 029
19102-87704-000	913 030
19102-87705-000	913 029
19103-87204-000	713 022HV
19145-26060-000	713 011HV
19145-87203-000	713 011HV
19145-87204-000	713 022HV

DAIHATSU

19145-87205-000	713 022HV
19145-87206-000	713 011HV
19145-87301	722 056HV
19145-87701	713 011HV
19145-87701-000	713 011HV
19901-87186-000	360 732
19901-87196-000	360 732
19901-87B87-000	360 436
90048-52072-000	470 252
90048-52095-000	470 252
90048-66019-000	360 732
90919-02257	470 537
90919-02262	470 461
99329-35902	713 011HV

DELPHI

1104082	470 450
1104091	470 483
19005212	470 399
19005267	470 487
19005293	470 475
19005316	470 607
19005358	470 545
19005362	470 547
28114820	470 475
28211913	470 609
28276583	470 620
28326927	470 545
28372862	470 475
28400714	470 626
CE20009-12B1	470 450
CE20014-12B1	470 432
CE20042-12B1	470 532
CE20044-12B1	470 532
GN10210-12B1	470 475
GN10236-12B1	470 429
GN10314-12B1	470 461
GN10571-12B1	470 475
GN10572-12B1	470 475

DENSO

029 120-135	813 099
029 120-139	813 114
029 120-152	813 119
029 120-167	813 099
029 120-224	813 278
029 120-227	813 119
029 120-234	813 278
029 120-253	813 257
029 120-255	813 099
029 120-256	813 099
029 120-263	813 251
029 120-265	813 248
029 120-273	813 278
029 120-282	813 252
029 120-321	813 265
029 120-333	813 275
029 120-340	813 267
029 120-357	813 272
029 120-366	813 273
029120-0600	813 093
029120-0601	813 093
029120-0741	813 092
029120-0760	813 094
029120-1020	813 099
029120-1080	813 102
029120-1290	813 113
029120-1390	813 114
029120-1410	813 262
029120-1480	813 117
029120-1510	813 122

DENSO

029120-1520	813 119
029120-1540	813 107
029120-1600	813 240
029120-1700	813 241
029120-1720	813 128
029120-1850	813 123
029120-2120	813 278
029120-2130	813 262
029120-2291	813 245
029120-2311	813 093
029120-2590	813 123
029120-2610	813 258
029180-0240	913 014
029180-0241	913 014
029180-0340	913 014
029180-0430	913 014
029180-0580	913 014
029180-0660	913 027
029180-0910	913 029
029180-0920	913 028
029180-0921	913 028
029180-0930	913 029
029180-0990	913 030
029180-1130	913 030
029180-1230	913 029
029180-1260	913 030
029180-1280	913 034
029180-1300	913 034
029180-1310	913 028
029180-1391	913 028
029350-0200	713 011HV
029350-0270	713 011HV
029350-0550	713 022HV
029350-0650	713 011HV
029350-0660	713 022HV
029350-0690	713 011HV
029350-0740	713 022HV
029350-0820	713 022HV
029350-0860	713 011HV
029700-5430	470 197
029700-6700	470 135
029700-6760	470 170
029700-6770	470 289
029700-6780	470 289
029700-6820	470 202
029700-7050	470 203
029700-7051	470 203^U
029700-7180	470 170
029700-7301	470 322
029700-7531	470 289
029700-7700	470 285S
029700-7910	470 170
029700-8240	470 432
029700-8291	470 432
099 700-061	470 457
099 700-072	470 457
099 700-101	470 522
099 700-114	470 457

DS

5970 91	470 475
96 712 145 80	470 609
96 753 909 80	470 620

DUCATI

11 30 26	606 030
31 30 26	606 030
331.04.0290	606 030
1129.26. 00	606 030
1129.26. 90	606 030
1130.26. 00	606 030

DUCATI

1130.26. 90	606 030
3011.30. 26	606 030
4011.29.2600	606 030
4011.29.2690	606 030
4011.30.2600	606 030
4011.30.2690	606 030

EFI AUTOMOTIVE

1420	359 920
1429	358 244
1431	360 492
1439	358 049
1443	360 681
1514	470 419
151401	470 419
151408	470 518
1543	470 403
154301	470 403
154302	470 405
154303	470 405
155001	470 314
155002	470 386
155003	470 398
155004	470 316
155006	470 397
155009	470 480
155010	470 532
155013	470 376
155014	470 378
155015	470 196
155016	470 596
155017	470 146
155018	470 355
155019	470 356
155020	470 442
155022	470 400
155022	470 400
155025	470 275
155026	490 414
155026	490 414
155027	470 408
155027	470 408
155028	470 459
155028	470 459
155029	470 400
155031	470 509
155032	470 407
155032	470 407
155033	470 188
155034	470 189
155038	470 508
155039	470 450
155039	470 450
155040	470 476
155041	470 476
155045	470 398
155046	470 507
155049	470 475
155050	470 365
155051	470 345
155054	470 434
155056	470 108
155057	470 272
155058	470 148
155059	470 155
155060	470 228
155061	470 107
155062	470 341
155064	470 140
155065	470 158
155066	470 214
155067	470 374
155068	470 394

EPS		EPS		EPS		EPS	
1.312.073	812 073	1.322.040	822 040	1.331.140	831 140	1.413.034	913 034
1.312.074	812 074	1.322.041	822 041	1.331.143	831 143	1.413.036	913 036
1.312.075	812 075	1.322.046	822 046	1.331.144	831 144	1.415.081	915 081
1.313.092	813 092	1.322.048	822 048	1.331.145	831 145	1.415.083R	915 083R
1.313.093	813 093	1.322.057	822 057	1.331.147	831 147	1.415.088	915 088
1.313.094	813 094	1.322.058	822 058	1.331.149	831 149	1.415.088R	915 088R
1.313.099	813 099	1.322.060	822 060	1.331.150	831 150	1.415.089R	915 089R
1.313.102	813 102	1.322.063	822 063	1.331.151	831 151	1.415.091	915 091
1.313.107	813 107	1.322.068	822 068	1.331.152	831 152	1.415.094	915 094
1.313.113	813 113	1.322.069	822 069	1.331.154	831 154	1.415.094R	915 094R
1.313.114	813 114	1.322.071	822 071	1.331.155	831 155	1.415.096R	915 096R
1.313.117	813 117	1.322.073	822 073	1.331.158	831 158	1.415.097	915 097
1.313.119	813 119	1.322.075	822 075	1.331.161	831 161	1.415.099R	915 099R
1.313.122	813 122	1.322.076	822 076	1.331.168	831 168	1.415.101	915 101
1.313.123	813 123	1.322.077	822 077	1.331.169	831 169	1.415.102R	915 102R
1.313.128	813 128	1.322.079	822 079	1.331.170	831 170	1.415.103R	915 103R
1.313.240	813 240	1.322.082	822 082	1.331.172	831 172	1.415.104	915 104
1.313.241	813 241	1.322.084	822 084	1.338.242	838 242	1.417.052	917 052
1.313.245	813 245	1.322.088	822 088	1.338.243	838 243	1.417.052R	917 052R
1.313.248	813 248	1.322.089	822 089	1.342.043	842 043	1.417.058	917 058
1.313.251	813 251	1.322.092	822 092	1.347.025	847 025	1.419.085	919 085
1.313.252	813 252	1.322.093	822 093	1.347.027	847 027	1.419.092	919 092
1.313.254	813 254	1.328.070	828 070	1.406.012R	906 012R	1.419.094R	919 094R
1.313.256	813 256	1.328.075	828 075	1.406.014R	906 014R	1.422.052	922 052
1.313.257	813 257	1.328.078	828 078	1.406.018R	906 018R	1.422.056	922 056
1.313.258	813 258	1.328.083	828 083	1.406.021R	906 021R	1.422.066	922 066
1.313.259	813 259	1.328.085	828 085	1.406.023R	906 023R	1.422.069	922 069
1.313.262	813 262	1.328.091	828 091	1.406.024R	906 024R	1.422.069	922 069
1.313.265	813 265	1.328.093	828 093	1.406.024R	906 024R	1.422.070	922 070
1.313.267	813 267	1.328.093	828 093	1.406.025R	906 025R	1.422.073	922 073
1.313.272	813 272	1.328.094	828 094	1.406.025R	906 025R	1.422.073	922 073
1.313.273	813 273	1.328.096	828 096	1.406.026R	906 026R	1.422.081	922 081
1.313.273	813 273	1.328.098	828 098	1.406.027R	906 027R	1.422.082	922 082
1.313.275	813 275	1.328.098	828 098	1.406.034R	906 034R	1.422.085	922 085
1.313.275	813 275	1.328.099	828 099	1.406.045R	906 045R	1.422.086	922 086
1.313.278	813 278	1.328.099	828 099	1.406.045R	906 045R	1.422.086	922 086
1.313.278	813 278	1.328.100	828 100	1.406.049R	906 049R	1.422.092	922 092
1.315.041	815 041	1.328.101	828 101	1.406.049R	906 049R	1.422.092	922 092
1.315.045	815 045	1.328.101	828 101	1.406.055R	906 055R	1.422.093	922 093
1.315.049	815 049	1.328.102	828 102	1.406.056R	906 056R	1.422.094	922 094
1.315.054	815 054	1.328.103	828 103	1.406.056R	906 056R	1.422.094	922 094
1.315.058	815 058	1.328.104	828 104	1.406.059R	906 059R	1.422.095	922 095
1.315.059	815 059	1.328.104	828 104	1.406.060R	906 060R	1.422.097R	922 097R
1.315.062	815 062	1.328.105	828 105	1.406.061R	906 061R	1.422.098	922 098
1.315.063	815 063	1.328.106	828 106	1.406.061R	906 061R	1.422.098	922 098
1.315.065	815 065	1.328.106	828 106	1.406.067R	906 067R	1.422.102	922 102
1.315.066	815 066	1.330.059	830 059	1.406.067R	906 067R	1.422.102	922 102
1.315.067	815 067	1.330.069	830 069	1.406.070R	906 070R	1.428.006	928 006
1.315.068	815 068	1.330.069	830 069	1.406.112R	906 112R	1.428.007	928 007
1.315.069	815 069	1.330.076	830 076	1.406.113R	906 113R	1.428.012	928 012
1.315.070	815 070	1.330.081	830 081	1.406.114R	906 114R	1.428.014	928 014
1.315.071	815 071	1.330.082	830 082	1.406.114R	906 114R	1.428.014	928 014
1.315.072	815 072	1.330.082	830 082	1.406.115R	906 115R	1.428.021	928 021
1.315.073	815 073	1.330.086	830 086	1.406.115R	906 115R	1.428.021	928 021
1.315.074	815 074	1.330.086	830 086	1.406.116R	906 116R	1.428.022	928 022
1.315.075	815 075	1.330.086	830 086	1.406.116R	906 116R	1.428.022	928 022
1.315.077	815 077	1.330.090	830 090	1.406.117R	906 117R	1.428.024R	928 024R
1.315.078	815 078	1.330.090	830 090	1.406.117R	906 117R	1.428.024R	928 024R
1.315.079	815 079	1.330.093	830 093	1.406.117R	906 117R	1.428.025	928 025
1.315.080	815 080	1.330.093	830 093	1.406.118R	906 118R	1.428.025	928 025
1.315.081	815 081	1.330.098	830 098	1.406.118R	906 118R	1.428.025	928 025
1.315.082	815 082	1.330.098	830 098	1.406.119R	906 119R	1.428.026R	928 026R
1.315.083	815 083	1.330.101	830 101	1.406.121R	906 121R	1.428.027R	928 027R
1.315.084	815 084	1.330.101	830 101	1.406.121R	906 121R	1.428.027R	928 027R
1.315.085	815 085	1.330.104	830 104	1.406.122R	906 122R	1.428.028R	928 028R
1.315.086	815 086	1.330.104	830 104	1.406.122R	906 122R	1.428.028R	928 028R
1.315.087	815 087	1.330.109	830 109	1.406.123R	906 123R	1.428.029R	928 029R
1.315.088	815 088	1.330.109	830 109	1.406.123R	906 123R	1.428.029R	928 029R
1.315.091	815 091	1.330.110	830 110	1.406.125R	906 125R	1.428.030	928 030
1.317.014	817 014	1.330.110	830 110	1.406.125R	906 125R	1.428.030	928 030
1.317.016	817 016	1.330.111	830 111	1.406.126R	906 126R	1.430.029	930 029
1.317.023	817 023	1.330.111	830 111	1.406.126R	906 126R	1.430.029	930 029
1.317.029	817 029	1.330.114	830 114	1.406.127R	906 127R	1.430.036R	930 036R
1.319.083	819 083	1.330.114	830 114	1.406.127R	906 127R	1.430.036R	930 036R
1.319.092	819 092	1.330.115	830 115	1.406.131	906 131	1.430.037	930 037
1.319.093	819 093	1.330.115	830 115	1.406.131	906 131	1.430.037	930 037
1.322.003	822 003	1.330.116	830 116	1.406.140R	906 140R	1.430.037R	930 037R
1.322.011	822 011	1.331.003/00	831 003/001	1.406.140R	906 140R	1.430.037R	930 037R
1.322.022	822 022	1.331.109	831 109	1.406.146R	906 146R	1.430.040	930 040
		1.331.109	831 109	1.406.146R	906 146R	1.430.040	930 040
		1.331.114	831 114	1.406.147R	906 147R	1.430.041	930 041
		1.331.114	831 114	1.406.147R	906 147R	1.430.041	930 041
		1.331.116	831 116	1.406.148R	906 148R	1.430.042R	930 042R
		1.331.116	831 116	1.406.148R	906 148R	1.430.042R	930 042R
		1.331.117	831 117	1.406.149R	906 149R	1.430.047R	930 047R
		1.331.117	831 117	1.406.149R	906 149R	1.430.047R	930 047R
		1.331.118	831 118	1.407.701R	907 701R	1.430.051R	930 051R
		1.331.118	831 118	1.407.701R	907 701R	1.430.051R	930 051R
		1.331.120	831 120	1.410.179	910 179	1.430.054R	930 054R
		1.331.120	831 120	1.410.179	910 179	1.430.054R	930 054R
		1.331.121	831 121	1.412.090	912 090	1.430.055R	930 055R
		1.331.121	831 121	1.412.090	912 090	1.430.055R	930 055R
		1.331.122	831 122	1.412.093	912 093	1.430.057R	930 057R
		1.331.122	831 122	1.412.093	912 093	1.430.057R	930 057R
		1.331.125	831 125	1.412.093R	912 093R	1.430.058	930 058
		1.331.125	831 125	1.412.093R	912 093R	1.430.058	930 058
		1.331.126	831 126	1.412.095R	912 095R	1.430.059	930 059
		1.331.126	831 126	1.412.095R	912 095R	1.430.059	930 059
		1.331.131	831 131	1.412.096	912 096	1.430.060	930 060
		1.331.131	831 131	1.412.096	912 096	1.430.	

EPS		EPS		EPS		EPS	
1.431.119	931 119	1.500.511	359 511	1.501.373	360 373	1.501.691	360 691
1.431.131	931 131	1.500.513	359 513	1.501.374	360 374	1.501.699	360 699
1.431.132	931 132	1.500.514	359 514	1.501.376	360 376	1.501.702	360 702
1.431.133	931 133	1.500.527	359 527	1.501.385	360 385	1.501.709	360 709
1.431.134	931 134	1.500.539	359 539	1.501.393	360 393	1.501.711	360 711
1.431.136	931 136	1.500.543	359 543	1.501.398	360 398	1.501.719	360 719
1.431.137	931 137	1.500.572	359 572	1.501.399	360 399	1.501.723	360 723
1.431.138	931 138	1.500.573	359 573	1.501.401	360 401	1.501.729	360 729
1.431.139	931 139	1.500.578	359 578	1.501.411	360 411	1.501.730	360 730
1.438.262R	938 262R	1.500.587	359 587	1.501.413	360 413	1.501.731	360 731
1.438.263R	938 263R	1.500.597	359 597	1.501.415	360 415	1.501.732	360 732
1.446.014R	946 014R	1.500.605	359 605	1.501.417	360 417	1.501.738	360 738
1.446.016R	946 016R	1.500.608	359 608	1.501.433	360 433	1.501.739	360 739
1.499.004	358 004	1.500.609	359 609	1.501.434	360 434	1.501.740	360 740
1.499.005	358 005	1.500.612	359 612	1.501.435	360 435	1.501.741	360 741
1.499.006	358 006	1.500.613	359 613	1.501.436	360 436	1.501.745	360 745
1.499.007	358 007	1.500.615	359 615	1.501.443	360 443	1.501.753	360 753
1.499.013	358 013	1.500.616	359 616	1.501.446	360 446	1.501.760	360 760
1.499.020	358 020	1.500.623	359 623	1.501.447	360 447	1.501.764	360 764
1.499.028	358 028	1.500.634	359 634	1.501.451	360 451	1.501.767	360 767
1.499.049	358 049	1.500.650	359 650	1.501.479	360 479	1.501.789	360 789
1.499.059	358 059	1.500.655	359 655	1.501.484	360 484	1.501.792	360 792
1.499.061	358 061	1.500.660	359 660	1.501.489	360 489	1.501.793	360 793
1.499.064	358 064	1.500.666	359 666	1.501.491	360 491	1.501.813	360 813
1.499.069	358 069	1.500.674	359 674	1.501.492	360 492	1.501.817	360 817
1.499.100	358 100	1.500.688	359 688	1.501.497	360 497	1.501.819	360 819
1.499.106	358 106	1.500.689	359 689	1.501.499	360 499	1.501.823	360 823
1.499.107	358 107	1.500.692	359 692	1.501.499	360 499	1.501.823	360 823
1.499.111	358 111	1.500.694	359 694	1.501.501	360 501	1.501.835	360 835
1.499.119	358 119	1.500.700	359 700	1.501.503	360 503	1.501.841	360 841
1.499.120	358 120	1.500.716	359 716	1.501.504	360 504	1.501.851	360 851
1.499.159	358 159	1.500.725	359 725	1.501.505	360 505	1.501.856	360 856
1.499.170	358 170	1.500.725	359 725	1.501.506	360 506	1.501.879	360 879
1.499.170	358 170	1.500.727	359 727	1.501.507	360 507	1.501.880	360 880
1.499.181	358 181	1.500.736	359 736	1.501.507	360 507	1.501.880	360 880
1.499.195	358 195	1.500.737	359 737	1.501.508	360 508	1.501.882	360 882
1.499.199	358 199	1.500.737	359 737	1.501.508	360 508	1.501.882	360 882
1.499.199	358 199	1.500.737	359 737	1.501.509	360 509	1.501.883	360 883
1.499.208	358 208	1.500.747	359 747	1.501.511	360 511	1.501.887	360 887
1.499.208	358 208	1.500.748	359 748	1.501.518	360 518	1.501.888	360 888
1.499.214	358 214	1.500.768	359 768	1.501.527	360 527	1.501.888	360 888
1.499.223	358 223	1.500.780	359 780	1.501.529	360 529	1.501.889	360 889
1.499.229	358 229	1.500.801	359 801	1.501.529	360 529	1.501.900	360 900
1.499.230	358 230	1.500.802	359 802	1.501.531	360 531	1.501.904	360 904
1.499.231	358 231	1.500.802	359 802	1.501.549	360 549	1.501.914	360 914
1.499.231	358 231	1.500.808	359 808	1.501.551	360 551	1.501.921	360 921
1.499.232	358 232	1.500.815	359 815	1.501.559	360 559	1.501.932	360 932
1.499.234	358 234	1.500.839	359 839	1.501.562	360 562	1.501.933	360 933
1.499.235	358 235	1.500.846	359 846	1.501.562	360 562	1.501.937	360 937
1.499.236	358 236	1.500.864	359 864	1.501.568	360 568	1.501.937	360 937
1.499.236	358 236	1.500.864	359 864	1.501.569	360 569	1.501.942	360 942
1.499.239	358 239	1.500.884	359 884	1.501.569	360 569	1.501.942	360 942
1.499.241	358 241	1.500.884	359 884	1.501.575	360 575	1.501.947	360 947
1.499.242	358 242	1.500.887	359 887	1.501.575	360 575	1.501.947	360 947
1.499.242	358 242	1.500.888	359 888	1.501.580	360 580	1.501.976	360 976
1.499.244	358 244	1.500.888	359 888	1.501.585	360 585	1.501.984	360 984
1.499.244	358 244	1.500.889	359 889	1.501.585	360 585	1.501.984	360 984
1.499.245	358 245	1.500.889	359 889	1.501.595	360 595	1.501.990	360 990
1.499.245	358 245	1.500.900	359 900	1.501.601	360 601	1.906.153	406 153
1.499.246	358 246	1.500.920	359 920	1.501.601	360 601	1.906.159	406 159
1.499.247	358 247	1.500.920	359 920	1.501.607	360 607	1.906.160	406 160
1.499.248	358 248	1.500.956	359 956	1.501.608	360 608	1.906.193	406 193
1.499.248	358 248	1.500.965	359 965	1.501.609	360 609	1.906.193	406 193
1.499.249	358 249	1.501.007	360 007	1.501.614	360 614	1.906.219	406 219
1.499.251	358 251	1.501.025	360 025	1.501.614	360 614	1.906.219	406 219
1.499.252	358 252	1.501.025	360 025	1.501.619	360 619	1.906.222	406 222
1.499.252	358 252	1.501.078	360 078	1.501.619	360 619	1.906.222	406 222
1.499.255	358 255	1.501.138	360 138	1.501.624	360 624	1.906.223	406 223
1.500.347	359 347	1.501.138	360 138	1.501.625	360 625	1.906.231	406 231
1.500.351	359 351	1.501.140	360 140	1.501.625	360 625	1.906.231	406 231
1.500.354	359 354	1.501.140	360 140	1.501.630	360 630	1.906.233	406 233
1.500.372	359 372	1.501.145	360 145	1.501.634	360 634	1.906.244	406 244
1.500.386	359 386	1.501.209	360 209	1.501.634	360 634	1.906.244	406 244
1.500.398	359 398	1.501.231	360 231	1.501.639	360 639	1.906.244	406 244
1.500.415	359 415	1.501.237	360 237	1.501.640	360 640	1.912.010	412 010
1.500.415	359 415	1.501.237	360 237	1.501.641	360 641	1.912.011	412 011
1.500.417	359 417	1.501.278	360 278	1.501.641	360 641	1.912.011	412 011
1.500.417	359 417	1.501.281	360 281	1.501.643	360 643	1.915.017	415 017
1.500.429	359 429	1.501.281	360 281	1.501.649	360 649	1.915.019	415 019
1.500.432	359 432	1.501.300	360 300	1.501.649	360 649	1.915.019	415 019
1.500.456	359 456	1.501.305	360 305	1.501.654	360 654	1.928.202	428 202
1.500.466	359 466	1.501.323	360 323	1.501.657	360 657	1.930.161/1	430 161/1
1.500.471	359 471	1.501.332	360 332	1.501.658	360 658	1.930.163/1	430 163/1
1.500.491	359 491	1.501.332	360 332	1.501.660	360 660	1.930.176M	430 176M
1.500.493	359 493	1.501.343	360 343	1.501.660	360 660	1.930.176M	430 176M
1.500.494	359 494	1.501.343	360 343	1.501.667	360 667	1.930.177/1	430 177/1
1.500.507	359 507	1.501.344	360 344	1.501.671	360 671	1.930.178M	430 178M
1.500.509	359 509	1.501.345	360 345	1.501.671	360 671	1.930.178M	430 178M
		1.501.345	360 345	1.501.677	360 677	1.930.180M	430 180M
		1.501.353	360 353	1.501.680	360 680	1.930.182	430 182
		1.501.356	360 356	1.501.681	360 681	1.965.004	465 004
		1.501.363	360 363	1.501.682	360 682	1.965.005	465 005
		1.501.364	360 364	1.501.682	360 682	1.965.007	465 007
				1.501.686	360 686		

FACET		FACET		FACET		FACET	
1.7270	746 070	2.7630/28	813 258	2.8083PHT	828 083	3.7521RS	906 021R
1.7271	746 071	2.7630/29	813 259	2.8085PHT	828 085	3.7523RS	906 023R
1.7350	749 350	2.7630/32	813 262	2.8091PHT	828 091	3.7524RS	906 024R
2.7462	806 062	2.7630/35	813 265	2.8093PHT	828 093	3.7525RS	906 025R
2.7472PHT	806 072	2.7630/37	813 267	2.8094PHT	828 094	3.7526RS	906 026R
2.7476PHT	806 076	2.7630/42	813 272	2.8096PHT	828 096	3.7527RS	906 027R
2.7479PHT	806 079	2.7630/43	813 273	2.8098PHT	828 098	3.7534RS	906 034R
2.7480PHT	806 080	2.7630/45	813 275	2.8099PHT	828 099	3.7545RS	906 045R
2.7481PHT	806 081	2.7630/48	813 278	2.8100PHT	828 100	3.7549RS	906 049R
2.7490PHT	806 090	2.7641	815 041	2.8101PHT	828 101	3.7555RS	906 055R
2.7492PHT	806 092	2.7645	815 045	2.8102	828 102	3.7556RS	906 056R
2.7493PHT	806 093	2.7649PHT	815 049	2.8103	828 103	3.7559RS	906 059R
2.7494PHT	806 094	2.7654PHT	815 054	2.8104	828 104	3.7560RS	906 060R
2.7498	806 098	2.7658PHT	815 058	2.8105	828 105	3.7561RS	906 061R
2.7499	806 099	2.7659PHT	815 059	2.8106	828 106	3.7567RS	906 067R
2.7508PHT	806 108	2.7662PHT	815 062	2.8159	830 059	3.7570RS	906 070R
2.7509PHT	806 109	2.7663PHT	815 063	2.8169	830 069	3.7573/12RS	906 112R
2.7512PHT	806 112	2.7665PHT	815 065	2.8176	830 076	3.7573/13RS	906 113R
2.7517PHT	806 117	2.7666PHT	815 066	2.8181	830 081	3.7573/14RS	906 114R
2.7521PHT	806 121	2.7667PHT	815 067	2.8182	830 082	3.7573/15RS	906 115R
2.7523PHT	806 123	2.7668PHT	815 068	2.8186	830 086	3.7573/16RS	906 116R
2.7524PHT	806 124	2.7669PHT	815 069	2.8190	830 090	3.7573/17RS	906 117R
2.7527PHT	806 127	2.7670	815 070	2.8193	830 093	3.7573/18RS	906 118R
2.7528PHT	806 128	2.7671PHT	815 071	2.8198PHT	830 098	3.7573/19RS	906 119R
2.7529PHT	806 129	2.7672PHT	815 072	2.8201PHT	830 101	3.7573/21RS	906 121R
2.7530/10PHT	806 240	2.7673PHT	815 073	2.8204PHT	830 104	3.7573/22RS	906 122R
2.7530/11PHT	806 241	2.7674PHT	815 074	2.8209PHT	830 109	3.7573/23RS	906 123R
2.7530/14PHT	806 244	2.7675PHT	815 075	2.8210PHT	830 110	3.7573/25RS	906 125R
2.7530/17PHT	806 247	2.7677PHT	815 077	2.8211PHT	830 111	3.7573/26RS	906 126R
2.7530/18PHT	806 248	2.7678PHT	815 078	2.8214PHT	830 114	3.7573/27RS	906 127R
2.7530/19PHT	806 249	2.7679PHT	815 079	2.8215PHT	830 115	3.7573/31	906 131
2.7530/1PHT	806 231	2.7680PHT	815 080	2.8216PHT	830 116	3.7573/40RS	906 140R
2.7530/21PHT	806 251	2.7681PHT	815 081	2.8303/1	831 003/001	3.7573/46RS	906 146R
2.7530/22PHT	806 252	2.7682PHT	815 082	2.8322/14	831 114	3.7573/47RS	906 147R
2.7530/23PHT	806 253	2.7683PHT	815 083	2.8322/16	831 116	3.7573/48RS	906 148R
2.7530/26PHT	806 256	2.7684PHT	815 084	2.8322/17	831 117	3.7573/49RS	906 149R
2.7530/27PHT	806 257	2.7685PHT	815 085	2.8322/18	831 118	3.7575/1RS	907 701R
2.7530/28PHT	806 258	2.7686PHT	815 086	2.8322/20	831 120	3.7579	910 179
2.7530/30PHT	806 260	2.7687	815 087	2.8322/21	831 121	3.7590	912 090
2.7530/31PHT	806 261	2.7688	815 088	2.8322/22	831 122	3.7593	912 093
2.7530/33PHT	806 263	2.7691	815 091	2.8322/25	831 125	3.7593RS	912 093R
2.7530/36PHT	806 266	2.7714	817 014	2.8322/26	831 126	3.7595RS	912 095R
2.7530/3PHT	806 233	2.7716	817 016	2.8322/31	831 131	3.7596	912 096
2.7530/4PHT	806 234	2.7723PHT	817 023	2.8322/32	831 132	3.7597	912 097
2.7530/5PHT	806 235	2.7729	817 029	2.8322/34	831 134	3.7598	912 098
2.7530/6PHT	806 236	2.7783	819 083	2.8322/35	831 135	3.7600	912 100
2.7530/7PHT	806 237	2.7792PHT	819 092	2.8322/36	831 136	3.7614	913 014
2.7530/8PHT	806 238	2.7793PHT	819 093	2.8322/37	831 137	3.7627	913 027
2.7530/9PHT	806 239	2.7903	822 003	2.8322/38	831 138	3.7628	913 028
2.7535/1PHT	807 701	2.7911	822 011	2.8322/39	831 139	3.7629	913 029
2.7566PHT	812 066	2.7922	822 022	2.8322/40	831 140	3.7630	913 030
2.7573PHT	812 073	2.7940	822 040	2.8322/43	831 143	3.7634	913 034
2.7574PHT	812 074	2.7941	822 041	2.8322/44	831 144	3.7636	913 036
2.7575PHT	812 075	2.7946	822 046	2.8322/45	831 145	3.7681	915 081
2.7592	813 092	2.7948	822 048	2.8322/47	831 147	3.7683RS	915 083R
2.7593	813 093	2.7957	822 057	2.8322/49	831 149	3.7688	915 088
2.7594	813 094	2.7958	822 058	2.8322/50	831 150	3.7688RS	915 088R
2.7599	813 099	2.7960	822 060	2.8322/51	831 151	3.7689RS	915 089R
2.7602	813 102	2.7963	822 063	2.8322/52	831 152	3.7691	915 091
2.7607	813 107	2.7968	822 068	2.8322/54	831 154	3.7694	915 094
2.7613	813 113	2.7969	822 069	2.8322/55	831 155	3.7694RS	915 094R
2.7614	813 114	2.7971	822 071	2.8322/58	831 158	3.7696RS	915 096R
2.7617	813 117	2.7973	822 073	2.8322/61	831 161	3.7697	915 097
2.7619	813 119	2.7975	822 075	2.8322/68	831 168	3.7699RS	915 099R
2.7622	813 122	2.7976	822 076	2.8322/69	831 169	3.7701	915 101
2.7623	813 123	2.7977	822 077	2.8322/70	831 170	3.7702RS	915 102R
2.7628	813 128	2.7979	822 079	2.8322/72	831 172	3.7703RS	915 103R
2.7630/10	813 240	2.7982	822 082	2.8322/9	831 109	3.7704	915 104
2.7630/11	813 241	2.7984	822 084	2.8342	838 242	3.7752	917 052
2.7630/15	813 245	2.7988	822 088	2.8343	838 243	3.7752RS	917 052R
2.7630/18	813 248	2.7989	822 089	2.8543	842 043	3.7758	917 058
2.7630/21	813 251	2.7992	822 092	2.8625	847 025	3.7885	919 085
2.7630/22	813 252	2.7993	822 093	2.8627PHT	847 027	3.7892	919 092
2.7630/24	813 254	2.8070	828 070	3.7512RS	906 012R	3.7894RS	919 094R
2.7630/26	813 256	2.8075	828 075	3.7514RS	906 014R	3.7952	922 052
2.7630/27	813 257	2.8078	828 078	3.7518RS	906 018R	3.7956	922 056

FACET		FACET		FACET		FACET	
3.7966	922 066	4.7100	358 100	4.8688	359 688	4.9497	360 497
3.7969	922 069	4.7106	358 106	4.8689	359 689	4.9499	360 499
3.7970	922 070	4.7107	358 107	4.8692	359 692	4.9501	360 501
3.7973	922 073	4.7111	358 111	4.8694	359 694	4.9503	360 503
3.7981	922 081	4.7119	358 119	4.8700	359 700	4.9504	360 504
3.7982	922 082	4.7120	358 120	4.8716	359 716	4.9505	360 505
3.7985	922 085	4.7159	358 159	4.8725	359 725	4.9506	360 506
3.7986	922 086	4.7170	358 170	4.8727	359 727	4.9507	360 507
3.7992	922 092	4.7181	358 181	4.8736	359 736	4.9508	360 508
3.7993	922 093	4.7195	358 195	4.8737	359 737	4.9509	360 509
3.7994	922 094	4.7199	358 199	4.8747	359 747	4.9511	360 511
3.7995	922 095	4.7208	358 208	4.8748	359 748	4.9518	360 518
3.7997RS	922 097R	4.7214	358 214	4.8768	359 768	4.9527	360 527
3.7998	922 098	4.7223	358 223	4.8780	359 780	4.9529	360 529
3.8002	922 102	4.7229	358 229	4.8801	359 801	4.9531	360 531
3.8106	928 006	4.7230	358 230	4.8802	359 802	4.9549	360 549
3.8107	928 007	4.7231	358 231	4.8808	359 808	4.9551	360 551
3.8112	928 012	4.7232	358 232	4.8815	359 815	4.9559	360 559
3.8114	928 014	4.7234	358 234	4.8839	359 839	4.9562	360 562
3.8121	928 021	4.7235	358 235	4.8846	359 846	4.9568	360 568
3.8122	928 022	4.7236	358 236	4.8864	359 864	4.9569	360 569
3.8124RS	928 024R	4.7239	358 239	4.8884	359 884	4.9575	360 575
3.8125	928 025	4.7241	358 241	4.8887	359 887	4.9580	360 580
3.8126RS	928 026R	4.7242	358 242	4.8888	359 888	4.9585	360 585
3.8127RS	928 027R	4.7244	358 244	4.8889	359 889	4.9595	360 595
3.8128RS	928 028R	4.7245	358 245	4.8900	359 900	4.9601	360 601
3.8129RS	928 029R	4.7246	358 246	4.8920	359 920	4.9607	360 607
3.8130	928 030	4.7247	358 247	4.8956	359 956	4.9608	360 608
3.8229	930 029	4.7248	358 248	4.8965	359 965	4.9609	360 609
3.8236RS	930 036R	4.7249	358 249	4.9007	360 007	4.9614	360 614
3.8237	930 037	4.7251	358 251	4.9025	360 025	4.9619	360 619
3.8237RS	930 037R	4.7252	358 252	4.9078	360 078	4.9624	360 624
3.8240	930 040	4.7255	358 255	4.9138	360 138	4.9625	360 625
3.8241	930 041	4.8347	359 347	4.9140	360 140	4.9630	360 630
3.8242RS	930 042R	4.8351	359 351	4.9145	360 145	4.9634	360 634
3.8247RS	930 047R	4.8354	359 354	4.9209	360 209	4.9639	360 639
3.8251RS	930 051R	4.8372	359 372	4.9231	360 231	4.9640	360 640
3.8254RS	930 054R	4.8386	359 386	4.9237	360 237	4.9641	360 641
3.8255RS	930 055R	4.8398	359 398	4.9278	360 278	4.9643	360 643
3.8257RS	930 057R	4.8415	359 415	4.9281	360 281	4.9649	360 649
3.8258	930 058	4.8417	359 417	4.9300	360 300	4.9654	360 654
3.8259	930 059	4.8429	359 429	4.9305	360 305	4.9657	360 657
3.8260	930 060	4.8432	359 432	4.9323	360 323	4.9658	360 658
3.8323	931 023	4.8456	359 456	4.9332	360 332	4.9660	360 660
3.8330	931 030	4.8466	359 466	4.9343	360 343	4.9667	360 667
3.8331/10	931 110	4.8471	359 471	4.9344	360 344	4.9671	360 671
3.8331/13	931 113	4.8491	359 491	4.9345	360 345	4.9677	360 677
3.8331/18	931 118	4.8493	359 493	4.9353	360 353	4.9680	360 680
3.8331/19	931 119	4.8494	359 494	4.9356	360 356	4.9681	360 681
3.8331/31	931 131	4.8507	359 507	4.9363	360 363	4.9682	360 682
3.8331/32	931 132	4.8509	359 509	4.9364	360 364	4.9686	360 686
3.8331/33	931 133	4.8511	359 511	4.9373	360 373	4.9691	360 691
3.8331/34	931 134	4.8513	359 513	4.9374	360 374	4.9699	360 699
3.8331/36	931 136	4.8514	359 514	4.9376	360 376	4.9702	360 702
3.8331/37	931 137	4.8527	359 527	4.9385	360 385	4.9709	360 709
3.8331/38	931 138	4.8539	359 539	4.9393	360 393	4.9711	360 711
3.8331/39	931 139	4.8543	359 543	4.9398	360 398	4.9719	360 719
3.8331/7	931 107	4.8572	359 572	4.9399	360 399	4.9723	360 723
3.8331/8	931 108	4.8573	359 573	4.9401	360 401	4.9729	360 729
3.8331/9	931 109	4.8578	359 578	4.9411	360 411	4.9730	360 730
3.8362RS	938 262R	4.8587	359 587	4.9413	360 413	4.9731	360 731
3.8363RS	938 263R	4.8597	359 597	4.9415	360 415	4.9732	360 732
3.8714RS	946 014R	4.8605	359 605	4.9417	360 417	4.9738	360 738
3.8716RS	946 016R	4.8608	359 608	4.9433	360 433	4.9739	360 739
4.7004	358 004	4.8609	359 609	4.9434	360 434	4.9740	360 740
4.7005	358 005	4.8612	359 612	4.9435	360 435	4.9741	360 741
4.7006	358 006	4.8613	359 613	4.9436	360 436	4.9745	360 745
4.7007	358 007	4.8615	359 615	4.9443	360 443	4.9753	360 753
4.7013	358 013	4.8616	359 616	4.9446	360 446	4.9760	360 760
4.7020	358 020	4.8623	359 623	4.9447	360 447	4.9764	360 764
4.7028	358 028	4.8634	359 634	4.9451	360 451	4.9767	360 767
4.7049	358 049	4.8650	359 650	4.9479	360 479	4.9789	360 789
4.7059	358 059	4.8655	359 655	4.9484	360 484	4.9792	360 792
4.7061	358 061	4.8660	359 660	4.9489	360 489	4.9793	360 793
4.7064	358 064	4.8666	359 666	4.9491	360 491	4.9813	360 813
4.7069	358 069	4.8674	359 674	4.9492	360 492	4.9817	360 817

FIAT		FIAT		FIAT		FIAT	
46743086	360 505	7604907	359 386	9617237080	359 494	9934545	815 059
46749624	360 451	7604977	359 386	9619064880	359 674	9934549	815 045
46752948	470 416 ⁴	7604977	359 466	9622889780	470 188	9934652	806 079
46777288	470 442	7605191	359 808	9634131380	470 408	9934708	915 091
4830772	359 507	7608770	359 471	9654347080	470 405	9934726	930 037R
500309816	470 345	7609073	359 398	9753012580	465 005	9934727	930 037R
504142675	470 442	7612954	470 126	9753283180	465 005	9934728	830 093
55195775	358 170	7613158	359 466	9753293180	465 005	9934729	430 161/1
55195776	358 170	7613942	359 808	98080037	830 081	9934741	930 036R
55200112	470 423	7619338	359 351	9808037	930 036R	9935150	715 101
55200486	470 423	7625396	359 815	9902725	930 029	9935176	815 045
55202897	360 451	7625943	359 456	9903324	730 120	9935177	815 049
55203737	360 451	7626232	470 146	9908338	830 059	9935782	906 026R
55208723	470 423	7637165	359 354	9908418	930 029	9936014	806 079
55214926	470 549	7637166	359 347	9909412	730 150M	9936023	930 047R
55224110	470 549	7646974	470 158	9909413	730 120	9936027	830 098
55229959	470 549	7647722	359 398	9909418	930 029	9936331	430 163/1
55237442	358 170	7648797	470 168	9911453	730 127	9936677	715 106
55238422	358 170	7661948	359 471	9911509	830 082	9936734	615 039
55246099	470 442	7663177	470 108	9911552	730 120	9936735	815 058
55263679	470 549	7672018	470 146	9911554	730 123	9936807	917 052
55270217	470 549	7691421	359 808	9911960	930 029	9936814	817 016
553221201	813 094	7691421	359 815	9912921	730 127	9936823	717 020
553221203	713 011HV	7694366	359 615	9912922	730 127	9936831	917 052R
553221400	913 014	7694957	359 471	9913856	930 037	9936866	915 083R
5888330	359 507	7698431	470 108	9913857	930 037R	9937480	915 083R
59321119	828 078	7700267693	906 119R	9913860	830 069	9937592	815 049
59321324	928 012	7700267694	806 236	9913862	730 132	9937709	715 105
60558152	470 168	7703382	359 700	9915391	830 076	9937715	615 034
60562701	470 313	7716092	359 815	9915910	930 037	9937716	815 054
60586072	470 168	7716094	359 808	9916116	815 049	9937729	930 037R
60805420	470 146	7730973	359 692	9916117	915 083R	9937767	930 054R
60809492	470 146	7735100	359 613	9916118	715 055	9938166	615 039
60809606	470 168	7735397	359 655	9916593	930 037R	9938173	930 055R
60809702	806 236	7742005	359 694	9917213	930 037R	9938268	630 127
60810690	470 313	7742689	359 456	9918269	746 071	9938269	630 128
60815150	470 146	7745367	359 887	9918275	847 025	9938272	830 098
6313220203	930 054R	7746151	470 148	9919037	815 059	9938273	830 101
631322118	728 083MHV	7746152	470 108	9919038	715 056	9938274	830 104
631322322	928 006	7746153	470 158	9919040	715 056	9938276	730 146M
638326146	706 049HDVS	7746154	470 108	9919346	730 139	9938359	830 098
638326383	906 025R	7746226	490 303	9919348	930 037	9938360	830 104
6553202203	713 011HV	7749930	359 650	9919623	730 140	9938573	715 122
6553206203	713 022HV	7749930	359 692	9919627	930 036R	9938953	406 153
6553206400	913 034	7760523	360 363	9919628	830 081	9939707	906 023R
6553221201	813 094	7776810	359 616	9919628	830 081	9939762	430 161/1
6553221203	713 011HV	7785350	359 888	9919723	730 140	9939786	430 180M
6553221400	913 014	7787458	359 889	9920029	815 045	9939787	830 101
659321119	828 078	7789346	470 345	9920036	730 139	9939788	830 101
659321324	928 012	7789346	470 345	9920580	930 036R	9939788	430 176M
7073052	706 034HVS	7980793	730 139	9920581	830 081	9939789	830 109
7073054	906 045R	82205020	730 127	9921039	715 056	9939790	930 060
7073055	806 098	82272761	730 139	9921198	815 045	9940095	465 020
7073905	406 153 ⁵	82288614	906 025R	9921476	930 037R	9940302	915 094
7080442	806 079	82289883	706 049HDVS	9921508	930 037	9940428	930 057R
7080449	906 061R	82301158	930 037R	9921509	830 082	9940429	430 177/1
7080461	406 153	82301920	806 079	9922446	930 036R	9940437	906 061R
71739725	470 450	82305235	706 034HVS	9923115	930 037	9940569	730 149M
71742420	470 570	82305237	806 079	9924187	930 042R	9940656	830 101
71742423	358 013	82309214	930 041	9924316	830 086	9941231	430 176M
71744369	470 450	82316498	906 025R	9924394	930 041	9941693	430 176M
71779115	470 450	82345471	930 037R	9924654	930 037	9941720	430 180M
7540530	359 432	82348987	806 079	9924733	915 083R	9941721	815 080
7553120	470 158	82357741	906 115R	9925257	730 139	9942040	465 029
7582152	470 108	82361894	806 079	9925993	830 086	9942108	749 350
7588435	470 102	82361914	830 101	9926748	930 040	9943506	930 059
7588436	490 303	82361915	930 047R	9927624	706 029HV	9944407	930 060
7596550	359 347	82368100	830 093	9927962	906 025R	9944576	830 114
7596561	359 354	8660	730 140	9927967	906 025R	9944630	830 098
7596561	359 398	8661	730 139	9928245	630 117	9944668	830 115
7597831	359 347	9405937478	915 096R	9928247	930 042R	9944794	830 101
7598077	359 354	9463264180	470 408	9928250	830 090	9946355	830 114
7598155	359 398	9467511580	470 405	9928255	730 142	9946356	930 060
7598155	359 692	9564372380	415 019	9929182	730 139	9947326	830 115
7604095	359 650	9567469880	815 087	9929187	930 042R	9950519	830 115
7604227	359 354	9607405480	470 188	9929188	730 142	AXE2055	706 049HDVS
		9609493380	359 674	9934266	615 023	AXE2056	906 025R

FIAT (YV)		FORD		FORD		FORD	
7073052/1	730 132	1 111 221	360 976	1 517 813	470 532	3 241 724	406 153
7073054/1	917 052	1 113 148	360 691	1 523 785	806 081	3 243 330	406 153
7073055/1	830 069	1 113 150	360 691	1 523 817	806 079	3 395 566	931 133
		1 113 152	360 691	1 535 417	358 170	3 857 542	931 137
		1 113 154	360 691	1 535 419	358 170	3 880 181	931 133
		1 114 743	360 624	1 535 713	470 423	3 891 726	931 134
		1 114 744	360 624	1 568 737	706 049HDVS	3 898 173	831 137
		1 114 745	360 624	1 578 771	470 480	3 993 623	931 132
		1 119 835	470 532	1 583 458	806 081	4 006 232	831 132
		1 119 840	360 614	1 584 304	706 049HDVS	4 046 843	931 108
		1 119 841	360 614	1 584 305	706 049HDVS	4 132 265	831 121
		1 119 842	360 614	1 595 255	806 109	4 132 292	470 366S
		1 119 843	360 614	1 604 959	906 024R	4 367 127	358 214
		1 120 169	470 435	1 606 399	906 025R	4 367 128	358 214
		1 130 402	470 532	1 612 099	906 112R	4 429 613	358 214
		1 13E-12116-A	828 075	1 617 277	906 112R	4 434 842	358 214
		1 142 546 9	906 014R	1 619 343	470 532	4 538 936	358 214
		1 142 596 1	906 012R	1 626 385	360 078	4 641 63	706 034HVS
		1 142 598 1	906 012R	1 626 386	360 078	4M5E-12A366-AA	470 480
		1 142 609	360 984	1 626 387	360 078	4M5G-12029-ZA	470 481
		1 142 610	360 984	1 626 388	360 078	4M5G-12029-ZB	470 481
		1 142 611	360 984	1 626 434	360 281	4M5G-12A366-BA	470 480
		1 142 612	360 984	1 626 436	360 281	4M5G-12A366-BB	470 480
		1 144 700 2	806 072	1 627 668	360 281	4M5G-12A366-BC	470 480
		1 144 706 9	806 079	1 628 315	819 092	4M5G-12A366-BD	470 480
		1 151 630 2	706 021	1 641 610	830 098	4S7G-12029-AA	470 481
		1 154 411 5	706 047	1 641 611	930 057R	4S7G-12029-AB	470 481
		1 154 849 5	706 049HDVS	1 641 614	430 177/1	5 008 193	470 299S
		1 171 025 4	806 079	1 641 810	819 092	5 008 196	470 170
		1 171 025 5	806 076	1 643 632	819 093	5 014 402	819 083
		1 171 025 6	806 072	1 643 692	919 092	5 014 405	919 085
		1 171 026 8	806 072	1 649 067	470 135	5 018 844	706 049HDVS
		1 207 832	360 691	1 649 200	919 094R	5 019 831	706 049HDVS
		1 212 115	360 691	1 655 993	928 026R	5 021 112	906 061R
		1 213 032	360 691	1 657 033	360 007	5 027 482	719 044HV
		1 213 034	360 691	1 657 147	360 007	5 027 532	906 025R
		1 214 215	358 208	1 657 149	360 007	5 047 437	470 480
		1 224 925	470 480	1 660 332	906 121R	5 441 16	706 021
		1 231 646	360 614	1 663 375	360 145	5 484 95	706 049HDVS
		1 252 407	470 435	1 663 376	360 145	6 002 610	906 024R
		1 255 505	360 614	1 665 193	819 092	6 075 742	906 060R
		1 255 507	360 614	1 671 690	470 423	6 077 429	470 169
		1 255 509	360 614	1 673 468	470 435	6 077 487	828 083
		1 313 549	358 208	1 680 402	358 242	6 077 549	806 109
		1 313 550	358 208	1 680 403	358 242	6 084 817	360 078
		1 313 551	358 208	1 680 404	358 242	6 087 381	728 089
		1 313 552	358 208	1 680 405	358 242	6 124 108	906 061R
		1 314 271	470 480	1 727 629	470 481	6 125 612	406 233 ^S
		1 317 972	470 532	1 754 514	470 481	6 133 233	360 281
		1 319 060	358 208	1 760 593	470 619	6 134 771	906 121R
		1 319 061	358 208	1 776 803	470 619	6 137 397	360 281
		1 319 062	358 208	1 800 554	470 623	6 137 398	360 281
		1 319 063	358 208	1 823 596	470 481	6 137 399	360 281
		1 319 788	470 532	1 827 901	470 619	6 137 400	360 281
		1 319 929	470 532	1 836 729	470 623	6 137 406	360 281
		1 322 402	470 480	1 953 279	922 070	6 138 918	706 049HDVS
		1 331 283	470 435	1 953 281	822 046	6 146 328	360 281
		1 335 369	360 625	1 960 394	360 789	6 146 423	806 235
		1 335 371	360 625	1 960 491	922 102 ^C	6 147 957	406 153 ^S
		1 335 374	360 625	1 961 043	822 089	6 149 976	360 078
		1 335 377	360 625	1 961 207	360 789	6 152 292	360 281
		1 350 562	470 481	1S7G-12029-AB	470 532	6 152 293	360 281
		1 350 567	470 481	1S7G-12029-AC	470 532	6 152 294	360 281
		1 362 718	470 435	1S7G-12029-AD	470 532	6 153 386	828 096
		1 371 601	470 478	1S7G-12283-AE	360 614	6 153 387	928 026R
		1 444 043	919 085	1S7G-12283-AF	360 614	6 153 393	360 281
		1 451 676	906 012R	1S7G-12284-AD	360 614	6 153 394	360 281
		1 458 400	470 481	1S7G-12284-AE	360 614	6 155 949	360 078
		1 458 944	719 043HV	1S7G-12286-AE	360 614	6 160 862	360 281
		1 458 945	719 044HV	1S7G-12286-AF	360 614	6 161 016	360 078
		1 459 278	470 481	1S7G-12287-AD	360 614	6 166 882	360 078
		1 462 196	819 083	1S7G-12287-AE	360 614	6 166 884	360 078
		1 502 365	358 242	2S7E-12280-AF	358 214	6 166 886	360 078
		1 502 366	358 242	2S7E-12281-AE	358 214	6 170 394	360 078
		1 502 367	358 242	3 240 335	906 025R	6 170 395	360 078
		1 502 368	358 242	3 240 336	806 079	6 170 396	360 078

FORD		FORD		FORD		FORD	
6 170 397	360 078	6 958 305	470 170	988F-12024-AB	470 532^{*1}	E95F-12029-AA	470 170
6 170 844	360 078	681F-12107-AA	719 043HV	988F-12029-AB	470 532	E95Z-12029-A	470 170
6 171 209	360 078	682F-12107-AA	719 044HV	988F-12029-AC	470 532	E9TF-12029-AA	470 135
6 177 981	906 140R	6M21-12029-AA	470 435	988F-12029-AD	470 532	EOTA 12 160	728 083MHV
6 178 534	360 281	6M5G-12029-AA	470 478	988F-12029-AE	470 532	EOTA 12 162 C	728 083MHV
6 178 536	360 281	7 094 524	360 639	988F-12029-BA	470 532	EOTA 12 199 C	728 083MHV
6 182 127	806 253	7 094 525	360 639	988F-12257-AB	470 532^{*1}	EOTT-A1220-0A	928 007
6 182 576	406 233^{*N}	7 094 526	360 639	988F-12283-AA	360 624	EOTT-A1220-0B	928 007
6 182 577	406 233^{*N}	7 094 527	360 639	988F-12284-AA	360 624	EOTT-A1220-0C	928 007
6 182 579	906 061R	7 388 352	360 639	988F-12286-AA	360 624	F0TZ-12029-A	470 289
6 182 581	928 026R	7 388 353	360 639	988F-12286-AB	360 624	F1CZ-12029-A	470 233
6 182 871	359 864	7 388 354	360 639	988F-12287-AA	360 624	F1SU-12029-AA	470 170
6 182 872	359 864	7 388 355	360 639	98MF-12283-AA	360 625	F1VU-12029A-1A	470 312
6 182 904	359 864	71HM-12200-AA	906 012R	98MF-12284-AA	360 625	F1VY-12029-A	470 312
6 182 905	359 864	72HF-12106-AA	806 079	98MF-12286-AA	360 625	F220 18V00 A	831 121
6 183 208	360 007	72TF-12106-AA	806 081	98MF-12287-AA	360 625	F32Z-12106-C	831 137
6 183 213	360 007	72TF-12200-AA	906 024R	98MF-12287-AA	360 625	F32Z-12200-A	931 137
6 183 218	360 007	730X-12300B-AA	642 056	98MF-12287-AA	360 625	F32Z-12200-B	931 131
6 183 223	360 007	73TF-12200-AA	906 024R	98MF-12287-AA	360 625	F32Z-12200-C	931 133
6 184 281	360 078	77BF-12107-AA	706 049HDVS	98MF-12287-AA	360 625	F42Z-12200-A	931 137
6 184 283	360 078	77BF-12171-AA	706 049HDVS	98MF-12287-AA	360 625	F4BZ-12106-A	831 150
6 189 557	360 078	77HF-12107-AA	706 034HVS	A700X-12276-AGA	815 058	F4BZ-12200-A	931 132
6 189 558	360 078	78MU-12200-A	906 025R	A720-X12171-EA	722 056HV	F50U-12029-AA	470 312
6 234 60	719 044HV	78TF-12106-AA	806 081	A720-X12171-FA	715 056	F50U-12029-BA	470 312
6 383 157	470 289	79BB-12024-AA	470 169	A730-X12171-BA	722 056HV	F50Y-12029-A	470 312
6 486 345	360 007	80SX-12200-AA	906 061R	A730X-12300-AKA	615 023	F50Y-12029-B	470 312
6 486 346	360 007	81SF-12106-DA	828 083	A760-X12276-CA	830 069	F52Z-12200-A	931 134
6 486 347	360 007	81SF-12106-EA	806 109	A760-X12276-CA	830 069	F52Z-12200-B	931 131
6 486 348	360 007	81SF-12171-CA	728 089	A770-X12276-CA	815 058	F52Z-12200-C	931 134
6 489 415	470 170	81SF-12200-FA	906 060R	A770-X12300-CA	615 023	F52Z-12200-D	931 132
6 493 644	360 281	82HF-12200-AA	906 025R	A790-X12200-DA	915 091	F57U-12029-AA	470 289
6 493 645	360 281	82TF-12200-AA	906 024R	A790-X12200-RA	928 014	F57Z-12029-A	470 289
6 493 649	359 864	84AU-12A09-3A	406 153	A800-X12171-MA	715 056	F5RZ-12029-C	470 299S
6 493 650	360 281	84SF-12100-BA	406 233^{*N}	A800-X12276-RA	830 069	F5SU-12029-AA	470 170
6 493 651	360 281	84SF-12106-AA	828 096	A810-X12171-RA	715 056	F5SU-12029-AB	470 170
6 493 655	359 864	84SF-12200-AA	906 061R	A830-X12276-FA	815 058	F82U-12029-AA	470 289
6 493 656	360 281	84SF-12200-BA	906 121R	A830-X12300-EA	615 023	F0JY-12200-A	931 108
6 493 657	360 281	84SF-12200-CA	928 026R	A96BF-12024-ATB	470 364	FS01-18V05-A	931 137
6 493 661	359 864	88SF-12029A-1A	470 135	B657 18100	470 366S	G 509 193	706 047
6 493 662	360 281	88SF-12029A-2A	470 135	C3DF-12171-A	719 043HV	G 516 302	706 021
6 493 663	360 281	88SX-12200-AA	906 061R	C3DZ-12171-A	719 043HV	KK 150 18 V00	831 122
6 493 666	359 864	89SF-12100-JA	406 233^{*N}	C5AZ-12171-A	719 043HV	KK 150 18 V05	931 108
6 493 667	359 864	89SF-12200-AA	906 061R	C6AH-12106-A	819 083	KL01-18V00-A	831 137
6 503 279	470 135	89SF-12200-BA	906 121R	C6AH-12171-A	719 043HV	KL01-18V05-A	931 133
6 503 280	470 135	90TF-12029A-1A	470 289	C6AH-12200-A	919 085	V83H-F12200-AA	930 057R
6 542 391	830 101	919F-12029-AA	470 170	C6CH-12171-A	719 044HV	V83S-F12200-AA	906 112R
6 596 257	360 630	915F-12283-AC	359 864	C7AH-12200-A	919 085	V83S-F12200-AB	906 112R
6 596 258	360 630	915F-12286-AC	359 864	C7KH-12106-A	819 083	V90H-F12106-AA	830 101
6 596 259	360 630	915F-12287-AC	359 864	CM5G-12029-FA	470 481	XM34-12106-AA	831 132
6 596 260	360 630	920X-12107-BA	719 044HV	CM5G-12029-FB	470 481	XM34-12106-BA	831 121
6 609 875	359 864	928F-12029-CA	470 135	CM5G-12029-FC	470 481	XM34-12200-BA	931 108
6 609 876	359 864	928F-12029-CB	470 299S	CM5G-12A366-BA	470 619	XM34-4608-CA	470 366S
6 609 877	359 864	928F-12283-AG	360 630	CM5G-12A366-CA	470 619	XS6F-12283B-2C	360 691
6 609 878	359 864	928F-12283-AJ	360 630	CM5G-12A366-CB	470 619	XS6F-12283B-2D	360 691
6 630 365	470 170	928F-12284-AG	360 630	CM5G-12200-A	919 085	XS6F-12283B-4D	358 208
6 789 823	360 630	928F-12284-AJ	360 630	DIFZ-12106-A	806 079	XS6F-12284B-2D	360 691
6 789 824	360 630	928F-12286-AG	360 630	DIFZ-12200-A	906 012R	XS6F-12284B-4D	358 208
6 789 825	360 630	928F-12286-AJ	360 630	DORY-12200-A	919 085	XS6F-12286B-2D	360 691
6 789 826	360 630	928F-12287-AG	360 630	DS7G-12A366-BA	470 623	XS6F-12286B-4D	358 208
6 823 318	470 299	928F-12287-AJ	360 630	DS7G-12A366-BB	470 623	XS6F-12287B-2C	360 691
6 828 806	360 145	92GB-12024-AA	470 169	E32Z-12200-B	931 131	XS6F-12287B-2D	360 691
6 828 807	360 145	938F-12024-DA	470 299S	E3EE-12106-BA	819 092	XS6F-12287B-4D	358 208
6 831 197	360 007	968F-12283-AD	360 630	E3EE-12106-BB	819 092	XS8Z-12286-BA	360 624
6 831 198	360 007	968F-12284-AD	360 630	E5FZ-12106-B	819 092	XS8Z-12286-CA	360 624
6 831 199	359 864	968F-12286-AD	360 630	E5FZ-12106-C	819 092	XS8Z-12286-DA	360 624
6 831 200	360 007	968F-12287-AD	360 630	E6AE-12106-CA	819 093	YM21-12029-AA	470 435
6 831 201	360 007	96BF-12024A-1B	470 135	E6AZ-12106-A	819 093	YM21-12029-AB	470 435
6 831 202	359 864	96BF-12283-AA	360 007	E6EE-12200-AA	919 092	YM21-12029-AC	470 435
6 831 203	360 007	96BF-12284-AA	360 007	E6FZ-12200-A	919 092	YM21-12029-AD	470 435
6 831 204	360 007	96BF-12286-AA	360 007	E7EE-12200-DA	919 094R	YM2F-12024-AC	470 532^{*1}
6 831 205	359 864	96BF-12287-AA	360 007	E7GZ-12200-A	922 073	YM2F-12024-AD	470 532
6 831 206	360 007	96FB-12257-AB	470 364	E8BZ-12200-A	931 108	YM2F-12029-AA	470 532
6 831 207	360 007	96MF-12283-BA	360 619	E8TZ-12029-A	470 135	YM2F-12029-AB	470 532
6 831 208	359 864	96MF-12284-BA	360 619	E9DF-12029-AA	470 289	YS6F-12283A-1A	360 625
6 860 288	470 299	96MF-12286-BA	360 619	E9DZ-12029-A	470 289	YS6F-12283-AA	360 625
6 860 289	470 299S	96MF-12287-BA	360 619	E9FZ-12106-A	819 092	YS6F-12283B-1A	358 242

FORD

YS6F-12283B-9A	358 242
YS6F-12284A-1A	360 625
YS6F-12284-AA	360 625
YS6F-12284B-1A	358 242
YS6F-12284B-9A	358 242
YS6F-12286-AA	360 625
YS6F-12286B-1A	358 242
YS6F-12286B-9A	358 242
YS6F-12287A-1A	360 625
YS6F-12287-AA	360 625
YS6F-12287B-1A	358 242
YS6F-12287B-9A	358 242

FORD AUSTRALIA

6 958 305	470 170
938F-12024-DA	470 299S
ADH-2	806 244
ADR-3	906 131
B 593-18-V00 A	831 150
F S90-18-V00	822 092
F S90-18-V05	922 102
F5SU-12029-AA	470 170
F5SZ-12029-A	470 170
KL01-18-V05 A	931 133

FORD USA

3 880 181	931 133
3 891 726	931 134
3 898 173	831 137
4 132 292	470 366S
5 008 196	470 170
6 383 157	470 289
6 958 305	470 170
CM5G-12A366-BA	470 619
FOTZ-12029-A	470 289
F5SU-12029-AA	470 170
F5SU-12029-AB	470 170
XM34-4608-CA	470 366S

GENERAL MOTORS

01 972 927	812 073
01 985 771	812 074
01 986 109	912 096
01 988 515	912 097
02 894 488	706 034HVS
03 469 032	806 081
03 469 033	806 080
03 470 026	712 055HVS
03 470 056	912 093
03 474 227	470 109
03 474 232	470 341
03 474 282	470 341
03 474 283	470 140
03 479 003	812 066
06 682 671	906 012R
08 983 490	706 034HVS
09 117 892	360 904
09 117 893	360 904
09 117 894	360 904
09 117 895	360 904
09 119 169	360 506
1 104 082	470 450
1 104 091	470 483
1 972 927	812 073
1 977 958	465 025
1 978 503	412 010
1 979 107	465 025

GENERAL MOTORS

1 979 511	412 011
1 979 571	465 025
1 985 342	465 025
1 985 771	812 074
1 986 109	912 096
1 988 515	912 097
10 457 153	812 075
10 458 316	470 450
10 467 543	812 075
10 469 006	912 100
10 482 824	465 025
10 496 278	812 075
12 338 891	913 027
12 635 672	470 631
12 670 053	470 631
12 697 989	470 631
16 140 049	465 025
16 158 829	465 025
19 005 212	470 399
24 420 584	470 400
25 183 557	358 249
25 186 687	470 545
25 195 107	470 547
25 198 623	470 547
3 470 026	712 055HVS
3 470 056	912 093
3 470 061	812 066
3 470 093	912 093R
3 470 391	912 093R
3 474 221	470 111
3 474 227	470 109
3 474 283	470 140
3 474 600	615 023
3 479 003	812 066
3 639 500	470 609
3 639 845	470 620
3 648 847	470 475
30 584 237	470 192
55 561 655	470 545
55 573 735	470 547
55 575 499	470 547
55 577 898	470 547
55 579 072	470 547
55 584 404	470 545
7 406 087	806 072
7 426 989	706 029HV
7 992 026	728 083MHV
7 992 027	719 043HV
7 992 201	728 083MHV
7 992 202	719 044HV
7 992 205	828 075
7 992 206	828 070
7 992 207	819 083
7 992 214	928 006
7 992 216	928 007
7 992 217	919 085
7 992 219	706 047
7 992 221	706 021
7 992 222	706 032HV
7 992 224	706 034HVS
7 992 226	706 040
7 992 227	715 055
7 992 228	715 061
7 992 230	730 120
7 992 232	730 132
7 992 234	742 054
7 992 236	706 049HDVS
7 992 237	706 034HVS
7 992 238	715 111U
7 992 253	642 056
7 992 265	806 079
7 992 266	806 072
7 992 269	806 076
7 992 271	815 049
7 992 272	815 041
7 992 274	830 059

GENERAL MOTORS

7 992 275	830 069
7 992 279	842 043
7 992 280	830 081
7 992 281	806 080
7 992 284	906 012R
7 992 285	906 012R
7 992 286	906 014R
7 992 289	906 018R
7 992 290	906 021R
7 992 291	915 091
7 992 292	915 081
7 992 296	930 029
7 992 299	930 037
7 992 300	930 037
7 992 304	930 036R
7 992 318	730 123
7 992 319	730 127
7 992 324	706 029HV
7 992 326	713 011HV
7 992 330	706 034HVS
7 992 331	730 140
7 992 338	715 067
7 992 340	722 056HV
7 992 341	730 139
7 992 344	706 062
7 992 346	715 076
7 992 353	615 034
7 992 359	615 034
7 992 396	822 003
7 992 398	806 081
7 992 610	831 003/001
7 992 617	815 058
7 992 618	847 025
7 992 619	806 092
7 992 630	906 024R
7 992 632	930 037
7 992 633	930 037R
7 992 636	931 023
7 992 638	906 027R
7 992 639	915 088R
7 992 640	906 014R
7 992 645	706 040
7 992 646	715 111U
7 992 648	706 034HVS
7 992 650	746 071
7 992 653	715 064
7 992 654	706 029HV
7 992 655	706 049HDVS
7 992 658	706 047
7 992 663	706 049HDVS
7 992 668	715 056
7 992 680	642 056
7 992 850	642 056
7 992 852	642 056
7 992 857	815 058
7 992 859	806 072
7 992 865	806 079
7 992 874	930 054R
7 992 878	906 018R
7 992 883	906 018R
7 992 887	906 014R
7 992 888	906 021R
7 992 892	915 083R
7 992 896	930 029
7 992 951	713 011HV
7 992 953	730 132
7 992 957	706 034HVS
7 992 978	830 086
7 992 979	806 081
7 992 982	815 059
7 992 984	828 078
7 992 985	906 023R
7 992 986	906 026R
7 992 988	913 014
7 992 994	931 023
7 992 996	928 012

GENERAL MOTORS

82 044 5	912 090
9 119 567	470 508
9 193 022	360 506
9 198 834	470 507
9 300 152	906 045R
9 977 002	706 029HV
9 977 007	706 029HV
9 977 008	706 029HV
9 977 032	913 014
9 977 034	906 025R
90 006 499	465 034
90 006 547	906 056R
90 008 145	465 004
90 008 241	359 514
90 008 612	906 121R
90 009 490	606 212
90 010 693	812 066
90 010 695	912 095R
90 010 696	712 055HVS
90 087 360	906 026R
90 113 411	359 509
90 113 422	806 099
90 114 106	606 212
90 114 107	906 025R
90 114 676	465 004
90 140 187	465 004
90 141 495	906 055R
90 141 911	906 056R
90 230 573	906 127R
90 230 575	806 240 ^A
90 240 252	470 194
90 243 618	465 036 ^J
90 277 970	470 191
90 295 499	465 005
90 297 423	360 942
90 297 426	806 251
90 297 570	359 514
90 336 536	806 257 ^A
90 337 744	358 195
90 337 744	358 199
90 346 324	428 202 ^N
90 348 450	806 080
90 349 877	928 028R
90 349 878	828 099
90 350 021	470 192
90 350 555	359 527
90 350 560	359 956
90 350 748	806 080 ^A
90 350 765	806 249
90 350 988	806 256
90 350 997	828 100
90 360 314	465 036 ^J
90 360 315	465 036 ^J
90 369 031	806 258
90 369 758	359 513
90 376 979	915 103R
90 384 308	359 688
90 384 310	359 688
90 398 282	359 514
90 398 586	359 513
90 424 480	470 507
90 442 011	815 084
90 442 051	359 514
90 442 064	359 527
90 442 356	906 127R
90 442 358	806 257 ^A
90 442 404	359 634
90 442 405	359 514
90 442 406	360 237
90 442 410	360 237
90 442 448	359 513
90 443 584	359 688
90 443 687	359 688
90 443 690	360 237
90 443 691	360 237
90 443 692	359 689

GENERAL MOTORS

90 443 693	359 689
90 443 694	359 689
90 443 900	470 273
90 449 673	358 195
90 449 674	358 195
90 449 675	358 195
90 449 676	358 195
90 449 739	470 140
90 449 740	470 341
90 458 250	470 272
90 486 611	359 634
90 486 612	359 634
90 487 571	360 562
90 506 102	470 389
90 510 386	470 140
90 510 387	470 341
90 510 851	360 531
90 510 857	360 529
90 510 858	360 529
90 518 663	358 199
90 518 664	358 199
90 518 665	358 199
90 518 666	358 199
90 518 760	360 559
90 518 761	360 559
90 536 194	470 508
90 540 398	915 103R
90 542 968	360 529
90 543 059	470 398
90 543 253	470 400
90 543 259	360 559
90 543 260	360 559
90 543 261	360 559
90 543 262	360 559
91 103 092	906 061R
91 125 557	913 030
91 159 920	470 432
91 159 996	470 432
91 172 825	931 136
92 061 881	360 947
92 061 882	360 947
92 061 883	360 947
92 061 884	360 947
93 150 074	730 142
93 150 077	715 086
93 150 082	606 196
93 150 083	606 195
93 150 084	630 117
93 150 091	830 090
93 150 093	817 014
93 150 098	806 090
93 150 099	906 067R
93 150 102	906 034R
93 150 104	915 088
93 150 117	615 034
93 150 118	606 212
93 150 120	930 042R
93 150 124	615 034
93 150 126	806 093
93 150 134	915 088R
93 150 378	806 079
93 150 379	815 058
93 150 380	815 059
93 150 385	830 076
93 150 392	806 062
93 150 393	806 076
93 150 396	930 036R
93 150 398	930 041
93 150 399	930 042R
93 150 413	706 029HV
93 150 415	706 049HDVS
93 150 418	706 049HDVS
93 150 421	731 084
93 150 455	615 039
93 150 461	830 069
93 150 580	706 034HVS

GENERAL MOTORS

93 150 581	706 049HDVS
93 150 584	731 084
93 150 586	606 212
93 150 645	915 089R
93 150 904	713 022HV
93 150 906	806 099
93 150 907	830 093
93 150 911	906 116R
93 161 188	470 432
93 161 948	470 432
93 176 701	360 904
93 177 212	470 400
93 180 806	470 398
93 740 920	831 139
93 740 943	831 172
93 740 944	931 139
94 021 067	822 003
94 022 297	722 056HV
94 129 202	813 093
94 136 766	470 219
94 174 468	922 069
94 206 140	913 014
94 208 408	713 022HV
94 216 729	913 014
94 216 730	813 092
94 221 206	913 014
94 321 537	813 254
94 322 990	822 060
94 338 910	913 030
94 404 545	470 199
94 404 559	913 029
94 404 560	813 122
94 625 744	806 079
94 632 557	906 026R
94 632 558	806 080
94 840 127	470 197
94 844 585	913 027
94 845 144	913 027
94 845 173	813 119
94 847 241	913 029
94 850 617	813 248
94 853 695	470 199
94 855 135	813 265
95 512 934	470 442
95 517 924	470 450
95 528 319	470 547
96 052 016	913 030
96 053 294	813 107
96 055 178	913 030
96 056 629	931 108
96 058 494	360 415
96 059 524	813 093
96 061 556	913 034
96 061 557	813 245
96 064 787	931 131
96 064 788	831 140
96 066 463	913 028
96 066 464	813 123
96 067 826	931 131
96 068 686	831 144
96 288 956	358 006
96 291 306	358 007
96 342 284	360 730
96 460 220	360 677
96 460 221	358 247
96 460 222	358 247
96 460 223	358 247
96 460 224	358 247
96 460 224	358 247
96 476 983	470 545
96 497 773	360 680
96 518 123	360 634
96 984 145	358 249
V 510 858	706 034HVS
V 510 867	806 112
V 511 643	806 072
V 512 013	706 034HVS

HITACHI

43J83-17001	822 048
43S85-16001	922 073
43S85-17001	822 041
43S86-16001	922 073
4461-13301	722 056HV
4461-1700	822 003
4461-2700 B	822 003
4461-3330 A	722 056HV
4461-3330 AY	722 056HV
4461-4330 AY	722 056HV
44A2-13301	722 056HV
44A2-16001	922 052
44A5-13301	722 056HV
44AZ-13301	722 056HV
44P88-16001	922 093
44P88-17001	822 075
44R80-17001	822 057
44R84-16002	922 052
44R86-16001	922 073
44S88-17001	822 046
CM11-108	470 608
CM11-109	470 529
CM11-111	470 608
CM11-112	470 529
CM11-116	470 603
CM11-118	470 527
CM11-201	470 445
CM11-202	470 384
CM11-207A	470 457
CM12-100	470 265
CM1T-205	470 219
CM1T-209B	470 216
CM1T-217	470 216
CM1T-228	470 347
CM1T-228 A	470 347
CM1T-228 B	470 347
CM1T-228 C	470 347
DIS4-05	465 051
DIS4-08	465 072

HOLDEN

10457153	812 075
10467546	912 098
10495411	912 098
10496278	812 075
1910111060	813 265
1910115120	813 278
1910174050	813 278
1910174180	813 267
1910202010	913 027
1910211010	913 029
1910211031	913 029
1910211370	913 029
22157H9560	922 052
2216215M04	822 057
2243342L00	470 219
2243342L10	470 219
3314074010	713 011HV
3331070B50	931 119
3331082010	913 030
3331082610	913 028
3331086240	931 108
3332160A10	813 093
3332162E10	831 131
3332163B40	831 132
3332175110	813 093
3370083010	358 020
8941744680	922 069
8942167300	813 092
8942212060	913 014
8942389820	913 027
8943215370	813 254
8943229900	822 060
8943389100	913 030

HOLDEN

90008612	906 121R
90243618	465 036¹
90336536	806 257
90349877	928 028R
90350988	806 256
90350997	828 100
90443584	359 688
90443687	359 688
90443690	360 237
90443692	359 689
90443900	470 273
90449739	470 140
90458250	470 272
90487571	360 562
9091902135	470 197
9091902163	470 198
9091902164	470 199
9091922327	360 209
9091922370	360 793
92061881	360 947
92061882	360 947
92061883	360 947
92061884	360 947
GB819	806 080
GB835	806 112
GB838	906 056R
GB901	906 131
GB926	806 112
GD679	813 093
GD696	913 028
GH203	722 056HV
GH506	822 003
GH605	922 052
GH617	822 057
VS19424	906 127R
VS21273	906 121R

HONDA

06302-PT2-000	465 052
06302-PT2-A00	465 052
06302-PT3-000	465 052
06302-PT3-A00	465 052
06302-PT-A00	465 052
30102-590-075	822 003
30102-634-005	822 003
30102-634-0050	822 003
30102-634-0051	822 003
30102-POA-A01	822 082
30102-POA-A02	822 082
30102-P12-A01	822 076
30102-P1J-E01	828 106
30102-P2A-J01	822 093
30102-P2M-A01	822 082
30102-P45-G02	822 082
30102-P54-006	822 068
30102-PA1-732	822 011
30102-PA6-924	822 011
30102-PC1-004	822 011
30102-PCB-004	822 068
30102-PD2-006	822 022
30102-PD2-016	822 022
30102-PEL-J01	822 068
30102-PI2-A01	822 076
30102-PM3-015	822 071
30102-PM3-025	822 071
30102-PM3-035	822 071
30102-PM3-045	822 071
30102-PM5-A02	822 069
30102-PM5-A03	822 069
30102-PM5-A04	822 069
30102-PM5-A05	822 069
30102-PM7-006	822 069
30102-PM7-016	822 069
30102-PM7-036	822 069

HONDA

30102-PR3-003	822 069
30102-PR3-006	822 069
30102-PR3-026	822 069
30102-PR4-A02	822 069
30102-PT2-006	822 068
30102-PT2-016	822 068
30102-PT2-026	822 068
30102-PT3-A12	822 076
30102-PV1-A03	822 084
30102-PV1-A04	822 084
30102-PV1-A05	822 084
30103-657-005	922 052
30103-P01-005	922 081
30103-P08-003	922 095
30103-POA-A01	922 098
30103-P2A-J01	922 102
30103-P72-003	922 095
30103-PA1-732	922 056
30103-PA1-733	922 056
30103-PAA-A01	922 098
30103-PAI-732	922 056
30103-PC3-822	922 056
30103-PDA-E01	922 098
30103-PE1-731	922 073
30103-PE9-006	922 056
30103-PM0-B01	922 081
30103-PM3-015	922 081
30103-PM3-025	922 081
30103-PM5-702	922 082
30103-PM5-703	922 082
30103-PM5-A02	922 082
30103-PM5-A04	922 082
30103-PR3-006	922 082
30103-PT2-016	922 092
30103-PW0-G02	922 097R
30103-PW0-G03	922 097R
30105-590-075	722 056HV
30105-634-005	722 056HV
30105-634-0051	722 056HV
30105-657-005	722 056HV
30105-679-005	722 056HV
30120-PM-A01	465 052
30120-PR3-003	465 052
30120-PT2-004	465 052
30120-PT3-003	465 052
30120-PT3-004	465 052
30130-P54-006	465 052
30130-PR3-006	465 052
30130-PT2-006	465 052
30500-P01-005	470 216
30500-POA-A01	470 347
30500-POH-A01	470 347
30500-PAA-A01	470 347
30500-PCA-003	470 347
30500-PDA-E01	470 347
30500-PE0-006	470 212
30500-PH1-026	470 212
30500-PM3-005	470 216
30500-PM3-015	470 216
30500-PM5-A02	470 213
30500-PM5-A03	470 213
30500-PR4-A02	470 215
30500-PT0-005	470 216
30510-P73-A01	470 214
30510-P73-A02	470 214
30510-PT2-006	470 214
30520-P8E-A01	470 457
30520-P8E-S01	470 457
30520-P8F-A01	470 457
30520-P8F-A02	470 457
30520-PDF-E01	470 168
30520-PGK-A01	470 457
30520-PH7-006	470 211
30520-PH7-016	470 211
30520-PVF-A01	470 457
30520-PVJ-A01	470 457

HONDA

30520-PWA-003	470 529
30520-PWA-013	470 529
30520-PWA-S01	470 529
30520-RB0-003	470 603
30520-RB0-013	470 603
30520-RB0-S01	470 603
30520-RCA-A01	470 457
30520-RCA-A02	470 457
30520-RCA-S01	470 457
30520-REA-Z01	470 529
30520-RJA-A01	470 457
30520-RNA-A01	470 522
30521-PWA-003	470 608
30521-PWA-013	470 608
30521-PWA-S01	470 608
30521-RBJ-003	470 527
30521-RBJ-013	470 527
30521-RBJ-S01	470 527
30521-REA-Z01	470 608
32700-POD-000	360 711
32700-POK-G00	360 711
32700-PIJ-E01	360 686
32700-P5K-003	360 711
32700-P5N-G01	360 711
32700-PEL-004	360 699
32700-PHK-003	360 709
32700-PT0-000	360 711
32700-PT0-G00	360 711
32701-P14-A00	360 711
32701-PT0-000	360 711
32702-P14-A00	360 711
32702-PT0-000	360 711
32703-P14-A00	360 711
32703-PT0-000	360 711
32704-P14-A00	360 711
32704-PT0-000	360 711
32722-P2A-000	360 702
32722-P2A-003	360 702
32722-P2A-J00	360 702
32722-P2A-J01	360 702
32722-P2F-A02	360 702
32722-P2F-A03	360 702
32722-P75-A01	360 709
32722-PT3-A00	360 711
33105-590-075	722 056HV
8-94174-468-0	922 069
8-94322-990-0	822 060

HYUNDAI

27110-02503	831 121
27110-02750	831 170
27110-21020	831 003/001
27110-21021	831 003/001
27110-21060	831 003/001
27110-22000	806 124
27110-32810	831 003/001
27110-36010	831 116
27115-21020	931 023
27115-32500	931 107
27115-35000	931 109
27120-11000	831 003/001
27131-02750	931 138
27131-11000	931 023
27131-22000	906 121R
27131-32810	931 107
27131-35010	931 109
27132-11000	931 023
27135-11000	731 084
27180-22000	406 244
27300-3F100	470 556
27301-02100	470 587 ^S
27301-02502	470 394 ^{EU}
27301-02600	470 496 ^S

HYUNDAI

27301-02630	470 496 ^S
27301-02800	470 496 ^S
27301-03000	470 579 ^S
27301-03010	470 579 ^S
27301-03015	470 579 ^S
27301-03035	470 579 ^S
27301-03110	470 612
27301-03200	470 622
27301-03HA0	470 647
27301-04000	470 614
27301-04110	470 638
27301-22600	470 585
27301-23700	470 581 ^S
27301-23710	470 581 ^S
27301-23900	470 581 ^S
27301-26600	470 586
27301-2B000	470 495
27301-2B010	470 543
27301-2B100	470 611
27301-3C000	470 492
27310-02611	470 587
27310-02612	470 587
27310-02620	470 496
27310-02630	470 496
27310-03010	470 579
27310-03020	470 579
27310-22600	470 585
27310-22600	470 586
27310-22610	470 585
27310-26600	470 586
27310-37110	470 579
27310-37120	470 589
27310-37130	470 589
27420-02610	358 235
27420-03011	358 255
27420-23700	360 385
27420-37200	358 236
27420-37310	358 236
27430-02610	358 235
27430-03000	358 255
27430-03011	358 255
27430-23700	360 385
27430-37200	358 236
27440-02610	358 235
27440-03000	358 255
27440-03011	358 255
27440-23700	360 385
27440-37200	358 236
27440-37310	358 236
27450-02610	358 235
27450-03000	358 255
27450-03010	358 255
27450-23700	360 385
27450-37200	358 236
27460-37200	358 236
27460-37310	358 236
27470-37200	358 236
27501-02A00	358 120
27501-02D00	358 235
27501-02H00	358 119
27501-22B00	358 119
27501-22B10	358 119
27501-23A00	360 385
27501-23B00	360 385
27501-23B01	360 385
27501-23B70	360 385
27501-26A00	358 111
27501-26C00	358 111
27501-26D00	358 111
27501-33A00	360 401
27501-37B00	358 236
27501-38B00	358 241
AA100-18100B	470 219 ¹
KK150-18V00A	831 122

INFINITI

22157-46N12	931 136
22157-70J00	922 085
22162-0M811	831 151
22162-53J00	822 073
22448-2V70A	470 626
22448-HG00A	470 626
22448-HG00B	470 626
22448-HG00C	470 626
22448-HG00E	470 626
22448-JA00C	470 552
22448-JA10C	470 533
22448-JA11C	470 533

INNOCENTI

39322140	470 101D
46543562	470 146
638326146	706 049HDVS
638326383	906 025R
6553206203	713 022HV
6553206400	913 034
6553221201	813 094
6553221203	713 011HV
6553221400	913 014
659321119	828 078
659321324	928 012
7735397	359 655
7746151	470 148
7746153	470 158
82361915	930 047R
9622889780	470 188
9938360	830 104
9940095	465 020
9940429	430 177/1
9941693	430 176M
9943506	930 059
9944668	830 115
9944794	830 101
9946355	830 114
9946356	930 060

ISUZU

GR 2384	713 022HV
2-23115-15	722 056HV
5-82311215-0	822 003
5-86202572-0	822 082
5-86202573-0	922 098
5-86206161-0	470 347
5-86207198-0	470 347
8-01979571-0	465 025
8-10495411-0	912 098
8-10496278-0	812 075
8-16140049-0	465 025
8-23115-14	722 056HV
8-23115-15	722 056HV
8-23212-14	822 003
8-94136766-0	470 219
8-94174468-0	922 069
8-94201644-0	713 011HV
8-94206140-0	913 014
8-94206144-0	713 022HV
8-94206145-0	713 022HV
8-94208-408	713 022HV
8-94216729-0	913 014
8-94216730-0	813 092
8-94221206-0	913 014
8-94221-206-00	913 014
8-94238982-0	913 027
8-94321537-0	813 254
8-94322990-0	822 060
8-94338910-0	913 030
8-94404545-0	470 199
8-94404559-0	913 029

ISUZU

8-94404560-0	813 122
9-40210-67	822 003
9-40222-97	722 056HV
9-42084-08	713 022HV
9-42212-06	913 014
9-82311214-0	822 003
9-82311515-0	722 056HV
9-82311518-0	722 056HV

IVECO

500309816	470 345
504142675	470 442
8024220	470 313

JAGUAR

AEU 1501	928 012
AEU 1502	828 085
JLM 150	828 098
JLM 1909	830 110
JLM 1911	930 058
JLM 381	928 027R
JLM 838	806 081
JLM 839	906 113R
JLM 9522	728 089
JLM 9528	828 085
JLM 9623	928 012
LNA 1508AA	470 170

JEEP

33003389	919 092
33004024	819 093
46337742	470 549
4728190	358 181
4728190AC	358 181
55224110	470 549
55229959	470 549
55263679	470 549
55270217	470 549
56026876	819 093
56027075	919 092
68298269AA	470 549
K68298228AA	470 549
K68298269AA	470 549
K68436928AA	470 549
T1031135	470 107

KIA

OK011-18100	470 168
OK201-18140	360 398
OK201-18150	360 398
OK201-18-150A	360 398
OK247-18-160A	360 841
OK247-18-160B	360 841
OK247-18-180A	360 841
OK247-18-180B	360 841
OK2A3-18-160A	360 841
OK2A3-18-180A	360 841
OK2BW-18160	360 841
OK2BW-18180	360 841
OK30A-18-140A	360 851
OK30B-18140	360 851
OK30E-18140	358 239
OK30F-18140	358 239
27300-3F100	470 556

KIA

27301-02700	470 589
27301-02710	470 589
27301-03010	470 579 ^{FS}
27301-03100	470 579 ^{FS}
27301-03110	470 612
27301-03200	470 622
27301-03HA0	470 647
27301-04000	470 614
27301-04110	470 638
27301-23700	470 581 ^{FS}
27301-23710	470 581 ^{FS}
27301-23720	470 581 ^{FS}
27301-23900	470 581 ^{FS}
27301-26600	470 586
27301-2B000	470 495
27301-2B010	470 543
27301-2B100	470 611
27301-3C000	470 492
27310-02611	470 587
27310-03010	470 579
27310-03020	470 579
27400-2X140	358 239
27401-2X000	360 851
27420-23700	360 385
27420-26700	358 111
27420-37310	358 236
27430-23700	360 385
27430-26700	358 111
27430-37200	358 236
27440-23700	360 385
27440-26700	358 111
27440-37310	358 236
27450-23700	360 385
27450-26700	358 111
27450-37200	358 236
27460-37310	358 236
27470-37200	358 236
27501-02H00	358 119
27501-23B70	360 385
27501-26D00	358 111
27501-33A00	360 401
27501-38B00	358 241
AA100-18-100B	470 219 ^{F1}
KK137-18-140A	360 398
KK137-18-150A	360 398
KK137-18V00	831 121
KK150-18V00	831 122
KK150-18-V00A	831 122
KK150-18V05	931 108
KK150-18-V05A	931 108
MB593-18V00	831 150
MB593-18-V00A	831 150
MB593-18V05	931 132
MB6BF-18V05	931 132
MF220-18-V00A	831 121

LADA

21010-3706020-10	946 014R
21010-3706500-00	847 025
21010-3706800-10	746 070
2101-3705000-02	470 101D
21013-7050560	470 101D
2101-3705060-00	470 101D
21013-7060010-10	946 014R ^C
2101-3706020	946 014R
2101-3706020-10	946 014R
2101-3706500	847 025
2101-3706800	746 071
2101-3706800-10	746 070
2107-3706020-10	946 014R
2107-3706020-20	946 014R
2107-3706500	847 025
2108-3706020	946 016R

LADA

2108-3706500	847 027
2108-3706500-10	847 027
2108-3734910-10	465 004
22 43 324 28R	470 613
22 43 361 34R	470 596
3037-06020	946 014R
3700-3118583	465 004
38-37060-20	946 014R
38-37065-00	847 025
82 00 765 882	470 432

LANCIA

4158493	470 101D
4386221	470 103
4460205	470 103
46403328	470 314
46413088	360 503
46425912	360 504
46446039	470 345
46472440	470 345
46473849	470 384
46474814	360 505
46480361	470 345
46543562	470 146
46548037	470 146
46749624	360 451
46777288	470 442
55200112	470 423
55202897	360 451
55208723	470 423
55214926	470 549
55229959	470 549
55246099	470 442
60562701	470 313
60805420	470 146
60809492	470 146
60809702	806 236
60810690	470 313
7080442	806 079
7588436	490 303
7612954	470 126
7625943	359 456
7626232	470 146
7646974	470 158
7648797	470 168
7663177	470 108
7672018	470 146
7700267693	906 119R
7703382	359 700
7735397	359 655
7742005	359 694
7742689	359 456
7746151	470 148
7760523	360 363
7776810	359 616
7785350	359 888
7787458	359 889
7789346	470 345
9463264180	470 408
9607405480	470 188
9622889780	470 188
9634131380	470 408
9924733	915 083R
9927962	906 025R
9934266	615 023
9934728	830 093
9934729	430 161/1
9935150	715 101
9936023	930 047R
9936027	830 098
9936331	430 163/1
9936735	815 058
9937767	930 054R

LANCIA

9938173	930 055R
9938360	830 104
9939707	906 023R
9939786	430 180M
9939787	830 101
9939788	430 176M
9939789	830 109
9940095	465 020
9940302	915 094
9940428	930 057R
9940429	430 177/1
9941721	815 080
9942040	465 029
9943506	930 059
9944407	930 060
9944576	830 114
9944668	830 115

LAND ROVER

00000A00069	817 023
00000A00070	917 058
00000A00071	717 024
00000A00072	617 097
1748018	470 352
262704	928 007
269987	728 083MHV
566859	828 075
600328	828 070
605190	828 091
AUU1675	360 900
AUU1676	360 900
AUU1677	360 900
AUU1678	360 900
ERR6045	470 168
ERR6566	470 168 ^{F1}
LRO22494	470 352
NEC000040	470 352
NEC100630	470 374
NEC101000L	470 352
NEC101010L	470 413
NGC103570	360 900
NGC103740	358 107
NGC103750	358 107
NGC103760	358 107
NGC103780	358 107
NGC103800	358 107
NGC104170L	360 889
NGC500370	360 900
NGC500380	360 900
NGC500390	360 900
NGC500400	360 900
NGC500410	360 900
NJD10010	828 093
NJE10003	928 029R
PRC9858	470 101D
RTC3197	828 091
RTC3199	928 022
RTC3270	728 083MHV
RTC3278	828 078
RTC3282	728 089
RTC3295	815 049
RTC3313	728 083MHV
RTC3339	928 012
RTC3341	915 091
RTC3473	615 034
RTC3526	615 034
RTC3612	928 006
RTC3613	928 014
RTC3614	928 012
RTC3616	915 091
RTC3618	928 021
RTC3881	728 083MHV
RTC4932	815 054
RTC4933	915 091

LAND ROVER

RTC4935	615 034
RTC5629	470 101D
RTC5946	728 089
RTC5947	728 089
RTC6627	728 089
RTC6629	928 022
STC1857	928 022
STC8368	828 091

LEXUS

90919-02185	470 202
90919-02197	470 203
90919-02208	470 203
90919-02244	470 466
90919-02248	470 458
90919-02250	470 537
90919-02251	470 538
90919-02255	470 538
90919-02256	470 537
90919-02258	470 536
90919-02260	470 458
90919-02266	470 466
90919-A2003	470 537
90919-A2004	470 538
90919-A2005	470 537
90919-A2007	470 538
90919-C2004	470 537

MARUTI

33102-75110	713 011HV ^{PF}
33310-82110	913 030
33321-78110	813 107

MASERATI

313220203	930 054R
6313220203	930 054R

MAZDA

0000-18-135A	360 760
0324-24-310	831 003/001
0324-24-312	931 023
0494-24-314	731 084
1E03-18-10X	470 532 ^{*1}
1E03-18-10XA	470 532 ^{*1}
1E04-18-10X	470 532
1E05-18-100	470 299
1E05-18-100A	470 299
1E05-18-100B	470 532
1E06-18-100	470 299S
1F20-18-100	470 532
1F20-18-100A	470 532
3710-24-310	822 003
3763-24-314	731 084
3823-24-314	731 084
3879-24-314	731 084
8BBG-18-140	360 398
8BBY-18-140	360 398
8BGP-18-140	360 760
8BGP-18-140A	360 760
8BGP-18-140B	360 760
8BGP-18-140C	360 760
AM01-24-312	931 023
AM15-18-V00	831 003/001
B303-18-V00	831 122
B303-18-V05	931 108
B33G-18-140A	360 741

MAZDA

B33G-18-140B	360 741
B3B1-18-V00	831 122
B3C7-18-V00	822 088
B3C7-18-V05	922 094
B3M5-18-V00	831 154
B3S5-18-V00	831 150
B541-18-V00	831 131
B541-18-V20	465 073 ^{*1}
B593-18-V00	831 150
B593-18-V00A	831 150
B593-18-V05	931 132
B601-18-V05	922 073
B616-18-V00	831 125
B61P-18-140C	360 745
B61V-18-V05	931 119
B69F-18-140A	360 231
B69F-18-140B	360 231
B6BF-18-140A	360 231
B6BF-18-140B	360 231
B6BF-18-V05	931 132
B6MC-18-140B	360 745
B6S7-18-100	470 366S
B6S7-18-10XA	470 233
B6S8-18-10XA	470 233
BPO5-18-V00	831 121
BPE8-18-140	360 745
BPE8-18-140A	360 745
C201-18-100	470 532
C201-18-100A	470 532
C201-18-100B	470 532
C201-18-160A	358 242
C201-18-170A	358 242
C201-18-180A	358 242
C201-18-190A	358 242
C401-18-100	470 481
C401-18-100A	470 481
E594-24-310	831 109
E5D5-18-V00A	831 118
F201-18-V00	831 125
F220-18-V00A	831 121
F220-18-V05	931 113
F2G8-18-V00	831 121
F829-18-V00	831 132
F829-18-V05	931 108
F855-24-312	931 023
FE01-24-310	831 109
FE01-24-310A	831 109
FE1H-18-V00	831 117
FE1H-18-V00A	831 117
FE2S-18-V00	831 132
FE2S-18-V00A	831 132
FE2S-18-V05	931 108
FEEN-18-V00	831 132
FEH1-18-V00A	831 117
FEJK-18-10X	470 366S
FP13-18-140A	359 884
FP13-18-140B	359 884
FP39-18-140	360 740
FP39-18-140A	360 740
FP85-18-140A	360 767
FP86-18-140A	360 767
FS01-18-140	359 884
FS01-18-V05	931 137
FS01-18-V05A	931 137
FS05-18-V00	822 077
FS05-18-V05	922 094
FS07-18-V05	931 131
FS07-18-V05A	931 131
FS90-18-V00	822 092
FS90-18-V05	922 102
FSD7-18-100	470 135
FSD7-18-140B	360 739
G601-18-V05	931 108
G602-18-V00	831 122
G609-18-V00	831 121
H612-24-310	831 003/001

MAZDA

K834-18-140A	360 760
KF33-18-140C	360 760
KF33-18-140D	360 760
KF33-18-140E	360 760
KF34-18-V00	831 149
KF34-18-V05	931 134
KF34-18-V05A	931 134
KL01-18-140C	360 760
KL01-18-V00	831 137
KL01-18-V00A	831 137
KL01-18-V05	931 133
KL01-18-V05A	931 133
KL47-18-140B	360 760
KL47-18-140C	360 760
KL64-18-100A	470 289
L813-18-140B	358 245
L813-18-140C	358 245
LF01-18-100	470 532
LF01-18-100A	470 532
LF16-18-100	470 480
LF16-18-100A	470 480
LF16-18-100B	470 480
P51B-18-100	470 627
PE01-18-100	470 627
PE20-18-100	470 627
PE20-18-100A	470 627
PYFS-18-100	470 627
YF09-18-10X	470 532
Z501-18-140	360 738
Z501-18-140A	360 738
ZJ01-18-100	470 514
ZJ01-18-100A	470 514
ZJ20-18-100	470 516
ZJ20-18-100A	470 516
ZL01-18-140A	360 729
ZZL0-18-100	470 289
ZZM0-24-310	819 093
ZZM0-24-312	919 092
ZZM1-24-310	819 093
ZZM2-24-310	819 093
ZZM7-18-100	470 289

MERCEDES-BENZ

A 000 150 04 80	470 317
A 000 150 05 80	470 317
A 000 150 15 80	470 420
A 000 150 19 80	470 487
A 000 150 25 80	470 420
A 000 150 26 80	470 487
A 000 150 27 80	470 487
A 000 150 29 80	470 420
A 000 158 06 02	806 062
A 000 158 07 02	806 072
A 000 158 07 90	706 029HV
A 000 158 15 31	906 018R
A 000 158 16 02	806 072
A 000 158 18 02	806 079
A 000 158 18 90	706 029HV
A 000 158 20 31	906 018R
A 000 158 20 90	706 021
A 000 158 21 31	906 021R
A 000 158 22 31	906 024R
A 000 158 22 90	706 049HDVS
A 000 158 23 31	906 023R
A 000 158 23 90	706 034HVS
A 000 158 24 90	706 034HVS
A 000 158 25 02	806 072
A 000 158 26 31	906 034R
A 000 158 27 02	806 092
A 000 158 27 31	906 025R
A 000 158 28 02	806 079
A 000 158 28 90	706 062
A 000 158 31 31	906 025R

MERCEDES-BENZ

A 000 158 33 31	906 061R
A 000 158 34 02	806 090 ^A
A 000 158 34 31	906 055R
A 000 158 35 31	906 060R
A 000 158 35 90	706 062
A 000 158 36 02	806 092 ^{*A}
A 000 158 36 31	906 049R
A 000 158 37 31	906 112R
A 000 158 37 90	706 062
A 000 158 39 31	906 121R
A 000 158 39 90	706 062
A 000 158 40 03	470 180
A 000 158 40 31	906 126R
A 000 158 40 90	706 034HVS
A 000 158 41 02	806 092 ^{*A}
A 000 158 42 02	806 090 ^{*A}
A 000 158 42 31	906 121R
A 000 158 43 02	806 108 ^{*A}
A 000 158 44 02	806 123 ^{*A}
A 000 158 45 03	470 178
A 000 158 48 02	806 234
A 000 158 48 03	470 178
A 000 158 49 02	806 234 ^A
A 000 158 50 03	470 178
A 000 158 52 02	806 239 ^A
A 000 158 53 03	470 178
A 000 158 54 03	470 178
A 000 158 56 03	470 179
A 000 158 58 03	470 179
A 000 158 61 03	470 178
A 000 158 62 03	470 178
A 000 158 64 03	470 179
A 000 158 70 03	470 316
A 000 158 71 03	470 316
A 000 158 73 03	470 417
A 000 158 75 03	470 316
A 000 158 77 03	470 414
A 000 158 78 03	470 417
A 102 150 53 18	360 657
A 102 150 54 18	360 654
A 102 150 54 18	360 657
A 102 150 55 18	360 654
A 102 150 55 18	360 657
A 102 150 56 18	360 654
A 102 150 56 18	360 657
A 102 150 56 18	360 657
A 102 150 58 18	360 657
A 102 150 59 18	360 654
A 103 158 00 02	806 237
A 103 158 02 31	906 125R
A 103 158 03 31	906 125R
A 112 150 01 18	360 649
A 112 150 02 18	360 649
A 112 150 06 18	360 649
A 112 150 07 18	360 649
A 119 158 01 31	906 146R
A 119 158 02 31	906 146R
A 119 158 03 31	906 146R
A 266 150 01 18	358 234
A 266 150 02 18	358 234
A 266 150 06 18	358 234
A 266 150 07 18	358 234
A 266 150 10 18	358 232
A 266 150 11 18	358 232
A 266 150 12 18	358 232
A 266 150 13 18	358 232
A 272 906 00 60	470 487
A 274 906 06 00	470 626
A 274 906 07 00	470 626
A 274 906 14 00	470 626
A 281 906 00 00	470 613

MG

NEC100630	470 374
NEC101000	470 413

MG

NEC101010 **470 413**

MINI

12 12 1 496 996 **360 719**
 12 12 1 496 997 **360 719**
 12 12 1 496 998 **360 719**
 12 12 1 496 999 **360 719**
 12 12 7 513 032 **360 719**
 12 12 7 513 033 **360 719**
 12 12 7 513 034 **360 719**
 12 12 7 513 035 **360 719**
 12 13 5 A06 753 **470 475**
 12 13 7 594 012 **470 475**
 12 13 7 551 049 **470 475**
 12 13 7 562 744 **470 475**
 12 13 7 571 643 **470 475**
 12 13 7 575 010 **470 475**
 12 13 7 594 596 **470 475**
 12 13 7 594 937 **470 475**
 12 13 7 594 938 **470 475**
 12 13 7 619 385 **470 632**
 12 13 8 615 991 **470 632**
 12 13 8 616 153 **470 475**
 12 13 8 643 360 **470 632**
 12 13 8 647 463 **470 632**
 12 13 8 657 273 **470 475**
 12 13 8 678 438 **470 632**
 7 571 643 **470 475**
 8 643 360 **470 632**
 8 647 463 **470 632**
 82 11 0 393 996 **360 719**
 82 11 0 404 488 **360 719**

MITSUBISHI

08605 **831 003/001**
 1832A016 **470 497**
 1832A028 **470 503**
 27110-21060 **831 003/001**
 27110-32810 **831 003/001**
 27131-32810 **931 107**
 49371 **831 145**
 62571 **831 143**
 J170 **465 073**
 MD134754 **360 401**
 MD183124 **360 278**
 MD192995 **360 401**
 MD193015 **360 278**
 MD198216 **360 278**
 MD310297 **360 278**
 MD315902 **360 278**
 MD332343 **360 753**
 MD334017 **360 278**
 MD334021 **360 278**
 MD334026 **360 278**
 MD334039 **360 278**
 MD334043 **360 764**
 MD336862 **360 764**
 MD338249 **360 344**
 MD338624 **360 764**
 MD343245 **358 251**
 MD362276 **360 882**
 MD365102 **360 883**
 MD371794 **360 344**
 MD371980 **360 344**
 MD602756 **831 003/001**
 MD602758 **931 023**
 MD602949 **831 003/001**
 MD604338 **913 014**
 MD604411 **813 117**
 MD607101 **731 084**
 MD607394 **731 085**

MITSUBISHI

MD607402 **731 085**
 MD607597 **831 003/001**
 MD611151 **931 107**
 MD611459 **931 109**
 MD611526 **831 116**
 MD611604 **831 003/001**
 MD611686 **831 003/001**
 MD611757 **931 109**
 MD611850 **931 023**
 MD618187 **931 131**
 MD618210 **831 003/001**
 MD618283 **831 158**
 MD618284 **931 119**
 MD618297 **831 134**
 MD618364 **831 131**
 MD618374 **831 135**
 MD618431 **831 143**
 MD618555 **831 138**
 MD618556 **931 137**
 MD618760 **831 147**
 MD618977 **831 138**
 MD618979 **831 147**
 MD619000 **931 136**
 MD619050 **831 161**
 MD619092 **831 169**
 MD619176 **831 143**
 MD619186 **831 158**
 MD619216 **931 136**
 MD619272 **931 131**
 MD619273 **931 137**
 MD619274 **931 134**
 MD619354 **931 136**
 MD619363 **831 168**
 MD619387 **831 169**
 MD619388 **831 168**
 MD619434 **931 136**
 MD619468 **831 168**
 MD619637 **931 136**
 MD620555 **913 030**
 MD626374 **831 135**
 MN195805 **470 505**
 T100T20871 **731 084**
 T100T20872 **731 084**
 T100T21271 **731 085**
 T100T21272 **731 084**
 T12271 **931 023**
 T13371 **931 030**
 T15672 **931 109**
 T15673 **931 109**
 T16571 **931 107**
 T16871 **931 108**
 T17371 **931 110**
 T232T42271 **831 003/001**
 T232T42471 **831 003/001**
 T232T42771 **831 003/001**
 T232T48972 **831 158**
 T31771 **831 139**
 T42271 **831 003/001**
 T43574 **831 109**
 T43576 **831 109**
 T43871 **831 003/001**
 T44771 **831 120**
 T45071 **831 118**
 T45372 **831 117**
 T45671 **831 125**
 T46371 **831 114**
 T46382 **831 114**
 T46671 **831 122**
 T46771 **831 003/001**
 T46772 **831 003/001**
 T46971 **831 121**
 T47371 **831 122**
 T48171 **831 132**
 T48271 **831 136**
 T48372 **831 131**
 T61471 **831 116**

MITSUBISHI

T880T12271 **931 023**
 T880T13371 **931 030**
 T880T21572 **931 119**

NISSAN

15501-208 **822 003**
 22102-01M11 **631 131**
 22145-18005 **722 056HV**
 22145-18005A **728 083MHV**
 22145-71301 **722 056HV**
 22145-73415 **731 085**
 22145-73416 **731 084**
 22145-78506 **722 056HV**
 22145-89900 **731 085**
 22145-89901 **731 085**
 22145-89905 **731 085**
 22145-U6001 **722 056HV**
 22145-U6002 **722 056HV**
 22149-B8900 **922 052**
 22149-N3602 **922 052**
 22157-03A00 **922 086**
 22157-03P10 **931 109**
 22157-0M512 **931 136**
 22157-0M810 **931 136**
 22157-10B10 **931 023**
 22157-17B00 **922 070**
 22157-17B10 **931 110**
 22157-18F00 **922 066**
 22157-1E410 **931 118**
 22157-20R00 **922 066**
 22157-21E00 **922 070**
 22157-21E01 **922 070**
 22157-21F01 **922 070**
 22157-23G15 **931 030**
 22157-27M02 **922 070**
 22157-27M15 **931 110**
 22157-2J210 **931 136**
 22157-30R00 **922 085**
 22157-40F00 **922 070**
 22157-46N11 **931 136**
 22157-46N12 **931 136**
 22157-4B000 **922 102**
 22157-50Y10 **931 131**
 22157-53F11 **931 118**
 22157-54C01 **922 085**
 22157-55K10 **931 119**
 22157-55Y00 **922 070**
 22157-70J00 **922 085**
 22157-70J01 **922 085**
 22157-71J00 **922 070**
 22157-71J10 **922 086**
 22157-72B00 **922 102**
 22157-73C00 **928 030**
 22157-77A01 **922 086**
 22157-78A00 **922 070**
 22157-99B01 **928 030**
 22157-99B03 **928 030**
 22157-H3602 **922 052**
 22157-H9560 **922 052**
 22157-KA030 **922 073**
 22157-M5610 **931 030**
 22157-N3602 **922 052**
 22157-R9006 **931 023**
 22157-R9007 **931 023**
 22157-U6001 **922 052**
 22157-U6091 **922 052**
 22157-U6091MP **922 052**
 22157-U6094 **922 052**
 22157-U6094DY **922 052**
 22162-01B01 **822 046**
 22162-03M00 **822 089**
 22162-06W00 **822 040**
 22162-06W03 **822 040**

NISSAN

22162-06W03MP **822 040**
 22162-06W04 **822 040**
 22162-06W04MP **822 040**
 22162-06W05 **822 040**
 22162-06W06 **822 040**
 22162-0M200 **822 089**
 22162-0M300 **822 089**
 22162-0M810 **831 151**
 22162-0M811 **831 151**
 22162-11E07 **822 063**
 22162-12E01 **822 046**
 22162-15M00 **822 057**
 22162-15M01 **822 057**
 22162-15M01MP **822 057**
 22162-15M02 **822 057**
 22162-15M02MP **822 057**
 22162-15M03 **822 057**
 22162-15M03MP **822 057**
 22162-15M04 **822 057**
 22162-17M00 **822 046**
 22162-17M01 **822 046**
 22162-17M02 **822 046**
 22162-17M03 **822 046**
 22162-17M04 **822 046**
 22162-17M05 **822 046**
 22162-18F01 **822 040**
 22162-1S700 **822 089**
 22162-21007 **822 003**
 22162-21F03 **822 046**
 22162-23G15 **831 114**
 22162-25G10 **831 120**
 22162-25G11 **831 120**
 22162-3S500 **822 089**
 22162-40F00 **822 046**
 22162-40F10 **831 114**
 22162-41B00 **828 105**
 22162-41L11 **831 126**
 22162-42L10 **831 126**
 22162-42L11 **831 126**
 22162-52A01 **822 057**
 22162-52H20 **831 126**
 22162-53J00 **822 073**
 22162-70F10 **831 152**
 22162-70F11 **831 152**
 22162-70J00 **828 102**
 22162-71300 **822 003**
 22162-71312 **822 003**
 22162-71J00 **828 103**
 22162-71J10 **828 101**
 22162-72Y10 **831 155**
 22162-73C00 **822 079**
 22162-78A00 **822 046**
 22162-78A10 **831 114**
 22162-82J00 **828 105**
 22162-94M01 **828 101**
 22162-94M11 **831 136**
 22162-99B00 **828 104**
 22162-A3514 **831 120**
 22162-G5710 **831 114**
 22162-G5711 **831 114**
 22162-KA020 **822 041**
 22162-N8801 **822 003**
 22162-N8801MP **822 003**
 22162-R9006 **831 003/001**
 22162-R9007 **831 003/001**
 22162-W4502 **822 040**
 22433-18R10 **470 219**
 22433-1E400 **470 296**
 22433-3529R **470 432**
 22433-42L10 **470 219**
 22440-1S700 **360 789**
 22440-1S710 **360 789**
 22440-2F200 **360 411**
 22440-2J210 **360 411**
 22440-57Y10 **360 399**
 22440-73C00 **360 399**

NISSAN

22440-73C10	360 399
22440-86J00	360 658
22440-86J10	360 658
22440-8B000	360 789
22440-99B00	359 608
22440-99B05	359 608
22440-99B06	359 608
22448-00A0C	470 432
22448-00Q0A	470 432
22448-00Q0B	470 432
22448-00Q0C	470 432
22448-00Q0E	470 596
22448-00Q0F	470 613
22448-00Q0G	470 432
22448-00QAA	470 432
22448-00QAB	470 432
22448-00QAC	470 596
22448-00QAD	470 419
22448-00QAE	470 432
22448-00QAH	470 432
22448-1E400	470 296
22448-1KCOA	470 551
22448-1KTOA	470 552
22448-1KT1A	470 552
22448-3RCOA	470 552
22448-6N000	470 557
22448-6N002	470 557
22448-6N010	470 557
22448-6N011	470 557
22448-6N012	470 557
22448-6N015	470 557
22448-95FOA	470 557
22448-AX001	470 602
22448-ED000	470 552
22448-ED800	470 489
22448-ED80A	470 489
22448-JA00A	470 552
22448-JA00C	470 552
22448-JA10A	470 533
22448-JA10C	470 533
22448-JA11C	470 533
22450-00Q0A	358 230
22450-00Q0B	358 244
22450-00Q0C	358 230
22450-00QAA	358 230
22450-00QAB	358 244
22450-71J25	359 609
22462-00Q0A	470 518
24488-00QAA	358 246
77001-07177	470 432
82006-72564	470 432
B2162-06W05	822 040

OPEL

01972927	812 073
01985771	812 074
03469033	806 080
1 46 015	906 024R
10458316	470 450
12 08 002	470 341
12 08 003	470 140
12 08 004	470 341
12 08 008	470 508
12 08 012	470 400
12 08 020	470 400
12 08 021	470 450
12 08 028	470 398
12 08 035	470 109
12 08 036	470 111
12 08 041	470 194
12 08 047	470 191
12 08 048	470 341
12 08 053	470 192
12 08 054	470 140

OPEL

12 08 065	470 273
12 08 070	470 140
12 08 071	470 272
12 08 076	470 389
12 08 086	470 545
12 08 092	470 547
12 08 093	470 547
12 08 096	470 547
12 08 098	470 545
12 08 108	470 442
12 08 117	470 631
12 08 120	470 450
12 08 123	470 547
12 08 241	465 004
12 08 243	465 034
12 08 246	465 004
12 08 248	465 005
12 08 306	470 398
12 08 307	470 399
12 11 000	806 249
12 11 006	428 202^{FN}
12 11 250	806 081
12 11 252	806 080
12 11 253	806 076
12 11 256	806 099
12 11 258	812 073
12 11 260	812 074
12 11 261	806 240^{FA}
12 11 262	806 251
12 11 265	806 080
12 11 266	828 099
12 11 267	806 080^{FA}
12 11 268	806 249
12 11 269	806 256
12 11 270	806 257^{FA}
12 11 271	828 100
12 11 273	806 258
12 11 275	815 084
12 11 276	806 257^{FA}
12 11 582	465 025
12 11 591	465 025
12 12 125	412 011
12 12 126	412 010
12 12 128	806 062
12 12 131	806 072
12 12 135	806 072
12 12 136	806 076
12 12 137	806 076
12 12 138	806 072
12 12 140	812 066
12 12 141	806 081
12 12 143	806 079
12 12 147	806 062
12 12 154	712 055HVS
12 12 200	928 028R
12 12 203	912 100
12 12 204	915 103R
12 12 206	906 127R
12 12 207	915 103R
12 12 208	912 093
12 12 213	906 026R
12 12 216	906 055R
12 12 217	906 056R
12 12 218	912 096
12 12 219	906 061R
12 12 220	906 056R
12 12 221	912 097
12 12 222	906 121R
12 12 224	906 127R
12 12 253	606 212
12 12 259	606 212
12 12 260	606 212
12 16 011	706 034HVS
12 37 334	465 036^{F1}
12 37 464	465 036^{F1}
12 37 504	465 025

OPEL

12 82 044	358 195
12 82 044	358 199
12 82 077	359 688
12 82 078	359 688
12 82 079	359 688
12 82 080	359 688
12 82 084	358 195
12 82 089	358 195
12 82 090	358 195
12 82 091	358 195
12 82 133	358 199
12 82 134	358 199
12 82 135	358 199
12 82 141	358 199
12 82 142	360 947
12 82 143	360 947
12 82 144	360 947
12 82 145	360 947
12 82 146	360 559
12 82 147	360 559
12 82 153	360 559
12 82 154	360 559
12 82 155	360 559
12 82 156	360 559
12 82 163	360 904
12 82 164	360 904
12 82 165	360 904
12 82 166	360 904
12635672	470 631
12670053	470 631
12697989	470 631
16 12 001	360 506
16 12 005	706 047
16 12 006	706 029HV
16 12 011	706 034HVS
16 12 013	360 506
16 12 229	712 055HVS
16 12 385	706 034HVS
16 12 433	706 049HDVS
16 12 434	359 509
16 12 459	359 514
16 12 477	360 942
16 12 479	359 514
16 12 497	359 527
16 12 512	359 956
16 12 523	359 513
16 12 524	359 514
16 12 527	359 513
16 12 531	359 527
16 12 532	359 513
16 12 533	360 237
16 12 539	359 514
16 12 541	360 237
16 12 542	359 514
16 12 543	359 634
16 12 544	360 237
16 12 545	359 513
16 12 552	359 688
16 12 556	360 237
16 12 557	360 237
16 12 558	359 689
16 12 559	359 689
16 12 560	359 689
16 12 561	359 688
16 12 591	359 634
16 12 592	359 634
16 12 598	360 562
16 12 606	360 529
16 12 607	360 529
16 12 608	360 531
16 12 610	360 237
16 12 639	360 529
16 12 646	360 506
16 12 651	359 634
16 12 657	360 904
17 84 226	906 012R

OPEL

17 84 228	912 093R
17 84 231	912 093R
17 84 234	912 095R
17 84 235	906 012R
19005212	470 399
25195107	470 547
25198623	470 547
3474283	470 140
3639500	470 609
3639845	470 620
3648847	470 475
42 91 891	913 030
42 94 009	813 093
42 94 029	470 219
43 00 976	813 254
43 00 982	822 060
43 12 974	922 069
43 13 484	913 030
44 08 283	470 432
44 08 389	470 432
44 13 233	470 432
44 32 202	470 432
5 97 091	470 475
55561655	470 545
55573735	470 547
55577898	470 547
55579072	470 547
55584404	470 545
62 35 037	470 507
62 37 753	465 025
90009490	606 212
90230575	806 240
90297426	806 251
90336536	806 257
90350765	806 249
90350988	806 256
90350997	828 100
90443900	470 273
90449572	470 273
90449739	470 140
90458250	470 272
90506102	470 389
90510386	470 140
90543059	470 398
90543253	470 400
91 19 567	470 508
91 98 834	470 507
91159996	470 432
93161188	470 432
93161948	470 432
93177212	470 400
93180806	470 398
95512934	470 442
95517924	470 450
95528319	470 547
9671214580	470 609
9675390980	470 620
RP 1 212 007	706 034HVS
RP 1 212 154	712 055HVS
RP121201	706 047
RP121202	706 029HV

PEUGEOT

00 600 665 00	730 132
16 075 767 80	470 505
16 115 478 80	470 459
5900 H1	415 019^{FN}
5900 H7	415 019^{FN}
5900 H9	415 019^{FN}
5900 J1	415 019^{FN}
5900 K3	415 019^{FN}
5900 K6	415 019^{FN}
5900 K7	415 019^{FN}
5904 06	406 153

PEUGEOT

5904 25	406 159
5904 F1	430 178M
5904 K3	415 017
5904 K8	415 019
5904 K9	415 017
5904 L3	415 019
5904 P5	415 019
5905 09	406 153
5927 09	715 055
5927 30	706 040
5927 35	715 112U
5927 43	715 076
5927 44	715 076
5927 50	706 034HVS
5927 65	706 049HDVS
5927 73	715 102
5927 83	715 103
5927 90	465 005
5927 92	715 105
5927 96	715 103
5937 05	915 091
5937 09	915 088
5937 16	915 091
5937 17	915 083R
5937 18	915 088R
5937 21	906 023R
5937 22	915 088
5937 25	906 056R
5937 26	906 049R
5937 28	915 094
5937 29	930 047R
5937 30	915 096R
5937 31	906 055R
5937 32	906 025R
5937 34	915 091
5937 40	906 061R
5937 42	906 119R
5937 43	915 094
5937 44	915 104
5937 47	915 102R
5937 49	915 096R
5937 51	906 026R
5940 52	806 241
5940 52	906 026R
5941 06	815 049
5941 08	815 049
5941 20	815 049
5941 23	815 054
5941 26	815 058
5941 27	806 079
5941 28	815 059
5941 30	830 101
5941 32	806 124
5941 41	815 067
5941 42	806 236 ^A
5941 43	830 098
5941 44	806 241
5941 45	815 077
5941 46	815 074
5941 47	806 252 ^A
5941 48	815 077
5945 02	465 005
5945 03	465 005
5945 10	730 146M
5945 25	465 005
5945 31	465 005
5945 33	465 005
5945 39	465 005
5945 48	465 005
5945 51	465 034
5948 04	642 056
5948 05	615 023
5948 06	615 023
5948 11	615 034
5948 17	615 034
5948 27	615 034

PEUGEOT

5967 79	359 846
5967 84	359 846
5967 C3	359 747
5967 E5	359 748
5967 H5	359 748
5967 K4	359 748
5967 K6	359 780
5967 K7	359 747
5967 K9	359 491
5967 L0	359 674
5967 L1	359 494
5967 L6	359 494
5967 L7	359 674
5967 L8	359 494
5967 L9	360 025
5967 N1	359 494
5967 N2	359 655
5967 N6	360 374
5967 N7	359 674
5967 P1	360 374
5970 11	470 101D
5970 28	470 101D
5970 42	470 106
5970 43	470 105
5970 45	470 155
5970 48	470 188
5970 49	470 189
5970 53	470 168
5970 64	470 475
5970 70	470 188
5970 72	470 403
5970 74	470 403
5970 75	470 408
5970 76	470 509
5970 78	470 405
5970 79	470 405
5970 80	470 407
5970 84	470 509
5970 85	470 483
5970 87	470 476
5970 88	470 461
5970 90	470 405
5970 91	470 475
5970 92	470 476
5970 96	470 497
5970 97	470 405
5970 98	470 408
5970 99	470 407
5970 A0	470 476
5970 A5	470 509
5970 A6	470 476
5970 A8	470 405
5970 A9	470 403
5970 C0	470 461
5970 C1	470 461
5979 A8	470 405
96 035 284	470 155
96 062 288	470 189
96 228 897	470 188
96 246 755 80	470 403
96 281 585 80	470 403
96 566 957 80	470 476
96 712 145 80	470 609
96 753 909 80	470 620
98 067 027 80	470 475
98 078 418 80	470 475

PIAGGIO

19102-87704-000	913 030
498325	430 180M
498327	465 020

PORSCHE

177 860 820 20	706 034HVS
616 602 215 00	806 062
616 602 215 02	806 076
616 602 221 00	906 018R
616 602 221 05	906 021R
616 602 223 00	706 034HVS
616 602 226 00	706 021
616 602 226 02	706 047
901 602 901 00	806 072
901 602 928 00	906 012R
901 602 932 00	730 132
901 602 960 00	706 049HDVS
901 602 960 03	706 047
901 602 963 00	806 072
923 602 929 00	906 025R
928 602 211 01	806 128 ^A
928 602 706 01	465 034
928 602 902 00	806 090 ^A
928 602 904 03	906 023R
930 602 902 00	906 024R
930 602 902 01	906 113R
930 602 902 02	906 113R
930 602 904 00	806 081
930 602 908 00	806 081
930 602 919 00	806 123 ^A
931 602 906 00	906 055R
944 602 251 00	806 117 ^A
944 602 901 00	906 070R
944 602 902 00	806 117 ^A
944 602 906 01	906 070R
955 602 101 00	470 434
955 602 101 01	470 434
955 602 101 02	470 434
955 602 101 03	470 434
955 602 101 04	470 434
955 602 101 05	470 434
958 602 101 00	470 434
958 602 102 00	470 427
958 905 110 00	470 636
958 905 110 01	470 636
PAB 905 715	470 434
PAC 905 110	470 636
PAC 905 110 A	470 636

PUCH

000 158 71 03	470 316
302 3 50 015 0	706 068
364 4 50 513 2	606 030
A 000 150 02 80	470 316
E 023 015	706 068
E 644 513	606 030

RELIANT

17 241	828 075
17 509	728 083MHV
90 792	828 078
91 119	828 078
210 803	719 044HV

RENAULT

08 02 119 800	642 056
08 51 874 100	815 049
08 51 877 600	642 056
08 53 712 500	615 023
08 54 120 600	915 091
08 54 137 800	715 055
08 54 233 000	642 056

RENAULT

08 54 719 900	815 041
08 54 720 000	915 081
08 54 725 600	715 061
08 54 910 100	642 056
08 54 913 400	842 043
08 54 921 500	742 054
08 54 923 300	642 056
08 54 943 800	642 056
08 54 954 600	715 056
08 55 054 100	915 083R
08 57 113 200	830 069
08 57 113 600	730 132
08 57 113 700	917 052
22 43 324 28R	470 613
22 43 325 97R	470 432
22 43 327 34R	470 552
22 43 335 29R	470 432
22 43 361 34R	470 596
22 43 392 77R	470 552
22 44 81K COA	470 551
22 44 81K TOA	470 552
22 44 83R COA	470 552
22 44 8JA 00C	470 552
22 44 8JA 10C	470 533
60 01 543 604	470 596
60 25 003 011	359 539
60 25 003 095	359 543
74 01 275 174	490 423
74 31 275 284	358 061
74 31 367 783	906 147R
74 33 501 944	806 260
74 39 135 700	358 064
74 39 445 258	358 064
77 00 100 589	470 376
77 00 100 643	470 378
77 00 102 012	815 072 TM
77 00 106 221	360 492
77 00 107 177	470 432
77 00 107 269	470 196
77 00 107 662	360 447
77 00 113 357	470 432
77 00 113 357 A	470 432
77 00 114 549	360 681
77 00 267 693	906 119R
77 00 267 694	806 236 ^A
77 00 267 728	806 236 ^A
77 00 273 226	360 443
77 00 273 826	358 244
77 00 274 008	470 596
77 00 552 370	470 101D
77 00 562 370	470 101D
77 00 682 481	359 839
77 00 720 781	359 539
77 00 720 842	359 539
77 00 726 529	359 839
77 00 726 626	359 543
77 00 726 736	815 069
77 00 727 261	915 097
77 00 729 838	815 091 ^B
77 00 730 116	815 066 ^B
77 00 733 982	815 073 TM
77 00 736 209	815 072 TM
77 00 739 893	815 083 ^B
77 00 740 118	359 539
77 00 741 025	359 415
77 00 742 835	359 801
77 00 742 837	359 802
77 00 742 853	815 083 ^B
77 00 743 290	815 083 TM
77 00 743 602	815 083 TM
77 00 749 450	470 228
77 00 749 516	359 415
77 00 749 516	359 802
77 00 749 517	359 801
77 00 749 521	360 332
77 00 749 521	360 497

RENAULT

77 00 749 877	359 415
77 00 850 462	359 539
77 00 850 463	359 543
77 00 850 475	359 802
77 00 851 781	815 072^M
77 00 854 306	470 275
77 00 854 307	470 276
77 00 855 322	359 415
77 00 855 902	360 497
77 00 857 045	360 332
77 00 857 980	359 920
77 00 857 981	359 920
77 00 857 981	360 499
77 00 859 053	815 086^M
77 00 863 020	470 355
77 00 863 021	470 356
77 00 866 923	360 446
77 00 872 265	470 275
77 00 872 449	470 365
77 00 872 692	470 276
77 00 872 834	470 365
77 00 873 186	360 499
77 00 874 109	360 447
77 00 874 564	360 501
77 00 875 000	470 432
77 01 000 998	642 056
77 01 003 813	742 054
77 01 008 141	742 054
77 01 008 855	642 056
77 01 012 471	642 056
77 01 012 533	706 049HDVS
77 01 012 535	906 012R
77 01 012 536	806 079
77 01 012 957	815 045
77 01 018 729	615 034
77 01 019 468	815 049
77 01 019 885	915 081
77 01 019 886	815 041
77 01 020 079	615 034
77 01 020 357	915 088
77 01 020 378	842 043
77 01 020 784	815 054
77 01 021 676	642 056
77 01 021 905	906 023R
77 01 021 981	915 091
77 01 022 130	615 023
77 01 022 175	815 041
77 01 025 237	928 012
77 01 025 238	728 089
77 01 025 240	830 098
77 01 025 241	930 047R
77 01 026 824	915 094
77 01 027 411	815 059
77 01 027 491	815 059
77 01 027 870	915 094
77 01 029 263	806 079
77 01 029 971	815 063
77 01 029 972	915 097
77 01 029 973	815 070
77 01 030 505	830 101
77 01 031 135	470 107
77 01 031 149	715 126^{FP}
77 01 031 411	715 127^{FP}
77 01 031 989	730 148M
77 01 032 418	715 126^{FP}
77 01 033 621	815 081
77 01 033 622	915 101
77 01 034 946	830 111
77 01 034 947	930 059
77 01 041 607	470 355
77 01 041 608	470 356
77 01 041 745	806 236^A
77 01 065 086	470 489
77 01 200 739	715 086
77 01 200 876	706 040
77 01 202 293	815 063

RENAULT

77 01 202 683	815 066^M
77 01 202 755	815 088^M
77 01 203 118	815 082
77 01 203 118	815 083^M
77 01 348 252	470 101D
77 01 349 467	359 543
77 01 349 467	359 839
77 01 349 468	359 839
77 02 001 761	730 132
77 02 037 711	706 034HVS
77 02 037 713	906 012R
77 02 038 122	806 079
77 02 038 190	730 140
77 02 038 439	906 025R
77 02 124 314	717 024
77 02 124 317	617 097
77 02 124 320	917 058
77 02 124 325	817 023
77 02 163 081	717 026
82 00 025 256	470 419
82 00 035 420	470 432
82 00 084 401	470 419
82 00 122 243	358 049
82 00 141 149	470 365
82 00 154 186	470 432
82 00 154 186 A	470 432
82 00 208 611	470 432
82 00 380 267	470 432
82 00 405 098	470 432
82 00 486 877	358 230
82 00 506 297	358 244
82 00 568 671	470 432
82 00 575 895	358 229
82 00 672 564	470 432
82 00 702 693	470 518
82 00 713 680	358 246
82 00 765 882	470 432
82 00 805 133	358 230
82 00 943 801	358 252
85 51 874 100	815 049
89 00 568 671	470 432
89 33 003 389	919 092
89 33 004 024	819 093
89 56 026 876	819 093
H77 00 873 701	470 596
H77 00 875 000	470 432
H82 01 154 128	470 613

ROLLS-ROYCE

12 13 5 A06 753	470 475
12 13 7 571 643	470 475
12 13 8 616 153	470 475
12 13 8 657 273	470 475
UE 46152	906 070R
UE 46153	806 117^A

ROVER

AUU1186	828 093
AUU1641	928 029R
AUU1690	928 024R
ERR6045	470 168
GCL110	470 101D
GCL145	470 211
GCL146	470 211
GCL161	470 213
GCL195	470 214
GCL201	470 374
GCL204	470 189
GCL207	470 347
GCS124	728 089

ROVER

GDC136	828 078
GDC152	828 093
GDC156	828 094
GDC160	828 093
GDC214	815 049
GDC346	822 069
GDC347	822 069
GDC377	828 093
GDC384	828 093
GDC405	822 068
GDC406	822 068
GDC407	822 082
GHT274	360 711
GHT284	360 888
GHT287	360 914
GRA114	928 012
GRA138	928 024R
GRA143	928 025
GRA2123	915 091
GRA2138	928 024R
GRA2143	928 025
GRA2236	906 060R
GRA2245	922 056
GRA2264	906 060R
GRA2274	928 024R
GRA2285	928 029R
GRA2287	922 082
GRA2310	928 029R
GRA2324	922 095
GRA2327	922 098
GSC113	615 034
NEC100530	470 214
NEC100630	470 374
NEC100630SLP	470 374
NEC100631	470 374
NEC100710	470 189
NEC100750	470 347
NEC101000	470 413
NEC101000SLP	470 413
NEC101010	470 413
NGC000040	360 889
NGC000060	360 914
NGC000090	360 888
NJD10006	822 069
NJD10008	822 069
NJD10009	822 069
NJD10010	828 093
NJD100150	822 068
NJD100190	822 082
NJD100200	828 106
NJE100060	922 095
NJE100070	928 029R
NJE100100	922 102
NJI100030	922 098
NJL100030	465 052
NJL100040	465 052
NJW100030	465 052
RTC3433	470 101D
RTC6620	615 034
RTC6627	728 089
STC8368	828 091

SAAB

10 458 316	470 450
12 08 053	470 192
30 584 237	470 192
40 23 149	465 034
42 26 031	470 192
51 71 111	470 192
59 60 059	465 034
74 86 822	406 193
75 01 216	806 079
75 03 600	465 034

SAAB

75 19 309	906 055R
75 64 420	906 123R
78 63 236	906 012R
78 66 353	706 034HVS
78 66 932	806 076
83 52 346	806 079
83 55 919	706 049HDVS
83 55 935	806 079
83 55 950	906 025R
85 22 328	470 101D
88 17 520	360 138
88 22 686	906 121R
88 57 617	406 244^N
89 80 534	465 007
90 350 021	470 192
90 350 987	470 192
90 369 434	470 192
91 19 567	470 508
91 70 259	806 124
93 06 697	906 025R
93 37 346	360 140
93 50 323	906 026R
93 51 743	606 195
93 55 488	906 026R
93 59 597	706 049HDVS
93 90 220	465 004

SEAT

000 389 117 3	730 132
000 389 287 3	917 052
000 389 806 0	630 117
000 389 806 5	930 042R
000 389 842 4	915 083R
000 389 948 9	930 054R
000 389 973 1	615 039
000 389 976 9	830 098
000 389 977 0	930 047R
000 389 978 9	817 014
000 398 066 5	806 079
000 398 066 6	906 056R
000 398 090 7	830 101
000 992 918 8	730 142
000 993 470 8	915 091
000 993 623 8	930 042R
000 993 667 7	715 106
000 993 673 4	615 039
000 993 673 5	815 058
000 993 681 4	817 016
000 993 683 1	917 052R
000 993 686 6	915 083R
007083.06	730 120
008415.06	930 029
022 905 100 A	470 435
022 905 100 D	470 435
022 905 100 E	470 434
022 905 100 G	470 435
022 905 100 H	470 434
022 905 100 K	470 435
022 905 100 N	470 435
022 905 100 P	470 434
022 905 715	470 434
022 905 715 C	470 435
026 905 207 2	806 094
026 905 207 A	815 068
026 905 225 2	906 121R
026 905 225 K	915 099R
026 905 359 2	406 233
027 905 207 A	806 266
030 905 065	406 223
030 905 065 B	406 223
030 905 205 AE	430 182^N
030 905 207	806 094
030 905 207 A	830 116
030 905 225 C	930 057R

SEAT		SEAT		SEAT		SEAT	
030 905 430 J	360 595	06A 905 430 AA	360 484	N10 050 201	360 549	SE 141914.007A	630 128
030 905 430 K	360 595	06A 905 430 AC	360 585	N10 050 205	359 725	SE 141914.007C	615 039
030 905 430 L	360 595	06A 905 430 AD	360 585	N10 050 205	359 965	SE 141915.000A	470 101D
030 905 430 M	360 595	06A 905 430 AE	360 585	N10 052 706	359 965		
030 905 430 N	360 601	06A 905 430 AG	360 585	N10 052 808	359 736		
030 905 430 P	360 601	06A 905 430 H	360 585	N10 052 809	360 364		
030 905 430 Q	360 601	06A 905 430 J	360 585	N10 052 812	359 736		
030 905 430 R	360 601	06A 905 430 K	360 585	N10 052 817	360 518		
030 998 065	406 193	06A 905 430 L	360 585	N10 052 902	359 736		
030 998 065 B	406 234	06A 905 430 M	360 489	N10 052 902	360 364		
032 905 106	490 420	06A 905 430 N	360 489	N10 052 903	360 518		
032 905 106 B	490 420	06A 905 430 P	360 489	N10 052 904	360 364		
032 905 106 D	490 420	06A 905 430 Q	360 489	N10 052 904	360 937		
032 905 106 E	490 420	06A 905 430 R	360 484	N10 052 907	359 725		
032 905 106 F	490 420	06A 905 430 S	360 484	N10 052 907	360 933		
032 905 430 B	360 569	06A 905 430 T	360 484	N10 070 210	360 549		
032 905 430 C	360 569	06B 905 115 B	470 445	N10 070 210	360 551		
032 905 430 E	360 569	06B 905 115 D	470 429	N10 243 607	360 551		
036 905 100 A	470 474	06B 905 115 E	470 445	N10 264 601	359 965		
036 905 100 B	470 474	06B 905 115 G	470 429	N10 316 401	360 932		
036 905 100 C	470 474	06B 905 115 H	470 429	N10 316 401	360 933		
036 905 100 D	470 474	06B 905 115 J	470 429	N10 316 401	360 937		
036 905 225 H	906 056R	06B 905 115 L	470 429	N10 316 402	360 932		
036 905 430 AA	360 575	06B 905 115 M	470 429	N10 316 402	360 933		
036 905 430 AB	360 575	06B 905 115 N	470 429	N10 316 402	360 937		
036 905 430 AC	360 575	06B 905 115 P	470 429	N10 316 403	360 932		
036 905 430 AD	360 575	06B 905 115 Q	470 429	N10 316 403	360 933		
036 905 430 AE	360 575	06B 905 115 R	470 429	N10 316 403	360 937		
036 905 430 H	360 575	06C 905 115 C	470 429	N10 316 404	360 932		
036 905 430 J	360 575	06F 905 115 A	470 426	N10 316 404	360 933		
036 905 430 K	360 575	06F 905 115 B	470 426	N10 316 404	360 937		
036 905 430 L	360 575	06F 905 115 C	470 426	N10 316 404	360 932		
036 905 430 M	360 575	06F 905 115 E	470 426	N10 421 002	360 932		
036 905 430 N	360 575	06F 905 115 F	470 426	N10 430 003	360 569		
036 905 430 Q	360 575	06H 905 110 D	470 636	NGO 020 010 6	717 020		
036 905 430 R	360 575	06H 905 110 E	470 636	NGO 930 023 1	930 037R		
036 905 430 S	360 575	06H 905 110 F	470 636	NG1 023 020 6	830 069		
036 905 430 T	360 575	06H 905 110 G	470 636	NG1 116 013 1	730 139		
036 905 715	470 474	06H 905 110 H	470 636	NG1 195 053 1	930 042R		
036 905 715 A	470 474	06H 905 110 L	470 636	NG1 213 340 6	917 052		
036 905 715 C	470 474	06H 905 115	470 426	NG1 214 610 6	730 132		
036 905 715 E	470 474	06H 905 115 A	470 426	NG1 215 023 1	930 037R		
036 905 715 F	470 474	06H 905 115 B	470 426	NG1 323 013 1	930 037		
036 905 715 G	470 474	06L 905 110 B	470 636	NG1 424 023 1	930 042R		
036 905 715 H	470 474	06L 905 110 C	470 636	NG1 539 013 1	930 037R		
037 905 205 M	406 223^{FN}	06L 905 110 D	470 636	NG1 811 683 1	630 117		
037 905 207	806 263	06L 905 110 E	470 636	NG1 860 360 6	817 016		
03D 905 115 F	470 431	06L 905 110 F	470 636	NG1 975 023 1	730 142		
03D 905 115 G	470 431	06L 905 110 H	470 636	NG2 155 013 1	830 093		
03D 905 715 A	470 431	06L 905 110 K	470 636	NG2 337 310 6	730 139		
04C 905 110 B	470 599	071 905 143	465 074	NG9 810 442 9	706 034HVS		
04C 905 110 D	470 599	07K 905 715	470 426	NG9 810 462 9	906 025R		
04C 905 110 E	470 599	07K 905 715 A	470 426	SE 021028.301A	359 612		
04C 905 110 H	470 599	07K 905 715 B	470 426	SE 021913.010A	465 004		
04C 905 110 J	470 599	07K 905 715 C	470 426	SE 021914.001A	806 079		
04C 905 110 L	470 599	07K 905 715 D	470 426	SE 021914.001B	830 101		
04E 905 110	470 599	07K 905 715 E	470 426	SE 021914.004A	906 056R		
04E 905 110 A	470 599	07K 905 715 F	470 426	SE 021914.004B	906 121R		
04E 905 110 B	470 599	07K 905 715 G	470 426	SE 021914.016A	406 193		
04E 905 110 E	470 599	102312.06	830 069	SE 021970.015B	359 612		
04E 905 110 K	470 599	102541.06	730 127	SE 022028.301A	359 612		
04E 905 110 P	470 599	121334.06	930 037	SE 022970.015A	359 612		
050 905 205 A	406 159^{FN}	121461.06	730 132	SE 028914.001B	817 029		
050 905 205 AH	406 223^{FN}	186035.06	817 014	SE 028915.000B	470 196		
051 905 205	406 159^{FN}	186036.06	817 016	SE 127914.001A	817 016		
051 905 205 C	406 233^{FN}	191 905 351 B	465 007	SE 127914.004A	930 042R		
051 905 207	806 266	211 905 115 D	470 125	SE 127914.004B	915 083R		
051 905 225	906 121R	233731.06	730 139	SE 127914.006A	717 020		
052 905 225 C	906 121R	244311.06	930 041	SE 127914.006B	730 142		
055 905 225 B	906 055R	3892873	917 052	SE 141914.001B	830 098		
058 905 105	470 354S	3899489	930 054R	SE 141914.001C	817 014		
06A 905 115	470 429	4D0 905 351	465 076	SE 141914.001D	815 058		
06A 905 115 A	470 429	6N0 905 104	490 414	SE 141914.004B	930 047R		
06A 905 115 B	470 429	701 905 104 A	490 416	SE 141914.004C	917 052R		
06A 905 115 C	470 429	867 905 105 A	470 159	SE 141914.004D	915 091		
06A 905 115 D	470 429	867 905 352	490 414	SE 141914.006A	730 146M		
		N 038 885 1	359 725	SE 141914.006B	730 132		

SKODA

004 026 254 A	838 243
004 050 014	490 414
004 050 016	490 414
007 901 696	360 373
007 901 697	360 373
007 901 698	360 373
007 901 699	360 373
007 901 700	360 373
022 905 715	470 434
030 905 065	406 223
030 905 207	806 094
030 905 207 A	830 116
030 905 225 C	930 057R
032 905 106	490 420
032 905 106 B	490 420
032 905 106 D	490 420
032 905 106 E	490 420
032 905 106 F	490 420
032 905 430 F	360 569
032 905 430 G	360 569
032 905 430 H	360 569
032 905 430 P	360 569
032 905 430 Q	360 609
032 905 430 R	360 609
032 905 430 T	360 609
036 905 100 A	470 474
036 905 100 B	470 474
036 905 100 C	470 474
036 905 100 D	470 474
036 905 430 AB	360 575
036 905 430 AC	360 575
036 905 430 AD	360 575
036 905 430 AE	360 575
036 905 715	470 474
036 905 715 A	470 474
036 905 715 C	470 474
036 905 715 E	470 474
036 905 715 F	470 474
036 905 715 G	470 474
036 905 715 H	470 474
03D 905 115	470 431
03D 905 115 A	470 431
03D 905 115 B	470 431
03D 905 115 C	470 431
03D 905 115 D	470 431
03D 905 115 E	470 431
03D 905 115 F	470 431
03D 905 115 G	470 431
03D 905 715 A	470 431
03F 905 409 A	358 248
03F 905 409 B	358 248
03F 905 409 C	358 248
04C 905 110 A	470 599
04C 905 110 B	470 599
04C 905 110 D	470 599
04C 905 110 E	470 599
04C 905 110 H	470 599
04C 905 110 J	470 599
04C 905 110 L	470 599
04E 905 110	470 599
04E 905 110 A	470 599
04E 905 110 B	470 599
04E 905 110 E	470 599
04E 905 110 K	470 599
04E 905 110 M	470 599
04E 905 110 P	470 599
052 905 225 C	906 121R

SKODA

058 905 101	470 354S
058 905 105	470 354S
06A 905 115	470 429
06A 905 115 A	470 429
06A 905 115 B	470 429
06A 905 115 C	470 429
06A 905 115 D	470 429
06A 905 430 AA	360 484
06A 905 430 AC	360 585
06A 905 430 AD	360 585
06A 905 430 AE	360 585
06A 905 430 AG	360 585
06A 905 430 AH	360 585
06A 905 430 AJ	360 585
06A 905 430 AK	358 223
06A 905 430 AL	358 223
06A 905 430 AM	358 223
06A 905 430 AN	358 223
06A 905 430 AP	360 585
06A 905 430 AQ	360 585
06A 905 430 D	360 479
06A 905 430 E	360 479
06A 905 430 F	360 479
06A 905 430 G	360 479
06A 905 430 H	360 585
06A 905 430 J	360 585
06A 905 430 K	360 585
06A 905 430 L	360 585
06A 905 430 M	360 489
06A 905 430 N	360 489
06A 905 430 P	360 489
06A 905 430 Q	360 489
06A 905 430 R	360 484
06A 905 430 S	360 484
06A 905 430 T	360 484
06B 905 115 B	470 445
06B 905 115 D	470 429
06B 905 115 E	470 445
06B 905 115 G	470 429
06B 905 115 H	470 429
06B 905 115 J	470 429
06B 905 115 L	470 429
06B 905 115 M	470 429
06B 905 115 N	470 429
06B 905 115 P	470 429
06B 905 115 Q	470 429
06B 905 115 R	470 429
06B 905 430	360 585
06B 905 430 A	360 585
06B 905 430 B	360 585
06B 905 430 C	360 585
06C 905 115 C	470 429
06F 905 115 C	470 426
06F 905 115 F	470 426
06H 905 110 D	470 636
06H 905 110 E	470 636
06H 905 110 F	470 636
06H 905 110 G	470 636
06H 905 110 H	470 636
06H 905 110 L	470 636
06H 905 115	470 426
06H 905 115 A	470 426
06H 905 115 B	470 426
06L 905 110 C	470 636
06L 905 110 D	470 636
06L 905 110 E	470 636
06L 905 110 F	470 636
06L 905 110 H	470 636
06L 905 110 K	470 636
07K 905 715 A	470 426
07K 905 715 B	470 426
07K 905 715 C	470 426
07K 905 715 D	470 426
07K 905 715 F	470 426
07K 905 715 G	470 426
113 911 051	838 242

SKODA

113 911 052	838 242
113 911 400	938 262R
113 911 401	736 045
114 911 070	938 263R
115 911 400	906 055R
115 911 401	938 263R
4D0 905 351	465 076
6N0 905 104	490 414
6U0 905 430	360 569
N10 070 210	360 609

SMART

A 132 158 00 03	470 503
A 281 906 00 00	470 613
Q 0002576V002000000	360 643
Q 0003100V004000000	470 414
Q 0003100V005000000	470 414

SOLO

05 20 100	606 030
05 20 144	706 071
05 20 145	606 180
05 20 146	706 083

SSANGYONG

0001587003	470 316
0001587103	470 316
0001587503	470 316

STERLING

182 182 000 30	470 211
----------------	----------------

SUBARU

22107-KA080	731 084
22136-KA050	731 084*
22157-AA030	922 052
22157-AA040	922 073
22157-AA080	922 093
22157-KA010	922 073
22157-KA020	913 030
22157-KA030	922 073
22157-KA040	913 029
22157-KA060	931 119
22162-AA030	822 058
22162-AA040	822 046
22162-AA060	822 075
22162-AA090	831 145
22162-KA010	813 241
22162-KA020	822 041
22162-KA050	822 041
22162-KA100	813 259
22433-AA230	470 265
22433-AA240	470 266
22433-AA360	470 265
22433-AA370	470 266
22451-AA341	360 835
22451-AA450	360 835
22451-AA511	360 835
22451-AA630	360 835
22451-AA640	360 835
22451-AA660	360 817
22451-AA660	360 819
22451-AA661	358 100

SUBARU

22451-AA661	360 817
22451-AA661	360 819
22451-AA710	358 100
22451-AA710	360 817
22451-AA74A	360 835
22451-AA780	360 819
22451-AA781	360 819
22451-AA793	360 887
22451-AA800	360 813
22451-AA810	360 813
22451-AA822	360 887
22451-AA890	358 100
22451-AA940	358 106
22452-AA112	360 835
22452-AA120	360 835
22452-AA160	360 835
22452-AA682	360 887
22452-AA690	358 106
22453-AA140	358 106
22454-AA140	358 106
33310-71C30	913 028
33321-63B10	813 123
33400-62J00	470 570
33400-83E10	470 570
39100-0601	822 003
39101-4302	913 014
39146-4302	713 022HV
39146-4312	713 022HV
49100-5501	822 048
49100-8711	822 057
49101-3202	913 014
49101-7102	913 014
49101-8711	922 052
49146-7011	722 056HV
89100-4111	822 003
89146-4111	722 056HV
89146-4821	722 056HV
90919-02257	470 537

SUZUKI

33140-74010	713 011HV
33140-74010-000	713 011HV
33310-56B10	931 131
33310-56B10-000	931 131
33310-60B50	913 034
33310-60B50-000	913 034
33310-60C30	931 131
33310-60C30-000	931 131
33310-60C31	931 131
33310-60C31-000	931 131
33310-63B10	913 028
33310-63B10-000	913 028
33310-70B50	931 119
33310-70B50-000	931 119
33310-70E00	931 136
33310-70E00-000	931 136
33310-70E01	931 136
33310-70E01-000	931 136
33310-71C30	913 028
33310-71C30-000	913 028
33310-73010	913 014
33310-73010-000	913 014
33310-75F00	922 073
33310-75F00-000	922 073
33310-77090	913 014
33310-77090-000	913 014
33310-80C10	913 036
33310-80C10-000	913 036
33310-82010	913 030
33310-82010-000	913 030
33310-82032	931 108
33310-82032-000	931 108
33310-82110	913 030
33310-82110-000	913 030
33310-82610	913 028
33310-82610-000	913 028
33310-86240	931 108
33310-86240-000	931 108
33321-56B10	831 140
33321-56B10-000	831 140
33321-58B10	831 144
33321-58B10-000	831 144
33321-60A10	813 093
33321-60A10-000	813 093
33321-62E10	831 131
33321-62E10-000	831 131
33321-63B10	813 123
33321-63B10-000	813 123
33321-63B40	831 132
33321-63B40-000	831 132
33321-64B10	822 046
33321-64B10-000	822 046
33321-75110	813 093
33321-75110-000	813 093
33321-78110	813 107
33321-78110-000	813 107
33321-78B40	831 139
33321-78B40-000	831 139
33321-79210	813 102
33321-79210-000	813 102
33321-79611	813 107
33321-79611-000	813 107
33321-80C10	813 256
33321-80C10-000	813 256
33321-82010	813 107
33321-82010-000	813 107
33321-85570	813 245
33321-85570-000	813 245
33321-86510	813 123
33321-86510-000	813 123
33400-60R00	470 621
33400-60R00-000	470 621
33400-62J00	470 570
33400-62J00-000	470 570
33400-65G00	470 535
33400-65G00-000	470 535
33400-65G01	470 535
33400-65G01-000	470 535
33400-65G02	470 535
33400-65G02-000	470 535
33400-78P00	470 621
33400-78P00-000	470 621
33400-81P00	470 621
33400-81P00-000	470 621
33400-83E10	470 570
33400-83E10-000	470 570
33400M68P10	470 621
33400M68P10-000	470 621
33400M79F00	470 570
33400M79F00-000	470 570
33400M83E10	470 570
33400M83E10-000	470 570
33410-57B10	470 201
33410-57B10-000	470 201
33410-66D00	470 591
33410-66D00-000	470 591
33410-66D01	470 591
33410-66D01-000	470 591
33410-66D10	470 591
33410-66D10-000	470 591
33410-80C10	470 201
33410-80C10-000	470 201
33700-51G10	360 413
33700-51G10-000	360 413
33700-60A10	360 415
33700-60A10-000	360 415
33700-60A20	360 415
33700-60A20-000	360 415
33700-80001	358 020

SUZUKI

33700-80001-000	358 020
33700-80012	358 020
33700-80012-000	358 020
33700-82610	358 020
33700-82610-000	358 020
33700-83010	358 020
33700-83010-000	358 020
33700-83020	360 417
33700-83020-000	360 417
33700M70FA0	358 231
33700M70FA0-000	358 231
33705-51G10	360 413
33705-51G20	360 434
33705-51G20-000	360 434
33705-57B21	358 004
33705-66D00	358 005
33705-66D00-000	358 005
33705-75F02-000	358 028
33705-75F03-000	358 028
33705-80040	358 020
33705-80040-000	358 020
33705-80G00	358 013
33705-80G00-000	358 013
33705-83020	360 417
33705-83020-000	360 417
33705-86G00	358 013
33705-86G00-000	358 013
33705M79F00	358 005
33705M79F00-000	358 005
33710-51G10-000	360 413
33710-57B20	358 004
33710-57B20-000	358 004
33710-63B30-000	360 413
33710-75F00-000	358 028
33710-80010	358 020
33710-80010-000	358 020
33710-82010	360 413
33710-82010-000	360 413
33710-83020	360 417
33710-83020-000	360 417
33710-86001-000	360 413
33710M70F30	358 231
33710M70F30-000	358 231
33730-86G00-000	358 013
33740-86G00-000	358 013

TALBOT

0013 52 9900	906 025R
0013 56 6600	406 153
0016 85 6600	815 058
0017 67 1000	815 054
0017 67 1100	915 091
0043 21 2900	915 094
0043 23 7300	906 061R
0055 50 5600	470 101D
0057 18 9700	465 005
0060 06 6500	730 132
0174 98 900	706 034HVS
1350 02 00	815 049
1350 03 00	915 091
1352 99 00	906 025R
1353 00 00	806 079
1356 65 00	806 079
1361 48 00	615 034
1361 51 00	715 111U
1364 49 00	706 034HVS
1685 66 00	815 058
1690 1	815 049
1743 05 00	615 034
1832 10 01	806 079
1832 20 01	906 025R
2009 9Z	715 055
2882 9V	615 023
3065 2H	815 045

TALBOT

3792 5	615 034
3798 9P	715 111U
3888 0	815 045
4033 01 9620	706 034HVS
4519 2Q	715 067
4613 6	815 045
5043 70 9	828 075
5135 00 300	915 091
7506 20 75	728 083MHV
7506 37 64	928 012
7506 60 02	915 091
7506 63 87	828 078
9150 49 1280	465 005
9150 63 3880	465 005
9405 92 7838	715 103
9405 93 7228	915 088
9405 94 8178	615 034
9611 6	915 083R

TOYOTA

04191-41010	713 011HV
19070-74170	470 285S
19080-66010	470 285S
19101-01030	813 119
19101-02020	806 094
19101-10020	813 240
19101-11010	813 122
19101-11032	813 278
19101-11060	813 265
19101-11300	813 275
19101-15010	813 092
19101-15120	813 278
19101-15140	813 262
19101-15160	813 262
19101-16080	813 119
19101-16220	813 119
19101-16250	813 248
19101-25070	813 093
19101-35010	813 273
19101-35020	813 099
19101-35120	813 099
19101-35140	813 099
19101-35180	813 099
19101-35190	813 099
19101-38011	813 093
19101-38210	813 099
19101-66010	813 272
19101-71010	813 113
19101-71020	813 114
19101-74050	813 278
19101-74180	813 267
19101-75040	813 278
19101-76010	813 252
19101-88363	813 251
19102-02010	913 027
19102-02020	906 121R
19102-02030	913 036
19102-10020	913 014
19102-11010	913 029
19102-11030	913 029
19102-11031	913 029
19102-11050	913 029
19102-11370	913 029
19102-15021	913 027
19102-16040	913 027
19102-16060	913 027
19102-26150	913 014
19102-26151	913 014
19102-33011	913 014
19102-33012	913 014
19102-35160	913 027
19102-38160	913 014
19102-38210	913 027

TOYOTA

19102-73060	913 030
19102-74040	913 036
19102-75010	913 030
19102-87705	913 029
19145-10020	713 022HV
19145-14010	713 022HV
19145-26060	713 011HV
19145-38011	713 011HV
19145-40010	713 011HV
19145-40010C	706 034HVS
19145-41010	713 011HV
19145-41020	713 011HV
19145-41030	713 011HV
19145-87701	713 011HV
19500-74040	470 203^U
19500-74090	470 285^U
19500-74091	470 285^U
19500-74100	470 285^U
19500-74120	470 285^U
90080-19015	470 461
90080-19019	470 461
90080-19021	470 459
90080-19023	470 466
90118-WA474	470 632
90919-02135	470 197
90919-02163	470 198
90919-02164	470 199
90919-02185	470 202
90919-02197	470 203
90919-02200	470 322
90919-02208	470 203
90919-02209	470 285S
90919-02229	470 459
90919-02239	470 461
90919-02240	470 459
90919-02243	470 466
90919-02244	470 466
90919-02247	470 458
90919-02248	470 458
90919-02250	470 537
90919-02251	470 538
90919-02252	470 536
90919-02255	470 538
90919-02256	470 537
90919-02257	470 537
90919-02258	470 536
90919-02260	470 458
90919-02262	470 461
90919-02265	470 459
90919-02266	470 466
90919-02270	470 459
90919-02271	470 645
90919-22209	360 823
90919-22210	360 823
90919-22327	360 209
90919-22329	360 393
90919-22369	360 793
90919-22370	360 793
90919-22373	360 435
90919-22386	360 856
90919-22387	360 792
90919-22395	360 880
90919-22400	360 856
90919-A2001	470 458
90919-A2002	470 538
90919-A2003	470 537
90919-A2004	470 538
90919-A2005	470 537
90919-A2006	470 458
90919-A2007	470 538
90919-A2008	470 537
90919-C2002	470 458
90919-C2004	470 537
90919-C2006	470 458
90919-T2001	470 458
90919-T2002	470 461

TOYOTA

90919-T2005	470 458
90919-T2006	470 461
90919-T2008	470 458
90919-W2001	470 461
90919-W2002	470 459
90998-99001	360 879
90998-99002	360 879
98989-01161	713 022HV
SU001-01125	470 609

VALEO

1203	615 023
18 137	915 083R
22 321	815 058
23 263	715 064
2790	470 101D
71 129	715 056
71 133	715 055
71 974	715 061
72 192	915 081
243 408	730 146M
243 410	730 149M
243 592	736 045
243 758	630 128
243 842	815 077
243 870	815 063
243 871	815 072^M
243 876	822 022
243 881	847 025
243 882	806 080
243 886	806 241
243 887	828 094
243 889	815 081
243 890	806 252
243 893	830 111
243 910	915 096R
243 964	915 097
243 965	906 115R
243 969	906 112R
243 970	913 014
244 512	815 086^M
245 001	470 106
245 027	470 105
245 039	470 155
245 040	470 188
245 041	470 189
245 042	470 140
245 043	470 341
245 049	470 108
245 052	470 158
245 054	470 107
245 057	470 272
245 059	470 103
245 060	470 109
245 062	470 111
245 064	470 125
245 066	470 355
245 067	470 356
245 068	470 228
245 071	470 374
245 076	470 355
245 077	470 356
245 079	470 365
245 080	470 178
245 082	470 194
245 083	470 103
245 509	465 029
245 510	465 005
245 516	465 036
245 519	465 004
245 521	465 007
245 527	465 020
245 531	490 414

VALEO		VALEO		VALEO		VALEO	
245 536	465 034	B4514	906 014R	CB 646	815 068	D 313	715 105
245 550	465 052	B4515	906 021R	CB 649	817 023	D 316	715 106
248 880	928 025	B4516	906 012R	CB 651	815 080	D 323	715 122
248 881	915 101	B4528	906 026R	CB 652	815 081	D 329	715 067
248 885	930 059	CB 001	742 054	CD 001	915 091	D 332	715 076
248 888	815 080	CB 002	706 034HVS	CD 002	915 088	D 333	715 101
248 889	815 081	CB 003	719 043HV	CD 003	915 094	D 337	715 111U
520 004	470 101D	CB 004	712 055HVS	CD 005	915 089R	D 338	715 112U
520 023	470 101D	CB 005	715 086	CD 006	915 081	D 396	915 104
520 064 A	470 107	CB 006	715 111U	CD 007	912 093	D 512	815 086 TM
520 073	470 105	CB 007	715 112U	CD 008	919 085	D 703	615 023
582 018	715 086	CB 008	717 024	CD 009	906 014R	D 707	615 034
582 133	715 103	CB 011	715 055	CD 010	906 021R	D 708	615 023
582 156	715 105	CB 014	730 142	CD 011	906 012R	D 709	642 056
582 169	615 034	CB 017	715 105	CD 012	930 037	D 801	815 058
582 199	715 106	CB 018	715 103	CD 013	928 012	D 805	815 058
582 309	715 122	CB 019	715 106	CD 016	915 083R	D 806	815 054
582 482	715 126 ^{TP}	CB 021	715 122	CD 017	930 042R	D 807	815 049
607 453	615 023	CB 027	715 056	CD 018	906 012R	D 808	815 041
608 640	715 067	CB 029	715 061	CD 019	906 023R	D 810	815 065
618 015	715 076	CB 030	715 064	CD 020	906 055R	D 811	815 059
618 642	715 101	CB 031	728 089	CD 021	906 056R	D 812	815 068
660 740	915 089R	CB 033	713 011HV	CD 022	906 059R	D 814	815 067
661 920	815 058	CB 034	722 056HV	CD 024	906 024R	D 815	815 079
662 165	815 054	CB 035	731 084	CD 025	906 112R	D 816	815 074
662 414	815 049	CB 036	730 146M	CD 026	906 114R	D 842	815 077
662 434	815 041	CB 039	715 076	CD 027	906 116R	D 870	815 063
664 203	915 094	CB 042	706 040	CD 028	906 121R	D 871	815 072 TM
664 225	915 088	CB 043	706 049HDVS	CD 029	930 041	D 881	915 104
664 369	815 065	CB 044	730 120	CD 030	930 051R	D 888	815 080
664 518	915 096R	CB 045	730 132	CD 031	930 054R	D 889	815 081
664 813	815 059	CB 046	730 139	CD 032	930 060	D 901	915 083R
664 895	915 091	CB 047	730 140	CD 033	906 060R	D 902	915 081
665 561	615 034	CB 048	728 083MHV	CD 034	928 026R	D 905	915 089R
666 349	815 068	CB 050	719 044HV	CD 035	930 047R	D 908	915 094
666 867	915 099R	CB 052	717 026	CD 036	930 055R	D 909	915 088
667 287	815 067	CB 055	730 149M	CD 038	912 096	D 910	915 096R
667 308	815 079	CB 060	715 101	CD 040	915 096R	D 911	915 091
A 422	712 055HVS	CB 070	715 067	CD 042	906 026R	D 913	915 099R
A4037	812 066	CB 304	606 212	CD 048	915 099R	D 936	915 104
A4050	812 073	CB 310	630 117	CD 049	917 058	D 964	915 097
A4522	912 093	CB 318	615 023	CD 050	915 101	E 456	717 026
A4534	912 096	CB 319	615 034	CD 051	906 025R	E 833	817 016
B 15	606 212	CB 331	606 196	CD 303	470 101D	E 928	930 029
B 414	706 034HVS	CB 336	606 257	CD 308	470 105	F 420	719 043HV
B 415	706 040	CB 338	630 127	CD 309	470 101D	F 421	719 044HV
B 429	706 049HDVS	CB 344	615 023	CD 315	470 101D	F4036	819 083
B 721	606 196	CB 601	806 093	CD 321	470 106	F4521	919 085
B 732	606 257	CB 602	806 094	CD 323	470 101D	J 436	713 011HV
B 817	806 081	CB 603	806 109	CD 324	470 102	J 438	722 056HV
B 820	806 093	CB 604	806 109	CD 325	470 107	J 454	713 022HV
B 821	806 094	CB 605	806 129	CD 328	470 108	J 830	813 093
B 822	806 108	CB 606	806 231	CD 330	470 155	J 836	831 109
B 824	806 109	CB 607	828 096	CD 331	470 188	J 876	822 022
B 825	806 121	CB 608	830 109	CD 334	470 189	J 927	913 014
B 826	806 124	CB 609	815 049	CD 338	470 140	J 970	913 014
B 827	806 129	CB 610	812 066	CD 339	470 341	L 431	728 083MHV
B 828	806 231	CB 611	819 083	CD 440	470 272	L 453	728 089
B 882	806 080	CB 612	806 079	CD 442	470 103	L 837	828 096
B 886	806 241	CB 613	828 078	CD 443	470 111	L 880	928 025
B 890	806 252	CB 614	830 069	CD 444	470 109	L 887	828 094
B 914	906 012R	CB 618	842 043	CD 446	470 125	L 935	928 026R
B 915	906 023R	CB 624	830 090	CD 605	465 029	L4035	828 078
B 916	906 025R	CB 625	815 058	CD 856	465 005	L4520	928 012
B 917	906 055R	CB 626	815 058	CD 859	415 019	M 20	630 117
B 918	906 056R	CB 627	815 041	CK 006	715 126 ^{TP}	M 32	617 097
B 919	906 059R	CB 628	806 076	CK 007	715 126 ^{TP}	M 34	630 127
B 921	906 024R	CB 631	815 059	D 204	615 034	M 408	730 146M
B 922	906 112R	CB 632	815 074	D 214	715 126 ^{TP}	M 410	730 149M
B 923	906 114R	CB 633	815 054	D 236	715 126 ^{TP}	M 416	730 132
B 924	906 116R	CB 635	830 098	D 301	715 064	M 417	730 140
B 925	906 121R	CB 636	830 104	D 303	715 056	M 418	730 139
B 965	906 115R	CB 640	815 067	D 304	715 055	M 419	730 120
B 969	906 112R	CB 641	812 073	D 306	715 061	M 432	730 142
B4025	806 076	CB 643	815 079	D 309	715 086	M 450	717 024
B4027	806 079	CB 645	815 065	D 312	715 103	M 459	730 149

VALEO

M 758	630 128
M 840	830 109
M 881	847 025
M 885	930 059
M 893	830 111
M 930	930 041
M 931	930 051R
M 932	930 054R
M 933	930 060
M 934	906 060R
M4029	830 069
M4043	830 090
M4045	830 104
M4047	817 023
M4048	830 098
M4518	930 037
M4530	930 042R
M4533	930 047R
M4535	917 058
M4536	930 055R
MTR-01	465 005
S 406	742 054
S4010	842 043
U 592	736 045
2 524 134	815 074
2 525 628	815 078 ^M
2 526 009	470 106
2 526 015	470 102
2 526 017	470 101D
2 526 017 0	470 101D
2 526 023	470 107
2 526 026	470 155
2 526 026 A	470 155
2 526 030	470 108
2 526 034	470 228
2 526 035 A	470 189
2 526 037 A	470 188
2 526 039	470 189
2 526 040 A	470 188
2 526 048	470 107
2 526 048 A	470 107
2 526 049	470 140
2 526 050	470 341
2 526 051	470 355
2 526 052	470 356
2 526 055	470 272
2 526 055 A	470 272
2 526 060	470 103
2 526 062	470 111
2 526 063	470 109
2 526 071	470 125
2 526 073	470 374
2 526 079	470 365
2 526 081	470 194
2 526 082	470 103
2 526 110	470 355
2 526 111	470 356
2 526 208	470 405
2 528 001	465 029
2 528 001 A	465 029
2 528 008	465 005
2 528 008 A	465 005
2 537 077	815 080
2 537 260	915 104
2 553 495	815 081
2 553 499 0	915 101
2 558 654	915 096R
2 558 743	915 101
2 559 115	915 097
2 590 166	715 126 ^P
2 590 251	642 056
2 590 253	715 111U
2 590 254	715 112U
2 590 832	470 101D
2 590 841	713 022HV
2 590 843	717 026

VALEO

2 590 846	730 149
2 590 862	606 196
2 590 871	606 257
2 590 874	806 081
2 590 877	806 093
2 590 878	806 094
2 590 879	806 108
2 590 880	806 109
2 590 881	806 121
2 590 882	806 124
2 590 883	806 129
2 590 884	806 231
2 590 886	813 093
2 590 889	817 016
2 590 892	831 109
2 590 893	828 096
2 590 896	830 109
2 590 897	906 012R
2 590 898	906 023R
2 590 899	906 025R
2 590 900	906 055R
2 590 901	906 056R
2 590 902	906 059R
2 590 904	906 024R
2 590 905	906 112R
2 590 906	906 114R
2 590 907	906 116R
2 590 908	906 121R
2 590 910	913 014
2 590 911	930 029
2 590 913	930 041
2 590 914	930 051R
2 590 915	930 054R
2 590 916	930 060
2 590 917	906 060R
2 590 918	928 026R
2 590 935	815 077
2 590 945	415 019
2 591 820	731 084
2 591 821	730 149M
2 591 823	730 146M
2 591 824	630 127
2 591 838	906 112R
2 595 007	465 004
2 595 009	465 007
2 595 013	465 020
2 595 016	465 036
2 595 020	490 414
2 595 025	465 034
2 595 041	465 052
21597716-4	470 476
21603121-9	470 432
21603800-7	470 476
245098	470 408
245104	470 432
245139	470 532
245142	470 429
245178	470 461
26951960-3	470 405
400 01503	742 054
400 10603	706 034HVS
400 10703	706 040
400 10803	730 132
400 10903	730 140
400 11003	730 139
400 11103	730 120
400 11203	719 043HV
400 11303	719 044HV
400 11403	712 055HVS
400 11703	706 049HDVS
400 11903	728 083MHV
400 12003	730 142
400 12403	713 011HV
400 12603	722 056HV
400 20903	717 024
400 21203	728 089

VALEO

402 60303	906 014R
402 60403	906 021R
402 60503	906 012R
402 60703	930 037
402 60903	928 012
402 61003	919 085
402 61103	912 093
403 53803	842 043
403 80603	806 079
403 80703	806 076
403 80903	830 069
403 81503	819 083
403 81603	812 066
403 81803	828 078
413 80403	830 090
413 80603	830 104
413 80803	817 023
413 80903	830 098
413 81103	812 073
414 50303	906 026R
414 50503	930 042R
414 50803	930 047R
414 50903	912 096
414 51003	917 058
414 51103	930 055R
430 40603	606 212
430 41003	630 117
430 90703	617 097
430 90903	630 127
441 19102	470 101D
7 350 370 2	465 005
735 02 602	465 029
735 03 702	465 005
949033	806 108
949034	806 121
949035	817 016
949041	812 073
949042	912 096

VAUXHALL

10458316	470 450
12635672	470 631
12670053	470 631
12697989	470 631
19005212	470 399
25195107	470 547
25198623	470 547
3639500	470 609
3639845	470 620
5 97 091	470 475
55561655	470 545
55573735	470 547
55577898	470 547
55579072	470 547
55584404	470 545
7079424	928 007
7100387	828 070
7101586	928 007
90006145	465 004
90114676	465 004
90140187	465 004
90240252	470 194
90277970	470 191
90458250	470 272
90506102	470 389
90543059	470 398
90543253	470 400
91159996	470 432
9119567	470 508
9198834	470 507
93161188	470 432
93161948	470 432
93177212	470 400
93180806	470 398

VAUXHALL

95512934	470 442
95517924	470 450
95528319	470 547
9671214580	470 609
9675390980	470 620

VOLVO

076978	906 021R
0769786	906 021R
1269920	806 236 ^A
12699203	806 236 ^A
1269921	906 119R
12699211	906 119R
1275174	490 423
1275284	358 061
12752846	358 061
1275603	358 059
1276620	406 153
1306169	706 034HVS
13061692	706 034HVS
1332584	465 034
13325840	465 034
1336240	906 055R
13362405	906 055R
1336241	906 055R
13362413	906 055R
1346787	906 118R
13467873	906 118R
1346788	806 127 ^A
13467881	806 127 ^A
1346792	406 222
13467923	406 222
1357418	906 122R
13574181	906 122R
1367052	906 122R
13670526	906 122R
1367783	906 147R
13677836	906 147R
1389425	906 121R
13894258	906 121R
233260	806 062
2332609	806 062
233910	706 029HV
2339109	706 029HV
238036	706 021
2380368	706 021
238859	706 021
2388593	706 021
240149	706 047
2401495	706 047
240247	906 012R
2402477	906 012R
240305	906 012R
2403053	906 012R
241652	706 049HDVS
2416527	706 049HDVS
241653	806 076
2416535	806 076
241655	806 062
241664	706 034HVS
2416642	706 034HVS
241669	806 072
2416691	806 072
243460	706 034HVS
243632	806 076
2436327	806 076
243657	906 024R
2436574	906 024R
243658	806 081
2436582	806 081
243796	906 025R
243797	806 079
2437978	806 079

VOLVO		VOLVO		VW		VW	
243801	706 062	33428632	915 097	026 905 206 AD	406 159 ^N	035 905 105 A	470 126
2438018	706 062	3342864	815 070	026 905 206 B	406 159 ^N	035 905 205	406 153
243803	806 081	33428640	815 070	026 905 206 C	406 159 ^N	035 905 205 A	406 153 ^N
2438034	806 081	33444092	360 332	026 905 206 E	406 159 ^N	035 905 205 B	406 153 ^N
243903	906 025R	34181545	359 415	026 905 206 F	406 159 ^N	035 905 205 C	406 153 ^N
2439032	906 025R	34333625	359 417	026 905 206 G	406 159 ^N	035 905 205 D	406 153 ^N
243922	906 023R	3449620	915 097	026 905 206 H	406 159 ^N	035 905 205 E	406 153 ^N
2439222	906 023R	3501944	806 260 ^A	026 905 206 J	406 159 ^N	035 905 205 Q	406 153 ^N
245664	706 034HVS	35019447	806 260 ^A	026 905 206 K	406 159 ^N	035 905 206 AF	406 223 ^N
2456642	706 034HVS	35312776	359 372	026 905 206 T	406 159 ^N	035 905 207	806 093
2714830	359 372	3638411	470 101D	026 905 207	806 129	035 905 207 A	806 093
284509	915 083R	36384113	470 101D	026 905 207 2	806 094	035 905 209 B	806 231
2845097	915 083R	546279	806 079	026 905 207 A	815 068	035 905 225	906 116R
30711786	470 480	70863020	470 355	026 905 209	806 129	035 905 225 B	906 055R
30713416	470 448	708630207	470 355	026 905 225	906 116R	035 905 225 C	906 059R
30713417	470 478	70863021	470 356	026 905 225 1	906 055R	035 905 225 D	906 121R
30731419	470 481	708630215	470 356	026 905 225 2	906 121R	035 905 225 F	906 121R
30731424	358 242	8677837	470 478	026 905 225 K	915 099R	035 905 315	406 153
30735759	470 532	869474	470 480	026 905 359 2	406 233	035 998 065 A	406 219
3100134	715 055	8694741	470 480	027 905 205 F	406 159 ^N	035 998 065 A*	406 231
31001340	715 055	870690	806 062	027 905 205 H	406 159 ^N	035 998 065 A***	406 231
3100770	915 083R	8706905	806 062	027 905 205 M	406 159 ^N	036 905 100 A	470 474
31007701	915 083R	9125601	470 448	027 905 205 Q	406 159 ^N	036 905 100 B	470 474
3100771	815 049	9135701	358 064	027 905 205 R	406 159 ^N	036 905 100 C	470 474
31007719	815 049	9445258	358 064	027 905 207	806 094	036 905 100 D	470 474
3102885	615 023	9487221	470 481	027 905 207 A	806 266	036 905 225 H	906 056R
31028855	615 023			027 905 225	906 025R	036 905 295 B	606 257
31216444	470 481			028 905 207 C	815 049	036 905 409 K	360 575
31359976	470 532			030 905 065	406 223	036 905 430 AA	360 575
31375294	470 480			030 905 065 A	406 223	036 905 430 AB	360 575
31422170	470 481			030 905 065 B	406 223	036 905 430 AC	360 575
3213390	915 096R			030 905 205	406 193 ^N	036 905 430 AD	360 575
32133902	915 096R			030 905 205 A	406 193 ^N	036 905 430 AE	360 575
3213392	815 059			030 905 205 AE	430 182 ^N	036 905 430 D	360 575
32133928	815 059			030 905 205 B	406 193 ^N	036 905 430 E	360 575
3267443	715 055			030 905 205 D	406 193 ^N	036 905 430 F	360 575
32674434	715 055			030 905 205 J	406 193 ^N	036 905 430 G	360 575
3277417	815 054			030 905 207	806 094	036 905 430 H	360 575
32774176	815 054			030 905 207 A	830 116	036 905 430 J	360 575
3277441	615 023			030 905 225 C	930 057R	036 905 430 K	360 575
32774416	615 023			030 905 430 J	360 595	036 905 430 L	360 575
3277442	815 049			030 905 430 K	360 595	036 905 430 M	360 575
32774422	815 049			030 905 430 L	360 595	036 905 430 N	360 575
32774424	815 049			030 905 430 M	360 595	036 905 430 P	360 575
3277840	712 055HVS			030 905 430 N	360 601	036 905 430 Q	360 575
32778409	712 055HVS			030 905 430 P	360 601	036 905 430 R	360 575
3277854	812 066			030 905 430 Q	360 601	036 905 430 S	360 575
32778540	812 066			030 905 430 R	360 601	036 905 430 T	360 575
3277855	912 095R			030 998 065	406 193	036 905 715	470 474
32778557	912 095R			030 998 065 A	406 233 ^S	036 905 715 A	470 474
3287598	815 059			030 998 065 B	406 234	036 905 715 C	470 474
32875981	815 059			032 905 106	490 420	036 905 715 E	470 474
3287599	915 096R			032 905 106 B	490 420	036 905 715 F	470 474
32875999	915 096R			032 905 106 D	490 420	036 905 715 G	470 474
3287677	470 107			032 905 106 E	490 420	036 905 715 H	470 474
32876773	470 107			032 905 106 F	490 420	036 998 051	706 049HDVS
32879249	360 332			032 905 430 E	360 569	036 998 051 A	706 049HDVS
32879256	360 332			032 905 430 F	360 569	036 998 051 C	706 049HDVS
3342161	815 063			032 905 430 G	360 569	036 998 051 D	706 049HDVS
33421611	815 063			032 905 430 H	360 569	037 905 205 M	406 223 ^N
3342163	915 097			032 905 430 K	360 723	037 905 207	806 263 ^A
33421637	915 097			032 905 430 L	360 723	039 905 225	906 061R
3342164	815 070			032 905 430 M	360 723	03D 905 115	470 431
33421645	815 070			032 905 430 N	360 723	03D 905 115 A	470 431
3342440	815 072 ^M			032 905 430 P	360 640	03D 905 115 B	470 431
33424409	815 072 ^M			032 905 430 P	360 641	03D 905 115 C	470 431
3342441	915 097			032 905 430 Q	360 640	03D 905 115 D	470 431
3342442	815 069			032 905 430 Q	360 641	03D 905 115 E	470 431
33424425	815 069			032 905 430 R	360 640	03D 905 115 F	470 431
3342443	815 070			032 905 430 R	360 641	03D 905 115 G	470 431
33424433	815 070			032 905 430 T	360 640	03D 905 715 A	470 431
33428467	359 415			032 905 430 T	360 641	03F 905 409 B	358 248
33428467	359 417			034 905 207	806 231 ^A	03F 905 430	358 248
3342862	815 069			034 905 207 A	806 231 ^A	03F 905 430 A	358 248
33428624	815 069			034 905 207 B	806 231 ^A	03F 905 430 B	358 248
3342863	915 097			034 998 065	406 219	03F 905 430 C	358 248

VW		VW		VW		VW	
03F 905 430 D	358 248	058 998 051 B	706 062	06C 905 115 G	470 436	07K 905 715 G	470 426
03F 905 430 E	358 248	059 905 207	806 076	06C 905 115 H	470 436	111 905 207 B	806 062
03F 905 430 F	358 248	059 905 225	906 021R	06C 905 115 K	470 436	111 905 207 D	806 076
03F 905 430 G	358 248	059 998 015	706 034HVS	06C 905 115 L	470 436	111 905 225 B	906 018R
040 905 225	906 045R	059 998 051	706 034HVS	06C 905 115 M	470 436	111 905 225 C	906 018R
040 905 359 1	406 160	059 998 051 B	706 034HVS	06D 905 115	470 427	111 905 225 F	906 014R
041 905 207 2	806 098	060 905 295	606 196	06D 905 115 A	470 427	111 905 225 G	906 014R
043 905 115 A	470 101D	066 905 100	470 437	06D 905 115 C	470 427	111 998 051	706 047
043 905 115 C	470 101D	066 905 100 B	470 437	06D 905 115 D	470 427	111 998 053	706 029HV
043 905 207	806 079	066 905 100 C	470 437	06D 905 115 F	470 427	111 998 055	706 029HV
043 905 225	906 025R	066 905 100 D	470 437	06D 905 115 G	470 427	111 998 059	706 032HV
046 905 105	470 169	066 905 100 G	470 437	06D 905 115 K	470 427	111 998 063	706 040
047 905 205 C	406 153 ^N	066 905 715	470 437	06E 905 115	470 427	111 998 295	706 034HVS
048 905 105 1	470 168	06A 905 115	470 429	06E 905 115 A	470 427	113 905 207 A	806 079
049 905 206 D	406 159 ^N	06A 905 115 A	470 429	06E 905 115 B	470 427	113 905 207 B	806 079
049 905 206 F	406 159 ^N	06A 905 115 B	470 429	06E 905 115 C	470 427	113 905 207 C	806 079
049 905 206 G	406 159 ^N	06A 905 115 C	470 429	06E 905 115 D	470 427	113 905 225 E	906 021R
049 905 207	806 079	06A 905 115 D	470 429	06E 905 115 E	470 427	175 905 206 A	406 159 ^N
049 905 225 C	906 115R	06A 905 409 L	360 585	06E 905 115 F	470 427	181 905 225	906 012R
049 905 225 D	906 115R	06A 905 409 N	358 223	06E 905 115 G	470 427	181 905 225 C	906 025R
04C 905 110 A	470 599	06A 905 409 P	360 585	06F 905 115	470 426	181 998 053	706 029HV
04C 905 110 B	470 599	06A 905 430 AA	360 484	06F 905 115 A	470 426	191 905 115 A	470 126
04C 905 110 D	470 599	06A 905 430 AF	360 585	06F 905 115 B	470 426	191 905 351 A	465 007
04C 905 110 E	470 599	06A 905 430 AH	360 585	06F 905 115 C	470 426	191 905 351 B	465 007
04C 905 110 H	470 599	06A 905 430 AJ	360 585	06F 905 115 E	470 426	211 905 115 B	470 132
04C 905 110 J	470 599	06A 905 430 AK	358 223	06F 905 115 F	470 426	211 905 115 C	470 132
04C 905 110 L	470 599	06A 905 430 AL	358 223	06H 905 110 D	470 636	211 905 115 D	470 125
04E 905 110	470 599	06A 905 430 AM	358 223	06H 905 110 E	470 636	211 905 351	465 004
04E 905 110 A	470 599	06A 905 430 AN	358 223	06H 905 110 F	470 636	211 905 351 A	465 004
04E 905 110 B	470 599	06A 905 430 AP	360 585	06H 905 110 G	470 636	211 905 351 B	465 004
04E 905 110 E	470 599	06A 905 430 AQ	360 585	06H 905 110 H	470 636	211 905 351 D	465 004
04E 905 110 H	470 599	06A 905 430 D	360 479	06H 905 110 L	470 636	211 905 351 E	465 004
04E 905 110 K	470 599	06A 905 430 E	360 479	06H 905 115	470 426	221 100 019	470 101D
04E 905 110 L	470 599	06A 905 430 F	360 479	06H 905 115 A	470 426	251 905 115 A	470 125
04E 905 110 P	470 599	06A 905 430 G	360 479	06H 905 115 B	470 426	281 905 207	806 094
050 905 205	406 159	06A 905 430 H	360 585	06K 905 110 K	470 636	311 998 063	706 034HVS
050 905 205 A	406 159 ^N	06A 905 430 J	360 585	06L 905 110 A	470 636	311 998 063 1	706 034HVS
050 905 205 AH	406 223 ^N	06A 905 430 K	360 585	06L 905 110 B	470 636	325 905 207 1	806 129
050 905 205 AL	406 223 ^N	06A 905 430 L	360 585	06L 905 110 C	470 636	325 905 207 2	806 094
050 905 205 B	406 159 ^N	06A 905 430 M	360 489	06L 905 110 D	470 636	325 905 209 2	406 153
050 905 205 BA	406 223 ^N	06A 905 430 N	360 489	06L 905 110 E	470 636	357 905 105	470 269
050 905 205 C	406 159 ^N	06A 905 430 P	360 489	06L 905 110 F	470 636	411 963 073	606 030
050 905 205 D	406 159 ^N	06A 905 430 Q	360 489	06L 905 110 H	470 636	477 905 206	406 153
050 905 205 E	406 159 ^N	06A 905 430 R	360 484	06L 905 110 K	470 636	4A0 905 351	465 051
050 905 205 F	406 159 ^N	06A 905 430 S	360 484	071 905 143	465 074	4D0 905 351	465 076
050 905 205 H	406 159 ^N	06A 905 430 T	360 484	071 905 225	906 067R	6N0 905 104	490 414
050 905 205 J	406 159 ^N	06B 905 106 A	490 420	071 905 225 A	906 067R	701 905 104 A	490 416
050 905 205 K	406 159 ^N	06B 905 115	470 445	073 905 207	806 081	71 314 347	906 045R
051 905 205	406 159 ^N	06B 905 115 B	470 445	073 905 207 B	806 233	71 314 348	806 098
051 905 205 B	406 233 ^N	06B 905 115 D	470 429	073 905 225	906 024R	811 905 115	470 127
051 905 205 C	406 233 ^N	06B 905 115 E	470 445	073 905 225 A	906 117R	867 905 105 A	470 159
051 905 207	806 266	06B 905 115 G	470 429	073 998 051	706 034HVS	867 905 352	490 414
051 905 225	906 121R	06B 905 115 H	470 429	077 905 115 AA	470 425	892 031 048	806 076
052 905 105	470 101D	06B 905 115 J	470 429	077 905 115 B	470 433	892 031 090	706 029HV
052 905 225	906 026R	06B 905 115 L	470 429	077 905 115 C	470 433	892 031 520	906 018R
052 905 225 A	915 089R	06B 905 115 M	470 429	077 905 115 E	470 433	8D0 905 351	465 072
052 905 225 B	906 114R	06B 905 115 N	470 429	077 905 115 F	470 433	J19 101 350 10	813 273
052 905 225 C	906 121R	06B 905 115 P	470 429	077 905 115 G	470 425	J19 101 351 80	813 099
052 905 295	606 195	06B 905 115 Q	470 429	077 905 115 H	470 433	J19 101 710 10	813 113
052 998 051	706 049HDVS	06B 905 115 R	470 429	077 905 115 J	470 425	J19 101 710 20	813 114
052 998 051 D	706 049HDVS	06B 905 115 S	470 429	077 905 115 K	470 433	J19 102 160 60	913 027
052 998 065	406 223	06B 905 430	360 585	077 905 115 M	470 425	J19 102 261 51	913 014
053 905 225 1	906 061R	06B 905 430 A	360 585	077 905 115 P	470 433	J19 145 260 60	713 011HV
053 905 431	360 356	06B 905 430 B	360 585	077 905 115 Q	470 433	J90 919 021 97	470 203
053 905 433	360 356	06B 905 430 C	360 585	077 905 115 R	470 425	N 038 875 3	359 727
055 905 207	806 094	06B 905 431 A	360 585	077 905 115 S	470 425	N 038 885 1	359 493
055 905 225	906 027R	06B 905 431 C	360 585	077 905 115 T	470 433	N 038 885 1	359 725
055 905 225 B	906 055R	06B 905 433 A	360 585	077 905 205	806 248 ^{FA}	N 038 885 1	359 737
056 905 205 L	406 159	06B 905 435 A	360 585	077 905 207	806 248 ^{FA}	N 038 887 5	359 493
058 905 101	470 354S	06B 905 437 A	360 585	07K 905 715	470 426	N 038 908 5	359 727
058 905 105	470 354S	06C 905 115 A	470 436	07K 905 715 A	470 426	N10 050 201	359 768
058 905 207	806 079	06C 905 115 B	470 436	07K 905 715 B	470 426	N10 050 201	360 549
058 905 409 A	360 491	06C 905 115 C	470 429	07K 905 715 C	470 426	N10 050 205	359 725
058 905 447 C	360 491	06C 905 115 D	470 436	07K 905 715 D	470 426	N10 050 205	359 965
058 998 051	706 062	06C 905 115 E	470 436	07K 905 715 E	470 426	N10 052 601	359 737
058 998 051 A	706 062	06C 905 115 F	470 436	07K 905 715 F	470 426	N10 052 704	359 493

VW

N10 052 704	360 671
N10 052 706	359 965
N10 052 706	360 667
N10 052 801	360 671
N10 052 805	360 660
N10 052 808	358 159
N10 052 808	360 660
N10 052 808	360 682
N10 052 809	359 493
N10 052 809	360 364
N10 052 809	360 660
N10 052 812	358 159
N10 052 812	360 682
N10 052 815	360 660
N10 052 903	360 640
N10 052 903	360 660
N10 052 903	360 682
N10 052 904	360 364
N10 052 904	360 660
N10 052 904	360 937
N10 052 907	358 159
N10 052 907	359 493
N10 052 907	359 725
N10 052 907	360 933
N10 052 911	360 580
N10 070 202	359 768
N10 070 210	360 549
N10 070 210	360 551
N10 204 402	360 353
N10 238 502	360 356
N10 243 603	360 667
N10 243 604	360 667
N10 243 607	360 551
N10 243 608	360 667
N10 243 611	360 353
N10 243 612	360 667
N10 264 601	359 965
N10 266 901	360 356
N10 316 401	360 932
N10 316 401	360 933
N10 316 401	360 937
N10 316 402	360 932
N10 316 402	360 933
N10 316 402	360 937
N10 316 403	360 932
N10 316 403	360 933
N10 316 403	360 937
N10 316 404	360 932
N10 316 404	360 933
N10 316 404	360 937
N10 316 602	360 932
N10 418 501	360 580
N10 418 502	360 580
N10 418 503	360 580
N10 418 504	360 580
N10 421 002	360 932
N10 430 003	360 569
N10 430 003	360 641
ZBA 905 225 B	906 025R

YUGO

46600871	907 701R
4660870	807 701

ZASTAVA

1335050	830 081
1335052	730 140
1335055	930 036R
46600193	806 079
46600861	707 701

ZASTAVA

46600871	907 701R
4660870	807 701
5248175	806 079



CROSS REFERENCE LIST OTHER MANUFACTURERS

·TABELLA COMPARATIVA ALTRI COSTRUTTORI ·TABLE DE COMPARAISON D'AUTRES FABRICANTS
·VERGLEICHSTABELLE ANDERE HERSTELLER ·TABLA DE EQUIVALENCIAS OTRAS FABRICANTES

POSSIBLE CROSS REFERENCE FROM OTHER MANUFACTURERS

- POSSIBILI CROSS REFERENCE DI ALTRI COSTRUTTORI
- RENVOIS POSSIBLES À D'AUTRES FABRICANTS
- MÖGLICHE QUERVERWEISE AUF ANDERE HERSTELLER
- POSIBLES REFERENCIAS CRUZADAS DE OTRAS FABRICANTES

1203	615 023	243 592	736 045	415 088	928 007	607 453	615 023
1203 B	615 023	243 758	630 128	418 726	928 007	607 453	615 023
1203 C	615 023	243 842	815 077	422	730 120	608 012	715 055
1205	615 023	243 870	815 063	422 A	730 120	608 460	615 034
1205 D	615 023	243 871	815 072^M	423 153	728 083MHV	608 514	715 111U
1216	615 023	243 876	822 022	438	730 120	608 515	715 111U
8194	815 049	243 881	847 025	440	730 123	608 640	715 067
9500	615 023	243 882	806 080	448	730 132	608 640	715 067
9534	615 023	243 886	806 241	450 001	815 049	608 719	715 112U
1203	615 023	243 887	828 094	450 002	915 083R	608 728	815 058
16 575	815 058	243 889	815 081	450 005	615 039	608 969	715 111U
16 903	915 091	243 890	806 252	450 009	915 083R	609 082	815 058
18 132	815 049	243 893	830 111	451	730 139	609 504	615 034
18 137	915 083R	243 910	915 096R	452	730 140	610 891	915 088
18 137	915 083R	243 964	915 097	453	746 071	611 037	815 049
18 435	815 049	243 965	906 115R	454	730 142	611 149	815 049
19 401	815 058	243 969	906 112R	455	730 139	611 152	815 049
22 321	815 058	243 970	913 014	455	730 143	611 228	715 111U
22 321	815 058	244 512	815 086^M	460	717 024	611 514	815 058
22 946	815 059	2443- 1	930 041	463	717 026	611 723	915 091
23 263	715 064	245 001	470 106	466	730 146M	618 015	715 076
23 263	715 064	245 027	470 105	467	730 149M	618 015	715 076
27 620	842 043	245 039	470 155	469	730 148M	618 431	715 111U
27 630	642 056	245 040	470 188	4765	930 029	618 435	815 049
27 637	642 056	245 041	470 189	520	715 106	618 642	715 101
2790	470 101D	245 042	470 140	520 004	470 101D	618 642	715 101
47 430	815 049	245 043	470 341	520 023	470 101D	618 701	715 055
49 423	915 091	245 049	470 108	520 064	470 107	618 765	715 101
54 099	642 056	245 052	470 158	520 064 A	470 107	620	728 083MHV
69 211	642 056	245 054	470 107	520 073	470 105	623	728 089
69 272	642 056	245 057	470 272	520 073	470 105	623 V	728 089
71 129	715 056	245 059	470 103	520 073 A	470 105	660 494	615 034
71 129	715 056	245 060	470 109	521 008	465 005	660 501	615 034
71 133	715 055	245 062	470 111	521 013	465 005	660 542	815 058
71 133	715 055	245 064	470 125	525 409 D	815 073^M	660 548	915 088R
71 974	715 061	245 066	470 355	525 536	815 072^M	660 588	815 059
71 974	715 061	245 067	470 356	525 536 B	815 072^M	660 740	915 089R
72 192	915 081	245 068	470 228	525 536 F	815 069	660 740	915 089R
72 192	915 081	245 071	470 374	525 551 B	415 019^N	660 996	815 049
72 196	815 041	245 076	470 355	531	715 126	661 004	915 091
76 901	815 049	245 077	470 356	532	715 127	661 149	815 049
79 432	915 083R	245 079	470 365	540	715 086	661 152	815 049
79 874	642 056	245 080	470 178	542	715 055	661 154	915 091
80	701 006	245 082	470 194	545	715 102	661 156	915 083R
C 1	642 056	245 083	470 103	546	715 103	661 371	915 088
D 409	715 056	245 509	465 029	548	715 105	661 450	815 054
D 4511	915 091	245 510	465 005	567	715 055	661 764	915 091
J 438	722 056HV	245 516	465 036	570	715 056	661 822	815 054
P 17	642 056	245 519	465 004	570 V	715 056	661 822 E	815 054
S 1	642 056	245 521	465 007	572	715 061	661 920	815 058
S 406	742 054	245 527	465 020	573	742 054	661 920	815 058
S 4010	842 043	245 531	490 414	582 018	715 086	662 165	815 054
114	706 047	245 536	465 034	582 018	715 086	662 165	815 054
116	706 029HV	245 550	465 052	582 130	715 102	662 368	915 091
141	706 029HV	248 880	928 025	582 133	715 103	662 414	815 049
141 F	706 029HV	248 881	915 101	582 133	715 103	662 414	815 049
142	706 021	248 885	930 059	582 156	715 105	662 434	815 041
143	706 029HV	248 888	815 080	582 156	715 105	662 434	815 041
147	706 029HV	248 889	815 081	582 169	615 034	662 471	815 059
149	706 060	250	706 034HVS	582 186	715 106	662 540	615 034
157	706 032HV	251	706 034HVS	582 191	715 106	662 899	915 089R
161	706 034HVS	254	706 034HVS	582 199	715 106	662 913	815 058
164	706 049HDVS	258	706 049HDVS	582 199	715 106	663 205	815 059
166	706 060	260	706 083	582 309	715 122	663 296	615 034
167	706 064	263	707 701	582 309	715 122	663 550	915 094
171	706 040	335	730 127	582 482	715 126^P	663 869	915 094
178	706 071	343	722 056HV	582 482	715 126^P	664 203	915 094
179	706 062	343 V	722 056HV	582 514	815 063	664 203	915 094
185	706 083	344	713 011HV	583	715 064	664 225	915 088
186	706 068	352	712 055HVS	585	715 067	664 225	915 088
187	706 071	361	731 084	589	715 111U	664 369	815 065
192	706 062	362	713 022HV	594	715 111U	664 369	815 065
193	706 034HVS	368	731 084	594 525	465 005	664 518	915 096R
194	706 049HDVS	400 051	928 006	595	715 112U	664 518	915 096R
195	706 034HVS	405 468	928 006	596	715 076	664 706	615 039
196	706 049HDVS	407 030	928 007	599 178	728 089	664 813	815 059
197	706 062	408 355	928 007	599 183	722 056HV	664 813	815 059
243 408	730 146M	410 610	928 006	599 210	830 069	664 895	915 091
243 410	730 149M	413	715 076	607 374	815 058	664 895	915 091

665 561	615 034	CB 008	717 024	CD 012	930 037	D 396	915 104
665 561	615 034	CB 011	715 055	CD 013	928 012	D 512	815 086TM
665 752	815 070	CB 014	730 142	CD 016	915 083R	D 607453	615 023
665 757	815 063	CB 017	715 105	CD 017	930 042R	D 703	615 023
665 852	915 097	CB 018	715 103	CD 018	906 012R	D 707	615 034
666 203	815 073TM	CB 019	715 106	CD 019	906 023R	D 708	615 023
666 349	815 068	CB 021	715 122	CD 020	906 055R	D 709	642 056
666 349	815 068	CB 027	715 056	CD 021	906 056R	D 801	815 058
666 592	815 062	CB 029	715 061	CD 022	906 059R	D 805	815 058
666 777	915 097	CB 030	715 064	CD 024	906 024R	D 806	815 054
666 778	815 073TM	CB 031	728 089	CD 025	906 112R	D 807	815 049
666 867	915 099R	CB 033	713 011HV	CD 026	906 114R	D 808	815 041
666 867	915 099R	CB 034	722 056HV	CD 027	906 116R	D 810	815 065
667 287	815 067	CB 035	731 084	CD 028	906 121R	D 811	815 059
667 287	815 067	CB 036	730 146M	CD 029	930 041	D 812	815 068
667 308	815 079	CB 039	715 076	CD 030	930 051R	D 814	815 067
667 308	815 079	CB 042	706 040	CD 031	930 054R	D 815	815 079
7083	730 120	CB 043	706 049HDVS	CD 032	930 060	D 816	815 074
750	736 045	CB 044	730 120	CD 033	906 060R	D 842	815 077
803 34 A	465 036	CB 045	730 132	CD 034	928 026R	D 870	815 063
8415	930 029	CB 046	730 139	CD 035	930 047R	D 871	815 072TM
848 90 D	465 036	CB 047	730 140	CD 036	930 055R	D 881	915 104
908 081	642 056	CB 048	728 083MHV	CD 038	912 096	D 888	815 080
908 086	642 056	CB 050	719 044HV	CD 040	915 096R	D 889	815 081
908 148	642 056	CB 052	717 026	CD 042	906 026R	D 901	915 083R
908 149	642 056	CB 055	730 149M	CD 048	915 099R	D 902	915 081
908 247	742 054	CB 060	715 101	CD 049	917 058	D 905	915 089R
9575- 2	715 064	CB 070	715 067	CD 050	915 101	D 908	915 094
9575- 3	715 064	CB 304	606 212	CD 051	906 025R	D 909	915 088
A 422	712 055HVS	CB 310	630 117	CD 303	470 101D	D 910	915 096R
A4037	812 066	CB 318	615 023	CD 308	470 105	D 911	915 091
A4050	812 073	CB 319	615 034	CD 309	470 101D	D 913	915 099R
A4522	912 093	CB 331	606 196	CD 315	470 101D	D 936	915 104
A4534	912 096	CB 336	606 257	CD 321	470 106	D 964	915 097
B 15	606 212	CB 338	630 127	CD 323	470 101D	DAB 126	465 036
B 414	706 034HVS	CB 344	615 023	CD 324	470 102	DAB 134	465 036
B 415	706 040	CB 601	806 093	CD 325	470 107	DAB 201	465 005
B 429	706 049HDVS	CB 602	806 094	CD 328	470 108	DAB 202	465 029
B 721	606 196	CB 603	806 109	CD 330	470 155	DAB 400	465 004
B 732	606 257	CB 604	806 109	CD 331	470 188	DAB 402	465 007
B 817	806 081	CB 605	806 129	CD 334	470 189	DAB 405	465 034
B 820	806 093	CB 606	806 231	CD 338	470 140	DAB 703	465 025
B 821	806 094	CB 607	828 096	CD 339	470 341	DAB 800	465 020
B 822	806 108	CB 608	830 109	CD 440	470 272	DAB 954	490 414
B 824	806 109	CB 609	815 049	CD 442	470 103	DC 625	830 069
B 825	806 121	CB 610	812 066	CD 443	470 111	DC 627	830 069
B 826	806 124	CB 611	819 083	CD 444	470 109	DCB 203	615 034
B 827	806 129	CB 612	806 079	CD 446	470 125	DCB 207	615 039
B 828	806 231	CB 613	828 078	CD 605	465 029	DCB 214	642 056
B 882	806 080	CB 614	830 069	CD 856	465 005	DCB 221	615 023
B 886	806 241	CB 618	842 043	CD 859	415 019	DCB 222	642 056
B 890	806 252	CB 624	830 090	CK 006	715 126^{TP}	DCB 225	642 056
B 914	906 012R	CB 625	815 058	CK 007	715 126^{TP}	DCB 239	615 034
B 915	906 023R	CB 626	815 058	CL 1	470 101D	DCB 243	615 039
B 916	906 025R	CB 627	815 041	CL 101	470 101D	DCB 404	606 212
B 917	906 055R	CB 628	806 076	CS 19	728 089	DCB 413	606 196
B 918	906 056R	CB 631	815 059	CS 25	715 056	DCB 414	606 195
B 919	906 059R	CB 632	815 074	CS 75	722 056HV	DCB 427	606 212
B 921	906 024R	CB 633	815 054	CS 91	728 089	DCB 532	606 257
B 922	906 112R	CB 635	830 098	CS 303	722 056HV	DCB 633	617 097
B 923	906 114R	CB 636	830 104	D 1203	615 023	DCB 867	630 117
B 924	906 116R	CB 640	815 067	D 71129	715 056	DCB 874	630 117
B 925	906 121R	CB 641	812 073	D 204	615 034	DCB 874E	630 117
B 965	906 115R	CB 643	815 079	D 214	715 126^{TP}	DCB 880	630 127
B 969	906 112R	CB 645	815 065	D 236	715 126^{TP}	DCB 881	630 128
B4025	806 076	CB 646	815 068	D 301	715 064	DCJ 233	631 131
B4027	806 079	CB 649	817 023	D 303	715 056	DDB 100	828 104
B4514	906 014R	CB 651	815 080	D 304	715 055	DDB 105	828 070
B4515	906 021R	CB 652	815 081	D 306	715 061	DDB 106	828 075
B4516	906 012R	CD 001	915 091	D 309	715 086	DDB 108	828 078
B4528	906 026R	CD 002	915 088	D 312	715 103	DDB 109	828 096
BD 12-2	470 101D	CD 003	915 094	D 313	715 105	DDB 119	828 091
CB 001	742 054	CD 005	915 089R	D 316	715 106	DDB 130	828 098
CB 002	706 034HVS	CD 006	915 081	D 323	715 122	DDB 132	828 099
CB 003	719 043HV	CD 007	912 093	D 329	715 067	DDB 133	828 100
CB 004	712 055HVS	CD 008	919 085	D 332	715 076	DDB 150	828 083
CB 005	715 086	CD 009	906 014R	D 333	715 101	DDB 152	828 085
CB 006	715 111U	CD 010	906 021R	D 337	715 111U	DDB 175	828 091
CB 007	715 112U	CD 011	906 012R	D 338	715 112U	DDB 176	828 091

DDB 182	828 094	DDB 506	806 257	DLB 125	470 169	DRB 435	906 018R
DDB 184	828 093	DDB 507	806 247	DLB 204	470 107	DRB 436	906 021R
DDB 199	828 078	DDB 508	806 248	DLB 205	470 105	DRB 439	906 024R
DDB 208	815 049	DDB 627	830 069	DLB 206	470 106	DRB 441	906 025R
DDB 208E	815 049	DDB 627C	830 069	DLB 232	470 180	DRB 445	906 067R
DDB 209	815 054	DDB 628	817 016	DLB 233	470 155	DRB 446	906 027R
DDB 209E	815 054	DDB 630	817 014	DLB 246	470 127	DRB 447	906 026R
DDB 217	815 059	DDB 633	817 023	DLB 301	470 228	DRB 453	906 023R
DDB 221	815 049	DDB 701	812 066	DLB 303	470 101D	DRB 455	906 034R
DDB 222	815 041	DDB 705	812 073	DLB 305	470 341	DRB 462	906 056R
DDB 223	815 058	DDB 751	819 092	DLB 310	470 192	DRB 464	906 055R
DDB 224	842 043	DDB 752	819 093	DLB 312	490 303	DRB 466	906 060R
DDB 230	815 058	DDB 754	819 083	DLB 313	470 126	DRB 467	906 116R
DDB 231	815 058	DDB 754C	819 083	DLB 314	470 146	DRB 468	906 059R
DDB 231E	815 058	DDB 804	830 076	DLB 401	470 127	DRB 469	906 061R
DDB 232	815 059	DDB 806	830 111	DLB 403	470 125	DRB 470	906 112R
DDB 232E	815 059	DDB 813	830 086	DLB 701	470 111	DRB 472	906 034R
DDB 235	815 059	DDB 816	830 090	DLB 702	470 109	DRB 473	906 055R
DDB 237	815 059	DDB 851	847 025	DLB 703	470 341	DRB 475	906 061R
DDB 238	815 062	DDB 861	830 069	DLB 704	470 140	DRB 476	906 112R
DDB 245	815 065	DDB 863	830 081	DLB 705	470 213	DRB 480	906 067R
DDB 246	815 067	DDB 864	830 059	DLB 706	470 148	DRB 484	906 117R
DDB 247	815 068	DDB 882	830 104	DLB 708	470 159	DRB 485	906 115R
DDB 248	815 069	DDB 883	830 093	DLB 800	470 108	DRB 488	906 067R
DDB 249	815 074	DDB 886	830 101	DLB 801	470 102	DRB 491	906 024R
DDB 250	815 081	DDB 888	830 098	DLB 802	470 103	DRB 493	906 117R
DDB 251	815 082	DDB 889	830 098	DLJ 402	470 233	DRB 494	906 112R
DDB 252	815 080	DDB 891	830 101	DMB 200	470 188	DRB 498	906 113R
DDB 302	815 079	DDB 894	830 098	DMB 201	470 189	DRB 499	906 114R
DDB 304	822 068	DDB 895	830 098	DMB 300	470 168	DRB 500	906 115R
DDB 400	806 094	DDB 897	830 109	DMB 400	470 162S	DRB 501	906 116R
DDB 401	806 093	DDB 900	815 077	DMB 751	470 135	DRB 504	906 045R
DDB 412	806 079	DDB 901	815 086	DMB 800	470 272	DRB 505	906 067R
DDB 413	806 079	DDB 954	838 242	DPB 801	430 161/1	DRB 506	906 117R
DDB 436	806 062	DDB 955	847 027	DPB 808	430 180M	DRB 507	906 118R
DDB 437	806 076	DDJ 100	822 003	DPB 812	430 176M	DRB 508	906 119R
DDB 438	806 072	DDJ 106	831 003/001	DPB 813	430 177/1	DRB 510	906 121R
DDB 439	806 081	DDJ 107	822 011	DRB 100	928 030	DRB 511	906 122R
DDB 440	806 092	DDJ 115	822 057	DRB 101	928 006	DRB 512	906 123R
DDB 441	806 080	DDJ 156	822 046	DRB 104	928 012	DRB 514	906 126R
DDB 442	806 079	DDJ 167	822 057	DRB 106	928 007	DRB 515	906 125R
DDB 450	806 072	DDJ 189	828 103	DRB 113	928 014	DRB 518	906 127R
DDB 453	806 099	DDJ 190	828 101	DRB 117	928 028R	DRB 519	906 070R
DDB 457	806 092	DDJ 191	828 102	DRB 121	928 027R	DRB 520	906 140R
DDB 458	806 090	DDJ 201	831 003/001	DRB 126	928 007	DRB 625	917 052
DDB 460	806 090	DDJ 206	831 137	DRB 128	928 007	DRB 626	917 052R
DDB 462	806 109	DDJ 220	831 003/001	DRB 131	928 029R	DRB 627	930 029
DDB 467	806 108	DDJ 224	813 117	DRB 139	928 021	DRB 628	930 036R
DDB 470	806 079	DDJ 235	831 114	DRB 147	928 025	DRB 631	917 058
DDB 472	806 079	DDJ 258	831 131	DRB 148	928 026R	DRB 633	930 041
DDB 473	806 079	DDJ 261	831 117	DRB 149	928 024R	DRB 701	912 093
DDB 475	806 108	DDJ 300	831 003/001	DRB 151	928 029R	DRB 701R	912 093R
DDB 478	806 121	DDJ 301	813 252	DRB 195	928 022	DRB 703	912 090
DDB 479	806 123	DDJ 302	813 256	DRB 204	915 083R	DRB 704	912 096
DDB 480	806 123	DDJ 303	813 259	DRB 205	915 091	DRB 705	912 095R
DDB 481	806 124	DDJ 305	822 040	DRB 205E	915 091	DRB 706	912 097
DDB 482	806 098	DDJ 306	822 041	DRB 205R	915 091	DRB 707	912 100
DDB 483	806 076	DDJ 307	831 116	DRB 208	915 089R	DRB 750	919 085
DDB 484	806 062	DDJ 308	831 121	DRB 208E	915 089R	DRB 752	919 085
DDB 485	806 079	DDJ 309	831 125	DRB 221	915 091	DRB 757	919 094R
DDB 486	806 233	DDJ 310	831 132	DRB 222	915 081	DRB 811	930 037R
DDB 487	806 231	DDJ 311	831 155	DRB 229	915 091	DRB 812	930 042R
DDB 488	806 123	DDJ 404	813 093	DRB 233	915 088	DRB 815	930 037R
DDB 489	806 090	DDJ 407	813 094	DRB 233R	915 088R	DRB 817	930 042R
DDB 490	806 127	DDJ 411	813 092	DRB 234	915 094	DRB 853	946 014R
DDB 491	806 128	DDJ 420	813 099	DRB 234R	915 094	DRB 862	930 029
DDB 492	806 234	DDJ 427	813 102	DRB 238	915 096R	DRB 863	930 036R
DDB 493	806 235	DDJ 428	813 107	DRB 239	915 097	DRB 864	930 036R
DDB 494	806 241	DDJ 440	813 113	DRB 240	915 091	DRB 864R	930 036R
DDB 495	806 240	DDJ 442	822 022	DRB 243	915 097	DRB 868	930 041
DDB 496	806 237	DDJ 446	813 262	DRB 244	915 099R	DRB 869	930 040
DDB 497	806 239	DDJ 447	813 114	DRB 246	915 101	DRB 871	930 042R
DDB 498	806 238	DDJ 450	813 240	DRB 247	915 104	DRB 871E	930 042R
DDB 500	806 117	DDJ 451	813 119	DRB 301	922 095	DRB 871R	930 042R
DDB 501	806 257	DDJ 463	813 107	DRB 431	906 014R	DRB 872	930 037
DDB 502	806 249	DDJ 464	813 122	DRB 431N	906 014R	DRB 886	930 047R
DDB 503	806 256	DDJ 491	822 069	DRB 432	906 012R	DRB 889	930 051R
DDB 504	806 258	DLB 101	470 101D	DRB 432N	906 012R	DRB 890	930 054R
DDB 505	806 253	DLB 105	470 101D	DRB 433	906 021R	DRB 891	930 055R

DRB 892	930 060	DSB 443V	706 034HVS	DUB 430	806 081	0 221 119 035	470 101D
DRB 893	930 057R	DSB 445	706 049HDVS	DUB 443	906 026R	0 221 119 048	470 101D
DRB 895	930 059	DSB 445V	706 049HDVS	DUB 455	806 258	0 221 122 008	470 169
DRB 900	915 102R	DSB 446	706 034HVS	DUB 455	906 113R	0 221 122 012	470 103
DRB 954	938 262R	DSB 446S	706 034HVS	DUB 753	819 093	0 221 122 022	470 132
DRB 957	946 014R	DSB 447	706 062	DVB 865	730 139	0 221 122 023	470 132
DRB 958	946 016R	DSB 448	706 040	E 456	717 026	0 221 122 031	470 169
DRJ 102	922 052	DSB 625	730 132	E 833	817 016	0 221 122 334	470 126
DRJ 104	922 092	DSB 625V	730 132	E 928	930 029	0 221 122 349	470 125
DRJ 107	922 056	DSB 626	730 140	F 420	719 043HV	0 221 122 350	470 125
DRJ 119	922 066	DSB 626V	730 140	F 421	719 044HV	0 221 122 357	470 126
DRJ 125	922 070	DSB 627	715 064	F4036	819 083	0 221 122 358	470 126
DRJ 131	922 069	DSB 628	730 139	F4521	919 085	0 221 122 369	470 194
DRJ 153	922 070	DSB 628V	730 139	J 436	713 011HV	0 221 122 379	470 127
DRJ 154	922 085	DSB 629	730 120	J 438	722 056HV	0 221 122 380	470 127
DRJ 201	931 133	DSB 629V	730 120	J 454	713 022HV	0 221 122 386	470 125
DRJ 202	931 023	DSB 631	715 064	J 830	813 093	0 221 122 399	470 126
DRJ 202R	931 023	DSB 633	717 024	J 836	831 109	0 221 122 400	470 126
DRJ 206	931 137	DSB 636	730 127	J 876	822 022	0 221 122 402	470 191
DRJ 220	931 023	DSB 636V	730 127	J 927	913 014	0 221 122 403	470 191
DRJ 224	931 107	DSB 637	717 026	J 970	913 014	0 221 122 408	470 192
DRJ 245	931 108	DSB 700	712 055HVS	L 431	728 083MHV	0 221 122 409	470 192
DRJ 300	931 131	DSB 700S	712 055HVS	L 453	728 089	0 221 123 007	470 101D
DRJ 401	913 014	DSB 700V	712 055HVS	L 837	828 096	0 221 502 009	470 112
DRJ 409	913 027	DSB 752	719 044HV	L 880	928 025	0 221 502 431	470 178
DRJ 419	913 014	DSB 753	719 043HV	L 887	828 094	0 221 502 433	470 179
DRJ 425	913 027	DSB 800	730 140	L 935	928 026R	0 221 503 001	470 273
DRJ 438	913 029	DSB 801	746 071	L4035	828 078	0 221 503 003	470 189
DRJ 447	922 082	DSB 801V	746 071	L4520	928 012	0 221 503 004	470 188
DSB 101	728 083MHV	DSB 853	746 070	M 20	630 117	0 221 503 006	470 189
DSB 109	728 083MHV	DSB 853V	746 070	M 32	617 097	0 221 503 011	470 389
DSB 191	728 089	DSB 861	730 132	M 34	630 127	0 221 503 014	470 398
DSB 201	706 034HVS	DSB 861V	730 132	M 408	730 146M	0 221 503 022	470 414
DSB 204	715 086	DSB 862	730 120	M 410	730 149M	0 221 503 024	470 189
DSB 210	715 105	DSB 862V	730 120	M 416	730 132	0 221 503 025	470 188
DSB 210E	715 105	DSB 863	730 140	M 417	730 140	0 221 503 035	470 417
DSB 213	715 111U	DSB 863V	730 140	M 418	730 139	0 221 503 036	470 417
DSB 215	715 064	DSB 865	730 139	M 419	730 120	0 221 503 407	470 168
DSB 220	715 076	DSB 865V	730 139	M 432	730 142	0 221 503 457	470 168
DSB 230	715 103	DSB 868	730 142	M 450	717 024	0 221 503 468	470 507
DSB 230E	715 103	DSB 868V	730 142	M 459	730 149	0 221 503 471	470 398
DSB 232	715 106	DSB 869	730 127	M 758	630 128	0 221 503 485	470 481
DSB 232E	715 106	DSB 869V	730 127	M 840	830 109	0 221 503 486	470 481
DSB 241	715 055	DSB 880M	730 146M	M 881	847 025	0 221 503 487	470 481
DSB 242	715 061	DSB 883M	730 148M	M 885	930 059	0 221 503 491	470 532
DSB 242V	715 061	DSB 884	730 149	M 893	830 111	0 221 503 700	470 272
DSB 244	715 067	DSB 884M	730 149M	M 930	930 041	0 221 503 800	470 547
DSB 245	715 056	DSB 886	730 148M	M 931	930 051R	0 221 504 004	470 352
DSB 246	742 054	DSB 887	730 149M	M 932	930 054R	0 221 504 006	470 314
DSB 250	715 067	DSB 951	736 045	M 933	930 060	0 221 504 026	470 549
DSB 252	715 101	DSB 956	707 701	M 934	906 060R	0 221 504 029	470 352
DSB 252E	715 101	DSJ 100	722 056HV	M4029	830 069	0 221 504 036	470 549
DSB 255	715 111U	DSJ 100V	722 056HV	M4043	830 090	0 221 504 100	470 475
DSB 256	715 112U	DSJ 204	731 084	M4045	830 104	0 221 504 410	470 412
DSB 266	715 055	DSJ 205	731 084	M4047	817 023	0 221 504 456	470 313
DSB 275	715 122	DSJ 402	713 011HV	M4048	830 098	0 221 504 463	470 475
DSB 276	706 049HDVS	DSJ 403	713 011HV	M4518	930 037	0 221 504 467	470 475
DSB 279	715 126 ^{FP}	DSJ 405V	713 022HV	M4530	930 042R	0 221 504 471	470 607
DSB 280	715 127 ^{FP}	DTB 415	706 034HVS	M4533	930 047R	0 221 504 472	470 607
DSB 283	715 056	DTB 419	706 034HVS	M4535	917 058	0 221 504 474	470 412
DSB 431	706 032HV	DTB 422	706 040	M4536	930 055R	0 221 504 801	470 607
DSB 431V	706 032HV	DTB 812	730 140	MTR-01	465 005	0 221 505 437	470 317
DSB 432	706 034HVS	DTJ 452	713 011HV	RA 13	928 014	0 221 505 438	470 317
DSB 432C	706 034HVS	DTJ 453	713 011HV	RA 29	915 091	0 221 506 002	470 316
DSB 432S	706 034HVS	DUB 105	828 091	RA 200	906 014R	0 221 506 003	470 316
DSB 432V	706 034HVS	DUB 107	928 022	S 406	742 054	0 221 506 444	470 316
DSB 433	706 021	DUB 107	828 075	S4010	842 043	0 221 506 445	470 316
DSB 435	706 047	DUB 107	928 006	U 592	736 045	0 221 601 012	490 423
DSB 436	706 049HDVS	DUB 111	828 098	0 009 3079 13	712 055HVS	0 221 604 001	470 448
DSB 436S	706 049HDVS	DUB 111	928 027R	0 221 102 088	470 132	0 221 604 008	470 448
DSB 436V	706 049HDVS	DUB 114	828 085	0 221 102 090	470 101D	0 221 604 010	470 478
DSB 437	706 040	DUB 114	928 012	0 221 102 091	470 101D	0 221 604 014	470 489
DSB 438	706 029HV	DUB 115	828 091	0 221 118 307	470 180	0 221 604 115	470 426
DSB 438V	706 029HV	DUB 115	928 021	0 221 118 329	470 178	0 221 604 116	470 426
DSB 439	706 029HV	DUB 116	828 091	0 221 118 398	470 126	0 221 604 701	470 626
DSB 440	706 029HV	DUB 116	928 021	0 221 119 008	470 101D	0 227 100 030	465 076
DSB 443	706 034HVS	DUB 226	815 054	0 221 119 018	470 101D	0 227 100 100	465 004
DSB 443C	706 034HVS	DUB 226	915 088	0 221 119 025	470 101D	0 227 100 101	465 004
DSB 443S	706 034HVS	DUB 227	815 054	0 221 119 027	470 101D	0 227 100 102	465 005

0 227 100 103	465 004	0 237 004 005	406 153^{NI}	0 237 020 167	406 159^{NI}	0 237 024 027	406 159^{NI}
0 227 100 104	465 004	0 237 005 002	406 153^{NI}	0 237 020 169	406 159^{NI}	0 237 024 028	406 159^{NI}
0 227 100 110	465 005	0 237 005 004	406 153^{NI}	0 237 020 170	406 159^{NI}	0 237 024 029	406 159^{NI}
0 227 100 111	465 005	0 237 006 001	406 153^{NI}	0 237 020 171	406 159^{NI}	0 237 024 030	406 159^{NI}
0 227 100 112	465 005	0 237 006 003	406 153^{NI}	0 237 020 172	406 159^{NI}	0 237 024 031	406 159^{NI}
0 227 100 113	465 004	0 237 006 005	406 153^{NI}	0 237 020 175	406 159^{NI}	0 237 024 032	406 159^{NI}
0 227 100 118	465 004	0 237 006 006	406 153^{NI}	0 237 020 176	406 159^{NI}	0 237 024 033	406 159^{NI}
0 227 100 123	465 005	0 237 006 009	406 153^{NI}	0 237 020 177	406 159^{NI}	0 237 024 034	406 159^{NI}
0 227 100 124	465 034	0 237 006 010	406 153^{NI}	0 237 020 178	406 159^{NI}	0 237 024 037	406 159^{NI}
0 227 100 137	465 004	0 237 008 001	406 153^{NI}	0 237 020 180	406 159^{NI}	0 237 024 038	406 159^{NI}
0 227 100 138	465 004	0 237 008 002	406 153^{NI}	0 237 020 182	406 159^{NI}	0 237 026 013	406 193^{NI}
0 227 100 139	465 004	0 237 009 003	406 153^{NI}	0 237 020 183	406 159^{NI}	0 237 026 014	406 193^{NI}
0 227 100 142	465 007	0 237 009 010	406 153^{NI}	0 237 020 184	406 159^{NI}	0 237 035 001	406 159^{NI}
0 227 100 143	465 007	0 237 009 033	406 153^{NI}	0 237 020 185	406 159^{NI}	0 237 037 001	406 193^{NI}
0 227 100 147	465 007	0 237 011 003	406 153^{NI}	0 237 020 186	406 159^{NI}	0 237 037 002	406 193^{NI}
0 227 100 211	465 076	0 237 012 001	406 153^{NI}	0 237 020 187	406 159^{NI}	0 237 037 003	406 193^{NI}
0 227 100 212	465 076	0 237 012 002	406 153^{NI}	0 237 020 188	406 159^{NI}	0 237 037 004	406 193^{NI}
0 237 001 002	406 153^{NI}	0 237 020 081	406 159^{NI}	0 237 020 189	406 159^{NI}	0 237 037 005	406 193^{NI}
0 237 001 005	406 153^{NI}	0 237 020 083	406 159^{NI}	0 237 020 190	406 159^{NI}	0 237 037 007	406 193^{NI}
0 237 001 006	406 153^{NI}	0 237 020 084	406 159^{NI}	0 237 020 191	406 159^{NI}	0 237 037 008	406 193^{NI}
0 237 001 007	406 153^{NI}	0 237 020 085	406 159^{NI}	0 237 020 192	406 159^{NI}	0 237 037 009	406 193^{NI}
0 237 001 008	406 153^{NI}	0 237 020 086	406 159^{NI}	0 237 020 193	406 159^{NI}	0 237 037 010	406 193^{NI}
0 237 002 001	406 153^{NI}	0 237 020 087	406 159^{NI}	0 237 020 194	406 159^{NI}	0 237 505 005	406 153^{NI}
0 237 002 003	406 153^{NI}	0 237 020 088	406 159^{NI}	0 237 020 195	406 159^{NI}	0 237 505 009	406 153^{NI}
0 237 002 004	406 153^{NI}	0 237 020 089	406 159^{NI}	0 237 020 196	406 159^{NI}	0 237 520 001	406 233^{NI}
0 237 002 005	406 153^{NI}	0 237 020 090	406 159^{NI}	0 237 020 197	406 159^{NI}	0 237 520 036	406 223^{NI}
0 237 002 006	406 153^{NI}	0 237 020 091	406 159^{NI}	0 237 020 198	406 159^{NI}	0 237 520 037	406 223^{NI}
0 237 002 008	406 153^{NI}	0 237 020 095	406 159^{NI}	0 237 020 199	406 159^{NI}	0 237 520 048	406 223^{NI}
0 237 002 010	406 153^{NI}	0 237 020 096	406 159^{NI}	0 237 020 200	406 159^{NI}	0 237 520 054	406 244^{NI}
0 237 002 011	406 153^{NI}	0 237 020 097	406 159^{NI}	0 237 020 201	406 159^{NI}	0 237 521 003	406 233^{NI}
0 237 002 012	406 153^{NI}	0 237 020 098	406 159^{NI}	0 237 020 202	406 159^{NI}	0 237 521 006	406 223^{NI}
0 237 002 013	406 153^{NI}	0 237 020 099	406 159^{NI}	0 237 020 203	406 159^{NI}	0 237 521 019	406 233^{NI}
0 237 002 015	406 153^{NI}	0 237 020 100	406 159^{NI}	0 237 020 204	406 159^{NI}	0 237 521 020	406 233^{NI}
0 237 002 017	406 153^{NI}	0 237 020 103	406 159^{NI}	0 237 020 205	406 159^{NI}	0 237 521 024	406 244
0 237 002 018	406 153^{NI}	0 237 020 105	406 159^{NI}	0 237 020 212	406 159^{NI}	0 237 521 024	806 256^B
0 237 002 020	406 153^{NI}	0 237 020 109	406 159^{NI}	0 237 020 213	406 159^{NI}	0 237 521 024	906 121R
0 237 002 021	406 153^{NI}	0 237 020 110	406 159^{NI}	0 237 021 026	406 193^{NI}	0 237 521 046	406 233^{NI}
0 237 002 022	406 153^{NI}	0 237 020 111	406 159^{NI}	0 237 021 027	406 193^{NI}	0 237 521 047	406 233^{NI}
0 237 002 035	406 153^{NI}	0 237 020 112	406 159^{NI}	0 237 021 028	406 193^{NI}	0 237 521 048	406 223^{NI}
0 237 002 038	406 153^{NI}	0 237 020 113	406 159^{NI}	0 237 021 034	406 193^{NI}	0 237 521 050	406 223^{NI}
0 237 002 039	406 153^{NI}	0 237 020 114	406 159^{NI}	0 237 021 035	406 193^{NI}	0 237 521 058	406 223^{NI}
0 237 002 050	406 153^{NI}	0 237 020 115	406 159^{NI}	0 237 021 036	406 193^{NI}	0 237 522 011	406 223^{NI}
0 237 002 053	406 153^{NI}	0 237 020 116	406 159^{NI}	0 237 021 040	406 193^{NI}	0 290 004 019	806 266
0 237 002 054	406 153^{NI}	0 237 020 117	406 159^{NI}	0 237 021 041	406 193^{NI}	0 290 004 032	806 231^A
0 237 002 057	406 153^{NI}	0 237 020 118	406 159^{NI}	0 237 021 042	406 193^{NI}	0 290 004 035	806 231^A
0 237 002 065	406 153^{NI}	0 237 020 119	406 159^{NI}	0 237 021 043	406 193^{NI}	0 290 004 500	806 090^A
0 237 002 069	406 153^{NI}	0 237 020 120	406 159^{NI}	0 237 021 044	406 193^{NI}	0 290 004 501	806 092^A
0 237 002 071	406 153^{NI}	0 237 020 131	406 159^{NI}	0 237 021 045	406 193^{NI}	0 290 004 502	806 090^A
0 237 002 072	406 153^{NI}	0 237 020 133	406 159^{NI}	0 237 021 046	406 193^{NI}	0 290 004 503	806 092
0 237 002 073	406 153^{NI}	0 237 020 134	406 159^{NI}	0 237 021 047	406 193^{NI}	0 290 004 505	806 090
0 237 002 075	406 153^{NI}	0 237 020 135	406 159^{NI}	0 237 021 048	406 193^{NI}	0 310 396	465 004
0 237 002 076	406 153^{NI}	0 237 020 136	406 159^{NI}	0 237 021 051	406 193^{NI}	0 310 397	465 005
0 237 002 078	406 153^{NI}	0 237 020 137	406 159^{NI}	0 237 021 052	406 193^{NI}	0 310 411	465 007
0 237 002 087	406 153^{NI}	0 237 020 138	406 159^{NI}	0 237 021 054	406 193^{NI}	0 347 0056	912 093
0 237 002 088	406 153^{NI}	0 237 020 140	406 159^{NI}	0 237 021 056	406 193^{NI}	0 347 9003	812 066
0 237 002 089	406 153^{NI}	0 237 020 141	406 159^{NI}	0 237 021 074	406 234^{NI}	0 348 6037	912 095R
0 237 002 109	406 153^{NI}	0 237 020 144	406 159^{NI}	0 237 022 035	406 159^{NI}	0 356 100 107	360 607
0 237 002 113	406 153^{NI}	0 237 020 145	406 159^{NI}	0 237 022 036	406 159^{NI}	0 356 100 107	360 608
0 237 002 114	406 153^{NI}	0 237 020 146	406 159^{NI}	0 237 022 037	406 159^{NI}	0 356 901 808	359 572
0 237 002 115	406 153^{NI}	0 237 020 147	406 159^{NI}	0 237 022 038	406 159^{NI}	0 356 901 814	359 578
0 237 002 128	406 153^{NI}	0 237 020 148	406 159^{NI}	0 237 022 039	406 159^{NI}	0 356 901 819	359 597
0 237 002 129	406 153^{NI}	0 237 020 149	406 159^{NI}	0 237 022 041	406 159^{NI}	0 356 912 052	360 649
0 237 002 133	406 153^{NI}	0 237 020 150	406 159^{NI}	0 237 022 043	406 159^{NI}	0 356 912 054	360 649
0 237 003 001	406 153^{NI}	0 237 020 151	406 159^{NI}	0 237 022 047	406 159^{NI}	0 356 912 948	360 649
0 237 003 003	406 153^{NI}	0 237 020 152	406 159^{NI}	0 237 022 049	406 159^{NI}	0 356 912 950	360 649
0 237 003 007	406 153^{NI}	0 237 020 153	406 159^{NI}	0 237 022 058	406 159^{NI}	0 356 912 975	360 643
0 237 003 008	406 153^{NI}	0 237 020 154	406 159^{NI}	0 237 022 060	406 159^{NI}	0 356 913 006	358 232
0 237 003 009	406 153^{NI}	0 237 020 155	406 159^{NI}	0 237 024 007	406 159^{NI}	0 356 913 008	358 232
0 237 003 018	406 153^{NI}	0 237 020 156	406 159^{NI}	0 237 024 008	406 159^{NI}	0 356 913 013	358 234
0 237 003 024	406 153^{NI}	0 237 020 157	406 159^{NI}	0 237 024 009	406 159^{NI}	0 356 913 017	358 234
0 237 003 027	406 153^{NI}	0 237 020 158	406 159^{NI}	0 237 024 010	406 159^{NI}	0 356 913 019	358 234
0 237 003 034	406 153^{NI}	0 237 020 159	406 159^{NI}	0 237 024 016	406 159^{NI}	0 356 913 021	358 232
0 237 003 035	406 153^{NI}	0 237 020 160	406 159^{NI}	0 237 024 017	406 159^{NI}	0 356 913 023	358 232
0 237 003 036	406 153^{NI}	0 237 020 161	406 159^{NI}	0 237 024 018	406 159^{NI}	0 986 221 003	470 345
0 237 003 040	406 153^{NI}	0 237 020 162	406 159^{NI}	0 237 024 019	406 159^{NI}	0 986 221 011	470 354S
0 237 003 041	406 153^{NI}	0 237 020 163	406 159^{NI}	0 237 024 022	406 159^{NI}	0 986 221 025	470 376
0 237 003 042	406 153^{NI}	0 237 020 164	406 159^{NI}				

0986 221 030	470 355	029120-1540	813 107	06.549	359 386	060717101012	470 518
0986 221 031	470 356	029120-1600	813 240	06.551	359 398	060717104012	470 408
0986 221 033	470 196	029120-1700	813 241	06.552	359 398	060717105012	470 480
0986 221 034	470 403	029120-1720	813 128	06.557	359 466	060717106012	470 219
0986 221 103	470 638	029120-1850	813 123	06.558	359 386	060717111012	470 495
0986 221 114	470 556	029120-2120	813 278	06.560	359 351	060717113012	470 607
0986 221 146	470 647	029120-2130	813 262	06.561	359 347	060717119012	470 466
0986 22A 000	470 557	029120-2291	813 245	06.562	359 354	060717123012	470 203
0986 22A 201	470 420	029120-2311	813 093	06.563	359 815	060717126012	470 461
0986 22A 203	470 354S	029120-2590	813 123	06.565	359 815	060717130012	470 431
0986 22A 204	470 442	029120-2610	813 258	06.568	359 615	060717131012	470 374
0986 22A 205	470 483	029180-0240	913 014	06.569	359 808	060717135012	470 423
0986 22A 206	470 408	029180-0241	913 014	06.570	359 887	060717137012	470 547
0986 22A 207	470 570	029180-0340	913 014	06.572	359 616	060717144012	470 487
0986 22A 209	470 450	029180-0430	913 014	06.573	359 650	060717146012	470 481
0986 22A 216	470 619	029180-0580	913 014	06.574	359 456	060717148012	470 492
0986 22A 218	470 608	029180-0660	913 027	06.576	359 613	060717149012	470 556
0986 22A 222	470 533	029180-0910	913 029	06.577	359 655	060717150012	470 522
0986 22A 402	470 374	029180-0920	913 028	06.578	359 616	060717151012	470 536
0986 356 345	358 223	029180-0921	913 028	06.579	360 363	060717156012	470 450
0986 356 717	359 615	029180-0930	913 029	06.580	360 503	060717157012	470 483
0986 356 835	359 716	029180-0990	913 030	06.584	359 808	060717158012	470 445
0986 356 928	360 209	029180-1130	913 030	06.585	359 808	060717160012	470 435
0986 357 226	360 531	029180-1230	913 029	06.587	359 655	060717163012	470 417
0986 357 252	360 446	029180-1260	913 030	06.588	359 889	060717164012	470 602
0986 357 261	360 503	029180-1280	913 034	06.591	360 504	060717167012	470 436
0986 357 277	360 732	029180-1300	913 034	06.592	359 398	060717168012	470 586
0986 AG0 506	470 466	029180-1310	913 028	06.594	359 887	060717169012	470 433
0.71374201.010	830 116	029180-1391	913 028	06.598	360 505	060717173012	470 619
0.71377402.010	930 057R	029350-0200	713 011HV	0601-9106-5	831 139	060717175012	470 427
005.300	701 006	029350-0270	713 011HV	060690003010	470 101D	060717176012	470 516
01.522	359 623	029350-0550	713 022HV	060705404010	470 102	060717183012	470 420
01.526	359 660	029350-0650	713 011HV	060705404010	470 148	060717185012	470 507
01.527	359 623	029350-0660	713 022HV	060705409010	470 228	060717187012	470 612
01.529	359 716	029350-0690	713 011HV	060705604010	470 108	060717188012	470 609
01.534	359 623	029350-0740	713 022HV	060705606010	470 158	060717190012	470 518
01.538	360 608	029350-0820	713 022HV	060705738010	470 106	060717193012	470 611
01.538C	360 608	029350-0860	713 011HV	060705754010	470 155	060717199012	470 599
01.543	360 607	029700-5430	470 197	060708038010	470 146	060717202012	470 442
01.543C	360 607	029700-6700	470 135	060708049010	470 196	060717203012	470 552
014 885 0000	470 417	029700-6760	470 170	060708149010	470 196	060717206012	470 545
014 885 0005	470 487	029700-6770	470 289	060717006012	470 269	060717206012	470 545
014 885 0015	470 505	029700-6780	470 289	060717008012	490 414	060717207012	470 476
014 885 0017	470 503	029700-6820	470 202	060717009012	470 155	060717243012	470 614
014 885 0018	470 626	029700-7050	470 203	060717011012	470 140	060717244012	470 589
02.506	359 768	029700-7051	470 203^U	060717014012	470 105	060717247012	470 529
02.520	360 491	029700-7180	470 170	060717015012	470 106	060717250012	470 551
02.520C	360 491	029700-7301	470 322	060717017012	470 108	060717251012	470 505
029 120-135	813 099	029700-7531	470 289	060717020012	470 228	060717256012	470 537
029 120-139	813 114	029700-7700	470 285S	060717021012	470 347	060740303010	470 442
029 120-152	813 119	029700-7910	470 170	060717022012	470 214	060780002010	470 146
029 120-167	813 099	029700-8240	470 432	060717023012	470 215	060792001010	470 345
029 120-224	813 278	029700-8291	470 432	060717024012	470 213	060794001010	470 423
029 120-227	813 119	03.506	359 694	060717026012	470 233	060801005010	470 532
029 120-234	813 278	0347	360 883	060717029012	470 146	060801006010	470 312
029 120-253	813 257	0350	360 732	060717030012	470 405	060801012010	470 450
029 120-255	813 099	0355	360 413	060717031012	470 403	060810070010	470 432
029 120-256	813 099	04.500	359 572	060717037012	470 168	060810090010	470 384
029 120-263	813 251	04.506	359 572	060717042012	490 420	060810160010	470 602
029 120-265	813 248	04.527	359 572	060717043012	470 188	060810167010	470 431
029 120-273	813 278	05.513	360 374	060717044012	470 272	060810176010	470 475
029 120-282	813 252	05.515	359 674	060717048012	470 170	060810187010	470 489
029 120-321	813 265	05.516	359 780	060717051012	470 196	060810196010	470 426
029 120-333	813 275	05.518	359 494	060717052012	470 399	060810210010	470 475
029 120-340	813 267	05.524	359 748	060717053012	470 429	060810212010	470 475
029 120-357	813 272	05.528	359 494	060717055012	470 419	060810224010	470 549
029 120-366	813 273	056181168010	630 117	060717060012	470 596	060810229010	470 529
029120-0600	813 093	056181176010	630 117	060717064012	470 508	060810245010	470 314
029120-0601	813 093	056181182010	630 127	060717067012	470 345	060810269010	470 480
029120-0741	813 092	056181183010	630 128	060717068012	470 376	060810270010	470 481
029120-0760	813 094	056181202010	630 117	060717069012	470 378	061110041010	430 176M
029120-1020	813 099	06.500	359 386	060717070012	470 275	061110055010	430 176M
029120-1080	813 102	06.5100	360 451	060717071012	470 356	061110062010	430 176M
029120-1290	813 113	06.533	359 429	060717072012	470 365	061110103010	430 180M
029120-1390	813 114	06.543	359 466	060717073012	470 355	061110126010	430 180M
029120-1410	813 262	06.544	359 347	060717078012	470 459	064825072010	490 303
029120-1480	813 117	06.546	359 432	060717082012	470 407	064833040010	465 020
029120-1510	813 122	06.547	359 347	060717086012	470 458	0675	359 351
029120-1520	813 119	06.548	359 354	060717093012	470 591	0689	359 432

07.508	359 398	1 217 013 001	706 060	1 234 332 301	906 055R	1 234 335 305	906 059R
07.509	359 398	1 217 013 002	706 060	1 234 332 303	906 067R	1 234 335 801	912 093R
07.513	359 808	1 217 013 003	706 060	1 234 332 305	906 059R	1 234 335 802	915 091
07.514	359 692	1 217 013 006	706 060	1 234 332 309	906 055R	1 234 335 805	915 083R
07.515	359 398	1 217 013 009	706 064	1 234 332 313	906 112R	1 234 335 845	915 088R
07.516	359 456	1 217 013 015	706 060	1 234 332 317	906 117R	1 235 522 040	806 081
07.518	359 700	1 217 013 020	706 083	1 234 332 332	906 024R	1 235 522 041	806 081
07.521	359 650	1 217 013 021	706 068	1 234 332 333	906 070R	1 235 522 050	806 076
07.525	359 456	1 217 013 022	706 068	1 234 332 337	906 049R	1 235 522 051	806 072
07.528	359 456	1 217 013 025	706 083	1 234 332 340	906 114R	1 235 522 053	806 081
070005501010	830 059	1 217 013 103	706 060	1 234 332 341	906 122R	1 235 522 056	806 079
070189501010	930 029	1 217 031 015	706 068	1 234 332 343	906 115R	1 235 522 058	806 076
071006701010	730 120	1 220 522 019	470 192	1 234 332 344	906 112R	1 235 522 059	806 076
071093003010	930 054R	1 221 122 409	470 192	1 234 332 346	906 113R	1 235 522 060	806 072
071101607010	930 051R	1 227 010 003	465 034	1 234 332 347	906 119R	1 235 522 074	806 092
071111601010	730 139	1 227 010 039	465 034	1 234 332 348	906 116R	1 235 522 075	806 081
071118501010	730 140	1 227 020 029	470 191	1 234 332 349	906 118R	1 235 522 103	806 072
071119505010	930 042R	1 227 022 008	465 004	1 234 332 350	906 121R	1 235 522 107	806 062
071129001010	830 082	1 227 022 030	490 414	1 234 332 351	906 112R	1 235 522 109	806 072
071142401010	930 036R	1 227 030 030	490 414	1 234 332 353	906 117R	1 235 522 134	806 062
071142402010	930 042R	1 227 030 051	470 269	1 234 332 359	906 055R	1 235 522 141	806 076
071153901010	930 037R	1 227 030 052	470 269	1 234 332 360	906 121R	1 235 522 144	806 076
071171101010	830 086	1 227 030 059	470 386	1 234 332 364	906 122R	1 235 522 145	806 076
071171301010	930 040	1 227 030 062	470 387	1 234 332 365	906 125R	1 235 522 146	806 072
071174301010	830 090	1 227 030 071	470 397	1 234 332 366	906 121R	1 235 522 147	806 072
071197502010	730 142	1 230 500 221	406 160	1 234 332 370	906 123R	1 235 522 154	806 072
071237201010	930 047R	1 230 591 003	806 080	1 234 332 371	906 122R	1 235 522 155	806 079
071237202010	930 057R	1 230 591 040	806 266	1 234 332 374	906 121R	1 235 522 157	806 062
071237801010	930 047R	1 234 211 018	406 153	1 234 332 381	906 127R	1 235 522 158	806 072
071243702010	830 098	1 234 211 218	406 153	1 234 332 382	906 126R	1 235 522 159	806 072
071246105010	830 101	1 234 332 024	906 018R	1 234 332 387	906 121R	1 235 522 167	806 076
071275301010	930 055R	1 234 332 029	906 018R	1 234 332 390	906 147R	1 235 522 169	806 076
071277902010	730 146M	1 234 332 030	906 018R	1 234 332 393	906 121R	1 235 522 171	806 072
071277905010	730 149M	1 234 332 033	906 012R	1 234 332 395	906 140R	1 235 522 173	806 076
071293402010	730 148M	1 234 332 062	906 018R	1 234 332 399	906 121R	1 235 522 175	806 076
071302701010	830 109	1 234 332 072	906 018R	1 234 332 401	906 061R	1 235 522 176	806 072
071319801010	430 161/1	1 234 332 074	906 012R	1 234 332 402	906 121R	1 235 522 177	806 072
071319804010	430 163/1	1 234 332 076	906 014R	1 234 332 408	906 146R	1 235 522 179	806 076
071326901010	430 177/1	1 234 332 082	906 014R	1 234 332 414	906 121R	1 235 522 181	806 072
071347401010	430 180M	1 234 332 087	906 018R	1 234 332 417	906 125R	1 235 522 183	806 079
071349101010	430 176M	1 234 332 088	906 018R	1 234 332 421	906 148R	1 235 522 185	806 079
071351702010	930 059	1 234 332 089	906 014R	1 234 332 422	906 146R	1 235 522 188	806 079
071358401010	830 111	1 234 332 106	906 021R	1 234 332 426	906 149R	1 235 522 189	806 079
071366701010	830 101	1 234 332 107	906 021R	1 234 332 800	912 093	1 235 522 193	806 079
071366702010	830 101	1 234 332 109	906 021R	1 234 332 801	912 093R	1 235 522 195	806 081
071366801010	830 098	1 234 332 144	906 067R	1 234 332 802	915 091	1 235 522 196	806 080
071371301010	930 060	1 234 332 158	906 067R	1 234 332 803	915 081	1 235 522 198	806 081
08.502	360 654	1 234 332 162	906 067R	1 234 332 805	915 083R	1 235 522 199	806 079
08.510	360 305	1 234 332 173	906 024R	1 234 332 808	930 037	1 235 522 201	806 079
08.512	360 323	1 234 332 177	906 023R	1 234 332 809	930 037R	1 235 522 202	806 080
0825	359 514	1 234 332 197	906 024R	1 234 332 810	930 037	1 235 522 203	806 079
0890	360 888	1 234 332 200	906 113R	1 234 332 811	930 037R	1 235 522 208	806 090
09.506	359 509	1 234 332 204	906 034R	1 234 332 812	930 037	1 235 522 213	806 094
09.515	360 237	1 234 332 208	906 027R	1 234 332 813	930 037R	1 235 522 218	806 093
09.516	359 527	1 234 332 209	906 067R	1 234 332 814	930 036R	1 235 522 219	806 079
09.518	359 514	1 234 332 213	906 025R	1 234 332 827	913 014	1 235 522 227	806 079
09.519	359 634	1 234 332 215	906 025R	1 234 332 828	913 014	1 235 522 229	806 081
09.531	359 688	1 234 332 216	906 026R	1 234 332 836	906 014R	1 235 522 256	806 079
09.532	360 562	1 234 332 220	906 115R	1 234 332 838	915 088R	1 235 522 290	806 081
09.536	360 531	1 234 332 236	906 024R	1 234 332 841	915 088R	1 235 522 295	806 081
09.538	360 529	1 234 332 237	906 024R	1 234 332 845	915 088R	1 235 522 307	806 099
09.539	359 688	1 234 332 242	906 116R	1 234 332 848	928 012	1 235 522 315	806 079
09.543	359 527	1 234 332 261	906 025R	1 234 332 849	930 042R	1 235 522 322	806 109
09.545	359 689	1 234 332 271	906 061R	1 234 332 850	915 083R	1 235 522 323	806 092
09.554	360 947	1 234 332 272	906 117R	1 234 332 859	946 014R	1 235 522 324	806 090
099 700-061	470 457	1 234 332 273	906 056R	1 234 332 860	915 094	1 235 522 325	806 117^A
099 700-072	470 457	1 234 332 275	906 061R	1 234 332 861	912 096	1 235 522 326	806 108
099 700-101	470 522	1 234 332 276	906 112R	1 234 332 902	906 012R	1 235 522 327	806 108^A
099 700-114	470 457	1 234 332 277	906 117R	1 234 332 903	906 014R	1 235 522 329	806 123
1 046 7543	812 075	1 234 332 279	906 060R	1 234 332 904	906 018R	1 235 522 330	806 123^A
1 046 7546	912 098	1 234 332 280	906 027R	1 234 332 906	906 021R	1 235 522 332	806 124
1 049 5408	912 098	1 234 332 281	906 115R	1 234 332 907	906 021R	1 235 522 333	806 121
1 049 5411	912 098	1 234 332 282	906 049R	1 234 332 908	906 025R	1 235 522 356	806 079
1 049 5822	812 075	1 234 332 284	906 117R	1 234 332 918	912 093R	1 235 522 357	806 094
1 049 6278	812 075	1 234 332 285	906 026R	1 234 335 082	906 014R	1 235 522 361	806 121
1 103 516	412 011^N	1 234 332 288	906 115R	1 234 335 215	906 025R	1 235 522 362	806 081^A
1 103 549	412 011^N	1 234 332 291	906 067R	1 234 335 216	906 026R	1 235 522 364	806 238
1 212 208	912 093	1 234 332 296	906 060R	1 234 335 280	906 027R	1 235 522 365	806 238^A
1 214 140	812 066	1 234 332 300	906 055R	1 234 335 300	906 055R	1 235 522 366	806 127

1 235 522 368	806 123	1 235 522 930	812 066	1 237 013 112	706 062	1 237 013 916	706 034HVS
1 235 522 369	806 231	1 235 522 931	806 080	1 237 013 113	706 049HDVS	1 237 013 917	706 034HVS
1 235 522 370	806 129	1 235 525 056	806 079	1 237 013 114	706 034HVS	1 237 013 918	712 055HVS
1 235 522 371	806 231	1 235 525 059	806 076	1 237 013 115	706 062	1 237 013 919	730 132
1 235 522 372	806 261	1 235 525 196	806 080	1 237 013 116	706 034HVS	1 237 013 920	730 139
1 235 522 374	806 235	1 235 525 801	812 066	1 237 013 117	706 034HVS	1 237 013 921	730 140
1 235 522 375	806 266	1 235 525 803	815 049	1 237 013 119	706 034HVS	1 237 013 923	706 034HVS
1 235 522 380	806 234^{FA}	1 235 525 806	815 045	1 237 013 121	706 049HDVS	1 237 013 924	712 055HVS
1 235 522 381	806 234	1 235 525 812	842 043	1 237 013 122	706 062	1 237 015 802	712 055HVS
1 235 522 382	806 127^{FA}	1 237 000 065	806 241^{FA}	1 237 013 123	706 034HVS	1 237 015 804	730 132
1 235 522 384	806 237	1 237 010 027	406 223	1 237 013 124	706 034HVS	1 237 015 805	730 139
1 235 522 385	806 231^{FA}	1 237 010 033	406 233	1 237 013 125	706 034HVS	1 237 015 806	730 140
1 235 522 387	806 236	1 237 010 039	406 223	1 237 013 129	706 049HDVS	1 237 015 808	715 055
1 235 522 388	806 236^{FA}	1 237 011 073	406 159	1 237 013 130	706 034HVS	1 237 015 821	742 054
1 235 522 390	806 233	1 237 011 076	406 193	1 237 013 138	706 034HVS	1 237 015 848	715 103
1 235 522 391	806 239	1 237 011 081	406 219	1 237 013 139	706 062	1 237 031 093	406 244
1 235 522 392	806 239^{FA}	1 237 011 111	406 193	1 237 013 140	706 034HVS	1 237 031 123	406 153^{FS}
1 235 522 395	806 128^{FA}	1 237 011 114	406 233	1 237 013 143	706 062	1 237 031 180	406 233
1 235 522 396	806 247^{FA}	1 237 011 119	406 234	1 237 013 144	706 034HVS	1 237 031 296	406 223
1 235 522 397	806 247	1 237 011 122	406 223	1 237 013 145	706 034HVS	1 237 031 339	406 244
1 235 522 399	806 240	1 237 011 124	406 223	1 237 013 146	706 049HDVS	1 237 330 035	606 030
1 235 522 400	806 240^{FA}	1 237 013 000	706 047	1 237 013 147	706 049HDVS	1 237 330 036	606 030
1 235 522 401	806 241	1 237 013 001	706 047	1 237 013 150	706 034HVS	1 237 330 039	606 030
1 235 522 404	806 231	1 237 013 002	706 034HVS	1 237 013 151	706 049HDVS	1 237 330 307	606 212
1 235 522 405	806 231^{FA}	1 237 013 003	706 047	1 237 013 152	706 049HDVS	1 237 330 310	606 196
1 235 522 408	806 260^{FA}	1 237 013 006	706 029HV	1 237 013 157	706 049HDVS	1 237 330 316	606 195
1 235 522 409	806 080^{FA}	1 237 013 007	706 029HV	1 237 013 158	706 049HDVS	1 237 330 340	606 212
1 235 522 417	806 251^{FA}	1 237 013 008	706 021	1 237 013 300	715 106	1 237 330 348	606 257
1 235 522 418	806 251	1 237 013 009	706 029HV	1 237 013 302	715 106	1 237 330 353	606 212
1 235 522 419	806 248	1 237 013 010	706 029HV	1 237 013 305	715 105	1 237 330 801	615 023
1 235 522 420	806 248^{FA}	1 237 013 025	706 029HV	1 237 013 307	736 045	1 237 330 803	615 023
1 235 522 421	806 238	1 237 013 027	706 021	1 237 013 600	722 056HV	1 237 330 805	615 034
1 235 522 423	806 253	1 237 013 029	706 029HV	1 237 013 710	706 029HV	1 237 330 806	615 034
1 235 522 424	806 080	1 237 013 039	706 032HV	1 237 013 712	706 034HVS	1 237 330 810	642 056
1 235 522 426	806 233	1 237 013 041	706 021	1 237 013 713	730 120	1 237 330 811	642 056
1 235 522 434	806 257	1 237 013 042	706 021	1 237 013 714	730 132	1 237 330 828	630 117
1 235 522 435	806 257^{FA}	1 237 013 044	706 034HVS	1 237 013 715	719 043HV	1 601 0892	465 025
1 235 522 436	806 249	1 237 013 045	706 029HV	1 237 013 717	715 061	1 612 229	712 055HVS
1 235 522 437	806 256	1 237 013 047	706 021	1 237 013 718	715 064	1 847 291	912 090
1 235 522 438	806 258	1 237 013 049	706 029HV	1 237 013 719	728 083MHV	1 849 955	912 090
1 235 522 439	806 258^{FA}	1 237 013 051	706 034HVS	1 237 013 720	715 056	1 883 500	912 090
1 235 522 442	806 252^{FA}	1 237 013 052	706 049HDVS	1 237 013 724	719 044HV	1 905 590	912 090
1 235 522 443	806 094	1 237 013 053	706 029HV	1 237 013 728	719 043HV	1 909 590	912 090
1 235 522 444	806 266	1 237 013 055	706 032HV	1 237 013 802	712 055HVS	1 936 109	912 096
1 235 522 447	806 260	1 237 013 056	706 029HV	1 237 013 803	730 120	1 945 376	730 127
1 235 522 449	806 233^{FA}	1 237 013 057	706 040	1 237 013 804	730 132	1 972 927	812 073
1 235 522 453	806 263	1 237 013 059	706 049HDVS	1 237 013 805	730 139	1 977 958	465 025
1 235 522 454	806 263^{FA}	1 237 013 060	706 047	1 237 013 806	730 140	1 979 107	465 025
1 235 522 456	806 079	1 237 013 061	706 049HDVS	1 237 013 808	715 055	1 985 771	812 074
1 235 522 465	806 094	1 237 013 062	706 049HDVS	1 237 013 809	715 061	1 986 109	912 096
1 235 522 496	806 080	1 237 013 063	706 034HVS	1 237 013 811	715 064	1 987 231 000	713 011HV
1 235 522 801	812 066	1 237 013 065	706 034HVS	1 237 013 812	715 067	1 987 231 001	713 011HV
1 235 522 803	815 049	1 237 013 066	706 034HVS	1 237 013 814	715 111U	1 987 231 004	722 056HV
1 235 522 804	815 041	1 237 013 068	706 040	1 237 013 819	728 083MHV	1 987 231 006	731 084
1 235 522 805	815 045	1 237 013 074	706 034HVS	1 237 013 821	742 054	1 987 231 015	731 084
1 235 522 806	815 045	1 237 013 075	706 062	1 237 013 824	730 123	1 987 231 020	713 022HV
1 235 522 807	830 069	1 237 013 077	706 034HVS	1 237 013 826	713 011HV	1 987 231 032	731 084
1 235 522 810	830 081	1 237 013 079	706 062	1 237 013 827	715 076	1 987 231 033	731 085
1 235 522 812	842 043	1 237 013 081	706 034HVS	1 237 013 828	715 111U	1 987 231 900	713 011HV
1 235 522 816	822 003	1 237 013 082	706 049HDVS	1 237 013 831	730 142	1 987 231 904	722 056HV
1 235 522 819	822 003	1 237 013 083	706 034HVS	1 237 013 832	722 056HV	1 987 231 915	731 084
1 235 522 822	819 083	1 237 013 086	706 062	1 237 013 835	730 127	1 987 231 932	731 084
1 235 522 829	830 086	1 237 013 087	706 034HVS	1 237 013 837	746 071	1 987 231 933	731 085
1 235 522 831	828 075	1 237 013 088	706 034HVS	1 237 013 838	715 086	1 987 233 003	831 003/001
1 235 522 832	815 059	1 237 013 090	706 034HVS	1 237 013 840	715 102	1 987 233 008	822 003
1 235 522 835	847 025	1 237 013 091	706 062	1 237 013 842	712 055HVS	1 987 233 012	831 003/001
1 235 522 836	830 069	1 237 013 094	706 034HVS	1 237 013 846	712 055HVS	1 987 233 020	831 003/001
1 235 522 837	817 014	1 237 013 096	706 034HVS	1 237 013 848	715 103	1 987 233 022	813 093
1 235 522 843	828 078	1 237 013 098	706 034HVS	1 237 013 901	706 047	1 987 233 030	813 262
1 235 522 844	830 090	1 237 013 101	706 047	1 237 013 902	706 029HV	1 987 233 032	813 122
1 235 522 845	815 054	1 237 013 102	706 029HV	1 237 013 904	706 032HV	1 987 233 033	813 092
1 235 522 863	812 073	1 237 013 103	706 029HV	1 237 013 906	706 034HVS	1 987 233 036	822 011
1 235 522 901	806 076	1 237 013 105	706 032HV	1 237 013 907	706 040	1 987 233 037	822 022
1 235 522 902	806 072	1 237 013 106	706 034HVS	1 237 013 910	715 055	1 987 233 043	831 118
1 235 522 903	806 076	1 237 013 107	706 040	1 237 013 911	742 054	1 987 233 044	831 121
1 235 522 904	806 072	1 237 013 108	706 062	1 237 013 912	706 049HDVS	1 987 233 047	822 057
1 235 522 905	806 079	1 237 013 109	706 034HVS	1 237 013 913	706 034HVS	1 987 233 051	822 040
1 235 522 907	806 062	1 237 013 110	706 034HVS	1 237 013 914	706 034HVS	1 987 233 052	822 046
1 235 522 908	806 079	1 237 013 111	706 034HVS	1 237 013 915	706 049HDVS	1 987 233 054	813 123

1987 233 055	813 107	106.005E	470 314	111.002	470 419	13 3812	470 431
1987 233 908	822 003	106.006E	470 387	111.003	470 432	13 3828	470 445
1987 233 912	831 003/001	1060	406 193	111.003E	470 432	13 3831	470 427
1987 234 001	913 014	1061	406 231	111.005	470 518	13 3832	470 450
1987 234 003	913 014	1062	406 223	111.006	470 518	13 3834	470 436
1987 234 009	931 023	1063	406 234	111.010	470 613	13 3835	470 427
1987 234 015	922 052	1064	406 233	111.010E	470 613	13 3836	470 426
1987 234 021	913 014	108.001	470 316K	11-14 885 0002	470 407	13 8001	465 005
1987 234 024	931 023	108.007	470 487	11-14 885 0004	470 509	13 8002	465 004
1987 234 025	913 027	108.007E	470 487	11-14 885 0006	470 483	13 8004	465 007
1987 234 027	913 029	108.011E	470 626	11-14 885 0007	470 408	13 8007	490 414
1987 234 031	922 073	1087	406 159	114 213	470 433	13 8012	465 034
1987 234 033	931 113	109 039	470 474	114 885 0005	470 425	13 8026	465 025
1987 234 038	931 110	109 316	490 420	114 885 0006	470 429	13 8030	465 029
1987 234 041	913 028	109 540	470 445	114 885 0007	490 420	13 8034	465 036
1987 234 042	922 056	109 541	470 429	114.001	470 474	13 8052	465 051
1987 234 901	913 014	109.001	470 399	114.002	470 429	13 8068	465 052
1987 234 909	931 023	109.001E	470 399	114.006	470 427	13 8082	465 020
1987 948	812 075	109.002	470 398	114.006E	470 427	13 8106	406 153
1988 515	912 097	109.003	470 400	114.007	470 426	13 8131	415 019
10.509	359 747	109.004	470 508	114.007E	470 426	13 8134	415 017
10.510	359 748	109.004E	470 508	114.008	470 445	13 8172	430 161/1
10.511	359 494	109.005	470 507	114.008E	470 445	13 8174	430 163/1
10.513	360 025	109.005E	470 507	114.009	470 354S	13 8185	430 178M
10.515	359 494	109.006E	470 450	114.009E	470 354S	13 8191	430 177/1
10.516	359 674	109.020	470 547	114.010E	470 474	13 8192	430 180M
10.520	360 374	109.020E	470 547	114.013	470 434	13 8193	430 176M
10.521	360 374	109.029	470 631	114.014	470 436	13 8194	430 180M
100 885 0001	470 354S	109.029E	470 631	114.014E	470 436	13 8416	490 416
100 885 0002	470 445	109006	470 450	114.015	470 431	131.002E	470 457
100 885 0007	470 436	109007	470 400	114.016	470 433	131.005	470 608
100 885 0012	470 431	11.513	359 801	114.016E	470 433	131.005E	470 608
100 885 0020	470 437	11.514	359 801	114.019	470 434	131.006	470 529
100 885 0022	470 434	11.515	359 539	114.020	470 599	131.006E	470 529
100 885 0023	470 427	11.517	359 801	114.022	470 435	131.008	470 522
100 885 0024	470 599	11.522	359 802	114.022E	470 435	131.008E	470 522
100 885 0026	470 433	11.523	360 332	114.024	470 425	131.009E	470 603
100 885 0027	470 354S	11.527	359 920	114010	470 474	131.012	470 527
100 885 0040	470 474	11.530	360 446	115.002E	470 480	132.002	470 516
100 905 0007	490 414	11.532	359 539	115.004	470 619	132.002E	470 516
100 905 0025	470 426	11.534	359 417	115.004E	470 619	132.003	470 514
1002	701 005	11.535	360 447	116 400	470 599	133.001E	470 459
1003	406 153	11.536	359 543	118.001	470 448	133.003	470 461
101 106	470 101D	11.538	360 447	118.001E	470 448	133.008	470 458
101 106 K	470 101D	11.539	358 244	118.002	470 478	133.008E	470 458
101 406	470 132	11.541	359 415	118.002E	470 478	133.010	470 466
101 407	470 127	11.543	360 492	12.508	359 612	133.010E	470 466
101 413	470 125	11.545	359 801	12.509	359 725	133.012	470 536
101.001	470 386K	11.546	358 244	12.512	359 725	133.012E	470 536
101.002	470 387K	11.548	358 049	12133- 1	917 052	133.015	470 537
101.002E	470 387	11.560	358 230	12133- 4	917 052	133009	470 461
101.006	470 397	11.561	358 246	12146- 1	730 132	133800	470 432
101.006E	470 397	11.861	358 246	12146- 3	730 140	133805	470 354S
101.300	701 005	110 572	470 436	125.003	470 591	133806	470 429
10230- 2	830 069	110 921	470 434	125.003E	470 591	133806	470 429
10230- 4	830 069	110.001	470 403	1250	430 161/1	133807	470 474
10230- 7	830 069	110.001E	470 403	1252	430 163/1	133809	470 399
10230-12	830 069	110.002	470 405	126.008	470 557	133810	470 508
10230-13	830 069	110.007E	470 408	126.008E	470 557	133812	470 431
10249-43	617 097	110.010E	470 407	126.009	470 489	133817	470 403
10249-43J	617 097	110.011	470 509	126.009E	470 489	133818	470 405
10254- 1	730 127	110.020	470 483	126.012	470 602	133819	470 407
1029005-6005	706 068	110.020E	470 483	126.016	470 551	133825	470 475
103 240	470 125	110.022	470 620	126.018E	470 552	133828	470 445
104 033	490 414	110.023	470 609	1264	430 180M	133831	470 427
104.001	470 413	110.023E	470 609	1266	430 176M	133832	470 450
104.004	470 412	110.024	470 497	1269	430 177/1	133832	470 450
104.005	470 607	110.024E	470 497	1270	430 180M	133834	470 436
104.005E	470 607	110007	470 408	1272	430 178M	133836	470 426
104.008	470 162S	110010	470 407	129.009E	470 638	133841	470 397
104.011E	470 475	110021	470 461	129.010	470 611	133842	470 476
104.012	470 632	1101	406 222	129.010E	470 611	133843	470 509
104003	470 475	1104082	470 450	129.011E	470 492	133845	470 433
1057	406 219	1104091	470 483	129.012	470 556	133846	470 461
106.002	470 442	111 088	470 431	129.012E	470 556	133846	470 461
106.002E	470 442	111 310	470 354S	13 3805	470 354	133847	470 434
106.003	470 384	111 621	470 427	13 3806	470 429	133848	470 435
106.003E	470 384	111 741	470 426	13 3807	470 474	133852	470 480
106.005	470 314	111 743	470 435	13 3808	470 426	133854	470 483

133860	470 557	134376	358 241	14.514	359 965	155049	470 475
133861	470 387	134377	358 251	14.515	359 737	155050	470 365
133863	470 489	134431	359 674	14.516	360 667	155051	470 345
133870	470 448	134432	359 494	14.517	360 575	155054	470 434
133874	470 458	134464	360 446	14.521	360 580	155056	470 108
133875	470 475	134467	359 616	14.523	360 640	155057	470 272
133876	470 607	134471	359 780	14.524	360 601	155058	470 148
133879	470 507	134484	359 615	14.525	360 601	155059	470 155
133883	470 408	134497	360 025	14.526	359 725	155060	470 228
133883	470 408	134518	360 503	14.532	360 609	155061	470 107
133909	470 602	134528	360 385	14.534	360 489	155062	470 341
133910	470 529	134534	360 363	14.561	358 223	155064	470 140
133913	470 457	134560	358 061	1420	359 920	155065	470 158
133926	470 384	134603	358 111	1429	358 244	155066	470 214
133929	470 551	134619	360 883	1431	360 492	155067	470 374
133930	470 608	134758	360 363	1439	358 049	155068	470 394
133936	470 516	134871	359 634	1443	360 681	155069	470 159
133939	470 514	134952	360 643	145.002	470 503	155070	470 414
133941	470 536	134955	358 245	145.002E	470 503	155071	470 199
133944	470 527	134958	358 059	15 43 01	470 403	155072	470 417
133950	470 586	134961	358 248	15 43 02	470 405	155073	490 423
133956	470 623	1351	415 019	15.506	360 078	155074	470 423
133962	470 620	1355	415 017	15.508	360 281	155074	470 423
133963	470 591	138.004	470 495	15.513	360 281	155075	470 481
133965	470 627	138.004E	470 495	15.514	359 864	155076	470 168
133971	470 536	138.005	470 543	15.515	360 630	155077	470 317
133973	470 645	138.005E	470 543	15.516	359 864	155079	470 219
133974	470 538	138.006	470 614	15.520	360 630	155082	470 105
134003	470 603	138.006E	470 614	15.527	360 619	155083	470 106
134006	470 492	138415	490 414	15.528	360 630	155085	470 178
134010	470 466	138425	490 420	15.534	360 691	155086	470 213
134035	470 543	138701	470 269	15.536	360 634	155088	470 448
134038	470 537	138704	490 420	15.541	360 568	155089	470 273
134041	470 487	138709	470 417	15.542	360 614	155092	470 557
134044	470 522	138712	470 419	15.543	360 624	155093	470 585
134045	470 495	138713	470 518	1514	470 419	155095	470 313
134048	470 547	138716	470 178	151401	470 419	155100	470 162S
134051	470 609	138718	470 582	151408	470 518	155102	470 427
134058	470 613	138727	470 423	1543	470 403	155103	470 425
134080	470 611	138730	470 146	154301	470 403	155104	470 431
134081	470 614	138734	470 296	154302	470 405	155106	470 435
134083	470 497	138735	470 228	154303	470 405	155109	470 437
134085	470 619	138736	470 275	155001	470 314	155110	470 436
134086	470 503	138737	470 266	155002	470 386	155111	470 433
134087	470 505	138738	470 196	155003	470 398	155113	470 586
134090	470 632	138739	470 345	155004	470 316	155118	470 580
134093	470 631	138744	470 179	155006	470 397	155119	470 589
134094	470 626	138746	470 496	155009	470 480	155125	470 602
134114	358 239	138749	470 586	155010	470 532	155136	470 475
134117	358 235	138752	470 155	155013	470 376	155138	470 489
134119	360 509	138754	470 105	155014	470 378	155140	470 461
134130	360 209	138756	470 189	155015	470 196	155140	470 461
134132	360 880	138757	470 355	155016	470 596	155141	470 466
134202	359 514	138758	470 356	155017	470 146	155142	470 458
134203	359 689	138759	470 376	155018	470 355	155148	470 483
134214	359 689	138760	470 188	155019	470 356	155149	470 347
134227	360 634	138762	470 272	155020	470 442	155154	470 233
134234	360 531	138765	470 365	155022	470 400	155164	470 168
134236	360 680	138766	470 378	155022	470 400	155166	470 585
134239	360 731	138769	470 423	155025	470 275	155174	470 495
134246	360 529	138780	470 140	155026	490 414	155177	470 581
134260	358 006	138793	470 168	155026	490 414	155180	470 478
134263	358 007	138800	470 135	155027	470 408	155183	470 496
134268	360 511	138803	470 169	155027	470 408	155184	470 535
134272	360 451	138803	470 532	155028	470 459	155190	470 475
134273	360 739	138810	470 347	155028	470 459	155200	470 413
134275	360 531	138811	470 532	155029	470 400	155205	470 545
134276	359 608	138812	470 214	155031	470 509	155205	470 545
134278	358 242	138856	470 579	155032	470 407	155400	470 162S
134279	360 278	138866	470 198	155032	470 407	155500	470 354S
134280	360 411	138868	470 203	155033	470 188	155700	470 162S
134286	360 745	14.502	359 736	155034	470 189	156100	490 420
134287	360 888	14.503	360 549	155038	470 508	156200	470 432
134296	360 237	14.506	359 725	155039	470 450	156200	470 432
134332	360 504	14.507	359 725	155039	470 450	156300	470 399
134333	360 505	14.508	360 364	155040	470 476	157100	470 384
134337	358 236	14.510	359 493	155041	470 476	157400	470 474
134373	360 889	14.512	360 364	155045	470 398	157400	470 474
134375	358 249	14.513	359 737	155046	470 507	157400P	470 474

157500	470 429	2 525 684 A	415 019^{NI}	2 526 131 A	470 509	2 591 820	731 084
157500	470 429	2 525 687 A	415 019^{NI}	2 526 151 A	470 596	2 591 821	730 149M
157600	470 445	2 525 693 A	415 019^{NI}	2 526 180 A	470 432	2 591 821	730 149M
157700	470 427	2 525 696 A	415 019^{NI}	2 526 182 A	470 407	2 591 823	730 146M
157900	470 426	2 525 698 A	415 019^{NI}	2 526 182 B	470 407	2 591 823	730 146M
16-14 885 0001	470 596	2 525 708 A	415 019^{NI}	2 526 208	470 405	2 591 824	630 127
16-14 885 0002	470 432	2 525 711 A	415 019^{NI}	2 528 001	465 029	2 591 824	630 127
16-14 885 0003	470 419	2 525 712 A	415 019^{NI}	2 528 001 A	465 029	2 591 838	906 112R
16-14 885 0004	470 518	2 525 713 A	415 019^{NI}	2 528 001 A	465 029	2 595 007	465 004
16-14 885 0006	470 196	2 525 747 A	415 019^{NI}	2 528 008	465 005	2 595 009	465 007
16-14 885 0010	470 365	2 525 750 A	415 019^{NI}	2 528 008 A	465 005	2 595 013	465 020
16-14 885 0015	470 613	2 525 753	415 019^{NI}	2 528 008 A	465 005	2 595 016	465 036
1650	412 010	2 525 755	415 019^{NI}	2 537 065	815 080	2 595 020	490 414
1651	412 011	2 525 756 A	415 019^{NI}	2 537 077	815 080	2 595 025	465 034
17-5607	465 005	2 525 765 A	415 019^{NI}	2 537 260	915 104	2 595 041	465 052
18.507	359 417	2 526 009	470 106	2 537 260	915 104	2 783 039 001 Z	706 068
18.510	359 372	2 526 009	470 106	2 537 268	815 075	2 790 000	470 101D
18.511	358 064	2 526 009 A	470 106	2 553 495	815 081	2001	465 005
18.515	358 061	2 526 015	470 102	2 553 499 0	915 101	2002	465 005
18.516	359 417	2 526 015	470 102	2 558 654	915 096R	2003	465 004
18.519	359 372	2 526 015 A	470 102	2 558 654	915 096R	2007	465 007
18.524	358 059	2 526 017	470 101D	2 558 743	915 101	202 515	359 514
1801	358 013	2 526 017	470 101D	2 558 743	915 101	202 527	359 689
18051-3	917 052R	2 526 017 0	470 101D	2 559 115	915 097	202 530	359 634
18603	817 016	2 526 023	470 107	2 559 115	915 097	202 531	360 531
18603-1	817 014	2 526 023	470 107	2 590 166	715 126^{RP}	205 106	360 529
18603-3	817 014	2 526 023 A	470 107	2 590 166	715 126^P	2053	465 025
18603-5	817 014	2 526 026	470 155	2 590 251	642 056	206 242	359 688
18603-6	817 016	2 526 026 A	470 155	2 590 253	715 111U	206 636	470 140
18603-8	817 016	2 526 026 A	470 155	2 590 253	715 111U	206 638	470 272
18603-9	817 016	2 526 030	470 108	2 590 254	715 112U	206 640	470 399
18603-11	817 014	2 526 034	470 228	2 590 254	715 112U	206 641	470 398
18603-11J	817 014	2 526 035 A	470 189	2 590 264	415 017	206 643	470 508
19005212	470 399	2 526 035 A	470 189	2 590 832	470 101D	206.001E	470 146
19005267	470 487	2 526 037 A	470 188	2 590 841	713 022HV	206.002	470 345
19005293	470 475	2 526 037 A	470 188	2 590 843	717 026	206.002E	470 345
19005316	470 607	2 526 039	470 189	2 590 846	730 149	206.004	470 108
19005358	470 545	2 526 040 A	470 188	2 590 862	606 196	206.004E	470 108
19005358	470 545	2 526 040 A	470 188	2 590 871	606 257	206.009	470 168
19005362	470 547	2 526 040 A	470 188	2 590 874	806 081	206.009E	470 168
2 207 013 002	706 064	2 526 048	470 107	2 590 877	806 093	206.010	470 103
2 207 013 003	706 064	2 526 048 A	470 107	2 590 878	806 094	206001	470 146
2 207 013 004	706 071	2 526 048 A	470 107	2 590 879	806 108	206007	470 423
2 207 013 005	706 071	2 526 049	470 140	2 590 880	806 109	207 022	470 432
2 207 013 007	706 064	2 526 049 A	470 140	2 590 881	806 121	207 466	470 450
2 207 110 007	706 071	2 526 050	470 341	2 590 882	806 124	208 333	470 547
2 207 330 011	606 030	2 526 050 A	470 341	2 590 883	806 129	208 441	470 545
2 207 330 041	606 180	2 526 051	470 355	2 590 884	806 231	208 441	470 545
2 207 330 050	606 180	2 526 051 A	470 355	2 590 886	813 093	208.001	470 417
2 524 086	815 069	2 526 051 A	470 355	2 590 889	817 016	208.001E	470 417
2 524 128	815 070	2 526 052	470 356	2 590 892	831 109	209.002	470 272
2 524 132	915 097	2 526 052 A	470 356	2 590 893	828 096	209.002E	470 272
2 524 134	815 074	2 526 052 A	470 356	2 590 893	828 096	209.006	470 219
2 524 134	815 074	2 526 055	470 272	2 590 896	830 109	209.006E	470 219
2 525 551 B	415 019^{NI}	2 526 055 A	470 272	2 590 897	906 012R	209.008	470 140
2 525 623 D	815 086^{MI}	2 526 055 A	470 272	2 590 898	906 023R	209.008E	470 140
2 525 626 B	415 017^{NI}	2 526 055 A	470 272	2 590 899	906 025R	209.009E	470 341
2 525 626 C	415 017^{NI}	2 526 060	470 103	2 590 900	906 055R	209.013	470 389
2 525 628	815 078^{MI}	2 526 062	470 111	2 590 901	906 056R	209.013E	470 389
2 525 628	815 078^{MI}	2 526 063	470 109	2 590 902	906 059R	20936100	470 475
2 525 628 B	815 078^{MI}	2 526 071	470 125	2 590 904	906 024R	20936113	470 475
2 525 640 B	415 017^{NI}	2 526 073	470 374	2 590 905	906 112R	20945031	470 475
2 525 640 C	415 017^{NI}	2 526 073 A	470 374	2 590 906	906 114R	20945032	470 475
2 525 645 A	815 083^{RB}	2 526 078 A	470 365	2 590 907	906 116R	21 940 002	715 056
2 525 651 A	415 019^{NI}	2 526 078 B	470 365	2 590 908	906 121R	21 940 401	615 023
2 525 652 A	415 019^{NI}	2 526 079	470 365	2 590 910	913 014	21 943 200	830 069
2 525 653 A	415 019^{NI}	2 526 081	470 194	2 590 911	930 029	21 943 202	830 069
2 525 656 A	415 019^{NI}	2 526 082	470 103	2 590 913	930 041	21 945 800	906 014R
2 525 657 A	415 019^{NI}	2 526 110	470 355	2 590 914	930 051R	21.500	359 511
2 525 658 A	415 019^{NI}	2 526 110 A	470 355	2 590 915	930 054R	210.001	470 155
2 525 659 A	415 019^{NI}	2 526 110 A	470 355	2 590 916	930 060	210.001E	470 155
2 525 660 A	415 019^{NI}	2 526 111	470 356	2 590 917	906 060R	210.002	470 105
2 525 661 A	415 019^{NI}	2 526 111 A	470 356	2 590 918	928 026R	210.002E	470 105
2 525 663 A	415 019^{NI}	2 526 111 A	470 356	2 590 935	815 077	210.003	470 106
2 525 667 A	415 019^{NI}	2 526 114 A	470 376	2 590 935	815 077	210.003E	470 106
2 525 680	415 019^{NI}	2 526 115 A	470 378	2 590 938	415 017	210.004	470 188
2 525 680 A	415 019^{NI}	2 526 116 A	470 508	2 590 945	415 019	210.004E	470 188
2 525 683 A	415 017^{NI}	2 526 117 A	470 403	2 590 945	415 019	210.005	470 189
2 525 683 B	415 017^{NI}	2 526 118 A	470 408	2 591 820	731 084	2102	465 036

211.001	470 228	245111	470 146	245727	470 427	2503973	470 645
211.001E	470 228	245117	470 442	245731	470 607	2503974	470 538
211.002	470 196	245119	470 192	245733	470 458	2504003	470 603
211.002E	470 196	245122	470 228	245736	470 457	2504006	470 492
211.003	470 365	245124	470 108	245738	470 483	2504010	470 466
211.003E	470 365	245129	470 275	245744	470 589	2504033	470 599
211.004	470 596	245130	470 374	245745	470 487	2504035	470 543
211.004E	470 596	245134	470 345	245750	490 303	2504038	470 537
211.005	470 376	245138	470 196	245757	470 612	2504041	470 487
211.005E	470 376	245139	470 532	2458	358 244	2504044	470 522
211.006	470 378	245141	470 474	245817	470 552	2504045	470 495
211.006E	470 378	245142	470 429	245818	470 533	2504048	470 547
211.007	470 275	245155	470 314	245823	470 536	2504051	470 609
211.007E	470 275	245159	490 420	2476	359 802	2504058	470 613
214 800 0001	470 146	245160	470 135	2476	359 802	2504080	470 611
214 885 0000	470 345	245163	470 431	2497	359 415	2504081	470 614
214 885 0001	470 442	245164	470 426	25.501	360 417	2504083	470 497
214 885 0009	470 423	245165	470 3545	25.503	360 417	2504085	470 619
214 885 0010	470 168	245166	470 168	25.504	358 004	2504086	470 503
214 885 0012	470 148	245168	470 399	25.507	360 413	2504087	470 505
214 885 0015	470 549	245170	470 219	25.509	360 434	2504090	470 632
214.001E	490 420	245174	470 459	25.510	360 434	2504093	470 631
214.002E	490 414	245175	470 448	25.514	358 013	2504094	470 626
214001	490 420	245178	470 461	25.515	360 434	2508415	490 414
214002	490 414	245182	470 433	25.516	360 413	2508419	490 414
215.002	470 135	245187	470 417	25.518	358 013	2508425	490 420
215.004	470 170	245188	470 347	25.519	360 417	2508704	490 420
215.007E	470 532	245189	470 170	2503800	470 596	2508709	470 417
215.009E	470 481	245190	470 203	2503801	470 442	2508712	470 419
2150	465 020	245193	470 532	2503805	470 3545	2508713	470 518
215007	470 532	245195	470 518	2503806	470 429	2508716	470 178
21595273-2	470 432	245203	470 478	2503807	470 474	2508718	470 582
21597716-4	470 476	245205	470 581	2503809	470 399	2508727	470 423
21597716-4	470 476	245207	470 387	2503810	470 508	2508730	470 146
21603121-9	470 432	245215	470 492	2503812	470 431	2508735	470 228
21603800-7	470 476	245223	470 389	2503817	470 403	2508736	470 275
21603800-7	470 476	245228	470 233	2503818	470 405	2508737	470 266
22.509	360 711	245245	470 394	2503819	470 407	2508738	470 196
22.511	360 888	245249	470 480	2503828	470 445	2508739	470 345
22.517	360 914	245250	470 557	2503831	470 427	2508744	470 179
22.518	360 889	245252	470 496	2503832	470 450	2508749	470 586
22.523	360 719	245253	470 489	2503834	470 436	2508752	470 155
2200	465 029	245262	470 582	2503835	470 427	2508754	470 105
22132- 1	930 036R	245265	470 586	2503836	470 426	2508756	470 189
22132- 1J	930 036R	245270	470 179	2503841	470 397	2508757	470 355
222.002	470 214	245271	470 198	2503842	470 476	2508758	470 356
222.002E	470 214	245273	470 386	2503843	470 509	2508759	470 376
222.003	470 347	245277	470 397	2503845	470 433	2508760	470 188
222.003E	470 347	245280	470 450	2503846	470 461	2508762	470 272
222.004	470 213	245283	470 591	2503847	470 434	2508764	470 596
222.004E	470 213	245286	470 538	2503848	470 435	2508765	470 365
22431- 1	930 041	245303	470 466	2503852	470 480	2508766	470 378
22488- 1	917 052	245304	470 522	2503854	470 483	2508769	470 423
229.001	470 394	245320	470 529	2503860	470 557	2508780	470 140
229.001E	470 394	245321	470 608	2503861	470 387	2508793	470 168
229.002E	470 496	245324	470 507	2503863	470 489	2508800	470 135
229.009	470 582	245344	470 296	2503870	470 448	2508810	470 347
229.009E	470 582	245349	470 505	2503874	470 458	2508812	470 214
232.001	470 233	245352	470 556	2503876	470 607	2508856	470 579
232.001E	470 233	245358	470 516	2503879	470 507	2508866	470 198
23373- 1	717 020	245359	470 614	2503883	470 408	2508868	470 203
23373- 2	717 020	245360	470 611	2503894	470 599	2571	360 503
23373- 3	717 020	245367	470 503	2503902	470 533	2576 12.70.01	465 004
238.002	470 589	245372	470 632	2503909	470 602	2590	359 509
238.006	470 586	245374	470 620	2503910	470 529	26.505	360 411
238.006E	470 586	245375	470 619	2503913	470 457	26.506	360 411
238.007	470 581	245378	470 425	2503926	470 384	26.508	360 658
238.007E	470 581	245380	470 587	2503929	470 551	26.512	360 411
24.503	360 609	245390	470 537	2503930	470 608	26.513	360 658
24.504	360 569	2456	359 801	2503936	470 516	26951960-3	470 405
24431- 1	930 041	2457	358 244	2503939	470 514	26951960-3	470 405
245	359 725	245701	470 545	2503941	470 536	27.502	360 436
245092	490 414	245701	470 545	2503944	470 527	27.503	360 436
245098	470 408	245703	470 112	2503947	470 535	28.503	360 278
245104	470 432	245707	470 2855	2503950	470 586	28.506	360 401
245106	470 376	245709	470 445	2503962	470 620	28.509	360 401
245107	470 378	245718	470 435	2503963	470 591	28.514	360 401
245108	470 508	245720	470 436	2503965	470 627	28.516	360 401
245109	470 403	245723	470 602	2503971	470 536	28.528	360 883

28114820	470 475	32.513	360 760	36 501 003	722 056HV	402 61003	919 085
28-14 885 0000	470 589	32.514	360 231	36 501 025	722 056HV	402 61103	912 093
28-14 885 0003	470 614	32.516	360 739	36.501	360 433	4020	359 386
28211913	470 609	32493	917 052R	36.503	360 731	4020	806 079
28276583	470 620	32493- 1	917 052R	36.504	360 680	4021	806 081
28326927	470 545	32493- 1JGI	930 054R	36.505	360 677	4022	806 080
28326927	470 545	33.523	360 856	36.506	360 634	4024	806 240
28372862	470 475	33.525	360 435	36.507	360 942	4025	806 081
28400714	470 626	33.543	360 856	36.508	360 731	4026	806 081
28994- 1	917 058	33-14 885 0003	470 591	36.509	358 007	4027	806 092
28994- 1J	917 058	335 622	465 004	36.510	360 730	4029	806 231
29.502	360 401	33828- 1	615 023	36.511	360 677	403 51103	842 043
29.505	358 119	33829- 7	815 058	36.512	360 680	403 53803	842 043
29.506	360 385	33830- 1	915 091	36.514	360 433	403 53803	842 043
29.507	358 120	339 109	465 004	36.520	358 249	403 80603	806 079
29.508	358 119	339 373	465 007	36.820	358 249	403 80703	806 076
29.509	360 401	339 700	490 414	36-14 885 0005	470 557	403 80903	830 069
29.510	360 401	33924- 2	717 024	36-14 885 0007	470 489	403 81503	819 083
29.511	360 385	33924- 2J	717 024	36-14 885 0008	470 602	403 81603	812 066
29.512	358 119	33924- 4	717 026	36-14 885 0010	470 552	403 81803	828 078
29.513	360 385	33924- 4J	717 026	37-14 885 0004	470 492	4032	806 099
29.519	360 385	3414	359 511	37-14 885 0008	470 543	4035	806 093
2995	360 505	346001	358 059	37-14 885 0009	470 581	4-037-0602-0	946 016R
2997	359 694	346004	358 241	37-14 885 0010	470 495	4-037-0650-0	847 027
3 470 026	712 055HVS	346009	360 730	37-14 885 0012	470 612	4038	806 098
3 470 056	912 093	346023	360 740	37-14 885 0015	470 611	4039	806 098
3 474 221	470 111	346025	358 239	37-14 885 0016	470 556	4041	806 094
3 474 227	470 109	346038	360 509	38.501	360 398	4042	806 108
3 474 232	470 341	346040	358 006	38.504	360 851	4044	806 090
3 474 282	470 341	346065	360 739	400 01503	742 054	4047	806 123
3 479 003	812 066	346076	360 732	400 01503	742 054	4049	806 124
3 486 037	912 095R	346080	360 883	400 10103	715 056	4050	806 231
3 489 003	812 066	346090	360 507	400 10603	706 034HVS	4051	806 094
300 065	470 169	346094	358 252	400 10703	706 040	4052	806 117
30-14 885 0002	470 203	346134	359 846	400 10803	730 132	4053	806 233
30-14 885 0004	470 461	346135	359 780	400 10903	730 140	4054	806 234
30-14 885 0005	470 459	346139	359 688	400 11003	730 139	4055	806 127
30-14 885 0006	470 458	346156	360 503	400 11103	730 120	4056	806 235
30-14 885 0010	470 466	346167	360 511	400 11203	719 043HV	4057	806 241
30-14 885 0011	470 536	346186	360 504	400 11303	719 044HV	4058	360 507
30-14 885 0014	470 537	346204	359 509	400 11403	712 055HVS	4058	806 231
302 104	470 532	346244	358 244	400 11703	706 049HDVS	4059	806 129
302 444	470 481	346248	360 505	400 11903	728 083MHV	4060	360 415
302 726	470 480	346267	360 436	400 12003	730 142	4060	806 238
3-037-0602-0	946 014R	346285	360 446	400 12403	713 011HV	4061	359 815
304 321	470 423	346299	360 025	400 12603	722 056HV	4063	806 256
304 553	470 478	346316	360 753	400 12603	722 056HV	4064	806 251
305 126	470 619	346326	358 061	400 20903	717 024	4065	806 257
30766- 1	817 023	346340	360 634	400 21203	728 089	4066	806 258
30766- 1J	817 023	346354	358 235	400 876	470 178	4067	806 249
30922038	470 474	346355	360 731	4002	360 373	4068	806 094
30927470	470 429	346404	359 689	4002	806 062	4069	806 253
31.502	360 711	346405	359 634	4003	806 072	4071	806 248
31.505	360 686	346418	360 209	4004	359 386	4072	806 247
31.506	360 686	346451	360 278	4004	806 072	4074	806 236
31.507	360 709	346452	360 856	4005	360 373	4077	806 094
310 481	490 416	346481	358 120	4005	806 076	408 395	470 487
311 354	490 414	346524	359 716	4006	359 511	4081	359 347
311 740	490 420	346558	360 880	4008	359 511	4086	806 112
31-14 885 0002	470 457	346574	359 597	401 465	470 417	4088	806 237
31-14 885 0003	470 214	346577	359 605	4013	806 260	4089	806 263
31-14 885 0005	470 529	346594	359 608	40-14 885 0000	470 403	409 10015	715 056
31-14 885 0006	470 608	346595	360 745	40-14 885 0001	470 155	40928108	470 450
31-14 885 0007	470 522	346598	360 711	40-14 885 0002	470 405	41.500	359 511
311886	465 074	346651	359 780	40-14 885 0005	470 188	4100	359 965
314 139 0000	470 162S	346656	360 889	40-14 885 0006	470 189	4102	359 725
314 885 0006	470 607	346670	359 514	40-14 885 0008	470 476	4113	359 736
314 885 0009	470 632	346675	360 411	40-14 885 0011	470 620	4120	360 415
318 738	465 004	346676	358 223	40-14 885 0012	470 609	413 80403	830 090
3186	701 006	346679	360 643	4015	360 634	413 80603	830 104
32.502	360 745	346681	358 007	4016	806 076	413 80803	817 023
32.503	360 398	346691	360 681	4018	806 079	413 80903	830 098
32.504	360 231	346692	358 230	402 05203	742 054	413 81103	812 073
32.505	359 884	346694	358 246	402 60003	915 091	414 50303	906 026R
32.506	360 639	346698	360 451	402 60303	906 014R	414 50503	930 042R
32.507	360 231	35.502	360 835	402 60403	906 021R	414 50803	930 047R
32.508	360 760	35.507	360 835	402 60503	906 012R	414 50903	912 096
32.509	360 760	35-14 885 0002	470 516	402 60703	930 037	414 51003	917 058
32.512	360 398	35-14 885 0004	470 514	402 60903	928 012	414 51103	930 055R

4148	360 630	4334	360 025	4654	830 114	48147	470 607
4149	360 007	4384	822 003	4656	830 115	48149	470 387
4150	359 864	4385	822 088	4664	831 003/001	48158	470 233
4153	359 616	4391	822 003	4668	831 003/001	48162	470 489
4158	359 616	4392	822 011	4673	831 118	48165	470 437
4159	359 888	4393	822 057	4677	831 121	48170	470 496
4162	360 363	4396	822 040	4678	831 131	48176	470 394
4163	360 506	43J83-17001	822 048	4713	838 242	48179	470 457
4167	359 884	43S85-16001	922 073	4767	842 043	48183	470 591
4168	360 503	43S85-17001	822 041	48000	490 414	48184	470 466
4169	359 573	43S86-16001	922 073	48001	470 532	48188	470 2855
4173	360 585	4402	822 022	48002	470 432	48201	470 602
4176	360 639	4404	359 839	48003	470 474	48202	470 266
4177	359 700	4405	359 543	48004	470 450	48206	470 475
4178	360 624	4407	822 048	48005	470 429	48216	470 475
4193	360 568	4408	822 041	48006	470 399	4823	847 027
4194	360 568	441 19102	470 101D	48007	470 419	48239	470 543
42.513	360 345	4417	822 069	48008	470 3545	48245	470 495
4201	812 066	44229	360 345	48010	490 420	48257	470 538
4204	812 075	44248	358 049	48011	470 508	48266	470 522
4205	360 575	44263	360 209	48013	470 146	48269	470 537
4206	360 504	44265	360 411	48014	470 407	48274	470 492
4207	360 575	44278	358 246	48015	470 431	48278	470 458
4221	812 073	44317	358 251	48019	470 376	48287	470 586
4222	812 074	44330	358 230	48020	470 378	48290	470 589
4272	813 099	44331	358 007	48021	470 135	48292	470 529
4274	813 093	44334	358 236	48023	470 403	48293	470 608
4276	813 094	44337	360 385	48024	470 417	48306	470 194
4277	813 117	44338	358 229	48025	470 168	48308	470 126
4279	813 092	44341	358 249	48028	470 275	48337	470 487
4284	813 102	44344	359 605	48030	470 188	48339	470 180
4286	813 107	4451	813 123	48032	470 408	48340	470 169
4290	813 262	4456	813 119	48033	470 475	48341	470 132
4291	813 113	4458	822 063	48035	470 435	48342	470 101D
4293	813 122	4461-13301	722 056HV	48040	470 436	48344	470 127
4295	813 240	4461-1700	822 003	48041	470 427	48346	470 192
4298	813 254	4461-2700 B	822 003	48042	470 426	48348	470 533
430 00103	642 056	4461-3330 A	722 056HV	48052	470 345	48363	470 202
430 01203	642 056	4461-3330 AY	722 056HV	48054	470 214	48395	470 536
430 01303	642 056	4461-4330 AY	722 056HV	48056	470 272	48397	470 551
430 01403	642 056	4486	359 539	48057	470 140	48404	470 547
430 02303	642 056	44A2-13301	722 056HV	48058	470 356	48408	470 599
430 02403	642 056	44A2-16001	922 052	48059	470 374	48410	470 613
430 02473	642 056	44A5-13301	722 056HV	48060	470 196	48682	470 296
430 21203	642 056	44AZ-13301	722 056HV	48061	470 442	49052	470 556
430 40603	606 212	44P88-16001	922 093	48062	470 105	49054	470 614
430 41003	630 117	44P88-17001	822 075	48063	470 480	49055	470 611
430 50803	615 023	44R80-17001	822 057	48064	470 108	49061	470 632
430 90703	617 097	44R84-16002	922 052	48065	470 434	49062	470 619
430 90903	630 127	44R86-16001	922 073	48066	470 155	49068	470 516
4301	815 049	44S88-17001	822 046	48067	470 189	49069	470 527
4302	815 041	45.501	360 643	48068	470 355	49073	470 603
4303	359 747	4502	819 083	48071	470 476	49086	470 423
4303	815 058	4519	828 075	48072	470 509	49097	470 609
4304	359 491	4525	828 078	48078	470 365	49099	470 631
4304	815 058	4526	828 083	48079	470 170	49100	470 620
4305	815 062	4533	828 085	48082	470 445	49133	470 549
4306	815 065	4536	819 092	48088	470 433	50 001	706 047
4309	815 059	4537	828 094	48094	470 198	50 002	706 029HV
4310	359 748	4538	819 093	48098	470 213	50 002 V	706 029HV
4315	815 054	4540	828 091	48099	470 215	50 004	706 021
4316	815 058	4541	828 099	48103	470 386	50 012	706 032HV
4318	815 059	4542	828 100	48104	470 397	50 012 V	706 032HV
4319	815 062	4623	830 111	48105	470 203	50 014	706 034HVS
4320	815 059	4624	830 069	48107	470 461	50 014 S	706 034HVS
4321	815 067	4627	830 081	48108	470 518	50 014 V	706 034HVS
4322	815 065	4631	847 025	48111	470 347	50 016	706 049HDVS
4323	815 074	4632	830 086	48115	470 178	50 016 S	706 049HDVS
4324	815 068	4634	830 082	48121	470 148	50 016 V	706 049HDVS
4325	815 067	4637	830 076	48123	470 228	50 017	706 040
4326	815 075	4638	830 090	48124	470 483	50 020	706 034HVS
4328	815 072	4640	830 101	48127	470 448	50 021	706 034HVS
4329	815 069	4641	817 023	48129	470 219	50 026	706 029HV
4330	815 070	4643	830 101	48132	470 106	50 027	706 049HDVS
4331	359 674	4646	830 093	48135	470 507	50 029	706 034HVS
4331	815 080	4647	807 701	48136	470 384	50 029 S	706 034HVS
4332	815 081	4649	830 098	48139	470 557	50 029 V	706 034HVS
4333	359 494	4652	830 109	48140	470 478	50 030	706 049HDVS
4333	815 079	4653	817 016	48145	470 389	50 030 S	706 049HDVS

50 031	706 034HVS	52 039	715 105	54 403 235	828 098	5641	930 047R
50 032	706 049HDVS	52 043	715 111U	54 403 806	828 094	5645	930 055R
50 033	706 062	52 044	715 112U	54 403 880	828 093	5651	930 051R
50 039	706 034HVS	52 045	715 076	54 403 899	928 025	5652	930 060
50 039 S	706 034HVS	52 048	715 106	54 404 052	928 026R	5663	931 023
50 040	706 062	52 050	715 122	54 404 224	928 024R	5665	931 023
50 045	706 034HVS	52 052	715 126	54 404 506	828 096	5672	931 113
50 047	706 062	52 053	715 127	54 404 778	928 027R	5673	931 110
50 048	706 049HDVS	5200	912 093	54 405 507	928 026R	5676	931 119
50 050	706 049HDVS	5201	912 093R	54 405 729	928 028R	57 006	742 054
500 959	470 475	5202	912 095R	54 405 782	828 099	5723	906 014R
500 961	470 162S	5203	912 098	54 405 821	428 202^{FN}	5724	906 014R
5011	906 012R	5212	912 090	54 406 537	828 100	581700540000	490 303
5012	906 018R	5213	912 096	54 407 831	828 104	581700540010	490 303
5015	906 012R	5215	912 097	54 408 133	828 105	581701070000	465 020
502 143	470 607	5216	912 100	54 408 776	828 106	5823	946 016R
5020	906 014R	5247098	907 701R	54 413 568	728 083MHV	5DA 006 623-951	490 414
5021	906 014R	5247810	707 701	54 414 513	828 070	5DA 193 175-061	470 314
5022	906 055R	5248175	806 079	54 414 514	828 075	5DA 193 175-331	470 450
5023	906 121R	5267	913 028	54 417 214	828 075	5DA 193 175-341	470 146
5026	906 018R	5270	913 014	54 418 661	828 091	5DA 193 175-391	470 596
5027	906 021R	5271	913 014	54 419 082	928 014	5DA 193 175-401	470 135
5028	906 021R	5277	913 027	54 419 946	728 083MHV	5DA 193 175-411	470 532
5029	906 024R	5283	913 029	54 420 877	919 085	5DA 193 175-421	470 188
5030	906 023R	5284	913 030	54 420 889	819 083	5DA 193 175-431	470 403
5032	907 701R	5285	922 082	54 420 904	912 090	5DA 193 175-441	470 405
5033	906 026R	53 003	730 120	54 421 149	928 014	5DA 193 175-481	470 543
5034	906 025R	53 003 V	730 120	54 422 043	928 014	5DA 193 175-491	470 607
5036	906 056R	53 006	730 123	54 422 044	928 014	5DA 193 175-501	470 474
5037	906 061R	53 007	730 127	54 422 803	928 012	5DA 193 175-511	470 495
5039	906 070R	53 009	730 132	54 423 546	828 078	5DA 193 175-591	470 433
5040	906 027R	53 009 V	730 132	54 424 762	928 022	5DA 193 175-681	470 557
5041	906 067R	53 010	730 139	54 427 109	828 078	5DA 193 175-691	470 168
5047	906 034R	53 010 V	730 139	54 527 109	828 078	5DA 193 175-701	470 436
5050	906 115R	53 011	730 140	54 987 086	465 036	5DA 193 175-711	470 607
5055	906 116R	53 011 V	730 140	5400	922 069	5DA 193 175-731	470 407
5056	906 060R	53 013	730 142	5402	922 066	5DA 193 175-741	470 384
5060	906 112R	53 013 V	730 142	5403	922 081	5DA 193 175-761	470 442
5062	906 059R	53 014	746 071	5406	922 094	5DA 193 175-781	470 480
5065	906 115R	53 014 V	746 071	5407	360 363	5DA 193 175-791	470 481
5069	906 067R	53 019	717 024	55 005	728 083MHV	5DA 193 175-801	470 478
5070	906 117R	53 021	707 701	55 005 V	728 083MHV	5DA 193 175-821	470 419
5071	906 115R	53 023	717 026	55 006 V	719 043HV	5DA 193 175-831	470 518
5073	906 112R	5301	915 091	55 007 V	719 044HV	5DA 193 175-881	470 275
5074	906 049R	5302	915 081	55 008	728 083MHV	5DA 193 175-901	470 431
5075	360 411	5304	915 083R	55 008 V	728 083MHV	5DA 193 175-911	470 429
5075	906 112R	5307	915 088	55 013 V	728 089	5DA 193 175-921	470 426
5078	906 112R	5311	915 088	5501	928 006	5DA 193 175-931	470 459
5080	906 117R	5312	915 088R	5502	919 085	5DA 193 175-951	470 599
5081	906 127R	5313	915 089R	5505	928 012	5DA 193 175-961	470 612
5087	906 114R	5315	915 091	5506	928 021	5DA 193 175-971	470 614
5088	906 117R	5316	915 091	5509	928 029R	5DA 193 175-981	470 445
5092	906 119R	5317	915 094	5517	928 007	5DA 193 175-991	470 417
50926869	470 532	5318	915 094	5527	928 024R	5DA 230 035-041	470 228
5093	906 122R	5320	915 097	5529	928 026R	5DA 230 035-561	470 466
50936999	470 532	5321	915 099R	5530	928 025	5DA 230 035-731	470 429
5094	906 118R	5322	915 104	5531	919 092	5DA 230 035-781	470 433
51 003	712 055HVS	5323	915 101	5532	928 028R	5DA 230 035-861	470 436
51 003 S	712 055HVS	5355	360 880	56 009	736 045	5DA 230 035-901	470 458
51 003 V	712 055HVS	5361	360 856	561 811 68	630 117	5DA 230 036-001	470 425
5101	360 562	5385	922 052	561 811 76	630 117	5DA 230 036-101	470 552
5101	906 140R	5388	922 056	561 811 82	630 127	5DA 230 036-191	470 522
5108	906 125R	5397	922 073	561 811 83	630 128	5DA 230 036-311	470 556
5112	906 148R	54 002	713 011HV	561 812 02	630 117	5DA 230 036-371	470 603
5113	906 147R	54 002 V	713 011HV	561 812 03	630 117	5DA 230 036-511	470 611
5114	906 149R	54 006	722 056HV	5618	930 029	5DA 230 036-521	470 516
514 885 0002	470 448	54 006 V	722 056HV	5619	930 055R	5DA 230 036-541	470 551
514 885 0006	470 478	54 014	731 084	5622	930 059	5DA 230 036-611	470 527
52 004	715 055	54 020	713 022HV	5623	930 060	5DA 230 036-661	470 623
52 006	715 056	54 026	731 084	5628	930 037	5DA 358 000-001	470 435
52 006 V	715 056	54 400 071	728 089	5629	930 054R	5DA 358 000-011	470 170
52 007	715 061	54 401 050	928 022	5633	930 036R	5DA 358 000-041	470 508
52 007 V	715 061	54 401 291	828 083	5634	930 036R	5DA 358 000-051	470 354S
52 013	715 064	54 401 627	828 085	5635	930 042R	5DA 358 000-061	470 228
52 014	715 111U	54 402 059	828 078	5636	930 042R	5DA 358 000-071	470 448
52 016	715 067	54 402 069	828 091	5637	930 041	5DA 358 000-091	470 529
52 025	715 086	54 402 212	828 091	5638	930 042R	5DA 358 000-131	470 603
52 037	715 102	54 402 221	728 089	5639	946 014R	5DA 358 000-141	470 214
52 038	715 103	54 402 689	928 021	5640	917 058	5DA 358 000-171	490 420

5DA 358 000-251	470 365	607 054 09	470 228	701 184 01	730 123	712 934 02	730 148M
5DA 358 000-271	470 423	607 056 01	470 102	701 403	470 403	7121	359 612
5DA 358 000-291	470 272	607 056 04	470 108	701 724	470 489	713 027 01	830 109
5DA 358 000-311	470 483	607 056 06	470 158	701 857	470 613	713 053 01	930 060
5DA 358 000-331	470 507	607 057 01	470 106	701 895 01	930 029	713 198 01	430 161/1
5DA 358 000-341	470 547	607 057 38	470 106	701 918	470 552	713 198 04	430 163/1
5DA 358 000-371	470 425	607 080 38	470 146	703 880 03	930 041	713 269 01	430 177/1
5DA 358 000-381	470 466	607 081 38	470 275	705 197 01	730 127	713 277 01	430 180M
5DA 358 000-411	470 432	607 081 54	470 276	710 067 01	730 120	713 284 01	430 176M
5DA 358 000-461	470 536	607 120 02	470 101D	710 070 01	730 123	713 473 01	430 176M
5DA 358 000-471	470 475	60921666	470 432	710 595 01	730 127	713 474 01	430 180M
5DA 358 000-491	470 345	610 453 24	430 177/^{FN}	710 596 01	730 127	713 491 01	430 176M
5DA 358 000-571	470 496	610 800 24	430 161/^{FN}	710 613 03	830 081	713 524 01	930 058
5DA 358 000-581	470 518	6100	606 196	710 615 01	930 036R	713 528 01	830 110
5DA 358 000-631	470 427	6102	360 711	710 638 01	830 069	713 584 01	830 111
5DA 358 000-651	470 489	6102	606 195	710 640 01	930 037	713 667 01	830 101
5DA 358 000-661	470 591	611 100 41	430 176M^{FN}	710 640 02	930 037	713 667 02	830 101
5DA 358 000-671	470 487	611 100 55	430 176M^{FN}	710 650 01	730 132	713 668 01	830 098
5DA 358 000-711	490 414	611 100 62	430 176M^{FN}	710 851 01	830 076	713 668 02	830 098
5DA 358 000-831	470 108	611 100 66	430 176M^{FN}	710 861 01	930 037R	713 713 01	930 060
5DA 358 000-841	470 155	611 100 76	430 176M^{FN}	710 930 01	930 037R	713 756 01	830 116
5DA 358 000-861	470 341	611 101 03	430 180M^{FN}	710 930 02	930 037R	713 774 02	930 057R
5DA 358 000-871	470 399	611 101 26	430 180M^{FN}	710 930 03	930 054R	71351702	930 059
5DA 358 000-891	470 408	6115	606 212	7103	359 623	71374201	830 116
5DA 358 000-911	470 178	6128	606 257	7109	360 343	71376201	830 098
5DA 358 000-931	470 434	614 885 0003	470 272	711 016 07	930 051R	714 885 0001	470 481
5DA 358 000-991	470 522	614 885 0004	470 508	711 116 01	730 139	714 885 0002	470 480
5DA 358 057-021	470 516	614 885 0006	470 399	711 116 02	730 139	714 885 0005	470 135
5DA 358 057-131	470 198	614 885 0007	470 450	711 116 03	730 139	714 885 0011	470 532
5DA 358 057-231	470 608	614 885 0017	470 507	711 185 01	730 140	714 885 0013	470 619
5DA 358 057-261	470 437	614 885 0022	470 547	711 195 01	930 036R	714 885 0014	470 623
5DA 358 057-321	470 611	6209	358 239	711 195 02	930 036R	7151	360 760
5DA 358 057-381	470 602	623 901	470 632	711 195 03	930 042R	7155	360 654
5DA 358 057-401	470 537	623 903	470 516	711 195 04	930 036R	7171	359 888
5DA 358 057-441	470 556	623 904	470 614	711 195 05	930 042R	7171	360 278
5DA 358 057-451	470 538	623 905	470 459	711 214 01	930 037	7172	360 401
5DA 358 057-481	470 514	623 906	470 345	711 215 01	930 037R	7175	360 446
5DA 358 057-491	470 492	623 907	470 537	711 215 02	930 037R	718 097 01	730 126
5DA 358 057-541	470 497	623 908	470 536	711 275 01	830 081	718 098 01	730 096
5DA 358 057-591	470 627	6257	360 529	711 290 01	830 082	720 311	470 155
5DA 358 057-601	470 527	6258	360 730	711 299 01	930 036R	720 313	470 188
5DA 358 057-661	470 551	62937080	470 408	711 323 01	930 037	7200	358 244
5DA 358 057-691	470 533	6301	358 241	711 424 01	930 036R	7201	359 716
5DA 358 057-811	470 505	6302	358 236	711 424 02	930 042R	7209	360 504
5DA 358 057-821	470 611	6303	615 023	711 476 01	730 143	721 404	470 408
5DA 358 057-921	470 631	6304	358 059	711 539 01	930 037R	721 501	359 780
5DA 358 057-931	470 609	6304	615 023	711 711 01	830 086	721 906	470 407
5DA 358 057-941	470 589	6305	615 023	711 713 01	930 040	721 907	470 476
5DA 358 168-041	470 632	6308	615 034	711 743 01	830 090	7210	360 686
5DA 358 168-131	470 503	6310	615 034	711 975 01	730 142	722 637	470 483
5DA 358 168-181	470 549	6311	615 034	711 975 02	730 142	723 459	470 497
5DA 358 168-341	470 622	6317	615 039	711 980 01	730 139	7237	360 278
5DA 358 168-391	470 626	6431	359 372	711 985 01	730 140	7240	359 768
5DA 749 475-101	470 355	6462	358 061	711 985 02	730 132	7246	359 493
5DA 749 475-131	470 397	6467	359 372	711.005.300	701 006	7247	359 725
5DA 749 475-261	470 386	6468	358 064	711.101.300	701 005	7251	359 808
5DA 749 475-601	470 476	6469	358 064	7116	359 432	7255	359 386
5DA 749 475-661	470 532	648 250 72	490 303	7119	359 612	7260	359 398
5DA 749 475-781	470 432	648 330 20	465 005	712 155 01	830 093	7262	359 429
5DA 749 475-851	470 475	648 330 40	465 020	712 160 01	430 161/1	7263	360 305
5DA 749 475-891	470 461	6522	360 138	712 160 03	430 163/1	7264	359 398
5DA 749 475-901	470 466	6625	630 117	712 279 01	930 042R	7266	359 692
5WK 6105	465 004	6626	617 097	712 372 01	930 047R	7267	359 471
5WK 90611	470 272	6628	630 117	712 372 02	930 057R	7270	359 815
5WK 9397	470 545	6629	630 128	712 378 01	930 047R	7272	359 386
5WK 9397	470 545	6630	630 127	712 437 01	830 098	7273	359 650
5WK9 3171	470 508	6764	642 056	712 437 02	830 098	7274	359 471
60 410 049	719 044HV	6794	360 681	712 437 04	830 098	7275	359 507
60 410 050	719 043HV	6812	359 608	712 437 05	830 098	7275	359 674
600 567	470 466	6980	359 507	712 461 04	830 101	7276	359 471
600 630	470 146	7 350 260 2	465 029	712 461 05	830 101	7282	359 354
600 650	470 461	7 350 370 2	465 005	712 461 06	830 101	7285	359 808
6005	606 030	7 350 370 2	465 005	712 461 07	830 104	7285	360 025
6020	358 006	700 055 01	830 059	712 462 03	830 101	7287	359 386
6022	360 509	700 121	470 196	712 478 02	730 146M	7296	359 386
606 900 03	470 101D	700 123	470 596	712 753 01	930 055R	7297	359 354
607 029 02	470 103	700 221	470 365	712 779 02	730 146M	735 02 602	465 029
607 029 03	470 103	700 471	470 419	712 779 03	730 146M	735 03 702	465 005
607 054 04	470 148	701 049	470 518	712 779 05	730 149M	7371	359 780

7401	470 101D	85.30091	470 135	85.30255A2	470 478	85.30644A2	470 645
7412	358 111	85.30092	470 140	85.30256	470 426	8530133	470 475
7414	360 401	85.30093	470 105	85.30256A2	470 426	8530154	470 475
7418	360 619	85.30095	470 189	85.30262	470 198	8530164	470 432
7419	360 984	85.30096	470 188	85.30267	470 591	8530165	470 474
7420	360 492	85.30097	470 168	85.30268	470 450	8530171	470 429
7421	360 585	85.30097A2	470 168	85.30268A2	470 450	8530184	470 408
7700	360 753	85.30106	490 414	85.30277	470 389	8530249	470 475
7801100	470 432	85.30109	470 399	85.30278	470 495	8530251	470 475
7802200	470 459	85.30109A2	470 399	85.30284	470 296	8530268	470 450
7802207	470 461	85.30110	470 435	85.30285	470 203	8530302	470 532
7803300	470 532	85.30117	470 192	85.30286	470 266	8530304	470 461
78100	470 432	85.30119	470 496	85.30302	470 532	8610	360 711
78207	470 461	85.30121	470 214	85.30303	470 483	8655	360 699
78300	470 532	85.30123	470 272	85.30303A2	470 483	8735	360 278
8 204 45	912 090	85.30123A2	470 272	85.30304	470 461	8839	360 740
8010300	470 432	85.30126	470 355	85.30305	470 466	9 011 4106	606 212
8010318	470 532	85.30127	470 356	85.30306	470 543	9 220 332 702	470 101D
8010328	470 429	85.30127A2	470 356	85.30306A2	470 543	9 230 087 016	406 153^N
8010351	470 475	85.30128	470 374	85.30308	470 458	9 230 087 019	406 153^N
8010391	470 408	85.30133	470 475	85.30308A2	470 458	9 230 087 030	406 153^N
8010444	470 461	85.30135	470 480	85.30310A2	470 549	9 230 087 036	406 153^N
8010478	470 474	85.30135A2	470 480	85.30320	470 397	9 230 087 038	406 153^N
8010480	470 450	85.30144	470 419	85.30341	470 202	9 230 087 039	406 153^N
8010530	470 475	85.30144A2	470 419	85.30343	470 529	9 230 087 044	406 153^N
8010551	470 408	85.30145	470 445	85.30344	470 608	9 230 087 046	406 153^N
8010564	470 475	85.30145A2	470 445	85.30349	470 2855	9 230 087 056	406 153^N
8010628	470 532	85.30149	470 314	85.30349A2	470 2855	9 230 087 062	406 153^N
8101	360 677	85.30154	470 475	85.30351	470 265	9 230 087 065	406 153^N
8106	358 120	85.30160	470 448	85.30352	470 322	9 231 064 336	906 131
81932056	470 461	85.30160A2	470 448	85.30355A2	470 457	9 231 064 346	906 131
820 768	470 581	85.30161	470 489	85.30360	470 556	9 231 065 501	806 112
820 773	470 586	85.30161A2	470 489	85.30366	470 599	9 231 065 502	806 072
820 774	470 585	85.30164	470 432	85.30373	470 487	9 231 065 503	806 072
820 780	470 496	85.30164A2	470 432	85.30373A2	470 487	9 231 065 504	806 072
8208	359 615	85.30165	470 474	85.30386	470 538	9 231 065 506	806 112
821 429	470 495	85.30168	470 427	85.30392	470 492	9 231 065 516	806 112
821 495	470 556	85.30168A2	470 427	85.30405	470 547	9 231 065 529	806 244
821 669	470 543	85.30171	470 429	85.30405AS	470 547	9 231 067 027	706 034HVS
821 670	470 611	85.30171A2	470 429	85.30408	470 536	9 231 081 319	806 098
821 719	470 612	85.30175	470 387	85.30412	470 614	9 231 081 413	806 098
8275	360 731	85.30176	470 397	85.30412A2	470 614	9 231 081 628	906 045R
8300	358 120	85.30180A2	470 518	85.30413	470 611	9 231 081 678	806 098
8458	360 531	85.30182	470 403	85.30421	470 533	9 231 086 370	806 094
8471	359 674	85.30182A2	470 403	85.30423	470 552	9 231 087 552	406 160
8474	360 702	85.30183A2	470 384	85.30425	470 505	9 231 087 677	906 121R
8480	359 494	85.30184	470 408	85.30426	470 497	9 231 140 245	806 079
8492	358 061	85.30184A2	470 408	85.30447	470 532	9 231 335 584	817 029
85.30008	470 394	85.30186	470 508	85.30456	470 613	9 231 337 005	717 024
85.30017	470 219	85.30186A2	470 508	85.30456A2	470 613	9 231 337 005	717 024
85.30021	470 589	85.30187	470 407	85.30459	470 579	9 231 337 005 706	717 024
85.30029	470 431	85.30187A2	470 407	85.30459S	470 579	9 231 337 005 706	717 024
85.30029A2	470 431	85.30190	470 423	85.30461	470 551	9 231 337 041	730 132
85.30032	470 108	85.30190A2	470 423	85.30485	470 522	9 231 337 041	730 132
85.30032A2	470 108	85.30194	470 434	85.30489	470 537	9 231 337 072	717 024
85.30034	470 345	85.30194A2	470 434	85.30490	470 503	9 231 337 072	717 024
85.30034A2	470 345	85.30195	470 437	85.30494	470 387	9 231 337 072 706	717 024
85.30035	470 106	85.30196	470 433	85.30525	470 527	9 231 337 072 706	717 024
85.30036	470 146	85.30197	470 425	85.30526	470 603	9 231 337 074	717 026
85.30036A2	470 146	85.30207	470 509	85.30526A2	470 603	9 231 337 074	717 026
85.30037	470 196	85.30212	470 602	85.30529	470 609	9 232 081 442	806 094
85.30038	470 155	85.30212A2	470 602	85.30529A2	470 609	9 232 337 354	617 097
85.30040	470 148	85.30214	470 557	85.30532	470 632	9 232 337 354	617 097
85.30042	470 228	85.30214A2	470 557	85.30532A2	470 632	9 232 337 354 706	617 097
85.30045	470 442	85.30217	470 170	85.30536	470 619	9 232 337 354 706	617 097
85.30045A2	470 442	85.30218	470 347	85.30536A2	470 619	9 233 335 511	817 014
85.30057	470 365	85.30228A2	470 459	85.30538A2	470 481	9 233 335 511	817 014
85.30057A2	470 365	85.30234	470 112	85.30539	470 620	9 233 335 551	817 023
85.30058	470 596	85.30235	470 178	85.30539A2	470 620	9 307 913	712 055HVS
85.30058A2	470 596	85.30236	470 178	85.30541	470 631	9 460 4446	806 098
85.30059	470 376	85.30237	470 179	85.30573A2	470 627	9 575 2	715 064
85.30060	470 378	85.30243	470 507	85.30578	470 623	90 034	706 034HVS
85.30062	490 420	85.30243A2	470 507	85.30578A2	470 623	90 069	906 014R
85.30062A2	490 420	85.30245A2	470 398	85.30581	470 638	90 246 G	806 079
85.30072	470 436	85.30249	470 475	85.30582	470 626	92 500	706 040
85.30072A2	470 436	85.30251	470 475	85.30582A2	470 626	92 500 X	706 040
85.30088	470 3545	85.30252	470 607	85.30586	470 622	92 504	706 034HVS
85.30090	470 417	85.30252A2	470 607	85.30592	470 647	92 504 B	706 034HVS
85.30090A2	470 417	85.30255	470 478	85.30592A2	470 647	92 712 E	706 049HDVS

9262	360 451	ADR 5008	906 014R	B 965/1	906 112R	CM1T-228 C	470 347
940038500010	465 004	ADR 5031	913 014	B 967/1	906 112R	D 485	815 049
941044110501	359 716	ADR 5050	922 085	B 968/5	906 117R	D 487	815 041
941085180570	359 494	ADR 5052	931 119	B 969/1	906 122R	D 489	815 058
941094040575	359 432	ADT31477	470 461	B 971/5	906 117R	D 490	815 058
941094060576	359 507	AEI 600 C	490 303	B 972/5	906 117R	D 492	915 091
941095100582	360 451	AEI 600 F	490 303	B 974/1	906 122R	D 494	915 081
941095130583	359 616	ATA 1722	470 101D	B 975/5	906 114R	D 495	915 083R
941095680607	359 615	ATA 00115	470 101D	B 1000/5	906 045R	D 498	915 088
941095700609	359 694	B 3	806 112	B 1001/1	906 070R	D 498 A	915 088R
941095780616	359 616	B 11	806 124	B 1003/1	906 121R	D 499	915 088
941095790617	360 363	B 12	806 231	B 1005/1	906 119R	D 499 A	915 088R
941095800618	360 503	B 13	806 129	B 1008/1	906 118R	D 500	815 058
941095870625	359 888	B 13K	806 266	B 1009/1	906 127R	D 553 A	915 083R
941095910629	360 504	B 14	806 117	BAE 209 B	470 103	D 554 A	915 089R
941095980634	360 505	B 15	806 234	BAE 209 C	470 103	D 556	915 094
941125070664	359 509	B 16	806 235	BAE 403 C	470 442	D 556 A	915 094
941125120666	360 237	B 17	806 127	BAE 504 B	470 107	D 558	915 097
941125180672	359 514	B 18	806 240	BAE 504 D	470 148	D 559/1	915 099R
941125190673	359 634	B 19	806 241	BAE 504 L	470 228	D 560/1	915 104
941125310683	359 688	B 20	806 237	BAE 506	470 108	D 751	815 059
941125360686	360 531	B 21K	806 231^A	BAE 506 A	470 102	D 752	815 058
941125380688	360 529	B 22	806 238	BAE 506 D	470 108	D 753	815 059
941135120700	359 780	B 23	806 236	BAE 506 F	470 158	D 756	815 058
941135130701	360 025	B 24	806 094	BAE 507 AK	470 106	D 758	815 058
941135160703	359 674	B 38	806 062	BAE 680 C	470 532	D 759	815 062
941215240807	358 059	B 38 P	806 076	BAE 680 D	470 312	D 760	815 059
941285030866	360 278	B 39	806 072	BAE 800 AK	470 146	D 761	815 068
941285120871	360 753	B 53	806 072	BAE 800 B	470 146	D 762	815 067
941315020889	360 711	B 54	806 076	BAE 800 B	470 146	D 763	815 065
941318111002	358 244	B 54 A	806 079	BAE 800 DK	470 146	D 764	815 069
941318111140	360 529	B 54 G	806 094	BAE 800 EK	470 196	D 765	815 074
941318111161	360 451	B 64	906 018R	BAE 801 AK	470 275	D 766	815 075
941318111274	360 209	B 70	906 012R	BAE 801 BK	470 276	D 767	815 054
941318111287	360 681	B 73	906 018R	BAE 801 EK	470 196	D-107 P	730 127
941318111313	358 013	B 75	906 012R	BAE 920 A	470 345	D-107P	730 127
941318111315	358 230	B 76	906 014R	BAE 920 A	470 345	D-1957	465 025
941318111320	358 245	B 76 A	906 014R	BAE 920 AX	470 345	D-1958	465 025
941365030926	360 680	B 81	906 018R	BAE 920 AX	470 345	D-1961	465 025
94220291	913 027	B 82	906 021R	BAE 940 A	470 423	D-340	812 073
94238982	913 027	B 84	906 024R	BAE 940 A	470 423	D-436	912 097
949033	806 108	B 84/1	906 060R	BAE403C245	470 442	D-444	912 098
949034	806 121	B 87	906 025R	BAE409A245	470 432	DG 435	470 135
949035	817 016	B 87/1	906 061R	BAE800B245	470 146	DG 438	470 289
949041	812 073	B 88	906 026R	BAE851AE245	490 414	DG 440	470 170
949042	912 096	B 88/1	906 056R	BE 200 B	470 101D	DG 449	470 312
9616	360 209	B 89	906 067R	BK 3 A	470 101D	DG 458	470 2995
983 347	706 068	B 89/1	906 067R	BKL 2 A	465 005	DG 459	470 289
9856	360 745	B 91/1	906 112R	BKL 4 A	465 020	DG 460	470 312
9985	359 608	B 93	906 034R	B0100	470 432	DG 461	470 312
ADH 2	806 244	B 93/1	906 112R	B0207	470 461	DGE-446	470 289
ADH 5006	806 062	B 97	906 027R	B0300	470 532	DGE-447	470 233
ADH 5007	806 072	B 98	906 115R	CE 22 B	630 117	DGE-456	470 170
ADH 5013	822 003	B 99	906 023R	CE 22 C	630 117	DH 390	819 092
ADH 5016	822 003	B 99/1	906 049R	CE 39 A	630 117	DH 390B	819 092
ADH 5025	828 070	B 100	906 055R	CE 39 G	630 117	DH 390E	819 092
ADH 5027	828 075	B 100/1	906 055R	CE 39 P	630 127	DH 433	819 093
ADH 5032	822 003	B 1009/1	906 127R	CE 39 R	630 128	DH 434	819 093
ADH 5043	806 079	B 101	806 079	CE10000	470 399	DH 444	831 121
ADH 5071	831 131	B 103	806 081	CE20009-12B1	470 450	DHE 411	819 092
ADP 1	728 083MHV	B 105	806 081	CE20014-12B1	470 432	DHE 439	831 122
ADP 12	719 043HV	B 106	806 080	CE20042-12B1	470 532	DHE 440	831 125
ADP 92	728 083MHV	B 107	806 081	CE20044-12B1	470 532	DHE 441	831 121
ADP 5002	706 029HV	B 109	806 081	CM11-108	470 608	DHE 448	831 137
ADP 5007	722 056HV	B 110	806 081	CM11-109	470 529	DIC-0100	470 461
ADP 5009	713 011HV	B 112	806 092	CM11-111	470 608	DIC-0102	470 466
ADP 5010	706 032HV	B 113	806 093	CM11-112	470 529	DIC-0103	470 536
ADP 5011	706 029HV	B 116	806 092	CM11-116	470 603	DIC-0111	470 589
ADP 5018	719 044HV	B 117	806 099	CM11-118	470 527	DIC-0115	470 586
ADP 5019	706 049HDVS	B 119	806 098	CM11-201	470 445	DIC-0116	470 219
ADP 5020	706 034HVS	B 121	806 108	CM11-202	470 384	DIC-0134	470 458
ADP 5021	706 034HVS	B 122	806 123	CM11-207A	470 457	DIC-0143	470 522
ADP 5032	706 034HVS	B 124	806 090	CM12-100	470 265	DIC-0144	470 457
ADP 5033	706 049HDVS	B 125	806 233	CM1T-205	470 219	DIC-0200	490 414
ADP 5034	713 011HV	B 955	906 116R	CM1T-209B	470 216	DIC-0207	470 611
ADR 3	906 131	B 955/1	906 059R	CM1T-217	470 216	DIC-0209	470 614
ADR 71	928 006	B 958/1	906 115R	CM1T-228	470 347	DIS4-05	465 051
ADR 76	928 007	B 963	906 117R	CM1T-228 A	470 347	DIS4-08	465 072
ADR 5004	912 090	B 964	906 115R	CM1T-228 B	470 347	DN 192	722 056HV

DN 222	615 023	EDP 3 D	728 083MHV	FM 700	847 025	MTR 01	465 005
DN 428	906 014R	EDP 19	706 021	FM 701	830 086	P 603	838 242
DR 22	906 025R	EDP 36	706 034HVS	FM 702	830 090	P-125-3706-800	746 071
DR 195	715 056	EDP 36 D	706 034HVS	FM 706	830 076	P-125-500	847 025
DR 214	812 066	EDP 38	706 049HDVS	FM 707	830 101	QA 1140	706 047
DR 217	812 073	EDP 38 D	706 049HDVS	FM 710	830 082	QA 1160	706 029HV
DR 218	812 074	EDP 50	706 034HVS	FM 711	830 093	QA 1420	706 021
DR 220A	919 085	EDP 51	728 083MHV	FM 712	830 098	QA 1470	706 029HV
DR 226	912 090	EDP 59	722 056HV	FM 713	830 098	QA 1570	706 032HV
DR 239	912 093	EDP 60	715 056	FM 714	830 098	QA 1610	706 034HVS
DR 240	912 095R	EDP 75	706 034HVS	FM 717	830 109	QA 1640	706 049HDVS
DR 241	912 096	EDP 103	731 084	FM 725	930 042R	QA 1710	706 040
DR 242 A	912 095R	EDP 109	728 089	FM 725 A	930 042R	QA 1920	706 062
DR 243	912 097	EDP 131	706 049HDVS	FM 726 A	946 014R	QA 2990	713 022HV
DR 244	912 100	EDP 137	706 034HVS	FM 727	930 042R	QA 3430	722 056HV
DR 375A	919 092	EDP 198	706 021	FM 727 A	930 042R	QA 3440	713 011HV
DRE 90	919 085	EDR 2	928 006	FM 728 A	930 055R	QA 3520	712 055HVS
DRE 381	922 073	EDR 2 D	928 006	FM 735/5	930 051R	QA 4090	731 084
DRE 383	931 108	EDR 3	919 085	FM 736	930 060	QA 4400	730 123
DRE 385	931 113	EDR 3 D	919 085	GN10210-12B1	470 475	QA 4480	730 132
DRE 388	931 108	EDR 3 S	919 085	GN10236-12B1	470 429	QA 4510	730 139
DRE 389	931 137	EDR 12	906 012R	GN10248-11B1	470 608	QA 4520	730 140
DRE 389 A	931 137	EDR 12 D	906 012R	GN10314-12B1	470 461	QA 4540	730 142
DRE 390	931 131	EDR 12 S	906 012R	GN10337-12B1	470 557	QA 5120	719 043HV
DRE 390 A	931 131	EDR 23	906 024R	GN10571-12B1	470 475	QA 5130	719 044HV
DRE 391	931 133	EDR 40	906 012R	GN10572-12B1	470 475	QA 5400	715 086
DRE 394	931 132	EDR 40 D	906 012R	J 610	813 102	QA 5450	715 102
DRE 395	931 134	EDR 49	906 024R	J 611	813 094	QA 5480	715 105
DT 453 AX	430 177/1 ^N	EDR 80	931 023	J 617	822 057	QA 5670	715 055
DT 458 BX	430 182 ^N	EDR 85	915 091	J 619	822 011	QA 5705	715 056
EDC 62	615 023	EDR 92	928 014	J 623	813 092	QA 5730	742 054
EDC 173	615 023	EDR 98	906 060R	J 627	813 099	QA 6200	728 083MHV
EDG 27	470 169	EDR 109	906 025R	J 633	822 003	QA 6200	728 083MHV
EDG 43	470 135	EDR 113	906 024R	J 641	831 003/001	QB 1030	642 056
EDH 8	828 070	EDR 123	906 112R	J 644	813 093	QB 1640	615 023
EDH 10	828 075	EDR 130	906 121R	J 659	913 014	QB 4010	615 034
EDH 10D	828 075	EDR 135	906 112R	J 660	931 023	QB 4011	615 034
EDH 12	819 083	EDR 151	906 061R	J 661	913 014	QB 5180	630 117
EDH 12 D	819 083	EDR 157	906 061R	J 662	906 018R	QB 5310	606 196
EDH 12 S	819 083	EDR 159	928 026R	J 666	931 023	QB 5390	606 195
EDH 16	819 083	EDR 161	930 057R	J 667	922 052	QB 6060	606 212
EDH 24	806 079	EDR 182	906 121R	J 670	913 027	QC 0720	906 018R
EDH 24 D	806 079	EDR 183	906 121R	J 672	922 056	QC 0750	906 012R
EDH 25	806 076	EDR 187	906 061R	J 675	913 014	QC 0760	906 014R
EDH 25 D	806 076	EDR 210	930 057R	J 686	922 073	QC 0810	906 018R
EDH 26	806 072	EDR 240	906 140R	J 852	813 107	QC 0820	906 021R
EDH 27	806 072	EDR 248	906 121R	J 855	831 003/001	QC 0840	906 024R
EDH 279	806 253	EDR 249	928 026R	J 856	822 022	QC 0841	906 060R
EDH 28	806 081	EDR 309	406 233 ^S	J 858	822 040	QC 0880	906 026R
EDH 30	806 062	F 155 A	806 112	J 864	813 262	QC 0930	906 034R
EDH 31	806 072	F 160	819 092	J 865	813 113	QC 0970	906 027R
EDH 36	806 079	F 161	819 093	J 871	822 046	QC 1130	931 023
EDH 38	806 081	F 190	919 092	J 873	813 117	QC 2390	912 093
EDH 42	806 081	F 000 99C 602	358 246	J 875	813 122	QC 3770	928 006
EDH 67	806 076	F 000 ZSO 001	470 192	J 876	831 118	QC 3830	928 007
EDH 75	806 081	F 000 ZSO 111	470 140	J 878	822 041	QC 3890	919 085
EDH 88	806 081	F 000 ZSO 206	470 416 ^S	J 879	822 048	QC 3910	928 012
EDH 93	830 069	F 000 ZSO 207	470 416	JD 633	822 003	QC 4410	930 037
EDH 95	830 069	F 01R 00A 025	470 188	JD 659	913 014	QC 4440	930 036R
EDH 117	806 081	FE 900	817 014	JD 661	913 014	QC 4950	915 091
EDH 125	806 109	FE 903	817 023	JD 662	906 018R	QC 4990	915 088
EDH 128	828 083	FE 926	917 058	JP 873	813 117	QC 5560	915 094
EDH 130	806 079	FM 412	830 059	L 330	928 025	QC 5640	930 047R
EDH 142	830 069	FM 417	830 069	L 330/1	928 026R	QC 6590	913 014
EDH 170	830 098	FM 420	830 081	L 347	828 085	QC 7250	930 042R
EDH 183	806 235	FM 431	930 029	L 350	828 083	QC 9565	928 014
EDH 189	831 109	FM 432	930 029	L 360	828 094	QC 9580	906 055R
EDH 196	830 098	FM 436?	930 037	L 366	828 070	QC 9585	913 027
EDH 199	828 096	FM 437	930 037R	L 368	819 083	QC 9590	906 112R
EDH 201	830 098	FM 438	930 037	L 371	828 075	QC 9600	906 067R
EDH 208	830 098	FM 439	930 029	L 373	828 078	QC 9605	912 096
EDH 216	828 094	FM 441	930 037R	L 377	928 006	QC 9610	912 096
EDH 226	830 098	FM 442	930 037	L 379	928 007	QC 9660	806 062
EDH 390	819 092	FM 443	930 037R	L 381	928 007	QC 9665	806 062
EDP 1	719 043HV	FM 444	930 036R	L 383	928 007	QD 0380	806 062
EDP 1 D	719 043HV	FM 445	930 036R	L 387	919 085	QD 0390	806 072
EDP 2	719 044HV	FM 446	930 037R	L 390 A	915 088	QD 0541	806 079
EDP 2 D	719 044HV	FM 447	930 040	L 391	928 012	QD 1060	806 080
EDP 3	728 083MHV	FM 449	930 041	L 399/1	928 024R	QD 1070	806 081
						QD 1120	806 092
						QD 1130	806 093
						QD 1170	806 099
						QD 2025	828 091

QD 2140	812 066
QD 3500	828 083
QD 3660	828 070
QD 3680	819 083
QD 3710	828 075
QD 3730	828 078
QD 4170	830 069
QD 4200	830 081
QD 4276	813 094
QD 4600	842 043
QD 4643	830 101
QD 4850	815 049
QD 5000	815 058
QD 6190	822 011
QD 6200	831 109
QD 6330	822 003
QD 6410	831 003/001
QD 6440	813 093
QD 7020	830 090
QD 7530	815 059
QD 8550	806 121
QD 8555	806 081
QD 8570	813 092
QD 8590	813 114
QD 8595	822 003
QD 8600	806 108
QD 8610	812 073
QD 8615	822 022
QD 8625	806 123
QD 8630	831 003/001
QD 8640	813 119
S 57/45	930 029
SE 100 AX	430 176M ^{*N}
SE 100 CX	430 176M ^{*N}
SE 100 EX	430 176M ^{*N}
SE 100 GX	430 176M ^{*N}
SE 100 HXY	430 176M ^{*N}
SE 101 AB	430 180M ^{*N}
SE 101 C	430 180M ^{*N}
SM 800 AX	430 161/1 ^{*N}
SM 800 BX	430 161/1 ^{*N}
SM 803 AX	430 161/1 ^{*N}
SM 806 AX	430 161/1 ^{*N}
SM 807 AX	430 163/1 ^{*N}
SV 460	842 043
US 130	847 027
US 139/1	946 016R



CONDENSERS

CONDENSATORI
CONDENSATEURS
KONDENSATOREN
CONDENSADORES

Code		New code
606 180	E	
606 195	E	
615 023	E	
615 034	E	
615 039	E	
642 056	E	

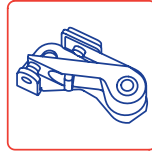

CONTACT SETS

COPPIE CONTATTI
RUPTEURS
KONTAKTSÄTZE
PLATINOS

Code		New code
706 040	E	
706 047	E	
706 064	E	
715 056	E	
715 056HV	E	
715 067	E	
715 076	E	
715 102	E	
715 103	E	
715 111U	E	
715 112U	E	
717 024	E	
719 043HV	S	
728 089	E	
730 126	E	
730 140HV	E→	730 140
730 149	E	

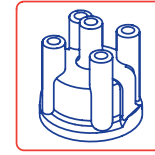

DISTRIBUTOR CAPS

CALOTTE
TÊTES D'ALLUMEUR
VERTEILERKAPPEN
TAPAS DEL DISTRIBUIDOR

Code		New code
806 098	E	
806 099	E	
806 235	E	
806 236	S	
806 237	S	
806 238	S	
806 240	S	
806 248	S	
806 252	S	
806 253	S	
806 257	S	
806 258	E	
806 261	E	
812 066	S	
812 073	S	
812 074	E	
812 075	S	
813 092	S	
813 099	S	
813 102	S	
813 107	S	
813 113	S	
813 117	S	
813 119	S	
813 122	S	
813 127	E	
813 128	E	
813 240	E	
813 248	S	
813 251	E	
813 252	S	
813 256	S	
813 257	S	
813 259	E	
813 262	S	
813 267	S	
813 272	E	

E	Dropped	Eliminato	Éliminé	Gestrichen	Eliminado
→	New code	Nuovo codice	Nouvelle reference	Neue Teile-NR.	Nuevo codigo
S	Supplied until depletion	Fornibile fino ad esaurimento	Fourni jusqu'à l'épuisement du stock	Liefefar solange Vorrat reicht	Suministrado hasta el stock termina

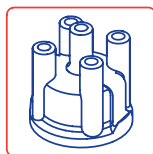

DISTRIBUTOR CAPS

CALOTTE
 TÊTES D'ALLUMEUR
 VERTEILERKAPPEN
 TAPAS DEL DISTRIBUIDOR

Code		New code
813 273	E	
815 041	E	
815 045	S	
815 049	S	
815 065	S	
815 066	S	
815 075	S	
815 077	E	
815 078	E	
815 084	S	
815 088	S	
817 014	E	
817 016	S	
819 083	S	
819 092	S	
819 093	S	
822 003	S	
822 004	E	
822 011	E	
822 022	S	
822 046	S	
822 058	E	
822 060	S	
822 063	E	
822 069	S	
822 071	S	
822 073	S	
822 075	S	
822 077	S	
822 079	S	
822 082	S	
822 084	E	
822 088	S	
822 092	E	
822 093	S	
828 070	S	
828 075	S	

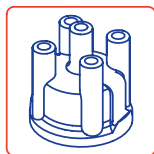

DISTRIBUTOR CAPS

CALOTTE
 TÊTES D'ALLUMEUR
 VERTEILERKAPPEN
 TAPAS DEL DISTRIBUIDOR

Code		New code
828 078	S	
828 083	S	
828 085	S	
828 094	E	
828 096	E	
828 099	E	
828 100	S	
828 102	S	
828 103	S	
828 106	S	
830 076	E	
830 093	S	
830 110	S	
831 116	S	
831 117	S	
831 122	S	
831 126	S	
831 131	S	
831 132	S	
831 135	E	
831 136	E	
831 137	S	
831 140	S	
831 147	E	
831 149	S	
831 151	S	
831 152	S	
831 154	E	
831 155	S	
831 158	S	
831 169	E	
847 027	S	

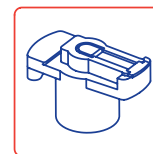

ROTORS

DISTRIBUTORI
 DISRUPTEURS
 VERTEILERLÄUFER
 ROTORES DEL DISTRIBUIDOR

Code		New code
906 021R	S	
906 034R	E	
906 045R	E	
906 113R	E	
906 117R	E	
906 119R	S	
906 122R	E	
906 125R	S	
912 090	S	
912 093	E	
912 097	E	
913 010	E	
913 034	S	
915 080	E→	915 091
915 088R	E	
915 096R	S	
919 092	S	
919 094R	E	
922 052	S	
922 056	S	
922 070	S	
922 081	E	
922 086	S	
922 097R	E	
928 014	S	
928 021	S	
928 025	S	
930 036R	S	
930 041	E	
930 042R	S	
930 051R	E	
930 058	E	
931 023	S	
931 030	S	
931 107	S	
931 133	S	
931 137	S	

E	Dropped	Eliminato	Éliminé	Gestrichen	Eliminado
→	New code	Nuovo codice	Nouvelle reference	Neue Teile-NR.	Nuevo codigo
S	Supplied until depletion	Fornibile fino ad esaurimento	Fourni jusqu'à l'épuisement du stock	Lieferbar solange Vorrat reicht	Suministrado hasta el stock termina



VARIATIONS COMPARED TO PREVIOUS CATALOGUE EDITION

•VARIAZIONI RISPETTO AI PRECEDENTI CATALOGHI •VARIATIONS RAPPORTÉES AUX CATALOGUES PRÉCÉDENTS
 •ÄNDERUNGEN IM VERGLEICH ZU FRÜHEREN KATALOGAUSGABEN •VARIACIONES CON RESPECTO A CATALOGOS ANTERIORES

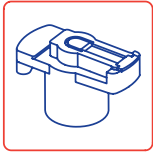

ROTORS

DISTRIBUTORI
DISRUPTEURS
VERTEILERLÄUFER
ROTORES DEL DISTRIBUIDOR

Code	New code
946 016R	S

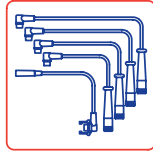

IGNITION CABLE SETS

SERIE CAVI ACCENSIONE COMPLETA
JEUX CABLES D'ALLUMAGE
ZÜNDKABELSÄTZE
JUEGOS DE CABLES DE ENCENDIDO

Code	New code
358 004	S
358 005	E
358 020	S
358 028	E
358 049	S
358 059	S
358 061	S
358 064	S
358 069	E
358 100	E
358 107	E
358 111	S
358 120	S
358 159	E
358 181	E
358 195	E
358 199	E
358 214	S
358 231	E
358 236	S
358 239	S
358 241	S
358 245	S
358 247	S
358 251	S
359 351	S
359 354	S
359 372	S
359 386	S
359 398	S
359 415	E
359 417	E
359 429	E
359 432	S
359 456	E
359 466	S
359 471	S

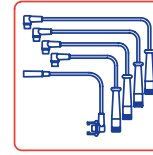

IGNITION CABLE SETS

SERIE CAVI ACCENSIONE COMPLETA
JEUX CABLES D'ALLUMAGE
ZÜNDKABELSÄTZE
JUEGOS DE CABLES DE ENCENDIDO

Code	New code
359 491	E
359 493	S
359 494	S
359 507	S
359 509	S
359 511	E
359 513	E
359 514	S
359 527	E
359 539	E
359 543	E
359 572	E
359 573	E
359 578	E
359 587	E
359 608	S
359 609	E
359 612	E
359 613	E
359 623	S
359 634	S
359 650	E
359 655	E
359 660	E
359 666	E
359 674	S
359 688	S
359 689	S
359 692	E
359 694	S
359 700	E
359 716	S
359 725	S
359 727	E
359 736	S
359 737	S
359 747	E

E	Dropped	Eliminato	Éliminé	Gestrichen	Eliminado
→	New code	Nuovo codice	Nouvelle reference	Neue Teile-NR.	Nuevo codigo
S	Supplied until depletion	Fornibile fino ad esaurimento	Fourni jusqu'à l'épuisement du stock	Lieferbar solange Vorrat reicht	Suministrado hasta el stock termina

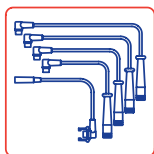

IGNITION CABLE SETS

SERIE CAVI ACCENSIONE COMPLETA
JEUX CABLES D'ALLUMAGE
ZÜNDKABELSÄTZE
JUEGOS DE CABLES DE ENCENDIDO

Code		New code
359 748	E	
359 768	E	
359 801	S	
359 802	S	
359 808	E	
359 815	E	
359 839	E	
359 864	E	
359 884	E	
359 887	S	
359 888	S	
359 889	E	
359 900	E	
359 956	E	
360 007	S	
360 025	S	
360 078	S	
360 138	E	
360 140	E	
360 145	S	
360 209	S	
360 231	E	
360 237	S	
360 278	S	
360 281	E	
360 300	S	
360 323	E	
360 332	S	
360 343	E	
360 344	E	
360 345	S	
360 353	E	
360 356	E	
360 363	S	
360 364	S	
360 373	E	
360 374	E	

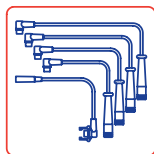

IGNITION CABLE SETS

SERIE CAVI ACCENSIONE COMPLETA
JEUX CABLES D'ALLUMAGE
ZÜNDKABELSÄTZE
JUEGOS DE CABLES DE ENCENDIDO

Code		New code
360 376	E	
360 385	S	
360 393	E	
360 398	E	
360 399	E	
360 401	E	
360 411	S	
360 413	S	
360 415	S	
360 417	E	
360 420	E	
360 433	E	
360 434	E	
360 435	E	
360 443	E	
360 446	S	
360 447	E	
360 479	E	
360 484	E	
360 489	S	
360 491	S	
360 492	E	
360 497	S	
360 499	S	
360 501	E	
360 506	E	
360 508	E	
360 509	S	
360 511	S	
360 518	E	
360 529	S	
360 531	S	
360 549	E	
360 551	S	
360 559	S	
360 562	E	
360 580	S	

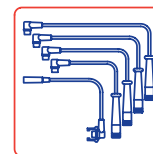

IGNITION CABLE SETS

SERIE CAVI ACCENSIONE COMPLETA
JEUX CABLES D'ALLUMAGE
ZÜNDKABELSÄTZE
JUEGOS DE CABLES DE ENCENDIDO

Code		New code
360 595	E	
360 607	E	
360 608	E	
360 609	S	
360 614	S	
360 619	S	
360 624	S	
360 630	S	
360 634	S	
360 639	S	
360 640	S	
360 641	S	
360 643	S	
360 649	S	
360 654	E	
360 657	E	
360 658	E	
360 660	S	
360 667	E	
360 671	E	
360 677	E	
360 680	S	
360 682	E	
360 686	E	
360 691	S	
360 699	S	
360 702	S	
360 709	E	
360 711	S	
360 719	S	
360 723	S	
360 729	E	
360 730	S	
360 731	S	
360 732	S	
360 738	E	
360 739	S	

E	Dropped	Eliminato	Éliminé	Gestrichen	Eliminado
→	New code	Nuovo codice	Nouvelle reference	Neue Teile-NR.	Nuevo codigo
S	Supplied until depletion	Fornibile fino ad esaurimento	Fourni jusqu'à l'épuisement du stock	Lieferbar solange Vorrat reicht	Suministrado hasta el stock termina

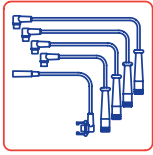

IGNITION CABLE SETS

SERIE CAVI ACCENSIONE COMPLETA
 JEUX CABLES D'ALLUMAGE
 ZÜNDKABELSÄTZE
 JUEGOS DE CABLES DE ENCENDIDO

Code		New code
360 740	S	
360 741	E	
360 745	S	
360 753	S	
360 760	E	
360 764	E	
360 767	S	
360 789	E	
360 792	E	
360 793	E	
360 813	S	
360 817	E	
360 819	S	
360 823	S	
360 835	S	
360 841	S	
360 851	S	
360 856	S	
360 878	E	
360 879	E	
360 880	S	
360 882	E	
360 883	S	
360 887	S	
360 888	S	
360 900	S	
360 904	S	
360 914	S	
360 921	E	
360 932	S	
360 933	E	
360 937	S	
360 942	E	
360 947	S	
360 954	E	
360 955	E	
360 962	E	

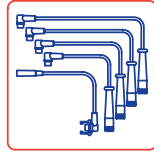

IGNITION CABLE SETS

SERIE CAVI ACCENSIONE COMPLETA
 JEUX CABLES D'ALLUMAGE
 ZÜNDKABELSÄTZE
 JUEGOS DE CABLES DE ENCENDIDO

Code		New code
360 963	E	
360 976	E	
360 984	E	
360 990	E	

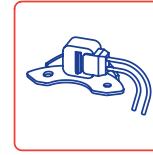

PICK-UPS

IMPULSORI
 CAPTEURS
 IMPULSGEBER
 CAPTADORES

Code		New code
406 153	E	
406 160	S	
430 161/1	S	
430 163/1	S	
430 176M	S	
430 177/1	S	
430 180M	S	

E	Dropped	Eliminato	Éliminé	Gestrichen	Eliminado
→	New code	Nuovo codice	Nouvelle reference	Neue Teile-NR.	Nuevo codigo
S	Supplied until depletion	Fornibile fino ad esaurimento	Fourni jusqu'à l'épuisement du stock	Lieferbar solange Vorrat reicht	Suministrado hasta el stock termina

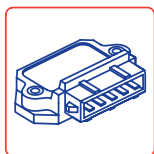

IGNITION MODULES

MODULI DI ACCENSIONE
 MODULES D'ALLUMAGE
 ZÜNDMODULE
 MÓDULOS DE ENCENDIDO

Code		New code
465 007	E	
465 068	E	
465 073	E	

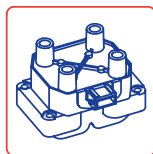

IGNITION COILS

BOBINE DI ACCENSIONE
 BOBINES D'ALLUMAGE
 ZÜNDSPULEN
 BOBINAS DE ENCENDIDO

Code		New code
470 107	E	
470 109	E	
470 110	E→	470 341
470 155	S	
470 159	E	
470 191	E	
470 197	E	
470 199	E	
470 201	E	
470 211	E	
470 212	E	
470 216	E	
470 252	E	
470 273	E	
470 276	E	
470 283	E	
470 284	E	
470 285	E→	470 285S
470 289	E	
470 299	E	
470 299S	E	
470 312	E	
470 313	E	
470 316	E	
470 316K	E	
470 317	E	
470 344	E	
470 352	E	
470 364	E	
470 366S	E	
470 376	S	
470 377	E→	470 596
470 378	S	
470 389	S	
470 393	E	
470 412	E	
470 413	E	

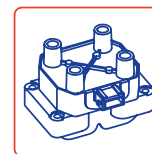

IGNITION COILS

BOBINE DI ACCENSIONE
 BOBINES D'ALLUMAGE
 ZÜNDSPULEN
 BOBINAS DE ENCENDIDO

Code		New code
470 414	E	
470 416	E	
470 507	S	
470 557	S	
470 583	S	
490 307	E	
490 416	E	
490 423	E	

E	Dropped	Eliminato	Éliminé	Gestrichen	Eliminado
→	New code	Nuovo codice	Nouvelle reference	Neue Teile-NR.	Nuevo codigo
S	Supplied until depletion	Fornibile fino ad esaurimento	Fourni jusqu'à l'épuisement du stock	Lieferbar solange Vorrat reicht	Suministrado hasta el stock termina

GENERAL CONDITIONS OF SALE

1. SCOPE AND EFFECTIVENESS

All supplies of products made by Facet S.r.l. (the «Seller») to a customer (the «Buyer») are governed by these general terms and conditions which shall prevail on purchase conditions of the Buyer, as well as by any special conditions provided for in offers and/or order confirmations by the Seller. In the case of conflict between the general terms and conditions and the special conditions, the latter shall prevail. The data and illustrations relating to products appearing in the Seller's catalogues or brochures are indicative in nature and not binding, unless expressly provided so in the order confirmation by the Seller and may be subject to changes in design and materials without notice. The original product codes indicated in the catalogues and in other documents are mentioned only for the purpose of identifying the spare parts. The Seller supplies only products of its own production identified with its own product codes and not products having OE codes.

2. COMPLETION OF THE CONTRACT

The supply contract is considered being completed only on the Seller's written confirmation accepting the Buyer's order. The Seller reserves the right not to accept orders in cases where there is a dispute with the customer relating to a previous order.

3. PRICES AND PAYMENTS

Unless otherwise agreed, payments of the price must be carried out by the Buyer in accordance with the terms and conditions provided and using the method provided for in the order confirmation at the domicile of the Seller. Payments made by the Buyer to finders and/or agents without a special Power of Attorney will not be enforceable on the Seller. In the event of a delay in payment, the Buyer will be liable for the payment of late payment default interest at the rate of the European Central Bank in force on that date plus 7 (seven) points. In every case, the Seller has the right to ask for compensation for the greater damage suffered. The Buyer will not for any reason, except with written authorisation, be able to off-set or retain sums due to the Seller, nor will he be able to suspend payments. The prices of the products are to be considered in Euros and do not include VAT, packaging, transport and insurance costs. The Seller may change the prices and rates in force at any time and without notice, except for ongoing orders. Price increases are possible for increases in raw materials, labour, transport, insurance premiums, etc.

4. TERMS OF DELIVERY AND PRODUCTION

Unless otherwise stated in the order confirmation, supplies of the products are intended for goods delivered in accordance with Incoterms 2010: FCA Orbassano. The goods always travel on behalf of and at the risk of the Buyer.

The terms of delivery are indicative and in the event of delay the Buyer is not entitled to request termination of the contract and/or compensation for damages.

5. RETENTION OF TITLE

The delivered products remain the property of the Seller until full payment of the price has been received.

The Buyer shall have the right to sell the purchased products, or the new products which incorporate the products supplied by the Seller, on the understanding that in such cases, all the proceeds will be transferred to the Seller right down to the agreed price due from the Buyer to the Seller for the supply of such products.

The right to sell the products shall lapse if the Buyer has failed to comply with payment obligations for a period greater than 20 (twenty) working days after the payment deadline. In such event, it will be the responsibility of the Seller to revoke the right to sell in writing to the Buyer. The Buyer should put in place every measure necessary for the protection of the products subject to the retention of title, and any other measure necessary to not confuse the products of the Seller with products from other suppliers and keep the products of the Seller in well defined areas and easily identifiable.

6. RESPONSIBILITY OF THE SELLER AND LIMITS

The Seller is exclusively responsible for the correct production of products supplied, which will require to have all the features provided by the Seller in the order confirmation. The Seller does not assume any responsibility, however, for possible faulty operation of machines or systems made by the Buyer using products supplied by the Seller.

The products must be properly installed by trained and qualified technicians only, in accordance with the vehicle specifications and complying with the requirements of national regulations.

In such cases, the Buyer will not be able seek damages for lost profits, loss of production, reputational damages, vehicle breakdown.

The liability of the Seller is, however, limited to the value of the goods supplied, unless due to serious negligence or willful misconduct within the meaning of the law.

7. FORCE MAJEURE

Should the Seller be unable to comply with the contract for reasons of force majeure or independent factors outside his control, the deadlines for the supply shall be automatically extended for a period equivalent to the lingering effects of the force majeure event. The following are to be regarded as causes of force majeure (without limitation): lack of energy or raw materials, strikes, public administration measures, impediments to circulation or to production activities.

8. COMPLAINTS and ACCEPTANCE OF PRODUCTS

Any complaint concerning the non-conformity of the goods delivered or for damages caused by transportation or for any missing quantities with respect to the products ordered, must be communicated by registered letter, with receipt acknowledgment, addressed directly to the Seller within 8 (eight) days from the date of delivery of the products in the case of visible defects and within 8 (eight) days from the discovery in the case of hidden defects, and in any case, within a month from delivery, with a detailed explanation of the facts. In the event of non-compliance with the above, the amounts invoiced are considered, to all effects, accepted and no longer contestable by the Buyer.

The return of goods will not be accepted unless previously agreed in writing by the Seller.

9. CONFORMITY TO THE SPECIFICATIONS AND GUARANTEE TERMS

The Seller guarantees that the products will be compliant with the technical specifications declared by the Seller to the Buyer in the order confirmation and the guarantee will be valid for 2 (two) years from the date of delivery of the products and for products or parts replaced, from the day of their replacement.

During the guarantee period, the Seller to whom the Buyer has made a formal notice of the defects, undertakes, at his own discretion, and within a reasonable period of time, to repair or replace the products or the defective parts free of charge. The costs and risks of transportation of the defective products to the Seller's address are borne by the Buyer. The replaced products remain the property of the Seller.

The guarantee is considered lapsed where the end use of the product does not conform with the regular use of such products or not provided for in the catalogues of the Seller or if the products have been modified or repaired without the Seller's authorisation.

10. GUARANTEE OF THE SUITABILITY OF THE PRODUCTS ONLY TO EU RULES

The Seller guarantees that the products will conform to the standards of the European Union (EU) as they may be applicable.

No guarantee is issued by the Seller for the conformity of these products with the rules and regulations, expressly including those rules regarding safety and accident prevention, in force in the Buyer's country, where those reside outside the EU, or more generally, in any country that does not belong to the EU in which the supplied products are used.

11. CONFIDENTIALITY AND DATA PROTECTION

Documents of any kind provided by the Seller shall remain the Seller's property and cannot be transferred to a third party or reproduced. The Buyer undertakes, even after the end of the contract, not to disclose commercial secrets and confidential information that the Buyer has been party to or which has come to his knowledge in the course of his relationship with the Seller.

The Seller herewith declares that he will use the personal data transferred by the Customer in respect of the terms provided under the Italian privacy law (Legislative Decree n. 196/03).

12. TERMINATION OF THE CONTRACT

The contract may be terminated pursuant to art. 1456 of the Italian Civil Code by virtue of a simple written declaration on the part of the Seller, taking advantage of this termination clause if the Buyer:

- omits or delays payments due;

- is placed in liquidation or has been subject to any insolvency proceedings.

13. INTELLECTUAL PROPERTY

The Seller retains the intellectual property of projects, studies, drawings, models and products which are realised or made in his name and on his behalf. The brands under which the products are sold may not be used by the Buyer if they are not identified as such.

14. APPLICABLE LAW AND DISPUTE RESOLUTION CLAUSE

All contracts with the Seller shall be governed by Italian law. Any dispute will be referred to the exclusive jurisdiction of the Court of Turin.

Date: _____ Stamp, Name, Surname and Signature of the Buyer: _____

Pursuant to articles. 1341 and 1342 of the Italian Civil Code, the Buyer declares to have read and specifically approved the terms contained in the following articles of general conditions: art. 3 Set-off Prohibition; art. 5 Retention of title; art. 6 Limitation of Liability; art. 8 Complaints and Acceptance of Products; art. 14 Dispute Resolution Clause.

Date: _____ Stamp, Name, Surname and Signature of the Buyer: _____

CONDIZIONI GENERALI DI VENDITA

1. AMBITO DI APPLICAZIONE E EFFICACIA

Tutte le forniture di prodotti effettuate da Facet S.r.l. (il "Venditore") a un cliente (l'"Acquirente") sono disciplinate dalle presenti condizioni generali che prevalgono sulle condizioni d'acquisto dell'Acquirente, nonché dalle condizioni particolari previste nelle offerte e/o conferme d'ordine del Venditore. In caso di contrasto fra quanto contenuto nelle condizioni generali e nelle condizioni particolari, queste ultime prevarranno.

I dati e le illustrazioni relative ai prodotti risultanti dai cataloghi o prospetti del Venditore hanno carattere indicativo e non valore vincolante se non espressamente previsto nella conferma d'ordine del Venditore e possono essere soggetti a modifiche di disegno e materiale senza preavviso.

I numeri originali (OE) indicati nei cataloghi od in altri documenti sono menzionati solamente al fine di identificare le parti di ricambio. Il venditore fornisce unicamente prodotti di propria produzione contrassegnati con il proprio codice articolo e non prodotti con i numeri OE.

2. FORMAZIONE DEL CONTRATTO

Il contratto di fornitura si perfeziona con la conferma scritta del Venditore di accettazione dell'ordine dell'Acquirente. Il Venditore si riserva il diritto di non accettare ordini nel caso in cui vi sia una controversia con il cliente relativa ad un ordine precedente.

3. PREZZI E PAGAMENTI

Salvo diverso accordo, i pagamenti del prezzo devono essere effettuati dall'Acquirente nei termini e con le modalità previsti nella conferma d'ordine presso il domicilio del Venditore. I pagamenti fatti dall'Acquirente a procuratori e/o agenti senza una procura specifica non saranno opponibili al Venditore.

In caso di ritardo nei pagamenti, l'Acquirente sarà tenuto al pagamento degli interessi moratori pari al tasso della Banca Centrale Europea in vigore a quella data, maggiorato di 7 (sette) punti, salvo in ogni caso la facoltà per il Venditore di chiedere il risarcimento del maggior danno subito.

L'Acquirente non potrà per qualunque motivo, salvo autorizzazione scritta, compensare o trattenere somme dovute al venditore, né potrà sospendere i pagamenti.

I prezzi dei prodotti si intendono in Euro e non comprendono IVA, imballo, spese di trasporto e assicurazione. Il Venditore può modificare i prezzi e le tariffe in vigore in ogni momento e senza preavviso, salvo per gli ordini in corso. Ciò se si verificano rincari delle materie prime, della manodopera, dei trasporti, dei premi d'assicurazione, etc.

4. TERMINI DI CONSEGNA E RESA

Se non diversamente stabilito nella conferma d'ordine, le forniture dei prodotti si intendono per merce resa secondo Incoterms 2010: FCA Orbassano. La merce viaggia sempre per conto e rischio dell'Acquirente.

I termini di consegna si intendono indicativi e in caso di ritardo l'Acquirente non ha il diritto di richiedere la risoluzione del contratto e/o il risarcimento dei danni.

5. RISERVA DI PROPRIETÀ

I prodotti consegnati restano di proprietà del Venditore fino al completo pagamento del relativo prezzo.

L'Acquirente avrà il diritto di vendere i prodotti acquistati, o i nuovi prodotti in cui i prodotti fornitigli dal Venditore siano stati incorporati, fermo restando che in tal caso tutti i proventi verranno trasferiti al Venditore fino alla concorrenza del prezzo dovuto dall'Acquirente al Venditore per la fornitura di tali Prodotti.

Tale diritto di vendere i prodotti decade qualora l'Acquirente sia rimasto inadempiente all'obbligo di pagamento per un periodo di tempo superiore a 20 (venti) giorni lavorativi rispetto alla scadenza. A tal fine, sarà onere del Venditore comunicare per iscritto all'Acquirente la revoca del diritto a vendere. L'Acquirente dovrà porre in essere ogni misura necessaria per la protezione dei prodotti oggetto della riserva di proprietà, nonché ogni misura per non confondere i prodotti del Venditore con i prodotti di altri fornitori e conservare i prodotti del Venditore in spazi ben delimitati e facilmente individuabili.

6. RESPONSABILITÀ DEL VENDITORE E LIMITI

Il Venditore è esclusivamente responsabile della corretta produzione dei prodotti forniti, che dovranno avere le caratteristiche previste nella conferma d'ordine del Venditore. Il Venditore non assume, invece, alcuna responsabilità per l'eventuale difettoso funzionamento di macchine o sistemi realizzati dall'Acquirente con i prodotti forniti dal Venditore.

I prodotti devono essere installati in modo appropriato solo da tecnici competenti e qualificati, conformemente alle specifiche del veicolo e rispettando i requisiti delle normative nazionali.

In ogni caso, l'Acquirente non potrà chiedere il risarcimento dei danni per mancato profitto, perdita di produzione, perdita di immagine, fermo dell'autoveicolo.

La responsabilità del Venditore è, comunque, limitata al valore della merce fornita, salvo dolo o colpa grave ai sensi di legge.

7. FORZA MAGGIORE

Qualora il Venditore sia impossibilitato a rispettare il contratto per cause di forza maggiore o comunque indipendenti dalla sua volontà, i termini previsti per l'esecuzione della fornitura sono automaticamente prorogati per un periodo equivalente al perdurare degli effetti dell'evento di forza maggiore. A tal fine, sono da considerarsi cause di forza maggiore, ai fini esplicativi e non esaustivi: carenza di energia o di materie prime, scioperi, provvedimenti della pubblica amministrazione, impedimenti alla circolazione o alle attività produttive.

8. RECLAMI ed ACCETTAZIONE DEI PRODOTTI

Qualsiasi reclamo relativo alla non conformità delle merci consegnate o per danni conseguenti al trasporto o per eventuali quantità mancanti rispetto ai prodotti ordinati dovrà essere comunicato per lettera raccomandata con avviso di ricezione indirizzata direttamente al venditore entro 8 (otto) giorni dalla data di consegna dei Prodotti, in caso di vizi palesi ed entro 8 (otto) giorni dalla scoperta in caso di vizi occulti, e, comunque, entro un mese dalla consegna, con una dettagliata esposizione dei fatti. In difetto, gli importi fatturati si intenderanno, a tutti gli effetti, accettati e non più contestabili dall'Acquirente. Non si accettano rese delle merci se non preventivamente autorizzate per iscritto dal Venditore.

9. CONFORMITÀ ALLE SPECIFICHE E TERMINI DI GARANZIA

Il Venditore garantisce che i prodotti saranno conformi alle specifiche tecniche dichiarate dal Venditore stesso all'Acquirente nella conferma d'ordine e detta garanzia avrà validità per 2 (due) anni decorrenti dalla data di consegna dei prodotti e, per i prodotti o componenti sostituiti, dal giorno della loro sostituzione.

Nel periodo di garanzia, il Venditore al quale l'Acquirente abbia denunciato i difetti, si impegna, a sua scelta, entro un termine ragionevole, a riparare o sostituire gratuitamente i prodotti o le parti di esse che fossero risultati difettosi. Le spese e i rischi per il trasporto dei prodotti risultati difettosi alla sede del Venditore sono a carico dell'Acquirente. I prodotti sostituiti restano di proprietà del Venditore.

La garanzia decade nel caso di utilizzo non conforme alla destinazione finale abituale dei prodotti o non prevista nei cataloghi del venditore oppure se i prodotti sono stati modificati o riparati senza l'autorizzazione del Venditore.

10. GARANZIA PER L'ADEGUATEZZA DEI PRODOTTI ALLE SOLE NORME UE

Il Venditore garantisce che i Prodotti saranno conformi alle norme dell'Unione europea (UE) a essi eventualmente applicabili.

Nessuna garanzia viene rilasciata dal Venditore in merito alla conformità di tali Prodotti con le norme e i regolamenti, ivi espressamente incluse le norme in tema di sicurezza e di antinfortunistica, in vigore nella nazione dell'Acquirente, ove questi risieda al di fuori della UE, o più in generale, in qualsivoglia nazione che non appartenga alla UE in cui i Prodotti forniti vengono utilizzati.

11. RISERVATEZZA E TUTELA DEI DATI

I documenti di qualsiasi natura forniti dal Venditore rimarranno di sua proprietà e non possono essere trasferiti a terzi o riprodotti. L'Acquirente si impegna, anche dopo la fine del contratto a non divulgare i segreti commerciali e le informazioni riservate che siano state al medesimo comunicati o dei quali venga a conoscenza nel corso del suo rapporto con il Venditore.

Il Venditore con le presenti dichiara che utilizzerà i dati personali trasferiti dal Cliente nel rispetto delle previsioni del codice italiano sulla privacy (Decreto Legislativo n. 196/03).

12. RISOLUZIONE DEL CONTRATTO

Il contratto di fornitura potrà essere risolto di diritto ai sensi dell'art. 1456 c.c. per effetto della semplice dichiarazione scritta del Venditore di avvalersi della presente clausola risolutiva espressa qualora l'Acquirente:

- Ometta o ritardi i pagamenti dovuti;
- Venga posto in liquidazione o sia stato assoggettato ad una qualsiasi procedura concorsuale.

13. PROPRIETÀ INTELLETTUALE

Il Venditore conserva la proprietà intellettuale dei progetti, degli studi, dei disegni, dei modelli e dei prodotti che realizza o che vengono realizzati a suo nome e per suo conto. I marchi sotto quali i prodotti sono venduti non possono essere utilizzati dall'Acquirente se non per identificarli.

14. LEGGE APPLICABILE E MODALITÀ DI RISOLUZIONE DELLE CONTROVERSIE

Tutti i contratti con il Venditore saranno disciplinati dalla legge italiana. Qualsiasi controversia sarà devoluta alla competenza esclusiva del Foro di Torino.

Data: _____ Timbro, Nome Cognome e firma dell'Acquirente: _____

Ai sensi degli artt. 1341 e 1342 c.c. l'Acquirente dichiara di avere letto e approvato specificamente le previsioni contenute nei seguenti articoli delle condizioni generali: art. 3 Divieto di compensazione art. 5 Riserva di proprietà; art. 6 Limitazione della responsabilità; art. 8 Reclami ed accettazione dei Prodotti; art. 14 Modalità di risoluzione delle controversie.

Data: _____ Timbro, Nome Cognome e firma dell'Acquirente: _____

CONDITIONS GÉNÉRALES DE VENTES

1. DOMAINE D'APPLICATION ET EFFICACITÉ

Toutes les fournitures de produits effectuées par Facet S.r.l. (le « Vendeur ») à un client (l'« Acheteur ») sont régies par les présentes conditions générales qui l'emportent sur les conditions générales d'achat de l'Acheteur ainsi que sur les conditions particulières établies dans les offres et/ou confirmations de commande du Vendeur. En cas de contraste entre ce qui est exposé dans les conditions générales et dans les conditions particulières, ces dernières l'emporteront.

Les données et les illustrations relatives aux produits telles qu'elles figurent aux catalogues ou brochures du Vendeur ont un caractère indicatif et n'ont aucune valeur contraignante sauf disposition contraire expresse dans la confirmation de commande du Vendeur et elles sont susceptibles de modifications sans préavis concernant le dessin et le matériel.

Les codes originaux (OE) indiqués dans les catalogues ou dans autres documents sont mentionnés uniquement pour identifier les pièces de rechange. Le Vendeur livre seulement produits de propre production et avec propre code article et non produits avec codes OE.

2. FORMATION DU CONTRAT

Le contrat de fourniture sera finalisé par la confirmation écrite du Vendeur d'acceptation de la commande de l'Acheteur. Le Vendeur se réserve le droit de ne pas accepter de commande en cas de litige en cours avec le client concernant une commande précédente.

3. PRIX ET PAIEMENTS

Sauf si les parties n'en conviennent autrement, les paiements du prix doivent être effectués par l'Acheteur dans les délais et aux conditions établis dans la confirmation de commande au domicile du Vendeur. Les paiements effectués par l'Acheteur à des apporteurs d'affaires et/ou agents sans mandat spécifique ne seront pas opposables au Vendeur.

En cas de retard de paiement, l'Acheteur sera tenu de verser des intérêts de retard au taux de la Banque Centrale Européenne en vigueur à la date en question, majoré de 7 (sept) points, sans préjudice de la faculté du Vendeur de demander les dommages intérêts pour tout dommage ultérieur.

L'Acheteur ne pourra pas, pour quelque raison que ce soit, sauf autorisation écrite, compenser ou garder toute somme due au Vendeur et il ne pourra non plus suspendre les paiements.

Les prix des produits s'entendent en Euros et sont hors TVA, emballage, frais de transport et d'assurance. Le Vendeur peut modifier les prix et les tarifs en vigueur à n'importe quel moment et sans préavis, sauf pour les commandes en cours. Cela en cas de renchérissement des matières premières, de la main d'œuvre, des transports, des prix d'assurance, etc.

4. DÉLAIS DE LIVRAISON ET MISE À DISPOSITION

Sauf si les parties n'en conviennent autrement dans la confirmation de commande, les fournitures des produits s'entendent pour mise à disposition de la marchandise selon les Incoterms 2010: FCA Orbassano. La marchandise voyage toujours pour le compte et aux risques et périls de l'Acheteur.

Les délais de livraison sont indicatifs et en cas de retard l'Acheteur n'aura aucun droit de demander la résiliation du contrat et/ou les dommages-intérêts.

5. RÉSERVE DE PROPRIÉTÉ

Les produits livrés restent la propriété du Vendeur jusqu'au complet paiement du prix relatif.

L'Acheteur aura le droit de vendre les produits achetés, ou les nouveaux produits ayant intégré les produits fournis par le Vendeur, étant entendu qu'en ce cas-là tous les revenus seront transférés au Vendeur jusqu'à concurrence du prix dû par l'Acheteur au Vendeur pour la fourniture desdits Produits.

Ce droit de vendre les produits expire dès lors que l'Acheteur n'aurait pas accompli son obligation de paiement pour une période de plus de 20 (vingt) jours ouvrables à partir de l'échéance. À cet effet, il incombe au Vendeur d'informer par écrit l'Acheteur de la révocation du droit de vendre. L'Acheteur devra mettre en œuvre toute mesure nécessaire pour la protection des produits faisant l'objet de la réserve de propriété ainsi que toute mesure permettant de ne pas confondre les produits du Vendeur avec les produits d'autres fournisseurs et de garder les produits du Vendeur dans des espaces bien délimités et facilement identifiables.

6. RESPONSABILITÉ DU VENDEUR ET LIMITATIONS

Le Vendeur ne sera responsable que de la bonne production des produits fournis, qui devront avoir les caractéristiques indiquées dans la confirmation de commande du Vendeur. Par contre, le Vendeur ne prend aucune responsabilité concernant l'éventuel mauvais fonctionnement de machines ou systèmes réalisés par l'Acheteur avec les produits fournis par le Vendeur.

Les produits doivent être correctement installés seulement par des techniciens formés et qualifiés, conformément aux spécifications du véhicule et en respect des réglementations nationales.

De toute manière, l'Acheteur ne pourra pas demander de dommages-intérêts pour manque à gagner, perte de production, perte d'image, immobilisation du véhicule automobile.

La responsabilité du Vendeur est de toute manière limitée à la valeur de la marchandise fournie, sauf en cas de dol ou de faute grave aux termes de la loi.

7. FORCE MAJEURE

Au cas où le Vendeur serait empêché de respecter le contrat pour des raisons de force majeure ou de toute manière indépendantes de sa volonté, les délais prévus pour l'exécution de la fourniture seront automatiquement prorogés d'une période correspondant à la durée des effets de l'événement de force majeure. À cet effet, on entend pour raisons de force majeure, à titre purement explicatif et non exhaustif : pénurie d'énergie ou de matières premières, grèves, mesures de l'administration publique, entraves à la circulation ou aux activités productives.

8. RÉCLAMATIONS et ACCEPTATION DES PRODUITS

Toute réclamation pour la non conformité des marchandises livrées ou pour des dommages découlant du transport ou pour des quantités manquantes par rapport aux produits commandés devra être communiquée par lettre recommandée avec avis de réception adressée directement au Vendeur dans un délai de 8 (huit) jours de la date de livraison des Produits, en cas de vices apparents et dans un délai de 8 (huit) jours de la découverte de vices cachés et, de toute manière, dans le délai d'un mois de la livraison, accompagnée de l'exposition détaillée des faits. À défaut de cela, les montants facturés seront considérés acceptés, à tous les effets, et ne seront plus contestables par l'Acheteur.

Aucun retour de marchandises ne sera accepté sans l'autorisation préalable écrite du Vendeur.

9. CONFORMITÉ AUX SPÉCIFICATIONS ET TERMES DE GARANTIE

Le Vendeur garantit que les produits seront conformes aux spécifications techniques déclarées par le Vendeur même à l'Acheteur dans la confirmation de commande et ladite garantie sera valable pour 2 (deux) ans à partir de la date de livraison des produits et, pour les produits ou les composants remplacés, à partir du jour de leur remplacement.

Pendant la période de garantie, le Vendeur auquel l'Acheteur aurait dénoncé les défauts, s'engage, de son choix, à réparer ou remplacer gratuitement dans un délai raisonnable les produits ou leurs parties résultant défectueux. Les frais et les risques du transport chez le Vendeur des produits résultant défectueux sont à la charge de l'Acheteur. Les produits remplacés restent la propriété du Vendeur.

La garantie expire en cas d'utilisation non conforme à la destination finale habituelle des produits ou non prévue dans les catalogues du vendeur ou bien si les produits ont été modifiés ou réparés sans l'autorisation du Vendeur.

10. GARANTIE DE LA CONFORMITÉ DES PRODUITS AUX SEULES NORMES UE

Le Vendeur garantit que les Produits seront conformes aux normes de l'Union européenne (UE) qui leur seront éventuellement applicables.

Le Vendeur ne délivre aucune garantie concernant la conformité de ces Produits aux normes et règlements, y compris expressément les normes en matière de sécurité et accidents, en vigueur dans la nation de l'Acheteur, si ce dernier est résident en dehors de l'UE ou, plus en général, en quelque nation que ce soit n'appartenant pas à l'UE dans laquelle les Produits fournis sont utilisés.

11. CONFIDENTIALITÉ ET PROTECTION DES DONNÉES

Les documents de quelque nature que ce soit fournis par le Vendeur resteront sa propriété et ne pourront être transférés à des tiers ou reproduits. L'Acheteur s'engage, également après la fin du contrat, à ne pas divulguer à des tiers les secrets commerciaux ou les informations réservées lui ayant été communiqués et dont il viendrait à connaissance au cours de son rapport avec le Vendeur.

Par les présentes le Vendeur déclare qu'il utilisera les données personnelles communiquées par le Client dans le respect des dispositions du code italien en matière de confidentialité (Décret Législatif n. 196/03).

12. RÉSILIATION DU CONTRAT

Le contrat de fourniture pourra être résilié de plein droit aux termes de l'art.1456 du code civil par la simple déclaration écrite du Vendeur de se prévaloir de la présente clause résolutoire expresse dans les cas suivants :

- en cas de défaut ou de retard de paiement de l'Acheteur
- si l'Acheteur est mis en liquidation judiciaire ou a été soumis à une procédure collective.

13. PROPRIÉTÉ INTELLECTUELLE

Le Vendeur garde la propriété intellectuelle des projets, des études, des dessins, des modèles et des produits qu'il réalise ou qui sont réalisés en son nom ou pour son compte. Les marques sous lesquelles les produits sont vendus ne peuvent être utilisées par l'Acheteur que pour les identifier.

14. LOI APPLICABLE ET MODALITÉS DE RÈGLEMENT DES LITIGES

Tous les contrats avec le Vendeur seront régis par le droit italien. Tout litige sera soumis à la compétence exclusive du Tribunal de Turin.

Date: _____ Cachet, Prénom Nom et signature de l'Acheteur: _____

Aux termes des articles 1341 et 1342 du c.v. l'Acheteur déclare avoir lu et approuvé spécifiquement les dispositions des articles suivants des conditions générales : art. 3 Interdiction de compensation art. 5 Réserve de propriété; art. 6 Limitation de la responsabilité; art. 8 Réclamation et Acceptation des Produits; art. 14 Modalités de règlement des litiges.

Date: _____ Cachet, Prénom Nom et signature de l'Acheteur: _____

ALLGEMEINE VERKAUFSBEDINGUNGEN

1. GELTUNGSBEREICH UND WIRKSAMKEIT

Für alle Lieferungen von Produkten durch die Gesellschaft Facet S.r.l. (der "Verkäufer") an einen Kunden (der "Käufer") gelten die vorliegenden allgemeinen Verkaufsbedingungen, die vor den Einkaufsbedingungen des Käufers sowie den besonderen Bedingungen in den Angeboten und/oder Auftragsbestätigungen des Verkäufers Vorrang haben. Sollten Widersprüche zwischen dem Inhalt der allgemeinen Bedingungen und dem Inhalt der besonderen Bedingungen bestehen, sind Letztere vorrangig.

Die Daten und Abbildungen in Bezug auf die Produkte in den Katalogen oder Broschüren des Verkäufers sind Beispiele und haben keinen bindenden Wert, wenn dies in der Auftragsbestätigung des Verkäufers nicht ausdrücklich vorgesehen ist. Zudem können diese Daten und Abbildungen Änderungen am Design und Material unterliegen, ohne dass diese vorher angekündigt werden müssen.

Die angegebenen Originalnummern in Katalogen oder anderen Dokumenten sind nur zum Zwecke der Identifikation angegeben. Der Verkäufer liefert nur Produkte aus eigener Produktion, die mit Facet Artikel-Nrn. und nicht OE P/Nr. identifiziert sind.

2. ZUSTANDEKOMMEN DES VERTRAGS

Der Liefervertrag kommt zustande, wenn der Verkäufer die Auftragsannahme des Käufers schriftlich bestätigt. Der Verkäufer behält sich das Recht vor, Aufträge nicht anzunehmen, wenn Streitigkeiten mit einem Kunden in Bezug auf einen vorhergehenden Auftrag vorliegen.

3. PREISE UND ZAHLUNGEN

Unbeschadet anderslautender Vereinbarungen, sind die Zahlungen vom Käufer innerhalb der in der Auftragsbestätigung vorgesehenen Zahlungsfristen und Modalitäten am Geschäftssitz des Verkäufers zu leisten. Zahlungen, die vom Käufer an Vermittler und/oder Vertreter geleistet werden, können ohne eine Sondervollmacht nicht beim Verkäufer geltend gemacht werden.

Im Fall von verspäteten Zahlungen ist der Käufer verpflichtet, Verzugszinsen in Höhe des von der Europäischen Zentralbank festgelegten und zu jenem Datum geltenden Zinssatzes zu zahlen, die um 7 (sieben) Prozent erhöht werden. Unbeschadet davon bleibt das Recht des Verkäufers, einen größeren Schaden geltend zu machen.

Der Käufer ist nicht befugt, aus welchem Grund auch immer, Summen, die dem Verkäufer zustehen, zu verrechnen oder einzubehalten oder die Zahlungen einzustellen, es sei denn, dies wurde schriftlich genehmigt.

Die Preise für die Produkte sind in Euro und ohne Mehrwertsteuer, Verpackung, Transportkosten und Versicherung angegeben. Der Verkäufer kann jederzeit geltende Preise und Tarife ohne Vorankündigung ändern. Dies gilt nicht für laufende Aufträge. Solche Änderungen können vorkommen, wenn sich die Preise für Rohstoffe, die Löhne, die Transportkosten und Versicherungspolizen usw. erhöhen.

4. LIEFERFRISTEN UND WARENRÜCKNAHME

Insofern nicht anders in der Auftragsbestätigung vereinbart, erfolgt die Lieferung der Produkte nach den Incoterms 2010: FCA (frei Frachtführer) Orbassano. Die Ware wird stets im Namen und auf Risiko des Käufers transportiert.

Die Lieferfristen verstehen sich als Richtzeiten. Im Fall von Verspätungen ist der Käufer nicht berechtigt, die Auflösung des Vertrags und Schadensersatz geltend zu machen.

5. EIGENTUMSVORBEHALT

Die gelieferten Produkte bleiben bis zur vollständigen Bezahlung des entsprechenden Preises Eigentum des Verkäufers.

Der Käufer ist berechtigt, die erworbenen Produkte oder neue Produkte, in welche die gelieferten Waren eingefügt werden, weiterzuveräußern, vorausgesetzt, dass alle Erträge in diesem Fall an den Verkäufer gehen, bis diese den Preis erreichen, den der Käufer dem Verkäufer für die Lieferung dieser Produkte schuldig ist.

Sollte der Käufer seiner Zahlungspflicht länger als 20 (Zwanzig) Arbeitstage nach Fälligkeit der Zahlung nicht nachkommen, verfällt dieses Recht auf Weiterveräußerung der Produkte. Diesbezüglich obliegt es dem Verkäufer, dem Käufer den Widerruf des Rechts auf Weiterveräußerung schriftlich mitzuteilen. Der Käufer muss jede notwendige Maßnahme zum Schutz der Produkte, die dem Eigentumsvorbehalt unterliegen, sowie alle Maßnahmen umsetzen, damit die Produkte des Verkäufers nicht mit denen anderer Lieferanten verwechselt werden. Der Käufer muss die Produkte des Verkäufers in abgegrenzten und leicht erkennbaren Bereichen aufbewahren.

6. HAFTUNG DES VERKÄUFERS UND BESCHRÄNKUNGEN

Der Verkäufer ist ausschließlich für die ordnungsgemäße Herstellung der gelieferten Produkte verantwortlich. Die gelieferten Produkte müssen die in der Auftragsbestätigung des Verkäufers vorgesehenen Merkmale aufweisen. Hingegen übernimmt der Verkäufer keinerlei Haftung für den eventuellen mangelhaften Betrieb der Maschinen oder Systeme, die mit den vom Verkäufer gelieferten Produkten realisiert worden sind.

Die Produkte müssen in angemessener Weise nur von zuständigen und qualifizierten Technikern verbunden sein und müssen nach den Bestimmungen der nationalen Vorschriften den Angaben des Fahrzeugs entsprechen.

In jedem Fall kann der Käufer keinen Schadensersatz für Profitausfall, Produktionsausfall, Verlust des Images und Stillstand des Kraftfahrzeugs geltend machen.

Die Haftung des Verkäufers beschränkt sich nur auf den Wert der gelieferten Ware unter Vorbehalt des Vorsatzes und des groben Verschuldens im Sinne des Gesetzes.

7. HÖHERE GEWALT

Sollte es dem Verkäufer unmöglich sein, den Vertrag aufgrund von höherer Gewalt oder von Ereignissen, die nicht von ihm zu vertreten sind, einzuhalten, dann werden die Fristen für die Ausführung der Lieferung automatisch um die Dauer der Ereignisse verlängert. Diesbezüglich sind rein beispielhaft ohne Anspruch auf Vollständigkeit als Gründe für höhere Gewalt anzusehen: Stromausfall, Mangel an Rohstoffen, Streiks, Maßnahmen der öffentlichen Verwaltung, Störungen im Straßenverkehr oder Produktionsstörungen.

8. REKLAMATIONEN und ANNAHME DER PRODUKTE

Alle Reklamationen in Bezug auf die Nichtkonformität der gelieferten Ware, Schäden durch den Transport oder eventuell fehlende Mengen gegenüber der bestellten Produktmenge müssen dem Verkäufer direkt und per Einschreiben mit Rückschein mitgeteilt werden. Diese Mitteilung muss bei offensichtlichen Mängeln innerhalb von 8 (acht) Tagen ab dem Lieferdatum und bei versteckten Mängeln innerhalb von 8 (acht) Tagen ab dem Datum, an dem diese entdeckt worden sind, und in jedem Fall innerhalb eines Monats nach Lieferung der Produkte erfolgen und eine ausführliche Beschreibung der Mängel enthalten. Mangels dieser Mitteilung werden die abgerechneten Beträge mit voller Rechtswirksamkeit als angenommen angesehen und können vom Käufer nicht mehr beanstandet werden.

Warenrücknahmen werden nicht angenommen, wenn diese nicht vorher vom Verkäufer genehmigt wurden.

9. ÜBEREINSTIMMUNG MIT DEN SPEZIFIKATIONEN UND GARANTIEBEDINGUNGEN

Der Verkäufer garantiert, dass die Produkte mit den technischen Spezifikationen übereinstimmen, die der Verkäufer in der Auftragsbestätigung für den Käufer angegeben hat. Die genannte Garantie gilt 2 (zwei) Jahre ab dem Datum der Lieferung der Produkte. Für die ersetzten Produkte oder Bestandteile gilt die Garantie ab dem Tag der Auswechslung.

Während der Garantiezeit verpflichtet sich der Verkäufer, die mangelhaften Produkte oder Teile davon innerhalb einer angemessenen Zeit wahlweise kostenlos zu reparieren oder zu ersetzen, wobei der Käufer dem Verkäufer diese Mängel mitzuteilen hat. Die Kosten und Risiken des Transports der mangelhaften Produkte an den Sitz des Verkäufers gehen zulasten des Käufers. Die ersetzten Produkte bleiben Eigentum des Verkäufers.

Die Garantie erlischt, wenn die Verwendung nicht mit dem bestimmungsgemäßen Gebrauch oder mit den in den Katalogen des Verkäufers vorgesehenen Gebrauch der Produkte übereinstimmt. Die Garantie erlischt ebenfalls, wenn die Produkte ohne die Genehmigung des Verkäufers verändert oder repariert wurden.

10. GEWÄHRLEISTUNG IN BEZUG AUF DIE ÜBEREINSTIMMUNG DER PRODUKTE MIT DEN EU-NORMEN

Der Verkäufer garantiert, dass die Produkte mit den eventuell anwendbaren Normen der Europäischen Union (EU) übereinstimmen.

Für die Übereinstimmung dieser Produkte mit Normen und Richtlinien, die im Land des Käufers gelten, sollte dieser seinen Sitz außerhalb der EU haben, oder allgemein die in jedem Land außerhalb der EU gelten, in dem die gelieferten Produkte verwendet werden, übernimmt der Verkäufer keine Garantie. Von der Garantie ausgeschlossen sind ausdrücklich die Normen über Sicherheit und Unfallverhütung.

11. VERTRAULICHKEIT UND DATENSCHUTZ

Dokumente jeder Art, die vom Verkäufer bereitgestellt werden, bleiben in dessen Besitz und dürfen nicht an Dritte weitergegeben oder vervielfältigt werden. Der Käufer verpflichtet sich, auch nach Vertragsende keine Geschäftsgeheimnisse und vertrauliche Informationen weiterzugeben, oder von deren er im Lauf der Beziehungen mit dem Verkäufer Kenntnis erlangt hat. Der Verkäufer erklärt hiermit, die vom Kunden angegebenen sensiblen Daten unter Einhaltung der Bestimmungen im italienischen Datenschutzkodex (Legislativdekret Nr. 196/03) zu behandeln.

12. AUFLÖSUNG DES VERTRAGS

Der Liefervertrag kann im Sinne von Art. 1456 des ital. ZGB („codice civile“) durch die einfache schriftliche Erklärung des Verkäufers, dass er von dieser ausdrücklichen Aufhebungs Klausel Gebrauch machen will, von Rechts wegen aufgehoben werden, wenn der Käufer:

- die fälligen Zahlungen unterlässt oder verspätet leistet;
- der Liquidation oder einem beliebigen Konkursverfahren unterzogen wird.

13. GEISTIGES EIGENTUM

Die Rechte am geistigen Eigentum in Bezug auf Projekte, Forschungen, Zeichnungen, Modelle und Produkte, die der Verkäufer realisiert oder die in seinem Namen und auf seine Rechnung realisiert werden, verbleiben beim Verkäufer. Die Marken, unter denen die Produkte verkauft werden, dürfen vom Käufer nur verwendet werden, um diese erkenntlich zu machen.

14. ANWENDBARES GESETZ UND MODALITÄTEN ZUR BEILEGUNG VON STREITIGKEITEN

Alle Verträge mit dem Verkäufer werden vom italienischen Gesetz geregelt. Alle Streitigkeiten werden der ausschließlichen Zuständigkeit des Gerichtssprengels in Turin zugewiesen.

Datum: _____ Stempel, Vor- und Zuname und Unterschrift des Käufers: _____

Der Käufer erklärt im Sinne der Art. 1341 und 1342 des ital. ZGB („codice civile“), die in den folgenden Artikeln der allgemeinen Verkaufsbedingungen enthaltenen Bedingungen gelesen zu haben und diese ausnahmslos anzunehmen: Art. 3) Verrechnungsverbot, Art. 5) Eigentumsvorbehalt, Art. 6) Haftungsbeschränkung, Art. 8) Reklamationen und Annahme der Produkte, Art. 14) Modalitäten zur Beilegung von Streitigkeiten.

Datum: _____ Stempel, Vor- und Zuname und Unterschrift des Käufers: _____

CONDICIONES GENERALES DE VENTA

1. AMBITO DE APLICACIÓN Y EFICACIA

Todas las entregas de productos efectuadas por Facet S.r.l. (el "Vendedor") a un cliente (el "Comprador") se regirán por las presentes condiciones generales que prevalecerán sobre las condiciones de adquisición del Comprador, así como las condiciones particulares previstas en las licitaciones y/o confirmación de pedido del Vendedor. En caso de conflicto entre lo estipulado en las condiciones generales y en las condiciones particulares, prevalecerán estas últimas.

Los datos y las ilustraciones referidas a los productos resultantes de los catálogos o prospectos del Vendedor tienen carácter indicativo y no valor vinculante, salvo lo dispuesto expresamente en la confirmación del pedido por parte del vendedor y pueden ser sujetos a modificaciones de diseño y material sin previo aviso.

Los números originales (OE) indicados en los catálogos o en otros documentos sólo son mencionados para identificar las partes de repuesto.

El vendedor suministra únicamente los productos de su propia producción contrasñados con su propio código de artículo y no productos con los números OE.

2. FORMALIZACIÓN DEL CONTRATO

El contrato de suministro se perfecciona con la confirmación escrita del Vendedor de aceptación del pedido del Comprador. El Vendedor se reserva el derecho de no aceptar pedidos en el caso que haya una controversia con el cliente relativa a un pedido anterior

3. PRECIOS Y FORMAS DE PAGO

Salvo pacto en contrario, los pagos del precio deben ser efectuados por el Comprador en los términos y con la modalidad prevista en la confirmación del pedido en la dirección del Vendedor. Los pagos realizados por el Comprador a Corredores de Comercio y/o Agentes sin un poder legal específico no tendrán fuerza ejecutiva contra el Vendedor.

En caso de retraso en los pagos, el Comprador deberá abonar los intereses de demora iguales a los establecidos por el Banco Central Europeo en vigor en la fecha, más 7 (siete) puntos, reservándose en cada caso la facultad el Vendedor de pedir daños y perjuicios.

El Comprador no podrá, por ningún motivo, salvo autorización escrita, compensar o retener cantidades adeudadas al Vendedor, ni podrá suspender los pagos.

Los precios de los productos se entienden en Euros y no incluyen el IVA, embalaje, gastos de transporte o seguro. El Vendedor podrá modificar los precios y las tarifas en vigor en cada momento sin previo aviso, salvo en el caso de los pedidos en curso. Es decir, si se verifican recargos en las materias primas, mano de obra, en los transportes, en las primas de seguros, etc.

4. CONDICIONES DE ENTREGA Y DEVUOCIONES

A menos que se disponga lo contrario en la confirmación del pedido, el suministro de los productos se entiende realizado conforme a la Incoterms 2010: FCA Orbassano. La mercancía viaja siempre por cuenta y riesgo del Comprador.

Los plazos de entrega se entienden indicativos y en caso de retraso, el Comprador no tiene derecho a solicitar la resolución del contrato y/o el resarcimiento de los daños.

5. RESERVA DE PROPIEDAD

Los productos suministrados permanecerán de propiedad del Vendedor hasta el pago total del precio.

El Comprador tendrá el derecho de vender los productos adquiridos, o nuevos productos en los que los productos suministrados por el Vendedor hayan sido incorporados, salvo que en este caso, todos los ingresos serán transferidos al Vendedor hasta el total del precio debido al Vendedor por el Comprador por el suministro de tales Productos.

Tal derecho de vender los productos decae si el Comprador no ha cumplido la obligación de pago durante un periodo de tiempo superior a 20 (veinte) días laborables desde la fecha límite. A tal fin, será potestad del Vendedor comunicar por escrito al Comprador la revocación del derecho a vender. El Comprador deberá tomar todas las medidas necesarias para la protección de los productos objeto de la reserva de propiedad, así como las medidas para no confundir los productos del Vendedor con los productos de otros proveedores y conservar los productos del Vendedor en espacios bien delimitados y fácilmente individualizables.

6. RESPONSABILIDAD DEL VENDEDOR Y LIMITACIONES

El Vendedor es exclusivamente responsable de la correcta producción de los productos suministrados, que deberán tener las características previstas en la confirmación del pedido por parte del Vendedor. Sin embargo, el Vendedor no asume, ninguna responsabilidad por el eventual mal funcionamiento de equipos o sistemas realizados por el Comprador con los productos suministrados por el Vendedor.

Los productos deben ser instalados solamente por técnicos competentes y cualificados, en conformidad con las especificaciones del vehículo y cumpliendo con los requisitos de las normativas nacionales.

En cualquier caso, el Comprador no podrá reclamar el resarcimiento de los daños y perjuicios por el lucro cesante, pérdida de producción, daños de imagen o parada de vehículo.

La responsabilidad del Vendedor es, por lo tanto limitada al valor de la mercancía suministrada, salvo dolo o culpa grave de conformidad con la ley.

7. LA FUERZA MAYOR

Si el Vendedor no puede cumplir el contrato por causa de fuerza mayor o cualquier circunstancia ajena a su voluntad, los plazos previstos para la ejecución de la oferta son automáticamente prorrogados por un periodo equivalente al de los efectos del evento de fuerza mayor. A tal fin, son consideradas causas de fuerza mayor, con fines explicativos y no exhaustivos: ausencia de energía o de materias primas, huelgas, medidas de la Administración Pública, obstáculos en la circulación, o en las actividades productivas.

8. RECLAMACIONES y ACEPTACIÓN DE LOS PRODUCTOS

Toda reclamación relativa a la no conformidad de las mercancías consignadas o por daños debidos al transporte o por eventuales faltas de cantidad respecto a los productos encargados debe ser comunicada por carta registrada con acuse de recibo dirigida directamente al vendedor en los 8 (ocho) días desde la fecha de entrega de los Productos, en el caso de vicios ocultos y dentro de los 8 (ocho) días desde el descubrimiento y dentro del mes siguiente de la entrega, con una exposición detallada de los hechos. En su defecto, los importes facturados se entenderán, a todos los efectos, aceptados y no cuestionables por el Comprador.

No se aceptan productos devueltos si no han sido previamente autorizados por escrito por el Vendedor.

9. CONFORMIDAD DE LAS ESPECIFICACIONES Y CONDICIONES DE GARANTÍA

El Vendedor garantiza que los productos serán conformes a las especificaciones técnicas declaradas por el Vendedor mismo al Comprador en la confirmación del pedido y dicha garantía tendrá validez de 2 (dos) años desde la fecha de la consigna de los productos y para los productos o componentes en sustitución, desde la fecha de sustitución.

Durante el periodo de garantía, el Vendedor al que el Comprador haya denunciado los defectos, se compromete, a su elección, dentro de unos términos razonables, a reparar o sustituir gratuitamente los productos o las partes de los mismos que hubieran resultado defectuosos. Los costes y los riesgos debidos al transporte de los productos defectuosos a la sede del Vendedor, son a cargo del Comprador. Los productos sustituidos quedan de propiedad del Vendedor.

La garantía no es válida en el caso de uso no conforme al destino final habitual de los productos o no prevista en los catálogos del vendedor o incluso si los productos han sido modificados o reparados sin la autorización del Vendedor.

10. GARANTÍA DE ADECUACIÓN DE LOS PRODUCTOS A LAS NORMAS UE

El Vendedor garantiza que los Productos serán conformes a las normas de la Unión Europea (UE) y pueden eventualmente ser aplicables.

No existe ninguna garantía del Vendedor en relación a la conformidad de estos Productos con las normas y regulaciones, fuera de las expresamente incluidas en las normas relativas a la seguridad y prevención de accidentes, en vigor en el país del Comprador, cuando este tenga su residencia fuera de la UE, o más en general, en cualquier nación que no pertenezca a la UE en la que los Productos suministrados vengán siendo utilizados.

11. CONFIDENCIALIDAD Y PROTECCIÓN DE DATOS

Los documentos de cualquier naturaleza facilitados por el Vendedor permanecerán de su propiedad y no podrán ser transferidos a terceros o reproducidos. El Comprador se compromete, incluso después de la finalización del contrato a no divulgar los secretos comerciales y las informaciones confidenciales que le hayan sido comunicadas o de las cuales tenga conocimiento en el transcurso de su relación con el Vendedor.

El Vendedor con la presente declara que usará los datos personales transferidos por el Cliente con el respeto a lo establecido en el Código de Privacidad Italiano (Decreto Legislativo n. 196/03)

12. RESOLUCIÓN DEL CONTRATO

El contrato de suministro podrá ser resuelto conforme a derecho según el art. 1456 C.C. por medio de declaración simple por escrito del Vendedor haciendo uso de la presente cláusula de rescisión si el Comprador:

- Omite o retrasa los pagos adeudados
- Se somete a liquidación o se encuentra sujeto a cualquier procedimiento concursal

13. PROPIEDAD INTELECTUAL

El Vendedor conserva la propiedad intelectual de los proyectos, de los estudios de los diseños, de los modelos y de los productos que realice o sean realizados en su nombre o por su cuenta. Las marcas bajo las cuales los productos son vendidos no pueden ser usadas por el Comprador salvo para identificarlos.

14. LEYES APLICABLES Y MODOS DE RESOLUCION DE LAS CONTROVERSIAS

Todos los contratos con el Vendedor serán sometidos a la legislación italiana. Cualquier controversia será resuelta por la jurisdicción exclusiva del Foro de Turín.

Fecha: _____ Sello, Nombre y Apellido y firma del Comprador: _____

En el sentido de los arts. 1341 y 1342 C.C. el Comprador declara haber leído y aceptado específicamente las previsiones contenidas en los siguientes artículos de las condiciones generales: art. 3 Prohibición de compensación, art. 5 Reserva de la propiedad; art. 6 Limitación de la responsabilidad; art. 8 Reclamaciones y Aceptación de los Productos; art. 14 Modos de resolución de las controversias.

Fecha: _____ Sello, Nombre y Apellido y firma del Comprador: _____

OUR PACKAGING

KW-IGN22Q1

-LE NOSTRE CONFEZIONI -NOTRE CONDITIONNEMENT -UNSERE VERPACKUNGSTYPEN -NUESTROS ENVASES



(A)	 (mm) X x Y x Z	cm ³	(B)	(B)	(B)
			Q / P15 L589 X W389 X H299MM	Q / P25 L389 X W189 X H299MM	Q / P35 L389 X W189 X H149MM
1	27 X 45 X 62	75	720	200	100
3	40 X 46 X 98	180	360	90	20
3,5	74 X 80 X 42	250	252	72	36
04	77 X 97 X 74	550	120	36	18
04,5	37 X 126 X 144	815	90	30	15
05	97 X 128 X 74	920	72	21	9
05,5	72 X 76 X 194	1060	60	12	-
07	128 X 148 X 93	1760	36	12	5
07,5	128 X 185 X 100	2370	27	9	3
08	128 X 186 X 148	3520	18	6	-
08,5	194 X 380 X 72	5300	12	-	-
08,6	180 X 415 X 70	5220	8	-	-
08,7	120 X 470 X 70	3950	13	-	-
08,8	170 X 405 X 90	6200	6	-	-
09	145 X 293 X 127	5400	12	-	-

470 543

05,5

(A) Packaging size

IGNITION COILS

Agente/Supplier:

HYUNDAI

27301-28010

KIA

27301-28010

ITEM NOW AVAILABLE FROM PRODUCTION

ARTICOLO ORA DISPONIBILE PER LA VENDITA

ARTICLE DISPONIBLE EN PRODUCTION COURANTE

ARTIKEL NUNDA DISPONIBEL EN PRODUKTION

ARTÍCULO AHORA DISPONIBLE EN PRODUCCIÓN

MARKET DIFFUSION: HIGH



Illustrated section

- PARTE FIGURATA
- PARTIE ILLUSTRÉE
- BILDTTEIL BEISPIEL
- PARTE ILUSTRADA

	ømm	ømm
	8,81	5,60

HYUNDAI	648	12/08 → 12/12
DD 1.4 CVT LPG	648	01/09 → 06/12
DD 1.4 CVT LPG	648	01/13 →

P15

(B) Shipping box

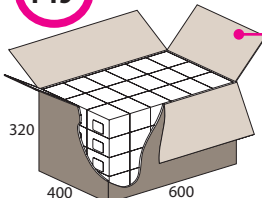

- PACCO SPEDIZIONI
- COLIS D'EXPEDITION
- VERPACKUNG
- BULTO PARA EL DESPACHO



RICAMBI ELETTRICI AUTO - ELECTRICAL AUTO

AUTOMOTRICES - PIÈCES AUTO

ELECTRIQUES - AUTO-ELEKTRIK-TEILE

ELETTRICI AUTO

RICAMBI E

TRICI AUTO - ELECTRICAL

ELECTRIQUES - AUTO-ELEKTRIK-TEILE

MADE IN ITALY

AUTOMOTRICES

RICAM

530 183

TEMPERATURE SENDER OBE
8 012510 168615
MERCEDES
009 542 35 17
MERCEDES BENZ
CLASSE C C 180 01/5
CLASSE C C 180 T 01

530 183

TEMPERATURE SENDER OBE
8 012510 168615
MERCEDES
009 542 35 17
MERCEDES BENZ
CLASSE C C 180 01/5
CLASSE C C 180 T 01

530 183

TEMPERATURE SENDER OBE
8 012510 168615
MERCEDES
009 542 35 17
MERCEDES BENZ
CLASSE C C 180 01/5
CLASSE C C 180 T 01

530 183

TEMPERATURE SENDER OBE
8 012510 168615
MERCEDES
009 542 35 17
MERCEDES BENZ
CLASSE C C 180 01/5
CLASSE C C 180 T 01

530 183

TEMPERATURE SENDER OBE
8 012510 168615
MERCEDES
009 542 35 17
MERCEDES BENZ
CLASSE C C 180 01/5
CLASSE C C 180 T 01

530



KW-TM Thermal management - Gestione Termica - Gestion thermique - ThermoManagement - Gestión térmica



KW-IGN Ignition - Accensione - Allumage - Zündung - Encendido



FA-SEN Sensors - Sensori - Capteurs - Sensoren - Sensores



KW-SWI Switches - Interruttori - Interrupteurs - Shalter - Interruptores



KW-EM Exhaust Management - Gestione Gas di Scarico - Gestion Des Gaz D'echappement - Abgas-Management - Gestión De Gas De Escape