



NEW PRODUCTS AVAILABLE FOR SALE

KW 470 613

05,5

COILS

Adatt./Suitable:

BOSCH
0 986 221 079**DACIA**
22 43 324 28R**HITACHI**
134058
2504058**LADA**
22 43 324 28R**MAGNETI MARELLI**
060810258010**MERCEDES-BENZ**
A 281 906 00 00**NISSAN**
22448-00Q0F**RENAULT**
22 43 324 28R
H82 01 154 128**SMART**
A 281 906 00 00**NEW - ITEM NOW AVAILABLE FROM PRODUCTION**

- NUOVO - ARTICOLO ORA DISPONIBILE PER LA VENDITA
- NOUVEAU - ARTICLE DISPONIBLE EN PRODUCTION COURANTE
- NEU - JETZ ZUM VERKAUF VERFÜGBARER ARTIKEL
- NUEVO - ARTICULO AHORA DISPONIBLE EN PRODUCCION

MARKET DIFFUSION: HIGH

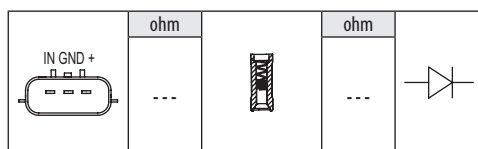
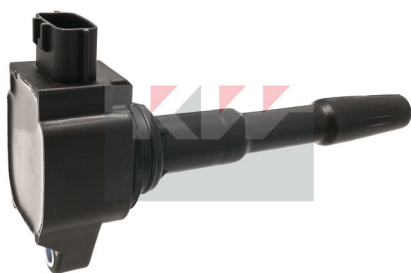

DACIA

DOKKER 1.2 TCe	H5F402, H5F408	11/12 ⇨
DOKKER 1.2 TCe 115	--, H5F402, H5F408	12/12 ⇨
DOKKER 1.6	H4M738, H4M740	11/12 ⇨
DOKKER 1.6 LPG	H4M740	04/15 ⇨
DUSTER 1.2 TCe 125	H5F404, H5F408	01/12 ⇨
DUSTER 1.2 TCe 125 4x4	H5F404, H5F410	10/13 ⇨
DUSTER 1.6 S Ce 115	H4M438, H4M738	06/15 ⇨
DUSTER 1.6 S Ce 115 4x4	H4M430, H4M730, H4M738	06/15 ⇨
DUSTER 1.6 S Ce 115 LPG	H4M740	06/15 ⇨
LODGY 1.2 TCe	H5F402, H5F408	03/12 ⇨
LODGY 1.6	H4M738	03/12 ⇨
LODGY 1.6 LPG	H4M740	04/15 ⇨
LODGY 1.6 S Ce 100	H4M738, H4M740	06/15 ⇨
LOGAN II TCe 90	H4B400, H4B408, H4B410	10/12 ⇨
LOGAN II TCe 90 LPG	H4B410	09/15 ⇨
LOGAN II MCV TCe 90	H4B400, H4B408	02/13 ⇨
LOGAN II MCV TCe 90 LPG	H4B410	09/15 ⇨
SANDERO II TCe 90	--, H4B400, H4B408	10/12 ⇨
SANDERO II TCe 90 LPG	H4B410	09/15 ⇨

LADA

VESTA 1.6	H4M	11/19 ⇨
-----------	-----	---------

MERCEDES-BENZ

CITAN 112	M200.711	06/13 ⇨ 08/21
-----------	----------	---------------

NISSAN

JUKE I 1.2 DIG-T	HR12DDT, HRA2DDT	05/14 ⇨
MICRA V 0.9 IG-T	HR09DET	12/16 ⇨
MICRA V 0.9 LPG	HR09DET	03/19 ⇨
PULSAR 1.2 DIG-T	HRA2DDT	10/14 ⇨
TERRANO III 1.6	H4M	12/15 ⇨
TERRANO III 1.6 4x4	H4M	12/15 ⇨
QASHQAI II 1.2 DIG-T	HR12DDT, HRA2DDT	11/13 ⇨

RENAULT

MEGANE IV 1.2 TCe 100	H5F408	11/15 ⇨
MEGANE IV 1.2 TCe 130	H5F408	11/15 ⇨
MEGANE IV 1.6 16V	H4M738, H4M750	11/15 ⇨
MEGANE IV 1.6 S Ce	H4M738, H4M750	10/16 ⇨
CAPTUR 0.9 TCe 90	H4B400, H4B408	06/13 ⇨
CAPTUR 1.2T	H5F403	06/13 ⇨
CAPTUR 1.2 TCe 120	H5F403, H5F408, H5F412	06/13 ⇨
MEGANE III 1.2 TCe	H5F400, H5F404, H5F405, H5F408, H5F412	03/12 ⇨
KANGOO II 1.2 TCe 115	H5F400, H5F408, H5F412	07/13 ⇨

RENAULT

CLIO IV 0.9 TCe 75	H4B408	05/18 ⇨
CLIO IV 0.9 TCe 90	H4B400, H4B408	11/12 ⇨
CLIO IV 0.9 TCe 90 LPG	H4B410	08/15 ⇨
CLIO IV 1.2 TCe 120	H5F403, H5F408, H5F412	03/13 ⇨
CLIO 0.9 TCe 90	H4B400	01/14 ⇨
DUSTER 1.6 16V	H4M438	06/15 ⇨
DUSTER 1.6 16V 4x4	H4M430	06/15 ⇨
GRAND SCÉNIC III 1.2 TCe	H5F400, H5F404, H5F408	04/12 ⇨
GRAND SCÉNIC IV 1.2 TCe 115	H5F408	09/16 ⇨
GRAND SCÉNIC IV 1.2 TCe 130	H5F408	09/16 ⇨
KADJAR 1.2 TCe 130	H5F408	06/15 ⇨
KAPTUR 1.6	H4M429, H4M438	03/16 ⇨
LOGAN/STEPWAY 1.6	H4M429, H4M438	09/16 ⇨
SANDERO II 1.6	H4M429, H4M438	09/16 ⇨
SANDERO II TCe 90	H4B400	09/15 ⇨
SCÉNIC III 1.2 TCe	H5F400, H5F404, H5F408	04/12 ⇨
SCÉNIC IV 1.2 TCe 115	H5F408	09/16 ⇨
SCÉNIC IV 1.2 TCe 130	H5F408	09/16 ⇨
TWINGO III 0.9 TCe 110	H4B401	11/16 ⇨
TWINGO III 0.9 TCe 90	H4B401	09/14 ⇨
TWINGO III 0.9 TCe 90 LPG	H4B451	08/18 ⇨
TWINGO III 1.0 S Ce 70	H4D400	09/14 ⇨
MEGANE CC 1.2 TCe	H5F400, H5F404	09/12 ⇨

SMART

FORFOUR III 0.9	M281.910	11/14 ⇨
FORFOUR III 0.9 Brabus	M281.910	07/16 ⇨
FORFOUR III 1.0	M281.920	07/14 ⇨
FORTWO III 0.9	M281.910	09/14 ⇨
FORTWO III 0.9 Brabus	M281.910	07/16 ⇨
FORTWO III 1.0	M281.920	07/14 ⇨

KW 470 620

05,5

COILS

Adatt./Suitable:

BOSCH
0 986 221 102**CITROËN**
96 753 909 80**DS**
96 753 909 80**GENERAL MOTORS**
3 639 845**HITACHI**
133962
2503962**OPEL**
3639845
9675390980**PEUGEOT**
96 753 909 80**VAUXHALL**
3639845
9675390980**NEW - ITEM NOW AVAILABLE FROM PRODUCTION**

- NUOVO - ARTICOLO ORA DISPONIBILE PER LA VENDITA
- NOUVEAU - ARTICLE DISPONIBLE EN PRODUCTION COURANTE
- NEU - JETZ ZUM VERKAUF VERFÜGBARER ARTIKEL
- NUEVO - ARTICULO AHORA DISPONIBLE EN PRODUCCION

MARKET DIFFUSION: HIGH

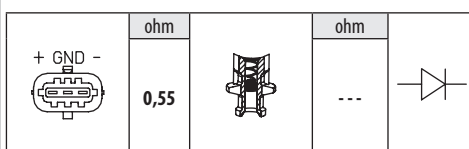

CITROËN

C4 PICASSO II 1.2 THP 130	HNY(EB2DTS)	04/14 ⇨
C3 III PureTech 110	HNZ(EB2DT)	03/19 ⇨
C3 AIRCROSS PureTech 82	HNZ(EB2DT)	05/19 ⇨
C3 PICASSO 1.2 THP 110	HNZ(EB2DT)	01/15 ⇨
C3 II 1.2 THP 110	HNZ(EB2DT)	10/14 ⇨
C4 II 1.2 THP 110	HNZ(EB2DT)	02/15 ⇨
C4 II 1.2 THP 130	HNY(EB2DTS)	04/14 ⇨
C4 CACTUS 1.2 THP 110	HNZ(EB2DT)	09/14 ⇨
C4 CACTUS PureTech 130	HNY(EB2DTS)	05/19 ⇨
C4 SPACETOURER 1.2 PureTech 110	HNY(EB2DTS)	04/18 ⇨
C4 SPACETOURER PureTech 130	HNY(EB2DTS)	05/19 ⇨

KW 579 946



09

THERMOSTATS
Adatt./Suitable:**SEAT**
032 121 111 BM
SKODA
032 121 111 BM
VW
032 121 111 BM**NEW - ITEM NOW AVAILABLE FROM PRODUCTION**

- NUOVO - ARTICOLO ORA DISPONIBILE PER LA VENDITA
- NOUVEAU - ARTICLE DISPONIBLE EN PRODUCTION COURANTE
- NEU - JETZ ZUM VERKAUF VERFÜGBARER ARTIKEL
- NUEVO - ARTICULO AHORA DISPONIBLE EN PRODUCCION

110 with seal

- con guarnizione
- avec joint d'étanchéité
- mit Dichtung
- con junta

MARKET DIFFUSION: **MEDIUM**

°C

87

SEAT		
ALTEA 1.4 16V	BXW, CGGB	05/06 →
ALTEA XL 1.4 16V	BXW, CGGB	10/06 →
IBIZA III 1.4 16V	BXW	05/06 → 11/09
CORDOBA II 1.4 16V	BXW	05/06 → 11/09
IBIZA IV 1.4	BXW, CGGB	03/08 → 05/15
IBIZA IV 1.4 LPG	BXW	03/08 → 05/11
IBIZA 1.4	BXW, CGGB	07/08 → 05/15
LEON II 1.4 16V	BXW, CGGB	06/06 → 12/12
TOLEDO III 1.4 16V	BXW	05/06 → 05/09

SKODA		
FABIA I 1.4 16V	BUD	04/06 → 12/07
OCTAVIA II 1.4	BUD, CGGA	06/04 → 06/13
ROOMSTER 1.4	BXW	09/06 → 05/15
ROOMSTER 1.4 LPG	BXW	03/10 → 05/15
FABIA II 1.4	BXW	01/07 → 12/14
FABIA II 1.4 LPG	BXW	01/07 → 11/14

VW		
GOLF VI 1.4	BUD, CGGA	10/08 → 07/13
GOLF V 1.4	BUD	06/07 → 07/09
GOLF V 1.4 16V	BCA, BUD, CGGA	10/03 → 12/13
CADDY III 1.4	BCA, BUD	03/04 → 08/10
POLO IV 1.4 16V	BUD	05/06 → 11/09
POLO IV 1.4 BiFuel	BUD	05/06 → 11/09
POLO V 1.4	CGGB, CLPA	03/09 → 05/14
POLO V 1.4 BiFuel	CMAA	03/10 → 01/11

KW 579 950



08

THERMOSTATS
Adatt./Suitable:**DENSO**
DTM91363**FORD**
1 765 657
1 829 180
1 872 633
CM5G-9K478-FA
CM5G-9K478-FB
CM5G-9K478-GA**NEW - ITEM NOW AVAILABLE FROM PRODUCTION**

- NUOVO - ARTICOLO ORA DISPONIBILE PER LA VENDITA
- NOUVEAU - ARTICLE DISPONIBLE EN PRODUCTION COURANTE
- NEU - JETZ ZUM VERKAUF VERFÜGBARER ARTIKEL
- NUEVO - ARTICULO AHORA DISPONIBLE EN PRODUCCION

110 with seal

- con guarnizione
- avec joint d'étanchéité
- mit Dichtung
- con junta

MARKET DIFFUSION: **MEDIUM**

°C

92

FORD		
B-MAX 1.0 EcoBoost	M1JA, M1JE, M1JH, SFJA, SFJB, SFJC, SFJD, YYJC	08/12 →
C-MAX II 1.0 EcoBoost	M1DA, M1DD, M2DA, M2DC	10/12 →
ECOSPORT 1.0 EcoBoost	M1JC, M1JJ, M1JU, SFJL, YYJD, YYJF	10/13 →
FIESTA VI 1.0	P4JA, P4JB, P4JC, P4JD, XMJA, XMJB, XMJC, XMJD	10/12 →
FIESTA VI 1.0 EcoBoost	M1JE, M1JH, SFJA, SFJB, SFJC, SFJD, YYJA, YYJB	09/12 →
FIESTA VI 1.0 Sport	YYJA, YYJB	05/14 →
FIESTA VII 1.0 EcoBoost	M1JL, M1JM, Q0JA, Q0JB, Q0JC, Q0JD, SFJE, SFJF, SFJH, SFJL, SFJK, SFJN, SFJP, YYJE	05/17 →
FIESTA VII 1.1 Ti-VCT	OBM1ST, FSJB, XPJA, XPJB, XPJC, XPJD, XYJA, XYJB, XYJC, XYJD, XYJF	05/17 →
FOCUS III 1.0 EcoBoost	M1DA, M1DC, M1DD, M1DH, M2DA, M2DB, M2DC, SFDA, SFDB	02/12 →
GRAND C-MAX 1.0 EcoBoost	M1DA, M1DD, M2DA, M2DC	10/12 →
MONDEO IV 1.0 EcoBoost	M1CA, M1CB	02/15 →
TOURNEO COURIER 1.0 EcoBoost	SFCA, SFCB, SFCC, SFCD, SFCE, SFCE	02/14 →
TOURNEO CUSTOM 1.0 EcoBoost PHEV	M1FA	04/20 →
TRANSIT CONNECT II 1.0 EcoBoost	M2GA, M2GB	02/13 →
TRANSIT COURIER 1.0 EcoBoost	SFCA, SFCB, SFCC, SFCD, SFCE, SFCE	02/14 →
TRANSIT CUSTOM 1.0 EcoBoost PHEV	M1FA	04/20 →

KW 579 971



04

THERMOSTATS
Adatt./Suitable:**GENERAL MOTORS**
12 669 633 *V**OPEL**
12669633 *V
VAUXHALL
12669633 *V**NEW - ITEM NOW AVAILABLE FROM PRODUCTION**

- NUOVO - ARTICOLO ORA DISPONIBILE PER LA VENDITA
- NOUVEAU - ARTICLE DISPONIBLE EN PRODUCTION COURANTE
- NEU - JETZ ZUM VERKAUF VERFÜGBARER ARTIKEL
- NUEVO - ARTICULO AHORA DISPONIBLE EN PRODUCCION

***V Supplied only the thermostat, without housing**

- Fourni solo il termostato, senza alloggiamento
- Fourni uniquement le thermostat, sans le boîtier
- Nur der Thermostat wird ohne Gehäuse geliefert
- Sólo se suministra el termostato, sin la carcasa (cárter)

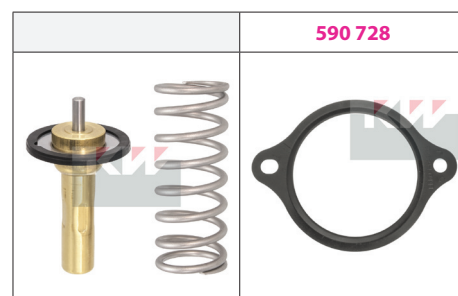

°C

84

OPEL		
INSIGNIA B 1.5	B15SFL, B15SFT, D15SFL, D15SFT	03/17 →

VAUXHALL		
INSIGNIA 1.5	B15SFL, B15SFT, D15SFL, D15SFT, D15XHT, D15XHT	03/17 →



REVOLUTION AND TIMING (CKP AND CMP) SENSORS

Adatt./Suitable:

AUDI
06E 905 163
BOSCH
0 986 280 431
VW
06E 905 163

NEW - ITEM NOW AVAILABLE FROM PRODUCTION

- NUOVO - ARTICOLO ORA DISPONIBILE PER LA VENDITA
- NOUVEAU - ARTICLE DISPONIBLE EN PRODUCTION COURANTE
- NEU - JETZT ZUM VERKAUF VERFÜGBARER ARTIKEL
- NUEVO - ARTICULO AHORA DISPONIBLE EN PRODUCCION



L	L1		
---	24	Hall Effect	

AUDI

Model	Code	Start	End
A4 II 54 quattro	BBK	03/03	12/04
A4 III 2.7 TDI	BPP, BSG	11/05	03/09
A4 III 3.0 TDI quattro	ASB, BKN	11/04	03/09
A4 III 3.2 FSI	AUK	01/05	03/09
A4 III 3.2 FSI quattro	AUK, BKH	01/05	03/09
A4 III 54 quattro	BBK, BHF	03/04	03/09
A6 III 2.4	BDW	05/04	10/08
A6 III 2.4 [CHN]	BDW	04/05	
A6 III 2.4 quattro	BDW	01/05	10/08
A6 III 2.7 TDI	BPP, BSG	11/04	08/11
A6 III 2.7 TDI quattro	BPP, BSG	11/04	08/11
A6 III 3.0 TDI	ASB	06/06	08/11
A6 III 3.0 TDI quattro	ASB, BMK, BNG, CDYA, CDYC	05/04	08/11
A6 III 3.2 FSI	AUK, BKH	05/04	05/09
A6 III 3.2 FSI quattro	AUK, BKH	05/04	10/08
A6 III 4.2 quattro	BAT	05/04	05/06
A8 II 3.0 TDI quattro	ASB, BNG	08/03	07/10
A8 II 3.2 FSI	BPK	06/05	07/10
A8 II 3.2 FSI quattro	BPK	06/05	07/10
A8 II 4.0 TDI quattro	ASE	05/03	07/05
A8 II 4.2 TDI quattro	BMC, BVN	01/05	07/10
ALLROAD 4.2 V8 quattro	BAS	07/02	08/05
Q7 I 3.0 TDI quattro	BUG, BUN, CASA	03/06	08/15
Q7 I 4.2 TDI quattro	BTR	03/07	06/09

VW

Model	Code	Start	End
PHAETON 3.0 V6 TDI 4motion	BMK	09/04	05/07
TOUAREG I 3.0 TDI	BUN	04/06	05/10
TOUAREG I 3.0 V6 TDI	BKS, CATA	11/04	05/10



REVOLUTION AND TIMING (CKP AND CMP) SENSORS

Adatt./Suitable:

KIA
39300-2A050

NEW - ITEM NOW AVAILABLE FROM PRODUCTION

- NUOVO - ARTICOLO ORA DISPONIBILE PER LA VENDITA
- NOUVEAU - ARTICLE DISPONIBLE EN PRODUCTION COURANTE
- NEU - JETZT ZUM VERKAUF VERFÜGBARER ARTIKEL
- NUEVO - ARTICULO AHORA DISPONIBLE EN PRODUCCION



L	L1		
---	24,2	Hall Effect	

KIA

Model	Code	Start	End
OPTIMA IV 1.7 CRDi	D4FD	11/15	⇔
RIO IV 1.4 CRDi 77	D4FC	01/17	⇔
RIO IV 1.4 CRDi 90	D4FC	01/17	⇔
STONIC 1.6 CRDi	D4FB	07/17	⇔



REVOLUTION AND TIMING (CKP AND CMP) SENSORS

Adatt./Suitable:

CITROËN
96 742 659 80
DS
96 742 659 80
FORD
1 871 863
2 224 144
DS7Q-9E731-BA
DS7Q-9E731-BB
FORD USA
1 871 863
2 224 144
DS7Q-9E731-BA
DS7Q-9E731-BB

NEW - ITEM NOW AVAILABLE FROM PRODUCTION

- NUOVO - ARTICOLO ORA DISPONIBILE PER LA VENDITA
- NOUVEAU - ARTICLE DISPONIBLE EN PRODUCTION COURANTE
- NEU - JETZT ZUM VERKAUF VERFÜGBARER ARTIKEL
- NUEVO - ARTICULO AHORA DISPONIBLE EN PRODUCCION

GENERAL MOTORS

3 553 117
OPEL
3553117
9674265980

PEUGEOT
96 742 659 80

TOYOTA
SU001-A3602

VAUXHALL
3553117
9674265980

MARKET DIFFUSION: MEDIUM

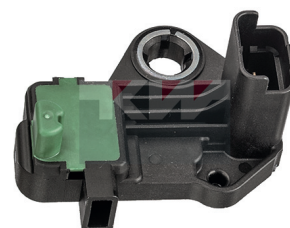

L	L1		
---	---	Hall Effect	

CITROËN

Model	Code	Start	End
C4 PICASSO II 2.0 BlueHdi 135	AHV(DW10FD), RHD(DW10CB)	09/13	⇔
C4 PICASSO II 2.0 BlueHdi 135 Hybrid	AHS(DW10FD)	09/13	⇔
C4 PICASSO II 2.0 BlueHdi 150	AHE(DW10FD), AHR(DW10FD), AHX(DW10FD)	09/13	⇔
C4 PICASSO BlueHdi 150	AHX(DW10FD)	09/13	⇔
C4 SPACETOURER 2.0 BlueHdi 150	AHX(DW10FD)	04/18	⇔
C4 SPACETOURER 2.0 BlueHdi 160	EHY(DW10FCC)	04/18	⇔
C5 II 2.0 Hdi 150 / BlueHdi 150	AHR(DW10FD)	04/09	⇔
C5 II 2.0 Hdi 180	AHW(DW10FC)	03/15	⇔
C5 AIRCROSS 2.0 BlueHdi 180	EHZ(DW10FC)	11/18	⇔
C4 GRAND PICASSO II 2.0 BlueHdi 135	AHV(DW10FD), RHD(DW10CB)	09/13	⇔
C4 GRAND PICASSO II 2.0 BlueHdi 135 Hybrid	AHS(DW10FD)	09/13	⇔
C4 GRAND PICASSO II 2.0 BlueHdi 150	AHR(DW10FD), AHX(DW10FD)	06/13	⇔
DS4 2.0 BlueHdi 150	AHX(DW10FD)	07/14	⇔ 07/15
DS4 2.0 BlueHdi 150 Hybrid	AHR(DW10FD)	07/14	⇔ 07/15
DS4 2.0 BlueHdi 180	AHW(DW10FC)	07/14	⇔ 07/15
DS5 2.0 BlueHdi 135 Hybrid	AHS(DW10FD)	11/11	⇔ 07/15
DS5 2.0 BlueHdi 150	AHX(DW10FD)	07/14	⇔ 07/15
DS5 2.0 BlueHdi 180	AHW(DW10FC)	08/13	⇔ 07/15
DS5 2.0 Hdi 150 Hybrid	AHX(DW10FD)	11/11	⇔ 07/15
GRAND C4 SPACETOURER 2.0 BlueHdi 150	AHR(DW10FD), AHX(DW10FD)	04/18	⇔
GRAND C4 SPACETOURER 2.0 BlueHdi 160	EHY(DW10FCC)	04/18	⇔
GRAND C4 SPACETOURER BlueHdi 160	EHY(DW10FCC)	05/19	⇔
JUMPER III 2.0 BlueHdi 110	1K9K422	07/15	⇔ 09/19
JUMPER III 2.0 BlueHdi 130	AHN(DW10FUD)	07/15	⇔ 09/19
JUMPER III 2.0 BlueHdi 130 4x4	AHN(DW10FUD)	04/16	⇔ 09/19
JUMPER III 2.0 BlueHdi 160	AHP(DW10FUC)	07/15	⇔ 09/19
JUMPER III 2.0 BlueHdi 160 4x4	AHP(DW10FUC)	04/16	⇔ 09/19

CITROËN		
JUMPER III 2.2 BlueHDi 120	4HK(DW12RUE)	08/19 →
JUMPER III 2.2 BlueHDi 140	4HJ(DW12RUD)	08/19 →
JUMPER III 2.2 BlueHDi 165	4HH(DW12RUC)	08/19 →
JUMPY III 2.0 BlueHDi 120	6GW4D20E	04/16 →
JUMPY III 2.0 BlueHDi 150	AHX(DW10FD)	04/16 →
JUMPY III 2.0 BlueHDi 180	AHH(DW10FC), EHZ(DW10FDCU)	04/16 →
SPACETOUREUR 2.0 BlueHDi 120	6GW4D20E	12/19 →
SPACETOUREUR 2.0 BlueHDi 145	EHS(DW10FDDU370), EHT(DW10FDDU340)	09/20 →
SPACETOUREUR 2.0 BlueHDi 150	AHX(DW10FD)	04/16 →
SPACETOUREUR 2.0 BlueHDi 180	AHH(DW10FC), EHZ(DW10FDCU)	04/16 →

DS		
DS 5 2.0 BlueHDi 135	AHV(DW10FDD)	06/15 → 12/18
DS 5 2.0 BlueHDi 150	AHR(DW10FD)	04/15 → 12/18
DS 5 2.0 BlueHDi 180	AHW(DW10FC)	04/15 → 12/18
DS 7 2.0 BlueHDi 180	EHZ(DW10FC)	09/17 →
DS4 / DS4 CROSSBACK 2.0 BlueHDi 150	AHR(DW10FD)	07/15 → 12/18
DS4 / DS4 CROSSBACK 2.0 BlueHDi 180	AHW(DW10FC)	07/15 → 12/18

FORD		
C-MAX II 2.0 TDCi	--, T7DB, T7DC, T7DD, T8DE	03/15 →
FOCUS III 2.0 TDCi	T7DA, T7DB	11/14 →
FOCUS III 2.0 TDCi ST	T8DA	11/14 →
GALAXY III 2.0 TDCi	--, T7CI, T7CJ, T7CK, T7CL, T8CG, T8CH, T8CI, T8CJ, UFCA, UFCB	01/15 →
GALAXY III 2.0 TDCi 4x4	T7CI, T7CJ, T7CL, T8CG, T8CH, T8CI, T8CJ	05/15 → 06/18
GALAXY III 2.0 TDCi Bi-Turbo	T9CB, T9CC	01/15 → 06/18
GRAND C-MAX 2.0 TDCi	T7DB, T7DC, T8DE	03/15 →
KUGA II 2.0 TDCi	T7MA, T7MB, T7MC, T7MD, X7MA, X7MB	09/14 →
KUGA II 2.0 TDCi 4x4	T7MA, T7MB, T8MA, T8MB	09/14 →
MONDEO IV 2.0 TDCi	T7CA, T7CC, T7CD, T7CE, T7CF, T7CN, T7CP, T7CQ, T8CA, T8CB, T8CC, T8CD, T8CL	09/14 →
MONDEO IV 2.0 TDCi 4x4	T7CA, T7CC, T7CD, T7CE, T7CF, T7CN, T7CP, T7CQ, T8CA, T8CB, T8CC, T8CD, T8CL	09/14 →
MONDEO IV 2.0 TDCi Bi-Turbo	T9CA	03/15 →
S-MAX II 2.0 TDCi	--, T7CI, T7CJ, T7CK, T7CL, T8CG, T8CH, T8CI, T8CJ, UFCA, UFCB	01/15 →
S-MAX II 2.0 TDCi 4x4	T7CI, T7CJ, T7CK, T7CL, T8CG, T8CH, T8CI, T8CJ	01/15 → 06/18
S-MAX II 2.0 TDCi Bi-Turbo	T9CB, T9CC	01/15 → 06/18

FORD USA		
EDGE 2.0 TDCi AWD	T8CM	08/15 → 07/18
EDGE 2.0 TDCi Bi-Turbo AWD	T9CE	08/15 → 07/18

OPEL		
GRANDLAND X 2.0 CDTI	D20DTH(DW10FC)	11/17 →
GRANDLAND X 2.0 D	D20DTH(DW10FC)	11/17 →
VIVARO C 2.0	D20DTH(DW10FD), D20DTL(DW10FE), D20DTR(DW10FDCU), DW10FDDU340, DW10FDDU370	03/19 →
ZAFIRA LIFE 2.0	D20DTH(DW10FD), D20DTL(DW10FE), D20DTR(DW10FDCU), DW10FDDU340, DW10FDDU370	03/19 →

PEUGEOT		
BOXER II 2.0 BlueHDi 110	AHM(DW10FUE)	07/15 → 09/19
BOXER II 2.0 BlueHDi 130	AHN(DW10FUD)	07/15 → 09/19
BOXER II 2.0 BlueHDi 160	83JF	07/15 → 09/19
BOXER II 2.2 BlueHDi 120	4HK(DW12RUE)	07/19 →
BOXER II 2.2 BlueHDi 140	4HJ(DW12RUD)	07/19 →
BOXER II 2.2 BlueHDi 165	4HH(DW12RUC)	07/19 →
308 II 2.0 BlueHDi 150	AHX(DW10FCD), AHX(DW10FD)	11/13 →
308 II 2.0 GT BlueHDi 180	AHW(DW10FC), EHZ(DW10FC)	06/14 →
308 II 2.0 GT HDi 180 / BlueHDi 180	AHW(DW10FC)	06/14 →
508 I 2.0 BlueHDi 150	AHX(DW10FD)	04/14 → 12/18
508 I 2.0 BlueHDi 180	AHW(DW10FC)	04/14 → 12/18
508 II 2.0 BlueHDi 160	EHY(DW10FCC)	09/18 →
508 II 2.0 BlueHDi 180	EHZ(DW10FC)	09/18 →
3008 I 2.0 HDi 150 / BlueHDi 150	AHX(DW10FD)	06/09 → 08/16
3008 II 2.0 BlueHDi 136	AHV(DW10FD)	11/16 →
3008 II 2.0 BlueHDi 150	AHX(DW10FD)	05/16 →
3008 II 2.0 BlueHDi 180	AHW(DW10FC), EHZ(DW10FC)	05/16 →
3008 II BlueHDi 180	EHZ(DW10FC)	01/18 →
5008 I 2.0 HDi 150 / BlueHDi 150	5GLMP22L2, AHX(DW10FD)	06/09 → 03/17
5008 II 2.0 BlueHDi 136	AHS(DW10FD), AHV(DW10FD)	12/16 →

PEUGEOT		
5008 II 2.0 BlueHDi 150	AHX(DW10FD)	12/16 →
5008 II 2.0 BlueHDi 180	AHW(DW10FC), EHZ(DW10FC)	12/16 →
5008 II BlueHDi 180	EHZ(DW10FC)	01/18 →
EXPERT III 2.0 BlueHDi 120	AHK(DW10FE)	04/16 →
EXPERT III 2.0 BlueHDi 150	AHX(DW10FD)	04/16 →
EXPERT III 2.0 BlueHDi 180	AHH(DW10FC), EHZ(DW10FDCU)	04/16 →
TRAVELLER 2.0 BlueHDi 120	AHX(DW10FE)	09/19 →
TRAVELLER 2.0 BlueHDi 145	EHS(DW10FDDU370), EHT(DW10FDDU340)	09/20 →
TRAVELLER 2.0 BlueHDi 150	AHX(DW10FD)	04/16 →
TRAVELLER 2.0 BlueHDi 180	AHH(DW10FC), EHZ(DW10FDCU)	04/16 →

TOYOTA		
PROACE 2.0 D4d	4WZ-FHV, 4WZ-FTV	02/16 →
PROACE 2.0 D4d 4x4	4WZ-FTV	04/18 →
PROACE VERSO 2.0 D4d	4WZ-FHV, 4WZ-FTV	02/16 →

VAUXHALL		
GRANDLAND X 2.0 D	D20DTH(DW10FC)	10/17 →
VIVARO 2.0	D20DTH(DW10FD), D20DTL(DW10FE), D20DTR(DW10FDCU)	03/19 →
VIVARO LIFE 2.0	D20DTH(DW10FD), D20DTR(DW10FDCU), DW10FDDU340, DW10FDDU370	03/19 →

KW 498 540  **04,5**

OXYGEN SENSORS

Adatt./Suitable:

BOSCH
0 281 004 226

DACIA
22 6A 474 53R

MERCEDES-BENZ
A 415 542 04 00

NISSAN
22693-00Q0B

RENAULT
22 6A 474 53R

NEW - ITEM NOW AVAILABLE FROM PRODUCTION

• NUOVO - ARTICOLO ORA DISPONIBILE PER LA VENDITA

• NOUVEAU - ARTICLE DISPONIBLE EN PRODUCTION COURANTE

• NEU - JETZT ZUM VERKAUF VERFÜGBARER ARTIKEL

• NUEVO - ARTICULO AHORA DISPONIBLE EN PRODUCCION

MARKET DIFFUSION: MEDIUM



TS	N°	L	F S B SH				
WB55011	5	350	-	-	-	A	WBP

DACIA		
DOKKER 1.5 dCi	K9K612, K9K626	11/12 →
DOKKER 1.5 dCi / Blue dCi 75	K9K626	11/12 →
DUSTER 1.5 dCi	K9K612, K9K626	10/10 →
LOGDY 1.5 dCi	K9K612, K9K626	03/12 →
LOGAN II 1.5 dCi	K9K612, K9K626	10/12 →
LOGAN II 1.5 dCi / Blue dCi 75	K9K612, K9K626	10/12 →
LOGAN II MCV 1.5 dCi	K9K612, K9K626, K9K872	02/13 →
SANDERO II 1.5 dCi	K9K612, K9K626	10/12 →
SANDERO II 1.5 dCi 75 / Blue dCi 75	K9K612, K9K626, K9K838, K9K872	10/12 →

MERCEDES-BENZ		
CITAN 108 CDI	OM607.951	11/12 → 08/21
CITAN 109 CDI	OM607.951	11/12 → 08/21
CITAN 111 CDI	OM607.951	06/13 → 08/21

NISSAN		
JUKE I 1.5 dCi	K9K410, K9K646, K9K896	06/10 →
JUKE I dCi	K9K636	06/10 →
MICRA V 1.5 DCi	K9K	12/16 →
QASHQAI II 1.5 dCi	K9K872	06/18 →

RENAULT		
CAPTUR 1.5 dCi	K9K628	06/13 →
CAPTUR 1.5 dCi 110	K9K646	01/15 →
CAPTUR 1.5 dCi 90	K9K608, K9K609, K9K629, K9K830, K9K838, K9K628	06/13 →
KANGOO II 1.5 dCi 75	K9K628	11/12 →
KANGOO II 1.5 dCi 90	K9K628	06/08 →
CLIO IV 1.5 dCi	K9K628	11/12 →
CLIO IV 1.5 dCi 110	K9K646	06/16 →

RENAULT		
CLIO IV 1.5 dCi 75	K9K612, K9K626, K9K628	11/12 →
CLIO IV 1.5 dCi 90	K9K626, K9K629, K9K628	11/12 →
FLUENCE 1.5 dCi	K9K656, K9K826	07/14 →
KOLEOS 2.0 BLUE dCi 190 4WD	M9R730	06/19 →
KOLEOS 2.0 dCi 175	M9R868	08/16 →
KOLEOS 2.0 dCi 175 4WD	M9R868	08/16 →
LOGAN/STEPWAY 1.5 dCi	K9K612	12/13 →

KW 498 541  **04,5**

OXYGEN SENSORS

Adatt./Suitable:

BOSCH
0 258 027 156
0 281 004 225

NISSAN
22690-00Q1K
22690-00Q2C

RENAULT
22 69 078 25R
22 6A 426 02R
H82 01 499 129

NEW - ITEM NOW AVAILABLE FROM PRODUCTION

• NUOVO - ARTICOLO ORA DISPONIBILE PER LA VENDITA

• NOUVEAU - ARTICLE DISPONIBLE EN PRODUCTION COURANTE

• NEU - JETZT ZUM VERKAUF VERFÜGBARER ARTIKEL

• NUEVO - ARTICULO AHORA DISPONIBLE EN PRODUCCION

MARKET DIFFUSION: MEDIUM



TS	N°	L	F S B SH				
WB55011	5	500	-	-	-	A	WBP

NISSAN		
X-TRAIL III 1.6 dCi	R9M	04/14 →
X-TRAIL III 1.6 dCi ALL MODE 4x4-i	R9M	04/14 →
X-TRAIL III 2.0 dCi	M9R	10/16 →
X-TRAIL III 2.0 dCi ALL MODE 4x4-i	M9R	10/16 →
QASHQAI II 1.6 dCi	R9M	11/13 →
X-TRAIL 1.6 dCi	R9M	12/14 →
X-TRAIL 1.6 dCi ALL MODE 4x4-i	R9M	04/16 →
X-TRAIL dCi	R9M	04/14 →
X-TRAIL dCi 4x4	R9M	04/14 →

RENAULT		
MEGANE IV 1.6 dCi 130	R9M409, R9M410, R9M412	11/15 →
MEGANE IV 1.6 dCi 165	R9M452	11/15 →
ESPACE V 1.6 dCi 130	R9M409	06/15 →
ESPACE V 1.6 dCi 160	R9M452	06/15 →
GRAND SCÉNIC IV 1.6 dCi 130	R9M409	09/16 →
GRAND SCÉNIC IV 1.6 dCi 160	R9M452	09/16 →
KADJAR 1.6 dCi 130	R9M410, R9M414	06/15 →
KADJAR 1.6 dCi 130 4x4	R9M414, R9M412	06/15 →
KOLEOS 1.6 dCi 130	R9M409	08/16 →
KOLEOS 2.0 dCi 175	M9R868	08/16 →
KOLEOS 2.0 dCi 175 4WD	M9R868	08/16 →
SCÉNIC IV 1.6 dCi 130	R9M409	09/16 →
SCÉNIC IV 1.6 dCi 160	R9M452	09/16 →
TALISMAN 1.6 dCi 130	R9M409	11/15 →
TALISMAN 1.6 dCi 160	R9M452, R9M453, R9M453	06/15 →



WHEEL SPEED SENSORS

Adatt./Suitable:

BOSCH
0 265 009 931
CITROËN
BO 010 091 80
PEUGEOT
BO 010 091 80
TOYOTA
89542-0H040

NEW - ITEM NOW AVAILABLE FROM PRODUCTION

- NUOVO - ARTICOLO ORA DISPONIBILE PER LA VENDITA
- NOUVEAU - ARTICLE DISPONIBLE EN PRODUCTION COURANTE
- NEU - JETZT ZUM VERKAUF VERFÜGBARER ARTIKEL
- NUEVO - ARTICULO AHORA DISPONIBLE EN PRODUCCION

MARKET DIFFUSION: HIGH

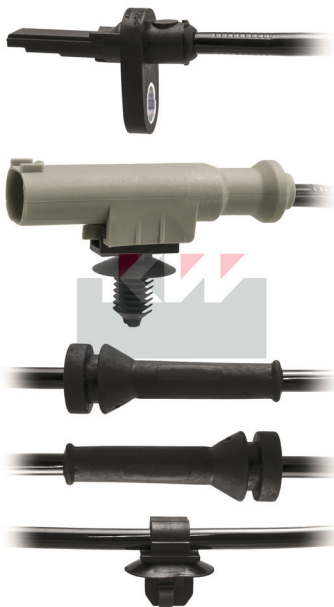

L	L1		OUT
815	27,9	Hall Effect	

CITROËN

C1 II 1.0VTi 68	CFB(1KR)	04/14 ⇨
C1 II 1.0VTi 72	CFB(1KR)	06/18 ⇨
C1 II 1.2VTi 82	7HL16S, HMT(EB2D), HMZ(EB2F)	04/14 ⇨

PEUGEOT

108 1.0VTi	1KR-FE, CFB(1KR)	05/14 ⇨
108 1.0VTi 72	CFB(1KR)	05/18 ⇨
108 1.2	HMT(EB2D), HMZ(EB2), HMZ(EB2F)	05/14 ⇨
108 1.2VTi	HMZ(EB2)	05/14 ⇨
108 108 1.2	HMZ(EB2F)	05/14 ⇨

TOYOTA

AYGO II 1.0	1KR-FE	05/14 ⇨
AYGO II 1.0VVTi	1KR-FE	03/18 ⇨



EXHAUST GAS TEMPERATURE SENSORS (EGT)

Adatt./Suitable:

VOLVO
31319265
31319840
31370466
31431048

NEW - ITEM NOW AVAILABLE FROM PRODUCTION

- NUOVO - ARTICOLO ORA DISPONIBILE PER LA VENDITA
- NOUVEAU - ARTICLE DISPONIBLE EN PRODUCTION COURANTE
- NEU - JETZT ZUM VERKAUF VERFÜGBARER ARTIKEL
- NUEVO - ARTICULO AHORA DISPONIBLE EN PRODUCCION

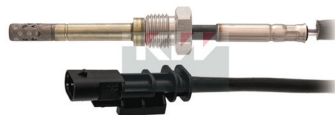

			L1	Ang	L2	
			50	0°	500	RTD-PT

VOLVO

S60 II 2.4 D4 AWD	D5244T21	03/15 ⇨ 05/18
S60 II D4 Polestar AWD	D5244T21	03/15 ⇨ 07/18
S60 II D5 AWD	D5244T15, D5244T10	04/10 ⇨ 12/15
S80 II 2.4 D	D5244T19, D5244T14	03/06 ⇨ 03/11
S80 II D5	D5244T15, D5244T10	01/10 ⇨ 04/15
S80 II D5 AWD	D5244T15, D5244T10, D5244T10/F	01/10 ⇨ 04/15
V60 I 2.4 D4 AWD	D5244T12	09/13 ⇨ 12/15
V60 I 2.4 D5 AWD	D5244T15	04/11 ⇨ 12/15
V60 I 2.4 Hybrid D6 AWD	ACsynchron(20/50), D82PHEV(D5,	06/12 ⇨ 12/15
V60 I D4 AWD	D5244T12, D5244T17, D5244T21	05/12 ⇨ 05/18
V60 I D4 Polestar AWD	D5244T21	03/15 ⇨ 05/18
V60 I D5	D5244T23	04/14 ⇨ 12/15
V60 I D5 AWD	D5244T15, D5244T10	07/10 ⇨ 12/15
V70 III 2.4 D	D5244T19, D5244T14	04/07 ⇨ 12/10
V70 III D4 AWD	D5244T12	10/13 ⇨ 04/16
V70 III D5 AWD	D5244T15, D5244T10	12/09 ⇨ 04/16
XC60 I 2.4 D / D3 / D4 AWD	D5244T16, D5244T17	05/08 ⇨ 02/17
XC60 I D4 AWD	D5244T12, D5244T17, D5244T21	09/13 ⇨ 02/17
XC60 I D5 AWD	D5244T11, D5244T15, D5244T20, D5244T22, D5244T10, D5244T10/F	07/09 ⇨ 02/17
XC70 II 2.4 D / D4 AWD	D5244T16, D5244T17	08/07 ⇨ 04/16
XC70 II 2.4 D4 AWD	D5244T17	09/13 ⇨ 04/16
XC70 II 2.4 D5 AWD	D5244T15	09/13 ⇨ 12/16
XC70 II D4 AWD	D5244T12	10/13 ⇨ 04/16
XC70 II D5 AWD	D5244T11, D5244T15, D5244T20, D5244T10, D5244T10/F	04/09 ⇨ 04/16



EXHAUST GAS TEMPERATURE SENSORS (EGT)

Adatt./Suitable:

GENERAL MOTORS
55 351 838
JEEP
68228514AB
68228514AC
K68228514AA
K68228514AB
K68228514AC
MOPAR PARTS
68228514AC
OPEL
55351838
8 55 514
VAUXHALL
55351838

NEW - ITEM NOW AVAILABLE FROM PRODUCTION

- NUOVO - ARTICOLO ORA DISPONIBILE PER LA VENDITA
- NOUVEAU - ARTICLE DISPONIBLE EN PRODUCTION COURANTE
- NEU - JETZT ZUM VERKAUF VERFÜGBARER ARTIKEL
- NUEVO - ARTICULO AHORA DISPONIBLE EN PRODUCCION

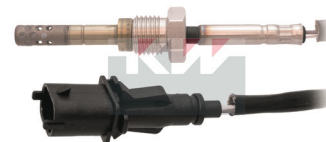

			L1	Ang	L2	
			35	0°	500	RTD-PT

JEEP

CHEROKEE V 2.0 CRD	EBS, EBT	04/14 ⇨ 08/18
CHEROKEE V 2.0 CRD 4x4	EBS, EBT	04/14 ⇨ 08/18
CHEROKEE V 2.2 CRD	EBV	09/18 ⇨
CHEROKEE V 2.2 CRD 4x4	EBU, EBV, LAU61	08/15 ⇨
CHEROKEE 2.0 CRD	EBS, EBT	04/14 ⇨ 08/18
CHEROKEE 2.2 CRD	EBU, EBV	08/15 ⇨ 08/18

OPEL

SIGNUM 2.0 Turbo	Z2ONET	05/03 ⇨ 12/08
VECTRA C 2.0 16V Turbo	Z2ONET	03/03 ⇨ 08/08
VECTRA C 2.0 Turbo	Z2ONET	10/03 ⇨ 08/08

VAUXHALL

SIGNUM 2.0 i Turbo	Z2ONET	03/03 ⇨ 10/08
VECTRA C 2.0 16V Turbo	Z2ONET	01/00 ⇨ 10/08



EXHAUST GAS TEMPERATURE SENSORS (EGT)

Adatt./Suitable:

AUDI
03N 906 081 A
03N 906 081 D
MAN
03N 906 081 A
65.27421-0011
65.27421-0050
SEAT
03N 906 081 A
03N 906 081 D
SKODA
03N 906 081 A
03N 906 081 D
VOLVO
30668640
VW
03N 906 081 A
03N 906 081 D

NEW - ITEM NOW AVAILABLE FROM PRODUCTION

- NUOVO - ARTICOLO ORA DISPONIBILE PER LA VENDITA
- NOUVEAU - ARTICLE DISPONIBLE EN PRODUCTION COURANTE
- NEU - JETZT ZUM VERKAUF VERFÜGBARER ARTIKEL
- NUEVO - ARTICULO AHORA DISPONIBLE EN PRODUCCION

MARKET DIFFUSION: HIGH

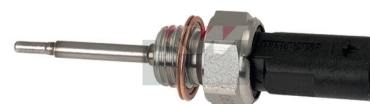

16	M12x1,5		NTC

AUDI

A1 1.4 TDI	CUSB	11/14 ⇨ 10/18
A1 1.6 TDI	CXMA	11/14 ⇨ 10/18

AUDI		
A4 IV 2.0 TDI	CAGB, CAHB, CGLD, CJCX, CNHA, CNHC, CSUB	11/07 → 12/15
A4 IV 2.0 TDI quattro	CNHA, CSUA	05/13 → 12/15
A3 III 1.4 TFSI	CXSB, CZCA	09/13 →
A3 III 1.6 TDI	CLHA, CRKB, CXXB, DBKA, DDYA, DGTE	10/12 →
A3 III 2.0 TDI	CRBC, CRBD, CRFA, CRFC, CRLB, CRLC, CRUA, CUNA, DBGA, DCYA, DEJA, DFGA	04/12 →
A3 III 2.0 TDI quattro	CRBC, CRLB, CUNA, DCYA, DGCA, DJGA	10/12 → 10/20
A3 III 30 TDI	DDYA, DGTE	07/18 → 10/20
A3 III 35 TDI	CRBC, CRLB, CRUA, DBGA, DCYA, DEJA, DFGA	07/18 → 10/20
A3 III 40 TDI quattro	CUNA, DGCA, DJGA	07/18 → 10/20
A3 IV 30 TDI	DSUD, DTRD	11/19 →
A3 IV 35 TDI	DSRB, DTSB	11/19 →
A3 IV 40 TDI quattro	DTUA	12/20 →
A4 V 2.0 TDI	CZHA, DESA, DETA, DETB, DEUA, DEUB, DEUC, DFVA	05/15 →
A4 V 2.0 TDI quattro	DESA, DETA, DETB, DEUA, DFVA	09/15 → 11/19
A4 V 30 TDI	DEUC	05/16 → 11/19
A4 V 30 TDI Mild Hybrid	DEZB, DTNB	07/19 →
A4 V 35 TDI	CZHA, DEUA	08/15 → 11/19
A4 V 35 TDI Mild Hybrid	DEZE, DTNA	03/19 →
A4 V 40 TDI	DESA, DETA, DFVA	05/15 → 11/19
A4 V 40 TDI Mild Hybrid quattro	DTPA	05/20 →
A4 V 40 TDI quattro	DESA, DETA, DFVA	09/15 → 09/20
A4 V RS4 quattro	DECA	10/17 →
A4 V S4 TDI Mild Hybrid quattro	DEWB	05/19 →
A4 V ALLROAD 2.0 TDI quattro	DESA, DETA, DETB, DEUA, DEUB, DFVA	01/16 →
A4 V ALLROAD 40 TDI Mild Hybrid quattro	DTPA	09/20 →
A4 V ALLROAD 40 TDI quattro	DESA, DETA, DFVA	01/20 →
A5 I 2.0 TDI	CNHA, CSUB	09/09 → 01/17
A5 I 2.0 TDI quattro	CNHA	09/13 → 01/17
A4 IV ALLROAD 2.0 TDI quattro	CNHA, CNHC, CSUB	04/09 → 05/16
A5 II 2.0 TDI	CZHA, DESA, DETA, DEUA, DEUB	07/16 →
A5 II 2.0 TDI quattro	CZHA, DESA, DETA, DEUA	10/16 →
A5 II 30 TDI Mild Hybrid	DEZB	10/19 →
A5 II 35 TDI	CZHA, DEUA	01/17 → 02/20
A5 II 35 TDI Mild Hybrid	DEZE, DTNA	10/19 →
A5 II 40 TDI	DESA, DETA	06/16 → 02/20
A5 II 40 TDI Mild Hybrid quattro	DTPA	09/20 →
A5 II 40 TDI quattro	DESA, DETA	08/16 → 02/20
A5 II RS5 quattro	DECA	04/17 →
A5 II S5 TDI MILD HYBRID QUATTRO	DEWB, DMKC	12/18 →
A6 IV 2.0 TDI	CNHA, CSUD, CSUE, CZJA, DDCA, DDCB, DDDA	01/12 →
A6 IV 2.0 TDI quattro	CNHA, DDDA	04/15 → 09/18
A6 V 30 TDI Mild Hybrid	DEZF	01/19 →
A6 V 35 TDI Mild Hybrid	DEZD, DTPB	03/19 →
A6 V 35 TDI Mild Hybrid quattro	DTPB	11/20 →
A6 V 40 TDI Mild Hybrid	DFBA, DTPA	02/18 →
A6 V 40 TDI Mild Hybrid quattro	DFBA, DTPA	07/18 →
A6 V 55 TDI Mild Hybrid quattro	DEWA	03/19 →
A6 V 56 TDI Mild Hybrid quattro	DEWA	03/19 →
A7 40 TDI Mild Hybrid	DFBA	09/18 →
A7 40 TDI Mild Hybrid quattro	DFBA	09/18 →
A7 S7 TDI Mild Hybrid quattro	DEWA	03/19 →
Q2 1.6 TDI	DDYA, DGTE	06/16 → 10/18
Q2 2.0 TDI	DFGA, DTTC	09/16 →
Q2 2.0 TDI quattro	DFGA, DFHA, DTTC	07/16 →
Q2 30 TDI	DDYA, DGTE, DTRB, DTRD	07/18 →
Q2 35 TDI	DFGA, DTTC	09/16 →
Q2 35 TDI quattro	DFGA, DTTC	09/18 →
Q3 2.0 TDI	CUVB, CUVC, CUVD, CUWA, DBBA, DFTA, DFTB, DFTC, DFUA	09/11 →
Q3 2.0 TDI quattro	CUVC, CUWA, CYLA, DFTA, DFUA	11/14 → 10/18
Q3 35 TDI	DFGA, DTSB	09/18 →
Q3 35 TDI quattro	DFGA, DTSB	09/18 →
Q3 40 TDI quattro	DFHA, DTUA	10/18 →
Q5 I 2.0 TDI	CNHA, CSUA, CSUB	11/10 → 05/17
Q5 I 2.0 TDI quattro	CNHA, CNHC, CSUA, CSUB	11/08 → 05/17
Q5 I 3.0 SQ5 TDI Mild Hybrid quattro	DEWB	02/19 → 11/20
Q5 II 2.0 TDI	DEUA, DEUB	01/17 → 11/20
Q5 II 2.0 TDI quattro	DESA, DETA, DETB	06/16 → 08/18

AUDI		
Q5 II 35 TDI	DTNA	04/21 →
Q5 II 35 TDI Mild Hybrid	DEZE	11/19 → 11/20
Q5 II 35 TDI quattro	DETB	08/18 → 11/20
Q5 II 40 TDI Mild Hybrid quattro	DFBA	11/19 → 11/20
Q5 II 40 TDI quattro	DESA, DETA, DTPA	10/18 →
Q5 II SQ5 TDI	DMKC	02/21 →
Q5 II SQ5 TDI Mild Hybrid quattro	DEWB	02/19 →
TT III 2.0 TDI	CUNA	07/14 →
TT III 2.0 TDI quattro	CUNA	01/17 →
MAN		
TGE 2.0 TDI	DAUA, DAUB, DAVA	11/16 →
TGE 2.0 TDI AWD	DAUA, DAVA	02/17 →
TGE 2.0 TDI RWD	DASA, DASB, DAWA	05/17 →
SEAT		
ALHAMBRA TDI	CUVC, CUWA, DFLA, DFMA	05/15 →
ALHAMBRA TDI 4Drive	CUVC	05/15 →
ARONA 1.6 TDI	DGTA, DGTD	07/17 →
ATECA 1.6 TDI	DDYA, DGTE	04/16 →
ATECA 2.0 TDI	CRVA, CRVC, DFFA, DTRD, DTTC	04/16 →
ATECA 2.0 TDI 4Drive	DFFA, DFHA, DTTC	04/16 →
ALHAMBRA III 2.0 TDI	CUVA, CUVC, CUWA, DFLA, DFLD, DLTA, DLUB	05/11 →
ALHAMBRA III 2.0 TDI 4Drive	CUVC, DFLA, DFMA, DLUB	05/15 →
IBIZA IV 1.4 TDI	CUSA, CUSB, CUTA, CYZA	05/15 → 06/17
IBIZA V 1.6 TDI	DGTA, DGTC, DGTD	09/17 →
LEON III 1.6 TDI	CLHA, CLHB, CRKB, CXXA, CXXB, DBKA, DDYA, DDYB, DGTE	09/12 →
LEON III 1.6 TDI 4Drive	CLHA, CXXB, DGTE	04/14 →
LEON III 2.0 TDI	CKFC, CRBC, CRGA, CRLB, CRLD, CRMB, CRVA, CRVC, CUNA, CUPA, DFFA, DFGA, DJGA	09/12 →
LEON III 2.0 TDI 4Drive	CRBC, CRLB, CRMB, CUNA, DCYA, DFGA, DJGA	04/14 →
LEON IV 2.0 TDI	DSTB, DTRD	11/19 →
TARRACO 2.0 TDI	DFGA	09/18 →
TARRACO 2.0 TDI 4Drive	DFGA, DFHA, DTUA	09/18 →
TOLEDO IV 1.4 TDI	CUSB	05/15 → 04/19
TOLEDO IV 1.6 TDI	CXMA	05/15 → 04/19
SKODA		
KAMIQ 1.6 TDI	DGTA, DGTD	07/19 →
KAROQ 1.6 TDI	DDYA, DGTE	07/17 →
KAROQ 2.0 TDI	DFFA, DTRB, DTRD, DTTA	07/17 →
KAROQ 2.0 TDI 4x4	DFFA, DFHA	07/17 →
KODIAQ 2.0 RS Bi-TDI 4x4	CUAA	11/18 →
KODIAQ 2.0 TDI	DBGC, DFGA, DTSB	10/16 →
KODIAQ 2.0 TDI 4x4	CRGB, DBGG, DFGA, DFHA, DTSB, DTUA	10/16 →
OCTAVIA III 1.6 TDI	CLHA, CLHB, CRKA, CRKB, CXXA, CXXB, DBKA, DDYA, DDYB, DGTA, DGTE	11/12 →
OCTAVIA III 1.6 TDI 4x4	CLHA, CRKB, CXXB, DBKA, DGTE	11/12 →
OCTAVIA III 2.0 TDI	CKFB, CKFC, CRMB, CRVC, CYKA, DCYA, DFFA	11/12 →
OCTAVIA III 2.0 TDI / TDI RS 4x4	CUNA, CUPA, DJGA	05/13 →
OCTAVIA III 2.0 TDI 4x4	CKFC, CRMB, DCYA, DFFA	11/12 →
OCTAVIA III 2.0 TDI RS	CUNA, CUPA, DJGA	05/13 →
OCTAVIA IV 2.0 TDI	CRVC, DSTA, DSTB, DSUD, DTRB, DTRD, DTTA, DTTC	11/19 →
OCTAVIA IV 2.0 TDI 4x4	DSTA, DTTA, DTTC	09/20 →
OCTAVIA IV 2.0 TDI RS	DTUA	07/20 →
OCTAVIA IV 2.0 TDI RS 4x4	DTUA	07/20 →
RAPID 1.4 TDI	CUSB	05/15 → 12/19
RAPID 1.6 TDI	CXMA	05/15 → 12/19
SCALA 1.6 TDI	DGTA, DGTD	02/19 →
FABIA III 1.4 TDI	CUSA, CUSB, CUTA	08/14 →
SUPERB III 1.6 TDI	CVRA., DCXA, DCZA	03/15 →
SUPERB III 2.0 TDI	CRGA, CRLB, DDAE, DFCA, DFEA, DFGA, DFHA, DSRA, DSRB, DTRA, DTSB, DTUA	03/15 →
SUPERB III 2.0 TDI 4x4	CRLB, DDAE, DFCA, DFEA, DFGA, DFHA, DTUA	03/15 →
YETI 2.0 TDI	CUUB, DFSA, DFUB	05/15 →
YETI 2.0 TDI 4x4	CUUA, CUUB	11/09 → 12/17
VOLVO		
S90 B4 Mild-Hybrid	B420T6	03/20 →
S90 B6 Mild-Hybrid AWD	B420T	03/20 →
V60 II B5 Mild-Hybrid AWD	B420T2	03/20 →
V90 B6 Mild-Hybrid AWD	B420T	03/20 →
V90 D5 Mild Hybrid AWD	D420T2	12/20 →
XC60 II B4 Mild-Hybrid	D420T8	05/19 →
XC60 II B4 Mild-Hybrid AWD	D420T8	04/19 →
XC60 II B5 Mild-Hybrid AWD	D420T2	04/19 →
XC90 II B5 Mild-Hybrid AWD	D420T2	04/19 →
VW		
ARTEON 2.0 TDI	DBGA, DFGA, DFHA, DSRA, DSRB, DTSB, DTUA	03/17 →
ARTEON 2.0 TDI 4motion	CUAA, DFHA, DTUA	03/17 →
BETLE 2.0 TDI	CUUA, CUUB, CVCA, DELA	06/14 → 09/18
CADDY III 2.0 TDI	CUUB, CUUD, CUUF, DFSD, DFSC, DFFD, DFFS	05/15 →
CADDY III 2.0 TDI 4motion	CUUE, DFSD, DFSC, DFSE	05/15 →
POLO VI 1.6 TDI	DGTC, DGTD	11/17 →
CADDY IV TDI BMT	DTRC, DTRE, DTRF	09/20 →
CALIFORNIA 2.0 TDI	CXEB, CXEC, CXFA, CXGA, CXGB, CXGD, CXHA, CXHB, CXHC, DMZA, DNAA, DNAB, DNAC	04/15 →
BlueMotion CAMPMOBILE 2.0 TDi BlueMotion	CXEB, CXFA, CXGB, CXHA	04/15 →
CC 2.0 TDI	CUVC, CUWA	05/15 → 12/16
CRAFTER 2.0 TDI	CKTB, CKUB, CSLA, CSLB, CSLC, CSNA, DAUA, DAUB, DAVA	05/11 →
CRAFTER 2.0 TDI 4motion	CSNA, DAUA, DAVA	07/11 →
CRAFTER 2.0 TDI RWD	DASA, DASB, DASC, DAWA	11/16 →
T-CROSS 1.6 TDi	DGTD	12/18 →
GOLF VI 2.0 TDI	CUUA, CUUB	11/13 → 05/16
GOLF VII 1.6 TDI	CLHA, CLHB, CRKA, CRKB, CXXA, CXXB, DBKA, DDYA, DDYB, DGTE	08/12 →
GOLF VII 1.6 TDI 4motion	CLHA, CRKB, CXXB	11/12 →
GOLF VII 1.6 TDI BlueMotion	CLHA, CLHB, CRKA, CRKB, CXXA, CXXB	08/12 →
GOLF VII 1.6 TDi BlueMotion 4motion	CLHA	05/13 → 03/17
GOLF VII 2.0 GTD	CUNA, DGCA, DJGA	04/13 →
GOLF VII 2.0 TDI	CRBB, CRBC, CRGA, CRLB, CRLD, CRMB, CRUA, CRVA, CRVC, CYKB, DCYA, DCYB, DEJA, DEJB, DFGA, DFGB	08/12 →
GOLF VII 2.0 TDI 4motion	CKFC, CRBC, CRLB, CRMB, CUNA, DCYA, DGCA, DJGA	11/12 →
GOLF VII 2.0 TDi BlueMotion	CRBC, CRLB	04/13 → 03/17
GOLF VII 2.0 TDi BlueMotion 4motion	CRBC, CRLB	04/13 →
PASSAT VI 1.6 TDI	DCXA, DCZA	08/14 →
PASSAT VI 2.0 TDI	CRGA, CRLB, CRLD, CUPA, DBGA, DBGB, DDAE, DFCA, DFGA, DFGB, DFHA, DSRA, DSRB, DTRA, DTSB, DTUA	11/14 →
PASSAT VI 2.0 TDI 4motion	CRLB, CUAA, CUPA, DDAE, DFCA, DFEA, DFHA, DTUA	08/14 →
GOLF VIII 2.0 TDI	DSRB, DSUD, DTRB, DTRD, DTSB, DTSB	08/19 →
GOLF VIII 2.0 TDI 4motion	DTUA	09/20 →
GOLF VIII 2.0 TDI GTD	DTUA	09/20 →
GRAND CALIFORNIA 2.0 TDI	DAVA	04/19 →
GRAND CALIFORNIA 2.0 TDI 4motion	DAVA	04/19 →
JETTA VI 2.0 TDI	CUUA, CUUB, CVCA, DELA, DGMA	10/10 →
MULTIVAN 2.0 TDI	CXEB, CXEC, CXFA, CXGA, CXGB, CXHA, CXHB, CXHC, DMZA, DNAA, DNAB	04/15 →
MULTIVAN 2.0 TDI 4motion	CXEB, CXEC, CXFA, CXHA, DMZA, DNAA	06/15 →
POLO V 1.4 TDI	CUSA, CUSB, CUTA, CYZA, CYZB	02/14 →
PASSAT V 2.0 TDI	CVCA	06/14 →
T-ROC 1.6 TDI	DGTE	03/18 →
T-ROC 2.0 TDI	DFFA	03/18 →
T-ROC 2.0 TDI 4motion	DFFA, DFHA	09/17 →
T-ROC 2.0 TDI SCR	DTRD	11/20 →
SCIROCCO III 2.0 TDI	CUUB, CUWA, CUXA	11/13 → 11/17
SHARAN II 2.0 TDI	CFFE, CUVA, CUVC, CUWA, DFLA, DFLD, DFMA, DLTA, DLTC, DLUB	05/11 →
SHARAN II 2.0 TDI 4motion	CUVC, DFLA, DFMA, DLTA, DLUB	05/15 →
TIGUAN I 2.0 TDI	CUVC	05/15 → 07/18
TIGUAN I 2.0 TDI 4motion	CUVC, CUWA	05/15 → 07/18
TIGUAN II 1.6 TDI	DGDB	05/16 → 06/20
TIGUAN II 2.0 TDI	CRFD, CRGB, CUVE, CYKC, DBGG, DFGA, DFGC, DTRC, DTSB, DTSB	05/15 →
TIGUAN II 2.0 TDI 4motion	CRGB, CUAA, DBGG, DFGA, DFHA, DTSB, DTUA	01/16 →
TIGUAN TDI BlueMotion	DFHA	01/16 → 07/20
TOURAN II 1.6 TDI	CRKB, DGDA	05/15 →
TOURAN II 2.0 TDI	CRVA, CYKB, DFEA, DFEB, DFGA, DFGB, DFGC, DFHA, DTRC, DTSB	05/15 →
TRANSPORTER VI 2.0 TDI	CAAB, CXEB, CXEC, CXFA, CXGA, CXGB, CXGD, CXHA, CXHB, CXHC, DMZA, DNAA, DNAB, DNAC	04/15 →
TRANSPORTER VI 2.0 TDI 4motion	CXEB, CXEC, CXFA, CXHA, DMZA, DNAA	06/15 →
XL I 0.8 TDI E-Hybrid	CSCA	02/14 →

422 293

KW 422 293



EXHAUST GAS TEMPERATURE SENSORS (EGT)

Adatt./Suitable:

FIAT
55199673

NEW - ITEM NOW AVAILABLE FROM PRODUCTION

- NUOVO - ARTICOLO ORA DISPONIBILE PER LA VENDITA
- NOUVEAU - ARTICLE DISPONIBLE EN PRODUCTION COURANTE
- NEU - JETZT ZUM VERKAUF VERFÜGBARER ARTIKEL
- NUEVO - ARTICULO AHORA DISPONIBLE EN PRODUCCION



17	M14x1,5		L1	Ang	L2	RTD-PT
			50	90°	910	

FIAT		
PUNTO III / GRANDE PUNTO 1.9 D Multijet	199A5.000, 939A1.000, 939A7.000	10/05 ⇌

FIAT		
DUCATO III 100 Multijet 2,2 D 4HV	F1AE0481D, F1AE3481G	07/06 ⇌
DUCATO III 110 Multijet 2,3 D	F1AE0481D, F1AGL4114	08/06 ⇌
DUCATO III 120 Multijet 2,3 D	F1AE0481D, F1AGL4114	07/06 ⇌
DUCATO III 160 Multijet 3,0 D	F1CE0481D	07/06 ⇌

PEUGEOT		
BOXER II 3.0 HDi	F1CE0481D(F30DT)	04/06 ⇌
BOXER II 3.0 HDi 145	F1CE3481N(F30DTE)	04/10 ⇌
BOXER II 3.0 HDi 160	F1CE0481D(F30DT)	04/06 ⇌

KW 422 295



EXHAUST GAS TEMPERATURE SENSORS (EGT)

Adatt./Suitable:

AUDI
059 906 088 AE

NEW - ITEM NOW AVAILABLE FROM PRODUCTION

- NUOVO - ARTICOLO ORA DISPONIBILE PER LA VENDITA
- NOUVEAU - ARTICLE DISPONIBLE EN PRODUCTION COURANTE
- NEU - JETZT ZUM VERKAUF VERFÜGBARER ARTIKEL
- NUEVO - ARTICULO AHORA DISPONIBLE EN PRODUCCION

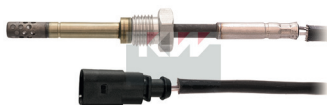

17	M14x1,5		L1	Ang	L2	RTD-PT
			50	0°	450	

AUDI		
A6 III 2.7 TDI	BPP, BSG, CANA, CANB	11/04 ⇌ 08/11
A6 III 3.0 TDI quattro	ASB, BNG, CDYA, CDYB, CDYC	05/04 ⇌ 08/11

AUDI		
A5 II 3.0 TDI	CSWB	11/16 ⇌ 08/18
A5 II 3.0 TDI quattro	CRTC, CSWB	07/16 ⇌

KW 422 297



EXHAUST GAS TEMPERATURE SENSORS (EGT)

Adatt./Suitable:

ALFA ROMEO
51802892

NEW - ITEM NOW AVAILABLE FROM PRODUCTION

- NUOVO - ARTICOLO ORA DISPONIBILE PER LA VENDITA
- NOUVEAU - ARTICLE DISPONIBLE EN PRODUCTION COURANTE
- NEU - JETZT ZUM VERKAUF VERFÜGBARER ARTIKEL
- NUEVO - ARTICULO AHORA DISPONIBLE EN PRODUCCION

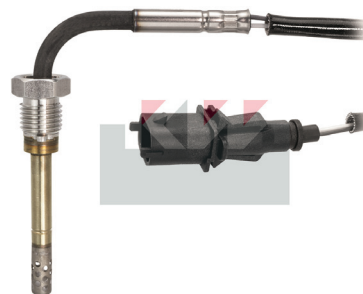

17	M14x1,5		L1	Ang	L2	RTD-PT
			50	90°	390	

ALFA ROMEO		
159 2.4 JTDM Q4	939A9.000	05/07 ⇌ 11/11

KW 422 294



EXHAUST GAS TEMPERATURE SENSORS (EGT)

Adatt./Suitable:

CITROËN
16 095 203 80
1618 FY

NEW - ITEM NOW AVAILABLE FROM PRODUCTION

- NUOVO - ARTICOLO ORA DISPONIBILE PER LA VENDITA
- NOUVEAU - ARTICLE DISPONIBLE EN PRODUCTION COURANTE
- NEU - JETZT ZUM VERKAUF VERFÜGBARER ARTIKEL
- NUEVO - ARTICULO AHORA DISPONIBLE EN PRODUCCION

FIAT
51825673
55215116

PEUGEOT
16 095 203 80
1618 FY



17	M14x1,5		L1	Ang	L2	RTD-PT
			50	90°	490	

CITROËN		
JUMPER III 3.0 HDi 145	F30DTE(F1CE3481N)	07/10 ⇌
JUMPER III 3.0 HDi 155	F1CE0481D(F30DT)	07/10 ⇌
JUMPER III 3.0 HDi 160	F1CE0481D(F30DT)	09/06 ⇌

KW 422 296



EXHAUST GAS TEMPERATURE SENSORS (EGT)

Adatt./Suitable:

AUDI
4M0 906 088 AD

NEW - ITEM NOW AVAILABLE FROM PRODUCTION

- NUOVO - ARTICOLO ORA DISPONIBILE PER LA VENDITA
- NOUVEAU - ARTICLE DISPONIBLE EN PRODUCTION COURANTE
- NEU - JETZT ZUM VERKAUF VERFÜGBARER ARTIKEL
- NUEVO - ARTICULO AHORA DISPONIBLE EN PRODUCCION

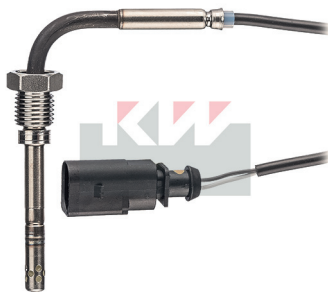

17	M14x1,5		L1	Ang	L2	RTD-PT
			50	90°	440	

AUDI		
A4 V 3.0 TDI	CSWB	09/15 ⇌ 08/18
A4 V 3.0 TDI quattro	CRTC, CSWB	05/15 ⇌ 08/18
A4 V ALLROAD 3.0 TDI quattro	CRTC, CSWB	01/16 ⇌ 08/18

KW 422 298



EXHAUST GAS TEMPERATURE SENSORS (EGT)

Adatt./Suitable:

GENERAL MOTORS
55 575 039

NEW - ITEM NOW AVAILABLE FROM PRODUCTION

- NUOVO - ARTICOLO ORA DISPONIBILE PER LA VENDITA
- NOUVEAU - ARTICLE DISPONIBLE EN PRODUCTION COURANTE
- NEU - JETZT ZUM VERKAUF VERFÜGBARER ARTIKEL
- NUEVO - ARTICULO AHORA DISPONIBLE EN PRODUCCION

OPEL
55575039
8 55 287

SAAB
55 575 039

VAUXHALL
55575039



17	M14x1,5		L1	Ang	L2	RTD-PT
			50	120°	390	

OPEL		
INSIGNIA A 2.0 Biturbo CDTI	A20DTR, A20DTR(LBY), A20DTR(LBY-NE9-KL9)	07/08 ⇌ 03/17

OPEL		
INSIGNIA A 2.0 Biturbo CDTi 4x4	A20DTR, A20DTR(LBY-NE9-F46), A20DTR(LBY-NE9-KL9)	07/08 ⇒ 03/17
INSIGNIA A 2.0 CDTi 4x4	A20DTR	09/13 ⇒ 03/17
SAAB		
9-5 2.0TTiD	A20DTR	05/10 ⇒ 01/12
9-5 2.0TTiD XWD	A20DTR	05/10 ⇒ 01/12
VAUXHALL		
INSIGNIA 2.0 Biturbo CDTi	A20DTR, A20DTR(LBY-NE9-KL9)	03/12 ⇒ 05/17
INSIGNIA 2.0 Biturbo CDTi 4x4	A20DTR, A20DTR(LBY-NE9-KL9)	03/12 ⇒ 05/17
INSIGNIA 2.0 CDTi	A20DTR, A20DTR(LBY), A20DTR(LBY-NE9-KL9)	10/08 ⇒ 05/17
INSIGNIA 2.0 CDTi 4x4	A20DTR, A20DTR(LBY)	05/09 ⇒ 05/17

KW 422 299

04,5

EXHAUST GAS TEMPERATURE SENSORS (EGT)

Adatt./Suitable:

MERCEDES-BENZ
 A 000 905 39 05

NEW - ITEM NOW AVAILABLE FROM PRODUCTION

- NUOVO - ARTICOLO ORA DISPONIBILE PER LA VENDITA
- NOUVEAU - ARTICLE DISPONIBLE EN PRODUCTION COURANTE
- NEU - JETZT ZUM VERKAUF VERFÜGBARER ARTIKEL
- NUEVO - ARTICULO AHORA DISPONIBLE EN PRODUCCION

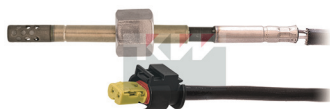

17	M14x1,5		L1	Ang	L2	RTD-PT
			50	0°	570	

MERCEDES-BENZ

SPRINTER II 210 CDI	OM651.955, OM651.956	03/09 ⇒ 12/13
SPRINTER II 211 CDI	OM651.955	04/16 ⇒
SPRINTER II 214 CDI	OM651.955	04/16 ⇒
SPRINTER II 310 CDI	OM651.955, OM651.956	03/09 ⇒ 12/13
SPRINTER II 311 CDI	OM651.955	05/16 ⇒
SPRINTER II 314 CDI	OM651.955	05/16 ⇒
SPRINTER II 314 CDI 4x4	OM651.955	05/16 ⇒
SPRINTER II 411 CDI	OM651.955	04/16 ⇒
SPRINTER II 414 CDI	OM651.955	05/16 ⇒
SPRINTER II 414 CDI 4x4	OM651.955	05/16 ⇒
SPRINTER II 416 CDI 4x4	OM651.955, OM651.957	11/13 ⇒
SPRINTER II 511 CDI	OM651.955	05/16 ⇒
SPRINTER II 514 CDI	OM651.955	05/16 ⇒
SPRINTER II 514 CDI 4x4	OM651.955	05/16 ⇒
SPRINTER 3,5-T 314 CDI Trazione integrale	OM651.958	01/19 ⇒
SPRINTER 3,5-T 316 CDI Trazione integrale	OM651.958	01/19 ⇒
SPRINTER 3-T 211 CDI RWD	OM651.958	02/18 ⇒
SPRINTER 3-T 214 CDI RWD	OM651.958	02/18 ⇒
SPRINTER 3-T 216 CDI RWD	OM651.958	02/18 ⇒
SPRINTER 4-T 414 CDI Trazione integrale	OM651.958	01/19 ⇒
SPRINTER 4-T 416 CDI Trazione integrale	OM651.958	01/19 ⇒
SPRINTER 5-T 516 CDI Trazione integrale	OM651.958	01/19 ⇒

KW 422 302

04,5

EXHAUST GAS TEMPERATURE SENSORS (EGT)

Adatt./Suitable:

MERCEDES-BENZ

 A 005 153 21 28
 A 007 153 50 28
 A 008 153 30 28

NEW - ITEM NOW AVAILABLE FROM PRODUCTION

- NUOVO - ARTICOLO ORA DISPONIBILE PER LA VENDITA
- NOUVEAU - ARTICLE DISPONIBLE EN PRODUCTION COURANTE
- NEU - JETZT ZUM VERKAUF VERFÜGBARER ARTIKEL
- NUEVO - ARTICULO AHORA DISPONIBLE EN PRODUCCION

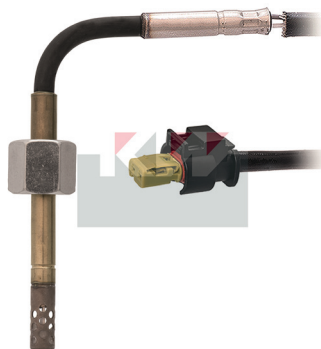

17	M14x1,5		L1	Ang	L2	RTD-PT
			50	90°	1140	

MERCEDES-BENZ

CLASSE E III E 280 CDI 4-matic	OM642.921	03/05 ⇒ 12/08
CLASSE E III E 280 T CDI 4-matic	OM642.921	03/05 ⇒ 07/09
CLASSE E III E 320 CDI 4-matic	OM642.921	03/05 ⇒ 12/08
CLASSE E III E 320 T CDI 4-matic	OM642.921	03/05 ⇒ 07/09
CLASSE SV S 320 CDI	OM642.930	10/05 ⇒ 12/13
CLASSE SV S 320 CDI 4-matic	OM642.932	10/05 ⇒ 12/13
CLASSE SV S 350 CDI	OM642.930	06/09 ⇒ 12/13
CLASSE SV S 350 CDI 4-matic	OM642.932	01/09 ⇒ 07/13

KW 422 303

04,5

EXHAUST GAS TEMPERATURE SENSORS (EGT)

Adatt./Suitable:

MERCEDES-BENZ

 A 000 905 22 05
 A 000 905 79 01
 A 005 153 45 28
 A 007 153 25 28
 A 007 153 79 28
 A 007 153 98 28

NEW - ITEM NOW AVAILABLE FROM PRODUCTION

- NUOVO - ARTICOLO ORA DISPONIBILE PER LA VENDITA
- NOUVEAU - ARTICLE DISPONIBLE EN PRODUCTION COURANTE
- NEU - JETZT ZUM VERKAUF VERFÜGBARER ARTIKEL
- NUEVO - ARTICULO AHORA DISPONIBLE EN PRODUCCION

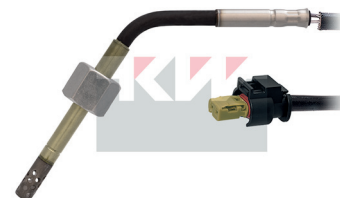

17	M14x1,5		L1	Ang	L2	RTD-PT
			50	60°	840	

MERCEDES-BENZ

CLASSE CLS II CLS 300	M276.952, M276.957	09/11 ⇒
CLASSE CLS II CLS 350	M276.952	01/11 ⇒ 08/14
CLASSE CLS II CLS 350 BlueTEC / d	OM642.852, OM642.853	02/13 ⇒ 12/17
CLASSE CLS II CLS 350 BlueTEC / d 4-matic	OM642.854, OM642.858	02/13 ⇒ 12/17
CLASSE CLS II CLS 350 CDI / d	OM642.853	01/11 ⇒ 08/14
CLASSE CLS II CLS 350 CDI / d 4-matic	OM642.854	09/11 ⇒ 08/14
CLASSE C III C 300	M276.957	02/11 ⇒ 01/14
CLASSE C III C 300 4-matic	M276.957	02/11 ⇒ 01/14
CLASSE C III C 300 CDI	OM642.832	01/11 ⇒ 08/14
CLASSE C III C 300 CDI 4-matic	OM642.960	01/07 ⇒ 08/14
CLASSE C III C 320 CDI	OM642.961	07/07 ⇒ 01/14
CLASSE C III C 350	M276.957	01/11 ⇒
CLASSE C III C 350 4-matic	M276.957	01/11 ⇒
CLASSE C III C 350 CDI	OM642.830, OM642.834, OM642.960	08/07 ⇒ 08/14
CLASSE C III C 350 CDI 4-matic	OM642.832, OM642.961	08/07 ⇒ 08/14
CLASSE C III C 350 CGI	M272.982, M276.957	09/08 ⇒ 08/14
CLASSE CLS I CLS 320 CDI	OM642.920	01/05 ⇒ 12/10
CLASSE CLS I CLS 350 CDI	OM642.920	04/09 ⇒ 12/10
CLASSE E III E 280 CDI	OM642.920	03/05 ⇒ 12/08
CLASSE E III E 280 T CDI	OM642.920	03/05 ⇒ 07/09
CLASSE E III E 300 BlueTEC	OM642.920	09/07 ⇒ 12/08
CLASSE E III E 320 CDI	OM642.920	03/05 ⇒ 12/08
CLASSE E III E 320 T CDI	OM642.920	03/05 ⇒ 07/09
CLASSE E IV E 300	M276.952, M276.957	04/11 ⇒ 12/16
CLASSE E IV E 300 4-matic	M276.952	07/11 ⇒ 12/16
CLASSE E IV E 300 CDI / BlueTEC	OM642.852	11/09 ⇒ 12/16
CLASSE E IV E 350	M276.952, M276.957	04/11 ⇒ 12/15
CLASSE E IV E 350 4-matic	M276.952	09/11 ⇒ 12/16
CLASSE E IV E 350 BlueTEC	OM642.838, OM642.850, OM642.852	01/09 ⇒ 12/16
CLASSE E IV E 350 BlueTEC 4-matic	OM642.858	11/12 ⇒ 12/16
CLASSE E IV E 350 CDI	OM642.836, OM642.838	01/09 ⇒ 12/13
CLASSE E IV E 350 CGI	M272.982, M272.983, M272.984	01/09 ⇒ 12/14
CLASSE E IV E 400	M276.820	06/13 ⇒ 12/16
CLASSE GLK 300 4-matic	M276.957	09/09 ⇒ 12/15
CLASSE GLK 320 CDI 4-matic	OM642.961	06/08 ⇒ 06/15
CLASSE GLK 350 4-matic	M276.957	06/08 ⇒ 06/15
CLASSE GLK 350 CDI 4-matic	OM642.832, OM642.835	07/09 ⇒ 06/15
CLASSE R R 280 CDI	OM642.870, OM642.872, OM642.950	05/06 ⇒ 12/12
CLASSE R R 280 CDI 4-matic	OM642.950	05/06 ⇒ 12/12
CLASSE R R 300 CDI	OM642.870, OM642.872, OM642.950	07/09 ⇒ 12/12
CLASSE R R 320 CDI 4-matic	OM642.870, OM642.950	01/06 ⇒ 12/12
CLASSE R R 350 CDI 4-matic	OM642.870, OM642.872, OM642.950	01/06 ⇒ 12/14
SPRINTER II 311 CDI	OM646.701	09/13 ⇒

MERCEDES-BENZ

SPRINTER II 411 CDI	OM646.701	09/13 →
---------------------	-----------	---------

KW 422 304



04,5

EXHAUST GAS TEMPERATURE SENSORS (EGT)

Adatt./Suitable:

MERCEDES-BENZ
A 000 905 02 32
A 000 905 08 05

NEW - ITEM NOW AVAILABLE FROM PRODUCTION

- NUOVO - ARTICOLO ORA DISPONIBILE PER LA VENDITA
- NOUVEAU - ARTICLE DISPONIBLE EN PRODUCTION COURANTE
- NEU - JETZT ZUM VERKAUF VERFÜGBARER ARTIKEL
- NUEVO - ARTICULO AHORA DISPONIBLE EN PRODUCCION

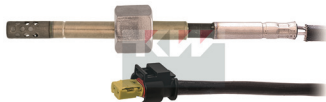

			L1	Ang	L2	RTD-PT
17	M14x1,5		50	0°	650	

MERCEDES-BENZ

CLASSE C IV C 220 d 4-matic	OM651.921	04/15 → 05/18
CLASSE C IV C 250 BlueTEC / d 4-matic	OM651.921	02/14 → 05/18
CLASSE C IV C 250 d 4-matic	OM651.921	04/16 → 05/18
CLASSE GLC 220 d 4-matic	OM651.921	06/15 → 04/19
CLASSE GLC 250 d 4-matic	OM651.921	06/15 → 04/19

KW 422 308



04,5

EXHAUST GAS TEMPERATURE SENSORS (EGT)

Adatt./Suitable:

INFINITI
22630-4HK0C
22630-HG00J
22630-HG00K

MERCEDES-BENZ
A 000 905 20 05
A 000 905 35 05
A 000 905 77 01
A 001 905 28 00

NEW - ITEM NOW AVAILABLE FROM PRODUCTION

- NUOVO - ARTICOLO ORA DISPONIBILE PER LA VENDITA
- NOUVEAU - ARTICLE DISPONIBLE EN PRODUCTION COURANTE
- NEU - JETZT ZUM VERKAUF VERFÜGBARER ARTIKEL
- NUEVO - ARTICULO AHORA DISPONIBLE EN PRODUCCION



			L1	Ang	L2	RTD-PT
17	M14x1,5		50	90°	440	

INFINITI

Q70 2.2 D	6CA4GX13-01	10/14 →
-----------	-------------	---------

MERCEDES-BENZ

CLASSE E IV E 220 BlueTEC 4-matic	OM651.924	12/14 → 12/16
CLASSE E IV E 250 CDI / BlueTEC 4-matic	OM651.924	07/10 → 12/16

MERCEDES-BENZ

CLASSE GLK 200 CDI	OM651.913, OM651.916	07/10 → 06/15
CLASSE GLK 220 CDI	OM651.916	12/08 → 06/15
CLASSE GLK 220 CDI 4-matic	OM651912	12/08 → 06/15
CLASSE GLK 250 CDI 4-matic	0HH465Q-2E	09/09 → 06/15
CLASSE R R 320 4-matic	M276.826	01/14 →
CLASSE R R 350 CGI 4-matic	M276.958	10/11 → 12/14
CLASSE R R 400 4-matic	M276.825, M276.826, M276.925	01/14 →
CLASSE SL VI 350	M276.954	02/12 →
CLASSE SL VI 400	M276.825	04/14 →
CLASSE SLC 250 d	OM651.980	01/16 → 10/17

KW 422 309



04,5

EXHAUST GAS TEMPERATURE SENSORS (EGT)

Adatt./Suitable:

MERCEDES-BENZ
A 000 905 69 04
A 001 905 22 00

NEW - ITEM NOW AVAILABLE FROM PRODUCTION

- NUOVO - ARTICOLO ORA DISPONIBILE PER LA VENDITA
- NOUVEAU - ARTICLE DISPONIBLE EN PRODUCTION COURANTE
- NEU - JETZT ZUM VERKAUF VERFÜGBARER ARTIKEL
- NUEVO - ARTICULO AHORA DISPONIBLE EN PRODUCCION



			L1	Ang	L2	RTD-PT
17	M14x1,5		50	120°	390	

MERCEDES-BENZ

CLASSE GL II GL 350 CDI / BlueTEC 4-matic	OM642.826	07/12 → 10/15
CLASSE GLE 350 d 4-matic	OM642.824, OM642.826	03/15 → 10/19
CLASSE M III ML 350 BlueTEC 4-matic	OM642.826	06/11 → 02/15
CLASSE M III ML 350 CDI 4-matic	OM642.826	06/11 → 02/15

KW 422 322



04,5

EXHAUST GAS TEMPERATURE SENSORS (EGT)

Adatt./Suitable:

GENERAL MOTORS
55 588 650

OPEL

12 47 580
55588650

VAUXHALL

55588650

NEW - ITEM NOW AVAILABLE FROM PRODUCTION

- NUOVO - ARTICOLO ORA DISPONIBILE PER LA VENDITA
- NOUVEAU - ARTICLE DISPONIBLE EN PRODUCTION COURANTE
- NEU - JETZT ZUM VERKAUF VERFÜGBARER ARTIKEL
- NUEVO - ARTICULO AHORA DISPONIBLE EN PRODUCCION



			L1	Ang	L2	RTD-PT
17	M14x1,5		50	75°	1740	

OPEL

INSIGNIA A 2.0 Biturbo CDTI	A20DTR, A20DTR(LBY), A20DTR(LBY-NE9-KL9)	07/08 → 03/17
INSIGNIA A 2.0 Biturbo CDTI 4x4	A20DTR	07/08 → 03/17
INSIGNIA A 2.0 CDTI 4x4	A20DTR	09/13 → 03/17

VAUXHALL

INSIGNIA 2.0 Biturbo CDTI	A20DTR, A20DTR(LBY-NE9-KL9)	03/12 → 05/17
INSIGNIA 2.0 Biturbo CDTI 4x4	A20DTR	03/12 → 05/17
INSIGNIA 2.0 CDTI	A20DTR, A20DTR(LBY), A20DTR(LBY-NE9-KL9)	10/08 → 05/17
INSIGNIA 2.0 CDTI 4x4	A20DTR	05/09 → 05/17

KW 422 323

04,5

EXHAUST GAS TEMPERATURE SENSORS (EGT)

Adatt./Suitable:

GENERAL MOTORS
55 572 422OPEL
55572422
8 55 431VAUXHALL
55572422

NEW - ITEM NOW AVAILABLE FROM PRODUCTION

- NUOVO - ARTICOLO ORA DISPONIBILE PER LA VENDITA
- NOUVEAU - ARTICLE DISPONIBLE EN PRODUCTION COURANTE
- NEU - JETZ ZUM VERKAUF VERFÜGBARER ARTIKEL
- NUEVO - ARTICULO AHORA DISPONIBLE EN PRODUCCION

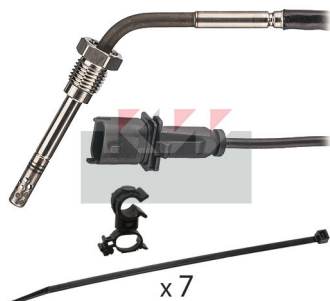

17	M14x1,5		L1 50	Ang 60°	L2 1640	RTD-PT
----	---------	--	----------	------------	------------	--------

OPEL

ASTRA J 2.0 BiTurbo CDTI	A20DTR	09/12 ⇨ 10/15
ZAFIRA C 2.0 BiTurbo CDTI	A20DTR	01/13 ⇨
CASCADA 2.0 CDTI	A20DTR	04/13 ⇨ 06/15

VAUXHALL

CASCADA 2.0 CDTI	A20DTR	02/13 ⇨
ASTRA VI 2.0 BiTurbo CDTI	A20DTR, A20DTR(LBY-NE9)	12/12 ⇨

KW 422 324

04,5

EXHAUST GAS TEMPERATURE SENSORS (EGT)

Adatt./Suitable:

GENERAL MOTORS
55 574 737OPEL
55574737
8 55 283SAAB
55 574 737VAUXHALL
55574737

NEW - ITEM NOW AVAILABLE FROM PRODUCTION

- NUOVO - ARTICOLO ORA DISPONIBILE PER LA VENDITA
- NOUVEAU - ARTICLE DISPONIBLE EN PRODUCTION COURANTE
- NEU - JETZ ZUM VERKAUF VERFÜGBARER ARTIKEL
- NUEVO - ARTICULO AHORA DISPONIBLE EN PRODUCCION

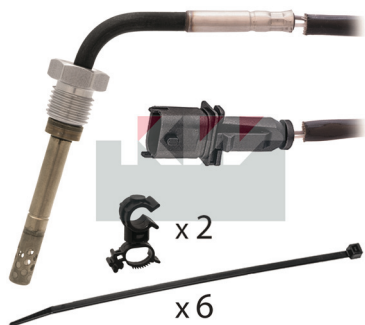

17	M14x1,5		L1 50	Ang 75°	L2 1440	RTD-PT
----	---------	--	----------	------------	------------	--------

OPEL

INSIGNIA A 2.0 Biturbo CDTI	A20DTR	07/08 ⇨ 03/17
-----------------------------	--------	---------------

OPEL

INSIGNIA A 2.0 Biturbo CDTI 4x4	A20DTR, A20DTR(LBY), A20DTR(LBY-NE9-F46), A20DTR(LBY-NE9-KL9)	07/08 ⇨ 03/17
INSIGNIA A 2.0 CDTi 4x4	A20DTR	09/13 ⇨ 03/17

SAAB

9-5 2.0 TTDi XWD	A20DTR	05/10 ⇨ 01/12
------------------	--------	---------------

VAUXHALL

INSIGNIA 2.0 Biturbo CDTI	A20DTR, A20DTR(LBY-NE9-KL9)	03/12 ⇨ 05/17
INSIGNIA 2.0 Biturbo CDTI 4x4	A20DTR, A20DTR(LBY-NE9-KL9)	03/12 ⇨ 05/17
INSIGNIA 2.0 CDTI	A20DTR, A20DTR(LBY), A20DTR(LBY-NE9-KL9)	10/08 ⇨ 05/17
INSIGNIA 2.0 CDTI 4x4	A20DTR, A20DTR(LBY)	05/09 ⇨ 05/17

KW 422 326

04,5

EXHAUST GAS TEMPERATURE SENSORS (EGT)

Adatt./Suitable:

AUDI
059 906 088 G

NEW - ITEM NOW AVAILABLE FROM PRODUCTION

- NUOVO - ARTICOLO ORA DISPONIBILE PER LA VENDITA
- NOUVEAU - ARTICLE DISPONIBLE EN PRODUCTION COURANTE
- NEU - JETZ ZUM VERKAUF VERFÜGBARER ARTIKEL
- NUEVO - ARTICULO AHORA DISPONIBLE EN PRODUCCION



17	M14x1,5		L1 50	Ang 45°	L2 690	RTD-PT
----	---------	--	----------	------------	-----------	--------

AUDI

A4 III 3.0 TDI quattro	ASB, BKN	11/04 ⇨ 03/09
------------------------	----------	---------------

KW 422 327

04,5

EXHAUST GAS TEMPERATURE SENSORS (EGT)

Adatt./Suitable:

MERCEDES-BENZ
A 005 153 82 28
A 007 153 82 28
A 007 153 87 28
A 008 153 26 28

NEW - ITEM NOW AVAILABLE FROM PRODUCTION

- NUOVO - ARTICOLO ORA DISPONIBILE PER LA VENDITA
- NOUVEAU - ARTICLE DISPONIBLE EN PRODUCTION COURANTE
- NEU - JETZ ZUM VERKAUF VERFÜGBARER ARTIKEL
- NUEVO - ARTICULO AHORA DISPONIBLE EN PRODUCCION

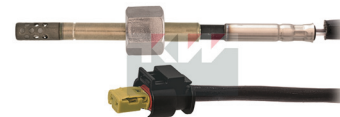

17	M14x1,5		L1 50	Ang 0°	L2 300	RTD-PT
----	---------	--	----------	-----------	-----------	--------

MERCEDES-BENZ

CLASSE C II C 320 CDI	OM642.910	01/05 ⇨ 08/07
CLASSE CLK II 320 CDI	OM642.910	01/05 ⇨ 05/09
CLASSE E III E 420 CDI	OM629.910	01/06 ⇨ 12/08

KW 422 329

04,5

EXHAUST GAS TEMPERATURE SENSORS (EGT)

Adatt./Suitable:

GENERAL MOTORS
55 575 652OPEL
55575652
8 55 433VAUXHALL
55575652

NEW - ITEM NOW AVAILABLE FROM PRODUCTION

- NUOVO - ARTICOLO ORA DISPONIBILE PER LA VENDITA
- NOUVEAU - ARTICLE DISPONIBLE EN PRODUCTION COURANTE
- NEU - JETZ ZUM VERKAUF VERFÜGBARER ARTIKEL
- NUEVO - ARTICULO AHORA DISPONIBLE EN PRODUCCION

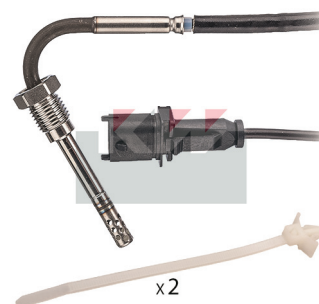

17	M14x1,5		L1 50	Ang 120°	L2 610	RTD-PT
----	---------	--	----------	-------------	-----------	--------

OPEL

ASTRA J 2.0 BiTurbo CDTI	A20DTR	09/12 ⇨ 10/15
ZAFIRA C 2.0 BiTurbo CDTI	A20DTR	01/13 ⇨
CASCADA 2.0 CDTI	A20DTR	04/13 ⇨ 06/15

VAUXHALL

CASCADA 2.0 CDTI	A20DTR	02/13 ⇨
ASTRA VI 2.0 BiTurbo CDTI	A20DTR, A20DTR(LBY-NE9)	12/12 ⇨
ZAFIRA C 2.0 BiTurbo CDTI	A20DTR, A20DTR(LBY-NE9)	11/12 ⇨ 08/18

EXHAUST GAS TEMPERATURE SENSORS (EGT)

Adatt./Suitable:

GENERAL MOTORS

55 570 307
55 593 602

OPEL

12 47 706

VAUXHALL

55570307
55593602

NEW - ITEM NOW AVAILABLE FROM PRODUCTION

- NUOVO - ARTICOLO ORA DISPONIBILE PER LA VENDITA
- NOUVEAU - ARTICLE DISPONIBLE EN PRODUCTION COURANTE
- NEU - JETZ ZUM VERKAUF VERFÜGBARER ARTIKEL
- NUEVO - ARTICULO AHORA DISPONIBLE EN PRODUCCION

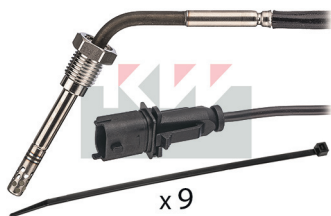

17	M14x1,5		L1	Ang	L2	RTD-PT
			50	60°	1840	

OPEL

ASTRA J 2.0 BiTurbo CDTI A20DTR(LBY-NE9) 09/12 ⇨ 10/15

ZAFIRA C 2.0 BiTurbo CDTI A20DTR(LBY-NE9) 01/13 ⇨

CASCADA 2.0 CDTI A20DTR 04/13 ⇨ 06/15

VAUXHALL

CASCADA 2.0 CDTI A20DTR 02/13 ⇨

ZAFIRA C 2.0 BiTurbo CDTI A20DTR, A20DTR(LBY-NE9) 11/12 ⇨ 08/18

EXHAUST GAS TEMPERATURE SENSORS (EGT)

Adatt./Suitable:

MERCEDES-BENZ

A 000 905 53 05
A 000 905 86 04
A 005 153 18 28
A 007 153 65 28
A 008 153 34 28

NEW - ITEM NOW AVAILABLE FROM PRODUCTION

- NUOVO - ARTICOLO ORA DISPONIBILE PER LA VENDITA
- NOUVEAU - ARTICLE DISPONIBLE EN PRODUCTION COURANTE
- NEU - JETZ ZUM VERKAUF VERFÜGBARER ARTIKEL
- NUEVO - ARTICULO AHORA DISPONIBLE EN PRODUCCION



17	M14x1,5		L1	Ang	L2	RTD-PT
			50	90°	610	

MERCEDES-BENZ

CLASSE G II G 350 BlueTEC OM642.970 07/09 ⇨

CLASSE G II G 350 CDI OM642.886 07/11 ⇨

CLASSE GL I GL 320 CDI / 350 BlueTEC 4-matic OM642.820 12/09 ⇨ 08/12

MERCEDES-BENZ

CLASSE GL I GL 320 CDI 4-matic	OM642.940	09/06 ⇨ 05/09
CLASSE GL I GL 350 CDI 4-matic	OM642.822, OM642.940	05/09 ⇨ 08/12
CLASSE GL I GL 420 CDI 4-matic	OM629.912	09/06 ⇨ 05/09
CLASSE GL I GL 450 CDI 4-matic	OM629.912	05/09 ⇨ 08/12
CLASSE GLE 250 d	OM651.960	04/15 ⇨ 10/18
CLASSE GLE 250 d 4-matic	OM651.960	04/15 ⇨ 10/18
CLASSE GLE 350 d 4-matic	OM642.824, OM642.826	03/15 ⇨ 10/19
CLASSE M II ML 300 CDI 4-matic	OM642.940	07/09 ⇨ 12/11
CLASSE M II ML 320 CDI 4-matic	OM642.820, OM642.940	07/05 ⇨ 07/11
CLASSE M II ML 350 CDI 4-matic	OM642.820, OM642.940	07/09 ⇨ 12/11
CLASSE M II ML 420 CDI 4-matic	OM629.912	02/06 ⇨ 09/09
CLASSE M II ML 450 CDI 4-matic	OM629.912	09/09 ⇨ 12/11
CLASSE M III ML 250 CDI / BlueTEC 4-matic	OM651.960	06/11 ⇨ 12/15
CLASSE M III ML 350 BlueTEC 4-matic	OM642.826	06/11 ⇨ 02/15
CLASSE M III ML 350 CDI 4-matic	OM642.826	06/11 ⇨ 02/15
CLASSE V V 200 CDI / d	OM651.950	03/14 ⇨
CLASSE V V 220 CDI / d	OM651.950	03/14 ⇨
CLASSE V V 250 BlueTEC / d	OM651.950	03/14 ⇨
MARCO POLO 200 CDI	OM651.950	03/15 ⇨
MARCO POLO 200 CDI 4-matic	OM651.950	03/15 ⇨
MARCO POLO 220 CDI	OM651.950	03/15 ⇨
MARCO POLO 220 CDI 4-matic	OM651.950	03/15 ⇨
MARCO POLO 250 CDI	OM651.950	03/15 ⇨
MARCO POLO 250 CDI 4-matic	OM651.950	03/15 ⇨
VITO III 114 CDI / 114 BlueTEC 4-matic	OM651.950	07/15 ⇨
VITO III 114 CDI 4-matic	OM651.950	07/15 ⇨
VITO III 114 CDI 4x4	OM651.950	07/15 ⇨
VITO III 116 CDI / 116 BlueTEC 4-matic	OM651.950	07/15 ⇨
VITO III 116 CDI 4-matic	OM651.950	07/15 ⇨
VITO III 116 CDI 4x4	OM651.950	07/15 ⇨

EXHAUST GAS TEMPERATURE SENSORS (EGT)

Adatt./Suitable:

SKODA

038 906 088 B

VW

038 906 088 B

NEW - ITEM NOW AVAILABLE FROM PRODUCTION

- NUOVO - ARTICOLO ORA DISPONIBILE PER LA VENDITA
- NOUVEAU - ARTICLE DISPONIBLE EN PRODUCTION COURANTE
- NEU - JETZ ZUM VERKAUF VERFÜGBARER ARTIKEL
- NUEVO - ARTICULO AHORA DISPONIBLE EN PRODUCCION



17	M14x1,5		L1	Ang	L2	RTD-PT
			50	90°	1340	

SKODA

SUPERB I 2.0 TDI BSS 10/05 ⇨ 03/08

VW

PASSAT IV 2.0 TDI BGW, BHW 12/03 ⇨ 05/05

KW 463 123

07,5

EGR VALVES

Adatt./Suitable:

IVECO
5802061038

NEW - ITEM NOW AVAILABLE FROM PRODUCTION

- NUOVO - ARTICOLO ORA DISPONIBILE PER LA VENDITA
- NOUVEAU - ARTICLE DISPONIBLE EN PRODUCTION COURANTE
- NEU - JETZT ZUM VERKAUF VERFÜGBARER ARTIKEL
- NUEVO - ARTICULO AHORA DISPONIBLE EN PRODUCCION

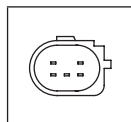

IVECO

DAILY V 33S14, 35S14, 35C14 | F1AGL411J

04/16 ⇨

KW 480 002

1

HIGH PRESSURE SENSORS

Adatt./Suitable:

BMW
13 62 8 507 634
8 507 634

NEW - ITEM NOW AVAILABLE FROM PRODUCTION

- NUOVO - ARTICOLO ORA DISPONIBILE PER LA VENDITA
- NOUVEAU - ARTICLE DISPONIBLE EN PRODUCTION COURANTE
- NEU - JETZT ZUM VERKAUF VERFÜGBARER ARTIKEL
- NUEVO - ARTICULO AHORA DISPONIBLE EN PRODUCCION

MARKET DIFFUSION: MEDIUM

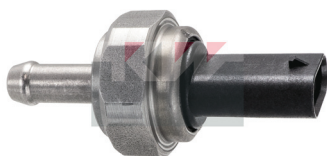

	kPa	mV	- 0 +
27	43,4 - 520,2	516 - 4750	

BMW

3 VI 316 d	N47D20C	03/12 ⇨ 06/19
3 VI 318 d	N47D20C	03/12 ⇨ 06/19
3 VI 318 d xDrive	N47D20C	07/13 ⇨ 06/15
3 VI 320 d	N47D20C	11/11 ⇨ 06/19
3 VI 320 d xDrive	N47D20C	08/12 ⇨ 06/19
3 VI 325 d	N47D20D	03/13 ⇨ 06/16
3 VI 328 d [USA]	--	10/11 ⇨
3 VI 328 d xDrive [USA]	--	10/11 ⇨
3 VI 330 d	N57D30A	07/12 ⇨
3 VI 330 d xDrive	N57D30A	03/13 ⇨
3 VI 335 d xDrive	N57D30B	07/13 ⇨

BMW

1 II 114 d	N47D16A	07/12 ⇨
1 II 116 d	N47D16A, N47D20C	07/11 ⇨
1 II 118 d	N47D20C	07/11 ⇨
1 II 118 d xDrive	N47D20C	05/13 ⇨
1 II 120 d	N47D20C	07/11 ⇨
1 II 120 d xDrive	N47D20C	01/12 ⇨
1 II 125 d	N47D20D	12/11 ⇨
2 218 d	N47D20C	03/14 ⇨ 06/15
2 220 d	B47D20A, N47D20C	10/12 ⇨
2 225 d	N47D20D	01/14 ⇨
3 V 318 d	N47D20A, N47D20C	02/07 ⇨ 06/12
3 V 320 d	N47D20A, N47D20C	12/04 ⇨ 12/13
3 V 320 d xDrive	N47D20C	09/08 ⇨ 06/13
4 418 d	N47D20C	03/14 ⇨ 06/15
4 420 d	N47D20C	07/13 ⇨
4 420 d xDrive	N47D20C	11/13 ⇨
4 425 d	N47D20D	03/14 ⇨ 02/16
4 430 d	N57D30A	11/13 ⇨
4 430 d xDrive	N57D30A	03/14 ⇨
4 435 d xDrive	N57D30B	11/13 ⇨
X5 III sDrive 25 d	B47D20B, N47D20D	12/13 ⇨ 07/18
X5 III xDrive 25 d	B47D20B, N47D20D, N57D30A	12/13 ⇨ 07/18
X5 III xDrive 30 d	N57D30A	08/13 ⇨ 07/18
X5 III xDrive 35 d [USA]	N57D30A	01/13 ⇨
X5 III xDrive 40 d	N57D30B, N57D30B(N57Z)	12/13 ⇨ 07/18
5 VI 518 d	N47D20C	07/13 ⇨ 02/17
5 VI 520 d	N47D20C	06/10 ⇨ 02/17
5 VI 520 d xDrive	N47D20C	01/13 ⇨ 02/17
5 VI 525 d	0DA465Q-2, 3DA465Q, N47D20D	09/11 ⇨ 02/17
5 VI 525 d xDrive	N47D20D	09/11 ⇨ 02/17
5 VI 530 d	N57D30A	09/10 ⇨ 02/17
5 VI 530 d xDrive	N57D30A	03/11 ⇨ 02/17
5 VI 535 d	N57D30B	09/10 ⇨ 02/17
5 VI 535 d xDrive	N57D30B	09/11 ⇨ 02/17
X3 II sDrive 18 d	N47D20C	10/12 ⇨ 03/14
X3 II xDrive 20 d	N47D20C	09/10 ⇨ 03/14
X3 II xDrive 28 d	N47D20C	09/14 ⇨
X3 II xDrive 30 d	N57D30A	04/11 ⇨ 08/17
X3 II xDrive 35 d	N57D30B	10/11 ⇨ 08/17
6 III 640 d	N57D30B	09/11 ⇨ 10/18
6 III 640 d xDrive	N57D30B	03/12 ⇨ 10/18
7 V 730 d	N57D30A	02/08 ⇨ 05/15
7 V 730 d LCI	N57D30A	01/11 ⇨
7 V 730 d xDrive	N57D30A	11/11 ⇨ 05/15
7 V 730Ld	N57D30A	06/08 ⇨
7 V 740 d	N57D30B	07/12 ⇨ 06/15
7 V 740 d LCI [USA]	N57D30B	01/11 ⇨
7 V 740 d LCI xDrive [USA]	N57D30B	01/11 ⇨
7 V 740 d xDrive	N57D30B	07/12 ⇨ 06/15
X6 II xDrive 30 d	N57D30A	08/14 ⇨ 07/19
X6 II xDrive 40 d	N57D30B	12/14 ⇨ 07/19
X1 I sDrive 16 d	N47D20C	04/12 ⇨ 06/15
X1 I sDrive 18 d	N47D20C	03/09 ⇨ 06/15
X1 I sDrive 20 d	N47D20C	10/09 ⇨ 06/15
X1 I xDrive 18 d	N47D20C	03/09 ⇨ 06/15
X1 I xDrive 20 d	N47D20C	09/09 ⇨ 06/15
X1 I xDrive 25 d	N47D20D	10/09 ⇨ 06/15
X4 I xDrive 30 d	N57D30A	04/14 ⇨ 03/18
X4 I xDrive 35 d	N57D30B	04/14 ⇨ 03/18
5 VI GT 520 d	N47D20C	04/11 ⇨ 02/17
5 VI GT 530 d	N57D30A	08/09 ⇨ 02/17
5 VI GT 530 d xDrive	N57D30A	06/10 ⇨ 02/17
5 VI GT 535 d	N57D30B	03/10 ⇨ 02/17
5 VI GT 535 d xDrive	N57D30B	03/10 ⇨ 02/17

KW 480 007

1

HIGH PRESSURE SENSORS

Adatt./Suitable:

BMW
13 62 8 570 936
8 570 936MINI
13 62 8 570 936TOYOTA
89421-WA010VOLVO
31319419

NEW - ITEM NOW AVAILABLE FROM PRODUCTION

- NUOVO - ARTICOLO ORA DISPONIBILE PER LA VENDITA
- NOUVEAU - ARTICLE DISPONIBLE EN PRODUCTION COURANTE
- NEU - JETZT ZUM VERKAUF VERFÜGBARER ARTIKEL
- NUEVO - ARTICULO AHORA DISPONIBLE EN PRODUCCION

MARKET DIFFUSION: HIGH

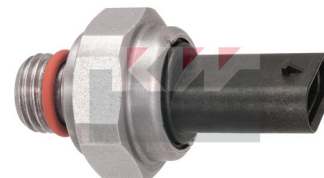

		kPa	mV	- 0 +
27	M14x1,5	43,2 - 527,9	508 - 4750	

BMW

3 VI 316 d	B47D20A	03/12 ⇨ 06/19
3 VI 318 d	B47D20A	03/12 ⇨
3 VI 318 d xDrive	B47D20A	07/15 ⇨ 02/18
3 VI 320 d	B47D20A	11/11 ⇨
3 VI 320 d xDrive	B47D20A	08/12 ⇨
1 II 114 d	B37D15A	06/15 ⇨
1 II 116 d	B37D15A	03/15 ⇨
1 II 118 d	B47D20A	07/11 ⇨
1 II 118 d xDrive	B47D20A	03/15 ⇨
1 II 120 d	B47D20A	07/11 ⇨
1 II 120 d xDrive	B47D20A	03/15 ⇨
1 II 125 d	B47D20B	03/15 ⇨
1 III 116 d	B37C15A	07/19 ⇨
1 III 118 d	B47C20B	07/19 ⇨
1 III 120 d	B47C20B	03/20 ⇨
1 III 120 d xDrive	B47C20B	07/19 ⇨
2 214 d	B37C15A	07/14 ⇨ 02/18
2 216 d	B37C15A	03/14 ⇨
2 218 d	B47C20A, B47C20B, B47D20A	11/13 ⇨
2 218 d xDrive	B47C20A, B47C20B	12/14 ⇨
2 220 d	B47C20A, B47C20B, B47D20A	03/14 ⇨
2 220 d Mild-Hybrid	B47D20B	08/21 ⇨
2 220 d xDrive	B47C20A, B47C20B, B47D20A	03/14 ⇨
2 225 d	B47D20B	07/15 ⇨
3 VII 316 d	B47D20B	03/20 ⇨
3 VII 316 d Mild-Hybrid	B47D20B	07/20 ⇨
3 VII 318 d	B47D20B	03/19 ⇨ 07/20
3 VII 318 d Mild-Hybrid	B47D20B	04/20 ⇨
3 VII 320 d	B47D20B	11/18 ⇨
3 VII 320 d Mild-Hybrid	B47D20B	03/20 ⇨
3 VII 320 d Mild-Hybrid xDrive	B47D20B	03/20 ⇨
3 VII 320 d xDrive	B47D20B	11/18 ⇨ 02/20
3 VII 330 d	B57D30A	03/19 ⇨
3 VII 330 d xDrive	B57D30A	07/19 ⇨
3 320 d	B47D20B	07/19 ⇨ 02/20
3 320 d Mild-Hybrid	B47D20B	03/20 ⇨
3 320 d Mild-Hybrid xDrive	B47D20B	03/20 ⇨
3 320 d xDrive	B47D20B	07/19 ⇨ 02/20
3 330 d	B57D30A	11/19 ⇨
3 330 d xDrive	B57D30A	11/19 ⇨
4 418 d	B47D20A	03/14 ⇨
4 420 d	B47D20A	07/13 ⇨
4 420 d Mild-Hybrid	B47D20B	07/20 ⇨
4 420 d Mild-Hybrid xDrive	B47D20B	07/20 ⇨
4 420 d xDrive	B47D20A	11/13 ⇨
5 VII 518 d	B47D20B	07/18 ⇨ 06/20
5 VII 518 d Mild-Hybrid	B47D20B	07/20 ⇨
5 VII 520 d	B47D20A, B47D20B	09/16 ⇨
5 VII 520 d Mild-Hybrid	B47D20B	11/19 ⇨
5 VII 520 d Mild-Hybrid xDrive	B47D20B	11/19 ⇨

BMW		
5 VII 520 d xDrive	B47D20A, B47D20B	09/16 →
5 VII 525 d	B47D20B	07/17 → 06/19
5 VII 530 d	B57D30A	09/16 →
5 VII 530 d xDrive	B57D30A	09/16 →
5 VII 540 d xDrive	B57D30B	07/17 →
5 VI 518 d	B47D20A	07/13 → 02/17
5 VI 520 d	B47D20A	06/10 → 02/17
5 VI 520 d xDrive	B47D20A	10/13 → 02/17
X3 II sDrive 18 d	B47D20A	04/14 → 08/17
X3 II xDrive 20 d	B47D20A	04/14 → 08/17
5 SERIES 520d Mild-Hybrid	B47D20B	11/19 →
6 IV GT 620 d	B47D20B	07/18 → 06/20
6 IV GT 620 d Mild-Hybrid	B47D20B	07/20 →
6 IV GT 620 d Mild-Hybrid xDrive	B47D20B	07/20 →
6 IV GT 620 d xDrive	B47D20B	07/18 → 06/20
6 IV GT 630 d	B57D30A	06/17 → 06/20
6 IV GT 630 d xDrive	B57D30A	06/17 → 06/20
6 IV GT 640 d xDrive	B57D30B	11/17 → 06/20
8 840 d xDrive	B57D30B	07/18 → 10/20
X1 II sDrive 16 d	B37C15A	11/14 →
X1 II sDrive 18 d	B47C20A, B47C20B	07/15 →
X1 II sDrive 20 d	B47C20A, B47C20B	11/15 →
X1 II xDrive 18 d	B47C20A, B47C20B	11/14 →
X1 II xDrive 20 d	B47C20A, B47C20B	07/15 →
7 VI 725 d, Ld	B47D20B	07/16 → 02/19
7 VI 730 d	B57D30A	07/15 → 06/20
7 VI 730 d xDrive	B57D30A	09/15 → 06/20
7 VI 730 d, Ld Mild-Hybrid xDrive	B57D30B	07/20 →
7 VI 730 d, Ld xDrive	B57D30A	09/15 → 06/20
7 VI 740 d, Ld xDrive	B57D30B	11/15 → 06/20
X2 sDrive 16 d	B37C15A	11/18 →
X2 sDrive 18 d	B47C20A, B47C20B	03/18 →
X2 sDrive 20 d	B47C20A, B47C20B	11/18 →
X2 xDrive 18 d	B47C20B	03/18 →
X2 xDrive 20 d	B47C20A, B47C20B	11/17 →
X3 III sDrive 18 d	B47D20A	04/18 →
X3 III sDrive 18 d Mild-Hybrid	B47D20B	07/20 →
X3 III xDrive 20 d	B47D20A	08/17 →
X3 III xDrive 30 d	B57D30A	08/17 →
X3 III xDrive 30d	B57D30A	08/17 → 06/20
X3 III xDrive M40 d	B57D30B	08/18 → 06/20
X4 I xDrive 20 d	B47D20A	04/14 → 03/18
X4 II xDrive 20 d	B47D20A, B47D20B	04/18 → 03/20
X4 II xDrive 25 d	B47D20B	04/18 →
X5 IV xDrive 25 d	B47D20B	08/19 →
X6 III xDrive 30 d	B57D30A	08/19 → 07/20
X7 xDrive 30 d	B57D30A	03/19 →

MINI		
MINI III Cooper D	B37C15A, B47C20A, B47C20B	10/13 →
MINI III Cooper D ALL4	B47C20A, B47C20B	10/16 →
MINI III Cooper SD	B47C20A, B47C20B	09/13 →
MINI III Cooper SD ALL4	B47C20A, B47C20B	04/15 →
MINI III One D	B37C15A	02/14 →

TOYOTA		
AURIS II 1.6 D4-D	1WW	04/15 → 12/18
AVENSIS III 1.6 D4-D	1WW	04/15 → 10/18
AVENSIS III 2.0 D-4D	2WW	04/15 → 10/18
RAV 4 IV 2.0 D	2WW	10/15 → 11/18
RAV 4 2.0 D4d	2WW	10/15 → 11/18
VERSO 1.6 D4-D	1WW	11/13 → 08/18

VOLVO		
S60 II 2.0 D2	D4204T20	03/15 → 05/18
S60 II 2.0 D3	D4204T4, D4204T9	03/15 → 05/18
S60 II 2.0 D4	D4204T14	03/15 → 05/18
S60 II 2.0 D5	D4204T11	03/15 → 05/18
S60 II D4	D4204T5	09/13 → 12/15
S60 II D4 Drive-E Polestar	D4204T14	03/15 → 05/18
S60 II D5 Drive-E Polestar	D4204T11	03/15 → 05/18
S80 II D4	D4204T5	09/13 → 12/16
S90 D3	D4204T16, D4204T9	03/16 → 08/18
S90 D4	D4204T14, D4204T7	03/16 →
S90 D4 AWD	D4204T14	03/16 →
S90 D4 Drive-E Polestar	D4204T14	03/16 →
S90 D4 Drive-E Polestar AWD	D4204T14	03/16 →
S90 D5 AWD	D4204T23	03/16 →
S90 D5 Polestar AWD	D4204T23	06/19 →
V40 II D2	D4204T13, D4204T8	02/15 → 08/18
V40 II D3	D4204T16, D4204T9	04/15 →
V40 II D4	D4204T14	05/14 →
V40 II D4 Polestar	D4204T14	05/14 →
V60 I 2.0 D2	D4204T20	03/15 → 05/18
V60 I 2.0 D3	D4204T4, D4204T9	03/15 → 05/18
V60 I 2.0 D4	D4204T14	03/15 → 05/18
V60 I 2.0 D4 Drive-E Polestar	D4204T14	03/15 → 05/18
V60 I D4	D4204T5	10/13 → 12/15

VOLVO		
V60 I D5	D4204T11	03/15 → 05/18
V60 II D3	D4204T16	02/18 →
V60 II D3 AWD	D4204T4	09/18 →
V60 II D4	D4204T14	02/18 →
V60 II D4 AWD	D4204T14	09/18 →
V60 II D4 Polestar	D4204T14	02/18 →
V60 II D4 Polestar AWD	D4204T14	02/18 → 12/20
V70 III D4	D4204T5	10/13 → 04/16
V90 D3	D4204T16, D4204T9	03/16 → 08/18
V90 D3 AWD	D4204T4	03/16 →
V90 D4	D4204T14, D4204T7	03/16 →
V90 D4 AWD	D4204T14, D4204T7	03/16 →
V90 D4 Polestar	D4204T14	10/16 →
V90 D5 AWD	D4204T23	03/16 →
V90 Polestar AWD	D4204T14, D4204T23	10/16 →
XC40 2.0 D3	D4204T16	09/18 →
XC40 2.0 D3 AWD	D4204T16	09/18 →
XC40 2.0 D4 AWD	D4204T12	10/17 →
XC40 D4 Polestar AWD	D4204T12	01/19 →
XC60 I D3	D4204T4	03/15 → 04/17
XC60 I D4	D4204T14, D4204T5	10/13 → 02/17
XC60 II D3	D4204T4	03/17 →
XC60 II D4	D4204T14, D4204T7	03/17 →
XC60 II D4 AWD	D4204T14	03/17 →
XC60 II D4 Polestar	D4204T14	05/20 →
XC60 II D4 Polestar AWD	D4204T14	05/20 →
XC60 II D5 AWD	D4204T23	03/17 →
XC60 II D5 Polestar AWD	D4204T23	10/18 →
XC70 II D4	D4204T5	10/13 → 04/16
XC90 II 2.0 D5 Polestar AWD	D4204T23	10/18 →
XC90 II D4	D4204T14	06/15 → 12/18
XC90 II D4 AWD	D4204T6	10/15 → 12/18
XC90 II D5 AWD	D4204T11, D4204T23	09/14 → 12/19
XC90 II D5 Drive Polestar AWD	D4204T23	03/16 →